



**THE CONELOG® IMPLANT SYSTEM –
CONICAL CONNECTION
AND EASY HANDLING**

CONELOG[®] FROM A-Z CONVINCINGLY BETTER





INTRODUCTION

The best ideas come from practice. CAMLOG has held to this maxim since market introduction of the CAMLOG® Implant System in 1999 – and with great success. The CAMLOG® Implant System counts among the world's leading implant systems. More than two million CAMLOG® implants have been inserted to date. The CONELOG® Implant System was successfully introduced in 2011. Its advantage is the identical outer "SCREW-LINE" geometry and therefore identical surgical procedure. The ease of prosthetic handling of the CONELOG® Implant System familiar from the CAMLOG® Implant System is impressive. Many users, who prefer a conical connection design, have been won over and are inspired by the ease of handling.

In the scientific documentation of treatment successes, CAMLOG is among the world's leading companies. Whether implant surface, time of implantation or implant loading, primary stability, connection design or type of superstructure, **the implant systems from CAMLOG are impressive across the board.**

With each implant, each component, CAMLOG continues its proven ways as the practice partner to offer reliable, user-friendly solutions at all times.

This brochure provides you with an overview of the CONELOG® Implant System and briefly and distinctly shows you its compelling product benefits.

MAXIMUM
PRECISION FOR
YOUR **SAFETY**

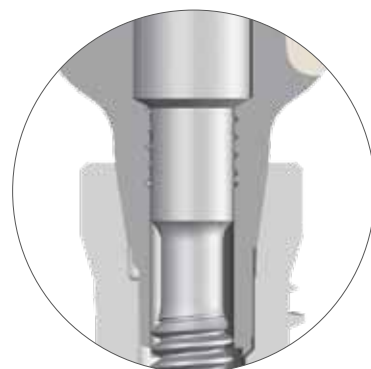
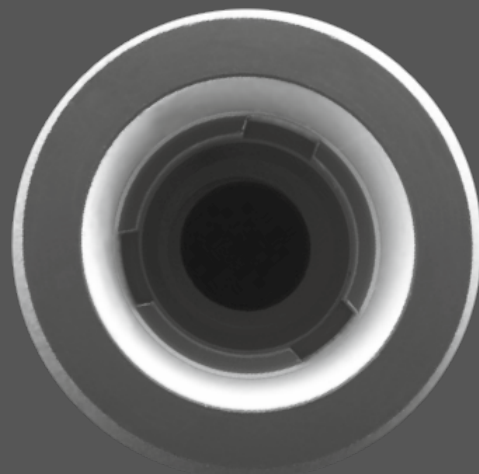
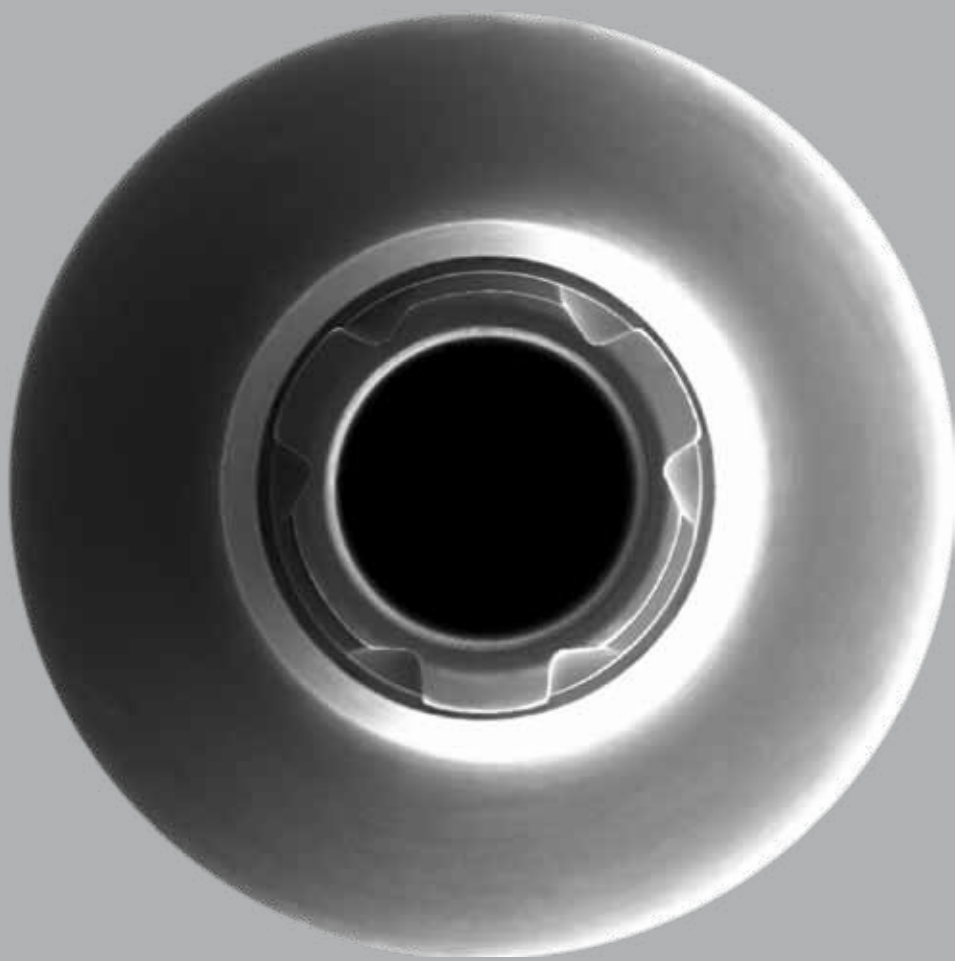

The conical CONELOG® implant-abutment connection: precision and ease of use.

THE CONICAL CONELOG® IMPLANT-ABUTMENT CONNECTION

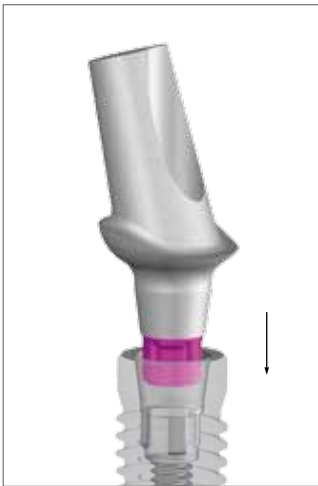

Insertion of the abutment

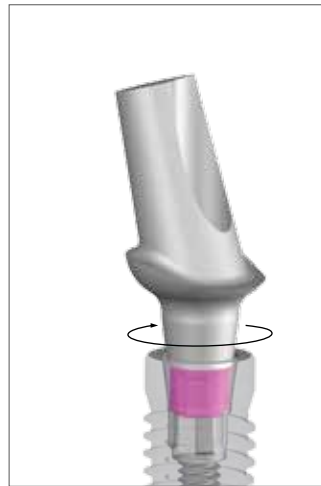

Easy rotation of the abutment

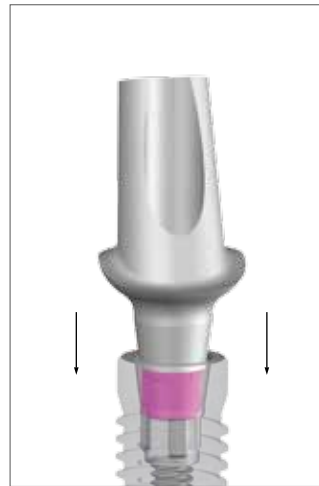

Perceptible tactile engagement of the abutment



Required position of the abutment achieved

CONELOG® SCREW-LINE implants are equipped with a 7.5° internal taper for reliable transfer of force and torque and the three proven CAMLOG grooves for precision abutment positioning. Clearly perceptible tactile feedback lets the user know when the abutment is positioned correctly by the three grooves and apical external taper.

THE ADVANTAGES AT A GLANCE

- High level of user safety thanks to the connection design
- High positioning accuracy
- No complicated transfer key for abutments required
- Time savings due to quick and easy positioning of the abutment

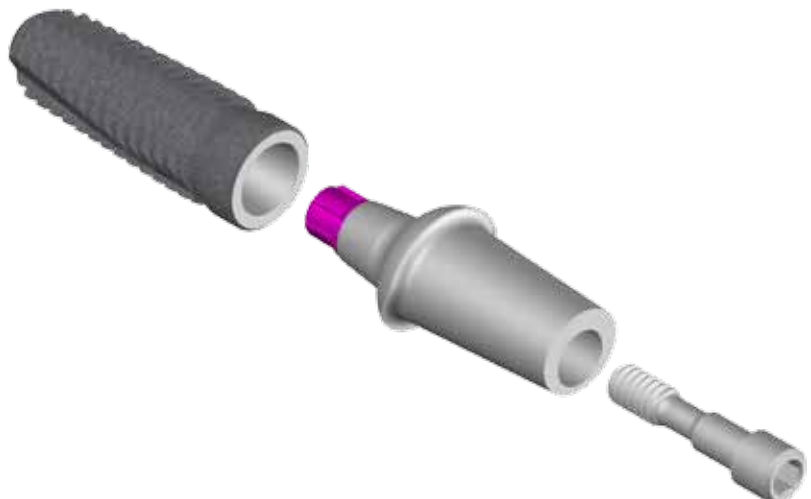
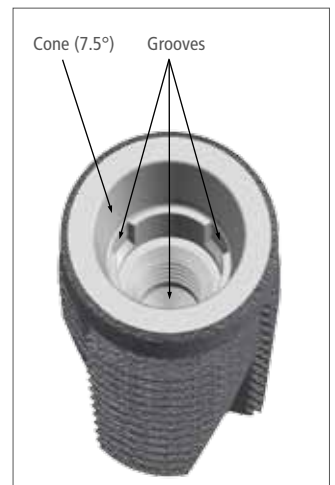
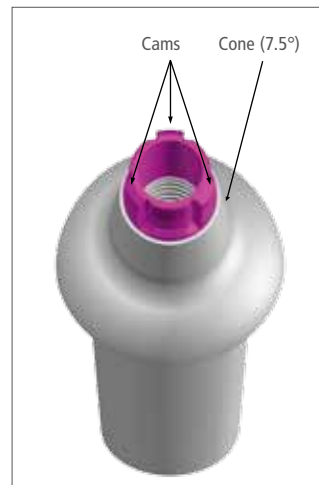

DOWN TO THE **SMALLEST**
DETAIL, ANYTHING
OTHER THAN SUPERFICIAL

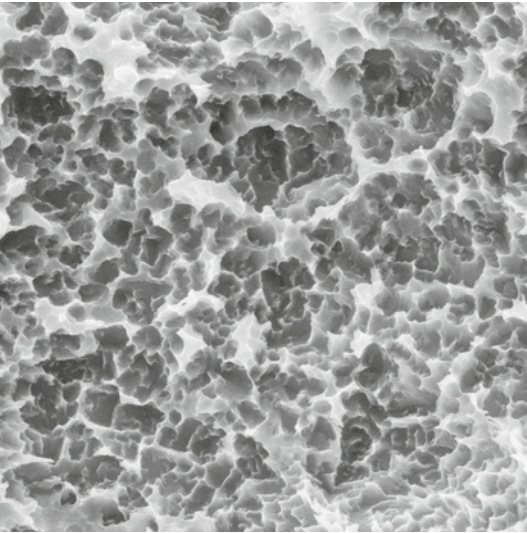

PROMOTE® SURFACE

The sandblasted, acid-etched Promote® surface is based on current scientific knowledge. Promote® represents state of the art and favors rapid osseointegration. Scientific results from cell cultures, osteohistology and in pull-out trials as well as clinical studies clearly illustrate this.

The CONELOG® SCREW-LINE implant, Promote® plus, has an acid-etched, beveled implant shoulder (45°).



- Sandblasted, acid-etched Promote® surface
- Acid-etched, beveled implant shoulder (45°)
Height: 0.1-0.2 mm (variable corresponding to implant diameter)
- Machined implant shoulder surface



THE CONELOG® IMPLANTS

CONELOG® SCREW-LINE IMPLANT



CONELOG® SCREW-LINE implants are conical, self-tapping screw implants in their geometry.

The implants are not only suitable for late, but also for immediate or delayed immediate implantation. The implant is easily inserted because the taper of the external implant body of 3° to 9° (depending on lengths and diameters), induces self-centering. The self-tapping thread provides continuous grip on the bone and high primary stability. Optimal rounding of the apical geometry ensures gentle insertion of the SCREW-LINE implants into the bone.

IMPLANT SIZES

Length ∅	7 mm	9 mm	11 mm	13 mm	16 mm
3.3 mm	—	✓	✓	✓	✓
3.8 mm	✓	✓	✓	✓	✓
4.3 mm	✓	✓	✓	✓	✓
5.0 mm	✓	✓	✓	✓	✓

SHORT IMPLANTS



The CONELOG® SCREW-LINE implant is also available in a 7 mm length for diameters 3.8/4.3/5.0 mm.

INTEGRATED PLATFORM SWITCHING



The CONELOG® abutment does not cover the implant shoulder, thus allowing integrated platform switching.

ONE SURGERY SET FOR TWO IMPLANT SYSTEMS

–CAMLOG® AND CONELOG®



THE SURGERY

The CAMLOG name stands for consistently designed implants systems, that are logical and uncomplicated in handling. The smart design of the implants and associated surgical instruments simplifies the entire surgery. Whether the type of healing or soft-tissue management, CONELOG® implants give you maximum freedom of choice and maximum user-friendliness.

CONELOG® SCREW-LINE implants have the proven outer geometry of the CAMLOG® SCREW-LINE implants. Implant bed preparation for CONELOG® and CAMLOG® SCREW-LINE implants is carried out using the same instrumentation from the CAMLOG®/CONELOG® SCREW-LINE surgery set.

Form drills specific to diameter and length made of durable matted material are available for each implant size. The cutting-edge geometry ensures excellent cutting performance and produces coarse, vital bone grafts. Graft shearing slots ensure flawless concentricity. The form drills are color-coded and laser-marked. In addition, the set includes a corresponding color-coded depth stop.

ALL ADVANTAGES AT A GLANCE

- Logical sequence of the drilling protocol thanks to the corresponding color-coded order of the instruments in the surgical cassette by sequence of treatment
- Depth stops and laser markings for proper maintenance of the implant bed depth
- Matted surface of the drills to prevent light reflection and for good visual control
- Drill design and quality ensure effective and accurate drilling
- Cortical bone drill for controlled circular preparation in hard cortical bone
- Implant insertion options:
 - mechanical
 - manual
- Torque wrench with continuous torque adjustment up to 30 Ncm, also lockable
- The cover screw is located in the handle and can be easily removed and inserted
- Reusable drills and taps with no internal irrigation
- The insertion post can be removed after inserting the implant with good primary stability without locking

THE HEALING

With CONELOG® implants, you have the choice between submerged or open healing. Each implant has a cover screw, that can be used for submerged healing.

SUBMERGED HEALING

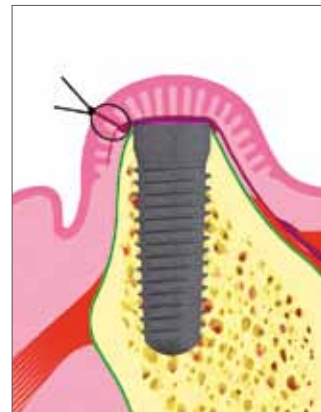

Cover screw and wound closure

OPEN HEALING



For successful soft-tissue management, you can choose between three different types of healing caps (see p. 17)

CONELOG® HEALING CAP

The healing cap sits on the machined implant shoulder, but does not cover it completely. As a result, the soft tissue over the shoulder can be adapted. The conical surfaces do not come into contact.





**PRECISION
IMPRESSIONS WITH NO
VERTICAL OFFSET**

IMPRESSION-TAKING

Impression-taking of the CONELOG® implants is possible with impression posts, open or closed tray. All impression-taking components are color-coded based on the implant diameter. High-precision components ensure correct transfer of the intraoral situation.

The CONELOG® impression posts do not lock into the cone of the CONELOG® implants, but lie on the implant shoulder. Thus, a vertical offset is prevented when taking the impression.

The antirotational mechanism is ensured by the CONELOG® groove/cam connection.

ALL ADVANTAGES AT A GLANCE

- The diameters of the impression posts are smaller than those of the healing caps for easier insertion and protection of the gingiva
- No vertical offset as the impression posts sit on the implant shoulder and do not engage with the cone of the implant

OPEN-TRAY IMPRESSION-TAKING METHOD

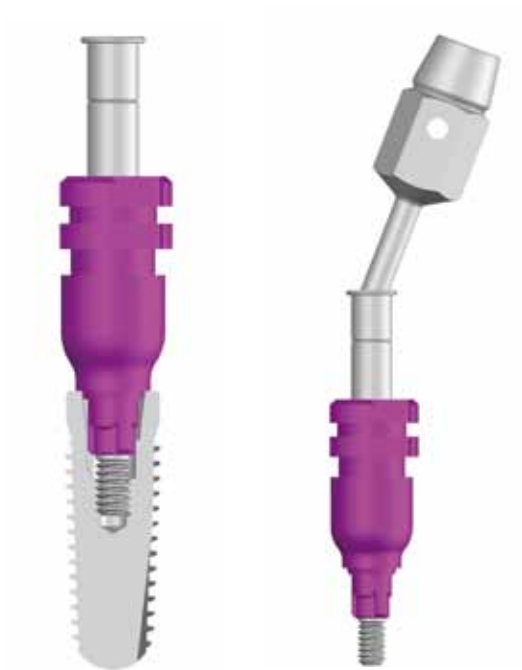

The open-tray impression-taking method requires a custom-made impression tray that is perforated for the protrusion of the fixing screw extending from the implant axis. The fixing screw is secured in the CONELOG® impression post with an O-ring and must only be tightened by hand using the screwdriver, hex, both in the CONELOG® implant as well as in the CONELOG® lab analog.

The fixing screw is equipped with a predetermined breaking point. If space limitations are encountered, it can be shortened extraorally by 3.0 mm by breaking it off with a screwdriver, hex.

CLOSED-TRAY IMPRESSION-TAKING METHOD



A prefabricated impression tray can be used for the closed-tray impression-taking method. After the impression post has been inserted correctly, the fixing screw protrudes approximately 2 mm from the post. After tightening the screw, it sits flush with the upper edge. This allows the user to visually check that the impression post is correctly seated on the implant.

CONOLOG® PROSTHETICS

- SMART SOLUTIONS



CONICAL SURFACES



The conical surfaces of the implant are not stressed by the healing caps or impression-taking. They are only used when inserting the final restoration. Thanks to minimum fabrication tolerances and the resulting precision, above-average precision fit and rotational stability of the implant-abutment connection are achieved. In addition, excellent transfer of force and torque is possible thanks to the self-locking cone geometry.

ADVANTAGES

- The conical surfaces are only loaded when inserting the abutment
- Highly precise, stable and rotation-resistant connection

DISCONNECTOR



Due to the above-average precision fit between abutment and implant, a tool may be needed to remove the abutment from the implant (adhesion force). A specially developed disconnector is screwed into the screw channel until the abutment releases from the internal taper of the CONELOG® implant/lab analog.

ADVANTAGES

- Quick and easy release of the abutment
- High level of safety when inserting and removing the abutment in the patient's mouth

CONELOG® VARIO SR ABUTMENTS



The Vario SR prosthetic components can be used to fabricate occlusally screw-retained crown and bridge restorations with the CONELOG® Implant System. Bar restorations are also possible. Where bone supply is reduced and anatomical structures are unfavorable for implantation, the implants can be set at an angle. Optimum use of the bone supply is thus ensured. To bridge any resulting implant axis divergences, 20° and 30° angled Vario SR abutments are available.

ADVANTAGES

- Sterile-packaged and color-coded abutments
- Bridging of large implant axis divergences
- Occlusally screw-retained superstructures

CONELOG® ESTHOMIC® ABUTMENTS



Partially preformed structural components allow for optimal stump design. The abutment bodies have a convex shape and oval, anatomically shaped shoulder contour. The angled Esthomic® abutments are available in A and B versions differentiated by a cam offset of 60°. Six prosthetically oriented rotation positions are thus possible to achieve optimal prosthetic axis alignment.

ADVANTAGES

- Time savings due to fewer grinding corrections thanks to the anatomically shaped shoulder contour
- Flexibility in the prosthetic alignment

INDIVIDUAL SOLUTIONS COMBINED WITH MAXIMUM SAFETY



Modeled mesostructures on titanium bases
CAD/CAM*

*Images courtesy of:
R+K CAD/CAM GmbH & Co. KG, Berlin
Dr. med. Sebastian Schöntube, Berlin

CONELOG® TITANIUM BASES CAD/CAM

CONELOG® titanium bases CAD/CAM make restorations with individual two-piece abutments made of zirconium oxide on CONELOG® SCREW-LINE implants possible. They are available in gingival heights of 0.8 and 2.0 mm and are used as bonding bases for individual implant-borne restorations such as mesostructures as well as crown, bridge and double crown restorations. To simplify the procedure, each package includes one abutment screw and one bonding aid.

ALL ADVANTAGES AT A GLANCE

- CONELOG® implant-abutment connection with self-locking conical inner geometry for precise, stable and rotation-resistant connection
- Available in two gingival heights for optimal adjustment to the vertical implant position and emergence profile
- Large bonding surface provides high stability and bonding adhesion
- Bonding aid and abutment screw included
- Clear and quick positioning of the titanium base CAD/CAM through precise abutment guiding in the implant

CONELOG® SCANBODY

The scanbody is used for optical three-dimensional localization of implants in the mouth and of lab analogs in the working model. The scanbodies are available for implant diameters 3.3/3.8/4.3/5.0 mm and are delivered sterile including abutment screws.

ALL ADVANTAGES AT A GLANCE

- Sterile scanbodies allow immediate intraoral use
- Optimal detection of all important geometries

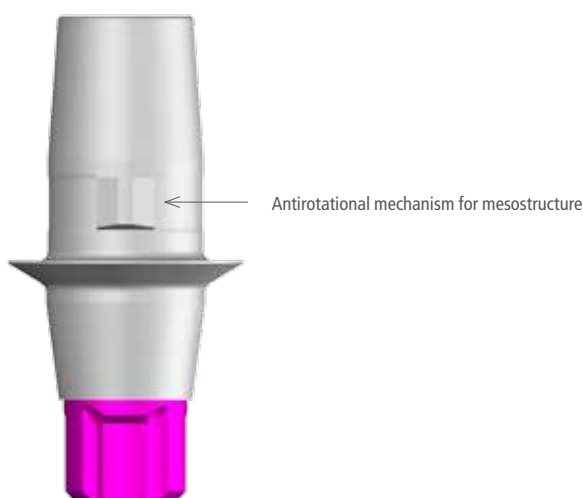



EVERYTHING YOU
NEED,
BUT NOT TOO MUCH

CONELOG® IMPLANTS AND ASSOCIATED COMPONENTS

SURGERY



CONELOG® SCREW-LINE implants



CONELOG® Cover screw

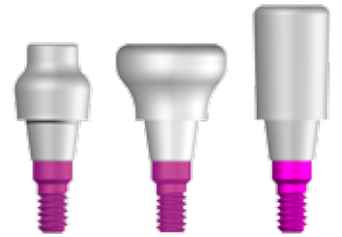

CONELOG® Healing caps
bottleneck, wide body, cylindrical

PROSTHETICS

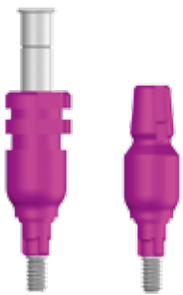

CONELOG® Impression posts,
open and closed tray



CONELOG® Temporary abutment

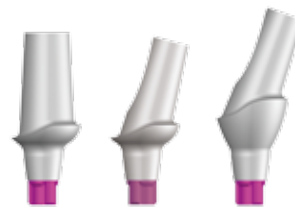

CONELOG® Esthomic® abutments



CONELOG® Gold-plastic abutment



CONELOG® Vario SR abutments



CONELOG® Universal and
telescope abutments

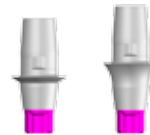

CONELOG® titanium base CAD/CAM



CONELOG® Ball abutments



CONELOG® Bar abutments

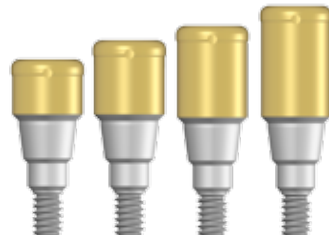

CONELOG® Locator abutments







HEADQUARTERS

CAMLOG Biotechnologies AG | Margarethenstrasse 38 | CH-4053 Basel | Switzerland
info@camlog.com | www.camlog.com

Manufacturer of CAMLOG® and CONELOG® products: ALTATEC GmbH, Maybachstraße 5, D-71299 Wimsheim

camlog