

AD-A101 547

LITTLE (ARTHUR D) INC CAMBRIDGE MA
IDENTIFICATION AND EVALUATION OF UNDERGROUND OBSTACLE SENSOR EM--ETC(U)
JAN 80 J S HOWLAND, R H BODE

F/G 14/2

DAAK70-79-D-0036

NL

UNCLASSIFIED

1 of 2

AD A
101547

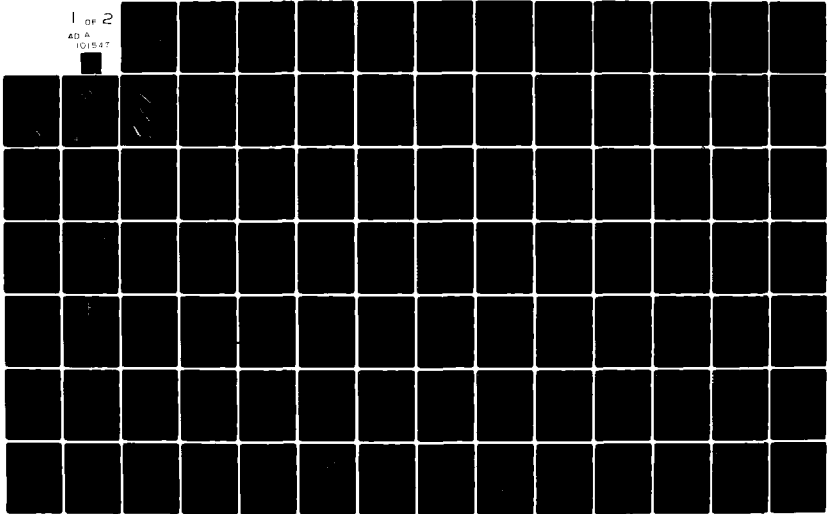

LEVEL

(2)

AD A101547

**IDENTIFICATION AND EVALUATION OF
UNDERGROUND OBSTACLE SENSOR
EMBODIMENTS FOR THEIR APPLICABILITY
TO THE COMBAT ENGINEERS'
RAPID EXCAVATION MISSION(S)**

report to

**US ARMY MOBILITY EQUIPMENT RESEARCH
AND DEVELOPMENT COMMAND**

CONTRACT NO. DAAK70-79-D-0036

ORDER NO. 0003

JANUARY 1980

**DTIC
ELECTE
JUL 17 1981**

**THIS DOCUMENT IS BEST QUALITY PRACTICABLE.
THE COPY IS UNLESS INDICATED OTHERWISE A
SIGNIFICANT NUMBER OF PAGES WHICH DO NOT
REPRODUCE LEGIBLY.**

DTIC FILE COPY

Arthur D Little Inc

DISCLAIMER NOTICE

THIS DOCUMENT IS BEST QUALITY PRACTICABLE. THE COPY FURNISHED TO DTIC CONTAINED A SIGNIFICANT NUMBER OF PAGES WHICH DO NOT REPRODUCE LEGIBLY.

IDENTIFICATION AND EVALUATION OF
UNDERGROUND OBSTACLE SENSOR EMBODIMENTS
FOR THEIR APPLICABILITY TO THE COMBAT ENGINEERS'
RAPID EXCAVATION MISSION(S)

Report to

US Army Mobility Equipment Research
and Development Command

¹⁵
Contract No. DAAK70-79-D-0036

Order No. 0003

111
January 1980

10 1-80
Arthur D Little Inc

FOREWORD

This document summarizes key findings and presents the background material relevant to the study entitled, "Identification and Evaluation of Underground Obstacle Sensor Embodiments for their Applicability to the Combat Engineers' Rapid Excavation Mission(s)". The report presents a systems analysis approach and evaluation of:

- Survey of pertinent information relating to ground exploration using seismic, acoustic, or other methods consistent with MERADCOM's R&D Program for Passive Protection Achieved by Rapid Excavation in a Military Environment. (Subtask 1)
- Evaluation of each underground obstacle sensor embodiment for its applicability and value to the combat engineers' rapid excavation mission(s), (Subtask 2)
- Results as regards feasibility, costs, and benefits of each concept and the most promising concepts translated into preliminary system specifications covering the projected underground obstacle sensor field embodiments. (Subtask 3)

The salient finding of this study is that there is not currently available any underground obstacle detection system that can be readily transformed into an embodiment suitable for the combat engineers' field fortification rapid excavation mission.

The conclusion of this study presents a need for subsequent evaluation as follows:

One specialized underground radar system is available commercially and two others will likely become available in the near future. With either of these systems, a significant survey could be made utilizing skilled operators and a known terrain in Central Europe in which field fortifications rapid excavation obstacles have been pinpointed through probing and bore hole techniques. This experimental survey would yield

a potential benefit cost analysis without attempting to develop a military embodiment of the electromagnetic pulse reflection methodology.

This report is submitted to US Army Mobility Equipment Research and Development Command (MERADCOM) Fort Belvoir, Virginia 22060 by Arthur D. Little, Inc., 20 Acorn Park, Cambridge, Massachusetts 02140, and was prepared under Task Order No. 3 of Contract No. DAAK70-77-D-0036. This report was prepared under the guidance of Miss Guice Sarazen, and Messrs. Jerry Dean, Frank Tremain, and Harry Keller of MERADCOM. Questions of a technical nature should be addressed to Robert H. Bode, 617-864-5770, the Manager of the study or to John S. Howland, the principal author and principal investigator. Technical questions concerning seismic reflection or refraction techniques should be addressed to Peter von Thuna, the principal investigator for seismic and related technologies.

APPROVED FOR

GR&I

DATE

BY

23

A

TABLE OF CONTENTS

	Page
SUMMARY	
1.0 INTRODUCTION	S-1
2.0 OBJECTIVE	S-1
3.0 SCOPE OF WORK	S-1
4.0 BACKGROUND	S-2
5.0 FINDINGS	S-6
6.0 CONCLUSION	S-10
7.0 RECOMMENDATIONS	S-10
SUBTASK 1 - INFORMATION SURVEY	
1.0 Information Survey	1-1
1.1 General Studies	1-1
1.2 Electrical Properties	1-2
1.3 Radar	1-5
1.4 Magnetic Properties	1-8
1.5 Acoustic Methods	1-9
1.6 Infrared Methods	1-10
1.7 Nuclear Methods	1-10
1.8 Mechanical Probing	1-11
1.9 Gravimeters and Gravity Gradiometers	1-11
1.10 Tiltmeters	1-13
SUBTASK 2 - ANALYSIS	
2.1 Underground Radar	2-1
2.2 Seismic Methods	2-13
SUBTASK 3 - CONCLUSIONS, BENEFITS, AND SPECIFICATIONS	
3.1 Findings and Conclusions	3-1
3.2 Benefits	3-3
BIBLIOGRAPHY	Bib-1
APPENDIX A - Ground-Penetrating Radar Equipment and Survey Services	A-1
APPENDIX B - Analysis of Gravimetry and Gravity Gradiometry	B-1
APPENDIX C - Abstracts of Selected References	C-1

SUMMARY

1.0 INTRODUCTION

This report summarizes the key findings and background investigations from work conducted under Task 0003 of Contract DAA70-79-D-0036 entitled, "Identification and Evaluation of Underground Obstacle Sensor Embodiments for their Applicability to the Combat Engineers' Rapid Excavation Mission(s)".

2.0 OBJECTIVE

The task objective has been: First, the identification of all known promising techniques for sensing underground obstacles that would impede or preclude the combat engineers' rapid excavation mission(s) in a military environment, and second, the analysis of the most promising detection techniques to determine their applicability to rapid excavation, field fortification missions.

3.0 SCOPE OF WORK

The work on this task has been subdivided into three subtasks as follows:

Subtask 1: Survey.

This subtask included a literature search and review of all pertinent information relating to potential methods of ground exploration in the range of interest. Principal researchers were interviewed and existing hardware was studied.

Subtask 2: Analysis.

Based upon Subtask 1 information, each promising concept was examined for the range of variables of interest in the combat engineers' rapid excavation mission(s).

Subtask 3: Conclusions, Benefits, and Specifications.

Conclusions were then drawn as to the feasibility of each exploration or obstacle detection concept, and for each feasible concept, costs, benefits, and preliminary system specifications were compiled for a projected field embodiment.

4.0 BACKGROUND

Arthur D. Little, Inc., recently completed a task for formulating an R&D program for passive protection achieved by rapid excavation in a military environment for the time frame 1985 to 1995. (1) *

The results of this program indicated that the major missions for the combat engineers will consist of rapid excavation of long, relatively narrow trenches to provide protected fighting, firing emplacement and non-combat defilade positions for tanks, armored personnel carriers, mobile ordnance, and miscellaneous non-combat vehicles. The request and frequency requirements for these field fortifications in a short time frame imposes an excavation need to accomplish these trenches within short time periods ranging from 7 to 20 minutes.

The excavation equipment which will likely be used for such missions will consist of improved, high capacity military versions of conventional scoop-type excavators or continuous chain or wheel excavators designed especially for the military mission.

Both of these types of excavators are limited in their ability to handle underground obstacles. Neither can excavate through underground ledge or consolidated rock. The scoop excavators could handle rock or boulders up to several feet in diameter but most continuous excavator concepts would be limited to rocks smaller than about two feet in diameter. Unrotted ground roots or logs would present a serious obstacle to either type of machine. Likewise, man-made obstacles such as pipes or buried foundations would also impede these devices.

The study of Reference (1) included a detailed analysis of the combat excavation tasks requested during one play period of the E-FOSS war games. It was found that the three tasks shown schematically in Figures S-1, S-2, and S-3 represent 92.2% of total excavated volume and 81.3% of on-site duration for the mix of equipment assumed. Each of these excavations takes the form of a trench with a depth of 5 feet, below grade. The widths of the trenches vary from 11.5 to 17.7 feet and the lengths vary up to about 100 feet. The remaining excavations

*Numbers in parentheses refer to references in the Bibliography.

E-FOSS Tasks 3-10, 3-11, 3-12

52.5% of Total Volume Excavated (21 periods)

53.5% of Total On-Site Duration (21 periods)

Volume Excavated 74 BCM or 97 BCY

Berm Deposited 14+ LCM or 18+ LCY

On-Site Duration 0.45 hrs. for M9 Tractor

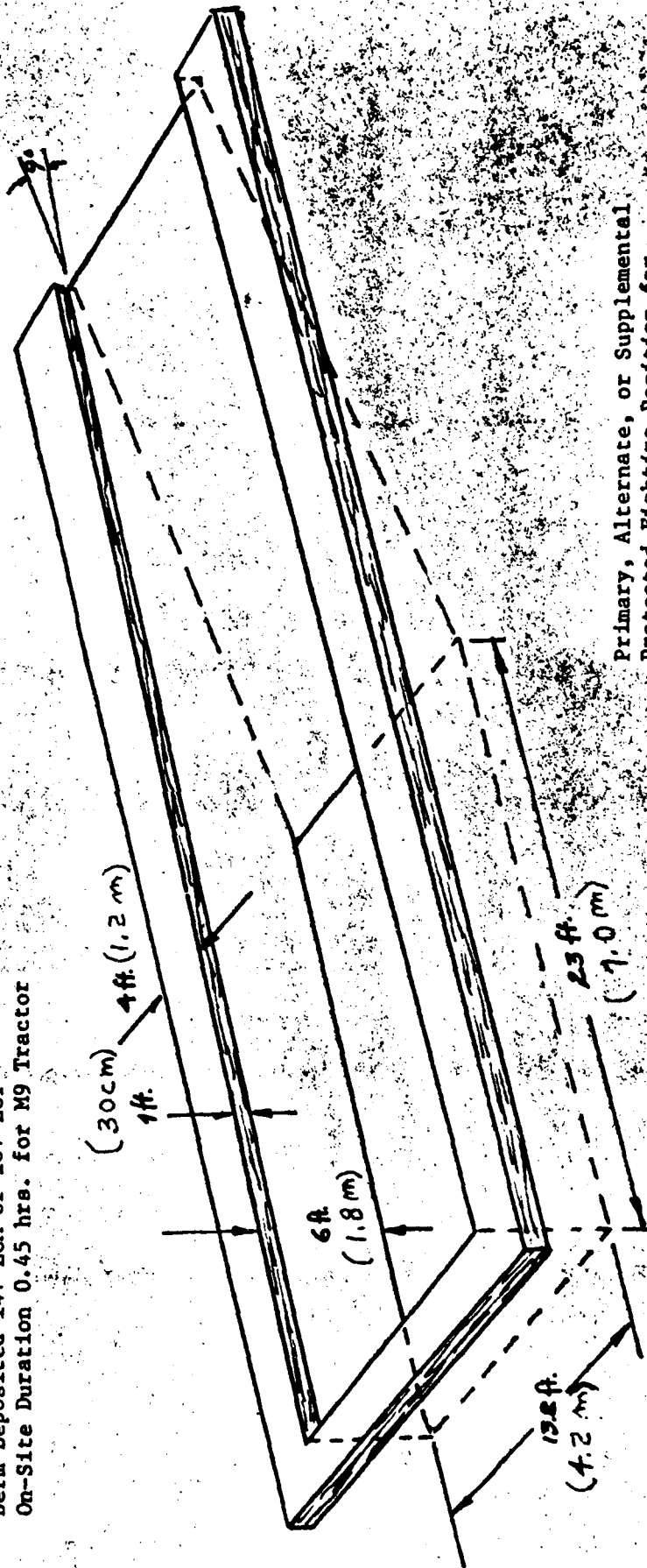

Primary, Alternate, or Supplemental
Protected Fighting Position for
Medium Tank or Armored Personnel
Carrier (APC)

Figure S-1

E-FOSS Tasks 3-15, 3-16, 3-17

28.9% of Total Volume Excavated (21 Periods)

19.7% of Total On-Site Duration (21 Periods)

Volume Excavated 217.7 BCM or 284.7 BCY

Berm Deposited: None; Spoil Removed by

Front End Loader

On-Site Duration 0.82 hrs. for M9 Tractor

and 2 1/2 CY Wheeled Scoop Loader

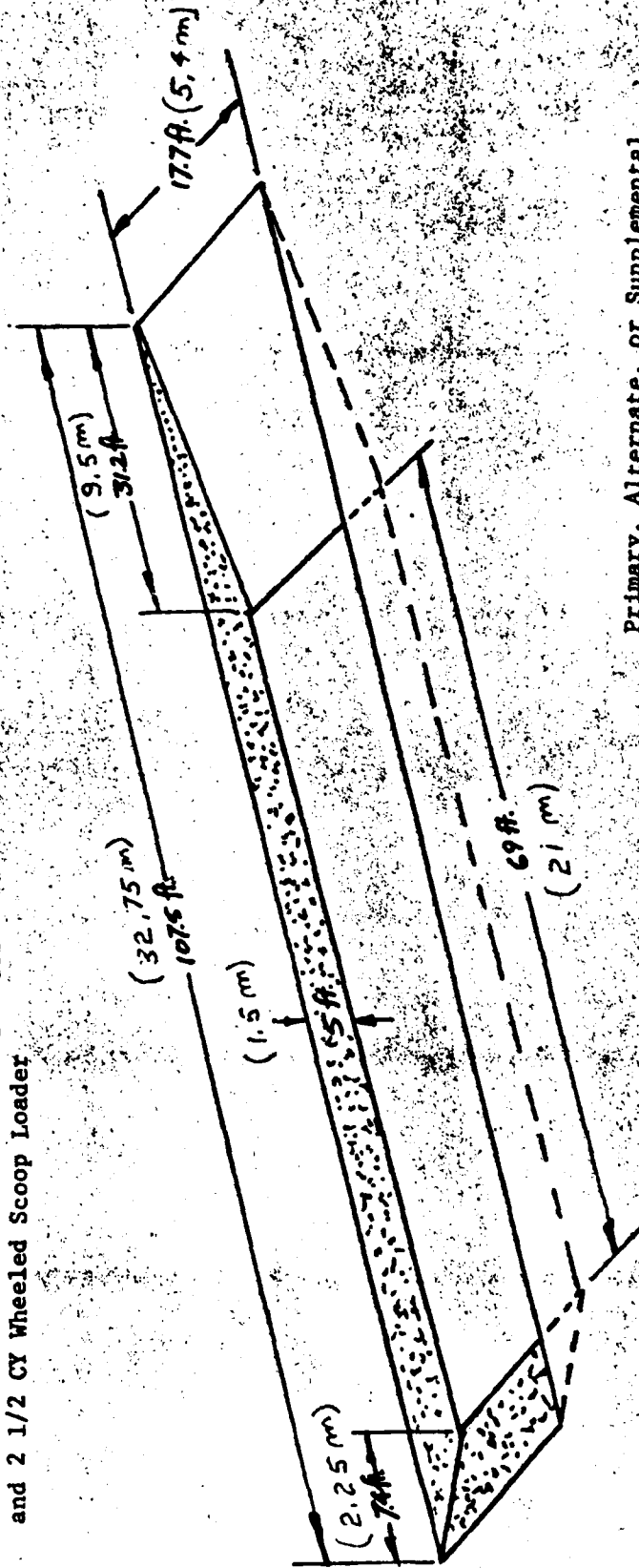

Primary, Alternate, or Supplemental
Firing Emplacement for Self-Propelled
(SP) Howitzer

Figure S-2

E-FOSS Task 3-14

- 10.8% of Total Volume Excavated (21 periods)
- 6.1% of Total On-Site Duration (21 periods)
- Volume Excavated 72 BCM or 94 BCY
- Berm Deposited 23.2 LCM or 30.4 BCY
- On-Site Duration 0.3 hrs. for One M9 Tractor and One 2 1/2 CY Scoop Loader

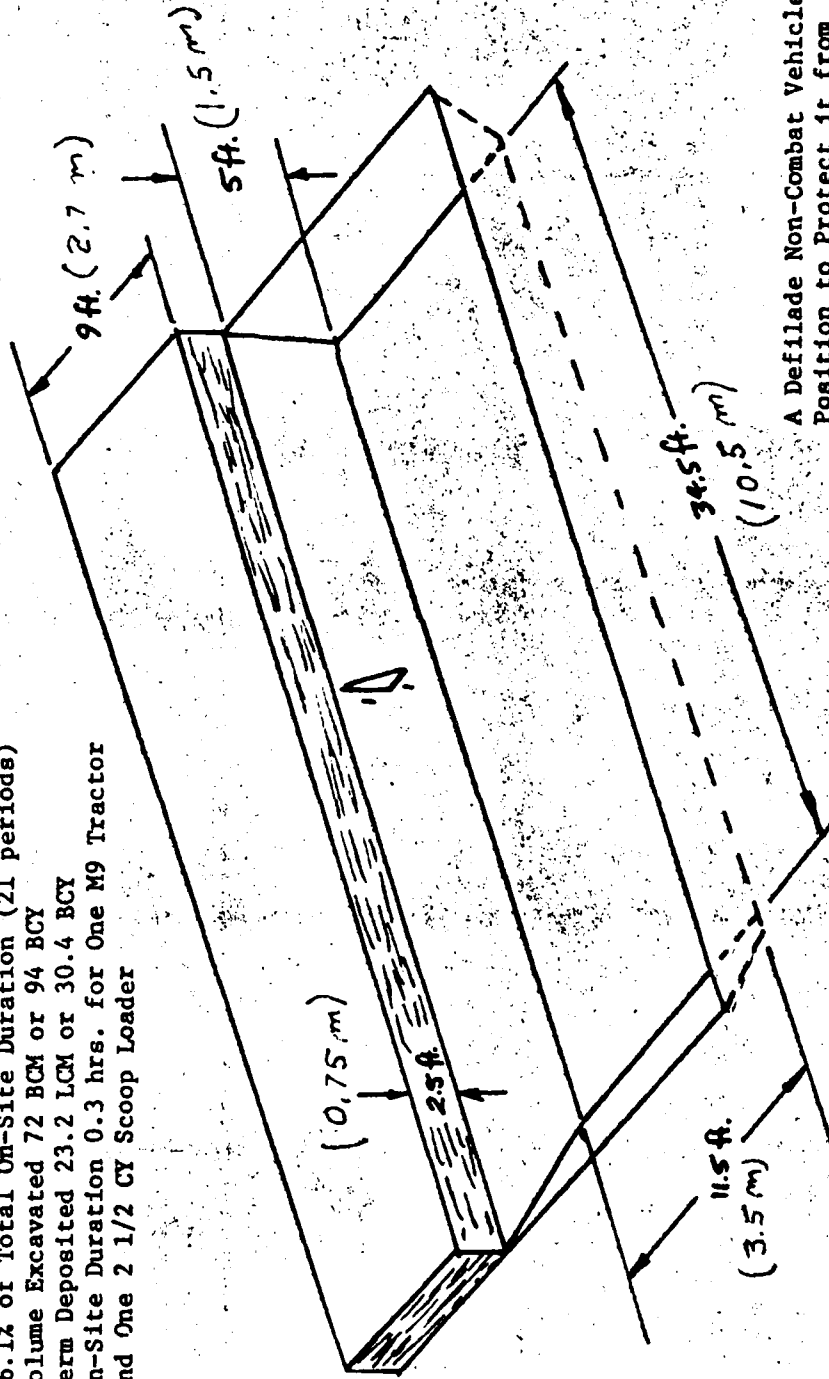

A Defilade Non-Combat Vehicle Position to Protect it from Indirect Fire

Figure S-3

vary widely in form as shown in Figure S-4. However, the maximum depth of the excavations is 2 meters (6.7 feet). Most of the specific excavations have maximum depths below grade of 6 feet or less.

Since these excavations are required in very short periods during or preparatory to combat, the effectiveness of machinery available to the engineer units can be maximized by minimizing the possibility of false starts or trial and error procedures for the location of obstacles which would prevent the excavation in a specific location. For this reason, a need exists for a very rapid method of surveying the proposed site of the potential field fortification to detect any obstacles, within five feet of the surface, which would deter or defeat accomplishing, with the available equipment, the excavation for the field fortification.

A secondary objective of the survey method is the detection of tunnels or voids below the five foot depth. Each of the major excavations will be used as a protected or defilade position for a vehicle. If a significant void exists below the trench, the bottom may cave in and trap the vehicle.

5.0 FINDINGS

5.1 The salient finding of this study is that there is not currently available any underground obstacle detection system which can be readily transformed into an embodiment suitable for the combat engineers' field fortification rapid excavation mission.

5.2 There are two detection technologies which provide promise for the future development of a suitable embodiment of a detection system for the combat engineers' field fortification rapid excavation mission, namely,

- Electromagnetic pulse reflection (radar)
- Seismic reflection or refraction techniques

5.3 A number of substantially similar underground pulse radar systems have been developed by prior researchers and are and will be produced by several firms and research organizations. Most of this prior work has been aimed at detecting cavities, buried utilities, items of ordnance, and geological strata. Little prior work has been aimed specifically

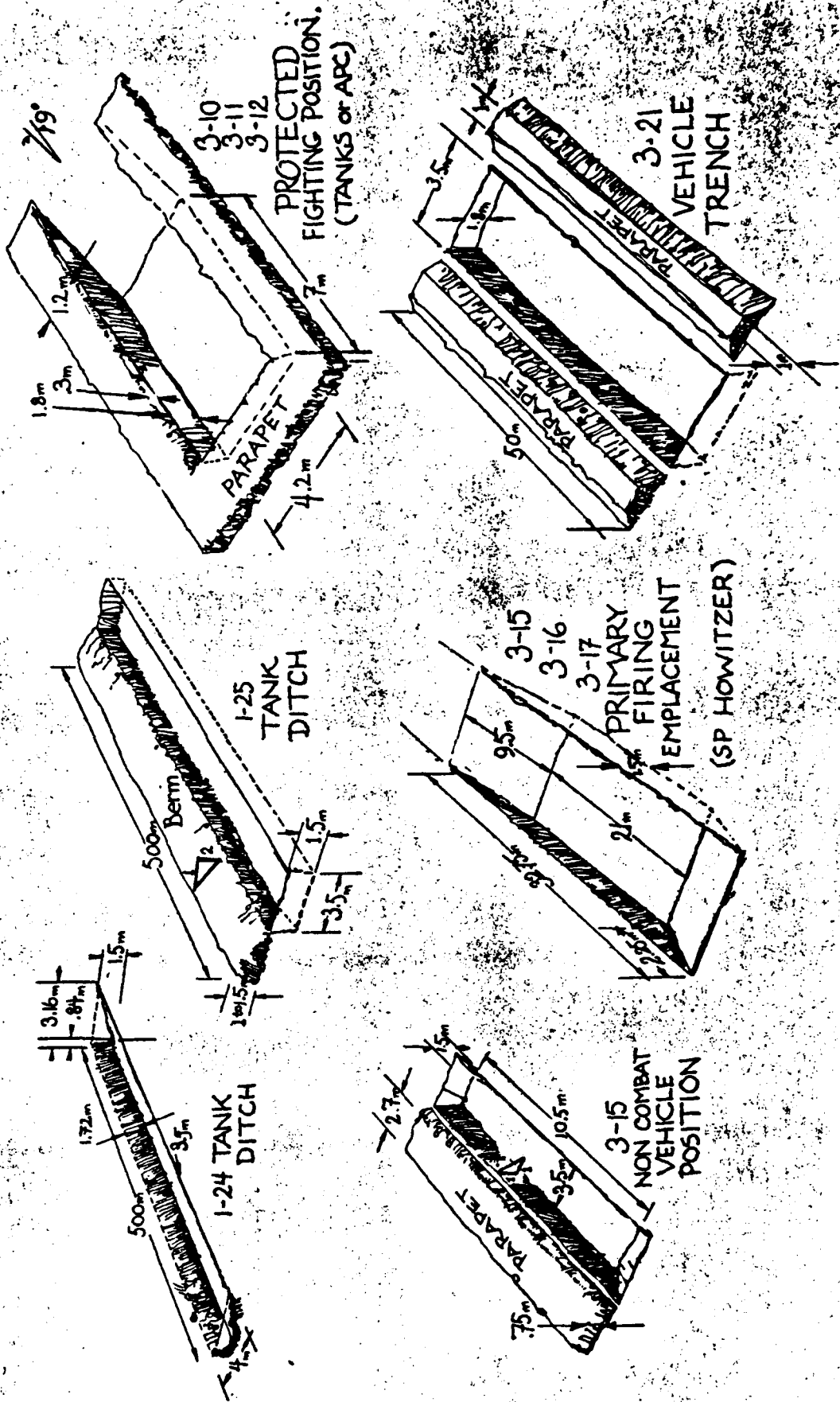

FIGURE S-4 EXCAVATION TASKS DIMENSIONAL SCHEMATIC

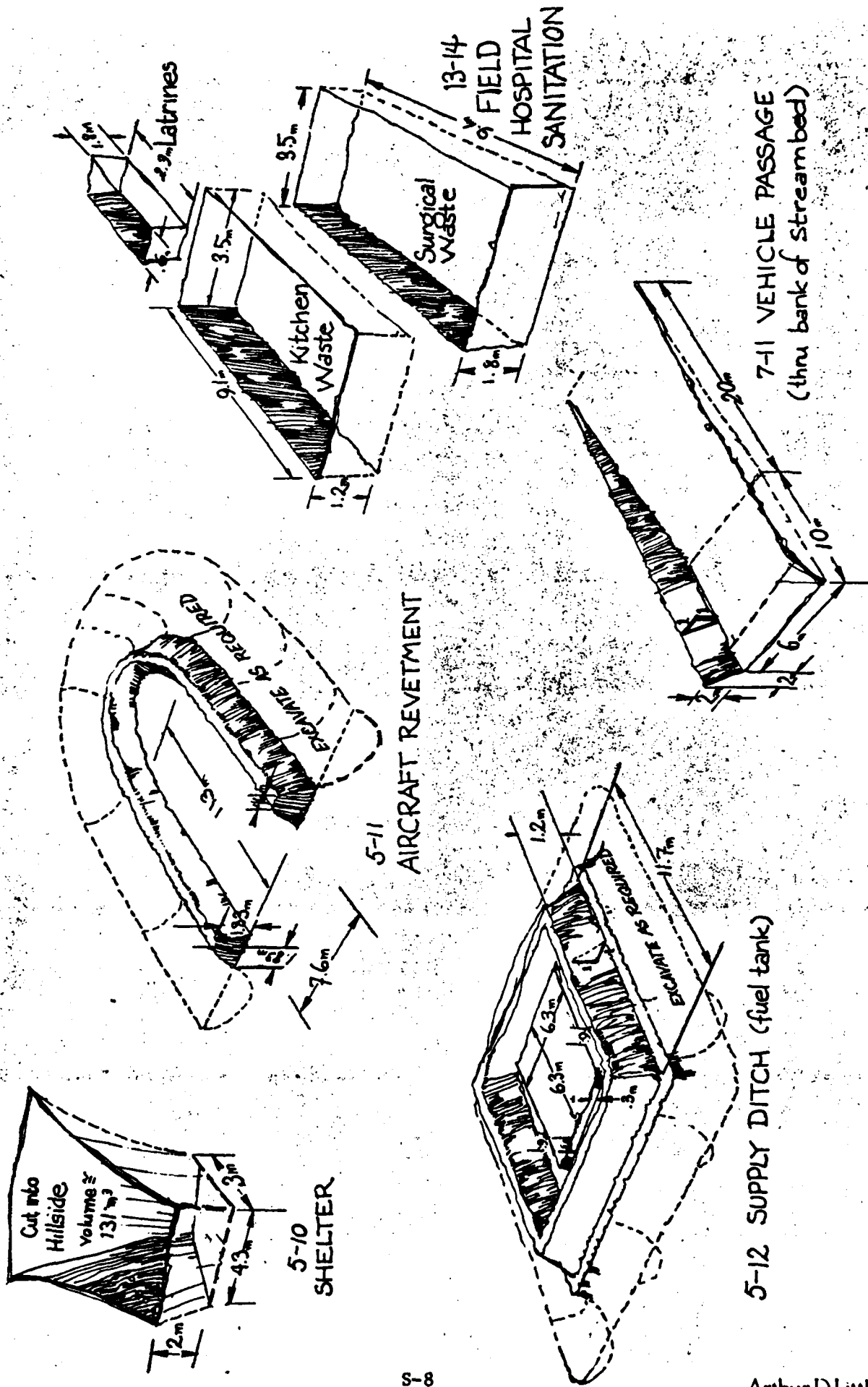

FIGURE S-4 (Cont.) EXCAVATION TASKS DIMENSIONAL SCHEMATIC

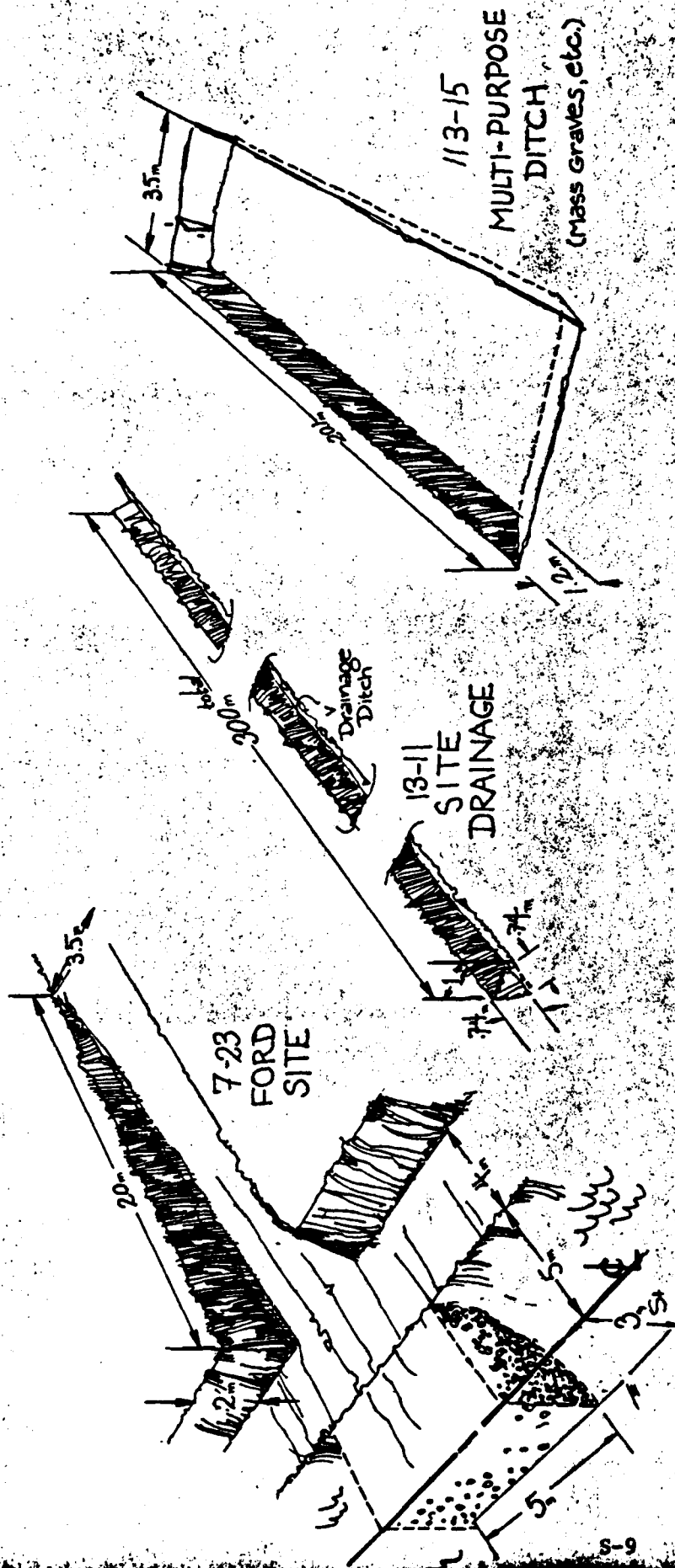

FIGURE S-4 (Cont.) EXCAVATION TASKS DIMENSIONAL SCHEMATIC

at geological obstacles, such as large rocks and boulders. It also appears that it is not always possible to distinguish between hard and soft materials, thus clay lenses appear similar to rock layers or cavity boundaries.

5.4 While penetration to depths of five feet is clearly feasible in many soils by underground pulse radar, it is known that in moist clays, or salty soils, penetration is very difficult. Seismic methods have a significant relative advantage over radar methods with their capability of propagating signals in saturated soils. Hence, seismic methods represent a complementary methodology to radar.

5.5 The basic difficulty with seismic methods is the relative difficulty of coupling the seismic transducers to the ground.

5.6 Radar represents a potentially fast, portable dynamic technique of obstacle detection, while seismic methodologies represent a slow, static, heavier and bulkier technique.

6.0 CONCLUSION

One specialized underground radar system is available commercially and two others will likely become available in the near future. With either of these systems, a significant survey could be made utilizing skilled operators and a known terrain in Central Europe in which field fortifications rapid excavation obstacles have been pinpointed through probing and bore hole techniques. This experimental survey would yield a potential benefit cost analysis without attempting to develop a military embodiment of the electromagnetic pulse reflection methodology.

7.0 RECOMMENDATIONS

7.1 Undertake field tests with commercially available ground radar systems in the geographical areas of interest (e.g., Central Europe, Middle East, Korea, etc.). Surveys should be conducted over known terrain having field fortification rapid excavation obstacles and/or cavities. If any given location has a significant seasonal ground-water variation, tests should be run at different seasons.

7.2 If the commercially available system still appears promising after these tests with skilled operators, a program to develop effective target recognition and/or imaging equipment should be undertaken.

1.0 Information Survey - Subtask 1.

Subtask 1 included a literature search and review followed by interviews of the key researchers for the promising detection methods. Several specific embodiments of the ground radar concept were identified which are either available products or are in advanced stages of development and these were investigated. Finally, a field test of both bore hole and surface antenna radar tests was attended. This information survey is covered in this section of the report.

1.1 General Studies.

The only general study for a similar detection objective found in the search was that of Gates and Armistead (2). This study was performed for the Electric Power Research Institute and the U. S. Department of the Interior and was aimed primarily at detection methods to support trenching for the underground installation of utilities. As such and from the military standpoint, it overstresses man-made obstacles such as existing pipes, drainage conduits, and foundations. In general, many of the selected sites of interest for this application had been previously excavated for earlier public work and did not contain ledge or large boulders.

The general conclusion reached by Gates and Armistead is that pulsed UHF radar in the 0.4 to 1 GHz frequency range is the most promising single method; however, it is not suitable for wet soils. In compacted or saturated soils an acoustic pulse-echo (Sonar) in the 1 to 10 kHz frequency range is better. Less promising, especially for the type of natural (ledge and boulders) obstacles of interest here, were magnetic methods.

However, Gates and Armistead proposed the development of a mobile system consisting of these three methods along with a computer to process the data and interpret the detector information.

The estimated speed of detection is not determined explicitly in the study. However, a statement that the cart could be driven at one mph is made. This, of course, is about 1.5 feet/second which is in the range of interest if a wide enough path could be detected on each traverse at this speed.

Based upon the work of Gates and Armistead (2) and a survey of the other literature, the matrix of applications of Table 1-1 was constructed. This lists the general methods that have been applied or investigated for various detection, prospecting, or survey tasks in various fields. It can be seen that many of these techniques are available as commercial equipment or are commonly applied to a variety of geological or geophysical survey tasks. However, most have either not been applied or have only been investigated in an R&D program as an adjunct to rapid excavation tasks.

Table 1-2 summarizes the physical characteristics of a number of actual or potential survey methods and their applicability against the specific types of targets of interest in this study. Based upon this preliminary evaluation, the only methods that appear to be promising against all of the targets are seismic and acoustic, mechanical probes, or ground-penetrating radar.

Each of these general methods are discussed in the following subsections to summarize the conclusions of prior investigators and the prospects of application to the field fortification excavation missions of interest.

1.2 Electrical Properties.

Gates and Armistead provide a good summary of electrical and low-frequency or long-wave electromagnetic methods. These have been used extensively for geophysical prospecting and exploration. The major methods are as follows:

- Electrical Well-Logging - The resistivity of the ground is measured by multiple electrodes lowered into holes.
- Galvanic Resistance - Probes are used to introduce a current into the earth and to map the resulting potential field. The observation scale is typically hundreds or thousands of feet and objects in the range of tens of feet cannot be resolved.

Table 1-1
Matrix of Applications

Method Purpose	Electrical Properties	Magnetic Properties	Radar	Infra- red	Nuclear	Acoustic	Mech. Probe	Gravimeter and Gravity Gradiometer
Army Mines, Buried Ordnance and Tunnels	A	F	A	F	N	QF	A	QF
Petroleum Well-Logging	A	N	A	NF	A	A	NA	A
Geological Prospecting	A	A	A	N	A	A	NA	A
Utilities Trenching	A	QF	A	QF	NF	A - Passive QF - Active	N	NA
Rapid Excavation and Tunnelling in Hard Rock	QF	N	QF	N	N	QF	NA	NA

Key: A - Applicable - Existing Commercial Equipment or Technique

NA - Not Applicable

F - Feasible - Technique Investigated

NF - Not Feasible - Technique Investigated

N - No Prior Art Yet Identified

QF - Questionable Feasibility - Based on Available Investigations

Table 1-2
Survey Methods

			Target			
	Method	Parameter Measured	Remarks	Boulder	Cavity	Ledge
Mechanical	Seismic refraction	Velocity $\sqrt{E/\rho}$	Tedious set-up	With care	Yes	Yes
	Seismic reflection	Impedance $\sqrt{E\rho}$	Coupling to ground is difficult.	Yes	Yes	Yes
	Tiltmeter	Tilt of surface under static load	Difficult to interpret, slow	No	Perhaps	Probably
	Penetrometer	Strength, friction	Slow, false alarm	Yes	Yes	Yes
	Drill	Strength, density	Slow, false alarm	Yes	Yes	Yes
	Gravimeter	Mass distribution	Very slow, difficult	Probably	Yes	No
Electrical	Ground-penetrating radar	Conductivity and dielectric constant	Falls in clay, alkaline, and wet soil, fast	Yes, quickly	Yes, quickly	Yes, quickly
	Resistivity	Soil resistance	Tedious set-up	Probably	Yes	Probably
	Self potential	Electrochemistry		Not likely	No	Not likely
Magnetic		Susceptibility	Depends on nature of rod	Not likely	No	No
Radioactive		Natural radioactivity neutron cross section gamma cross section	Depends on nature of rod	Not likely	No	No
Thermal		Thermal diffusivity, heat capacity	Requires fast ambient temperature changes, has very shallow range.	Very shallow ones	Very shallow ones	Perhaps

- Induced Polarization - Low frequency voltages are applied to the ground, and the resulting polarization gives information on the macro-structure of the medium. Again, the scale of observation is large and unsuited to this application.
- Radio Wave - Very low frequency radio waves are used in airborne surveys to prepare maps of surface conductivity over very large areas.
- Induction - This is the common metal detector which operates at about 100 kHz and as high as 5000 kHz. They are quite effective for buried metal objects but are ineffective for non-conducting objects (see Fountain (3)).

None of the above methods has any promise at all for our application. Gates and Armistead (1) concluded that the resolution required in this type of application must be many orders of magnitude greater than that achievable at a frequency below 1 MHz. Lytle, et al., (4) found that tunnels could be detected in a cross-borehole technique using a transmitted signal in the range of 60 MHz.

Thus, a probing frequency between 60 KHz and 1 GHz is likely to be required. Since the application will likely preclude the use of boreholes or insertion of electrodes due to time limitation, an echo-sounding or radar technique is the most promising.

1.3 Radar.

Radar technology is well advanced for use in the atmosphere or space, but underground radar is in its infancy (2). There are two basic types of system, pulse and continuous wave (CW) systems. Gates and Armistead (2) state that the CW type produces an echo that is much more difficult to interpret than a pulse system and that the latter can be more easily developed at this point.

In fact, every system investigated to date in any detail is a pulsed system (2, 5-17). For example, Southwest Research Institute investigated a pulse radar with a bandpass between 30 MHz and 300 MHz for detection of

deeply buried ordnance and concluded that the concept was feasible but a reliable system would require a long-term design and development program (6). Aiming at site investigation in advance of rock tunnelling, Ensco concluded that radar can detect geologic structures of interest to planners at ranges greater than 25 feet (16, 17). They made use of a proprietary pulse radar developed by Geophysical Survey Systems, Inc., (GSS) of Hudson, New Hampshire (9). This system is also cited by Gates and Armistead (2) as a promising starting place for the development of the utility trenching detector. Building on the basic GSS antenna design, Ensco has recently developed smaller, more portable electronics and read-out equipment which are permissible for coal mine operation.

Another major center of pulse-radar development is the Ohio State University Electroscience Laboratory (7, 8, 10-15). Most of the work covered in the references obtained are aimed at geological surveying in hard rock in advance of rapid excavation or tunnelling. The system reportedly has promise for this application which, of course, is the same one investigated by Ensco with the GSS radar.

Recent work at Ohio State has been concerned with target identification based on the complex natural resonances of the target (15). The results of this work showed considerable promise for shallow buried mine-like objects. The method is fairly fast, requiring only algebraic operations in the signal processing. If the correct predictors can be developed for typical obstacles to excavation, it is a likely method for approaching a "go-no go" type of output.

Based on an Ohio State system, Microwave Associates has licensed and developed an extremely portable radar called the Terrascan*. The price goal for this system is reportedly much lower than the previous systems such as the GSS Inc. system and its display is much simpler than the usual facsimile or recorder display of multiple return signals. However, this system has been many years in field evaluation and probably has not achieved the desired reliability goals over a wide variety of ground conditions. In the present configuration, the device is intended as a pipe locator and is most efficient for pipe-like objects or long discontinuities in dielectric constant.

*Microwave Associates' trademark 1-6

Arthur D Little Inc

Several organizations are experienced in assembling special ground radars for specific purposes or conducting research programs using this type of equipment. Principal among these are now SRI International which specializes in archaeological and geophysical surveys (19-24); Southwest Research Institute which specializes in geological and military applications (3, 6); and Ohio State University which specializes in utilities location and geological survey (7, 8, 10-15). As part of this information survey, researchers at all three of these organizations were interviewed for their opinions on the applicability of the ground-probing radar to the subject field fortification excavation missions. On the basis of these interviews, the following findings have been summarized:

- A video pulse radar operating in the 50 to several hundred MHz frequency range appears to be the most promising for this application.
- Under favorable conditions, such a system is capable of detecting strong reflections from obstacles in the size range of interest.
- However, interpretation of the radar reflection data is, at this point in time, largely an art form heavily dependent upon previous experience and supporting data from other sources. Substantial development will be needed to reach the point where a simple "go-no go" or graphic visual display can be produced, if indeed, this will ever be feasible from a technical as well as economic standpoint.
- In many soils, especially clays or saturated soils where salt ions are present, even a five foot penetration would not be feasible. While equipment manufacturers claim that the systems are good in soils with conductivities up to 50 millimhos per meter which would cover essentially the entire U. S., one

researcher stated that it is not reliable above 5 millimhos/m. which would eliminate substantial portions of the nation. Conductivity information on overseas areas of interest was not obtained.

- In some cases where the soil conductivity is acceptable, there may not be enough difference between the dielectric constant or permeability of the obstacle and surrounding earth to provide a sharp reflection.
- In summary, underground radar state of the art is still in its infancy, especially with respect to the detection of natural obstacles and target identification.

Of the three firms offering or developing ground radar equipment for sale, both GSS Inc. and Ensco offer both equipment and survey services while Microwave Associates appears primarily interested in marketing a radar system*. On the basis of our interviews of personnel at GSS and Ensco, it appears that the entire system, as now applied, costs of the order of \$35,000 to \$45,000. More than half of this cost is for the tape recorder and graphic display equipment. If a radar and antenna system alone were developed without a need for the recorder and graphics, for example, using a simple oscilloscope or light display, the cost would be much lower--probably in the \$10,000 to \$15,000 range.

1.4 Magnetic Properties.

Several types of magnetic detection methods have been used for underground detection or mapping (2, 27). These all involve the use of instruments to measure some property of the magnetic field near the buried object or the introduction of an induced field in the object and the measurement of the properties of the induced field. The latter method was discussed previously under induction and, of course, can be used for detecting any buried conductive object. The passive magnetic methods, however, require that the buried objects be ferro-magnetic. Thus, they are promising only in the case of buried pipes or other man-made objects which are not of primary interest in this application.

*See Appendix A for these company brochures.

Gates and Armistead have recommended that a magnetic sensor be used on the prototype utility excavation detector as a pipe sensor (2).

1.5 Acoustic Methods.

Various types of acoustic or seismic methods have been proposed or tested for underground obstacle detection.

The simplest is the use of a geophone, analagous to a hydrophone, to listen for sound being transmitted by the underground obstacle. In the case of pipes, for example, the flowing liquid or gas generates flow noise which can be detected. If some portion of the piping system is exposed, it can be struck or connected to a noise source. None of these methods have any application to the current problem.

A related method, however, has been used to measure bedrock elevation. A noise is introduced at several locations by means of a percussive drill. The strength of the wave is then measured at various listening points with a geophone (28). Although this method has some potential in terms of large-scale mapping of ledge, it does not appear promising for the rapid detection needed for the field fortification excavation application.

Most underground obstacle detection work has been concentrated on the pulse-echo method or the related "scanned acoustical sounding" method. Gates and Armistead conclude that frequencies in the range of 1 to 10 kHz are required for the optimum combinations of resolution and transmission in soils (2). However, very high signal absorption will occur for soils that are not compacted or saturated with water. Moreover, coupling the energy into the ground at the transducer-ground interface is difficult. For a moving system this will be a major problem. They did not find any commercially available equipment for the pulse-echo method.

Several researchers have investigated acoustic probing as a technique for detecting obstacles or anomalies ahead of rapid excavation in rock (29-42). Here, of course, the transmission or absorption problem is not as acute as it is in soil. The coupling problem still occurs,

however, and is usually solved by insertion of water or glycerine between the transducer and the surface of the rock (32, 33, 42). All of the various investigators have used frequencies in the range of 5 to 50 kHz.

Even in rock, the complexity of the reflected signals is considerable and much of the research effort has been devoted to methods for processing the signals. Holosonics has developed an imaging technique that allows the construction of an optical image of the target (35-39). Honeywell has developed a computer signal processing system to interpret the return from an array of beams (29-31).

It would appear from the literature that the sonar system is in an even earlier stage of development than the radar ground system. However, it may be the only feasible detection system for wet ground. Thus, we have carried the evaluation of the seismic or sonar methods further for this application as will be discussed in the next section of this report.

1.6 Infrared Methods.

Gates and Armistead have evaluated the potential of infrared methods for the utility detection problem (2). Infrared imaging is used for both commercial and military purposes to survey large areas to detect objects buried beneath the surface, ground that has been disturbed, or hidden heat sources. Because of the clutter, the method is not felt to have much promise for local detection of deeply-buried and relatively small objects (i.e., boulders) or even large objects (ledge) that is several feet below the surface. Hence, infrared methods are not considered promising for detection of obstacles to the rapid excavation task.

1.7 Nuclear Methods.

Gates and Armistead have analyzed a number of nuclear radiation methods for essentially the same application (2). They conclude that a very costly and complex detector system would be required to apply these methods up to four feet and that they would not be useful beyond this depth. Moreover, they are not consistent with rapid scanning of an area. Thus, no further investigation appears warranted for this application.

1.8 Mechanical Probing.

No specific references were found applying a mechanical probing technique to this specific problem. Probing, of course, has long been a common method for detecting buried antipersonnel mines. A bayonet is normally used as the probe. Various devices have been investigated for rapidly penetrating the ground including vibratory or acoustical probes (50, 51), explosives and augers or drills.

The problem here is that an array of holes would be required to 5 foot depths on about 2 to 3 foot centers all over the intended area of the trench. No known methods exist for putting this number of holes in the ground in a few minutes. For example, a 12 x 100 foot trench would require about 300 holes.

Finally, the low energy methods that would be stopped by large rocks would also be stopped by small rocks, having a size slightly larger than the probe diameter. These rocks, of course, would present no impediment to the rapid excavator. Higher energy methods might also penetrate or split the large rocks and thus fail to give the required signal. Thus, the false alarm rate would likely be high.

For these reasons, the mechanical probe was not carried further into Subtask 2.

1.9 Gravimeters and Gravity Gradiometers.

Gravimeters have long been used for mapping anomalies in the earth's gravity field, and thus providing a measure of local density variations (52). The gravimeter is basically a very sensitive balance or force-measure device. Several of the types which have been used are capable of measuring the type of local anomaly produced by a 3 or 4 foot boulder buried at 5 foot depths*. However, each measurement takes about five minutes with skilled personnel. After recording the gravimetric data, it may be processed to produce a map of the gravimetric potential of the survey area as shown in Figure 1-1. This map will show obstacles if the survey is detailed enough for the required resolution.

*Private communication with Dwain K. Butler, U. S. Waterways Experimental Station, Vicksburg, Mississippi.

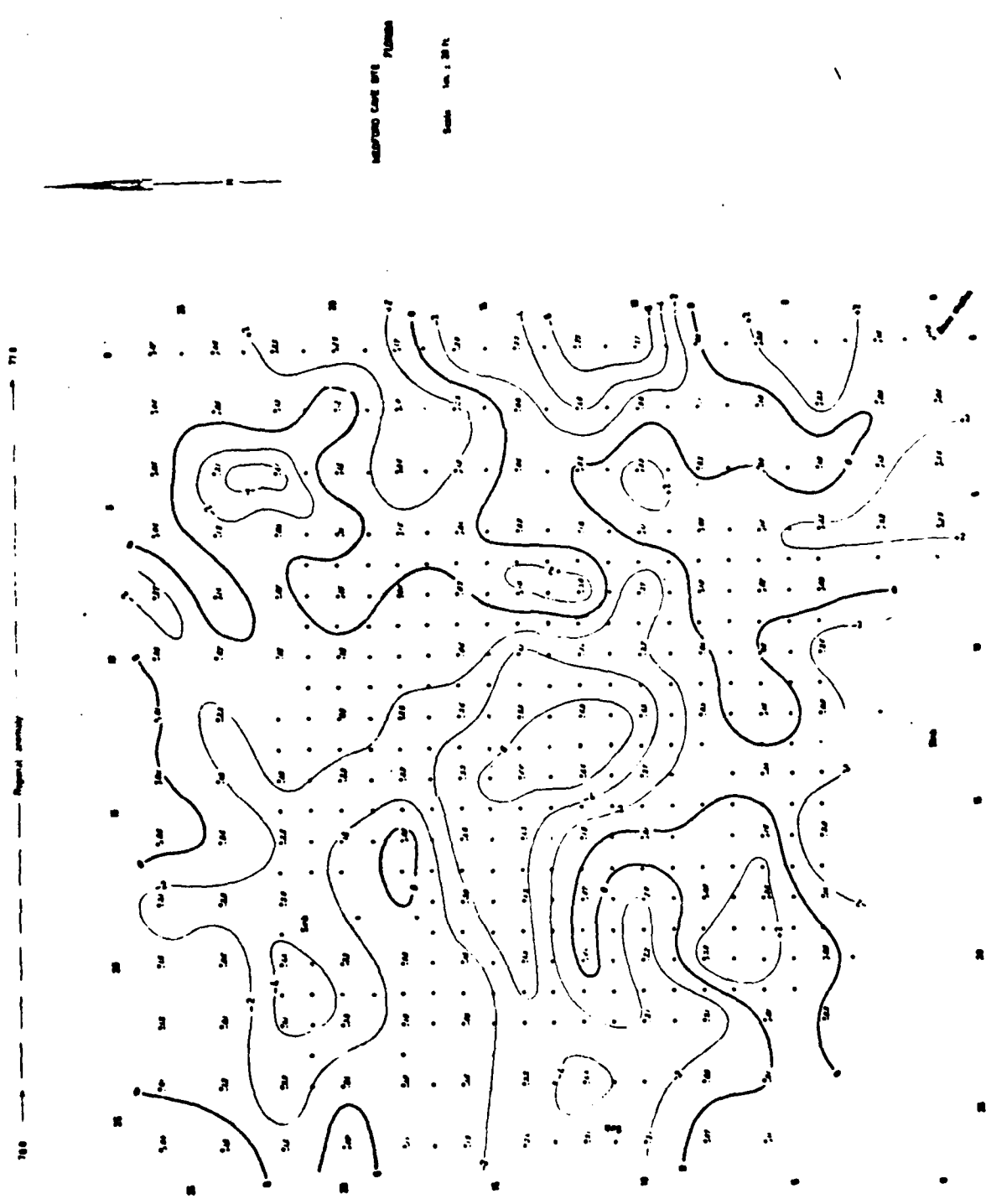

Figure 1-1 Gravimetric Map of the Medford Cave Site
 (Courtesy of Dwin K. Butler, US Army Waterways Experimental Station)

Because the method is slow, it does not have promise for the excavation mission. However, in recent years, gravity gradiometers have been under development for use from moving platforms (53). This approach or simplifications of it have the potential of a more rapid gravimetric survey but will still likely be so expensive as to be far beyond the range of economic justification for the excavation mission.

However, for completeness, the gravimeter has been analyzed in more detail and the results are presented in Appendix B.

1.10 Tiltmeters.

These devices measure static or very low frequency tilt of the ground with respect to the local gravitational vertical. Simple tiltmeters employ a pendulum or bubble level with electric or optical pick-off and readout. Bubble devices are typically limited in sensitivity, while a mechanical pendulum requires a very fragile suspension in order to suppress mechanical hysteresis effects. One extremely sensitive yet rugged and simple design, bypassing these problems, uses a small graphite cylinder suspended diamagnetically in an inhomogeneous permanent magnetic field. The axial position of the cylinder is read out by photoelectric detectors, and the instrument acts as a frictionless pendulum of extreme length without any stick-slip or mechanical hysteresis (55). Other considerably more complex tiltmeters have been built using mechanical feedback where the tilt sensor is only a null device. It has the advantages of greater accuracy and linearity over comparatively large ranges of tilt.

Many of these designs are available in a stage of perfection where they can readily, and with good resolution, measure earth tides. On solid land this is an effect typically of the order of 0.1 arc seconds (corresponding to a tilt of approximately 0.5 mm per km). The best tiltmeters, in fact, approach the thermal noise of the proof-mass itself. It has for each a degree of mechanical freedom an average energy of kT , where k is Boltzmann's constant. Thermal noise is a fundamental limit of all displacement, acceleration, and velocity sensors, but it is reached rarely in practice--in contrast to electrical measurements, where it is today a quite commonly encountered limit.

Tiltmeters are useful in soil mechanical studies, earthquake prediction, study of volcanoes, and in other geological investigations. Often they are used in shallow boreholes to get away from surface disturbances, but in any case, they require careful emplacement. In order to actively study a given area (other than to observe natural tidal, volcanic or seismic events) one would administer a load/unload cycle on the ground in the civinity. In such a configuration, a tiltmeter would readily be able to tell whether ledge is near the surface by the comparative stiffness of the ground and by the distance at which tilt can still be observed. Single boulders, however, at a depth comparable to their size, would have only a very small effect in stiffening the surface and would thus be difficult to detect. At the very least, a dense grid of measurement stations would be necessary to indicate their presence. The slowness of such a method and the necessity of repeating the load/unload cycle for each tiltmeter location would be a great problem in practice. We conclude that tiltmeters are not likely to be cost- and time-effective in this application.

2.0 Analysis - Subtask 2.

2.1 Underground Radar.

2.1.1 Basic System.

The simplest functional block diagram of the underground radar is shown in Figure 2-1. An expanded block diagram of typical electronics and display package is shown in Figure 2-2.

This system is, of course, functionally identical to any other radar system, especially a mapping system where the antennas are moved along a path to locate and identify a number of fixed targets.

There are a number of major differences, however, which affect the nature of the signal used, the design of the antennas, and the type of signal processing.

The first difference is the much shorter range compared with normal above ground radar practice. Because we are concerned with ranges of only a few meters, the round trip time for the radar pulse is much shorter, usually 10 to 100 nanoseconds. In order to separate the direct-coupled transmitted pulse and the reflected signals in the time domain, a pulse length shorter than this is required. Typically, the transmitted pulse ranges from about 1 to 10 ns. The characteristics of a very short version designed for detection of shallow objects are shown in the time and frequency domain in Figure 2-3.

The broad frequency band and short time response results in peculiar receiver and antenna design. The receiver is not tuned but rather is broad band and must use sampling techniques to convert the received signal to a useful form. Digital sampling techniques are usually used to sample each successive wavelength and reconstruct a similar waveform in the audio frequency range for recording and display.

Researchers have used a variety of antenna types including folded dipoles, bow-tie structures, and horns. Typically, a dipole is used which is resistively loaded to increase the bandwidth and avoid resonance. Parallel and cross polarity between the transmitting antenna and

Basic underground-radar system.

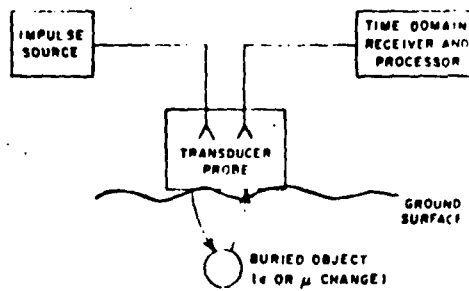
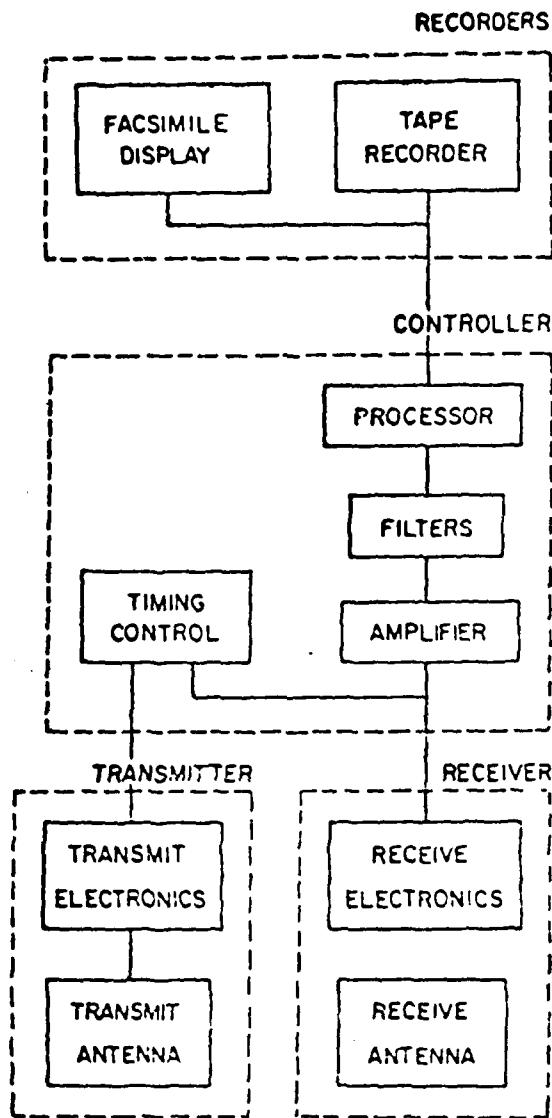

Figure 2-1

Ref. (57)



GROUND-PROBING RADAR BLOCK DIAGRAM

Figure 2-2

Ref. (25)

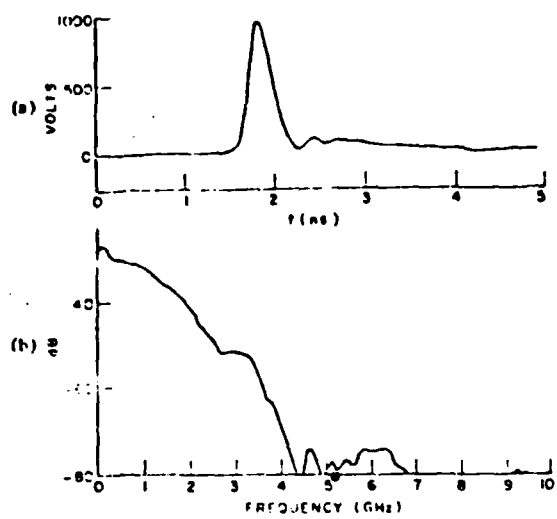

Characteristics of the impulse source in time and frequency domain.

Figure 2-3

Ref. (15)

the receiving antenna are both used, depending upon the nature of the target of interest. The latter is preferable for pipes, tunnels, and artifacts, while the former is better for planar targets such as strata and ledges.

2.1.2 Target Depth.

The depth, d , to a target can be expressed as,

$$d = \frac{Ct}{2} \text{ meters} \quad (2-1)$$

where C = wave velocity in the ground m/sec.

t = round trip time, sec.

The dielectric constant ϵ_r , of the ground may be expressed as,

$$\epsilon_r = \left(\frac{C_0}{C} \right)^2 \quad (2-2)$$

Thus, combining equations (2-1) and 2-2),

$$d = \frac{C_0 t}{2\sqrt{\epsilon_r}} \quad (2-3)$$

where $C_0 = 3 \times 10^8$ m/sec.

The dielectric constant, ϵ_r , of a number of earth materials is given in Table 2-1. It can be seen that they vary over a range of at least 30 for materials of interest. Thus, the depth will be unknown within a factor of 5 or 6 unless the nature of the local ground material is known or the system is calibrated against an object of known depth at the outset.

A problem is that seasonal variations alone can change the ground constants by a factor of 3 and a 50% change can occur over a 10 foot spacing (56). Thus, it becomes almost mandatory to make an in situ measurement of properties or a calibration if results are required to any degree of accuracy.

2.1.3 Attenuation.

The ground is a very lossy medium and signal attenuation is heavily dependent upon frequency, moisture content, and conductivity. Variation in penetration from less than a foot to hundreds of feet have been

Table 2-1

Approximate VHF Electromagnetic Parameters
of Typical Earth Materials

<u>Material</u>	<u>Approximate Conductivity σ (mho/m)</u>	<u>Approximate Dielectric Constant ϵ_r</u>
Air	0	1
Fresh Water	10^{-4} to 3×10^{-2}	81
Sea Water	4	81
Sand "Dry"	10^{-7} to 10^{-3}	4 to 6
Sand, Saturated (Fresh Water)	10^{-4} to 10^{-2}	30
Silt, Saturated (Fresh Water)	10^{-3} to 10^{-2}	10
Clay, Saturated (Fresh Water)	10^{-1} to 1	8 to 12
Dry, Sandy, Flat Coastal Land	2×10^{-3}	10
Marshy, Forested Flat Land	8×10^{-3}	12
Rich Agricultural Land Low Hills	10^{-2}	15
Pastoral Land, Medium Hills and Forestation	5×10^{-3}	13
Fresh Water Ice	10^{-4} to 10^{-2}	4
Permafrost	10^{-5} to 10^{-2}	4 to 8
Granite (Dry)	10^{-8}	5
Limestone (Dry)	10^{-9}	7

Ref. (9)

measured under various conditions. The attenuation of several materials of interest was calculated by Morey (9) as shown in Table 2-2. Since we are interested in a penetration of about 2 meters, this would indicate that a signal in the 100 MHz range could be used in most cases of interest.

However, the moist soil cases of Table 2-2 may be optimistic. The highest useful conductivities cited by any of the prior investigators was 50 millimhos/meter or 0.05 mhos/m. Referring to Table 2-1, it can be seen that this can be exceeded in the case of saturated clay which is not uncommon. Moreover, at least one investigator felt that radar could not be used with any degree of reliability where the conductivity exceeds 5 millimhos/meter. This can occur with virtually any type of soil.

For reference, a conductivity map of the U. S. showing conductivity in millimhos/m. is presented in Figure 2-4.

All of the information obtained during interviews suggested that there were significant areas of the earth where the use of underground radar to detect objects at 5 feet will not be feasible due to signal attenuation in the ground.

2.1.4 Signal Display.

The usual practice followed by investigators and equipment developers to date is to display the processed audio signal on a facsimile x-y recorder. In this display, the x-axis represents the delay time, and thus, is proportional to the depth of the reflecting surface in the ground and the y-axis is controlled in some manner by the traverse of the antennas along the path of travel.

Two such displays are shown in Figures 2-5 and 2-6 (Geophysical Survey Systems, Inc.). In the first of these, a boulder is visible at the edge of the lake bottom; the second shows peat and clay veins in the ground.

Many of these facsimile displays obtained by all of the prior investigators were studied during this survey. It must be emphasized

Table 2-2

<u>Material</u>	Attenuation in Decibels/Meter			
	Frequency in MHZ			
	1	10	100	500
Pure Water	0.025	0.039	0.408	16.191
Sandy Soil (Moist)	0.471	0.513	0.773	4.047
Clay Soil (Dry)	0.013	0.075	0.425	1.649
Clay Soil (Moist)	0.780	3.803	17.93	53.75
Sea Water	34.50	108.54	326.65	592.03
Granite (Dry)	$.732 \times 10^{-5}$	$.732 \times 10^{-5}$	$.723 \times 10^{-5}$	$.732 \times 10^{-5}$

Ref. (9)



Figure 2-4 Ground Conductivity in Millimhos
per Meter

LAKE BOTTOM

DISTANCE (ft)

75

WATER SURFACE

0

10

20

BOULDERS

WATER

LAKE BOTTOM

GLACIAL TILL

Geophysical
Survey
Systems, Inc.

126-1680

Figure 2-5 Facsimile display of a
Lake Bottom

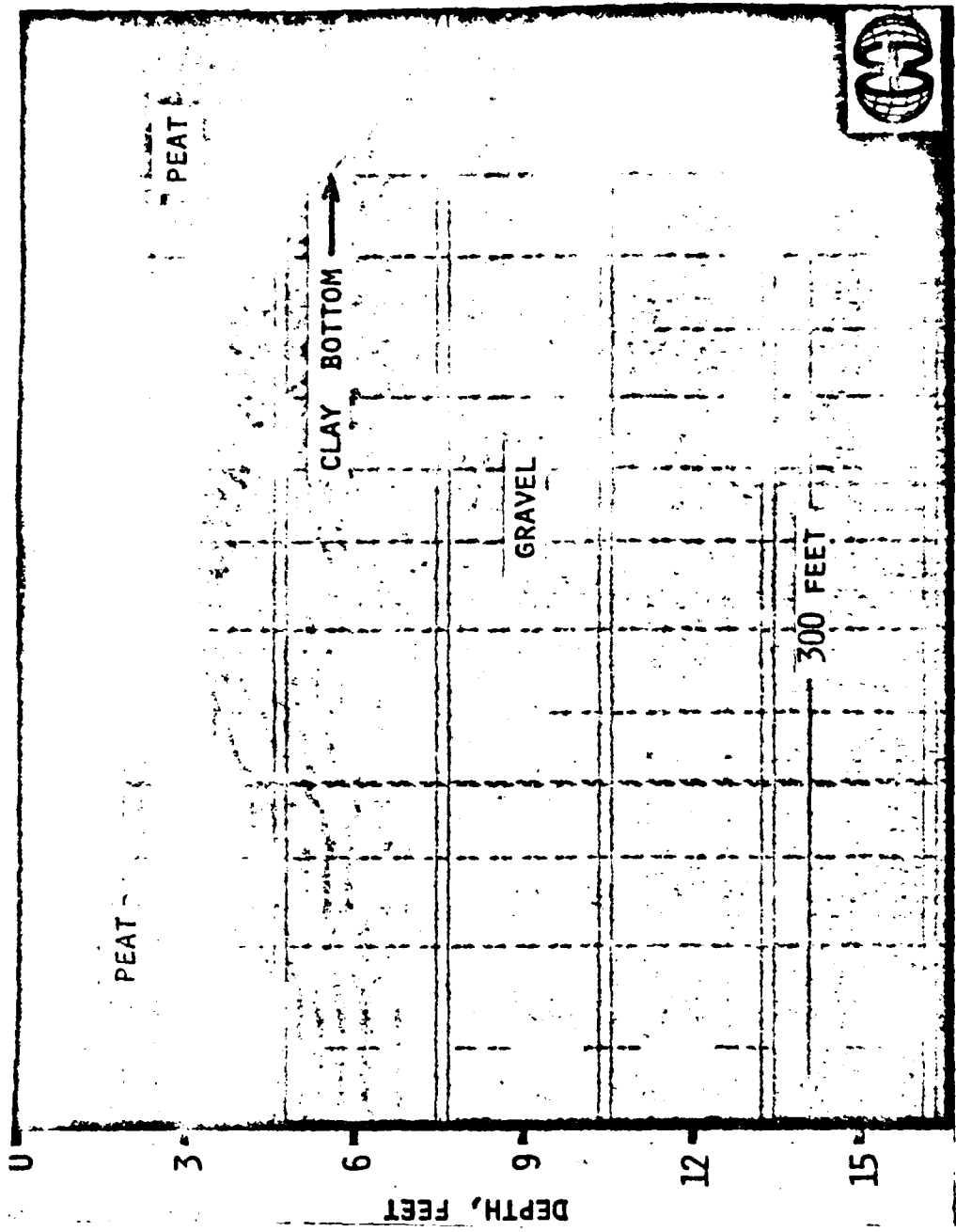

RADAR DEPTH PROFILE OF PEAT AT POND PERIMETER

Figure 2-6 Facsimile Display of a Peat Layer

strongly that those shown in Figures 2-5 and 2-6 are spectacular in comparison with most surveys that we have seen.

The degree of imaging provided by the facsimile display along with some knowledge of the local geology often allows a skilled individual to identify some of the major features or targets.

However, much more refined signal processing will likely be required for use by relatively unskilled military personnel in the field.

The Terrascan system being developed by Microwave Associates provides a simple digital representation of the actual received signal in the time domain along with a depth readout. However, the operator must decide whether the signal is consistent with a buried pipe. He does this by the variation in signal as the pipe is approached and the antenna is rotated. Such a system requires some skill and is too slow for the survey times required in the military application.

The recent work done by Ohio State University on a predictor-correlator method for determining the characteristic resonant frequencies of the underground object provides a possible direction for eliminating the operator decision part of the process (15). It may ultimately be possible to program a device to recognize groups of resonances that are typical of large rocks and display a "Go no-go" signal along with a depth. This sophistication, however, will require considerably more development, if, indeed, it proves possible.

2.1.5 Outlook.

In summary, the state of the art for underground radar allows the detection of buried obstacles or tunnels at 5 foot depths in many earth conditions, providing skilled operators with some idea of the underground features are interpreting the processed data.

To go the next step to a field device to be used in advance of rapid military excavation will require significant development effort before feasibility can be determined or demonstrated. It is believed that the following sequential steps are logical for this development effort:

- Field tests should be run with an available system in the geographical areas of interest (e.g., Europe, Middle East, Far East, etc.). If a given location has significant seasonal groundwater variation, tests should be run at different seasons. Tests should include buried obstacles or cavities of the types that would interfere with excavation.
- If the basic system still appears promising after such tests, a program to develop effective target recognition or imaging equipment should be conducted.

2.2 Seismic Methods.

2.2.1 Basis.

Seismic methods of shallow excavation directly sense those very properties of the soil that affect its excavatability. For example, there is a marked difference in the magnitude of seismic velocities between the various soils and rocks as shown in Table 2-3; that is the chief advantage of these methods over others. Electrical properties of the soil, by comparison, would need to be correlated by geological experience to soil mechanical properties.

2.2.2 Seismic Waves.

Seismic surveys are based on observing the propagation of waves through the ground. These may be (longitudinal) compressional waves or (transversal) shear waves. There are also other modes of wave propagation: the so-called Rayleigh and Love waves, which occur along or near the surface of the ground. However, these do not generally appear to be useful for shallow excavation surveys. In fact, they, as well as acoustic transmission through the air, contribute spurious signals and interference to seismic surveys.

Compressional waves propagate with the following velocity (52):

$$v_p = \frac{E}{\rho} \sqrt{\frac{1-\sigma}{(1-2\sigma)(1+\sigma)}} \quad (2-4)$$

where Poisson's constant $\sigma = \frac{\Delta w/w}{\Delta l/l}$ (around $\sigma = 0.3$ for rock and 0.1 to 0.5 for soils)

ρ is the density, and
 E is the modulus of elasticity
 (Young's modulus).

Table 2-3

Typical Seismic Compressional Velocities

<u>Material</u>	<u>Ft/Sec</u>	<u>M/Sec</u>
<u>Igneous at Shallow Depth</u>		
Granite	15,750 - 18,500	4,800 - 5,600
Diorite	19,000	5,800
Gneiss	11,500	3,500
<u>Sedimentary Rocks</u>		
Limestone	5,600 - 23,200	1,700 - 7,100
Marble	12,300 - 22,750	3,700 - 6,900
Chalk	8,465	2,600
Slate	14,000	4,300
<u>Unconsolidated Sediments</u>		
Wet Clay	4,900 - 5,400	1,500 - 1,650
Sand (Tight)	2,000 - 6,100	600 - 1,850
Sand (Loose)	655 (min. meas.)	200
Soil	360 - 660	110 - 200
Talus	260 - 850	80 - 260
Weathered Layer	1,000 - 3,000	300 - 900
Gravel, Rubble, or Dry Sand	1,500 - 3,000	450 - 900
Water	4,700 - 5,500	1,400 - 1,700
Ice	12,050	3,670

Shear waves travel at a velocity:

$$v_s = \sqrt{\frac{E}{\rho} \frac{1}{2(1+\sigma)}} \quad (2-5)$$

which is always less than the compressional wave velocity (by a factor around 2 to 3). (58) Shear waves can be polarized, being transversal. Independent measurement of shear and compression wave velocities allows calculation of Poisson's ratio and the shear modulus. This is particularly useful for soil-mechanical studies of foundations and their rigidity and stability. Density and modulus affect both velocities similarly, and therefore cannot be separated in this way. Density must be estimated and independently to compute modulus.

Rayleigh waves are yet slower than shear waves, and their velocity depends on frequency, lower frequencies propagating typically faster. At higher frequencies where the wavelength is small compared to the depth of the top layer their speed is about 9/10 of the shear velocity in that layer.

Shallow seismic work uses compressional waves only because they always are the first useful signals to arrive. First signals stand out clearly on a recording and are easiest to time, in particular, when simple impulse sources are used.

Unfortunately, sources acting on the surface of the ground tend to excite a large amount of surface waves, which may arrive, in spite of their slower velocity, earlier than the wanted signal from a reflecting subsurface layer.

2.2.3 Seismic Impulse Sources.

While pure shear waves are difficult to excite, as a twisting or torsional moment has to be applied to the ground, the excitation of compressional waves is comparatively simply accomplished by mechanical impact. A blow with a sledgehammer on a plate on the ground or from a falling weight will typically generate enough compressional wave signal to propagate low frequencies (less than 100 Hz) some tens to hundreds of feet, while for longer ranges (as in oil exploration), explosive charges are more practical. Impact sources at the surface, being generally

directional and unsymmetrical, also put out large amounts of shear wave energy which must be discriminated against, by their slower velocity, in the interpretation of the data. The elastic limits of the soil set a definite upper limit to the energy that can be imparted to the ground. At some power density, the ground ceases to behave as an elastic body and an increasing portion of the impact energy is dissipated on the spot rather than propagated as a wave. The situation is improved by imposing a suitable mechanical matching system--a steel plate in the simplest case--between "hammer" and soil. However, direct mechanical impulse in particular, for the generation of high frequencies, is definitely limited by this effect.

For the shallow survey work under consideration here, available commercial systems typically use, quite successfully, a simple sledge-hammer impulse source*.

One might propose the use of a gun to fire a projectile into the ground. This has been found (58) not to work well because of the gross mismatch in weight and velocity of the projectile to the properties of the ground. Gas exploders (58) are used commercially but are rather heavy.

Most of the practical experience has been with seismic frequencies below, say, 200 Hz. In our application, frequencies around 1000 Hz will be needed to achieve the required resolution around one foot. Present simple sources do not, apparently, function well at those frequencies, and some development effort would be needed to identify or to design more suitable ones. Modulated vibrators, discussed in the next section, look promising.

2.2.4 Seismic Vibratory Sources.

Some recent systems employ, instead of impulse excitation, a vibratory excitation over a comparatively long time period. The necessary signal-to-noise ratio at the geophones and receivers is obtained in that system not from one or a few cycles of very large amplitude, but from frequency- or phase-coded waveforms of lesser and constant

*For example: Bison Instruments, Minneapolis, Minnesota

amplitude but long duration. Evidently a pure sinusoid can be received with better and better signal-to-noise ratio as observation time is increased. In that situation, the signal adds coherently in time while noise adds incoherently. Alternatively, the effect could be described as the result of a very narrow bandwidth ($\Delta f \approx 1/\text{observation-time}$). This reduces noise power by reducing the effective bandwidth while not affecting the single frequency signal.

However, a pure sinusoid does not allow timing its "arrival", and thus cannot be used to measure travel time. To do that, some coding, i.e., modulation, is required. The simplest such code is to transmit only one or a few cycles, as in the impulse source. This is what a seismic hammer blow does or the capacitor discharge into the antenna of a videopulse ground-penetrating radar. However, such coding by amplitude modulation will lead to a severe problem of dynamic range, that is, excessive peak powers are required at the transmitter in order to obtain from one impulse a sufficient signal-to-noise ratio. This can be improved only by repeating the process and coherent addition of the resulting signals--a comparatively slow procedure. In contrast, frequency or phase modulation can time-code the transmitter signal and improve signal-to-noise ratio without increasing the dynamic range. (59) Phase modulation (although successfully used in some radar systems) is difficult to realize in a mechanical vibrator, while frequency modulation, i.e., a "chirp", is comparatively easy. A very successful system under the name "Vibroiseis" is based on this scheme.

Truck-mounted vibrators exist for such frequency-modulated signals that are powerful enough to do deep seismic exploration. In many cases they have eliminated the need for explosive charges to reach great depths. The signals are picked up by conventional geophones and fed from there to correlators where they are processed together with a reference waveform from the vibrator source. These correlators can be partly passive analog circuits or, more recently, are realized by digital computation. The geophones and receivers are designed with particular care not to produce amplitude, phase and delay distortion in the passband of interest between the seismic signal and the correlator. The result of the

correlation computation is suppression of uncorrelated noise and spurious signals (such as surface waves), and a determination of the time shift between the transmitted and the received waveform. This yields a measurement of travel time and thus of seismic velocity. Not only does this method eliminate the need for strong impulse sources, but it also lends itself particularly well to signal enhancement by repeating the process, the "chirp", over and over in order to increase the accuracy by coherent adding of the wanted signals and better and better rejection of the typically incoherent ambient disturbances and system noise.

In conclusion, these "chirp" systems, while more complex, are inherently superior to older methods to excite and receive and evaluate seismic waves. Whether this extra performance is required for our shallow survey task is not clear at this stage. Their most important contribution may, in fact, be the suppression of noise and disturbances.

2.2.5 Seismic Receivers.

The geophone is the usual seismic receiver. It is typically directly sensitive to velocity as it normally consists of a low-tuned, comparatively heavy voice coil held by a spring in a magnetic field. The output of that coil is directly proportional to ground velocity when the geophone body moves with the ground while the voice coil stands still in space, due to its inertia. Such a geophone is directional, and it is emplaced by the operator so that it responds to vertical velocity when used with compressional wave surveys.

Typical geophones have self-resonant frequencies below 10 Hz, i.e., they are useful for frequencies above 10 Hz. The upper cutoff of the system is set in the amplifiers at a few hundred Hz in common shallow surveys. For our application, greater resolution is needed to detect single boulders. Therefore, our system would use higher frequencies of the order of 2000 Hz. This would generally allow making the geophone of higher resonant frequency thus smaller and more rugged.

It may even be advantageous to employ piezoelectric accelerometers instead of the present velocity-sensitive geophones. In a sinusoidal

vibration, displacement, velocity, and acceleration are related by:

$$s = S_0 \sin \omega t \text{ (m)}$$

$$v = \omega s_0 \cos \omega t \text{ (m/sec)}$$

$$a = -\omega^2 s_0 \sin \omega t \text{ (m/sec}^2\text{)}$$

At higher frequencies ω , measurement of acceleration becomes thus an easier means to measure and characterize a vibration than measurement of displacement or velocity. Accelerometers are high-tuned, i.e., their self-resonant frequency lies above the band of interest. They are therefore small and rugged and, as a piezoelectric device, much less expensive than present geophones. They would constitute an electrical signal source of much higher impedance and lesser power output than present velocity geophones, but different amplifier designs can easily make up for that.

2.2.6 Reflection Surveys.

A compressional wave is reflected at an interface where the acoustic impedance changes abruptly. For the case of perpendicular incidence on a flat interface, the amplitude ratio, i.e., the reflection coefficient is given by:

$$x_r/x_1 = \frac{\rho_2 V_2 - \rho_1 V_1}{\rho_2 V_2 + \rho_1 V_1} \quad (2-6)$$

where $\rho V \sqrt{E/\rho}$ is the acoustic impedance of the respective medium. As the variations in density between different formations are usually very much less than the variations in modulus, the influence of the latter will dominate in most situations. This will be particularly true in our case of rock imbedded in soil.

When the reflecting surface is irregularly shaped or the reflecting object is of the order of the wavelength or smaller, the shape of the wavefront is changed entirely by the reflection, i.e., the wave is scattered. For objects very small compared to a wavelength, the scattering efficiency drops with a high power of the linear dimension and objects much smaller than the wavelength become, in practice, undetectable. Irregularly shaped objects larger than a wavelength give returns which may or

may not be specular in some direction, depending on the shape and orientation of the object. One result is that the return from a uniform scatterer falls off with the square of the range (in amplitude), while the return from a specular reflector, perpendicular to the line of sight, falls off linearly with range.

In our case, the problem is to detect ledge or large obstacles within, say, six feet of the surface. Obstacles smaller than perhaps three feet in diameter could be removed by most excavating machines and are therefore of little interest. A wavelength of one foot or less would therefore appear capable of resolving the obstacles of interest and of giving an unambiguous indication that they are located within the comparatively shallow depth of interest. As discussed before, purely sinusoidal signals cannot measure range, and therefore either a real or a synthetic impulse is required. This will then contain a spectrum of frequencies, although that spectrum need not be extremely wide in our case because the required relative range resolution is so modest.

Reflections at the surface of the ground could become a serious problem in a practical embodiment of the reflection method to find underground obstacles. Source and geophone must be coupled well to the ground in order to attain reasonable efficiency and to keep such unwanted reflections down. They must be designed for operation against an acoustic impedance typical of soil, not of air. Since compressional waves will be used, liquid coupling to the ground could be most useful.

In conclusion, reflection surveys respond to differences in acoustic impedance. By themselves, they give no data as to the absolute seismic properties of the media on the two sides of the interface, but only on the geometric configuration of the subsurface formation. Reflection would therefore appear to be well suited for the direct and simple detection of boulders, other obstacles, and cavities beneath a source-geophone combination. Technical problems would be expected in obtaining sufficient coupling of this device to the ground and from direct coupling of surface waves from the source to the receiver.

2.2.7 Refraction Survey.

This is the classic seismic method originally applied to the interpretation of earthquake signals. It involves laying out a linear or spatial array of typically one geophone and several sources (hammer blows) and then recording the arriving signals (See Figure 2-7). These are typically compressional waves that have been refracted by the (horizontally layered) formations of higher sound velocity which typically underlie a formation of lower velocity. The geophones are located beyond some minimum distance from the source. The earliest arriving signal will, in that case, have traveled from the source downward at the critical angle:

$$i_c = \text{arc sin } V_0/V_1 \quad (2-7)$$

until it hits the interface of the formation. There it will be refracted exactly parallel to the interface because it arrived exactly at the critical angle; it will follow that interface exactly, and it will finally return upward to the receiver at the same angle i_c . The two figures, Figure 2-8 and Figure 2-9, were taken from Dobrin (52) and are self-explanatory in illustrating these principles. After the arrivals at several geophone locations are recorded, the arrival data have to be interpreted by fitting them to a suitable model of the subsurface formation. This is comparatively simple under the assumption that the subsurface consists of discrete horizontal layers where the velocity always increases to greater depths. If, however, a low velocity layer underlies a high velocity one, the method fails because the rays are, in that case, refracted downward at the interface and are not guided along it. The low velocity layer is not detectable in that case. Fortunately, this situation is rare and quite unlikely to occur in our case of shallow refraction surveys.

Refraction would appear to be well suited therefore to detect ledge at shallow depths. The very large velocity contrast would make detection easy. However, refraction appears not well suited to the detection of discrete boulders unless the survey spacing were to be made so narrow that the relatively small high velocity volumes could be detected. In that

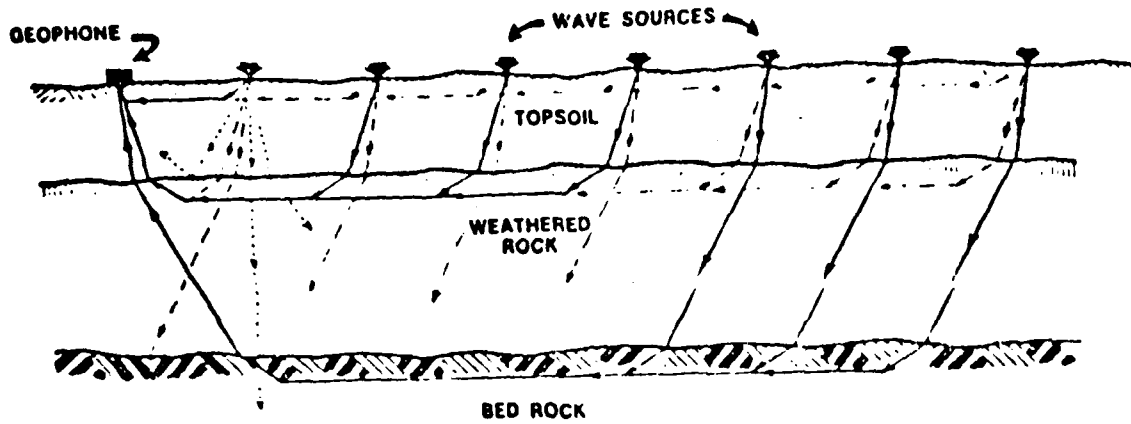
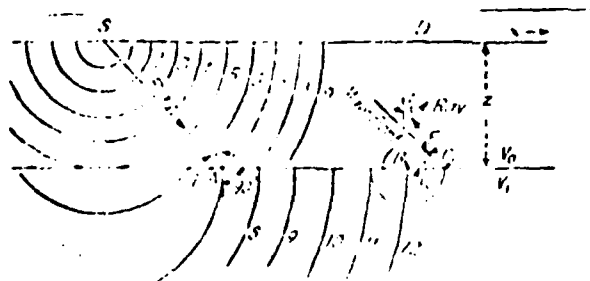
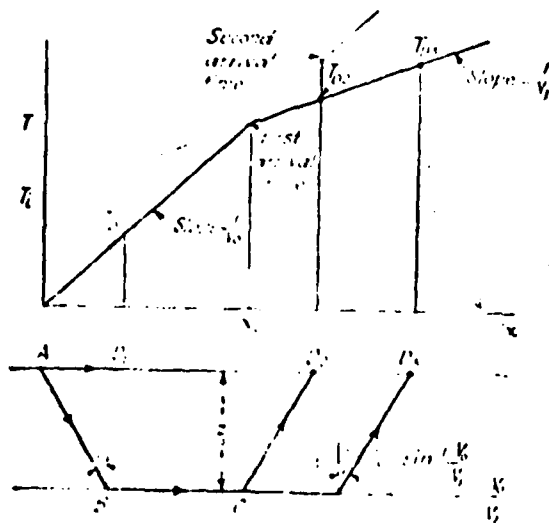

Figure 2-7 (Caterpillar, Ref. 60)
The solid lines mark the early signals.



Mechanism for transmission of refracted waves in two layered earth. (After Dix, Geophysics, 1939.)

Figure 2-8 (Dobrin, Ref. 52)



Ray paths of least time and time distance curve for two layers separated by horizontal interface.

Figure 2-9 (Dobrin, Ref. 52)

case, a refraction survey would be very slow because the spacing must be of the same order of magnitude as the size of the obstacles and their maximum depth.

A significant advantage of refraction methods over reflection is their ability to yield absolute estimates of velocity (see Figure 2-10) and thus of mechanical properties. Apparently good correlation exists between velocity and excavatability. As said before, the densities of soil and rock do not vary nearly as much as their moduli. Seismic velocity of compression wave is therefore a good indicator of modulus alone and thus of excavatability or rippability. Illustrative data are given in Figures 2-11 and 2-12 and Tables 2-4, 2-5, taken mostly from Ref. 60 and 62.

2.2.8 Attenuation of Seismic Waves.

The propagation of a compressional or transversal seismic wave in a homogeneous medium takes place in all directions, i.e., spherically. On a scale large compared to the wavelength, the energy must therefore fall off with the square of the distance and the amplitude linear with distance. In analogy to optics, these spreading losses can, of course, be reduced by suitable beam shaping, e.g., by arrays of the sources. Receivers can also be set up to shape their directional characteristics.

In addition to these purely geometric effects, the medium is not perfectly elastic and therefore has inherent loss mechanisms that convert part of the wave energy into heat. The result will be a constant fractional attenuation per unit length, described by:

$$E = E_0 e^{-\alpha x} \quad (2-8)$$

where x is the distance and α an attenuation coefficient measured in the above formula in Neper/unit length (or dB/unit length if powers of ten are used). In agreement with theoretical considerations, this attenuation is found, in practice, to be approximately proportional to frequency. Measured attenuation coefficients are well represented by:

$$\alpha \sim \frac{\pi f}{vQ} \sim \frac{\pi}{\lambda Q} \quad (\text{Neper/unit length}) \quad (2-9)$$

where v is the velocity of the wave, f its frequency, λ its wavelength,

MATERIAL

COMPRESSIONAL VELOCITY (m/sec)

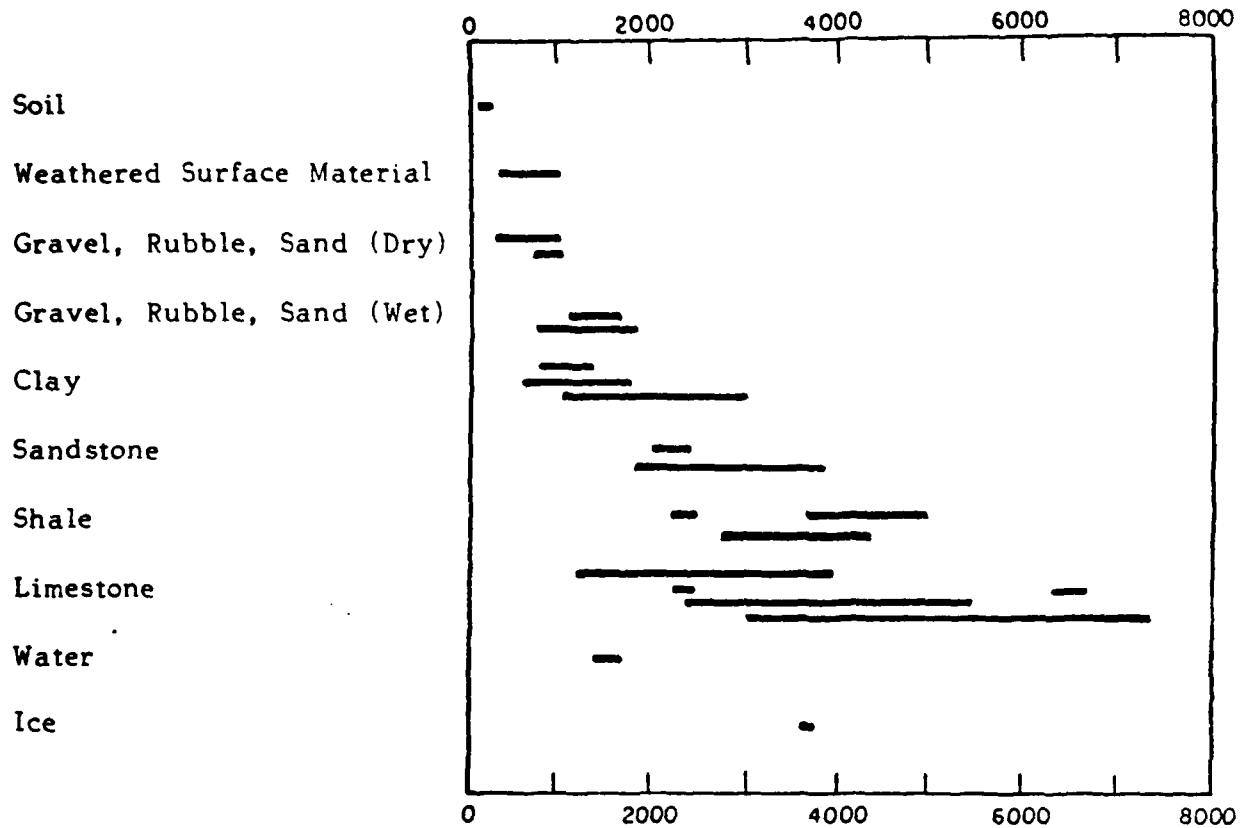

Figure 2-10

Compressional Velocities for
Typical Overburden Materials

(Mostly from Lagace, Ref. 61)

Seismic velocity method for determination of excavation characteristics.

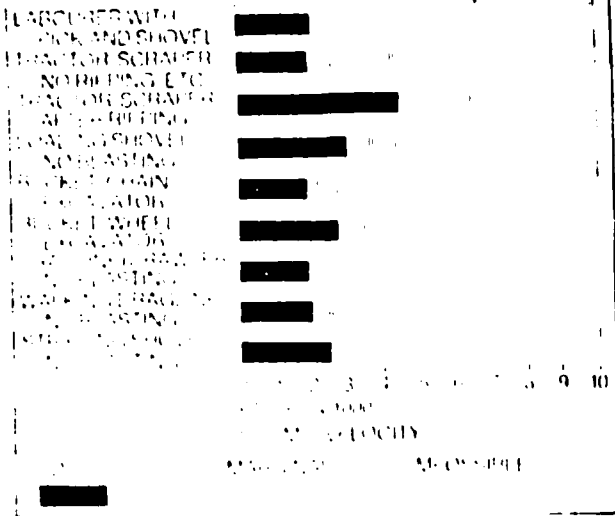

Figure 2-11 (Coal Age, September 1979)

TYPICAL CHART OF RIPPER PERFORMANCE AS RELATED TO SEISMIC WAVE VELOCITIES

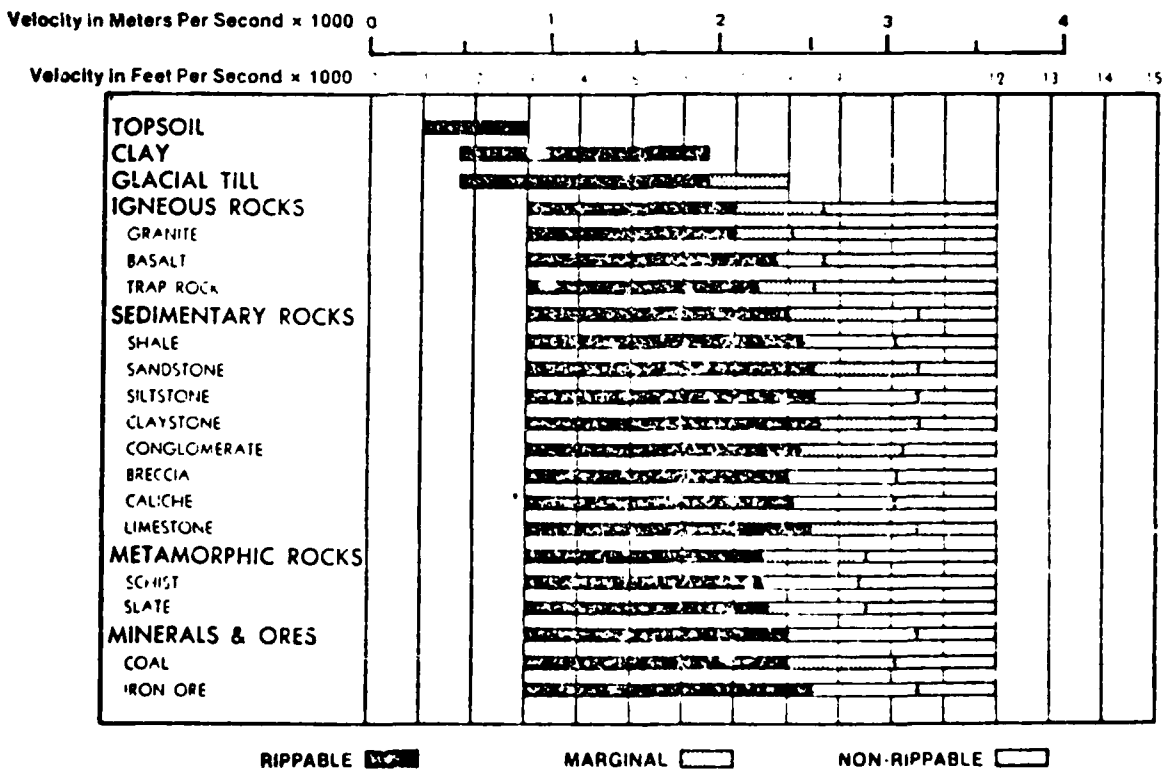

Figure 2-12 (Caterpillar, Ref. 60)

Arthur D Little Inc

Table 2-4

Excavation Effort by Dredging vs. Seismic Velocities

Velocity (ft./sec.)	Probable Excavation Characteristics
6,000	Mostly easy or normal dredging
6,500	Normal excavation with very little hard dredging
7,000	Little normal to some normal and some hard
7,500	Little normal and some hard or mostly hard
8,000	Very hard dredging
8,000 to 10,000	Assume Blasting

(from Ref. 62)

Table 2-5

Typical Q's, logarithmic decrements,
velocities, and frequencies for
30 cm ~ 1 ft. wavelength

<u>Formation</u>	<u>Q</u>	<u>$\delta = \pi/Q$ (Neper/wave)</u>	<u>V_p (m/sec)</u>	<u>f (for $\lambda \sim 1$ ft.) (Hz)</u>
<u>Weathered Layers</u>				
Pottsville sandstone	7	0.45	2,500 assumed	8,200
Pierre shale	23	0.14	2,200	7,200
Weathering zone	15	0.21	1,200	4,000
Weathering zone	10	0.31	600	2,000
<u>Rock</u>				
Dolomite	200	0.016	4,900	16,000
Limestone	180-120	0.017-0.026	5,000-5,500	17,000
Sandstone	50	0.063	2,500	8,200
Sandstone	50	0.063	3,000	9,800
Granite	125-160	0.025-0.020	4,300-4,500	14,400

Compiled from White (Ref. 63) and Lagace (Ref. 61)

and Q a "quality factor" of the formation. We can eliminate the wavelength from the above equation and arrive at an expression for attenuation per wavelength, i.e., for logarithmic decrement:

$$\delta \sim \pi/Q \quad (\text{Neper/wavelength}) \quad (2-10)$$

In a vibratory system, the fractional energy losses per cycle and also the fractional width of the resonance curve are both described by the same quantity Q. This same numerical value also applies to the attenuation of a propagating seismic wave. The quality factor Q can thus be measured independently in the laboratory, and it is known for many rocks and types of soil. Table 2-5 gives representative values for compressional waves. Attenuation coefficients for shear waves tend to be several times larger than for compressional waves. They are not included in this data.

Equation 2-10 is particularly useful because it gives a clear guide to the choice of wavelength for a given configuration. An object of a given size has to be detected at some given range. First, the wavelength must be smaller than the object in order to resolve it, or at least to produce a substantial backscatter signal. Second, the range is limited by the allowable total transmission loss (round trip, in the case of a reflection method). That allowable transmission loss, in turn, is determined by the ambient and system noise level at the geophones and by the power that can be injected into the ground by the source. Since resolution and loss can both be measured not in units of length but in units of wavelength (and regardless of frequency), the choice of wavelength becomes straightforward. The configuration can then be scaled by changing frequency, but the maximum ratio of range to resolution is always uniquely determined by the allowable total loss.

The result, in our particular case, is that very high attenuation per wavelength is permissible. We need to detect obstacles of, say, three feet diameter at distances of, say, six feet in a weathering zone of comparatively low Q. A Q of 7 would lead to a logarithmic decrement around 1/2 Neper per wave. If we employ wavelengths of about one foot for good resolution, we would expect a round trip attenuation around 6 Neper, corresponding to a factor of 400. A wavelength of one foot in soil might

correspond to a frequency around 2,000 Hz. Geometric spreading losses by the irregularly shaped obstacles (instead of the specular reflection one would expect from ledge) will reduce the signal level further. However, there is little doubt that the total amplitude losses, of the order of 1,000, could readily be tolerated by even a comparatively simple seismic source and detection system. Problems can be expected from the direct arrival of surface waves, however, and field data would have to be obtained on these phenomena in a typical, practical set-up.

2.2.9 Display of Seismic Survey Results.

The ideal output from the excavation obstacle sensor would be a large and simple "Go-no go" signal.

However, no seismic methods have come to our attention that would promise such an unambiguous automatic answer in all situations. To even partially automate the evaluation process would require a large development effort, although the final hardware would probably not be particularly expensive. The main problem would lie in defining the statistics of obstacles and the statistics of the background and clutter against which these obstacles have to be detected. Detection theory is well developed from radar and sonar technology and, as soon as target and background statistics are known, will lead to conclusive answers. It may turn out, however, that the necessary trade-off between "missed targets" and "false alarms" will be difficult.

Also, the emplacement of the measurement stations would, in any case, require some minimum skill and understanding of the methods by the operator. These stations are necessary because, so far, no seismic apparatus appears to exist that can simply be rolled over the terrain in a continuous motion in the same way as the ground-penetrating radar can.

An automated excavation obstacle sensor with a high false alarm rate might, in fact, be worse than no sensor at all. At best, it would merely discredit the method. But at worst, it would lead to the mistaken abandoning of a tactically good site for a field fortification. In most systems false alarms are a serious problem. But in our case, they are not only

psychologically bad, but particularly pernicious to the ultimate purpose of the excavation system.

In view of this, it would appear that some minimum skill and understanding are absolutely required of the men who plan and execute the excavation. In that case, automatic signal processing to a "Go-no go" signal may not be necessary, and a visual display (on a CRT) of the seismic results clearly has the best potential. It will use the pattern recognition ability of the operator; and it will place the output in a self-explanatory and intuitively understandable relation to the terrain around him. Perhaps more important, it will, in most cases, tell when the sensor has failed either because it has met a condition it cannot cope with or because it is not used correctly.

2.2.10 Seismic Holography.

Holography brought strikingly novel results when it was first applied to optical imaging problems. Until the advent of strong coherent optical sources (i.e., lasers), imaging consisted of recording the energy distribution in the image plane, but not the amplitude and phase in the wavefront from the object. Films and photodetectors are "quadratic", which means they respond to energy density and do not record the phase of the incident wave. In holography, an optical reference wave is added to the wave scattered by the object before the sum of the two waves is squared and the integral recorded on film. Phase information is thus stored in addition to amplitude.

In acoustic or seismic imaging, on the other hand, the waves have always been recorded by linear receivers, and the output of the geophone is an exact electrical replica of the input, including phase. Also, the rate of information in a seismic wave is small compared to the one in optical imaging. Comparatively simple electrical processing, using a reference signal from the source, can generate a seismic hologram which entirely describes the seismic wavefront. The image can be reconstructed by standard holographic techniques if a suitable modulator for an optical wavefront can be made from the acoustic hologram. A better approach, though, is to compute the reconstruction of the object and to display it

from the computer's output. Several methods to do this are known and corrections for velocity inhomogeneities, for different viewpoints, for suppression of clutter, and to generate images from different locations can, to some degree, be included in the reconstruction. In our particular application, fortunately, neither the spatial resolution nor the field of view nor the amplitude resolution ("gray scale" in optics) need to be good, and this would significantly reduce the required computational effort.

A problem in acoustic holography, as with any acoustic imaging method, are the generally unknown and fairly large velocity inhomogeneities in the bulk medium. These would be analagous to variations of optical index of refraction in holography. In our case, however, little accuracy is required in the image. As long as the system yields a clear, although distorted, view of the obstacle, it would be useful. Substantial errors in scale are tolerable, as we typically will be searching for three foot objects at six foot distances.

Attenuation is also not a serious problem in our application, because of the short range. This and the permissible coarse resolution make a total round-trip range of only a few tens of waves quite sufficient. Even in the weathering zone near the surface such ranges can be attained at tolerable round-trip losses. In fact, a modestly high attenuation may even be beneficial in suppressing multiple reflections. One round trip may have an attenuation of, say, -60 dB, and if the gain of the system is set for approximately this signal level, then a second round trip, either in an unwanted reflection from the surface or as a return from deeper structures, would be very effectively suppressed. This would be especially beneficial in holography, where a CW source of seismic waves would typically be used and where signals are not inherently coded by arrival time, i.e., by range. It is possible to take holograms from short bursts, but signal-to-noise ratio would clearly be improved by extended observation times, thus requiring long wavetrains and inviting problems from multiple reflections and deep structures.

Another benefit of holographic method lies in the fact that not the complete time record from each receiver station (geophone) but only the

integrated holograph value generated from signal and reference wave needs to be stored for each location. This collection of the data clearly does not need to be done simultaneously from the whole array. It can be distributed in time by moving the receiver or the source from station to station, thus synthesizing a "scanned hologram".

In conclusion, holography by itself does not provide any improved seismic detection. It does nothing which other well developed seismic evaluation techniques could not do, and it is, of course, based on the same rationale as these techniques are. However, holography may well make for a simpler system in practice if a pictorial display of the results is wanted. If such a display were not acceptable but rather a simple "Go-no go" indicator, holography would not be applicable.

2.2.11 Other Visualizations of Seismic Waves.

TRW made a proposal (66) to MERADCOM in 1974 in which they suggested, as far as we know, an optical processing of seismic returns in a mine detection scheme. A thin rubber membrane was to couple a liquid tank to the ground. A separate source would inject seismic waves into the ground which would, after having been scattered by the objects to be detected, enter the liquid through the membrane from the ground. A laser beam was to interact in the liquid, presumably by variation of the index of refraction with the sound field from the ground and make it or its irregularities visible to the operator.

We were not given a copy of the proposal by TRW as it is proprietary. We believe that it may contain ideas and techniques useful to this particular application. However, as in the case of holography, it would be valuable only if a pictorial display would be desired as the final output of the obstacle detector. It also appears as if the arrangement might be comparatively large and cumbersome when applied to the detection of large objects.

3. Conclusions, Benefits, and Specifications - Subtask 3.

3.1 Findings and Conclusions.

The salient finding of the survey performed in this study is that there is not currently any available obstacle detection system which can be readily transformed into an embodiment suitable for the combat engineers' rapid excavation mission.

Two detection technologies,

- Electromagnetic Pulse Reflection (Radar)
- Seismic Reflection or Refraction Techniques

provide the most promise for the development of a system for this purpose.

Of these, the radar system has been developed to a greater degree and offers a faster and simpler embodiment for the field fortification excavation mission. At least one specialized underground radar system is available commercially and two others will likely become available in the near future. However, these are all intended for geophysical or utility line surveys and do not necessarily conform to likely military time (duration) or signal (direct interpretation, e.g., Go-no go) interpretation limitations.

Seismic techniques offer the potential capability to operate in ground conditions where radar will not penetrate. Because they sense velocity of propagation and/or mechanical impedance which are related to stiffness and strength, they operate more directly on properties which define an obstacle. However, seismic pulses or waves are more difficult to couple into the ground, a factor adversely affecting the speed of operation of a seismic system. Signal interpretation problems are just as serious as those for the radar and are no further developed.

Specific findings or limitations for each of these two methods are summarized in the following subsections.

3.1.1 Underground Radar.

- Substantially similar underground pulse radar systems have been developed by a number of prior researchers and can be produced by several firms and research organizations.

- Most of the prior work has been aimed at detecting cavities, buried utilities, land mines, and geological strata. Little has been aimed at geological obstacles such as large rocks. There is a paucity of examples in the data accumulated by these researchers to illustrate the capability or resolution of the method for this purpose.
- While penetration to depths of 5 feet is clearly feasible in many soils, the proportion of the earth's surface where sufficient resolution will be attainable at this depth has not been established.
- It is known that this will be difficult in moist clays or salty soils with even trace amounts of water. The best areas appear to be glacial till, high woodlands, or areas where so much groundwater flow has occurred that all salts have been leached out of the soil.
- The facsimile displays which are used by most investigators to study the reflected signals can clearly show obstacles and underground cavities. However, it is not possible to distinguish between "hard" and "soft" materials. Thus, clay lenses appear similar to rock layers or cavity boundaries.
- The converse can also occur. If the electromagnetic properties of a rock and its surrounding soil are similar, no reflection will result and the rock will be invisible.
- Thus, even in a location where ideal radar signal propagation is possible, the identification of targets is a problem. Substantial development will be required to attain a level of signal processing which is capable of producing a "Go-no go" display or an easily read image without a high false signal ratio.

3.1.2 Seismic Methods.

- Perhaps the single most significant relative advantage to seismic methods is their capability of propagating signals in saturated soils. However, they are poor in dry or uncompacted soils. Thus, they are to a degree complementary to radar.
- A major problem is the relative difficulty of coupling the seismic transducers to the ground. This is now only feasible by actually emplacing the transducers in holes at specific stations, a methodology which is not conducive to a portable, moving survey requirement.
- A relative advantage is the large difference in wave propagation speed between consolidated rocks and soil. Thus, seismic methods should be able to distinguish the type of obstacles of interest.
- Seismic methods are reported to suffer from a large amount of background and clutter, leading to false signal problems. However, this may simply be due to the lack of a similar degree of development of signal discrimination processes as that which has been accomplished for radar.
- In any event, there is every indication that the development of a field acceptable signal processing and display method will be at least as difficult as that for the radar method.
- Transducer hardware for the seismic methods is more complex and potentially heavier and more bulky than that for the radar.

3.2 Benefits.

Analysis of the E-FOSS war games reported in Ref. (1) showed that, during the preparation period (Period 2), the total excavated soil for

protected fighting positions was 875,644 BCY. With 40 available M9 tractors, this would require 3,783 on-site hours. With one improved excavator embodiment, this might be reduced to 1,360 on-site hours, thus allowing a reduction in the elapsed time for Period 2 from 15 1/2 days to 5 1/2 days with the same number of excavators.

All of these estimates were made assuming that excavation can be accomplished at the rates normal for the respective machines in normal earth materials. If an area were encountered which contained a large number of buried rocks too large for the excavator or contained ledge, false starts or excess time to remove the obstacles could decrease the excavation rate significantly. This would require either additional machines or a larger elapsed time for the preparation period.

For example, if the probability of encountering an unexcavatable obstacle is P and it can be assumed that this occurs, on the average, halfway through the excavation, then the volume V_w excavated unnecessarily as a result of the obstacle encounter is,

$$V_w = 0.5 PV \quad (3-1)$$

where V is the total volume to be excavated.

If the tactical situation dictates a given total on-site time, then the number of machines must be increased to supply this wasted excavation time. For example, if the total number of machines is expressed by,

$$N = \frac{V}{rT} \quad (3-2)$$

where V is the total excavated volume, BCY

r is the excavation rate, BCY/hr, of one machine

T is the total on-site time, hrs.

and the number of machines required to excavate false starts is similarly given by,

$$N_w = \frac{V_w}{rT} \quad (3-3)$$

then, combining equations 3-1, 3-2, and 3-3 gives,

$$N_w = 0.5 PN \quad (3-4)$$

The incremental cost increase, ΔC , for the extra machinery is simply,

$$\Delta C = \frac{N_w}{N} C = 0.5 PC \quad (3-5)$$

where C is the total cost for N excavators.

If this incremental cost, ΔC , increase is considered to be the breakeven cost for a detector system capable of serving N excavating machines, then the total detector system cost, C_d , must be less than this breakeven cost or,

$$C_d \leq \Delta C = 0.5 PC \quad (3-6)$$

If the detector system is fast enough to serve N excavators, then equation (3-6) can be considered to express the breakeven cost of a detection system for N excavators. The total detector system cost, C_d , becomes,

$$C_d = n C_e \quad (3-7)$$

where C_e = cost of a single detector embodiment and n is the number of detector embodiments for the total detector system. Combining equations (3-6) and (3-7) gives

$$C_e = \frac{C_d}{n} = \frac{0.5 PC}{n} \quad (3-8)$$

If C is the total cost of N excavators and C_x is the cost of each excavator

$$C = N C_x \quad (3-9)$$

$$C_e = \frac{0.5 PN C_x}{n} \quad (3-10)$$

An example of this relationship for an assumed excavator cost of \$200,000 is given in Figure 3-1. It can be seen that with a 10% probability ($p=0.1$) of encounter and a detector embodiment that is slow enough so that it can serve only one excavating machine ($N/n=1$), the justifiable detector cost is only about \$10,000. The survey showed that the simplest radar system

will cost more than \$10,000 and it is unlikely that a seismic system will be less costly. Thus, this combination of assumed conditions cannot justify a detection system embodiment.

However, if the detector can be made fast enough to survey excavation sites ahead of several excavators or if the probability of obstacle encounter increases, the justifiable cost quickly rises into the likely cost range for a detector system. If $P = 10\%$, $N/n = 5$, $C_x = \$200,000$ then $C_e = \$50,000$.

It should be noted that, as the probability of encounter increases, a point will be reached where detection time will be slowed down due to the necessity to survey additional sites. This non-linearity is not included in this simple analysis.

The speed of traverse of a radar system is consistent with survey at several times excavation speed. Thus, if requested excavation sites were close enough one detector might serve several excavators. The probability of encounter, however, cannot be assessed without a survey of the actual geographical areas of interest. Thus, a final estimate of the cost benefits of a detector system would require such a study.

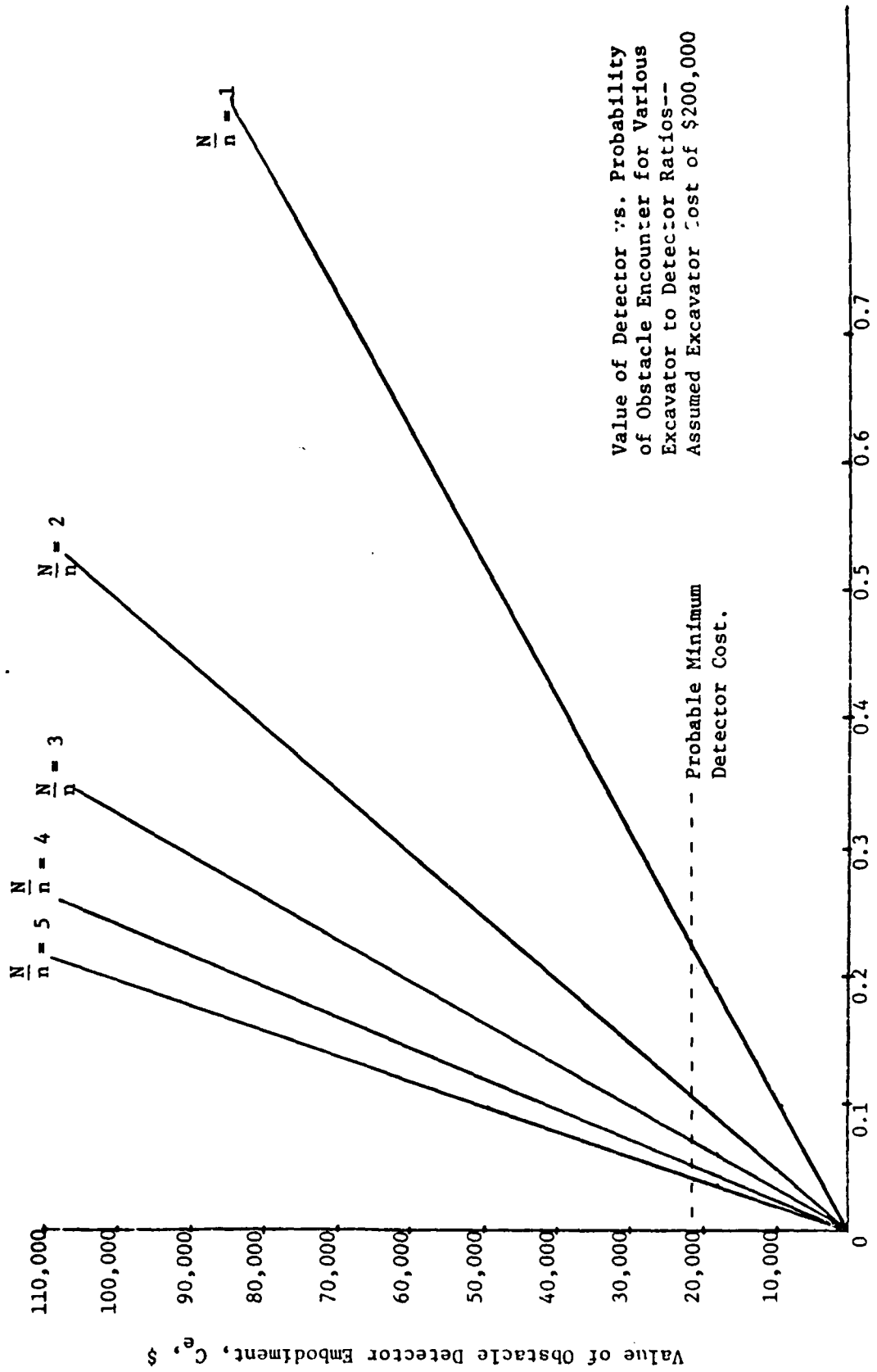

Figure 3-1 Probability of Encountering an Unexcavatable Obstacle

BIBLIOGRAPHY

BIBLIOGRAPHY

1. Formulation of a Research and Development Program for Passive Protection Achieved by Rapid Excavation in a Military Environment, Arthur D. Little, Inc., Cambridge, MA, Report to USAMERADCOM under Contract DAAK70-77-D-0024, June 1979.
2. Gates, D. C. and Armistead, R. A., The Use of Advanced Technologies for Locating Underground Obstacles, Stanford Research Institute, Report prepared for EPRI, June 1974, PB 237690.
3. Fountain, L. S., Evaluation of the U.S. Army AN/PSS-11 Mine Detector for Shallow Underground Ordnance Detection, Southwest Res. Inst., Report prepared for Ralph M. Parsons Co., June 1978.
4. Lytle, R. J., et al., Finding a Tunnel Using a Cross-Borehole Electromagnetic Probing, Lawrence Livermore Lab., ARPA Tunnel Detection Meeting, published by Stanford Res. Inst., Nov. 1976.
5. Cook, J. C., Seeing Through Rock with Radar, Proc. North American Rapid Excavation and Tunnelling Conference, Chicago, June 5-7, 1972.
6. Duff, B. M. and Johnson, E. P., Investigation of Ground Penetrating Radar for Deep Ordnance Search and Detection, Southwest Res. Inst., Report prepared for Ralph M. Parsons Co., April 1978.
7. Moffatt, D. L. et al., An Electromagnetic Pulse Hazard Detection System, Proc. North American Rapid Excavation and Tunnelling Conference, Chicago, June 5-7, 1972.
8. Moffatt, D. L., Subsurface Video Pulse Radars, Proceedings of Conference on Subsurface Exploration for Underground Excavation and Heavy Construction, American Society of Civil Engineers, August 1974.
9. Morey, R. M., Continuous Subsurface Profiling by Impulse Radar, Proceedings of Conference on Subsurface Exploration for Underground Excavation and Heavy Construction, American Society of Civil Engineers, August 1974.
10. Peters, L. and Burrell, G., Design Concepts for Video Pulse Radars for Detection of Tunnels, Ohio State University, ARPA Tunnel Meeting, published by Stanford Res. Inst., November 1976.
11. Ohio State University, Electrosience Laboratory, Electromagnetic Pulse Sounding for Geological Surveying with Application in Rock Mechanics and Rapid Excavation Program, Semiannual Technical Report prepared for ARPA, Oct. 1971, AD 734231.

12. Peters, L. and Moffatt, D. L., Electromagnetic Pulse Sounding for Geological Surveying with Application in Rock Mechanics and Rapid Excavation Program, Ohio State University, Electroscience Laboratory, Final Report prepared for ARPA, Sept. 1972, AD 754847.
13. Moffatt, D. L., et al., Electromagnetic Pulse Sounding for Geological Surveying with Application in Rock Mechanics and Rapid Excavation Program, Ohio State University, Report prepared for ARPA, April 1973, AD 763758.
14. Moffatt, D. L., et al., Electromagnetic Pulse Sounding for Geological Surveying with Application in Rock Mechanics and Rapid Excavation Program, Ohio State University, Report prepared for ARPA, Sept. 1973, AD 772065.
15. Chan, L. C., et al., A Characterization of Subsurface Radar Targets, Proc. IEEE, Vol. 67, No. 7, July 1979.
16. Rubin, L. A., et al., Subsurface Site Investigation by Electromagnetic Radar, ENSCO Inc., Report prepared for NSF (RANN), March 1976.
17. Rubin, L. A., et al., Research in Subsurface Site Investigation by Ground-Probing Sensors, Phase II, ENSCO Inc., Report prepared for NSF (RANN), Interim Reports, Nov. 1976, Dec. 1976, and March 1978.
18. Carr, K. L., Field Evaluation of a New Microwave Underground Utility Locator, paper distributed by Microwave Associates, Inc., Burlington, MA.
19. Vickers, R., et al., Archaeological Investigations at Chaco Canyon Using a Subsurface Radar, SRI International Report, undated.
20. Dolphin, L. and Barokut, N., et al., Electromagnetic Sounder Experiments at the Pyramids of Giza, prepared for the National Science Foundation, May 1975.
21. Dolphin, L. T., et al., Radar Probing of Victorio Peak, New Mexico, Geophysics, Vol. 43, No. 7, Dec. 1978.
22. Vickers, R. S., An Evaluation of High-Frequency Electromagnetic Sounding for Uranium Exploration and Mining, Stanford Research Institute report to U.S. ERDA, Oct. 1976.
23. Vickers, R. S. and Bollen, R., An Experiment in the Radio Echo Sounding of Temperate Glaciers, Stanford Research Institute report to U.S. Geological Survey, Oct. 1974.
24. Vickers, R. S. and Bollen, R., Results of a Radar Survey for the Oswego West Side Sewer Project, SRI International report to Pratt & Pratt Archaeological Consultants, Oct. 1978.

25. Fowler, J. C., Subsurface Reflection Profiling Using Ground-Probing Radar, Society of Mining Engineers of AIME Preprint 79-341, Oct. 1979.
26. Coons, J. B., et. al., Experimental Uses of Short Pulse Radar in Coal Seams, preprint of paper presented at the Annual International Meeting and Exposition of Exploration Geophysicists, Nov. 1979.
27. Fountain, L. S., Investigation of Magnetometer Methods for Deep Ordnance Search and Detection, Southwest Res. Inst., Report prepared for Ralph M. Parsons Co., May 1978.
28. Stimpson, W. E., et al., Determining Bedrock Elevation by Acoustic Sounding Technique, Proceedings of Conference on Rock Engineering, University of Colorado, Aug. 15-18, 1976, published by ASCE.
29. Soland, D. E., et al., Excavation Seismology, Honeywell, Inc., Report for ARPA, March 1972, AD 742146.
30. Soland, D. E., et al., Excavation Seismology, Honeywell, Inc. Report for ARPA, Dec. 1972, AD 755211.
31. Soland, D. E., et al., Excavation Seismology, Honeywell, Inc. Report for ARPA, May 1974, AD 782264.
32. Gupta, R. R., Seismic Determination of Geological Discontinuities Ahead of Rapid Excavation, Bendix Research Laboratories, Report prepared for ARPA, Nov. 1971, AD 736692.
33. Gupta, R. R., Seismic Determination of Geological Discontinuities Ahead of Rapid Excavation, Bendix Research Laboratories, Report prepared for ARPA, Sept. 1972, AD 749977.
34. Gupta, R. R., et al., Seismic Determination of Geological Discontinuities of Rapid Excavation, Proc. North American Rapid Excavation and Tunnelling Conference, Chicago, June 5-7, 1972.
35. Fitzpatrick, G. L., Seismic Imaging by Holography, Proc. IEEE, Vol. 67, No. 4, April 1979.
36. Price, T. O., Demonstration of Acoustical Underground Survey System in the Washington Metropolitan Area, Holosonics, Inc., Federal Highway Administration Report No. FHNA-RD-75-82, June 1975.
37. Price, T. O., et al., Scanned Acoustic Holography for Geological Prediction in Advance of Rapid Underground Excavation, Phase I Interim Report, Holosonics, Inc., Report for NSF (RANN), Feb. 1975, PB 263-242.

38. Price, T. O., et al., Scanned Acoustic Holography for Geological Prediction in Advance of Rapid Underground Excavation, Phase I Interim Report, Holosonics, Inc., Report for NSF (RANN), May 1975, PB 245-147.
39. Price, T. O., et al., Scanned Acoustic Holography for Geological Prediction in Advance of Rapid Underground Excavation, Phase II, Progress Report, Holosonics, Inc., Report for NSF (RANN), May 1976, PB 260-278.
40. Mossman, R. W. and Heim, G. E., Seismic Exploration Applied to Underground Excavation Problems, Proc. North American Rapid Excavation and Tunnelling Conference, Chicago, June 5-7, 1972.
41. Murphy, V. J., Seismic Velocity Measurements for Moduli Detection in Tunnels, Proc. North American Rapid Excavation and Tunnelling Conference, Chicago, June 5-7, 1972.
42. Unterberger, R. R., Sonar Probing as a Mining and Tunnelling Tool, Texas A&M University, Progress Reports prepared for NSF, June 1978, and December 1978, PB 289-810, PB 292-243.
43. Scott, J. H., Prediction of Geologic and Hydrologic Conditions Ahead of a Rapid Excavation Operation, Bureau of Mines, Denver Research Center, March 1972, AD 748637.
44. Scott, J. H. and Sena, J., Prediction of Geologic and Hydrologic Conditions Ahead of Rapid Excavation Operations by Inhole Geophysical Techniques, Bureau of Mines, Denver Research Center, November 1973, AD 771689.
45. Suhler, S. A., et. al., Development of a Deep-Penetrating Borehole Geophysical Technique for Predicting Hazards Ahead of Coal Mining, Southwest Res. Inst., Report prepared for U.S. Bureau of Mines, Sept. 1975.
46. Yardley, D. H., ed., Proceedings of Tunnel and Shaft Conference, Minneapolis, MN, May 15-17, 1968.
47. Robbins, R. J. and Conlon, R. J., ed., Proceedings of 1976 Rapid Excavation and Tunnelling Conference, Las Vegas, June 14-17, 1976.
48. Proceedings of Symposium on Research and Development in Rapid Excavation, Sacramento State College, Oct. 28-29, 1968.
49. Proceedings of 2nd. Symposium on Rapid Excavation, Sacramento State College, Oct. 16-17, 1969.
50. Goldstein, S. R., An Analytical and Experimental Study to Develop a Nonmechanical System to Induce Resonance in a Rod Drill for Frozen Soil, Final Report for Contract DAAG17-68-C-0028, Foster-Miller Associates, Inc., Waltham, MA, June 1968.

51. Arthur D. Little, Inc., Ground Anchor Emplacing Mechanism, Progress Report for U.S. Army Natick Laboratories, 1963.
52. Dobin, M. B., Introduction to Geophysical Prospecting, McGraw-Hill, 1960.
53. Anthony, D., Gradiometer Applications and Status of Sensor Development, Report No. AFCRL-71-0314, Air Force Cambridge Research Laboratories, Bedford, MA, 1971.
54. Stone, R. S. and Simon, I., Laboratory Evaluation of a Null-Balance Gravity Gradiometer, Arthur D. Little, Inc., Final Report to the U.S. Geological Survey, Dec. 1975, Contract No. 1408-001-14898.
55. Simon, I., Sensitive Tiltmeter Utilizing a Diamagnetic Suspension, RSI, Vol. 39, Pl666, 1968.
56. Young, J., et al., Underground Radar Research at Ohio State University, IEEE Antennas and Propagation Society Newsletter, Vol. 21, n.4, Aug. 1979.
57. Eberle, A. C. and Young, J., Development and Field Testing of a New Locator for Buried Plastic and Metal Utility Lines, Transportation Research Record 631, National Academy of Sciences.
58. Mooney, H. B., Handbook of Engineering Geophysics, Bison Instruments, Inc., Minneapolis, MN.
59. Farnett, E. C., et al., Pulse Compression Radar, Ch. 20 of Radar Handbook, Skolnik, McGraw-Hill, 1970.
60. Caterpillar Tractor Co., Handbook of Ripping, publication AEDQ7903.
61. Lagace, R. L., Survey of Electromagnetic and Seismic Noise Related to Mine Rescue Communications, Vol. II Seismic Detection and Location of Isolated Miners, Arthur D. Little, Inc., Final Report to U.S. Bureau of Mines, Contract No. HO 122-026.
62. Murphy, V. J., Seismic Velocity Measurements for Offshore Dredging, etc., paper presented at Offshore Technology Conference, Dallas 1974.
63. White, J. E., Seismic Waves: Radiation, Transmission, and Attenuation, McGraw-Hill, 1965.

64. Brenden, B. B., Acoustic Holography, Optical Engineering Vol. 14, P.495-498, 1975.
65. Fitzpatrick, G. L., Seismic Imaging by Holography, Proc. IEEE, Vol. 67, P.536-553, 1979.
66. TRW, proposal 26103.000 to USAMERDC, Systems Group, Redondo Beach, CA, Jan. 1974.

Appendix A

Ground-Penetrating Radar Equipment and Survey Services

ENSCO, Inc.
Springfield, VA 22151

INTRODUCING ENSCO GUIDE SYSTEMS

FOR AUGER, DRILL,
AND MINE MACHINE GUIDANCE

ENSCO GUIDE DATA

ENSCO GUIDE is ENSCO's service mark for its proprietary line of customized sensing systems for auger, drill, and mine machine guidance. The building blocks that are put together to meet special needs include:

- **CABLELESS DRILL STRING TELEMETRY**
This feature permits real-time two-way data transmission between the drill bit and the operator without wires or cables.
- **DRILL SURVEY PACKAGE**
This system is now available in packages to fit 3" horizontal holes. It provides survey data equivalent to real-time multishot when used with our cableless telemetry.
- **RADAR INTERFACE DETECTOR**
This sensor provides a means of uniquely locking on coal, shale, coal clay, coal sand, and other interfaces and tracking them along a traverse. ENSCO's interface detector has been tested in measuring head coal, rib thickness, seam thickness, and in seam centering.

OVERVIEW

Recent developments at ENSCO in drilling telemetry and borehole radar interface detectors make guided systems for augering and drilling economically feasible.

- ENSCO's sensor guidance systems have been used to drill 1,000-foot methane-drainage holes in coal.
- They demonstrated the capability to guide coal augers over 500 feet.
- They are used as coal interface detectors.
- They demonstrated the capability to keep horizontal drills seam-centered and to measure seam thickness in coal and other strata.

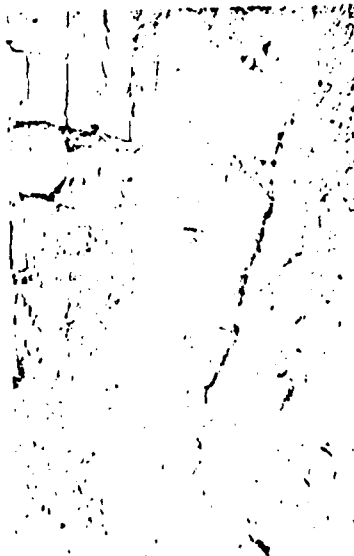

Please contact us to discuss your requirements.

Call or write: Mr. Hal P. Demuth
ENSCO, Inc.
Earth Sciences & Systems
Division
5400A Fort Royal Road
Springfield, VA 22151
(703) 327-6000

LET US SHOW YOU HOW ENSCO GUIDE SYSTEMS CAN
HELP YOU ACHIEVE GREATER PRODUCTIVITY.

TELESCOPE SYSTEMS CONTAIN GUIDED AUGERING, EXCILING, AND MINING A REALITY

ENSCO's Guide Systems can enable you to guide your drill, auger or mining machine along pre-determined paths, along seam centers, and at constant rib thicknesses through a combination of:

- Coal's existing telemetry
- New small borehole radar sensors
- Advanced real-time drill survey systems
- Unique radar interface detectors

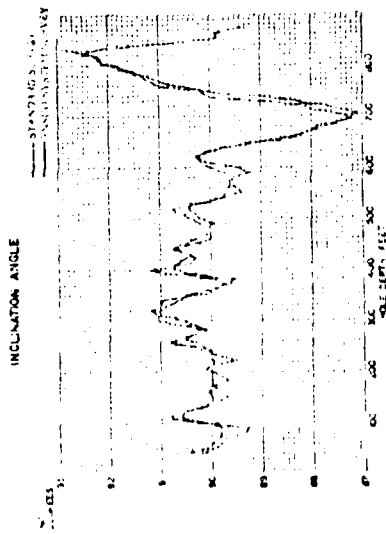

Comparison of results of ENSCO's real-time borehole survey system with a conventional survey tool in a horizontal bore. Our real-time borehole survey system was developed under contract to the U.S. Bureau of Mines.

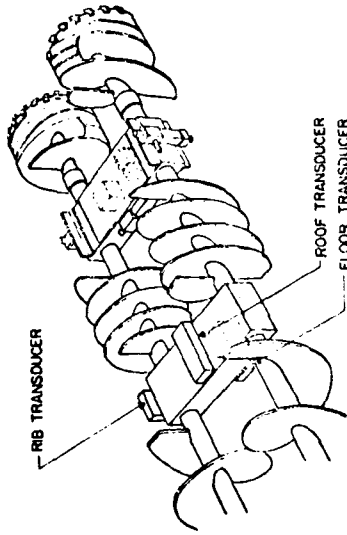

This is a proposed application of radar guidance for extended depth augering.

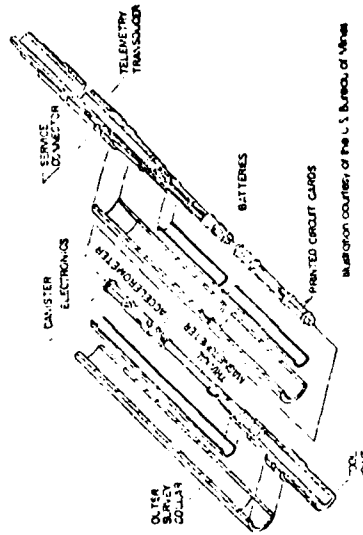

This real-time borehole survey tool is under development. It will be used to guide a horizontal drill in a coal seam.

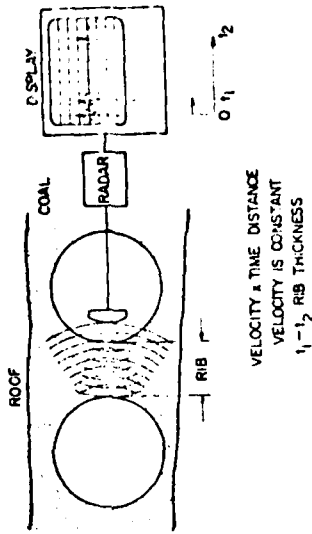

Radar measures rib thickness between adjacent ribs.

TYPICAL APPLICATIONS

COAL MINING

- Drilling
 - Methane drainage holes
 - Inspection holes
 - Seam thickness mapping
- Augering
 - Long (500-plus feet) holes
 - Seam centering sensing
 - Rib thickness sensing
- Mining
 - Coal thickness sensing on continuous miners
 - Coal interface detectors on longwall shears

OTHERS

- Seam horizontal drilling from trees, use of ground rods
- Seam roughness sensing
- Rib thickness sensing for under-aver and under-aver augering
- Pipe bursts

OVERVIEW

A combination of advanced data acquisition equipment and improved field techniques have put ENSCO at the forefront of radar technology.

ENSCO's radar-based systems have:

- located targets in coal seams
- penetrated over 100 feet of coal
- detected abandoned wells from both the surface and within the mine
- mapped geological features in trap rock
- mapped the stratigraphy of a 30-foot coal roof
- mapped geological features in base metal mines
- detected near-surface cavities under pavement

Our equipment includes:

- Microprocessor-based control units
 - Analog/digital recording capabilities
 - Hard copy displays
 - Surface antennas
 - Borehole antennas NX (3-inch)
 - Portable computer for in-field data analysis
- ENSCO provides electromagnetic profiling and conventional ground-probing radars two ways:
- We will conduct a survey of your property and provide a report with a map delineating subsurface features and analysis.
 - We will also design and build a custom radar profiling system to meet your specific requirements.

INTRODUCING THE ELECTROMAGNETIC ELECTRON PROFILING SYSTEM

USING MICROPROCESSOR-CONTROLLED,
GROUND-PROBING RADAR FOR ENHANCED
DETECTION, LOCATION, AND DELINEATION
OF GEOLOGICAL FEATURES IN COAL

FOR FURTHER INFORMATION

Call: Mr. Hal P. Demuth
ENSCO, INC.
Earth Sciences & Systems
Division
5475A Fort Royal Road
Charlottesville, VA 22901
(703) 321-4100

ENSCO SHOWS YOU HOW ENSCO'S
ELECTROMAGNETIC PROFILING SYSTEMS CAN HELP
ACHIEVE GREATER PRODUCTIVITY

LOAD DATA CONSOLE SYSTEM MAPPING OF GEOLOGICAL FEATURES IN MINE IS POSSIBLE

The new Geophysical Profiling System, designed by Arthur D. Little, Inc., is built in association with the CONSOL Company (CONSOL), features a user controller with a self-contained microprocessor and a self-contained microprocessor unit for analog and digital data processing to enhance weak signals. The system, in association with the portable facility of the CONSOL Company, is a useful data acquisition system for coal mine and other applications. The system is designed to be permissible for operation in all areas of the mine.

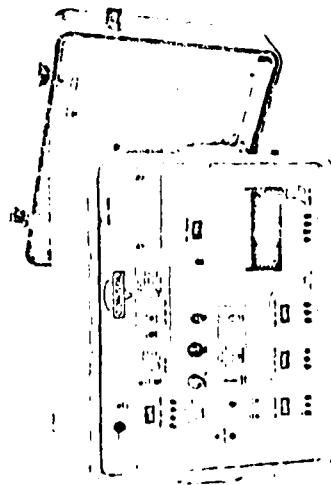

Control unit designed for CONSOL to be permissible for coal mining applications.

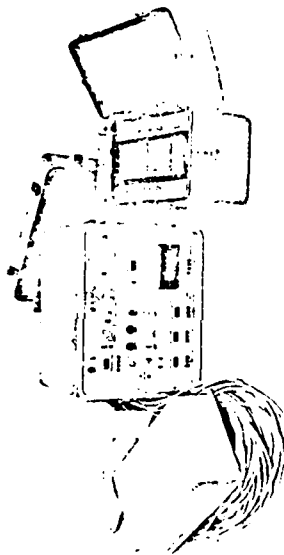

Complete field system for geophysical measurements.

TYPICAL APPLICATIONS IN DETECTION, LOCATION, AND DELINEATION OF GEOLOGICAL ANOMALIES

COAL MINING

- Abandoned wells
- Old mine workings
- Clay veins
- Pyrite and carbonate balls
- Roof stratigraphy
- Seam pinch-outs
- Channel sands
- Roof profiling
- Pillar examination
- Fault detection

GEO TECHNICAL

- Site Investigation
 - Mapping of man-made utilities
 - Mapping of geologic joints and voids
 - Finding faults and shear zones
- Maintenance Aids
 - Locating voids in pavement
 - Mapping cavities in limestone
 - Locating leaks in culverts
 - Evaluating tunnel linings
- Miscellaneous
 - Locating buried ordnance
 - Finding archeological artifacts
 - Evaluating soil grout placements

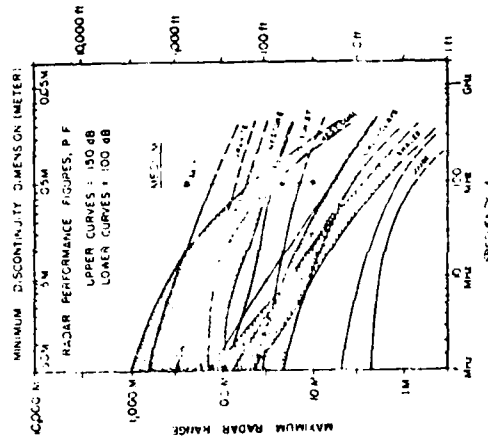

Radar probing distances through typical rocks.

Geophysical Survey Systems, Inc.

Hudson, NH 03051

SIR SYSTEMS

SUBSURFACE INTERACT RADAR

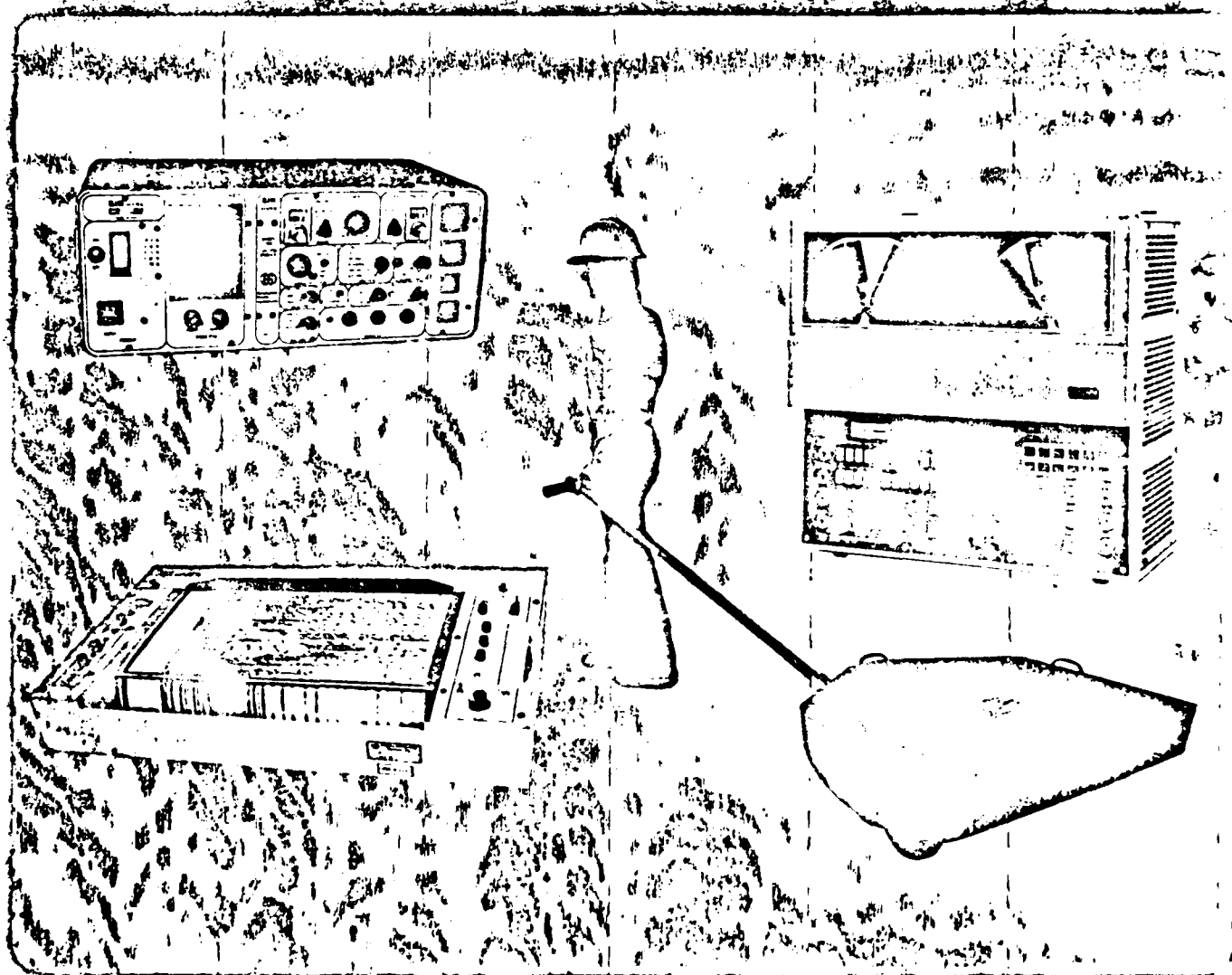

Geophysical Survey Systems, Inc.

Electromagnetic Subsurface Profiling

Electromagnetic Subsurface Profiling (ESP) is an advanced impulse radar procedure that is performed with a SIR SYSTEM. The System transducer is moved along a line while the System Recorder produces a continuous high-resolution profile of the subsurface. The unique feature of the ESP procedure is its ability to automatically generate a continuous map of subsurface features — not a point-by-point sample from which extrapolations are made, but a complete high resolution profile.

An electromagnetic impulse is propagated into the media from a Transducer unit on its surface. When the impulse strikes an interface between two materials of differing electrical properties — a soil-bedrock interface, a soil-water interface, a pipe buried in soil — some of the impulse energy is reflected and the rest continues on through the material to other interfaces. The reflected signals are received by the Transducer where replica waveforms of the transmitted pulse followed by the reflected signals are generated and sent back to system Control Unit to be monitored on its oscillograph, printed on a graphic recorder, and recorded on magnetic tape. The graphic record of the signal waveforms is a close approximation of the interfaces one would see in a vertical wall of a trench dug along the path of the Transducer.

The ESP procedure has been used successfully to locate buried objects such as pipes; map the bottom topography of fresh water rivers and lakes; measure fresh water ice and sea ice thickness; locate ice wedges in permafrost; and profile bedrock interfaces beneath the soil.

In areas of low soil conductivity, the depth range of the electromagnetic impulse can be as much as 30 meters. High conductivity soil inhibits transmission of the impulse energy, causing the depth of penetration to be limited in some areas. The radar impulses are also blocked by networks of iron or steel, such as those used as reinforcements in concrete highways. However, the higher frequency transducers can penetrate around some reinforcing.

The uses of ESP are many and varied. For anyone who has ever wished he could see through the surface beneath his feet, ESP is the answer.

- For a utilities engineer who must plan new lines or locate existing ones to make repairs or add lines, ESP is a time and money saver. Test pits aren't needed, traffic is only momentarily interrupted for each scan, and interpretation of the ESP printout will give accurate information on both the location and depth of underground systems. Boulders and bedrock interfaces may also be located. Plans can then be made to avoid obstacles and make the most efficient use of time.
- For a contractor planning a major construction project, ESP provides the lay of bedrock, the location of soil interfaces, the size and location of boulders, and possible areas of subsidence. Knowing in advance what is underneath will help prevent costly delays and changes in mid-project.
- For an oil driller, a pipeline engineer, or a research scientist working in the Arctic or Antarctic, ESP is a vital aid. On sea ice, ESP is used to assure the safety of camps, landing strips, and vehicles by measuring ice thickness and detecting hidden cracks and crevasses. Along pipeline routes on permafrost, ESP detects the presence and size of ice wedges beneath the surface so they can be avoided. Glacial ice depth and structure can also be detected, recorded, and studied.
- For an engineer interested in going through or under fresh water lakes and rivers, ESP records the bottom contours. ESP has also been used to look through to the sub-bottom to detect interfaces and pipe crossings.

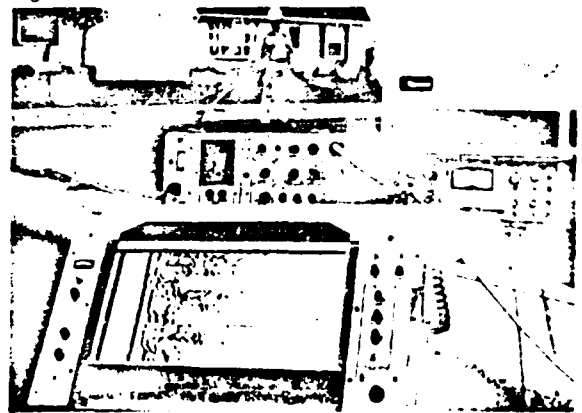

New uses for ESP are constantly being discovered. Surveys using ESP to locate areas of interest at archaeological sites have had successful results. ESP has also been used as a coal seam thickness sensor to facilitate highwall coal mining. In addition, surveys along highwalls have been performed to gain information about the structure of the surrounding rock to detect potential mining hazards. Borehole transducers are available to lower into boreholes, profiling laterally and extending borehole data.

Computer processing is now being used to remove background noise and thus enhance ESP data. Further computer analysis techniques are being developed to add to the information gained from the data by studying the shape of the reflected waveforms.

Transducers

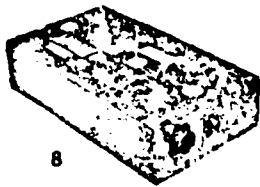
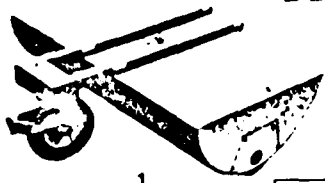

#	MODEL NO.	CENTER FREQUENCY	PULSE WIDTH	APPLICATION
1	3112	80MHZ	6ns	Deep probing - mono or bi-static
2	3110	120	5	Light weight version of 3055
3	3055	120	5	General Purpose
4	3020	120	5	Sea ice profiling
5	H6/110	120	5	Borehole T/R or cross hole
6	3105	300	3	High resolution—shielded
7	3103	400	2.5	High resolution bi-static
8	101C	900	1	Very high resolution—shielded

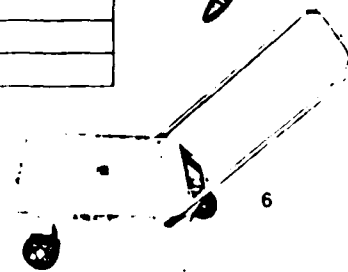
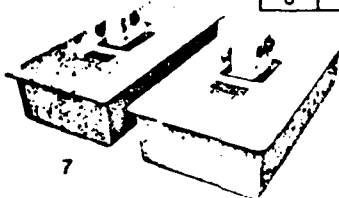
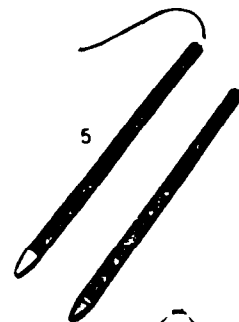

the world of GSSI

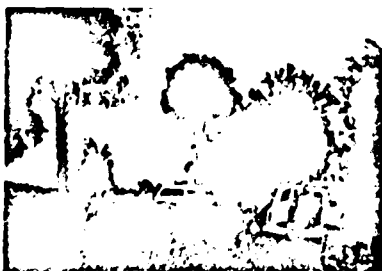

From the hot sands of Saudi Arabia to both Poles, GSSI equipment has performed with distinction under extreme environmental conditions. Whether the desired target is a cavity in Florida, a massive ice wedge in permafrost at Tuktoyuktuk, a gas pipeline crossing under the Mississippi River, a water main in downtown Tehran or a safe route across sea ice to Melville Island, GSSI Systems are ready. A SIR SYSTEM may be the answer to one of your subsurface problems.

Let Us Help

For further information, please write, call or visit us. We will be happy to assist with your project and provide a firm price and delivery quotation for a standard or custom system best suited to meet your needs.



Geophysical Survey Systems, Inc.

15 FLAGSTONE DRIVE
HUDSON, NEW HAMPSHIRE 03051 U.S.A. (603) 889-4841

Printed in U.S.A.

N7AF

ELECTROMAGNETIC SUBSURFACE PROFILING (ESP). RADAR 'EYES' FOR THE ENGINEER AND SCIENTIST.



With a small antenna unit . . .

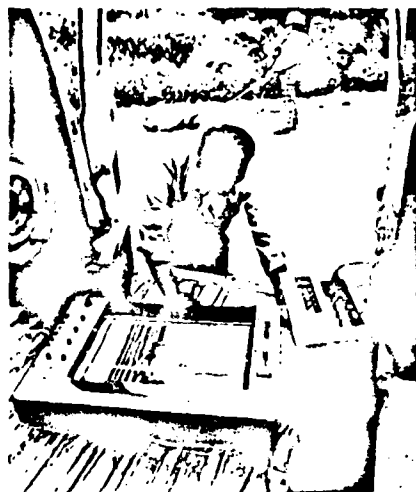

and a compact instrument package, ESP probes and records . . .



features beneath land, water, or ice.

Electromagnetic subsurface profiling (ESP), developed by Geophysical Survey Systems, Inc., is a survey method which enables engineers and scientists to actually "see" under the ground, water or ice by means of reflected radar impulses.

The ESP system utilizes a special downward-looking radar to obtain an accurate, continuous subsurface profile. It can record and report the location and depth of bedrock, interfaces, objects and voids underground; the contours of lake and river bottoms; and the depth of sea, lake and glacial ice.

ESP — the utilization of radar to send and receive meaningful signals through solid and liquid media — is a true scientific advance which solves an age-old problem. For thousands of years, ever since man first started to construct buildings and roads, the engineers of every century have been forced to grope their way along, laboriously digging simply to determine the position and depth of underlying geologic and man-made features. Even

in modern times, test-pits, core-drilling and seismic soundings have been cumbersome and, worse, have provided only single plot points, with nothing but guesswork left in between.

Now, ESP changes all that. Electromagnetic subsurface profiling is unique because it generates, for the first time, a continuous linear plot of subsurface features. Moreover, the plot normally pinpoints all objects regardless of material — both metallic and non-metallic. ESP records data many times more detailed than other methods, and generates the data more quickly and often more economically as well.

Introduced just a few years ago, ESP is now a tested, proven system. ESP surveys are easy to run. And Geophysical Survey Systems makes ESP easy for everyone to use by offering options: users can purchase the equipment for their own or joint regional operations; or they can contract for surveys with Geophysical Survey Systems.

Building the profile: surveying, interpreting, reporting.

The ESP system consists of a small, wheeled antenna unit which sends and receives the radar pulses and an instrument package which records the radar echo patterns on magnetic tape. The tape then typically feeds to an oscilloscope and to a hardcopy graphic recorder.

The instrument package can be carried in any appropriate vehicle, a light truck or all-terrain vehicle on land; a small boat on water; and a tracked vehicle on snow or ice. The antenna unit is towed behind the vehicle or pulled by hand, and, in a boat, stowed aboard along with the instruments. The survey is taken along a predetermined path at average speeds of 3 to 5 miles per hour, and the tape is keyed to benchmarks along the route. When a linear plot is all that's needed, a single pass is sufficient. When an area is to be surveyed, a grid is laid out and each path is traversed.

The antenna unit contains a transceiver which transmits radar impulses (consisting of both electrical and magnetic energy) at a rate of 50 KHZ, or 50,000 pulses per second. The impulses are partially reflected by the interfaces of materials. The degree of reflectance is governed by the differentials in the electrical characteristics of the materials — the dielectric constant and the conductivity.

Reflected radar echoes are picked up by the transceiver and transmitted by cable to the instrument package. The oscilloscope displays the wave pattern of the reflected impulse. The operator, by noting changes in the echo patterns, can often gain a considerable amount of information as the path is traversed.

The hardcopy version of the echo patterns provides the data from which a plan view is drawn, with positions and depths of features indicated. Normal accuracy in both lateral and vertical aspects is within 10% of the distance from the transceiver to the target. Profiles of any or all paths can be taken off if required. The output can be computer-

processed to sharpen and clarify the signal. Current research is exploring further use of the computer to improve analysis and reporting still further.

Radar pulses are blocked by networks of iron or steel such as those used as reinforcement in concrete highways. Similarly, the presence of salt interferes with transmittance. This can limit usage on heavily salted roads or in coastal areas with salt water intrusion. However, it is an advantage when measuring the depth of sea ice. A third and minor limitation is the inability of the pulses to clearly measure during the first few inches of travel — so the depth of most pavements is not recorded.

ESP: vital tool on land, water and ice

On land. Used for non-destructive probing underground, ESP reveals the location of bedrock, boulders, soil strata interfaces, ground water, and voids. Also recorded are installed utilities — pipes of metal, plastic and clay, and conduits and cables.

The depths at which ESP is presently effective are influenced by the conductivity of the soil. Average maximum effective depth for any region in the U.S. can be determined from the following table:

Conductivity in millimhos/meter	Range — ground surface to metal target (feet)
0.5	100
1.0	50
2.0	25
4.0	14
8.0	8
16.0	5
32.0	4

On water. On fresh water lakes, ponds and rivers, ESP can render accurate bottom profiles and also indicate the existence of any cables or underwater obstructions.

On ice. ESP has been extensively used to determine the thickness of sea ice and is effective to depths of 25 feet. Bottom contours of the ice

show clearly due to the strong reflection at the salt water interface. In the same way the thickness of glaciers and snow-fields up to 200 feet deep can be charted.

ESP: problem-solver for the civil engineer and scientist.

Utilities engineering. ESP is a time-saver and money-saver for the utilities engineer who must plan new or replacement lines or locate existing lines for repairs or tie-ins.

Using ESP, the engineer doesn't break pavement or interrupt traffic, and he can use his ESP drawings to give him a complete plan of mains and service connections. He can then plot his locations, knowing that he will encounter smooth excavation without hitches when the job gets underway. He'll know the positions of ledge and boulders so he can avoid them when possible and make accurate cost estimates for removal when needed. His job will be executed on time, and at the least possible expense to the utility, agencies or taxpayers.

Construction engineering. ESP can pay for itself many times over when used by the architect, consulting engineer, contractor or owner who is planning foundations and utilities for buildings, sewers, highways, and other construction projects. ESP can provide a continuous profile showing the exact lay of bedrock or ledge and the boundaries of such strata as glacial till, hardpan, gravel and peat. Also indicated are the size and position of boulders, such potential hazards as voids or areas of subsidence, and installed utilities or other objects.

In preparing bids for projects, the builder or contractor can use an ESP survey to cost out excavation and foundation work with a certainty that never would have been justified otherwise, increasing his chances of bringing in the lowest bid. Used in the planning stages of both public and private projects, ESP can help insure that each job stays within budget. By helping to forecast time and equipment needed for excavation, ESP les-

sens the risk of over-running costs or of incurring late-completion penalties. The engineer, by knowing what he will find before he digs, now can avoid costly delays and extensive changes in plans.

Exploration. ESP is a special aid to the crews working in the Arctic and Antarctic on exploratory oil drilling and pipeline projects, and in other research studies. Used on sea ice, ESP measures ice depth to assure the safety of camps, vehicles, and landing strips. Sea ice thickness surveys have been performed from a helicopter at altitudes of 150 feet and speeds of 40 mph. Along road and pipeline routes on permafrost, ESP detects the presence and size of ice wedges. In geological exploration, underlying structures are surveyed, faults and fissures are located, and glacial ice depth is recorded.

In the future. Other areas of use for ESP are continually being discussed and developed. In connection with transportation on sea ice, an ESP unit mounted on every vehicle would serve as a thin ice early warning system. ESP would be invaluable during location of archeological sites and for planning the excavations. It has been proposed for ground water surveys, and for location of subsidence voids and natural tunnels and caves that might affect structures or highways.

Various mining applications for ESP are being investigated. In rock tunnels, surveys along tunnel walls and faces can provide information on the structure of the surrounding rock, detecting potential mining hazards. ESP is being evaluated for use as a coal seam thickness sensor in conjunction with automatic coal mining machines.

Further adaptation of the ESP system might lead to new borehole logging tools which would be lowered into boreholes and record laterally, greatly extending borehole data. Computer-aided signature analysis of the ESP returns will eventually provide additional engineering information, for example, the density and moisture content of the soil and rock. Further development of air-borne ESP units for rapid surveys has also been suggested.

The ESP Instrument package.

The ESP system includes an antenna unit encased in durable fiberglass and the radar instrument package. The package includes the following components:

Controller unit. Interfaces all system units. Provides power and trigger signals to the transceiver. Synchronizes the tape recorder and the graphic recorder with the echo signals.

Graphic recorder. Produces a hardcopy version of the radar signals.

Tape recorder. (optional) Records radar echoes on magnetic tape. Records 16 times faster than the graphic recorder, allowing rapid traverses and subsequent input into the graphic recorder when time is available.

Pre-record playback unit. (optional) Permits proper phasing of control signals on each reel of tape.

Converters. (optional) Permits system to be operable from an automobile heavy duty alternator.



Putting ESP to work for you.

If you're in need of the data that ESP can generate for you, select the arrangement that best suits your projected volume of usage. The best plan may be to purchase a complete ESP system. With this option, we provide a free training course in survey technique, and follow-up assistance in analyzing and interpreting data.

If your own use does not justify full individual purchase, then arrange a cooperative purchase among your organization and others with similar interests in your city or region. For example, several utilities in a single city can purchase and share time on an ESP unit, developing survey information in common as local projects arise.

In another arrangement, a contractor owning an ESP unit would operate the unit as a service in his area.

If purchase does not fit your program, or if you would like to assess the effectiveness of ESP in your area prior to purchase, Geophysical Survey Systems will be glad to discuss your needs and provide firm quotes for a survey.

For further information about Electromagnetic subsurface profiling, call or write to us at the address below.

Technical specifications are subject to change without notice.



**Geophysical
Survey
Systems, Inc.**

15 FLAGSTONE DRIVE
HUDSON, NEW HAMPSHIRE 03051

TELEPHONE (603) 889-4841

OUR INTERESTS AND APPLICATIONS ARE



Geophysical
Survey
Systems, Inc.

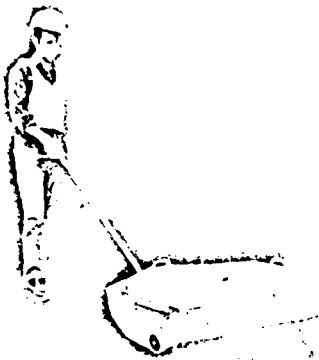

SIR SYSTEMS

SUBSURFACE INTERFERE RADAR

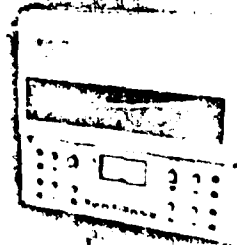
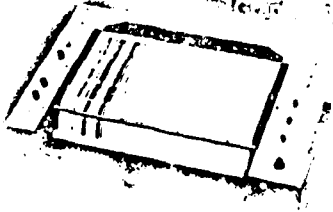
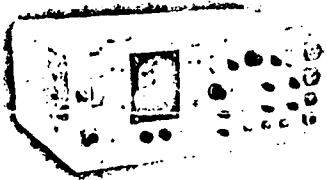

Geophysical Survey Systems, Inc.

SUBSURFACE INTERFACE RADAR

STANDARD
RESOLUTION
RANGE

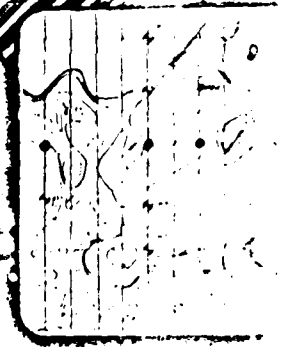
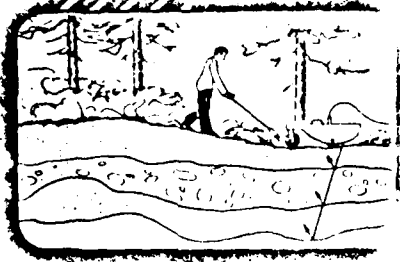

INTEGRATED
VOICE RECORD

SIR SYSTEMS

Underground Eyes

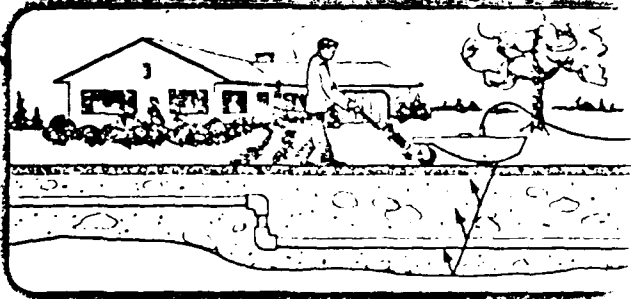

FOR THE BEST
RESULTS
SEE THE SIR SYSTEMS
ADVERTISING
CAMPAIGN
ON THE
NEXT PAGE

SEE THE SIR SYSTEMS ADVERTISING CAMPAIGN ON THE NEXT PAGE



**Geophysical
Survey
Systems, Inc.**

15 FLAGSTONE DRIVE
HUDSON, NEW HAMPSHIRE 03051 (603) 889 4841

YOUR UNDERGROUND PASSPORT

Microwave Associates

Burlington, MA



**Microwave
Associates**
A *M/A*COM COMPANY



TerrascanTM

Underground Utility Locator

FEATURES

- Portable
- Locate both metallic and non-metallic pipe to a depth of 10 feet/3.0 m
- Accuracy within 6 inches/15 cm in depth and position
- Battery operated. Can be recharged from 110 VAC or from 12 Volt ignition systems
- Digital readout of pipe depth
- High intensity display is easily readable in direct sunlight
- Waterproof antenna housing; will operate on wet ground
- Comfortable harness allows freedom of movement
- Expand Mode - any 3 foot/1 m segment of a selected range can be displayed over 32 columns of display.

Burlington, Massachusetts 01803 ■ Telephone (617) 272-3000 ■ TWX. 710-332-6789 ■ Telex 94 9864
Bulletin No. 8002D

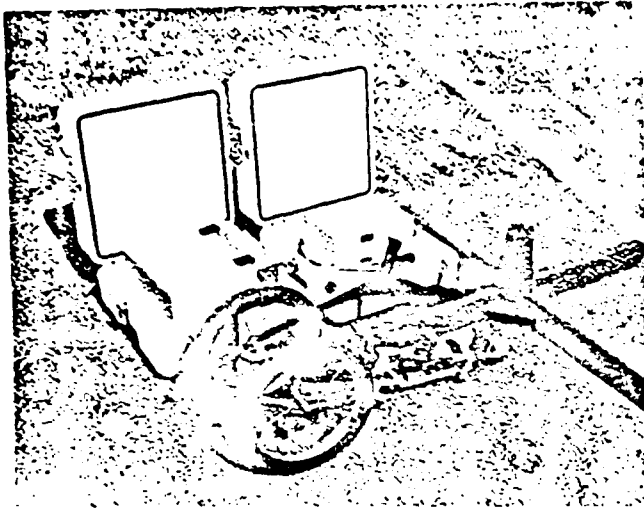

COMPLETE SYSTEM WITH TRANSIT CASES



FIELD REPLACEABLE BATTERY PACK

DESCRIPTION

A technique termed "downward-looking radar" is employed. A "downward-looking radar" is similar to a conventional radar in that they both use a pulse echo technique, where an electro-magnetic pulse is transmitted and any object in its path reflects a portion of the pulse. The important difference between the radars is that conventional radar looks into the atmosphere, while the "downward-looking radar" looks into the earth.

TERRASCANTM employs a time-domain technique. In operation, the antenna is set upon the ground and the pulse is transmitted into the earth. Any changes in the electrical properties of the soil causes part of the pulse to be reflected back to the surface and, in turn, to the receiver. A buried pipeline is quite different electrically from the surrounding soil.

Plastic pipe represents a change in the dielectric constant when compared with the surrounding soil; a metal pipe represents a better conductor. The particular antenna configuration developed distinguishes cylindrical objects, such as pipe, from all other echoes. It also efficiently couples the transmitted energy into the ground and not into the surrounding atmosphere.

APPLICATIONS

The TERRASCANTM underground utility locator will detect both metallic and non-metallic pipe.

Non-metallic pipe, especially poly-vinyl chloride (PVC), has become increasingly widespread in use mainly due to its lower cost and non-corrosive properties. Metal wire or foil tracers are buried with the plastic pipe so that the metal detectors could locate the pipe at some future time. However, there are a number of disadvantages experienced with a metal pipe detector when searching for a plastic pipe.

- a) The metal tracers are often not connected or have corroded.
- b) Precise location of utility is inaccurate.
- c) Affected by surrounding metal objects (i.e., metal fences, overhead power lines, parked cars, etc.).
- d) Difficult to determine depth or detail (i.e., branching or parallel lines).

TERRASCANTM can determine whether the utility is metallic or non-metallic. It will operate efficiently in parking lots, alongside chain link fences and railroad tracks, is accurate in locating utilities to a depth of 10 feet (3.0 meters) and is unaffected by inclement weather conditions.

AD-A101 547

LITTLE (ARTHUR D) INC CAMBRIDGE MA
IDENTIFICATION AND EVALUATION OF UNDERGROUND OBSTACLE SENSOR EM--ETC(U)
JAN 80 J S HOWLAND, R H BODE

F/G 14/2

DAAK70-79-D-0036

NL

UNCLASSIFIED

2 OF 2

AD A
1101047



END
DATE
FILMED
8-81
DTIC

SPECIFICATIONS

Electrical Characteristics

The instrument is battery-operated and can be recharged from 110 VAC or source a vehicle having a 12 Volt ignition system. The gas discharge display panel is a matrix of small lamps 11 rows high x 32 rows long, approximately 4 inches/10 cm wide x 2 inches/5 cm high. The signature or signal return is traced out by lighted lamps similar to an oscilloscope waveform display. The display employs a non-reflective filter to reduce glare; yet remains bright enough to be seen in direct sunlight.

A unique feature of the unit is a digital readout of pipe depth. The operator can move a cursor to the target and press switch to read the pipe depth on the display directly.

MECHANICAL CHARACTERISTICS

The instrument has 3 parts - The Antenna, The Display Package and The Power Supply. The Display package and Power Supply are either mounted on the furnished cart or are worn by the operator on an optional harness. The antenna weighs approximately 11 pounds/5 kg and can easily be moved with one hand. The approximate combined weight of the Display Package and Power Supply is 37 pounds/16,8 kg.

TYPICAL DISPLAYS

No target display, or null. Row of dots at top is the "cursor" associated with the digital readout.

Target.

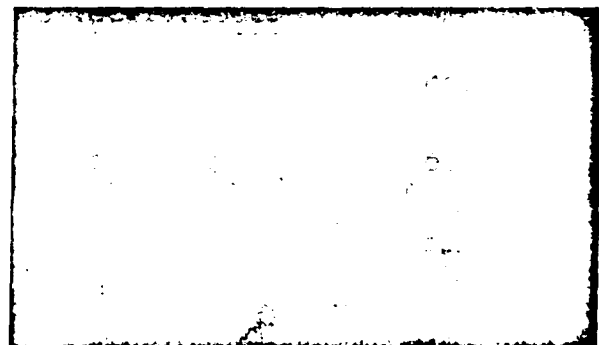

Target inverted. Inversion is obtained through 90° rotation of antenna. A useful technique to discriminate infinitely long targets from stones, etc.

Digital readout.

OPTIONAL MANPACK HARNESS CONFIGURATION

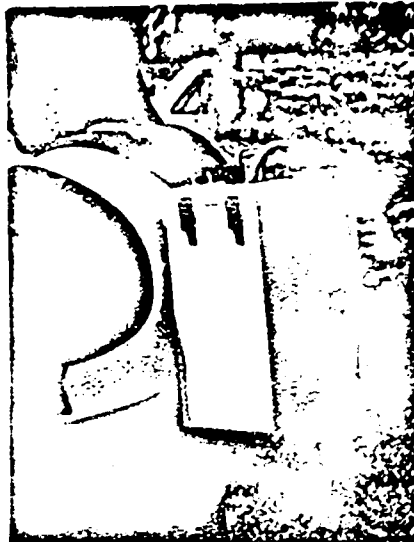

DISPLAY UNIT

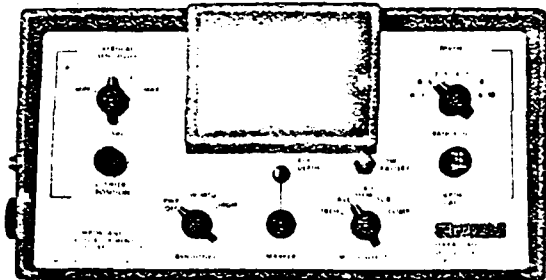

ANTENNA DISPLAY UNIT AND POWER SUPPLY



ENTIRE SYSTEM CAN BE CARRIED IN TRUNK OF CAR WITH TRANSIT CASE OR ASSEMBLED AND READY TO USE.

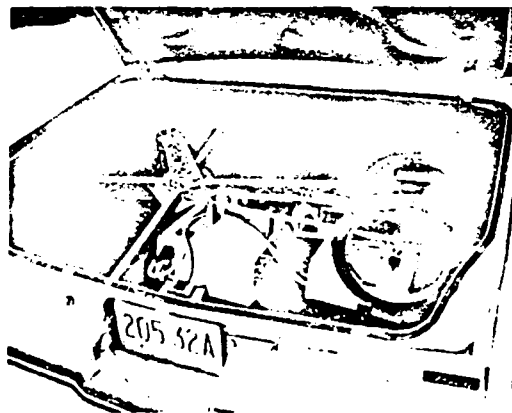
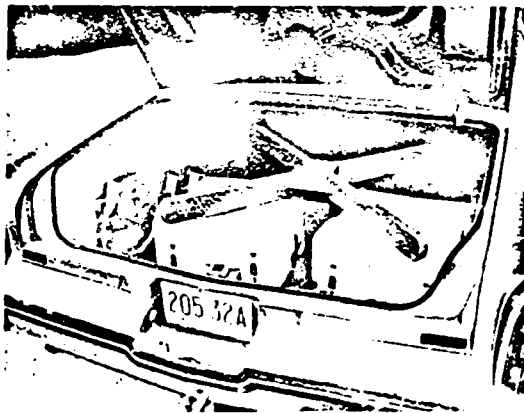

"Operation of this device is authorized under a waiver of Subpart D of Part 15 of the FCC rules dated 14 April 1977 and subject to the condition that no harmful interference is caused. On notification that harmful interference is being caused, operation of this device must be terminated until the harmful interference is eliminated.

Appendix B

Analysis of Gravimetry and Gravity Gradiometry

The gravimeter has the special attraction that it directly senses mass distribution in its immediate vicinity. By the inverse square law, it is most sensitive to near masses and this, in theory, gives it a chance at very close range to detect boulders or cavities in the soil. The best presently available exploration instruments are believed, from field experience*, to be able to detect a 4 foot boulder at 6 foot depth when sampling on a 10 foot grid. However, each measurement will take about five minutes with skilled personnel. After recording the raw gravimetric data from a survey, it takes a fairly elaborate, albeit in principle, simple, evaluation which leads to a map of the gravitational potential surface over the survey area. This map will show obstacles if the resolution is carried far enough. If there are disturbances from nearby activity or if there are problems with the instrument, which is not uncommon, the progress will get much slower or become impossible.

The gravimetric method is, in principle, quite straightforward, but a quick back-of-the-envelope estimate of its engineering basis helps in appreciating the unusual instrumental problems that have to be overcome:

Gravitation is an exceedingly weak force and unless caused by enormous masses (e.g., the earth) is detectable at very short ranges only:

$$F = \gamma \frac{m_1 m_2}{r^2} \quad (1)$$

where $\gamma = 6.67 \times 10^{-11} \text{ m}^3 \text{ kg}^{-1} \text{ sec}^{-2}$ is the gravitational constant.

The vertical gradient of gravity is:

$$\frac{dg}{dr} = \frac{-2g}{R} \text{ sec}^{-2} \quad (2)$$

with the earth's radius $R = 6.38 \times 10^6 \text{ m}$

$$\frac{dg}{dr} = 3.1 \times 10^{-6} \text{ sec}^{-2}$$

and with the definition of the "Eötvös Unit" of $1 \text{ EU} = 10^{-9} \text{ sec}^{-2}$:

$$\frac{dg}{dr} = 3100 \text{ EU} \quad (3)$$

This is the normal vertical gradient at the earth's surface.

*Private communication from Dwaine K. Butler, U. S. Waterways Experiment Station, Vicksburg, Mississippi.

A buried boulder could be detected by gravimeter or by gradiometer. The former cannot be operated until it is completely at rest because accidental acceleration of the instrument is indistinguishable from the effect of gravity. The gradiometer is, in principle, not so limited. It would be the equivalent of two gravimeters rigidly mounted one above the other (for vertical gradient) with the difference of their readings indicating gradient. Equal acceleration of both gravimeters would then produce no output.

Let a boulder too heavy to be removed by a quick excavating method lie at 1 m ~ 3 foot depth. Its size will be larger than 3 x 3 x 3 feet, corresponding to about 0.7 m³ and 1500 kg mass. Its density might be 20% higher than the surrounding soil, and we therefore have to detect a mass anomaly of 300 kg at 1 m range. This causes a very small acceleration:

$$a \approx 2 \times 10^{-9} \text{ g}$$

Clearly such an effect would be very hard to extract by gravimeter from the natural acceleration noise background in a practical situation.

A gradiometer is somewhat more promising. The gradient at the surface is the superposition of the earth's gradient and the gradient of the field of the boulder:

$$\begin{aligned} \frac{da}{dr} &= \frac{-2 \gamma m}{r^3} \text{ sec}^{-2} & (4) \\ &= 40 \text{ EU} \end{aligned}$$

This local change in gradient must be detected against a natural gradient of about 3000 EU; i.e., one is looking for changes of the order of 3% to indicate the presence of a boulder. Acceleration of the gradiometer will, to first order, not affect the measurement.

These rough calculations also show that it would, in practice, be impossible to find ledge by gravimetry unless its depth or density were to change drastically within the area investigated. Absolute measurements of g or dg/dr will not be good enough with present instruments--only relative gravimetric maps can be expected at best. Uniform ledge underneath the whole area will merely shift the datum of the map.

Gravity gradiometers for operation from moving platforms, particularly from airplanes, are presently being developed by several companies (Hughes, Bell Aircraft, C. S. Draper Labs) for special mapping purposes, in particular, in order to remove systematic errors from inertial guidance. These systems will need accuracies an order of magnitude better than 20 EU in three axes, and there is apparently hope that this performance will become achievable in the field, albeit at a system cost of several million dollars, and corresponding operating efforts.

A vertical-only gradiometer operating at rest only would be very much simpler. Such instruments are being developed, for example (54) for oil-well logging and may be adaptable for the present purpose. However, they probably would still cost no less than \$100,000 and require skilled and careful operations.

We must conclude that gravimetry and gradiometry are not going to be useful for quick, shallow excavation surveys in the foreseeable future. This is, however, not due to fundamental limits of measurement (such as thermal noise, statistics, uncertainty relations, etc.) but to engineering problems. They may be amenable either to persistent efforts driven by other urgent user needs or to a novel approach bypassing some of the practical problems.

APPENDIX C

Abstracts of Selected References

Scanned Acoustical Holography for Geological Prediction in
Advanced of Rapid Under Sand Excavation, Phase I

Holosonics, Inc., Richmond, Wash.*National Science Foundation,
Washington, D.C. Research Applied to National Needs. (391
200)

Advanced technical report.

AUTHOR: Price, T. G.; Stenden, E. B.; Collins, H. D.; Spalek,
J.

C5332H3 FIG: 13B, 081, 50B*, 48A*, 82A GRA17524

30 May 75 1150*

Grant: NSF-GI-43086

Monitor: NSF/RA/T-75/024

Abstract: In order to make underground space utilization a
viable alternative to surface utilization, an intensive effort
is underway to examine the factors involved in underground

excavation and determine these factors can be affected to
improve productivity. A high priority for increasing
productivity is the development of geological techniques for
determining rock and groundwater conditions prior to
excavation. This program was to demonstrate the use of
acoustical holography methods to detect and image targets in a
volume of rock, and to show how the existing state of
rectilinear scanned holography could be so modified to be cost
efficient and most compatible for 'real-time' use in a tunnel
with a tunnel boring machine. The primary goal of Phase I is
to demonstrate holographic imaging of programmed targets in a
volume of rock using rectilinear and circular scanning
systems.

Descriptors: *Tunneling(Excavation), *Underground surveys,
*Holography, Acoustic detection, Acoustic signatures,
Tunneling machines, Geophysical surveys

Identifiers: *Rapid excavation, *Acoustic recognition,
NTIS:SFRA

PB-245 147/45T NTIS Prices: PC A06/VE A01

Scanned Acoustical Holography for Geological Prediction in
Advance of Rapid Underground Excavation, Phase I

Holosonics, Inc., Richland, Wash. *National Science Foundation,
Washington, D.C. Research Applied to National Needs. (391
200)

Interim rept. no. 1

AUTHOR: Price, T. D.; Brenden, E. B.; Collins, H. D.; Spalek,
J.

D1802A2 Fld: 135, 31, 506, 48A, 82A GRAI7709

Feb 75 92p

Grant: NSF-GI-43586

Monitor: NSF/RA/T-75/075

See also PB-245 147.

Abstract: A discussion and reports on the progress to date are
presented in this interim report on the Phase I program. Two
tasks of the four scheduled have been completed. First,
results of a comprehensive review of the current state of
research in seismic and acoustical holography (pertinent to
its application to geologic prediction) are included in the
sections entitled, 'Review of Seismic and Acoustical
Holography Research,' and 'Analysis of Scanned Acoustical
Holography.' The second task details the implementation of the
Holosonic model 200 Scanned Acoustical Holography System to
demonstrate the range of imaging available with current
techniques in a small rock sample, and laboratory
demonstrations are conducted using a marble block as a test
model.

Descriptors: *Tunneling(Excavation), *Underground tunnels,
*Holography, Acoustic detection, Acoustic structures,
Tunneling machines, Geophysical surveys

Identifiers: *Rapid excavation, *Acoustic holography,
NTISNSFRA

PB-263 242/05T NTIS Prices: PC A05, VF A01

Scanned Acoustical Holography for Geological Prediction in
Advanced of Rapid Underground Excavation. Phase II

Holosonics, Inc., Richland, Wash. *National Science Foundation,
Washington, D.C. Research Applied to National Needs. (39:
200)

Progress report.

AUTHOR: Price, Ted O.; Fitzpatrick, Gerald L.; Brennan, James
M.

D1062F2 Fld: 13B, 17A, 81, 50B, 82A, 48A GRA17704

May 76 59p

Contract: NSF-APR75-10376

Monitor: NSF/RA-760297

See also PB-245 147.

Abstract: A large circular scanner, five feet in diameter, was
activated in January 1976. The system employs microcomputers
for determining the reference wave phase angles in real-time.
Holograms were made and reconstructed in less than ten
minutes. The quality of the hologram is excellent and the
laser reconstructions (reconstructed images) are of good
quality showing good resolution and good image definition. A
variety of "roughness" features were modeled on a variety of
objects immersed in a large water tank. These features
simulate properties that will be encountered when actual
geologic conditions are examined. Also developed were a
variety of new image enhancement techniques essential for the
success of the effort when real-world situations were
encountered. Plans for an actual field demonstration of the
system in rock are proceeding. A variety of new prototype
designs for data gathering, data storage, data processing and
display techniques were also completed. The authors predict
that implementation of a large tunnel boring machine with an
acoustic holography system will be highly successful.

Descriptors: *Tunneling (Excavation), *Underground surveys,
*Holography, Acoustic detection, Acoustic signatures,
Tunneling machines, Geophysical surveys

Identifiers: *Rapid excavation, *Acoustic holography,
NTISNSFRA

PB-260 768/75T NTIS Prices: PC A04/NF A01

Excavation Seismology

Honeywell Inc Minneapolis Minn Systems and Research Center (402649)

Final technical rept. 23 May 72-31 Dec 73
AUTHOR: Larson, Robert W.; Wooney, Harold W.; Soland, Duane E.
G325213 F101 15B, 15C, 49A, 50B. GRA17419
May 74 670
Rept No: F0154-TR2
Contract: HC222070
Project: APPA Order-1170
Monitor: 18
See also AD-755 211.

Abstract: The objective of the program is to develop seismic techniques and equipment which can be used in a hand-held, rapid-excavation system to provide indication of potential hazardous or changing geologic conditions ahead of the working face. The seismic reflection method is considered the most suitable one for this application. The principal technical problem is identification of reflections superimposed on other source-produced complex interference. The major part of the program emphasized the development of a seismic source/receiver combination which produced a simple, repeatable transmitted seismic pulse. In the final part of the program the field recording system was used to collect fault reflection data in an underground copper mine. The final report discusses experimental procedures and interpretation and the problems encountered in the underground environment. (Modified author abstract)

Descriptors: *Underground structures. *Faults (Geology). *Seismic detection. Seismic analysis. Discontinuities. Waveforms. Signal processing. Data processing. Structural geology.

Identifiers: *Rapid excavation, NTIS00050

AD-782 264/6 NTIS Prices: PC A04/MF A01

AD-742 146
Excavation Seismology; Annual technical rept. no. 1. 15 Feb 71-19 Feb 72
Soland, Duane E.; Wooney, Harold W.; Tack, Duane E.; Richard, Richard
Honeywell Inc St Paul Minn Research Dept
Mar 72 228p
See also AD-731 707.

Excavation Seismology

Honeywell Inc. St. Paul, Minn. Systems and Research Center
170188)

Semiannual technical rept. 23 May-22 Nov 72
AUTHOR: Soland, Duane E.; Woonay, Harold M.
C042304 Fld: 133, 50, 603, 64F, 830 GRA17307
Dec 72 74p
Rept No: F0154-TR1
Contract: H0220070, ARPA Order-1579
Monitor: 18

Abstract: The objectives of this program are to verify and evaluate two promising existing array techniques for use in underground hard-rock excavations. The two array techniques to be evaluated are: A three-dimensional method of displaying the output signals from a two-dimensional array of transmitting sources and receivers to enable an operator to visually detect reflections from discontinuities within the probed rock volume; and A beamforming method developed in a previous study which employs sophisticated array signal processing to enhance reflections returned from specific directions. (Author)

Descriptors: (*Underground structures, Structural geology), (*Defects(Materials), Seismic waves), (*Rock(Geology), Anomalies), Detectors, Faults(Geology), Safety, Mechanical waves, Cathode ray tubes, Piezoelectric transducers, Design

Identifiers: *Rapid excavation, Discontinuities, Beam steering, Seismic detection, Seismic arrays, Rock mechanics

AD-755 211 NTIS Price: PC A04, MF A01

Electromagnetic Pulse Sounding for Geological Surveying with Application in Rock Mechanics and Rapid Excavation Program

Ohio State Univ. Columbus. Electroscience Lab. (402251)

Final rept. 24 Feb 71-23 Feb 72
AUTHOR: Moffatt, David L.; Peters, L. Jr.
C036201 Fld: 80, 145, 133, 64F, 730 GRA17306
Sep 72 115p
Rept No: ESL-3190-2
Contract: H0210042, ARPA Order-1579
Monitor: 18
See also report dated 13 Oct 71, AD-734 231.

Abstract: Progress toward the development of an electromagnetic pulse sounding probe for the detection and delineation of geological anomalies, primarily in a hard rock medium, is reported. This report covers research performed on Contract H0210042 during the period 24 February 1971 to 23

February 1972. Analytical studies on design data for the probe and on the scattering by planar and spherical contrasts are summarized. Successful measurements made using a 1st generation version of the probe on conducting and dielectric cylindrical targets in a lossy overburden and on steel anomalies in a limestone medium are reported. (Author)

Descriptors: (*Rock(Geology), Non-destructive testing), *Non-destructive testing, Electromagnetic, PC 599, *Probes(Electromagnetic), Design, Anomalies, Geology, Geoprospecting, Limestone

Identifiers: *Rock excavation, Echo sounding

AD-754 847 NTIS Prices: PC A06/MF A01

Electromagnetic Pulse Sounding for Geological Surveying with Application in Rock Mechanics and the Rapid Excavation Program

Ohio State Univ Columbus Electroscience Lab (402251)

Semiannual technical rept. 1 Sep 72-28 Feb 73
AUTHOR: Moffatt, D. L.; Puskar, R. J.; Peters, L. Jr
CI321A1 F10: 138, 139, 8G, 609, 646, 830 GRA17317
Apr 73 81p
Rept No: ESL-3408-1
Contract: ARPA Order-1579, Contract, H0230009
Monitor: 18

Abstract: A full scale version of an electromagnetic pulse sounding probe is described with attendant experimental data.

Propagation and scattering measurements in limestone and dolomite media are presented. The scattering measurements are for targets consisting of faults, joints and layered contrasts in a dolomite medium. Measured frequency dependent constitutive parameters for the limestone and dolomite media are given and realistic pulse propagation calculations using these data are shown. The basic problem of probe calibration is discussed and progress toward solution of this problem is described. (Author)

Descriptors: (*Probes(Electromagnetic), Design), *Rock(Geology), Anomalies, (*Underground structures, Construction), Pulse systems, Video signals, Faults, Joints, Calibration, Experimental data, Safety, Hazards

Identifiers: Rapid excavation, Rock mechanics, Electromagnetic pulse sounding, SD

AD-763 758 NTIS Prices: PC E03/MF A01

Electromagnetic Pulse Sounding for Geological Tunneling and
Application in Rock Mechanics and the Rapid Excavation of Tunnels

Ohio State Univ Columbus Electroscience Lab (402231)

Final technical report
AUTHOR: Moffatt, D. L.; Puskar, R. J.; Peters, L. W.
C220311 FID: 130, 2M, 503, 500 GRA17405
Sep 73 170p
Rept No: ESL-3408-1
Contract: HC230009, ARPA Order-1579
Monitor: 18

Abstract: A full scale version of an electromagnetic pulse sounding probe is described with attendant experimental data. Propagation and scattering measurements in limestone and dolomite media are presented. The scattering measurements are for targets consisting of faults, joints and lithologic contrasts in a dolomite limestone and dolomite media are given and realistic pulse propagation calculations using these data are shown. Probe calibration procedures are described and illustrated. (Modified author abstract)

Descriptors: *Probes(Electromagnetic), *Rock, *Underground structures, *Geophysical prospecting, Tunnels, Design, Pulse generators, Video signals, Faults(Geology), Experimental data

Identifiers: *Rapid excavation, Rock mechanics, *Electromagnetic pulse sounding, SD

AD-772 065/9 NTIS Prices: PC A09, MF A01

Seismic Determination of Geological Discontinuities Ahead of
Rapid Excavation

Bendix Research Labs Southfield Mich (304180)

Semiannual technical report 30 Apr-31 Oct 71
AUTHOR: Gupta, R. R.; Johnson, Charles F.
A374593 FID: 80, 21, 170, 64F, 631 GRA17207
30 Nov 71 40p
Rept No: RLD-0051
Contract: HD210033, ARPA Order-1579
Project: ARPA-1F10, DRL-2412

Abstract: The need for the on-site knowledge of large geological discontinuities ahead of rapid excavation is very desirable for avoiding hazardous or difficult formations ahead of excavation surfaces and for expediting the rate of excavation. The objective of this program is to study the feasibility of using ultrasonic acoustic signals and seismic impulses to rapidly predict the presence of large geological discontinuities or other potential sources of danger, such as old mine workings filled with water or gas, lying within a reasonable working range (a few feet to a few tens-of-feet) ahead of excavation surfaces. The principal geologic medium of interest is hard or crystalline rock. (Author)

Descriptors: (*Sound ranging, Faults(Geology)), (*Rock(Geology), Anomolies), (*Mining engineering, Hazards), Sound signals, Ultrasonic radiation, Pulse systems, Pulse transmitters, Transducers, Experimental data

Identifiers: Seismic detection

AD-736 692 NTIS Prices: PC A03, MF A01

Descriptors: (*Rock(Geology), Non-destructive testing),
*Non-destructive testing, Electromagnetic pulsing,
*Probes(Electromagnetic), Design), Anomalies, Geophysics
prospecting

Identifiers: Rock excavation

AD-734 231 NTIS Prices: PC A03/MF A01

Seismic Determination of Geological Discontinuities Ahead of
Rapid Excavation

Bendix Research Labs Southfield Mich (304180)

Final technical report, 30 Apr 71-31 Jul 72

AUTHOR: Gupta, R. R.

A536113 Fld: BG, BI, 17J, 64F, 63I, 64I GRA17223

Sep 72 88p

Rept No: RLD-5311

Contract: HD210033, ARPA Order-1579

Project: BRL-2412

Monitor: 18

Abstract: The need for the on-site knowledge of large geological discontinuities ahead of rapid excavation is very desirable so that hazardous or difficult formations ahead of an excavation face can be avoided or prepared for. Such information could result in fewer machine breakdowns, proper preparation for entry into zones where special precautions must be taken, and considerable savings in cost and human resources. The objective of this program is to study the feasibility of using ultrasonic acoustic signals and seismic impulses to rapidly predict the presence of large geological discontinuities or other potential sources of danger, such as old mine workings filled with water or gas, lying within a reasonable working range ahead of excavation surfaces. The principle geologic medium of interest is 'hard' or crystalline rock. (Author)

Descriptors: (*Seismic engineering, *Faults(Geology), (*Rock(Geology), Andromeda), (*Mining engineering, Hazards), Sound signals, Ultrasonic radiation, Pulse systems, Pulse transmitters, Piezoelectric transducers, Experimental data, Feasibility studies

Identifiers: Seismic detection, *Rapid excavation systems,
Field tests

AD-749 977 NTIS Prices: PC A05/MF A01

Prediction of Geological and Hydrologic Conditions Ahead of a
Rapid Excavation Operation

Bureau of Mines Denver, Colo Denver Mining Research Center (068170)

Annual technical rept. : Feb-31 Dec 71
AUTHOR: Scott, James H.
AS21102 Fid: 8G, 137, 64F, 60H GRA17221
1 Mar 72 17p
Rept No: P87-2
Contract: ARPA Order-1579
Monitor: 18

Abstract: A well logging system for making measurements of physical properties of rock penetrated by vertical drill holes was designed and partially developed by adapting standard Bureau of Mines equipment to special needs for geological-hydrological prediction problems associated with tunneling at depths of several thousand feet in hard rock. Calibration holes and models were developed for providing a means of improved quality control required for the quantitative measurements of interest. A new interpretive technique for determining P- and S-wave velocities for acoustic logs was developed and preliminary tests were performed to evaluate its effectiveness. (Author)

Descriptors: (*Structural geology, Predictions), (*Underground structures, *Engineering geology), Well logging, *Hydrology, Data processing systems, Waveform generators, Calibration

Identifiers: Rapid excavation, Cross hole measurement, Tunnels(Excavations)

AD-748 637 NTIS Prices: PC A02/MF A01

Electromagnetic Pulse Sounding for Geological Surveying with Application in Rock Mechanics and Rapid Excavation Program

Ohio State Univ Columbus Electroscience Lab (402251)

Semiannual technical rept. 22 Febr-22 Aug 71
AUTHOR: Moffatt, D. L.
A340184 F10: 8G, 14B, 13B, 64F, 73D GRA17203
18 Oct 71 46p
Rept No: ESL-3190-1
Contract: HQ210042, ARPA Order-1579
Project: ARPA-1F10

Abstract: Analytical results on the scattering by various planar and spherical conductivity contrasts and on design data for an electromagnetic pulse sounding probe are described and illustrated. A first generation version of the probe is given and initial measured data demonstrating certain features of the probe are presented. (Author)

The Variation of the Angle of Internal Friction with Size Consist for Mechanically-Chipped Material

Pennsylvania State Univ University Park Coll of Earth and Mineral Sciences (405416)

Semi-annual technical rept. 1 Apr-30 Sep 71
AUTHOR: Saperstein, Lee W.
A3313F1 F10: 8G, 13B, 13W, 64L, 60H GRA17202
20 Oct 71 45p
Rept No: HQ210027-1
Contract: HQ210027, ARPA Order-1579

Abstract: In order to improve aspects of materials handling in the rapid excavation process, research is being conducted to characterize the rock from mechanical tunnel boring operations. The specific project involves the correlation of the angle of internal friction, to the size consist, often termed gradation, of this mechanically-chipped material. Existing references demonstrate that this angle depends upon mineral type, and for a given mineral type upon size of particle. Particle shape is usually a function of mineral type character, and is not as important a parameter in influencing this angle. The project investigators have visited mine tunnels and have samples from seven rock types collected include granite, limestone, mica schist, sandstone, and shale. A facility for testing these specimens is being created and will consist of a flexible arrangement of 2.8 or 6-ton triaxial cells, pressure system, testing machine, and automated data collection system. The latter will insure the removal of personal bias from the data. Testing of samples can begin soon after a load cell is delivered. (Author)

Descriptors: (+Rock(Geology), Internal friction, Underground structures, Drilling), Granite, Limestone, Mica, Sandstone, Shale, Particle size, Correlation techniques, Handling, Sampling, Earth-handling equipment, Drills

Identifiers: +Rapid excavation, Rock mechanics, Excavation

AD-733 486 NTIS Prices: PC A03/MF A01

Prediction of Geologic and Hydrologic Conditions Ahead of
Rapid Excavation Operations by Inhole Geophysical Techniques

Bureau of Mines Denver Colo Denver Mining Research Center (008170)

Final technical rept. 1 Jan 72-30 Jun 73
AUTHOR: Scott, James H.; Sana, Joe
C2185K3 Fld: 8G, 13W, 50B, 46F GRA17405
Nov 73 38p
Rept No: P87-4
Contract: ARPA Order-1579
Monitor: 18
See also report dated 1 Mar 72, AD-748 637.

Abstract: The objective of this research project was to develop inhole geophysical measurement techniques for assessing geologic and hydrologic conditions ahead of tunnels constructed by rapid excavation methods. The research plan was to perform preliminary research, design and detailed specifications for instrumentation, contract with custom equipment manufacturers for its fabrication, and test, evaluate and describe in reports its field applicability. Measurement techniques developed and tested include magnetic susceptibility, electrical resistivity, acoustic waveform, bulk density, oriented 3-point caliper, 3-point resistance, and temperature. (Modified author abstract)

Descriptors: *Structural geology, *Engineering geology, *Well logging, Tunneling, Geophysical prospecting, Predictions, Data processing

Identifiers: Rapid excavation, *Tunneling(Excavation), SO

AD-77: 639/7 NTIS Prices: PC A03, YF A01

1/7/1

AD-A053 174/9ST NTIS PRICES: PC A04/MF A01

GEOPHYSICAL SURVEY OF CAVERNOUS AREAS, PATOKA DAM, INDIANA

ARMY ENGINEER WATERWAYS EXPERIMENT STATION VICKSBURG MISS (038100)

AUTHOR: COOPER, STAFFORD S.; BIEGANOUSKY, WAYNE A.
FINAL REPT.

E143303 FLD: 86, 138, 48F, 50B GRAI7815

JAN 78 54P

REPT NO: WES-MP-S-78-1

MONITOR: 18

ABSTRACT: THREE SELECTED GEOPHYSICAL METHODS, I.E., ACOUSTIC, RESISTIVITY, AND INFRARED TECHNIQUES WERE APPLIED TO THE PROBLEM OF SOLUTION CAVITY DETECTION AND DELINEATION AT PATOKA DAM SITE. THE INFRARED TECHNIQUE WAS ABANDONED AFTER EARLY EFFORTS INDICATED IT WOULD NOT PROVE SUCCESSFUL IN THIS APPLICATION. BOTH THE ACOUSTIC AND RESISTIVITY METHODS, HOWEVER, YIELDED RESULTS. THE GENERAL SEVERITY OF SOLUTIONING ACTIVITY COULD BE SURMISED FROM THE RESISTIVITY PROFILE PRODUCED USING THE WENNER ELECTRODE ARRAY. SPECIFIC FEATURES WERE FURTHER DEFINED USING A MODIFICATION OF THE BRISTOW RESISTIVITY SURVEY. THESE FEATURES, HOWEVER, HAVE NOT BEEN VERIFIED BY EXPLORATORY DRILLING THUS FAR. THE ACOUSTIC TECHNIQUE EMPLOYED WAS VERY SUCCESSFUL IN DELINEATING THE TREND OF SUBTERRANEAN FEATURES FOR A DISTANCE OF APPROXIMATELY 200 FEET FROM THE LOCATION OF THE ENERGY SOURCE. EXPLORATORY DRILLING PROVED THE EXISTENCE OF SEVERAL FEATURES INDICATED BY THE ACOUSTIC TECHNIQUE. A COMPARISON OF THE ELECTRICAL RESISTIVITY AND ACOUSTIC RESULTS WAS VERY FAVORABLE. (AUTHOR)

A NEW SENSING SYSTEM FOR PRE-EXCAVATION SUBSURFACE INVESTIGATION FOR TUNNELS IN ROCK MASSES. VOLUME II. APPENDICES: DETAILED THEORETICAL, EXPERIMENTAL AND ECONOMIC FOUNDATION

ENSCO, INC., SPRINGFIELD, VA. ♦ FEDERAL HIGHWAY ADMINISTRATION, WASHINGTON, D.C. (406 167)

AUTHOR: RUBIN, L. A.; FOWLER, J. C.; GRIFFIN, J. N.; STILL, W. L.
FINAL REPT.

E0804A2 FLD: 13B, 13C, 50B, 50C, 63 GRA17809

AUG 76 505P

REPT NO: 1061-TR-3-1-VOL-2

CONTRACT: DOT-FH-11-S602

MONITOR: FHWA/RD-77/11

SEE ALSO VOL. 1, PB-276 720.

ABSTRACT: CONTENTS: THEORETICAL STUDIES-(ALTERNATIVES CONSIDERED FOR A FEASIBLE BASELINE SYSTEM, ROCK CHARACTERISTICS OF SIGNIFICANCE IN TUNNELING, RANGE AND RESOLUTION, ACOUSTIC WAVE PROPAGATION IN HARD ROCK, ACOUSTIC SENSING SYSTEM, GROUND-PROBING RADAR, ELECTRICAL RESISTIVITY, SIGNAL PROCESSING TECHNIQUES APPLICABLE TO SUBSURFACE INVESTIGATION OF ROCK MASSES THROUGH BOREHOLES, CONCEPTUAL DESIGN OF HARD ROCK SENSOR CONVEYANCE DEVICE, APPLICABILITY OF DRILL RIGS AS PROPULSION DEVICES); CRITICAL LABORATORY EXPERIMENTS-(STUDIES OF GEO-ENGINEERING PROPERTIES OF ROCK RELATED TO THE USE OF RADAR AND SONAR PROBING SYSTEMS, TRANSVERSE-DIPOLE BOREHOLE ANTENNAS, SUBSURFACE EXPERIMENTS WITH RADAR); ECONOMIC CONSIDERATIONS-(COMPARATIVE STUDY OF PROBABILITIES OF SUCCESS OF CANDIDATE SYSTEM DESIGN CONCEPTS, ECONOMIC ANALYSIS OF THE FULL-CAPABILITY SYSTEM, COST OF PILOT TUNNELS, ANALYSIS OF SENSING COST-BENEFIT RATIOS AS FUNCTIONS OF BOREHOLE SIZE, COST-EFFECTIVENESS CONSIDERATIONS FOR PROPULSION AND PENETRATION).

3/7/1
PB-276 720/0ST NTIS PRICES: PC A10/MF A01

A NEW SENSING SYSTEM FOR PRE-EXCAVATION SUBSURFACE INVESTIGATION FOR TUNNELS IN ROCK MASSES. VOLUME I. FEASIBILITY STUDY AND SYSTEM DESIGN

ENSCO, INC., SPRINGFIELD, VA. ♦ FEDERAL HIGHWAY ADMINISTRATION,
WASHINGTON, D.C. (406 167)

AUTHOR: RUBIN, L. A.; FOWLER, J. C.; GRIFFIN, J. N.; STILL, W. L.
FINAL REPT.

E0804A1 FLD: 13B, 13C, 50B, 50C, 63 GRAI7809

AUG 76 206P

REPT NO: 1061-TR-3-1-VOL-1

CONTRACT: DOT-FH-11-8602

MONITOR: FHWA/RD-77/10

SEE ALSO VOL. 2, PB-276 721.

ABSTRACT: THIS REPORT INCLUDES A FEASIBILITY STUDY AND SYSTEM DESIGN FOR AN INITIAL PROTOTYPE OF A SENSING SYSTEM FOR PRE-EXCAVATION SUBSURFACE INVESTIGATION FOR TUNNELS IN ROCK. TUNNELS IN ROCK ARE VERY EXPENSIVE, AND COSTS OFTEN RISE FAR ABOVE ESTIMATES WHEN UNFORESEEN PROBLEMS ARE ENCOUNTERED DURING EXCAVATION. NEW TECHNIQUES IN RAPID EXCAVATION TECHNOLOGY, SUCH AS THE DEVELOPMENT OF BORING MACHINES, HAVE INCREASED THE NEED FOR IMPROVED SITE INVESTIGATION. POSSIBILITIES FOR A NEW SENSING SYSTEM THAT WILL PROVIDE MORE COMPLETE DATA ON SUBSURFACE CONDITIONS WERE INVESTIGATED. FAVORABLE RESULTS OBTAINED FROM HIGH-RESOLUTION GEOPHYSICAL SENSING IN BOREHOLES HAVE BEEN COMBINED WITH IMPROVEMENTS IN DRILLING OF LONG, HORIZONTAL, PRECISE BOREHOLES IN ORDER TO PROVIDE AN ECONOMICAL ALTERNATIVE TO PILOT TUNNEL FOR SUBSURFACE INVESTIGATION. PILOT TUNNEL COSTS AS WITH ALL SUBSURFACE CONSTRUCTION ARE RISING AT RATES MUCH HIGHER THAN THE ECONOMY. THUS THE USE OF BOREHOLE SITE INVESTIGATION HAS POTENTIALLY VERY HIGH BENEFIT/COST CHARACTERISTICS. THE PROTOTYPE SYSTEM DESIGNED IS A HIGHLY MOBILE GEOPHYSICAL MEASUREMENT (DATA ACQUISITION) SYSTEM. THE SYSTEM WILL TAKE ELECTROMAGNETIC RADAR MEASUREMENTS, PULSED ACOUSTICAL MEASUREMENTS, AND MULTI-SPACED ARRAY RESISTIVITY MEASUREMENTS. THE SENSORS WILL BE USED IN TRAVERSES ALONG THE BOREHOLE, AND DATA WILL BE TAKEN AND STORED ON MAGNETIC TAPE FOR SUBSEQUENT REDUCTION AND ANALYSIS AT A COMPUTATIONAL CENTER. THE SYSTEM COULD REDUCE ACCIDENTS, REDUCE BID CONTINGENCIES, AND REDUCE OTHER FACTORS CONTRIBUTING TO RAPID ESCALATING COSTS OF SUBSURFACE EXCAVATION. VOLUME I DESCRIBES THE FEASIBILITY STUDY AND SYSTEM DESIGN. VOLUME II CONTAINS THE APPENDICES A-R.

4/7/1

PB-263 242/0ST NTIS PRICES: PC A05/MF A01

SCANNED ACOUSTICAL HOLOGRAPHY FOR GEOLOGICAL PREDICTION IN ADVANCE OF RAPID UNDERGROUND EXCAVATION. PHASE I

HOLOSONICS, INC., RICHLAND, WASH. NATIONAL SCIENCE FOUNDATION, WASHINGTON, D.C. RESEARCH APPLIED TO NATIONAL NEEDS. (391 200)

AUTHOR: PRICE, T. D.; BRENDEN, B. B.; COLLINS, H. D.; SPALEK, J.
INTERIM REPT. NO. 1
D1802A2 FLD: 13B, 81, 50B, 48A, 82A GRA17709
FEB 75 92P
GRANT: NSF-61-43686
MONITOR: NSF/RA/T-75/075
SEE ALSO PB-245 147.

ABSTRACT: A DISCUSSION AND REPORTS ON THE PROGRESS TO DATE ARE PRESENTED IN THIS INTERIM REPORT ON THE PHASE I PROGRAM. TWO TASKS OF THE FOUR SCHEDULED HAVE BEEN COMPLETED. FIRST, RESULTS OF A COMPREHENSIVE REVIEW OF THE CURRENT STATE OF RESEARCH IN SEISMIC AND ACOUSTICAL HOLOGRAPHY (PARTICULARLY AS IT APPLIED TO GEOLOGIC PREDICTION) ARE INCLUDED IN THE SECTIONS ENTITLED, "REVIEW OF SEISMIC AND ACOUSTICAL HOLOGRAPHY RESEARCH," AND "ANALYSIS OF SCANNED ACOUSTICAL HOLOGRAPHY." THE SECOND TASK DETAILS THE IMPLEMENTATION OF THE HOLOSONIC MODEL 200 SCANNED ACOUSTICAL HOLOGRAPHY SYSTEM TO DEMONSTRATE THE RANGE OF IMAGING AVAILABLE WITH CURRENT TECHNIQUES IN A SMALL ROCK SAMPLE, AND LABORATORY DEMONSTRATIONS ARE CONDUCTED USING A MARBLE BLOCK AS A TEST MODEL.

? SACUSTICAL (W) HOLOGRAPHY AND GEOLOGICAL (W) PREDICTION/TI

30 ACOUSTICAL (W) HOLOGRAPHY

3 GEOLOGICAL (W) PREDICTION/TI

5

3 ACOUSTICAL (W) HOLOGRAPHY AND GEOLOGICAL (W) PREDICTION/TI

? T5/6/1-3

10/7/1
AD-752 777 NTIS PRICES: PC A02/MF A01

EXPERIMENTAL CAPABILITIES OF THE ARL SEDIMENT TANK FACILITY IN THE
STUDY OF BURIED OBJECT DETECTION

TEXAS UNIV AUSTIN APPLIED RESEARCH LABS (404434)

AUTHOR: MUIR, THOMAS G.
TECHNICAL MEMO.
C016404 FLD: 17A, 63A GRAI7303
4 OCT 72 20P
REPT NO: ARL-TM-72-32
CONTRACT: N00014-70-A-0166-0010
PROJECT: NR-240-014
MONITOR: 18

ABSTRACT: AN UNDERWATER ACOUSTICS RESEARCH TANK AT APPLIED RESEARCH
LABORATORIES HAS BEEN MODIFIED FOR USE IN RESEARCH PERTAINING TO THE
DETECTION OF OBJECTS BURIED IN A WATER-FILLED SAND. PARAMETER AND
DESIGN DATA ON THIS FACILITY ARE PRESENTED FOR BOTH LINEAR AND
PARAMETRIC ACOUSTIC MEASUREMENTS. IT IS SHOWN THAT A WIDE RANGE OF
ACOUSTIC PARAMETERS CAN BE USED IN THE SIMULATION OF IN SITU
CONDITIONS. (AUTHOR)

11/7/1
AD-752 776 NTIS PRICES: PC A02/MF A01

ON THE POSSIBILITY OF DETECTING AN OBJECT BURIED BELOW AN INTERFACE
USING TOTALLY REFLECTED WAVES

TEXAS UNIV AUSTIN APPLIED RESEARCH LABS (404434)

AUTHOR: HORTON, CLAUDE W. SR
TECHNICAL MEMO.
C016403 FLD: 20A, 63A GRAI7303
27 SEP 72 12P
REPT NO: ARL-TM-72-28
CONTRACT: N00014-70-A-0166-0010
PROJECT: NR-240-014
MONITOR: 18

ABSTRACT: A PRELIMINARY SURVEY OF LITERATURE PERTAINING TO THE
ACOUSTIC DETECTION OF OBJECTS BURIED AT SUBCRITICAL ANGLES IN
SEDIMENTS IS PRESENTED. ALTHOUGH NO GENERAL SOLUTION TO THIS PROBLEM
HAS BEEN FOUND, IT IS SHOWN THAT THEORETICAL SOLUTIONS FOR SIMILAR
PROBLEMS PROVIDE A BASIS FOR THE DEVELOPMENT OF THEORY FOR SUBCRITICAL
TARGET DETECTION. (AUTHOR)

12/7/1
AD-782 264/6 NTIS PRICES: PC A04/MF A01

EXCAVATION SEISMOLOGY

HONEYWELL INC MINNEAPOLIS MINN SYSTEMS AND RESEARCH CENTER (402349)

AUTHOR: LARSON, RODNEY M.; MOONEY, HAROLD M.; SOLAND, DUANE E.
FINAL TECHNICAL REPT. 23 MAY 72-31 DEC 73
0325213 FLD: 13B, 86, 48A♦, 50B♦ GRA17419
MAY 74 67P♦
REPT NO: F0154-TR2
CONTRACT: H0220070
PROJECT: ARPA ORDER-1579
MONITOR: 18
SEE ALSO AD-755 211.

ABSTRACT: THE OBJECTIVE OF THE PROGRAM IS TO DEVELOP SEISMIC TECHNIQUES AND EQUIPMENT WHICH CAN BE USED IN A HARD-ROCK RAPID-EXCAVATION SYSTEM TO PROVIDE INDICATION OF POTENTIALLY HAZARDOUS OR CHANGING GEOLOGIC CONDITIONS AHEAD OF THE WORKING FACE. THE SEISMIC REFLECTION METHOD IS CONSIDERED THE MOST SUITABLE ONE FOR THE APPLICATION. THE PRINCIPAL TECHNICAL PROBLEM IS IDENTIFICATION OF REFLECTIONS SUPERIMPOSED ON OTHER SOURCE-PRODUCED COHERENT INTERFERENCE. THE INITIAL PART OF THE PROGRAM EMPHASIZED THE DEVELOPMENT OF A SEISMIC SOURCE/RECEIVER COMBINATION WHICH PRODUCES A SIMPLE, REPEATABLE TRANSMITTED SEISMIC PULSE. IN THE FINAL PART OF THE PROGRAM THE FIELD RECORDING SYSTEM WAS USED TO COLLECT FAULT REFLECTION DATA IN AN UNDERGROUND COPPER MINE. THE FINAL REPORT DISCUSSES EXPERIMENTAL PROCEDURES AND INTERPRETATION AND THE PROBLEMS ENCOUNTERED IN THE UNDERGROUND ENVIRONMENT. (MODIFIED AUTHOR ABSTRACT)

12/7/2
AD-755 211 NTIS PRICES: PC A04/MF A01

EXCAVATION SEISMOLOGY

HONEYWELL INC ST PAUL MINN SYSTEMS AND RESEARCH CENTER (170198)

AUTHOR: SOLAND, DUANE E.; MOONEY, HAROLD M.
SEMIANNUAL TECHNICAL REPT. 23 MAY-22 NOV 72
C042364 FLD: 13B, 8G, 60B, 64F, 83C GRAI7307
DEC 72 74P
REPT NO: F0154-TR1
CONTRACT: H0220070, ARPA ORDER-1579
MONITOR: 18

ABSTRACT: THE OBJECTIVES OF THIS PROGRAM ARE TO VERIFY AND EVALUATE TWO PROMISING SEISMIC ARRAY TECHNIQUES FOR USE IN UNDERGROUND HARD-ROCK EXCAVATIONS. THE TWO ARRAY TECHNIQUES TO BE EVALUATED ARE: A THREE-DIMENSIONAL METHOD OF DISPLAYING THE OUTPUT SIGNALS FROM A TWO-DIMENSIONAL ARRAY OF TRANSMITTING SOURCES AND RECEIVERS TO ENABLE AN OPERATOR TO VISUALLY DETECT REFLECTIONS FROM DISCONTINUITIES WITHIN THE PROBED ROCK VOLUME; AND A BEAMFORMING METHOD DEVELOPED IN A PREVIOUS STUDY WHICH EMPLOYS SOPHISTICATED ARRAY SIGNAL PROCESSING TO ENHANCE REFLECTIONS RETURNED FROM SPECIFIC DIRECTIONS. (AUTHOR)

12/7/3
AD-742 146 NTIS PRICES: PC A11/MF A01

EXCAVATION SEISMOLOGY

HONEYWELL INC ST PAUL MINN RESEARCH DEPT (401799)

AUTHOR: SOLAND, DUANE E.; MOONEY, HAROLD M.; TACK, DUANE; BELL, RICHARD
ANNEX6PTECHNICAL REPT. NO. 1, 19 FEB 71-19 FEB 72
A441404 FLD: 13B, 17J, 13L, 60B, 63I, 64L GRAI7213
MAR 72 229P
REPT NO: 12289-TR2
CONTRACT: H0210025, ARPA ORDER-1579
PROJECT: ARPA-1F10
SEE ALSO AD-731 707.

ABSTRACT: THE OBJECTIVE OF THE PROGRAM IS TO DEVELOP SEISMIC TECHNIQUES AND EQUIPMENT WHICH CAN BE USED IN A HARD-ROCK RAPID-EXCAVATION SYSTEM TO PROVIDE INDICATION OF POTENTIALLY HAZARDOUS OR CHANGING GEOLOGIC CONDITIONS AHEAD OF THE WORKING FACE. THE SEISMIC REFLECTION METHOD IS CONSIDERED THE MOST SUITABLE ONE FOR THE APPLICATION. THE PRINCIPAL TECHNICAL PROBLEM IS IDENTIFICATION OF REFLECTIONS SUPERIMPOSED ON OTHER SOURCE-PRODUCED COHERENT INTERFERENCE. SIGNAL PROCESSING TECHNIQUES SUCH AS CROSS-CORRELATION AND VELOCITY FILTERING OR BEAMFORMING USING AN ARRAY OF RECEIVING SENSORS ARE BEING INVESTIGATED FOR ENHANCEMENT OF REFLECTIONS. THE INITIAL PART OF THE PROGRAM EMPHASIZED THE DEVELOPMENT OF A SEISMIC SOURCE/RECEIVER COMBINATION WHICH PRODUCES A SIMPLE, REPEATABLE TRANSMITTED SEISMIC PULSE. (AUTHOR)

12/7/4

AD-731 707 NTIS PRICES: PC A07/MF A01

EXCAVATION SEISMOLOGY

HONEYWELL INC ST PAUL MINN RESEARCH DEPT (401799)

AUTHOR: SOLAND, DUANE E.; MOONEY, HAROLD M.; SINGH, SUDARSHAN
SEMIANNUAL TECHNICAL REPT. NO. 1, 19 FEB-18 AUG 71
A316404 FLD: 13B, 17J, 60B, 64L, 63I GRA17124
SEP 71 135P
REPT NO: 13289-TR1
CONTRACT: HQ210025, APPA ORDER-1579
PROJECT: ARPA-1F10

ABSTRACT: THE OBJECTIVE OF THE PROGRAM IS TO DEVELOP SEISMIC TECHNIQUES AND EQUIPMENT WHICH CAN BE USED IN A HARD-ROCK RAPID-EXCAVATION SYSTEM TO PROVIDE INDICATION OF POTENTIALLY HAZARDOUS OR CHANGING GEOLOGIC CONDITIONS AHEAD OF THE WORKING FACE. THE SEISMIC REFLECTION METHOD IS CONSIDERED THE MOST SUITABLE ONE FOR THE APPLICATION. THE PRINCIPAL TECHNICAL PROBLEM IS IDENTIFICATION OF REFLECTIONS SUPERIMPOSED ON OTHER SOURCE-PRODUCED COHERENT INTERFERENCE. SIGNAL PROCESSING TECHNIQUES SUCH AS CROSS-CORRELATION AND VELOCITY FILTERING OR BEAMFORMING USING AN ARRAY OF RECEIVING SENSORS ARE BEING INVESTIGATED FOR ENHANCEMENT OF REFLECTIONS. THE INITIAL PART OF THE PROGRAM WAS EMPHASIZED THE DEVELOPMENT OF A SEISMIC SOURCE/RECEIVER COMBINATION WHICH PRODUCES A SIMPLE, REPEATABLE TRANSMITTED SEISMIC PULSE. A FIELD RECORDING SYSTEM HAS BEEN ASSEMBLED AND SEISMIC SIGNALS RECORDED AND DIGITIZED FOR REFLECTIONS FROM FREE SURFACES ON GRANITE BLOCKS USING A SINGLE RECEIVER AT VARIOUS LOCATIONS TO SIMULATE AN ARRAY OF RECEIVERS. THE DIGITIZED SIGNALS WILL SUBSEQUENTLY BE PROCESSED BY DIGITAL COMPUTER TO SIMULATE AND ASSESS SIGNAL PROCESSING TECHNIQUES. (AUTHOR)

3/7/1

0092283 A78061390

SEISMIC PROFILING IN MIRAMICHI BAY, NEW BRUNSWICK

HOWELLS, K.; MCKAY, A.G.

GEOPHYS. DIV., NOVA SCOTIA RES. FOUND. CORP., DARTMOUTH, NOVA
SCOTIA, CANADA

CAN. J. EARTH SCI. (CANADA) VOL.14, NO.12 2909-27 DEC. 1977

CODEN: CJESAP

TREATMENT: EXPERIMENTAL

JOURNAL PAPER

A COMBINED ECHO SOUNDER AND SEISMIC PROFILING SURVEY IN MIRAMICHI BAY HAS DETECTED TWO PROMINENT SEISMIC REFLECTORS. THE UPPER REFLECTOR PROBABLY REPRESENTS A MARINE TERRACE, ABOVE WHICH ARE RECENT SEDIMENTS. THE SEA BED CONSISTS MAINLY OF SANDS IN THE BARRIER ISLAND AND OUTER BAY AREA, WHEREAS THE INNER BAY CONSISTS MAINLY OF SANDY MUDS AND MUDS. A DISCONTINUOUS "GAS" REFLECTOR IN THE MUDS OF THE INNER BAY MASKS ALL DEEPER SEISMIC REFLECTORS WHERE IT IS PRESENT. THE LOWER SEISMIC REFLECTOR IS PROBABLY THE PENNSYLVANIAN BEDROCK SURFACE. BETWEEN THE UPPER AND LOWER REFLECTORS, PROGLACIAL SEDIMENTS AND GLACIAL TILL ARE PROBABLY PRESENT. THE BEDROCK SURFACE HAS BEEN ERODED INTO DEEP, LINEAR CHANNELS BY A PRE-PLEISTOCENE DRAINAGE SYSTEM WHICH MAY HAVE BEEN SUBSEQUENTLY OVERDEEPEMED BY GLACIAL SCOURING. THESE CHANNELS MAY HAVE BEEN ERODED ALONG LINES OF WEAKNESS IN THE CARBONIFEROUS SEDIMENTS REPRESENTING STRUCTURES, SUCH AS JOINTS, FRACTURES, OR FAULTS IN THE BEDROCK. THESE STRUCTURES MAY BE RELATED TO THE EXTENSION OF THE CATAMARAN FAULT ZONE IN THE PRE-CARBONIFEROUS BASEMENT ROCKS BENEATH MIRAMICHI BAY (41 REFS)

4/1/1

0154191 A78096306, B79002404

FILTERING AND FIELD FOCUSING PROCEDURES FOR ELECTROMAGNETIC
DETECTION OF UNDERGROUND QUARRIES

DUBUS, J.P.; CLICQUE, D.; BAUDET, J.; GABILLARD, R.

UNIV. DE SCI. ET TECHNIQUES DE LILLE, VILLENEUVE D'ASCQ, FRANCE

GEOPHYS. PROSPECT. (NETHERLANDS) VOL.26, NO.2 407-20 JUNE 1978

CODEN: GPPRAR

TREATMENT: APPLICATION PRACTICAL APPLICATION

JOURNAL PAPER

LANGUAGES: FRENCH

THE ELECTROMAGNETIC SURFACE DETECTION OF UNDERGROUND QUARRIES BY CLASSICAL METHODS BECOMES DIFFICULT WHEN THEY ARE SITUATED AT DEPTHS GREATER THAN TEN METERS AND WHEN THE THICKNESS AND CONDUCTIVITY OF THE SUPERFICIAL LAYERS ARE IRREGULAR. THE PROBLEM IS TACKLED IN TWO STAGES AT FIRST USING SUCCESSIVE APPROXIMATIONS, CHARACTERISTICS OF THE MISCELLANEOUS LAYERS OF A STRATIFIED MEDIUM ARE IDENTIFIED, AND THE QUARRIES ARE THEN DETECTED BY OBSERVATION OF THE CONDUCTIVITY CHANGES OF ONE OF THE LOWER LAYERS. COMPUTER INTERPRETATION, HOWEVER, IS NECESSARY. THE CHANGES OF DETECTION OF THE QUARRIES ARE CONSIDERABLY IMPROVED BY A FIELD LOCALIZATION METHOD. COMPUTER INTERPRETATION IS ELIMINATED. THE NEW ASPECT IS AN AUXILIARY TRANSMITTER WHICH ANNULS THE CURRENTS INDUCED BY THE PRINCIPAL TRANSMITTER IN THE UPPERMOST-GENERALLY MORE CONDUCTIVE-LAYERS. THE THEORETICAL AND EXPERIMENTAL RESULTS SHOW THAT THE PROBABILITY OF DETECTION OF THE QUARRIES BY THIS METHOD ARE FOUR TIMES AS HIGH AS BY THE CLASSICAL ONE (5 REFS)

2/7/1

ID NO. - EI790533799 933799

INVERSION OF TDEM (NEAR-ZONE) SOUNDING CURVES WITH CATALOG
INTERPOLATION.

RODRIGUEZ, JUAN CARLOS

Q COLO SCH MINES V 73 N 4 OCT 1978 P 57-69 CODEN: QCSMAC

ISSN 0010-1753

TIME DOMAIN ELECTROMAGNETIC (TDEM) SOUNDING TECHNIQUES ARE USED IN PROSPECTING FOR GEOTHERMAL SYSTEMS. RESULTS OF SUCH SURVEYS ARE OFTEN INTERPRETED USING THE METHOD OF GENERALIZED LINEAR INVERSION. INVERSION REQUIRES THE CALCULATION OF A LARGE NUMBER OF THEORETICAL CURVES FOR POSSIBLE EARTH MODELS. IN THE TIME DOMAIN ELECTROMAGNETIC SOUNDING METHOD, COMPUTATION OF THESE MODELS IS EXPENSIVE. THE COST CAN BE REDUCED MARKEDLY IF A CATALOG OF PRECALCULATED CURVES IS STORED IN DIGITAL FORM IN THE COMPUTER, AND WHEN A FORWARD MODEL IS NEEDED DURING THE INVERSION PROCESS, IT IS OBTAINED BY INTERPOLATION BETWEEN THE ALREADY EXISTING CURVES. THIS METHOD WAS PROGRAMMED AND THE PROGRAM PROVIDED REASONABLE RESULTS FOR SEVERAL ELECTROMAGNETIC SOUNDINGS IN THE BLACK ROCK DESERT PROJECT IN NEVADA. 29 REFS.

? SBLACK(OR)ROCK/TI AND ELECTROMAGNETIC (W) SURVEY/TI

6 BLACK (W) ROCK/TI

4 ELECTROMAGNETIC (W) SURVEY/TI

3 1 BLACK (W) ROCK/TI AND ELECTROMAGNETIC (W) SURVEY/TI

? T3/7/1

3/7/1

ID NO. - EI790533798 933798

TIME-DOMAIN ELECTROMAGNETIC SURVEY IN BLACK ROCK DESERT-HUALAPAI
FLAT AREA OF NORTHWESTERN NEVADA.

KELLER, G. V.; CREWSON, R. A.; DANIELS, J. J.

Q COLO SCH MINES V 73 N 4 OCT 1978 P 47-56 CODEN: QCSMAC

ISSN 0010-1753

AN EXPERIMENTAL TIME-DOMAIN ELECTROMAGNETIC SURVEY WAS CARRIED OUT IN AND AROUND THERMAL AREAS IN THE BLACK ROCK DESERT AND HUALAPAI FLAT OF NORTHWEST NEVADA TO EVALUATE THE UTILITY OF SUCH SURVEYS IN GEOTHERMAL EXPLORATION. TWO GROUNDED-WIRE SOURCES WERE USED, ORIENTED IN MUTUALLY PERPENDICULAR DIRECTIONS. THESE SOURCE CABLES WERE ENERGIZED WITH STEPMOVES OF CURRENT TO GENERATE AN ELECTROMAGNETIC FIELD. IT IS CONCLUDED THAT THE TIME-DOMAIN ELECTROMAGNETIC SOUNDING METHOD IS EFFECTIVE IN DETERMINING EARTH CONDUCTIVITY TO A DEPTH OF 1 TO 2 KILOMETERS UNDER CONDITIONS ENCOUNTERED IN THE SURVEY. 15 REFS.

? SSCHLUMBERGER AND ROOSEVELT/TI

157 SCHLUMBERGER

8 ROOSEVELT/TI

4 1 SCHLUMBERGER AND ROOSEVELT/TI

LMED
-8