

# THÈSE

Pour obtenir le grade de  
Docteur

Délivré par UNIVERSITE MONTPELLIER 2

Préparée au sein de l'école doctorale **SIBAGHE -  
Systèmes intégrés en Biologie, Agronomie,  
Géosciences, Hydrosociences et Environnement**  
Et de l'unité de recherche **UMR 212 EME -  
Écosystèmes Marins Exploités**

Spécialité : **ESA-Ecosystèmes et sciences  
agronomiques**

Présentée par **AVADÍ TAPIA Angel Daniel**

**Durabilité de la filière d'anchois du Pérou, de  
la mer aux rayonnages: vers une nouvelle  
stratégie d'utilisation optimale des  
ressources**

(Sustainability of the Peruvian *anchoveta* supply  
chains from sea to shelf: towards a new strategy  
for optimal use of resources)

Soutenue le 25/03/2014 devant le jury composé de

Mme. Catherine MARIOJOULS, PhD, AgroParisTech

Rapporteuse/Présidente

Mme. Friederike ZIEGLER, PhD, SIK

Rapporteuse

Mr. Arnaud HÉLIAS, PhD, INRA

Examineur

Mr. Peter TYEDMERS, PhD, Dalhousie University

Co-directeur de thèse

Mr. Pierre FRÉON, PhD, IRD

Directeur de thèse

Mr. Sylvain PERRET, PhD, CIRAD

Examineur

## Acknowledgements

These three years of PhD thesis have been very educative, in various ways. I trust I have grown both as a researcher and as a person during this endeavour.

I would like to thank, in the very first place, my dear supervisor and benevolent yet strict and scientifically righteous boss **Dr. Pierre Fréon**, who believed in me from the beginning, and successfully guided me into developing a limited yet (over)confident knowledge on sustainability issues of and sustainability assessment strategies for fishfood systems.

IRD-DSF financed my research and my life for three years. Merci beaucoup!

The long list of people I worked with, who guided me, made me a better researcher and helped me find the tip of the path to science is long. For instance, Peter Tyedmers thought me to isolate what matters, while the other members of my thesis committee (Jorge Tam, Isabel Quispe, Marc Legendre, Sylvestre Voisin and Christian Mullon) asked me many insightful and relevant questions towards a more coherent research. Jesús Núñez took me to Iquitos and showed me the ways of rainforest aquaculture. The DISCOH chiefs (Arnaud Bertrand, Gilles Domalain et al.) financed my data-harvesting adventures in Peru, from Tacna to Puno to Chimbote, and even my show-off visit to the LCAFood 2012 conference in St. Malo. Isabel Quispe hosted me in Lima, Peter Tyedmers in Halifax, Philippe Roux and Marc Legendre in Montpellier, Pierre Fréon everywhere. My external reporters Friederike Ziegler and Catherine Mariojouis especially have my endless gratefulness, as do the remaining members of my defense jury: Pierre, Peter, Arnaud Hélias and Sylvain Perret.

Other colleagues who helped me and/or with whom I collaborated include (in no particular chronological or affective order):

From Peru: Rosa Amelia Vinatea, Marilyn Montesinos, Federico Iriarte, Mariano Gutiérrez, Oscar Francisco Miro, Juan Carlos Sueiro, Santiago de la Puente, Camilo Cuba, Wilbert Marin Soto, Richard Negrón, Marilú Bouchon, Yuri Landa, Sigbjørn Tveterås, Carlos Paredes; and countless researchers and scientists from IMARPE and ITP, among other institutions, as well as various actors in the anchoveta supply chains.

From France: Joël Aubin, Christian Chaboud, Diane Cambrillat, Stéphane Ralite, Pascale Talamond and Philippe Roux (and the ELSA team).

From Canada: Nathan Ayer, Nathan Pelletier, Rob Parker, Keegan McGrath and Ahmed Khan.

From the rest of the world: Ian Vázquez-Rowe, Sara Hornborg, Patrik Henriksson and Steven Prescott.

The ~~bloodthirsty~~ reviewers who contributed to improve my papers have also a place in my heart.

How to forget my loving family, my beloved, and so many friends from around the world who bore with me during my ups, downs and gastritis?

Finally, and just because:



*Moloch is my shepherd, I shall not want.*

## Abstract

The research performed a sustainability assessment of supply chains of the *anchoveta* (*Engraulis ringens*) in Peru. The corresponding fisheries lands 6.5 million t per year, of which <2% is rendered into products for direct human consumption (DHC) and 98% reduced into feed ingredients (fishmeal and fish oil, FMFO), for export. Several industries compete for the anchoveta resources, generating local and global impacts. The need for understanding these dynamics, towards sustainability-improving management and policy recommendations, determined the development of a sustainability assessment framework: 1) characterisation and modelling of the systems under study (with Life Cycle Assessment and other tools) including local aquaculture, 2) calculation of sustainability indicators (i.e. energy efficiency, nutritional value, socio-economic performances), and 3) sustainability comparison of supply chains; definition and comparison of alternative exploitation scenarios.

Future exploitation scenarios were defined by combining an ecosystem and a material flow models: continuation of the *status quo* (Scenario 1), shift towards increased proportion of DHC production (Scenario 2), and radical reduction of the anchoveta harvest in order for other fish stocks to recover and be exploited for DHC (Scenario 3). Scenario 2 was identified as the most sustainable.

Management and policy recommendations include improving of: controls for compliance with management measures, sanitary conditions for DHC, landing infrastructure for small- and medium-scale (SMS) fisheries; the development of a national refrigerated distribution chain; and the assignation of flexible tolerances for discards from different DHC processes.

**Keywords:** *Anchoveta*; *Engraulis ringens*; fisheries; fuel use efficiency; Life Cycle Assessment; Peru; supply chain modelling; sustainability assessment.

## Résumé

La recherche a porté sur l'évaluation de la durabilité des filières d'anchois (*Engraulis ringens*) au Pérou. Les pêcheries locales débarquent 6,5 millions de t par an, dont <2% sont transformés en produits destinés à la consommation humaine directe (CHD) et 98% en farine et huile de poisson (FHP), destinées à l'exportation. Plusieurs industries sont en concurrence pour les ressources d'anchois, générant des impacts locaux et mondiaux. La nécessité de comprendre ces dynamiques, dans un but de recommandations de gestion et de politique de développement durable, a déterminé le développement d'un cadre d'évaluation de la durabilité: 1) caractérisation et modélisation des filières étudiées (avec l'évaluation du cycle de vie et autres outils) incluant l'aquaculture locale, 2) calcul d'indicateurs de durabilité (efficacité énergétique, valeur nutritive, performances socio-économiques), et 3) comparaison de la durabilité des chaînes d'approvisionnement; définition et comparaison de scénarios alternatifs d'exploitation.

Les scénarios d'exploitation ont été définis en combinant un modèle écosystémique et un modèle de flux de matières: maintien du *status quo* (Scénario 1), augmentation de la proportion de production destinée à la CHD (Scénario 2), et réduction radicale des captures d'anchois dans le but du rétablissement et de l'exploitation d'autres stocks de poissons dont les captures seraient destinées à la CHD (Scénario 3). Le Scénario 2 a été identifié comme étant le plus durable.

Les recommandations de gestion et de politique comprennent l'amélioration: des contrôles de conformité aux mesures de gestion, des conditions sanitaires pour la CHD, des infrastructures pour le débarquement des pêcheries artisanales; le développement d'une chaîne nationale de distribution réfrigérée; et l'attribution de tolérances flexibles pour les rejets liés à différents processus de production pour la CHD.

**Mots clés:** Analyse du Cycle de Vie, *anchoveta*, chaîne d'approvisionnement, efficacité de la consommation de carburant, énergie, *Engraulis ringens*, évaluation de la durabilité, pêche, Pérou.

## Resumen ejecutivo

La investigación llevó a cabo un análisis de sostenibilidad de las cadenas productivas de la *anchoveta* (*Engraulis ringens*) en Perú. La pesquería correspondiente desembarca 6.5 millones de toneladas al año, de las cuales <2% es procesado en productos para el consumo humano directo (CHD) y 98% es reducido en ingredientes para alimentos balanceados (harina y aceite de pescado, HP-AP), para exportar. Varias industrias compiten por el recurso anchoveta, generando impactos locales y globales. La necesidad de comprender dichas dinámicas, en pro de recomendaciones de manejo y política que mejoren su sostenibilidad, determinaron la construcción de un marco de evaluación de la sostenibilidad: 1) caracterización y modelado de los sistemas estudiados (con Análisis de Ciclo de Vida y otras herramientas) incluyendo acuicultura local, 2) cálculo de indicadores de sostenibilidad (i.e. eficiencia energética, valor nutricional, rendimiento socio-económico), y 3) comparación de la sostenibilidad de las cadenas productivas; definición y comparación de escenarios alternativos de explotación.

Los escenarios de explotación futuros fueron definidos combinando dos modelos, uno ecosistémico y otro de flujo de materiales: continuación del *status quo* (Escenario 1), incremento de la proporción de productos de CHD (Escenario 2), y reducción drástica de las capturas de anchoveta para permitir que otras poblaciones de peces se recuperen y puedan ser explotadas (Escenario 3). El Escenario 2 fue identificado como el más sostenible.

Recomendaciones de manejo y política incluyen la mejora de: controles para el cumplimiento de las medidas de manejo, condiciones sanitarias de CHD, infraestructura de desembarque para pesquerías de pequeña y mediana escala; así como el desarrollo de una cadena de distribución de pescado refrigerada; y la asignación de tolerancias flexibles para los descartes de los diferentes procesos para CHD.

**Palabras clave:** Análisis de Ciclo de Vida, *anchoveta*, cadena de suministros, eficiencia del uso de combustible, energía, *Engraulis ringens*, evaluación de la sostenibilidad, pesca, Perú.

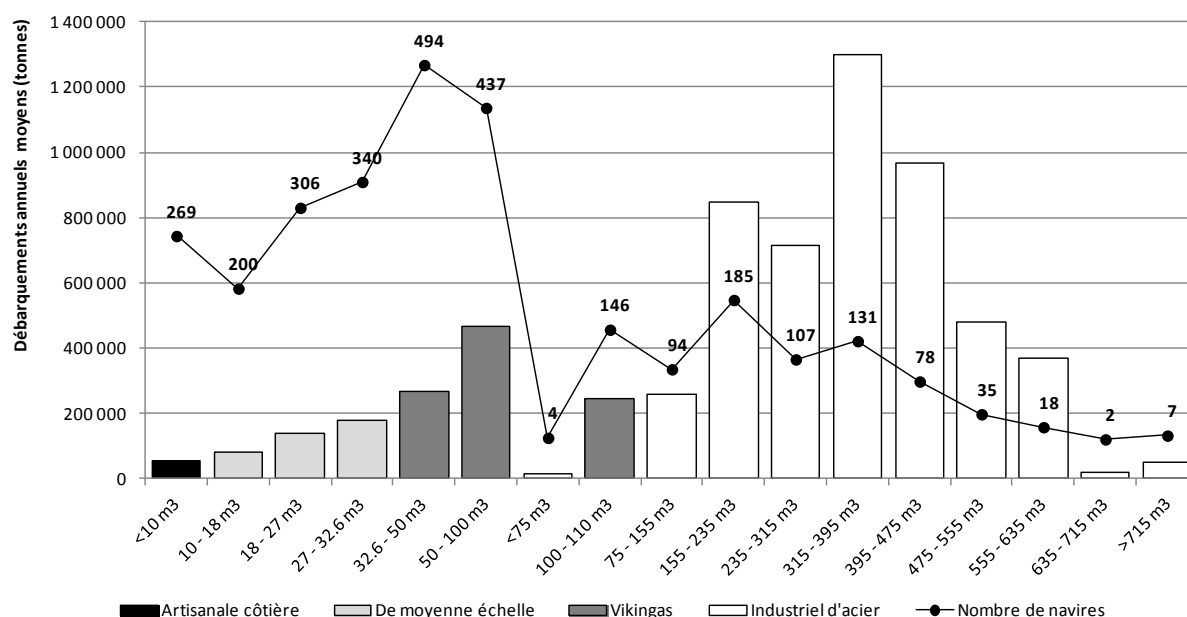
## Résumé substantiel

La durabilité des systèmes alimentaires comporte plusieurs dimensions d'intérêt, y compris les aspects environnementaux, socio-économiques et technologiques, ainsi que la sécurité alimentaire, les modes de consommation et d'information, et les aspects de gouvernance/politique.

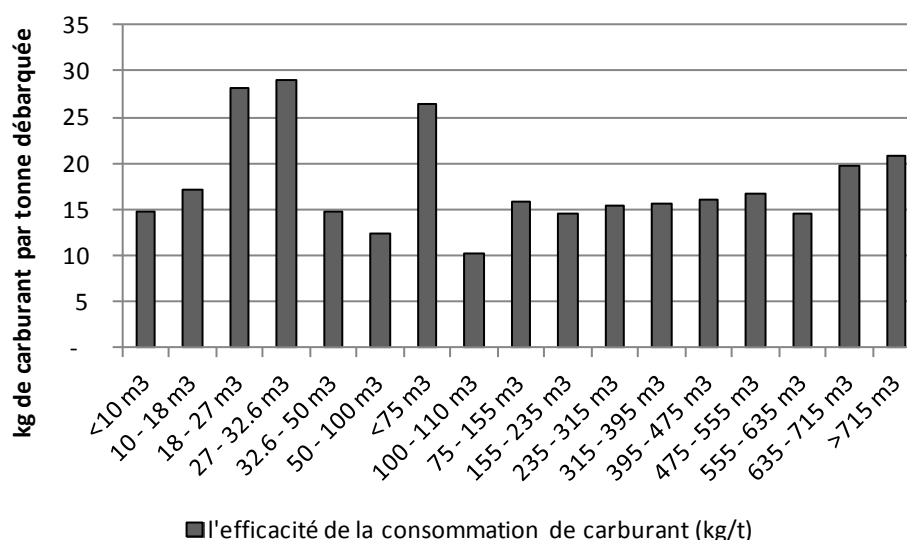
Les systèmes de production agricoles, halieutiques et aquacoles nourrissent le monde. Malgré la petite taille relative du système économique mondial de produits de la mer par rapport à l'agriculture, il englobe des réseaux socio-économiques complexes ayant un impact considérable sur l'environnement. Au plan économique, les produits de la mer représentent environ 10% des exportations agricoles totales en termes de valeur, et montrent une tendance croissante. La pêche et l'aquaculture (y compris la conchyliculture) ont fourni 142 millions de tonnes de poisson dans le monde en 2008 (dont près de 20% ont été utilisés pour la consommation humaine indirecte, par exemple pour la production de farines et huiles de poisson). Au niveau nutritionnel, les poissons représentent plus de 20 % de l'apport protéinique d'origine animale dans les pays à faible revenu et à déficit alimentaire. L'industrie des produits de la mer fournit plus de 180 millions d'emplois dans le monde, ce qui représente le moyen de subsistance de 8% de la population mondiale. Pour ces raisons, il est impératif d'appliquer les principes de durabilité pour l'évaluation et la gestion des systèmes pêche et d'aquaculture maritimes.

Ce travail de recherche porte sur l'évaluation de la durabilité des chaînes d'approvisionnement de l'anchois (*Engraulis ringens*) au Pérou. La pêcherie correspondante possède la plus grande flotte nationale destinée à une seule espèce, dans le monde entier. Cette flotte hétérogène (Fig. A) a débarqué en moyenne 6,5 millions de tonnes par an au cours de la période 2001-2010. Un faible pourcentage de la capture est destiné à la consommation humaine directe (CHD), tandis que la majorité des prises est réduite en farine et huile de poisson (FHP), puis exportée pour l'alimentation d'animaux d'élevage aquacole ou terrestre, principalement en Asie et en Europe. La flotte de pêche à l'anchois est concentrée dans deux principaux grands segments opérant sous des régimes juridiques différents: la flotte industrielle d'une part, et celle artisanale côtière et de moyenne échelle (ACME) d'autre part. La flotte industrielle (navires de plus de 32,6 m<sup>3</sup> de capacité de cales) comprend des navires en acier et des navires en bois surnommé « *Vikingas* ». La flotte artisanale côtière comprend les navires de moins de 10 m<sup>3</sup> de capacité de cale, tandis que ceux de la flotte de moyenne échelle ont une capacité de 10 à 32,6 m<sup>3</sup>. Les navires artisanaux diffèrent également de ceux de moyenne échelle de par leur niveau de technicité; les unités de pêche artisanales sont caractérisées par l'importance du travail manuel à bord et par l'usage d'une technologie de base. La capture de la flotte de bateaux d'acier représente environ 81% des captures totales d'anchois destinées à la FHP, tandis que les *Vikingas* en capturent 19%. Les débarquements de l'ensemble de la flotte industrielle destinés à la consommation humaine indirecte (FHP) représentent plus de 98 % des captures totales, tandis que les débarquements de la flottille d'ACME pour la CHD (frais, congélation, conserves en boîtes, semi-conserves salées, salaisons) représentent entre 1 et 2% des captures totales, selon les statistiques officielles.

a) Débarquements moyens annuels (période 2005-2010) et nombre de navires par sous-segments de capacité de cale



b) Intensité de la consommation de carburant (moyenne pondérée 15 kg/t)



**Fig. A** Principales caractéristiques des pêcheries d’anchois du Pérou

Plusieurs filières halieutiques et aquacoles entrent en compétition pour l’utilisation de la ressource anchois, générant une série d’impacts sur l’écosystème marin du Pérou, sur la société, ainsi que sur l’environnement et l’économie mondiale. La compréhension aussi exhaustive que possible de ces dynamiques et des impacts associés est la motivation de ce travail de recherche, de manière à ce que les décideurs tout au long des filières soient informés, et que des mesures soient prises pour améliorer la durabilité de la pêche et des industries de produits de mer à base d’anchois. La principale question que pose cette recherche est donc de savoir si la fourniture d’un tableau de bord d’indicateurs et la construction de scénarios peut être utilisés pour évaluer le niveau d’optimisation de l’équilibre entre les différentes composantes de la chaîne d’approvisionnement d’anchois (au niveau des performances

énergétiques, alimentaires, écologiques, environnementales et socio-économiques). Pour y répondre, un cadre conceptuel est proposé pour évaluer la performance de la durabilité des systèmes de produits de la mer, à un niveau élevé d'agrégation (c'est à dire ne prenant pas en compte les organisations et des entreprises individuelles, mais les secteurs). Il couvre trois phases principales :

1. Caractérisation et modélisation des flux biophysiques et socio-économiques associés aux systèmes de produits de la mer étudiés.
2. Comparaison de la durabilité des chaînes d'approvisionnement à l'aide d'un ensemble d'indicateurs de développement durable (couvrant l'énergie, la nutrition, les aspects écologiques, environnementaux, sociaux et économiques).
3. Détermination et simulation de scénarios alternatifs d'exploitation et d'usage de l'anchois basés sur différentes options politiques et sur la modélisation bioéconomique.

Enfin, le but ultime de la recherche est de fournir des recommandations stratégiques et de gestion basées sur les résultats d'évaluations/comparaisons.

Les phases 1) et 2) sont dans une certaine mesure simultanée, du fait que la sélection des indicateurs de durabilité souhaités détermine dans une large mesure la direction et la complexité de l'effort de caractérisation (collecte et traitement des données).

L'étude des flux biophysiques illustre les interactions écosystème/industrie et fournit des données sur les flux et les stocks de matières et d'énergie qui se produisent le long de la chaîne d'approvisionnement, y compris leurs effets sur l'environnement. De son côté, l'analyse des flux socio-économiques offre un aperçu sur les dynamiques sociales et économiques se produisant en parallèle à celles des matériaux. En comprenant le système à partir d'au moins ces trois perspectives, la durabilité peut être évaluée.

Le cadre comptable biophysique utilisé est celui de l'analyse du cycle de vie (ACV) (EC- JRC, 2010; ISO 2006) et le logiciel Simapro© couplée avec la base de données internationale ecoinvent (Ecoinvent, 2012). L'ACV est une approche mature, et les méthodes d'évaluation des impacts du cycle de vie actuelles englobent une grande diversité de catégories d'impact environnemental.

Un certain nombre d'indicateurs d'efficacité énergétique, de valeur nutritionnelle et de composantes socio-économiques pour l'industrie des produits de mer ont été sélectionnés à partir de la littérature existante, à savoir l'utilisation biotique des ressources, la demande cumulée d'énergie, le retour sur investissement de l'énergie industrielle (incluse dans le produit), les impacts sur les ressources biotiques naturelles au niveau des espèces et au niveau de l'écosystème, le niveau trophique moyen des débarquements, le pourcentage de prédateurs dans les débarquements d'espèces commerciales, l'inverse de la pression de pêche, les indicateurs de l'ACV, un indice nutritionnel personnalisé, l'emploi, les coûts de production, la valeur ajoutée et le profit.

L'indice nutritionnel retenu a été adapté à partir d'indices bien établis dans la littérature. Il tente de combler les carences nutritionnelles existantes au Pérou, qui ont été identifiés comme étant les sels minéraux, les vitamines et autres carences en macro- et micro-éléments, en particulier en vitamine A et fer, et les insuffisances d'apports caloriques et protéiniques. Les nutriments retenus pour l'évaluation sont donc les protéines, les acides gras Oméga-3, les acides gras non-saturés (EPA + DHA), les autres lipides non saturés (y compris les acides gras Oméga-6), la vitamine A, les vitamines B -12 et D, le calcium, le potassium et le phosphore, le fer (substances nutritives bénéfiques); et le sodium et les acides gras saturés (substances nutritives à limiter).

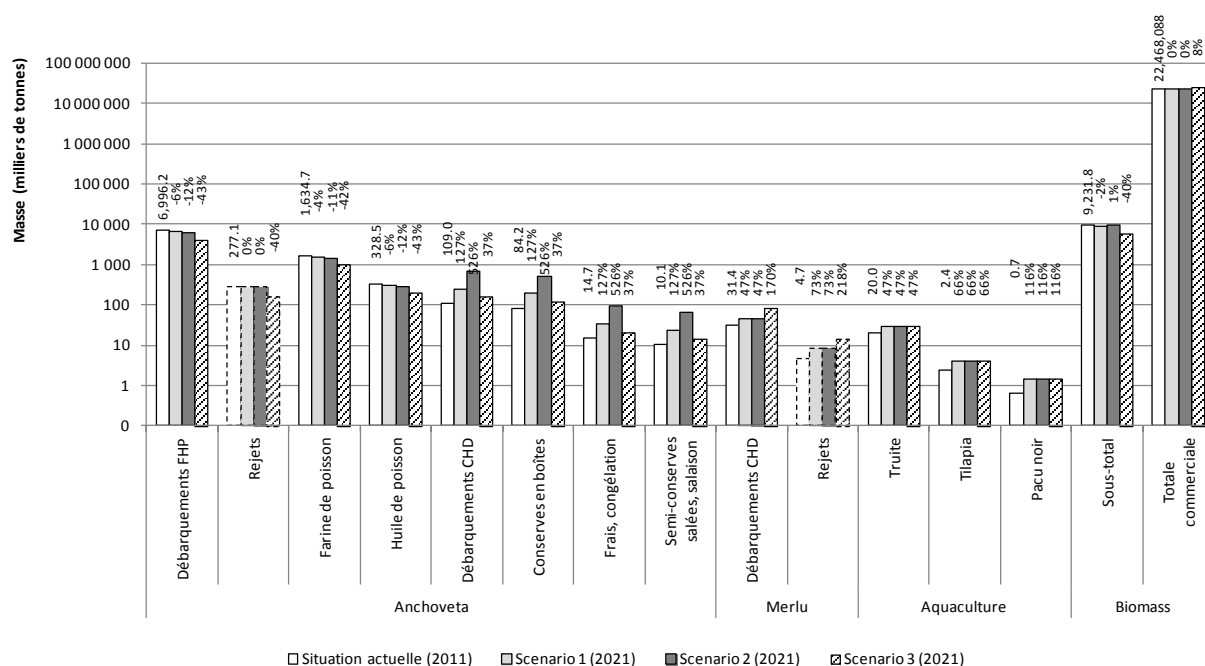


L'emploi et les indicateurs économiques ont été calculés sur la base des données obtenues à partir de la littérature et des principales parties prenantes industrielles et de recherche au Pérou. Néanmoins, l'essentiel de l'effort d'analyse s'est concentré sur les dimensions écologiques et environnementales.

Les scénarios d'exploitation ont été définis par le couplage d'un modèle écosystémique avec un modèle de flux de matières et d'énergie. Le couplage de modèles a été conçu comme un moyen d'identifier et d'analyser les interactions unilatérales écosystème/anthroposphère. Le modèle écosystémique retenu est un modèle trophique du Système du Courant de Humboldt Nord (SCHN), développé dans *Ecopath with Ecosim* (EwE) et fondée sur une utilisation antérieure de ce modèle pour le SCHN. Le domaine du modèle écosystémique s'étend de 4°S à 16°S, et 60 miles nautiques au large, couvrant une superficie d'environ 165 000 km<sup>2</sup>, et comporte 32 groupes fonctionnels. Le modèle a été ajusté aux séries chronologiques historiques de biomasse et de captures des principales ressources halieutiques de 1995 à 2003. Après cette période, les simulations de scénarios ont été exécutées pour la période 2004-2033, mais l'année 2011 a été choisie pour représenter la situation actuelle et l'année 2021 retenue comme année de référence pour les trois scénarios.

La modélisation des flux de matériel et d'énergie a été réalisée avec Umberto©, un outil de modélisation des flux industriels. Cette sélection d'outils et d'approches de modélisation est fortuite: toute combinaison de modèles couplés associant un modèle écosystémique exhaustif et un modèle de flux de matière et d'énergie serait appropriée, surtout si ce couplage peut être dynamique.

Les scénarios étudiés incluent une projection du *statu quo* (scénario 1), une évolution vers davantage de CHD au détriment de la production de FHP (scénario 2) et un scénario de diversification radicale qui réduit de moitié la mortalité par pêche de l'anchois afin que d'autres stocks de poissons se rétablissent et puissent être exploités pour la CHD (scénario 3). Les principales biomasses associées aux scénarios modélisés sont présentés dans la Fig. B.



**Fig.B** Principales biomasses associées à des scénarios modélisés, en milliers de tonnes (notez l'échelle logarithmique des masses)

Les principales conclusions de cette recherche, utilisées comme base pour des recommandations stratégiques et de gestion, sont les suivantes :

- La pêche de l’anchois affiche la plus faible intensité de consommation de carburant au monde. Toutefois, la consommation de carburant est la principale source d’impacts environnementaux et sur les coûts. Parmi les flottes d’anchois, les flottes industrielles montrent une performance d’usage du carburant (kg de carburant par tonne d’anchois débarqués) au moins deux fois supérieures à celle des flottes ACME, en raison des économies d’échelle. Néanmoins, la flotte industrielle *Vikinga* est plus efficace, au niveau de l’impact environnemental, que la flotte ACME et que la flotte industrielle des bateaux d’acier en raison d’une combinaison d’économies d’échelle et de stratégies de pêche. Il en va de même pour les plus petits bateaux de la flotte ACME (flottille artisanale), pour les deux même raisons à laquelle se rajoute la plus grande concentration d’anchois dans les zones côtières exploitées par cette flottille. En outre, le nombre absolu d’emplois fournis par les pêcheries industrielles est beaucoup plus grand au Pérou que celui des pêcheries d’ACME. Cela est dû au plus grand développement de la pêche industrielle; toutefois, comme dans les études précédentes, les flottes d’ACME génèrent plus d’emplois par tonne débarquées (à la fois en masse et en termes monétaires) que la flotte industrielle, plus de poissons pour la CHD et moins de rejets en mer. En ce qui concerne les indicateurs d’impact environnemental, la performance des flottes d’ACME est environ 50% moins bonne que celle des flottes industrielles, telle qu’évaluée par un score unique des impacts du cycle de vie, et >70% moins bonne selon les catégories individuelles clés d’impact sur l’environnement. Il reste que, en valeur absolue, la flotte d’ACME est la moins impactante, surtout parce qu’elle consomme beaucoup moins de carburant par an (mais évidemment génère moins débarquements que les autres flottes). En conséquence, l’effort sur l’amélioration de l’impact environnemental doit être consacré en priorité aux flottes industrielles, en particulier pour le segment de la flotte de l’acier, parce que sa prépondérance dans les débarquements est peu susceptible de changer radicalement. Il est donc logique de penser que les meilleures opportunités pour améliorer les performances de durabilité des pêcheries d’anchois se situent avant tout sur l’amélioration de cette flotte en particulier. Bien sûr, les autres flottes ne peuvent pas être négligées, et certains chercheurs ont suggéré un certain nombre de mesures d’amélioration telles que l’augmentation de la technification (par exemple, acoustique et d’autres équipements électroniques) et l’usage de matériaux de construction alternatifs.
- La pêche illégale, non déclarée et non réglementée parasite les pêcheries d’anchois, en grande partie en raison de failles dans la législation actuelle, de défaillances dans sa mise en application et du manque de contrôle, entre autres raisons complexes.
- En ce qui concerne la réduction en FHP, l’utilisation du gaz naturel comme source d’énergie est plus opportune en termes de plusieurs dimensions de l’analyse, notamment l’environnementale et l’économique. La farine résiduelle dispose d’une efficacité alimentaire moindre (ratio poisson frais/farine) que les autres qualités de farine. Certaines usines de farine résiduelle sont utilisées pour traiter illégalement du poisson frais en lieu et place des résidus et déchets de CHD.
- Parmi les systèmes d’aquaculture en eau douce étudiés —truite, pacu noir (*Colossoma macropomum*) et tilapia—, les aliments aquacoles pour truites génèrent des impacts environnementaux plus élevés que les aliments aquacoles pour les autres (espèces herbivores/omnivores). Une tendance similaire est observée pour l’élevage de ces espèces, principalement en raison de la contribution des aliments aquacoles dans leurs pressions

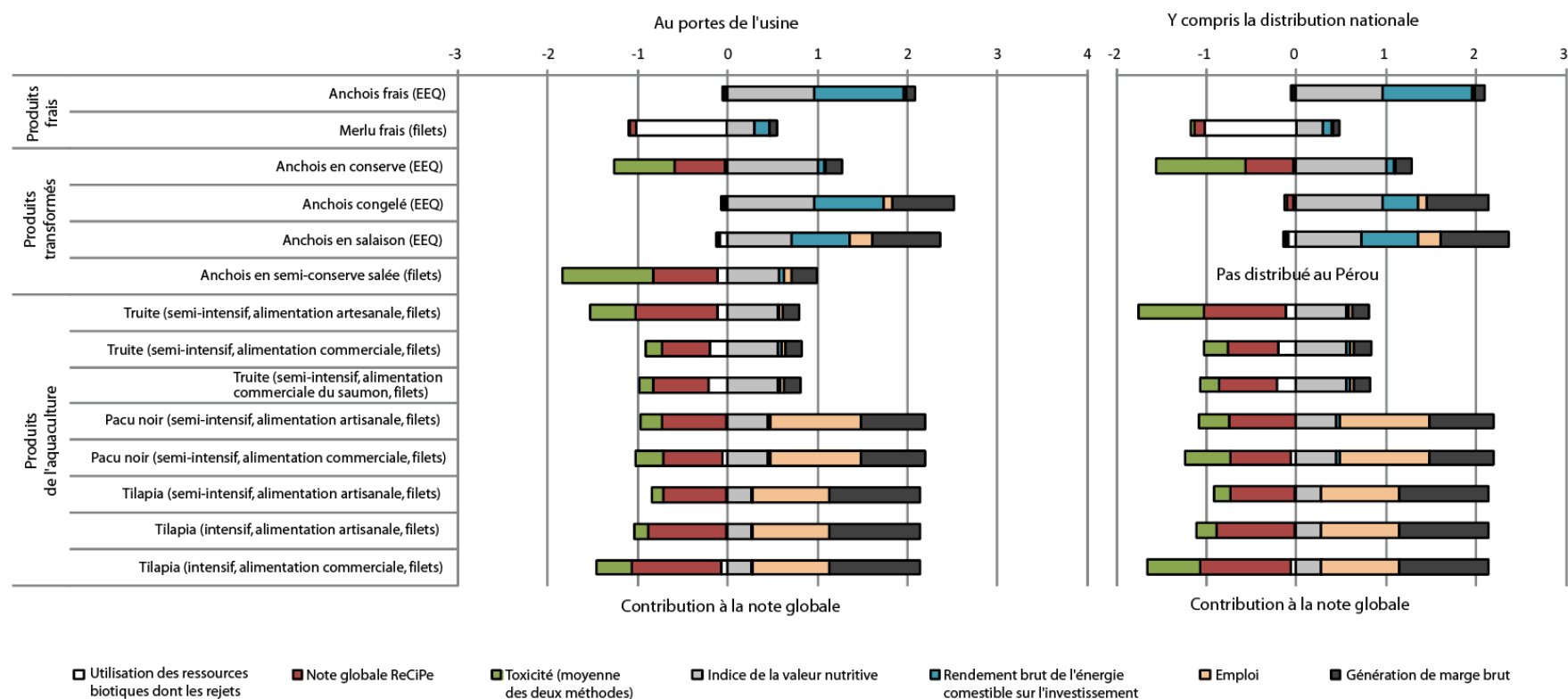
environnementales. Quelle que soit l'espèce, la substitution des aliments artisanaux par des aliments commerciaux, en dépit de l'amélioration systématique des taux de conversion alimentaire (TCA), ne réduit pas toujours les impacts environnementaux globaux. Cela est dû à l'utilisation d'énergie supplémentaire et, dans une moindre mesure, à des exigences de transports associés à l'usage d'aliments du commerce. La performance environnementale des ingrédients des aliments est fortement influencée par leur degré de transformation, en particulier par la contribution énergétique des activités spécifiques de traitement. Parmi les espèces étudiées, l'aquaculture du pacu noir montre la meilleure performance environnementale. Compte tenu de l'importance des aliments dans les effets globaux du cycle de vie des produits d'aquaculture, l'industrie péruvienne des aliments aquacoles devrait préférentiellement s'approvisionner d'entrants moins raffinés et, en général, moins impactant sur l'environnement, dans la mesure où le rendement de la pisciculture n'en est pas pour autant fortement affecté, en particulier le TCA et la structure des coûts. Par exemple, des produits à base de soja bolivien doivent être préférés à ceux du Brésil ; la farine de poisson de haute qualité doit être préférée à celle de qualité inférieure ; les concentrés de protéines doivent être évités, etc.

- En ce qui concerne l'impact environnemental des produits de CHD à base d'anchois, à savoir, en conserve, semi-conserve salée, salaison et congelé ; les produits les plus raffinés (produits en conserve et semi-conserves) représentent une charge plus lourde que les produits moins raffinés (salaisons, surgelés). En outre, les produits hautement transformés et à forte intensité énergétique (anchois en conserve ou semi-conserve) représentent une charge plus lourde que les produits moins énergivores (anchois en salaisons et congelés, produits de l'aquaculture). Cette tendance est confirmée lorsque l'on compare tous les produits par rapport à leur ratio énergie industrielle sur énergie nutritionnelle. En ce qui concerne les autres dimensions de l'analyse, la tendance est similaire : les produits d'anchois en salaisons et congelés génèrent moins d'emplois et un profit inférieur que des conserves et semi-conserves, et beaucoup moins que les produits de l'aquaculture. Les produits dérivés de l'anchois disposent de meilleures propriétés nutritionnelles que les produits de l'aquaculture. Dans l'ensemble, les industries moins énergivores (congélation et salage d'anchois) sont moins satisfaisantes en termes d'impact économique, mais offrent une meilleure valeur nutritive et un plus faible impact environnemental. Les produits de l'aquaculture maximisent le profit et la création d'emplois, mais disposent d'une efficacité énergétique et d'une valeur nutritionnelle plus faible que des produits à base d'anchois pour la CHD. Les produits en conserve sont parfois préférables pour améliorer la nutrition des communautés vulnérables (et souvent distantes des lieux de production) au Pérou, en raison de leur longue durée de vie et leur facilité de transport et de stockage. Cependant, le prix élevé et les préférences des consommateurs remettent en cause cet avantage. Le dilemme pourrait être résolu par la mise en œuvre d'une chaîne de froid pour les poissons frais et congelés, malgré l'augmentation des impacts sur l'environnement associé, en particulier si la chaîne s'étend dans les régions montagneuses du pays. Une autre solution serait d'améliorer le système de conditionnement actuel, de remplacer les boîtes métalliques par des emballages en plastique ou composites afin de réduire les coûts et les impacts de la production et du transport sur l'environnement.
- Lors de la modélisation de la distribution nationale des produits de CHD (plus celle des chaînes frigorifiques si nécessaire), la performance environnementale globale des produits de CHD et d'aquaculture augmente avec une large gamme d'intensités (de 3% pour les produits en conserve à 250% pour les produits congelés). Néanmoins, le classement environnemental relatif

de tous les produits étudiés ne change pas de manière significative car la distribution constitue en général une contribution mineure des impacts totaux des produits les plus impactants.

Une comparaison et un classement de tous les produits finaux de DHC de toutes les chaînes d'approvisionnement étudiés sont présentés dans la Fig. C, à la fois à la porte de l'usine et incluant la distribution.

En ce qui concerne la comparaison de scénarios, le scénario 2 présente une meilleure contribution en termes de durabilité au Pérou, en raison d'un meilleur compromis entre les impacts environnementaux, sociaux et économiques (négatifs ou positifs), déterminé par la part accrue des produits de CHD. Une telle augmentation nécessiterait de relever le défi de trouver un marché pour ces produits, idéalement en grande partie au Pérou, mais aussi dans les marchés d'exportation. Dans tous les scénarios, la contribution à la durabilité de la pêche et de l'aquaculture sera renforcée par une chaîne de distribution réfrigérée nationale. Le scénario 3 montre de mauvaises performances mais mérite une exploration plus poussée (diminution moins drastique des FHP, prise en compte des changements dans davantage d'espèces de l'écosystème, en particulier toutes les espèces commerciales et toutes celles ayant un potentiel d'exploitation touristique).



**Fig. C** Classement de tous les produits de DHC des chaînes d’approvisionnement d’anchois étudiées, selon l’ensemble d’indicateurs proposé, par tonne de poisson dans le produit (les plus courtes barres négatives et les plus longues barres positives représentent une meilleure performance). L’intervalle maximal possible dans la partie de droite du graphique est le même que celui de la partie gauche (-3 à 4), mais sa taille affichée a été réduite par commodité. HGT: étêté, éviscéré, équeuté

Plusieurs sources d'incertitude ont été identifiées et traitées, à savoir celles liées à l'ACV, la modélisation de l'écosystème et le couplage des modèles. Les résultats ont identifié d'assez fortes tendances de la performance environnementale et socio-économique de la chaîne d'approvisionnement d'anchois, de telle manière que des conclusions relativement robustes ont pu être proposées et que des conseils pour améliorer la durabilité ont pu être donnés. Les limites de ces conclusions ont toutefois été identifiées et discutées dans le cadre de leur transférabilité vers les organes de décision. Il s'agit en particulier :

- Des choix méthodologique en ACV : approche attributionnelle plutôt que conséquentielle, méthode d'allocation des impacts, critères de limite du périmètre, imprécision et incomplétude des catégories d'impacts, usage d'approximations dans la régionalisation des facteurs de caractérisation, etc.
- Du choix des indicateurs de soutenabilité retenus.
- Des simplifications inhérentes aux modélisations en général et plus particulièrement à celle, très amont, de l'écosystème marin, susceptible de générer une longue propagation d'erreur.

Des recommandations de gestion pour améliorer la performance des chaînes d'approvisionnement basées sur l'anchois peuvent être envisagées:

- Améliorer l'isolation des cales à poisson à bord des bateaux et faire respecter l'utilisation de la glace (ou des techniques de conservation de substitution) pour les navires débarquant du poisson pour la CHD. Cette mesure permettrait d'améliorer la qualité de l'anchois et d'augmenter ses quantités débarquées pour la CHD. Cela permettrait en outre d'améliorer les conditions sanitaires.
- Améliorer la sensibilisation des pêcheurs et du personnel de contrôle aux points de débarquement sur les questions sanitaires. Les conditions sanitaires de manipulation des poissons étant toujours un problème dans de nombreux points de débarquement au Pérou, une amélioration de cette situation serait très vraisemblablement susceptible d'augmenter la consommation de poisson frais, y compris celle des anchois.
- Construction/optimisation d'infrastructures de débarquement et de quais publics pour la pêche ACME. Cette initiative permettrait ici encore d'améliorer les conditions sanitaires de la manipulation du poisson et de stimuler la production et la consommation de produits de CHD.
- Développer des chaînes de froid pour les produits de la mer. Il s'agit d'une mesure essentielle à entreprendre en vue d'améliorer la consommation de poisson au Pérou, en particulier dans les hautes terres et les collectivités isolées.
- Améliorer les pratiques d'aquaculture par la mise en œuvre de meilleures pratiques de gestion, en particulier par les producteurs artisans, afin d'optimiser les TCA au moyen d'une meilleure gestion de l'alimentation (par exemple calcul de rations quotidiennes; alimentation variée selon les stades de développement). Une approche globale, combinant une meilleure gestion de l'aquaculture et des aliments de bonne qualité (qui optimisent les caractéristiques nutritionnelles et la performance environnementale) est souhaitable. En outre, et afin d'améliorer les performances environnementales, les producteurs d'aliments devraient favoriser les ingrédients agricoles moins néfastes pour l'environnement (par exemple le maïs et le riz locaux, la farine de soja bolivienne au lieu de brésilienne). Il en va de même pour la faible intégration des produits extrêmement raffinés (par exemple les aliments incorporant du gluten, des extraits de protéines, des huiles végétales avec des impacts liés à la transformation de terres naturelles élevées, etc.; dans la mesure où les TCA ne sont pas compromis).

Les recommandations de politique des pêches sont également proposés, dont certains sont basés sur l'analyse critique de la littérature et représentent les opinions consensuelles de scientifiques et d'autres analystes au Pérou:

- Attribuer des seuils de tolérances flexibles pour les rejets de différents processus de CHD, en fonction de leurs exigences inhérentes de qualité. Le seuil actuellement fixé à 40% pour tous les débarquements destinés à la CHD est arbitraire, car les différentes industries de CHD disposent de différents niveaux d'adaptabilité aux variations de qualité de la matière première. La mesure contribuerait également à réduire la taille de l'industrie de production de farine de poisson issue de la pêche illégale.
- Permettre le développement de la chaîne d'approvisionnement d'anchois frais. Actuellement, les navires de la flotte ACME CHD sont tenus par la loi de livrer du poisson aux usines de transformation pour la CHD seulement. Une légalisation de la vente directe en frais/réfrigéré, actuellement limitée, est donc nécessaire, en plus de l'amélioration des infrastructures et de la distribution.
- Homogénéiser et rationaliser la législation de la pêche, afin de permettre une approche écosystémique de la gestion des pêches solide, en résolvant les problèmes existants associés à l'existence de plusieurs régimes pour les différentes flottes de pêche d'anchois.

Cette thèse de doctorat s'insère dans le projet Anchoveta Supply Chain (ANCHOVETA-SC, <http://anchoveta-sc.wikispaces.com>), et constitue une contribution au Laboratoire Mixte International «Dynamique du Système du Courant de Humboldt» (LMI-DISCOH) coordonné par l'Institut de Recherche pour le Développement (IRD) et l'Instituto del Mar del Perú (IMARPE), et regroupant plusieurs autres institutions. Elle a été réalisée sous le parrainage de la Direction des programmes de Recherche et de la formation au Sud (DPF) de l'IRD. Le projet a démarré au début 2010, mais la collecte de données complémentaires pour la réalisation de cette thèse a été effectuée de Juillet 2011 à Avril 2013. La publication fondatrice de l'ensemble projet est Fréon et al. (2010). Le projet comprend un grand nombre de scientifiques, d'étudiants et de chercheurs, à la fois au Pérou et à l'étranger, ainsi que plusieurs institutions péruviennes clés. En particulier, la coopération avec l'IMARPE (<http://www.imarpe.pe/imarpe/>) et son Ministère de tutelle PRODUCE (<http://www.produce.gob.pe/>), l'ITP (<http://www.itp.gob.pe/webitp/>), l'Instituto de Investigaciones de la Amazonía Peruana (IIAP, <http://www.iiap.org.pe/>), Universidad Nacional Federico Villareal (<http://www.unfv.edu.pe/site/>), la Pontificia Universidad Católica del Perú (<http://www.pucp.edu.pe/en/>), un projet de développement de la truite du gouvernement régional de Puno (PETT, <http://pett.regionpuno.gob.pe/>) et le Centre de durabilité de l'environnement à l'Universidad Peruana Cayetano Heredia (<http://csa-upch.org/>), entre autres, ont été la cruciaux lors de la collecte de données primaires et secondaires. Un certain nombre de visites sur le terrain ont été réalisées par le doctorant, y compris: certains ports péruviens de pêche, des usines de farine de poisson, des usines de transformation du poisson (mise en conserve, congélation, salage), des fabriques de glace et chantiers navals, ainsi que des usines d'aliments aquacoles et des fermes d'aquaculture dans les principales régions productrices du Pérou. Les données secondaires ont été obtenues à partir de la littérature primaire et « grise », y compris des jeux de données non publiés. Le corpus de cette thèse résume les résultats de recherche présentés sous la forme de neuf articles se trouvant à divers stades du processus d'évaluation et de publication, présentées en annexes.

**Mots clés:** Analyse du Cycle de Vie, *anchoveta*, chaîne d'approvisionnement, efficacité de la consommation de carburant, énergie, *Engraulis ringens*, évaluation de la durabilité, pêche, Pérou.

## Table of contents

|   |     |
|---|-----|
| Acknowledgements .....  | i   |
| Abstract .....  | ii  |
| Résumé .....  | iii |
| Resumen ejecutivo .....   | iv  |
| Résumé substantiel .....  | v   |
| Table of contents .....   | xv  |
| List of Tables .....  | xix |
| List of Figures .....   | xx  |
| List of Abbreviations .....   | xxi |
| 1 Introduction .....  | 1   |
| 1.1 The need for sustainability in food systems .....   | 1   |
| 1.2 Case study: the Peruvian <i>anchoveta</i> supply chains .....                                       | 2   |
| 1.3 Research overview .....   | 5   |
| 2 Literature review: Modelling and sustainability assessment of fishfood supply chains .....            | 8   |
| 2.1 Impacts of fishfood systems/supply chains .....   | 8   |
| 2.2 Understanding fishfood systems/supply chains via modelling .....                                    | 9   |
| 2.2.1 Marine ecological/ecosystem modelling .....   | 10  |
| 2.2.2 Marine bio-economic modelling .....   | 12  |
| 2.2.3 Supply chain modelling: generalities .....  | 13  |
| 2.2.4 Agrifood and fishfood supply chain modelling .....  | 14  |
| 2.2.5 Coupled marine ecosystem/supply chain models .....  | 16  |
| 2.3 Concepts and tools for sustainability and sustainability assessment .....                           | 19  |
| 2.3.1 Sustainability assessment at the micro, macro and meso levels .....                               | 19  |
| 2.3.2 Sustainability indicators .....   | 23  |
| 2.3.3 Life Cycle Management and life cycle methods .....  | 28  |
| 2.4 Methodologies and indicators applied to food supply chains .....                                    | 33  |
| 2.4.1 Paper 1: Life Cycle Assessment of fisheries: a review for fisheries scientists and managers ..... | 38  |



|       |  |     |
|-------|--|-----|
| 2.4.2 | LCA applied to aquaculture .....   | 77  |
| 3     | Proposed framework: sustainability performance of fishfood supply chains.....  | 80  |
| 3.1   | Characterisation and modelling .....   | 81  |
| 3.2   | Indicators for sustainability assessment and scenarios .....   | 83  |
| 3.2.1 | Sustainability indicators.....   | 83  |
| 3.2.2 | Paper 7a: Coupled ecosystem/supply chain modelling from sea to plate, Part 1: background and framework .....   | 85  |
| 4     | Case study: characterisation and modelling of Peruvian <i>anchoveta</i> supply chains.....   | 100 |
| 4.1   | Data sources .....   | 100 |
| 4.2   | Partial characterisation.....  | 104 |
| 4.2.1 | Paper 2: Life cycle assessment of the Peruvian industrial anchoveta fleet: boundary setting in life cycle inventory analyses of complex and plural means of production ..... | 104 |
| 4.2.2 | Paper 3: Environmentally-extended comparison table of large- vs. small- and medium-scale fisheries: the case of the Peruvian anchoveta fleet .....                           | 136 |
| 4.2.3 | Paper 4: Comparative environmental performance of artisanal and commercial feed use in Peruvian freshwater aquaculture.....  | 169 |
| 4.2.4 | Paper 5: Environmental assessment of Peruvian anchoveta food products: is less refined better?.....  | 206 |
| 4.3   | Comprehensive characterisation and sustainability assessment.....  | 234 |
| 4.3.1 | Paper 6: A set of sustainability performance indicators for seafood: direct human consumption products from Peruvian anchoveta fisheries and freshwater aquaculture .....    | 234 |
| 4.3.2 | Paper 7b: Coupled ecosystem/supply chain modelling from sea to plate, Part 2: the Peruvian anchoveta case .....  | 262 |
| 5     | Management of uncertainty.....   | 303 |
| 5.1   | Uncertainty in modelling .....   | 303 |
| 5.1.1 | Uncertainty in marine ecosystem modelling in general and EwE in particular.....  | 304 |
| 5.1.2 | Uncertainty in material flow analysis and modelling .....  | 304 |
| 5.1.3 | Uncertainty in LCA .....   | 305 |
| 5.2   | Uncertainty management in the modelling of anchoveta supply chains.....  | 306 |
| 6     | Conclusions and portents for the future .....  | 308 |
| 6.1   | Management and policy suggestions towards a more sustainable future .....  | 312 |

|     |  |     |
|-----|--|-----|
| 6.2 | Framework limitations and transfer potential .....   | 313 |
| 6.3 | Directions for further research.....   | 314 |
|     | Bibliography.....  | 316 |
|     | Appendices .....   | 346 |
|     | Appendix A: The EwE modelling approach.....  | 346 |
|     | References.....  | 348 |
|     | Appendix B: The Umberto modelling approach.....  | 349 |
|     | References.....  | 351 |
|     | Appendix C: A comparison of current Life Cycle Impact Assessment methods.....                          | 352 |
|     | References.....  | 355 |
|     | Appendix D: The ReCiPe LCIA method.....  | 357 |
|     | References.....  | 358 |
|     | Appendix E: Extended introduction to the case study - the Peruvian <i>anchoveta</i> supply chains..... | 359 |
| 1   | The Humboldt Current System.....   | 359 |
| 2   | Engraulis ringens.....   | 360 |
| 3   | Institutions.....  | 361 |
| 4   | The anchoveta fishery .....  | 361 |
| 5   | The reduction industries.....  | 364 |
| 6   | The processing industry for DHC .....  | 368 |
| 7   | Distribution channels.....   | 369 |
| 8   | Key anchoveta-based aquaculture systems .....  | 370 |
| 9   | Fisheries management and policy environment.....   | 370 |
| 10  | Impacts of climate change on fisheries and related industries.....                                     | 375 |
| 11  | Socio-economics of the anchoveta supply chains.....  | 375 |
| 12  | Nutritional value of fishfood products of the anchoveta supply chains .....                            | 377 |
| 13  | Ecosystem and bio-economic modelling of the Peruvian anchoveta fishery.....                            | 378 |
|     | References.....  | 379 |
|     | Appendix F: Posters.....   | 386 |

|   |     |
|---|-----|
| Appendix G: Institutions, labs, projects..... | 388 |
| List of publications as of April 2014.....    | 389 |

## List of Tables

|  |     |
|--|-----|
| Table 1: Main bio-economic model types for fisheries .....   | 12  |
| Table 2: Non-exhaustive taxonomy of sustainability assessment tools and methodologies.....   | 22  |
| Table 3: Conceptual frames for the development process of sustainability indicators systems .....  | 24  |
| Table 4: Nutrient profile models featuring beneficial nutrients and nutrients to limit .....   | 27  |
| Table 5: Standards and guidelines governing the application of life cycle methods .....  | 30  |
| Table 6: MSC's principles and criteria for sustainable fishing .....   | 37  |
| Table 7: Impact categories most commonly used in aquaculture LCA studies .....   | 78  |
| Table 8: Overview of proposed sustainability indicators .....  | 84  |
| Table 9: Main data sources for calculating environmental and energy indicators .....   | 101 |
| Table 10: Examples of sources of uncertainty in LCA, and tools to reduce and/or illustrate it towards improving reliability in LCA results .....                 | 305 |
| Table 11: Sensitivity and uncertainty issues of the ecosystem-supply chain coupled model and treatments .....  | 306 |
| Table 12 Comparison of Peruvian and international fisheries and aquaculture products in terms of their edible protein Energy Return On Investment (epEROI) ..... | 309 |
| Table 13: Brief history of the Peruvian anchoveta fishery .....  | 362 |
| Table 14: Size of the Peruvian anchoveta fleet (2012).....   | 364 |
| Table 15: Changes in industrial fishmeal plant capacity in Peru (2000-2012) .....  | 365 |
| Table 16: Anchoveta landings for IHC and export figures (2001-2011) .....  | 367 |
| Table 17: Fish to fishmeal and fish oil conversion ratios (2001-2006), various national averages.....  | 368 |
| Table 18: Anchoveta landings for DHC and processing volumes (2001-2011).....   | 369 |
| Table 19: Changes in industrial DHC plant capacity in Peru (2005-2011) .....   | 369 |
| Table 20: Top sectors contributing to the Peruvian economy .....   | 375 |
| Table 21: Peruvian exports of fishmeal (tariff group 2301) and fish oil (tariff group 150420), per destination (2007-2011) .....                                 | 376 |
| Table 22: Manpower employed by the Peruvian seafood sector with emphasis on anchoveta (2000-2007) .....  | 377 |
| Table 23: Bio-economic models of the Peruvian anchoveta fishery .....  | 378 |

## List of Figures

|   |     |
|---|-----|
| Figure 1: Map of Peru showing key fish landing, culturing and processing areas .....  | 4   |
| Figure 2: Supply chain representation from ecosystem to consumer (single fish species) .....  | 16  |
| Figure 3: Ecosystem (a) and human (b) components for creating social–ecological scenarios .....   | 18  |
| Figure 4: Eco-efficiency and other sustainability concepts .....  | 21  |
| Figure 5: Ideal life cycle of a product .....   | 28  |
| Figure 6: LCA study design for an aquafeed production plant .....   | 83  |
| Figure 7: From reality to modelling .....   | 304 |
| Figure 8: CPUE-adjusted environmental score (ReCiPe single score) associated to the alternative exploitation scenarios, per key product, edible portions, at plant gate; on a $\log_{10}$ scale ..... | 311 |
| Figure 9 Comparison of energy efficiency ratios for fisheries and aquaculture products, with adjusted CPUE, for future scenarios .....  | 311 |
| Figure 10: Lindeman spine of the Humboldt Current System on a La Niña year .....  | 348 |
| Figure 11: Example Umberto network showing basic element types .....  | 349 |
| Figure 12: Example of Sankey diagram (waste sorting with cogeneration) .....  | 351 |
| Figure 13: Midpoint and endpoint indicators used in ReCiPe .....  | 358 |
| Figure 14: Relative abundance of anchoveta and sardine in the HCS, as illustrated by annual catches (historical, 1951-2011) .....   | 359 |
| Figure 15: Fish catches vs. primary productivity for the four main EBUEs (1998-2005) .....  | 360 |
| Figure 16: Geographical distribution of anchoveta .....   | 361 |
| Figure 17: Historical annual anchoveta landings and critical ENSO and policy events (1951-2011) .....   | 362 |
| Figure 18: Historical relation between fleet holding capacity and processing capacity (1951-2011) .....   | 366 |
| Figure 19: Simplified flow diagram of fishmeal and oil production .....   | 367 |
| Figure 20: Changes in fish oil yields as a percentage of processed raw material (1981-2006) .....   | 368 |
| Figure 21: Fleet size vs. duration of the anchoveta fishing season (historical, 1951-2011) .....  | 372 |

## List of Abbreviations

|       |   |        |   |
|-------|---|--------|---|
| ADEME | French Agency for the Environment and Energy Management   | EPR    | Extended Producer Responsibility                        |
| ALCA  | Attributional Life Cycle Assessment                       | EROI   | Energy Return On Investment                             |
| AR    | Argentina   | ERSEM  | European Regional Seas Ecosystem Model                  |
| BNR   | Biotic Natural Resource                                   | ESAM   | Extended Single-species Assessment Models               |
| BO    | Bolivia   | EwE    | Ecopath with Ecosim                                     |
| BR    | Brazil  | EY     | Edible Yield  |
| BRU   | Biotic Resource Use                                       | FAO    | Food and Agriculture Organization of the United Nations |
| CBA   | Cost–Benefit Analysis                                     | FAQ    | Average Quality fishmeal                                |
| CED   | Cumulative Energy Demand                                  | FCR    | Feed Conversion Ratio                                   |
| CEENE | Cumulative Exergy Extraction from the Natural Environment | FIFO   | Fish-In Fish-Out  |
| CEPA  | Cumulative Energy Requirements Analysis                   | FM     | Fishmeal  |
| CERES | Coalition for Environmentally Responsible Economics       | FMFO   | Fishmeal and fish oil                                   |
| CF    | Carbon Footprint  | FO     | Fish oil  |
| CFN   | Calories for Nutrient                                     | FR     | France  |
| CL    | Chile   | FU     | Functional Unit   |
| CLCA  | Consequential Life Cycle Assessment                       | GEC    | Gross Energy Content                                    |
| CML   | Center of Environmental Science of Leiden University      | GFN    | Global Footprint Network                                |
| CPA   | Cleaner Production Assessment                             | GHG    | Greenhouse Gas  |
| CPUE  | Capture Per Unit of Effort                                | GPS    | Global Positioning System                               |
| DEA   | Data Envelopment Analysis                                 | GRI    | Global Reporting Initiative                             |
| DEFRA | UK Department of Environment, Food and Rural Affairs      | GRT    | Gross Registered Tonnage                                |
| DHA   | Docosahexaenoic acid                                      | GT     | Gross Tonnage   |
| DHC   | Direct Human Consumption                                  | GWP    | Global Warming Potential                                |
| DM    | Dry Matter  | HANPP  | Human appropriation of net primary production           |
| DPSIR | Driving Force–Pressure–State–Impact–Response              | HCS    | Humboldt Current System                                 |
| DV    | Daily value   | HGT    | Headed-Gutted-Tailed fish                               |
| EIOA  | Environmental Input-Output Analysis                       | HPC    | High Protein Content Fishmeal                           |
| EEIOA | Environmentally Extended Input-Output Analysis            | IBM    | Individual-Based Models                                 |
| EA    | Energy/Exergy/Emergy Analysis                             | IGBEM  | Integrated Generic Bay Ecosystem Model                  |
| ED    | Energy Density  | IHC    | Indirect Human Consumption                              |
| EDP   | Environmental Product Declaration                         | IMARPE | Instituto del Mar del Perú                              |
| EE    | Eco-Efficiency  | IOA    | Input Output Analysis                                   |
| EEA   | European Environmental Agency                             | IPCC   | International Panel for Climate Change                  |
| EF    | Ecological Footprint                                      | IPP    | Integrated Product Policy                               |
| EIA   | Environmental Impact Assessment                           | ISAR   | International Standards of Accounting and Reporting     |
| EPA   | Eicosapentaenoic acid                                     | ISO    | International Organization for Standardization          |
|       |   | IUU    | Illegal, Unreported and Unregulated                     |

|         |  |          |  |
|---------|--|----------|--|
| IVQ     | Individual Vessel Quota                                | QCFU     | Quality-Corrected Functional Unit                          |
| LCA     | Life Cycle Assessment                                  | RA       | Risk Analysis/Assessment                                   |
| LCC     | Life Cycle Costing                                     | RA       | Risk Assessment  |
| LCI     | Life Cycle Inventory                                   | RACC     | Reference Amount Customarily Consumed                      |
| LCIA    | Life Cycle Impact Assessment                           |          |  |
| LCM     | Life Cycle Management                                  | RDI      | Reference Daily Intake                                     |
| LCS     | Life Cycle Screening                                   | RRR      | Ratio of recommended to restricted food components         |
| LCSP    | Lowell Center for Sustainable Production               | SA       | Sustainability Assessment                                  |
| LIM     | Limited nutrients/ nutrients to limit                  | SCM      | Supply Chain Management                                    |
| LPY     | Lost Potential Yield                                   | SCOR     | Supply Chain Operations Reference                          |
| MCDA    | Multi-Criteria Decision Analysis                       | SCP      | Sustainable Consumption and Production                     |
| MCS     | Marine Conservation Society                            |          |  |
| MFA     | Material Flow Assessment/Analysis/Accounting           | SEA      | Strategic Environmental Assessment                         |
| MFM     | Material Flow Management                               | SEAPODYM | Spatial Ecosystem And Populations Dynamics Model           |
| MIPS    | Material Input per Service Unit                        | SES      | Social-ecological modelling                                |
| MODR    | Marine Oil Dependency Ratio                            | SETAC    | Society of Environmental Toxicology and Chemistry          |
| MPDR    | Marine Protein Dependency Ratio                        |          |  |
| MRM     | Minimum Realistic Models                               | SFA      | Substance Flow Analysis                                    |
| MS      | Medium-Scale   | SLCA     | Social Life Cycle Assessment                               |
| MSC     | Marine Stewardship Council                             | SMS      | Small- and Medium-Scale                                    |
| MSY     | Maximum Sustainable Yield                              | SS       | Small-Scale  |
| MUFA    | Monounsaturated Fatty Acid                             | TAC      | Total Allowable Catch                                      |
| MY      | Malaysia   | TCA      | Total Cost of Accounting                                   |
| NAR     | Nutrient Adequacy Ratio                                | TCO      | Total Cost of Ownership                                    |
| NFC     | Nutrient for Calorie                                   | TL       | Trophic Level  |
| NHCS    | Northern Humboldt Current System                       | UK       | United Kingdom   |
| NM      | Nautical Miles   | UNCTAD   | United Nations Conference on Trade and Development         |
| NNR     | Naturally Nutrient Rich                                |          |  |
| NPPU    | Net Primary Production Used                            | UNEP     | United Nations Environment Programme                       |
| NQI     | Nutritional Quality Index                              |          |  |
| NRF     | Nutrient Rich Food                                     | US       | United States of America                                   |
| OECD    | Organisation for Economic Co-operation and Development | VEC      | Vulnerable, Endangered and Critically endangered (species) |
| PCR     | Product Category Rule                                  | VMS      | Vessel Monitoring System                                   |
| PE      | Peru   | WBCSD    | World Business Council for Sustainable Development         |
| PPR     | Primary Production Required                            |          |  |
| PRODUCE | Ministry of Production of Peru                         | WF       | Water Footprint  |
| PSR     | Pressure-State-Response                                |          |  |

# Chapter 1

---

Presentation of the research, overview and objectives. The main goal of this research is thus: to assess the sustainability of key competing Peruvian supply chains based upon anchoveta, with a dominant focus on environmental, nutritional and energetic performance; and to provide sustainability-improving management and policy recommendations for future exploitation strategies.

The system under study encompasses the supply chains from the extraction (fisheries and their impact on the Northern Humboldt Current ecosystem), through reduction activities for fishmeal and fish oil production, aquafeed production (including secondary analysis of agricultural inputs to aquafeeds), aquaculture and, finally, a fishfood product at a retailer's shelf.

---

## 1 Introduction

### 1.1 The need for sustainability in food systems

The principle of sustainable development received global recognition at the 1992 Earth Summit, in Rio de Janeiro. In June 2012 progress in global sustainability was reviewed in the RIO+20 conference, whose final document, *The Future we Want*, calls for a new framework for action, in order to implement sustainable development (UN, 2012).

Sustainable development, as defined in and extensively quoted from the *Brundtland report*, consists of humanity's ability to render development (understood as economic growth) sustainable, that is to say, that it fulfils present needs without preventing future generations from fulfilling their needs (WCED, 1987). The concept predates earlier concepts associated to the capacity of the ecosystems to provide resources to the economic systems and to absorb unwanted outputs, as described for instance in Boulding (1966). Among those concepts, the need for decoupling economic growth from resource depletion and environmental degradation, as well as the ideas of sustainable consumption and production; have been since explored, researched and applied to virtually every production environment, including food systems (Freibauer et al., 2011; Nellemann et al., 2009).

Sustainability in food systems features several dimensions of concern, including the environmental (Ingram et al., 2010; Power, 1999), socio-economic aspects and food security (Nellemann et al., 2009; SOFA, 2011), consumption patterns (Tukker et al., 2011), technology (Spiertz, 2010), information (Wognum et al., 2011) and governance/policy (McMichael, 2011). Moreover, sustainability arises from the complex interrelation amongst these factors, and thus science should focus on the most significant cause-and-effect relationships and driving forces that shape those interrelations, as to inform and provide tools for management and policy (Dahl, 2012).

A recent journal editorial stressed the growing challenges of sustainability in food systems, given the increasing demand for food (due to increasing population and rising affluence) and the environmental impacts associated to modern food production. The editorial refers to the relevance of trade policy and



trade impacts on vulnerable communities, as well as to the need for globally-accepted metrics and policies for sustainability (Food Policy, 2011). Such narrative is very representative of the generalised concern of the research community of studying and advancing sustainability tools for policy and decision making in general.

Agricultural and **fishfood** (fisheries + aquaculture) systems feed the world. Despite the relative small size of the global fishfood economic system in comparison to agriculture, it encompasses complex socio-economic networks with considerable impact of the world's environment. Economically, fish products represent about 10% of total agricultural exports, value-wise, and featuring showing a growing trend. Fisheries and aquaculture (including shellfish) provided the world with 142 million t of fish in 2008 (of which almost 20% was used for non-direct human consumption, e.g. for reduction) (SOFIA, 2010). Nutritionally, fish represent over 20% of animal protein intake in low income and food-deficient countries (SOFIA, 2012; SOFIA, 2010). The fish industry provides over 180 million jobs worldwide, which represents the livelihood of 8% of the world's population. Therefore, it is imperative to apply sustainability principles to the assessment and management of fishfood systems.

## 1.2 Case study: the Peruvian *anchoveta* supply chains

This research focuses on the sustainability assessment of global supply chains whose starting point is the Peruvian fishery for *anchoveta* (*Engraulis ringens*). Anchoveta is exploited by a large and heterogeneous fleet; a small percentage of the catch is rendered into seafood products for direct human consumption while the majority of the catch is reduced into feed ingredients (fishmeal, fish oil), and then exported off Peru to feed various aquacultures and animal husbandry operations, mainly in Asia and Europe. There are various sub-fleets in operation, differentiated by their holding capacities, hull construction materials and legal regimes governing them (notably a regime for vessels landing for reduction and another for those landing for food products). Several fishfood and agricultural supply chains compete for the anchoveta resources, generating a series of impacts on the Peruvian ecosystem and society, as well as on the global environment and economy. For instance, there is marine and continental aquaculture, fed and non-fed, operating at various levels of technical intensification. Despite the fact that the bulk of reduction products is consumed by foreign aquafeed and aquaculture industries, their study was excluded, due to time and resources constraints. The dynamics of those complex Peruvian supply chains have never been studied in a holistic, sustainability-imbued way. Understanding those dynamics and impacts to the largest extent possible is the motivation of this research, in such a way that decision makers along the chains are informed and actions are taken to improve the sustainability of the anchoveta-based fisheries and industries.

The Peruvian *anchoveta* fishery is the largest national fleet targeting a single species, worldwide (Fréon et al., 2010). It landed in average 6.5 million tonnes per year in the period 2001-2010 (2010 featured a drop in landings), according to statistics from the Ministry of Production of Peru, PRODUCE (PRODUCE, 2012). The anchoveta is targeted by a large fleet, clustered in two main groups operating under different legal regimes: the industrial fleet and the small- and medium-scale (SMS) fleets. The industrial fleet (vessels larger than 32.6 m<sup>3</sup> holding capacity) includes steel vessels and wooden vessels nicknamed "Vikingas". The small-scale fleet includes vessels under 10 m<sup>3</sup> holding capacity, while the medium-scale fleet vessels featuring 10 to 32.6 m<sup>3</sup> holding capacity. Small-scale vessels also differ from medium-scale ones in the level of technification and capture systems used; small-scale vessels are characterised by manual labour and basic technology (Alvarado, 2009). Catches by the steel fleet represent around 81% of the total anchoveta catches for reduction, while the Vikingas capture 19%, according to statistics by Instituto del Mar del Perú, IMARPE (Marilú Bouchon, personal communication, 2011). The industrial fleet landings for indirect human consumption (reduction) represent more than 99% of total catches, while the SMS fleet landings for direct

human consumption (fresh, freezing, canning, curing) represent between 1% and 2% of total catches (depending on the year), according to PRODUCE statistics.

This case study will apply the proposed sustainability assessment framework to the competing fates of anchoveta landings over a complex supply chain, which encompasses fishing, reduction, feed manufacturing, aquaculture, processing for DHC and commercial distribution. Moreover, three scenarios of anchoveta exploitation will be modelled, involving changes in fate (final fishfood product). After the assessment, a good estimation of the sustainability (especially environmental) performance anchoveta industry and related supply chains will be available.

A political map of Peru showing key fish landing, culturing and processing regions is presented in Figure 1. A detailed description of the case study is presented in **Chapter 4** and in **Appendix E: Extended introduction to the case study - the Peruvian *anchoveta* supply chains**.

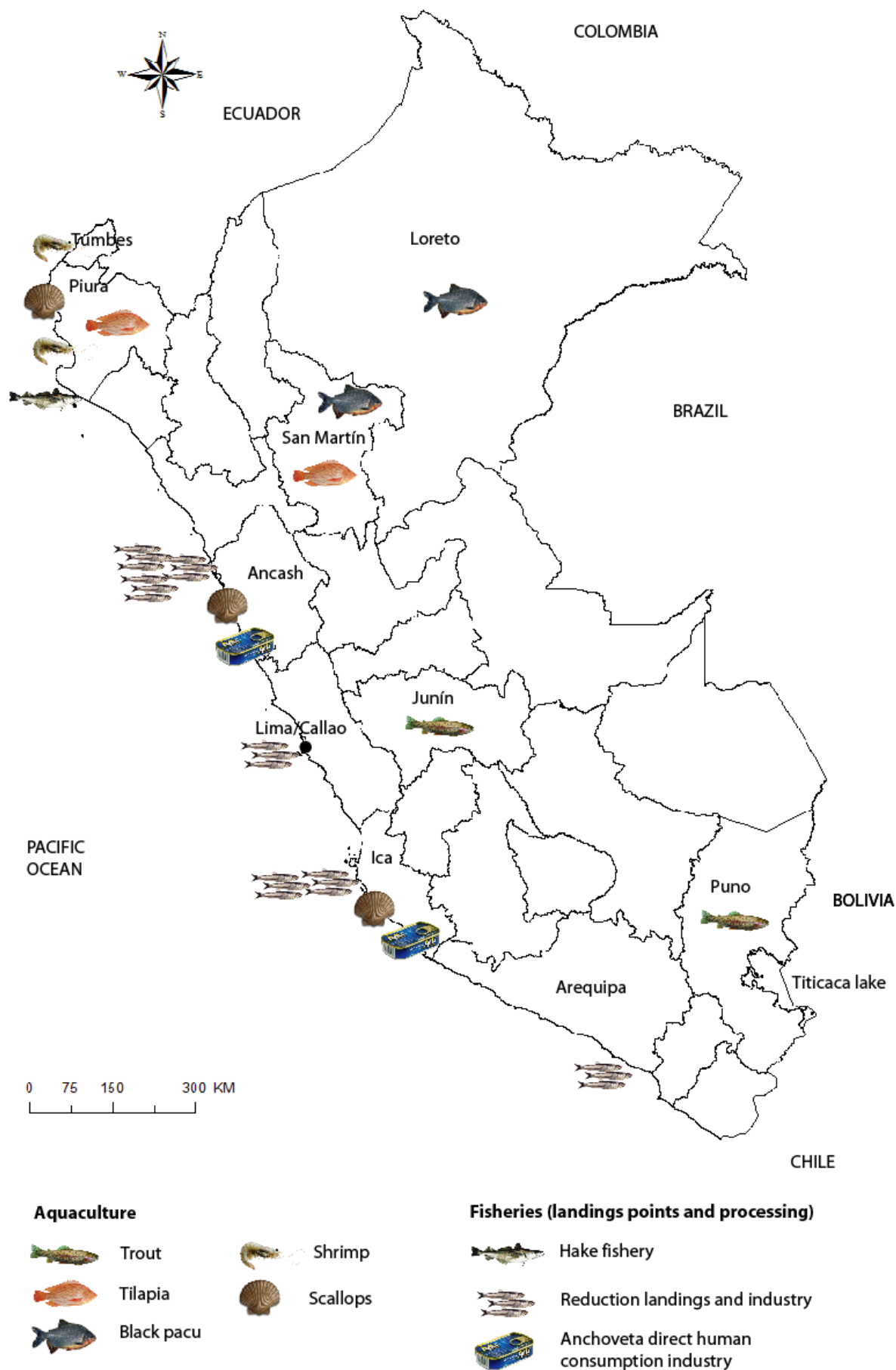


Figure 1: Map of Peru showing key fish landing, culturing and processing areas  
Based on data detailed in Chapter 4 and Appendix E.

### 1.3 Research overview

The key scientific question addressed by this research is whether the present balance between the different components of the anchoveta supply chains is sub-optimal regarding energetic, nutritional, environmental and socio-economic performance, to be measured by a tailored accounting framework. The current situation suffers from a number of shortcomings and challenges, including the low consumption of anchoveta as food fish despite nutritional deficiencies in some Peruvian communities, the lack of governmental success in promoting that consumption, the over-exploitation of several fish stocks and thus the need for fisheries ecosystem management (FAO, 2003; SOFIA, 2012), limits and non-compliance with fisheries legislation (e.g. overshoot of fishing quotas, catches of juveniles, by-catch and discards, diminishing of marine mammal and bird populations, etc); among others.

The main goal of this research is thus:

**to assess the sustainability of key competing Peruvian supply chains based on anchoveta, with a dominant focus on environmental, nutritional and energetic performance; and to provide sustainability-improving management and policy recommendations for future exploitation strategies.**

The system under study encompasses the supply chains from the extraction (fisheries and their impact on the Northern Humboldt Current ecosystem), through reduction activities for fishmeal and fish oil production, aquafeed production (including secondary analysis of agricultural inputs to aquafeeds), aquaculture and, finally, a fishfood product at a retailer's shelf. The research topic connects with the wider topic of sustainability assessment of food systems, and its importance derives from the relevance of the Peruvian fishmeal in relation with international food supply chains (SOFIA, 2012): Peruvian fishmeal and fish oil exports represent half and a third of the global annual production, respectively (IFFO, 2012).

The fundamental outcome of this endeavour will be a framework for assessing and comparing alternative supply chains, from a multidisciplinary set of sustainability-imbued criteria. Such framework will be illustrated by comparing the supply chains associated to various fates of landed anchoveta, under the current situation and future alternative exploitation scenarios. In general terms, the framework will provide the tools to perform the following groups of activities (methodology):

1. Characterise and model the biophysical flows associated to anchoveta-based supply chains. Additionally, understand the present management and policy environment.
2. By means of a set of sustainability indicators (spanning energy, nutrition, ecological, environmental, social and economic aspects), compare sustainability of supply chains.
3. Determine and simulate alternative policy- and bio-economic modelling-based exploitation scenarios and fates of anchoveta.
4. Provide management and policy recommendations based upon assessment/comparison results.

The dissertation is organised in such a way that the intended sustainability assessment framework is fully explained and grounded on state of the art theory and practice. The framework is introduced and applied to the study of anchoveta-based supply chains, for which suggestions for improvement are ultimately produced. Chapters 1 to 6 describe the research, including published and submitted manuscripts featuring detailed results; and the section **Appendices** lists additional information relevant for the thesis.

**Chapter 1** (Introduction) introduces and justifies the research and its objectives.

**Chapter 2** (Literature review) discusses the philosophical and practical foundation of the research, by reviewing existing concepts, tools and frameworks for sustainability assessment and supply chain analysis; complemented with extensive reviews of their application. Particular emphasis is assigned to Life Cycle Assessment, sustainability indicators and supply chain modelling approaches in relation to seafood systems. This chapter includes **Paper 1: Life Cycle Assessment of fisheries: a review for fisheries scientists and managers** (section 2.4.1).

**Chapter 3** (Proposed framework) briefly introduces the proposed framework for sustainability assessment of fishfood supply chains, centring the discussion on the three predefined keystones: characterisation and modelling of supply chains, sustainability assessment/comparison, and simulation of alternative scenarios towards policy recommendations. Details and illustration of the framework are introduced in the following chapter (which is based on papers and manuscripts). This chapter includes **Paper 7a: Coupled ecosystem/supply chain modelling from sea to plate, Part 1: background and framework** (section 3.2.2).

**Chapter 4** (Case study) fully illustrates the proposed framework by applying it to the anchoveta fishery and subsequent supply chains, and moreover by discussing current management and policy issues based on the conclusions drawn from the supply chains/scenarios comparisons. An extended introduction of the Peruvian anchoveta supply chains is presented in **Appendix E: Extended introduction to the case study - the Peruvian anchoveta supply chains**. The foundation characterisation and the final comprehensive sustainability assessment and scenario analysis are presented in several papers<sup>1</sup>:

- **Paper 2: Life cycle assessment of the Peruvian industrial anchoveta fleet: boundary setting in life cycle inventory analyses of complex and plural means of production** (section 4.2.1).
- **Paper 3: Environmentally-extended comparison table of large- vs. small- and medium-scale fisheries: the case of the Peruvian anchoveta fleet** (section 4.2.2).
- **Paper 4: Comparative environmental performance of artisanal and commercial feed use in Peruvian freshwater aquaculture** (section 4.2.3).
- **Paper 5: Environmental assessment of Peruvian anchoveta food products: is less refined better?** (section 4.2.4).
- **Paper 6: A set of sustainability performance indicators for seafood: direct human consumption products from Peruvian anchoveta fisheries and freshwater aquaculture** (section 4.3.1).
- **Paper 7b: Coupled ecosystem/supply chain modelling from sea to plate, Part 2: the Peruvian anchoveta case** (section 4.3.2).

**Chapter 5** (Uncertainty management) discusses uncertainty management in the context of the research, especially regarding ecosystem modelling and life cycle assessment.

**Chapter 6** (Conclusions) proposes a number of policy and management measures inspired by the supply chain and alternative exploitation scenario analyses. The chapter analyses the lessons learned from

---

<sup>1</sup> An additional paper was produced and published in the context the research, in the Journal of Cleaner Production: "Eco-efficiency assessment of the Peruvian anchoveta steel and wooden fleets using the LCA+DEA framework" (Avadí et al., 2014a). The paper compares and discusses the eco-efficiency of different fleet segments by means of a combined Data Envelopment Analysis and Life Cycle Assessment framework. It was not included in the thesis document because it was not considered central to the thesis topic, and to prevent further enlargement of the thesis document.

designing and applying the framework to the studied system, and proposes ways to advance further sustainable development of the Peruvian anchoveta-based supply chains and Peruvian fisheries in general. The chapter draws from all appendices presenting research papers.

Additionally, two selected presentations prepared in the context of the thesis are also available in **Appendix F: Posters** presents “A framework for sustainability comparison of seafood supply chains” and “LCA of locally produced feeds for Peruvian aquaculture”, posters presented at the LCA Food 2012 conference. Abstracts published in Corson, M.S., van der Werf, H.M.G. (Eds.), 2012. Proceedings of the 8th International Conference on Life Cycle Assessment in the Agri-Food Sector (LCA Food 2012), 1-4 October 2012, Saint Malo, France. INRA, Rennes, France.

# Chapter 2

---

Discussion of the philosophical and practical foundation of the research, by reviewing existing concepts, tools and frameworks for sustainability assessment and supply chain analysis; complemented with extensive reviews of their application. Particular emphasis is assigned to Life Cycle Assessment, sustainability indicators and supply chain modelling approaches in relation to seafood systems.

- Paper 1: Life Cycle Assessment of fisheries: a review for fisheries scientists and managers
- 

## **2 Literature review: Modelling and sustainability assessment of fishfood supply chains**

The concept of sustainability and the theory and practice of sustainable development are growing in importance and relevance in society. Decision-makers at all levels of society, ranging from the company level to the international policy environment, are increasingly considering sustainability as a policy objective (Singh et al., 2009).

A variety of methodologies have been developed for assessing sustainability. The preferred approach to assess and communicate sustainability of anthropogenic systems is the use of indicators. Sustainability indicators are suitable tools to address the need for consolidating information flows associated to economic, social and environmental processes from heterogeneous sources (Hák et al., 2007).

This chapter explores the theory and practice of sustainability in relation with its applicability on seafood systems and supply chains. First, the nature of impacts exerted by the fishfood sector is discussed, followed by a description of models for describing food and fishfood systems and, finally, a discussion on suitable tools, frameworks and methodologies for sustainability assessment of those systems.

### **2.1 Impacts of fishfood systems/supply chains**

Human-produced impacts on marine ecosystems are mainly due to polluting flows and activities from settlements in coastal areas and to unsustainable exploitation of marine resources. These anthropogenic effects are diffuse and cumulative (Smith et al., 2010; Villasante et al., 2011). The magnitude of human impacts on marine and coastal ecosystems is considerable, and thus pro-sustainability actions should be prioritised (Villasante et al., 2011). Direct and indirect effects of fisheries, the starting point of fishfood supply chains, includes removal of species, alteration of marine trophic webs, destruction of benthos and benthic communities, and in general alterations of ecosystems structure and function (FAO, 2003; Naylor and Burke, 2005; Kaiser and Jennings, 2002; Smith et al., 2010).

Aquaculture is often considered as the ultimate source of fishfood products required by the increasing population, given the declining of fish stocks targeted by some capture fisheries (Hasan and Halwart,

2009; Naylor and Burke, 2005; Welch et al., 2010). Nonetheless, carnivore and some herbivore/omnivore cultured fish are fed on aquafeed containing reduction products from wild-caught forage fish, thus it has been suggested that aquaculture exerts pressure on forage fisheries (Naylor et al., 2009).

The sustainability and ethics of using forage fish as inputs to aquaculture is part of an ongoing discussion. Some aspects of such controversy include whether or not it is sustainable or morally correct to fish for reduction rather than fishing for food (Hasan and Halwart, 2009; Tacon and Metian, 2009; Wijkström, 2010), the effects of fishing down in the marine food web (Naylor et al., 2000) and the high fish-in-fish-out (FIFO) ratios of cultured carnivorous species (Tacon and Metian, 2008; Jackson, 2009; Kaushik and Troell, 2010). Some authors relate the use of wild caught fish for aquaculture feed to food security in developing countries (e.g. Wijkström, 2009, 2010; Muir, 2013), both under positive and negative lights (see discussion in Fréon et al, 2013).

Further sustainability discussions about global fishfood systems include the following issues:

- Environmental and ecosystem impacts of fisheries and aquaculture: biological and ecosystem impacts of fisheries (target and non-target stocks, seafloor habitats); fuel, refrigerant, antifouling use of fishing fleets; and production and use of feeds for aquaculture (Cappell et al. 2007; Kaiser and Jennings, 2002; Peacock et al., 2011; Pelletier and Tyedmers, 2008). See sections 2.4.1 and 2.4.2 for further discussion on those issues.
- Exploitation intensity of fish stocks (an important and increasing percentage of fish stocks are considered as overexploited, depleted or recovering) and related governance issues (UNEP, 2009; SOFIA, 2010).
- Sensitivity of fisheries and aquaculture to exogenous shocks to ecosystems, e.g. climate change, and its reliance on common-pool resources, e.g. open-access to fish stocks (Smith et al., 2010).
- The relation between trade behaviour of fishfood products and undernourishment and governance (Smith et al., 2010).
- Sustainability awareness of consumers of fishfood, as well as fishfood supply chain challenges such as traceability, certifications and labelling, etc (UNEP, 2009).

All of the abovementioned concerns justify the need for sustainability assessment of fishfood systems in a holistic way, in order to improve their sustainability performance by identifying and streamlining key issues sensitive to management and policy measures.

## **2.2 Understanding fishfood systems/supply chains via modelling**

“Fishfood system” is an umbrella term for complex fishfood-producing anthropogenic systems featuring important interaction with their surrounding aquatic and terrestrial ecosystems. Resource management science and research have produced a variety of approaches for capturing the interactions between the natural and the socio-economic realms occurring under such systems.

An essential feature of all approaches to understanding complex systems is modelling (Schlüter et al., 2012). Models are abstractions/simplifications/generalisations of real world systems, used to reduce complexity and present only the sub-systems of research interest (Wahlström, 1994). Models thus incorporate enough data as to reproduce observed patterns on a particular scale, and rather than



including the largest possible amount of detail, focus on the main/minimum detail set required for not contradicting reference observations (Levin, 1992).

Various types of models linking the natural and socio-economic systems can be clustered into the following categories: ecological/ecosystem, bio-economic and social-ecological modelling (SES) (Horan et al., 2011; Schlüter et al., 2012). In general terms, ecological models attempt to explain the effects of harvesting resources on the providing ecosystem (including interactions between species) while bio-economic models analyse those interactions in both directions. The emerging cross-cutting field of SES extends bio-economic models by including non-linear behaviour and by treating links from the ecosystems as ecosystem services rather than as utility-providing resources. Such complexity is possible due to the fact that SESs benefit from a variety of modelling fields, and SESs have been applied to a variety of applications: fisheries, rangeland, wildlife, bio-economics, ecological economics, resilience, and complex systems (Schlüter et al., 2012).

### **2.2.1 Marine ecological/ecosystem modelling**

Ecological processes such as predation, competition, environmental regime shifts, and habitat effects have the potential to impact bio-economic dynamics (recovery of exploited stocks, surplus production, etc) (Link, 2002). Such impacts may manifest themselves in an order of magnitude comparable to that exerted by fisheries pressure.

Ecological/ecosystem modelling is a rich, well established research field: nonetheless, it is not always included in fisheries modelling and management (Link, 2002). Several taxonomies exist, but in general marine ecosystem models can be classified into the following categories (Plagányi, 2007):

- Whole ecosystem models, which try to account for all trophic levels in the studied ecosystem. Some of the most notable examples are ECOPATH (Christensen and Pauly, 1992) and ECOSIM (Walters et al., 1997).
- Dynamic multi-species models or Minimum Realistic Models (MRM), which try to account for selected species of the studied ecosystem, normally due to their interactions with a key species of interest. This category may include some Individual-Based Models and Multi-species Statistical Models, as well as Extended Single-species Assessment Models (ESAM), which extend existing single-species assessments by accounting for some additional interactions.
- Dynamic System Models, mainly Individual-Based Models (IBM), which try to represent both physical and biological forces interacting in the studied ecosystem, while practicing size-based discrimination. These models have been used for both single-species and multi-species modelling, for instance, OSMOSE (Shin and Cury, 2001).

An emerging topic in marine ecosystem modelling is the concept of end-to-end ecosystem models. The end-to-end modelling framework attempts to include the effect of both climate change (through the higher trophic levels) and anthropogenic intervention in multi-trophic models (Rose et al., 2010; Allen and Fulton, 2010). Those models arise out of the needs of ecosystem-based management, which demands models able to take into account climate change and time and space variations, such as OSMOSE and EwE/ECOSPACE (Rose et al., 2010).

Climate drivers (abiotic processes) considered in end-to-end models include temperature, light and acidification, circulation/stratification; ecological drivers include benthos, phyto- and zooplankton, small pelagic and piscivores; and anthropogenic drivers refer to fishing, pollution, invasive species and

eutrophication (Allen and Fulton, 2010). Those climate-related and ecological processes can be further disaggregated into the following (Fulton, 2010; Travers et al., 2007):

- Relevant abiotic processes: atmospheric inputs; currents, upwelling, downwelling, turbulence and re-suspension; wind; irradiance and photic zone; precipitation; temperature, salinity and mixed layer.
- Ecological processes (in addition to benthos and trophic levels): nutrients and biogeochemical cycling, microbial and various types of detritus.
- Anthropogenic processes: terrestrial run-off; coastal development, ports and shipping; fishing; tourism, recreational activities; oil and gas prospection and extraction; and war-related activities.

A key research topic in end-to-end modelling is the type of combination and interlinking between hydrodynamic, low and high trophic levels sub-models: one-way forcing/linking/coupling or two-way coupling (Fulton, 2010; Rose et al., 2010; Travers et al., 2009). The latter allows for dynamic feedbacks related to density-dependent responses of high trophic level organisms and to interaction between biological and physical processes (Rose et al., 2010). Moreover, feedbacks add mathematical and computational complexity to the model.

Thus, a full end-to-end model would include a) a biogeochemical model providing hydrodynamic flows and low trophic levels, b) a model of intermediate and high trophic levels (age structured or individual based), c) a fish population model, ideally featuring spatial discretisation and including fishing pressure and multiple fleets (Fulton, 2010; Rose et al., 2010; Travers et al., 2007). The major issue of such a full model is over-parameterisation. Several tens or hundreds of parameters are required, but usually the value of less than a half of them is known and associated to reasonable confidence intervals (the rest resulting from gross estimations and empirical tunings). The sensitivity of the model output to such gross estimations and tunings is seldom performed.

The most commonly used (whole ecosystem, but not strictly end-to-end) ecosystem modelling approach is probably Ecopath with Ecosim (EwE), a combination of ECOPATH, ECOSIM and a constantly increasing number of add-ons. In 2008, EwE celebrated 25 years<sup>2</sup> of continuous development and application. A software implementation of EwE is freely available for evaluating ecosystem impacts of fisheries (Pauly et al., 2000; Christensen and Walters, 2004). EwE currently includes ECOSPACE, a spatially-sensitive dynamic model developed to overcome the lack of spatial sensibility of the original EwE (Walters et al., 1999). Also, EwE can accommodate as a plug-in the ECOTROPH model, which describes ecosystem dynamics as flows of biomass from lower to higher trophic levels (Gascuel and Pauly, 2009). EwE is described in detail in **Appendix A: The EwE modelling approach**. Other whole/end-to-end models include:

- Extended biogeochemical models such as ERSEM (European Regional Seas Ecosystem Model), IGBEM (Integrated Generic Bay Ecosystem Model) and BM2 (Bay Model 2); focus on the dynamics of nutrients and low trophic levels. High trophic levels are modelled in terms of their physiological processes and population processes (Travers et al., 2007).
- Size-based models rely on the theory that biological rates and predator-prey interactions are based on their relative sizes, and thus the studied ecosystem is represented in that way. Several models of this type focus on different levels of the ecosystem and even on the whole food web. Some of them are coupled with hydrodynamic and bio-energetic models (Travers et al., 2007). A

---

<sup>2</sup> Ecopath 25 years: conference and workshops (<http://conference.ecopath.org/>).

representative example of size-based models is OSMOSE, a space sensitive, individual-based, high trophic level model based upon the assumption that predation is a size-based opportunistic process, depending only on relative sizes and spatial co-occurrence between predators and prey (Plagányi, 2007; Shin and Cury, 2001).

- Some coupled models, such as Spatial Ecosystem And Populations Dynamics Model (SEAPODYM) and ATLANTIS are considered by some authors as end-to-end models (Fulton, 2010; Rose et al., 2010). SEAPODYM was developed for the study of tuna populations, and is a spatially-sensitive coupled physical-biological interaction model working at the ocean basin level (Lehodey et al., 2003). ATLANTIS (formerly IGBEM) is a spatially and temporally-sensitive coupled physical-biogeochemical process model working at the bay level and beyond (Fulton et al., 2004a, 2004b).

## 2.2.2 Marine bio-economic modelling

In the context of agriculture and fisheries management, it is essential to understand the links, inter-relations and trade-offs between biological/ecological and economic drivers and activities, in both directions. The field of bio-economic modelling emerged to address such need in fisheries. Bio-economic models aim to provide tools for avoiding over-fishing, reducing over-capacity and prevent rent dilution (Seijo et al., 1997). Their relevance for fisheries management relies on their usefulness for determining sustainable levels of catch and fishing effort, as well as for establishing a strategy to reach sustainable equilibrium and even rebuilding stocks. Such capabilities are due to the combination of population dynamics, harvest function and associated costs, and economic value of the harvest (Larkin et al., 2011).

A number of bio-economic models developed for fisheries pioneered the field and until today inspire more complex models. Some of those conventional models are briefly introduced in Table 1.

**Table 1: Main bio-economic model types for fisheries**  
Based on Seijo et al. (1997), Landa (2012), Larkin (2011).

| Authors→<br>Criteria↓  | a) Gordon (1954)<br>b) Schaefer (1954) and variations: Fox (1970), Pella & Tomlinson (1969) | a) Smith (1968)<br>b) Clark (1985)  | a) Csirke and Caddy (1983)<br>b) Caddy and Defeo (1996) | a) Beverton and Holt (1957)<br>b) Seijo and Defeo (1994b) |
|------------------------|---|---|---|---|
| Type                   | Static production surplus<br>a) linear<br>b) exponential                                    | Dynamic production surplus<br>a) linear, polynomial<br>b) exponential             | Yield-mortality<br>a) logistic<br>b) exponential        | Age-structured<br>a) static<br>b) dynamic                 |
| Exploitation scenarios | Open access, restricted access, single owner  | Open access, restricted access, single owner                                      | Open access   | Open access   |
| Parameters             | Logistic biological growth, constant harvest price, constant unit cost of effort, harvest   | Static parameters plus<br>a) Stock and fishing effort<br>b) Capital discount rate | Total mortality ( <i>in lieu</i> of fishing effort)     | Growth, recruitment, mortality, age-specific parameters   |

Key fisheries-oriented bio-economic models currently in use in the EU were described in the detailed meta review by Prellezo et al. (2009). Such models are normally based on the conventional approaches listed in Table 1. Agriculture research also benefits from bio-economic models, as described for instance

in Brown (2000). In fisheries management, bio-economic models are applied mainly for stock assessment and the establishment of limits and thresholds (Cooper, 2006).

### 2.2.3 Supply chain modelling: generalities

Socio-economic systems have also been profusely modelled, especially by economists. Many approaches have attempted to represent and describe the socio-economic dynamics occurring in those complex systems (e.g. agricultural and fishfood systems), including the following (Legarde and Macombe, 2011):

- The Value Chain (Porter, 1985), and extensions of that organisation-wise model such as the Global Value Chain (Gereffi et al., 2001), focus on flows of goods and services from producer to consumer and on the hierarchy and power relations among vertical players (suppliers, purchasers).
- The *Filière* is an adaptation of value chain concepts by French research institutions, starting in the 1960's, and focused on vertically integrated agricultural production and distribution systems (Raikes et al., 2000).
- The Strategic Arena (Rothschild, 1984; Bidault, 1988) integrates the concepts of value chain, competitive environment and *Filière*. It focuses on the relations (competition, collaboration) among chains in a globalised world.
- Business strategies such as Competitive Dynamics and Co-opetition. Competitive Dynamics (Smith et al., 1992) focuses on the competitive context and strategic interactions (actions and reactions) between firms within an industry (Smith et al., 2001). Co-opetition and the Value Net (Brandenburger and Nalebuff, 1996) analyses competition and cooperation dynamics among firms, and introduces the concept of "complementor" (a complementary product that enhances the value of another products in the perception of consumers).
- The Supply Chain is a concept used since the early 1980's referring to the dynamics between firms (value chains) contributing to the provision of a good or service. It encompasses all value chains, integrated or not, along the life cycle of the delivered product (Jain et al., 2010), as well as material, information and financial flows circulating among those value chains (Kasi, 2005).
- An extension of the supply chain concept is the Ecological Supply Chain, that is to say, a supply chain built and managed according to the principles of Industrial Ecology: recycling and back-feeding of materials, energy and information towards zero-emissions; use of environmentally friendly materials in production and transportation; etc. It aims to solve the trade-offs between environmental and economic-oriented supply chain management (Ji and Zhang, 2009). The product is closely related to the industrial ecology theory and practice of Industrial Symbiosis.

The supply chain concept is the ideal approach to study nowadays economic organisations, immerse in a globalised world and both featuring and lacking vertical integration. Related concepts and research fields include corporate strategy, customer relationship management, knowledge management, logistics, marketing, operations research, quality management, risk management, sourcing and supplier management, stakeholder theory, sustainability, systems theory, etc (Lavassani and Movahedi, 2010; Bjørndal et al., 2004).

Supply Chain Management (SCM) is the theory and practice of streamlining the dynamics among supply chain players towards better integration, efficiency and sustainability; by means of strategic

collaboration (Gold et al., 2010). Applications of SCM include problems as varied as environmental proactivity, strategic purchasing, supply management, green supply (Gold et al., 2010), etc.

Supply chain modelling is practiced for understanding, analysing and improving efficiency, effectiveness and sustainability of supply chains. A review of applications suggests supply chain redesigning, validation and verification, sensitivity analysis, optimisation, robustness, risk and uncertainty analysis, etc; are amongst the issues addressed by supply chain modelling (Kleijnen, 2005). Various approaches to supply chain modelling have been described and several taxonomies proposed. Some key trends in published classifications include the following:

- Several authors propose a high level first segregation of models into stochastic and deterministic (Keramati 2010; Keramati and Eldabi, 2011). **Stochastic** (probabilistic) models consider uncertainty and randomness into account, while **deterministic**<sup>3</sup> (non-probabilistic) models do not (Beamon, 1998; Min and Zhou, 2002).
- Shapiro (2000) proposed a high level segregation of models into descriptive (including simulation models) and normative/optimisation. Descriptive models are aimed to understanding dynamics of the supply chain, while the normative aim to inform decision-making.
- Kasi (2005) proposed a double segregation. Descriptive models describe the supply chain in terms of processes or another descriptive device while normative models allow comparison and prescribe “better” models. Analytic models describe the supply chain as a set of mathematical relations (equations), which allows for the application of optimisation techniques to design solutions for improving supply chains functionalities; while simulation models are dynamic representation of the supply chain as a set of interplaying variables.
- Acar et al. (2010) proposed, in line with previous taxonomies, a high level segregation of models into analytical (deterministic, stochastic or hybrid) and simulation.
- Further sub-categories proposed include IT-driven models, which rely on software platforms such as Enterprise Resource Planning, Material Requirement Planning and logistic support systems to integrate and coordinate, in real time, different phases of supply chain management (Min and Zhou, 2002); and economic and simulation models (Beamon, 1998; Min and Zhou, 2002; Kim et al., 2004)

Regarding the overall approach (meta-model, framework) required to guide supply chain modelling, more than one has been proposed, but the Supply Chain Operations Reference (SCOR), a descriptive type, provides a widely accepted way of depicting supply chains in a standardised fashion that allows for model comparison (Kasi, 2005; SCC, 2010). SCOR is one of the most widely used frameworks in business and research (Lavassani and Movahedi, 2010). Further guidelines are described in Kasi (2005) and Min and Zhou (2002), and a number of methods to assess supply chain performance are contrasted in Aramyan (2007).

#### **2.2.4 Agrifood and fishfood supply chain modelling**

SCM applied to food supply chains addresses issues such as food safety and risk management (Deep and Sani, 2009), redesigning the supply chain towards performance improvements (van der Vorst and

---

<sup>3</sup> Deterministic modellers use techniques such as linear programming, dynamic programming, mixed integer programming and goal programming; while stochastic modellers apply stochastic programming, stochastic dynamic programming, simulation and risk programming (Ahumada and Villalobos, 2009; Acar et al., 2010).

Beulens, 1999), trade-offs between logistic costs and final product quality (Dabbene et al., 2008; Jensen et al., 2010), accounting and reducing food waste (Parfitt et al., 2010), etc.

Food firms face a complex and dynamic environment, featuring driving forces inducing change such as increasing consumer concerns regarding food safety, bio-industrial production, environmental aspects, etc; unpredictability of consumer demand; intensification of competition due to market liberalisation and globalisation; quality requirements and demand for compliance with labelling and packaging standards; and advances in food and information technologies (Verdouw, 2010). Therefore, it is widely recognised that food firms should involve themselves in demand-driven supply chains, that is to say, in supply chains that reacts to consumer demand signals in a timely and cost-effective fashion. Demand-driven supply chains rely heavily on information technology and information management, rather than in inventory management (Verdouw, 2010).

Supply chain modelling theory has been extensively applied to the study of food supply chains. The goal of supply chain modelling in food systems involves cost reduction, safety and quality, flexibility and responsiveness, among other aspects (Jensen et al., 2010).

Ahumada and Villalobos (2009) compiled an extensive list of models for activity planning developed for non-perishable agrifood supply chains, for fresh agricultural products, as well as for tackling other agricultural supply chain problems. Despite the fact that food —and especially agrifood— supply chains apply preferentially business process modelling (descriptive/normative type), simulation type modelling have also proved useful for certain situations, as listed in Ahumada and Villalobos (2009), which also pointed out that multi-objective and multi-criteria decision-making models have been successfully applied to agricultural decision making. Moreover, food-specific modelling environments have been developed, such as the one proposed in van der Vorst et al. (2009) aimed for integrated decision making on product quality, sustainability and logistics.

Fishfood supply chains face specific supply chain challenges, such as: quality variation between batches, given that most wild caught species are identified by batches; variation and uncertainty of catches leading to complex trading systems such as auction markets (Jensen et al., 2010); sustainability issues such as trade-offs between resource base conservation and socio-economic objectives (Bjørndal et al., 2004); traceability (Mai et al., 2010); shelf life and safety, etc.

Supply and value chain analysis, as well as modelling approaches, have been applied to fisheries, aquaculture and whole fishfood supply chains, as extensively reviewed in Bjørndal et al. (2004). Non-modelling studies have focused on reducing costs, increasing efficiency and improving product quality, as well as (more recently) in developing or re-shaping existing supply chains (Howieson and Lawley, 2010).

Ecosystem modelling, with emphasis on stock assessment, population dynamics and multiple species interactions (in fisheries), as well as fish growth and interactions with the environment (in aquaculture); has been widely practiced. Economic modelling has focused on increased industrialisation and collective behaviour on open access situations (in fisheries) and prices dynamics (in aquaculture and fisheries) (Bjørndal et al., 2004), among other topics.

Operations research-oriented models span objectives as diverse as:

- In fisheries: resource allocation problems, uncertainty management, harvest policy and strategy, harvest timing, quota decisions, experimental management regimes, investment in fleet capacity, stock switching by fishermen, etc (Bjørndal et al., 2004).

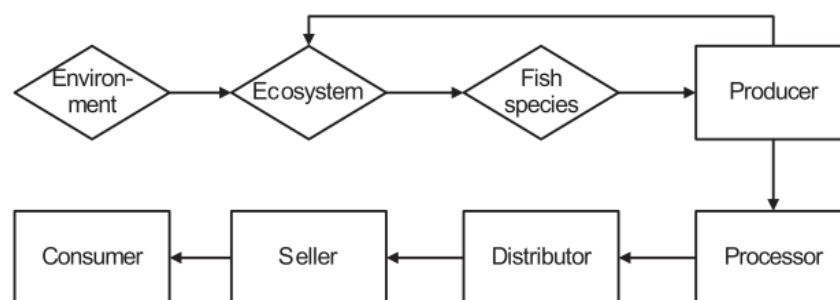
- In aquaculture: trade-offs of alternative activities, strategic planning requirements for emerging technologies, planning and management, optimal harvesting time and other optimal control frameworks, feeding regimes, risk management, etc (Bjørndal et al., 2004).
- Modelling of whole fishfood supply chains is less common, thus it has been suggested future research should focus on optimal production planning, costs associated to additional sorting of raw materials (due to the batch nature of many landed species) and quality aspects (Jensen et al., 2010). Past research has focused on handling and preservation practices for extended shelf life (Howieson and Lawley, 2010).

In conclusion, despite the fact supply chain analysis and modelling of agrifood systems is quite common, modelling of fishfood supply chains is less represented in research.

## 2.2.5 Coupled marine ecosystem/supply chain models

Few efforts have been oriented to develop coupled models combining ecosystem models and fishfood supply chains models (fishfood SES). The reduced number of examples of SES models applied to fisheries, as listed in Schlüter et al. (2012), showed spatial sensitivity and inclusion of fishermen/vessel behaviour and their impact on management systems. Despite those few examples, most of the fisheries-related modelling research has historically focused on ecological (or ecosystem) modelling, that is to say, on ecosystem-fisheries interactions which do not explore socio-economic aspects.

Regarding two-way coupling of ecosystem and supply chain models, Khan (2009) proposed combining a fish chain modelling approach with an EwE trophic model for modelling policy scenarios for stock recovery. Such approach was based on an idea later published in Christensen et al. (2011), where a SES consisting on a combined ecosystem (using EwE trophic models) and a proprietary value chain modelling approach is proposed. The model coupling proposed in Christensen et al. (2011), was eventually implemented in EwE in terms of the underlying mathematical logic (master equations): it defines constituencies of seafood supply chains from an economic perspective, e.g. distinguishing between producers, processors, distributors, sellers, and consumers; and describes product flows amongst them in economic terms, although with a limited feedback. A working value chain module has been implemented as a plug-in for the last stable version of Ecopath with Ecosim (EwE 6.2).



**Figure 2: Supply chain representation from ecosystem to consumer (single fish species)**

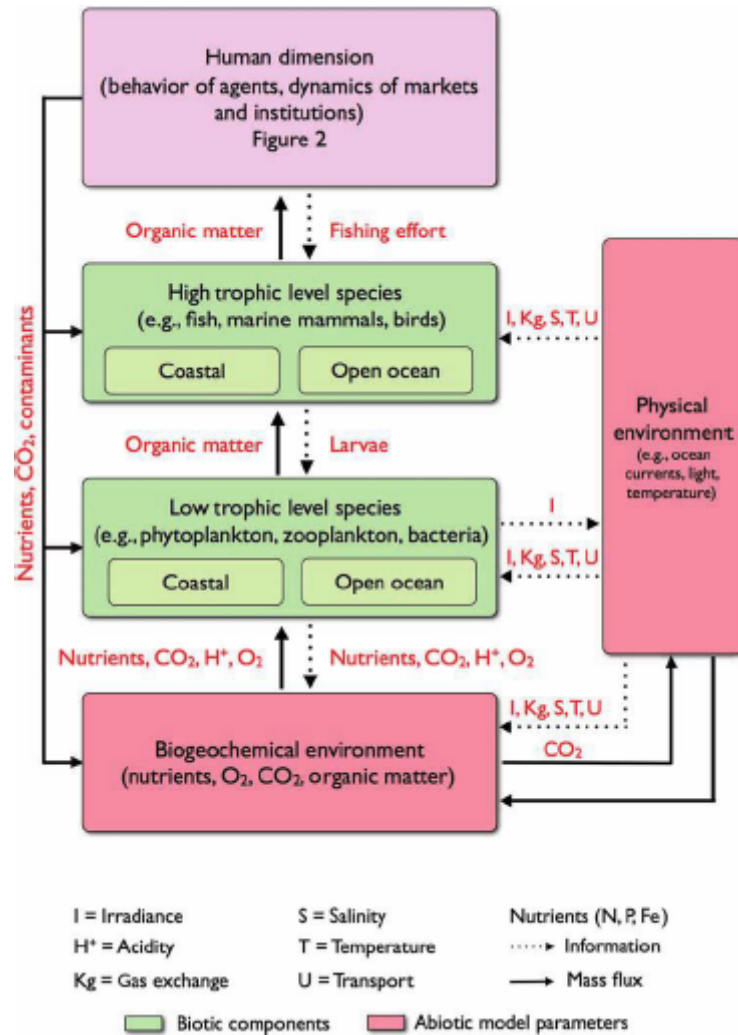
Reproduced from Christensen et al. (2011). Diamond-shaped elements are modelled in Ecopath with Ecosim and rectangles (firms) are modelled in the value chain modelling tool (implemented in Umberto).

A recent publication highlights the use and relevance of “model-based scenarios as a scientific tool for adaptive stewardship” in the face of the consequences on human well-being of anthropogenic impacts on marine ecosystems (Österblom et al., 2013). The same publication reviews the relevant aspects that should be modelled “in order to understand marine ecosystem dynamics from a social–ecological

systems approach”, as depicted in Figure 3 (diagram of the marine ecosystem dynamics includes the physical and biogeochemical environments, food-web dynamics, and the anthropogenic dimension; while the diagram of the human dimension includes a variety of societal actors such as fishermen, aquaculture, farmers, etc).



a) Ecosystem components (Figure 1)



b) Human dimension (Figure 2)

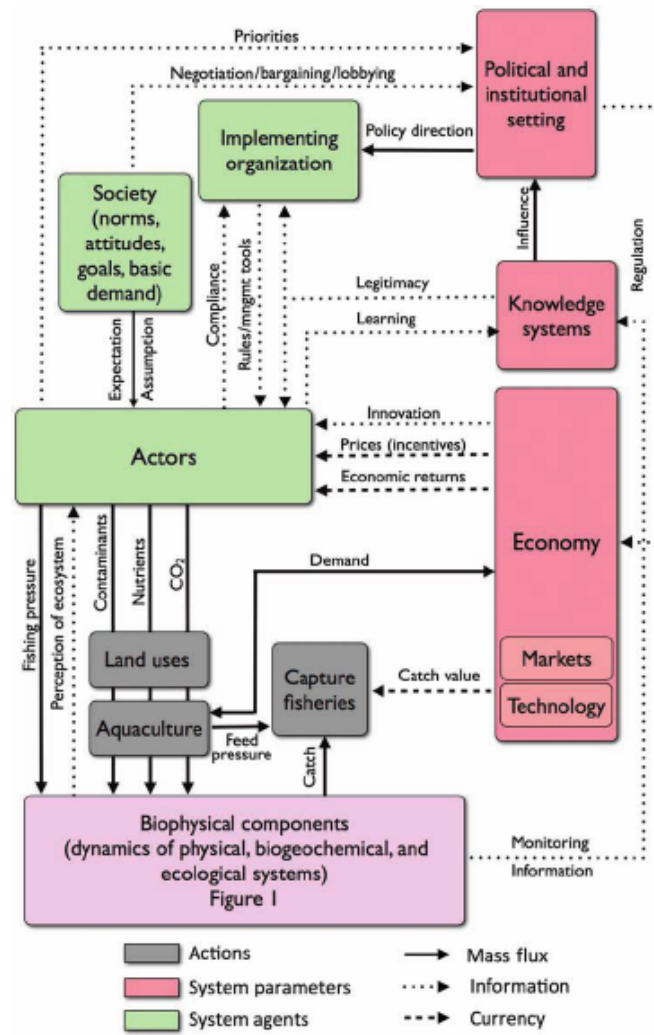


Figure 3: Ecosystem (a) and human (b) components for creating social–ecological scenarios

Reproduced from Österblom et al. (2013).

## 2.3 Concepts and tools for sustainability and sustainability assessment

Sustainability concerns pervade policy instruments and management approaches applied to all types of human activities. Food and fishfood supply chains are not the exception, thus a number of theoretical and practical solutions have been developed to tackle those needs. In this literature review, various concepts and tools for sustainability assessment will be described, followed by a more detailed description of their use in food and fishfood systems in particular.

### 2.3.1 Sustainability assessment at the micro, macro and meso levels

Concepts related to material and economic efficiency, as well as to waste minimisation such as sustainable consumption and production (SCP), eco-efficiency and cleaner production dominated the development of sustainability science at the micro (firm, project) level:

- The World Business Council for Sustainable Development (WBCSD) introduced the term **eco-efficiency** in its influential publication *Changing Course: A Global Business Perspective on Development and the Environment* (Schmidheiny, 1992), associating it to the availability of oil and resources as an accepted constraint to growth and to the carrying capacity of existing waste and emissions sinks. Eco-efficiency is basically a management philosophy and practice of combining industrial efficiency and ecological concerns into economic activities, in such a way that efficient use of resources yields more products with less associated waste and emissions (WBCSD, 2006). Energy efficiency constitutes the main theme in eco-efficiency as an economy-wide phenomenon (Nilsson et al., 2009).
- **Cleaner production** (CP) is generally defined as “the continuous application of an integrated preventive environmental strategy to processes, products and services to increase eco-efficiency and reduce risks to humans and the environment”, that is to say, a management approach to industrial dynamics oriented to improve environmental and economic performance. It includes resource use optimisation, input substitution, on-site recycling, technology and process modifications (designing or re-designing production systems), etc. The CP approach contrasts with end-of-pipe solutions to industrial pollution and is related to other environmental management and preventive approaches such as waste minimisation, pollution prevention, reduction and prevention of toxic substances use, etc. (van Berkel, 2002; van Berkel, 2007; VDI, 2005).
- **Sustainable consumption and production** (SCP), a concept related to eco-efficiency, cleaner production, environmental management systems, etc; is oriented at environmental, economic and social benefits derived from addressing resource and material flows that are related to environmental degradation and economic drawbacks (e.g. costs of raw materials). SCP is stimulated mainly through policy instruments, aiming to decouple economic growth from resource and material use (CSCP/GTZ, 2006). The SCP concept is amply researched in the context of food systems (Ayer et al., 2009; Freibauer et al., 2011).

Other concepts extend the search for sustainability to the industrial collaboration realm and to the regional, national and international level:

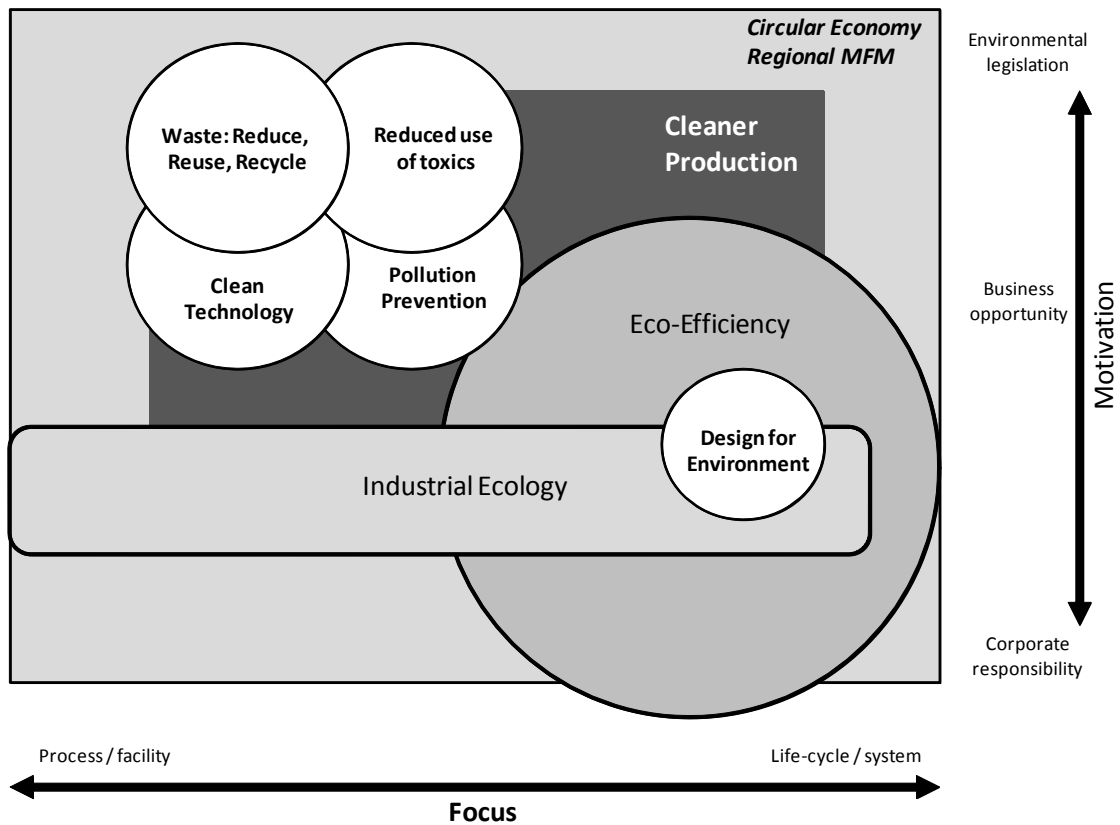
- **Industrial Ecology (IE)** is an approach related to industrial metabolism<sup>4</sup>, basically a business-oriented promotion of eco-efficiency approaches with emphasis on the search for synergies rather than isolated CP solutions. IE promotes industrial ecosystems, concept that implies inter-company interplay (Deutz and Gibbs, 2008). It has also been described as an approach to the study of ecologically sustainable industrial systems (Cote, 2008). A main contribution of IE to sustainability is its influence on economists and policy makers into the study of physical (material and energy) flows as to complement the study of abstract monetary flows (Korhonen, 2004).
- **Industrial Symbiosis (IS)**, is regarded as a sub-set of IE which “engages traditionally separate entities in a collective approach to competitive advantage involving physical exchange of materials, energy, water, and by-products” (Chertow, 2007). The idea that waste from one industrial process can become the raw materials for another was first described and then popularised in the influential article *Strategies for Manufacturing* (Frosch and Gallopoulos, 1989). IS has historically taken the form of substances exchange (by-products, wastes), infrastructure and utility sharing, joint services provision and eco-industrial parks (Deutz and Gibbs, 2008; van Berkel, 2006). The pioneer and lighthouse project for IS is the one implemented in the industrial complex of Kalundborg (Denmark) from the beginning of the 1960 and known as the “Kalundborg initiative” (Chertow, 2007; Ehrenfeld and Gertler, 1997).
- **Circular Economy (CE)** refers to the redefinition of a regional economy to the industrial metabolism and IE paradigm in which “waste” does not exist, but all outputs from a process feed other processes; and both resource utilisation and load on natural sinks are reduced (Heck, 2006). Key issues in CE include closed substance loops, optimisation and rationalisation of energy (emphasis on decentralised renewable generation) and materials (waste management, design for environment, reduced use of toxic chemicals), SCP and material flow management (Heck, 2006; McKinsey & Company, 2012). Since 2009 China possesses a Law Promoting Circular Economy, whose implementation is widely discussed in peer-reviewed literature. The federal German state of Rhineland-Palatinate incorporates circular economy concepts into its environmental strategy (MUFV, 2008).
- **Material Flow Management (MFM)** is a generic term identifying a global philosophy and interdisciplinary approach, a goal-oriented toolset for implementing sustainable strategies related to energy and materials; waste, water and wastewater management; sustainable job creation, etc (Helling et al., 2005). MFM applies concepts and tools from different disciplines, such as cost-benefit analysis, material flow analysis, IE, etc; at different scopes, ranging from firms to whole regions. Among the variety of tools under the MFM philosophy, which are based upon the concepts of industrial (and socio-economic) metabolism (Ayres and Simonis, 1994; Haberl et al., 2004a; Janssen and van den Bergh, 1999), Material Flow Analysis has been successfully applied for regional sustainability purposes (e.g. MUFV, 2008). The terms Material

---

<sup>4</sup> Industrial metabolism is a conception of anthropogenic (especially productive) processes occurring in society (the socio-economic system) as following the same behaviour as natural processes occurring within living organisms: consumption of materials and energy as inputs to produce useful products, while discharging unusable leftovers as waste (Janssen and van den Bergh, 1999). This concept supports efficiency and development approaches such as eco-efficiency and various forms of industrial collaboration.

Flow Assessment/Analysis/Accounting<sup>5</sup> (MFA) represent a family of methods for studying the flow of materials in anthropogenic systems, ranging from micro to macro level applications (Finnveden and Moberg, 2005). Materials and energy flow analysis, the foundation of MFM and MFA, combines methods from and is used in ecology, economics and sustainability assessment (Suh, 2005).

The relationship between some of these concepts (and others not explicitly described here) is depicted in Figure 4.



**Figure 4: Eco-efficiency and other sustainability concepts**

Adapted from CECP (2007).

Regarding sustainability assessment, a number of frameworks have been developed for evaluating projects, firms, industrial sectors, regions, countries, national and international supply chains, country blocks and even the progress of sustainable development at the global level. Some assessment frameworks, approaches and tools target specific aspects of sustainability, more commonly the environmental or the economic dimensions of performance but, more recently, there is a trend towards integrated sustainability assessment, especially at the firm and whole industrial sector level.

Two distinct general methodologies are applied for sustainability assessment: economists usually use monetary aggregation methods (i.e. valuing the natural environment from the perspective of its functions, aka ecosystem services), while ecologists prefer biophysical indicators (Singh et al., 2009).

<sup>5</sup> Material Flow Analysis/Assessment in particular refers to the systematic assessment of the flows and stocks of materials and energy within a time and space-bound system (Brunner and Rechberger, 2003), often industrial or regional. Material Flow Accounting commonly applies to national scopes.

Sustainability assessment frameworks have been classified based upon numerous criteria. A generalised classification criterion is to identify frameworks as procedural or analytic, and stating each method's focus/level and dimension of sustainability addressed (Finnveden and Moberg, 2005; Jeswani et al., 2010; Ness et al., 2007; Schepelmann et al., 2009; Štreimikienė et al., 2009). Table 2 presents a synthesis of key methods.

**Table 2: Non-exhaustive taxonomy of sustainability assessment tools and methodologies**

Adapted from Finnveden and Moberg (2005), Haberl et al. (2004b), Hoekstra et al. (2011), Jeswani et al. (2010), Ness et al. (2007), Schepelmann et al. (2009), Štreimikienė et al. (2009), Tukker et al. (2006), and Tyedmers (2000).

| <b>Procedural frameworks</b>   | <b>Focus/Level</b>                   | <b>EN</b> | <b>EC</b> | <b>SO</b> |
|--|--------------------------------------|-----------|-----------|-----------|
| <i>Environmental Impact Assessment (EIA)</i> : Multi-tool framework aimed to explicitly consider environmental and social impacts associated to new project developments. Often required by legislation in public projects.  | Micro (project)                      | X         |           | X         |
| <i>Strategic Environmental Assessment (SEA)</i> : Multi-tool framework similar to EIA but oriented to evaluate policy instruments, often in situations of high uncertainty.  | Meso, macro (policy)                 | X         |           | X         |
| <i>Sustainability Assessment (SA)</i> : Umbrella term encompassing different methods and tools aiming to comprehensive sustainability assessment. Often profiting on life cycle methods.   | Macro, micro (policy, project)       | X         | X         | X         |
| <i>Multi-Criteria Decision Analysis (MCDA)</i> : Collection of decision support methods aimed to compare alternatives based on a set of decision criteria. Suitable for conflicting decision situations.   | Micro, meso, macro (project, policy) | X         | X         | X         |
| <b>Analytical frameworks</b>   | <b>Focus/Level</b>                   | <b>EN</b> | <b>EC</b> | <b>SO</b> |
| <i>Material Flow Assessment/Analysis/Accounting (MFA)</i> : Systematic accounting of flows and stocks of materials and energy occurring within an economic system, often a whole region or country.<br><i>Substance Flow Analysis (SFA)</i> : MFA-type assessment focusing on the fate of specific substances, at the regional or national level.  | Macro (policy, plan)                 | X         |           |           |
| <i>Material Input per Service Unit (MIPS)</i> : Estimation of the environmental pressure associated to products and services expressed as a life cycle-wise ratio of natural resources consumption to benefit provided.  | Micro (product, service)             | X         |           |           |
| <i>Energy/Exergy/Energy Analysis (EA)</i> : Group of methods aimed to account for energy flows occurring in the studied system, usually a process or product system. Exergy refers to energy of certain quality (useful to produce work).<br><i>Energy Return On Investment (EROI)</i> : A ratio of industrial energy embedded in a product vs. the energetic content of the product, representing energy efficiency. A variation of EROI, Edible Protein EROI, is used to compare energy efficiency of food production systems. | Micro (process, product, service)    | X         |           |           |
| <i>Risk Analysis/Assessment (RA)</i> : Assessment toolset aimed to environmental, health and safety-related risks associated to projects or product systems (chemicals, hazardous substances, and industrial facilities).  | Micro (project, chemicals)           | X         |           |           |
| <i>Eco-Efficiency (EE) Analysis</i> : Concept aligned with the growing environmental concerns of the economic sectors, which can be defined as a management philosophy encouraging business to search for more environmentally-sound alternatives producing similar economic benefits.   | Micro (product, service)             | X         | X         |           |
| <i>Life Cycle Assessment (LCA)</i> : Life-cycle tool aimed to account for the environmental impacts, expressed in a number of impact categories,   | Micro (process, product,             | X         |           |           |

|  |   |   |   |   |
|--|---|---|---|---|
| <p>associated to the provision of a good or service over its whole life cycle. Various existing “footprints” are related to LCA, but focusing on single issues/indicator categories:</p> <ul style="list-style-type: none"> <li>• <i>Carbon Footprint (CFP)</i>: Can be considered as a sub-set of LCA focusing on global warming potential.</li> <li>• <i>Ecological Footprint (EF)</i>: Accounts for the land use associated to the provision of a product. EF can be complemented with Human appropriation of net primary production (HANPP), which studies the proportion of original primary production that remains on a space-specifically defined land area given specific land use practices.</li> <li>• <i>Water Footprint (WF)</i>: Accounts for the freshwater resource appropriation (including fresh, rain and polluted water volumes affected) associated to the provision of a product, in a spatiotemporally explicit fashion.</li> </ul> | service)<br>Macro, Meso<br>(footprints)         |   |   |   |
| <p><i>Environmental (Extended) Input-Output Analysis (E(E)IOA)</i>: Extension of the established Input Output Analysis (IOA) methodology to include environmental impact data in a sector-wise economic assessment. The conventional IOA monetary datasets are either extended with environmental impact coefficients or replaced with biophysical based datasets.</p> <p><i>Hybrid LCA</i>: combination of IOA/EIOA with LCA usually aimed to provide data for the cradle-to-gate portion (basic industries providing raw materials).</p>   | Meso, macro<br>(policy,<br>product,<br>service) | X |   |   |
| <p><i>Life Cycle Costing (LCC)</i>: Life-cycle tool aimed to account for all the costs associated to the provision of a good or service. Proposed as a complement to LCA.</p>  | Micro (product,<br>service)                     |   | X |   |
| <p><i>Social Life Cycle Assessment (SLCA)</i>: Life-cycle tool aimed to account for all the social impacts associated to the provision of a good or service. Proposed as a complement to LCA.</p>  | Micro<br>(product)                              |   |   | X |
| <p><i>Cost–Benefit Analysis (CBA)</i>: Analysis tool for the assessment of costs and benefits, expressed in terms of money, of projects or activities (often government projects). Used to compare alternatives. Includes the costs associated to environmental and social impacts.</p>  | Micro, meso,<br>macro (project,<br>policy)      |   | X |   |
| <p><i>Total Cost of Ownership (TCO)</i>: Can be considered as a limited type of LCC focused on the product user and addressing only the use phase.</p> <p><i>Total Cost Accounting (TCA)</i>: Equivalent to LCC, focusing on less tangible, hidden and liability costs.</p>  | Micro (product,<br>service)                     |   | X |   |
| Sustainability dimensions: EN - Environmental, EC - Economic, SO - Social.   |   |   |   |   |

Sustainability assessment methods either rely on indicator sets or directly consist of indicator frameworks (Ness et al., 2007). Simple and composite indicators and indices consolidate information on performance measurements and system dynamics into basic metrics, easy to communicate and compare (Singh et al., 2009).

The following sub-sections focus on sustainability assessment methodologies, especially those applied to food and fishfood systems.

### 2.3.2 Sustainability indicators

Sustainability indicators can be applied to assess sustainability performance of processes, firms, industrial/economic sectors; and even sustainable development at the regional, national, international and global levels (Štreimikienė et al., 2009).

In general, it can be stated that a simple compilation of sustainability indicators does not properly reflect the overall sustainability of a given system, unless system dynamics are modelled and alternative scenarios are explored (Dahl, 2012). Under such perspective, indicators are considered useful to flag significant parameters (e.g. environmental hotspots) in the studied system as to prevent damage, support decision making and strategic planning, and anticipate conditions and trends (Singh et al., 2009; Dahl, 2012).

The production of a comprehensive set of sustainability indicators is often a very complex endeavour, when multiple stakeholders are involved in the process. Two main conceptual frames for such creation/compilation process have been proposed: knowledge production and norm creation (Rametsteiner et al., 2011). Table 3 describes those conceptual frames, together with examples proposed and adopted by leading international organisations (Bowen and Riley, 2003; Rametsteiner et al., 2011; Singh et al., 2009).

**Table 3: Conceptual frames for the development process of sustainability indicators systems**  
Modified from Rametsteiner et al. (2011).

|                             | <b>Knowledge production</b>  | <b>Norm creation</b>  |
|-----------------------------|--|---|
| Background and input        | Scientific and technical objective knowledge.  | Norms, values and interest.   |
| Actors                      | Scientists and experts.  | (Democratically) elected politicians as representatives, bureaucrats, stakeholders, and citizens.   |
| Ideal knowledge application | “Best available” reflection of factual knowledge.  | “Best possible” reflection of societal norms, values and interest.  |
| Ideal process               | Scientific methods of disciplinary, inter-, multi- or trans-disciplinary science; Decisions on indicators based on their relative factual importance in human system–ecosystem interaction.  | Democratic voting; decisions on indicators based on their relative value for society.   |
| Outcomes                    | “Truthful” representation of human system–ecosystem interaction.   | Democratically legitimized preferences on values of nature, inter- and intra-generational equity.   |
| Examples                    | <ul style="list-style-type: none"> <li>The Pressure-State-Response (PSR) framework, developed by the Organisation for Economic Co-operation and Development (OECD). PSR is based on the idea that human activities impose <b>pressures</b> on the environment, altering its the capacity of providing ecosystem services (<b>state</b>), thus, society provides <b>response</b> in terms of policy instruments aimed to have positive effect on the degraded state (OECD, 2001).</li> <li>The Driving Force-Pressure-State-Impact-Response (DPSIR) Model has been adopted by the European Environmental Agency (EEA). It extends the PSR framework with <b>driving forces</b> to pressures (e.g. population and economic growth, urbanisation and agricultural intensification) and <b>impacts</b> due to the change in state (on the functioning and life-supporting</li> </ul> | <ul style="list-style-type: none"> <li>The Lowell Center Indicator Framework, by the Lowell Center for Sustainable Production (LCSP), University of Massachusetts; is a five-step approach for organising existing indicators and developing new ones, basically by means of aggregating indicators from the facility to the supply chain to the sustainable society (Veleva and Ellenbecker, 2001).</li> </ul> |

|  |  |  |
|--|--|--|
|  | abilities of ecosystems, on human health and on the socio-economic performance of society) (Smeets and Weterings, 1999). |  |
|--|--|--|

At the project or process/product system level, sustainability indicators used are those associated to the assessment frameworks applied. For instance, when life cycle methods are applied to evaluate product systems, life cycle impact assessment methods applied feature pre-defined sets of environmental indicators (LCA), while existing guidelines propose a series of socio-economic indicators (LCC, SLCA). A very recent recommendation/guidelines for the application of environmental assessment frameworks to products and organisations has been developed by the European Commission (European Commission, 2013; Pelletier et al., 2013). The recommendation proposes a specific selection of Life Cycle Assessment impact categories (see section 2.3.3).

At the firm (corporate) level, the use of sustainability indicators is associated to the practice of sustainability reporting, decision-making at the strategic level and supply chain management (Searcy, 2009). The United Nations Environment Programme (UNEP) together with the NGO Coalition for Environmentally Responsible Economics (CERES) launched in the late 1990's the Global Reporting Initiative (GRI). This initiative features over 100 indicators aggregated around the classical three pillars of sustainability (social, environmental and economic), and aims to provide a trusted and credible framework for organisations of any kind to report their sustainability performance (Müller and Sturm, 2001; Labuschagne et al., 2005; GRI, 2006). GRI is the most widely used framework for corporate sustainability reporting. Other indicator sets/environmental assessment frameworks developed for the organisational level include, among others:

- The abovementioned European Commission “recommendation on the use of common methods to measure and communicate the life cycle environmental performance of products and organisations” (European Commission, 2013).
- The Greenhouse Gas Protocol guidelines, by the WBCSD (WBCSD, 2000; WRI and WBCSD, 2004)
- ISO 14064:2006 and related guidelines for GHG accounting/reporting for organisations (ISO, 2006d,e; ISO/WD, 2010).
- *Bilan Carbone* v5.0, a GHG accounting framework for private and public organisations by the French Agency for the Environment and Energy Management –ADEME (ADEME, 2007).
- A GRI-based GHG accounting/reporting guideline by the UK Department of Environment, Food and Rural Affairs –DEFRA (DEFRA, 2009).

At the industrial sector level, various frameworks and indicator sets have been produced, including international and multi-sectorial oriented (Labuschagne et al., 2005; Singh et al., 2009). Composite indicators, or *indices*, consolidate a number of indicators into a single metric and are used to compare/benchmark sustainability performance of countries and territories (Villasante et al., 2011). Such consolidation is usually based upon a weighting of chosen indicators in order to express them in a common meaningful unit of measurement (Singh et al., 2009). Normalisation and weighting is, by definition, a subjective matter. Some 160 sustainability indices have been proposed, yet most are not widely used by policy-makers due to subjectivity issues (Bandura, 2008).



Singh et al. (2009) reviewed a large range of indices, and proposed a comprehensive classification into: innovation, knowledge and technology indices; development indices; market- and economy-based indices; eco-system-based indices; composite sustainability performance indices for industries; investment, ratings and asset management indices; product-based sustainability indices; sustainability indices for cities; environmental indices for policies, nations and regions; environment indices for industries; energy-based indices; and social and quality of life-based indices.

Assessment of sustainable development is considered to consist of a two-step process: measure progress in selected fields by means of sustainability indicators; and assess overall progress by analysing those indicators in combination (Singh et al., 2009). Sustainable development is measured for cities, regions, countries, regional economic sectors and at the international/global level (Dahl, 2012; Rametsteiner et al., 2011; Singh et al., 2009). Frameworks and indicator sets developed for the city, provincial, national and international level have been reviewed in Côté and McCollough (2007), including the sustainability indicators set of the European Union EUROSTAT SDI, used to monitor the European Union Sustainable Development Strategy (Adelle and Pallemarts, 2009).

Nutritional aspects have been seldom considered in indicator frameworks and sets. Such inclusion takes the form of nutrient requirements of agriculture (e.g. the gross nutrient balance by EEA) and, very rarely, nutrition-related health/well-being impacts of products. Nutritional qualities of products are handled within composite indices such as, for instance, the Global Seafood Market Performance Index proposed by Villasante et al. (2011). Nutritional performance of production systems under sustainability assessment is not usually highlighted, but frequently fused within the social dimension of sustainability.

A separate, wide body of research has addressed the nutritional nature of foodstuffs. Aside from sustainability indicators, various nutrient profile models have been created to assess nutritional qualities of food products and diets, and communicate nutritional value of foods via food labels. The most relevant of those profiles, currently in use, were summarised in Drewnowski and Fulgoni (2008), among other studies, as depicted in Table 4.

**Table 4: Nutrient profile models featuring beneficial nutrients and nutrients to limit**

Adapted from Drewnowski and Fulgoni (2008).

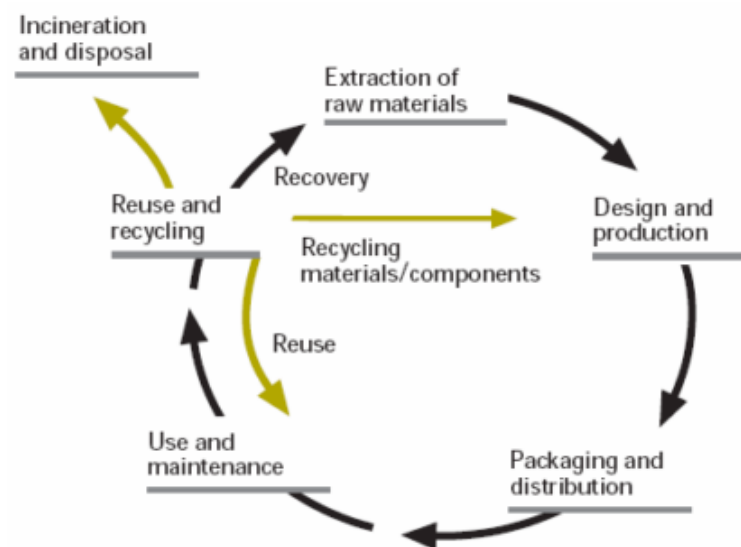
| Score  | Macronutrients                       | Vitamins   | Minerals                     | Nutrients to limit                                  | Algorithm  | Amount     | Comment   |
|--|--------------------------------------|--|------------------------------|---|--|------------|---|
| Nutritional Quality Index (NQI)                          | Protein, fibre, MUFA, carbs          | A, C, thiamin, riboflavin, B <sub>6</sub> , B <sub>12</sub> , niacin                                 | Ca, Fe                       | Fat, saturated fat, cholesterol                     | $NQI = (N/RDA_n)/(kcal/1000)$  | 1 000 kcal | Calculated separately for each nutrient (N), so not a total score.  |
| Calories for Nutrient (CFN)                              | Protein                              | A, C, thiamin, riboflavin, niacin, B <sub>6</sub> , B <sub>12</sub> , folate                         | Ca, Fe, Zn, Mg               |   | $CFN = ED/\sum_{1-3}(\%DV)/13$   | 100 g      | A caloric penalty approach. Energy density (ED) divided by mean of percent DVs for 13 nutrients, based on 100 g of food.            |
| Nutritious Food Index                                    | Fibre                                | A, C, thiamin, riboflavin, niacin, folate  | Ca, Fe, Zn, Mg, K, Ph        | Total fat, saturated fat, cholesterol, Na           | $NFI = \sum (wDFC/RDI + wLDFC/RDI)$  | Serving    | Sum of weighted (w) desirable (DFC) and less desirable (LDFC) food components; each divided by RDI.                                 |
| Ratio of recommended to restricted food components (RRR) | Protein, fibre                       | A, C   | Ca, Fe                       | Energy, saturated fat, total sugar, cholesterol, Na | $RRR = \frac{\sum (Nutrient_{recommended}/6)}{\sum (Nutrient_{restricted}/5)}$ | Serving    | A ratio score based on nutrients listed on the food label   |
| Naturally Nutrient Rich (NNR)                            | Protein, fibre, MUFA                 | A, C, D, E, thiamin, riboflavin, B <sub>12</sub> , folate  | Ca, Fe, Zn, K                |   | $NNR = \sum_{1-15} ((Nutrient/DV) \times 100)/15$                              | 2 000 kcal | Unweighted arithmetic mean of % DVs for 15 nutrients. DVs based on 2000 kcal and capped at 2000%DV.                                 |
| Nutrient for Calorie (NFC)                               | Protein, fibre                       | A, C, E, B <sub>12</sub>   | Ca, Fe, Zn, Mg, K, Ph        | Saturated fat, Na                                   | $NFC = \sum_{1-11} (\%DV)/11 - \sum_{1-3} (\%DV)/3$                            |            | Sum of 11 positive nutrients minus sum of 3 negative nutrients  |
| Nutrient Adequacy Ratio (NAR) SAIN16, SAIN23             |                                      |  |                              |   | $NAR_n = \sum_{1-n} ((Nutrient/DV) \times 100)/n$                              | 100 g      | NAR based on nutrients (n) and 100 g of food.   |
| Nutrient Density Score NDS16                             | Protein, fibre                       | A, C, D, E, thiamin, riboflavin, niacin, pantothenic acid, B <sub>6</sub> , B <sub>12</sub> , Folate | Ca, Fe, Mg                   |   |  |            |   |
| Nutrient Density Score NDS23                             | Protein, fibre, linolenic acids, DHA | A, C, D, E, thiamin, riboflavin, niacin, B <sub>6</sub> , B <sub>12</sub> , folate                   | Ca, Fe, Zn, Mg, K, Cu, I, Se |   | $NDS_n = (NAR_n/ED) \times 100$  | 100 kcal   | NDS calculated by dividing NAR by energy density (ED)   |
| Limited nutrients (LIM) score                            |                                      |  |                              | Saturated fat, added sugar, Na                      | $LIM = \sum_{1-3} (Nutrient/MRV)/3 \times 100/Q$                               | 100 g      | Based on maximum recommended values (MRV) for 3 negative nutrients and 100 g  |
| FSA model SSCg3d   | n-3 fatty acids, F + V (g)           |  | Ca, Fe                       | Energy, saturated fat, added sugar, Na              |  |            | Total score = C (negative nutrients) – A (positive nutrients) unless C > 11.<br>Complex score for nut, vegetable and fruit content. |
| FSA model WXYfm  | Protein, fibre, F + V + nuts (g)     |  |                              | Energy, saturated fat, total sugar, Na              |  |            |   |
| Nutrient Rich Food, NRF <sub>n</sub>                     |                                      |  |                              |   | $NRF_n = (\sum_{1-n} ((Nutrient/DV) \times 100)/n)/ED$                         | 100 kcal   | Unweighted arithmetic mean of %DV for n nutrients.  |
| Nutrient Rich Food NRF <sub>n,3</sub>                    |                                      |  |                              |   | $NRF_n - LIM$  | RACC       | Calculated by subtracting LIM from NRF <sub>n</sub> . Calculations based on RACC  |

Abbreviations: DHA, docosahexanoic acid; F + V, fruit and vegetables; MUFA, monounsaturated fatty acids; DV, daily value; RACC, reference amount customarily consumed; RDI, reference daily intake. The following daily values based on 2000 kcal/day are used for building nutrient profiles: Protein, 50 g; Fibre, 25 g; Linoleic acid, 9 g; Linolenic acid, 1.8 g; DHA, 0.11 g; Vitamin A, 5 000 international units; Vitamin C, 60 mg; Vitamin D, 400 international units (10 µg); Vitamin E, 30 international units (20 mg); Vitamin K, 80 µg; Thiamin, 1.5 mg; Riboflavin, 1.7 mg; Niacin, 20 mg; Vitamin B<sub>6</sub>, 2.0 mg; Vitamin B<sub>12</sub>, 6 µg; Folate, 400 µg; Pantothenic acid, 10 mg; Calcium, 1 000 mg; Iron, 18 mg; Magnesium, 400 mg; Zinc, 15 mg; Phosphorus, 1 000 mg; Selenium, 70 µg; Copper, 2.0 mg; Potassium, 3,500 mg; Iodine, 150 µg; Fat, 65 g; Saturated fat, 20 g (10% energy of 2000 kcal diet); Monounsaturated fat, 20 g (10% energy of 2000 kcal diet); Cholesterol, 300 mg; Sugar (total), 50~125 g; Sugar (added), 50 g (10% energy of 2000 kcal diet); Sodium, 2,400 mg.

There is no evidence in literature for a nutritional profile model specific for fishfood (and it does not seem necessary), so nutrition information labels for fishfood products use standard profiles. Comparisons of nutritional characteristics of different fishfood products have focused on vitamins, minerals, protein, energy content and specially Omega-3 fatty acids, namely eicosapentaenoic acid (EPA, 20:5) and docosahexaenoic acid (DHA, 22:6). EPA and DHA are considered to bring large health benefits to humans, when consumed (Bellows et al., 2010, Pike and Jackson, 2010).

### 2.3.3 Life Cycle Management and life cycle methods

In the last decade, the so called “life cycle thinking” has spread from the environmental assessment field into management and planning: life cycle thinking helps organisations and firms to integrate social, economic and environmental dimensions of their activities. Moreover, life cycle thinking helps extending the focus from, for instance, production into a product’s whole life cycle, including resource extraction, emissions, social performance, etc (UNEP/SETAC, 2006). The life cycle of a product is graphically represented in Figure 5. Life cycle tools assess product systems over its whole life cycle, including extraction of raw materials, processing, manufacturing, use phase and disposal, including the infrastructure necessary for those phases and provision of associated materials and energy.



**Figure 5: Ideal life cycle of a product**  
Reproduced from UNEP/SETAC (2006).

**Life Cycle Management (LCM)** is the application of the life cycle thinking philosophy to business practice, in such a way that the whole operations of a firm or organisation strives for more sustainable consumption and production, eco-efficiency, and in general increased sustainability. LCM is a toolset and a management framework encompassing a variety of tools and techniques aimed to improve environmental, social and economic performance of products, processes and organisations (UNEP/SETAC, 2006). LCM encompasses the following constituencies<sup>6</sup>:

- Strategies and concepts: dematerialization, Cleaner Production, Industrial Ecology and Eco-efficiency.

<sup>6</sup> Life Cycle Management: A Business Guide to Sustainability - CD-ROM:  
(<http://www.unep.fr/shared/publications/cdrom/DTIx0889xPA/>).

- Systems and processes: certification, Extended Producer Responsibility (EPR), Integrated and Environmental Management Systems and Integrated Product Policy (IPP).
- Programmes: Public Green Procurement, Design for Environment (DfE), Supply Chain Management, communication, Corporate Social Responsibility (CSR), stakeholder engagement and Public Green Procurement.
- Data, information and models: databases, best practice references, fate models, etc.
- Tools and techniques: standards, voluntary agreements, audits, checklists and life cycle tools.

LCM features a variety of life cycle tools, such as (UNEP/SETAC, 2007): Life Cycle Assessment (LCA), Life Cycle Costing (LCC), Cost Benefit Analysis (CBA), Material and Substance Flow Analysis (MFA/SFA), Input-Output Analysis (IOA), Material Input Per Unit of Service (MIPS), Cumulative Energy Requirements Analysis (CEPA), Cleaner Production Assessment (CPA) and Risk Assessment (RA). Many of these tools, some of which are described in Table 2, focus on the environmental performance of firms, organisations and industrial sectors.

A fundamental driver for changing an existing anthropogenic system towards increased sustainability is the potential environmental impact of its products (manufactured and consumed), of running the system and delivering its outputs. To address the need of understanding and preventing/reducing those impacts the tool **Life Cycle Assessment (LCA)** is increasingly being used. The ISO 14040 (ISO, 2006a,b) series provides guidelines on how to conduct a LCA, which is a detailed account of all resources consumed and emissions associated to a specific product along its whole life span (life cycle), from raw materials acquisition through processing and utilisation to final disposal. LCA can assist in improving the environmental performance of a product, inform decision makers towards more sustainable strategic planning and for companies to communicate environmental performance (i.e. as a marketing or compliance instrument) (ISO, 2006a).

See **Paper 1: Life Cycle Assessment of fisheries: a review for fisheries scientists and managers** (section 2.4.1) for more details on LCA in general, including **Attributional LCA (ALCA)** and **Consequential LCA (CLCA)** and see **Appendix C: A comparison of current Life Cycle Impact Assessment methods** for the comparison of currently available LCIA methods. Among them, the ReCiPe method (Goedkoop et al., 2009) integrates and harmonises midpoint and endpoint indicators in a coherent framework (see **Appendix D: The ReCiPe LCIA method**). ReCiPe moreover extends and complements previous methods widely used in fishfood research (Parker, 2012; Avadí and Fréon, 2013): CML and Ecoindicator 99 (Goedkoop et al., 1998; Goedkoop and Spriensma, 2001).

Despite its maturity, the LCA method still features a number of technical problems, data gaps and problematic decisions, as thoroughly discussed in Reap et al. (2008a,b). Among those, the following abridged list is representative:

- Functional unit definition does not fully reflect the product system, for instance, by including only the primary function of the product and by excluding temporal and quality constraints (Cooper, 2003; Reap et al., 2008a).
- Allocation strategies and the ISO allocation hierarchy pose fundamental theoretical and implementation problems, and thus allocation of impacts among co-products is one of the most difficult and controversial methodological aspects of LCA studies, to a large extent due to its effects on results (Ardente and Cellura, 2012; Ayer et al., 2007; Curran, 2007; Ekvall and Finnveden, 2001; Reap et al., 2008a; Suh et al., 2010; Weidema, 2000).

- Data gaps, uncertainty and bias regarding aspects such as toxicity (Reap et al., 2008b; Sleeswijk, 2010) and normalisation (Heijungs et al., 2007; Reap et al., 2008b; Sleeswijk et al., 2008; Norris, 2001). Pedigree assessment of the data used for LCIs has been practiced (e.g. pedigree indicators in Ecoinvent), and further pedigree-related data protocols have been suggested for primary, secondary and background data management (Henriksson et al., 2013). Data uncertainty in particular is a great issue in LCA, and a number of approaches have been developed to address it, account for it and communicate it (Cooper and Kahn, 2012); including parameterisation (the practice of presenting LCA data by means of raw data and formulas, without computation (Cooper et al., 2012)).
- Spatial and temporal variation; and local environmental uniqueness (Jeswani et al., 2010; Reap et al., 2008b).
- Exclusion of capital goods without proper analysis (Frischknecht et al., 2007).
- Methodological and data-driven uncertainties of LCA (Thrane, 2004b; Reap et al., 2008b).
- Implications for application in business (Baitz et al., 2012).
- Exclusion of human labour (Rugani et al., 2012)

Moreover, fundamental criticism to LCA in relation to its use and usability in international supply chains (supply chain capitalism) has been raised, notably in Freidberg (2013).

LCA can be considered as the most extended life cycle tool. It can profit on other tools such as MFA and Input-Output Analysis, and is related (or even spawned) other tools such as LCC<sup>7</sup>, SLCA<sup>8</sup> and various footprints (carbon, water, ecological) (Guinée et al., 2006; Schepelmann et al., 2009). It is widely accepted that LCA started the life cycle thinking development that originated LCM. As mentioned before, LCA and related life cycle tools are governed by a number of ISO and other international standards, listed in Table 5.

**Table 5: Standards and guidelines governing the application of life cycle methods**

Self elaboration.

| Life Cycle methods | ISO standards   | Other standards and guidelines  |
|--------------------|---|---|
| Carbon Footprint   | ISO 14067<br>(products,<br>draft)<br>ISO 14069<br>(organisations,<br>draft) | British Standards Institution: PAS 2050:2011 (BSi, 2011)<br>World Business Council for Sustainable Development:<br>Greenhouse Gas Protocol guidelines (WBCSD, 2000; WRI<br>and WBCSD, 2004)<br>International Panel for Climate Change: 2006 IPCC Guidelines<br>for National Greenhouse Gas Inventories (IPCC, 2006) |

<sup>7</sup> LCC was developed to complement traditional cost-accounting systems which failed to encompass all the costs, especially environmental costs, associated to product systems over their complete life cycle (Gluch, 2004). LCC is used to predict costs associated to decisions and actions, as well as to capture the trade-offs between environmental impacts and economic costs and benefits, towards improved decision-making and policy-making (Huppes et al., 2004).

<sup>8</sup> SLCA was developed basically to enhance the utility of LCA, by providing information on potential social impacts associated to the life cycle of a product system. It relies on the basis that firms are socially responsible and carry out their activities in search for profit, and is intended for firms to conduct socially responsible business (Dreyer et al., 2006).

|   |                        |   |
|---|------------------------|---|
|   |                        | United Nations Framework Convention on Climate Change: Clean Development Mechanism methodologies <sup>9</sup> and tools<br>Carbon Trust's Carbon footprint measurement methodology (Carbon Trust, 2007)   |
| Ecological Footprint  |                        | Global Footprint Network: GFN (2009)  |
| Environmental footprints (combination of LCA impact categories)                       |                        | Recommendation on the use of common methods to measure and communicate the life cycle environmental performance of products and organisations (European Commission, 2013; Pelletier et al., 2013)   |
| Environmental Product Declaration (EPD)/Product Claim and Product Category Rule (PCR) | ISO 14025              | Product rule (GHG Protocol Product Standard)<br>Supplemental requirements (PAS, 2050)   |
| Life Cycle Accounting and Reporting   |                        | Global Reporting Initiative: Sustainability Reporting Framework (GRI, 2006)<br>United Nations Conference on Trade and Development (UNCTAD) and Intergovernmental Working Group of Experts on International Standards of Accounting and Reporting (ISAR): guidelines on corporate responsibility reporting and eco-efficiency (UNCTAD, 2004; UNCTAD/ISAR, 2006, 2008)<br>World Business Council for Sustainable Development: Corporate, value chain and life cycle accounting and reporting standard (WBCSD 2000, 2011a,b) |
| Life Cycle Assessment   | ISO 14040<br>ISO 14044 | Guinée et al. (2002)<br>International Reference Life Cycle Data System: ILCD (2010)   |
| Life Cycle Costing  |                        | Society of Environmental Toxicology and Chemistry (SETAC): Swarr et al. (2011)<br>Country and sector-specific guidelines and standards  |
| Material Flow Analysis  |                        | Brunner and Rechberger (2003)   |
| Social Life Cycle Assessment  |                        | United Nations Environment Programme/SETAC Life Cycle Initiative: UNEP/SETAC (2009)   |
| Water Footprint   | ISO 14046 (draft)      | Water Footprint Network: Hoekstra et al. (2011)   |

From the various footprints proposed to assess the environmental performance of single impact categories with a life cycle perspective, carbon and ecological footprints are tightly integrated within the LCA framework, to the extent that accepted and generalised calculation approaches have been produced. For instance, **Carbon Footprint** is equivalent to the LCA impact category Global Warming Potential, while **Ecological Footprint** is implemented in databases and LCA software as a single-issue LCIA method. The newer **Water Footprint**, in the other hand, extends existing water depletion LCA indicators into a wider and more complex approach, still under consolidation by the scientific community. The water footprint accounts for water consumption, in terms of the part of the water withdrawal that evaporates or gets incorporated into a product, and assesses the use of ground and surface water, rainwater, as well as the generation of water pollution (Hoekstra et al., 2011).

Environmental Product Declarations (EPD) and Product Claims are environmental performance statements made over a product and backed up by LCA. The way EPDs should be prepared in order to

<sup>9</sup> CDM Methodologies (<http://cdm.unfccc.int/methodologies/index.html>).

render comparison of products within a category possible, is defined by Product Category Rules (PCR), whose preparation is standardised by the ISO 14025 (ISO, 2006c). A product category is a family of products fulfilling equivalent functions (ISO, 2006c; Schau and Fet, 2008). There are various national PCRs for food products (e.g. in Sweden, Norway, Japan, Korea and France), but few are devoted to fish/fishfood, namely a Norwegian PCR for wild caught fish and a Japanese<sup>10</sup> one for seafood excluding aquaculture (Inwersen and Stevenson, 2012; Schau, 2006; Schau, 2012).

LCA, with its focus on the environmental impacts of systems, is the most mature of existing life cycle methods. Additional tools focusing on other aspects of sustainability, in various levels of application (micro, meso, macro) are used and further developed, as listed in Table 2. Research on the possibility of combining LCA and some of those tools for more comprehensive sustainability assessments is very ample and growing (Guinée et al., 2006; Guinée et al., 2011; Halog and Manik, 2011; Heijungs et al., 2010; Jeswani et al., 2010; Klöpffer, 2008; Schepelmann et al., 2009; Swarr et al., 2011; Valdivia et al., 2011), yet no mature or widely used combined approach has been produced. The following combination possibilities have been explored (Guinée et al., 2006):

- Extension of LCA, building on its maturity, for achieving one consistent model.
- Use of a toolbox, that is to say, to use separate models in combination (e.g. Life Cycle Sustainability Assessment).
- Hybrid analysis, a combination of models with data flows between them (e.g. hybrid LCA).

In this context, attempts for deepening (improvement and classification of standards) and broadening (extension, combination with other tools) LCA have been researched, towards a more comprehensive sustainability assessment framework that improves decision-making (Jeswani et al., 2010; Schepelmann et al., 2009). Some of the challenges faced by LCA are expected to be addressed by such integration/combination with other tools, for instance:

- Characterisation of toxicity (Rosenbaum et al., 2008; Sleeswijk, 2010).
- Spatial and temporal differentiation (Jeswani et al., 2010).
- Characterisation of ecological impacts (Jeswani et al., 2010; Cappell et al.; 2007; Pelletier et al., 2007).
- Integration/linking to socio-economic aspects (Jeswani et al., 2010; Swarr et al., 2011; Valdivia et al., 2011).
- Extension to meso and macro levels, and consistency among levels (Jeswani et al., 2010).

The **Life Cycle Sustainability Assessment (LCSA)** toolbox, first proposed in Klöpffer (2008), can be expressed as  $LCSA = LCA + LCC + SLCA$ . Such integration of life cycle methods could take the form of a toolset sharing system boundaries or a full integration of LCC and SLCA into LCA, as additional impact categories (Klöpffer, 2008). The main challenges for such integration include the maturity level of LCC and SLCA, which are not yet standardised (Swarr et al., 2011), as well as a number of practical issues associated to the four LCSA/LCA stages: goal and scope definition, inventory analysis, impact assessment and interpretation/communication (Valdivia et al., 2011). Frameworks for SLCA integration have been proposed, for instance, in Heijungs et al. (2010) and Valdivia et al. (2011). Recently, a whole issue of the *International Journal of Life Cycle Assessment* (Volume 18, Issue 9, November 2013) was devoted to the

<sup>10</sup> Produced in the context of the Japanese government pilot Project on Carbon Footprinting (2009-2011), <http://www.cms-cfp-japan.jp/english/pcr/pcrs.html>

transition from LCA to LCSA (Zamagni et al., 2013). Other frameworks, e.g. the proposed in Halog and Manik (2011); further extend LCSA with tools such as MCDA and Data Envelopment Analysis<sup>11</sup> (DEA) for assessing sustainability of very complex systems (supply chains, eco-industrial parks, policies).

## 2.4 Methodologies and indicators applied to food supply chains

Many of the described concepts and methodologies have been applied to food (agrifood, animal husbandry, fishfood) systems and supply chains. Numerous and diverse initiatives have arisen to provide information about the environmental and sustainability performance of food products, but yet there is not to date any commonly applied methodology for environmental/sustainability assessment of food supply chains (Peacock et al., 2011). LCA and life cycle management in particular play a key role in sustainable supply chain management (Seuring, 2011; Tarabella and Burchi, 2011). The following list is representative of the application of such methodologies on food systems:

- EIA and SEA have been widely utilised for environmental assessment and monitoring in various regional aquaculture systems (Phillips et al., 2009; Tyedmers and Ayer, 2011).
- LCA and carbon/ecological footprints have been widely applied to assess environmental performance of food products, systems and supply chains, including fishfood (Tukker and Jansen, 2006; ART, 2008; Mogensen et al., 2009; Roy et al., 2009; Flachowsky and Kamphues, 2012; Nijdam et al., 2012). Under the life cycle thinking, various impact categories, indicators and LCIA methods have been developed for or have been successfully used for agriculture, food and fishfood LCA studies, for instance, ecological footprint (Tyedmers, 2001; Tyedmers and Ayer, 2011; Samuel-Fitwi et al., 2012), biotic resource use (Tyedmers, 2000; Papatryphon et al., 2004; Pelletier et al., 2009), seafloor disturbance indices (Nilsson and Ziegler, 2007), Fisheries in Balance (Pauly et al., 2012), primary production-based indicators (Christensen et al., 2000); among others (Fulton et al., 2005).
- Emphasis has been put on the use of biomass —food waste, other organic wastes and agricultural products, by-products and wastes— for the production of energy carriers (e.g. biofuels) and energy generation (Hall and Howe, 2012; IEA, 2007; Meisterling, 2011). Cleaner production, LCA and other discussed concepts and methodologies play a relevant role in such endeavours (Hall and Howe, 2012; MUFV, 2008).
- LCC has been applied for seafood sustainability research, in at least one published study so far (Utne, 2009), yet its future utilisation for sustainability assessment of food products, in combination with other life cycle tools, is expected (Tarabella and Burchi, 2011).
- The assessment of material and energy associated to agricultural and fishfood products, for instance by means of MIPS, EROI and other methodologies, is growing (Hall, 2011; Mancini et al., 2012; Pelletier, 2006; Tyedmers, 2000; Tyedmers et al., 2005; Vázquez-Rowe et al., 2013).
- MFA has been applied to study material and energy flows at the regional level, including agricultural and forestry systems (Barrett et al., 2002; Kytzia et al., 2004; MUFV, 2008).
- A number of energy-related analysis tools have been applied to food systems, for instance:

---

<sup>11</sup> Data Envelopment Analysis, DEA, is a data-driven, linear programming methodology for identifying critical factors to be addressed to improve the performance of decision-making units, in situations of multiple inputs and outputs (Halog and Manik, 2011).



- Exergy analysis, a life cycle approach similar to LCA focusing on the useful energy embedded in substances, has been applied in the food industry in various areas and, suggested for assessing the environmental performance of food supply chains (Apaiah et al., 2006). Cumulative Exergy Demand (CExD) is a LCIA method implementing exergy calculations of resources extracted (Bösch et al., 2007).
- Emergy analysis, a research field pioneered by H.T. Odum (Odum, 1996), expresses energy carriers, electricity, and goods in terms of the solar energy required to produce them. It has been applied to study food production (agriculture, animal husbandry) and ecosystems, including marine ecosystems. It has been recommended the use of emergy analysis in combination with LCA (to account for ecosystems-product system interactions) and with exergy analysis (Hau and Bakshi, 2004).
- Cumulative Energy Demand (CED) accounts for all the primary energy associated to the provision of a product, over its life cycle (VDI, 1997). It is implemented as a LCIA method and thus commonly carried out in the context of LCA studies (Frischknecht et al., 2007; Hirschler and Weidama, 2010).
- Both CED and CExD have been used in food LCA studies, yet those methods fail to account for all types of resources commonly used. To overcome such a limitation, a new CExD-based approach called Cumulative Exergy Extraction from the Natural Environment (CEENE) has been proposed (Dewulf et al., 2007) and used in seafood studies (Huysveld et al., 2013). CEENE subdivides resources into fossil fuels, metal ores, nuclear energy, land resources (including biomass) other non-biomass renewable resources, minerals, atmospheric resources and water resources (Dewulf et al., 2007; Huysveld et al., 2013).

Sustainability indicators have been developed for assessing food and fishfood systems. Since the 1990s, sustainability indicators have been developed for agricultural systems. Important themes in such indicator systems are soil quality and sustainable land use (Qiu et al., 2007). Countries have often developed national sets of indicators for assessing their agricultural systems. Many sustainability indicators have been frequently used for various stages of the food supply chain (agriculture, transportation, manufacturing/industry and retailing), representing the perspective of firms, researchers and other stakeholders (Gerbens-Leenes et al., 2003). For instance, Heller and Keoleian (2000) proposed a set of life cycle-based sustainability indicators to assess US agriculture-based food systems and supply chains as a whole.

Socio-economic indicators have also started to be developed for food and seafood systems, often intended to complement LCA studies (ART, 2008; Bowen and Riley, 2003; Kruse et al., 2008; Seung and Zhang, 2011). The use of socio-economic indicators has been also described in relation with integrated coastal management (Bowen and Riley, 2003), stress on water resources (ART, 2008), climate change and fisheries (OECD, 2010), etc.

In the context of fishfood sustainability, used indicators were focused initially on biological, ecosystem and environmental impacts, and later in more complex indices accounting also for economic, management and technology drivers (Villasante et al., 2011). Some indicator development methodologies and specific indicators have been proposed to address fishfood and fishfood-related ecosystems management, and assess impacts of fisheries and fishfood production (aquaculture, fish processing); for instance:

- Rey-Valette et al. (2008) proposed a collaborative approach for co-construction of sustainable development indicators in aquaculture.
- Potts (2006) proposed a framework for analysing indicator sets for fisheries, and applied it on two different reporting systems. Leadbitter and Ward (2007) proposed a criteria set for evaluating integrated fishery assessment systems (including indicator sets).
- Specific indicators designed to represent the fishing pressure on marine ecosystems, such as Primary Production Required (PPR), intended to measure biotic resource use (BRU) (Pauly and Christensen, 1995), and Fisheries-in-Balance (FiB), measuring whether a fishery is ecologically balanced<sup>12</sup> (Pauly et al., 2000); have been widely used for comparing fisheries (e.g. Coll et al., 2006). Those indicators are often used in the context of LCA studies, both related to fisheries and aquaculture (Henriksson et al., 2011; Parker, 2012; Avadí and Fréon, 2013).
  - BRU is widely applied and seems a good candidate for standardisation within the LCA framework, as proposed by Libralato et al. (2008) and Langlois et al. (2011, 2012), although in different ways. The BRU concept and its equation for exploited fish resources,  $BRU = catches/9^{(Trophic\ Level - 1)}$ , are widely accepted, yet they rely on fundamental assumptions that might be challenged by fish scientists: a 9:1 ratio of fish wet weight to carbon and a 10% transfer efficiency per trophic level. For instance compiled estimates of transfer efficiency by type of ecosystems show variations ranging from 5 to 14 (Libralato et al., 2008), which are likely to reflect mainly fish species variability. Additionally, BRU is extremely sensitive to the estimation of the species trophic level, which varies largely with ontogeny in most fish species.
  - Efforts to quantify BRU include estimates of the Primary Production (PP) appropriated by the harvested biomass. According to various authors, this quantity is called PP required (PPR), net PP (NPP) or net PP used (NPPU) (Pauly and Christensen, 1995; Cappell et al., 2007; Pelletier et al., 2007; Hornborg et al., 2012a) although it is not always clear if net of gross PP is used. This impact category allows comparing diverse food systems, including terrestrial ones. A recent publication proposes a specific discard assessment indicator, the Global Discard Index (also based on PPR), to be included in fisheries LCAs (Vázquez-Rowe et al., 2012b). Other recent publications propose the combined use of two differentiated discard indicators in LCA, namely, appropriation of PPR and the potential discard impacts on vulnerable, endangered and critically endangered (VEC) species (Hornborg, 2012; Hornborg et al., 2012a, 2012b). Current utilisation of BRU (defined as PPR) has been criticised in Hornborg et al. (2013), suggesting it is prone to misinterpretation by overlooking actual catch data, temporal and spatial domains, and the effects of fisheries management.
  - Another approach based on PP has been suggested, and consists in considering not only the PPR to produce the harvested species but also the depletion in secondary production downstream of the trophic flow, with respect to the unfished state, using the latter as a proxy for quantifying ecosystems effects of fishing (Libralato et al., 2008). Such an approach encompasses both ecosystem properties and features of fishing activities (trophic level of catches and PPR).

---

<sup>12</sup> Ecologically balanced fisheries means in this context that a decline in the trophic level of catches should be compensated by an increase in total catches (Pauly et al., 2000).

- The Fish-In Fish-Out (FIFO) ratio, comparing the fish inputs (fishmeal and oil) to cultured fish production (and also considering the feed:gain efficiency); is another indicator widely used to measure ecological efficiency of cultured fish (Tacon and Metian, 2008; Jackson, 2009; Kaushik and Troell, 2010; Welch et al., 2010). PPR is considered a finer measure of ecological efficiency than FIFO (Welch et al., 2010). Crampton et al. (2010) criticised the FIFO ratio for not taking into account the relative nutritional value of protein and lipids in both feed fish and cultured fish. To overcome such alleged limitation, they proposed dividing the protein and lipids of marine origin (fishmeal and oil, respectively) used by a specific culture by the amount of protein and lipids produced by that culture, to compute a Marine Protein Dependency Ratio (MPDR) and a Marine Oil Dependency Ratio (MODR). Crampton et al. (2010) illustrated their approach with a tank study of Atlantic salmon and their results suggest that salmon culture may be marine protein and oil neutral or even be net producer of fish protein and oil (MPDR and MODR < 1). A drawback for widespread application of this new approach may be its higher data requirements (i.e. initial and harvest weights and protein contents of cultured fish), respect to FIFO.
- Langlois et al. (2011, 2012) suggest going further in a broader use of PP appropriation within a framework of a sea-use impact category, similar to land use. They suggest using the three-dimensional approach proposed by Milà i Canals et al. (2007) to account for time (occupation and restoration), space and a quality index reflecting transformation by usage and including a possible permanent or irreversible impact. The authors proposed a typology of marine activity and suggested regrouping under sea use at least the following three ones: artificial structures, biotic resource extraction, shipping lanes. Some additional marine activities such as seafloor destruction (in particular by trawling) or change of habitat surface or volume could also be accounted for using the same index through avoided or added (artificial reef) biomass. Accounting for the impacts of biomass removal on Biotic Natural Resources (BNR) at the species level and at the ecosystem level has also been proposed (Langlois et al., 2014).
- A recent publication (Emanuelsson et al., 2013) proposes a new midpoint impact indicator to quantify depletion of exploited fish stocks: the Lost Potential Yield (LPY)<sup>13</sup>. This indicator utilises current stock assessment data to predict future yields by means of a surplus yield production function. The LPY is the difference in future yields between the consequences of current exploitation levels and alternative exploitation levels defined by the maximum sustainable yield (MSY) approach. The LPY concept features also the midpoints overfishing through fishing mortality (OF) and overfishedness of biomass (OB). OB and  $I_{\text{BNR}}$  might be considered as competing indicators, where OB is more correct and  $I_{\text{BNR}}$  is easier to compute due to lower data requirements.
- Spatialised indicators of fishing pressure were proposed by different authors. For instance, Linnane et al. (2000) summarised various bottom trawling impact studies and Nilsson and Ziegler (2007) proposed a spatialised seafloor impact (i.e. damage to benthos) methodology based on the number of times per year a given area was likely to be swept by a trawl. They combined this value with the recoverability of the habitat to estimate impact on seafloor. In another example, Fréon et al. (2005b) proposed a mean ratio of fished area and area of distribution by species, exploited fraction of the ecosystem surface area, mean bottom depth of catches, and mean distance of catches from the coast. Hornborg et al., (2012a) used seafloor disturbance data from bottom trawling to assess impacts of discard for VEC fish species.

---

<sup>13</sup> In an earlier publication, this concept was referred to as “Wasted Potential Yield - WPY” (Emanuelsson et al., 2012).

To date, there is no accepted/standardised method to assess target and non-target species removal. It has been argued that species removal, together with seafloor impacts, should not necessarily be included in quantitative LCAs for hot-spot identification (Thrane, 2006). However, we assert that when the goal of the study is providing data for environmental protection, those categories must be considered, ideally also quantitatively, by means of existing or new approaches. In contrast to most of above-reviewed indicator related to species removal, the used primary production can be assigned to a given fishery and can allow comparison with other activities such as aquaculture and agriculture.

Moreover, the sustainability of fishfood supply chains has been addressed in the last two decades by policy and market mechanisms such as certification and labelling, as well as by mechanisms and tools towards increased transparency and accountability (Iles, 2007). Other topics addressed by fishfood supply chain research include harvesting practices, processing, LCA, eco-efficiency, waste management, distribution and consumption, total energy costs, and conservation of resources and biodiversity (Ayer et al., 2009).

Some of the policy-related initiatives produced to foster sustainability and sustainability assessment of food chains, include for instance:

- The European Food Sustainable Consumption and Production Round Table, aimed to promote a scientific and coherent approach for SCP in the food sector, including environmental interactions (Peacock et al., 2011).
- The principles, criteria, guidelines and recommendations of sustainability oriented institutions for fishfood, such as the Food and Agriculture Organization of the United Nations (FAO), the Marine Stewardship Council (MSC), the Global Aquaculture Alliance, Friend of the Sea, the Marine Conservation Society (MCS), Greenpeace, World Wide Fund for Nature (WWF); among others (Parkes et al, 2010; Pelletier and Tyedmers, 2008). Specific for fisheries, the Code of Conduct for Responsible Fisheries (FAO, 1995), the MSC’s principles and criteria for sustainable fishing<sup>14</sup> (see Table 6) and the Common Fisheries Policy of the European Union (EU, 2012) are of great relevance.

**Table 6: MSC’s principles and criteria for sustainable fishing**  
Adapted from MSC (2010).

|             |   |
|-------------|---|
| Principle 1 | A fishery must be conducted in a manner that does not lead to over-fishing or depletion of the exploited populations and, for those populations that are depleted, the fishery must be conducted in a manner that demonstrably leads to their recovery.   |
| Principle 2 | Fishing operations should allow for the maintenance of the structure, productivity, function and diversity of the ecosystem (including habitat and associated dependent and ecologically related species) on which the fishery depends.                   |
| Principle 3 | The fishery is subject to an effective management system that respects local, national and international laws and standards and incorporates institutional and operational frameworks that require use of the resource to be responsible and sustainable. |

LCA in particular has been widely applied for assessing the environmental performance of fishfood systems and constituencies of fishfood supply chains, mainly to fisheries and aquaculture, but also to transportation, packaging, retailing and other aspects. The following sub-sections explore in detail the role of LCA in fisheries and aquaculture sustainability research.

<sup>14</sup> A 2004 study applied the MSC principles and criteria to assess sustainability of the Peruvian anchoveta fishery and the North Sea sandeel fisheries (RSPB, 2004).

### 2.4.1 Paper 1: Life Cycle Assessment of fisheries: a review for fisheries scientists and managers

A paper reviewing the use of LCA in fisheries research was produced in the context of this dissertation and published in Fisheries Review (Avadí and Fréon, 2013). It reviewed the application of Life Cycle Assessment for environmental research of fisheries.

|  |                           |
|--|---------------------------|
| Paper idea and design                            | Angel Avadí, Pierre Fréon |
| Experiment design                                | N/A                       |
| Data collection                                  | Angel Avadí               |
| Data processing, statistical analysis, modelling | Angel Avadí               |
| Discussion                                       | Angel Avadí, Pierre Fréon |
| Writing and editorial                            | Angel Avadí, Pierre Fréon |

#### Life Cycle Assessment of fisheries: a review for fisheries scientists and managers

Angel Avadí <sup>a,b,\*</sup>, Pierre Fréon <sup>b</sup>

<sup>a</sup> Université Montpellier 2 – Sciences et Techniques, 2 Place Eugène Bataillon, 34095 Montpellier Cedex 5, France.

<sup>b</sup> UMR 212 EME, Institut de recherche pour le développement (IRD). Centre de Recherche Halieutique Méditerranéenne et Tropicale, Avenue Jean Monnet CS 30171, 34203 SETE cedex. France.

\* Corresponding author

#### Abstract

This review aims to synthesise and discuss current literature applying the Life Cycle Assessment (LCA) framework for the environmental assessment of fisheries. The review introduces and illustrates the LCA framework, and highlights energy use by fishing vessels, among other key factors determining environmental impacts of fisheries operations. Moreover, the review concludes with recommendations on future developments of LCA in the fisheries and seafood sectors. We reviewed 16 studies on LCA applied to fisheries, with perspectives from a few additional publications on closely related topics. The main Aspects considered in the ad hoc comparison of studies include: scope and system boundaries, functional units, allocation strategies for co-products, conventional and fishery-specific impact categories used, fuel use, impact assessment methods, level of detail in inventories, normalisation of results and sensitivity analyses. A number of patterns and singularities were detected. Fishery-specific impact categories, despite not being standardised, and fuel use in fishing operations were identified as the main contributors to environmental impacts. Energy efficiency was found to be strongly related to the fishing gear used. Several studies discussed the impacts of antifouling substances and metals use. The need for standardisation of fisheries LCA research is justified and ideas on how to do so and what elements to standardise (fisheries-specific impact categories, inventory details, normalisation references, etc.) are discussed. Finally, fisheries LCA constitute a useful research field when studying the sustainability of seafood and fisheries-based agrifood, and it should likewise contribute to an ecosystem approach to fisheries.

Keywords: Allocation, energy, environmental impacts, fisheries, Life Cycle Assessment

## 1 Introduction

Fisheries represent a primary industry and the starting point of supply chains of local, regional and global relevance. They play a key role in food security due to the rich protein (and often lipid) content of fish: seafood supply chains provided more than half of the world's population with at least 15% of their average animal protein intake as of 2010, and the output of key activities in those supply chains (capture and aquaculture) features a growing trend (SOFIA, 2012). The seafood industry generates over 180 million jobs worldwide, which represents the livelihood of 8% of the world's population (SOFIA, 2010). Moreover, seafood products represented about 10% of total agricultural exports (figure showing a growth trend), while fisheries and aquaculture (including shellfish) provided the world with 142 million t of fish in 2008 (of which almost 20% was used for non-direct human consumption, e.g. for reduction into fishmeal and fish oil) (SOFIA, 2010).

Conventional fishery research has, for a long time, focused mostly on individual stock assessment and management. Only in the last decade, in a limited number of countries, has research addressed the ecosystem approach to fisheries (EAF) (FAO, 2003; reviews in Fréon et al., 2005a; Garcia and Cochrane, 2005; Plagányi, 2007). The need for understanding and limiting the ecosystem impacts of fisheries is evident in the principles of the EAF (FAO, 2003), and thus research on the environmental impacts of fisheries has expanded. However, it is nowadays mostly limited to on-site effects, including: removal of target species and non-target species, adverse effects on top-predator species populations (e.g. marine birds and mammals), changes in marine food webs and other alterations of ecosystem structure,, and cumulative impacts on marine ecosystems related to the destruction of benthic communities and substrates due to certain fishing practices (e.g. bottom trawling). These impacts have been discussed at different levels. For instance, they have been compiled and described in the FAO guideline for Ecosystem Approach to Fisheries

(FAO, 2003), analysed in great detail in the Handbook of Fish Biology and Fisheries (Reynolds and Hart, 2002) and discussed within the context of sustainability (Smith et al., 2010). Nonetheless these direct effects are seldom considered within the context of an integrated life cycle approach. Moreover, the indirect and off-site effects of fishing activities have been largely ignored until only recently.

Environmental impacts resulting indirectly from fishing operations are mostly associated with the extraction and transformation of natural materials and fossil fuels used for the construction, use and maintenance of fishing units. These indirect and often global —or at least large scale impacts— include: emissions related to fuel combustion, release of antifouling substances, use of cooling agents, provision and loss of fishing gear, further transportation, wastewater and waste discharge, release of cleaning agents and refrigerant gases, etc; as discussed in Ziegler et al. (2003), Thrane (2004a), Hospido and Tyedmers (2005) and Cappell et al. (2007).

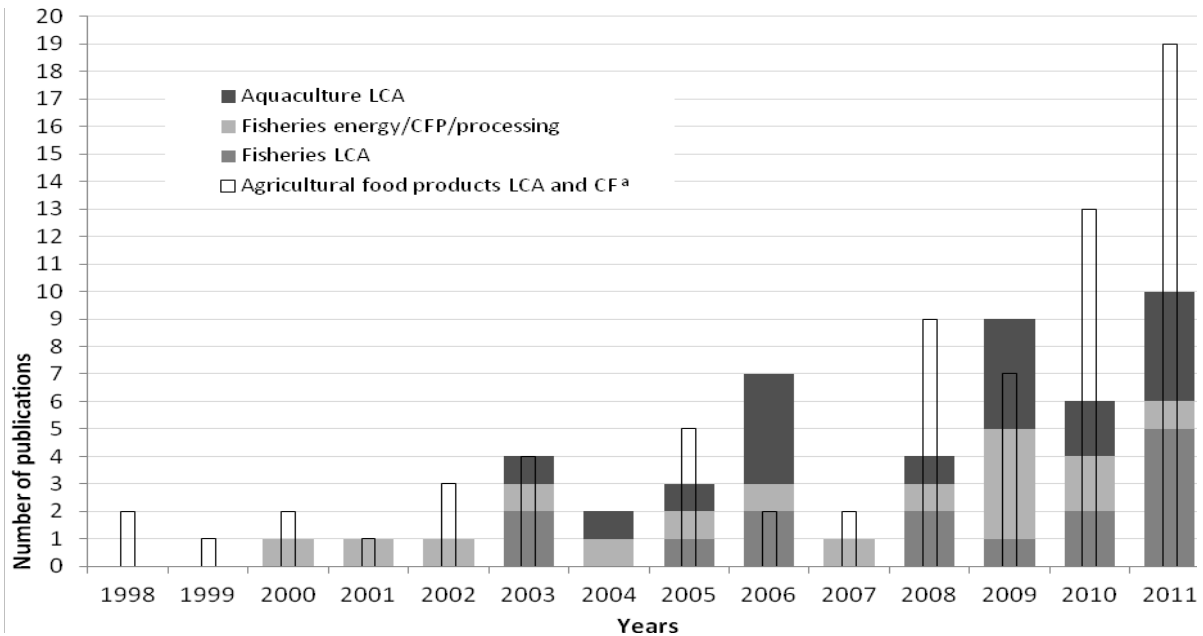
Life Cycle Assessment (LCA) is a widespread framework for environmental assessment of food systems, including fisheries. It benefits from an International Organisation for Standardisation (ISO) standard —the ISO 14040 series— and a large body of theoretical and methodological research. LCA is one of the approaches developed to address the increasing concerns regarding environmental impacts inherent in the provision of products and services, and the need to understand and minimise these impacts. LCA allows for comprehensive evaluations to be made on the environmental impacts related to products over their whole life cycle, that is to say, encompassing infrastructure, energy provision, extraction of raw materials, manufacturing (cradle-to-gate), distribution, use and final disposal (cradle-to-grave) (ISO, 2006b). Nonetheless, in practice, all life cycle stages of a product are not always addressed in LCA studies due to data restrictions or to the goal of the study. LCA is thus a tool aimed to, among other purposes, identify opportunities for improving

environmental performance and inform decision makers on the environmental performance of products, product systems and even their alternatives (ISO, 2006a). It can moreover assist in selecting environmental performance indicators (e.g. for sustainability assessment) and be used for marketing purposes (ISO, 2006b). Marketing claims based on LCA could reduce the risk of it being perceived as biased, i.e. “green washing” (Horiuchi et al., 2009).

LCA applied to food systems and agricultural production dates at least from the mid 1990s, but has been applied to aquaculture and fisheries research only in the last decade (Figure 1). Early seafood LCA studies found valuable information on previous research such as energy analyses of fleets and seafood products, for instance as in Tyedmers (2001) and Thrane (2004a). Energy analyses are relevant in relation to fisheries LCA due to the accepted importance of fuel consumption for fleet operations (Tyedmers, 2001) and associated environmental impacts (Thrane, 2004a; Schau et al., 2009; Driscoll and Tyedmers, 2010). Carbon footprint (CF), often

considered as a sub-set of LCA (EC/JRC, 2007), is closely associated to fisheries LCA due to the strong impact of fuel consumption on the single impact category considered by CF: global warming. Pioneering studies on LCA and CF applied to fisheries include Eyjólfsson et al. (2003), Ziegler et al. (2003), Thrane (2004a) and Hospido and Tyedmers (2005).

This review mainly aims to illustrate the LCA framework by discussing its application to fisheries research in order to bridge the gap between the conventional fisheries scientist community and the LCA one, and more broadly the Industrial Ecology and environmental management communities. Furthermore, it discusses literature on environmental assessment of fisheries based on LCA and energy analyses of fishing vessels and fleets, in order to identify challenges in fisheries LCA research. This work complements recently published reviews on the use of LCA in fisheries and seafood research, namely Vázquez-Rowe et al. (2012c) and Parker (2012).



<sup>a</sup> Dominated by dairy and meat products (excluding bio-energy studies). LCA: Life Cycle Assessment, CF: Carbon Footprint.

**Figure 1** Histogram of published LCA studies in selected areas from 1998 to 2011

## 2 Material and methods

We reviewed a number of studies, mostly LCAs of fishing vessels and fleets, and identified patterns and discrepancies. The pertinent ISO standard was used as a comparison/analysis structure (ISO, 2006a,b).

The reviewed studies here were found by web searches in environmental assessment and fisheries research journals, and citations in leading fisheries LCA publications. Peer-reviewed literature on fisheries LCA is limited, thus all available studies were included, plus a few additional works focusing on energy aspects and CF of fishing operations: 16 studies on LCA applied to fisheries, two studies focused on energy aspects of national fishing operations (e.g. fuel-per-landed fish ratios) and one CF of a national fishing fleet; as listed in Table 1.

This review focuses on extraction activities and therefore excludes seafood processing (except when it occurs onboard). One of the LCA studies also features extensive energy analysis of various fishing fleets. Additional studies based on the same datasets as these 19 studies are also quoted in various sections of this review. Further studies were identified in the form of master theses, but were excluded to rely almost exclusively on peer-reviewed publications. Two very representative and cited doctoral theses were also included: an energy and ecological footprint analysis (Tyedmers, 2001) and a very detailed LCA (Thrane, 2004a). Theses feature well recognised contribution to fisheries research in a life cycle context and provide supplementary information on primary literature articles by the same authors, also reviewed here. Work in progress by the authors (Fréon et al., in prep.), soon to be submitted for publication, has also been cited in this review. The abovementioned study supports several positions and recommendations expressed in this review, as for instance, the relevance of the construction phase of fishing vessels (often considered as irrelevant in literature) and our contribution to the discussion of co-product allocation in fisheries.

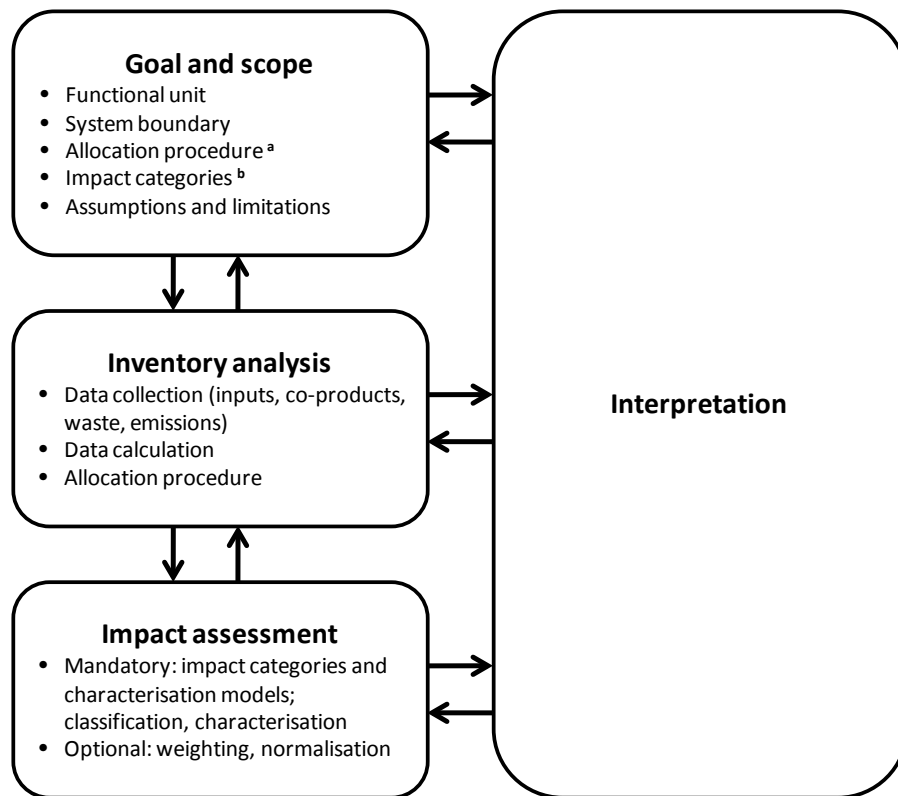
All LCA studies reviewed were dissected using the four LCA stages defined by the ISO standard (Figure 2): goal and scope definition, life cycle inventory (LCI) analysis, life cycle impact assessment (LCIA) and interpretation (ISO, 2006a). It is worth noting that LCA studies require a critical review process if the results are to be publically disclosed (ISO, 2006b; Klöpffer, 2012). The LCA phases will be explained in more detail and illustrated with examples from fisheries research over the following section, while conclusions drawn on both the state of the art and the future of fisheries LCA are discussed in the last section.



**Table 1:** Major features of reviewed fisheries LCA studies, including some non-LCA complementary studies. Studies are alphabetically ordered. Fuel use data used in (3) is published in Ziegler and Hansson (2003). Fuel use and other data used in (8) are published in Ziegler et al. (2009). Fuel use and other data used in (7) are published in (4). Fuel use data used in (13) was published in (18).

| No | Authors                                 | Targeted species   | Fishery gear                              | Fishing region                          | No. of years | No. of vessels   | Capture      |     |             |     | Processing |              |     |             | Functional Unit | LCA type, justification and allocation | Sensitivity analysis                         |  |
|----|---|--|---|---|--------------|------------------|--------------|-----|-------------|-----|------------|--------------|-----|-------------|-----------------|--|--|--|
|    |   |  |   |   |              |                  | Construction | Use | Maintenance | EOL | Transport. | Construction | Use | Maintenance |                 |  |  | EOL  |
| 1  | (Tyedmers 2001) <sup>a</sup>            | <i>Codfish, Small pelagic fish, Tuna, Shrimps &amp; prawns, Lobster &amp; crab</i>                         | <i>trawling purse seining trapping</i>    | <i>Northeast Atlantic</i>               | 3            | 186              |              | X   | X           |     | X          |              |     |             |                 | N/A                                    | N/A  | N/A  |
| 2  | (Eyjólfssdóttir et al. 2003)            | Cod  | trawling                                  | Northeast Atlantic                      | 1            | 25               |              | X   | X           |     | X          |              | X   | X           | X               | 9 kg frozen fillet                     | ALCA (descriptive), mass                     | no   |
| 3  | (Ziegler et al. 2003)                   | Cod  | trawling gillnetting                      | Northeast Atlantic                      | 1            | X                |              | X   | X           |     | X          |              | X   | X           | X               | 400 g frozen fillet                    | ALCA (descriptive), economic                 | no   |
| 4  | (Thrane 2004a) <sup>a</sup>             | Codfish (various), Norway lobster, Northern prawn, Shrimp, Herring, Mackerel, Industrial fish (e.g. Tobis) | trawling purse seining                    | Northeast Atlantic                      | 1~2          | 330              |              | X   |             |     | X          |              | X   |             | X               | 1 kg frozen fillet                     | CLCA (stated by author), system expansion    | yes, product substitution, Ecoindicator 99 vs EDIP |
| 5  | (Hospido & Tyedmers 2005)               | Skipjack Yellowfin tuna  | purse seining                             | Atlantic, Pacific, Indian oceans        | 10           | 9                | X            | X   | X           |     |            |              |     |             |                 | 1 t frozen fish                        | ALCA (descriptive), avoided                  | yes, allowable emissions from ships                |
| 6  | (Ellingsen & Aanondsen 2006)            | Cod  | trawling purse seining                    | Northeast Atlantic                      | 1            | X                |              | X   | X           |     | X          |              |     |             | X               | 200 g fillet                           | ALCA (descriptive), mass & economic          | yes, Ecoindicator 95 vs EDIP                       |
| 7  | (Thrane 2006)                           | Flatfish   | trawling                                  | Northeast Atlantic                      | 1            | 330              |              | X   |             |     | X          |              | X   |             | X               | 1 kg frozen fillet                     | CLCA (stated by author), system expansion    | yes, product substitution, Ecoindicator 99 vs EDIP |
| 8  | (Emanuelsson et al. 2008)               | Southern pink shrimp   | trawling artisanal trawling               | Eastern Central Atlantic                | 2            | 19               |              | X   | X           |     | X          |              |     |             |                 | 1 kg frozen packed shrimps             | ALCA (descriptive), economic                 | yes, 8 different criteria                          |
| 9  | (Ziegler & Valentinsson 2008)           | Norway lobster   | creeling trawling                         | Northeast Atlantic                      | 2            | 19               |              | X   |             |     | X          |              | X   |             | X               | 1 kg landed lobster                    | ALCA (descriptive), economic                 | yes, Ecoindicator 99 vs CML                        |
| 10 | (Guttormsdóttir 2009)                   | Cod  | trawling long lining                      | Northeast Atlantic                      | 3            | 2                |              | X   | X           |     | X          |              | X   | X           | X               | 1 kg of frozen light salted fillets    | ALCA (descriptive), mass                     | yes, elimination of fossil fuels                   |
| 11 | (Driscoll & Tyedmers 2010) <sup>a</sup> | <i>Atlantic herring</i>  | <i>trawling purse seining</i>             | <i>Northwest Atlantic</i>               | 12           | 364 <sup>b</sup> |              | X   |             |     |            |              |     |             |                 | N/A                                    | N/A  | N/A  |
| 12 | (Iribarren et al. 2010) <sup>a</sup>    | <i>European hake, Atlantic horse mackerel, European pilchard, Anglerfish, Tuna</i>                         | <i>trawling long lining purse seining</i> | <i>Atlantic, Pacific, Indian oceans</i> | 1            | 84               |              | X   | X           |     |            |              |     |             |                 | 1 t landed fish                        | ALCA (descriptive), economic                 | No   |
| 13 | (Vázquez-Rowe et al. 2010a)             | European hake, Atlantic horse mackerel, Atlantic mackerel, Blue whiting                                    | trawling                                  | Northeast Atlantic                      | 1            | 24               | X            | X   | X           |     |            |              |     |             |                 | 1 kg landed fish                       | ALCA (mgmt-policy dimension), not discussed  | Data Envelopment Analysis                          |
| 14 | (Vázquez-Rowe et al. 2012a)             | Common octopus   | trawling                                  | Eastern Central Atlantic                | 1            | 8                | X            | X   | X           |     | X          |              |     |             |                 | 1 t landed fish                        | ALCA (predictive scenarios), mass & economic | no   |
| 15 | (Ramos et al. 2011)                     | Atlantic mackerel  | purse seining                             | Northeast Atlantic                      | 8            | 27-45            | X            | X   | X           |     |            |              |     |             |                 | 1 t landed fish                        | ALCA (descriptive), timeframes               | no   |
| 16 | (Svanes et al. 2011a)                   | Cod  | long lining                               | Northeast Atlantic                      | 1            | 10               |              | X   |             |     | X          |              | X   |             | X               | 1 kg product                           | ALCA (descriptive), mass & economic          | yes, fuel use                                      |
| 17 | (Vázquez-Rowe et al. 2011)              | European hake  | trawling long lining                      | Northeast Atlantic                      | 1            | 21               | X            | X   | X           |     | X          |              |     |             |                 | 500 g fillet                           | ALCA (mgmt-policy dimension), mass           | no   |
| 18 | (Vázquez-Rowe et al. 2010b)             | Atlantic horse mackerel  | trawling purse seining                    | Northeast Atlantic                      | 1            | 54               | X            | X   | X           |     |            |              |     |             |                 | 24 kg carton frozen octopus            | ALCA (descriptive), mass                     | no   |
| 19 | (Fréon et al. in prep.)                 | Anchoveta  | purse seining                             | Southeast Pacific                       | 6            | 20-400           | X            | X   | X           | X   |            |              |     |             |                 | 1 t landed fish                        | CLCA (predictive scenarios), avoided         | yes  |

<sup>a</sup> Lines in italics are studies which do not present full or exclusively LCA results: (12) is a carbon footprint study, (4) features both LCA and energy analyses, (1) and (11) are energy analyses. <sup>b</sup> Number of observations refers to number of vessels surveyed, except in (11), where trips are sampled.



<sup>a</sup> In the ISO standard, and in this review, the allocation procedure is introduced in Goal and scope and detailed in Inventory analysis. <sup>b</sup> Impact categories are part of both Goal and scope and Impact assessment. In this review, the discussion on impact categories was carried out in the Impact assessment section.

**Figure 2** Stages in LCA (ISO, 2006a,b)

### 3 Results and discussion

#### 3.1 Goal and scope definition

##### 3.1.1 Goal and scope

The goal and scope definition stage of LCA consists in the design of the study according to its objective. The goal and scope describe a series of methodological decisions made. Such methodological decisions determine assumptions and effort intensity of subsequent stages.

The ISO standard states that goal and scope of LCA studies are to be clearly defined at the beginning, in such a way that they are consistent with the intended application of the study. In reality, both goal and scope are often refined, or even redefined, during the subsequent phases of an LCA, hence the double arrows in Figure 1. The goal must declare the intended application and audience of the study, while the scope must

include the following elements detailed below: the system boundary, the functional unit and its associated reference flow(s) within the system, the allocation strategy, data requirements and other relevant design and implementation decisions (ISO, 2006b).

The goals of reviewed studies were generally clearly stated, and were mainly centred on assessing environmental performance of fisheries, often focusing on the identification of hotspots and/or the comparison of alternative fishing methods, and identifying opportunities to improve that performance. All studies analysed fuel-related impacts, and several also analysed the use of metals.

##### 3.1.2 System boundaries

The system boundaries delimit the studied system by means of including and excluding unit processes. Boundary definition is key to delimit

the scope of the study and to be able to compare different LCAs in time or space. The decision on which processes to include within the system boundary should be based on clearly stated and well justified cut-off criteria, including criteria such as mass, energy or environmental significance (ISO, 2006b). Nonetheless, those criteria are not always applied (Suh et al., 2004).

The reviewed studies featured a variety of system boundary definitions. In general terms, four life cycle stages are recognised in fisheries LCA: construction, use, maintenance and end of life (EOL), though stage names vary according to different authors. Most studies encompassed two stages only: the vessel use and maintenance phases of fishing operations (Table 1). A few among the studies included the construction or at least production of materials for construction, end of life phases and pre-fishing activities such as production of diesel and antifouling paints (e.g. Hospido and Tyedmers, 2005; Fréon et al., in prep.). Nonetheless most studies excluded the construction phase (capital goods) deeming its contribution to environmental impacts as negligible (e.g. Ziegler et al., 2003). Most of the studies included the transportation activities related to landing and delivery to places of transformation/ processing when necessary, while some also include processing operations clearly separated from the extraction phase (which exceeds the scope of this review). Studies following in full or in part the consequential approach to LCA (see section Implications of the attributional and consequential approaches) included avoided products and alternative exploitation scenarios (Thrane 2004a). Others reviewed different management/policy elements such as predictive scenarios (Vázquez-Rowe et al., 2010a, 2011; Fréon et al., in prep.).

The environmental impact of fisheries research, fishery administration (from the fishing companies and the government), surveillance and control, stock assessment, among other non-fishing but complementary fisheries-related activities can be representative in high value fisheries that do not require many fishing vessels. In our opinion, they

could, when relevant, be included within the system boundaries of LCA endeavours (at least as a screening) and allocated among seafood products in a coherent way, subject to justification and discussion. Aspects to be considered would be limited to infrastructure (e.g. vessels) and energy consumption (fuel, electricity).

### **3.1.3 Functional unit**

The functional unit (FU) is a numerical representation of the function(s) provided by the studied system. The FU is thus the reference unit that quantifies the performance of a product system and defines a reference flow (measure of the outputs from the system required to fulfil the function defined by the FU) as a systems comparison device (ISO, 2006b). It is thus a representation of the function delivered by the studied system, which can be used to compare it with alternative systems delivering the same function. The functional unit often measures only the primary function of the product system under study. To overcome such limitation, it has been suggested that a FU definition should include not only the magnitude of the service (e.g. 1 kg of product, 1 unit of product) but also temporal and quality constraints (Cooper, 2003). For instance, a partial FU would be “1 kg of Peruvian anchovy”, while a comprehensive one would be “1 kg of Peruvian anchovy, with canning quality, landed on a non-El Niño year”.

Functional units chosen in the reviewed studies were heterogeneous, ranging from serving or retailing units (e.g. seafood portions) to distribution units (1 kg or 1 t of fresh fish, frozen fish or seafood product). Occasionally, packaging material was included in the functional unit (Table 1).

### **3.1.4 Allocation**

Allocation is the process of dividing inputs, outputs and associated impacts among several products (co-products) produced in the same process, or one product supplying several processes (ISO, 2006b). The need to perform such allocation arises in multi-functional systems. In

fisheries, the need for allocation arises, for instance, when fishing fleets land by-catch or target multiple species, or when fishing vessels feature both canning and fishmeal factories on board, among other situations. In the Life Cycle Inventory (LCI) phase described later on, allocation strategies used in the reviewed studies, as well as described in other LCA literature, are discussed.

### **3.1.5 Implications of the attributional and consequential approaches**

In LCA literature, there are two main currents or schools of thought regarding the purpose, scope, system boundaries and philosophy of specific studies: Attributional LCA (ALCA) and Consequential LCA (CLCA). The latter has been increasingly used by researchers, yet the approach has not to date been systematised (Zamagni et al., 2012). There is an ongoing debate regarding the pros and cons of each approach, and on when, how and why to perform ALCA or CLCA (Baitz et al., 2012). One of the main conceptual differences between the two approaches is that ALCA describes a given (usually retrospective or present) situation which does not deal with the indirect effects of changing markets, while CLCA attempts to predict future changes of environmental impacts and product flows as indirect consequences of market-mediated choices made within the system boundaries (Weidema, 2003; Brander et al., 2008; Earles and Halog, 2011). In other words, ALCA is descriptive and CLCA is predictive/prospective (Weidema, 2003; Finnveden and Moberg, 2005; Brander et al., 2008; Thomassen et al., 2008; Zamagni et al., 2012).

A very clear feature of CLCA studies is the modelling of substituted systems rather than the actual system under study. An example of the former could be the fishmeal/fish oil process in the Danish LCA Food database ([www.lcafood.dk/](http://www.lcafood.dk/)), which features the substitution of fish oil with rapeseed oil.

Under the consequential and attributional philosophies, different allocation strategies are

used. CLCA prioritises system expansion while ALCA commonly applies mass/economic allocation, although system expansion is also applicable within ALCA (see section Allocation strategies). In fisheries context this is illustrated in Thrane (2004a). A simple definition of both approaches, from the perspective of the system delimitation, states that “The consequential approach uses marginal data and avoids co-product allocation by system expansion. The attributional approach uses average or supplier-specific data and treats co-product allocation by applying allocation factors” (Schmidt, 2008).

Some CLCA practitioners defend the use of CLCA in political decision contexts due to its market-based system delimitation. For instance, Thrane (2004a) has argued that the focus of CLCA relies on “hot-spots and improvement potentials regarding production processes rather than environmental consequences of product substitution”. In a fisheries context, as illustrated by the reviewed studies, it is almost never clearly indicated to which school (ALCA or CLCA) a specific study belongs to. Moreover, as LCA literature suggests (e.g. Schmidt, 2008; Finnveden et al., 2009; Suh et al., 2010), there is a grey scale between pure attributional and consequential analyses. The reviewed studies were similarly found to occasionally feature elements of both approaches (Table 1), a common case in LCA in general. Those displaying features of the consequential approach addressed substituted products and future exploitation scenarios (Thrane, 2004a), substitutes (Ellingsen and Aanonsen, 2006) or competing present or future technologies (Emanuelsson et al., 2008; Ziegler and Valentinsson, 2008; Guttormsdóttir, 2009).

Seafood LCA studies should clearly state whether consequential elements of analysis are considered. Seafood or agrifood supply chains associated to a fishery influence and could determine systemic (market and policy-based) changes in the fishery, and vice versa. For instance, in the case of the globally important Peruvian anchoveta fleet, we observed that the bargaining power of major vertically-integrated fishing/processing companies

seems to influence purchase prices of fish landed for reduction by independent fishermen. Moreover, the operational strategy of the fleet seems to be related to the exploitation regime dictated by the government (e.g. introduction of Total Allowable Catch system in 2009), as well as to other economic and policy drivers. Thus, CLCA studies could be used to elaborate scenarios featuring demand and policy changes. We consider that the main criteria to decide whether to carry out an LCA following the attributional or consequential philosophy should depend on the intention of the study (descriptive, predictive/prospective), its intended use of market mechanisms and attention to indirect effects.

### **3.1.6 Impact categories**

Impact categories selected for an LCA study reflect the environmental issues associated to the product system under study, as well as the goal and scope (ISO, 2006b). In the Life Cycle Impact Assessment (LCIA) phase described later on, inventory flows (e.g. methane or nitrogen oxides) are converted using characterisation factors and compiled into LCIA categories (e.g. global warming, eutrophication, acidification) by using sets of rules. See Supplementary Material for details on the LCIA impact categories proposed by the major LCIA methods and the distinction between midpoint and endpoint categories.

## **3.2 Life cycle inventory (LCI)**

Life cycle inventories are compiled by collecting data on environmental inputs and outputs belonging to each unit process within the system boundaries. Such data should describe, both quantitatively and qualitatively, material and energy inputs and outputs, as well as releases to air, soil and water (ISO, 2006b). LCI data is compiled and often communicated in relation to the reference flow (e.g. 1 t of fish). Following the inventory compilation, allocation of resources and emissions among co-products is performed when necessary.

### **3.2.1 Inventory**

Unit process data describe the inputs and outputs at process level. Today, LCI databases can provide many of the supporting unit processes used by fisheries LCAs. The most commonly used database, ecoinvent ([www.ecoinvent.org](http://www.ecoinvent.org)), includes unit processes on energy (electricity, fuels), transportation, building materials, biomass, wood and fibres, metals, chemicals, electronics, mechanical engineering, paper and pulp, plastics, waste treatment and agricultural products (Frischknecht et al., 2007). Such datasets are commonly used by LCA practitioners for background processes to their study system, as well as proxies for processes for which data are not available. There is a trade-off between accuracy of the model and resources invested in its preparation: the use of ecoinvent and other third-party LCI databases processes facilitates modelling inputs and outputs, but at the expense of accuracy (given that most unit processes to be modelled display spatial and temporal variation). The reviewed studies featured inventory data collected from fishing fleets, local fishers and local fishing companies, supplies and equipment providers for fishing operations, government statistics, reports and previous publications. Collection of primary data was performed mainly by means of interviews or questionnaires sent to skippers and companies (sample sizes and timeframes are detailed in Table 1). Ecoinvent was used when other primary or system-specific data were not available, and to populate background processes (e.g. provision of fossil fuels and chemicals).

The number of inventory items included varied amongst the reviewed studies, as well as the detail of their chemical composition (e.g. metal used in engines and onboard installations). Selection of inventory items was inconsistent except for fuel used in fishing vessels, as shown in Table 2. Levels of detail of data collected for LCIs of fisheries appear highly heterogeneous, from narratives included in the reviewed LCA studies, and often briefly documented.

We suggest a more detailed inventory of the construction phase than currently practiced (i.e. different classes of steel, because their relative impacts largely differ) should be performed, unless irrelevant within the chosen goal and scope. This suggestion is based on the fact that the impacts of the construction phase have been found to be important in some studies and reviews, i.e. Svanes et al. (2011a), Vázquez-Rowe et al. (2012c) and Fréon et al. (in prep.). Furthermore, certain behaviours leading to further emissions to water could be considered when relevant, depending upon the impact categories that are in focus. For instance, items such as solid waste, wastewater and used lubricating oil wasted at sea should be considered in detail when the fishery under study is

associated with fishing grounds where they could accumulate or reach the shore, particularly in countries/regions where such waste is common practice. They should also be considered when relevant impact categories, such as eco-toxicity, are accounted for. Most of the reviewed studies are far too reliant on the use of third-party LCI database without considering to what extent such processes accurately represent the conditions of the supply chains they are modelling.

The exploitation status of the stocks (target and non-target species) and the type of marine ecosystem impacted (e.g. levels of biodiversity, productivity, global scarcity) could be indicated when available and trustable, in order to qualitatively or quantitatively weight the impact of species removal.

**Table 2:** Detail level of inventories used in published fisheries LCA studies. X = considered, blank space = excluded, N/A = not applicable.

| Category     | Inventory items       | Studies                      |                              |                       |                              |                             |                               |                |                           |                                 |                       |   |                                      |                              |                              |                     |                       |                             |                              |                          |
|--------------|-----------------------|------------------------------|------------------------------|-----------------------|------------------------------|-----------------------------|-------------------------------|----------------|---------------------------|---------------------------------|-----------------------|---|--------------------------------------|------------------------------|------------------------------|---------------------|-----------------------|-----------------------------|------------------------------|--------------------------|
|              |                       | (Tyedmers 2001) <sup>a</sup> | (Eyjólfssdóttir et al. 2003) | (Ziegler et al. 2003) | (Thrane, 2004a) <sup>a</sup> | (Hospido and Tyedmers 2005) | (Ellingsen and Aanonsen 2006) | (Thrane, 2006) | (Emanuelsson et al. 2008) | (Ziegler and Valentinsson 2008) | (Guttormsdóttir 2009) | (Driscoll and Tyedmers 2010) <sup>a</sup> | (Iribarren et al. 2010) <sup>a</sup> | (Vázquez-Rowe et al., 2010a) | (Vázquez-Rowe et al., 2010b) | (Ramos et al. 2011) | (Svanes et al. 2011a) | (Vázquez-Rowe et al., 2011) | (Vázquez-Rowe et al., 2012a) | (Fréon et al., in prep.) |
| Fishing unit | Steel                 |                              |                              |                       |                              | X                           |                               |                |                           |                                 |                       |   |                                      | X                            | X                            | X                   |                       | X                           | X                            | X                        |
|              | Engine                |                              |                              |                       |                              | X                           |                               |                |                           |                                 |                       |   |                                      |                              |                              |                     |                       |                             |                              | X                        |
|              | Wood                  |                              |                              |                       |                              | N/A                         |                               |                |                           |                                 |                       |   |                                      |                              | X                            |                     |                       |                             |                              | X                        |
| Operations   | Diesel                | X                            | X                            | X                     | X                            | X                           | X                             | X              | X                         | X                               | X                     | X   | X                                    | X                            | X                            | X                   | X                     | X                           | X                            | X                        |
|              | Antifouling and paint |                              | X                            | X                     | X                            | X                           | X                             | X              | X                         | X                               |                       | X   | X                                    | X                            | X                            | X                   | X                     | X                           | X                            | X                        |
|              | Lubricating oil       |                              |                              |                       |                              | X                           |                               |                |                           |                                 |                       |   | X                                    | X                            | X                            |                     | X                     | X                           | X                            |                          |
|              | Refrigerants          |                              | X                            |                       | X                            |                             |                               | X              | X, X <sup>b</sup>         |                                 | X                     |   | X <sup>c</sup>                       |                              | X                            | X                   | X                     |                             | X                            | N/A                      |
|              | Ice                   |                              | N/A                          | X                     | X                            | N/A                         |                               | X              | X <sup>b</sup>            |                                 | N/A                   |   |                                      | X                            | X                            | X                   | X <sup>b</sup>        | X                           | N/A                          | N/A                      |
|              | Grid energy           |                              | X <sup>b</sup>               | N/A                   | X <sup>b</sup>               | X                           |                               | X <sup>b</sup> | X <sup>b</sup>            | X <sup>b</sup>                  |                       |   | X                                    | N/A                          | N/A                          |                     | X <sup>b</sup>        | X <sup>b</sup>              | X <sup>b</sup>               | N/A                      |
|              | Packaging             |                              | X <sup>b</sup>               | X                     | X <sup>b</sup>               | N/A                         |                               | X <sup>b</sup> | X <sup>b</sup>            | X <sup>b</sup>                  | X <sup>b</sup>        |   |                                      | N/A                          | N/A                          |                     | X <sup>b</sup>        | X <sup>b</sup>              | X <sup>b</sup>               | N/A                      |
|              | Bait                  |                              | N/A                          | N/A                   | N/A                          | N/A                         | N/A                           | N/A            | N/A                       | X                               | N/A                   |   |                                      | N/A                          | N/A                          |                     | X                     | X                           | N/A                          | N/A                      |
| Gear         | Net                   |                              | X                            | X                     | X                            |                             |                               | X              |                           | X                               | X                     |   | X                                    | X                            | X                            | X                   | X                     | X                           | X                            | X                        |
|              | Hooks and lines       |                              | N/A                          | N/A                   | N/A                          | N/A                         | N/A                           | N/A            | N/A                       | N/A                             | N/A                   |   | X                                    | N/A                          | N/A                          | N/A                 | X                     |                             | N/A                          | N/A                      |

<sup>a</sup> Lines in *italics* are studies which do not present full or exclusively LCA results: (12) is a carbon footprint study, (4) features both LCA and energy analyses, (1) and (11) are energy analyses. <sup>b</sup> Materials used for a separate processing stage, after landing. <sup>c</sup> Iribarren et al. (2010) features a follow-up study (Iribarren et al., 2011) which includes refrigerants in the inventory.

### 3.2.2 Allocation strategies

The selection of an allocation strategy, is one of the most difficult and controversial methodological aspects of LCA studies, and often greatly influences the results (Weidema, 2000; Guinée et al., 2001; Ayer et al., 2007; Suh et al., 2010; Peacock et al., 2011; Pelletier and Tyedmers, 2011; Svanes et al., 2011b). Allocation problems have been discussed and contextualised in detail by several authors (e.g. Weidema, 2000; Ekvall and Finnveden, 2001, Curran, 2007, Reap et al., 2008). The approach for allocation recommended by the ISO standard (ISO, 2006b) suggests a hierarchy of steps to address allocation problems, in the following order:

1. Avoidance of allocation when possible by means of a) subdivision: dividing the multifunction process into independent sub-processes that can be assigned to individual co-products, or b) system expansion: the product system is “expanded” to include the functions associated to the co-products, that is to say, the system boundaries are expanded to include the whole subsystem of co-products;
2. Allocation based on a physical relationship (e.g. mass or energy content); and
3. Allocation based on other non-physical relationship (e.g. economic value).

A common, yet non-strictly ISO interpretation of the system expansion approach is known as “substitution”, and consists in modelling the processes associated to the avoided production of co-products, considering them as alternatives to other products on the global market. The system expansion/substitution approaches can be very complex, its application is not shared by many attributional analysts, and have been profusely discussed in LCA literature (e.g. Weidema, 2000; Ekvall and Finnveden, 2001; Suh et al., 2010; Weidema and Schmidt, 2010). Moreover, certain authors consider avoiding allocation by means of system expansion, or allocating based on a physical relationship, is always possible and thus reject the use of economic allocation. Nonetheless

economic allocation is widely practiced in many fields of LCA application.

In the context of fisheries, the strongest influence of allocation arises from landed by-catch, not necessarily targeted by separate fisheries and thus unsuitable for allocation avoidance; and secondary co-products (by-products) from seafood processing (review in Ayer et al., 2007). The study of multi-species fisheries also poses important allocation challenges (Schau et al., 2009).

Subdivision is rarely attempted in fisheries LCA literature, because processes for multi-species fisheries, by-catch and seafood by-products often cannot be isolated and fully accounted for (Ayer et al., 2007; Schau et al., 2009). In the other hand, system expansion/substitution would be always possible, since fisheries are commonly destined for delivering protein and thus their products can always, in theory, be substituted by another fishery or non-fishery animal protein source. A notable example is the analysis in Thrane (2004a), where the fuel consumption per landed kg of fish of several (or most) Danish fishing operations was calculated and contrasted by applying mass allocation, economic allocation and system expansion. Each by-catch species was addressed separately by assessing additional fleets targeting these species (also landing by-catch) and summarising their contribution to landings of each species (target and by-catch).

A number of approaches have been suggested when subdivision/system expansion is not possible or impractical:

- Ayer et al. (2007) propose gross energy content for LCA at different stages of seafood (and in general food) products—including all food co-products—, suggesting that such an approach more realistically reflects flows of food co-products occurring within and outside production systems. See Pelletier and Tyedmers (2011) for more details.
- Suh et al. (2010) suggest allocation problems in general to be handled as numerical problems under an input-output economic approach,



specifically the supply-use framework. It would be challenging to apply this approach to fisheries, because it requires often unavailable data at country or regional scales. None of the reviewed studies applies input-output analysis in combination with LCA, a novel research field often aiming to broaden and deepen LCA (Suh et al., 2004; Finnveden et al., 2009; Jeswani et al., 2010).

- Svanes et al. (2011b) describe a hybrid allocation approach combining mass and economic allocation, and the use of global functional units where all products are included within the same FU. Hospido and Tyedmers (2005) made use of a global functional unit by considering various target species within their FU. Nonetheless this is practical only if the proportion of co-products is constant over time and space and when the goal of the study is to improve environmental performance of the fishing stage in general. This global functional unit can be understood as system expansion.
- Schau and Fet (2008) propose the use of quality-corrected functional units (QCFUs), for food products, including seafood. A QCFU incorporates in the definition of the FU nutritional features of the product (i.e. yield, lipids, protein and carbohydrates, the basis for gross energy content computation). The author suggests QCFUs can be used as a basis for allocation, or may even overcome the need for co-product allocation at all.

Pelletier and Tyedmers (2011) understand LCA as a bio-physical accounting framework, and therefore state it should rely on bio-physically-driven relationships, not market ones. Therefore they suggest market information should be avoided in life cycle modelling, due to its sourcing on the current neoclassical economic system, which patently fails to account for the value of ecosystem services and limits to growth as opposed to the continuous (eco-efficient or not) growth paradigm. Instead they defend the use of bio-physical drivers such as gross energy content

for addressing issues such as allocation in seafood systems, based on the assumption that the ultimate driver behind food production is the provision of food energy. In contrast, a recent publication (Ardente and Cellura, 2012) revisits economic allocation (the last alternative according to the ISO standard) as a very suitable approach in several situations. Both perspectives nonetheless conclude that there is no “best” allocation method or allocation decision rule, but the allocation procedure/strategy has to be established on a case-by-case basis.

Amongst the reviewed, few studies discussed allocation challenges and addressed the selection/development of the best allocation strategy for the studied system. Occasionally, allocation between targeted catches and by-catch was not necessary due to the nature of the targeted fish stock (e.g. Hospido and Tyedmers, 2005; Fréon et al., in prep.). Further allocations beyond catch and co-products are not explicitly mentioned in the reviewed studies.

Given that subdivision and system expansion (the recommended allocation avoidance approaches according to the ISO standard) are not always practical, we stand for the contrasting application of at least two allocation methods in LCA studies, as practiced in many of the reviewed studies and promoted by ISO 14040 (e.g. Thrane, 2004a; Ellingsen and Aanondsen, 2006; Vázquez-Rowe et al., 2010b; Svanes et al., 2011a). The choice of the allocation methods should be aligned with the goal and scope of the study and data availability.

We suggest an approach for the specific case of multi-species finfish fisheries, where three main situations can be identified: 1) one or several high-value target species and one or several edible by-catch species of lower commercial value; 2) one or several high-value target species and one or several non-edible by-catch species; and 3) one or several abundant low-value target species and one or several high-value target or non-target species. In our opinion, regarding case 1) and 2), if the low-value species are discarded at sea, obviously the direct environmental impacts

associated to their mortality may simply be fully attributed to the landed species, using a mortality rate of discard lower than 100% when necessary in order to reflect the proportion of discard survival (if relevant). If these low-value species are mainly used for direct human consumption, we suggest using a mass allocation if the energy-content (and/or protein content) of all species are equivalent. If not, an energy or protein content-based allocation should be preferred, as economic allocation could underestimate the impact of the by-catch species compared to the target one. The situation is more complex if the low-value species are aimed at reduction into fishmeal and fish oil on land, and even more if reduction occurs onboard as possibly in case 2) or 3), because of increased complexity for subdivision. In both cases mass allocation is not appropriate because environmental impacts differ largely according to the fate of the fish. Subdivision is not always possible because disentangling the processes related to each species appears not always practical (common sub-processes, detailed data required).

According to Pelletier and Tyedmers (2011) and Ardente and Cellura (2012), practical issues should guide the choice between alternative methods (system expansion, economic or energy-content allocation), a recommendation that seems consensual in LCA practice (EC/JRC, 2010) and shared by us. Moreover, consistency with methodological principles and the internal consistency of the resulting model and model outputs should guide the choice between alternative methods. Nonetheless, according to the ISO standard, system expansion would be preferable —when possible— to allocation (ISO, 2006b: section 4.3.4.2), despite the fact that resource or data constraints might render following such a path impractical in particular cases.

### **3.3 Life cycle impact assessment (LCIA)**

The LCIA phase (optional according to the ISO standard) consists of classifying and assigning characterisation factors to the LCI results, for the

selected impact categories (ISO, 2006b). In such a way, the diverse LCI results can be more easily expressed as a reduced number of environmental indicators.

LCIA methods are usually applied by means of dedicated LCA software. However, it is equally possible to implement LCIA methods in a self-made spreadsheet or even by means of proprietary scripts. All the reviewed studies used SimaPro (<http://www.pre-sustainability.com/content/simapro-lca-software>), the most widely used LCA software application. LCIA methods used where CML (Center of Environmental Science of Leiden University, Guinée et al. (2001)), EDIP (Environmental Design of Industrial Products, DK LCA Center, Wenzel et al. (1997)) and Ecoindicator 99 (PRÉ Consultants, Hischer et al., 2010; Huppés and van Oers, 2011).

In the three following sub-sections we first indicate the impact categories most commonly used in the reviewed studies, their classification (assignment) and characterisation, and finally two optional steps: normalisation and weighting.

#### **3.3.1 Impact categories in LCIA**

The reviewed studies focused on typical LCA impact categories: global warming, acidification, eutrophication, ozone layer depletion and aquatic/marine/terrestrial eco-toxicity; and dealt mainly with indirect/off-site impacts (see Table 3 and Supplementary Material). Only a few of the studies addressed CED, at various levels of detail, and identified fuel used for fishing operations as the larger contributor to energy consumption in fishing operations. On this regard, Thrane (2004a, 2006) and Schau et al. (2009) analysed energy consumption as a function of both fish species and fishing gear.

A vast majority of the reviewed studies also discussed some fishery-specific impacts aimed to account for direct/on-site impacts, namely discards, by-catch and seafloor disturbance impacts (see Supplementary Material). These specific impacts were commonly assessed outside the LCA methodology, and often in a qualitative

way. A notable exception is Emanuelsson et al. (2008) and related approaches proposed by Ziegler et al. (2009), Ziegler et al. (2011) and Vázquez-Rowe et al. (2012b), which quantitatively analyse discard data. Other impacts were occasionally addressed: undersized catch, idle and ghost fishing gear, and marine pollution.

Species removal and seafloor impacts were sporadically accounted for in the reviewed studies, under novel impact categories related to food systems (e.g. Biotic Resource Use) and fisheries-specific (e.g. seafloor disturbance indices). These effects can be detailed as: removal of target and non-target species, unintended mortality of non-removed species, physical damage to habitat (in particular for benthic habitats), alteration of trophic dynamics and reduction in genetic diversity; all those elements not being directly accounted for in a specific LCA indicator.

It seems particularly difficult to account for some of these effects, thus various initiatives have addressed such need in fisheries, aquaculture (not considered in this study) and environmental assessment literature:

- Biotic Resource Use (BRU), based on the carbon content of crop inputs and trophic levels/transfer efficiencies of fish inputs (Pauly and Christensen, 1995), is widely applied and seems a good candidate for standardisation, as proposed by Libralato et al. (2008) and Langlois et al. (2011, 2012), although in different ways. The BRU concept and its equation for exploited fish resources,  $BRU = catches/9^{(Trophic\ Level - 1)}$ , are widely accepted, yet they rely on fundamental assumptions that might be challenged by fish scientists: a 9:1 ratio of fish wet weight to carbon and a 10% transfer efficiency per trophic level. For instance compiled estimates of transfer efficiency by type of ecosystems show variations ranging from 5 to 14 (Libralato et al., 2008), which are likely to reflect mainly fish species variability. Additionally, BRU is extremely sensitive to the estimation of the species trophic level, which varies with ontogeny.
- Efforts to quantify BRU include estimates of the Primary Production (PP) appropriated by the harvested biomass. According to various authors, this quantity is called PP required (PPR), net PP (NPP) or net PP used (NPPU) (Pauly and Christensen, 1995; Cappell et al., 2007; Pelletier et al., 2007; Hornborg et al., 2012) although it is not always clear if net of gross PP is used. This impact category allows comparing diverse food systems, including terrestrial ones. A recent publication proposes a specific discard assessment indicator, the Global Discard Index (also based on PPR), to be included in fisheries LCAs (Vázquez-Rowe et al., 2012b). Another recent publication proposes the combined use of two differentiated discard indicators in LCA, namely, appropriation of PPR and the potential discard impacts on vulnerable, endangered and critically endangered (VEC) species (Hornborg et al., 2012).
- Another approach based on PP has been suggested, and consists in considering not only the PPR to produce the harvested species but also the depletion in secondary production downstream of the trophic flow, with respect to the unfished state, using it as a proxy for quantifying ecosystems effects of fishing (Libralato et al., 2008). Such an approach encompasses both ecosystem properties and features of fishing activities (trophic level of catches and PPR).
- Langlois et al. (2011, 2012) suggest going further in a broader use of PP appropriation within a framework of a sea-use impact category, similar to land use. They suggest using the three-dimensional approach proposed by Milà i Canals et al. (2007) to account for time (occupation and restoration), space and a quality index reflecting transformation by usage and including a possible permanent or irreversible impact. The authors proposed a typology of marine activity and suggested regrouping under sea use at least the following three ones: artificial structures, biotic resource extraction, shipping

lanes. Some additional marine activities such as seafloor destruction (in particular by trawling) or change of habitat surface or volume could also be accounted for using the same index through avoided or added (artificial reef) biomass (Langlois et al., submitted).

- A recent consultation report (Emanuelsson et al., 2012), produced in the context of a LCA-related project under the EU's Seventh Framework Programme for Research (FP7), proposes a new midpoint impact indicator to quantify depletion of exploited fish stocks: the Wasted Potential Yield (WPY). This indicator utilises current stock assessment data to predict future yields by means of a surplus yield production function. The WPY is the difference in future yields between the consequences of current exploitation levels and alternative exploitation levels defined by the maximum sustainable yield (MSY) approach.
- Alteration of trophic dynamics has also been addressed in various publications and identified with the "fishing down marine food webs" situation as measured by the catches' mean trophic level (Pauly et al., 1998). Pauly et al. (2000) proposed the Fisheries-in-Balance (FiB) index to represent such situations. Although these indicators are standardised, they cannot be used within the LCA framework because they are not fishery-specific and nearly all marine ecosystems are exploited by more than one fishery.
- Spatialised indicators of fishing pressure were proposed by different authors. For instance, Linnane et al. (2000) summarised various bottom trawling impact studies and Nilsson and Ziegler (2007) proposed a spatialised seafloor impact (i.e. damage to benthos) methodology based on the number of time per year a given area was likely to be swept by a trawl. They combined this value with the recoverability of the habitat to estimate impact on seafloor. In another example, Fréon et al. (2005b) proposed a mean ratio of fished area

and area of distribution by species, exploited fraction of the ecosystem surface area, mean bottom depth of catches, and mean distance of catches from the coast. Hornborg et al., 2012 used seafloor disturbance data from bottom trawling to assess impacts of discard for VEC fish species.

- To date, there is no accepted/standardised method to assess target and non-target species removal. It has been argued that species removal, together with seafloor impacts, should not necessarily be included in quantitative LCAs for hot-spot identification (Thrane, 2006). However, we assert that when the goal of the study is providing data for environmental protection, those categories must be considered, ideally also quantitatively, by means of existing or new approaches. In contrast to most of above-reviewed indicator related to species removal, the used primary production can be assigned to a given fishery and can allow comparison with other activities such as aquaculture and agriculture.
- Regarding alteration of marine ecosystems, Cappell et al. (2007, p. 24) states that "Although biotic resource use is a recognised LCA impact category, seafood LCA research has largely failed to take into account impacts such as direct impacts to targeted stocks, by-catch of target and non-target species, loss of genetic diversity, alteration of trophic dynamics, and disturbance and displacement of benthic communities"; a view shared at large by the fisheries LCA community including us.

In conclusion, we believe fisheries-specific impact categories addressing seafloor disturbance, sea use and species removal should be used in fisheries LCA, and when possible standardised towards comparability of studies. Moreover, we assert it is necessary to apply seafood-relevant/specific impact categories such as the above-mentioned in order to allow for whole supply chain analyses and comparisons. If done so, specific impacts could be followed, in an additive fashion, along whole supply chains (e.g. BRU of

various products along a seafood supply chain could be contrasted/combined, namely, fish, fishmeal, crop inputs to feeds, feed formulations, and final aquaculture products).

### **3.3.2 Classification and characterisation**

Once the LCIA method and/or list of impact categories have been chosen, it is mandatory to associate LCI results to specific major impact categories, process known as classification (ISO, 2006b), although we believe “assignment” would be a less confusing terminology. The next step is characterisation, which consists in expressing LCI results in a reduced set of common units, which can be aggregated into impact categories (ISO, 2006b). In other words, impacts associated to LCI results are aggregated into categories. Characterisation factors are used for such aggregation, and are usually included in LCIA methods as constituencies of characterisation models.

Characterisation factors used in the reviewed studies identified major contributions from fuel production and use, besides direct specific impacts due to target and non-target species removal. GWP was the main impact indicator affected, mostly due to fuel use. Other inventory items identified as contributing to impacts are maintenance activities and substances (antifouling, refrigerants, lubricants, cleaners, etc), and fishing gear use. The maintenance stage was found to have a small contribution to impacts, although it was often insufficiently inventoried. Most of the studies found the fishing phase to be the main contributor to impacts in the seafood lifecycle. Bottom trawling was identified as having a higher impact than other fishing methods in terms of associated emissions (GWP) and certain fishery-specific impact categories (e.g. seafloor impacts).

The reviewed studies featured fisheries-specific impact categories such as species removal and seafloor impacts. Various studies calculated the impacts related to the removal of target and non-target species (by-catch and discard), as shown in the Supplementary Material. Several studies calculated the seafloor area disturbed, some of

them by means of the seafloor impact index methodology proposed by Nilsson and Ziegler (2007). The impact of trawling and other bottom gear is discussed in detail in Eyjolfsdottir et al. (2003), Thrane (2004a), Ziegler and Valentinsson (2008), Guttormsdóttir (2009) and Vázquez-Rowe et al. (2012a).

Emissions to air and water were calculated based on fuel use data and accepted ratios for substance losses, for instance, two thirds of antifouling paint lost to the marine environment, as applied by Hospido and Tyedmers (2005).

We observed that antifouling paints in use contain toxic components (i.e. biocides) that are not considered because data is not available in the currently used databases and/or characterisation is not considered in current LCIA methods. Besides, persistent pollutants (e.g. metals) get very high characterisation factors in toxicity models used by LCIA methods used in the reviewed studies. A way to overcome such limitations could be the utilisation when applicable of the United Nations Environment Programme/Society of Environmental Toxicology and Chemistry (UNEP/SETAC) USEtox toxicity model (Rosenbaum, 2008), which claims to be a consensus model. USEtox, for instance, models exposure and impacts only in coastal waters, treating deep sea as a sink; and features characterisation factors for some basic antifouling substances used. It must nonetheless be noted that toxicity models in general feature great intrinsic uncertainty.

### **3.3.3 Normalisation and weighting**

Normalisation can be understood as the scaling of non-comparable category indicators (e.g. GWP and Eutrophication Potential) towards the same reference as to render them comparable and better understand the relative magnitude of each one (ISO, 2006b). It is an optional and controversial step in LCA, carried out by means of dividing indicators results by a selected reference value known as normalisation factor (ISO, 2006b). LCIA methods such as ReCiPe (Sleeswijk et al., 2008) feature normalisation references like: European and global normalisation factors based

on reference year 2000, considered as a follow up (and improvement) to Huijbregts et al. (2003)'s 1990/1995-based normalisation factors; and characterisation factors updated from Guinée et al. (2002). Normalisation factors are simply the total sum of the characterised flows at the corresponding scale. As a result one estimates the share of the modelled results in a European or worldwide total. Normalisation only highlights the most important impact dimensions if one assumes that all impact categories are of equal importance; a view that few endorse. Weighting is another optional step in LCA, which consists in deciding —on the base of subjective value choices— the relative importance of impact categories, characterised and normalised (occasionally with regards to an aggregated single score).

Normalisation was carried out in only two of the reviewed studies: Thrane (2006) applied normalisation references for Danish economic activities (Thrane (2004a) used earlier Danish normalisation references), while Hospido and Tyedmers (2005) used total global emissions for baseline years 1990/1995 like normalisation references, as defined in Huijbregts et al., 2003. The reason for this limited use of normalisation is, in our opinion, linked to frequent criticisms of this approach. This in particular regards to the referent regional or global systems used for scaling (e.g. featuring localisation in terms of regions and impact categories), which are often poorly estimated leading to uncertainty (Sleeswijk et al., 2008). Lack of emission data and/or characterisation factors leading to bias (Heijungs et al., 2007) may be another reason, alongside overall congruency issues (Norris, 2001).

Because normalisation is useful in highlighting the most important environmental impact dimensions of the fishing activities, we suggest that when normalisation is performed, to apply global resource consumption and emission rates in order to show the specificity of fisheries, as in Hospido and Tyedmers (2005), but to present only semi-quantitative results such as an indication of which factors have the most impact (with additional

attention in the cases where toxicity impact categories are taken into consideration).

In addition to a normalisation based on reference global data on all types of human activities, the fishery and seafood research community could keep contrasting individual case studies to global data on this sector for the major impacting factors: fuel consumption ratios (as completed in Tyedmers (2001) and Table 4 in this review) and extracted species indicators, although in this later case proper generic indices still need to be agreed upon. Impact categories formalising fuel consumption in LCA are abiotic resource depletion (of fossil fuels) and Cumulative Energy Demand (energy equivalence of fossil fuels consumed) (VDI, 1997; van Oers et al, 2002).

**Table 3:** Impact categories used in published fisheries LCA studies. Excludes non-LCA/CFP studies and Fréon et al. (in prep.), which applies ReCiPe (hybrid method featuring 18 midpoint indicators plus three endpoint indicators).

| Impact assessment method:          | Ecoindicator 99 (endpoint) |          |          |          |          |          |          |          |          | CML 2000/2001 (midpoint) |           |           |          |          |          |          |          |          | EDIP 97 (endpoint) |          |          |          |          |          |          |          |          | Additional impact categories |          |  |
|------------------------------------|----------------------------|----------|----------|----------|----------|----------|----------|----------|----------|--------------------------|-----------|-----------|----------|----------|----------|----------|----------|----------|--------------------|----------|----------|----------|----------|----------|----------|----------|----------|------------------------------|----------|--|
|                                    | FF                         | A/E      | E        | CC       | RI       | RO       | M        | OL       | C        | GWP                      | AP        | EP        | POFP     | ODP      | HTP      | FETP     | METP     | TETP     | CED                | ADP      | GW       | OD       | A        | NE       | OF       | ETWC     | ETWA     |                              | ETSC     | Total  |
| (Eyjólfssdóttir et al. 2003)       | X                          | X        | X        | X        | X        |          |          | X        |          |                          |           |           |          |          |          |          |          |          |                    |          |          |          |          |          |          |          |          |                              | 6        | By-catch, discards, seafloor disturbance                                       |
| (Ziegler et al. 2003) <sup>a</sup> |                            |          |          |          |          |          |          |          |          | X                        | X         | X         | X        |          |          |          | X        |          |                    |          |          |          |          |          |          |          |          |                              | 5        | By-catch, discards, seafloor disturbance                                       |
| (Hospido and Tyedmers 2005)*       |                            |          |          |          |          |          |          |          |          | X                        | X         | X         | X        | X        | X        |          | X        |          |                    |          |          |          |          |          |          |          |          |                              | 7        |  |
| (Ellingsen and Aanonsen 2006)      | X                          | X        | X        | X        | X        |          |          |          | X        |                          |           |           |          |          |          |          |          |          |                    |          |          |          |          |          |          |          |          |                              | 6        | Feeding efficiency for non-fishery products, land use vs. seafloor disturbance |
| (Thrane, 2004a; Thrane, 2006)      |                            |          |          |          |          |          |          |          |          |                          |           |           |          |          |          |          |          |          | X                  |          | X        | X        | X        | X        | X        | X        | X        | X                            | 8        | Catch, discards, by-catch  |
| (Emanuelsson et al. 2008)          |                            |          |          |          |          |          |          |          |          | X                        | X         | X         | X        | X        | X        |          | X        | X        | X                  |          |          |          |          |          |          |          |          |                              | 9        | By-catch, discards, under-sized seafloor disturbance                           |
| (Ziegler and Valentinsson 2008)*   |                            |          |          |          |          |          |          |          |          | X                        | X         | X         | X        |          |          |          | X        |          |                    | X        |          |          |          |          |          |          |          |                              | 6        | Discards, seafloor disturbance   |
| (Guttormsdóttir 2009)              | X                          | X        | X        | X        | X        | X        | X        | X        | X        |                          |           |           |          |          |          |          |          |          |                    |          | X        |          |          |          |          |          |          |                              | 10       | By-catch, discards, seafloor disturbance (qualitative)                         |
| (Iribarren et al. 2010)            |                            |          |          |          |          |          |          |          |          | X                        |           |           |          |          |          |          |          |          |                    |          |          |          |          |          |          |          |          |                              | 1        |  |
| (Vázquez-Rowe et al., 2010a)*      |                            |          |          |          |          |          |          |          |          | X                        | X         | X         | X        | X        |          |          |          |          |                    | X        |          |          |          |          |          |          |          |                              | 6        | Discards   |
| (Vázquez-Rowe et al., 2010b)*      |                            |          |          |          |          |          |          |          |          | X                        | X         | X         | X        | X        | X        | X        | X        |          |                    | X        |          |          |          |          |          |          |          |                              | 9        | Discards   |
| (Ramos et al. 2011)*               |                            |          |          |          |          |          |          |          |          | X                        | X         | X         |          | X        |          |          | X        |          |                    | X        |          |          |          |          |          |          |          |                              | 6        | Discards, Fisheries-in-Balance   |
| (Svanes et al. 2011a)*             |                            |          |          |          |          |          |          |          |          | X                        | X         | X         | X        | X        |          |          |          |          | X                  |          |          |          |          |          |          |          |          |                              | 6        |  |
| (Vázquez-Rowe et al., 2012b)*      |                            |          |          |          |          |          |          |          |          | X                        | X         | X         | X        | X        |          |          | X        |          |                    | X        |          |          |          |          |          |          |          |                              | 7        | Discards   |
| (Vázquez-Rowe et al., 2011)*       |                            |          |          |          |          |          |          |          |          | X                        | X         | X         |          | X        |          |          | X        |          |                    | X        |          |          |          |          |          |          |          |                              | 6        | Discards, seafloor impact  |
| <b>Total:</b>                      | <b>3</b>                   | <b>3</b> | <b>3</b> | <b>3</b> | <b>3</b> | <b>1</b> | <b>1</b> | <b>2</b> | <b>2</b> | <b>11</b>                | <b>10</b> | <b>10</b> | <b>8</b> | <b>8</b> | <b>3</b> | <b>1</b> | <b>8</b> | <b>1</b> | <b>3</b>           | <b>6</b> | <b>2</b> | <b>1</b> | <b>1</b> | <b>1</b> | <b>1</b> | <b>1</b> | <b>1</b> | <b>1</b>                     | <b>1</b> |  |

<sup>a</sup> No specific life cycle impact assessment method used. FF: Fossil Fuels, A/E: Acidification/Eutrophication, E: Ecotoxicity, CC: Climate Change, RI: Resp. Inorganics, RO: Resp. Organics, M: Minerals, OL: Ozone Layer, C: Carcinogens, GWP: Global Warming Potential, AP: Acidification Potential, EP: Eutrophication Potential, POFP: Photo-oxidant Formation Potential, ODP: Ozone Depletion Potential, HTP: Human Toxicity Potential, FETP: Freshwater Aquatic Ecotoxicity Potential, METP: Marine Aquatic Ecotoxicity Potential, TETP: Terrestrial Ecotoxicity Potential, CED: Cumulative Energy Demand, ADP: Abiotic Depletion Potential, GW: Global Warming, OD: Ozone Depletion, A: Acidification, NE: Nutrient Enrichment, OF: Ozone Formation, ETWC: Ecological Toxicity Water Toxic, ETWA: Ecological Toxicity Water Acute, ETSC: Ecological Toxicity Soil Chroni

**Table 4:** Fuel use by targeted species aggregation vs. fish gear. Fuel consumption has been standardised to kg fuel per tonne of landed fish. Marine fuel density used for calculations: 0.832 kg/L. Studies reference numbers are linked to Table 1. This table is expanded and complemented in the Supplementary Material.

|                         | Artisanal trawling |                         | Creeling/trapping |                         | Gill-netting |                         | Long lining |                         | Purse seining             |                         | Trawling    |                         |                 |                         |                             |
|-------------------------|--------------------|-------------------------|-------------------|-------------------------|--------------|-------------------------|-------------|-------------------------|---------------------------|-------------------------|-------------|-------------------------|-----------------|-------------------------|-----------------------------|
| Species aggregation     | # Studies          | Fuel use average (kg/t) | # Studies         | Fuel use average (kg/t) | # Studies    | Fuel use average (kg/t) | # Studies   | Fuel use average (kg/t) | # Studies                 | Fuel use average (kg/t) | # Studies   | Fuel use average (kg/t) | Total # Studies | Fuel use average (kg/t) | Fuel use standard deviation |
| Cephalopods             |                    |                         |                   |                         |              |                         |             |                         |                           | (14)                    | 1,736       |                         | 1               | 1,736                   | N/A                         |
| Codfish                 |                    |                         |                   |                         | (3)          | 283                     | (10)(16)    | 270                     |                           | (1)(2)(3)<br>(4)(6)(10) | 666         |                         | 7               | 536                     | 315                         |
| Ground fish             |                    |                         |                   |                         |              |                         |             |                         |                           | (7)(12)                 | 1,518       |                         | 2               | 1,518                   | 1,455                       |
| Hake                    |                    |                         |                   |                         |              |                         | (12)(17)    | 1,428                   |                           | (17)                    | 2,104       |                         | 2               | 1,653                   | 409                         |
| Lobster & crab          |                    |                         | (1)(9)            | 1,052                   |              |                         |             |                         |                           | (1)(4)(9)               | 3,852       |                         | 3               | 2,732                   | 2,882                       |
| Mackerel                |                    |                         |                   |                         |              |                         |             |                         | (4)(15)(18)               | 86                      | (4)(12)(18) | 298                     | 4               | 192                     | 183                         |
| Shrimps & prawns        | (8)                | 524                     |                   |                         |              |                         |             |                         |                           | (1)(4)(8)               | 1,056       |                         | 3               | 950                     | 698                         |
| Small pelagic fish      |                    |                         |                   |                         |              |                         |             |                         | (1)(4)(6)<br>(11)(12)(19) | 75                      | (4)(11)     | 99                      | 6               | 83                      | 51                          |
| Tuna                    |                    |                         |                   |                         |              |                         |             |                         | (1)(5)(12)                | 708                     |             |                         | 3               | 708                     | 641                         |
| <b># papers/average</b> | <b>1</b>           | <b>524</b>              | <b>2</b>          | <b>1,052</b>            | <b>1</b>     | <b>283</b>              | <b>4</b>    | <b>849</b>              | <b>9</b>                  | <b>290</b>              | <b>13</b>   | <b>1,416</b>            |                 |                         |                             |



### 3.4 Interpretation

The final stage of LCA, interpretation, consists of extracting conclusions based on the inventory analysis and impact assessment, in such a way that results of the LCA can be presented and used for decision-making (ISO, 2006b). It includes identification of key issues derived from the LCI and/or LCIA stages (given that LCIA is an optional phase); an evaluation of completeness, sensitivity and consistency; and the statement of conclusions, limitations and recommendations (ISO, 2006b).

#### 3.4.1 Key findings

The reviewed studies focused mainly on European operations, mostly in the Atlantic Ocean and North Sea, but occasionally in African waters and the other oceans waters, during the last decade (2001-2011).

The most common pattern found in the studies is the fact that fishing operations (the vessel use phase, including but not limited to fuel use) are the main contributor to environmental impacts during the extraction phase as previously found in other reviews (e.g. Pelletier et al., 2007).

Construction and EOL phases were generally roughly considered (i.e. limiting the inventory to steel weight of hull or hull plus engine) or directly omitted from analyses, due to the extended assertion that those phases generate negligible impacts in comparison to use and maintenance. The few studies dealing with construction, too partially in most cases, indicate the dominant importance of metals on environmental impacts related to toxicity to humans and the environment, but also to the metal depletion indicator recently implemented in the ReCiPe method (Goedkoop et al., 2008). The only work addressing EOL of vessels shows a non-negligible effect on freshwater and marine water toxicity (Fréon et al., in prep.).

All studies reviewed deal with emissions to air due to combustion of fossil fuels during the use phase. Some of the studies discussed the impacts due to vessel maintenance, emphasising the use of antifouling and refrigerants and assigning great importance to these substances as contributors to

impacts. Copper was the most often mentioned antifouling component, although other conventional components such as lead, zinc, tributyltin (TBT), xylene and various phenyl-, pyridine- or ethyl-derived —or new ones like dibutyltin oxide, “sea nine” 211e (4,5-dichloro-2-n-octyl-4-isothiazolin-3-one)— are often used with or without copper and also present a high level of toxicity. However, most of those elements are either not considered in the LCA, not described in used databases or not characterised in used LCIA methods (except for zinc, tin and copper ions, as well as TBT, but not complex molecules). Ideally, the USEtox consensus method should be enlarged to include marine eco-toxicity, and thus enriched with characterisation factors for substances included in antifouling paints and other waterborne emissions such as bilge oil or (used) lubricating oil. Many of those waterborne emissions are also missing from other toxicity models.

It is not always clear which substances are present in the studied fisheries although nowadays all antifouling paints use several toxic substances with or without addition of copper derivatives (Yebra et al., 2004). Eyjólfssdóttir et al. (2003) mentioned that in the case of Icelandic fisheries the non-use of TBT reduces considerably the environmental impacts of antifouling use. This early discontinuation of TBT use is exceptional, because a 2001 ban on the use of this agent (and organotins in general) by the International Maritime Organisation just entered into force in 2008. Consequently, TBT and other organotins are currently banned in most European and American countries, as well as in a few Asian countries (Sonak et al., 2009). Nowadays, substitute agents —as well as polymer coatings, biocides, etc.— are used (IMO 2002), but as mentioned, many of those substances are not characterised in most environmental databases and LCIA methods and thus unfortunately omitted from studies.

Impacts resulting from the use of lubricating oil and refrigerating agents, ice production and net production, use and loss were considered in various studies (Eyjólfssdóttir et al., 2003; Ramos et

al., 2011; Vázquez-Rowe et al, 2010a,b, 2011, 2012a), as detailed in Table 2. Those inventory items were generally found to have a minor (even negligible) contribution to impacts, especially when compared with impacts derived from fuel consumption.

### 3.4.2 Fuel use

Fuel use was found to be the greatest single source of most environmental burdens among all inputs to fishing activities. This item was assessed in all reviewed studies, but in general terms it is not clear which fuel-burning activities are included (i.e. only fishing trips plus on-board processing or also tests, relocations between fishing ports or areas, etc).

Many of the studies emphasised that energy efficiency and other environmental impacts depend, among other factors, on the fishing gear used, a conclusion confirmed by Thrane (2004a), Vázquez-Rowe (2011c) and by this review (Table 4 and Supplementary Material). From the reviewed studies it can thus be generalised that energy efficiency in relation to fuel use is strongly dependent on the fishing gear utilised. Generally, trawling methods (despite the differences between bottom and mid-water trawling) were the most energy-intensive among those listed when related to landed kg of fresh fish equivalents. Ultimately, fuel consumption per functional unit of a given fleet operating on a given ecosystem is subject to complex factors often unaccounted for (Thrane, 2004b). Among them, natural abundance of the resource, stock status, spatiotemporal variability of catchability (level of aggregation, depth, distance from the coast, etc.) management regime, skill level of the vessel crew (the “skipper effect”, Vázquez-Rowe and Tyedmers, 2012), proportion of by-catch or hull technology. Additionally, emissions from marine fuel combustion depend on the quality of the fuel itself and the condition and technology of the engine, yet those factors have been overlooked in the reviewed studies.

All of the studies discussed energy use of fisheries expressed as quantities of fuel consumed per

landed mass of fish at different stages of transformation and using different units of mass or volume. We standardised energy efficiency data from all studies as a ratio of kg of fuel used per tonne of landed fresh unprocessed fish, and thus render comparison possible. Onboard processing losses and energy used for processing were considered when applicable. Additionally, non-LCA studies were included (Tyedmers, 2001; additional fuel use calculations in Thrane, 2004a; Driscoll and Tyedmers, 2010) in order to extend the energy use in the data set. Figures offered by Thrane (2004a) are calculated using system expansion including cross-calculation of all main by-catches. Nonetheless, the study also presents fuel figures calculated using mass allocation and thus results are found closer to other studies, for instance, Tyedmers (2001). Despite the availability of these system expansion calculations, the mass-allocated figures were used in this review to make comparisons with other studies feasible (Table 4 and Supplementary Material). Differences arising from the allocation method used can be important. For instance, trawling of Norway lobster (aggregated into the Lobster and crab category) consumes 3 214 kg fuel/t landed according to mass allocation and 16 762 kg fuel/t landed according to systems expansion (Thrane, 2004a).

Fuel use should be disaggregated as far as possible regarding the specific activities involved (e.g. on-board processing). Non-fishing, fuel-consuming activities can be non-negligible and thus it should be clear whether they are accounted for. For instance, we have found that in countries like Peru, fishing vessels are often seasonally relocated between North and South, over a very long coastline. Moreover, we assert that in multi-species fisheries there is a need of allocating those activities between landed catches of different species.

### 3.4.3 Sensitivity and uncertainty analyses

Sensitivity analysis consists in the evaluation of the impacts of changes in data and methodological choices over LCIA results, while uncertainty analysis is the evaluation of the

impacts of the propagation of data- and assumptions-related uncertainties over LCIA results (ISO, 2006b). Sensitivity and uncertainty analyses should be performed in order to better reflect the accuracy of LCI and LCA studies.

The ISO standard and Guinée et al. (2001) recommend sensitivity analyses to be carried out when several choices seem applicable by contrasting allocation methods. In practice often mass vs. economic allocations are contrasted, despite the fact that, according to the ISO standard, economic allocation should be the least preferred alternative. However, a sensitivity analysis could be carried out, for example, among criteria such as energy content and nutritional value. In fisheries LCA, the selection of allocation strategy and accounting of fuel consumption are the main causes for large variation in results, and thus sensitivity analysis is very relevant in such a context. As discussed for instance in Thrane (2004a) and EC/JRC (2010), there are several sources of uncertainty in LCA (methodological, inventory data and characterisation factors) that need to be evaluated quantitatively via uncertainty analyses, which typically are performed by means of random sampling methods (e.g. Monte Carlo simulations).

Several of the reviewed studies performed sensitivity analyses. Nonetheless, sensitivity results are communicated in very diverse fashions, ranging from a simple statement to several paragraphs of discussion. The analyses themselves have been carried out based on various criteria, including: contrasting impact assessment methods or allocation methods, modifying allowable emissions, simulating different volumes of key substances (i.e. fossil fuels) and varying several operational factors.

Data uncertainty was mentioned in some of the reviewed studies, but explanations on how uncertainties were dealt with are superficial. One single study, a doctoral thesis (Thrane, 2004a); discussed in great detail data and methodological uncertainty as well as their effects on LCA results. Moreover, only one additional study (Fréon et al.,

in prep.) accounts for variability and uncertainty during the LCI, by means of Monte Carlo simulations.

The ISO standard, as well as guidelines such as Guinée et al. (2001) and the ILCD Handbook (EC/JRC, 2010); offer criteria for sensitivity analysis. We detail those recommendations by suggesting it should preferentially be related to important (i.e. >5% of individual contribution to impacts) items, especially when high uncertainty is associated to underlying data and assumptions. Results from such analyses should be presented in such a way that scenarios can be outlined based on important variations of critical items. A key example in fisheries would be data on fuel use, catches and discards, the last two being relevant for computing fisheries-specific impact categories. Furthermore, in the LCIA stage, extreme values should be investigated, as discussed in Thrane (2004a).

#### **3.4.4 Fishery-specific methodological concerns**

To date there is no agreement regarding methodological choices for carrying out and presenting LCAs of fisheries, which makes it difficult to compare studies (Ayer et al., 2007; Svanes et al., 2011b). However, the studies in this review have been screened for patterns and singularities in an attempt to characterise the state-of-the-art of LCA applied to fishing activities and to contribute to the ongoing discussion on sensitive issues of LCA in general (i.e. allocation, impact categories, normalisation, sensitivity and uncertainty analyses).

In fisheries LCA, a number of methodological issues arise, beyond the issues inherent to the state of the art of LCA. Those issues include the lack of standardised and widely applicable fishery-specific impact categories and how to deal with important technological, spatial and even temporal variability in fishing operations, especially with regards to fuel use.

### **3.5 LCA in the context of sustainability assessment methods**

Discussion of socio-economic issues has been minimal in the context of fisheries LCA literature (Pelletier et al., 2007). Since LCA alone has focused on environmental impacts of production systems, as well as on resource depletion, other life cycle methods, namely Social LCA (SLCA) and Life Cycle Costing (LCC), have been developed as necessary complements for capturing trade-offs between environmental, social and economic interest along the life cycle of production systems (Dreyer et al., 2006; Guinée et al., 2011).

LCA, SLCA and LCC are philosophically related tools within the larger framework of Life Cycle Sustainability Assessment (LCSA) (Klöpffer, 2008; Klöpffer and Ciroth, 2011; Swarr et al., 2011; Valdivia et al., 2011).

A comprehensive review of approaches for SLCA has been compiled by Jørgensen et al. (2008) and a recent guideline attempts to pioneer the standardisation of SLCA practice (Andrews et al., 2009). LCC is, on the other hand, a mature approach aimed to assess all costs associated to the life cycle of a (product) system (Huppel et al., 2004). No dedicated and comprehensive standard exists to date for LCC (other than guidelines and sector-specific standards —e.g. ISO 15686-5 for the construction sector—), but it predates on a

rich body of literature and accepted accounting/costing techniques. See Supplementary Material for a list of standards and guidelines for life cycle methods.

LCSA has also been applied to fisheries research, for instance, precursor works such as Kruse et al. (2008) attempted to apply in a seafood context recent developments in SLCA (although this approach is still under development).

Beyond life cycle methods, a great variety of system analysis tools have been developed, focusing on diverse types of impacts and dimensions of sustainability (natural resources, environmental, social, economic impacts), and spanning different spatial scales/levels of study (micro, macro, meso), as described in great detail, for instance, in Finnveden and Moberg (2005) and Jeswani et al. (2010). Some of those methods could complement fisheries LCAs for a wider, more holistic study. Examples include the combination of LCA and data envelopment analysis (Vázquez-Rowe et al., 2010a), the use of geographical information systems (GIS) data for computing certain impact categories (Ziegler and Valentinsson, 2008) and the computation of the FiB index in the context of an LCA study (Ramos et al., 2011). See Table 5 for a list of environmental methods and Supplementary Material for sustainability methods.

**Table 5:** Methods for environmental assessment in the context of fisheries (partially based on Loiseau et al., 2012)

| Method                | Local/ Global   | Mono / Multicriteria | Qualitative /Quantitative | Real/Potential impacts | Life cycle thinking | Strategy            | Comment   |
|-----------------------|-----------------|----------------------|---------------------------|------------------------|---------------------|---------------------|---|
| CF                    | Global          | Mono                 | Quantitative              | Potential              | ++                  | Bottom-up           | Useful in combination with or as a preliminary step of LCA.   |
| EAF                   | Local           | Multi                | Mostly quantitative       | Real                   | —                   | Bottom-up/ Top-down | This approach encompasses many methods dealing with ecological, environmental and socio-economic issues.  |
| EF                    | Global          | Mono                 | Quantitative              | Potential              | +                   | Bottom-up/ Top-down | Useful in combination with or as a preliminary step of LCA.   |
| Exergy/ Energy        | Global          | Mono                 | Quantitative              | Potential              | ++                  | Bottom-up/ Top-down | Focus on energy. Relevant for fisheries.  |
| (HE)RA                | Local           | Mono or Multi        | Qualitative               | Real                   | —                   | Bottom-up           | Not adapted to fisheries, except in special circumstances (possibly stock or fishery collapses due extreme events such as large-scale oil spill, tsunami, strong El Niño events)  |
| Input-Output Analysis | Local or Global | Multi                | Quantitative              | Potential              | ++                  | Top-down            | Useful for extending and completing LCA to better quantify flows of material and energy.  |
| LCA                   | Global          | Multi                | Quantitative              | Potential              | ++                  | Bottom-up           | Can be considered as one of the various methods included in EAF.  |
| LIA                   | Local           | Multi                | Quantitative              | Real                   | —                   | Top-down            | Could be applied to contamination impacts, seabed disturbance, etc. Can be considered as one of the various methods included in EAF.  |
| MFA                   | Local           | Multi                | Quantitative              | Potential              | +                   | Top-down            | Useful as a preliminary step of LCA to better quantify flows of material and energy.  |
| Specific EAF methods  | Local           | Mostly Mono          | Mostly quantitative       | Real                   | —                   | Bottom-up/ Top-down | These methods, included in EAF, aim at the evaluation of exploited stock (or whole marine ecosystem) status through population dynamics models, trophic models, bio-economical models, operational management procedure, management strategy evaluation, etc. |

CF: Carbon Footprint, EAF: Ecosystem Approach to Fisheries, EF: Ecological Footprint, (HE)RA: (Human and Environmental) Risk Assessment, LIA: Local Impact Assessment, MFA: Material Flow Analysis.

## 4 Conclusions and perspectives

Future LCA studies of fisheries will hopefully continue contributing to a) mapping the environmental performance of fisheries worldwide (most studies to date focus on the Northern Atlantic and other few fishing areas), showing increasing attention to aspects that have been neglected so far; and b) enriching LCA studies on supply chains based on or strongly connected to fisheries (e.g. aquaculture, animal husbandry, etc).

We advocate not only for more strictly following the ISO norms (for the sake of increased consistency and comparability) but, beyond this, for specific standardisation of fisheries LCA practice towards an accepted fisheries/seafood LCA framework. Such framework would address, when possible, boundaries setting, impact categories and characterisation, normalisation references, allocation strategies and sensitivity analyses, presentation of results, etc. These suggestions are in line with an on-going project developing a carbon footprint standard for the fisheries industry, by the British Standards Institution (BSI, 2012).

Despite the fact that existing fisheries LCA studies are difficult to contrast due to a general lack of detail and standardisation, valuable conclusions can be mined from available literature, concluding that fuel consumption, use of antifouling paints and associated release of substances are key contributors to environmental impacts as measured by conventional LCAs. Such findings can easily be translated into operational recommendations to improve environmental performance of fisheries, within the framework of the ecosystem approach to fisheries and, in the future, certification and labelling of fisheries.

Nonetheless, target and non-target species removal and other fisheries-specific impact categories, such as sea use and seafloor disturbance, are not included in most quantitative LCAs to date. Furthermore, the stage of fishing unit construction, and the lesser contributing stage of EOL, are often neglected. Another

pressing need, not specific to fisheries LCA, is to use data that actually reflects the specifics of the supply chains of concern, instead of an over-reliance on often unrepresentative data from third-party commercial LCI databases. The treatment of these issues, perceivable as weak points in fisheries LCA research, should be included in the abovementioned standardisation of LCA practice for fisheries and seafood research. Thus, future LCAs would ideally include a) key inventory data and detailed explanations of energy input per mass of landed fish; b) inclusion of the whole life cycle of vessels, namely construction, use, maintenance and, to a lesser extent EOL with focus on use of fuel, metals and toxic products release; c) justification of allocation strategies applied; d) when necessary use proper data for most impacting processes, instead of LCI databases, or modify/adapt the later; e) sensitivity and uncertainty analyses (focusing for instance on seafood-specific allocation criteria such as energy content, content of protein and lipids, etc); f) inclusion of fisheries-specific impact categories, detailed and explained; and g) generalised normalisation references presented semi-quantitatively.

We advocate for the consensual elaboration of a Product Category Rule (PCR) for Fisheries and Seafood LCIs. A PCR is the set of guidelines, requirements and specific rules for communicating LCA results, under the form of an Environmental Product Declaration (EPD), of a family of products fulfilling equivalent functions (known as product category) (ISO, 2006c; Schau and Fet, 2008). Such a PCR for fisheries and seafood would include a standard format with optional sections according to the type of fishery and the purpose of the study. It would demand a number of observations, inventory items and other methodological details to be clearly communicated. Such standardisation may result from a workshop gathering LCA practitioners and fisheries scientists under the auspices of an international LCA entity such as the UNEP/SETAC Life Cycle Initiative.

Future, ideally standardised fisheries LCAs, should contribute to better decision making on fisheries management and seafood consumption. The decrease of environmental impacts produced by marine fisheries depends not only on technical improvement aimed at reducing adverse effects of construction, use, maintenance and EOL of fishing units, but specially on the management of the fishing sector in order to decrease fishing effort on overexploited stocks and limit fishing and processing overcapacity. For instance, we believe that some of the driving factors of fuel use per landed catch, namely the selection of fishing gear and the size of fishing units, depend on design/management decisions that should be addressed by fisheries policy and management.

There is also a need for a comprehensive assessment of environmental (and sustainability) impacts of fisheries in the context of whole supply chains, as well as for standardised tools, approaches and methods to do so. The LCSA framework seems promising, and once it reaches maturity, life cycle comprehensive sustainability assessment of seafood supply chains will be more accessible. In the meantime, the inclusion of brief discussion on socio-economic issues in future fisheries LCA studies would be advisable to render them more valuable for decision makers, fishing and seafood companies, as well as for social and economic researchers.

### Acknowledgements

This work is a contribution to the International Joint Laboratory “Dynamics of the Humboldt Current system” (LMI - DISCOH) coordinated by the Institut de Recherche pour le Développement (IRD) and the Instituto del Mar del Perú (IMARPE), and involving several other institutions. It was carried out under the sponsoring of the Direction des Programmes de Recherche et de la formation au Sud (DPF) of the IRD, by means of a doctoral scholarship of which the first author is a grateful recipient. The authors also thank the Pontificia Universidad Católica del Perú for hosting, and the colleagues who criticised the manuscript and thus contributed to improve it, especially Peter

Tyedmers, at the School for Resource & Environmental Studies, Dalhousie University; and Ian Vázquez-Rowe. Two anonymous reviewers are also acknowledged for their helpful comments. The authors are members of the ELSA research group (Environmental Life Cycle and Sustainability Assessment, <http://www.elsa-lca.org/>).

### References

- Andrews, E. S., Barthel, L.-P., Tabea, B., Benoît, C., Ciroth, A., Cucuzzella, C., et al. 2009. Guidelines for social life cycle assessment of products. (C. Benoît & B. Mazijn, Eds.). UNEP/SETAC Life Cycle Initiative. United Nations Environment Programme.
- Ardente, F., Cellura, M. 2012. Economic allocation in Life Cycle Assessment. *J. Ind. Ecol.*, 16(3), 387–398.
- ART, 2008. Proceedings of the 6th International Conference on LCA in the agri-food sector – Towards a sustainable management of the food chain. in: Nemecek, T. and Gaillard, G. (Eds.), 6th International Conference on Life Cycle Assessment in the Agri-Food Sector. Zurich: Agroscope Reckenholz-Tänikon Research Station ART.
- Ayer, N., Tyedmers, P., Pelletier, N., Sonesson, U., Scholz, A. J., 2007. Co-product allocation in life cycle assessments of seafood production systems: Review of problems and strategies. *Int. J. Life Cycle Ass.*, 12(7), 480–487.
- Baitz, M., Albrecht, S., Brauner, E., Broadbent, C., Castellan, G., Conrath, P., et al. 2012. LCA’s theory and practice: like ebony and ivory living in perfect harmony? *Int. J. Life Cycle Ass.*, in press. doi: 10.1007/s11367-012-0476-x.
- Bartley, D.M., Brugère, C., Soto, D., Gerber, P., Harvey, B. (Eds), 2007. Comparative assessment of the environmental costs of aquaculture and other food production sectors: methods for meaningful comparisons. FAO/WFT Expert Workshop. 24-28 April 2006, Vancouver, Canada. FAO Fisheries Proceedings. No. 10. Rome, FAO. 2007. 241p.
- Brander, M., Tipper, R., Hutchison, C., Davis, G., 2008. Consequential and attributional approaches to LCA: a guide to policy makers with specific reference to greenhouse gas LCA of biofuels. *Ecometrica*, Edinburgh, (April).
- BSI. 2012. PAS 2050-2: 2012. Project Set-up report March 2012. British Standards Institution, pp. 1-8.

- Cappell, R., Wright, S., Nimmo, F., 2007. Sustainable production and consumption of fish and shellfish - environmental impact analysis. DEFRA LCA.
- Christensen, V., Steenbeek, J., Failler, P., 2011. A combined ecosystem and value chain modeling approach for evaluating societal cost and benefit of fishing. *Ecol. Model.*, 222(3), 857-864.
- Cooper, J., 2003. Specifying functional units and reference flows for comparable alternatives. *Int. J. Life Cycle Ass.*, 8(6), 337-349.
- Curran, M. A., 2007. Co-product and input allocation approaches for creating life cycle inventory data: a literature review. *Int. J. Life Cycle Ass.*, 12(1), 65–78.
- Dreyer, L., Hauschild, M., Schierbeck, J., 2006. A framework for social life cycle impact assessment. *Int. J. Life Cycle Ass.*, 11(2), 88–97.
- Driscoll, J., Tyedmers, P., 2010. Fuel use and greenhouse gas emission implications of fisheries management: the case of the New England Atlantic herring fishery. *Mar. Policy*, 34(3), 353-359.
- Earles, J. M., Halog, A., 2011. Consequential life cycle assessment: a review. *Int. J. Life Cycle Ass.*, 16(5), 445-453.
- EC/JRC. 2007. Carbon footprint: What it is and how to measure it. Ispra: European Platform on Life Cycle Assessment European Commission – Joint Research Centre Institute for Environment and Sustainability.
- EC/JRC., 2010. ILCD Handbook: General guide for Life Cycle Assessment - Detailed guidance. European Commission - Joint Research Centre. Luxembourg, Publications Office of the European Union.
- Ekvall, T., Finnveden, G., 2001. Allocation in ISO 14041 – a critical review. *J. Clean. Prod.*, 9, 197-208.
- Ellingsen, H., Aanonsen, S., 2006. Environmental impacts of wild caught cod and farmed salmon - a comparison with chicken. *Int. J. Life Cycle Ass.*, 11(1), 60-65.
- Emanuelsson, A., Flysjö, A., Thrane, M., Ndiaye, V., Eichelsheim, J.L., Ziegler, F., 2008. Life Cycle Assessment of southern pink shrimp products from Senegal. 6th International Conference on Life Cycle Assessment in the Agri-Food Sector, Zurich, pp. 1-9.
- Emanuelsson, A., Ziegler, F., Hornborg, S., & Sonesson, U. 2012. Target catch methods in Life Cycle Assessment of seafood products: Accounting for overfishing in a Wasted Potential Yield framework. Public consultation. LC-IMPACT. Retrieved from [http://lc-impact.eu/userfiles/D\\_1\\_3a\\_marine\\_resources\\_use.pdf](http://lc-impact.eu/userfiles/D_1_3a_marine_resources_use.pdf)
- Evans, Y., Tveteras, S., 2011. Status of fisheries and aquaculture development in Peru: case studies of Peruvian anchovy fishery, shrimp aquaculture, trout aquaculture and scallop aquaculture. Background Report. Pontificia Universidad Católica del Perú. Lima.
- Eyjólfssdóttir, H., Yngvadóttir, E., Jónsdóttir, H., Skúladóttir, B., 2003. Environmental effects of fish on the consumers dish–Life cycle assessment of Icelandic frozen cod products. IFL Report 06-03. Reykjavik.
- FAO. 2003. Fisheries management. The ecosystem approach to fisheries. FAO Technical Guidelines for Responsible Fisheries, 4 (Suppl. 2). 112 pp.
- Finnveden, G., Hauschild, M. Z., Ekvall, T., Guinée, J., Heijungs, R., Hellweg, S., Koehler, A., et al. 2009. Recent developments in Life Cycle Assessment. *J. Environ. Manage.*, 91(1), 1–21.
- Finnveden, G., Moberg, Å., 2005. Environmental systems analysis tools - an overview. *J. Clean. Prod.*, 13(12), 1165-1173.
- Ford, J. S., Pelletier, N. L., Ziegler, F., Scholz, A. J., Tyedmers, P. H., Sonesson, U., Kruse, S.A., et al. 2012. Proposed local ecological impact categories and indicators for Life Cycle Assessment of aquaculture. *J. Ind. Ecol.*, 16(2), 254-265.
- Fréon, P., Bouchon, M., Domalain, G., Estrella, C., Iriarte, F., Lazard, J., et al., 2010. Impacts of the Peruvian anchoveta supply chains: from wild fish in the water to protein on the plate. *GLOBEC International Newsletter*, (April), 27-31.
- Fréon, P., Cury, P., Shannon, L., Roy, C., 2005a. Sustainable exploitation of small pelagic fish stocks challenged by environmental and ecosystem changes. *B. Mar. Sci.* 76 (2), 385–462.
- Fréon, P., Drapeau, L., David, J., Fernández Moreno, A., Leslie, R., Oosthuizen, H., Shannon, L.J., van der Lingen, C.D., 2005b. Spatialised ecosystem indicators in the Southern Benguela. *ICES J. Mar. Sci.*, 62, 459-468.
- Frischknecht, R., Jungbluth, N., Althaus, H.-J., Doka, G., Heck, T., Hellweg, S., Hirschler, R., et al., 2007. Overview and methodology. *ecoinvent report No. 1*. Dübendorf: Swiss Centre for Life Cycle Inventories.
- Garcia, S., Cochrane, K., 2005. Ecosystem approach to fisheries: a review of implementation guidelines. *ICES J. Mar. Sci.*, 62(3), 311-318.



- Goedkoop, M., Heijungs, R., Huijbregts, M., Schryver, A. D., Struijs, J., Zelm, R. V. 2009. ReCiPe 2008. A life cycle impact assessment method which comprises harmonised category indicators at the midpoint and the endpoint level. Report I: Characterisation. Ministry of Housing, Spatial Planning and Environment (VROM).
- Guinée, J. B., Gorreé, M., Heijungs, R., Huppes, G., Kleijn, R., de Koning, A., van Oers, L., et al., 2001. Life cycle assessment. An operational guide to the ISO standards. Ministry of Housing, Spatial Planning and the Environment (VROM) and Centre of Environmental Science - Leiden University (CML). Part 2a: Guide and Part 2b: Operational annex.
- Guinée, J., Heijungs, R., Huppes, G., Zamagni, A., Masoni, P., Buonamici, R., Ekvall, T., et al., 2011. Life cycle assessment: past, present, and future. *Environ. Sci. Technol.*, 45(1), 90-6.
- Guttormsdóttir, A. B., 2009. Life Cycle Assessment on Icelandic cod product based on two different fishing methods. Environmental impacts from fisheries. Masters Dissertation. University of Iceland.
- Heijungs, R., Guinée, J., Kleijn, R., Rovers, V., 2007. Bias in normalization: causes, consequences, detection and remedies. *Int. J. Life Cycle Ass.*, 12(4), 211–216.
- Heijungs, R., Huppes, G., Guinée, J. B., 2010. Life cycle assessment and sustainability analysis of products, materials and technologies. Toward a scientific framework for sustainability life cycle analysis. *Polym. Degrad. Stabil.*, 95(3), 422-428.
- Henriksson, P., Guinée, J. B., Kleijn, R., de Snoo, G. R. 2011. Life cycle assessment of aquaculture systems — a review of methodologies. *Int. J. Life Cycle Ass.*, 17, 304–313.
- Hischier, R., Weidema, B., Althaus, H.-jörg, Bauer, C., Doka, G., Dones, R., Frischknecht, R., et al., 2010. Implementation of Life Cycle Impact Assessment Methods.ecoinvent report No. 3. Dübendorf. Swiss Centre for Life Cycle Inventories.
- Horiuchi, R., Schuchard, R., Shea, L., & Townsend, S., 2009. Understanding and preventing greenwash: A business guide. London: Futerra Sustainability. BSR/Futerra.
- Hornborg, S., Nilsson, P., Valentinsson, D., & Ziegler, F., 2012. Integrated environmental assessment of fisheries management: Swedish Nephrops trawl fisheries evaluated using a life cycle approach. *Mar. Pol.*, 36(6), 1–9.
- Hospido, A, Tyedmers, P., 2005. Life cycle environmental impacts of Spanish tuna fisheries. *Fish. Res.*, 76(2), 174-186.
- Huijbregts, M., Breedveld, L., Huppes, G., Koning, A. de, Oers, L. van, Suh, S., 2003. Normalisation figures for environmental life-cycle assessment The Netherlands (1997/1998), Western Europe (1995) and the world (1990 and 1995). *J. Clean. Prod.*, 11(7), 737-748.
- Huppes, G., van Oers, L. 2011. Background review of existing weighting approaches in Life Cycle Impact Assessment (LCIA). European Commission, Joint Research Centre, Institute for Environment and Sustainability.
- Huppes, G., van Rooijen, M., Kleijn, R., Heijungs, R., de Koning, A., van Oers, L., 2004. Life cycle costing and the environment. CML, Leiden University.
- IMO, 2002. Focus on IMO. Background information, in: International Maritime Organisation, London, pp. 1-31.
- International Organisation for Standardisation (ISO), 2006a. Environmental management - Life Cycle Assessment – Principles and framework. EN ISO 14040.
- International Organisation for Standardisation (ISO), 2006b. Environmental management - Life Cycle Assessment - Requirements and Guidelines. EN ISO 14044.
- International Organisation for Standardisation (ISO), 2006c. Environmental labelling and declarations – Type III environmental declarations – Principles and procedures (ISO 14025:2006).
- International Organization for Standardization (ISO). 2012. Carbon footprint of products — Requirements and guidelines for quantification and communication (DRAFT). (ISO 14067).
- Iribarren, D., Vázquez-Rowe, I., Hospido, A., Moreira, M. T., & Feijoo, G. 2011. Updating the carbon footprint of the Galician fishing activity (NW Spain). *Sci. Total Environ.*, 409(8), 1609–11.
- Iribarren, D., Vázquez-Rowe, I., Hospido, A., Moreira, M. T., Feijoo, G., 2010. Estimation of the carbon footprint of the Galician fishing activity (NW Spain). *Sci. Total Environ.*, 408(22), 5284-94.
- Jeswani, H. K., Azapagic, A., Schepelmann, P., Ritthoff, M., 2010. Options for broadening and deepening the LCA approaches. *J. Clean. Prod.*, 18(2), 120-127.

- Jørgensen, A., Le Bocq, A., Nazarkina, L., Hauschild, M., 2008. Methodologies for social life cycle assessment. *Int. J. Life Cycle Ass.*, 13(2), 96–103.
- Kaiser, M.J. Jennings S., 2002. Ecosystem effects of fishing, in: J. D. Reynolds and P. J. B. Hart (Eds.), *Handbook of Fish Biology and Fisheries - Volume 2 Fisheries*, Blackwell Science, Oxford, pp. 342–366.
- Klöpffer, W. 2008. Life cycle sustainability assessment of products. *Int. J. Life Cycle Ass.*, 13(2), 89–95.
- Klöpffer, W., 2012. The critical review of life cycle assessment studies according to ISO 14040 and 14044. *Int. J. Life Cycle Ass.*, 17(9), 1087–1093.
- Klöpffer, W., Citroth, A., 2011. Is LCC relevant in a sustainability assessment? *Int. J. Life Cycle Ass.*, 16(2), 99-101.
- Kruse, S., Flysjö, A., Kasperczyk, N., Scholz, A. J., 2008. Socioeconomic indicators as a complement to life cycle assessment—an application to salmon production systems. *Int. J. Life Cycle Ass.*, 14(1), 8-18.
- Langlois, J., Fréon P., Delgenes, J-P, Steyer, J-P, Hélias, A. 2012. Biotic resources extraction impact assessment in LCA of fisheries. in: Corson, M.S., van der Werf, H.M.G. (Eds.), *Proceedings of the 8th International Conference on Life Cycle Assessment in the Agri-Food Sector (LCA Food 2012)*, 1-4 October 2012, Saint Malo, France. INRA, Rennes, France, p. 517-523.
- Langlois, J., Hélias, A., Delgenes, J.-P., Steyer, J.-P., 2011. Review on land use considerations in life cycle assessment: methodological perspectives for marine ecosystems, in: Finkbeiner, M. (Ed.), *Towards Life Cycle Sustainability Management*, Chapter 9, Springer, Dordrecht, 85-96.
- Libralato, Coll, M., Tudela, S., Palomera, I. Pranovi, F., 2008. Novel index for quantification of Ecosystem Effects of Fishing as removal of secondary production. *Marine Ecology Progress Series* 355, 107–129.
- Linnane, A., Ball, B., Munday, B., van Marlen, B., Bergman, M., Fonteyne, R., et al., 2000. A review of potential techniques to reduce the environmental impact of demersal trawls. *Irish Fisheries Investigations. Series B (Marine)*, 7, 39 pp.
- Loiseau, E., Junqua, G., Roux, P., & Bellon-Maurel, V. 2012. Environmental assessment of a territory: An overview of existing tools and methods. *J. Environ. Manage.*, 112(0), 213–225.
- Mila i Canals, L., Romanya, J., Cowell, S., 2007. Method for assessing impacts on life support functions (LSF) related to the use of “fertile land” in Life Cycle Assessment (LCA). *J. Clean. Prod.*, 15(15), 1426–1440.
- Misund, O. A., Kolding, J., Fréon, P., 2002. Fish capture devices in industrial and artisanal fisheries and their influence on management, in: J. D. Reynolds and P. J. B. Hart (Eds.), *Handbook of Fish Biology and Fisheries - Volume 2 Fisheries*. Blackwell Publishing.
- Nilsson, P., Ziegler, F., 2007. Spatial distribution of fishing effort in relation to seafloor habitats in the Kattegat, a GIS analysis. *Aquat. Conserv.*, 17(4), 421-440.
- Norris, G. A., 2001. The requirement for congruence in normalization. *Int. J. Life Cycle Ass.*, 6(2), 85–88.
- O’Brien, M., Doig, A., Clift, R., 1996. Social and environmental life cycle assessment (SELCA). *Int. J. Life Cycle Ass.*, 1(4), 231-237.
- Parker, R. 2012. Review of life cycle assessment research on products derived from fisheries and aquaculture: A report for Seafish as part of the collective action to address greenhouse gas emissions in seafood. Final Report. Edinburgh: Sea Fish Industry Authority. Retrieved from [http://www.seafish.org/media/583639/seafish\\_lca\\_rev\\_iew\\_report\\_final.pdf](http://www.seafish.org/media/583639/seafish_lca_rev_iew_report_final.pdf)
- Pauly, D., Alder, J., Bennett, E., Christensen, V., Tyedmers, P., Watson, R., 2003. The future for fisheries. *Science*, 302(5649), 1359-61.
- Pauly, D., Christensen, V., 1995. Primary production required to sustain global fisheries. *Nature*, 374(6519), 255-257.
- Pauly, D., Christensen, V., Dalsgaard, J., Froese, R., Torres Jr., F., 1998. Fishing down marine food webs. *Science*, 279(5352), 860-863.
- Pauly, D., Christensen, V., Walters, C., 2000. Ecopath, Ecosim, and Ecospace as tools for evaluating ecosystem impact of fisheries. *ICES J. Mar. Sci.*, 57(3), 697-706.
- Peacock, N., Camillis, C., Pennington, D., Aichinger, H., Parenti, A., Renaud, J.-P., Raggi, A., et al., 2011. Towards a harmonised framework methodology for the environmental assessment of food and drink products. *Int. J. Life Cycle Ass.*, 16(3), 189-197.
- Pelletier, N., Ayer, N., Tyedmers, P., Kruse, S., Flysjö, A., Robillard, G., Ziegler, F., et al., 2007. Impact categories for life cycle assessment research of seafood production systems: Review and prospectus. *Int. J. Life Cycle Ass.*, 8(1), 39-421.

- Pelletier, N., Tyedmers, P., 2011. An ecological economic critique of the use of market information in Life Cycle Assessment research. *J. Ind. Ecol.*, 15(3), 342-354.
- Ramos, S., Vázquez-Rowe, I., Artetxe, I., Moreira, M. T., Feijoo, G., Zufía, J., 2011. Environmental assessment of the Atlantic mackerel (*Scomber scombrus*) season in the Basque Country. Increasing the timeline delimitation in fishery LCA studies. *Int. J. Life Cycle Ass.*, 16(7), 599-610.
- Reap, J., Roman, F., Duncan, S., Bras, B., 2008a. A survey of unresolved problems in life cycle assessment - Part 1: goal and scope and inventory analysis. *Int. J. Life Cycle Ass.*, 13(4), 290-300.
- Roque d'Orbcastel, E., Blancheton, J.-P., Aubin, J., 2009. Towards environmentally sustainable aquaculture: Comparison between two trout farming systems using Life Cycle Assessment. *Aquacult. Eng.*, 40(3), 113-119.
- Schau, E., and Fet, A. 2008. LCA studies of food products as background for environmental product declarations. *Int. J. Life Cycle Ass.*, 13(3), 255-264.
- Schau, E., Ellingsen, H., Endal, A., & Aanonsen, S., 2009. Energy consumption in the Norwegian fisheries. *J. Clean. Prod.*, 17(3), 325-334.
- Schmidt, J. H. 2008. System delimitation in agricultural consequential LCA. *Int. J. Life Cycle Ass.*, 13(4), 350-364.
- Sleeswijk, A. W., van Oers, L. F. C. M., Guinée, J. B., Struijs, J., Huijbregts, M. a J., 2008. Normalisation in product life cycle assessment: an LCA of the global and European economic systems in the year 2000. *Sci. Total Environ.*, 390(1), 227-40.
- Smith, M. D., Roheim, C., Crowder, L. B., Halpern, B. S., Turnipseed, M., Anderson, J. L., et al., 2010. Sustainability and global seafood. *Science*, 327(5967), 784.
- SOFIA, 2010. The State of World Fisheries and Aquaculture 2010. Rome: FAO Fisheries and Aquaculture Department.
- SOFIA. 2012. The State of World Fisheries and Aquaculture 2012 (p. 209). Rome: FAO Fisheries and Aquaculture Department.
- Sonak, S., Pangam, P., Giriyan, A., Hawaldar, K., 2009. Implications of the ban on organotins for protection of global coastal and marine ecology. *J. Environ. Manage.*, 90 Suppl 1, S96-108.
- Suh, S., Lenzen, M., Treloar, G., & Hondo, H., 2004. System boundary selection in life-cycle inventories using hybrid approaches. *Environ. Sci. Technol.*, 38(3), 657-664.
- Suh, S., Weidema, B., Schmidt, J. H., Heijungs, R., 2010. Generalized make and use framework for allocation in Life Cycle Assessment. *J. Ind. Ecol.*, 14(2), 335-353.
- Svanes, E., Vold, M., Hanssen, O. J., 2011a. Environmental assessment of cod (*Gadus morhua*) from autoline fisheries. *Int. J. Life Cycle Ass.*, 16(7), 611-624.
- Svanes, E., Vold, M., Hanssen, O. J., 2011b. Effect of different allocation methods on LCA results of products from wild-caught fish and on the use of such results. *Int. J. Life Cycle Ass.*, 16(6), 512-521.
- Swarr, T. E., Hunkeler, D., Klöpffer, W., Pesonen, H.-L., Ciroth, A., Brent, A. C., Pagan, R., 2011. Environmental life-cycle costing: a code of practice. *Int. J. Life Cycle Ass.*, 16(5), 389-391.
- Tam, J., Taylor, M. H., Blaskovic, V., Espinoza, P., Michael Ballón, R., Díaz, E., Wosnitza-Mendo, C., et al., 2008. Trophic modeling of the Northern Humboldt Current Ecosystem, Part I: Comparing trophic linkages under La Niña and El Niño conditions. *Prog. Oceanogr.*, 79(2-4), 352-365.
- Thomassen, M. A, Dalgaard, R., Heijungs, R., Boer, I., 2008. Attributional and consequential LCA of milk production. *Int. J. Life Cycle Ass.*, 13(4), 339-349.
- Thrane, M., 2004a. Environmental impacts from Danish fish products – Hot spots and environmental policies. PhD Dissertation. Aalborg University, Denmark.
- Thrane, M., 2004b. Energy consumption in the Danish fishery: identification of key factors. *J. Ind. Ecol.* 8(1), 223-239.
- Thrane, M., 2006. LCA of Danish Fish Products. New methods and insights. *Int. J. Life Cycle Ass.*, 11(1), 66-74.
- Tyedmers, P., 2001. Energy consumed by North Atlantic fisheries. Fisheries impacts on North Atlantic ecosystems: Catch, effort, and national/regional data sets, 9, 12-34.
- Valdivia, S., Ugaya, C., Sonnemann, G., & Hildenbrand, J. (Eds.). 2011. Towards a Life Cycle Sustainability Assessment: Making informed choices on products. UNEP/SETAC Life Cycle Initiative.
- van Oers, L., De Koning, A., Guinée, J. B., & Huppes, G., 2002. Abiotic resource depletion in LCA. Road and

- Hydraulic Engineering Institute. Retrieved from [http://www.universiteitleiden.nl/cml/ssp/projects/lca2/report\\_abiotic\\_depletion\\_web.pdf](http://www.universiteitleiden.nl/cml/ssp/projects/lca2/report_abiotic_depletion_web.pdf)
- Vázquez-Rowe, I., Hospido, A., Moreira, M. T., & Feijoo, G., 2012c. Best practices in life cycle assessment implementation in fisheries. Improving and broadening environmental assessment for seafood production systems. *Trends Food Sci. Tech.*, 28(2), 116-131.
- Vázquez-Rowe, I., Iribarren, D., Moreira, M. T., Feijoo, G., 2010a. Combined application of life cycle assessment and data envelopment analysis as a methodological approach for the assessment of fisheries. *Int. J. Life Cycle Ass.*, 15(3), 272-283.
- Vázquez-Rowe, I., Moreira, M. T., Feijoo, G., 2010b. Life cycle assessment of horse mackerel fisheries in Galicia (NW Spain). Comparative analysis of two major fishing methods. *Fish. Res.*, 106(3), 517-527.
- Vázquez-Rowe, I., Moreira, M. T., Feijoo, G., 2011. Life Cycle Assessment of fresh hake fillets captured by the Galician fleet in the Northern Stock. *Fish. Res.*, 110(1), 128-135.
- Vázquez-Rowe, I., Moreira, M. T., Feijoo, G., 2012a. Environmental assessment of frozen common octopus (*Octopus vulgaris*) captured by Spanish fishing vessels in the Mauritanian EEZ. *Mar. Policy*, 36(1), 180-188.
- Vázquez-Rowe, I., Moreira, M. T., Feijoo, G., 2012b. Inclusion of discard assessment indicators in fisheries life cycle assessment studies. Expanding the use of fishery-specific impact categories. *Int. J. Life Cycle Ass.*, 17(5), 535-549.
- Vázquez-Rowe, I., Tyedmers, P. 2012. Identifying the importance of the “skipper effect” within sources of measured inefficiency in fisheries through data envelopment analysis (DEA). *Mar. Pol.*, (in press doi: 10.1016/j.marpol.2012.06.018).
- VDI. 1997. Cumulative Energy Demand - Terms, Definitions, Methods of Calculation. In: VDI-Richtlinien 4600. Verein Deutscher Ingenieure, Düsseldorf.
- Weidema, B. P. 2000. Avoiding co-product allocation in Life-Cycle Assessment. *J. Ind. Ecol.*, 4(3), 11-33.
- Weidema, B. P. 2003. Market information in life cycle assessment. Danish Environmental Protection Agency. Environmental Project.
- Weidema, B. P., Schmidt, J. H. 2010. Avoiding Allocation in Life Cycle Assessment Revisited. *J. Ind. Ecol.*, 14(2), 192-195.
- Wenzel, H, Hauschild, M, Alting, L. 1997. Environmental Assessment of Products, Vol. 1: Methodology, tools and case studies in product development. Chapman & Hall, London
- Yebra, D. M., Kiil, S., Dam-Johansen, K. 2004. Antifouling technology—past, present and future steps towards efficient and environmentally friendly antifouling coatings. *Prog. Org. Coat.*, 50(2), 75-104.
- Zamagni, A., Guinée, J., Heijungs, R., Masoni, P., Raggi, A. 2012. Lights and shadows in consequential LCA. *Int. J. Life Cycle Ass.*, 17(7), 904-918.
- Ziegler, F., Hansson, P.-A., 2003. Emissions from fuel combustion in Swedish cod fishery. *J. Clean. Prod.*, 44(4), 244.
- Ziegler, F., Eichelsheim, J.L., Emanuelsson, A., Flysjö, A., Ndiaye, V., Thrane, M., 2009. Life Cycle Assessment of southern pink shrimp products from Senegal. An environmental comparison between artisanal fisheries in the Casamance region and a trawl fishery based in Dakar. *FAO Fisheries and Aquaculture Circular No. 1044*, 29 p.
- Ziegler, F., Emanuelsson, A., Eichelsheim, J. L., Flysjö, A., Ndiaye, V., Thrane, M., 2011. Extended life cycle assessment of southern pink shrimp products originating in Senegalese artisanal and industrial fisheries for export to Europe. *J. Ind. Ecol.*, 15(4), 527-538.
- Ziegler, F., Nilsson, P., Mattsson, B., Walther, Y., 2003. Life cycle assessment of frozen cod fillets including fishery-specific environmental impacts. *Int. J. Life Cycle Ass.*, 8(1), 39-47.
- Ziegler, F., Valentinsson, D., 2008. Environmental life cycle assessment of Norway lobster (*Nephrops norvegicus*) caught along the Swedish west coast by creels and conventional trawls—LCA methodology with case study. *Int. J. Life Cycle Ass.*, 13(6), 487-497.

Supplementary Material

Table A Fuel use by targeted species aggregation vs. fish gear

| Species aggregation | Artisanal trawling |                         | Creeling/trapping |                         | Gillnetting |                         | Long lining |                         | Purse seining |                         | Trawling |                         | Total # papers | Fuel use average (kg/t) | Fuel use standard deviation |
|---------------------|--------------------|-------------------------|-------------------|-------------------------|-------------|-------------------------|-------------|-------------------------|---------------|-------------------------|----------|-------------------------|----------------|-------------------------|-----------------------------|
|                     | # Papers           | Fuel use average (kg/t) | # Papers          | Fuel use average (kg/t) | # Papers    | Fuel use average (kg/t) | # Papers    | Fuel use average (kg/t) | # Papers      | Fuel use average (kg/t) | # Papers | Fuel use average (kg/t) |                |                         |                             |
| Cephalopods         |                    |                         |                   |                         |             |                         |             |                         |               |                         | (14)     | 1,736                   | 1              |                         |                             |
|                     |                    |                         |                   |                         |             |                         |             |                         |               |                         |          | 1,736                   | 1              | 1,736                   | N/A                         |
| Codfish             |                    |                         |                   |                         | (3)         | 283                     | (16)        | 241                     |               |                         | (6)      | 470                     |                |                         |                             |
|                     |                    |                         |                   |                         |             |                         | (10)        | 300                     |               |                         | (4)      | 391                     |                |                         |                             |
|                     |                    |                         |                   |                         |             |                         |             |                         |               |                         | (3)      | 1,165                   |                |                         |                             |
|                     |                    |                         |                   |                         |             |                         |             |                         |               |                         | (2)      | 632                     |                |                         |                             |
|                     |                    |                         |                   |                         |             |                         |             |                         |               |                         | (10)     | 915                     |                |                         |                             |
|                     |                    |                         |                   |                         |             |                         |             |                         |               |                         | (1)      | 424                     |                |                         |                             |
|                     |                    |                         |                   |                         |             | 283                     |             | 270                     |               |                         |          | 666                     | 7              | 536                     | 315                         |
| Ground fish         |                    |                         |                   |                         |             |                         |             |                         |               |                         | (12)     | 2,547                   |                |                         |                             |
|                     |                    |                         |                   |                         |             |                         |             |                         |               |                         | (7)      | 489                     |                |                         |                             |
|                     |                    |                         |                   |                         |             |                         |             |                         |               |                         |          | 1,518                   | 2              | 1,518                   | 1,455                       |
| Hake                |                    |                         |                   |                         |             |                         | (12)        | 1,551                   |               |                         | (17)     | 2,104                   |                |                         |                             |
|                     |                    |                         |                   |                         |             |                         | (17)        | 1,305                   |               |                         |          |                         |                |                         |                             |
|                     |                    |                         |                   |                         |             |                         |             | 1,428                   |               |                         |          | 2,104                   | 2              | 1,653                   | 409                         |
| Lobster & crab      |                    |                         | (9)               | 1,830                   |             |                         |             |                         |               |                         | (4)      | 3,214                   |                |                         |                             |
|                     |                    |                         | (1)               | 275                     |             |                         |             |                         |               |                         | (9)      | 7,488                   |                |                         |                             |
|                     |                    |                         |                   |                         |             |                         |             |                         |               |                         | (1)      | 853                     |                |                         |                             |
|                     |                    |                         |                   | 1,052                   |             |                         |             |                         |               |                         |          | 3,852                   | 3              | 2,732                   | 2,882                       |
| Mackerel            |                    |                         |                   |                         |             |                         |             |                         | (15)          | 15                      | (12)     | 316                     |                |                         |                             |
|                     |                    |                         |                   |                         |             |                         |             |                         | (4)           | 67                      | (4)      | 83                      |                |                         |                             |
|                     |                    |                         |                   |                         |             |                         |             |                         | (18)          | 176                     | (18)     | 496                     |                |                         |                             |
|                     |                    |                         |                   |                         |             |                         |             |                         |               | 86                      |          | 298                     | 4              | 192                     | 183                         |
| Shrimps & prawns    | (8)                | 524                     |                   |                         |             |                         |             |                         |               |                         | (8)      | 2,163                   |                |                         |                             |
|                     |                    |                         |                   |                         |             |                         |             |                         |               |                         | (4)      | 449                     |                |                         |                             |
|                     |                    |                         |                   |                         |             |                         |             |                         |               |                         | (4)      | 849                     |                |                         |                             |
|                     |                    |                         |                   |                         |             |                         |             |                         |               |                         | (1)      | 764                     |                |                         |                             |
|                     |                    | 524                     |                   |                         |             |                         |             |                         |               |                         |          | 1,056                   | 3              | 950                     | 698                         |
| Small pelagic fish  |                    |                         |                   |                         |             |                         |             |                         | (6)           | 70                      | (4)      | 125                     |                |                         |                             |
|                     |                    |                         |                   |                         |             |                         |             |                         | (12)          | 175                     | (4)      | 83                      |                |                         |                             |
|                     |                    |                         |                   |                         |             |                         |             |                         | (4)           | 116                     | (11)     | 90                      |                |                         |                             |
|                     |                    |                         |                   |                         |             |                         |             |                         | (19)          | 19                      |          |                         |                |                         |                             |
|                     |                    |                         |                   |                         |             |                         |             |                         | (1)           | 52                      |          |                         |                |                         |                             |
|                     |                    |                         |                   |                         |             |                         |             |                         | (11)          | 17                      |          |                         |                |                         |                             |
|                     |                    |                         |                   |                         |             |                         |             |                         |               | 75                      |          | 99                      | 6              | 83                      | 51                          |
| Tuna                |                    |                         |                   |                         |             |                         |             |                         | (5)           | 363                     |          |                         |                |                         |                             |
|                     |                    |                         |                   |                         |             |                         |             |                         | (12)          | 313                     |          |                         |                |                         |                             |
|                     |                    |                         |                   |                         |             |                         |             |                         | (1)           | 1,448                   |          |                         |                |                         |                             |
|                     |                    |                         |                   |                         |             |                         |             |                         |               | 708                     |          |                         | 3              | 708                     | 641                         |
| # studies/average   | 1                  | 524                     | 2                 | 1,052                   | 1           | 283                     | 4           | 849                     | 9             | 290                     | 13       | 1,416                   |                |                         |                             |

Fuel consumption has been standardised to kg fuel per t of landed fish. Marine fuel density used for calculations: 0.832 kg/l. Studies reference numbers as follows: (1) Tyedmers (2001), (2) Eyjólfsdóttir et al. (2003), (3) Ziegler et al. (2003), (4) Thrane (2004a), (5) Hospido & Tyedmers (2005), (6) Ellingsen & Aanonsen (2006), (7) Thrane (2006), (8) Emanuelsson et al. (2008), (9) Ziegler & Valentinsson (2008), (10) Guttormsdóttir (2009), (11) Driscoll & Tyedmers (2010), (12) Iribarren et al. (2010), (13) Vázquez-Rowe et al. (2010a), (14) Vázquez-Rowe et al. (2012a), (15) Ramos et al. (2011), (16) Svanes et al. (2011a), (17) Vázquez-Rowe et al. (2011), (18) Vázquez-Rowe et al. (2010b), (19) Fréon et al. (in prep.).

**Table B** Fuel use by targeted species aggregation vs. ecosystem type

| Species aggregation         | Coastal pelagic |                         | Estuary  |                         | Hard shelf |                         | Hard slope |                         | Offshore pelagic |                         | Soft shell |                         | Total # papers | Fuel use average (kg/t) | Fuel use standard deviation |
|-----------------------------|-----------------|-------------------------|----------|-------------------------|------------|-------------------------|------------|-------------------------|------------------|-------------------------|------------|-------------------------|----------------|-------------------------|-----------------------------|
|                             | # Papers        | Fuel use average (kg/t) | # Papers | Fuel use average (kg/t) | # Papers   | Fuel use average (kg/t) | # Papers   | Fuel use average (kg/t) | # Papers         | Fuel use average (kg/t) | # Papers   | Fuel use average (kg/t) |                |                         |                             |
| <b>Cephalopods</b>          |                 |                         |          |                         | (14)       | 1,736                   |            |                         |                  |                         |            |                         | <b>1</b>       | <b>1,736</b>            | <b>N/A</b>                  |
|                             |                 |                         |          |                         | (6)        | 470                     |            |                         |                  |                         |            |                         |                |                         |                             |
|                             |                 |                         |          |                         | (16)       | 241                     |            |                         |                  |                         |            |                         |                |                         |                             |
|                             |                 |                         |          |                         | (4)        | 391                     |            |                         |                  |                         |            |                         |                |                         |                             |
|                             |                 |                         |          |                         | (3)        | 1,165                   |            |                         |                  |                         |            |                         |                |                         |                             |
|                             |                 |                         |          |                         | (3)        | 283                     |            |                         |                  |                         |            |                         |                |                         |                             |
|                             |                 |                         |          |                         | (2)        | 632                     |            |                         |                  |                         |            |                         |                |                         |                             |
|                             |                 |                         |          |                         | (10)       | 915                     |            |                         |                  |                         |            |                         |                |                         |                             |
|                             |                 |                         |          |                         | (10)       | 300                     |            |                         |                  |                         |            |                         |                |                         |                             |
|                             |                 |                         |          |                         | (1)        | 424                     |            |                         |                  |                         |            |                         |                |                         |                             |
| <b>Codfish</b>              |                 |                         |          |                         |            | <b>536</b>              |            |                         |                  |                         |            |                         | <b>7</b>       | <b>536</b>              | <b>315</b>                  |
|                             |                 |                         |          |                         |            |                         | (12)       | 2,547                   |                  |                         | (7)        | 489                     |                |                         |                             |
| <b>Ground fish</b>          |                 |                         |          |                         |            |                         |            | <b>2,547</b>            |                  |                         |            | <b>489</b>              | <b>2</b>       | <b>1,518</b>            | <b>1,455</b>                |
|                             |                 |                         |          |                         | (12)       | 1,551                   |            |                         |                  |                         |            |                         |                |                         |                             |
|                             |                 |                         |          |                         | (17)       | 1,305                   |            |                         |                  |                         |            |                         |                |                         |                             |
|                             |                 |                         |          |                         | (17)       | 2,104                   |            |                         |                  |                         |            |                         |                |                         |                             |
| <b>Hake</b>                 |                 |                         |          |                         |            | <b>1,653</b>            |            |                         |                  |                         |            |                         | <b>2</b>       | <b>1,653</b>            | <b>409</b>                  |
|                             |                 |                         |          |                         | (4)        | 3,214                   |            |                         |                  |                         | (1)        | 275                     |                |                         |                             |
|                             |                 |                         |          |                         | (9)        | 7,488                   |            |                         |                  |                         |            |                         |                |                         |                             |
|                             |                 |                         |          |                         | (9)        | 1,830                   |            |                         |                  |                         |            |                         |                |                         |                             |
|                             |                 |                         |          |                         | (1)        | 853                     |            |                         |                  |                         |            |                         |                |                         |                             |
| <b>Lobster &amp; crab</b>   |                 |                         |          |                         |            | <b>3,346</b>            |            |                         |                  |                         |            | <b>275</b>              | <b>3</b>       | <b>2,732</b>            | <b>2,882</b>                |
|                             | (12)            | 316                     |          |                         |            |                         |            |                         |                  |                         |            |                         |                |                         |                             |
|                             | (15)            | 15                      |          |                         |            |                         |            |                         |                  |                         |            |                         |                |                         |                             |
|                             | (4)             | 67                      |          |                         |            |                         |            |                         |                  |                         |            |                         |                |                         |                             |
|                             | (4)             | 83                      |          |                         |            |                         |            |                         |                  |                         |            |                         |                |                         |                             |
|                             | (18)            | 496                     |          |                         |            |                         |            |                         |                  |                         |            |                         |                |                         |                             |
|                             | (18)            | 176                     |          |                         |            |                         |            |                         |                  |                         |            |                         |                |                         |                             |
| <b>Mackerel</b>             |                 | <b>192</b>              |          |                         |            |                         |            |                         |                  |                         |            |                         | <b>4</b>       | <b>192</b>              | <b>183</b>                  |
|                             |                 |                         | (8)      | 524                     |            |                         |            |                         |                  |                         | (8)        | 2,163                   |                |                         |                             |
|                             |                 |                         |          |                         |            |                         |            |                         |                  |                         | (4)        | 449                     |                |                         |                             |
|                             |                 |                         |          |                         |            |                         |            |                         |                  |                         | (4)        | 849                     |                |                         |                             |
|                             |                 |                         |          |                         |            |                         |            |                         |                  |                         | (1)        | 764                     |                |                         |                             |
| <b>Shrimps &amp; prawns</b> |                 |                         |          | <b>524</b>              |            |                         |            |                         |                  |                         |            | <b>1,056</b>            | <b>3</b>       | <b>950</b>              | <b>698</b>                  |
|                             | (6)             | 70                      |          |                         |            |                         |            |                         |                  |                         |            |                         |                |                         |                             |
|                             | (12)            | 175                     |          |                         |            |                         |            |                         |                  |                         |            |                         |                |                         |                             |
|                             | (4)             | 125                     |          |                         |            |                         |            |                         |                  |                         |            |                         |                |                         |                             |
|                             | (4)             | 116                     |          |                         |            |                         |            |                         |                  |                         |            |                         |                |                         |                             |
|                             | (4)             | 83                      |          |                         |            |                         |            |                         |                  |                         |            |                         |                |                         |                             |
|                             | (19)            | 19                      |          |                         |            |                         |            |                         |                  |                         |            |                         |                |                         |                             |
|                             | (1)             | 52                      |          |                         |            |                         |            |                         |                  |                         |            |                         |                |                         |                             |
|                             | (11)            | 17                      |          |                         |            |                         |            |                         |                  |                         |            |                         |                |                         |                             |
|                             | (11)            | 90                      |          |                         |            |                         |            |                         |                  |                         |            |                         |                |                         |                             |
| <b>Small pelagic fish</b>   |                 | <b>83</b>               |          |                         |            |                         |            |                         |                  |                         |            |                         | <b>6</b>       | <b>83</b>               | <b>51</b>                   |
|                             |                 |                         |          |                         |            |                         |            |                         | (5)              | 363                     |            |                         |                |                         |                             |
|                             |                 |                         |          |                         |            |                         |            |                         | (12)             | 313                     |            |                         |                |                         |                             |
|                             |                 |                         |          |                         |            |                         |            |                         | (1)              | 1,448                   |            |                         |                |                         |                             |
| <b>Tuna</b>                 |                 |                         |          |                         |            |                         |            |                         |                  | <b>708</b>              |            |                         | <b>3</b>       | <b>708</b>              | <b>641</b>                  |
| <b># studies/average</b>    | <b>8</b>        | <b>138</b>              | <b>1</b> | <b>524</b>              | <b>11</b>  | <b>1,818</b>            | <b>1</b>   | <b>2,547</b>            | <b>3</b>         | <b>708</b>              | <b>4</b>   | <b>607</b>              |                |                         |                             |

Fuel consumption has been standardised to kg fuel per t of landed fish. Marine fuel density used for calculations: 0.832 kg/l. Studies reference numbers as follows: (1) Tyedmers (2001), (2) Eyjólfsson et al. (2003), (3) Ziegler et al. (2003), (4) Thrane (2004a), (5) Hospido & Tyedmers (2005), (6) Ellingsen & Aanonsen (2006), (7) Thrane (2006), (8) Emanuelsson et al. (2008), (9) Ziegler & Valentinsson (2008), (10) Guttormsdóttir (2009), (11) Driscoll & Tyedmers (2010), (12) Iribarren et al. (2010), (13) Vázquez-Rowe et al. (2010a), (14) Vázquez-Rowe et al. (2012a), (15) Ramos et al. (2011), (16) Svanes et al. (2011a), (17) Vázquez-Rowe et al. (2011), (18) Vázquez-Rowe et al. (2010b), (19) Fréon et al. (in prep.).

**Table C** Publications on Life Cycle Assessment applied to food systems (agriculture and seafood)

| Year | Fisheries: energy, Carbon Footprint, processing                                 | Fisheries: LCA  | Aquaculture: LCA  | Agricultural food products: LCA and Carbon Footprint  |
|------|---|---|---|---|
| 1998 |   |   |   | (Andersson et al., 1998)<br>(Cederberg, 1998)   |
| 1999 |   |   |   | (Andersson & Ohlsson, 1999)   |
| 2000 | (Tyedmers, 2000) <sup>a</sup>   |   |   | (Andersson, 2000)<br>(Cederberg & Mattsson, 2000)   |
| 2001 | (1)   |   |   | (Haas et al., 2001)   |
| 2002 | (Ziegler, 2002)   |   |   | (Berlin, 2002)<br>(Cederberg, 2002)*<br>(Eide, 2002)  |
| 2003 | (Ziegler & Hansson, 2003)   | (3)<br>(2)  | (Silvenius & Grönroos, 2003)  | (Cederberg & Stadig, 2003)<br>(De Boer, 2003)<br>(Heller & Keoleian, 2003)<br>(Hospido et al., 2003)  |
| 2004 | (4) <sup>a</sup>  |   | (Papatryphon et al., 2004)  |   |
| 2005 | (Hospido, 2005) <sup>a</sup>  | (5)   | (Mungkung, 2005) <sup>a</sup>   | (Anton, 2005)<br>(Casey & Holden, 2005)<br>(Nunez et al., 2005)<br>(Sanjuan et al., 2005)<br>(Strid Eriksson et al., 2005)  |
| 2006 | (Hospido et al., 2006)  | (6)<br>(7)  | (6)<br>(Aubin et al., 2006)<br>(Grönroos et al., 2006)<br>(Mungkung, 2006)                        | (Casey & Holden, 2006)<br>(Ramírez et al., 2006)  |
| 2007 | (Ziegler, 2007)   |   |   | (Dalgaard, 2007) <sup>a</sup><br>(Ogino et al., 2007)   |
| 2008 | (Thrane, 2008)  | (8)<br>(9)  | (Ramírez et al., 2008)a   | (Avraamides & Fatta, 2008)<br>(Dalgaard et al., 2008)<br>(Lovett et al., 2008)<br>(Nemecek, 2008a)<br>(Nemecek, 2008b)<br>(Nemecek, 2008c)<br>(Pelletier, 2008)<br>(Thomassen et al., 2008a)<br>(Thomassen et al., 2008b)   |
| 2009 | (11)<br>(Schau et al., 2009)<br>(Winther et al., 2009)<br>(Thrane et al., 2009) | (10)  | (Ayer & Tyedmers, 2009)<br>(Pelletier et al., 2009)<br>(Sun, 2009)a<br>(d'Orbcastel et al., 2009) | (Blengini & Busto, 2009)<br>(Cederberg, 2009)<br>(Coltro et al., 2009)<br>(Davis et al., 2009)<br>(Edwards-Jones et al., 2009)<br>(Lehuger et al., 2009)<br>(van der Werf et al., 2009)   |
| 2010 | (12)<br>(Fulton, 2010) <sup>a</sup>   | (13)<br>(18)  | (Iribarren et al., 2010a)<br>(Iribarren et al., 2010b)  | (Beauchemin et al., 2010)<br>(Biswas et al., 2010)<br>(Drastig et al., 2010)<br>(Knudsen et al., 2010)<br>(Ledgard, 2010)<br>(Muñoz et al., 2010)<br>(Nilsson et al., 2010)<br>(Pelletier et al., 2010a)<br>(Pelletier et al., 2010b)<br>(Peters et al., 2010)<br>(Röös et al., 2010)<br>(Rotz et al., 2010)<br>(Schmidt, 2010)   |
| 2011 | (Iribarren et al., 2011)  | (14)<br>(15)<br>(16)<br>(17)<br>(Svanes et al. 2011b) | (Phong et al., 2011)<br>(Cao et al., 2011)<br>(Henriksson et al. 2011)<br>(Bosma et al. 2011)     | (Flysjö et al., 2011)<br>(Freitas de Alvarenga et al., 2011)<br>(Williams & Wikström, 2011)<br>(Crosson et al., 2011)<br>(Lesschen et al., 2011)<br>(Hagemann et al., 2011)<br>(Browne et al., 2011)<br>(Yan et al., 2011)<br>(Chauhan et al., 2011)<br>(Bartl et al., 2011)<br>(O'Brien et al., 2011)<br>(Nemecek et al., 2011)<br>(Gerber et al., 2011)<br>(Beauchemin et al., 2011)<br>(Cerutti et al., 2011)<br>(Cooper et al., 2011)<br>(Karakaya & Özilgen, 2011)<br>(Parent & Lavallée, 2011)<br>(Freitas et al. 2011) |

<sup>a</sup> Thesis. Studies reference numbers as follows: (1) Tyedmers (2001), (2) Eyjólfssdóttir et al. (2003), (3) Ziegler et al. (2003), (4) Thrane (2004a), (5) Hospido & Tyedmers (2005), (6) Ellingsen & Aanonsen (2006), (7) Thrane (2006), (8) Emanuelsson et al. (2008), (9) Ziegler & Valentínsson (2008), (10) Guttormsdóttir (2009), (11) Driscoll & Tyedmers (2010), (12) Iribarren et al. (2010), (13) Vázquez-Rowe et al. (2010a), (14) Vázquez-Rowe et al. (2012a), (15) Ramos et al. (2011), (16) Svanes et al. (2011a), (17) Vázquez-Rowe et al. (2011), (18) Vázquez-Rowe et al. (2010b).

**Table D** Comparison of current Life Cycle Impact Assessment methods

Based on Rosenbaum et al. (2008), van Zelm et al. (2009), ILCD (2010) and Hischier et al. (2010).

| Major methods →<br>Criteria ↓                     | CML 2001<br>CML 2002   | Eco-indicator 99   | EDIP 97<br>EDIP 2003  | ReCiPe   |
|---|--|--|---|--|
| <b>Background publication</b>                     | Guinée et al. (2001a,b)<br>Guinée et al. (2002)  | Goedkoop and Spriensma (2000a,b)   | Wenzel et al. (1997)<br>Hauschild and Potting (2005)  | Goedkoop et al. (2009)   |
| <b>Origin</b>                                     | Netherlands: Centre of Environmental Science - Leiden University (CML)   | Netherlands: Pré Consultants   | Denmark: Technical University of Denmark, Danish Environmental Protection Agency<br><b>EDIP 2003 is an alternative to EDIP 97, not an update</b>  | Netherlands: National Institute for Public Health and the Environment (RIVM), Radboud University, CML, Pré Consultants, CE Delft<br><b>This method integrates CML 2002 and Eco-indicator 99</b>  |
| <b>Regional validity</b>                          | Global (except for acidification and photo-oxidant formation: Europe)  | Global for climate change, ozone depletion and resources; Europe for other categories  | EDIP 97: Global<br>EDIP 2003: Europe  | Global for climate change, ozone depletion and resources; Europe for other categories  |
| <b>Midpoint impact categories</b>                 | Acidification potential<br>Climate change<br>Eutrophication potential<br>Freshwater aquatic ecotoxicity<br>Human toxicity<br>Land use<br>Marine aquatic ecotoxicity<br>Photochemical oxidation<br>Resources<br>Stratospheric ozone depletion<br>Terrestrial ecotoxicity<br>Freshwater sediment ecotoxicity<br>Malodours air<br>Marine sediment ecotoxicity<br>Ionising radiation | Carcinogenics<br>Climate change<br>Ionising radiation<br>Ozone layer depletion<br>Respiratory effects<br>Stored carcinogenics<br>Stored ionising radiation<br>Acidification and eutrophication<br>Ecotoxicity<br>Land occupation<br>Stored ecotoxicity<br>Fossil fuels<br>Mineral extraction | Acidification<br>Ecotoxicity (acute)<br>Ecotoxicity (chronic)<br>Global warming<br>Human toxicity<br>Land filling<br>Non-renewable resources<br>Nutrient enrichment<br>Photochemical ozone formation<br>Renewable resources<br>Stratospheric ozone depletion<br>Stored ecotoxicity<br>Stored human toxicity<br>Stored nutrient enrichment | Climate change (IPCC 2007 factors)<br>Ozone depletion<br>Terrestrial acidification<br>Freshwater eutrophication<br>Marine eutrophication<br>Human toxicity<br>Photochemical oxidant formation<br>Particulate matter formation<br>Terrestrial ecotoxicity<br>Freshwater ecotoxicity<br>Marine ecotoxicity<br>Ionising radiation<br>Agricultural land occupation<br>Urban land occupation<br>Natural land transformation<br>Water depletion<br>Metal depletion<br>Fossil depletion |
| <b>Endpoint impact categories</b>                 |  | Human health<br>Ecosystem quality<br>Resources   |   | Human health<br>Ecosystem<br>Resources   |
| <b>Remarks on implementation inecoinvent v2.2</b> | Multiple characterisation methods implemented.<br>Normalisation factors not implemented.<br>Explicit handling of long-term emissions.  | Three weighting sets (cultural perspectives) included: Hierarchist, Individualist and Egalitarian.<br>Normalisation and weighting implemented for each perspective.<br>Explicit handling of long-term emissions.   | Spatially differentiated characterisation models implemented in EDIP 2003, for 40+ European regions.<br>Normalisation and weighting factors not implemented.<br>Explicit handling of long-term emissions.   | Three weighting sets (cultural perspectives) included: Hierarchist, Individualist and Egalitarian.<br>Normalisation and weighting implemented for each perspective (except for land transformation and fresh water depletion).<br>Explicit handling of long-term emissions.  |



| Single issue methods<br>Criteria ↓ → | Cumulative Energy Demand (CED)   | Ecological footprint   | IPCC 2007   | USEtox  | USES-LCA 2.0   |
|--------------------------------------|--|--|---|---|--|
| Background publication               | VDI (1997)   | Wackernagel et al. (2005); Huijbregts et al. (2006)  | Fourth Assessment Report (IPCC 2007)  | Rosenbaum et al. (2008); Hauschild et al. (2008)  | van Zelm et al. (2009)   |
| Issue                                | Energy   | Land use   | GWP   | Toxicity (3000 substances)  | Toxicity   |
| Units                                | MJ   | Ha   | t CO <sub>2</sub> eq  | Human: CTU <sub>h</sub> , increase in morbidity in the total human population per unit mass of a chemical emitted (cases per kg)<br>Other: CTU <sub>e</sub> , potentially affected fraction of species (PAF) integrated over time and volume per unit mass of a chemical emitted (PAF m <sup>3</sup> day kg <sup>-1</sup> ) | Human: DALY, life years lost or disabled by diseases, which are influenced by impacts.<br>Other: species.yr, potentially disappeared fraction of species over area per year.   |
| Definition                           | Determination of the primary energy use along the life cycle of a product.   | Determination of the sum of time integrated direct land occupation and indirect land occupation, related to nuclear energy use and to CO <sub>2</sub> emissions from fossil energy use and clinker production.               | Characterisation of different gaseous emissions according to their global warming potential and the aggregation of different emissions in the impact category climate change. | Characterisation of human and ecotoxicological impacts. USEtox is a scientific consensus model based upon a list of previous widely used toxicity models: CalTOX, IMPACT 2002, USES-LCA, BETR, EDIP, WATSON, and EcoSense.  | Characterisation of human and ecotoxicological impacts. Implemented in the ReCiPe LCIA method, but not standalone in ecoinvent.  |
| Impact categories                    | Non-renewable resources (fossil, nuclear, primary forest)<br>Renewable resources (biomass, wind, solar, geothermal, water) | Carbon dioxide, fossil Nuclear (uranium, in ground)<br>Land occupation (arable, construction site, dump site, forest, industrial area, industrial area, benthos, pasture and meadow, permanent crop, sea and ocean, unknown) | Climate change (GWP 100a, 20a, 500a)  | Human toxicity, cancer<br>Human toxicity, non-cancer<br>Ecotoxicity   | Extra features, compared to USEtox:<br>Endpoint characterization factors are calculated.<br>Seawater and terrestrial ecotoxicity are also addressed.<br>Various scenario assumptions can be tested by changing settings. |

Life Cycle Impact Assessment methods implement midpoint and endpoint indicators. Midpoint indicators refer to the environmental mechanisms used to represent potentials impacts (problems) associated to the emission or extraction of substances (e.g. climate change, ozone depletion), while endpoints refer to effective impacts (damages) occurring at the level of “areas of protection” (e.g. human health) (Bare, 2000; Finnveden et al., 2009). Midpoint indicators are considered as more certain, while endpoints are considered as more concise and thus more suitable for informing decision-making (Bare, 2000). The mechanism by which midpoints are consolidated into endpoints in the ReCiPe method, generalisable for other methods, is depicted in the following figure.

**Table E** Standards and guidelines for life cycle methods

| Life Cycle methods                  | ISO standards          | Other standards and guidelines  |
|-------------------------------------|------------------------|---|
| Carbon Footprint                    | ISO 14067 (draft)      | British Standards Institution: PAS 2050:2011 (BSI, 2011)<br>World Business Council for Sustainable Development: Greenhouse Gas Protocol guidelines (WBCSD, 2000)<br>International Panel for Climate Change: 2006 IPCC Guidelines for National Greenhouse Gas Inventories (IPCC, 2006)<br>United Nations Framework Convention on Climate Change: Clean Development Mechanism methodologies (CDM Methodologies, <a href="http://cdm.unfccc.int/methodologies/index.html">http://cdm.unfccc.int/methodologies/index.html</a> ) and tools |
| Ecological Footprint                |                        | Global Footprint Network: GFN (2009)  |
| Life Cycle Accounting and Reporting |                        | Global Reporting Initiative: Sustainability Reporting Framework (GRI, 2006)<br>United Nations Conference on Trade and Development (UNCTAD) and Intergovernmental Working Group of Experts on International Standards of Accounting and Reporting (ISAR): guidelines on corporate responsibility reporting and eco-efficiency (UNCTAD, 2004; UNCTAD/ISAR, 2006, 2008)<br>World Business Council for Sustainable Development: Corporate, value chain and life cycle accounting and reporting standard (WBCSD 2000, 2011a,b)             |
| Life Cycle Assessment               | ISO 14040<br>ISO 14044 | Guinée et al. (2001)<br>International Reference Life Cycle Data System: ILCD (2010)   |
| Life Cycle Costing                  |                        | Society of Environmental Toxicology and Chemistry (SETAC): Swarr et al. (2011)  |
| Material Flow Analysis              |                        | Brunner and Rechberger (2003)   |
| Social Life Cycle Assessment        |                        | United Nations Environment Programme/SETAC Life Cycle Initiative: UNEP/SETAC (2009)   |
| Water Footprint                     | ISO 14046 (draft)      | Water Footprint Network: Hoekstra et al. (2011)   |

## References to SM

- Bare, J. 2000. Midpoints versus endpoints: The sacrifices and benefits. *The International Journal of Life Cycle Assessment*, 3(4), 97-326.
- Brunner, P. H., & Rechberger, H. 2004. *Practical handbook of material flow analysis*. New York: Lewis, 317.
- BSi. 2011. PAS 2050:2011 Specification for the assessment of the life cycle greenhouse gas emissions of goods and services. London: British Standards Institution, Crown and Carbon Trust.
- Finnveden, G., & Moberg, Å. 2005. Environmental systems analysis tools - an overview. *Journal of Cleaner Production*, 13(12), 1165-1173.
- Finnveden, G., Hauschild, M. Z., Ekvall, T., Guinée, J., Heijungs, R., Hellweg, S., Koehler, A., et al. 2009. Recent developments in Life Cycle Assessment. *Journal of Environmental Management*, 91(1), 1-21.
- GFN. (2009). *Ecological Footprint Standards 2009*. Oakland: Global Footprint Network.
- Goedkoop, M., Heijungs, R., Huijbregts, M., Schryver, A. D., Struijs, J., & Zelm, R. V. (2009). ReCiPe 2008. A life cycle impact assessment method which comprises harmonised category indicators at the midpoint and the endpoint level. Report I: Characterisation. Ministry of Housing, Spatial Planning and Environment (VROM). Retrieved from [www.lcia-recipe.info](http://www.lcia-recipe.info)
- GRI. (2006). *Sustainability Reporting Guidelines Version 3.0*. Global Reporting Initiative.
- Guinée, J. B., Gorreé, M., Heijungs, R., Huppes, G., Kleijn, R., de Koning, A., van Oers, L., et al. 2001. Life cycle assessment. An operational guide to the ISO standards. Part 2a: Guide. Retrieved from <http://www.cml.leiden.edu/research/industrialecology/researchprojects/finished/new-dutch-lca-guide.html>
- Haberl, H., Wackernagel, M., Krausmann, F., Erb, K.-H., & Monfreda, C. (2004). Ecological footprints and human appropriation of net primary production: a comparison. *Land Use Policy*, 21(3), 279–288.
- Hischier, R., Weidema, B., Althaus, H.-jörg, Bauer, C., Doka, G., Dones, R., Frischknecht, R., et al. 2010. Implementation of Life Cycle Impact Assessment Methods. ecoinvent report No. 3. Dübendorf.
- Hoekstra, A. Y., Chapagain, A. K., Aldaya, M. M., & Mekonnen, M. M. 2011. *The Water Footprint Assessment Manual*. London: Earthscan. Water Footprint Network. Retrieved from <http://www.waterfootprint.org/downloads/TheWaterFootprintAssessmentManual.pdf>
- ILCD. 2010. *International Reference Life Cycle Data System (ILCD) Handbook: Analysing of existing Environmental Impact Assessment methodologies for use in Life Cycle Assessment*. European Commission, Joint Research Centre, Institute for Environment and Sustainability.
- IPCC. (2006). *2006 IPCC Guidelines for National Greenhouse Gas Inventories*, The Intergovernmental Panel on Climate Change (IPCC)
- Jeswani, H. K., Azapagic, A., Schepelmann, P., & Ritthoff, M. 2010. Options for broadening and deepening the LCA approaches. *Journal of Cleaner Production*, 18(2), 120-127. Elsevier Ltd.
- Ness, B., Urbel-Piirsalu, E., Anderberg, S., & Olsson, L. 2007. Categorising tools for sustainability assessment. *Ecological Economics*, 60(3), 498-508.
- Rosenbaum, R. K., Bachmann, T. M., Gold, L. S., Huijbregts, M. a. J., Jolliet, O., Juraske, R., Koehler, A., et al. 2008. USEtox—the UNEP-SETAC toxicity model: recommended characterisation factors for human toxicity and freshwater ecotoxicity in life cycle impact assessment. *The International Journal of Life Cycle Assessment*, 13(7), 532-546.
- Schepelmann, P., Ritthoff, M., Jeswani, H., Azapagic, A., & Suomalainen, K. 2009. Options for Deepened and Broadened LCA. CALCAS: Co-ordination Action for innovation in Life-Cycle Analysis for Sustainability.
- Štreimikienė, D., Girdzijauskas, S., & Stoškus, L. 2009. Sustainability Assessment Methods and Their Application to Harmonization of Policies and Sustainability Monitoring. *Environmental Research, Engineering and Management = Aplinkos tyrimai, inžinerija ir vadyba*, 48(2), 51-62.
- Swarr, T. E., Hunkeler, D., Klöpffer, W., Pesonen, H.-L., Ciroth, A., Brent, A. C., & Pagan, R. 2011. Environmental life-cycle costing: a code of practice (Editorial). *The International Journal of Life Cycle Assessment*, 16(5), 389-391.
- Tukker, A., & Jansen, B. 2006. Environmental Impacts of Products: A Detailed Review of Studies. *Journal of Industrial Ecology*, 10(3), 159–182.

- Tyedmers, P. 2000. Salmon and Sustainability: The biophysical cost of producing salmon through the commercial salmon fishery and the intensive salmon culture industry. PhD Dissertation. The University of British Columbia. Retrieved from <https://circle.ubc.ca/handle/2429/13201>
- UNCTAD. 2004. A Manual for the Preparers and Users of Eco-efficiency Indicators Version 1.1. UNCTAD/ITE/IPC/2003/7. New York and Geneva: United Nations Conference on Trade and Development.
- UNCTAD/ISAR. 2006. 2006 Review of the Reporting Status of Corporate Responsibility Indicators. TD/B/COM.2/ISAR/CRP.4. United Nations Conference on Trade and Development, Intergovernmental Working Group of Experts on International Standards of Accounting and Reporting.
- UNCTAD/ISAR. 2008. Guidance on Corporate Responsibility Indicators in Annual Reports. UNCTAD/ITE/TEB/2007/6. New York and Geneva: United Nations Conference on Trade and Development, Intergovernmental Working Group of Experts on International Standards of Accounting and Reporting.
- UNEP/SETAC. 2009. Guidelines for social life cycle assessment of products. (C. Benoit & B. Mazijn, Eds.). UNEP/SETAC Life Cycle Initiative: United Nations Environment Programme. Retrieved from <http://biblio.ugent.be/record/624820>
- van Zelm, R., Huijbregts, M. a. J., & Meent, D. 2009. USES-LCA 2.0—a global nested multi-media fate, exposure, and effects model. *The International Journal of Life Cycle Assessment*, 14(3), 282-284.
- WBCSD. 2010. The GHG Protocol for Project Accounting. World Resources Institute and World Business Council for Sustainable Development.
- WBCSD. 2011. Product Life Cycle Accounting and Reporting Standard. World Resources Institute and World Business Council for Sustainable Development.

## 2.4.2 LCA applied to aquaculture

Aquaculture is an important protein production sector worldwide, providing in 2010 up to 59.9 million tonnes of cultured fish, crustaceans, molluscs and other aquatic animals for human consumption; representing USD 119 billion in terms of economic value (SOFIA, 2012). Contrasting with capture fisheries, aquaculture has featured steady growth in the last decades, at an average 8.8% per year (SOFIA, 2010, 2012). China is the main producer, representing over 60% (by volume) and over 50% (by value) of the world's production (SOFIA, 2010, 2012). Chinese aquaculture suffered huge losses in 2010 due to natural disasters, diseases and pollution (SOFIA, 2012).

Close to 60% of aquaculture takes place in freshwater, 32.3% in seawater and 7.7% in brackish water (SOFIA, 2010), which is represented in environmental and other research literature. Aquaculture production is absolutely dominated by the *Cyprinidae* family (carps), with 20.4 million tonnes produced in 2008 (SOFIA, 2010). Nonetheless, environmental research of aquaculture has extensively focused on carnivore cultured species (such as salmon, trout and shrimp) and the issue of wild caught fish used for aquafeed production (Hasan and Halwart, 2009; Henriksson et al., 2011; Naylor et al., 2009; Parker, 2012; Tacon and Metian, 2009), because their FIFO ratio is much higher than any other cultivated species. The issue of feed is perceived to be a main constraint and critical factor in aquaculture, despite the fact over 30% of cultured fishfood is feed-less (bivalves, filter-feeding carps). Such figure represents a diminishing percentage of feed-less cultures respect to the 50% levels in 1980, illustration consumer preferences for higher trophic level species and better growing rates of artificially fed species (SOFIA, 2012).

Among the negative environmental and socio-economic impacts associated to aquaculture, especially to those operations considered as examples of unsustainable aquaculture, the following have been extensively researched, as listed in Tacon et al. (2010):

- Direct environmental impacts, such as mangrove destruction, habitat loss; and pollution and degradation of the aquatic and benthic environments. Moreover, salinisation of potable water as well as groundwater and soil contamination has been also discussed.
- Effects on wild fish populations, due to escapes and genetic interactions, parasite and disease transfer, use of non-native species and genetically modified aquatic organisms, etc.
- Use of toxic/bio-accumulative chemicals and antibiotics (e.g. PCBs, heavy metals, etc), leading to environmental and both animal and human health issues (e.g. food safety).
- Additional practices, sometimes considered as issues, include the use of low value/trash fish, fish meal, and fish oil as feed inputs; the use of wild caught seed and associated by-catch;
- Interactions with marine mammals, turtles, and birds;
- A number of socio-economic impacts such as displacement of coastal fishing and farming communities; disruption of fishfood prices, local food supplies, and food security; livelihood impacts and reduced access to community resources; social exclusion, social unrest, and conflicts; conflicts with tourism, recreational fishing, and commercial fishing.

As mentioned, the use of fish inputs to aquaculture is a hot topic in aquaculture research. Despite the fact that inclusion rates of fishmeal and fish oil have been reducing over time, total use remains stable due to increased aquaculture production (Naylor et al., 2009) and to the use of alternative protein sources (Welch et al., 2010). Some authors predict a decline in the use of fishmeal and fish oil by

aquaculture, also due to the availability of agricultural protein sources increasingly used as substitutes and to increasing prices of fish-derived feed ingredients (Nordahl, 2011; Tacon and Metian, 2008; Tacon et al., 2011). Moreover, since a large proportion of aquaculture production worldwide is of non-carnivorous species (e.g. carps and other cyprinids), it has been argued that future sustainability of the sector is more related to the steady supply of agricultural inputs rather than to forage fish inputs (Tacon et al., 2011).

The use of agricultural protein sources as substitutes for forage fish inputs has been widely discussed (Bosma et al., 2011; Boissy et al., 2011; Naylor et al., 2009; Papatryphon et al., 2004; etc). Some studies show that in general terms the provision of crop-derived ingredients produce less associated environmental impacts (lower resource and emission intensity) than fish and livestock-derived ingredients, with notable exceptions such as soy cultivated in the Amazonia, canola oil and wheat gluten meal (Pelletier et al., 2009). Moreover, the nutritional (Hardy, 2006; Glencross et al., 2007) and economic challenges (Kristófersson and Anderson, 2004; Drakeford and Pascoe, 2010; Rana et al., 2009) of substituting fishmeal by, for instance, soybean meal; have been extensively discussed. Furthermore, it has been suggested that a) aquaculture is a net producer of fish, given that conversion efficiencies are greater in cultured environments than in the wild (without considering other protein inputs to aquafeeds); b) fishmeal and fish oil consumption are associated to carnivore cultured fish, which do not represent the bulk of aquaculture growth; and c) fishmeal demand could be met by better use of by-catch (Natale et al, 2012; Tidwell and Allan, 2001).

LCA is widely applied in aquaculture environmental research. Issues such as impact allocation among co-products, fishfood-specific impact categories, the use of market information, etc; have been extensively discussed (e.g. Ayer et al., 2007; Ford et al., 2012; Pelletier et al., 2007; Pelletier and Tyedmers, 2011). A number of reviews of LCA applied to aquaculture and aquafeed systems has been published, including Henriksson et al. (2011) and Parker (2012), who reviewed a large number of sources (including papers, theses and reports) and extracted a number of conclusions regarding the LCA practice and its challenges when applied to aquaculture and fishfood environmental research:

- Published research tends to be Europe-centric, and focus on salmonids (Atlantic salmon and Rainbow trout).
- Most studies have been executed and communicated in the academic world.
- Most studies have focused on a reduced set of impact categories, as shown in Table 7. Biotic resource use, whose use was pioneered by Papatryphon et al. (2004), is increasingly included as a key impact category.

**Table 7: Impact categories most commonly used in aquaculture LCA studies**

Adapted from Parker (2012).

| Impact category           | Typical reference species | Aquaculture (cases) | Feed (cases) |
|---------------------------|---------------------------|---------------------|--------------|
| Global warming potential  | CO2-e                     | 45                  | 16           |
| Acidification potential   | SO2-e                     | 40                  | 16           |
| Eutrophication potential  | PO4-e                     | 42                  | 16           |
| Cumulative energy demand  | CFC-11-e                  | 31                  | 14           |
| Biotic resource use       | C NPP                     | 23                  | 14           |
| Abiotic resource use      | Sb-e                      | 14                  | 2            |
| Ozone depletion potential | CFC-11-e                  | 8                   | 4            |
| Marine toxicity           | 1,4-DB-e                  | 10                  | 6            |

|   |                                  |    |   |
|---|----------------------------------|----|---|
| Photochemical oxidation potential   | H <sub>2</sub> C <sub>4</sub> -e | 8  | 2 |
| Human toxicity  | 1,4-DB-e                         | 13 | 2 |
| From a total of 20 aquaculture studies (representing 46 study cases) and 7 feed studies (representing 22 cases) |                                  |    |   |

- Most studies have applied midpoint indicators (usually included in the LCIA method CML) in an attributional LCA approach.
- Most studies applied economic and energy-based allocation.
- The studied system often included farm operations and feed provision. Feed provision commonly contributed with over 80% of overall impacts (especially GHG due to fuel consumption).
- Various studies analysed the impacts associated to alternative feed formulations.
- Various studies identified or addressed the relation between feed conversion ratio and GHG emissions.
- It is accepted that the environmental performance of aquafeeds including fishmeal and fish oil is conditioned by the fuel intensity of associated reduction fisheries.
- Many studies did not feature a complete set of sensitivity analyses, as mandated by the ISO standard.

# Chapter 3

---

Introduction of the proposed framework for sustainability assessment of fishfood supply chains, centring the discussion on the three predefined keystones: characterisation and modelling of supply chains, sustainability assessment and comparison towards management recommendations, and simulation of alternative scenarios towards policy recommendations.

- Paper 7a: Coupled ecosystem/supply chain modelling from sea to plate, Part 1: background and framework
- 

## **3 Proposed framework: sustainability performance of fishfood supply chains**

A framework is proposed for assessing sustainability performance of fishfood systems (supply chains), at a high level of aggregation, i.e. not considering individual organisations and firms, but sectors.

The proposed assessment approach encompasses three main phases:

- 1) Characterisation and modelling of the biophysical and socio-economic flows associated to the fishfood systems under study.
- 2) Definition and calculation of a set of sustainability indicators (spanning energy, nutrition, ecological, environmental, social and economic aspects).
- 3) Comparison of sustainability of supply chains. Definition and simulation of alternative policy- and bio-economic modelling-based exploitation scenarios and fates of anchoveta.

Phases 1) and 2) are to a certain extent concurrent, due to the fact that the selection of desired sustainability indicators determines to a large extent the direction and complexity of the characterisation endeavour (data collection and processing).

The framework is imbued by a number of philosophical and practical contributions from eco-efficiency, material flow management, sustainable consumption and production, and sustainable development, among others.

Since the main goal of the characterisation stage is to inform sustainability assessment of complex anthropogenic systems featuring direct interactions with ecosystems, such characterisation must encompass both biophysical and socio-economic flows. The study of biophysical flows illustrates ecosystem/industry interactions and provides data on flows and stocks of materials and energy occurring along the supply chain, including their effects on the environment; while the analysis of socio-economic flows offers insights on the social and economic dynamics occurring in parallel to the material ones. By understanding the system from at least those three perspectives, sustainability can be evaluated.

An approach for graphical modelling of both biophysical and socio-economic flows, commonly used for various industrial systems, was applied for the first time to fishfood systems. It combines and depicts existing models into a comprehensive Petri net representation.

The proposed framework is illustrated in **Paper 7b: Coupled ecosystem/supply chain modelling from sea to plate, Part 2: the Peruvian anchoveta case** (section 4.3.2).

### 3.1 Characterisation and modelling

This framework proposes an integrated ecosystem/supply chain model by coupling existing models and frameworks towards a holistic depiction of the ecosystem/seafood system interactions, flows and stocks of materials and energy occurring over the supply chain (from ecosystem to final consumer), and selected socio-economic elements. It follows previous endeavours (Khan, 2009; Christensen et al., 2011; Christensen et al., 2013) in the selection of EwE as a suitable ecosystem/bio-economic modelling platform (see **Appendix A: The EwE modelling approach**), apt to be coupled with mass/socio-economic models. Nonetheless, the framework differs in the supply chain modelling approach by deemphasising economic flows and highlighting flows associated to the set of sustainability indicators selected to better describe sustainability performance of the coupled system, with emphasis on environmental performance. The proposed one-way coupled ecosystem/supply chain model is thus normative in nature, because it aims to inform decision-making (Shapiro, 2000). Two-way coupling between models was not possible due to time and resource constraints.

Another reason for the selection of EwE as the type of (whole) ecosystem model to be used was availability of existing EwE models of the Northern Humboldt Current System, the ecosystem exploited by the Peruvian fisheries. Marine bio-economic models of the Peruvian fisheries were not used directly, but only to obtain parameters such as Maximum Sustainable Yield for computing certain indicators (see section 3.2).

Umberto<sup>15</sup>, a modelling tool specifically designed to study material flow networks, is proposed for implementing the coupled model. Umberto represents material flow networks (MFN) as Petri nets; that is to say, in terms of transitions (transformational processes), places (placeholders for materials and energy) and arrows (flows) (see **Appendix B: The Umberto modelling approach**).

The bio-physical accounting framework to be used is the LCA framework, because of its maturity and the fact that current LCIA methods encompass a great diversity of environmental impact categories (as opposite to simpler single-impact footprints). Socio-economic accounting should ideally be carried out by means of a combination of life cycle methods and economic analysis frameworks, such as LCC, SLCA and cost-benefit analysis. Nonetheless, due to time and resource constraints (including the current state of methodological development of other life cycle methods), a number of socio-economic top-bottom and bottom-up indicators for the fishfood industry have been selected following literature (e.g. Kruse et al. (2008)), and based on personal communications with Peruvian stakeholders and experts in the anchoveta industries.

---

<sup>15</sup> Umberto (<http://www.umberto.de/en/>) was created and is maintained, since the early 1990s, by the Institute for Environmental Informatics Hamburg (ifu, <http://www.ifu.com/en/>) in collaboration with the Institute for Energy and Environmental Research Heidelberg (ifeu, <http://www.ifeu.de/english/index.php?seite=startseite>). Ifu Hamburg is a software development and consulting company specialised in material flow accounting and industrial ecology solutions.



A number of LCA studies are required to characterise environmental impacts and resource consumption (including energy use) of the constituencies of fishfood supply chains, namely, fisheries, processing, reduction, aquaculture, distribution and consumption. Energy analysis, performed in and outside the context of LCA, is required given the energy-intensive nature of studied systems. Industrial energy use and industrial:nutritional energy ratios were considered sufficient for system comparison, while other energy analyses such as exergy- and emergy-based were not preferred due to time and data constraints.

The LCA platform SimaPro<sup>16</sup>, by PRé Consultants, which features Ecoinvent integration and a large variety of LCIA methods; is suggested for carrying out the LCAs, yet any other commercial or scientific LCA modelling environment would be suitable provided that the required commonly used methods and databases are available. LCA results (including additional and fishfood-specific impact categories and other LCI-based indicators), EwE outputs and socio-economic performance indicators then become inputs to the MFN modelling environment (Umberto), whose outputs include mass and energy balances.

Various LCIA methods were available and deemed suitable for the characterisation phase. They are detailed and compared in **Appendix C: A comparison of current Life Cycle Impact Assessment methods**.

As mentioned, various LCA studies need to be carried out targeting specific constituencies of the supply chain under study, including: fisheries, reduction for indirect human consumption, processing for direct human consumption, production of aquafeeds, aquaculture, distribution and consumption. The products of fish reduction industries (fishmeal, fish oil) also contribute to important agricultural supply chains, but following those ramifications exceeds the intended scope of the framework. These LCA studies are by definition nested, that is to say, whole LCAs become constituencies on other LCAs, as depicted in Figure 6.

Sensitivity and uncertainty analyses need to be carried out for the coupled model. A number of uncertainty and sensitivity issues arise from methodologies (e.g. the trophic model, LCA), from data (inventories, pedigrees) and from the coupling approach (feedbacks, back-loops). Those issues are discussed in **Chapter 5**.

Regarding socio-economic impacts, various key indicators were selected following Kruse et al. (2008) and topics discussed in de la Puente et al. (2011) and Paredes and Gutiérrez (2008), among others (see next section). Production costs, employment (direct, indirect), value added and gross profit, all associated to producing one functional unit, were found to be relevant and computable given available data. Regarding the nutritional dimension of products from the supply chain, nutritional profiles were calculated following a nutritional models meta-review in Drewnowski and Fulgoni (2008).

---

<sup>16</sup> SimaPro (<http://www.pre-sustainability.com/content/simapro-lca-software>) is the most widely used LCA software.

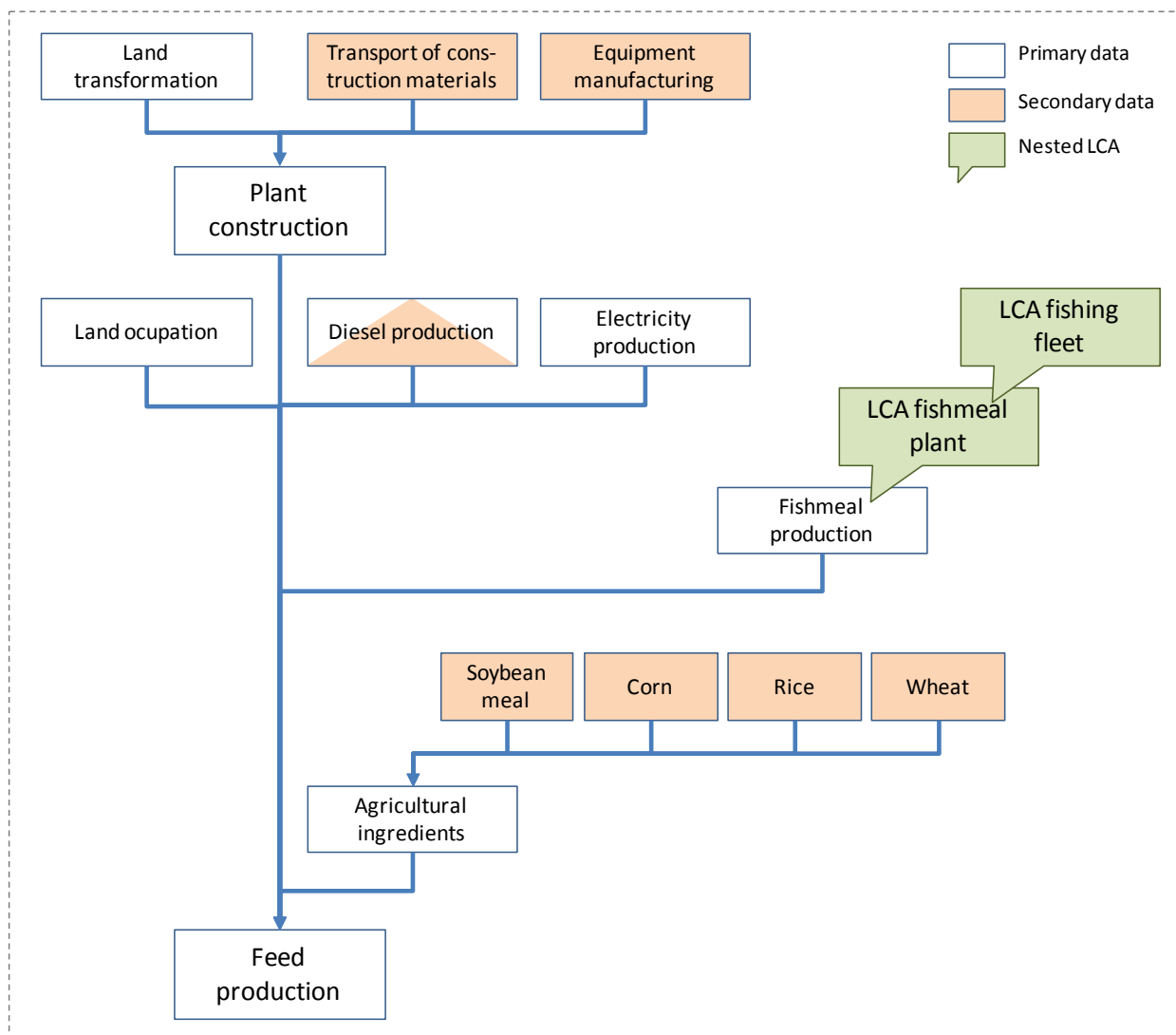


Figure 6: LCA study design for an aquafeed production plant  
Self elaboration.

## 3.2 Indicators for sustainability assessment and scenarios

### 3.2.1 Sustainability indicators

Once the target supply chains are modelled based upon detailed operational and socio-economic data collection, a set of sustainability indicators need to be calculated for performing sustainability assessment and comparison of alternative supply chains (e.g. a direct vs. an indirect human consumption chain based upon the same fishery). Moreover, following Dahl (2012), the use of sustainability indicators is combined with simulation of the studied system's dynamics, and the exploration of alternative scenarios (e.g. altering the ratio of lower vs. higher trophic level species captured, or simulating the effects of a fishing policy change).

A number of sustainability indicators were selected from the large indicators pool available in literature, in such a way that all aspects of sustainability (emphasising the environmental dimension) are addressed (Table 8). Main criteria for such selection were historical use in the fishfood research field; purpose, mainly environmental aspects plus key socio-economic aspects; practicability, given data availability; and comparability with other food systems. Furthermore, all indicators chosen are scientifically-backed, and thus under the "knowledge creation" conceptual framework of indicators theory.

**Table 8: Overview of proposed sustainability indicators**

Self elaboration.

| Sustainability dimension | Indicator (unit)   | Reference publications                                   |
|--------------------------|--|--|
| Ecological               | $I_{BNR,sp}$ (years), $I_{BNR,eco}$ (years)                                      | Langlois et al. (2014)                                   |
|                          | $TL_{land}$ , Proportion of predatory fish (%), Inverse fishing pressure (ratio) | Shin et al. (2010)                                       |
| Environmental            | BRU (g C/kg)   | Pauly and Christensen (1995)                             |
|                          | BRU-based discard assessment   | Hornborg (2012)<br>Hornborg et al. (2012b, a)            |
|                          | LCA/ReCiPe (Pt)  | Goedkoop et al.(2009)                                    |
|                          | LCA/CED (MJ)   | Hischier et al. (2010)                                   |
|                          | LCA/CML[USES-LCA] (kg 1,4-DB eq)   | Guinée et al. (2002)<br>van Zelm et al. (2009)           |
| Nutritional              | LCA/USEtox (CTU)   | Rosenbaum et al. (2008)                                  |
|                          | GEC (MJ/kg)  | Tyedmers (2000)  |
| Energy efficiency        | Nutritional profile  | Drewnowski and Fulgoni (2008)                            |
|                          | Gross edible EROI (%), Edible protein EROI (%)                                   | Tyedmers (2000)<br>Tyedmers et al. (2005)<br>Hall (2011) |
| Socio-economic           | Production costs (USD), Employment (USD), Value added (USD)                      | Kruse et al. (2008)                                      |
|                          | Gross profit generation (USD)  |  |

Abbreviations: BRU: Biotic Resource Use, CED: Cumulative Energy Demand, CTU: comparative toxic units, EROI: Energy Return On Investment, GEC: Gross Energy Content,  $I_{BNR,sp}$ : impacts on Biotic Natural Resources at the species level,  $I_{BNR,eco}$ : impacts on Biotic Natural Resources at the ecosystem level, LCA: Life Cycle Assessment, LCIA: Life Cycle Impact Assessment,  $TL_{land}$ : Trophic level of landings.

Different indicators are intended to compare various aspects of supply chains/scenarios, at different levels. For instance, some indicators are applied to compare specific constituencies of supply chains (e.g. aquafeed ingredients and formulations, fishfood products) while others apply to whole chains and scenarios. Sustainability and analysis dimensions addressed by selected indicators are: ecological (ecosystem), environmental (including energy use, resource use and toxicity-related effects), human nutrition and energy efficiency, and socio-economic aspects.

The proposed indicator set is explained in detail and illustrated in the Method section of **Paper 6: A set of sustainability performance indicators for seafood: direct human consumption products from Peruvian anchoveta fisheries and freshwater aquaculture** (section 4.3.1).

### 3.2.2 Paper 7a: Coupled ecosystem/supply chain modelling from sea to plate, Part 1: background and framework

Manuscript proposing a framework for comparing the sustainability performance of fisheries-based supply chains and potential policy-based scenarios. To be published, fused with Paper 7b, in PlosOne (Avadí et al., 2014d).

|  |                                      |
|--|--------------------------------------|
| Paper idea and design                            | Angel Avadí, Pierre Fréon            |
| Experiment design                                | N/A                                  |
| Data collection                                  | Angel Avadí, Pierre Fréon            |
| Data processing, statistical analysis, modelling | N/A                                  |
| Discussion                                       | Angel Avadí, Pierre Fréon, Jorge Tam |
| Writing and editorial                            | Angel Avadí, Pierre Fréon            |

### Coupled ecosystem/supply chain modelling from sea to plate, Part 1: background and framework

Angel Avadí <sup>a,b,\*</sup>, Pierre Fréon <sup>b</sup>, Jorge Tam <sup>c</sup>

<sup>a</sup> Université Montpellier 2 – Sciences et Techniques, 2 Place Eugène Bataillon, 34095 Montpellier Cedex 5, France.

<sup>b</sup> UMR 212 EME, Institut de recherche pour le développement (IRD). Centre de Recherche Halieutique Méditerranéenne et Tropicale, Avenue Jean Monnet CS 30171, 34203 SETE cedex. France.

<sup>c</sup> Laboratorio de Modelado Oceanográfico, Ecosistémico y de Cambio Climático (LMOECC), Instituto del Mar del Perú (IMARPE), Apdo. 22, Callao, Lima, Perú.

\* Corresponding author

#### Abstract

The sustainability assessment of food supply chains is relevant towards global sustainable development. A framework is proposed towards analysing fishfood supply chains with local or international scopes. It combines a material flow model (including an ecosystem dimension) of the supply chains, the calculation of a number of sustainability indicators (environmental, socio-economic, nutritional), and finally a multi-criteria comparison of alternative supply chains (e.g. fates of landed fish) and future exploitation scenarios. The first part of this work (this paper) reviews the ecosystem and supply chain modelling background and specifics of the proposed methodology. The second part (Avadí et al., 2014; this volume) illustrates the framework with a relevant case study.

Keywords: Fish exploitation scenarios; Life Cycle Assessment; material flow modelling; supply chain modelling; sustainability indicators; trophic modelling

## 1 Introduction

The principle of sustainable development received global recognition at the 1992 Earth Summit, in Río de Janeiro. In June 2012 progress in global

sustainability was reviewed in the RIO+20 conference, whose final document, The Future we Want, calls for a new framework for action, in order to implement sustainable development (UN,

2012). Sustainability in food systems features several dimensions of concern, including the environmental (Ingram et al., 2010; Power, 1999), socio-economic aspects and food security (Nellemann et al., 2009; SOFA, 2011), consumption patterns (Tukker et al., 2011), technology (Spiertz, 2010), information (Wognum et al., 2011) and governance/policy (McMichael, 2011). Moreover, sustainability arises from the complex interrelation amongst these factors, and thus science should focus on the most significant cause-and-effect relationships and driving forces that shape those interrelations, as to inform and provide tools for management and policy (Dahl, 2012).

A recent journal editorial stressed the growing challenges of sustainability in food systems, given the increasing demand for food (due to increasing population and rising affluence) and the environmental impacts associated to modern food production (Food Policy, 2011). The editorial refers to the relevance of trade policy and trade impacts on vulnerable communities, as well as to the need for globally-accepted metrics and policies for sustainability. Such narrative is very representative of the generalised concern of the research community for studying and advancing sustainability tools for policy and decision-making in general. Agricultural and fishfood systems feed the world. Despite the relative small size of the global fishfood economic system in comparison to agriculture, it encompasses complex socio-economic networks with considerable impact of the world's environment. Economically, fishfood products represent about 10% of total agricultural exports, value-wise, and featuring showing a growing trend. Nutritionally, fish represent over 20% of animal protein intake in low income and food-deficient countries (SOFIA, 2012; SOFIA, 2010). Therefore, it is imperative to apply sustainability principles to the design, operations and assessment of fishfood systems.

This study is developed in two papers; the first one introduces the proposed framework while the second one —Avadí et al. (2014), in this volume—

illustrates this framework by applying it to the Peruvian anchoveta supply chains. The second companion paper moreover describes the historical and current situation of the Peruvian anchoveta industries and discusses future exploitation strategies.

## **2 Background: ecosystem and supply chain modelling of fishfood systems**

“Fishfood system” is an umbrella term for complex fishfood-producing anthropogenic systems featuring important interaction with their surrounding aquatic and terrestrial ecosystems. Resource management science and research have produced a variety of approaches for capturing the interactions between the natural and the socio-economic realms occurring under such systems.

An essential feature of all approaches to understanding complex systems is modelling (Schlüter et al., 2012). Models are abstractions/simplifications/generalisations of real world systems, used to reduce complexity and present only the subsystems of research interest (Wahlström, 1994). Models thus incorporate enough data as to reproduce observed patterns on a particular scale, and rather than including the largest possible amount of detail, focus on the main/minimum detail set required for not contradicting reference observations (Levin, 1992). Such ideal level/zone of complexity in modelling has also been defined as the level of resolution under which both essential real-world dynamics are not neglected and analysis is not too burdensome (Grimm et al., 2005).

Various types of models linking the natural and socio-economic systems can be clustered into the following categories: ecological/ecosystem, bio-economic and social-ecological systems (SES) modelling (Horan et al., 2011; Schlüter et al., 2012). In general terms, ecological models attempt to explain the effects of harvesting resources on the providing ecosystem (including interactions between species) while bio-economic models analyse those interactions in both

directions. The emerging cross-cutting field of SES extends bio-economic models by including non-linear behaviour and by treating links from the ecosystems as ecosystem services rather than as utility-providing resources. Such complexity is possible due to the fact that SES profit from a variety of modelling fields, and have been applied to a variety of applications: fisheries, rangeland, wildlife, bio-economics, ecological economics, resilience, and complex systems (Schlüter et al., 2012).

## 2.1 Marine ecosystem modelling

In fisheries, ecological processes such as predation, competition, environmental regime shifts, and habitat effects have the potential to impact bio-economic dynamics (recovery of exploited stocks, surplus production, etc) (Link, 2002). Such impacts may manifest themselves in an order of magnitude comparable to that exerted by fisheries pressure. Ecological/ecosystem modelling is a rich, well established research field: nonetheless, it is not always included in fisheries modelling and management (Link, 2002). Several typologies exist, but in general marine ecosystem models can be classified into the following categories (Plagányi, 2007): whole ecosystem models, dynamic multi-species models (Minimum Realistic Models, MRM), and dynamic system models—including Individual-Based Models, IBM, such as OSMOSE (Shin and Cury, 2001), as well as biogeochemical models such as ATLANTIS (Fulton et al., 2004)—. Whole ecosystem models try to account for all trophic levels in the studied ecosystem. Some of the most notable examples are ECOPATH (Christensen and Pauly, 1992) and ECOSIM (Walters et al., 1997). An additional distinction between ecosystem models lies in the presence or absence of spatialisation.

An emerging topic in marine ecosystem modelling is the concept of end-to-end ecosystem models. The end-to-end modelling framework attempts to include the effect of both climate change (through the higher trophic levels) and anthropogenic intervention in multi-trophic models (Allen and Fulton, 2010; Rose et al., 2010). Those models

arise out of the needs of ecosystem-based management, which demands models considering climate change and time and space variations, such as OSMOSE and EwE/ECOSPACE (Rose et al., 2010). A key research topic in end-to-end modelling is the type of coupling between hydrodynamic, low and high trophic levels sub-models: one-way forcing/linking/coupling or two-way coupling (Fulton, 2010; Rose et al., 2010; Travers et al., 2009). The latter allows for dynamic feedbacks related to density-dependent responses of high trophic level organisms and to interaction between biological and physical processes (Rose et al., 2010). Moreover, feedbacks add mathematical and computational complexity to the model.

Nowadays, the most commonly used whole ecosystem modelling approach (not strictly an end-to-end model) is probably Ecopath with Ecosim (EwE), a combination of ECOPATH, ECOSIM and a constantly increasing number of add-ons (Travers et al., 2007). A software implementation of EwE is freely available for evaluating ecosystem impacts of fisheries (Christensen and Walters, 2004; Pauly et al., 2000). EwE modelling is very data-intensive, especially regarding biomasses and diets, and its outputs require interpretation to be used for policy-making support; among other limitations (Christensen and Walters, 2004).

## 2.2 Supply chain modelling

The Supply Chain is a concept used since the early 1980's referring to the dynamics between firms (value chains) contributing to the provision of a good or service. It encompasses all value chains, integrated or not, along the life cycle of the delivered product (Jain et al., 2010), as well as material, information and financial flows circulating among those value chains (Kasi, 2005). The supply chain concept is the ideal approach to study today's economic organisations, immerse in a globalised world and both featuring and lacking vertical integration. Related concepts and research fields include corporate strategy, customer relationship management, knowledge management, logistics, marketing, operations

research, quality management, risk management, sourcing and supplier management, stakeholder theory, sustainability, systems theory, etc (Bjørndal et al., 2004; Lavassani and Movahedi, 2010).

Supply chain modelling (SCM) is practiced for understanding, analysing and improving efficiency, effectiveness and sustainability of supply chains. A review of applications suggests supply chain redesigning, validation and verification, sensitivity analysis, optimisation, robustness, risk and uncertainty analysis, etc; are amongst the issues addressed by supply chain modelling (Kleijnen, 2005). Various approaches to supply chain modelling have been described and several typologies proposed (Acar et al., 2010; Ahumada and Villalobos, 2009; Beamon, 1998; Kasi, 2005; Keramati, 2010; Keramati and Eldabi, 2011; Kim et al., 2004; Min and Zhou, 2002; Shapiro, 2000). Regarding the overall approach (meta-model, framework) required to guide supply chain modelling, more than one has been proposed, but the Supply Chain Operations Reference (SCOR), a descriptive type, provides a widely accepted way of depicting supply chains in a standardised fashion that allows for model comparison (Kasi, 2005; SCC, 2010). SCOR is one of the most widely used frameworks in business and research (Lavassani and Movahedi, 2010). Further guidelines have been described (Kasi, 2005; Min and Zhou, 2002), and a number of methods to assess supply chain performance have been contrasted (Aramyan, 2007).

SCM applied to food supply chains addresses issues such as food safety and risk management (Deep and Dani, 2009), redesigning the supply chain towards performance improvements (van der Vorst and Beulens, 1999), trade-offs between logistic costs and final product quality (Dabbene et al., 2008; Jensen et al., 2010), accounting and reducing food waste (Parfitt et al., 2010), etc.

Supply chain modelling theory has been extensively applied to the study of food supply chains. The goal of supply chain modelling in food systems involves cost reduction, safety and quality,

flexibility and responsiveness, among other aspects (Jensen et al., 2010).

Ahumada and Villalobos (2009) compiled an extensive list of models for activity planning developed for non-perishable agrifood supply chains, for fresh agricultural products, as well as for tackling other agricultural supply chain problems. Despite the fact that food—and especially agrifood—supply chains apply preferentially business process modelling (descriptive/normative type), simulation type modelling have also proved useful for certain situations (Ahumada and Villalobos, 2009), which also pointed out that multi-objective and multi-criteria decision-making models have been successfully applied to agricultural decision making. Moreover, food-specific modelling environments have been developed, such as the one proposed in Van der Vorst et al. (2009) aimed for integrated decision making on product quality, sustainability and logistics.

Fishfood supply chains face specific supply chain challenges, such as: quality variation between batches, given that most wild caught species are identified by batches; variation and uncertainty of catches leading to complex trading systems such as auction markets (Jensen et al., 2010); sustainability issues such as trade-offs between resource base conservation and socio-economic objectives (Bjørndal et al., 2004); traceability (Mai et al., 2010); shelf life and safety; subsidies and rights; etc.

Supply and value chain analysis, as well as modelling approaches, have been applied to fisheries, aquaculture and whole fishfood supply chains, as extensively reviewed in Bjørndal et al. (2004). Non-modelling studies have focused on reducing costs, increasing efficiency and improving product quality, as well as (more recently) in developing or re-shaping existing supply chains (Howieson and Lawley, 2010).

Ecosystem modelling, with emphasis on stock assessment, population dynamics and multiple species interactions (in fisheries), as well as fish

growth and interactions with the environment (in aquaculture); has been widely practiced. Economic modelling has focused on increased industrialisation and collective behaviour on open access situations (in fisheries) and prices dynamics (in aquaculture) (Bjørndal et al., 2004).

Operations research-oriented models span diverse objectives, depending on the system under study. In fisheries, resource allocation problems, uncertainty management, harvest policy and strategy, harvest timing, quota decisions, experimental management regimes, investment in fleet capacity, stock switching by fishermen, etc (Bjørndal et al., 2004) are studied. In aquaculture, trade-offs of alternative activities, strategic planning requirements for emerging technologies, planning and management, optimal harvesting time and other optimal control frameworks, feeding regimes, risk management, etc (Bjørndal et al., 2004). Modelling of whole fishfood supply chains is less common, thus it has been suggested future research should focus on optimal production planning, costs associated to additional sorting of raw materials (due to the batch nature of many landed species) and quality aspects (Jensen et al., 2010). Past research has focused on handling and preservation practices for extended shelf life (Howieson and Lawley, 2010).

Despite that supply chain analysis and modelling of agrifood systems is quite common, modelling of fishfood supply chains is less represented in research.

### **2.3 Coupled ecosystem/supply chain modelling**

Few efforts have been oriented to develop models combining ecosystem models and (fishfood) supply chains. The reduced number of examples of SES models applied to fisheries —as listed in Schlüter et al. (2012)— and fisheries bio-economic models —e.g. those listed in Pallezo et al. (2012) and Pallezo et al. (2009)—, showed spatial sensitivity and inclusion of fishermen/vessel behaviour and their impact on management

systems. Despite those few examples, most of the fisheries-related modelling research has historically focused on ecological (or ecosystem) modelling, that is to say, on ecosystem-fisheries interactions which do not explore socio-economic aspects.

Khan (2009) proposed combining a fish chain modelling approach with an EwE trophic model for modelling policy scenarios for stock recovery. Such approach was based on an idea later published in (Christensen et al., 2011), where a SES consisting on a combined ecosystem (using EwE trophic models) and a proprietary value chain modelling approach is proposed. The model coupling (partial two-way interactions, limited to the feedback effect of the producer on the ecosystem) proposed in Christensen et al. (2011), was eventually implemented as a plug-in for EwE 6.2. The coupled model has been recently used in a case study (Christensen et al., 2013).

We borrowed the one-way vs. two-way coupling wording from ecosystem modelling and use it to define the types of interactions between an ecosystem model and a material flow (supply chain) model.

## **3 Proposed framework**

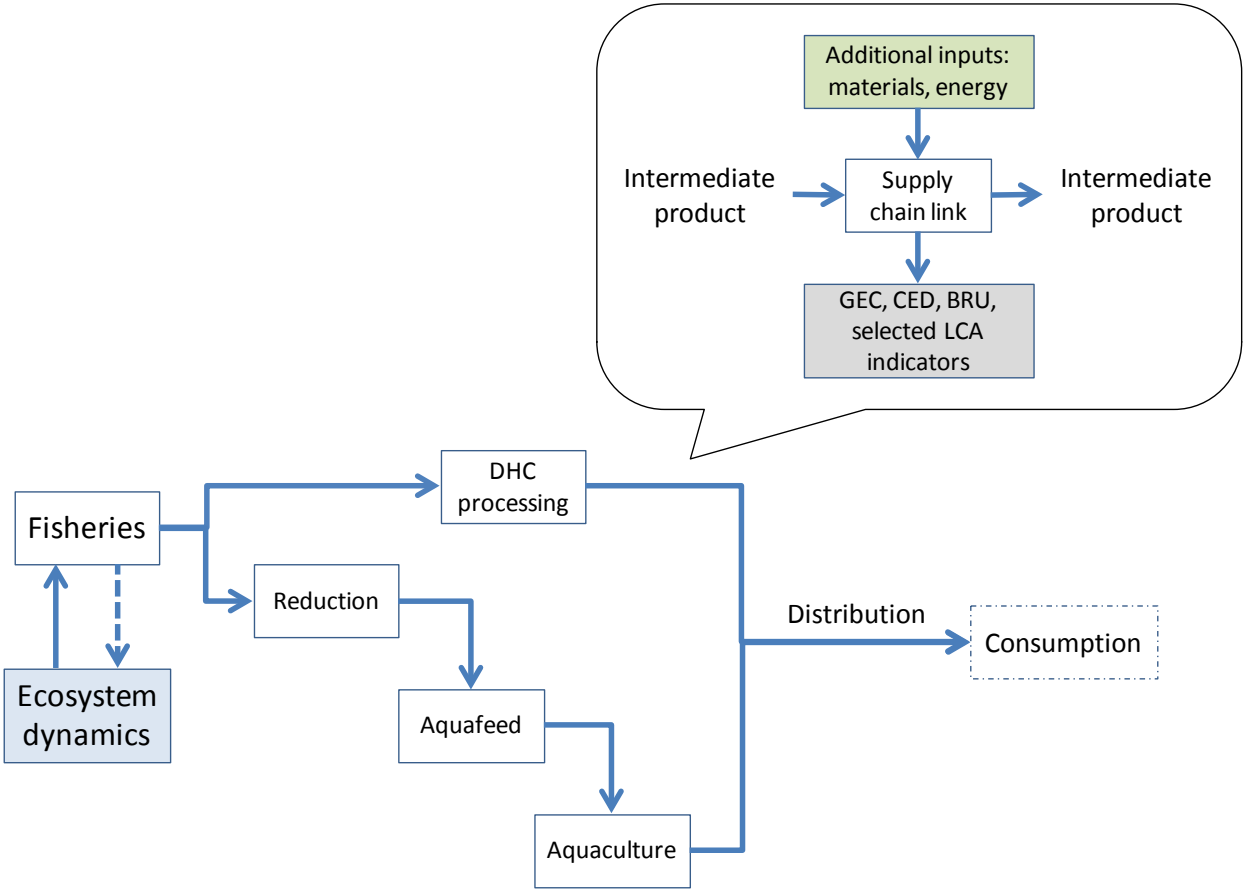
### **3.1 A one-way coupled ecosystem/supply chain model**

We propose an enlarged framework featuring an integrated ecosystem/supply chain model by combining existing models towards a holistic depiction of the ecosystem/seafood system interactions. This framework depicts flows and stocks of materials and energy occurring over the supply chain (from ecosystem to product retailing), and selected socio-economic elements, as shown in Fig. 1. The proposed framework follows previous endeavours (Christensen et al., 2013; Christensen et al., 2011; Khan, 2009) in the selection of EwE as a suitable ecosystem modelling platform, apt to be coupled in a one-way or two-way manner with mass/socio-economic models. The frameworks differ in the



supply chain modelling approach by deemphasising economic flows and highlighting flows associated to the set of sustainability indicators selected to better describe sustainability performance of the system, with emphasis on the environmental dimension (we consider the proposed coupled model as an example of “ecosystem-based supply chain

modelling”). Moreover, the goals of both approaches differ as well: the value chain analysis in Christensen et al. (2011) accounts for the socio-economic benefits of fisheries and subsequent links in the value chain, while our analysis compares the relative sustainability performance of competing fisheries-based supply chains.



**Fig. 1** Simplified ecosystem/supply chain one-way coupled model (the zoom view exemplifies how industrial processes and subprocesses are detailed within the supply chain; the environmental and socio-economic impacts of a given link of the supply chain are carried on to the next link)

In our framework, the monetary flows are analysed at the industrial segment level rather than at the value chain level, that is to say, no individual economic agents are modelled, but whole production sectors (e.g. fisheries, reduction industry, species-specific aquaculture sector, etc).

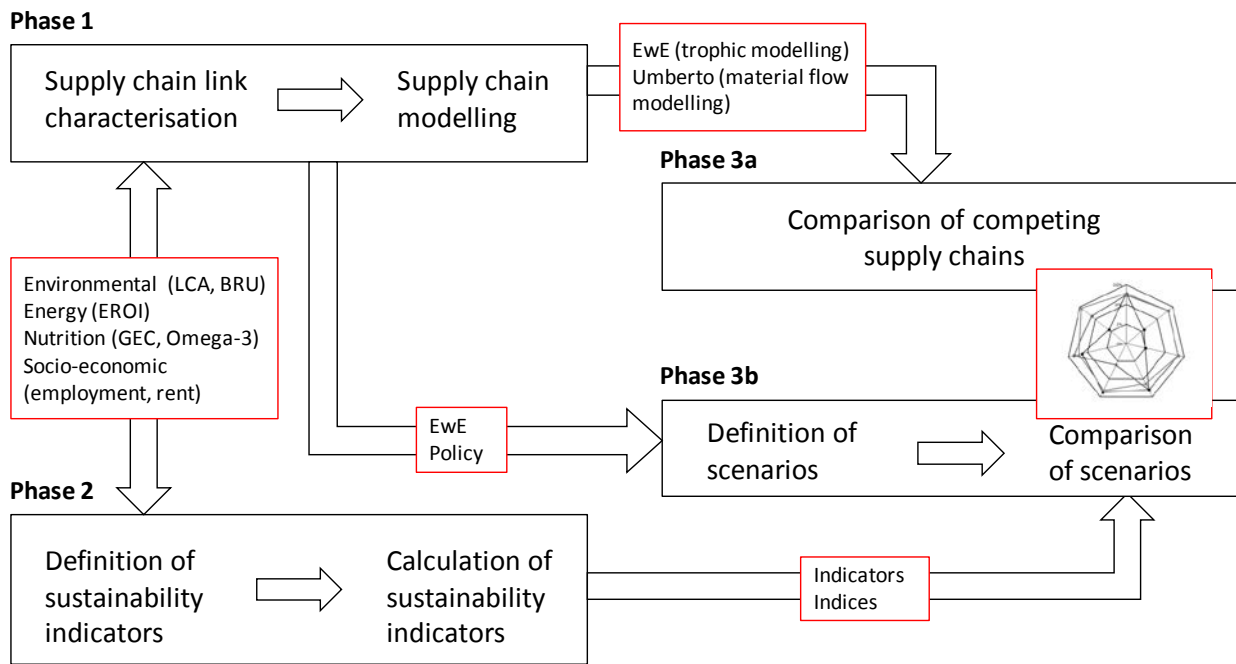
An EwE trophic model of the marine ecosystem exploited by the modelled supply chain can be used as the base ecosystem model. The outputs of the EwE model would feed a material and energy flow model, which could be built for instance with

Umberto, a modelling tool specifically designed to study material flow networks (IFU, 2005). Umberto represents material flow networks (MFN) as Petri nets; that is to say, in terms of transitions (transformational processes), places (placeholders for materials and energy) and arrows (flows). This is the selection of modelling tools/approaches that we retained, but is fortuitous: essentially any combination of combinable models associating a whole ecosystem model and a material flow model would be suitable, especially if the coupling could

be established in a dynamic fashion. Our one-way coupling is offline, that is to say, feedbacks between the models are resolved separately on each modelling environment, and hence the interlinking is not dynamic.

The proposed framework encompasses three main phases, as schematised in Fig. 2: 1) characterisation and modelling of the fishfood system under study, 2) definition and calculation

of sustainability indicators 3a) comparison of competing supply chains, and 3b) definition and comparison of alternative policy-scenarios for the greater supply chain. Phases 1 and 2 are to a certain extent concurrent, due to the fact that the selection of desired sustainability indicators determines to a large extent the direction and complexity of the characterisation endeavour (data collection and processing).



**Fig. 2** Scheme of the proposed sustainability assessment framework for seafood supply chains

In Phase 1, target supply chains, both short (DHC products) and long (reduction and aquaculture) are modelled in terms of material and energy flows, nutritional, energy and monetary flows. In Phase 2, a set of suitable sustainability indicators is compiled as a means to compare the performance of supply chains modelled in Phase 1, as detailed and illustrated for a subset of anchoveta supply chain-derived products in Avadí and Fréon (2014). In Phase 3, defined supply chains are compared and policy-based scenarios for future exploitation and production are defined and contrasted.

Since the main goal of the characterisation stage is to inform sustainability assessment of complex anthropogenic systems featuring direct interactions with ecosystems, such

characterisation must encompass both biophysical and socio-economic flows. The study of biophysical flows illustrates ecosystem/industry interactions and provides data on flows and stocks of materials and energy occurring along the supply chain, including their effects on the environment; while the analysis of socio-economic flows offers insights on the social and economic dynamics occurring in parallel to the material ones. By understanding the system from at least those three perspectives, sustainability can be evaluated.

### 3.2 Supply chain characterisation and modelling

The biophysical accounting framework used for supply chain modelling was Life Cycle Assessment (LCA). LCA is a mature approach, and current Life

Cycle Impact Assessment (LCIA) methods encompass a great diversity of environmental impact categories. Socio-economic accounting would ideally be carried out by means of a combination of life cycle methods and economic analysis frameworks, such as Life Cycle Costing, Social LCA and cost-benefit analysis. Nonetheless Social LCA is not yet a mature method and it is usually very difficult to obtain all required data from the fishery and the fishfood industry to apply this approach.

A number of LCA studies were required to characterise environmental impacts and resource consumption (including energy use) of the constituencies of fish supply chains, namely fisheries, processing for direct human consumption reduction into fishmeal and fish oil, aquaculture, and distribution. LCAs were performed using the software SimaPro (PRé, 2012); which features integration with the widely used database ecoinvent (Ecoinvent, 2012) and various LCIA methods, including CML baseline 2000 (Guinée et al., 2001a; Guinée et al., 2001b; Guinée et al., 2001c), ReCiPe (Goedkoop et al., 2012), Cumulative Energy Demand (Hischier et al., 2010) and USEtox (Rosenbaum et al., 2008). LCA results associated to the anchoveta supply chains are presented in Fréon et al. (2014a,b) and Avadí et al. (2014a, b, c).

A detailed discussion of LCA impact categories and additional nutritional and energy data used to calculate other assessment indicators of fishfood performances is presented in Avadí and Fréon (2014).

LCA results (including additional and fishfood-specific impact categories and other LCI-based indicators), EwE outputs and socio-economic performance indicators become inputs to the Umberto modelling environment. Umberto outputs include mass and energy balances and flow diagrams (e.g. Sankey diagrams).

### **3.3 Definition and calculation of indicator set**

Once the target supply chains are modelled based upon detailed operational and socio-economic data collection, a set of sustainability indicators is calculated for performing sustainability assessment and comparison of alternative supply chains (e.g. a direct vs. an indirect human consumption chain based upon the same fishery). Moreover, following Dahl (2012), the use of sustainability indicators is combined with simulation of the studied system's dynamics and the exploration of alternative scenarios. For instance, the ratio of lower vs. higher trophic level species captured can be altered, or the effects of a fishing policy change simulated.

A number of sustainability indicators were selected from the large indicators pool available in literature, in such a way that all aspects of sustainability —especially the environmental dimension, but also energy efficiency, human nutrition and socio-economic factors— are addressed. Main criteria for such selection were historical use in the fishfood research field; purpose, mainly environmental aspects plus key socio-economic aspects; practicability, given data availability; and comparability with other food systems.

Table 1 depicts the indicator set, introduced and detailed in Avadí and Fréon (2014), and expanded in this study with a few IndiSeas ecological indicators (Shin et al., 2010; Shin and Shannon, 2010), for the purpose of comparing alternative states of the exploited ecosystem. The chosen indicators, “Trophic level of landings”, “Proportion of predatory fish” and “Inverse fishing pressure”, can be used to measure two different management objectives, namely maintaining of the ecosystem's structure, functioning and conservation of biodiversity and maintaining the resource potential, respectively. The indicators are calculated by equations 1, 2 and 3 (Shin et al., 2010):

$$TL_{land} = \sum_s (TL_s \cdot Y_s) / Y \quad (1)$$

where  $TL$  is the trophic level,  $Y$  is catch and  $s$  is species,

$$\begin{aligned} & \text{Proportion of predatory fish} \quad (2) \\ & = \text{Biomass of predatory fish} / \text{Biomass} \end{aligned}$$

where *Biomass* includes the biomass of demersal, pelagic and commercially relevant invertebrates, and

$$\begin{aligned} & \text{Inverse fishing pressure} \quad (3) \\ & = (\text{Landings} / \text{Biomass})^{-1} \end{aligned}$$

where *Landings* and *Biomass* refer to the retained species. For these three indicators, a larger value represents a healthier ecosystem.

**Table 1** Overview of proposed sustainability indicators, modified from Avadí and Fréon (2014)

| Sustainability dimension         | Indicator (unit)                 | Reference publications                         | Calculation  |
|----------------------------------|----------------------------------|--|--------------|
| Ecological                       | $I_{BNR,sp}$ (years)             | Langlois et al. (2014)                         | Manual       |
|                                  | $I_{BNR,eco}$ (years)            |  |              |
|                                  | $TL_{land}$                      | Shin et al. (2010)                             |              |
|                                  | Proportion of predatory fish (%) |  |              |
| Inverse fishing pressure (ratio) |                                  |  |              |
| Environmental                    | BRU (g C/kg)                     | Pauly and Christensen (1995)                   | Manual       |
|                                  | BRU-based discard assessment     | Hornborg (2012)<br>Hornborg et al. (2012b, a)  |              |
|                                  | LCA/ReCiPe (Pt)                  | Goedkoop et al. (2009)                         | LCIA methods |
|                                  | LCA/CED (MJ)                     | Hischier et al. (2010)                         |              |
|                                  | LCA/CML[USES-LCA] (kg 1,4-DB eq) | Guinée et al. (2002)<br>van Zelm et al. (2009) |              |
| LCA/USEtox (CTU)                 | Rosenbaum et al. (2008)          |  |              |
| Nutritional                      | GEC (MJ/kg)                      | Tyedmers (2000)                                | Manual       |
|                                  | Nutritional profile              | Drewnowski and Fulgoni (2008)                  |              |
| Energy efficiency                | Gross edible EROI (%)            | Tyedmers (2000)                                | Manual       |
|                                  | Edible protein EROI (%)          | Tyedmers et al. (2005)<br>Hall (2011)          |              |
| Socio-economic                   | Production costs (USD)           | Kruse et al. (2008)                            | Manual       |
|                                  | Employment (USD)                 |  |              |
|                                  | Value added (USD)                |  |              |
|                                  | Gross profit generation (USD)    |  |              |

Abbreviations: BRU: Biotic Resource Use, CED: Cumulative Energy Demand, CTU: comparative toxic units, EROI: Energy Return On Investment, GEC: Gross Energy Content,  $I_{BNR,sp}$ : impacts on Biotic Natural Resources at the species level,  $I_{BNR,eco}$ : impacts on Biotic Natural Resources at the ecosystem level, LCA: Life Cycle Assessment, LCIA: Life Cycle Impact Assessment,  $TL_{land}$ : Trophic level of landings.

### 3.4 Definition of policy-based scenarios

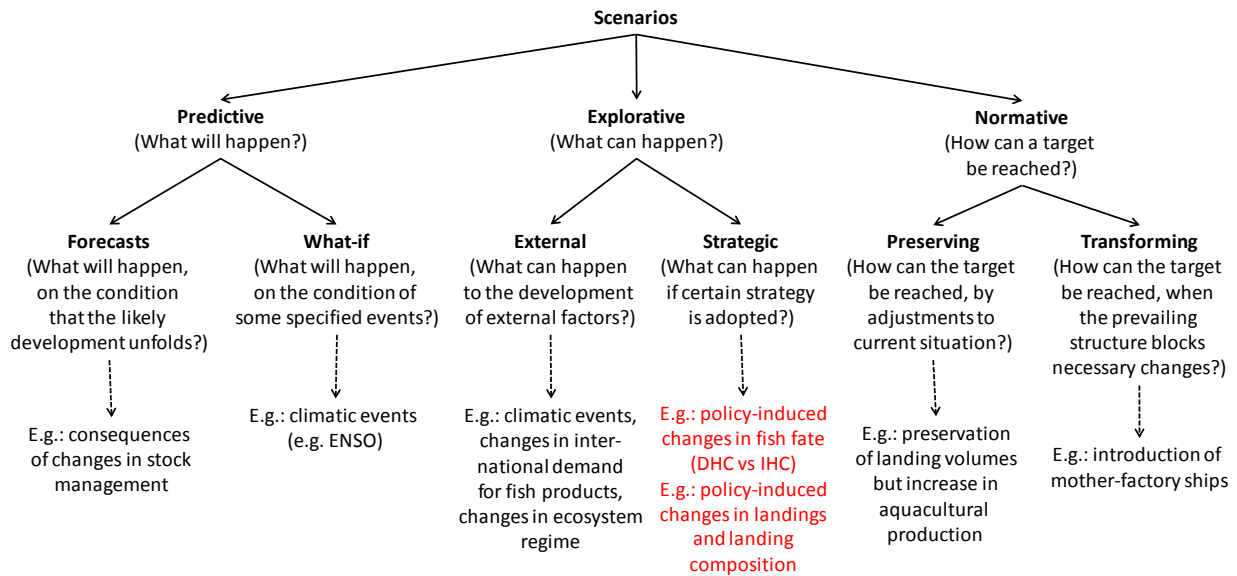
The field of futures research has produced several scenario typologies. The typology proposed by Börjeson et al. (2006) seems particularly suitable for scenario building in association to socio-economic modelling, given its organisation around

key questions about the future a model/scenario might attempt to answer: “What will happen?”, “What can happen?” and “How can a specific target be reached?”.

In the context of fishfood research, comparing the sustainability of competing or alternative

exploitation scenarios could inform decision making in that respect. Fig. 3 illustrates proposed

scenarios for fishfood supply chains sustainability comparison, under the discussed typology.



**Fig. 3** Types of scenarios suitable for seafood sustainability research. Source: based on Börjeson et al. (2006). Examples in red represent the preferences of this research. DHC: direct human consumption; IHC: indirect human consumption (i.e. reduction)

By integrating the ecosystem compartment in the supply chain model, it is possible to predict, for instance, changes in stock related to changes in exploitation regimes. It moreover can also assist in estimating the overall environmental impacts associated to alternative fates of landed fish materials.

### 3.5 Comparison of supply chains and scenarios

Comparison of supply chains and defined policy-based scenarios is carried out based on functional units, typically one tonne of produced or processed fish (live weight). Supply chain-wide flow analyses and product comparisons by means of the sustainability indicator set are the comparison tools. Visualisation devices include mass and energy balances, tables, Sankey diagrams (Schmidt, 2008b; Schmidt, 2008a) and graphs.

## 4 Conclusions and perspectives

This paper proposes a coherent sustainability assessment framework following the state of the

art in fishfood systems modelling practice and using mature methods, to be applied to complex supply chains starting with a fishery, with the option of being adapted to similar supply chains from the agricultural sector. The proposed methodology encompasses ecosystem and material flows modelling, as well as calculation of sustainability indicators and scenario generation. It is illustrated in detail in the second part of this paper, where it was applied to the case study of the Peruvian anchoveta supply chains.

It is worth noticing that no reference points are offered (e.g. distance-to-target assessments) for the compared product performances. The reason is that certain product features are very difficult or impossible to influence beyond certain technical point, such as the nutritional profile or the gross energy content of fishfood, the content of animal protein required in aquafeeds, etc. These technical points are product/process-specific. Future developments of the proposed framework will include the definition of reference points and a distance-to-target assessment, as well as an actualisation of the ecosystem model, as it

becomes outdated, to include the latest historical data.

## Acknowledgements

This work, carried out by a member of the Anchoveta Supply Chain (ANCHOVETA-SC) project (<http://anchoveta-sc.wikispaces.com>) is a contribution to the International Joint Laboratory “Dynamics of the Humboldt Current system” (LMI-DISCOH) coordinated by the Institut de Recherche pour le Développement (IRD) and the Instituto del Mar del Perú (IMARPE), and gathering several other institutions. It was carried out under the sponsoring of the Direction des Programmes de Recherche et de la formation au Sud (DPF) of the IRD.

## References

Acar Y, Kadipasaoglu S, Schipperijn P (2010) A decision support framework for global supply chain modelling: an assessment of the impact of demand, supply and lead-time uncertainties on performance. *Int J Prod Res* 48:3245–3268.

Ahumada O, Villalobos JR (2009) Application of planning models in the agri-food supply chain: A review. *Eur J Oper Res* 196:1–20.

Allen JI, Fulton E (2010) Top-down, bottom-up or middle-out? Avoiding extraneous detail and overgenerality in marine ecosystem models. *Prog Oceanogr* 84:129–133.

Aramyan L (2007) Measuring Supply Chain Performance in the Agri-Food Sector. Wageningen University, PhD Dissertation, <http://library.wur.nl/WebQuery/edepot/121904>

Avadí A, Fréon P (2014) A set of sustainability performance indicators for seafood: direct human consumption products from Peruvian anchoveta fisheries and freshwater aquaculture. *Ecol Indic* (in review).

Avadí A, Fréon P, Quispe I (2014c) Environmental assessment of Peruvian anchoveta direct human consumption products. *Int J Life Cycle Assess* (in review).

Avadí A, Pelletier N, Aubin J, Ralite S, Núñez J, Fréon P (2014b) Comparative environmental performance of

artisanal and commercial feed use in Peruvian freshwater aquaculture. *Aquaculture* (in review).

Avadí A, Vázquez-Rowe I, Fréon, P (2014a) Eco-efficiency assessment of Peruvian anchoveta steel and wooden fleets using the LCA+DEA framework. *J Clean Prod* (in press).

Avadí, A, Fréon, P, Tam, J (2014e) Ecosystem-based supply chain modelling from sea to plate, Part 2: the Peruvian anchoveta case. Manuscript.

Beamon B (1998) Supply chain design and analysis: Models and methods. *Int J Prod Econ* 55:281–294.

Bjørndal T, Lane DE, Weintraub A (2004) Operational research models and the management of fisheries and aquaculture: A review. *Eur J Oper Res* 156:533–540.

Börjeson L, Höjer M, Dreborg K-H, et al. (2006) Scenario types and techniques: Towards a user’s guide. *Futures* 38:723–739.

Christensen V, de la Puente S, Sueiro JC, et al. (2013) Valuing seafood: the Peruvian fisheries sector. *Mar Policy*

Christensen V, Pauly D (1992) ECOPATH II - a software for balancing steady-state ecosystem models and calculating network characteristics. *Ecol Modell* 61:169–185.

Christensen V, Steenbeek J, Failler P (2011) A combined ecosystem and value chain modeling approach for evaluating societal cost and benefit of fishing. *Ecol Modell* 222:857–864.

Christensen V, Walters CJ (2004) Ecopath with Ecosim: methods, capabilities and limitations. *Ecol Modell* 172:109–139.

Dabbene F, Gay P, Sacco N (2008) Optimisation of fresh-food supply chains in uncertain environments, Part I: Background and methodology. *Biosyst Eng* 99:348–359.

Dahl AL (2012) Achievements and gaps in indicators for sustainability. *Ecol Indic* 17:14–19.

Deep A, Dani S (2009) Managing Global Food Supply Chain Risks: A Scenario Planning Perspective. POMS 20th Annu. Conf. Production and Operation Management Society, Orlando, pp 1–21

- Drewnowski A, Fulgoni III V (2008) Nutrient profiling of foods: creating a nutrient-rich food index. *Nutr Rev* 66:23–39.
- Ecoinvent (2012) The ecoinvent Centre portal. <http://www.ecoinvent.ch/>.
- Food Policy (2011) The challenge of global food sustainability (Editorial). *Food Policy* 36:S1–S2.
- Fréon P, Avadí A, Marín W, Negrón R (2014b) Environmentally-extended comparison table of large- vs. small- and medium-scale fisheries: the case of the Peruvian anchoveta fleet. *Can J of Fish Aquat Sci* (in review).
- Fréon P, Avadí A, Vinatea RA, Iriarte F (2014a) Life cycle assessment of the Peruvian industrial anchoveta fleet: boundary setting in life cycle inventory analyses of complex and plural means of production. *Int J Life Cycle Assess* (in press).
- Fulton E (2010) Approaches to end-to-end ecosystem models. *J Mar Syst* 81:171–183.
- Fulton E, Fuller M, Smith A (2004) Ecological indicators of the ecosystem effects of fishing: final report. Report Number R99/1546 Australian Fisheries Management Authority [http://www.sainsolutions.net/Ecol\\_Ind\\_simulation\\_testing.pdf](http://www.sainsolutions.net/Ecol_Ind_simulation_testing.pdf)
- Goedkoop M, Heijungs R, Huijbregts M, et al. (2009) ReCiPe 2008. A life cycle impact assessment method which comprises harmonised category indicators at the midpoint and the endpoint level. Report I: Characterisation. Ministry of Housing, Spatial Planning and Environment (VROM) Ministry of Housing, Spatial Planning and Environment (VROM) [www.lcia-recipe.info](http://www.lcia-recipe.info)
- Goedkoop M, Heijungs R, Huijbregts M, et al. (2012) ReCiPe 2008. A life cycle impact assessment method which comprises harmonised category indicators at the midpoint and the endpoint level. First edition (revised) Report I: Characterisation. Ministry of Housing, Spatial Planning and the Environment (VROM) and Centre of Environmental Science - Leiden University (CML)
- Grimm V, Revilla E, Berger U, et al. (2005) Pattern-oriented modeling of agent-based complex systems: lessons from ecology. *Science* 310:987–91.
- Guinée JB, Gorreé M, Heijungs R, et al. (2001a) Life cycle assessment. An operational guide to the ISO standards. Part 1: LCA in Perspective. Ministry of Housing, Spatial Planning and the Environment (VROM) and Centre of Environmental Science - Leiden University (CML) <http://scholar.google.com/scholar?hl=en&btnG=Search&q=intitle:Life+cycle+assessment+An+operational+guide+to+the+ISO+standards#4>
- Guinée JB, Gorreé M, Heijungs R, et al. (2001b) Life cycle assessment. An operational guide to the ISO standards. Part 2a: Guide. Ministry of Housing, Spatial Planning and the Environment (VROM) and Centre of Environmental Science - Leiden University (CML) <http://www.cml.leiden.edu/research/industrialecology/researchprojects/finished/new-dutch-lca-guide.html>
- Guinée JB, Gorreé M, Heijungs R, et al. (2001c) Life cycle assessment. An operational guide to the ISO standards. Part 2b: Operational annex. 26:794–794.
- Guinée JB, Gorreé M, Heijungs R, et al. (2002) Handbook on life cycle assessment. Operational guide to the ISO standards. I: LCA in perspective. IIa: Guide. IIb: Operational annex. III: Scientific background. 692.
- Hall C a. S (2011) Introduction to Special Issue on New Studies in EROI (Energy Return on Investment). *Sustainability* 3:1773–1777.
- Hischier R, Weidema BP, Althaus H, et al. (2010) Implementation of Life Cycle Impact Assessment Methods. ecoinvent report No. 3 (v2.2). Dübendorf: Swiss Centre for Life Cycle Inventories
- Horan RD, Fenichel EP, Drury KLS, Lodge DM (2011) Managing ecological thresholds in coupled environmental-human systems. *Proc Natl Acad Sci U S A* 108:7333–8.
- Hornborg S (2012) Evaluating Fisheries Management from a Life Cycle Perspective with New Approaches to By-catch Impacts. University of Gothenburg, Licentiate thesis
- Hornborg S, Emanuelsson A, Sonesson U, Ziegler F (2012a) D.1.3b: By-catch methods in Life Cycle Assessment of seafood products. Public Consult 1–6.
- Hornborg S, Nilsson P, Valentinsson D, Ziegler F (2012b) Integrated environmental assessment of fisheries management: Swedish Nephrops trawl fisheries evaluated using a life cycle approach. *Mar Policy* 36:1–9.

- Howieson J, Lawley M (2010) Implementing Whole of Chain Analyses for the Seafood Industry: A Toolbox Approach. In: Ballantine P, Finsterwalder J (eds) Aust. New Zeal. Mark. Acad. Annu. Conf. 2010, Nov 29 2010. University of Canterbury, Christchurch, New Zealand, pp 1–8
- IFU (2005) Umberto – A Software Tool for Life Cycle Assessment and Material Flow Analysis – User Manual. Hamburg: Institut für Umweltinformatik Hamburg GmbH and ifeu – Institut für Energie und Umweltforschung Heidelberg GmbH
- Ingram J, Ericksen P, Liverman D (2010) Food security and global environmental change. London: Earthscan
- Jain J, Dangayach G, Agarwal G (2010) Supply Chain Management: Literature Review and Some Issues. *J Stud Manuf* 1:11–25.
- Jensen TK, Nielsen J, Larsen EP, Clausen J (2010) The Fish Industry—Toward Supply Chain Modeling. *J Aquat Food Prod Technol* 19:214–226.
- Kasi V (2005) Systemic Assessment of SCOR for Modeling Supply Chains. Proc. 38th Annu. Hawaii Int. Conf. Syst. Sci. Ieee, p 87b–87b
- Keramati AA (2010) Supply chain integration: A modelling classification. Eighth Annu. Int. Symp. Supply Chain Manag. [http://amir-keramati.com/so/SympoCanadfinal version.pdf](http://amir-keramati.com/so/SympoCanadfinal%20version.pdf)
- Keramati AA, Eldabi T (2011) Supply Chain Integration : Modelling Approach. In: Ghoneim A, Themistocleous M, Koufopoulos D, Kamal M (eds) Online Proc. 8th Eur. Mediterr. Middle East. Conf. Inf. Syst. Athens, pp 75–85
- Khan A (2009) A fish chain analysis of Northern Gulf cod recovery options: exploring EwE modeling approaches for policy scenarios. Ecopath 25 Years Conf. Proc. Ext. Abstr. 17:Vancouver.<http://scholar.google.com/scholar?hl=en&btnG=Search&q=intitle:Ecopath+25+Years#0>
- Kim C, Tannock J, Byrne M, et al. (2004) State of the art review: Techniques to model supply chain in an extended enterprise. VIVACE WP25/UNOTT/T/04021-10 1–69.
- Kleijnen J (2005) Supply chain simulation tools and techniques: a survey. *Int J Simul Process* 1:82–89.
- Kruse S, Flysjö A, Kasperczyk N, Scholz AJ (2008) Socioeconomic indicators as a complement to life cycle assessment—an application to salmon production systems. *Int J Life Cycle Assess* 14:8–18.
- Langlois J, Fréon P, Delgenes J-P, Steyer J-P, & Hélias A (2014) New methods for impact assessment of biotic-resource depletion in LCA of fishery: theory and application. *J Clean Prod.* doi:10.1016/j.jclepro.2014.01.087
- Lavassani KM, Movahedi B (2010) Critical Analysis of the Supply Chain Management Theories: Toward the Stakeholder Theory. POMS 21st Annu. Conf. Vancouver.<http://www.pomsmeetings.org/ConfProceedings/015/FullPapers/015-0545.pdf>
- Levin S (1992) The problem of pattern and scale in ecology. *Ecology* 6:1943–1967.
- Link J (2002) Ecological considerations in fisheries management: when does it matter? *Fisheries* 27:[http://www.tandfonline.com/doi/abs/10.1577/1548-8446\(2002\)027<0010:ECIFM>2.0.CO;2](http://www.tandfonline.com/doi/abs/10.1577/1548-8446(2002)027<0010:ECIFM>2.0.CO;2)
- Mai N, Bogason SG, Arason S, et al. (2010) Benefits of traceability in fish supply chains – case studies. *Br Food J* 112:976–1002.
- McMichael P (2011) Food system sustainability: Questions of environmental governance in the new world (dis)order. *Glob Environ Chang* 21:804–812.
- Min H, Zhou G (2002) Supply chain modeling: past, present and future. *Comput Ind Eng* 43:231–249.
- Nellemann C, MacDevette M, Manders T, et al. (2009) The environmental food crisis: the environment’s role in averting future food crises: a UNEP rapid response assessment. <http://www.grida.no/publications/rr/food-crisis/>
- Parfitt J, Barthel M, Macnaughton S (2010) Food waste within food supply chains: quantification and potential for change to 2050. *Philos Trans R Soc Lond B Biol Sci* 365:3065–81.
- Pauly D, Christensen V (1995) Primary production required to sustain global fisheries. *Nature* 374:255–257.
- Pauly D, Christensen V, Walters C (2000) Ecopath, Ecosim, and Ecospace as tools for evaluating ecosystem impact of fisheries. *ICES J Mar Sci* 57:697–706.



- Plagányi EE (2007) Models for an ecosystem approach to fisheries. FAO Fish Tech Pap No 477 108.
- Power A (1999) Linking ecological sustainability and world food needs. *Environ Dev Sustain* 1:185–196.
- PRé (2012) SimaPro by Pré Consultants. <http://www.pre-sustainability.com/content/simapro-lca-software/>.
- Prellezo R, Accadia P, Andersen JL, et al. (2009) Survey of existing bioeconomic models. Final report. Stud Pilot Proj Carr Out Common Fish Policy No FISH/2007/07 Lot 5 283.
- Prellezo R, Accadia P, Andersen JL, et al. (2012) A review of EU bio-economic models for fisheries: The value of a diversity of models. *Mar Policy* 36:423–431.
- Rose KA, Allen JI, Artioli Y, et al. (2010) End-To-End Models for the Analysis of Marine Ecosystems: Challenges, Issues, and Next Steps. *Mar Coast Fish Dyn Manag Ecosyst Sci* 2:115–130.
- Rosenbaum RK, Bachmann TM, Gold LS, et al. (2008) USEtox—the UNEP-SETAC toxicity model: recommended characterisation factors for human toxicity and freshwater ecotoxicity in life cycle impact assessment. *Int J Life Cycle Assess* 13:532–546.
- SCC (2010) Supply Chain Operations Reference (SCOR®) model - Overview - Version 10.0. 0–23.
- Schlüter M, Mcallister R, Arlinghaus R, et al. (2012) New horizons for managing the environment: A review of coupled social-ecological systems modeling. *Nat Resour Model* 25:219–272.
- Schmidt M (2008a) The Sankey Diagram in Energy and Material Flow Management. Part I. *J Ind Ecol* 12:82–94.
- Schmidt M (2008b) The Sankey Diagram in Energy and Material Flow Management. Part II. *J Ind Ecol* 12:173–185.
- Shapiro JF (2000) Supply chain management, integrated planning, and models. *Model. supply Chain*. Cengage Learning, pp 1–42
- Shin Y-J, Cury P (2001) Exploring fish community dynamics through size-dependent trophic interactions using a spatialized individual-based model. *Aquat Living Resour* 14:65–80.
- Shin YJ, Shannon LJ (2010) Using indicators for evaluating, comparing, and communicating the ecological status of exploited marine ecosystems. 1. The IndiSeas project. *ICES J Mar Sci* 67:686–691.
- Shin Y-J, Shannon LJ, Bundy A, et al. (2010) Using indicators for evaluating, comparing, and communicating the ecological status of exploited marine ecosystems. 2. Setting the scene. *ICES J Mar Sci* 67:692–716.
- SOFA (2011) The state of food and agriculture 2010–11. Rome: Food and Agriculture Organization of the United Nations (<http://www.fao.org/docrep/013/i2050e/i2050e.pdf>)
- SOFIA (2010) The state of world fisheries and aquaculture 2010. United Nations Food and Agriculture Program Rome: FAO Fisheries and Aquaculture Department <http://www.fao.org/docrep/013/i1820e/i1820e.pdf>
- SOFIA (2012) The State of World Fisheries and Aquaculture 2012. 209.
- Spieritz H (2010) Food production, crops and sustainability: restoring confidence in science and technology. *Curr Opin Environ Sustain* 2:439–443.
- Tam J, Taylor MH, Blaskovic V, et al. (2008) Trophic modeling of the Northern Humboldt Current Ecosystem, Part I: Comparing trophic linkages under La Niña and El Niño conditions. *Prog Oceanogr* 79:352–365.
- Travers M, Shin Y-J, Jennings S, Cury P (2007) Towards end-to-end models for investigating the effects of climate and fishing in marine ecosystems. *Prog Oceanogr* 75:751–770.
- Travers M, Shin Y-J, Jennings S, et al. (2009) Two-way coupling versus one-way forcing of plankton and fish models to predict ecosystem changes in the Benguela. *Ecol Modell* 220:3089–3099.
- Tukker A, Goldbohm RA, de Koning A, et al. (2011) Environmental impacts of changes to healthier diets in Europe. *Ecol Econ* 1–13.
- Tyedmers P (2000) Salmon and Sustainability: The biophysical cost of producing salmon through the commercial salmon fishery and the intensive salmon culture industry. The University of British Columbia,

PhD Dissertation,  
<https://circle.ubc.ca/handle/2429/13201>

Tyedmers P, Watson R, Pauly D (2005) Fueling global fishing fleets. *Ambio* 34:635–8.

UN (2012) The Future we Want. RIO+20 United Nations Conf. Sustain. Dev. Rio de Janeiro, pp 1–19

Van der Vorst JG a. J, Beulens A (1999) A Research Model for the Redesign of Food Supply Chains. *International J Logist Res Appl* 2:161–174.

Van der Vorst JG a. J, Tromp S, van der Zee D-J (2009) Simulation modelling for food supply chain redesign; integrated decision making on product quality, sustainability and logistics. *Int J Prod Res* 47:6611–6631.

Van Zelm R, Huijbregts M a. J, Meent D (2009) USES-LCA 2.0—a global nested multi-media fate, exposure, and effects model. *Int J Life Cycle Assess* 14:282–284.

Wahlström B (1994) Models, modelling and modellers: an application to risk analysis. *Eur J Oper Res* 75:477–487.

Walters C, Christensen V, Pauly D (1997) Structuring dynamic models of exploited ecosystems from trophic mass-balance assessments. *Rev Fish Biol Fish* 7:139–172.

Wognum PM (Nel., Bremmers H, Trienekens JH, et al. (2011) Systems for sustainability and transparency of food supply chains – Current status and challenges. *Adv Eng Informatics* 25:65–76.

# Chapter 4

---

Illustration of the proposed framework by applying it to the anchoveta fisheries and subsequent supply chains, and by discussing current management and policy issues based on the conclusions drawn from the supply chains/scenarios comparisons.

- Paper 2: Life cycle assessment of the Peruvian industrial anchoveta fleet: boundary setting in life cycle inventory analyses of complex and plural means of production
  - Paper 3: Environmentally-extended comparison table of large- vs. small- and medium-scale fisheries: the case of the Peruvian anchoveta fleet
  - Paper 4: Comparative environmental performance of artisanal and commercial feed use in Peruvian freshwater aquaculture
  - Paper 5: Environmental assessment of Peruvian anchoveta food products: is less refined better?
  - Paper 6: A set of sustainability performance indicators for seafood: direct human consumption products from Peruvian anchoveta fisheries and freshwater aquaculture
  - Paper 7b: Coupled ecosystem/supply chain modelling from sea to plate, Part 2: the Peruvian anchoveta case
- 

## **4 Case study: characterisation and modelling of Peruvian *anchoveta* supply chains**

The results of the characterisation and sustainability assessment of the constituencies of the Peruvian anchoveta supply chains are presented through papers. Papers 2 to 5 focused especially on the environmental performance of these constituencies, referred to as partial characterisation. Papers 6 and 7b, on the other hand, analyse the performance of the constituencies according with other sustainability dimensions, and consolidate partial characterisations into a comprehensive and homogeneous sustainability assessment.

### **4.1 Data sources**

This research was carried out in the context of the project “Sustainability of the Peruvian anchoveta supply chains: ANCHOVETA-SC” (<http://anchoveta-sc.wikispaces.com/>), a four-year project led by Dr. Pierre Fréon (<http://www.umar-eme.org/team/pfreon/>) and financed by the Institut de Recherche pour le Développement, IRD (<http://en.ird.fr/>). The project started in early 2010, yet additional data collection for this thesis was carried out from July 2011 to April 2013 by the candidate or under his co-supervision. The project’s keystone publication is Fréon et al. (2010).

The project involves a wide number of scientists and students, in Peru and abroad, as well as several key Peruvian institutions. Cooperation with, for instance, PRODUCE, IMARPE, the Institute of Fisheries Technology (ITP, <http://www.itp.gob.pe/>), the Research Institute of the Peruvian Amazonia (IIAP,

<http://www.iiap.org.pe/>), a trout development project from the regional Puno government (PETT, <http://pett.regionpuno.gob.pe/>), Universidad Nacional Federico Villareal, Pontificia Universidad Católica del Perú and its Peruvian Life Cycle Network (<http://red.pucp.edu.pe/ciclodevida/>) and the Centre for Environmental Sustainability at the Universidad Peruana Cayetano Heredia (<http://csa-upch.org/>); was key for collecting primary and secondary data. Some of these institutions are listed in **Appendix G: Institutions, labs, projects.**

A number of field visits were carried out, including: fishing ports along the Peruvian coast, fishmeal plants, fish processing plants (canning, freezing, curing), ice factories, shipyards, as well as aquafeed plants and aquaculture farms in the main fish producing regions of Peru.

Secondary data on Peruvian anchoveta fisheries and fish processing was compiled mainly from online sources of statistics and reports by PRODUCE, IMARPE and National Institute of Statistics and Informatics (INEI, <http://www.inei.gob.pe/>). Moreover, from the large volume of both peer-reviewed and grey literature available (papers, articles, reports), many sources were used (e.g. Alvarado, 2009; APOYO, 2008; Aranda, 2009; Arias, 2011; Bertrand et al., 2010; Estrella and Swartzman, 2010; Evans and Tvetaras, 2011; FAO, 2010; IFFO, 2009; IMARPE, 2009, 2010; Indacochea, 2012; Miro et al., 2009; Paredes, 2010; Paredes and Gutiérrez, 2008; PROMPERU, 2011; Rokovich, 2009; Salvattecchi and Mendo, 2005; SNP, 2010, 2011; Sueiro, 2008; Tvetaras et al., 2009; Werner et al., 2008).

Secondary data on Peruvian aquaculture and aquafeed was compiled mostly from official statistics and reports (Mendoza, 2013; Mendoza, 2011; PRODUCE, 2012; PRODUCE, 2010; PRODUCE, 2009; Ruiz, 2013). Other specific sources for secondary data included published sources, but also reports, theses and other “grey literature” documents (e.g. Baltazar, 2009; Baltazar and Palomino, 2004; Bezerra, 2002; Handal, 2006; Hurtado, 2005a; Hurtado, 2005b; Jiménez-Montealegre et al., 2005; Lochmann et al., 2009; Luna, 2008; Maradiague et al., 2005; Mendoza, 2013; Mendoza, 2011; promAmazonia, 2009; Rebaza et al., 2008; UNALM, 2012).

A detailed relation of sources used for calculating the biophysical indicators is presented in Table 9.

**Table 9: Main data sources for calculating environmental and energy indicators**

Self elaboration.

| Grouping                           | Material                               | Indicator | Source  |
|------------------------------------|--|-----------|---|
|                                    |  |           | GEC (MJ/kg)   |
| Fisheries and fish processing (PE) | Fresh anchoveta (HGT, for DHC)         | 19.5 ±2.2 | Calculated from GEC values of anchoveta muscle (calorimetry measurements, IMARPE-IRD, 2011, unpublished).   |
|                                    | Fresh anchoveta (whole, for reduction) | 7.9 ±0.2  | Average of values in Torry Research Station (1989) and IMARPE-ITP (1996)  |
|                                    | Fishmeal                               | 19.1 ±1.6 | Average of values from Booth et al. (2005), Dias et al. (2010), Glencross et al. (2007), Hasan et al. (2007), Higgs et al. (1995), Nankervis et al. (2000), NRC (1993), Sauviant et al. (2004), Schneider et al. (2004), Sklan et al. (2004), Tusche et al. (2011) and Vergara et al. (1999). Protein content 67-68%, lipid content ~8% (parameters consistent with Prime and Super Prime fishmeal, according to Peruvian producers such as <a href="http://www.tasa.com.pe/">http://www.tasa.com.pe/</a> ) |
|                                    | Residual fishmeal                      | 16.7      | Lowest fishmeal GEC value available (Higgs et al., 1995). Protein level ~55% (Peruvian producer, personal communication, 03.2013)   |
|                                    | Fish oil                               | 37.9 ±1.5 | Average of values from Booth et al. (2005), Sauviant et al. (2004) and Tyedmers (2000)  |

|                               |                           |      |      |  |
|-------------------------------|---------------------------|------|------|--|
|                               | Canned anchoveta          | 6.9  | ±2.4 | Average of values in ITP (2007)  |
|                               | Frozen anchoveta (whole)  | 7.9  | ±0.2 | Average of values in Torry Research Station (1989) and IMARPE-ITP (1996)   |
|                               | Cured anchoveta (salted)  | 5.3  |      | ITP (2007)   |
|                               | Cured anchoveta (anchovy) | 6.5  | ±0.1 | Average of values in ITP (2007)  |
|                               | Fresh hake                | 4.3  | ±0.7 | Average of values in Torry Research Station (1989) IMARPE (1970) and IMARPE-ITP (1996)   |
|                               | Brewer's yeast            | 7.8  |      | USDA (2012)  |
|                               | CDDGS                     | 21.9 | ±1.2 | Average of values from Kim et al. (2008) and Stein (2006)  |
|                               | Lupin seed                | 15.5 |      | USDA (2012)  |
|                               | Maize                     | 15.9 | ±1   | Average of values from International Database of Food Composition (2012), Jungbluth et al. (2007), Rosillo-Callé (2007), Sauvant et al. (2004), Sklan et al. (2004) and USDA (2012)    |
|                               | Maize gluten meal         | 20.3 | ±1.5 | Average of values from Dias et al. (2010), Sauvant et al. (2004) and Sklan et al. (2004)   |
|                               | Malt                      | 11.7 |      | Casanova-Flores and Chu-Koo (2008)   |
|                               | Meat and bone meal        | 17.4 |      | Fox et al. (2004)  |
|                               | Molasses                  | 12.1 |      | USDA (2012)  |
|                               | Palm oil                  | 37.0 |      | USDA (2012)  |
|                               | Pea protein               | 17.8 |      | Soybean protein isolate as proxy, Hajen et al. (1993)  |
|                               | Poultry by-product meals  | 19.6 | ±2.7 | Average of values from Hajen et al. (1993) and Sklan et al. (2004)   |
|                               | Rapeseed meal             | 18.3 | ±1.7 | Average of values from Sauvant et al. (2004) and Sklan et al. (2004)   |
| Agricultural feed ingredients | Rapeseed oil              | 37.7 |      | USDA (2012)  |
|                               | Rice                      | 15.3 | ±0.4 | Average of values from International Database of Food Composition (2012), Rosillo-Calle (2007), Sauvant et al. (2004) and USDA (2012)  |
|                               | Rice bran                 | 13.2 |      | USDA (2012)  |
|                               | Soy concentrate           | 13.9 |      | USDA (2012)  |
|                               | Soy lecithin              | 31.9 |      | USDA (2012)  |
|                               | Soybean meal              | 17.5 | ±0.3 | Average of values from Hajen et al. (1993), Sauvant et al. (2004), Sklan et al. (2004) and USDA (2012)   |
|                               | Soybean oil               | 37.0 |      | USDA (2012)  |
|                               | Sunflower meal            | 17.9 | ±0.1 | Average of values from Rodríguez et al. (2012) and Sklan et al. (2004)   |
|                               | Wheat                     | 16.0 | ±1.1 | Average of values from Dias et al. (2010), Hajen et al. (1993), International Database of Food Composition (2012), Rosillo-Calle (2007), Sauvant et al. (2004) and Sklan et al. (2004) |
|                               | Wheat bran                | 11.9 | ±4.1 | Average of values from Sauvant et al. (2004) and USDA (2012)   |
|                               | Wheat flour               | 15.3 | ±1   | Average of values for white, unenriched flour and whole grain flour (USDA, 2012) and Peruvian regional wheat flour (Casado et al., 2008)   |
|                               | Wheat gluten meal         | 15.6 | ±0.2 | Average of values from Dias et al. (2010) and USDA (2012)  |
|                               | Wheat middlings           | 16.2 | ±0.7 | Average of values from Hajen et al. (1993) and Zijlstra (2004)   |
| Aquaculture                   | Trout                     | 7.2  | ±1.6 | Average of values from Austreng and Refstie (1979) and Celik et al. (2007)   |
|                               | Gamitana                  | 8.2  | ±2   | Average of values from Almeida et al. (2008), Torry Research Station (1989) and Oishi et al. (2010)  |

|  |                            |             |   |
|--|----------------------------|-------------|---|
|  | Tilapia                    | 4.5 ±0.5    | Average of values from Torry Research Station (1989), Mendieta and Medina (1993) and and USDA (2012)  |
| BRU (g C/kg)   |                            |             |   |
| Fisheries and fish processing (PE)   | Fresh anchoveta            | 5,569       | Calculated following Pauly and Christensen (1995), using a trophic value of 2.7   |
|  | Anchoveta fishmeal         | 26,144      | Calculated using historical landings and fishmeal production data, showing a fish:fishmeal conversion factor of 4.3 (~23% yield)  |
|  | Residual fishmeal          | 27,844      | Calculated using a conservative fish residues:fishmeal conversion factor of 5 (Vázquez-Rowe, 2012, personal communication; residual fishmeal plant owner, 2013, personal communication) |
|  | Anchoveta fish oil         | 132,274     | Calculated using historical landings and fish oil production data, showing a fish:fish oil conversion factor of 26.6 (~4% yield)  |
|  | Canned anchoveta           | 9 133       |   |
|  | Frozen anchoveta           | 7 425       | Calculated from BRU values of anchoveta and their processing losses.  |
|  | Salted anchoveta           | 20 625      |   |
|  | Cured anchoveta            | 28 661      |   |
|  | Fresh hake                 | 221 696     | Calculated following Pauly and Christensen (1995), using a trophic value of 4.3   |
| Agricultural feed ingredients  | Soybean meal               | 410.2 ±56.6 | Average of values from Baes et al. (1984), Jungbluth et al. (2007) and Papatryphon et al. (2004)  |
|  | Maize                      | 257.7       | Average of values from Baes et al. (1984) and Papatryphon et al. (2004)   |
|  | Malt                       | 388.1       | Wood and Layzell (2003)   |
|  | Wheat                      | 312.8       | Average of values from Baes et al. (1984) and Papatryphon et al. (2004)   |
|  | Molasses                   | 550.0       | Sugar content taken as C content, USDA (2012)   |
|  | Rice                       | 419.4       | Jeong et al. (2009)   |
|  | Rice bran                  | 429.9       | Nakagawa et al. (2008)  |
|  | Meat and bone meal         | 4,020       | Poultry blood meal as proxy, Pelletier et al. (2009)  |
|  | Soybean oil                | 830         | Pelletier et al. (2009)   |
| Aquafeed (commercial)  | Trout                      | 21 445      | Own analysis based on industrial data   |
|  | Salmonids                  | 37 845      | Pelletier et al. (2009)   |
|  | Black pacu                 | 4 367       | Own analysis based on industrial data   |
|  | Tilapia                    | 4 514       | Own analysis based on industrial data   |
| Edible yields of DHC fish products (%)   |                            |             |   |
| Fisheries (PE)   | Fresh anchoveta            | 57.7 ±9.6   | Average of values from Torry Research Station (1989), IMARPE-ITP (1996) and Peter Tyedmers (personal communication, 2012)   |
|  | Fresh hake                 | 47.3 ±6     | Average of values in Torry Research Station (1989) IMARPE (1970) and IMARPE-ITP (1996)  |
| Aquaculture  | Trout                      | 59.4 ±5.2   | Average of values from Austreng and Refstie (1979), Celik et al. (2007) and Dumas et al. (2007)   |
|  | Gamitana                   | 41.8 ±3.4   | Average of values in Torry Research Station (1989)  |
|  | Tilapia                    | 36.0 ±1.4   | Average of values from Torry Research Station (1989) and Mendieta and Medina (1993)   |
| Protein content of DHC fish products (% combination of body and muscle compositions) |                            |             |   |
| Fisheries (PE)   | Fresh and frozen anchoveta | 19.1 ±0.1   | Average of values from Torry Research Station (1989), IMARPE-ITP (1996) and Peter Tyedmers (personal communication, 2012)   |
|  | Canned anchoveta           | 21.3 ±1.8   | Average of values in ITP (2007)   |
|  | Cured anchoveta            | 18.4        | ITP (2007)  |

|  |                            |      |      |   |
|--|----------------------------|------|------|---|
|  | (salted)                   |      |      |   |
|  | Cured anchoveta (anchovy)  | 30.0 |      | ITP (2007)  |
|  | Fresh hake                 | 16.6 | ±1   | Average of values in Torry Research Station (1989) IMARPE (1970) and IMARPE-ITP (1996)  |
| Aquaculture  | Trout                      | 18.4 | ±1.7 | Average of values from Austreng and Refstie (1979), Celik et al. (2007), Dumas et al. (2007), Fallah et al. (2011) and USDA (2012)      |
|  | Gamitana                   | 15.0 | ±1.9 | Average of values from Bezerra (2002), Torry Research Station (1989) and Machado and Sgarbieri (1991)                                   |
|  | Tilapia                    | 18.3 | ±1.5 | Average of values from Torry Research Station (1989), Mendieta and Medina (1993) and and USDA (2012)                                    |
| Lipid content of DHC fish products (%), combination of body and muscle compositions) |                            |      |      |   |
| Fisheries (PE)   | Fresh and frozen anchoveta | 8.8  | ±0.8 | Average of values from Torry Research Station (1989), IMARPE-ITP (1996) and calorimetry measurements of muscle (IRD, 2011, unpublished) |
|  | Canned anchoveta           | 9.0  | ±5.7 | Average of values in ITP (2007)   |
|  | Cured anchoveta (salted)   | 5.9  |      | ITP (2007)  |
|  | Cured anchoveta (anchovy)  | 4.0  |      | ITP (2007)  |
|  | Fresh hake                 | 1.2  | ±1.2 | Average of values in Torry Research Station (1989) IMARPE (1970) and IMARPE-ITP (1996)  |
| Aquaculture  | Trout                      | 7.6  | ±3.4 | Average of values from Austreng and Refstie (1979), Celik et al. (2007), Dumas et al. (2007), Fallah et al. (2011) and USDA (2012)      |
|  | Gamitana                   | 12.4 | ±5.4 | Average of values from Almeida et al. (2008), Bezerra (2002), Torry Research Station (1989) and Machado and Sgarbieri (1991)            |
|  | Tilapia                    | 1.9  | ±0.2 | Average of values from Torry Research Station (1989), Mendieta and Medina (1993) and and USDA (2012)                                    |

Key sources for methodological guidelines included Aubin et al. (2009), Kruse et al. (2008), Tyedmers (2000), Tam et al. (2008), and Papatryphon et al. (2004), among others.

## 4.2 Partial characterisation

### 4.2.1 Paper 2: Life cycle assessment of the Peruvian industrial anchoveta fleet: boundary setting in life cycle inventory analyses of complex and plural means of production

Paper analysing the environmental performance of the industrial anchoveta fishery, published in the International Journal of Life Cycle Assessment (Fréon et al., 2014a).

|  |  |
|--|--|
| Paper idea and design                            | Pierre Fréon   |
| Experiment design                                | Pierre Fréon, Angel Avadí (LCA modelling)                        |
| Data collection                                  | Pierre Fréon, Rosa Amelia Vinatea, Federico Iriarte, Angel Avadí |
| Data processing, statistical analysis, modelling | Pierre Fréon, Federico Iriarte, Rosa Amelia Vinatea, Angel Avadí |
| Discussion                                       | Pierre Fréon, Angel Avadí  |
| Writing and editorial                            | Angel Avadí, Pierre Fréon  |

# Life cycle assessment of the Peruvian industrial anchoveta fleet: boundary setting in life cycle inventory analyses of complex and plural means of production

Pierre Fréon <sup>a,\*</sup>, Angel Avadí <sup>a,b</sup>, Rosa Amelia Vinatea Chavez <sup>c</sup>, Federico Iriarte <sup>d</sup>

<sup>a</sup> UMR 212 EME, Institut de Recherche pour le Développement (IRD), Centre de Recherche Halieutique Méditerranéenne et Tropicale, Avenue Jean Monnet CS 30171, 34203 SETE cedex. France.

<sup>b</sup> Université Montpellier 2 – Sciences et Techniques, 2 Place Eugène Bataillon, 34095 Montpellier Cedex 5, France.

<sup>c</sup> Facultad de Oceanografía, Pesquería, Ciencias Alimentarias y Acuicultura, Universidad Federico Villarreal, Calle Roma 350, Lima, Peru.

<sup>d</sup> Iriarte & Asociados (I&A), Miro Quesada 191, of. 510, Cercado de Lima, Lima, Peru.

\* Corresponding author

## Abstract

**Purpose.** This work has two major objectives: 1) to perform an attributional LCA of a complex mean of production, the main Peruvian fishery targeting *anchoveta* (anchovy); 2) to assess common assumptions regarding the exclusion of items from the LCI. **Methods.** Data were compiled for 136 vessels of the 661 units in the fleet. The functional unit was 1 t of fresh fish delivered by a steel vessel. Our approach consisted of four steps: 1) a stratified sampling scheme based on a typology of the fleet; 2) a large and very detailed inventory on small representative samples with very limited exclusion based on conventional LCI approaches; 3) an impact assessment on this detailed LCI, followed by a boundary-refining process consisting of retention of items that contributed to the first 95% of total impacts; and 4) increasing the initial sample with a limited number of items, according to the results of 3). The LCIA method mostly used was ReCiPe v1.07 associated to the ecoinvent database. **Results and discussion.** Some items that are usually ignored in an LCI's means of production have a significant impact. The use phase is the most important in terms of impacts (66%), and within that phase, fuel consumption is the leading inventory item contributing to impacts (99%). Provision of metals (with special attention to electric wiring which is often overlooked) during construction and maintenance, and of nylon for fishing nets, follows. The *anchoveta* fishery is shown to display the lowest fuel use intensity worldwide. **Conclusions.** Boundary setting is crucial to avoid underestimation of environmental impacts of complex means of production. The construction, maintenance and EOL stages of the life cycle of fishing vessels have here a substantial environmental impact.

Keywords: Attributional LCA, complex production system, environmental impacts, fishing vessel, fuel use, Life Cycle Inventory

## 1 Introduction

The whole Peruvian *anchoveta* (*Engraulis ringens*) fishery is the largest mono-specific fishery in the world and supports the first national industry worldwide in terms of production and exportation of fishmeal and fish oil (mostly devoted to feeds for aquaculture and animal husbandry). The fleet

landed an average of 6.5 million t per year in the period 2001-2010, according to statistics from the Ministry of Production of Peru (PRODUCE 2012). The fleet consists of three segments, the most productive segment being the steel hulled industrial fishing vessels (approximately 660 units currently operating under regime Decree Law No. 25977). Catches by the steel fleet represent



approximately 81% of the total *anchoveta* catches (Fréon et al. 2010). Additionally, almost 700 wooden semi-industrial vessels (nicknamed “Vikingas”, operating under Law No. 26920) also target *anchoveta* for reduction and approximately 840 small- and medium-scale wooden vessels target mainly *anchoveta*, in principle for direct human consumption (PRODUCE 2012), although a large part of this third segment of the fleet is also illegally fishing for reduction (Fréon et al. 2010). There are 160 industrial reduction plants in Peru, most of them producing high protein fishmeal (PRODUCE 2012).

Industrial *anchoveta* fishing operations started in the 1960s and reached a captures peak in 1970 (over 12 million t, or ~20% of the world’s catch), to decline dramatically during the ‘70s and ‘80s due to the combination of overexploitation, a regime shift in the ecosystem and the occurrence of very strong El Niño events in 1972 and 1982, as shown in Online Resource 1. The fishery is regulated according to two main fishing areas: the north-centre area (from the border with Ecuador to 16°S) where more than 90% of the *anchoveta* catches of the industrial fleet occur and the south area (from 16°S to the border with Chile). A small part of the steel fleet moves seasonally from one area to the other.

Overcapitalisation affects the *anchoveta*-targeting fleets and reduction industries, which is largely a result of the existence of a semi-regulated open access system that was in place until the 2008 fishing season concluded. In 2007, the fishing fleet was estimated to be between 2.5 and 4.6 times its optimal size (Fréon et al. 2008; Paredes 2010). From January 2009 onwards, an individual vessel quota (IVQ) regime was implemented in Peru, largely to avoid the race for fishing and landing that maintained fishing overcapacity. Nonetheless, this measure resulted in a minor decommissioning of vessels and nearly no dismantling (Tveteras et al. 2011). Hence, there is interest, *per se*, in studying the environmental performance of this unnecessarily large fleet.

Despite the importance of this fishery, no comprehensive environmental assessment of the fleet currently exists in the literature, and this is possibly due to the large size and diversity of the fleet. To fill this gap, we compiled and analysed a Life Cycle Inventory (LCI) and later performed an initial LCA of the industrial *anchoveta* fleet, towards a future comprehensive assessment of the whole fleet, including the wooden artisanal and industrial fleets.

Any Life Cycle Assessment (LCA) is largely dependent on its related Life Cycle Inventory (LCI), which is the compilation of major flows of materials and energy used in the studied process or service. A number of methodological challenges are encountered when compiling inventories, particularly regarding cut-off criteria, i.e., the criteria for excluding items (processes or components) from the system boundaries of a case study (ISO 2006b). Suh et al. (2004) claim that system boundaries and cut-off criteria are not typically chosen on a scientific basis. These same authors add that *a priori* exclusion of items of the LCI assuming negligibility can significantly alter the results. The International Reference Life Cycle Data System (ILCD; European Commission 2010) provides other reasons why certain items are excluded from the LCI. Among those we underline the “personal interests in certain processes, lack of experience on what is key for the analysed process or system, no consideration of available experience” to which one can add simply the difficulty in obtaining some data and/or a representative sample. The boundary setting problem has been identified as an obstacle to overcome for comparative assessments, as recommended in the ISO standard (ISO 2006a). The cut-off criteria discussed in the LCA ISO standard are based on mass or energy demand contribution of an item of the LCI to the overall system under study, as well as on the environmental significance (contribution to impacts) of the item (ISO 2006b). Reynolds et al. (2000a,b) and Suh et al. (2004) have criticised the abovementioned ISO-recommended boundary selection methods. Reynolds et al. (2000a,b)

proposed a quantitative method for computing a cut-off parameter based upon a ratio between inputs and the functional unit. The Relative Mass-Energy-Economic (RMEE) method improves the qualitative approach initially proposed by Besnainou and Coulon (1996), which is also based on mass, energy and economic criteria. Suh et al. (2004) recommend the practice of hybrid LCA approaches (i.e., combination of input-output data for completing LCIs) for resolving system boundaries. The ideal practice would rely on the environmental significance of items for defining cut-offs, but environmental significance is often difficult to predict *a priori*.

This issue of boundary selection during LCI is particularly crucial in attributional LCAs of complex means of production such as large factories or fishing vessels. Typically, a vessel (or better, a fishing unit (vessel + fishing gear + crew)), is a complex object consisting of hundreds of items because it combines the complexity of a household, a transport facility and a sophisticated means of extraction. This situation generates two difficulties related to cut-off criteria. First, as quoted by Suh et al. (2004), “many excluded processes have often never been assessed by the practitioner, and therefore, their negligibility cannot be guaranteed”. Second, the **sum** of impacts of processes with small individual impacts (e.g., < 0.5% of the total) can be far from negligible. The problem is further complicated when these complex units of production are numerous (plurality) and diverse. In our case study this refers to hundreds of vessels of the industrial fleet which differ not only regarding their size but also their equipment, etc. The same could also apply to case studies related to fishmeal plants, which are also numerous and diverse, but also to many other means of industrial production, food-related or not. Here we present and apply an approach for setting boundaries for fishing unit LCIs based on detailed inventories, to make recommendations regarding which items must be included in future purse seiner LCIs of the same fleet or similar fleets. Published inventories of fishing vessels are limited to a few items, usually

less than ten, assuming that those left out have a negligible impact, which is not always obvious (Avadí and Fréon 2013). Moreover, certain arbitrary LCI design decisions have become common practice in the LCA community in general and in the fisheries LCA community in particular, where it is very common to exclude the construction and end-of-life (EOL) phases of fishing vessels, considering them negligible.

## 2 Methods

### 2.1 Goal and scope definition

There are two major objectives in this work: 1) to perform an attributional LCA of a complex mean of production, the Peruvian industrial fishery of steel vessels targeting *anchoveta* in order to identify the major sources of environmental impacts during different stages of the life cycle; 2) to assess common assumptions regarding exclusion of items from the LCI.

The goal of the LCA is to describe the environmental impacts associated with the activity (fishing *anchoveta*) of the most productive segment of the fishing fleet over the life cycle of its vessels. The functional unit of choice is one averaged metric tonne (t) of fresh *anchoveta* caught in the north-centre (4°S-16°S) fishing zone off Peru during the period 2008-2010 and delivered to a fishing terminal by a steel industrial Peruvian purse seiner. The Peruvian industrial fishery of *anchoveta* does not use a pier, wharf or quay for landing *anchoveta* aimed at reduction into fishmeal and fish oil; vessels are discharged by pumping at a floating terminal —a.k.a. “chata”— located several hundred meters from the factory where the fish are processed. This discharge process determines the system boundary to include the fishing and exclude the landing activities (the latter can be considered part of the reduction plant). Moreover, because the study intends to assess the contribution to environmental impacts of each phase of a vessel’s life cycle, the following phases of vessels were included in the system boundary, as depicted in Fig. 1: construction, use, maintenance and

decommissioning (that is EOL). Such boundaries can be defined as cradle-to-gate for the product (*anchoveta*) and cradle-to-grave for the vessels. We have distinguished the use and maintenance phases, which are often combined into an overall use phase (Avadí and Fréon 2013).

We have excluded from the study all items referring to fleet administration (workers, building, equipment and transportation) and on-shore processing, to delimit a perimeter strictly devoted to fishing operations. All fishing trips, successful or not, were considered, as were long trips made by part of the fleet when moving from South Peru (south of 16°S) to the main north-centre fishing zone, but long trips from north-centre to south and other short trips were not. The other short trips include trial trips, commuting to shipyard and commuting from one harbour to the other within the north-centre zone. Limited data available on these short trips suggest minimal impact in comparison to other trips. Crew impact is limited to emissions onboard (solid waste, wastewater) but exclude alimentation and transport. Work that is currently in progress will address the remaining items of the value chain and the detailed behaviour of fishing vessels and associated fuel consumption.

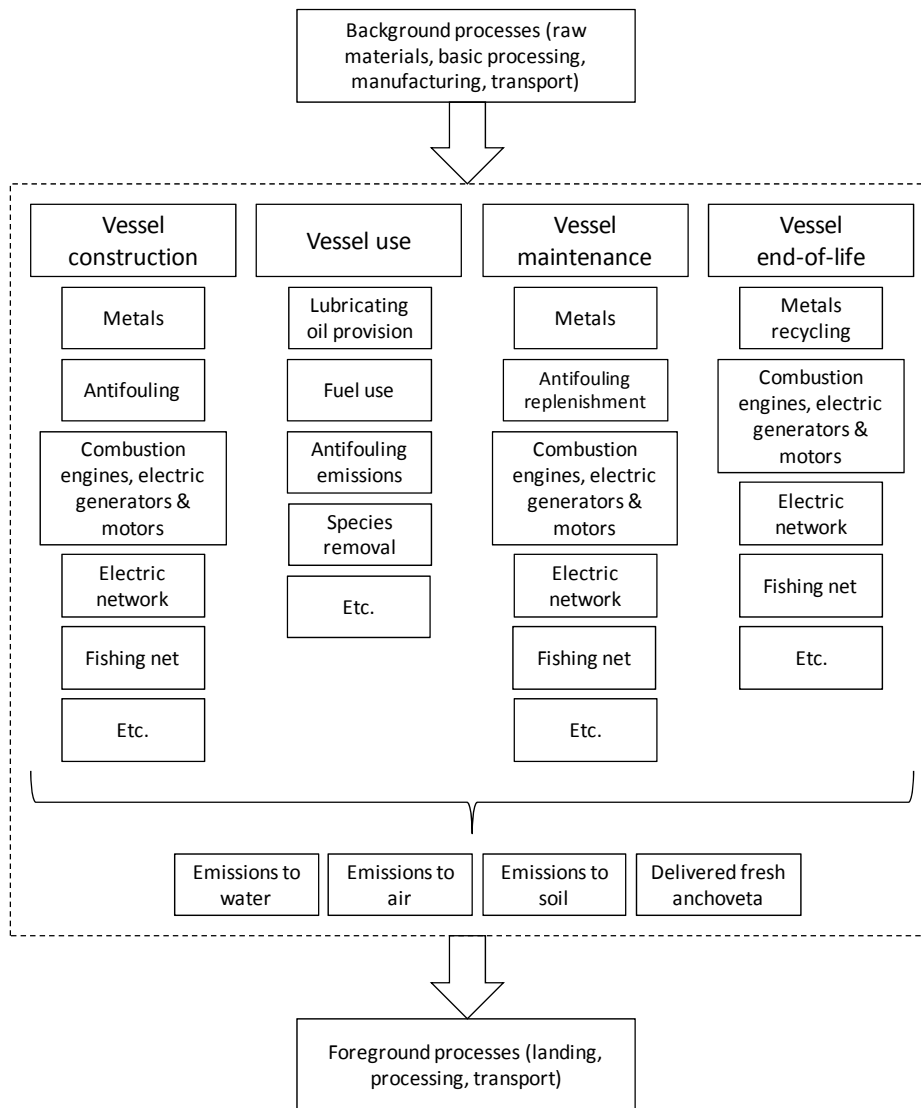
Due to the diversity (size, technology) in the types of vessels, a stratification of the sampling scheme was first applied. Then, a detailed preliminary inventory was performed on a small sub-sample of each vessel category, partly based on ISO 14044 recommendations for the initial cut-off criteria, with deliberately low thresholds for mass and monetary value and rough estimates of environmental significance. Finally, a precise contribution of inventory items to the overall environmental impacts was calculated in the Life Cycle Screening (LCS) and used as criteria for boundary refining in the final sampling. Because

the functional unit is related to a single product, there is no need for allocation between co-products.

The LCIA method ReCiPe v1.07 (Goedkoop et al. 2009) was applied to refine the system boundary and was later used for the LCS in combination with other single issue methods available in the LCA software SimaPro v7.3 (PRé 2012) and the widely used LCI database ecoinvent v2.2 (Ecoinvent 2012). Impact categories considered were Climate change, Terrestrial acidification, Marine eutrophication, Human toxicity, Photochemical oxidant formation, Marine ecotoxicity, Water depletion, Metal depletion, Fossil depletion and Cumulative Energy Demand (CED). CED was calculated by means of the single issue LCIA method Cumulative Energy Demand v. 1.08, also implemented in ecoinvent (Hischier et al. 2010).

Our boundary-refining approach accounted for the contribution of LCI items (processes or components) to impacts on several levels, as described below, with a single and arbitrary cut-off at 95% of cumulative values of impacts, as detailed in the LCI section.

We assumed that during the initial phase of the detailed inventory, no item contributing significantly to environmental impacts according to our final criteria of boundary-refining would be omitted. For this reason, we set low thresholds for selection. Several assumptions regarding the inventory were made when detailed information was unavailable (e.g., estimate of the contribution of the hull weight to the total weight of the vessel, metal composition of some device, proportion of wasted oil), and these assumptions are discussed below. The major limitation of this work was the access to detailed inventory data, especially for manufactured objects that are present on most vessels, including non-fishing-specific objects.



**Fig. 1** System boundary of the industrial *anchoveta* fleet (only major items are depicted)

## 2.2 Data sources

Data was collected for the period 2008-2011. Fishing and reduction companies were approached, as well as fishermen’s associations, shipyards, governmental bodies, universities and research institutions, and experts from the *anchoveta* supply chains.

The authors worked under the patronage of the Institut de Recherche pour le Développement (IRD 2012), a French public institution featuring cooperative research agreements with Peruvian institutions such as Instituto del Mar del Perú (Peruvian Institute of the Sea, a body of the Peruvian Ministry of Production, PRODUCE) (IMARPE 2012) and Sociedad Nacional de Pesquería (National Society for Fisheries, SNP).

The authors had access to various large fishing and reduction enterprises, from which some data were obtained. Moreover, detailed inventory and operative data were obtained for the period 2008-2010 from multiple confidential and anonymous sources. Experts and observers of the *anchoveta* industries were also approached, and historical datasets were obtained from these sources.

Surveys were filled out at *anchoveta* vessel docking sites or shipyards where vessels were meticulously inspected and their onboard documents screened, but some additional quantitative information (typically fuel consumption or weights of some items) obtained from the chief engineer or skipper was often incomplete or poor. Such incomplete datasets were complemented with data from industry

providers (i.e., marine engine providers, contractors for vessel maintenance and refurbishing work, marine paint providers, shipyard operators and other supply chain players). When necessary, chemical analyses were performed.

Fleet operations data were compiled from various sources, featuring annual landings, number of fishing trips, amounts of fuel consumed, trip duration, etc. Fuel consumption figures were not available for individual trips but were annually aggregated per vessel. Actual fuel delivery to vessels is monitored from pumping facilities physically separated from the vessels by significant distances, adding small errors to the measurements.

### 2.3 Life Cycle Inventory

Our approach to the LCI consisted of four steps (Fig. 2). First, due to the high number (661) of individual purse seiners constituting the industrial steel fleet exploiting *anchoveta* in Peru, it was found necessary to sample this population using a stratified sampling scheme. We therefore defined a typology for this section of the fleet. Two straightforward classification options were contemplated: a) the age of the vessel, from the assumption that more recently built vessels should benefit from more recent technology and equipment, and b) the size of the vessel with two options of easily available variables: vessel overall length or holding capacity. Classification b) assumes that a larger vessel can carry heavier equipment regarding the three abovementioned functions of a fishing vessel (household, transport facility and a means of extraction) and that the larger vessels were built more recently, i.e., they were more modern. Vessel size expressed in holding capacity was preferred (see discussion), and the vessels were clustered into sub-segments (holding capacity categories) with a class width of  $80 \text{ m}^3$ , a lower class limit of  $75 \text{ m}^3$  and an upper limit of  $875 \text{ m}^3$ . Such clustering was found to be the best trade-off among three needs: avoiding heterogeneity within classes ( $80 \text{ m}^3$  is a conservative value), limiting unbalance in the

sampling scheme and avoiding splitting vessels belonging to the same mode within the holding capacity histogram (and often constructed during the same period, with similar design and equipment) into two adjacent classes.

The second step consisted of compilation of a large and very detailed inventory of small and representative sub-samples (2 to 4 individual vessels) in each of the holding capacity categories, with very limited exclusion of obviously minor items based on conventional LCI approaches: mass ( $> \sim 0.1\%$  of vessel total weight), rough estimated level of environmental significance of items (expert knowledge with help of environmental impact databases when necessary), economical value ( $> \sim 500 \text{ USD}$ , that is  $> \sim 10^{-6}\%$  of the vessel's total price).

During the third step, a conventional impact assessment was performed on this detailed inventory using SimaPro, followed by a boundary-refining process based on the contribution of LCI items to impacts. An empirical cut-off criterion was applied to the cumulative impacts of items ordered by decreasing order of impact, retaining all items that contributed to the sum of the first 95% of the total (conservatively, if the last item that allows to reach the 95% results in a cumulated contribution  $> 95\%$ , it is retained). This same threshold was applied to three levels of reference: per impact category, across phases of the LCA; per phase, across impact categories; overall impact (single score). Any item contributing above any of the three levels was retained in the final LCI.

The fourth and final step consisted of increasing the initial sample in each category to a reasonable number (12 to approximately 30, when possible; Table 1), but now with a limited number of items in the LCI, according to the results obtained during step 3. Due to the difficulty of access to vessels or of obtaining detailed information once onboard, not all items of the refined LCI were sampled on each of the 136 vessels constituting the third step subset. In contrast, the most relevant inventory items (dimensions, holding capacity, age,

historical captures and fuel consumption) were available not only for all inventoried vessels but also for nearly all the fleet. Dimensions (length, width, depth) and nominal holding capacity of all fishing vessels operating in Peru are published online by PRODUCE. Such data were compared with both company records and confidential and anonymous sources for validation (only a few minor discrepancies were observed). Accurate weight data were seldom available (e.g., Light Ship Weight, *LSW*). Tonnage data (gross or net) were occasionally available from various sources. Fuel consumption was compiled for most of the fleet during the period 2008-2010, and aggregated, because we did not notice a marked change in fuel use intensity from 2008 to 2009 despite the implementation of IQs at the end of 2008 (biomasses were similar in both years). We did not manage to obtain sufficient samples on both ends of the vessel size distribution (<155 m<sup>3</sup> and >635 m<sup>3</sup>), and decided to omit them due to their low contribution to historical industrial landings (~5%).

A number of assumptions, based on expert opinions, were made for data manipulation and imputation of missing values:

- A total of 80% of the *LSW* value is assumed to correspond, *grosso modo*, to the weight of the hull (including the frame, steel sheets, deck, etc), while 20% of the *LSW* value corresponds to the weight of structural elements (thin walls, pipes, beams, joints), propulsion and other systems (several Peruvian naval engineers, pers. comm.). Weights of individually modelled items (main engine and its transmission system, propeller, fishing equipment and fishing gear manipulation equipment, wooden parts, additional engine operating pumps and generators, and ballast) were subtracted from the 20% weight to estimate the weight of structural elements.
- The composition of electric generators and electric motors was estimated based on their weights: 43% as steel, 33% as copper wire (mostly coil) and 24% as

aluminium (maintenance engineer at a large fishing/processing firm, pers. comm.). These motors are estimated to be replaced every 8 years, as an average of replacement time of the different motors, pumps and generators, which range from 4 to 12 years.

- Electrical wiring, for which few inventory data were available, was interpolated or extrapolated considering that the use of copper weight was proportional to the vessel overall length, a rule of thumb provided by naval engineers.
- The main engine (marine diesel) was assumed to be composed as follows: 65% cast iron, 34% chrome steel and 1% white metal alloys (Aluminium alloy 2024, AlCuMg<sub>2</sub>). The ancillary engine systems, consisting of lubricating oil system, fuel system, cooling system and exhaust system was assumed to feature a similar material composition and represent 10% of the engine's weight. These assumptions are based on the work of Reenaas (2005), who analysed a Wärtsilä 6L20 engine, weighting 9.3 t (more than 60% of engines surveyed weighed 6 t or more, and thus a similar composition could be expected). The main engine is estimated to be replaced once over the lifetime of the vessel.
- The lifetime of fishing vessels was estimated to be 40 years.
- 12% of the hull (steel sheets) is changed every two years over the vessel's lifetime (engineers from Peruvian military and private shipyards, pers. comm.).
- 100% of wastewater ("black water" and "grey water") and 50% of lubricating oil changed from the engines were assumed to be spilt in the ocean, the rest being processed on land.
- Following Iriarte (2011), 120 L of wastewater is produced per crew member per working day and 0.2 kg of solid waste is produced per landed t of *anchoveta*

(hazardous waste – mostly rags impregnated with lubricating oil – 38%, other rags 20%, plastic packaging 26%, paper 10%, organic matter 6%).

- The combined weight of all elements of the hydraulic system (excluding oil) and other mechanical equipment is negligible. Because the hydraulic system is made mostly of ordinary steel, the hydraulic system was not modelled separately but combined within the hull weight and thus accounted for as steel.
- Following Hospido and Tyedmers (2005), two thirds of the antifouling paint applied to vessels was assumed to be released into the ocean.
- The average number of fishing trips per vessel category and per year varies from 35 to 71 during the studied period (2008-2010). The single average value of 50 trips per year was retained for computing engine maintenance data because this average value is not a major source of environmental impact.
- Species removal was modelled in terms of recorded landings and considering a discard rate of 3.9%, following Torrejón et al. (2012). Although the impact of species removal is not characterised, it is considered by the LCA-fisheries community as crucial (Vázquez-Rowe et al., 2012, Avadi and Fréon 2013) and ongoing work aims at defining a sea-use impact category (Langlois et al. 2012).

*LSW* is considered a good proxy for estimating the steel content of a steel-hulled vessel. Unless a stability test and record are available – which was the case for 70 vessels – it was unlikely that the *LSW* of vessels would be known. We thus produced a number of statistical models to estimate the *LSW* from the holding capacity and physical dimensions of the vessels and used the most relevant model to estimate missing values of *LSW*:

- Histograms of candidate explanatory variables showed a close-to-normal shape,

so it multivariate analysis was performed without further transformations.

- Stepwise (backward and forward) and Best Subsets Regression tests were used to select the best among those variables to estimate *LSW* via a multiple regression model.
- Predicted values of *LSW* were computed using those explanatory variables in the most suitable linear model.

Ecoinvent 2.2 and other databases currently available in SimaPro do not include basic materials and equipment used in most industries (e.g., electric engines, specific grade steel types, etc.); thus, modelling challenges arose, and missing data had to be estimated. Moreover, various proxies had to be used for materials and processes either not represented in the databases or not characterised for Latin-American/ Peruvian conditions:

- Marine-grade steels used in Peru (ASTM A131-A and ASTM A36, classifications of the American Society for Testing and Materials) were modelled by modifying ecoinvent v2.2 steels. Characteristics of those steel alloys were obtained from an online material properties database (MATWEB 2012).
- Small electric engines and electric generators (<10 kW), water pumps, and similar equipment were modelled in terms of their dominant metal composition (steel and copper) and energy consumption when appropriate. Weights were obtained from vendors' specifications.
- Large combustion engines were modelled in terms of their metal composition, manufacturing, fuel consumption and maintenance (i.e., oil changes).
- Lead-acid batteries were modelled based upon their lead weight (Sullivan and Gaines 2010).
- *The Peruvian grid's* energy mix was modelled from existing process definitions and updated to represent the actual

Peruvian conditions *according to the last officially published comprehensive energy dataset (MINEM 2009)*.

- Wood was modelled by adapting existing ecoinvent records referring to tropical hardwoods (from Brazil) and considering the density of a common Peruvian construction wood type. Although illegal clear cutting is reported in Peru, we assumed that the wood used for the industrial steel fleet resulted from selective cutting.
- Antifouling paint compositions were obtained from vendors' specifications and an independent specialised laboratory analysis in France —one sample of each of the three main types of paint used in Peru (Online Resource 2). Most chemical components were already characterised in LCIA methods as waterborne emissions, including metal compounds (arsenic, copper, nickel, lead, zinc and tin) and tributyltin. Other biocides (sea-nine 211, dibutyltin, diphenyltin, triphenyltin, etc.) were not characterised in any LCIA method available.
- Diesel composition was adapted from ecoinvent v2.2 from a sample analysed by the above-mentioned independent specialised laboratory. In Peru, Diesel 2 blended with 2% biodiesel is used (mandatory since 2009). Since 2011, a blend of 5% biodiesel has been mandatory, but the level of enforcement is not clear.
- Other waterborne emissions, such as bilge oil and part of mineral oil, wastewater and

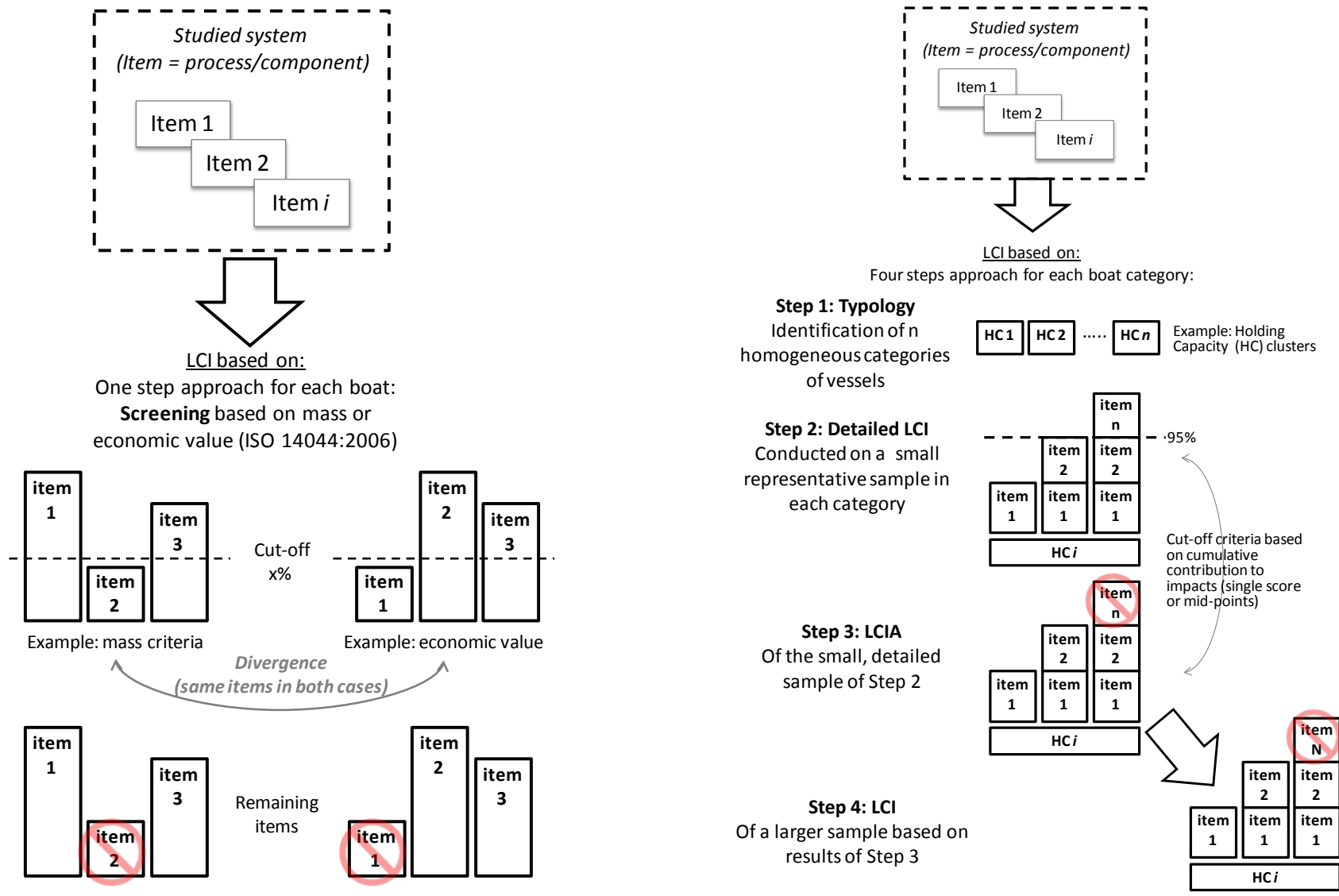
solid waste were not characterised in any LCIA method.

These customisations were all performed within ecoinvent, retaining the original background processes.

The retained ReCiPe method is a hybrid midpoint/endpoint method, featuring 18 midpoint impact categories aggregated into three endpoint categories or areas of protection: human health, ecosystem diversity and resource availability. Three different perspectives are available in the method: individualist, hierarchist and egalitarian. Each perspective represents a set of preferences regarding assumptions and choices for, basically, timeframes used for calculation of impacts and selection of impact types. The egalitarian perspective is the most precautionary, featuring longer time horizons and impact types which are not yet fully established (Goedkoop et al. 2009). This perspective was selected to remain as conservative as possible.

The final LCAs were performed on each vessel category separately for comparison purposes, using average values within a given category. Then, an overall LCA of the industrial steel segment of the fleet was obtained by performing a weighted averaging of all vessel categories, according to landings per category.





**Fig. 2** The effect of reducing LCI efforts on LCIA results: Comparing two boundary-refining approaches applied to the LCA of fishing vessels: left, ISO recommendation; right, this paper approach. According to the size of the fleet, step 3 can be applied to all vessels or to a large representative sample

**Table 1** Key inventory items for the provision of one t of landed *anchoveta* per holding capacity category. Some items contributed negligibly to impacts, as determined during boundary refining

| Input/<br>Output   | Holding capacity category                      | Unit           | Weighted<br>Average | 155-235 | 235-315 | 315-395 | 395-475 | 475-555 | 555-635 | >635 | <155 | Total      |
|--|--|----------------|---------------------|---------|---------|---------|---------|---------|---------|------|------|------------|
| <b>Basic data</b>  |  |                |                     |         |         |         |         |         |         |      |      |            |
|  | Population                                     | No.            |                     | 185     | 107     | 131     | 78      | 35      | 18      | 9    | 98   | <b>661</b> |
|  | Sample fuel use                                | No.            |                     | 64      | 38      | 88      | 64      | 29      | 16      | 4    | 13   | <b>316</b> |
|  | Sample other items (max)                       | No.            |                     | 22      | 12      | 34      | 34      | 12      | 12      | 3    | 6    | <b>135</b> |
|  | Light ship value (average)                     | t              |                     | 132     | 229     | 279     | 352     | 443     | 513     |      |      |            |
|  | Holding capacity (average)                     | m <sup>3</sup> |                     | 194     | 278     | 343     | 421     | 499     | 583     |      |      |            |
| <b>Construction</b>  |  |                |                     |         |         |         |         |         |         |      |      |            |
| I  | Ballast (concrete)*                            | g              | 100.0               | 116.3   | 101.4   | 93.8    | 94.6    | 119.0   | 94.4    |      |      |            |
| I  | Batteries (lead and sulphuric acid)*           | g              | 0.6                 | 1.3     | 0.9     | 0.7     | 0.5     | 0.5     | 0.4     |      |      |            |
| I  | Coils (copper wire)                            | g              | 1.1                 | 1.6     | 1.2     | 1.2     | 1.0     | 0.9     | 0.8     |      |      |            |
| I  | Electric network (copper wire)                 | g              | 5.3                 | 5.8     | 6.0     | 5.5     | 5.2     | 5.2     | 5.0     |      |      |            |
| I  | Engines (metals)                               | g              | 23.0                | 19.8    | 24.4    | 21.2    | 20.8    | 27.6    | 27.3    |      |      |            |
| I  | Fishing net (nylon, bronze, lead, steel, HDPE) | g              | 84.7                | 120.0   | 94.8    | 86.6    | 88.4    | 72.2    | 67.5    |      |      |            |
| I  | Hull and structure (marine steel)              | g              | 713.4               | 655.5   | 807.2   | 719.7   | 707.7   | 739.1   | 687.2   |      |      |            |
| I  | Propeller (bronze)                             | g              | 1.6                 | 1.3     | 11.3    | 1.0     | 0.9     | 0.8     | 0.8     |      |      |            |
| I  | Wood*  | g              | 172.6               | 188.7   | 197.1   | 179.5   | 167.1   | 166.6   | 161.0   |      |      |            |
| I  | Zinc*  | g              | 1.0                 | 0.7     | 0.5     | 1.2     | 1.2     | 1.1     | 0.7     |      |      |            |
| <b>Use</b>   |  |                |                     |         |         |         |         |         |         |      |      |            |
| O  | Antifouling emissions                          | g              | 10.4                | 16.8    | 15.0    | 12.6    | 8.6     | 8.6     | 6.4     |      |      |            |
| I  | Fuel use (2008-2010)                           | kg             | 15.6                | 14.6    | 15.4    | 15.6    | 16.1    | 16.6    | 14.5    |      |      |            |
| I  | Lubricant oil change*                          | g              | 80.6                | 123.6   | 99.8    | 76.0    | 77.2    | 80.7    | 66.0    |      |      |            |
| O  | Solid waste                                    | g              | 202.2               | 203.5   | 203.6   | 203.1   | 202.8   | 203.0   | 202.6   |      |      |            |
| <b>Maintenance (replenishment, fixtures or replacements)</b>     |  |                |                     |         |         |         |         |         |         |      |      |            |
| I  | Electric network and coils (copper wire)       | g              | 13.3                | 16.6    | 15.2    | 14.2    | 12.7    | 12.3    | 11.4    |      |      |            |
| I  | Engines (metals)                               | g              | 23.0                | 19.8    | 24.4    | 21.2    | 20.8    | 27.6    | 27.3    |      |      |            |
| I  | Fishing net (nylon, bronze, lead, steel, HDPE) | g              | 762.7               | 1,079.6 | 853.2   | 779.3   | 795.7   | 650.1   | 607.9   |      |      |            |
| I  | Hoses (rubber)*                                | g              | 7.0                 | 14.8    | 10.5    | 7.7     | 6.0     | 5.0     | 4.1     |      |      |            |
| I  | Hull (marine steel)                            | kg             | 1.5                 | 1.3     | 1.6     | 1.5     | 1.5     | 1.5     | 1.5     |      |      |            |
| I  | Hydraulic oil*                                 | g              | 34.2                | 56.8    | 40.3    | 40.7    | 31.8    | 26.6    | 21.8    |      |      |            |
| I  | Paint and antifouling                          | g              | 43.1                | 73.2    | 63.1    | 53.0    | 35.3    | 35.3    | 24.5    |      |      |            |
| I  | Wood*  | g              | 164.3               | 179.7   | 187.7   | 171.0   | 159.2   | 158.6   | 153.4   |      |      |            |
| <b>End of life (includes recycling during Maintenance phase)</b> |  |                |                     |         |         |         |         |         |         |      |      |            |
| O  | Engines (cast iron)                            | g              | 29.9                | 25.7    | 31.7    | 27.6    | 27.1    | 35.8    | 35.4    |      |      |            |
| O  | Electric network and coils (copper wire)       | g              | 23.1                | 27.9    | 26.2    | 24.3    | 22.6    | 21.6    | 20.2    |      |      |            |
| O  | Fishing net (lead)                             | g              | 122.0               | 175.1   | 137.8   | 124.9   | 126.7   | 103.6   | 96.6    |      |      |            |
| O  | Fishing net (nylon)                            | g              | 542.3               | 767.7   | 606.7   | 554.2   | 565.8   | 462.3   | 432.3   |      |      |            |
| O  | Hull and structure (marine steel)              | kg             | 2.2                 | 2.0     | 2.5     | 2.1     | 2.2     | 2.3     | 2.2     |      |      |            |

\* Inventory items NOT contributing to 95% accumulated impacts to either the overall impacts (ReCiPe single score), within impact categories (ReCiPe midpoints), and within each life cycle phase (ReCiPe single score). Impacts from waste water and used oils disposed at the sea were not characterised.

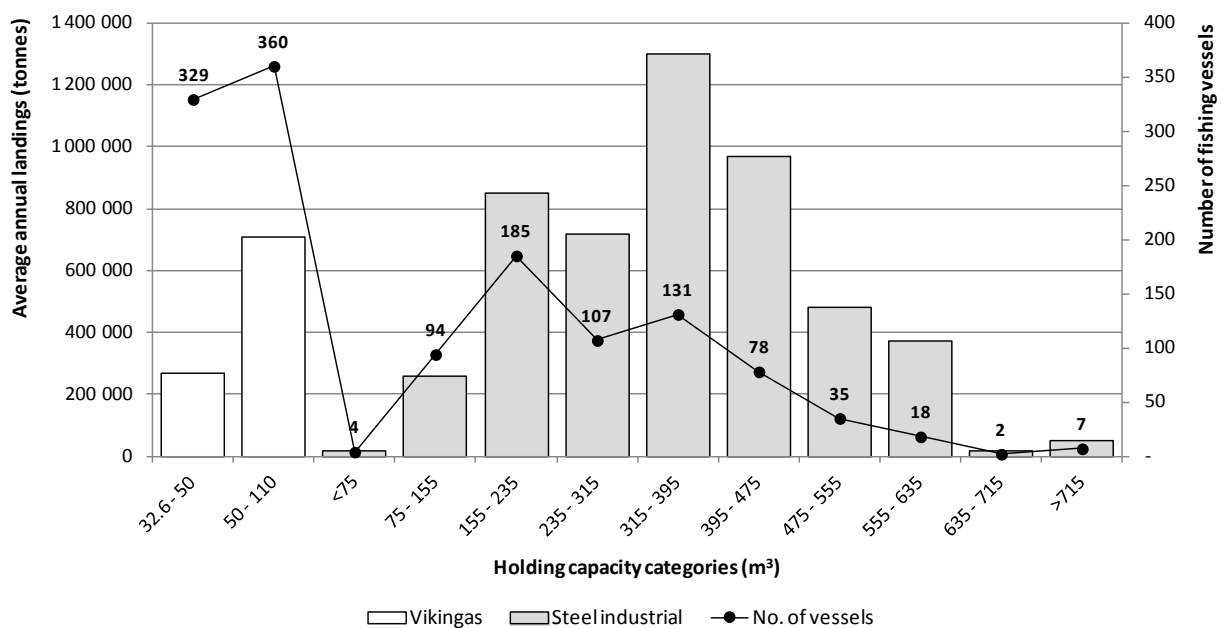
### 3 Results and discussion

#### 3.1 Inventory analysis

##### 3.1.1 Typology of fishing units

The holding capacity categories (sub-segments) representing more vessels and historical landings were found to be the 315-395 m<sup>3</sup> and the 395-475 m<sup>3</sup> segments. The smallest were found at each end of the distribution range, namely, the <155 m<sup>3</sup>

and >635 m<sup>3</sup> groups (Fig. 3). The 75-155 m<sup>3</sup> sub-segment includes a large number of vessels, yet it represents a minor contribution to overall landings in the 2005-2010 period (~4%). The two sub-segments above 635 m<sup>3</sup> contain only 7 vessels and represent ~1% of the historical industrial landings. The Vikinga fleet was included in Fig. 3 for scaling purposes (this fleet represents approximately 19% of landings).



**Fig. 3** Steel and wooden (“Vikinga”) anchoveta fleet landings (annual average 2005–2010) and number of fishing units per holding capacity category (all vessels operating from 2005 to 2010). Source: IMARPE data

The stratification of the sampling scheme was guided by the preliminary assumption that the best typology of the fleet could be based on categories of holding capacities. This assumption was assessed *a posteriori*, comparing the holding capacity criteria with alternatives such as the age of the fishing vessel or its overall length because we observed covariation among the three of them. Indeed, the holding capacity, overall length and level of equipment of a vessel are roughly inversely proportional to its age. A factor analysis was first performed on the most relevant LCI items (fuel consumption and weights of grade steel, engines, and antifouling paints) weighted by their contribution to the overall impact. Then, a

cluster analysis was performed on the first two factors. The results showed four clear clusters that were well-structured first by holding capacity, slightly less by overall length, and poorly by age. Age was less relevant than the two vessel size indices for two reasons: 1) additional equipment on recent vessels does not form part of the list of items contributing to the first 95% of overall impact, except for a small share of metals (additional engines and generators), and 2) age distribution is tri-modal with two major modes approximately 45 and 22 years old, and minor mode at 10, but these modes are not fully consistent with vessel size.

Linear discriminant analyses were performed to better assess the difference between a typology based on holding capacities versus a typology based on overall lengths and to determine whether we were too conservative in using seven clusters when the *a posteriori* cluster analysis suggests only four. The results showed a fairly good discrimination of the seven clusters of holding capacities, despite an overlap of the confidence ellipses of the three central classes (Online Resource 3), but an even better discrimination of clusters based on seven clusters of overall lengths, with an overlap of only two ellipses (Online Resource 4). The better performance of overall length was not expected because most of the mass of LCI items increases with volume rather than with length; however, the overall length of a vessel may better reflect its volume than does its holding capacity. Gross tonnage (*GT*) may be even more appropriate than overall length, but *GT* information was not always available to test this assumption. Another option could be to combine the three available vessel dimensions (length, width and depth) to estimate the *GT* as, for instance, Saetersdal et al. (1965) did.

All the above-mentioned multivariate analyses were performed on crude inventory data because these data were collected during the LCI stage. When the same analyses were performed on data per functional unit, results were much poorer, mainly because fuel consumption according to vessel size (or age) is largely optimised by fishing companies to minimise the scale effect (see below).

### 3.1.2 Initial detailed inventory

As expected, the initial detailed inventory resulted in the compilation of a large number of items per vessel, on the order of >40 items (Table 1 shows only the most important items). These values are largely above the number of items usually mentioned in the current literature, which is up to 8 items (Avadí and Fréon 2013), although it is not always clear if a boundary-refining approach had been applied first. In any case, our boundary-refined inventory (Table 1) contains some items

that were never considered in fisheries studies that are currently published, although these items belong to the items contributing to 95% of the cumulative impact in at least one impact category. These items include provision of copper, disposal of solid waste (although underestimated because it is characterized only as land field treatment for part of it since disposal at sea is not characterized), and impacts of paint other than antifouling releases as detailed below. The environmental impact of marine paints has often been limited to antifouling paint due to its release of toxic substances into the marine ecosystems (marine ecotoxicity). Nonetheless, other relevant impacts are freshwater eutrophication (4%), human toxicity (5.3%) and freshwater ecotoxicity (2.2%) resulting from the presence of other substances in both antifouling paints and larger quantities of oil paints for superstructures and interior of the vessels, including in their excipients.

### 3.1.3 Data calculation

In the context of the estimation of missing *LSW* values, a high correlation was found between *LSW* and the following variables: *holding capacity* ( $m^3$ ), *GT* (unitless index), *length* and *height* (m) but collinearity was found between *length* and *height*. Moreover, *GT* was also excluded from the explanatory variables due to the high number of missing values. Scatter plots of *LSW* versus each of the tested variables showed linearity, which justifies the use of a linear model. Finally, the best regression equation (adjusted  $r^2 = 0.79$ ) was found to be the following:

$$LSW = -263.81 + 0.57 \cdot \textit{holding capacity} + 43.77 \cdot \textit{width} \quad (1)$$

## 3.2 Impact assessment

### 3.2.1 Boundary-refining approach

Our approach, largely following the recommendations of ILCD (European Commission 2010) regarding cut-off criteria, combines the two suggested approaches (both seldom applied by LCA practitioners): “ a) apply the cut-off individually for each of the to-be-included impact

categories. This requires that the LCIA methods have been identified at that point; b) apply the cut-off for the normalised and weighted overall environmental impact. This requires that the LCIA methods, normalisation basis and the weighting set have been identified at that point". Our results indicate that the second approach results in more items retained in the LCI, as expected. Another difference between our approach and the ILCD approach is that we partly solved the issue of needing important approximations and extrapolations from the measured or calculated data separating the retained cut-off threshold from 100% because our initial detailed inventory on a small subsample is supposedly close enough to 100% to be considered as exhaustive. Our boundary-refining approach deals only with the inventory of items, not the background processes.

There are practical challenges in relating specific environmental impacts to inventory items defined as new processes created in SimaPro, in order to account separately for all upstream processes (typically fuel provision and combustion given that almost every process in SimaPro consumes fuel in one way or another). The way this difficulty and related ones were overcome is presented in Online Resource 5.

The major limitation of our approach is that it does not comply with one of the four criteria enunciated by Reynolds et al. (2000a) for an optimal system boundary selection: the optimal boundary selection method should "not require the quantification of environmental outputs from every unit process in the life-cycle system before system boundary selection", but it still presents the advantage of limiting inventory effort through sub-sampling when the means of production are plural and diverse.

The mass approach, using the cut-off criterion of 5%, results in selecting only 6 items from the detailed inventory versus 10 using the same criteria on per phase impacts (Table 2). As a result, the mass approach retained only 85% of impacts instead of the expected 95%. When extending the

5% cut-off criterion of our approach to individual impact categories, two additional items were retained: antifouling releases and solid waste.

Based upon such outcomes, and by applying our boundary-refining approach, the inventory data collection needs were redefined, and the inventory itself was refined to include the items presented in Table 7 and summarised in Fig. 1. Conservatively, several items whose impacts were found insignificant in other studies, including specific marine-grade steels and electronic equipment, were kept in the list because some of these issues were emblematic. This list of items does not contradict the more generic list in the Publicly Available Specification (PAS-2050-2) proposed by BSI (2012) for capture fisheries, but our list is more detailed and specific to purse-seiners fisheries.

The sometimes debatable allocation of some items of the LCI to the use or maintenance phase (e.g., antifouling repainting and engine lubricating oil changes) has an impact on the relative importance of these two phases and hence on the cut-offs of these items according to their relative contribution to the corresponding phase. Nonetheless, the option of using four phases instead of three after regrouping use and maintenance is more conservative and presents the advantage of outlining the importance of maintenance.

**Table 2** Comparison of inventory selection methods

| Phase   | Inventory item <sup>a</sup>                   | Mass <sup>b</sup><br>(g) | Accumulated<br>sum (g) | Accumulated<br>mass<br>contribution | Item contribution to overall<br>impacts |     |                             |      |
|---|---|--------------------------|------------------------|-------------------------------------|---|-----|-----------------------------|------|
|   |   |                          |                        |                                     | Mass method<br>(ranking)                |     | Impacts method<br>(ranking) |      |
| Use   | Fuel use (2008-2010)                          | 15,587.73                | 15,587.73              | 69.5%                               | 65.6%                                   | (1) | 65.6%                       | (1)  |
| EOL   | Hull and structure (marine steel)             | 2,195.08                 | 17,782.81              | 79.2%                               | 9.0%                                    | (2) | 9.0%                        | (2)  |
| Maintenance   | Hull (marine steel)                           | 1,472.35                 | 19,255.15              | 85.8%                               | 5.9%                                    | (3) | 5.9%                        | (3)  |
| Maintenance   | Fishing net (nylon, brass, lead, steel, HDPE) | 762.65                   | 20,017.81              | 89.2%                               | 0.8%                                    | (5) | -                           |      |
| Construction  | Hull and structure (marine steel)             | 713.39                   | 20,731.20              | 92.4%                               | 2.9%                                    | (4) | 2.9%                        | (5)  |
| EOL   | Fishing net (nylon)                           | 542.33                   | 21,273.53              | 94.8%                               | 0.6%                                    | (6) | -                           |      |
| Use   | Solid waste*                                  | 202.18                   | 21,475.71              | 95.7%                               | -                                       |     | -                           |      |
| <b>Contribution to overall impacts by a mass contribution (≥95%) method:</b>              |   |                          |                        |                                     | <b>84.8%</b>                            |     | <b>83.4%</b>                |      |
| Construction  | Wood*   | 172.56                   | 21,648.27              | 96.5%                               | -                                       |     | -                           |      |
| Maintenance   | Wood*   | 164.34                   | 21,812.61              | 97.2%                               | -                                       |     | -                           |      |
| EOL   | Fishing net (lead)*                           | 122.01                   | 21,934.61              | 97.7%                               | -                                       |     | 1.2%                        | (9)  |
| Construction  | Ballast (concrete)*                           | 100.00                   | 22,034.62              | 98.2%                               | -                                       |     | -                           |      |
| Construction  | Fishing net (nylon, brass, lead, steel, HDPE) | 84.74                    | 22,119.36              | 98.6%                               | -                                       |     | -                           |      |
| Use   | Lubricant oil change*                         | 80.55                    | 22,199.91              | 98.9%                               | -                                       |     | -                           |      |
| Maintenance   | Paint and antifouling*                        | 43.15                    | 22,243.06              | 99.1%                               | -                                       |     | -                           |      |
| Maintenance   | Hydraulic oil*                                | 34.24                    | 22,277.30              | 99.3%                               | -                                       |     | -                           |      |
| EOL   | Engines (cast iron)                           | 29.94                    | 22,307.24              | 99.4%                               | -                                       |     | -                           |      |
| EOL   | Engines (chrome steel)                        | 24.00                    | 22,331.24              | 99.5%                               | -                                       |     | -                           |      |
| EOL   | Electric network and coils (copper wire)      | 23.12                    | 22,354.36              | 99.6%                               | -                                       |     | 2.9%                        | (6)  |
| Construction  | Engines (metals)                              | 23.03                    | 22,377.39              | 99.7%                               | -                                       |     | -                           |      |
| Maintenance   | Engines (metals)                              | 23.03                    | 22,400.42              | 99.8%                               | -                                       |     | -                           |      |
| Maintenance   | Electric network and coils (copper wire)      | 13.27                    | 22,413.69              | 99.9%                               | -                                       |     | 1.9%                        | (7)  |
| Use   | Antifouling emissions                         | 10.40                    | 22,424.09              | 99.93%                              | -                                       |     | 1.6%                        | (8)  |
| Maintenance   | Hoses (rubber)*                               | 6.99                     | 22,431.09              | 99.96%                              | -                                       |     | -                           |      |
| Construction  | Electric network (copper wire)                | 5.33                     | 22,436.42              | 99.98%                              | -                                       |     | 0.9%                        | (10) |
| Construction  | Propeller (bronze)                            | 1.64                     | 22,438.06              | 99.988%                             | -                                       |     | 3.3%                        | (4)  |
| Construction  | Coils (copper wire)                           | 1.05                     | 22,439.12              | 99.993%                             | -                                       |     | -                           |      |
| Construction  | Zinc*   | 1.04                     | 22,440.15              | 99.997%                             | -                                       |     | -                           |      |
| Construction  | Batteries (lead and sulphuric acid)*          | 0.62                     | 22,440.78              | 100%                                | -                                       |     | -                           |      |
| <b>Contribution to overall impacts by the proposed impact contribution (≥95%) method:</b> |   |                          |                        |                                     | <b>84.8%</b>                            |     | <b>95.2%</b>                |      |

<sup>a</sup> Items are ranked according to their mass contribution. <sup>b</sup> Weighted average of all vessel categories modelled.

\* Items do not contribute to either at least 95% of mass or of overall impacts (Table 4).

**Table 3** Summary of landings and fuel consumption per holding capacity category of the six largest companies in the Peruvian *anchoveta* steel fleet (2008-2010). Source: Fishing companies

| Holding capacity categories                                     | Number of vessels |                         | (A) Average annual fuel use (kg) | (B) Average annual landings (t) | TOTAL LANDINGS (t)    |                         | (A/B) Fuel use per landed tonne (kg/t) | Category contribution to total landings |                         |
|---|-------------------|-------------------------|----------------------------------|---------------------------------|-----------------------|-------------------------|--|---|-------------------------|
|   | Whole fleet       | Six companies 2008-2010 | Six companies 2008-2010          | Six companies 2008-2010         | Whole fleet 2004-2010 | Six companies 2008-2010 | Six companies 2008-2010                | Whole fleet 2004-2010                   | Six companies 2008-2010 |
| <75   | 4                 | 1                       | 25,358                           | 957                             | 113,206               | 2,871                   | 26.50                                  | 0.4%                                    | 0.0%                    |
| 75-155  | 94                | 12                      | 36,962                           | 2,321                           | 1,498,412             | 27,853                  | 15.92                                  | 5.2%                                    | 0.4%                    |
| 155-235   | 185               | 64                      | 68,841                           | 4,729                           | 4,920,710             | 539,075                 | 14.56                                  | 17.1%                                   | 7.4%                    |
| 235-315   | 107               | 38                      | 102,812                          | 6,659                           | 4,357,091             | 512,778                 | 15.44                                  | 15.2%                                   | 7.0%                    |
| 315-395   | 131               | 88                      | 141,346                          | 9,066                           | 7,246,080             | 1,976,325               | 15.59                                  | 25.2%                                   | 27.1%                   |
| 395-475   | 78                | 64                      | 186,636                          | 11,622                          | 5,310,682             | 2,010,608               | 16.06                                  | 18.5%                                   | 27.6%                   |
| 475-555   | 35                | 29                      | 230,829                          | 13,868                          | 2,754,685             | 1,178,780               | 16.64                                  | 9.6%                                    | 16.2%                   |
| 555-635   | 18                | 16                      | 246,080                          | 16,952                          | 2,178,183             | 796,742                 | 14.52                                  | 7.6%                                    | 10.9%                   |
| 635-715   | 2                 | 2                       | 322,135                          | 16,360                          | 101,675               | 147,239                 | 19.69                                  | 0.4%                                    | 2.0%                    |
| 715-795   | 1                 | 1                       | 397,996                          | 15,511                          |                       | 46,532                  | 25.66                                  |   | 0.6%                    |
| >795  | 6                 | 1                       | 382,079                          | 18,342                          | 275,042               | 55,027                  | 20.83                                  | 1.0%                                    | 0.8%                    |
| <b>Total:</b>   | <b>661</b>        | <b>316</b>              | <b>2,141,074</b>                 | <b>Total: 28,755,766</b>        | <b>7,293,830</b>      |                         |  | <b>100%</b>                             | <b>100%</b>             |
| Weighted average fuel use per landed tonne of anchoveta (kg/t): |                   |                         |                                  |                                 |                       |                         |  | <b>15.62</b>                            | <b>15.88</b>            |

1 gal = 3.7854 L, 1 L marine diesel = 0.9 kg

### 3.2.2 Impact assessment of the refined inventory of the Peruvian anchoveta industrial fleet

LCI data show the benefits of scale but challenge the idea that “bigger is better”, as exemplified by the behaviour of the material flow per t of landed *anchoveta* associated with increasing holding capacity not strictly decreasing for all items (e.g. engine and hull steel), as shown in Table 1.

The variability between holding capacity categories was lower than expected (limited scale effect), likely due to the optimal strategy of use of the fleet by companies that usually own all the range of categories and use them according to the abundance of the resource and its distance from the harbour. Surprisingly, some of the largest vessels impact more than the medium-sized vessels due to the difficulty they have in filling their hold during the usual duration of a trip that seldom exceeds 24-30 h. This short duration results from the absence of a refrigeration facility in most of the vessels, or from the use of this facility by equipped vessels during only short periods (pulses). Continuous use is prevented by *anchoveta* scales blocking the circulation system (this issue has been solved by some companies after we completed this study). Understanding and explaining the variability within and between categories of holding capacity in more detail was not possible from the dataset alone, so further data were collected (e.g., historical data of consumption, Vessel Monitoring System data) and analysed to explain the phenomenon. The discussion on the effects of these factors on fuel consumption variability exceeds the scope of this paper and will thus be addressed in a separate paper by the authors. A summary of landings and fuel consumption is shown in Table 3.

A comparison with other reduction fisheries is presented in Table 6, showing that the Peruvian industrial *anchoveta* fishery displays the lowest fuel use intensity in the world on a per landed tonne basis, a fact that could be concluded from this study. Indeed the only other fisheries that compete with the Peruvian one are some of the

North Atlantic fisheries (e.g. capelin, *Mallotus villosus*), but these fisheries operate for a very short reproductive period of high catchability. Furthermore from the world database of fuel use intensity constructed by Tyedmers et al. (2005) and post-processing, there are no other documented industrial fisheries that display lower rates (Peter Tyedmers, Dalhousie University, pers. comm.).

The comparison of the performances of the different fleets do not seem related to the destination of landing despite the likely competitive advantages of fleet landing for reduction (no or little preservation; bulk storage; large holding capacity allowed). Indeed the second best performing fleet is the Basque DHC fishery of Atlantic mackerel and there is no link between the average vessel size and fuel use intensity. It is likely that the Peruvian fleet benefits from high abundance and catchability of the Peruvian *anchoveta* when compared to every other species. The biomass has been fluctuating between 5 and 10 million t since the 97/98 strong El Niño event (Oliveros-Ramos et al. 2010) and our study period is representative of this level of abundance. Although the underlying processes determining such abundance in Peru are still debated (Fréon et al. 2009, Chavez et al. 2008, Brochier et al. 2011, Bertrand et al. 2011), an inverse correlation between increase in abundance and fuel use of the fishery has been observed in other fisheries (Ziegler and Hornborg 2013). *Anchoveta* fish schools remain in the upper 25 m in most fishing grounds all year long due to a shallow oxycline in coastal waters that limit their vertical habitat (Bertrand et al. 2010) and make them available to purse-seiners nearly all year long. Furthermore, compared to tuna or mackerel, anchoveta are more coastal species and therefore fishing grounds are located closer to the coast, which limits fuel consumption.

The goal and definition of scope determined the initial study perimeter to be the construction, operation and disposal of *anchoveta* steel vessels. The LCIA produced predictable outcomes in terms

of the overall results: the use phase of fishing vessels is the most important in terms of impacts, and within that phase, fuel is the leading inventory item contributing to impacts with 65.5% of overall impacts, a value that is much higher (~90%) in more fuel intensive fisheries (Table 6). Other relevant single sources of impacts include the provision of nylon for the fishing nets during maintenance and the provision of metals during the construction and maintenance phases (steel, brass, copper). The following contributions to overall impacts were observed per phase: construction: ~11%, use: ~66%, maintenance: ~23% and EOL: -0.4%. All of the above-mentioned results correspond to one average t of *anchoveta* landed by the Peruvian industrial fleet exploiting the Peruvian north-central stock during the period 2008-2010. Detailed contribution to impacts is described in Table 4 (per inventory item) and Table 5 (per holding capacity category).

It is worth noting that PAS-2050-2 omits construction materials. Nonetheless, in fisheries that display higher rates of fuel use than the Peruvian one, the relative contribution of the construction phase to the total environmental impact is automatically lower. For the same reason the list of non-fuel-related items or subsystems retained in the boundary-refining approach is certainly longer in our case study than it will be in other more fuel intensive fisheries when using the same approach, a statement already made by Ramos et al. (2012), who also studies a fishery with low fuel intensity.

An uncertainty analysis of the relevance of various steel types was performed by comparing and applying a Monte Carlo analysis to a vessel, considering standard *ecoinvent* steel and customised marine-grade steels ASTM A131-A and AST A36. After 300 iterations, the results show that in every impact category in ReCiPe and >95% of the time, impacts (mostly metal depletion) will not increase significantly when specific marine steel types are modelled. Modelling specific marine grade steel types (carbon steel) is irrelevant, despite the fact that there are dramatic

differences between ASTM A131-A and AST A36. Nonetheless, one must make the distinction between chrome steels and carbon steels.

An *a priori* assumption was that antifouling releases would be relevant. Preliminary LCIA results proved that antifouling emissions contribute little to the environmental impacts of this fishery, despite the fact that essential metals (copper and zinc) are included in the ReCiPe egalitarian perspective we used. Marine ecotoxicity results were generated using CML methods as well (Guinée et al., 2001a,b), as shown in Table 5, to compare this study with other studies dealing with antifouling emissions, such as those by Hospido and Tyedmers (2005). CML baseline 2000, the most used method in previous LCA studies, applies an infinite time perspective for calculating marine ecotoxicity. Thus we observe huge differences when such results are compared against results obtained with CML 2001 for shorter time horizon (e.g. 500a) or ReCiPe (x41 and x24 respectively), which relate more between them, whereas USETox provide values similar to CML 2000 (x 1.25). Moreover, we have found that vessel LCIA results are very sensitive to the amount of copper modelled in the LCI in terms of toxicity. Because Hospido and Tyedmers (2005) did not explicitly model copper wiring (Peter Tyedmers, Dalhousie University, pers. comm.) — the main contributor to marine ecotoxicity in our model— their model assigns a higher relevance to antifouling emissions within that category. Indeed electrical wiring is often overlooked in LCI because this item is not at sight, even in shipyards. In modern vessels, copper weight in electrical wiring is expressed in 10<sup>th</sup> km of cable can be roughly estimated at 1 t per 10 m of overall length of the vessel, according to consulted engineers. In the compiled LCI, copper figures are less than that ratio, due to the age of the fleet.

Wood use, despite the fact that this material comes from primary forest in Peru and is used in large quantities (e.g., 84 t over the life cycle of a vessel in the 395-475 m<sup>3</sup> category), also contributes negligibly, which was unexpected. This



negligible contribution is due to a much higher contribution of soybean oil (as constituency of the Diesel 2/biodiesel mixture used in Peru) to impact category Natural Land Transformation, and to the fact that we consider selective extraction, excluding clear cutting.

As underlined by Parker (2012) comprehensive LCA of the whole Peruvian *anchoveta* fleet, including the steel and wooden fleets, will be useful to inform environmental assessment studies of supply chains based upon *anchoveta* fishmeal and fish oil worldwide, especially studies of cultured seafood products consuming high fishmeal/fish oil containing feeds. Such ongoing work, and others at the national scale, benefits from the results of the present study by limiting the relevant items to be included in the inventory and at the same time including others that are of importance but often overlooked in similar works. These studies, in particular the current one, allow some recommendations to be made to the Peruvian fishing sector, as summarised below.

**Table 4** Analysis of impact contribution of different inventory items to one average t of *anchoveta* expressed in percentages of three different references (ReCiPe endpoint): the overall impacts (single score), within impact categories, and within each life cycle phase

| Inventory items                                     | Contribution per impact category, across phases (midpoints) |                 |                           |                           |                       |                |                             |                              |                         |                        |                    |                    |                              |                       |                             |                 |                 |                  | Contribution per phase, across impact categories (endpoints) |             |             |             | Contribution to overall impacts (endpoints) |  |
|---|---|-----------------|---------------------------|---------------------------|-----------------------|----------------|-----------------------------|------------------------------|-------------------------|------------------------|--------------------|--------------------|------------------------------|-----------------------|-----------------------------|-----------------|-----------------|------------------|--|-------------|-------------|-------------|---|--|
|   | Climate change  | Ozone depletion | Terrestrial acidification | Freshwater eutrophication | Marine eutrophication | Human toxicity | Photochemical oxidant form. | Particulate matter formation | Terrestrial ecotoxicity | Freshwater ecotoxicity | Marine ecotoxicity | Ionising radiation | Agricultural land occupation | Urban land occupation | Natural land transformation | Water depletion | Metal depletion | Fossil depletion | Construction   | Use         | Maintenance | EOL         |   |  |
| Fuel  | 86.2  | 94.2            | 93.9                      | 27.1                      | 86.3                  | 34.3           | 96.3                        | 90.5                         | 71.5                    | 31.8                   | 9.2                | 57.8               | 92.0                         | 63.4                  | 98.7                        | 41.3            | 1.1             | 85.7             | 99.0   |             |             |             | <b>65.6</b>                                 |  |
| Hull, structural elements, engines (steel and iron) | 6.1   | 2.6             | 2.4                       | 46.0                      | 2.1                   | 26.7           |                             | 5.8                          | 14.5                    | 48.2                   | 18.9               | 37.8               | 6.0                          | 29.5                  |                             | 28.2            | 88.2            | 7.4              | 68.2   | 52.9        | 41.1        |             | <b>18.2</b>                                 |  |
| Electric network and coils (copper wire)            |   |                 |                           | 11.5                      |                       | 15.7           |                             |                              | 7.7                     | 6.5                    | 4.0                |                    |                              | 1.7                   |                             |                 | 2.3             |                  | 14.1   | 14.6        | 21.5        |             | <b>4.9</b>                                  |  |
| Fishing gear, propeller (bronze)                    |   |                 |                           | 7.1                       |                       | 9.8            |                             |                              | 4.7                     | 4.0                    | 2.5                |                    |                              | 1.2                   |                             |                 | 4.9             |                  | 5.4  | 11.8        |             |             | <b>3.3</b>                                  |  |
| Paints and antifouling                              |   |                 |                           | 4.0                       |                       | 5.3            |                             |                              |                         | 2.2                    |                    |                    |                              |                       |                             |                 |                 |                  | 1.0  | 6.7         |             |             | <b>1.6</b>                                  |  |
| Fishing gear (nylon)                                | 2.7   |                 |                           |                           | 5.4                   |                |                             |                              |                         | 4.5                    |                    |                    |                              |                       |                             | 25.9            |                 | 3.2              | 2.7  | 6.1         | 31.3        |             | <b>1.5</b>                                  |  |
| Fishing gear (lead)                                 |   |                 |                           |                           |                       | 3.5            |                             |                              |                         |                        |                    |                    |                              |                       |                             |                 |                 |                  | 1.0  | 4.6         | 5.1         |             | <b>1.2</b>                                  |  |
| Electronic equipment                                |   |                 |                           |                           |                       |                |                             |                              |                         |                        |                    |                    |                              |                       |                             |                 |                 |                  | 2.6  |             |             |             |   |  |
| Antifouling releases                                |   |                 |                           |                           |                       |                |                             |                              |                         | 61.3                   |                    |                    |                              |                       |                             |                 |                 |                  |  |             |             |             |   |  |
| Solid waste   |   |                 |                           |                           | 1.3                   |                |                             |                              |                         |                        |                    |                    |                              |                       |                             |                 |                 |                  |  |             |             |             |   |  |
| Sum contributions:                                  | 95.0  | 96.8            | 96.3                      | 95.8                      | 95.1                  | 95.3           | 96.3                        | 96.3                         | 98.4                    | 97.2                   | 95.8               | 95.6               | 98.0                         | 95.8                  | 98.7                        | 95.4            | 96.5            | 96.3             | 95.0   | 99.0        | 96.6        | 99.0        | 96.3  |  |
| Phase contribution to the whole life cycle:         |   |                 |                           |                           |                       |                |                             |                              |                         |                        |                    |                    |                              |                       |                             |                 |                 |                  |  | <b>11.4</b> | <b>66.2</b> | <b>22.7</b> | <b>-0.4</b>                                 |  |

All figures are expressed in %. Contributing items represent >=95% of impacts (cumulative contribution of processes, descending order).

**Table 5** Life cycle impacts associated with the provision of one t of landed anchoveta by different vessel holding capacity categories, using all inventoried items. Based on an extended sample (135 vessels) of LCI

| LCIA Method                                    | Impact category                       | Unit            | Holding capacity categories |              |              |              |              |              | Weighted average |
|--|---------------------------------------|-----------------|-----------------------------|--------------|--------------|--------------|--------------|--------------|------------------|
|  |                                       |                 | 235 m3                      | 315 m3       | 395 m3       | 475 m3       | 555 m3       | 635 m3       |                  |
| ReCiPe midpoint (excluding Marine ecotoxicity) | Climate change                        | kg CO2 eq       | 64.64                       | 68.34        | 67.79        | 69.41        | 71.51        | 62.96        | 67.68            |
|  | Ozone depletion                       | kg CFC-11 eq    | 7.11E-06                    | 7.54E-06     | 7.55E-06     | 7.74E-06     | 8.02E-06     | 7.02E-06     | 7.54E-06         |
|  | Terrestrial acidification             | kg SO2 eq       | 0.69                        | 0.72         | 0.73         | 0.75         | 0.77         | 0.67         | 0.73             |
|  | Freshwater eutrophication             | kg P eq         | 7.01E-03                    | 7.24E-03     | 6.68E-03     | 6.50E-03     | 6.61E-03     | 6.01E-03     | 6.56E-03         |
|  | Marine eutrophication                 | kg N eq         | 0.04                        | 0.04         | 0.04         | 0.05         | 0.05         | 0.04         | 0.04             |
|  | Human toxicity                        | kg 1,4-DB eq    | 435.41                      | 430.40       | 400.61       | 388.23       | 388.64       | 350.54       | 391.15           |
|  | Photochemical oxidant formation       | kg NMVOC        | 0.84                        | 0.89         | 0.90         | 0.92         | 0.95         | 0.83         | 0.90             |
|  | Particulate matter formation          | kg PM10 eq      | 0.23                        | 0.25         | 0.24         | 0.25         | 0.26         | 0.23         | 0.24             |
|  | Terrestrial ecotoxicity               | kg 1,4-DB eq    | 0.03                        | 0.03         | 0.03         | 0.03         | 0.03         | 0.02         | 0.03             |
|  | Freshwater ecotoxicity                | kg 1,4-DB eq    | 0.25                        | 0.27         | 0.25         | 0.25         | 0.25         | 0.23         | 0.25             |
|  | Ionising radiation                    | kg U235 eq      | 1.84                        | 1.99         | 1.90         | 1.91         | 1.99         | 1.78         | 1.89             |
|  | Agricultural land occupation          | m2a             | 1.45                        | 1.54         | 1.54         | 1.57         | 1.63         | 1.43         | 1.53             |
|  | Urban land occupation                 | m2a             | 0.16                        | 0.17         | 0.16         | 0.16         | 0.17         | 0.15         | 0.16             |
|  | Natural land transformation           | m2              | 0.07                        | 0.07         | 0.07         | 0.07         | 0.08         | 0.07         | 0.07             |
|  | Water depletion                       | m3              | 0.18                        | 0.18         | 0.17         | 0.17         | 0.17         | 0.15         | 0.17             |
| Metal depletion                                | kg Fe eq                              | 18.84           | 21.95                       | 19.69        | 19.42        | 20.18        | 18.92        | 19.60        |                  |
| Fossil depletion                               | kg oil eq                             | 21.14           | 22.13                       | 21.92        | 22.43        | 23.02        | 20.26        | 21.87        |                  |
| ReCiPe endpoint                                | Human Health                          | Pt (DALY)       | 15.29                       | 15.91        | 15.38        | 15.44        | 15.79        | 14.05        | 15.24            |
|  | Ecosystems                            | Pt (species.yr) | 9.89                        | 10.12        | 9.73         | 9.71         | 9.87         | 8.79         | 9.61             |
|  | Resources                             | Pt (\$)         | 1.45                        | 1.53         | 1.54         | 1.58         | 1.63         | 1.42         | 1.53             |
|  | <b>Single Score</b>                   | <b>Pt</b>       | <b>15.29</b>                | <b>15.91</b> | <b>15.38</b> | <b>15.44</b> | <b>15.79</b> | <b>14.05</b> | <b>15.24</b>     |
| CED  | Cumulative Energy Demand              | MJ              | 1,002                       | 1,050        | 1,037        | 1,059        | 1,087        | 958          | 1,034            |
| Various toxicity methods                       | <b>Human toxicity + ecotoxicity</b>   |                 |                             |              |              |              |              |              |                  |
|  | USETox <sup>a</sup>                   | CTU             | 22.54                       | 23.89        | 24.12        | 24.84        | 25.74        | 22.45        | 24.11            |
|  | <b>Marine ecotoxicity<sup>b</sup></b> |                 |                             |              |              |              |              |              |                  |
|  | ReCiPe                                | kg 1,4-DB eq    | 1,107                       | 1,033        | 897          | 702          | 704          | 575          | 787              |
| CML2000 and CML 2001 infinite                  | kg 1,4-DB eq                          | 22,147          | 22,006                      | 20,126       | 18,591       | 18,783       | 16,588       | 19,179       |                  |
| CML 2001 500a                                  | kg 1,4-DB eq                          | 654             | 609                         | 530          | 415          | 416          | 340          | 465          |                  |

<sup>a</sup> USETox features no characterisation factors for certain antifouling substances released in water (i.e. copper and tributyltin compounds).

<sup>b</sup> Differences in results among methods arise from differences in timeframes and characterisation factors.

**Table 6** Fuel efficiency on a per landed t basis, selected reduction fisheries

| Source                           | kg fuel per t fish  | Vessel size (m <sup>3</sup> ) <sup>a</sup> | Allocation       | Contribution <sup>b</sup> | Targeted species  | Fleet                                  | Gear                   | Destination of landings  |
|----------------------------------|---------------------|--|------------------|---------------------------|---|--|------------------------|--------------------------|
| Vázquez-Rowe et al. (2010)       | 176                 | 635  | mass             | 95.1%                     | Horse mackerel  | Galician fishery                       | purse seining          | DHC <sup>c</sup> (fresh) |
| Thrane (2004a)                   | 129                 | 395  | system expansion | 92.7%                     | Herring   | Average of Danish fisheries            | trawling/purse seining | Reduction and DHC        |
| Schau et al. (2009)              | 90                  | N/A  | N/A              | N/A                       | Small pelagics  | Average of Norwegian fisheries         | trawling/purse seining | Reduction                |
| Thrane (2004a)                   | 83                  | 395  | system expansion | 89.1%                     | Industrial fish (sandeel, European sprat, Norway pout)                              | Average of Danish fisheries            | trawling               | Reduction                |
| R. Parker (pers. comm., 09.2013) | 81                  | N/A  | N/A              | N/A                       | South Australian pilchard   | Indian Ocean                           | purse seining          | Reduction                |
| Driscoll and Tyedmers (2010)     | 75                  | 635  | N/A              | 89.3%                     | Herring   | Average of North Atlantic fisheries    | trawling/purse seining | Mainly for lobster bait  |
| Parker and Tyedmers (2012)       | 72-172 <sup>d</sup> | N/A  | N/A              | N/A                       | Capelin, herring, sand eels, mackerel, krill  | Average of Atlantic fisheries          | trawling               | Reduction                |
| Ellingsen and Aanondsen (2006)   | 70                  | 395  | mass             | 87.3%                     | Small pelagics  | Average of Norwegian fisheries         | trawling/purse seining | Reduction                |
| Ramos et al. (2011)              | 35                  | 395  | temporal         | 78.1%                     | Atlantic mackerel   | Basque fishery                         | mainly purse seining   | DHC (fresh and canned)   |
| Parker and Tyedmers (2012)       | 18-126 <sup>e</sup> | N/A  | N/A              | N/A                       | Capelin, herring, menhaden, mackerel, blue whiting, sand eels, other small pelagics | Average of North Atlantic fisheries    | purse seining          | Reduction                |
| Tyedmers (2004)                  | 18-99 <sup>f</sup>  | 635  | N/A              | 85.2%                     | Small pelagics  | Average of North Atlantic fisheries    | purse seining          | Reduction                |
| Parker and Tyedmers (2012)       | 17 <sup>g</sup>     | 395  | N/A              | 63.4%                     | Peruvian anchoveta  | Average of Peruvian industrial fishery | purse seining          | Reduction                |
| This study                       | 15.6                | 395  | none             | 60.5%                     | Peruvian anchoveta  | Average of Peruvian industrial fleet   | purse seining          | Reduction                |

<sup>a</sup> Holding capacity estimated from literature and adapted to a similar Peruvian fleet vessel size. <sup>b</sup> Contribution of fuel use and provision to overall impacts (ReCiPe endpoint, single score). <sup>c</sup> DHC: Direct human consumption. <sup>d</sup> This range corresponds to 4 North Atlantic fisheries and the South Atlantic krill fishery (average: 107). <sup>e</sup> This range corresponds to 8 North Atlantic fisheries (average: 66). <sup>f</sup> This range corresponds to 7 reduction fisheries in the late 1990s (average: 52). Values were estimated from landings and effort data and corroborated with a limited number of specific fuel usage data (P. Tyedmers, pers. comm., 09.2013). <sup>g</sup> The original source for this figure is a personal communication with a large Norwegian aquafeed producer, as mentioned in Winther et al. (2009).

**Table 7** Recommended level of detail (ad minima) for LCIs of purse seiners without processing plant or cooling system on board, after boundary refining, and contributions observed in our case study

| Item group   | Attributes  | Phase contribution <sup>a</sup> |       |
|--|---|---------------------------------|-------|
| <b>Construction phase</b>  |   |                                 |       |
| Hull   | Material and mass   | 11.4%                           |       |
| Structural elements  | Material and mass   |                                 |       |
| Main engine  | Materials and mass (cast iron, chrome steel, carbon steel, copper wire and aluminium alloy)           |                                 |       |
| Auxiliary skiff ("panga")  | Material and mass   |                                 |       |
| Electric motors, pumps, electric generators, etc.  | Materials and mass (cast iron, chrome steel, carbon steel, copper wire and aluminium alloy)           |                                 |       |
| Electric system  | Materials and mass of subsystems (wiring, transformers, electric generators and pumps; steel, copper) |                                 |       |
| Propulsion system  | Materials and mass (transmission, propeller)  |                                 |       |
| Fishing gear   | Materials and mass (nylon, lead, brass)   |                                 |       |
| Paint and antifouling  | Substances and mass (active substances, excipients)   |                                 |       |
| Batteries  | Material and mass (lead, sulphuric acid, glass, etc.)   |                                 |       |
| Ballast  | Material and mass   |                                 |       |
| <b>Use phase</b>   |   |                                 |       |
| Fuel   | Mass  |                                 | 66.2% |
| Solid waste (disposed at sea)  | Mass  |                                 |       |
| Wastewater (disposed at sea)   | Volume, BOD/COD   |                                 |       |
| Lubricant oil (disposed at sea)  | Mass  |                                 |       |
| Antifouling releases   | Mass  |                                 |       |
| Catches and discards of target and non-target species <sup>b</sup>   | Masses and by-catch/discards characterisation   |                                 |       |
| <b>Maintenance phase</b>   |   |                                 |       |
| Paint and antifouling  | Frequency and mass  | 22.7%                           |       |
| Fishing gear   | Mass  |                                 |       |
| Hull fixings   | Materials (steel, wood) and mass  |                                 |       |
| Engine replacement   | Frequency   |                                 |       |
| Electric motors, pumps, electric generators, etc; replacement  | Frequency and mass  |                                 |       |
| Batteries replacement  | Frequency and mass  |                                 |       |
| <b>End-of-Life phase</b>   |   |                                 |       |
| Not relevant (vessel elements recycled, namely steel, copper, nylon, lead, electronics, oils, wood and paints) |   | -0.4%                           |       |

<sup>a</sup> Contribution to overall impacts in the Peruvian steel fleet, according to impact assessment method ReCiPe endpoint (single score). <sup>b</sup> Catches and discard data should be also compiled, to compute species removal impact categories not currently formalised in LCA practice.

#### 4 Conclusions and recommendations

Collecting inventory data based on our boundary-refining approach of assessing contributions to impacts at various levels should allow future LCA studies of purse seining fleets to fully assess the environmental performance of these fleets.

It became obvious that the construction, maintenance and EOL stages of the life cycle of fishing vessels have a substantial environmental impact and should not be ignored in the LCI, although the use stage remains by far the most important source of environmental impact. The following items (some of them belonging to the use stage) are too often missing in fishing vessel inventories: metals other than cast iron, lubricating oil disposed at sea, nylon, electronic equipment, copper wire from the electrical system and generators, etc. (Avadi and Fréon 2013), and some of them might be relevant in specific cases. The maintenance phase, especially in common cases like the Peruvian *anchoveta* fleet where large volumes of materials are replaced over the vessel life cycle, is particularly sensitive to the level of detail in characterisations (e.g., certain varieties of steel such as chrome steel) and replenishment/replacement frequency. The importance of these non-use phases is exacerbated by the relatively low level of the fuel use intensity when compared to other fisheries.

We claim that the results of our study can be generalised for purse seiner LCA studies in general (at least those without processing plant or cooling system on board), and propose as sufficient and efficient the level of detail shown in Table 7. Catches and discard data should also be compiled to compute species removal impact categories not currently formalised in LCA practice.

The Peruvian steel *anchoveta* fleet is shown to display the lowest fuel use intensity worldwide, largely due to the great abundance and catchability (including availability and accessibility) of the targeted stock. This first LCA (and a comprehensive LCA of the entire *anchoveta* fleet, which is in progress) contributes to the

understanding of the environmental pressures exerted by this important fishery. It will need to be updated when a strong El Niño event will occur and modify the levels of abundance and catchability of the stock, hence the fuel use intensity of the fleet.

This study allows for environmental recommendations. Although the fleet is the least fuel intensive, fuel production and use remains the most contributing impact and fuel use intensity can be improved. The fleet is ageing and only some vessels benefit from the latest technological advances that allow energy saving either directly (e.g. electronic fuel injection engines, bulbous bow) or indirectly through yield increase (e.g. last generation of sonar and echosounder, navigation and communication means). A work in progress will detail actions aimed at decreasing fuel use. Hull construction and maintenance is the second item most contributing to environmental impacts. Alternative modern materials of construction exist and are used in other fisheries but only a consequential LCA could determine whether or not their environmental performance is better than steel. A traditional construction material, wood, is used in Peru by the semi-industrial fleet and a work in progress is comparing its benefit to steel's. Electrical network comes third in the list of the most impacting items due to the use of copper, but as far as we know there is not yet an alternative material available at industrial scale in the market. Nonetheless, and despite the increasing number of electric connections on-board modern fishing vessels, savings can result from an optimised wiring (naval electricity engineer, pers. comm.). The fishing net, another impacting item in the construction and maintenance phase, can also benefit from improvement of related impact, in particular through modern manipulation equipment that increase its life span. A different type of improvement can come from the recent and coming generations of antifouling paints which are less toxic than former ones. Their use must be encouraged, in particular those acting on the

interference with the settlement and attachment mechanisms which are the most promising environmentally benign option (Yebra et al. 2004). Last but not the least, a further reduction of the large overcapacity of the fleet is desirable in order to decrease its environmental impact through a decrease of the non-use phases of the life cycle.

Therefore there is room for decreasing the environmental impact of this fishery (and others) and the Peruvian Government has already taken some regulating measures in the right direction (e.g. electronic fuel injection engine, antifouling paint regulation, implementation of IVQs) that need to be enforced or improved, while others must be implemented or at least evaluated.

### Acknowledgements

This work, carried out by members of the Anchoveta Supply Chain (ANCHOVETA-SC) Project (<http://anchoveta-sc.wikispaces.com>) is a contribution to the International Joint Laboratory "Dynamics of the Humboldt Current system" (LMI - DISCOH) coordinated by the Institut de Recherche pour le Développement (IRD) and the Instituto del Mar del Peru (IMARPE), and gathering several other institutions. This work was carried out under the sponsorship of the Direction des Programmes de Recherche et de la formation au Sud (DPF) of the IRD. We acknowledge Philippe Roux (Cemagre, France) for suggesting a figure to formalise our ideas (Fig. 1). The first two authors are members of the ELSA research group (Environmental Life Cycle and Sustainability Assessment, <http://www.elsa-lca.org/>).

### References

Arias Schreiber M (2011) The evolution of legal instruments and the sustainability of the Peruvian anchovy fishery. *Mar Policy* 36(1): 78–89

Avadí, A. and Fréon, P. (2013). Life Cycle Assessment of fisheries: a review for fisheries scientists and managers. *Fish Res*, 143: 21– 38

Bertrand A, Ballon M, Chaigneau A (2010) Acoustic Observation of Living Organisms Reveals the Upper Limit of the Oxygen Minimum Zone. *PLoS ONE* 5(4): e10330

Bertrand A, Chaigneau A, Peraltilla S, et al. (2011) Oxygen: a fundamental property regulating pelagic ecosystem structure in the coastal southeastern tropical Pacific. *PLoS one* 6:e29558

Besnainou J Coulon R (1996) Chapter 12 - Life Cycle Assessment: A System Analysis. In: Curran MA (ed) *Environmental Life-cycle Assessment*. McGraw-Hill, New York

Brochier T, Lett C, Fréon P (2011) Investigating the "northern Humboldt paradox" from model comparisons of small pelagic fish reproductive strategies in eastern boundary upwelling ecosystems. *Fish and Fish* 12:94–109

BSI (2012) Publicly Available Specification (PAS) 2050-2:2012 Assessment of life cycle greenhouse emissions. Supplementary requirements for the application of PAS 2050:2011 to seafood and other aquatic food products. British Standards Institution, London.

Chavez F, Bertrand A, Guevara-Carrasco R, Soler P, Csirke J (2008) Editorial: The Northern Humboldt Current System: brief history, present status and a view towards the future. In: Werner F, Lough G, Bertrand A, Guevara-carrasco R, Soler P, Csirke J, & Chavez FP (eds) *The Northern Humboldt Current System: Ocean Dynamics, Ecosystem Processes, and Fisheries*. *Progr Oceanogr* 79: 95–412

Driscoll J, Tyedmers P (2010) Fuel use and greenhouse gas emission implications of fisheries management: the case of the New England Atlantic herring fishery. *Mar Policy* 34(3): 353-359

European Commission (2010) International Reference Life Cycle Data System (ILCD) Handbook: General guide for Life Cycle Assessment - Provisions and Action Steps. First edition March 2010, EUR 24708 EN, Luxembourg. European Commission - Joint Research Centre - Institute for Environment and Sustainability. Luxembourg, Publications Office of the European Union

Ecoinvent (2012) The ecoinvent Centre portal, <http://www.ecoinvent.ch/>

Ellingsen H, Aanonsen S (2006) Environmental Impacts of Wild Caught Cod and Farmed Salmon - A Comparison with Chicken. *Int J LCA* 11(1): 60-65

FAO (2012) FishStatJ, a tool for fishery statistics analysis. Release: 1.0.1. Food and Agriculture Organisation - Fisheries and Aquaculture Department, FIPS - Statistics and information

- Fréon P, Bouchon M, Domalain G, Estrella C, Iriarte F, Lazard J, Legendre M et al (2010) Impacts of the Peruvian anchoveta supply chains: from wild fish in the water to protein on the plate. *GLOBEC Int Newsl* (April): 27–31
- Fréon P, Bouchon M, Mullon C, Garcia C, Niquen M (2008) Interdecadal variability of anchoveta abundance and overcapacity of the fishery in Peru. *Progr Oceanogr* 79(2-4): 401–412
- Fréon P, Barange M, Arístegui, J 2009b Eastern boundary upwelling ecosystems: integrative and comparative approaches, an introduction. *Progr Oceanogr* 83(1-4): 1-14
- Goedkoop M, Heijungs R, Huijbregts M, Schryver A D, Struijs J, Zelm R V (2009) ReCiPe 2008. A life cycle impact assessment method which comprises harmonised category indicators at the midpoint and the endpoint level. Report I: Characterisation, Ministry of Housing, Spatial Planning and Environment (VROM). Retrieved from <http://www.lcia-recipe.info>
- Guinée et al. 2001a Guinée J. B., (final editor), Gorrée M., Heijungs R., Huppés G., Kleijn R., de Koning A., van Oers L., Wegener Sleeswijk A., Suh S., Udo de Haes H. A., de Bruijn H., van Duin R., Huijbregts M. A. J., Lindeijer E., Roorda A. A. H. and Weidema B. P. (2001a) Life cycle assessment; An operational guide to the ISO standards; Parts 1 and 2. Ministry of Housing, Spatial Planning and Environment (VROM) and Centre of Environmental Science (CML), Den Haag and Leiden, The Netherlands, retrieved from: <http://www.leidenuniv.nl/cml/ssp/projects/lca2/lca2.html>.
- Guinée et al. 2001b Guinée J. B., (final editor), Gorrée M., Heijungs R., Huppés G., Kleijn R., de Koning A., van Oers L., Wegener Sleeswijk A., Suh S., Udo de Haes H. A., de Bruijn H., van Duin R., Huijbregts M. A. J., Lindeijer E., Roorda A. A. H. and Weidema B. P. (2001b) Life cycle assessment; An operational guide to the ISO standards; Part 3: Scientific Background. Ministry of Housing, Spatial Planning and Environment (VROM) and Centre of Environmental Science (CML), Den Haag and Leiden, The Netherlands, retrieved from: <http://www.leidenuniv.nl/cml/ssp/projects/lca2/lca2.html>.
- Hischier R, Weidema B, Althaus H-jörg, Bauer C, Doka G, Dones R, Frischknecht R et al (2010) Implementation of Life Cycle Impact Assessment Methods.ecoinvent report N° 3 Dübendorf
- Hospido A, Tyedmers P (2005) Life cycle environmental impacts of Spanish tuna fisheries. *Fish Res* 76(2): 174–186
- IFFO (2009) The production of fishmeal and fish oil from Peruvian anchovy. datasheet (pp 1–10). International Fishmeal and Fish Oil Organisation
- IMARPE (2012) Peruvian Institute of the Sea, [http://www.imarpe.pe/imarpe/index.php?id\\_idioma=EN](http://www.imarpe.pe/imarpe/index.php?id_idioma=EN)
- International Organisation for Standardisation (ISO) 2006a Environmental management - Life Cycle Assessment – Principles and Framework. EN ISO 14040
- International Organisation for Standardisation (ISO) 2006b Environmental management - Life Cycle Assessment - Requirements and Guidelines. EN ISO 14044
- IRD (2012) Institut de recherche pour le développement, <http://en.ird.fr/>
- Iriarte F (2011) Propuestas políticas ambientales para flotas pesqueras (Proposals for environmental policy for fishing fleets). *Revista PESCA* (March - 117): 51–56. Retrieved from <http://www.revistapescaperu.com/index.php/revistas-descargas/finish/4-2011/29-revista-pesca-marzo-2011/0>
- Iribarren D, Vázquez-Rowe I, Hospido A, Moreira M T, Feijoo G (2010) Estimation of the carbon footprint of the Galician fishing activity (NW Spain). *SciTot Envir* 408(22): 5284-94
- Langlois J, Fréon P, Delgenes J-P, Steyer J-P, Hélias A (2012) Biotic resources extraction impact assessment in LCA of fisheries. In: Corson MS, van der Werf HMG (Eds.), *Proceedings of the 8th International Conference on Life Cycle Assessment in the Agri-Food Sector (LCA Food 2012)*, 1–4 October 2012, Saint Malo, France. INRA, Rennes, France, pp. 517–523.
- MATWEB (2012) Material property data, <http://www.matweb.com/index.aspx>
- MINEM (2009) Balance Nacional de Energía 2009. Lima: Ministerio de Energía y Minas, <http://www.minem.gob.pe/publicacionesDownload.php?idPublicacion=363>
- Yebra DM, Søren Kiil, Dam-Johansen K (2004) Antifouling technology—past, present and future steps towards efficient and environmentally friendly antifouling coatings. *Progr Organic Coatings* 50: 75–104 Oliveros-Ramos R, Guevara-Carrasco R, Simmonds J,

- Csirke J, Gerlotto F, Pena C, Tam J. 2010. Modelo de evaluación integrada del stock norte-centro de la anchoveta peruana *Engraulis ringens* Jenyns. *Bol Inst Mar Perú*, 25: 49-55
- Paredes C (2010) Reformando el Sector de la Anchoveta Peruana Progreso Reciente y Desafíos Futuros (Reforming the Peruvian anchovy sector: Recent progress and future challenges). Instituto del Perú - Cuadernos de Investigación (pp 1-23) Retrieved from [http://www.institutodelperu.org.pe/descargas/Publicaciones/DelInstitutodelPeru/DOC/contenido\\_carlos\\_paredes\\_-\\_reforma\\_de\\_la\\_presqueria\\_anchoveta\\_peru.pdf](http://www.institutodelperu.org.pe/descargas/Publicaciones/DelInstitutodelPeru/DOC/contenido_carlos_paredes_-_reforma_de_la_presqueria_anchoveta_peru.pdf)
- Parker R (2012) Review of Life Cycle Assessment Research on Products Derived from Fisheries and Aquaculture: A Report for Seafish as Part of the Collective Action to Address Greenhouse Gas Emissions in Seafood. Final Report. Sea Fish Industry Authority, Edinburgh. Retrieved from: [http://www.seafish.org/media/583639/seafish\\_lca\\_review\\_report\\_final.pdf](http://www.seafish.org/media/583639/seafish_lca_review_report_final.pdf). Accessed 22 September 2013
- Parker, R., & Tyedmers, P. (2012). Life Cycle Environmental Impacts of Three Products Derived from Wild-Caught Antarctic Krill (*Euphausia superba*). *Envir Sci Tech*, 46, 4958–4965.
- PRé (2012) SimaPro by Pré Consultants, <http://www.pre-sustainability.com/content/simapro-lca-software/>
- PRODUCE (2012) Ministry of Production of Peru, Statistics section, <http://www.produce.gob.pe/>
- Ramos, S., Vázquez-Rowe, I., Artetxe, I., Moreira, M. T., Feijoo, G., & Zufía, J. (2011). Environmental assessment of the Atlantic mackerel (*Scomber scombrus*) season in the Basque Country. Increasing the timeline delimitation in fishery LCA studies. *Int J LCA*, 16(7), 599–610.
- Raynolds M, Fraser R, Checkel D (2000a) The Relative Mass-Energy-Economic (RMEE) Method for System Boundary Selection. Part 1: A Means to Systematically and Quantitatively Select LCA Boundaries. *Int J LCA* 5(1): 37–46
- Raynolds, M, Fraser, R, Checkel, D (2000b) The Relative Mass-Energy-Economic (RMEE) Method for System Boundary Selection. Part 2: Selecting the Boundary Cut-off Parameter (ZRMEE) and its Relationship to Overall Uncertainty. *Int J LCA* 5(2): 96–104
- Reenaas M (2005) Solide Oxide Fuel Cell Combined With Gas Turbine Versus Diesel Engine As Auxiliary Power Producing Unit Onboard a Passenger Ferry: A Comparative Life Cycle Assessment And Life Cycle Cost Assessment. Masters Dissertation Norwegian University of Science and Technology
- Saetersda G, Tsukayama Alegre B 1965 Fluctuations in the apparent abundance of the anchovy stock in the 1959-1962. *Bol Inst Mar Peru* 2: 33-104
- Schau, E., Ellingsen, H., Endal, A., & Aanondsen, S. (2009). Energy consumption in the Norwegian fisheries. *J Clean Prod*, 17(3), 325–334.
- Suh S, Lenzen M, Treloar G, Hondo H (2004) System boundary selection in life-cycle inventories using hybrid approaches. *Envir Sci Tech* 38(3): 657–664 Sullivan J L, Gaines L (2010) A Review of Battery Life-Cycle Analysis : State of Knowledge and Critical Needs. Energy Systems Division, Argonne National Laboratory Tyedmers P, Watson R, Pauly D (2005). Fueling global fishing fleets. *Ambio*, 34(8): 635–8.
- Thrane M (2004) Environmental Impacts from Danish Fish Products – Hot spots and environmental policies. PhD Dissertation, Aalborg University, Denmark
- Torrejón J, Díaz E Limache J (2012) Descarte por exceso de captura en la pesquería del stock norte-centro de la anchoveta peruana (*Engraulis ringens* J.) entre el 2005 – 2011 (Discards due to overfishing in the Peruvian anchoveta north-central stock in 2005-2011). In: Indacochea A (ed) Libro de resúmenes digital. III CONCIMAR Congreso de Ciencias del Mar del Perú (p 361) Retrieved from <http://concimarperu2012.com/>
- Tveteras S, Paredes CE, Peña-Torres J 2011 Individual Fishing Quotas in Peru: Stopping the Race for Anchovies. *Mar Res Econ* 26: 225-232
- Tyedmers P (2001) Energy consumed by North Atlantic fisheries. In: Zeller D, Watson R and Pauly D (eds) Fisheries' Impacts on North Atlantic Ecosystems: Catch, Effort and National/Regional Datasets. Fisheries Centre, University of British Columbia, Vancouver, pp 12–34.
- Vázquez-Rowe I, Hospido A, Moreira MT, Feijoo G., 2012. Review: Best practices in Life Cycle Assessment implementation in fisheries. Improving and broadening environmental assessment for seafood production systems. *Trends Food Sci Technol* 28: 116-131
- Vázquez-Rowe I, Moreira MT, Feijoo G, (2010) Life cycle assessment of horse mackerel fisheries in Galicia (NW

Spain). Comparative analysis of two major fishing methods. *Fish Res.* 106 (3): 517–527

Winther, U., Ziegler, F., Hognes, E. S., Emanuelsson, A., Sund, V., & Ellingsen, H. (2009). Carbon footprint and energy use of Norwegian seafood products. SINTEF

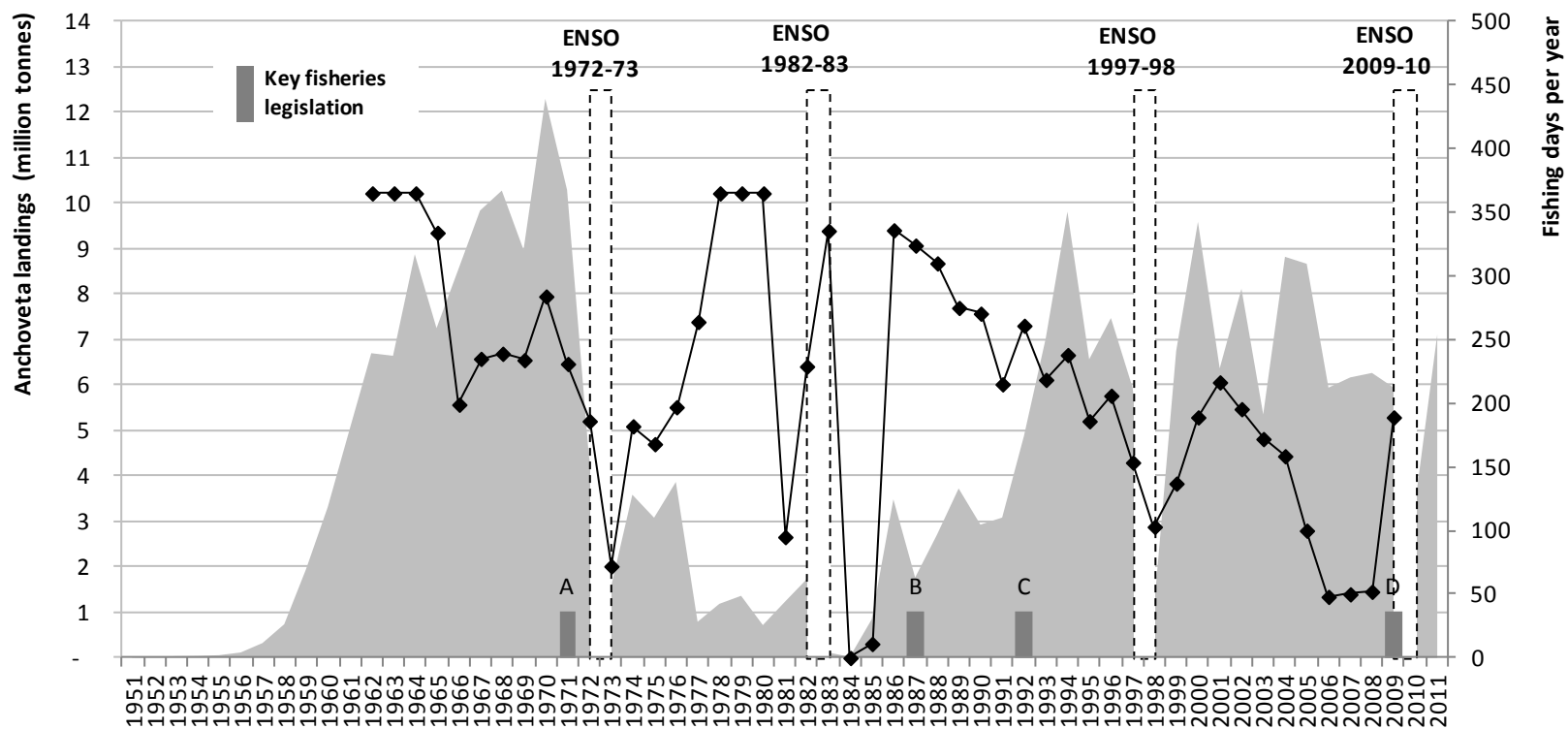
Fisheries and Aquaculture. Retrieved from [http://www.sintef.no/upload/Fiskeri\\_og\\_havbruk/Fiske\\_riteknologi/Filer%20fra%20Erik%20Skontorp%20Hogne/s/Carbon%20footprint%20and%20energy%20use%20of%20Norwegian%20seafood%20products%20-%20Final%20report%20-%2004\\_12\\_09.pdf](http://www.sintef.no/upload/Fiskeri_og_havbruk/Fiske_riteknologi/Filer%20fra%20Erik%20Skontorp%20Hogne/s/Carbon%20footprint%20and%20energy%20use%20of%20Norwegian%20seafood%20products%20-%20Final%20report%20-%2004_12_09.pdf)



## Supplementary material

### 1 Historical annual anchoveta landings

Historical annual anchoveta landings, annual fishing days, critical ENSO events and introduction of key policies (1955-2011). Source: based on Arias (2011) and statistics from FAO (2012) and PRODUCE (2012)



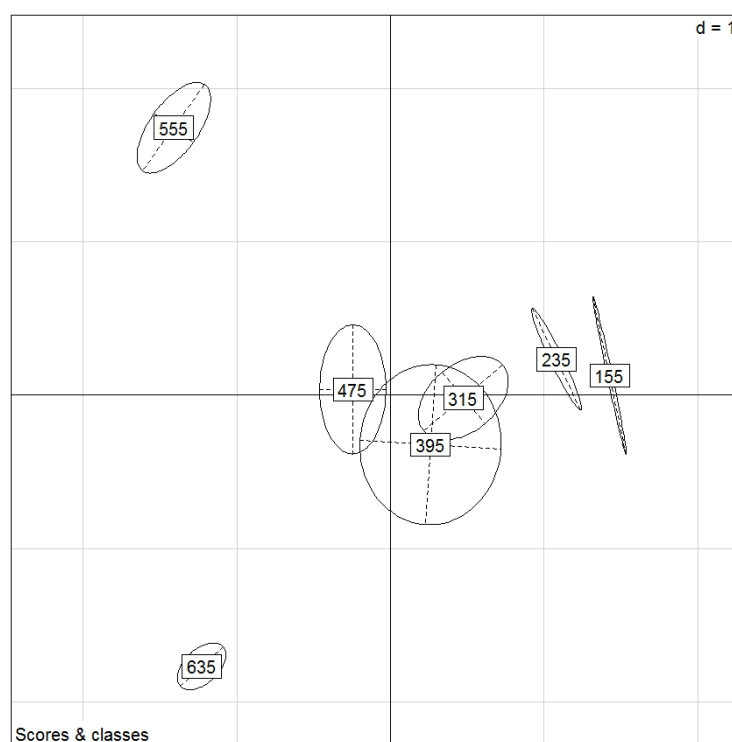
A: First General Fisheries Act, B: Second General Fisheries Act, C: Second General Fisheries Act and D: introduction of an Individual Vessel Quotas regime.

## 2 Chemical analyses of antifouling paints used in Peru

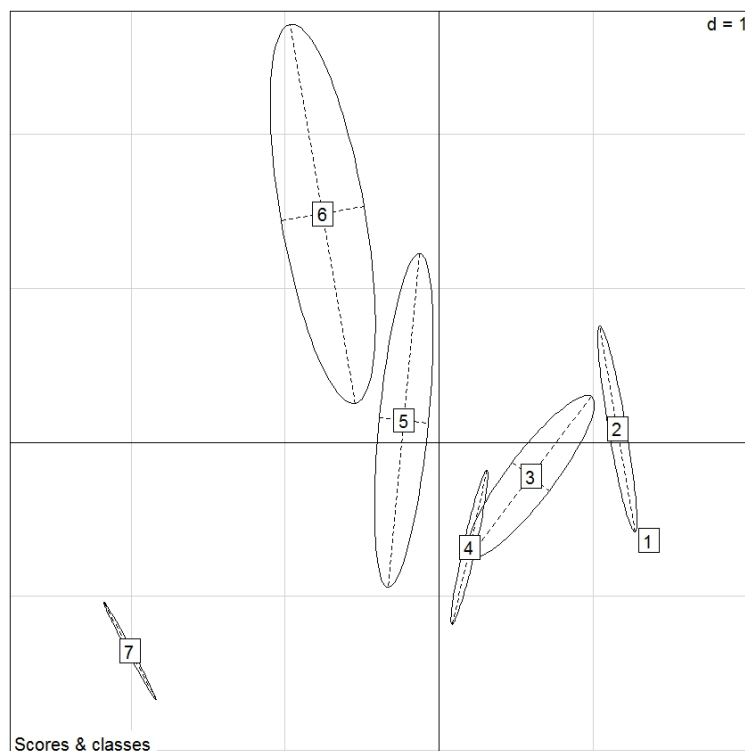
| Substance                 | Analysis parameter | Unit  | Sample 1 | Sample 2 | Sample 3 | Average | g/kg           |  |
|---------------------------|--------------------|-------|----------|----------|----------|---------|----------------|--|
| Arsenic                   | As                 | mg/kg | 1        | 6        |          | 3.50    | 0.004          |  |
| Copper                    | Cu                 | g/kg  | 405      | 363      | 254      | 340.67  | 340.667        |  |
| Nickel                    | Ni                 | mg/kg | 83       | 36       |          | 59.50   | 0.060          |  |
| Lead                      | Pb                 | mg/kg | 715      | 107      | 225      | 349.00  | 0.349          |  |
| Zinc                      | Zn                 | g/kg  | 1.5      | 100      | 187      | 96.17   | 96.167         |  |
| Tin                       | Sn                 | mg/kg |          |          | 390      | 390.00  | 0.390          |  |
| Monobutyltin *            | MBT                | mg/kg |          |          | 155      | 155.00  | 0.155          |  |
| Dibutyltin                | DBT                | mg/kg |          |          | 0.9      | 0.90    | 0.001          |  |
| Tributyltin               | TBT                | mg/kg | 1.7      | 0.5      | 1.1      | 1.10    | 0.001          |  |
| Monophenyltin *           | MPhT               | mg/kg |          |          | 0.17     | 0.17    | 0.000          |  |
| Diphenyltin               | DPhT               | mg/kg |          |          | 57       | 57.00   | 0.057          |  |
| Triphenyltin              | TPhT               | mg/kg |          |          | 17       | 17.00   | 0.017          |  |
| Trioctyltin *             | TOT                | mg/kg |          |          | 40       | 40.00   | 0.040          |  |
| <b>Active substances:</b> |                    |       |          |          |          |         | <b>437.907</b> |  |
| <b>Excipients</b>         |                    |       |          |          |          |         | <b>562.093</b> |  |

\* Not characterised in SimaPro/ecoinvent

## 3 Discriminant analysis on seven classes of holding capacities of vessels



#### 4 Discriminant analysis on seven classes of overall lengths of vessels



#### 5 Resolving practical challenges in relating specific environmental impacts to inventory items defined as new processes created in SimaPro

Since SimaPro and *ecoinvent* are used by the majority of LCA practitioners, it seemed important to us to address here the above issue. The main difficulty results from the near impossibility of avoiding the use of pre-defined processes (as included in SimaPro-available LCI databases such as *ecoinvent*). Such processes are used mostly when creating a new process related to an inventory item for filling in background processes, often related to a manufacturing, transportation or otherwise fuel-consuming activity. Those background processes are associated with more than one newly created process throughout a project, and it may therefore become difficult to "trace" an inventory item once input into the SimaPro software. Another reason preventing a simple matching of an inventory item with an environmental impact is that an inventory item most usually contributes to more than one category of mid-point environmental impact.

Such challenges have been addressed by isolating, when possible, all inventory items as separate unit processes, as opposed to defining them jointly in complex system processes. In this way, inventory items are clearly identifiable when generating contribution data on a per-functional unit basis. Moreover, we analysed contributions to impacts from inventory items, per impact category. Such an approach has proven particularly effective when dealing with fuel use by combustion engines, given that almost every process in SimaPro consumes fuel in one way or another. Moreover, this approach allowed us to account for all upstream processes associated with fuel provision, which are as significant as fuel combustion itself. If fuel use in combustion engines had not been isolated as a separate process, its background processes (i.e., fuel provision) would have been impossible to identify because they would have been mixed with the background processes for other fuel consumption activities.

6 Unit process details for the fleet segment 315-395 m3

| Unit processes          |  | Amount   | Unit | Notes        |
|-------------------------|--|----------|------|--------------|
| 0 - FU STEEL 315-395 m3 |  | 1        | t    |              |
|                         | 1 - CONSTRUCTION FISHING UNIT STEEL 315-395 m3                   | 2.76E-06 | p    |              |
|                         | CONSTRUCTION STEEL HULL  | 261.00   | t/p  |              |
|                         | Steel, low-alloyed, at plant/RER U ASTM A131-A                   | 80%      |      |              |
|                         | Steel, low-alloyed, at plant/RER U ASTM A36                      | 20%      |      |              |
|                         | Metal product manufacturing, average metal working/RER U         | 20%      |      |              |
|                         | Steel, low-alloyed, at plant/RER U ASTM A131-A                   | 7.18     | t/p  | Aux. skiff   |
|                         | Steel, low-alloyed, at plant/RER U ASTM A36                      | 2.00     | t/p  | Transmission |
|                         | Bronze, at plant/CH U  | 0.35     | t/p  |              |
|                         | Metal product manufacturing, average metal working/RER U         | 9.53     | t/p  |              |
|                         | Zinc, sheet/GLO  | 0.45     | t/p  |              |
|                         | Sawn timber, hardwood, raw, air dried, u=20%, at plant/IQUITOS U | 5.54     | m3/p |              |
|                         | ELECTRONIC EQUIPMENT STEEL VESSELS                               | 1.00     | p/p  |              |
|                         | MAINTENANCE PAINT  | 572.00   | kg/p |              |
|                         | MAINTENANCE ANTIFOULING  | 343.00   | kg/p |              |
|                         | Lubricating oil, at plant/RER U DEF                              | 1,002.00 | kg/p |              |
|                         | CONSTRUCTION FISHING NET (STEEL VESSEL)                          | 31.40    | t/p  |              |
|                         | Nylon 66, at plant/RER U   | 64%      |      |              |
|                         | Polyethylene, LDPE, granulate, at plant/RER U                    | 21%      |      |              |
|                         | Lead, at regional storage/RER U                                  | 14%      |      |              |
|                         | Bronze, at plant/CH U  | 1%       |      |              |
|                         | Steel, converter, chromium steel 18/8, at plant/RER U            | 1%       |      |              |
|                         | CONSTRUCTION BATTERY   | 250.00   | kg/p |              |
|                         | Synthetic rubber, at plant/RER U                                 | 140.00   | kg/p |              |
|                         | CONSTRUCTION ENGINE  | 7.70     | t/p  |              |
|                         | Cast iron, at plant/RER U  | 65%      |      |              |
|                         | Steel, converter, chromium steel 18/8, at plant/RER U            | 34%      |      |              |
|                         | Aluminium alloy, AlMg3, at plant/RER U                           | 1%       |      |              |
|                         | Metal product manufacturing, average metal working/RER U         | 100%     |      |              |
|                         | CONSTRUCTION MOTORS  | 1.30     | t/p  |              |
|                         | CONSTRUCTION ELECTRIC CIRCUIT                                    | 2.00     | t/p  |              |
|                         | CONSTRUCTION BALLAST   | 34.00    | t/p  |              |

|   |   |          |       |  |
|---|---|----------|-------|--|
| I | 2 - USE FISHING UNIT STEEL 315-395 m3                                   | 2.76E-06 | p     |  |
| I | Fish (in ground)  | 3.63E+05 | t/p   |  |
| I | Fish (in water - discards)  | 1.41E+04 | t/p   |  |
| I | FUEL USE  | 5.65E+03 | t/p   | Input is Diesel 2, outputs are combustion emissions to air |
| I | ANTIFOULING EMISSIONS   | 2.74E+04 | kg/p  |  |
| O | Arsenic   | 3.50     | mg/kg |  |
| O | Copper  | 340.70   | g/kg  |  |
| O | Nickel  | 59.50    | mg/kg |  |
| O | Lead  | 349.00   | mg/kg |  |
| O | Tin   | 390.00   | mg/kg |  |
| O | Zinc  | 96.20    | g/kg  |  |
| O | TBT   | 1.10     | mg/kg |  |
| O | Diphenyltin   | 57.00    | mg/kg |  |
| O | Dibutyltin  | 0.90     | mg/kg |  |
| O | Triphenyltin  | 17.00    | mg/kg |  |
| I | LUBRICANT OIL CHANGE  | 2.76E+04 | kg/p  |  |
| O | Wastewater  | 4.08E+03 | m3/p  |  |
| O | Disposal, municipal solid waste, 22.9% water, to sanitary landfill/CH U | 72.50    | t/p   |  |
| I | 3 - MAINTENANCE FISHING UNIT STEEL 315-395 m3                           | 2.76E-06 | p     |  |
| I | MAINTENANCE PAINT   | 1.14E+04 | kg/p  |  |
| I | Alkyd paint, white, 60% in solvent, at plant/RER U WT paint             | 33%      |       |  |
| I | Epoxy resin, liquid, at plant/RER U                                     | 67%      |       |  |
| O | VOC, volatile organic compounds   | 333.00   | g/kg  |  |
| I | MAINTENANCE ANTIFOULING   | 6.86E+03 | kg/p  |  |
| I | MAINTENANCE HYDRAULIC OIL   | 1.48E+04 | kg/p  |  |
| I | MAINTENANCE WOOD PARTS  | 6.20E+04 | kg/p  |  |
| I | MAINTENANCE STEEL HULL  | 535.00   | t/p   |  |
| I | Steel, low-alloyed, at plant/RER U ASTM A131-A                          | 100%     |       |  |
| I | Sheet rolling, steel/RER U - PERU                                       | 50%      |       |  |
| I | Welding, arc, steel/RER U   | 5.71E-03 | m/kg  |  |
| O | RECYCLING STEEL ASTM A131-A   | 100%     |       |  |
| I | MAINTENANCE ENGINE  | 7.70     | t/p   |  |
| I | MAINTENANCE MOTORS  | 6.50     | t/p   |  |

|   |  |          |      |                       |
|---|--|----------|------|-----------------------|
| I | MAINTENANCE NET  | 283.00   | t/p  |                       |
| I | MAINTENANCE BATTERY                                    | 2,000.00 | kg/p |                       |
| I | MAINTENANCE RUBBER                                     | 2,800.00 | kg/p |                       |
| I | MAINTENANCE ELECTRIC CIRCUIT                           | 3.00     | t/p  |                       |
| I | COPPER WIRE (with ecoinvent data)                      | 100%     |      | 50% of primary copper |
| O | RECYCLING COPPER                                       | 100%     |      |                       |
| I | 4 - END OF LIFE FISHING UNIT STEEL 315-395 m3          | 2.76E-06 | p    |                       |
| O | RECYCLING STEEL ASTM A131-A                            | 230.00   | t/p  |                       |
| O | RECYCLING STEEL ASTM A36                               | 40.00    | t/p  |                       |
| O | RECYCLING CAST IRON                                    | 5.01     | t/p  |                       |
| O | RECYCLING CHROMIUM STEEL                               | 3.18     | t/p  |                       |
| O | RECYCLING OIL  | 1,002.00 | kg/p |                       |
| O | RECYCLING LEAD   | 4.40     | t/p  |                       |
| O | RECYCLING NYLON FISHING NET                            | 20.10    | t/p  |                       |
| O | RECYCLING COPPER                                       | 2.43     | t/p  |                       |
| O | Dismantling, CRT screen, manually, at plant/CH U       | 30.00    | kg/p |                       |
| O | Dismantling, desktop computer, manually, at plant/CH U | 60.00    | kg/p |                       |
| O | Dismantling, laptop, manually, at plant/CH U           | 20.00    | kg/p |                       |
| O | RECYCLING BATTERY                                      | 250.00   | kg/p |                       |
| O | RECYCLING ALUMINIUM                                    | 312.00   | kg/p |                       |

All unit processes in CAPITALS are custom processes including inputs and outputs. Selected ones have been detailed.

#### 4.2.2 Paper 3: Environmentally-extended comparison table of large- vs. small- and medium-scale fisheries: the case of the Peruvian anchoveta fleet

Paper introducing LCA results of the wooden anchoveta fleets and comparing the environmental and socio-economic performance of the wooden and steel fleets, to be published by the Canadian Journal of Fisheries and Aquatic Sciences (Fréon et al., 2014b).

|  |   |
|--|---|
| Paper idea and design                            | Pierre Fréon, Angel Avadí                                     |
| Experiment design                                | Angel Avadí, Pierre Fréon                                     |
| Data collection                                  | Pierre Fréon, Wilbert Marin Soto, Richard Negrón, Angel Avadí |
| Data processing, statistical analysis, modelling | Angel Avadí, Pierre Fréon, Richard Negrón                     |
| Discussion                                       | Pierre Fréon, Angel Avadí                                     |
| Writing and editorial                            | Angel Avadí, Pierre Fréon                                     |

#### Environmentally-extended comparison table of large- vs. small- and medium-scale fisheries: the case of the Peruvian anchoveta fleet

Pierre Fréon <sup>a</sup>, Angel Avadí <sup>a,b,\*</sup>, Wilbert Marin Soto <sup>c</sup>, Richard Negrón <sup>d</sup>

<sup>a</sup> UMR 212 EME, Institut de recherche pour le développement (IRD). Centre de Recherche Halieutique Méditerranéenne et Tropicale, Avenue Jean Monnet CS 30171, 34203 SETE cedex.

<sup>b</sup> Université Montpellier 2 – Sciences et Techniques, 2 Place Eugène Bataillon, 34095 Montpellier Cedex 5, France.

<sup>c</sup> Area de Pesca Artesanal, Instituto del Mar del Perú (IMARPE), Apdo. 22, Callao, Lima, Peru

<sup>d</sup> Universidad Nacional Agraria La Molina (UNALM), Av. La Molina, Lima, Peru

\* Corresponding author

#### Abstract

Literature on small-scale fisheries usually depicts them as preferable over large-scale/industrial fisheries regarding societal benefits (jobs, jobs per investment) and relative fuel efficiency (e.g. Thomson 1980). We propose an environmentally-extended Thomson table for comparing the Peruvian *anchoveta* fleets of purse-seiners, backed up by methodological information and augmented with LCA-based environmental performance information, as a more comprehensive device for comparing fleets competing for the same resource pool.

A Life Cycle Assessment (LCA) of the wooden sub-fleets targeting Peruvian *anchoveta* (small-scale, medium-scale and semi-industrial) was carried out in order to establish the relative environmental performance of these fleet segments and of the whole wooden fleet. Findings from this and a previous study on the *anchoveta* steel fleet together allowed characterising the whole Peruvian *anchoveta* fishery. These results, along with socio-economic indicators, are used to build an environmentally-extended Thomson table of the fleet's main segments: the steel industrial, the wooden industrial and the wooden small- and medium-scale (SMS) fleets.

In contrast with the world figure, the Peruvian SMS fleets show a fuel performance nearly two times worse than the industrial fleets, due to economies of scale of the latter. Furthermore, the absolute

number of jobs provided by the industrial fisheries is much larger in Peru than those provided by the SMS fisheries. This is due to the relatively larger development of the industrial fishery, but as in previous studies, the SMS fleets generate more employment per t landed (both in mass and monetary terms) than the industrial fleet, more food fish and less discards at sea. Regarding environmental impact indicators, SMS fleets perform in average ~50% worse than the industrial fleets in terms of the life cycle impact assessment single score, and >70% worse according to key individual environmental impact categories, but the small-scale segment itself (<10 m<sup>3</sup>) performs similarly to the industrial steel fleet.

Keywords: *Engraulis ringens*, Life Cycle Assessment, fisheries, fuel use, Peru, Thomson table

## 1 Introduction

Large- and small-scale fisheries are often competing for the same marine resource, when not for the same maritime space. They also compete for the same manpower and subsidies from national governments. As a result, these two kinds of fisheries have been compared regarding their respective merits on a variety of aspects: catches, discards, illegal, unreported and unregulated (IUU) fishing, effects on the biomass and mean Trophic Level (TL) of the system, fuel consumption, *exergy*, employment, economical performances, etc. (Ruttan et al. 2000, Sumaila et al. 2001, Granzotto et al. 2004, Therkildsen 2007, Carvalho et al. 2011). Most of these works build on the seminal work of Thomson (1980) who proposed an illustrated comparative table of performance indicators regarding environmental, socio-economic and technical aspects of world fisheries. The results of these comparisons, which are not always properly documented, in particular when performed at the global scale (BNP 2008); are contrasted according to the authors and countries (see Discussion).

As identified and documented by Carvalho et al. (2011), the dominant paradigm during the three decades of fast economic development (1950–1970s) was that the natural progression of the world's fishing was necessarily towards the industrial mode, through the development of large-scale fisheries allowing a fast increase in fishing effort and capacity. In contrast, the conventional small-scale sector was considered inefficient and would either expand its scale of

production and modernise itself, or gradually disappear. Nonetheless, small-scale fisheries not only survived but even flourished in some developing countries; they constitute a means of life for approximately 50 million fishers worldwide (out of 51 million) and, depending on how they are defined, currently account for at least half of the fish production (Berkes et al. 2001, FAO 2013). Over the last decades there has been a growing awareness of the importance, efficiency and social benefits of small-scale fisheries for the sustainable use of fisheries resources in the context of growing overexploitation of fish stocks, energy saving and environmental threats to ecosystems (Carvalho et al. 2011). But at the same time the merits of these fisheries has been idealised (Johnson 2006) and in some instances they can represent a threat for some exploited stocks (e.g. Thiao et al. 2012).

The definition of small-scale fisheries varies by author and country, and it influences the results of the comparison with industrial fisheries. For many people, small-scale means artisanal and/or subsistence fisheries, consisting of small vessels that operate in coastal areas (Sumaila et al. 2001). Nonetheless, the boundary with large scale fishery remains fuzzy, especially regarding the medium size of vessels (10-20 m overall length). This segment can benefit or not from a variety of engines power (outboard or onboard) and equipment, and exploits coastal as well as offshore fishing grounds. Ruttan et al. (2000) categorises fisheries as small or large on a relative rather than an absolute scale, the scale used being based on vessel holding capacity, size or length,



depending on the availability of data. Other authors also consider the social structure of the activity and the fate of the catches (e.g. Johnson 2006).

Our case study, the Peruvian *anchoveta* (*Engraulis ringens*) fishery, supports the largest national fleet targeting a single species, worldwide (Ñiquen and Fréon 2006, Fréon et al. 2010). It operates a total of ~3 100 purse-seiners ranging from ~4 to ~60 m overall length (1 to 870 m<sup>3</sup> of holding capacity). Landings averaged 6.5 million metric tonnes (t) per year in the period 2005-2010, according to statistics from the Ministry of Production of Peru, PRODUCE (PRODUCE 2012a).

*Anchoveta* landings are destined to either reduction into fishmeal and fish oil (indirect human consumption, IHC) or food products (direct human consumption, DHC). The fleet is clustered by law into two main segments according to holding capacity, fate of landings and fishing rights: the steel and wooden industrial fleet and the wooden small- and medium-scale (SMS) fleet. In the period 2005-2010, catches by the industrial steel fleet represented around 76% of the total *anchoveta* landings for reduction, while the industrial wooden fleet landed ~18% and the SMS contributed ~7% (mostly IUU as detailed in section 2.2), according to the *Instituto del Mar del Perú* (IMARPE, unpublished data) and PRODUCE landing statistics (PRODUCE 2012a). In the same period, the landings for reduction from all fleets represented more than 98% of total catches, while the SMS fleet landings (including legal landings for DHC, landings legally channelled to IHC, and IUU landings) represented less than 2% of total *anchoveta* catches.

The industrial *anchoveta* fishery is characterised by a large overcapacity of vessels and fishmeal plants. This overcapacity, combined with a management by a single quota up to 2008, resulted in a race for fish and very short (~50 d·y<sup>-1</sup>) fishing season and an even smaller number of annual trips per year (mode at 35 trips, Fréon et al. 2008). When the Individual Vessel Quotas (IVQs) system was implemented, the fishing season

increased notably (50 to 200 d·y<sup>-1</sup>, Tveteras et al. 2011), but the number of operating vessels was not reduced accordingly —9% from 2008 to 2009 according to Paredes (2012). This was particularly the case in the *Vikinga* fleet due to non-transferability of the IVQs unless within companies. As a result, the annual catch per vessel and the number of annual trips did not vary substantially. The new regime of IVQs stopped the race for fish but not yet the overcapacity. Because the SMS fleet is not subject to quota, its number of annual trips per year is three times higher than for the *Vikinga* fleet.

Despite a low contribution of the SMS fleets to the national *anchoveta* catches, and the large volumes of their landings illegally redirected to the reduction industry, it supplies an important food industry in Peru (Avadí et al. 2014a), providing a large number of direct and indirect jobs (e.g. 9 400 direct jobs in processing plants for DHC). Moreover, the wooden fleet exerts a pressure on the environment that has not been systematically accounted for. The SMS segments of the wooden fleet normally operate within a few nautical miles off the coast, so their emissions to air and water may be of local relevance.

Given such complexity of the Peruvian *anchoveta* fleet and the usual resulting conflicts between its different segments, the aim of this work is to compare the large-, medium- and small-scale segments of the Peruvian *anchoveta* fishery which are respectively: 1) the steel industrial and the wooden industrial fleets, 2) the medium-scale wooden fleet and 3) the small-scale wooden fleet. The comparison includes their environmental and socio-economic performance, in order to cover the three pillars of sustainability and to provide quantitative data useful for managing the fleet. Life Cycle Assessment (LCA) is a widespread framework for environmental assessment of food systems, including fisheries —review in Avadí and Fréon (2013). It benefits from an International Organisation for Standardisation (ISO) standard — the ISO 14040 series— and a large body of theoretical and methodological research (ILCD

2010). We carried out a LCA of the wooden sub-fleet (small-scale, medium-scale and so-called *Vikinga*) in order to establish the relative environmental performance of these fleet segments and compare them with the results on the steel fleet obtained by Fréon et al. (2014). Findings from both environmental studies, which together characterise the whole Peruvian *anchoveta* fishery, and from socio-economic works are used to build an environmentally-extended Thomson table of the fleet's three main segments. This extended table can constitute a simple but powerful way of communicating scientific results to decision makers.

## 2 Material and methods

### 2.1 Methodological framework and data sources

We propose a version of the Thomson table for the Peruvian *anchoveta* fleets as a more comprehensive device for comparing competing or coexisting fishing fleets. Our table differs from most previous ones in four ways: 1) methodological information is provided; 2) the table is augmented with environmental performance information; 3) two socio-economic indicators are removed due to difficulty in estimating them for Peru, but two other employment-related indicators were added (Table 1); 4) it compares fleets targeting the same species and using the same gear.

**Table 1** Criteria for environmental Thomson table

| Conventional criteria <sup>a</sup>                   | Novel and environmental criteria <sup>b</sup>                 |
|--|---|
| <b>Retained</b>                                      |   |
| • Number of direct jobs per year                     | • Number of direct jobs per thousand landed tonnes            |
| • Landings for DHC per year                          | • Number of direct jobs per landed 1 million USD <sup>c</sup> |
| • Landings for IHC per year                          | • ReCiPe single score (weighted LCIA score) per landed tonne  |
| • Total landed value per year                        | • Cumulative Energy Demand per landed tonne                   |
| • Fuel use per year                                  |   |
| • Landed tonnes per fuel used                        | • Selected LCIA midpoint indicators per landed tonne          |
| <b>Excluded</b>                                      |   |
| • Capital cost per job                               | • Fish and other sea life discarded at sea                    |
| • Jobs per 1 million USD invested in fishing vessels |   |

LCA: Life Cycle Assessment, LCIA: Life Cycle Impact Assessment.

<sup>a</sup> Thomson (1980), <sup>b</sup> This study (except when stated otherwise), <sup>c</sup> Sumaila et al. (2001)

The environmental indicators were obtained from LCA impact categories (except for sea life discarded at sea). LCA allows for comprehensive evaluations to be made on the potential environmental impacts related to products over their whole life cycle, that is to say, encompassing related infrastructure, energy provision, extraction of raw materials, manufacturing (cradle-to-gate), distribution, use and final disposal (cradle-to-grave) (ISO, 2006a). A conventional LCA, as defined by the ISO standard and used here, consists of four phases: goal and

scope definition, life cycle inventory (LCI) analysis, life cycle impact assessment (LCIA) and interpretation (ISO, 2006b). Two important aspects of the first phase are the delimitation of the studied system boundary and the functional unit. The system boundary is a set of criteria specifying which unit processes are part of a product system. The level of modelling detail that is required to satisfy the goal of the study determines the boundary of a unit process. The functional unit is the quantified performance of a product system for use as a reference unit (ISO,

2006a). The LCI phase usually combines the use of primary inventory data collected specifically for the considered study, and secondary inventory data available in international databases. During the LCIA phase, potential impacts are estimated using different methods of characterisation of impacts at the midpoint or endpoint levels. Whereas a variable and often large number of midpoints (i.e. intermediate) are defined according to the method, only three endpoints are considered: natural environment, human health and resources. The LCA phases and how they can be applied to fisheries are explained in more detail and illustrated with examples in Avadí and Fréon (2013) and in Supplementary Material B.

Landings by the different sub-fleets are based on both official statistics by PRODUCE, data by IMARPE and estimations of IUU from other sources (see section 2.2). PRODUCE data is used for the industrial steel fleet. Official PRODUCE lists of vessels in the SMS fleets lack accuracy (they are cumulative from year to year and do not account for cloned or irregular vessels), so PRODUCE data was contrasted and complemented with comprehensive statistics of number of vessels and fishers per vessel collected by IMARPE with support from IRD (Estrella et al. (2010) and unpublished data). This latter data was preferred to estimate (part-time) employment figures. The *anchoveta* fleet was segmented beyond legislation-mandated clusters into smaller segments for the LCA, but the Thomson tables only show aggregated figures per fleet.

There are no official figures for jobs in the Peruvian fisheries other than those provided by the Peruvian Ministry of Labour (MINTRA 2012), aggregated for the whole industrial sector. Recently, a census of small- and medium-scale fisheries was carried out (PRODUCE 2012b). Other socio-economic indicators were extracted from publications quoted below.

Most datasets used span the period 2005-2010, yet some data spanning other time periods were used when 2005-2010 data was not available, but always with a large overlapping between the two

periods. Pre-2005 historical data were only used to establish trends.

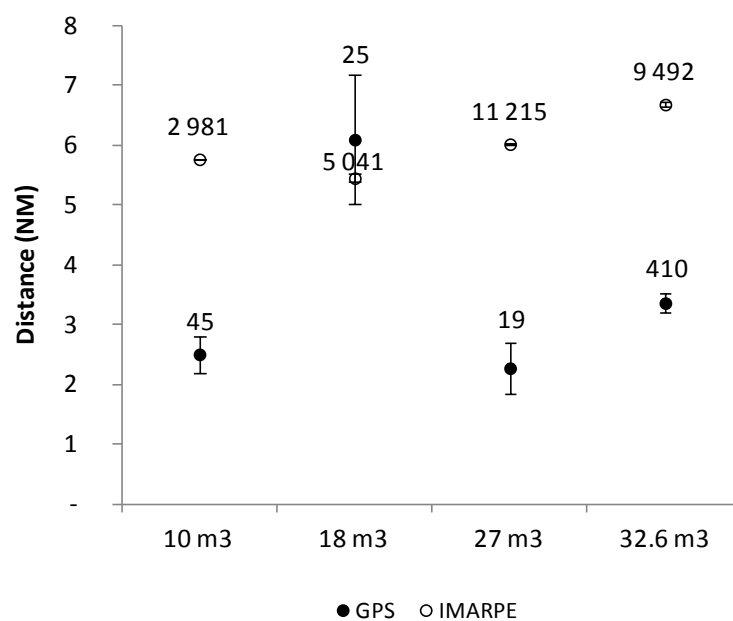
## 2.2 Segmentation of the anchoveta fleets

By law, the industrial fleet consists of vessels whose holding capacities are over 32.6 m<sup>3</sup>, land their catches exclusively for IHC, must fish outside the 5 coastal nautical miles (NM) during two specific fishing seasons subject to individual quotas since 2009 (and to a global quota before this date). It includes both steel vessels and wooden hull vessels. As of 2012, the wooden industrial sub-segment, nicknamed “*Vikinga*” fleet, consisted of nearly 700 vessels with holding capacities ranging between 32.6 and 110 m<sup>3</sup>, whereas the steel industrial sub-segment consisted of 660 vessels with holding capacities ranging between ~90 and 870 m<sup>3</sup>. The fishing grounds are located on the inner part of the continental shelf, seldom further than 35 NM from the coast, and inversely proportional to the size of the vessels (more details in (Avadí et al. 2014b).

Until 2011, the small-scale fleet consisted of a single segment defined by law as those vessels with holding capacity under 32.6 m<sup>3</sup>. This fleet has exclusive fishing access to the first 5 NM all year long, and in practice mostly operates within the first 2-7 NM (Fig. 1). Up to recently it was supposed to land exclusively for DHC. From 2012, it is subdivided by legislation into two sub-segments: small-scale proper (known as “*artesanales*” in Peru, featuring up to 10 m<sup>3</sup> holding capacity) and medium-scale (known as “*de menor escala*” in Peru, 10 to 32.6 m<sup>3</sup> holding capacity and with an overall length lower than 15 m). Moreover, from 2012 up to 40% of SMS anchoveta landings can be legally redirected to reduction, under certain conditions such as important deterioration of the fish at landing time, yet IUU in that fleet has been estimated to represent around 8 times that amount. Small-scale vessels also differ from medium-scale ones in the level of technification and fishing systems used: small-scale vessels are characterised by

intensive manual labour and basic technology (Alvarado 2009, Fréon et al. 2010). SMS vessels are allowed by legislation to land *anchoveta* exclusively for DHC. Nonetheless, IUU fishing is a recurrent problem in Peru, and it has been suggested to be responsible for between 2.9 and 4.3% of total landings in the whole *anchoveta* fishery (Paredes 2012). In the SMS fleets operations, IUU can reach 200% over the officially reported figures, according to various experts (anonymous personal communications, 2011-

2013) and journalistic reports. Due to the uncertainty in the SMS performance figures in relation to IUU catches estimates, we compared single scores obtained with two different assignments of those catches among segments in order to test the model's sensitivity to it: the present assignment based on anecdotic information and the documented prevalence of insulated holds and ice use, and an alternative assignment assuming IUU proportional to legal landings.



**Fig. 1** Distances to the coast of fishing hauls (net setting) of the SMS fleet, based on 499 GPS observations for 2010-2011 and on 28 729 IMARPE daily monitoring observations for 2005-2010, for five different landing points in the Peruvian coast. Labels represent the number of observations (n) and error bars the 95% confidence intervals ( $1.96 SD / \sqrt{n}$ ).

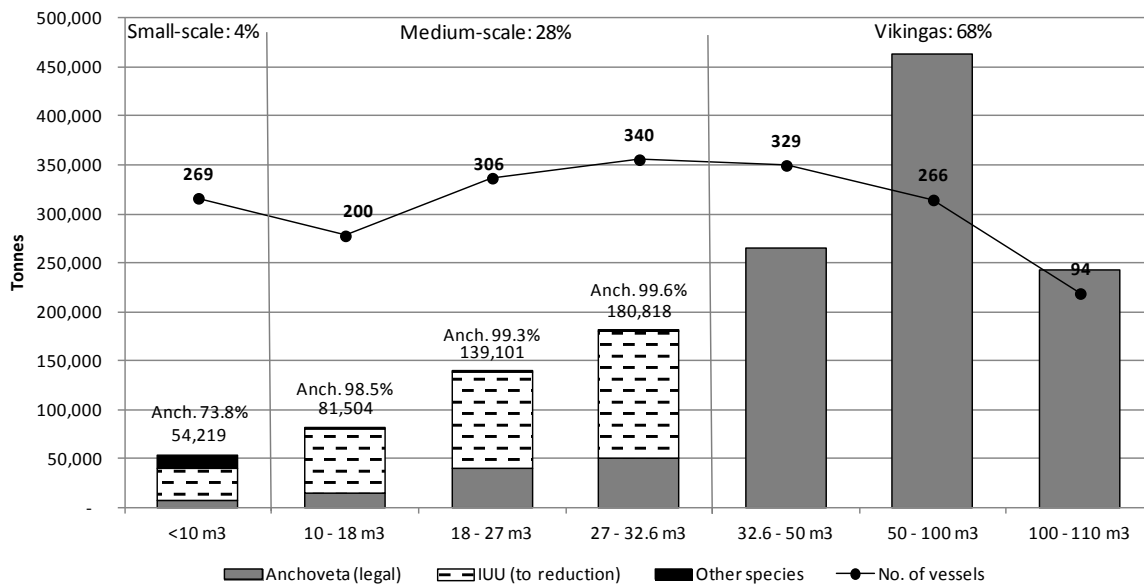
Officially, as of 2010 only 619 SMS vessels were authorised to land *anchoveta*, exclusively for DHC (PRODUCE 2010). This official count increased to 842 vessels in 2012, while IMARPE records list ~1 300 SMS vessels targeting *anchoveta* (among other species) for the same period, in practice channelling an important percentage of their landings to the fishmeal industry.

Given the large number of vessels, it was necessary to perform analyses on segments rather than on individual vessels. Following Ruttan et al. (2000), Sumaila et al. (2001) and Therkildsen (2007), we determined that holding capacity

would be one of the best criteria for a typology of vessels. Other criteria such as vessel age, engine power, etc; proved less determining of environmental performance. In any case engine power (P) and holding capacity (HC) are linearly correlated ( $P = 150.7 + 2.22 HP$ ;  $R^2 = 0.51$ ;  $N = 1345$ ) although an exponential relationship performs slightly better ( $P = 203.8 \exp^{(0.0039 HP)}$ ;  $R^2 = 0.57$ ). As of 2012, 67% of SMS vessels were less than 12 years old (PRODUCE 2012b). Inventory data collected for 72 SMS vessels suggests an average age of 16 years for the SS segment and of 10 years for the MS segment.

With the legislation-based official segmentation of the *anchoveta* fleets as a starting point, we further segmented the wooden fleets according to historical landings (Fig. 2) and observed clusters of vessels with similar holding capacities. The medium-scale and *Vikinga* fleets were too heterogeneous, in terms of average landings and other features, to be treated as single 10-32.6 m<sup>3</sup> and 32.6-110 m<sup>3</sup> large range segments, respectively. In order to assess the relevance of the retained segmentation, additional data were collected or compiled and considered in the discussion section: vessels equipment and overall length (PRODUCE data and our inventory data detailed below), distance to the coast of fishing grounds and total distance travelled (IMARPE data resulting from routine daily landing survey, Vessel Monitoring System (VMS) data for the industrial fleet using Joo et al. (2011) methodology and 80 validated GPS deployments onboard SMS vessels)

and socio-economic data (PAD 2008, Paredes and Gutiérrez 2008, Estrella et al. 2010, Paredes 2012). A similar approach was applied to segment the steel industrial fleet (<155 m<sup>3</sup>, 155-235 m<sup>3</sup>, 235-315 m<sup>3</sup>, 315-395 m<sup>3</sup>, 395-475 m<sup>3</sup>, 475-555 m<sup>3</sup>, 555-635 m<sup>3</sup> and >635 m<sup>3</sup>), as detailed and justified in Fréon et al. (2014). In contrast to the SMS and *Vikinga* fleet, the result show little differences between the numerically dominant segments of this fleet regarding their fuel consumption and single score environmental impacts, and largely in individual impact categories. Therefore only average data (weighted by landings within segments) are presented here for the steel fleet. The average age of the industrial fleet vessels was 26 years, based on a sample of 134 vessels. The older vessels have usually been refurbished in the mid 2000s, generally including replacement of the main engine.



**Fig. 2** Average annual landings (2005-2010) and segmentation of the wooden fleet. Percentages represent reported *anchoveta* landings plus estimated illegal, unregulated and unreported (IUU) landings and exclude reported landings of other species. Only SMS vessels landing >10% *anchoveta* (46% of the purse seine fleet) were included

## 2.3 Life Cycle Assessment

### 2.3.1 Scope and inventory

Due to data availability and variability (in particular yields), we considered average data during the period 2005-2010, except when unavailable for this period (e.g. employment). The Life Cycle Assessment of the steel industrial fleet presented in Fréon et al. (2014) was based on a very detailed inventory and its system boundary was wide: from cradle-to-grave and at least 95% of total estimated impacts for any impact category. For the wooden fleet, despite a larger number of vessels, a simpler inventory (both in terms of detail and number of vessels surveyed) was available as shown in Table 3. Inventory items investigated included wood supply chain, hull construction and caulking materials, holdings insulation materials, engines, rigging and fishing gear manipulation equipment (i.e. winch and power block), fishing net materials, consumption of fuel and lubricating oil, paint and antifouling used and releases to water, and electric network, in addition to a few minor items. Maintenance data was not available for the hull itself (carvel planks) while all wood used in the vessel represented 80 to 90% of the lightship weight. Conservatively, 500% of the hull was estimated to be replaced over the lifetime, equivalent to 60% of the hull or 30% of all the wood every 4-5 years (Francisco Miro, personal communication, 03.2013). End of life data was also unavailable and was excluded from the system boundary given its expected irrelevance, as demonstrated in Fréon et al. (2014) with steel vessels. Materials used for the steel fleet would yield a larger recycling impact than simpler, wooden vessels. The life span of wooden vessels was estimated by IMARPE to be 40 years (Estrella et al. 2005).

Fuel utilisation data was robust for the steel fleet, but it had to be estimated from multiple sources (and with large uncertainty) for the *Vikinga* and SMS fleets. In Peru, SMS vessel owners seldom keep records of their fuel consumption, despite the fact that fuel is normally the main cost driver for their operations. This drawback was overcome

by combining various partial records of fuel use from SMS vessels managed by fishing companies, partial surveys conducted by IMARPE and ourselves, and research results published by Peruvian institutions (e.g. PAD 2008). Those sources provide either total fuel use or fuel use rate according to the vessel speed, and did not always yield similar figures. Therefore averaged fuel values with high levels of uncertainty were computed and applied to thousands of individual trip durations recorded by IMARPE. Such fuel use figures per segment were improved by incorporating segmentation of fishing trips in three categories of vessel speed based on limited numbers of GPS data, and vessel engine average consumption rates (e.g. gal·h<sup>-1</sup> at various speeds) from surveys. Additionally, an empirical equation of fuel consumption rate (CR) based on time of use (time) approximated by total trip duration minus loading time, and engine power (P) expressed in horse power, was used to produce a third estimate (ASAE 2003):

$$CR = 0.2 \text{ kg} \cdot \text{P}^{-1} \cdot \text{time}^{-1} \quad (1)$$

Qualitative data was obtained from literature and fishing companies, for characterising by-catch by the studied fleets.

In order to allow a direct comparison of the different segments, regardless of the fate of their catches, the functional unit was one metric tonne (t) of fresh fish, mostly *anchoveta*, caught in the north-centre (4°S-16°S) fishing zone off Peru and delivered at any kind of fishing terminal, by a wooden industrial, small- or medium-scale Peruvian purse seiner.

Life Cycle Inventories (LCI) and impact assessment results were computed for each segment of the wooden fleet, and then combined with per segment results of the steel fleet to build the environmental component of the Thomson tables. Because fuel use is commonly the main contributor to impacts in fisheries (Avadí and Fréon 2013), a sensitivity analysis was performed by simulating variations of fuel use of ±20% with respect to retained fuel use values, and re-

computing single scores of the whole life cycle, considering mass allocation.

### 2.3.2 Allocation of environmental impacts

The small-scale, and to a lesser extent the medium-scale *anchoveta* sub-fleets, target and catch various species besides *anchoveta*, particularly chub mackerel (*Scomber japonicus*), jack mackerel (*Trachurus murphyi*), and Peruvian silverside (*Odontesthes regia regia*), which in most cases are sold for DHC. In contrast, other species such as white *anchoveta* (*Anchoa nasus*) are unwanted by consumers and sold for IHC. In the period 1997-2010 *anchoveta* accounted for 53% of all SMS landings, chub mackerel for 11%, Jack mackerel for 7% and Peruvian silverside for 2%, while ~94 other species completed the remaining 29% (IMARPE, unpublished data). The SMS vessels are generally not multi-specific within the same trip, but either target *anchoveta* or other species, even changing seasonally their purse-seines for some of them (~5%). All SMS vessels whose main targeted species was not *anchoveta*, and for which *anchoveta* represented  $\leq 10\%$  of their total landings in 2005-2010, were excluded from the analysis.

Once expunged the SMS fleet, it was necessary to allocate environmental impacts among *anchoveta* and other species (considered as a whole non-*anchoveta* group) for all preserved vessels. We applied mass and price as allocation criteria and contrasted the results, as recommended in (Avadí and Fréon 2013). Mass and price-based allocation factors used are available in the Supplementary Material A.

In contrast to the SMS fleet, the industrial fleet targeting *anchoveta* catches a very limited number of other species in recent years, which was not the case during the 1980s and 1990s, where sardine (*Sardinops sagax*) was abundant, and more recently (in the mid-2000s) when jack mackerel and chub mackerel were also abundant (Chavez et al. 2003, Ayón et al. 2011, Gerlotto et al. 2012). These two species are targeted by other

industrial purse-seiners fleets whose vessels are very similar to the largest ones targeting *anchoveta* (some of which shift from one fishery to the other) but they use larger mesh-size nets and are always equipped with a refrigerating system—such systems are seldom installed (and if installed seldom used) on board of *anchoveta* vessels—. Few specimens of piscivorous fish are often caught with *anchoveta* and part of them are shared by crew members, but their impacts were ignored due to lack of quantitative data. Such impacts are likely to be negligible regarding the environmental implications, but might be economically significant.

### 2.3.3 Life Cycle Impact Assessment

The hybrid midpoint/endpoint life cycle impact assessment method ReCiPe v. 1.08 (Goedkoop et al. 2009, 2013) was used as the main source of environmental indicators, based on LCA impact categories. It was complemented with the single indicator method Cumulative Energy Demand (CED) v. 1.08, which represents the energy demand, valued as primary energy during the complete life cycle of a product (Frischknecht 1998). SimaPro v7.3 (PRé 2012) was used to compute the impact assessment, while the widely utilised LCI database ecoinvent v2.2 (Hischier et al. 2010) was used for background processes. In general, the data treatment, life cycle inventory construction, process design and functional unit used for our LCA study on the industrial *anchoveta* steel fleet (Fréon et al. 2014) were applied to *Vikinga* and SMS segments.

A special attention was paid to the wood impact because a common belief is that using a natural product like wood would be less harmful for the environment than an industrial product like steel. Indeed previous study (review in Werner and Richter 2007) show that additional sources of carbon emission (cutting, transport, etc.) are negligible in comparison to overall emissions associated to steel emission, and therefore the wood carbon budget is low. Actually, the balance of biogenic carbon itself is close to zero because it is first stored as construction wood for a duration

similar to the duration of what would have been additional natural sequestration in the forest, and then released to the atmosphere at the end of life of the vessel. Moreover, this product does not generate any direct depletion of mineral resources, in contrast to steel. Nonetheless in our case study the belief is not necessarily true, because we consider that SMS boats are built using in average ~50% tropical wood from primary forest (selective extraction with no clear-cutting). Because legal and illegal clear-cutting exists in Peru but is not quantified (Hidalgo and Chirinos 2005), we conducted a sensitivity analysis considering different proportion of clear-cutting (0, 5 and 20%). Furthermore, In order to isolate the effect of the construction materials from other effects (CPUE, fuel use rates), we directly compared a wooden *Vikinga* vessel in the 100-110 m<sup>3</sup> segment (average holding capacity of 107 m<sup>3</sup>, average engine power of 406 HP), with a) a version of the same vessel having the same CPUE and fuel use but modified by simulating a steel hull, and b) a version of the same vessel featuring the CPUE and fuel use rate of a steel industrial vessel in the 75-155 m<sup>3</sup> segment (average holding capacity of 132 m<sup>3</sup>, average engine power of 360 HP). In both cases, linear adjustments were made for differences in holding capacity.

In order to compare the environmental impact per functional unit (i.e. per landed t) of the two fleets in a situation of absence of overcapacity in the industrial fleet, we simulated a two-fold and a three-fold increase of the annual catches by individual *Vikinga* vessel, without changing their catch rate.

## 2.4 Socio-economic aspects

Since the fishing activity in Peru is largely seasonal, in particular for the industrial sector, partial employment was converted into full time jobs (on the base of 236 working days per year). This conversion was performed according to the number of trips per year and their duration, augmented by one day after each trip in order to take into account the trip preparation, transport

to harbour and resting time associated with a hard job mostly performed at nighttimes.

Wholesale prices (5- and 10-year averages of price data from PRODUCE and IMARPE) for chub mackerel, jack mackerel and Peruvian silverside, which made up the bulk of other species landed by *anchoveta*-targeting purse seiners in 2005-2010 (13%), were used for the price allocation and to determine Thomson table indicators based on landed value.

## 3 Results

### 3.1 Conventional Thomson table indicators

We estimated ~10 300 fishers involved part-time in the steel fleet activity, ~8 700 for the *Vikinga* fleet, ~1 600 for the small-scale segment and ~7 300 for the medium-scale segments of the SMS fleet (Table 3). Those 27 900 fisher jobs are equivalent to 6 000 full-time jobs. Four jobs per thousand tonnes (kt) and 19 jobs per million USD landed by the industrial fleets (steel and *Vikinga*), as well as 19 jobs per kt and 96 jobs per million USD landed by the SMS fleets were estimated from employment, landing and price per species data. Final figures for landings of the wooden fleets used for this study, including IUU and landings of species other than *anchoveta*, are depicted in Fig. 2. The steel fleet landed on average 4.2 million t annually in the period 2005-2010 Fréon et al. (2014), while the wooden fleet landed 1.4 million t per year over the same period. At that time, average annual landings by the various wooden sub-fleets were as follows: the *Vikinga* fleet ~980 000 t, the medium-scale fleet ~410 000 t and small-scale fleet ~63 000 t, with a strong increasing trend for the two latter. These figures include global estimations of IUU of the SMS fleet, in the order of 360 000 t·a<sup>-1</sup> distributed as follows: <10 m<sup>3</sup>: 10%, 10-18 m<sup>3</sup>: 20%, 18-27 m<sup>3</sup>: 30% and 27-32.6 m<sup>3</sup>: 40%. Annual landings of the whole Peruvian SMS fleet for DHC were 130 000 t. As expected from the large difference in landings and the low difference unitary price between the fish landed by the two fleets, the total landed



value is much higher for the large-scale fleet than for the SMS fleet.

The fuel use figures estimated from surveys, GPS data and the empiric equation were different yet

depicting a similar trend (Table 2). Based on the chosen fuel use rates, in 2005-2010 the industrial fleets consumed ~84 000 t of fuel (62 t fish per t fuel) and the SMS fleet ~11 000 t (29 t fish per t fuel). Those values are listed in Tables 2 and 4.

**Table 2** Fuel use (relative consumption) estimations in relation to landed fish ( $\text{kg}\cdot\text{t}^{-1}$ ) and relevant parameters

| SMS segment            | Initial estimate <sup>a, b</sup> | GPS-complemented estimate <sup>c</sup> | Empiric equation estimate <sup>d</sup> |
|------------------------|----------------------------------|--|--|
| <10 m <sup>3</sup>     | 14.3                             | <b>14.7</b>                            | 16.6                                   |
| 10-18 m <sup>3</sup>   | 18.5                             | <b>17.2</b>                            | 22.2                                   |
| 18-27 m <sup>3</sup>   | 31.1                             | <b>28.1</b>                            | 24.0                                   |
| 27-32.6 m <sup>3</sup> | 31.7                             | <b>29.0</b>                            | 23.3                                   |

Retained values in **bold**. All values in kg fuel/t fish landed.

<sup>a</sup> Calculated from thousands of recorded trips (IMARPE surveys, 2005-2010). <sup>b</sup> Calculated from thousands of recorded trip durations and average engine fuel demand (IMARPE surveys, 2005-2010). <sup>c</sup> Calculated by applying the speed ratios from GPS data (300 data points from 80 trips, segregated into 3 engine consumption regimes: low, normal and full) to IMARPE recorded trip durations and averages of engine fuel demand at that regimes. <sup>d</sup> Equation 1.

After a more detailed analysis of the fuel consumption patterns of the SMS fleets, surprisingly enough, the pattern of relative fuel consumption (kg of fuel per landed t) of its four different segments was not found to show the expected effect of economies of scale. An unexpected positive trend of the relative fuel consumption according to holding capacity is observed (Fig. 3), possibly non-linear but our fuel use rate data are not numerous enough to appreciate precisely the shape of the relationship.

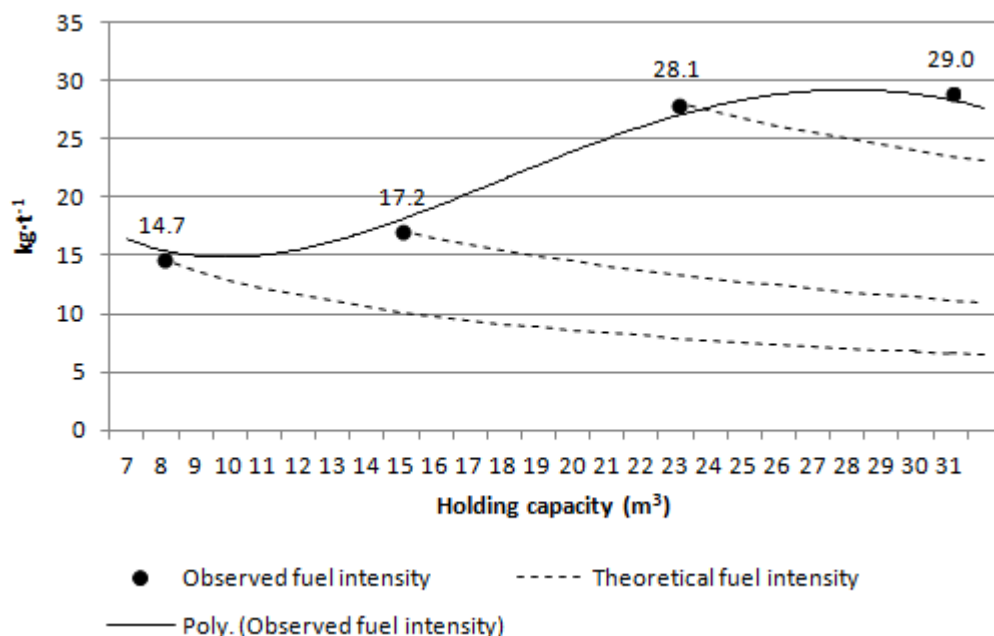
The relative fuel consumption ( $\text{kg}\cdot\text{t}^{-1}$ ) can also be expressed as the ratio between consumption rate ( $\text{kg}\cdot\text{h}^{-1}$ ) and CPUE ( $\text{t}\cdot\text{h}^{-1}$ ), which justifies a deeper analysis of these factors. First, we observe that the vessels belonging to the two first segments of the fleet travel on average over shorter distances (i.e. 7.8 vs. 11.7 NM between the farthest haul and the landing point) than the two last ones (Supplementary Material C). We can assume that they travel at slower speed because the ratio between the abovementioned distance and the

Nonetheless, after regrouping the segments into duets in order to get more confidence in our data, it seems obvious that the two first segments of the SMS fleet are more efficient than the two last ones. According to generic data of fuel consumption per t transported per nautical miles ( $\text{kg}\cdot\text{t}^{-1}\cdot\text{NM}^{-1}$ ), a 56% increase in the Gross Tonnage (GT) should result in a 22% decrease in  $\text{kg}\cdot\text{t}^{-1}\cdot\text{NM}^{-1}$ , whereas in our data, an opposite pattern is observed with a 64% increase in the value of relative fuel consumption expressed in  $\text{kg}\cdot\text{t}^{-1}$ .

trip duration itself is lower for the first two segments than for the last two (0.6 vs. 0.9). Second, the first two segments of the fleet are more selective than the last two ones regarding the election of fishing days and fishing areas, the latter being approximated by comparisons according to fishing harbours used for landing. The comparison of CPUEs of both segments groups, expressed in catch per total trip duration, shows that during the days where the two first segments are not at sea, the CPUE of the two last ones is on

average 10% lower than during the days where all segments are fishing. The selection of more favourable fishing areas is shown by comparing the relative CPUE per harbour ( $\overline{CPUE}$ ) weighted by the catches of the two groups of segments. It appears that the first two segments operate 72%

of their trips (representing 80% of their landings) in five locations, out of 17, where  $\overline{CPUE}$  is higher than the average CPUE by  $\geq 38\%$ . The last two segments, on the other hand, operate 59% of their trips at those points, representing 66% of their landings.



**Fig. 3** Theoretical vs. observed fuel consumption rates for the SMS fleet segments

### 3.2 Life Cycle Assessment of the wooden fleets

#### 3.2.1 Inventories

Certain differences exist between LCI of the SMS segments and the *Vikinga* segments, fundamentally due to the different intended fate of the catches: DHC and IHC, respectively. Some of the SMS vessels (~10% according to our estimations) carry ice and/or feature insulated holds, for preservation purposes, while the *Vikinga* vessels do not (Table 3). Moreover, the *Vikinga* vessels feature more equipment than the SMS ones. In the latter vessels, the presence of electronic equipment is limited and the hydraulic devices such as power-block to manipulate the net are systematically absent whereas they are systematically present on the *Vikinga* vessels.

The first segment of the wooden fleet, small-scale vessels (<10 m<sup>3</sup>), shows a relatively poor

performance regarding material intensity of some inventory items (e.g. construction materials). It is mainly due to economies of scale. Indeed the total annual landings per vessel of this segment, which on average is 202 t·a<sup>-1</sup>, is lower than in all other segments where vessels may land between 408 and 532 t·a<sup>-1</sup> for the medium-scale fleet and between 540 and 1 672 t·a<sup>-1</sup> for *Vikingas*. Another highlight is the variation in the use of steel and wood among segments, which is not proportional to the relative size of the vessels. According to our data from shipyards (based on a reduced number of observations, yet in our opinion sufficient for generalisations), vessels in the 18-27 m<sup>3</sup> and 32.6-50 m<sup>3</sup> segments use more steel for overboard and keel lining than smaller segments, as a proportion of the amount of wood used (7 and 10%, respectively, while all other segments use 2 to 6%). To conclude, the 10-18 m<sup>3</sup> segment features more wood and less steel used per landing t than adjacent segments.

**Table 3** Abridged Life Cycle Inventories data for the wooden fleet (2010-2012, except when stated otherwise)

|   | Unit                     | Small-scale | Medium scale |             |             | Vikingas    |             |                        |
|---|--------------------------|-------------|--------------|-------------|-------------|-------------|-------------|------------------------|
| Segment                                     | m <sup>3</sup>           | <10         | 10 - 18      | 18 - 27     | 27 - 32.6   | 32.6 – 50   | 50 - 100    | 100 - 110 <sup>a</sup> |
| Average capacity (2005-2010)                | m <sup>3</sup>           | 8           | 15           | 23          | 31          | 38          | 73          | 107                    |
| Population (2005-2010) <sup>b</sup>         | units                    | 269         | 200          | 306         | 340         | 329         | 266         | 94                     |
| Sample <sup>c</sup>                         | units                    | 9           | 5            | 1           | 3           | 6           | 3           | 1                      |
| Fishermen per vessel                        | No.                      | 6           | 8            | 9           | 9           | 12          | 13          | 14                     |
| Antifouling emissions                       | g·t <sup>-1</sup>        | 11.0        | 10.9         | 32.7        | 28.1        | 17.6        | 22.1        | 22.4                   |
| Annual fishing trips per vessel (2005-2010) | No.                      | 160         | 84.9         | 53.9        | 51.5        | 20.1        | 21.9        | 22.4                   |
| Annual landings per vessel (2005-2010)      | t                        | 202         | 408          | 455         | 532         | 540         | 1,065       | 1,672                  |
| Copper (electric network)                   | g·t <sup>-1</sup>        | 26.1        | 22.2         | 21.1        | 19.0        | 20.6        | 14.1        | 12.0                   |
| Epoxy resin (caulking)                      | g·t <sup>-1</sup>        | 5.5         | 5.6          | 7.8         | 6.7         | 9.7         | 6.6         | 5.1                    |
| Fiber glass (insulation)                    | g·t <sup>-1</sup>        | 4.1         | 2.2          | 3.7         | 4.7         | x           | x           | X                      |
| <b>Fuel use (2005-2010)</b>                 | <b>kg·t<sup>-1</sup></b> | <b>14.7</b> | <b>17.2</b>  | <b>28.1</b> | <b>29.0</b> | <b>15.3</b> | <b>12.7</b> | <b>10.1</b>            |
| Ice   | kg·t <sup>-1</sup>       | 16.4        | 65.2         | 127         | 109         | x           | x           | X                      |
| Lead (fishing nets)                         | g·t <sup>-1</sup>        | 8.4         | 11.9         | 29.1        | 30.5        | 30.5        | 25.7        | 26.7                   |
| Lubricant oil                               | kg·t <sup>-1</sup>       | 1.4         | 1.1          | 1.2         | 1.1         | 1.3         | 0.8         | 0.5                    |
| Nylon (fishing nets)                        | g·t <sup>-1</sup>        | 70.5        | 89.2         | 309         | 310         | 337         | 266         | 283                    |
| Paint and antifouling                       | g·t <sup>-1</sup>        | 2.4         | 2.5          | 5.4         | 4.6         | 4.7         | 4.4         | 3.7                    |
| Steel (hull lining and rigging)             | kg·t <sup>-1</sup>       | 0.6         | 0.8          | 1.9         | 2.0         | 2.2         | 2.2         | 2.0                    |
| Wood (hull)                                 | kg·t <sup>-1</sup>       | 18.9        | 39.1         | 31.4        | 50.6        | 21.1        | 40.8        | 35.8                   |
| Zinc  | g·t <sup>-1</sup>        | 43.9        | 45.0         | 68.5        | 66.4        | 54.9        | 32.0        | 22.9                   |

<sup>a</sup> The narrow class interval of 10 m<sup>3</sup> was used to separate this segment due to the large number of vessels it includes, in an attempt to balance Vikinga segments. Moreover, certain secondary information is based on such segmentation. <sup>b</sup> Small-scale medium-scale vessels landing >10% anchoveta. Such excluded vessels represented between 18 and 26% of vessels in the medium-scale sub-fleet and 33% in the small-scale sub-fleet, but their *anchoveta* landings contribute to less than 0.01% of the overall total anchoveta landings of SMS. <sup>c</sup> The indicated sample sizes correspond to full inventories, but close to 100% sampling was made for items such as landings, holding capacity, length and parameters to calculate fuel consumption (engine features, travelled distances and trip durations, etc). Ten or more samples per segment were available for SMS engines and hundreds for Vikinga engines.

Inventory data was obtained from surveys, except for those obtained for the period 2005-2010 from IMARPE unpublished data.

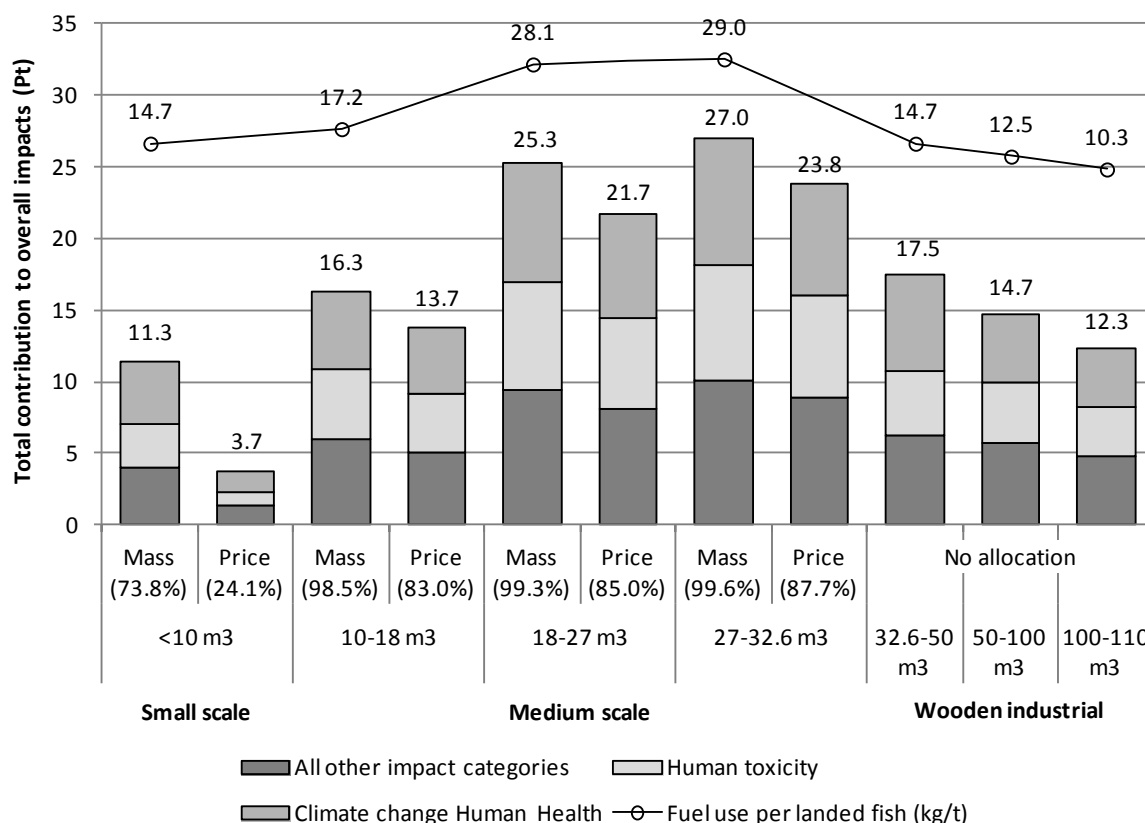
### 3.2.2 Impact assessment

Among the SMS fleet segments, overall environmental performance decreases with increasing holding capacity, while among the *Vikinga* segments, the trend is the opposite (Fig. 4). Such behaviour mimics the relative fuel use per landed tonne of each wooden fleet segment (adjusted  $r^2 = 94\%$ ;  $p$  value not shown because  $r^2$

is computed from average values). Exploring fuel use performance variability (driven by the “skipper effect”, abundance, catchability, on-board equipment, number of crew, etc.), as done for instance by Vázquez-Rowe and Tyedmers (2013) and Tingley et al. (2005), exceeds the scope of this study yet opens an interesting research direction.

The effect of the chosen allocation criterion, mass, is gauged by contrasting impact assessments calculated with mass and price allocation. Average wholesale prices in the period 2003-2012, at different Peruvian landing sites were used for main commercial species other than *anchoveta* targeted by *anchoveta* purse seiners. Impact assessment results change dramatically, yet the overall trend in relative performance shown in the

original mass-allocated analysis is in general maintained (Fig. 4). A key difference is that two segments of the SMS fleet show a better performance than the average performance of the *Vikinga* fleet when price allocation is considered, instead of one when mass allocation is used. This is because the *Vikinga* fleet lands almost exclusively *anchoveta* (thus allocation is not required).



**Fig. 4** Overall performance of the wooden fleet segments, for anchoveta, featuring top contributing impact categories (ReCiPe single score) according to allocation mode (mass-allocation versus price-allocation). Allocation factors for each segment in parenthesis. Only SMS vessels landing >10% *anchoveta* were included

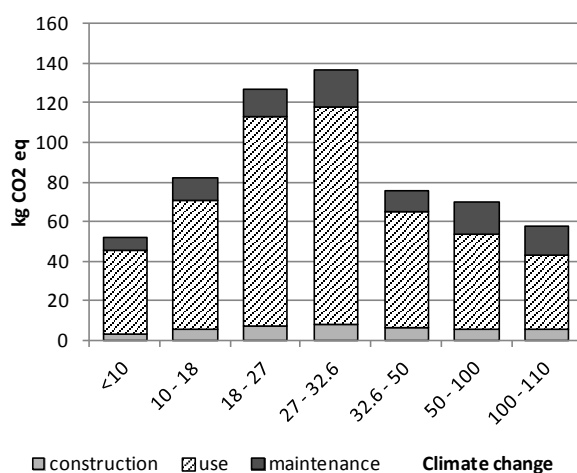
Results for key impact categories are depicted in Fig. 5; detailed LCIA results for the wooden fleets are shown in Supplementary Material A. On a per impact category basis, relative segment performance is more complex, for instance:

- Climate change, terrestrial acidification, natural land transformation, freshwater eutrophication and human and ecotoxicity follow a steady pattern

throughout the studied holding capacity segments. Performance worsens with increased holding capacity for the SMS segments and improves with increased holding capacity for the *Vikinga* segments. This pattern is closely related to (and associated with) the fuel use per landed tonne of each segment.

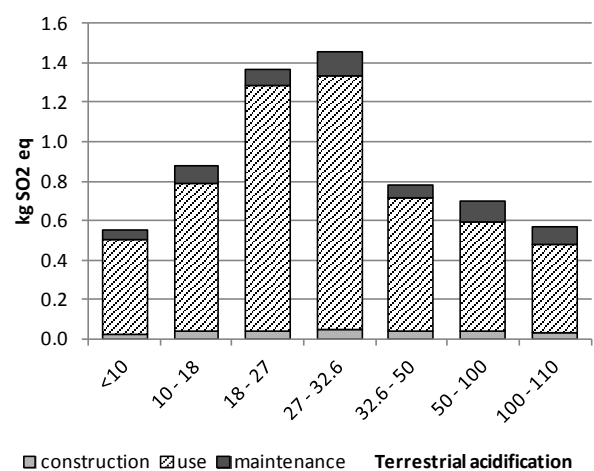
- Freshwater eutrophication performance, despite following the same trend as above (dominated by fuel use), is largely affected by the use of steel for keel and overboard lining, fishing equipment and rigging, scaled to a per landed tonne basis. The effect of steel use can be observed between the segments 27-32.6 and 32.6-50 m<sup>3</sup>, where the decrease in freshwater eutrophication potential is smoother than expected.
- CED deviates from the pattern followed by the other impact categories because, despite the fact it includes fuel use by vessels, it also considers construction and maintenance energy demand (e.g. for the provision of steel and wood), as well as the energy content of wood utilised, which follow a different pattern than that of fuel use per segment.

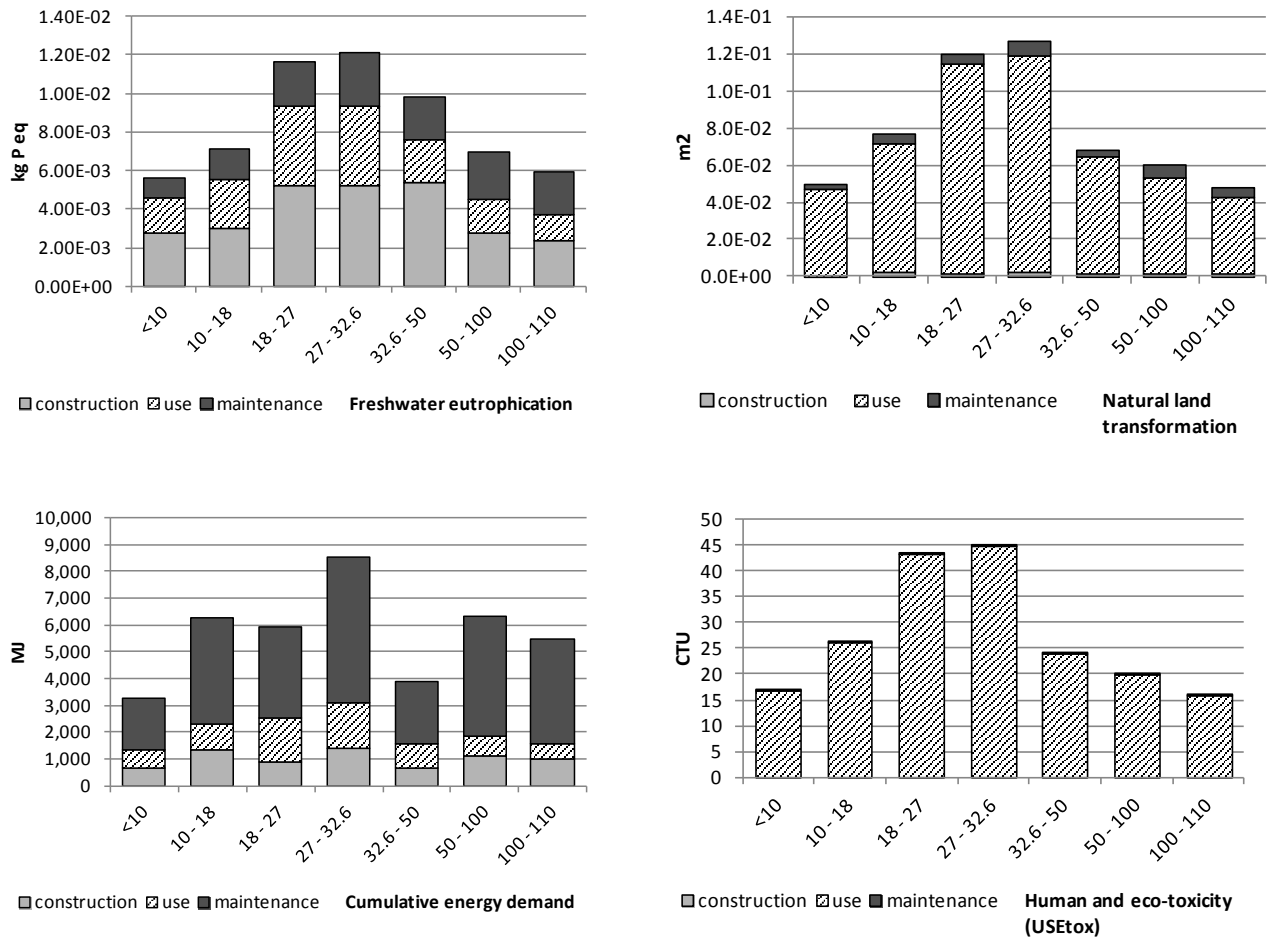
The SMS segment 27-32.6 m<sup>3</sup> features the worst environmental performance, due to a combination of high fuel consumption per landed tonne and higher steel and wood use than most other segments (except for the *Vikingas*, but those feature significantly lower fuel consumption per landed tonne). In general, *Vikinga* vessels performed better than SMS ones, both regarding overall impacts and on a per category basis.



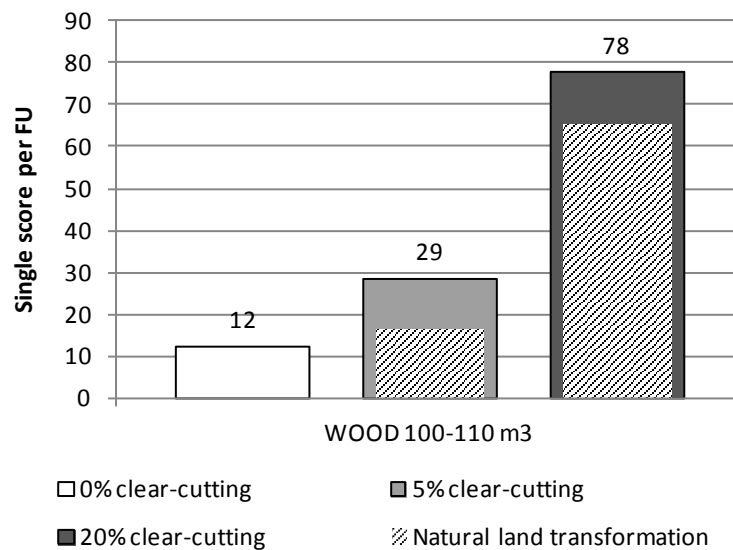
Results of the sensitivity analysis on fuel use show a higher sensitivity to fluctuations in fuel use for the 18-27 and 27-32.6 m<sup>3</sup> segments of the SMS fleet, as well as for the SMS fleet as a whole, than for the *Vikinga* and other sub-fleets (Supplementary Material A). The sensitivity analysis on total IUU allocation among segments demonstrates a very low sensitivity, especially for the upper segments (Supplementary Material A). The sensitivity analysis on the origin of wood shows a large influence of clear-cutting in all segments with wooden hull (Fig. 6). For instance, when 20% clear cutting is involved in the provision of wood for a large *Vikinga*, the natural land transformation category dramatically peaks for wood and affects the single score associated to the wooden vessel that shifts from 12 to 78, which is larger than the single score of any other steel vessel.

Without considering partial clear cutting, the CPUE-modified *Vikinga* that mimic an equivalent steel vessel features a better single score (33% lower value) than the original one. The hull-modified (steel) *Vikinga*, on the other hand, displays a worsening in single score (23%) with respect to the original value (Fig. 7).

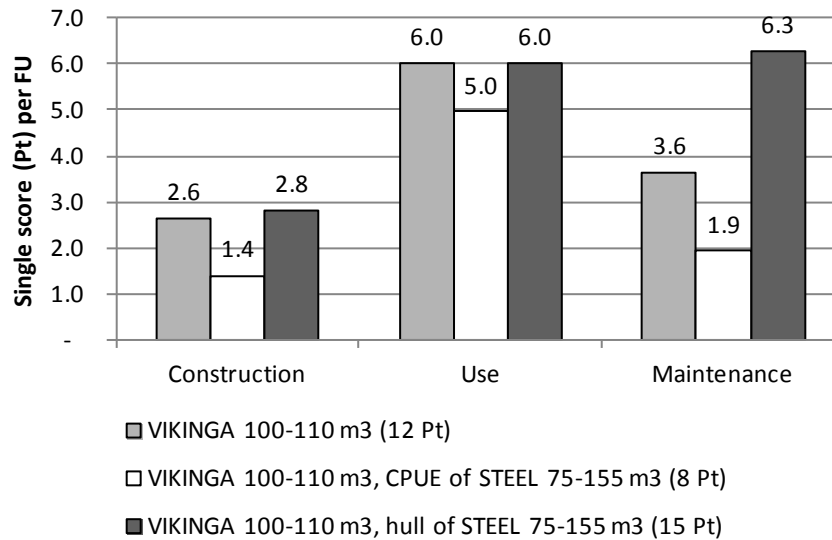




**Fig. 5** Key LCIA results for the wooden fleets, for *anchoveta* (mass-allocated), per phase for six mid-point impact categories. Only SMS vessels landing >10% *anchoveta* were included



**Fig. 6** Effects of clear-cutting in the overall environmental performance of a mass-allocated wooden fleet segment



**Fig. 7** Comparison of variations of a wooden Vikinga, separating the effect of construction materials and CPUE/fuel use rate

### 3.3 Environmentally extended Thomson tables





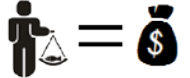


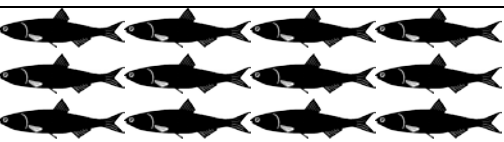





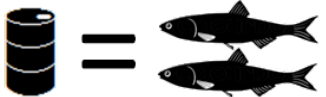
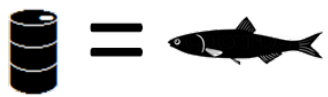






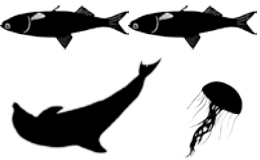

The industrial steel and wooden fleets were compared with the SMS fleets regarding environmental impact indicators (Table 4). There are little differences between the two industrial fleets. SMS fleets perform 63% worse than the industrial fleets in terms of the single score, and its CED is worst by a factor 3.6. Figures for the midpoint environmental impact categories are ~50 to ~70% worse for the SMS than for the industrial fleets.

Besides other (commercially interesting) small pelagics and jellyfish, the SMS fleets do not feature larger species in by-catch. Industrial fleets also capture jellyfish (Quiñones et al. 2013) and occasionally capture and kill small cetaceans (Van Waerebeek et al. 1997). No data on incidental catches of marine birds and turtles are available, but personal observations at sea suggest that they are limited (authors and Joanna Alfaro-Shigueto, personal communication, 07.2013). Discards by

those fleets, mostly composed of *anchoveta* juveniles, have been estimated in the order of 3.9% of landings (Torrejón et al. 2012), although much higher rates are reported in certain years where recruitment is delayed, despite temporal closure of some fishing grounds.

The simulation by a factor two or three of the overcapacity of the *Vikinga* fleet shows that the impacts of the construction, maintenance and end of life phases of the life cycle are divided by two or three, whereas the impact of the use phase is unchanged. Because the use phase has the biggest impact due to fuel provision and combustion, the results indicate a reduction of the single score impact of only 26 to 28% for the two-fold increase of catches per vessel and only 34 to 36% for a three-fold reduction, as shown in Supplementary Material A. This simulation demonstrates that the better environmental performance of the *Vikinga* fleet when compared to the SMS fleet would be even better without the penalty resulting from fleet overcapacity. The same conclusion certainly applies to the industrial steel fleet.

**Table 4** Thomson table of the industrial and SMS Peruvian *anchoveta* fleets, including landings of other species, mass-allocated (2005-2010 except when stated otherwise)

| Criteria  | Industrial fleet (steel + Vikinga)  | SMS fleet (SS, MS) <sup>g</sup>   |
|---|---|---|
| Number of fishers employed (full-time equivalents) <sup>a</sup>     | <br>3 103 (Vikingas: 783, Steel: 2 320)   | <br>2 885 (SS: 1055, MS: 1830)   |
| Number of fishers per landed 1000 t                                 | <br>4 (Vikingas: 9, Steel: 2)   | <br>19 (SS: 11, MS: 22)  |
| Number of fishers per landed 1 Million USD                          | <br>19 (Vikingas: 45, Steel: 12)  | <br>96 (SS: 61, MS: 110)   |
| Landings for DHC per year (t)                                       | 0   | <br>132 Thousand (SS: 17%, MS: 83%)  |
| Landings for IHC per year (t)                                       | <br>5.2 Million (Vikingas: 19%, Steel: 81%)   | <br>324 Thousand (SS: 10%, MS: 90%)  |
| Total landed value per year (USD) <sup>b</sup>                      | <br>1 025.7 Million (Vikingas: 195, Steel: 831)  | <br>91.4 Million (SS: 25.4, MS: 66)   |
| Fuel use per year (t)   | <br>84 Thousand (Vikingas: 9%, Steel: 91%)  | <br>11 Thousand (SS: 7%, MS: 93%)  |
| Landed tonne per t of fuel used (t)                                 | <br>70 (Vikingas: 124, Steel: 64)   | <br>40 (SS: 68; MS: 38)  |
| Weighted LCIA score <sup>c</sup> per landed t (Pt·t <sup>-1</sup> ) | <br>14 (Vikingas:15, Steel: 14)   | <br>23 (SS: 11; MS: 24)  |
| Cumulative Energy Demand per landed t (MJ·t <sup>-1</sup> )         | <br>1 890 (Vikingas: 5 470, Steel: 1050)  | <br>6 810 (SS: 3 260, MS: 7 210)   |
| Selected LCIA midpoint indicators per landed t <sup>d</sup>         | <br>CC: 67.5 (Vikingas: 68.9, Steel: 67.2)<br>AP: 0.72 (Vikingas: 0.69, Steel: 0.72)<br>EP: 6.7E3 (Vikingas: 7.5E3, Steel: 6.5E3)                               | <br>CC: 115 (SS: 52.1; MS: 123)<br>AP: 1.23 (SS: 0.55; MS: 1.31)<br>EP: 10E3 (SS: 5.7E3; MS: 11E3) |
| Fish and other sea life discarded at sea                            | <br>Dolphins (~640 individuals/year) <sup>e</sup><br><i>Anchoveta</i> juveniles (MORE)<br>Jellyfish (~5%) <sup>f</sup><br>Other fish species (<1%) <sup>f</sup> | <br><i>Anchoveta</i> juveniles (LESS)<br>Jellyfish   |

<sup>a</sup> Total jobs (partial time) per sub-fleet: Steel: 10 281, Vikingas: 8 727, SS: 1556, MS: 7 260. <sup>b</sup> Price range for 2003-2013, annual averages. <sup>c</sup> ReCiPe single score. <sup>d</sup> ReCiPe midpoint indicators (potentials); CC: Climate Change (kg CO<sub>2</sub> eq), AP: Terrestrial acidification (kg SO<sub>2</sub> eq), EP: Freshwater eutrophication (kg P eq). <sup>e</sup> Based on unpublished survey data from a large fishing company (2012). <sup>f</sup> Quiñones et al. (2013). <sup>g</sup> SMS: Small and Medium scale purse seine fleet landing >10% *anchoveta*, SS: Small scale, MS: Medium scale.



## 4 Discussion

### 4.1 Definition of fishing scale and segmentation of the fleet

As pointed out by Johnson (2006), the difficulty with the global Thomson tables is that “their authors fail to define the boundaries between the categories of small- and large-scale fisheries that they employ and to give their sources of data. Given the enormous diversity, complexity, and dynamism of small- and large-scale fisheries this is a serious oversight. Without being given the grounds for assessing the empirical basis for the tables, it is impossible to know whether they are anything more than just rhetorical devices for the value of small-scale fisheries”. This view is also shared by BNP (2008). In this study we retained the definition of SMS vessels provided by the Peruvian legislation (mostly based on hull material, holding capacity and maximum overall length) not only due to the availability of data but also because these limits make sense. The upper limit of 32.6 m<sup>3</sup> is close to the cutting point found using Ruttan’s approach on different fisheries, with values varying between 25 and 50 units of Gross Registered Tonnage (GRT) found by Ruttan et al. (2000), Sumaila et al. (2001) and Therkildsen (2007). Indeed such GRT interval corresponds to 71 to 142 m<sup>3</sup> of total internal volume, and if one considers that in principle half of this volume is used for holding fish, to 35 to 71 m<sup>3</sup> of usable holding capacity. Using overall vessel length, Carvalho found a cutting point of 12 m, which is close to the upper value observed in the SMS Peruvian fleet (15 m, which is also the official upper limit). Because all the indicators of the Thomson table are sensitive to the criteria used to scale the fisheries, we not only used the subdivision into small, medium and large (industrial) scale, but we also disaggregated the medium-scale and *Vikinga* segments into smaller categories when necessary.

Regarding the socio-economic criteria most commonly used for scaling fisheries, Johnson (2006) compiled and organised them in a table

with two (small vs. large) and three (subsistence vs. domestic commodity production vs. industrial) headings, with some degree of overlap between them. The first level of scaling of this table is not convenient for the Peruvian *anchoveta* fleets because it does not discriminate properly its different segments, nearly all of them falling into the large-scale category. This is partly due to the fact that the some characteristics retained for defining small-scale consider not met in our case study: multi-species and multi-gear activity (but we excluded vessels below 10 m<sup>3</sup> of holding capacity that do not target primarily *anchoveta*), the importance of household consumption, low catch capacity, non-motorized or low power engine and low capital investment. Using Johnson’s second level of scaling is more appropriate for purse-seine fisheries targeting large school of forage fish. It would result in excluding all vessels from the “subsistence” category and considering the whole *anchoveta* SMS fleet as part of the “Domestic commodity production” category. By combining “domestic” and “commodity” in the label of this category, Johnson (2006) clearly indicates that this fishery is engaged with and producing for the world market (in our case this applies to most of the catches aimed at IHC and to the exported part aimed at DHC). At the same time, the organisation of Johnson’s “Domestic commodity production” category still depends on affective relations of kinship, household, and community, which characterises the Peruvian SMS fleets (Estrella et al. 2005, 2010). The *Vikinga* and steel vessel segments would naturally fall into the “Industrial” category. Nonetheless, among the 19 characteristics proposed by Johnson (2006), the less discriminative to the Peruvian case is the nature of the work that varies from part-time, multi-occupational to full time when the scale is increasing. The opposite situation occurs in the Peruvian *anchoveta* fishery where fishers work close to full-time in the SMS segment but very seasonally in the industrial segments. This is due to the Peruvian fishing policy and the overcapacity of the industrial fleet, as detailed above.

## 4.2 Conventional Thomson table indicators

Most comparisons of fisheries take into account the whole fleets of a country, continent or the World. The merit of such multi-gear and multi-species comparisons is obvious, but the drawback is that they make the interpretation of the result difficult, especially in terms of how to disentangle the scale effect from the gear, vessel type and species abundance or price effect. For instance fuel consumption is known to vary largely, up to a factor 10 (Tyedmers 2000, Avadí and Fréon 2013), according to the fishing gear, even when the same species is caught in the same region. Furthermore, sailing vessels or mixed propulsion vessels allow for obvious energy saving when present in the small-scale segment. In our case study there is a single gear (the purse seine) a single type of vessel (motor boats) and a single dominant species (*anchoveta*) whose sub-stocks are exploited by all segments of the fishery. Even when landings are weighted by price, this species dominates the sales. More over we doubt that, in global comparisons, the scaling of the aggregated fisheries from different countries are performed using the same methodology (see section 4.1). Therefore our results are easier to interpret than global results, although still associated with some uncertainties as discussed in section 4.2.3. We start the next section with the second line of the conventional Thomson table (landings and their fate) because it the one that best characterises our case study and shows the comparison of our results to global results is biased.

### 4.2.1 Landings and fates

The volume of landings of the whole Peruvian SMS fleet for DHC is in the order of  $130\,000\text{ t}\cdot\text{a}^{-1}$  whereas the  $\sim 5.2$  million t of *anchoveta* caught by the industrial fishery is transformed into fishmeal and fish oil, a figure opposite to that depicted in global Thomson tables. Furthermore, most of the landing of the SMS fleet is also sent to fishmeal plants ( $324\,000\text{ t/a}$ ), a fate that was fully illegal until 2012, and from then partly legal. This situation explains why our case study fishery

differs from average since the majority of the fisheries in the world are aimed at producing fish for direct human consumption. Such a situation may appear surprising in a country where malnutrition and caloric deficit constitute major issues while *anchoveta* is a low-priced and highly nutritious fish, but it is mainly explained by the market laws (Fréon et al. 2013).

Current Peruvian fisheries policy and management aims to favour direct human consumption. It does so by applying two different exploitation and management regimes for the SMS fleets and the industrial fleets as detailed in section 2.2. The suitability of such an approach is debatable and profusely discussed in the Peruvian society (Paredes 2012, USMP 2013, Fréon et al. 2013). Moreover, such policy and management differences have historically generated evil incentives for IUU (Paredes 2013a), and has failed in dramatically increasing the production and consumption of *anchoveta* DHC products.

### 4.2.2 Employment

In Peru, whereas most of the industrial fleet has been targeting the extremely abundant *anchoveta* during the last decade, the situation is the opposite for the whole SMS fishery, which also targets many other less abundant and more manpower demanding species aimed at DHC (Estrella and Swartzman 2010, Alfaro-Shigueto et al. 2010). This situation explains why, in contrast to the original Thomson table, in Peru the small scale fleets targeting *anchoveta* employ less fishers than large-scale ones. The opposite results are obtained when considering the whole national fleets (see Supplementary Material A for more details).

Expressing employment data in relative values instead of absolute ones as above shows that in our results, the industrial fleet is the least labour-intensive, producing four jobs per thousand t landed, while the SMS fleet produced 19. These values are much lower and less contrasted than those previously published in Thomson tables using global data, from which one can compute

values of ~18 jobs per thousand t for the large scale fisheries versus ~400 jobs per thousand t for the small-scale fisheries. Despite these differences, mostly due to massive catches of an abundant species aimed at IHC in Peru, our results of a labour intensive small-scale fisheries sector support similar findings at national or local scales (e.g. Carvalho et al. 2011, Granzotto et al. 2004, Sumaila et al. 2001, Therkildsen 2007).

Another way to compare employment in both fisheries is to express it in fishers employed for each USD 1 million landed value, as in Sumaila et al. (2001). Our values of job creation in relation to each million USD landed are more contrasted than those in Sumaila et al. (2001): 47 jobs associated to small-scale landings and 48 jobs associated to large-scale landings for Atlantic Canada fisheries versus 96 and 19 jobs, respectively, in our case.

#### 4.2.3 Fuel use

Our results of fish caught per t of fuel consumed (Table 4) differ from published global results in two ways: 1) they are much higher than those previously published in global Thomson tables; 2) the large scale fleet is more fuel-efficient than the SMS fleet, by a factor 1.7. Indeed Thomson (1980), Lindquist (1988) and Berkes et al. (2001) proposed ranges of values similar between them but lower than ours, and with opposed order of fuel use of the two fleets (10-20 t of fish per t of fuel for small-scale fisheries versus 2-5 t per t for industrial fisheries). Pauly (2006) and Jacquet and Pauly (2008) proposed similar range between them but of even lower values than previous authors, still with an order of efficiency opposed to ours. Once more, these large differences partly result from the fact that the original Thomson table refers to global multi-species fisheries, while our analysis limits itself to the Peruvian mono-specific fishery targeting *anchoveta*. In any case, our results are not singular since Sumaila et al. (2001) in Norway and Therkildsen (2007) in New England also found the a higher fuel efficiency of the large scale fleets. In any case, the economies of scales can be largely attenuated by larger coastal abundance of fish and good strategies

regarding fuel use and catch rate, as observed in our case study within the SMS fleet segments (Avadí et al. 2014b).

The reasons why the SMS fleet escape the law of the economies of scale are first a better fuel use strategy resulting in a lower consumption rate ( $\text{kg}\cdot\text{h}^{-1}$ ), and second a better fishing strategy resulting in a higher CPUE ( $\text{t}\cdot\text{h}^{-1}$ ). It is likely that the first two segments found a niche of exploitation, since their average fuel consumption per landed t is close to the one of the industrial fleet which, on average, can carry 26 times more fish in its holds (15.9 kg of fuel per t for an average holding capacity of  $12 \text{ m}^3$  vs. 15.6 kg of fuel per t for an average holding capacity of  $309 \text{ m}^3$ ).

Although it is worth noting that the industrial fleet was not allowed to fish within the first five NM during our study period (now 10 NM), such performance of the smaller vessels of the SMS fleet is remarkable. Because the vessels of the SS fleet travel shorter distances than the MS fleet (31 NM according to GPS data versus >100 NM for the large-scale fleets according to VMS data), it permits them steaming at lower speeds in order to save fuel, without making longer trips than the MS fleet. Actually, the average trip duration of the first two segments is shorter than the duration of the last two ones (12.9 vs. 13.6 h), which can constitute an additional advantage for selling the catches. Shorter travelled distances are achieved, among other reasons, by fishing closer to the coast (in average, 3.9 NM for the first two segments vs. 5.5 NM for the last two ones), which is made possible by the use of purse-seines of lower height. Such smaller purse-seines can operate in shallower waters without reaching the sea floor, which is risky, especially on rocky grounds. The new legislation, which provides exclusivity of the first five NM to the SS fleet, will likely increase the gap in fuel use with the MS fleet. Another way to demonstrate the niche effect of the SS fleet and to understand why they are not subject to economies of scale is to compare hold occupation rates, defined as the relation between the average holding capacity and

the average landed t per trip, between segments. This rate averages 70% for the first two segments of the SMS fleet vs. 42% for the two upper ones (Supplementary Material C).

### 4.3 Environmentally extended Thomson table

As detailed above, we had access to a variety of data sources for inventory data to construct the environmentally extended tables. Although most of the data encompasses the years 2010-2012, other encompass different time bounds as above indicated. Nonetheless, the effect of this heterogeneity of dates is not important because all primary data on fuel use were in terms of consumption per trip or per hour, but not per landed t. Relative fuel use was then computed using landing data from the same period, which results in comparable effects of *anchoveta* abundance and catchability on the final results. However, uncertainty associated with fuel use estimations remains the weakest point of this work due to the paucity of data regarding all wooden fleet segments, as shown by our sensitivity analysis.

The outstanding environmental performance of the small-scale vessels lower than 10 m<sup>3</sup> of holding capacity is not only explained by their surprisingly low relative fuel use, but also by the negative inshore-offshore gradient of *anchoveta* abundance as quantified by Swartzman et al. (2008). The fact that the overall orientation of the individual trajectory of vessels belonging to SMS fleets, as shown by GPS data, is clearly along shore rather than perpendicular to the coastline confirms the existence of such a gradient, even in bottom depth shallower than those investigated by scientific vessels by Swartzman et al. (2008).

The even better performance of the *Vikinga* fleet and the industrial fleet with respect to the SMS fleet is less surprising, and is obviously due to an economies of scale effect. Nonetheless, the range of variation of the environmental single score impact weighted according to landings of the different segments (from 14 for the industrial fleet

to 23 for the SSM fleet) is much lower than the range of holding capacity similarly weighted (from 22 to 72). A similar result was obtained within the different segments of the industrial steel fleet and was interpreted as optimised strategy of use of the fleet, fully owned by a few large fishing companies. These companies usually own a wide range of holding capacity categories and use them appropriately according to the abundance of the resource and its distance from the harbour (Fréon et al. 2014). Within the industrial fleet as a whole, the upper range *Vikinga* segment (100 to 110 m<sup>3</sup> of holding capacity, single score 12; Fig. 4) performs better than the most similar segment of the steel fleet, the 75 to 155 m<sup>3</sup> segment, featuring a single score of 21 (and also than the average steel fleet: weighted single score 14). This is probably due to the fact that the *Vikinga* fleet is fully freelance regarding its sells and can therefore elect the best fishing days regarding fish catchability and distance to fishmeal plants, in a context of fish demand higher to fish supply due to the overcapacity of fishmeal plants (Fréon et al. 2008, 2013). In contrast, the large companies owning the steel fleet are vertically integrated and struggle to supply their plants, which must be either open and working to nearly full capacity, or closed in order to minimise exploitation costs.

If the results of our comparison of the performance of a *Vikinga* vessel in the 100-110 m<sup>3</sup> segment with simulated versions of a similar steel hull vessel (Fig. 7) can be generalised to the whole *Vikinga* and steel fleets, it can be concluded that the better performance of the *Vikinga* fleet in comparison to the steel fleet is influenced mostly by the combination of fuel use rate and CPUE, rather than by the choice of construction materials. The effect of wood as a hull construction material would be much stronger if a substantial proportion of clear cutting of the tropical forest would be considered, which generates high impacts, but nearly exclusively in the category "Natural land transformation", while use of steel mostly impacts "Eutrophication potential impact category". Among all the wooden fleet segments, provision of wood excluding clear-

cutting contributes minimally to overall impacts despite the large amounts used. Although wood provision contributes with 8 to 14% of impacts associated with construction and between 23 and 48% of the impacts of maintenance, these phases contribute much less than the use phase (Fig. 5), which is a common feature in LCA (e.g. Avadí and Fréon 2013). This also means that the influence of fuel use rate and CPUE is higher than other factors for wooden vessels.

The Cumulative Energy Demand (CED), as well as other environmental impact indicators, displays a better performance (factor 3.6) for the industrial fleets over the SMS ones (Table 4). This advantage is much higher than its advantage above the SMS fleets regarding fuel use (factor 1.7), when mass allocation is considered. This is because CED does not only compute direct fuel consumption by the vessel's engine, but also any type of energy (electricity and fuel mainly) used during the four phases of the LCA, as well as the gross calorific value of biomass. In the case of logging of primary rain forest, CED classifies the resource as non-renewable and attributes a high energy demand to its harvesting (Hischier et al. 2010). Within the wooden segments, the pattern is associated to varying proportions of wood and steel in the vessels, which are not relatively proportional to holding capacity. Therefore CED differences arise, especially in the maintenance phase (Fig. 5).

The comparison between small-scale and industrial fisheries can be extended to their impact on the food web (e.g. Granzotto et al. 2004), but this is not relevant in our case since we mostly deal with a single species, *anchoveta*. Furthermore, it could be desirable to link future local Thomson tables not only to LCA (as done in this paper), but also to other life cycle tools such as Social-LCA, Life Cycle Costing (LCC) and the emerging integrative framework of Life Cycle Sustainability Assessment (LCSA) (Klöpffer 2008, Zamagni 2012). Such life cycle-oriented Thomson tables would provide a refined comparison of large and small-scale fisheries, over their whole life cycles.

#### 4.4 Perception and valorisation of small-scale fisheries

The perception of small-scale fisheries is often associated with myths, idealisation and misconceptions, when not romanticism, as pointed for instance by Misund et al. (2002) and Johnson (2006). These fisheries are one of the battlefields in which the values of modern society have been contested, like for instance the maximisation of the economical rent, as opposed to maximisation of welfare (Béné et al. 2010). Johnson (2006) identified three “narratives” that represent the dominant ways in which changes in fisheries has been understood, and to some degree directed: modernisation, state socialism, and globalism. The first two narratives encourage intensification whereas globalism tends to eliminate the community basis of small-scale fisheries. Johnson (2006) states that “these narratives have asserted strong value-laden visions of progress based on technological development and economic growth [...] Small-scale fisheries have a particularly iconic role in these narratives of change because they stand for a traditional sector to be modernised or, as has been the case in more recent years, they stand for counter narratives of social justice and ecological sustainability [...]. These familiar observations anticipate the long-standing defence of small-scale fisheries according to the two values of ecological and social sustainability that are held to set them apart”.

The *anchoveta* Peruvian fisheries illustrate the above issues and, for the last two years, the sector suffers from a crisis that opposes tenants of industrialisation to tenants of the traditional SMS sector (Paredes 2012, Fréon et al. 2013). The former complain about the recent advantages provided to the SMS sector (extension of the reserved coastal area, allowance of selling catches to fishmeal plants, absence of quota). The latter complain about the dominant role of the large-scale fishery and fishmeal industry that limits the production of *anchoveta* for DHC and is viewed as unsustainable. But since the SMS fleet is more and

more “Domestic commodity production” orientated, it conforms less and less to socio-economic values it is supposed to embody. In addition, its environmental impact is larger than the impact of the industrial fleet, although less than expected and not when economic allocation is used to compare SMS fleet and the *Vikinga* fleet. The need of modernising the SMS fleet is debatable, since one of the most efficient segments of the whole fleet is the smallest one (Avadí et al. 2014b), which is also the less modern one. Although this is largely due to the facility of access to very shallow waters by this fleet and to its fishing strategy, it also means that modernisation is not crucial, except where sanitary conditions are concerned.

#### 4.6 Conclusions

This work confirms the vision of Johnson (2006) who states that “the values of social and ecological sustainability should best be seen not as intrinsic to small-scale fisheries but as principles that they are unlikely to meet perfectly”. This vision should be kept in mind when looking for the right balance between small- and large-scale fisheries in developing countries like Peru, and the quantitative criteria presented here, although improvable, could help in decision-making at the management and policy levels.

For the Peruvian case, we assert that the scale factor and the mono-specificity of industrial vessels determine their better performance in most criteria (especially when mass-allocation is retained) when compared to SMS vessels. Nonetheless, the SMS sector remains surprisingly efficient despite this scale handicap and the strong economic competition with the large-scale fishery. This is mainly due to an efficient strategy of fuel use, favoured by the present legislation regarding spatial access, and to a lower investment in sophisticated equipment, compensated by higher manpower. Moreover, the extended practice of IUU by the SMS fleet, tolerated by the Peruvian government, contributes to the SMS fleet’s relatively good performance in terms of landed fish per fuel used

and number of trips per year (and thus jobs), and therefore to several Thomson table indicators. Nonetheless, a formalisation of SMS operations (i.e. legalisation of landings for IHC by the medium-scale fleet, but under a quota system which is not currently the case) seems desirable, according to some analysts (e.g. Paredes 2013b). It would allegedly lower prices currently paid for IUU, stimulating more landings for DHC, especially if combined with enforcement of fish preservation measures onboard. It would also improve official statistics and facilitate further performance studies, especially if declared holding capacities are harmonised with actual ones.

Of course, policy and market-oriented measures do not always contribute to sustainable development, unless environmental and other dimensions are also taken into account. A general word of advice based on this work would be to reduce overcapacity of all fleet segments, in order to improve fuel, economic and environmental performance of the remaining vessels. Moreover, improving the operational conditions of the SMS fleet would perhaps enhance their willingness and capacity of delivering fresh *anchoveta* for DHC.

#### Acknowledgements

This work, carried out by members of the Anchoveta Supply Chain (ANCHOVETA-SC) project (<http://anchoveta-sc.wikispaces.com>) is a contribution to the International Joint Laboratory “Dynamics of the Humboldt Current system” (LMI - DISCOH) coordinated by the Institut de Recherche pour le Développement (IRD) and the Instituto del Mar del Peru (IMARPE), and gathering several other institutions. It was carried out under the sponsoring of the Direction des Programmes de Recherche et de la formation au Sud (DPF) of the IRD. The first two authors are members of the ELSA research group (Environmental Life Cycle and Sustainability Assessment, <http://www.elsa-lca.org/>). We acknowledge Marilú Bouchón and other colleagues at IMARPE in Lima and Ilo, as well as Federico Iriarte, Oscar Francisco Miro, Gilles Domalain and Rocío Joo, for both data and

insights on the dynamics of the Peruvian *anchoveta* fisheries; as well as Ian Vázquez-Rowe for his editorial insights.

## References

- Alfaro-Shigueto, J., Mangel, J.C., Pajuelo, M., Dutton, P.H., Seminoff, J. a., and Godley, B.J. 2010. Where small can have a large impact: Structure and characterization of small-scale fisheries in Peru. *Fish. Res.* 106: 8–17. Elsevier B.V. doi: 10.1016/j.fishres.2010.06.004.
- Alvarado, F. 2009. Diagnóstico social sobre el trabajo y el empleo en el sector pesquero de Ecuador y Perú. In *Proyecto para el desarrollo racional y sostenible del sector pesquero*. Madrid: Organización Internacional del Trabajo.
- ASAE. 2003. Agricultural Machinery Management. In ASAE EP496.2 FEB03. American Society of Agricultural Engineers (ASAE).
- Avadí, A., and Fréon, P. 2013. Life cycle assessment of fisheries: A review for fisheries scientists and managers. *Fish. Res.* 143: 21–38. Elsevier B.V. doi: 10.1016/j.fishres.2013.01.006.
- Avadí, A., Fréon, P., and Quispe, I. 2014a. Environmental assessment of Peruvian anchoveta food products: is less refined better? *Int. J. Life Cycle Assess.* in press. Elsevier Ltd. doi: 10.1007/s11367-014-0737-y.
- Avadí, A., Vázquez-Rowe, I., and Fréon, P. 2014b. Eco-efficiency assessment of the Peruvian anchoveta steel and wooden fleets using the LCA+DEA framework. *J. Clean. Prod.* in press. Elsevier Ltd. doi: 10.1016/j.jclepro.2014.01.047.
- Ayón, P., Swartzman, G., Espinoza, P., and Bertrand, a. 2011. Long-term changes in zooplankton size distribution in the Peruvian Humboldt Current System: conditions favouring sardine or anchovy. *Mar. Ecol. Prog. Ser.* 422: 211–222. doi: 10.3354/meps08918.
- Béné, C., Hersoug, B., and Allison, E.H. 2010. Not by Rent Alone: Analysing the Pro-Poor Functions of Small-Scale Fisheries in Developing Countries. *Dev. Policy Rev.* 28: 325–358. doi: 10.1111/j.1467-7679.2010.00486.x.
- Berkes, F., Mahon, R., McConney, P., Pollnac, R., and Pomeroy, R. 2001. *Managing small-scale fisheries. Alternative directions and methods*. Ottawa: International Development Research Centre (IDRC).
- BNP. 2008. *Small-scale capture fisheries: A global overview with emphasis on developing countries*. The Big Numbers Project, FAO and World Fish Center. Sponsored by PROFISH - World Bank.
- Carvalho, N., Edwards-Jones, G., and Isidro, E. 2011. Defining scale in fisheries: Small versus large-scale fishing operations in the Azores. *Fish. Res.* 109: 360–369. Elsevier B.V. doi: 10.1016/j.fishres.2011.03.006.
- Chavez, F.P., Ryan, J., Lluch-Cota, S.E., and Niquen C, M. 2003. From anchovies to sardines and back: multidecadal change in the Pacific Ocean. *Science* 299: 217–21. doi: 10.1126/science.1075880.
- Estrella, C., Castillo, G., and Fernández, J. 2005. II Encuesta Estructural de la Pesquería Artesanal Peruana - Regiones Moquegua y Tacna (Second Structural Survey of the Peruvian artisanal fisheries - Regions Moquegua and Tacna). Callao: Instituto del Mar del Perú. Available from <http://www.aacid.pe/documentos/store/doc.37.pdf>.
- Estrella, C., Fernández, J., Castillo, G., and Benites, C. 2010. Informe General de la Segunda Encuesta Estructural de la Pesquería Artesanal Peruana 2003-2005 (General report of the Second Structural Survey of the Peruvian artisanal fisheries 2003-2005). Lima: Instituto del Mar del Perú.
- Estrella, C., and Swartzman, G. 2010. The Peruvian artisanal fishery: Changes in patterns and distribution over time. *Fish. Res.* 101: 133–145. doi: 10.1016/j.fishres.2009.08.007.
- FAO. 2013. TECHNICAL CONSULTATION ON INTERNATIONAL GUIDELINES FOR SECURING SUSTAINABLE SMALL-SCALE FISHERIES. In TC-SSF/2013/2 TABLE. Rome: Food and Agriculture Organisation of the United Nations.
- Fréon, P., Avadi, A., Amelia, R., and Chavez, V. 2014. Life cycle assessment of the Peruvian industrial anchoveta fleet: boundary setting in life cycle inventory analyses of complex and plural means of production. *Int. J. Life Cycle Assess.* in press. doi: 10.1007/s11367-014-0716-3.
- Fréon, P., Bouchon, M., Domalain, G., Estrella, C., Iriarte, F., Lazard, J., Legendre, M., Quispe, I., Mendo, T., Moreau, Y., Nuñez, J., Sueiro, J.C., Tam, J., Tyedmers, P., and Voisin, S. 2010. Impacts of the Peruvian anchoveta supply chains: from wild fish in the water to protein on the plate. *GLOBEC Int. Newsl.*: 27–31.

- Fréon, P., Bouchon, M., Mullon, C., Garcia, C., and Niquen, M. 2008. Interdecadal variability of anchoveta abundance and overcapacity of the fishery in Peru. *Prog. Oceanogr.* 79: 401–412. doi: 10.1016/j.pocean.2008.10.011.
- Fréon, P., Sueiro, J.C., Iriarte, F., Miro Evar, O.F., Landa, Y., Mittaine, J.-F., and Bouchon, M. 2013. Harvesting for food versus feed: a review of Peruvian fisheries in a global context. *Rev. Fish Biol. Fish.* 24: 381–398. doi: 10.1007/s11160-013-9336-4.
- Frischknecht, R. 1998, March. Life cycle inventory analysis for decision-making. Scope-dependent inventory system models and context-specific joint product allocation. ETH Zurich. doi: 10.1007/BF02978487.
- Georgakaki, A., Coffey, R., and Sorenson, S.C. 2002. Development of a Database System for the Calculation of Indicators of Environmental Pressure Caused by Transport. Detailed Report 2: Maritime and Inland Shipping Modules. Department of Energy Engineering, Technical University of Denmark.
- Gerlotto, F., Gutiérrez, M., and Bertrand, A. 2012. Insight on population structure of the Chilean jack mackerel (*Trachurus murphyi*). *Aquat. Living Resour.* 25: 341–355. doi: 10.1051/alr/2012036.
- Goedkoop, M., Heijungs, R., Huijbregts, M., Schryver, A. De, Struijs, J., and Zelm, R. Van. 2009. ReCiPe 2008. A life cycle impact assessment method which comprises harmonised category indicators at the midpoint and the endpoint level. Report I: Characterisation. In Ministry of Housing, Spatial Planning and Environment (VROM). Ministry of Housing, Spatial Planning and Environment (VROM). Available from [www.lcia-recipe.info](http://www.lcia-recipe.info).
- Goedkoop, M., Heijungs, R., Huijbregts, M., Schryver, A. De, Struijs, J., and Zelm, R. van. 2013. ReCiPe 2008. A life cycle impact assessment method which comprises harmonised category indicators at the midpoint and the endpoint level. Report I: Characterisation. Ministry of Housing, Spatial Planning and Environment (VROM).
- Granzotto, A., Libralato, S., Pranovi, F., Raicevich, S., and Giovanardi, O. 2004. Comparison between artisanal and industrial fisheries using ecosystem indicators. *Chem. Ecol.* 20: 435–449. doi: 10.1080/02757540310001629224.
- Hidalgo, J. and Chirinos, C. 2005. Manual de normas legales sobre tala ilegal. Ediciones Nova Print SAC, Lima.
- Hischier, R., Weidema, B.P., Althaus, H., Bauer, C., Doka, G., Dones, R., Frischknecht, R., Hellweg, S., Humbert, S., Jungbluth, N., Köllner, T., Loerincik, Y., Margni, M., and Nemecek, T. 2010. Implementation of Life Cycle Impact Assessment Methods.ecoinvent report No. 3 (v2.2). Dübendorf: Swiss Centre for Life Cycle Inventories.
- ILCD. 2010. ILCD Handbook: General guide for Life Cycle Assessment - Provisions and action steps. doi: 10.2788/94987.
- Jacquet, J., and Pauly, D. 2008. Funding priorities: big barriers to small-scale fisheries. *Conserv. Biol. J. Soc. Conserv. Biol.* 22: 832–5. doi: 10.1111/j.1523-1739.2008.00978.x.
- Johnson, D.S. 2006. Category, narrative, and value in the governance of small-scale fisheries. *Mar. Policy* 30: 747–756. doi: 10.1016/j.marpol.2006.01.002.
- Joo, R., Bertrand, S., Chaigneau, A., and Niquen, M. 2011. Optimization of an artificial neural network for identifying fishing set positions from VMS data: An example from the Peruvian anchovy purse seine fishery. *Ecol. Modell.* 222: 1048–1059. doi: 10.1016/j.ecolmodel.2010.08.039.
- Klöppfer, W. 2008. Life cycle sustainability assessment of products. *Int. J. Life Cycle Assess.* 13: 89–95. doi: 10.1065/lca2008.02.376.
- Lindquist, A. 1988. The world's two marine fishing industries – how they compare. Figure 4 in Thanks for using NAGA. NAGA, ICLARM Q.: 17.
- MINTRA. 2012. Anuario estadístico sectorial 2011. In Serie Histórica /18. Lima: Ministerio de Trabajo y Promoción del Empleo.
- Misund, O.A., Kolding, J., and Fréon, P. 2002. Fish Capture Devices in Industrial and Artisanal Fisheries and their Influence on Management. In Handbook of Fish Biology and Fisheries - Volume 2 Fisheries. Edited by J.D. Reynolds and P.J.B. Hart. Blackwell Publishing.
- Niquen, M., and Fréon, P. 2006. A new record set by the Peruvian fishery: 2.5 million tonnes of anchovy landed in November 2005. *GLOBEC Int. Newsl.*: 56–57.



- PAD. 2008. Realidad Pesquera de la Flota Industrial de Madera: Mitos y Verdades. Escuela de Dirección, Universidad de Piura.
- Paredes, C. 2013a. Eficiencia y equidad en la pesca local: la reforma y los derechos. *El Comer.*: B6. Lima: March 29.
- Paredes, C. 2013b. La anchoveta en su laberinto. *Gestión*: 23. Lima: May 2.
- Paredes, C., and Gutiérrez, M.E. 2008. La industria anchovetera Peruana: Costos y Beneficios. Un Análisis de su Evolución Reciente y de los Retos para el Futuro (The Peruvian anchoveta industry: Costs and benefits. An analysis of recent evolution and challenges for the future). In Estudio preparado por encargo del Banco Mundial al Instituto del Perú de la Universidad de San Martín de Porres. Available from [http://institudodelperu.org.pe/descargas/informe\\_de\\_la\\_industria\\_de\\_anchoveta.pdf](http://institudodelperu.org.pe/descargas/informe_de_la_industria_de_anchoveta.pdf) [accessed 19 May 2011].
- Paredes, C.E. 2012. Eficiencia y equidad en la pesca peruana: La reforma y los derechos de pesca (Efficiency and equity in Peruvian fisheries: Reform and fishing rights). Lima: Instituto del Perú.
- Pauly, D. 2006. Major trends in small-scale marine fisheries, with emphasis on developing countries, and some implications for the social sciences. *Marit. Stud.* 4: 7–22. Available from [http://www.marecentre.nl/mast/documents/Pauly\\_Mast2006vol\\_4no\\_2\\_new.pdf](http://www.marecentre.nl/mast/documents/Pauly_Mast2006vol_4no_2_new.pdf) [accessed 26 May 2011].
- PRé. 2012. SimaPro by Pré Consultants. Available from <http://www.pre-sustainability.com/content/simapro-lca-software/>.
- PRODUCE. 2010. Resolución Ministerial: Registro de embarcaciones pesqueras artesanales para la extracción del recurso anchoveta para consumo humano directo. Ministerio de la Producción, Peru.
- PRODUCE. 2012a. Ministry of Production - Fisheries statistics. Available from <http://www.produce.gob.pe/index.php/estadistica/desembarque>.
- PRODUCE. 2012b. I Censo Nacional de la Pesca Artesanal Ambito Marítimo 2012 (I National Survey of the Marine Artisanal Fisheries 2012). Lima: Ministerio de la Producción. Available from <http://www.produce.gob.pe/index.php/estadisticas/ce-nso-pesquero-artesanal>.
- Quiñones, J., Monroy, A., Acha, E.M., and Mianzan, H. 2013. Jellyfish bycatch diminishes profit in an anchovy fishery off Peru. *Fish. Res.* 139: 47–50. doi: 10.1016/j.fishres.2012.04.014.
- Ruttan, L.M., Sumaila, U.R., Pauly, D., and Centre, F. 2000. Small versus large-scale fisheries: a multi-species multi-fleet model for evaluating their interactions and potential benefits. In *Methods for Evaluating the Impacts of Fisheries on North Atlantic Ecosystems*. Fisheries Centre Research Reports 8(2). Edited by D. Pauly and T.J. Pitcher. pp. 64–78.
- Sumaila, R., Liu, Y., and Tyedmers, P. 2001. Small versus large-scale fishing operations in the North Atlantic. *Fish. Cent. Res. Reports* 9: 28. Available from <http://www.fisheries.com/members/dpauly/booksReports/2001/FisheriesImpactsNorthAtlanticEcosystemsEvaluationPolicyExploration.pdf#page=31> [accessed 25 May 2011].
- Swartzman, G., Bertrand, A., Gutiérrez, M., Bertrand, S., and Vasquez, L. 2008. The relationship of anchovy and sardine to water masses in the Peruvian Humboldt Current System from 1983 to 2005. *Prog. Oceanogr.* 79: 228–237. doi: 10.1016/j.pocean.2008.10.021.
- Therkildsen, N.O. 2007. Small- versus large-scale fishing operations in New England, USA. *Fish. Res.* 83: 285–296. doi: 10.1016/j.fishres.2006.10.004.
- Thiao, D., Chaboud, C., Samba, A., Laloë, F., and Cury, P.M. 2012. Economic dimension of the collapse of the “false cod” *Epinephelus aeneus* in a context of ineffective management of the small-scale fisheries in Senegal. *African J. Mar. Sci.*: 37–41.
- Thomson, D. 1980. Conflict within the fishing industry. *ICLARM Newsl.*: 3–4.
- Tingley, D., Pascoe, S., and Coglan, L. 2005. Factors affecting technical efficiency in fisheries: stochastic production frontier versus data envelopment analysis approaches. *Fish. Res.* 73: 363–376. doi: 10.1016/j.fishres.2005.01.008.
- Torrejón, J., Díaz, E., and Limache, J. 2012. Descarte por exceso de captura en la pesquería del stock norte-centro de la anchoveta peruana (*Engraulis ringens* J.) entre el 2005 – 2011 (Discard due to excess captures in the North-Center stock of the Peruvian anchoveta fishery between 2005 and 2011). In III CONCIMAR Congreso de Ciencias del Mar del Perú, Libro de resúmenes digital. Edited by A. Indacochea.

Universidad Científica del Sur, Facultad de Biología Marina y Enegocios, Lima: 25 al 29 de Junio. p. 361. Available from <http://concimarperu2012.com/>.

Tveteras, S., Paredes, C., and Peña-Torres, J. 2011. Individual Fishing Quotas in Peru: Stopping the Race for Anchovies. In Marine Resource Economics. Marine Resources Foundation. Available from <http://fen.uahurtado.cl/wp/wp-content/uploads/2010/07/l263.pdf> [accessed 5 September 2011].

Tyedmers, P.H. 2000. Quantifying the energy consumed by North Atlantic fisheries. In Methods for assessing the impact of fisheries on marine ecosystems of the North Atlantic. Fisheries Centre Research Reports 8(2). Edited by D. Pauly and T. Pitcher.

USMP. 2013. MESA REDONDA ¿El marco legal está propiciando la pesquería formal en el país? Gestión: 15–18. Lima: May 14.

Vázquez-Rowe, I., and Tyedmers, P. 2013. Identifying the importance of the “skipper effect” within sources of measured inefficiency in fisheries through data envelopment analysis (DEA). *Mar. Policy* 38: 387–396. doi: 10.1016/j.marpol.2012.06.018.

Van Waerebeek, K., Van Bresseem, M., Félix, F., and Alfaro-Shigueto, J. 1997. Mortality of dolphins and porpoises in coastal fisheries off Peru and southern Ecuador in 1994. *Biol. Conserv.* 81: 43–49. Available from <http://www.sciencedirect.com/science/article/pii/S0006320796001528> [accessed 23 May 2013].

Werner, F., and Richer, K. 2007. Wooden Building Products in Comparative LCA. A Literature Review. *Int. J. Life Cycle Assess.* 12: 470–479. doi: 10.1065/lca2007.04.317.

Zamagni, A. 2012. Life cycle sustainability assessment. *Int. J. Life Cycle Assess.* 17: 373–376. doi: 10.1007/s11367-012-0389-8.

## Supplementary Material

### A. Supplementary analysis results

**Table A.1** Detailed LCIA results for the wooden fleet, for *anchoveta*, mass-allocated, per segment (results per landed tonne of *anchoveta*)

| LCIA Method                                    | Impact category                       | Unit            | Holding capacity segments (m <sup>3</sup> ) |             |             |             |             |             |             |
|--|---------------------------------------|-----------------|---|-------------|-------------|-------------|-------------|-------------|-------------|
|  |                                       |                 | <10   | 10 - 18     | 18 - 27     | 27 - 32.6   | 32.6 - 50   | 50 - 100    | 100 - 110   |
|  | Climate change                        | kg CO2 eq       | 52.09                                       | 82.64       | 126.99      | 137.21      | 76.08       | 70.47       | 58.19       |
|  | Ozone depletion                       | kg CFC-11 eq    | 6.92E-06                                    | 1.10E-05    | 1.64E-05    | 1.76E-05    | 9.18E-06    | 8.53E-06    | 6.94E-06    |
|  | Terrestrial acidification             | kg SO2 eq       | 0.55  | 0.88        | 1.37        | 1.46        | 0.78        | 0.70        | 0.57        |
|  | Freshwater eutrophication             | kg P eq         | 5.65E-03                                    | 7.13E-03    | 1.16E-02    | 1.21E-02    | 9.84E-03    | 7.02E-03    | 5.94E-03    |
|  | Marine eutrophication                 | kg N eq         | 0.03  | 0.05        | 0.08        | 0.08        | 0.05        | 0.04        | 0.03        |
|  | Human toxicity                        | kg 1,4-DB eq    | 368.44                                      | 468.05      | 719.74      | 755.82      | 578.54      | 408.32      | 342.54      |
| ReCiPe midpoint (excluding Marine ecotoxicity) | Photochemical oxidant formation       | kg NMVOC        | 0.69  | 1.09        | 1.69        | 1.81        | 0.96        | 0.87        | 0.70        |
|  | Particulate matter formation          | kg PM10 eq      | 0.18  | 0.29        | 0.45        | 0.48        | 0.26        | 0.24        | 0.19        |
|  | Terrestrial ecotoxicity               | kg 1,4-DB eq    | 0.04  | 0.06        | 0.08        | 0.09        | 0.05        | 0.05        | 0.05        |
|  | Freshwater ecotoxicity                | kg 1,4-DB eq    | 0.18  | 0.24        | 0.41        | 0.43        | 0.34        | 0.27        | 0.23        |
|  | Ionising radiation                    | kg U235 eq      | 2.24  | 3.38        | 4.90        | 5.46        | 3.52        | 3.08        | 2.58        |
|  | Agricultural land occupation          | m2a             | 1.16  | 1.83        | 2.92        | 3.08        | 1.71        | 1.51        | 1.20        |
|  | Urban land occupation                 | m2a             | 0.28  | 0.49        | 0.55        | 0.72        | 0.38        | 0.49        | 0.42        |
|  | Natural land transformation           | m2              | 0.05  | 0.08        | 0.12        | 0.13        | 0.07        | 0.06        | 0.05        |
|  | Water depletion                       | m3              | 0.13  | 0.20        | 0.33        | 0.35        | 0.27        | 0.24        | 0.20        |
|  | Metal depletion                       | kg Fe eq        | 7.47  | 8.92        | 19.67       | 20.20       | 21.42       | 19.60       | 17.70       |
|  | Fossil depletion                      | kg oil eq       | 18.43                                       | 28.16       | 42.47       | 45.86       | 26.09       | 23.94       | 19.69       |
| ReCiPe endpoint                                | Human Health                          | Pt (DALY)       | 11.34                                       | 16.29       | 25.33       | 27.02       | 17.52       | 14.69       | 12.28       |
|  | Ecosystems                            | Pt (species.yr) | 8.16  | 11.58       | 17.83       | 18.99       | 12.38       | 9.94        | 8.27        |
|  | Resources                             | Pt (\$)         | 0.25  | 0.39        | 0.62        | 0.66        | 0.37        | 0.37        | 0.32        |
|  | <b>Single Score</b>                   | <b>Pt</b>       | <b>11.3</b>                                 | <b>16.3</b> | <b>25.3</b> | <b>27.0</b> | <b>17.5</b> | <b>14.7</b> | <b>12.3</b> |
| CED  | Cumulative Energy Demand              | MJ              | 3,264                                       | 6,292       | 5,978       | 8,579       | 3,918       | 6,327       | 5,489       |
|  | <b>Human toxicity + ecotoxicity</b>   |                 |   |             |             |             |             |             |             |
| Various toxicity methods                       | USEtox <sup>a</sup>                   | CTU             | 16.91                                       | 26.38       | 43.39       | 44.94       | 24.03       | 20.09       | 15.89       |
|  | <b>Marine ecotoxicity<sup>b</sup></b> |                 |   |             |             |             |             |             |             |
|  | ReCiPe                                | kg 1,4-DB eq    | 1,113                                       | 1,172       | 3,104       | 2,761       | 1,829       | 2,087       | 2,069       |
|  | CML2000 and CML 2001 infinite         | kg 1,4-DB eq    | 19,690                                      | 24,020      | 45,738      | 45,047      | 32,361      | 29,145      | 26,591      |
|  | CML 2001 500a                         | kg 1,4-DB eq    | 660   | 701         | 1,852       | 1,650       | 1,086       | 1,252       | 1,242       |

<sup>a</sup> USEtox features no characterisation factors for certain antifouling substances released in water (i.e. copper and tributyltin compounds). <sup>b</sup> Differences in results among methods arise from differences in timeframes and characterisation factors.

**Table A.2** Detailed LCIA results for the wooden fleet, for *anchoveta*, price-allocated, per segment (results per landed tonne of *anchoveta*)

| LCIA Method                                    | Impact category                       | Unit         | Holding capacity segments (m <sup>3</sup> ) |             |             |             |             |             |             |       |
|--|---------------------------------------|--------------|---|-------------|-------------|-------------|-------------|-------------|-------------|-------|
|  |                                       |              | <10   | 10 - 18     | 18 - 27     | 27 - 32.6   | 32.6 - 50   | 50 - 100    | 100 - 110   |       |
| ReCiPe midpoint (excluding Marine ecotoxicity) | Climate change                        | kg CO2 eq    | 17.01                                       | 69.64       | 108.70      | 120.81      | 76.08       | 70.47       | 58.19       |       |
|  | Ozone depletion                       | kg CFC-11 eq | 2.26E-06                                    | 9.23E-06    | 1.40E-05    | 1.55E-05    | 9.18E-06    | 8.53E-06    | 6.94E-06    |       |
|  | Terrestrial acidification             | kg SO2 eq    | 0.18  | 0.74        | 1.17        | 1.29        | 0.78        | 0.70        | 0.57        |       |
|  | Freshwater eutrophication             | kg P eq      | 1.85E-03                                    | 6.01E-03    | 9.97E-03    | 1.07E-02    | 9.84E-03    | 7.02E-03    | 5.94E-03    |       |
|  | Marine eutrophication                 | kg N eq      | 0.01  | 0.04        | 0.07        | 0.07        | 0.05        | 0.04        | 0.03        |       |
|  | Human toxicity                        | kg 1,4-DB eq | 120.32                                      | 394.40      | 616.09      | 665.52      | 578.54      | 408.32      | 342.54      |       |
|  | Photochemical oxidant formation       | kg NMVOC     | 0.22  | 0.92        | 1.45        | 1.59        | 0.96        | 0.87        | 0.70        |       |
|  | Particulate matter formation          | kg PM10 eq   | 0.06  | 0.24        | 0.38        | 0.42        | 0.26        | 0.24        | 0.19        |       |
|  | Terrestrial ecotoxicity               | kg 1,4-DB eq | 0.01  | 0.05        | 0.07        | 0.08        | 0.05        | 0.05        | 0.05        |       |
|  | Freshwater ecotoxicity                | kg 1,4-DB eq | 0.06  | 0.21        | 0.35        | 0.38        | 0.34        | 0.27        | 0.23        |       |
|  | Ionising radiation                    | kg U235 eq   | 0.73  | 2.85        | 4.20        | 4.80        | 3.52        | 3.08        | 2.58        |       |
|  | Agricultural land occupation          | m2a          | 0.38  | 1.54        | 2.50        | 2.71        | 1.71        | 1.51        | 1.20        |       |
|  | Urban land occupation                 | m2a          | 0.09  | 0.41        | 0.47        | 0.63        | 0.38        | 0.49        | 0.42        |       |
|  | Natural land transformation           | m2           | 0.02  | 0.06        | 0.10        | 0.11        | 0.07        | 0.06        | 0.05        |       |
|  | Water depletion                       | m3           | 0.04  | 0.16        | 0.28        | 0.31        | 0.27        | 0.24        | 0.20        |       |
|  | Metal depletion                       | kg Fe eq     | 2.44  | 7.52        | 16.84       | 17.79       | 21.42       | 19.60       | 17.70       |       |
|  | Fossil depletion                      | kg oil eq    | 6.02  | 23.73       | 36.36       | 40.38       | 26.09       | 23.94       | 19.69       |       |
|  | ReCiPe endpoint                       | Human Health | Pt (DALY)                                   | 3.70        | 13.73       | 21.68       | 23.79       | 17.52       | 14.69       | 12.28 |
|  |                                       | Ecosystems   | Pt (species.yr)                             | 2.66        | 9.76        | 15.27       | 16.72       | 12.38       | 9.94        | 8.27  |
| Resources                                      |                                       | Pt (\$)      | 0.08  | 0.33        | 0.53        | 0.58        | 0.37        | 0.37        | 0.32        |       |
| <b>Single Score</b>                            |                                       | <b>Pt</b>    | <b>3.7</b>                                  | <b>13.7</b> | <b>21.7</b> | <b>23.8</b> | <b>17.5</b> | <b>14.7</b> | <b>12.3</b> |       |
| CED  | Cumulative Energy Demand              | MJ           | 1,066                                       | 5,302       | 5,117       | 7,554       | 3,918       | 6,327       | 5,489       |       |
| Various toxicity methods                       | <b>Human toxicity + ecotoxicity</b>   |              |   |             |             |             |             |             |             |       |
|  | USEtox <sup>a</sup>                   | CTU          | 5.52  | 22.23       | 37.14       | 39.57       | 24.03       | 20.09       | 15.89       |       |
|  | <b>Marine ecotoxicity<sup>b</sup></b> |              |   |             |             |             |             |             |             |       |
|  | ReCiPe                                | kg 1,4-DB eq | 363   | 988         | 2,657       | 2,431       | 1,829       | 2,087       | 2,069       |       |
|  | CML2000 and CML 2001 infinite         | kg 1,4-DB eq | 6,430                                       | 20,240      | 39,151      | 39,665      | 32,361      | 29,145      | 26,591      |       |
|  | CML 2001 500a                         | kg 1,4-DB eq | 216   | 591         | 1,585       | 1,453       | 1,086       | 1,252       | 1,242       |       |

<sup>a</sup> USEtox features no characterisation factors for certain antifouling substances released in water (i.e. copper and tributyltin compounds). <sup>b</sup> Differences in results among methods arise from differences in timeframes and characterisation factors.

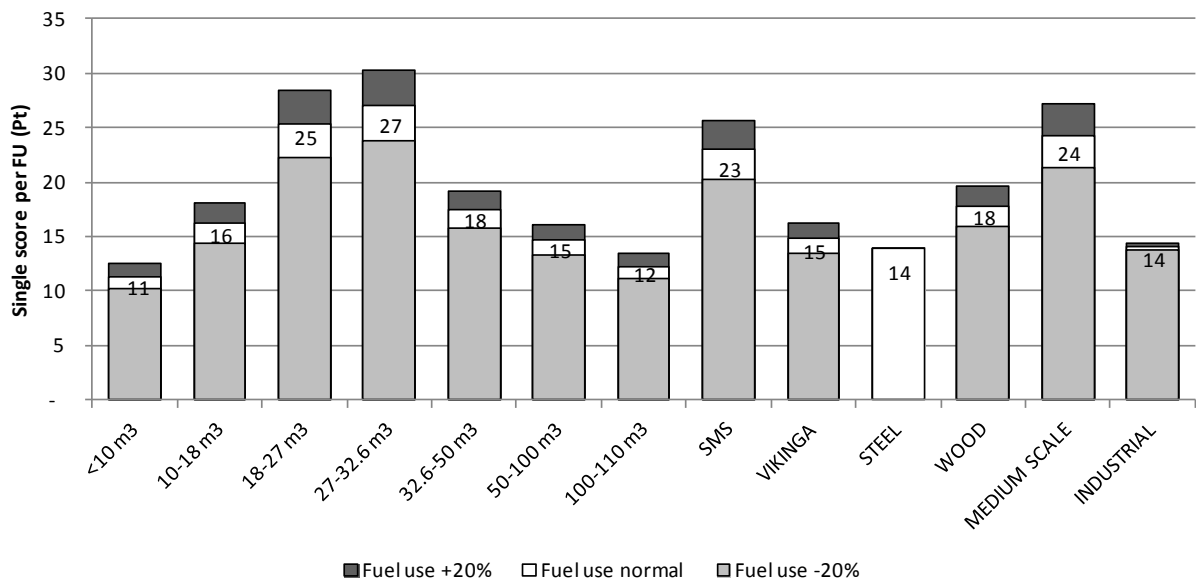
**Table A.3** Allocation factors for *anchoveta* landings, according to 6-year average mass and 5- and 10-year average prices, as used in the LCA phase of the study

| SMS Segment            | Anchoveta |       |
|------------------------|-----------|-------|
|                        | MASS      | PRICE |
| <10 m <sup>3</sup>     | 73.8%     | 24.1% |
| 10-18 m <sup>3</sup>   | 98.5%     | 83.0% |
| 18-27 m <sup>3</sup>   | 99.3%     | 85.0% |
| 27-32.6 m <sup>3</sup> | 99.6%     | 87.7% |

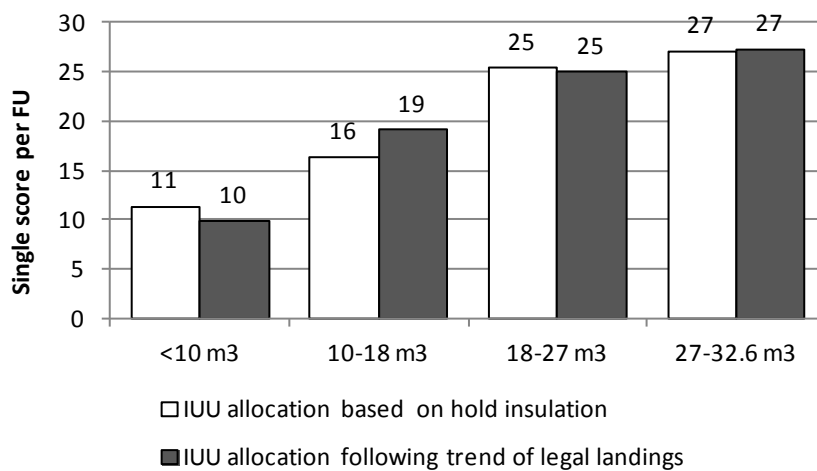
### Comparison of employment figures in the whole national fleet

No published up-to-date SMS fishery census was available in Peru as of early 2013, but a 2005 census indicates ~37 700 fishers (Estrella et al. 2010, Alfaro-Shigueto et al. 2010), and preliminary results from a 2012 census of the SMS fishery suggest ~44 000 fishers, out of which 8 700 utilise purse seine gear (PRODUCE 2012b). The latter value is larger than the value of 11 500 fisher jobs associated to the SMS fisheries under analysis, that can be obtained from our estimations and IMARPE data considering the whole SMS purse seiner population in Peru (~1 300, ~200 of which land <10% *anchoveta* and employ ~2 700 fishers). It would appear, based on PRODUCE figures, that the entire Peruvian SMS fishery provides substantially more direct employment than the national large-scale fishery. Nonetheless, in the global figures provided by Thomson (1980) and similar works, the ratio of small- to large-scale employment is varying between 16 and 100, whereas the figure for the Peruvian national fleets is only ~1.3. Some

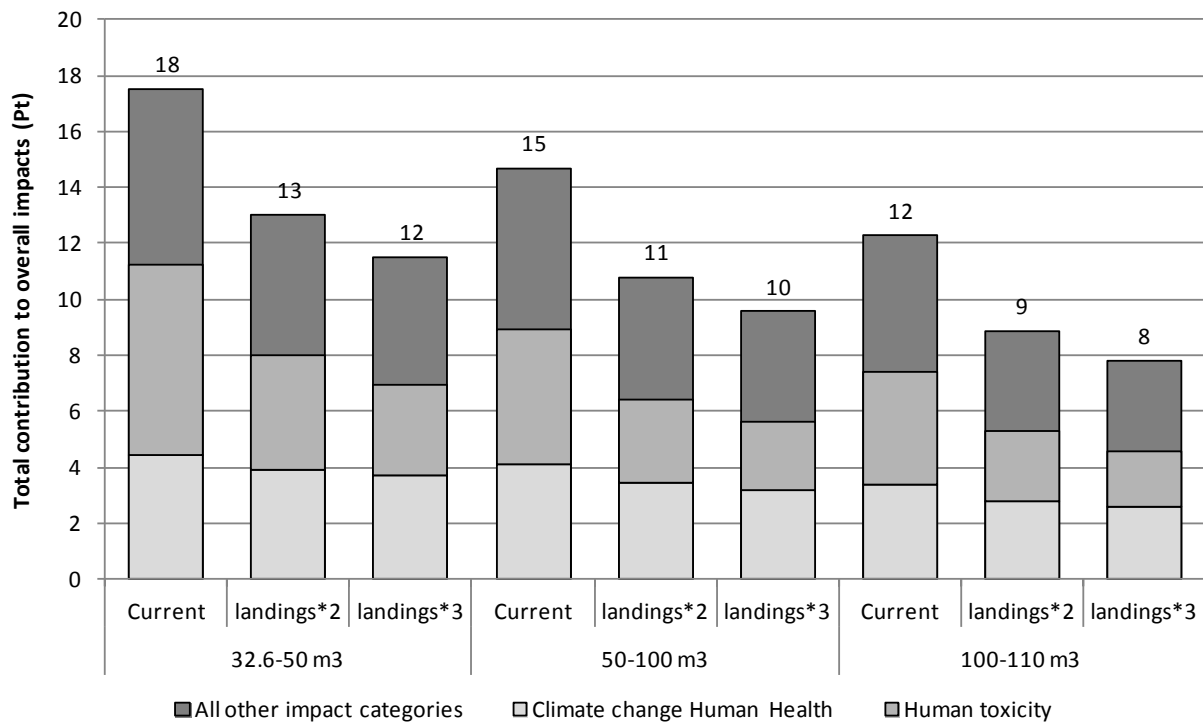
national or regional studies also confirm the Peruvian pattern of a low contrast in employment (e.g. Therkildsen (2007) for the New England fisheries, Sumaila et al. (2001) for the Canada Atlantic fisheries).



**Fig. A.1** Sensitivity analysis of the overall environmental performance of the *anchoveta* fleet in response to a  $\pm 20\%$  variation in average fuel use per landed tonne (of the wooden fleet only)

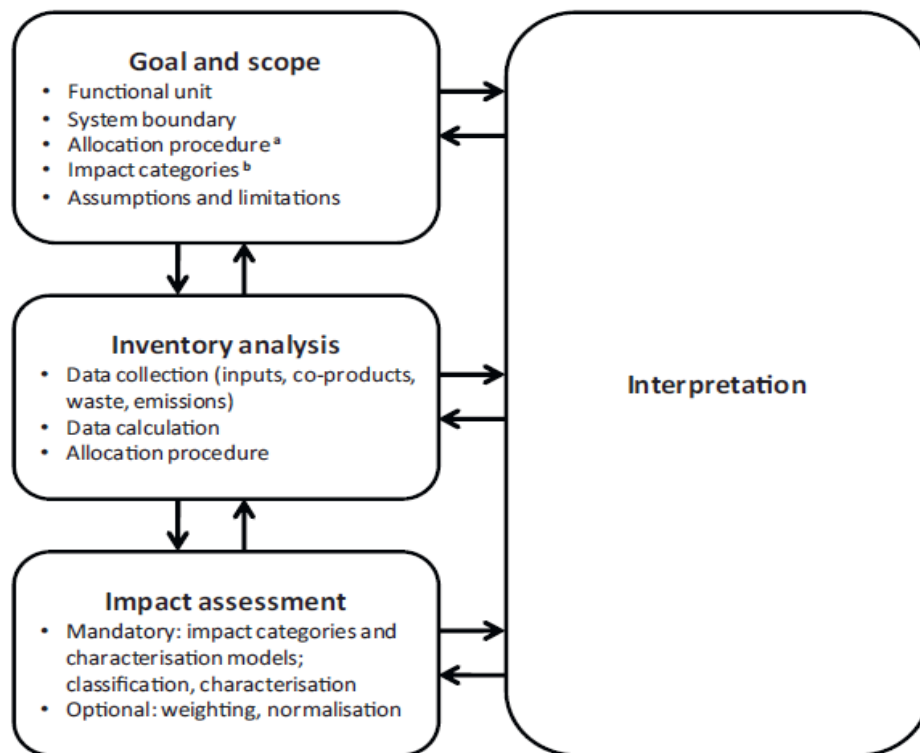


**Fig. A.2** Effects of different allocation strategies for IUU in the overall environmental performance of the SMS fleets (mass-allocation)



**Fig. A.3** Effects of increased efficiency (reduction of the fleet’s overcapacity) in the overall environmental performance of the Vikinga fleet, mass-allocated

**B. Supplementary data on Life Cycle Assessment (LCA) methodology**



**Fig. B.1** Stages in LCA (ISO, 2006a,b). (a) In the ISO standard and in this work, the allocation procedure is introduced in Goal and scope and detailed in Inventory analysis (b) Impact categories are part of both Goal and scope and Impact assessment.

### C. Supplementary data on fuel use estimations

**Table C.1** Supporting data for fuel use rate estimations for the SMS fleet, from IMARPE recorded trips

| SMS segment            | Average holding capacity (2005-2010) | Average gross tonnage <sup>a</sup> (2005-2010) | Average hold occupation per trip | CPUE (t·h <sup>-1</sup> ) | Average fishing distance to the coast (NM) | Average trip duration (h) | Maximum fishing distance to the coast (NM) |
|------------------------|--------------------------------------|--|----------------------------------|---------------------------|--|---------------------------|--|
| <10 m <sup>3</sup>     | 8.0                                  | 1.7  | 80%                              | 0.5                       | 3.7  | 12.5                      | 7.5  |
| 10-18 m <sup>3</sup>   | 15.2                                 | 3.4  | 61%                              | 0.7                       | 4.1  | 13.2                      | 8.1  |
| 18-27 m <sup>3</sup>   | 22.7                                 | 5.2  | 46%                              | 0.8                       | 5.6  | 13.6                      | 11.2                                       |
| 27-32.6 m <sup>3</sup> | 30.9                                 | 7.1  | 38%                              | 0.9                       | 5.4  | 13.7                      | 12.1                                       |

### 4.2.3 Paper 4: Comparative environmental performance of artisanal and commercial feed use in Peruvian freshwater aquaculture

Paper analysing the anchoveta-based aquafeed and Peruvian freshwater aquaculture industries, to be published in *Aquaculture* (Avadí et al., 2014c).

|  |   |
|--|---|
| Paper idea and design                            | Angel Avadí, Joël Aubin, Nathan Pelletier                   |
| Experiment design                                | Angel Avadí   |
| Data collection                                  | Angel Avadí, Jesús Núñez, Nathan Pelletier, Stéphane Ralite |
| Data processing, statistical analysis, modelling | Angel Avadí, Nathan Pelletier, Stéphane Ralite              |
| Discussion                                       | Angel Avadí, Nathan Pelletier, Joël Aubin, Pierre Fréon     |
| Writing and editorial                            | Angel Avadí, Nathan Pelletier, Pierre Fréon                 |

#### Comparative environmental performance of artisanal and commercial feed use in Peruvian freshwater aquaculture

Angel Avadí <sup>a,\*</sup>, Nathan Pelletier <sup>b</sup>, Joël Aubin <sup>c</sup>, Stéphane Ralite <sup>d</sup>, Jesús Núñez <sup>e</sup>, Pierre Fréon <sup>f</sup>

<sup>a</sup> Université Montpellier 2 – Sciences et Techniques, 2 Place Eugène Bataillon, 34095 Montpellier Cedex 5, France.

<sup>b</sup> Global Ecologic Environmental Consulting and Management Services, Canada.

<sup>c</sup> INRA, UMR1069, Sol Agro et hydrosystème Spatialisation, 65 rue de Saint Briec, CS 84215, F-35042 Rennes, France.

<sup>d</sup> A.M.N. Aquaculture Market & Nutrition, France.

<sup>e</sup> UMR 5554 ISEM, IRD, Institut des Sciences de l'Évolution Montpellier, CS 19519, 34960 Montpellier cedex 2, France.

<sup>f</sup> UMR 212 EME, Institut de Recherche pour le Développement (IRD). Centre de Recherche Halieutique Méditerranéenne et Tropicale, Avenue Jean Monnet CS 30171, 34203 SETE cedex, France.

\* Corresponding author

#### Abstract

We used life cycle assessment (LCA) to evaluate some of the environmental implications of using commercial versus artisanal feeds in Peruvian freshwater aquaculture of trout (*Oncorhynchus mykiss*), tilapia (*Oreochromis* spp.) and black pacu (*Colossoma macropomum*). Several scenarios believed to be representative of current Peruvian aquaculture practices were modelled, namely: production of trout in Andean lake cages; and culture of black pacu and tilapia in Amazonian and coastal lowland ponds, respectively. In general, Peruvian aquaculture is characterised by low technological intensity practices. Use of commercial aquafeeds is widespread, but artisanal feeds are frequently used in certain small-scale farms.

We found that trout feeds feature higher environmental burdens than do black pacu and tilapia feeds. A similar trend is observed for production of these species. Across species, the substitution of artisanal



with commercial feeds, despite improving feed conversion ratios in all cases, does not always reduce overall environmental impacts. This is due to the additional energy use and transportation requirements associated with commercial feed inputs. The substitution of artisanal feeds with commercial ones generally increases environmental impacts of the fish farming systems for the specific feeds considered, despite enhanced FCRs and economies of scale. This is due to the higher environmental impacts associated to certain feed inputs used in commercial feeds, in particular highly refined feed inputs. The environmental performance of feed ingredients is strongly influenced by the degree of processing, in particular the energy intensity of specific processing activities. Consequently, in light of the importance of feeds to overall life cycle impacts of aquaculture production, the Peruvian aquafeed industry should preferentially source less refined and, in general, less environmentally burdened feed inputs (e.g. Bolivian soybean products over Brazilian, high quality over lower quality fishmeal, avoiding protein concentrates, etc), to the extent that fish farming performance (i.e. feed conversion efficiency and cost structure) is not strongly affected. Among species, black pacu aquaculture shows the best environmental performance.

Keywords: Aquafeed, Black pacu, feed conversion ratio, Life Cycle Assessment, Peru, Trout, Tilapia

## 1 Introduction

Aquaculture is a globally important food production sector. Worldwide, 59.9 million tonnes of cultured fish, crustaceans, molluscs and other aquatic animals for human consumption, representing USD 119 billion in economic value, were produced in 2010 (SOFIA, 2012). In contrast to stagnation in fisheries landings, aquaculture production has grown, on average, 8.8% per year since the 1980s (SOFIA, 2012, 2010). Freshwater species, largely carps, account for close to 60% of production (SOFIA, 2010).

Feed provision is often considered to be a critical constraint in further expansion of the aquaculture sector (New and Wijkström, 2002) although this issue is highly debated (Asche and Tveterås, 2004; Tacon and Metian, 2008a; Tacon et al., 2011). Only 30% of cultured seafood is currently produced without feed (bivalves) or with limited feed inputs (extensive aquaculture of herbivorous fish species like cyprinids), compared to 50% in 1980 (Chiu et al., 2013; SOFIA, 2012). Moreover, the proportion of fed aquaculture continues to increase as a result of both consumer preference for higher trophic level species and producer preference for the superior growth rates achieved in fed aquaculture systems (SOFIA, 2012).

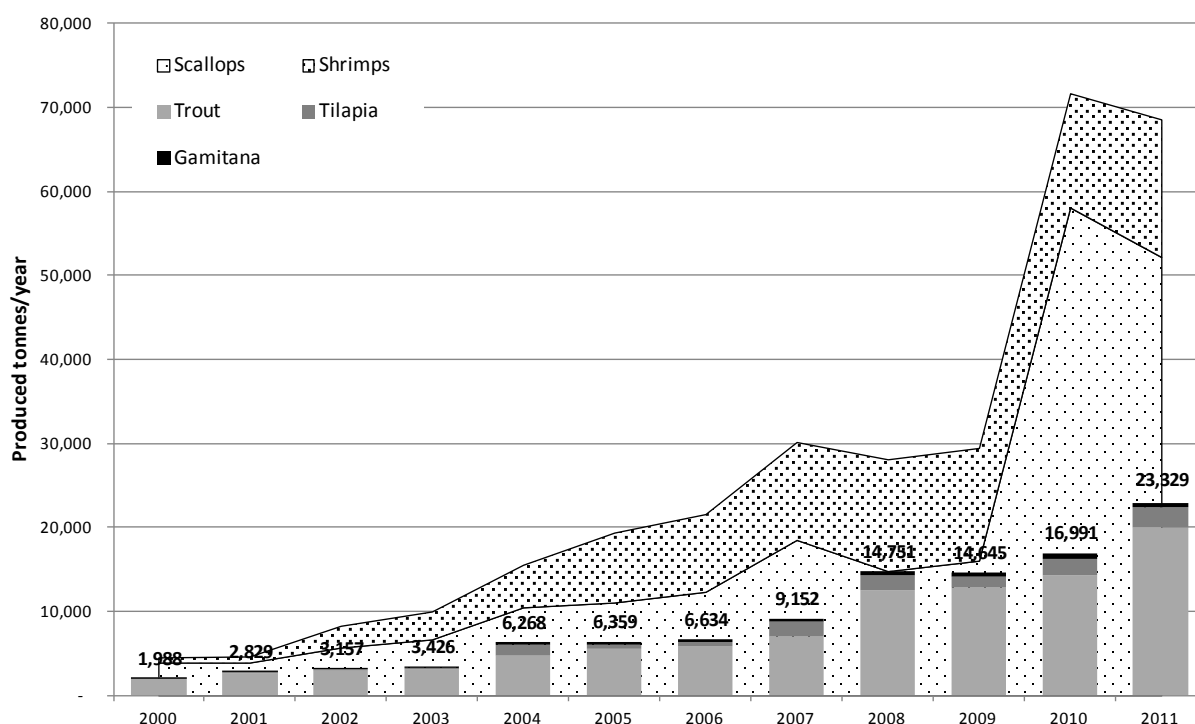
Availability of fish meal and oil (FMFO) is of particular concern with respect to ongoing global expansion of fed aquaculture. Despite that inclusion rates of FMFO have declined over time for salmonids and shrimps due to increasing use of alternative protein sources (Welch et al., 2010), overall demand has remained relatively constant due to increased use in the production of omnivorous and herbivorous species (Chiu et al., 2013; Naylor et al., 2009; SOFIA, 2012).

Previous research has shown that feed provision accounts for a large fraction of many of the environmental impacts associated with aquaculture supply chains (P. J. G. Henriksson et al., 2011). For instance, several publications highlight the contribution of feeds to overall impacts and specific environmental impact categories (Aubin et al., 2009; Boissy et al., 2011; Cao et al., 2011; Ellingsen and Aanonsen, 2006; Mungkung et al., 2013; Pelletier et al., 2009).

Peruvian aquaculture has grown at an average rate of 30% over the past 20 years. As shown in Fig. 1, production is dominated by marine species (scallops and shrimps, accounting respectively for 50% and 23% of all production), as well as freshwater species such as trout (22%), tilapia (3%) and, more recently, black pacu (1%)

(Mendoza, 2013; PRODUCE, 2009). Other than scallops, production of these species is reliant on exogenous feed inputs. Both artisanal and commercial feeds are used, but the use of commercial feeds is preferred when economically viable for cultured fish producers, especially in the case of trout, mainly because of improved feed conversion ratios (technical feed conversion ratio - FCR, defined as the total feed distributed divided by biomass weight gain). In other words, Peruvian fish farmers usually apply either one or a

combination of the following two feeding strategies: one is based on low cost (low value) artisanal feed with limited rearing performance, and the other is based on higher value industrial (commercial) feed with expected better rearing performances. These two strategies and the degree of overlap between them are dependent on the available operational budget of the farmer and the level of technical control over the production cycle.



**Fig. 1** Production level of the main aquaculture species in Peru (2000-2011). Source: (PRODUCE, 2012)

This paper focuses on the environmental performance of aquaculture, with specific attention to the role of feed provision, for rainbow trout (*Oncorhynchus mykiss*), red tilapia (*Oreochromis spp*) and black pacu (*Colossoma macropomum*) production in Peru. We developed full Life Cycle Assessment (LCA; ILCD, 2010) models for trout and black pacu production systems. In order to complete an overview of the three main cultured species in the Peruvian freshwater aquaculture sector, tilapia production was also modelled using a screening-level LCA (Wenzel, 1998). We assessed the environmental performance of various types of aquaculture

systems of the three above-mentioned species, at farm gate, in order to compare their environmental performance, taking into account the use of either commercial or artisanal feeds and feed formulations. Feeds were also compared directly, at mill gate, in order to gauge their relative environmental performance without considering feed conversion ratios.

The results of this analysis are intended to inform both aquafeed and cultured fish producers as to the relative environmental performance of feed and fish production for alternative species and feeds. A presupposition of this study was that

simpler feeds would perform better than more complex ones, when compared in isolation, on a per tonne basis. An *a priori* supporting argument was that certain feed inputs, especially those featuring more energy-intensive processing stages such as wet-milling, as well as higher levels of animal- and fish-derived inputs; would feature higher environmental impacts than less processed crop-derived feed inputs.

## 2 Methods

### 2.1 Goal and scope definition

This study follows the ISO-standardised framework for life cycle assessment (LCA) studies: 1) goal and scope definition, 2) life cycle inventories, 3) life cycle impact assessment and 4) interpretation (ISO, 2006a).

We constructed LCA models of scenarios for Peruvian fish aquaculture production systems that represent common practices in terms of choice of species (trout, black pacu, tilapia), rearing techniques (intensive and semi-intensive), feed origin (artisanal and commercial) and associated FCRs. In the case of trout and black pacu, only semi-intensive operations were considered because they represent 98% and 97% of national production, respectively (Mendoza, 2013, 2011a). In the case of tilapia, two different methods/operational scales common in Peru were

Full LCAs were performed for trout and black pacu production. Due to lack of access to primary data, a life cycle screening (LCS) —a lighter version of LCA (Wenzel, 1998)— based on secondary data was applied to tilapia production. The functional unit (FU) for this study was one metric tonne (t) of live weight, fresh farmed fish at farm gate; consistent for all species studied. A secondary FU, consisting of 1 t of fresh farmed fish, edible yield, was also used. Assessment results using both FUs were compared to isolate the effect of edible yields. Farm-level capital goods, transportation of key production inputs (e.g. fertilised eggs, fishmeal), provision of fry and land transformation

modelled (semi-intensive and super-intensive). These represent 11% and 88% of total national production, respectively (Baltazar, 2009). For the three species considered, the balance of Peruvian production is characterised by small-scale, subsistence operations (not included in the current analysis) (Mendoza, 2013). Both artisanal and commercial feeds were modelled. We define artisanal feeds as those produced with very simple technology (e.g. extruded cold-pressed pellets, air dried), at small scale, and relying on rather simple formulations that employ mostly local inputs. It is a common practice among Peruvian fish farmers, even small-scale producers, to use commercial feeds when feasible. However, artisanal feed is often used for part of or over the whole production cycles due to cost factors (Peruvian fish farmers, anonymous pers. comms.).

Overall, eight different scenarios were analysed in order to determine the influence of these different factors on environmental performance. Table 1 summarises the scenarios that were evaluated, including FCR and feeds used (commercial vs. artisanal). In most tables throughout the paper, abbreviated names are concatenations of three identifiers: the species name (two first letters of their name; “Ga” stands for gamitana —black pacu—), the type of feed used (three first letters) and the numbering of the scenario (S1 to S3) or the type of feed (F1 to F3).

activities were included in the analysis. Fig. 2 depicts the system boundaries for the analysis.

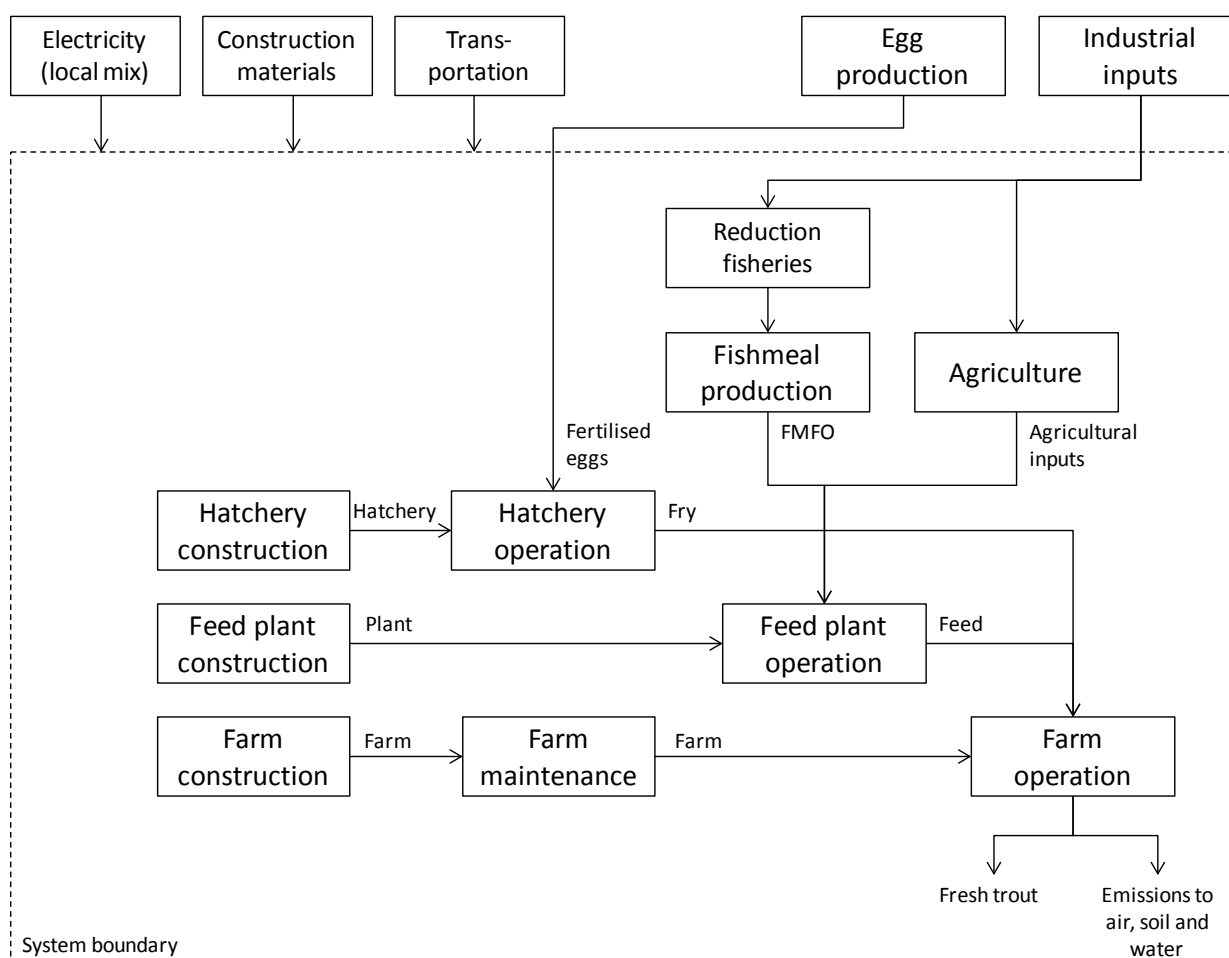
The environmental performances of each scenario were compared within and between species. Since no previous LCA studies of black pacu systems were available, our results were benchmarked against tilapia results (similar nutritional requirements and rearing practices at the semi-intensive level), as well as previous demonstrations that, under culture conditions, farming of black pacu and tilapia are similar in terms of yield (Peralta and Teichert-Coddington, 1989).

**Table 1** Peruvian aquaculture scenarios defined for this study. See Table 3 for a key of feeds

|                    | Artisanal feeds              | Commercial feeds       |                        |
|--------------------|------------------------------|------------------------|------------------------|
| Trout systems      | <b>TrArtS1</b>               | TrComS2                | TrComS3                |
| Rearing system     | <b>Cages, semi-intensive</b> | Cages, semi-intensive  | Cages, semi-intensive  |
| Feed               | TrArtF1                      | TrComF2                | TrComF3                |
| FCR (average)      | <b>1.8</b>                   | 1.4                    | 1.4                    |
| Black pacu systems | <b>GaArtS1</b>               | GaComS2                |                        |
| Rearing system     | <b>Ponds, semi-intensive</b> | Ponds, semi-intensive  |                        |
| Feed               | GaArtF1                      | GaComF3                |                        |
| FCR (average)      | <b>1.7</b>                   | 1.4                    |                        |
| Tilapia systems    | TiArtS1                      | TiArtS2                | TiComS3                |
| Rearing system     | Ponds, semi-intensive        | Ponds, super-intensive | Ponds, super-intensive |
| Feed               | TiArtF1                      | TiArtF1                | TiComF2                |
| FCR (average)      | 1.7                          | 1.7                    | 1.4                    |

Primary LCI data were collected for scenarios in bold.

Scenarios represent variations of the base scenario for each species/feed (TrArtS1, GaArtS1, TiArtS1) by replacing artisanal feeds with commercial feeds (expert-provided Peruvian commercial formulations TrComF2, GaComF3 and TiComF2, as detailed in Table 3). Peruvian FCRs are based on Peru-specific experience by the fifth author, and represent national averages.



**Fig. 2** System boundaries for the trout system model. For black pacu, egg production would be inside the perimeter. Processes outside the perimeter are modelled by modifyingecoinvent processes, except for “Egg production”, which was not included)

## 2.2 Life Cycle Inventory (LCI)

Data collection was carried out during 2012, in cooperation with civil servants of the Ministerio de la Producción —Peruvian Ministry of Production, PRODUCE—, Instituto del Mar del Perú —Peruvian Institute of the Sea, IMARPE (2012)—, Instituto de Investigaciones de la Amazonia Peruana —Research Institute of the Peruvian Amazonia, IIAAP (2012)—, and a trout development project of the regional Puno government (PETT, 2012). Five aquaculture farms, three hatcheries and three artisanal aquafeed plants were visited in Puno and Iquitos, and primary operational data collected for the purpose of building life cycle inventories.

General data on Peruvian aquaculture were compiled from official statistics and reports (Mendoza, 2013, 2011b; PRODUCE, 2012, 2010, 2009; Ruiz, 2013). Data for the Life Cycle Screening of Peruvian tilapia farming, including composition of artisanal feeds, were acquired from published sources, reports, theses and other informal literature (Baltazar, 2009; Baltazar and Palomino, 2004; Furuya et al., 2004; Gupta and Acosta, 2004; Handal, 2006; Hurtado, 2005a, b; Lochmann et al., 2009; Luna, 2008; Maradiague et al., 2005; Mendoza, 2013; Mendoza, 2011b; Pelletier and Tyedmers, 2010; UNALM, 2012). Infrastructure and basic maintenance activities were assumed to be similar (with minor adjustments only) to black pacu systems. For the purpose of quantifying inputs of capital goods, life spans of black pacu and tilapia production systems (infrastructure, ponds) were estimated at 20 years, while trout cage systems were expected to operate for 10 years (with net replacement every two years) before major infrastructure recapitalisation. The national Peruvian grid energy mix and the local Iquitos grid energy mix were modelled based on recent, official energy reports (MINEM, 2012, 2009).

Due to the importance of feed provision with respect to potential environmental impacts, we used country/product-specific inventory data for key fish (ANCHOVETA-SC project, unpublished

data) and agriculture-derived (Pelletier et al., 2009) feed input supply chains, as well as feed manufacturing subsystems. Filleting and other post-farm processing were not considered.

### 2.2.1 Rearing systems

Fig. 3 depicts the geographical distribution of main aquaculture production areas in Peru.

Most trout culturing operations are artisanal yet semi-intensive, especially those in the Puno area (Lake Titicaca and nearby water bodies), where the bulk of the national production takes place. Trout farming in the Puno region water bodies consist of artisanal wood- or metal-nylon floating cages (800 kg to 2 000 kg carrying capacity according to size and fish density) and larger scale metal-nylon floating cages (up to 6 t carrying capacity). The production cycle starts at hatcheries with fertilised eggs imported from the USA and Denmark. Fingerlings (fry) are directly transferred into water body-based systems. The total local cycle takes seven to nine months and consumes almost exclusively commercial feeds. Trout is mainly destined for export, despite increasing consumption in the producing areas and large Peruvian cities, particularly in the capital, Lima. Reference literature for the trout LCA, in complement to directly collected data, were derived from Aubin et al. (2009), Boissy et al. (2011), Grönroos et al. (2006) and Roque d'Orbcastel et al. (2009). Water management (i.e. pumping and aeration) is not required.

Black pacu farming is carried out mainly in large, semi-intensive artificial pond systems, yielding approximately  $10 \text{ t}\cdot\text{ha}^{-1}\cdot\text{y}^{-1}$ . The production cycle takes 12 months and consumes mostly commercial feeds. Water replenishment is estimated at 200% per cycle, hence associated energy inputs were included in the model. Fry are provided predominantly by IIAAP (2012). This species is cultured almost exclusively in the Amazon basin (Loreto and San Martin areas). Black pacu is mostly consumed locally, to a large extent due to the physical isolation of Amazonian breeders, the growing local demand that resulted

in overexploitation of wild stock (Anderson et al., 2011) and the lack of a cold transportation/storage chain for national distribution. No previously published LCA studies

of black pacu production are available, thus only directly collected data were used to model production-level activities.



**Fig. 3** Department map of Peru, showing main aquaculture-producing regions and main species (PRODUCE data). Labels in bold represent the leading producing region for each species

Tilapia is produced using a variety of methods and operational scales, mostly intensive. Most of the farms are located in northern Peru, in the Piura (>88% of production) and San Martín regions (>10% of production), and are either semi-intensive pond systems with an annual yield of 15 t·ha<sup>-1</sup> or intensive/super-intensive pond systems yielding 200 to 500 t·ha<sup>-1</sup>. Super-intensive production takes place in geomembrane-filled ponds or in concrete ponds with water replenishment rates of up to 700% over the production cycle, and pond aeration (80 HP·ha<sup>-1</sup>, 3 hours of use per day). Semi-intensive production usually takes place in semi-natural pond systems, with a water replenishment rate of ~200%, by stream derivation. In Peru, most tilapia fry produced are mono-sex males, obtained by hormone-induced sex reversal (Baltazar, 2009). The whole local production cycle of tilapia takes seven months, and consumes mostly commercial feeds. Tilapia was historically destined to the national market, but over the last decade increasing shares of production have been exported. In complement to directly collected data, reference data for the LCS of tilapia production were derived from a study of lake- and

pond-based tilapia farming in Indonesia (Pelletier and Tyedmers, 2010).

FCRs retained for all scenarios are Peru-specific estimations provided by a fish nutrition and aquaculture expert with experience in Peruvian aquaculture (the fifth author). Estimated technical FCRs represent Peruvian averages encompassing small and large producers, using artisanal and commercial feeds. Transportation activities (i.e. for commercial feeds and feed inputs transported from Lima to farm areas, and fertilised trout eggs imported mainly from North America) were modelled based on available *ecoinvent* (Ecoinvent, 2012) data, surveys and estimations of distances and routes. The use of fertilisers is very limited in the studied systems. However, the use of quicklime and organic fertiliser (poultry manure) in black pacu ponds and in semi-intensive tilapia farms was included in the models as free inputs, that is to say, without accounting for substitution of chemical fertilisers. Edible yields were obtained by averaging various reference values from literature.

Table 2 describes key features of the modelled systems.

**Table 2** Main features of studied Peruvian aquaculture systems (PRODUCE data, field data and informal literature: Baltazar, 2009; Luna, 2008; Mendoza, 2013; Rebaza et al., 2008; UNIDO, 2005)

| Features                                | Trout (LCA)   | Black pacu (LCA)                       | Tilapia (LCS)  |
|---|---|--|--|
| Species                                 | <i>Oncorhynchus mykiss</i>                                  | <i>Colossoma macropomum</i>            | <i>Oreochromis</i> spp.  |
| Edible yield (raw fillets) <sup>a</sup> | 61%   | 45%                                    | 35%  |
| Location                                | Titicaca lake, Puno   | Iquitos, Loreto                        | Lancones, Piura and San Martín   |
| Scale                                   | Semi-intensive (artisanal)                                  | Semi-intensive                         | Intensive  |
| Production                              | 10 t·cage system <sup>-1</sup> ·y <sup>-1</sup>             | 10 t·ha <sup>-1</sup> ·y <sup>-1</sup> | Semi-intensive: 15 t·ha <sup>-1</sup> ·y <sup>-1</sup><br>Intensive: 200 t·ha <sup>-1</sup> ·y <sup>-1</sup><br>Super-intensive: 500 t·ha <sup>-1</sup> ·y <sup>-1</sup><br>Average intensive: 350 t·ha <sup>-1</sup> ·y <sup>-1</sup> |
| Fry origin                              | Imported fertilised eggs, fry produced in Chichillapi, Puno | Fry produced and distributed by IIAP   | Fry produced locally by private companies  |
| Fry weight                              | 1.4 g   | 2.0 g                                  | 5.0 g  |
| Harvest weight                          | 350 g   | 1 200 g                                | 850 g  |
| Production cycle                        | 9 months  | 12 months                              | 7 months   |

| Technology                      | Lake floating cages  | Artificial ponds (soil walls), with fertilisation | Artificial ponds (geomembrane insulation), fertilisation when semi-intensive         |
|---------------------------------|----------------------|---|--|
| Mortality                       | 10%                  | 20%   | 15%  |
| Final density                   | 30 u·m <sup>-3</sup> | 0.5 u·m <sup>-3</sup>                             | Semi-intensive: 2-10 u·m <sup>-3</sup><br>Average intensive: 15-20 u·m <sup>-3</sup> |
| Representativeness <sup>b</sup> | 98%                  | 97%   | Semi-intensive: 11%<br>Average intensive: 88%  |
| Number of farms <sup>b</sup>    | 1 581                | 38  | 56   |

<sup>a</sup> Edible yields are averages of various sources, namely Celik et al. (2008) and Bugeon et al. (2010) for trout; Torry Research Station (1989) and Bocanegra and Bucchi (2001) for black pacu; and Torry Research Station (1989), Mendieta and Medina (1993) and Garduño-Lugo et al. (2003) for tilapia. <sup>b</sup> Percentage of the national production represented by the modelled system. <sup>b</sup> Only small-scale farms, in 2012 (in Peru, those producing less than 50 t per year).

**Note.** Figures used for the life cycle modelling are highlighted in bold.

### 2.2.2 Artisanal and commercial feeds

For commercial feed production, composition data were provided by industrial aquafeed producers (anonymous pers. comms.). A commercial salmonids feed used in Chilean salmon farming (Pelletier et al. 2009), which is sometimes used by Peruvian trout producers, was also modelled. Data for energy inputs to feed milling were derived from published sources (Pelletier and Tyedmers, 2010; Pelletier et al., 2009). Commercial aquafeeds were assumed to be transported from Lima (where most of aquafeed production in Peru takes place) to the farm location by truck.

Fisheries inputs to feeds were modelled using unpublished primary data (ANCHOVETA-SC project) that were collected in the period 2010-2013 and encompass three different fishmeal plants, as detailed in the Supplementary Material (SM), Table B.3. According to this research, fishmeal and fish oil yield rates were 21.3% and 4.3% respectively based on average data for the period 2002-2011. These figures are lower than other values recently reported for Peruvian and foreign FMFO industries (Péron et al., 2010; Samuel-Fitwi et al., 2013). Agricultural and animal husbandry inputs to feeds were based on the

aquaculture feed supply chain models reported in Pelletier et al. (2009). Additional models were developed (for instance, for Peruvian rice production) where necessary using equivalent modelling protocols (details are presented in SM, Appendix A). Geographical origins of feed inputs were assumed based on market share. Minor feeds inputs such as micronutrients (vitamin and mineral premixes) were not considered.

For artisanal feed production, composition and operational data were collected via survey. Transportation of all non-local inputs was included in the analysis. Input data for local agricultural feed crops were assumed to be equivalent to national average inputs except when specific data was available (e.g. for seasonal Amazonian rice). Table 3 presents detailed feed formulations, plus additional composition and performance data. Table 4 compares the retained FCRs with other values presented in literature.

It is worth noticing that fishmeal and oil used in Peru are 100% sourced in the country. The bulk of reduction produce is exported, but small amounts are sold for national use (INEI, 2012).



**Table 3** Composition of studied aquafeeds

|   | Trout             |                     |                         | Black pacu        |                     | Tilapia                   |                     |
|---|-------------------|---------------------|-------------------------|-------------------|---------------------|---------------------------|---------------------|
| Data source:                                      | Survey            | Expert <sup>b</sup> | Pelletier et al. (2009) | Survey A          | Expert <sup>b</sup> | UNALM (2012) <sup>c</sup> | Expert <sup>b</sup> |
| Feed production scale:                            | artisanal         | commercial          | commercial              | artisanal         | commercial          | generic                   | commercial          |
| Country and year of use:                          | PE 2012           | PE 2012             | CL 2007                 | PE 2012           | PE 2012             | PE 2012                   | PE 2012             |
| Abbreviation:                                     | TrArtF1           | TrComF2             | TrComF3                 | GaArtF1           | GaComF3             | TiArtF1                   | TiComF2             |
| <b>Ingredients</b>                                |                   |                     |                         |                   |                     |                           |                     |
| Aminoacids by-products                            |                   | 0.7% US             |                         |                   | 0.5% US             |                           | 0.5% US             |
| Blood Meal (poultry)                              |                   | 5.0% PE             |                         |                   |                     |                           | 5.0% PE             |
| Calcium carbonate, salt, etc.                     |                   | 0.8% PE             |                         |                   | 1.5% PE             | 0.5% PE                   | 2.0% PE             |
| Fish oil  | 5.0% PE           | 6.0% PE             | 17.2% PE<br>CL          |                   |                     | 0.3% PE                   | 1.0% PE             |
| Fishmeal  | 40.0% PE          | 20.0% PE            | 25.1% CL<br>PE<br>PY    | 6.0% PE           |                     | 10.0% PE                  | 4.0% PE             |
| Lupin seed  |                   |                     | 0.8% CL                 |                   |                     |                           |                     |
| Maize   | 15.0% BO          | 5.0% BO             |                         | 49.0% PE          | 15.0% BO            | 8.9% PE                   | 24.0% BO            |
| Maize gluten meal                                 |                   | 5.0% US             | 7.3% US<br>CL           |                   |                     |                           |                     |
| Meat Meal (poultry)                               |                   | 15.0% PE            | 15.1% BR<br>FR          |                   | 10.0% PE            |                           | 10.0% PE            |
| Molasses  | 5.0% PE           |                     |                         |                   |                     |                           |                     |
| Palm oil  |                   | 1.0% MY             |                         |                   |                     |                           |                     |
| Monocalcium phosphate                             |                   |                     |                         |                   | 2.5% PE             |                           | 1.5% PE             |
| Rapeseed meal                                     |                   |                     | 2.3% FR                 |                   |                     |                           |                     |
| Rapeseed oil                                      |                   |                     | 1.0% FR                 |                   |                     |                           |                     |
| Rice (broken grains, powder)                      |                   | 10.0% PE            |                         | 7.0% PE           |                     |                           | 10.0% PE            |
| Rice bran   |                   |                     |                         |                   | 35.0% PE            |                           | 20.0% PE            |
| Soy oil   |                   | 1.0% BO             | 4.8% AR                 |                   |                     |                           | 0.5% BO             |
| Soybean meal                                      | 15.0% BO          | 20.0% BO            | 9.7% AR                 | 34.0% BO          | 25.0% BO            | 32.2% US                  | 11.0% BO            |
| Sunflower meal                                    |                   |                     | 10.4% AR                |                   |                     |                           |                     |
| Vitamins, minerals (premix)                       |                   | 0.5% PE             |                         | 4.0% PE           | 0.5% PE             | 0.9% PE                   | 0.5% PE             |
| Wheat   | 20.0% PE          | 10.0% PE            | 5.8% CL                 |                   |                     | 36.0% PE                  |                     |
| Wheat bran  |                   |                     |                         |                   | 10.0% US            | 11.3% PE                  | 10.0% US            |
| Wheat gluten meal                                 |                   |                     | 0.6% UK                 |                   |                     |                           |                     |
| Number and refinement of main inputs <sup>e</sup> | 6 (4)             | 11 (8)              | 12 (10)                 | 5 (2)             | 6 (4)               | 6 (4)                     | 10(8)               |
| <b>Nutritional values and FCRs</b>                |                   |                     |                         |                   |                     |                           |                     |
| Protein   | 37.6%             | 42.0%               | 42.5%                   | 24.5%             | 24.0%               | 30.0%                     | 24-28%              |
| Lipid   | 8.7%              | 12.0%               | 27.2%                   | 3.0%              | 6.0%                | 5.3%                      | 6.0%                |
| Phosphorus  | 1.0% <sup>a</sup> | 1.0%                | 1.0% <sup>a</sup>       | 0.8% <sup>a</sup> | 0.8%                | 0.9%                      | 0.8%                |
| Humidity  | 15%               | 11%                 | 12%                     | 15%               | 11%                 | 15%                       | 11%                 |
| Digestible energy (kcal/kg)                       | 3 100             | 3 800               | 4 600                   | 2 750             | 2 550               | 2 700                     | 2 700               |
| FCR declared (fish and feed producers)            | 1.3               | 1.2-1.3             | 1.5                     | 1.5               | 1.5                 | 1.3-1.8 <sup>d</sup>      | 1.3                 |
| FCR retained (averages)                           | 1.8               | 1.4                 | 1.4                     | 1.7               | 1.4                 | 1.7                       | 1.4                 |

<sup>a</sup> Value adopted from commercial feeds. <sup>b</sup> Peruvian commercial formulations and retained FCRs were provided by an expert in aquafeeds and fish nutrition, based on Peru-specific experience and interactions with manufacturers (fifth author). The sourcing of inputs was based on national trade data and anecdotal accounts. <sup>c</sup> Based on unpublished data by the National Agricultural University La Molina (UNALM). UNALM produces aquaculture feeds commercially. 10% inclusion of fishmeal in commercial tilapia feeds is confirmed in Furuya et al. (2004). <sup>d</sup> A feed conversion ratio of 2.2 for super-intensive tilapia farming in Peru has been reported (Baltazar, 2009), but this rate is based on data from the 1990s. Recent data suggests 1.7 for intensive production in Latin America (third author), while IFFO suggests a range of 1.6-1.8 and UNALM suggests 1.3 for Peruvian production. <sup>e</sup> Only fish, animal and crop-derived inputs. Numbers in parenthesis represent inputs featuring more than 4 refining (i.e. energy-consuming) processes.

**ISO country codes.** AR: Argentina, BO: Bolivia, BR: Brazil, CL: Chile, FR: France, MY: Malaysia, PE: Peru, US: United States of America, UK: United Kingdom.

**Table 4** Comparison of average Peruvian FCRs and literature FCRs for the studied species

| Farming systems     | Retained FCRs | Literature FCRs |         |   |
|---------------------|---------------|-----------------|---------|---|
|                     |               | Country         | FCR     | Source                                    |
| Trout, cage         | 1.4-1.8       | Australia       | 1.5     | Glencross et al. (2002)                   |
|                     |               | Finland         | 1.3     | Grönroos et al. (2006)                    |
|                     |               | Chile           | 1.4     | Tacon and Metian (2008a)                  |
|                     |               | Peru            | 1.1-1.4 | Tacon and Metian (2008a)                  |
| Trout, flow-through | N/A           | France          | 1.1-1.2 | Aubin et al. (2009), Boissy et al. (2011) |
| Tilapia, pond       | 1.4-1.7       | China           | 1.4-1.9 | Chiu et al. (2013)                        |
|                     |               | Indonesia       | 1.7-2.1 | Mungkung et al. (2013)                    |
|                     |               | Indonesia       | 1.7     | Pelletier and Tyedmers (2010)             |
| Black pacu, pond    | 1.4-1.7       | Jamaica         | 1.9-2.0 | Watanabe et al. (2002)                    |
|                     |               | Argentina       | 1.4-1.7 | Bechara et al. (2005)                     |
|                     |               | Brazil          | 1.7-1.9 | Carvalho and Rodrigues (2009)             |
|                     |               | Brazil          | 1.7-1.9 | Nwannaa et al. (2008)                     |

### 2.2.3 Nutrient emissions

Nitrogen and phosphorus emissions to water from fish farm operations were modelled using the mass balance approach described in Cho and Kaushik (1990) and Kaushik and Cowey (1991). The method was complemented with an emissions fate analysis based on literature addressing nutrient flows in ponds (Gross et al., 2000; Jiménez-Montealegre et al., 2005). Modelling of emissions to water was based on specific feed and FCR values for each Peruvian scenario modelled.

### 2.2.4 Allocation

Allocation of impacts among agricultural (crop and animal husbandry) and fisheries inputs and their co-products was based on mass-weighted gross energy content (GEC) (Ayer et al., 2007; Pelletier and Tyedmers, 2011). In the case of fisheries

products, for instance, economic allocation (Aubin et al., 2009; Boissy et al., 2011) was deemed less preferable than GEC based allocation, given fluctuating relative prices for FM and FO (Fréon et al., 2013). Relative energy content of FM and FO is, despite natural fluctuations in oil content of fresh *anchoveta* (*Engraulis ringens*, the main species used for reduction in Peru), historically stable, as is the yield of FM and FO per tonne of fish. For methodological consistency, and in compliance with the International Organization for Standardization 14044 standard for LCA (ISO, 2006a, 2006b), a consistent allocation criterion was used for all feed inputs.

### 2.3 Life Cycle Impact Assessment (LCIA)

This study includes some of the impact categories most commonly used in aquaculture LCAs (Aubin, 2013; Parker, 2012), as listed in Table 5.

**Table 5** Impact categories and aggregated scores used in this study

| Impact category                | Method        | Typical unit          |
|--------------------------------|---------------|-----------------------|
| Acidification potential        | CML           | kg SO <sub>2</sub> -e |
| Agricultural land occupation   | ReCiPe        | m <sup>2</sup> ·yr    |
| Biotic resource use            | -             | kg C                  |
| Cumulative energy demand       | CMD           | MJ                    |
| Eutrophication potential       | CML           | kg PO <sub>4</sub> -e |
| Global warming potential       | CML           | kg CO <sub>2</sub> -e |
| Water depletion                | ReCiPe        | m <sup>3</sup>        |
| <b>Toxicity</b>                |               | <b>kg 1,4-DB-e</b>    |
| Freshwater aquatic ecotoxicity | CML           | kg 1,4-DB-e           |
| Human toxicity                 | CML           | kg 1,4-DB-e           |
| Terrestrial ecotoxicity        | CML           | kg 1,4-DB-e           |
| <b>ReCiPe single score</b>     | <b>ReCiPe</b> | <b>Pt</b>             |

Most of these impact categories are categorised in several Life Cycle Impact Assessment methods, such as CML 2 baseline 2000 v2.05 (Guinée et al., 2001a) and ReCiPe v1.07 (Goedkoop et al., 2012) and are available in the LCA software *SimaPro v7.3* (PRé, 2012), which was used in the current analysis.

The CML methods were used for most individual mid-point impact categories. However, we also included a mid-point land use impact category

that has been recommended for use in aquaculture studies (P. Henriksson et al., 2011) and a mid-point water depletion impact category (total water inputs to ponds, irrigation to crops) from ReCiPe. In addition, cumulative energy demand (CED), which accounts for all of the primary energy inputs associated with the provision of a product over its life cycle (Hischier et al., 2009; VDI, 1997), was quantified, as was biotic resource use (BRU). BRU represents the primary productivity that underpins production of

the fish, and is a function of the specific FCR and the primary productivity appropriated by the feed consumed (Papatryphon et al., 2004). The BRU of crop inputs to feeds is estimated from its carbon content and dry mater content (Papatryphon et al., 2004). The BRU of wild caught fish is calculated using  $BRU = catch \cdot 9^{-(Trophic\ Level - 1)}$ , a general equation assuming a 9:1 ratio of fish wet weight to carbon and a 10% transfer efficiency between trophic levels (Pauly and Christensen, 1995). BRU has been included in many LCAs of fisheries and aquaculture systems (reviews in Avadí and Fréon, 2013; Henriksson, 2010; Parker, 2012). Finally, end-point, aggregated scores were also calculated using ReCiPe.

Human, soil and freshwater ecotoxicity were included as characterised in CML 2 (Guinée et al., 2001a, 2001b), but with reservations due to the high uncertainty associated with these impact assessment methods (Vázquez-Rowe et al., 2010; Ziegler and Valentinsson, 2008).

Finally, interpretation of LCA results was two-fold. First we compared aquafeeds within and among species and then aquaculture scenarios, within and among species.

### **3 Results and discussion**

#### **3.1 Life Cycle Inventories**

Key LCI data for the modelled systems are summarised in Table 6.

Nutrient emissions to water for each culture system are depicted in Table 7. Nitrogen and phosphorus budgets (SM, Table B.4) show that trout systems release more nutrients, in terms of kg of nitrogen and phosphorus per t of fish produced, than do black pacu and tilapia systems. These values are not always consistent with previously published values (Aubin et al., 2009; Boissy et al., 2011; Grönroos et al., 2006; Jiménez-Montealegre et al., 2005; Pelletier and Tyedmers, 2010). For trout, nutrient emissions for our scenario using commercial feed are close to those described in literature. For black pacu, the observed difference may reflect that the

estimates from Jiménez-Montealegre et al. (2005) are based on data obtained from a laboratory experiment (working with juveniles) rather than a real, full production cycle. For tilapia, the difference relates to the differences in FCR assumed in this study compared to those reported in Pelletier and Tyedmers (2010), which are closer to the Peruvian tilapia scenarios using artisanal feeds (UNALM, 2012). Mortalities considered, another possible source of the differences in calculations, were not reported in Pelletier and Tyedmers (2010). Pond tilapia is able to fix nutrients from sources other than feeds, for instance, from inlet water, from dissolved P emitted by mud, through plankton production, etc (Avnimelech, 2007; De Schryver et al., 2008; Schroeder, 1983). For all species, systems using artisanal feeds release more nutrients per unit production than those using commercial feeds.

**Table 6** Main inputs to studied aquaculture systems, per tonne of live-weight fish at farm gate

| Inputs                                      | Unit           | Trout <sup>i</sup> | Black pacu <sup>ii</sup> | Tilapia <sup>iii</sup> | Tilapia <sup>iv</sup> |
|---|----------------|--------------------|--------------------------|------------------------|-----------------------|
| Fry provision                               | Unit           | 3 143              | 875                      | 1 235                  | 1 235                 |
| Feed provision (artisanal, commercial)      | t              | 1.8, 1.4           | 1.7, 1.4                 | 1.7, 1.4               | 1.7, 1.4              |
| Energy use (electricity, fuels) per t feed  |                |                    |                          |                        |                       |
| for artisanal feed production <sup>a</sup>  | MJ             | 1 333              | 1 333                    | 1 333                  | 1 333                 |
| for commercial feed production <sup>b</sup> | MJ             | 1,119              | 682                      | 682                    | 682                   |
| On-farm fuel use (water pumping, aeration)  | kg             | 14.0               | 8.9                      | -                      | 378                   |
| Land occupation (ponds)                     | ha             | N/A                | 0.10                     | 0.07                   | 0.003                 |
| Water use (ponds)                           | m <sup>3</sup> | N/A                | 29 000                   | 3 429                  | 514                   |

<sup>i</sup> Artisanal/semi-intensive in Puno. <sup>ii</sup> Semi-intensive in Iquitos. <sup>iii</sup> Semi-intensive in Piura. <sup>iv</sup> Super-intensive in Piura. <sup>a</sup> Estimated from two Black pacu feed plants and generalised for trout and tilapia due to similar equipment, processes and scale. <sup>b</sup> Based on commercial feed manufacturing figures in Pelletier et al. (2009) and Pelletier and Tyedmers (2010).

**Table 7** Nitrogen and phosphorus releases to water (per tonne of live-weight fish): comparison with other values in literature

| Emissions (kg/t fish) | Trout                       |                              |                        | Salmon              |                      |                         | Black pacu                  |                              |                                   | Tilapia                     |                              |                               |
|-----------------------|-----------------------------|------------------------------|------------------------|---------------------|----------------------|-------------------------|-----------------------------|------------------------------|-----------------------------------|-----------------------------|------------------------------|-------------------------------|
|                       | This study (artisanal feed) | This study (commercial feed) | Grönroos et al. (2006) | Aubin et al. (2009) | Boissy et al. (2011) | Pelletier et al. (2009) | This study (artisanal feed) | This study (commercial feed) | Jiménez-Montealegre et al. (2005) | This study (artisanal feed) | This study (commercial feed) | Pelletier and Tyedmers (2010) |
| Total N               | <b>80.3</b>                 | <b>66.1</b>                  | 52.6                   | 65.0                | 41.6                 | 71.3                    | <b>38.7</b>                 | <b>25.8</b>                  | 12.5                              | <b>53.6</b>                 | <b>34.7</b>                  | 64.0                          |
| Total P               | <b>13.6</b>                 | <b>9.6</b>                   | 6.6                    | 10.0                | 4.2                  | 12.6                    | <b>12.1</b>                 | <b>9.7</b>                   | N/A                               | <b>6.8</b>                  | <b>3.0</b>                   | 4.6                           |

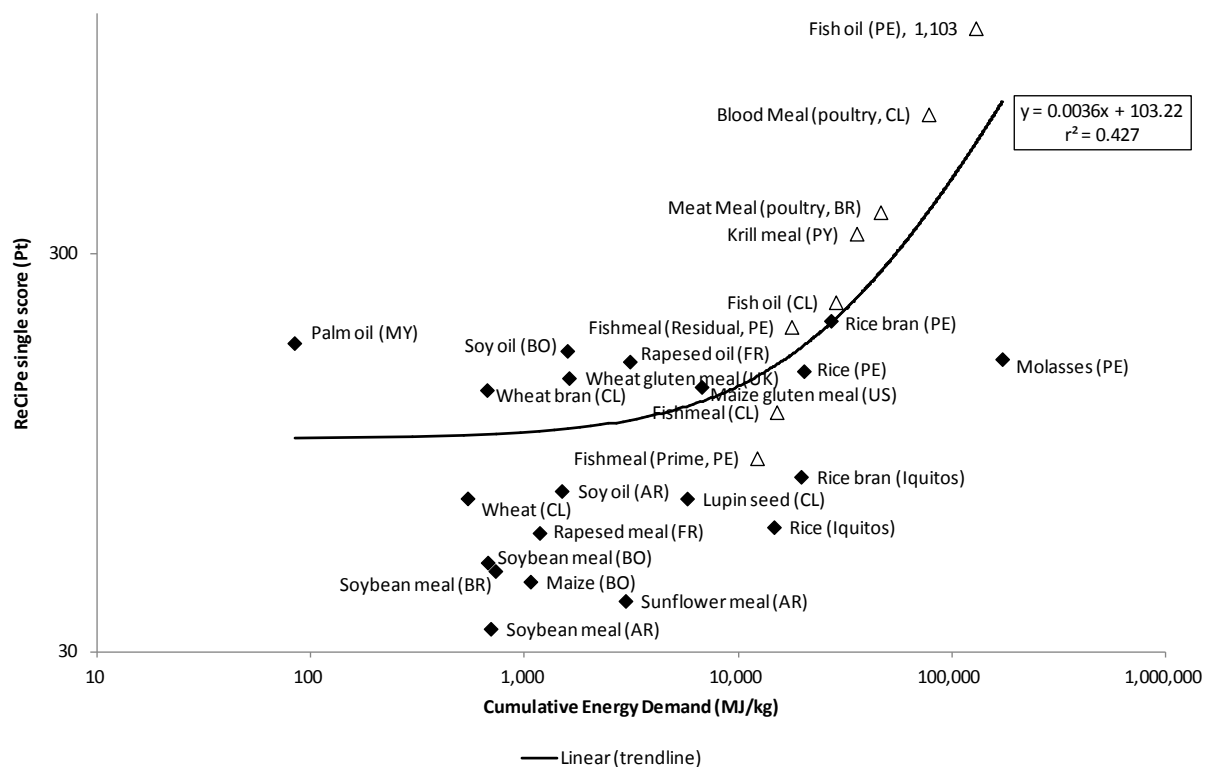
Feed conversion ratios used are shown in Table 1.

### 3.2 Life Cycle Impact Assessment

#### 3.2.1 Relative performance of aquafeeds: artisanal vs. commercial

In an attempt to generalise the initial hypothesis that more refined (and thus generally more energy-intensive) feed inputs are more environmentally burdened than less refined inputs, environmental impacts of various common feed inputs used in Peru were plotted against their associated CED (as an expression of its level of

refinement, despite that CED also includes the energy demand of fertilisers, etc). Results support the initial hypothesis, i.e. the trend is indeed positive yet with a very low value slope ( $p < 0.05$ ,  $m = 0.0036$ ), as shown in Fig. 4. Additionally, the relation between overall environmental impact of feeds and their digestible energy (Table 3) was tested, and no statistical trend was found for all studied feeds ( $p = 0.121$ ) nor for the subset of artisanal feeds ( $p = 0.163$ ), as shown in the SM (Fig. B.1).

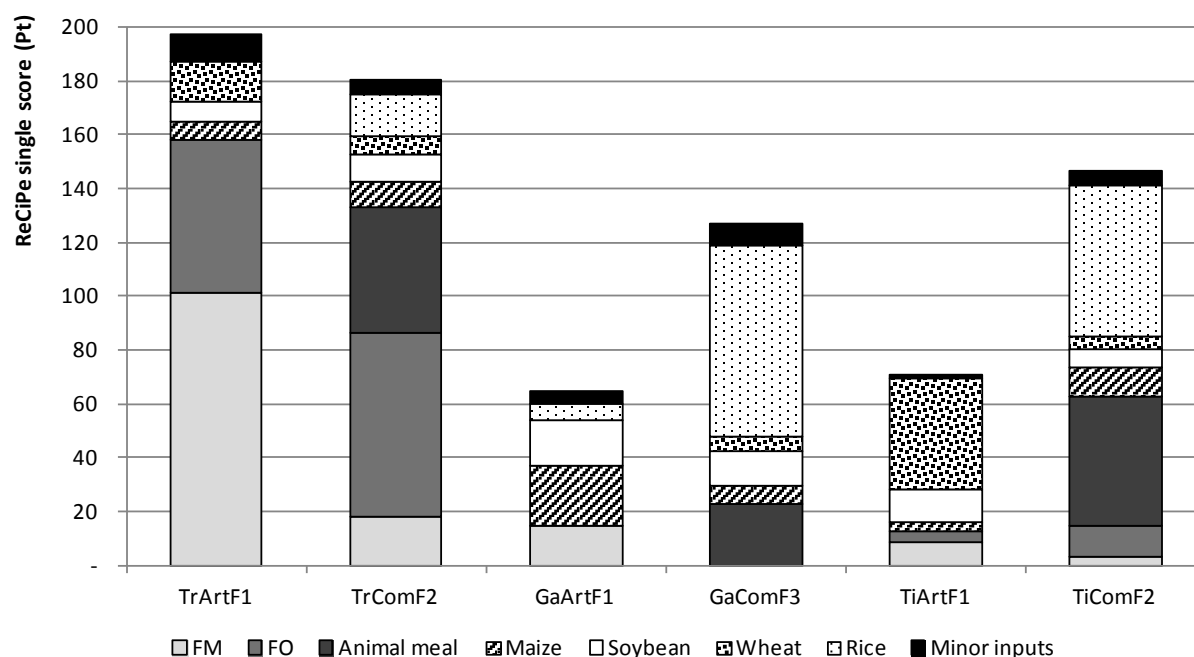


**Fig. 4** Environmental performance (ReCiPe single score) of common aquafeed inputs used in Peru in relation to their embodied energy inputs per tonne of product

It should be noted that artisanal feed producers usually use residual FM (access to high quality FM is limited for small producers, due to export pressure) while commercial producers have access to high quality FM (anonymous pers. comms.). Such disparity in access to high quality FM is relevant, because an almost two-fold difference (higher for residual FM) in associated impacts is observed (ANCHOVETA-SC project, unpublished data; Fig. 4). The main reasons for such difference between fishmeal qualities are the raw material to fishmeal ratio (4.2 for fresh anchoveta and 5.5 for fish residues, the raw material for residual

fishmeal), and the drying technology used (indirect, gas powered vs. direct fire by burning heavy fuel, as is common for residual fishmeal production).

Impacts were also compared per tonne of each feed modelled, taking into accounting only the upstream impacts of the raw material supply chains (i.e. transportation and feed milling were excluded) (Fig. 5). This analysis further supports the hypothesis that feeds composed of less refined inputs will, in general, be less impactful per tonne of feed produced.



**Fig. 5** Contribution analysis of aquafeeds excluding infrastructure, energy and transportation requirements of the milling process to the ReCiPe single score index

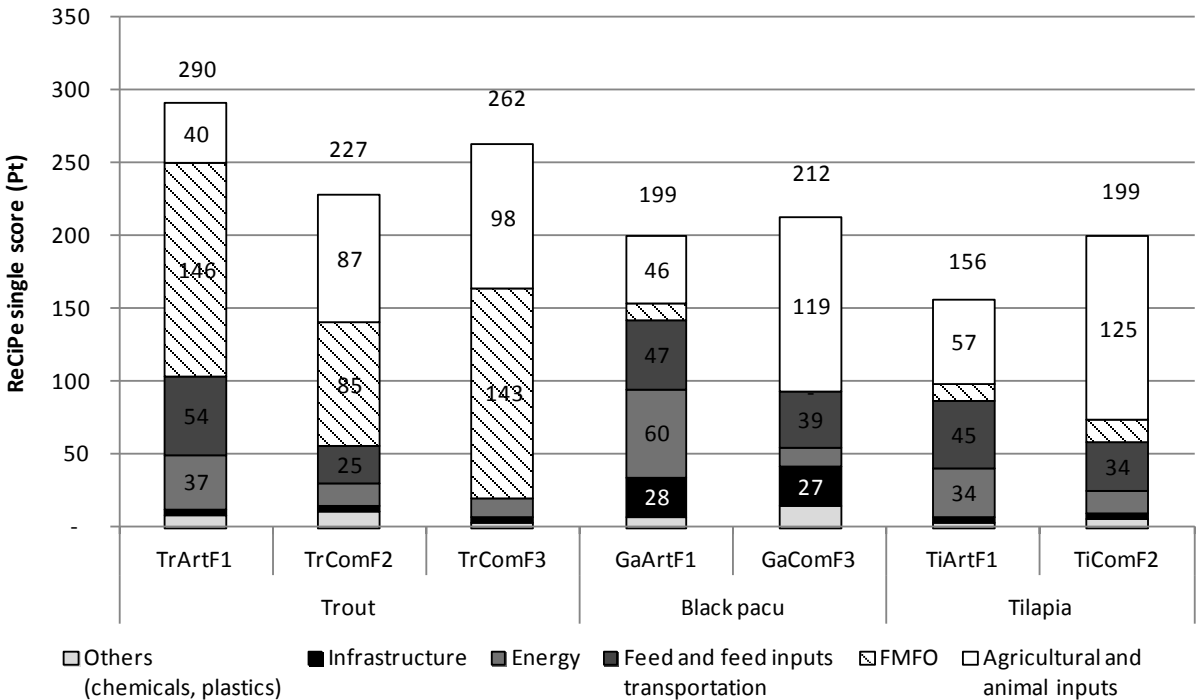
A contribution analysis of the studied feeds, at mill gate, is presented in Fig. 6. Trout feeds had the highest overall impacts per tonne of feed milled. This is, to a large extent, explained by the higher inclusion rates of FMFO (26-45% in trout feeds vs. 0-12% in black pacu and tilapia feeds). The overall impact associated with FMFO is higher than that of agricultural ingredients (as illustrated in Fig. 4). Feed formulations are driven fundamentally by requirements of protein, energy and Omega-3 fatty acid by the cultured fish. This also strongly influences their environmental performance due to the generally higher environmental impacts associated with the production of fish and animal protein inputs to feeds (Pelletier and Tyedmers, 2007). For instance, the GaComF3 feed features 10% inclusion of animal meat meal in substitute for FMFO. As expected, the contribution of FMFO to total impacts is very large in the trout feed, and less contributing than agricultural inputs in the black pacu and tilapia feeds (where inclusion levels are lower). In the black pacu feed, feed mill infrastructure contributes an atypically large share of impacts, due to the unusual isolation of the communities located in the Loreto province: most construction materials and equipment need to be

transported at least 500 km by boat from the next Peruvian city served by the national road system (Pucallpa), or flown in from elsewhere (usually Lima). Transportation of feed ingredients is relevant in all cases, due to international road, river and sea freight (e.g. road-transported soybean products from Bolivia). Black pacu and tilapia feeds generally feature similar environmental performance, given similar nutritional requirements.

All feeds were also compared per fed species (Fig. 7a, b, c). Among trout feeds (Fig. 7a), TrComF3 features higher associated BRU and toxicity due to greater inclusion of animal inputs, particularly >17% FO (the input with the highest BRU and worse overall environmental performance, Fig. 4). TrComF2 shows the best overall performance among trout feeds, because of reduced inclusion of some heavily environmentally burdened agricultural products such as certain refined maize, soybean and wheat products such as gluten and concentrates (Fig. 4). TrArtF1, despite a simpler formulation and lower impacts in various impact categories (eutrophication potential, global warming potential and BRU), is the worst environmentally performing feed as a result of

greater embodied energy requirements of inputs and transportation stages. Among black pacu feeds, the artisanal Amazonian GaArtF1 features better performance in most impact categories than GaComF3 and in total (Fig. 7b), despite the inclusion of FO, which GaComF3 excludes (but it includes an important share of animal meal, rice and wheat products, which have relatively high associated environmental impacts) (Fig. 4). Among the tilapia feeds (Fig. 7c), the artisanal TiArtF1 performs better than the commercial TiComF2, due to lower levels of fish inputs and highly burdened agricultural inputs.

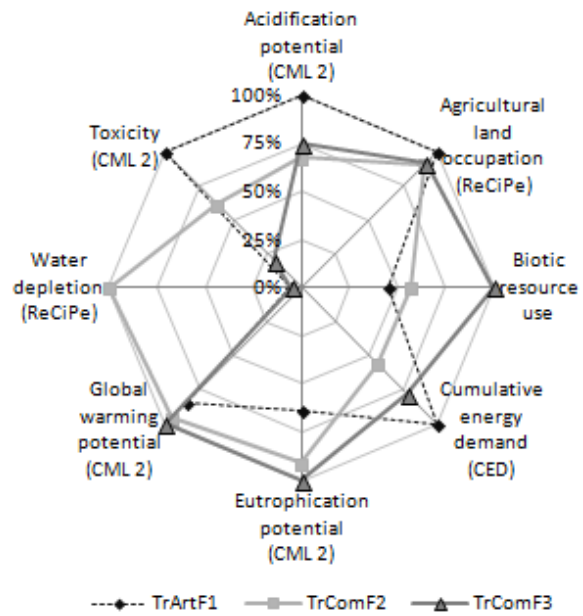
Despite the fact that commercial feeds feature a better nutrient balance for all species, as shown in Table 7, they also feature worse eutrophication potential. Such performance is due to the composition of both types of feeds. For instance, for Peru-made artisanal and commercial trout feeds, the main contributors to eutrophication are residual fishmeal and transportation for the former, and poultry by-products for the latter (which represents a larger contribution, both in absolute and relative terms).



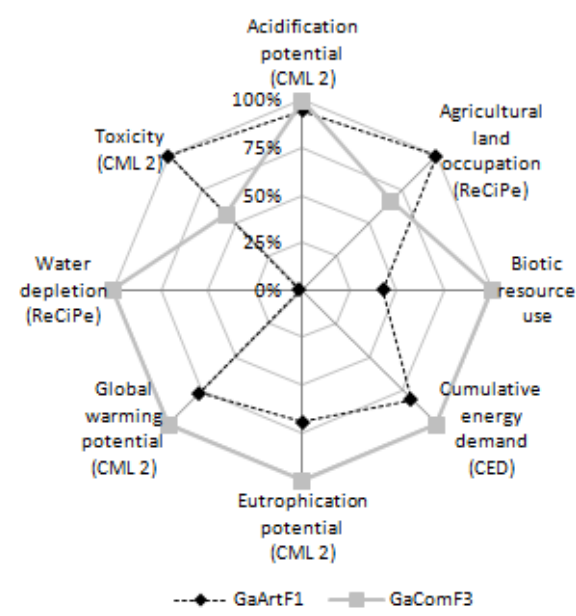
**Fig. 6** Contribution analysis of aquafeeds used in Peru (ReCiPe single score index)

Due to differences in the Pelletier et al (2009) model and this study’s, the value for “Agricultural land and animal inputs” in TrComF3 aggregates the contribution of feed input transportation. Contributions of <20 Pt are not labelled.

a) Trout feeds



b) Black pacu feeds



c) Tilapia feeds

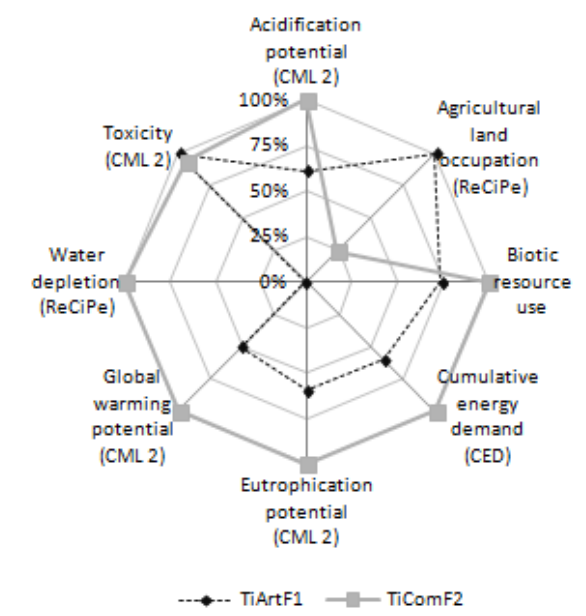


Fig. 7 Relative environmental performance of aquafeeds used in Peru, per tonne of feed, per species



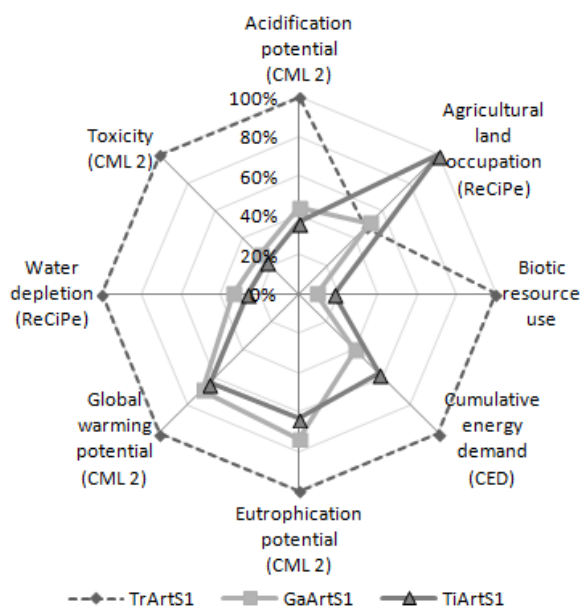
### 3.2.2 Relative performance of alternative aquaculture scenarios

The following highlights were identified when comparing scenarios featuring different feed inputs (detailed LCIA results for all modelled scenarios and feeds are presented in SM, Tables B.1 and B.2):

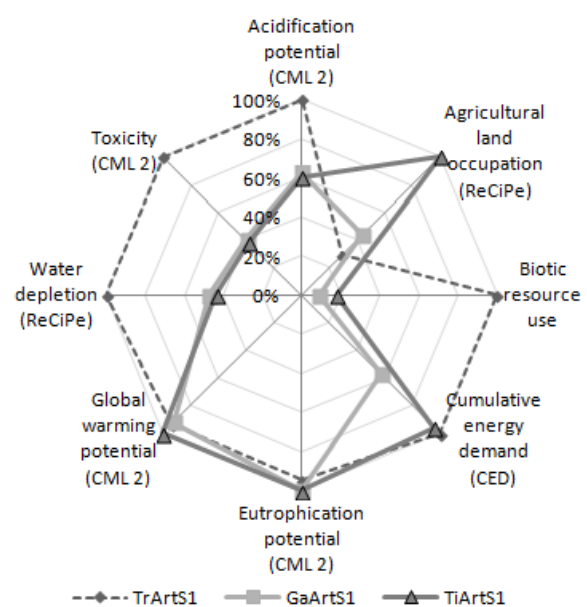
- When using the live weight based FU, black pacu and tilapia scenarios show very similar performance, due to similar rearing techniques (at semi-intensive scale) and feed features —composition and chemical values— (Table 3 and Fig. 8a). The poorer

performance of the tilapia scenario in certain categories (CED, BRU, and land use) is due to increased on-farm energy use and higher inclusion of fish inputs in the tilapia feed. When using the edible yield based FU, a dramatic deterioration in the performance of tilapia and black pacu systems, due to lower edible yield, is observed for several impact categories: global warming potential, eutrophication potential and CED (Fig. 8b).

a) per tonne of live weight fish



a) per tonne of edible portion



**Fig. 9** Relative environmental performance of reference Peruvian aquaculture scenarios, per impact category

- When using the live weight based FU, all trout scenarios perform, in general, worse than the black pacu and tilapia scenarios (Fig. 9a) despite its much simpler infrastructure and land transformation for infrastructure, to a large extent due to higher inclusion of FMFO and heavily burdened agricultural inputs in feeds. The relatively poor performance of the super-intensive tilapia systems (TiArtS2 and TiComS3), comparable to the performance of the best trout scenario (TrComS2)

despite less impacting feeds, is due to a high energy consumption for water pumping and aeration in tilapia rearing. Another reason for poor performance in the tilapia scenarios is the difference in the scale and intensity of farming practices (semi-intensive vs. intensive, artisanal vs. larger scale). For instance, the semi-intensive tilapia scenario features an overall performance comparable to that of the black pacu scenarios, which represent semi-intensive systems as well. The large

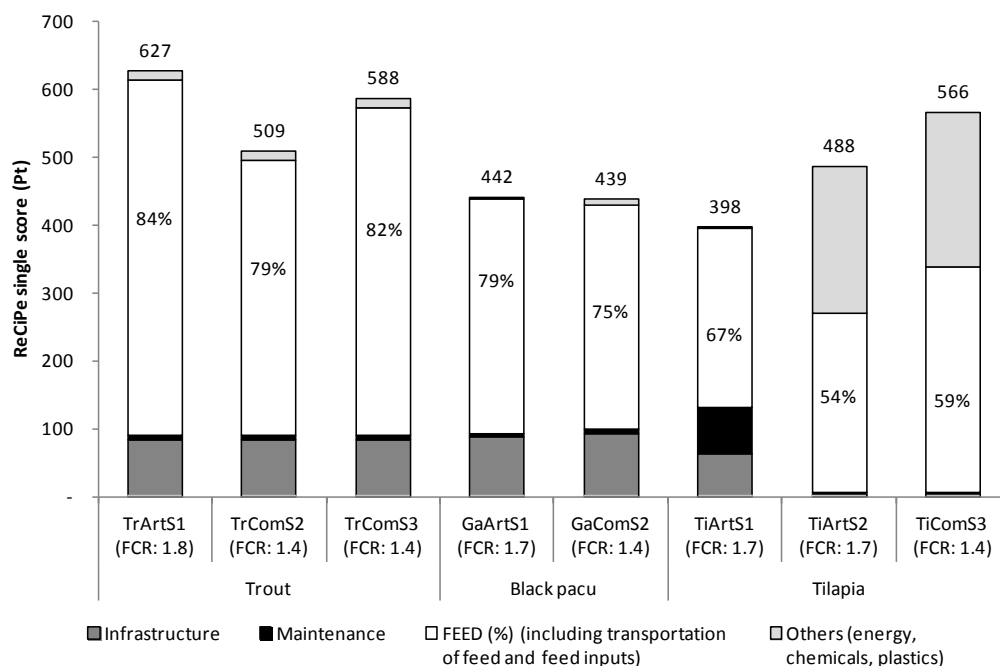
contribution of the Maintenance phase to the performance of TiArtS1 is due to the replacement of the geomembrane in ponds. Across scenarios considered, feed contributed between 54 and 82% of impacts (on an aggregated, single-score basis). When using the edible yield based FU, trout scenarios perform best and tilapia scenarios worst, proportionally to the differences in edible yields (61% and 35%, respectively).

- A comparison of all trout scenarios was performed, per impact category and using the live weight based FU, highlighting the contribution of feed (SM, Fig. B.2). As expected (Aubin et al., 2009; Boissy et al., 2011; Pelletier et al., 2009), feed provision contributed with over 50% of the total for most impact categories with the exception of eutrophication potential. For BRU, feed provision contributes 100%. The contribution of feeds to CED represents a larger share in the artisanal Peruvian scenarios, because the direct, on-farm energy inputs are low in those systems: in Peru it is common for fish farms to either generate their own electricity with diesel generators and/or use fuel-powered

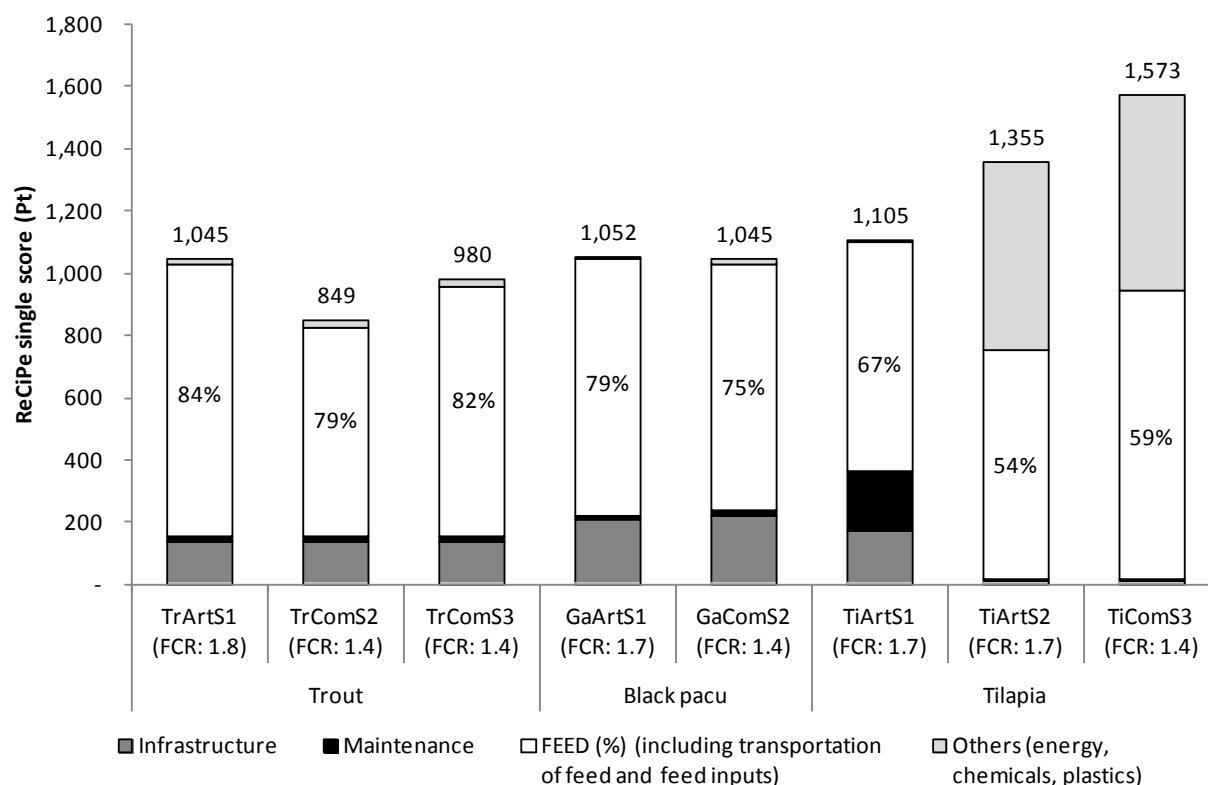
pumping and aeration systems. Trout farming in cages has minimal energy requirements, limited to powering a small storage hall and outboard motor boats.

Performance changes in aquaculture systems occur when replacing artisanal by commercial feeds. In general terms, such a replacement improves fish farming performance, mostly because of improved FCRs. Nonetheless, due to the large contribution of feeds to overall environmental performance, and the higher inclusion of more refined (and thus more impacting) inputs in commercial feeds, environmental performance of the aquaculture systems tend to deteriorate, despite improved FCRs and benefits of scale regarding energy use for feed manufacturing. A clear exception is the trout scenario TrComS2, where the overall performance of both the feed and the aquaculture system is determined by a lower inclusion of FMFO, which compensates for a more complex feed formulation featuring more refined inputs. Transportation of feed plays a minor role in the lower environmental performance, because in artisanal feeds most of the inputs are local (except for fish inputs and non-locally available agricultural inputs, such as soybeans).

a) per tonne of live weight fish



b) per tonne of edible portion



**Fig. 9** Relative environmental performance of Peruvian aquaculture scenarios and relative contribution of aquafeed (ReCiPe single score index)

### 3.3 Sensitivity and uncertainty

In LCA studies, there is uncertainty associated to input data, to normative choices and to the underlying mathematical models, or model uncertainty; as discussed in literature (e.g. Heijungs and Huijbregts, 2004; Lloyd and Ries, 2007). Methodological uncertainty is associated to characterisation factors, weighting and normalisation factors, and other elements of the LCA model, also discussed in literature (e.g. Hauschild et al., 2012). In this paper we focused on data uncertainty, mostly associated with assumptions regarding FCRs, feed compositions and modelling of agricultural feed input supply chains, including geographical origin. Some of these attributes were subject to sensitivity and uncertainty analyses, as follows.

Water content of feeds is a source of variation regarding FCRs. When FCRs are recalculated based on dry matter (DM) contents of both fish and feed, in order to compensate for differences in

humidity between artisanal (~15%) and commercial (11-12%) feeds, the results suggest that Peruvian commercial black pacu and trout feeds yield more fish DM per unit of feed DM (SM, Table C.1). This is not surprising given that commercial feeds are professionally formulated to match the nutritional needs and promote rapid growth of the cultured organism.

The sensitivity of the aggregate ReCiPe single score results to changes in FCR ( $\pm 20\%$ ) was also analysed. Trout scenarios show higher sensitivity to FCRs (SM, Fig. C1) due to the larger contribution of feeds to overall impacts compared with the tilapia and black pacu scenarios. Regarding emissions to water, results for all species show high sensitivity to changes in assumed FCRs (SM, Table C.2).

Soybean meal and oil are key components in aquafeeds worldwide (SOFIA, 2012). Peruvian feeds use soybean products mainly sourced in Bolivia, but also from Argentina, Brazil and the US.

We replaced Bolivian soybean meal in the Peruvian reference trout feed TrArtF1 used in the reference trout scenario TrArtS1 with US and Brazilian soybean meals, to test the influence on the environmental performance of the resulting aquafeed (SM, Fig. C.2). It appears that Bolivian and US products contribute comparably to overall impacts, while Brazilian soybean meal produces a 14% worsening in environmental performance. This difference is mainly due to changes in transportation required and land use demands (i.e. differences in yields). However, land use change and indirect land use change emissions were not considered.

#### **4 Conclusions**

Peruvian aquaculture is characterised by low levels of technological intensity at farm level (except for super-intensive systems) and the use of both simple artisanal as well as more complex commercial aquafeeds. The substitution of artisanal feeds with commercial ones generally increases environmental impacts of the fish farming systems for the specific feeds considered, despite enhanced FCRs and economies of scale (which decrease, for instance, energy use for feed milling). This reflects the higher environmental impacts attributable to certain feed inputs that are used in commercial feeds – in particular, highly refined feed inputs subject to energy-intensive processing, as well as higher levels of inclusion of animal-derived products. A selection of feed inputs that simultaneously meets the required nutritional profile for the cultured organisms, minimises costs for feed manufacturers, and lowers environmental burdens is therefore desirable. This can be achieved by the use of different feeds according to developmental stages, as shown by ongoing aquaculture, fish nutrition and environmental assessment research (e.g. Amaya et al., 2007; Bendiksen et al., 2011; Hardy, 2006; Li, 2004; Machado and Sgarbieri, 1991; Nguyen et al., 2009; Pelletier and Tyedmers, 2007; Rana et al., 2009; Rust et al., 2011; Samuel-fitwi et al., 2013).

Given the favourable environmental performance of cultured trout and black pacu compared to tilapia, when considering the edible yield in the FU, we recommend that further development of these culture systems be supported in order to increase trout and black pacu supply to both national and export markets. Black pacu aquaculture could be supported, for instance, by diversifying farming areas to regions with better transportation and cold storage infrastructure. Trout aquaculture would benefit from the national production of fertilised eggs which overcome existing genetic deficiencies of Peruvian broodstock.

We conclude that, faced with the pressure of increasing the utilisation of cheaper and more efficient commercial aquafeeds, Peruvian aquafeed vendors and aquaculture producers should prefer less environmentally burdened agricultural inputs (e.g. local maize and rice, Bolivian over Brazilian soybean meal) and low inclusion of highly refined inputs (e.g. gluten meals, protein extracts, vegetable oils with high natural land transformation burdens, etc, to the extent that FCR is not compromised). Peruvian agriculture has not previously been studied by means of life cycle methods, with the exception of a few crops used for bio-fuels (PUCP, 2010). It is advisable that Peruvian agricultural inputs to feeds are analysed using LCA, in order to determine with greater certainty whether local production is environmentally preferable to imported agricultural inputs. Prime instead of residual fishmeal should be used for artisanal feeds when possible because of lower associated environmental impacts.

Moreover, best management practices should be developed and applied to Peruvian aquaculture, especially by artisanal/small-scale producers, in order to optimise FCRs by means of enhanced feeding management (e.g. calculation of daily rations; varied feed according to developmental stages). A global approach combining best farming management and good quality feeds (which balance nutritional features and environmental performance) is desirable.

## Acknowledgements

This work, carried out by members of the Anchoveta Supply Chain (ANCHOVETA-SC) project (<http://anchoveta-sc.wikispaces.com>), is a contribution to the International Joint Laboratory “Dynamics of the Humboldt Current system” (LMI-DISCOH) coordinated by the Institut de Recherche pour le Développement (IRD) and the Instituto del Mar del Peru (IMARPE), and the International Joint Laboratory “Evolution and Domestication of Amazon Ichthyofauna” (LMI EDIA). It was carried out under the sponsoring of the Direction des Programmes de Recherche et de la formation au Sud (DPF) of the IRD. Some of the authors are members of the ELSA research group (Environmental Life Cycle and Sustainability Assessment, <http://www.elsa-lca.org/>). We acknowledge Hugo Treviño (IMARPE Puno), Camilo Cuba (Universidad Nacional Federico Villarreal) and the Instituto de Investigaciones de la Amazonia Peruana (IIAP) for their valuable support in data gathering. We acknowledge Peter Tyedmers (Dalhousie University) for his conceptual and design contributions to this paper.

## References

Amaya, E. a., Davis, D.A., Rouse, D.B., 2007. Replacement of fish meal in practical diets for the Pacific white shrimp (*Litopenaeus vannamei*) reared under pond conditions. *Aquaculture* 262, 393–401.

Anderson, J.T., Nuttle, T., Saldaña Rojas, J.S., Pendergast, T.H., Flecker, A.S., 2011. Extremely long-distance seed dispersal by an overfished Amazonian frugivore. *Proc. Biol. Sci.* 278, 3329–35.

Asche, F., Tveterås, S., 2004. On the Relationship Between Aquaculture and Reduction Fisheries. *J. Agric. Econ.* 55, 245–265.

Aubin, J., 2013. Life Cycle Assessment as applied to environmental choices regarding farmed or wild-caught fish. *CAB Rev.* 8.

Aubin, J., Papatryphon, E., van der Werf, H.M.G., Chatzifotis, S., 2009. Assessment of the environmental impact of carnivorous finfish production systems using life cycle assessment. *J. Clean. Prod.* 17, 354–361.

Avadí, A., Fréon, P., 2013. Life cycle assessment of fisheries: A review for fisheries scientists and managers. *Fish. Res.* 143, 21–38.

Avnimelech, Y., 2007. Feeding with microbial flocs by tilapia in minimal discharge bio-flocs technology ponds. *Aquaculture* 264, 140–147.

Ayer, N., Tyedmers, P., Pelletier, N., Sonesson, U., Scholz, A.J., 2007. Co-product allocation in life cycle assessments of seafood production systems: Review of problems and strategies. *Int. J. Life Cycle Assess.* 12, 480–487.

Ayer, N.W., Tyedmers, P.H., 2009. Assessing alternative aquaculture technologies: life cycle assessment of salmonid culture systems in Canada. *J. Clean. Prod.* 17, 362–373.

Baltazar, P., 2009. Situación actual de la tilapia en el Perú (Current situation of tilapia in Peru), in: Segunda Jornada de Actualización En Tilapia. Puerto Vallarta, México, 11-15 setiembre del 2009.

Baltazar, P., Palomino, A., 2004. Manual de cultivo de tilapia (Handbook of tilapia husbandry). Lima: Ministerio de la Producción y Fondo Nacional de Desarrollo Pesquero - FONDEPES.

Bechara, J. a, Roux, J.P., Ruiz Diaz, F.J., Flores Quintana, C.I., Longoni de Meabe, C. a, 2005. The effect of dietary protein level on pond water quality and feed utilization efficiency of pacu *Piaractus mesopotamicus* (Holmberg, 1887). *Aquac. Res.* 36, 546–553.

Bendiksen, E.Å., Johnsen, C.A., Olsen, H.J., Jobling, M., 2011. Sustainable aquafeeds: Progress towards reduced reliance upon marine ingredients in diets for farmed Atlantic salmon (*Salmo salar* L.). *Aquaculture* 314, 132–139.

Bocanegra, F.A., Bucchi, M.C., 2001. Piscicultura, seguridad alimentaria y desarrollo sostenible en la carretera Iquitos-Nauta y el Río Tigre (Pisciculture, food security and sustainable development in the Iquitos-Nauta road and the Tigre river), Programa de seguridad alimentaria para unidades productivas familiares de la carretera Iquitos-Nauta y el Río Tigre . PROSEAL UPF. Iquitos: Instituto de Investigaciones de la Amazonía Peruana –IIAP.

Boissy, J., Aubin, J., Drissi, A., van der Werf, H.M.G., Bell, G.J., Kaushik, S., 2011. Environmental impacts of plant-

- based salmonid diets at feed and farm scales. *Aquaculture* 321, 61–70.
- Bugeon, J., Lefevre, F., Cardinal, M., 2010. Flesh quality in large rainbow trout with high or low fillet yield. *J. Muscle Foods* 21, 702–721.
- Cao, L., Diana, J.S., Keoleian, G.A., Lai, Q., 2011. Life Cycle Assessment of Chinese Shrimp Farming Systems Targeted for Export and Domestic Sales. *Environ. Sci. Technol.* 45, 6531+6538.
- Carvalho, L., Rodrigues, C., 2009. Impact of pond management on tambaqui, *Colossoma macropomum* (Cuvier), production during growth-out phase. *Aquac. Res.* 40, 825–832.
- Celik, M., GÖKÇE, M., BASUSTA, N., KÜÇÜKGÜLMEZ, A., TASBOZAN, O., TABAKOGLU, S., 2008. Nutritional quality of rainbow trout (*Oncorhynchus mykiss*) caught from the Atatürk Dam Lake in Turkey. *J. Muscle Foods* 19, 50–61.
- Chiu, A., Li, L., Guo, S., Bai, J., Fedor, C., Naylor, R.L., 2013. Feed and fishmeal use in the production of carp and tilapia in China. *Aquaculture* 414-415, 127–134.
- Cho, C.Y., Kaushik, S.J., 1990. Nutritional energetics in fish: energy and protein utilization in rainbow trout (*Salmo gairdneri*). *World Rev. Nutr. Diet.* 61, 132–172.
- De Schryver, P., Crab, R., Defoirdt, T., Boon, N., Verstraete, W., 2008. The basics of bio-flocs technology: The added value for aquaculture. *Aquaculture* 277, 125–137.
- Dros, J.M., 2004. Managing the Soy Boom: Two scenarios of soy production expansion in South America, Forest Conversion Initiative. AIDEnvironment, Amsterdam.
- Ecoinvent, 2012. The ecoinvent Centre portal [WWW Document]. URL <http://www.ecoinvent.ch/>
- Ellingsen, H., Aanonsen, S., 2006. Environmental Impacts of Wild Caught Cod and Farmed Salmon - A Comparison with Chicken (7 pp). *Int. J. Life Cycle Assess.* 11, 60–65.
- Fréon, P., Sueiro, J.C., Iriarte, F., Miro Evar, O.F., Landa, Y., Mittaine, J.-F., Bouchon, M., 2013. Harvesting for food versus feed: a review of Peruvian fisheries in a global context. *Rev. Fish Biol. Fish.* 24, 381–398.
- Furuya, W.M., Pezzato, L.E., Barros, M.M., Pezzato, a C., Furuya, V.R.B., Miranda, E.C., 2004. Use of ideal protein concept for precision formulation of amino acid levels in fish-meal-free diets for juvenile Nile tilapia (*Oreochromis niloticus* L.). *Aquac. Res.* 35, 1110–1116.
- Garduño-Lugo, M., Granados-alvarez, I., Olvera-Novoa, M.A., Muñoz-Córdova, G., 2003. Comparison of growth, fillet yield and proximate composition between Stirling Nile tilapia (wild type) (*Oreochromis niloticus*, Linnaeus) and red hybrid tilapia (Florida red tilapia x Stirling red *O. niloticus*) males. *Aquac. Res.* 34, 1023–1028.
- Glencross, B., Curnow, J., Hawkins, W., Felsing, M., 2002. Evaluation of Yellow Lupin *Lupinus luteus* Meal as an Alternative Protein Resource in Diets for Sea-Cage Reared Rainbow Trout *Oncorhynchus mykiss*. *J. World Aquac. Soc.* 33, 287–296.
- Goedkoop, M., Heijungs, R., Huijbregts, M., Schryver, A. De, Struijs, J., Zelm, R. van, 2012. ReCiPe 2008. A life cycle impact assessment method which comprises harmonised category indicators at the midpoint and the endpoint level. First edition (revised) Report I: Characterisation. Ministry of Housing, Spatial Planning and the Environment (VROM) and Centre of Environmental Science - Leiden University (CML).
- Grönroos, J., Seppälä, J., Silvenius, F., 2006. Life cycle assessment of Finnish cultivated rainbow trout. *Boreal Environ.* 401–414.
- Gross, A., Boyd, C.E., Wood, C.W., 2000. Nitrogen transformations and balance in channel catfish ponds. *Aquac. Eng.* 24, 1–14.
- Guinée, J.B., Gorreé, M., Heijungs, R., Huppes, G., Kleijn, R., de Koning, A., van Oers, L., Weneger, A., Suh, S., Udo de Haes, H. a., de Bruijn, H., van Duin, R., Huijbregts, M., 2001a. Life cycle assessment. An operational guide to the ISO standards. Part 2a: Guide. Ministry of Housing, Spatial Planning and the Environment (VROM) and Centre of Environmental Science - Leiden University (CML).
- Guinée, J.B., Gorreé, M., Heijungs, R., Huppes, G., Kleijn, R., de Koning, A., van Oers, L., Weneger, A., Suh, S., Udo de Haes, H. a., de Bruijn, H., van Duin, R., Huijbregts, M., 2001b. Life cycle assessment. An operational guide to the ISO standards. Part 2b: Operational annex. Ministry of Housing, Spatial

- Planning and the Environment (VROM) and Centre of Environmental Science - Leiden University (CML).
- Gupta, M. V., Acosta, B.O., 2004. A review of global tilapia farming practices. *Aquac. Asia* 9, 7–16.
- Handal, J., 2006. Estudio Técnico y Económico de los dos sistemas de producción de Tilapia Roja (*Oreochromis sp.*) en la costa norte de Honduras (Technical and economic study of two production systems for red hybrid tilapia (*Oreochromis sp.*) in the northern coast of Honduras. Licent. thesis.
- Hardy, R.W., 2006. Worldwide fish meal production outlook and the use of alternative protein meals for aquaculture, in: LEC Suárez, DR Marie, MT Salazar, MGN López, DAV Cavazos, ACPC, and A.O. (Eds. . (Ed.), *Advances in Aquaculture Nutrition VIII. VIII International Symposium on Aquaculture Nutrition*. Universidad Autónoma de Nuevo León.
- Hasan, M., Halwart, M., 2009. Fish as feed inputs for aquaculture: practices, sustainability and implications., *FAO Fisheries and Aquaculture Technical Paper No. 518*. Food and Agriculture Organization of the United Nations (FAO).
- Hauschild, M.Z., Goedkoop, M., Guinée, J., Heijungs, R., Huijbregts, M., Jolliet, O., Margni, M., Schryver, A., Humbert, S., Laurent, A., Sala, S., Pant, R., 2012. Identifying best existing practice for characterization modeling in life cycle impact assessment. *Int. J. Life Cycle Assess.* 18, 683–697.
- Heijungs, R., Huijbregts, M.A.J., 2004. A Review of Approaches to Treat Uncertainty in LCA, in: Pahl-Wostl, C., Schmidt, S., Rizzoli, A.E., Jakeman, A.J. (Eds.), *Complexity and Integrated Resources Management*. Transactions of the 2nd Biennial Meeting of the International Environmental Modelling and Software Society, Volume 1. Osnabrück, pp. 332–339.
- Henriksson, P., 2010. Life Cycle Assessment on Aquaculture systems - A review article, in: *LCAFood 2010*.
- Henriksson, P., Guinée, J., Kleijn, R., 2011. Proposed LCA methodology revisions for aquaculture SEAT Life Cycle Assessment studies.
- Henriksson, P.J.G., Guinée, J.B., Kleijn, R., Snoo, G.R., 2011. Life cycle assessment of aquaculture systems—a review of methodologies. *Int. J. Life Cycle Assess.* 17, 304–313.
- Hischier, R., Weidema, B.P., Althaus, H.-J., Bauer, C., Doka, G., Dones, R., Frischknecht, R., Hellweg, S., Humbert, S., Jungbluth, N., Köllner, T., Loerincik, Y., Margni, M., Nemecek, T., 2009. Implementation of life cycle impact assessment methods - ecoinvent report No. 3 (v2.1), ecoinvent report No.3. Dübendorf: Swiss Centre for Life Cycle Inventories.
- Hurtado, N., 2005a. Tilapia: La alternativa social y económica del tercer milenio (Tilapia: The social and economic alternative of the third millenium).
- Hurtado, N., 2005b. La tilapia en el Perú (Tilapia in Peru). Lima: NH Ingenieros Consultores.
- IIAP, 2012. Instituto de Investigaciones de la Amazonía Peruana (Research Institute of the Peruvian Amazonia) [WWW Document]. URL <http://www.iiap.org.pe/>
- ILCD, 2010. *ILCD Handbook: General guide for Life Cycle Assessment - Provisions and action steps*.
- INEI, 2012. Perú: Compendio estadístico 2012. Pesca (Peru: Statistical compendium 2012. Fisheries). Lima: Instituto Nacional de Estadística e Informática (INEI).
- IMARPE, 2012. Instituto del Mar del Perú (Peruvian Institute of the Sea) [WWW Document]. URL [http://www.imarpe.pe/imarpe/index.php?id\\_idioma=EN](http://www.imarpe.pe/imarpe/index.php?id_idioma=EN)
- ISO, 2006a. Environmental management – Life cycle assessment – Principles and framework (ISO 14040:2006). International Organization for Standardization (ISO).
- ISO, 2006b. Environmental management – Life cycle assessment – Requirements and guidelines (ISO 14044:2006). International Organization for Standardization (ISO).
- Jiménez-Montealegre, R., Avnimelech, Y., Verreth, J.A.J., Verdegem, M.C.J., 2005. Nitrogen budget and fluxes in *Colossoma macropomum* ponds. *Aquac. Res.* 36, 8–15.
- Kaimowitz, J., Smith, D., 2001. Soybean Technology and the Loss of Natural Vegetation in Brazil and Bolivia, in: Angelsen, A., Kaimowitz, D. (Eds.), *Agricultural Technologies and Tropical Deforestation*. pp. 195–211.
- Kaushik, S.J., Cowey, C., 1991. Dietary factors affecting nitrogen excretion by fish, in: Cowey, C.B., Cho, C.Y. (Eds.), *Nutritional Strategies and Aquaculture Waste*.

- Proceedings of the First International Symposium on Nutritional Strategies in Management of Aquaculture Waste (NSMAW). University of Guelph, Fish Nutrition Research Laboratory.
- Li, P., 2004. Nutritional value of fisheries by-catch and by-product meals in the diet of red drum (*Sciaenops ocellatus*). *Aquaculture* 236, 485–496.
- Lloyd, S., Ries, R., 2007. Characterizing, Propagating, and Analyzing Uncertainty in Life Cycle Assessment: A Survey of Quantitative Approaches. *J. Ind. Ecol.* 11, 161–179.
- Lochmann, R., Chen, R., Chu-Koo, F., Camargo, W., Kohler, C., 2009. Effects of Carbohydrate-Rich Alternative Feedstuffs on Growth, Survival, Body Composition, Hematology, and Nonspecific Immune Response of Black Pacu, *Colossoma macropomum*, and Red Pacu, *Piaractus brachypomus*. *J. World Aquac. Soc.* 40, 33–44.
- Luna, M., 2008. Instalación de una piscigranja en Tocache, San Martín (Setting up of a pond farm in Tocache, San Martin). Licent. thesis. Universidad Nacional Agraria La Molina, Lima (Perú). Facultad de Zootecnia. Departamento de Producción Animal.
- Machado, M., Sgarbieri, V., 1991. Partial characterization and nutritive value of proteins from pacu (*Colossoma mitrei*, Berg 1895). *J. Agric. Food Chem.* 39, 1715–1718.
- Maradiague, R., Farro, E., Escala, J., Yi, D., 2005. Planeamiento estratégico para la producción y comercialización de tilapias (Strategic planning for production and commercialisation of tilapia). Masters Thesis.
- MAXIMIXE, 2010. Elaboración de Estudio de Mercado de la Trucha en Arequipa, Cusco, Lima, Huancayo y Puno - Estudio de Determinación y Especificaciones de la Trucha -. Lima: Ministerio de la Producción.
- Mendieta, O.W., Medina, M.L., 1993. Salado y secado solar de tilapia (*Oreochromis* sp) en la región de San Martín. Salting and solar drying of tilapia (*Oreochromis* sp) in the San Martin region. *Folia Amaz.* 5, 117–127.
- Mendoza, D., 2011a. Estudio sobre la acuicultura de la trucha a nivel mundial, el desenvolvimiento de la importación de ovas, la tendencia de la producción nacional y su comercialización. Lima: Dirección de Acuicultura, Ministerio de la Producción - PRODUCE.
- Mendoza, D., 2011b. Panorama de la acuicultura mundial, América Latina y el Caribe y en el Perú (Overview of global aquaculture, Latin America and the Caribbean, and Peru). Lima: Dirección de Acuicultura, Ministerio de la Producción - PRODUCE.
- Mendoza, D., 2013. Situación del extensionismo acuícola en el Perú (Situation of aquacultural extensionism in Peru), Report for Red de Acuicultura de las Américas (RAA) and FAO. Lima: Dirección de Acuicultura, Ministerio de la Producción - PRODUCE.
- MINEM, 2009. Balance Nacional de Energía 2009. Lima: Ministerio de Energía y Minas.
- MINEM, 2012. Anuario Estadístico de Electricidad 2010 [WWW Document]. URL <http://www.minem.gob.pe/descripcion.php?idSector=6&idTitular=3903>
- Mungkung, R., Aubin, J., Prihadi, T.H., Slembrouck, J., van der Werf, H.M.G., Legendre, M., 2013. Life Cycle Assessment for environmentally sustainable aquaculture management: A case study of combined aquaculture systems for carp and tilapia. *J. Clean. Prod.*
- Naylor, R., Hardy, R.W., Bureau, D.P., Chiu, A., Elliott, M., Farrell, A.P., Forster, I., Gatlin, D.M., Goldburg, R.J., Hua, K., Nichols, P.D., 2009. Feeding aquaculture in an era of finite resources. *Proc. Natl. Acad. Sci. U. S. A.* 106, 15103–10.
- New, M.B., Wijkström, U.N., 2002. Use of fishmeal and fish oil in aquafeeds: further thoughts on the fishmeal trap. *FAO Fish. Circ.*
- Nguyen, T., Davis, D., Saoud, I., 2009. Evaluation of alternative protein sources to replace fish meal in practical diets for juvenile Tilapia, *Oreochromis* spp. *J. World Aquac. Soc.* 40, 113–121.
- Nwannaa, L., Oishi, C., Pereira-Filho, M., 2008. Use of phytase to improve the digestibility of alternative feed ingredients by Amazon tambaqui, *Colossoma macropomum*. *Sci. Asia* 34, 353–360.
- Papatryphon, E., Petit, J., Kaushik, S.J., van der Werf, H.M.G., 2004. Environmental impact assessment of salmonid feeds using Life Cycle Assessment (LCA). *Ambio* 33, 316–23.
- Parker, R., 2012. Review of life cycle assessment research on products derived from fisheries and aquaculture: A report for Seafish as part of the



- collective action to address greenhouse gas emissions in seafood. Final Report. Edinburgh: Sea Fish Industry Authority.
- Pauly, D., Christensen, V., 1995. Primary production required to sustain global fisheries. *Nature* 374, 255–257.
- Pelletier, N., Tyedmers, P., 2007. Feeding farmed salmon: Is organic better? *Aquaculture* 272, 399–416.
- Pelletier, N., Tyedmers, P., 2010. Life Cycle Assessment of Frozen Tilapia Fillets From Indonesian Lake-Based and Pond-Based Intensive Aquaculture Systems. *J. Ind. Ecol.* 14, 467–481.
- Pelletier, N., Tyedmers, P., 2011. An Ecological Economic Critique of the Use of Market Information in Life Cycle Assessment Research. *J. Ind. Ecol.* 15, 342–354.
- Pelletier, N., Tyedmers, P., Sonesson, U., Scholz, A.J., Ziegler, F., Flysjö, A., Kruse, S., Cancino, B., Silverman, H., 2009. Not all salmon are created equal: life cycle assessment (LCA) of global salmon farming systems. *Environ. Sci. Technol.* 43, 8730–6.
- Peralta, M., Teichert-Coddington, D.R., 1989. Comparative Production of *Colossoma macropomum* and *Tilapia nilotica* in Panama. *J. World Aquac. Soc.* 20, 236–239.
- Péron, G., François Mittaine, J., Le Gallic, B., 2010. Where do fishmeal and fish oil products come from? An analysis of the conversion ratios in the global fishmeal industry. *Mar. Policy* 34, 815–820.
- PETT, 2011. Perfil de Proyecto: Mejoramiento de la producción de Truchas en zonas alto andinas de la Región Puno (Project profile: Trout production improvement in Andean zones of the Puno region). Puno: Special Project Trout Titicaca Lake, Puno Regional Government.
- PETT, 2012. Regional Government of Puno, Proyecto Especial Truchas Titicaca (Especial Project Trout Titicaca Lake) [WWW Document]. URL <http://pett.regionpuno.gob.pe/>
- PRé, 2012. SimaPro by Pré Consultants [WWW Document]. URL <http://www.pre-sustainability.com/content/simapro-lca-software/>
- PRODUCE, 2009. Plan Nacional de Desarrollo Acuicultura (Aquaculture Development National Plan). Lima: Ministerio de la Producción.
- PRODUCE, 2010. Anuario Estadístico 2010 - Sub sector Pesca. Lima: Ministerio de la Producción, Oficina General de Tecnología de la Información y Estadística.
- PRODUCE, 2012. Ministry of Production - Aquaculture statistics [WWW Document]. URL <http://www.produce.gob.pe/index.php/estadistica/acuicultura>
- PUCP, 2010. Estudio de Análisis de Ciclo de Vida de Biocombustibles en Perú (Life Cycle Assessment of biofuels in Peru). Lima: Pontificia Universidad Católica del Perú and SwissContact.
- Rana, K.J., Siriwardena, S., Hasan, M., 2009. Impact of rising feed ingredient prices on aquafeeds and aquaculture production., FAO Fisheries and Aquaculture Technical Paper 541. Food and Agriculture Organization of the United Nations (FAO), Rome.
- Rebaza, C., Valdivieso, M., Rebaza, M., Chu-Koo, F., 2008. Análisis económico del cultivo de Gamitana (*Colossoma macropomum*) y Paco (*Piaractus brachypomus*) usando una dieta extrusada comercial en Ucayali (Economic analysis of the Gamitana (*Colossoma macropomum*) and Paco (*Piaractus brachypomus*) pond culture using Folia Amaz. 17, 7–13.
- Roque d'Orbcastel, E., Blancheton, J.-P., Aubin, J., 2009. Towards environmentally sustainable aquaculture: Comparison between two trout farming systems using Life Cycle Assessment. *Aquac. Eng.* 40, 113–119.
- Ruiz, L., 2013. Estado de la acuicultura en el Perú (Status of aquaculture in Peru). *Rev. Aquat.* 99–106.
- Rust, M.B., Barrows, F.T., Hardy, R.W., Lazur, A., Naughten, K., Silverstein, J., 2011. The Future of Aquafeeds, NOAA Technical Memorandum NMFS F/SPO-124. NOAA/USDA Alternative Feeds Initiative.
- Samuel-fitwi, B., Meyer, S., Reckmann, K., Schroeder, J.P., 2013. Aspiring for environmentally conscious aquafeed: comparative life cycle assessment (LCA) of aquafeed manufacturing using different protein sources. *J. Clean. Prod.*
- Schroeder, G.L., 1983. Sources of fish and prawn growth in polyculture ponds as indicated by  $\delta C$  analysis. *Aquaculture* 35, 29–42.

- SOFIA, 2010. The state of world fisheries and aquaculture 2010, United Nations Food and Agriculture Program. Rome: FAO Fisheries and Aquaculture Department.
- SOFIA, 2012. The State of World Fisheries and Aquaculture 2012. Rome: FAO Fisheries and Aquaculture Department.
- Tacon, A., Hasan, M., Metian, M., 2011. Demand and supply of feed ingredients for farmed fish and crustaceans: trends and prospects., FAO Fisheries and Aquaculture Technical Paper. No. 564. Rome.
- Tacon, A., Metian, M., 2008a. Global overview on the use of fish meal and fish oil in industrially compounded aquafeeds: Trends and future prospects. *Aquaculture* 285, 146–158.
- Tacon, A., Metian, M., 2008b. Aquaculture feed and food safety. *Ann. N. Y. Acad. Sci.* 1140, 50–9.
- Tacon, A., Metian, M., Hasan, M., 2009. Feed ingredients and fertilizers for farmed aquatic animals. Sources and composition, FAO Fisheries and Aquaculture Technical Paper. Rome.
- Torry Research Station, 1989. Yield and nutritional value of the commercially more important fish species. Rome: Food and Agriculture Organisation of the United Nations.
- UNALM, 2012. Investigación en nutrición y alimentación de especies de acuicultura [WWW Document]. URL [http://www.lamolina.edu.pe/facultad/Zootecnia/PIPS/Prog\\_Alimentos/peces.htm](http://www.lamolina.edu.pe/facultad/Zootecnia/PIPS/Prog_Alimentos/peces.htm)
- UNIDO, 2005. Estudio de prospectiva para la cadena productiva de la industria pesquera en la región de la costa del Pacífico en América del Sur: Estudio de prospectiva del Perú. Lima: United Nations Industrial Development Organisation.
- Vázquez-Rowe, I., Iribarren, D., Moreira, M.T., Feijoo, G., 2010. Combined application of life cycle assessment and data envelopment analysis as a methodological approach for the assessment of fisheries. *Int. J. Life Cycle Assess.* 15, 272–283.
- VDI, 1997. Cumulative Energy Demand - Terms, Definitions, Methods of Calculation., VDI-Richtlinien 4600. Düsseldorf: Verein Deutscher Ingenieure.
- Watanabe, W.O., Losordo, T.M., Fitzsimmons, K., Hanley, F., 2002. Tilapia Production Systems in the Americas: Technological Advances, Trends, and Challenges. *Rev. Fish. Sci.* 10, 465–498.
- Welch, A., Hoenig, R., Stieglitz, J., Benetti, D., Tacon, A., Sims, N., O’Hanlon, B., 2010. From Fishing to the Sustainable Farming of Carnivorous Marine Finfish. *Rev. Fish. Sci.* 18, 235–247.
- Wenzel, H., 1998. Application dependency of LCA methodology: Key variables and their mode of influencing the method. *Int. J. Life Cycle Assess.* 3, 281–288.
- Ziegler, F., Valentinsson, D., 2008. Environmental life cycle assessment of Norway lobster (*Nephrops norvegicus*) caught along the Swedish west coast by creels and conventional trawls—LCA methodology with case study. *Int. J. Life Cycle Assess.* 13, 487–497.

## Supplementary Material

### Appendix A. Additional life cycle inventory details and assumptions

Certain assumptions and data treatments were made to construct the life cycle inventories, namely:

- LCIs were collected for the operational phases of aquaculture farming, namely construction, use (including fry and feed provision) and maintenance. No end-of-life or site remediation was considered.
- It was assumed that no chemicals were used during the farm phase of fish production.
- Farm maintenance included water replenishment (when relevant), pond fertilisation only in the cases of black pacu and semi-intensive tilapia farming, and materials replacement in the cases of trout and tilapia (nylon nets and geomembrane, respectively).
- The fuel consumption associated with aeration in super-intensive tilapia farming was calculated based on HP of air pumps and daily operation times.
- Commercial aquafeeds were assumed to be always transported from Lima, where most aquafeed production takes place in Peru, to the farm location. In the case of artisanal feeds produced in the vicinity of the farms, FMFO were assumed to be transported from Lima, while transportation of other non-local inputs (e.g. imported soybean meal and wheat, maize from other regions, etc) is calculated based on the most likely origin and known transportation strategies (e.g. Bolivian soybean meal transported by road, US products transported by freight ship, Chilean products transported by freight ship from Puerto Montt to Ilo, Peru, and then by road; etc).
- All agricultural and animal husbandry inputs were modelled with gross energy content allocation, following (Pelletier et al., 2009). System processes for all major inputs were created or adapted from existing models used in Pelletier et al. (2009). A main difference with the system process modelling described in Pelletier et al. (2009) and its Supplementary Material is that land use (impact category Agricultural land occupation) was considered in the LCIs. Background system data and minor inputs were taken from *ecoinvent* and adapted when necessary (i.e. molasses, monocalcium phosphate, calcium carbonate, and salt) to better approximate regional conditions. Marginal inputs accounting for ~1% of aquafeed formulations, such as vitamin and mineral pre-mixes, were excluded from the analysis. Peruvian fisheries inputs (FMFO) were modelled using gross energy content allocation, based on primary data.
- Peru imports most of the soybean meal (~100%), wheat (~90%) and maize (~60%) it consumes. The main sources of those products are Bolivia, US and Canada, and Argentina, respectively (<http://www.agrodataperu.com>, based on official trade data). System processes of those inputs were constructed as described in Pelletier et al. (2009).
- Peru is almost self-sufficient regarding rice production, importing barely ~7% of its needs. Two different types of rice cultivation were identified as relevant for Peruvian aquafeeds: average Peruvian rice, extensively produced in the north coastal region (with irrigation and high mechanisation), and rice grown in the Amazonas river basin. The latter is produced mostly for local consumption (thus it is used by aquafeed producers in Iquitos), and it is seasonally grown, taking advantage of the annual flooding of the Amazonas and its tributaries. An unallocated US rice farming process from *ecoinvent* was modified to represent both average Peruvian and the special Iquitos conditions (e.g. no irrigation, low mechanisation). Allocation between co-

products (polished rice, bran and shorts, and husk) was carried out according to a mass-weighted GEC criterion. Yield data for Iquitos and Peruvian average rice were taken from 5-year averages (2007-2011) by FAOSTAT (FAO, 2013) and the Peruvian Ministry of Agriculture (MINAG, 2012).

- The Peruvian grid's energy mix was modelled based on the last officially published comprehensive energy dataset (MINEM, 2009). Iquitos is isolated from the national grid system, and generates most of the electricity locally, by means of public and private thermal stations using diesel and heavy (residual) oil. The Iquitos energy mix was modelled using official data disaggregated by region (MINEM, 2012). Electricity use for feed production was included, while its use at farm level was considered unimportant and thus disregarded. The farming stage of both trout in cages and black pacu in ponds has minimal electricity requirements, while data for tilapia was not available. It is common in Peru for fish farms to either generate their own electricity with diesel generators or use fuel-powered pumping and aeration.

## Appendix B. Additional results

**Table B.1a** LCIA of modelled Peruvian scenarios, per t of live weight fish, allocated by gross energy content (see Table 3 for key of feed origins)

| Aquaculture scenarios -->      |                       | TrArtS1                      | TrComS2               | TrComS3               | GaArtS1                      | GaComS2               | TiArtS1                      | TiArtS2                | TiComS3                |
|--------------------------------|-----------------------|------------------------------|-----------------------|-----------------------|------------------------------|-----------------------|------------------------------|------------------------|------------------------|
| Species                        |                       | <b>Trout</b>                 | Trout                 | Trout                 | <b>Black pacu</b>            | Black pacu            | <b>Tilapia</b>               | Tilapia                | Tilapia                |
| Rearing system                 |                       | <b>Cages, semi-intensive</b> | Cages, semi-intensive | Cages, semi-intensive | <b>Ponds, semi-intensive</b> | Ponds, semi-intensive | <b>Ponds, semi-intensive</b> | Ponds, super-intensive | Ponds, super-intensive |
| Feed production                |                       | <b>artisanal</b>             | commercial            | commercial            | <b>artisanal</b>             | commercial            | <b>generic</b>               | generic                | commercial             |
| Feed origin                    |                       | <b>PE 2012</b>               | PE 2012               | CL 2007               | <b>PE 2012</b>               | PE 2012               | <b>PE 2012</b>               | PE 2012                | PE 2012                |
| FCR                            |                       | <b>1.8</b>                   | 1.4                   | 1.4                   | <b>1.7</b>                   | 1.4                   | <b>1.7</b>                   | 1.7                    | 1.4                    |
| LCIA categories                |                       | Unit                         |                       |                       |                              |                       |                              |                        |                        |
| Acidification potential        | kg SO <sub>2</sub> -e | <b>48.0</b>                  | 29.1                  | 33.2                  | <b>21.9</b>                  | 20.6                  | <b>18.2</b>                  | 28.6                   | 36.2                   |
| Agricultural land occupation   | m <sup>2</sup> .yr    | <b>6 843</b>                 | 4 849                 | 4 882                 | <b>7 235</b>                 | 3 938                 | <b>14 256</b>                | 14 262                 | 2 808                  |
| Biotic resource use            | kg C                  | <b>31 023</b>                | 30 023                | 52 983                | <b>2 796</b>                 | 6 550                 | <b>5 653</b>                 | 5 653                  | 6 320                  |
| Cumulative energy demand       | MJ                    | <b>61 810</b>                | 42 826                | 57 060                | <b>27 898</b>                | 33 254                | <b>42 164</b>                | 40 144                 | 52 798                 |
| Eutrophication potential       | kg PO <sub>4</sub> -e | <b>80.7</b>                  | 64.2                  | 76.4                  | <b>59.8</b>                  | 48.3                  | <b>51.3</b>                  | 53.7                   | 36.3                   |
| Global warming potential       | kg CO <sub>2</sub> -e | <b>2 794</b>                 | 3 159                 | 3 433                 | <b>2 056</b>                 | 2 460                 | <b>1 937</b>                 | 2 890                  | 4 124                  |
| Water depletion                | m <sup>3</sup>        | <b>15 132</b>                | 15 241                | 15 132                | <b>5 066</b>                 | 5 561                 | <b>3 973</b>                 | 1 058                  | 1 444                  |
| Toxicity LCIA categories       |                       | Unit                         |                       |                       |                              |                       |                              |                        |                        |
| Freshwater aquatic ecotoxicity | kg 1,4-DB-e           | <b>472</b>                   | 392                   | 340                   | <b>172</b>                   | 222                   | <b>167</b>                   | 151                    | 241                    |
| Human toxicity                 | kg 1,4-DB-e           | <b>2 517</b>                 | 1 305                 | 1 403                 | <b>689</b>                   | 622                   | <b>548</b>                   | 634                    | 811                    |
| Terrestrial ecotoxicity        | kg 1,4-DB-e           | <b>54.7</b>                  | 28.9                  | 12.1                  | <b>14.0</b>                  | 7.2                   | <b>9.1</b>                   | 10.3                   | 9.4                    |
| Total toxicity                 | kg 1,4-DB-e           | <b>3 045</b>                 | 1 726                 | 1 755                 | <b>875</b>                   | 851                   | <b>725</b>                   | 796                    | 1 061                  |
| LCIA single score              |                       | Unit                         |                       |                       |                              |                       |                              |                        |                        |
| ReCiPe single score (fish)     | Pt                    | <b>583</b>                   | 506                   | 584                   | <b>436</b>                   | 439                   | <b>398</b>                   | 488                    | 566                    |
| Ranking (1 = best)             |                       | <b>7</b>                     | 5                     | 8                     | <b>2</b>                     | 3                     | <b>1</b>                     | 4                      | 6                      |
| ReCiPe single score (feed)     | Pt                    | <b>266</b>                   | 225                   | 259                   | <b>196</b>                   | 212                   | <b>156</b>                   | 156                    | 199                    |
| Ranking (1 = best)             |                       | <b>8</b>                     | 6                     | 7                     | <b>3</b>                     | 5                     | <b>1</b>                     | 1                      | 4                      |

FCR: Feed Conversion Ratio.

**Table B.1b** LCIA of modelled Peruvian scenarios, per t of edible portion, allocated by gross energy content (see Table 3 for key of feed origins)

| Aquaculture scenarios -->      |                       | TrArtS1                      | TrComS2               | TrComS3               | GaArtS1                      | GaComS2               | TiArtS1                      | TiArtS2                | TiComS3                |
|--------------------------------|-----------------------|------------------------------|-----------------------|-----------------------|------------------------------|-----------------------|------------------------------|------------------------|------------------------|
| Species                        |                       | <b>Trout</b>                 | Trout                 | Trout                 | <b>Black pacu</b>            | Black pacu            | <b>Tilapia</b>               | Tilapia                | Tilapia                |
| Rearing system                 |                       | <b>Cages, semi-intensive</b> | Cages, semi-intensive | Cages, semi-intensive | <b>Ponds, semi-intensive</b> | Ponds, semi-intensive | <b>Ponds, semi-intensive</b> | Ponds, super-intensive | Ponds, super-intensive |
| Feed production                |                       | <b>artisanal</b>             | commercial            | commercial            | <b>artisanal</b>             | commercial            | <b>generic</b>               | generic                | commercial             |
| Feed origin                    |                       | <b>PE 2012</b>               | PE 2012               | CL 2007               | <b>PE 2012</b>               | PE 2012               | <b>PE 2012</b>               | PE 2012                | PE 2012                |
| FCR                            |                       | <b>1.8</b>                   | 1.4                   | 1.4                   | <b>1.7</b>                   | 1.4                   | <b>1.7</b>                   | 1.7                    | 1.4                    |
| LCIA categories                |                       | Unit                         |                       |                       |                              |                       |                              |                        |                        |
| Acidification potential        | kg SO <sub>2</sub> -e | 83.9                         | 49.2                  | 56.5                  | 52.8                         | 48.9                  | 50.6                         | 79.4                   | 100.7                  |
| Agricultural land occupation   | m <sup>2</sup> .yr    | 11 413                       | 8 082                 | 8 137                 | 17 228                       | 9 376                 | 39 601                       | 39 617                 | 7 799                  |
| Biotic resource use            | kg C                  | 31 023                       | 50 038                | 52 983                | 2 796                        | 14 555                | 5 653                        | 5 653                  | 17 556                 |
| Cumulative energy demand       | MJ                    | 122 581                      | 71 847                | 95 752                | 70 295                       | 79 176                | 117 164                      | 111 553                | 146 776                |
| Eutrophication potential       | kg PO <sub>4</sub> -e | 135.2                        | 107.0                 | 127.3                 | 142.6                        | 114.9                 | 142.6                        | 149.1                  | 100.9                  |
| Global warming potential       | kg CO <sub>2</sub> -e | 5 041                        | 5 290                 | 5 755                 | 4 969                        | 5 856                 | 5 384                        | 8 031                  | 11 463                 |
| Water depletion                | m <sup>3</sup>        | 25 221                       | 25 402                | 25 221                | 12 063                       | 13 242                | 11 036                       | 2 938                  | 4 010                  |
| Toxicity LCIA categories       |                       | Unit                         |                       |                       |                              |                       |                              |                        |                        |
| Freshwater aquatic ecotoxicity | kg 1,4-DB-e           | 821.6                        | 655.7                 | 569.6                 | 417.0                        | 527.6                 | 464.5                        | 420.5                  | 668.8                  |
| Human toxicity                 | kg 1,4-DB-e           | 4 331.5                      | 2 189.6               | 2 358.5               | 1663.8                       | 1480.2                | 1524.6                       | 1762.3                 | 2 257.8                |
| Terrestrial ecotoxicity        | kg 1,4-DB-e           | 92.2                         | 48.5                  | 20.6                  | 33.5                         | 17.1                  | 25.2                         | 28.6                   | 26.1                   |
| Total toxicity                 | kg 1,4-DB-e           | 5 245.3                      | 2 893.8               | 2 948.7               | 2 114.4                      | 2 024.9               | 2 014.3                      | 2 211.4                | 2 952.7                |
| LCIA single score              |                       | Unit                         |                       |                       |                              |                       |                              |                        |                        |
| ReCiPe single score (fish)     | Pt                    | 1045.3                       | 848.6                 | 979.9                 | 1051.9                       | 1045.3                | 1105.3                       | 1355.4                 | 1573.2                 |
| Ranking (1 = best)             |                       | 3                            | 1                     | 2                     | 5                            | 4                     | 6                            | 7                      | 8                      |
| ReCiPe single score (feed)     | Pt                    | 290.1                        | 227.3                 | 261.8                 | 199.4                        | 211.9                 | 155.7                        | 155.7                  | 198.9                  |
| Ranking (1 = best)             |                       | 8                            | 6                     | 7                     | 4                            | 5                     | 1                            | 1                      | 3                      |

FCR: Feed Conversion Ratio.

**Table B.2** LCIA of feeds used in the modelled Peruvian scenarios, per t of feed, allocated by gross energy content

| Feed associated to scenarios --> |                       | TrArtF1   | TrComF2    | TrComF3    | GaArtF1   | GaComF3    | TiArtF1 | TiComF2    |
|----------------------------------|-----------------------|-----------|------------|------------|-----------|------------|---------|------------|
| LCIA categories                  | Unit                  | artisanal | commercial | commercial | artisanal | commercial | generic | commercial |
|                                  |                       | PE 2012   | PE 2012    | CL 2007    | PE 2012   | PE 2012    | PE 2012 | PE 2012    |
| Acidification potential          | kg SO <sub>2</sub> -e | 27.3      | 18.4       | 20.4       | 12.7      | 13.4       | 9.6     | 15.8       |
| Agricultural land occupation     | m <sup>2</sup> -yr    | 3 792     | 3 446      | 3 469      | 4 239     | 2 798      | 8 369   | 1979       |
| Biotic resource use              | kg C                  | 17 235    | 21 445     | 37 845     | 1864      | 4 367      | 3 325   | 4 514      |
| Cumulative energy demand         | MJ                    | 38 015    | 21 324     | 29 648     | 15 705    | 19 197     | 10 487  | 17 412     |
| Eutrophication potential         | kg PO <sub>4</sub> -e | 2.9       | 4.2        | 4.6        | 2.6       | 3.7        | 2.6     | 4.4        |
| Global warming potential         | kg CO <sub>2</sub> -e | 1519      | 1725       | 1811       | 1157      | 1514       | 835     | 1645       |
| Water depletion                  | m <sup>3</sup>        | 4.8       | 82.2       | 4.1        | 5.4       | 358.1      | 3.2     | 278.4      |
| Terrestrial ecotoxicity          | kg 1,4-DB-e           | 29.2      | 18.0       | 5.8        | 8.1       | 4.6        | 4.4     | 4.1        |
| ReCiPe single score              | Pt                    | 290.1     | 227.3      | 261.8      | 199.4     | 211.9      | 155.7   | 198.9      |

**Table B.3** Abridged inventory table and overall environmental impacts (ReCiPe single score) of fishmeal production in Peru

| Main inventory items       |    | Prime | FAQ   | Residual |
|----------------------------|----|-------|-------|----------|
| Outputs                    |    |       |       |          |
| Fish meal                  | t  | 1.00  | 1.00  | 1.00     |
| Fish oil <sup>a</sup>      | t  | 0.19  | 0.19  | <0.19    |
| Inputs                     |    |       |       |          |
| Fresh fish                 | t  | 4.21  | 4.21  | 2.11     |
| Fish residues <sup>a</sup> | t  | -     | -     | 2.75     |
| Fuel use <sup>b</sup>      | MJ | 6,389 | 8,276 | 11,908   |
| Electricity                | MJ | 312   | 208   | 208      |
| Antioxidants               | kg | 0.86  | 1.06  | 0.50     |
| Emissions to water         |    |       |       |          |
| N                          | kg | 0.55  | 0.55  | 0.55     |
| P                          | kg | 0.005 | 0.005 | 0.005    |
| BOD <sub>5</sub>           | kg | 38.60 | 75.10 | 75.10    |
| ReCiPe single score        | Pt | 92    | 156   | 196      |

<sup>a</sup> Allocation factor fishmeal:fish oil (gross energy content): 73:27.

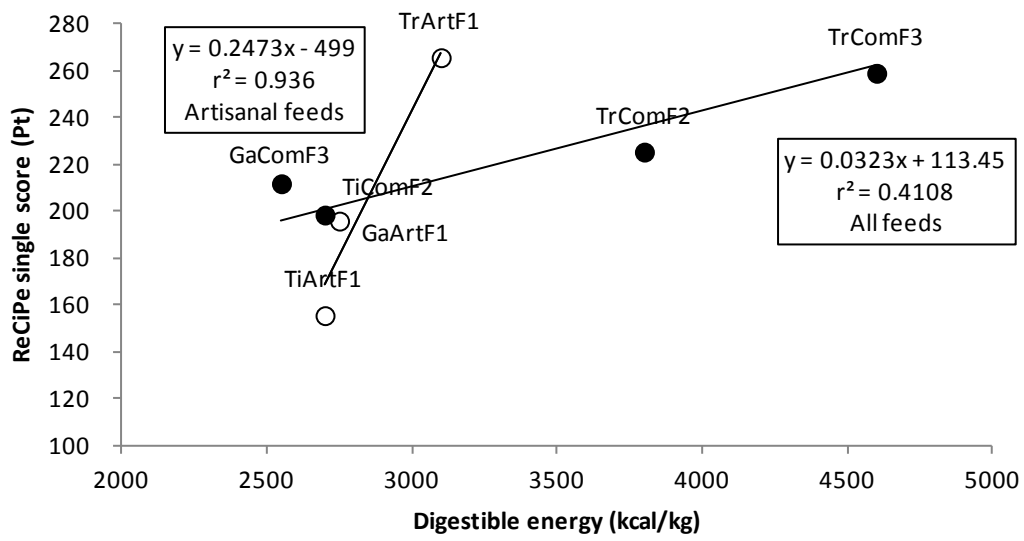
<sup>b</sup> Considering a 50% inclusion of fish residues (range 50-70%, affected by illegal landings for reduction). <sup>c</sup> Diesel, heavy fuel oil (R500) and natural gas.

**Table B.4** Nitrogen and phosphorus releases to water: N, P budgets and fate of nitrogen emissions

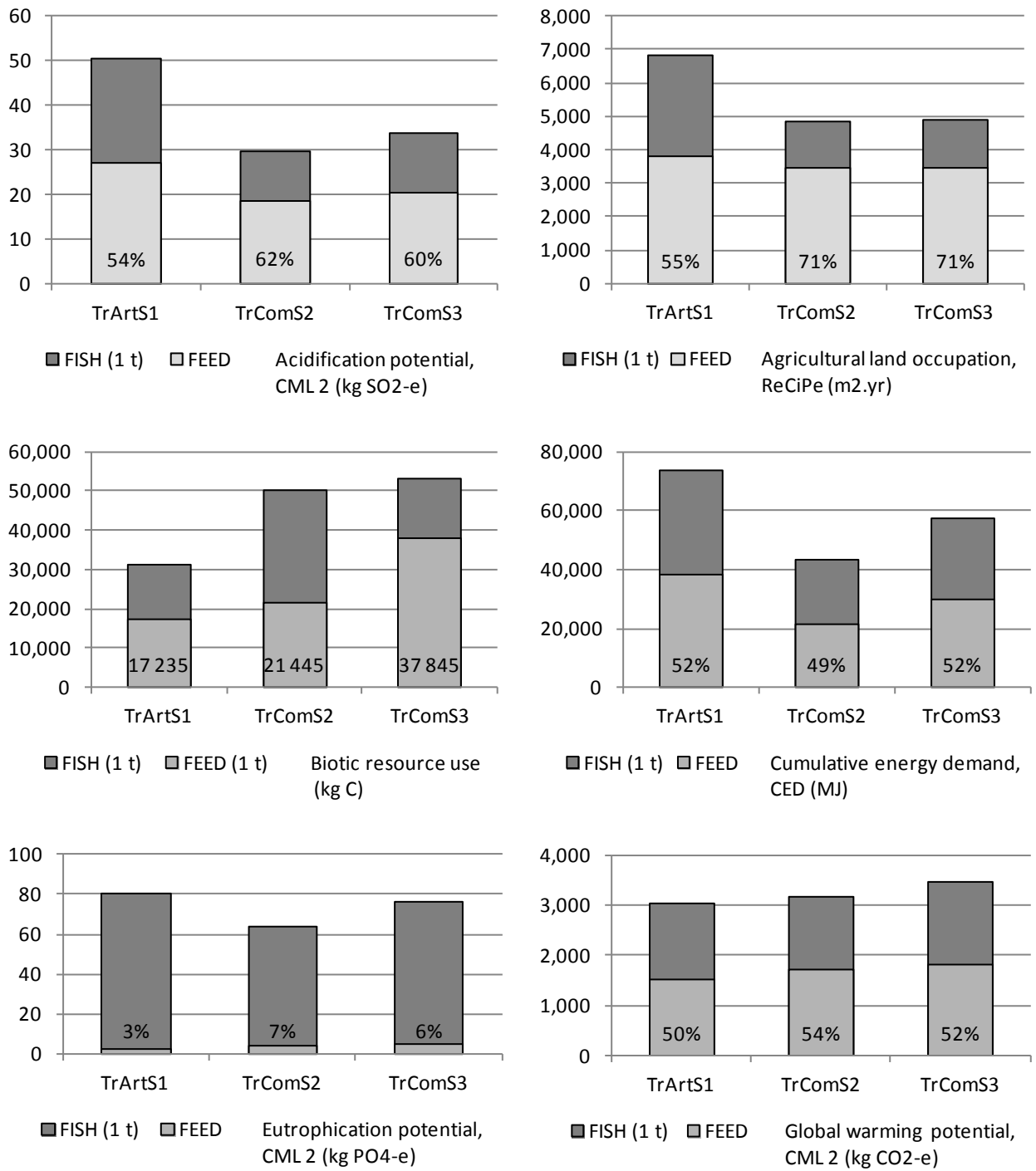
|                   |           | Trout<br>(artisanal<br>feed) | Trout<br>(commercial<br>feed) | Black pacu<br>(artisanal<br>feed) | Black pacu<br>(commercial<br>feed) | Tilapia<br>(artisanal<br>feed) | Tilapia<br>(commercial<br>feed) |
|-------------------|-----------|------------------------------|-------------------------------|-----------------------------------|------------------------------------|--------------------------------|---------------------------------|
| Total N emissions | kg/t fish | 80.31                        | 66.10                         | 42.15                             | 29.27                              | 56.05                          | 37.17                           |
| N solid           |           | 28.24                        | 24.54                         | 22.92                             | 18.49                              | 28.14                          | 21.63                           |
| N dissolved       |           | 52.07                        | 41.56                         | 19.23                             | 10.78                              | 27.92                          | 15.55                           |
| Total P emissions | kg/t fish | 13.63                        | 9.63                          | 12.33                             | 9.93                               | 7.50                           | 3.74                            |
| P solid           |           | 9.36                         | 7.28                          | 7.07                              | 5.82                               | 7.78                           | 5.82                            |
| P dissolved       |           | 4.27                         | 2.35                          | 5.25                              | 4.10                               | (0.28)                         | (2.08)                          |
| Fates             | kg/t fish |                              |                               |                                   |                                    |                                |                                 |
| N in sediment     |           | 30.52                        | 25.12                         | 16.02                             | 11.12                              | 21.30                          | 14.13                           |
| N in water column |           | 0.08                         | 0.07                          | 0.04                              | 0.03                               | 0.06                           | 0.04                            |
| N in fish         |           | 18.95                        | 17.95                         | 14.77                             | 12.71                              | 16.79                          | 14.48                           |
| N in seepage      |           | 30.76                        | 22.96                         | 11.33                             | 5.41                               | 17.91                          | 8.53                            |
| Digestibility     | %         |                              |                               |                                   |                                    |                                |                                 |
| Protein           |           | 92                           | 92                            | 82                                | 82                                 | 82                             | 82                              |
| Fat               |           | 95                           | 95                            | 60                                | 60                                 | 93                             | 93                              |
| Carbohydrates     |           | 71                           | 71                            | 80                                | 80                                 | 70                             | 70                              |
| Ash               |           | 50                           | 50                            | 50                                | 50                                 | 50                             | 50                              |
| Phosphorus        |           | 60                           | 60                            | 60                                | 60                                 | 60                             | 60                              |

Calculations are based on the average content of protein, lipids and phosphorus in available feeds and the reference production systems as defined in Table 3.





**Fig. B.1** Digestible energy vs. environmental impacts (ReCiPe single score) of Peruvian feeds



**Fig. B.2** Detailed impact category analysis of Peruvian trout scenarios, per tonne of live weight fish at farm gate

## Appendix C. Uncertainty and sensitivity analyses

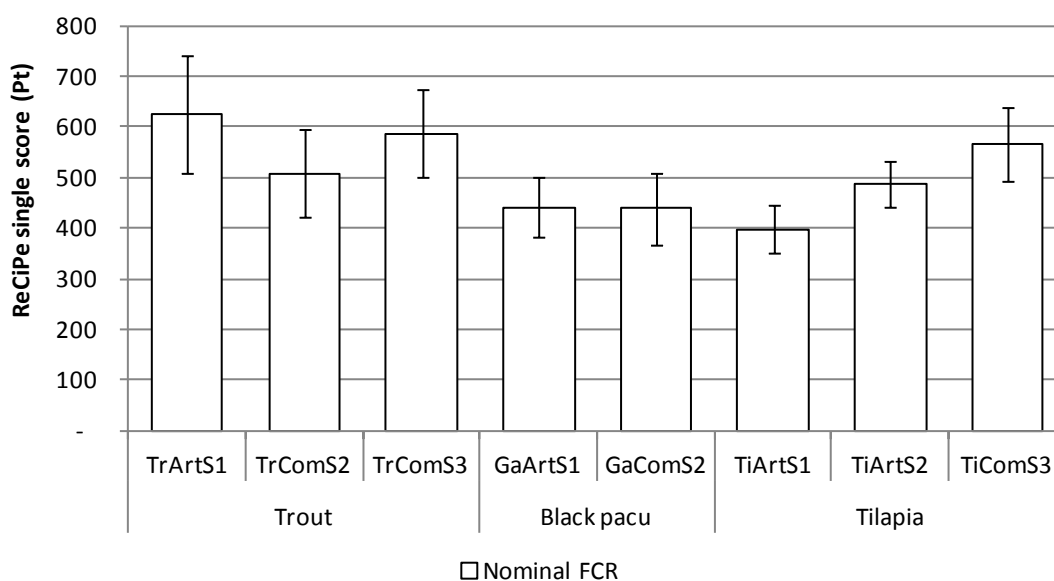
**Table C.1** Re-calculated FCRs for Peruvian aquaculture scenarios, based on dry matter (DM) of feeds and fish

| Species    | Scenarios       | DM feed | FCR | DM fish <sup>a</sup> | Dry FCR |
|------------|-----------------|---------|-----|----------------------|---------|
| Trout      | TrArtS1         | 85%     | 1.8 |                      | 5.9     |
|            | TrComS2         | 86%     | 1.4 | 26%                  | 4.6     |
|            | TrComS3         | 88%     | 1.4 |                      | 4.7     |
| Black pacu | GaArtS1         | 85%     | 1.7 | 29%                  | 5.0     |
|            | GaComS2         | 86%     | 1.4 |                      | 4.2     |
| Tilapia    | TiArtS1/TiArtS2 | 85%     | 1.7 | 19%                  | 7.6     |
|            | TiComS3         | 86%     | 1.4 |                      | 6.3     |

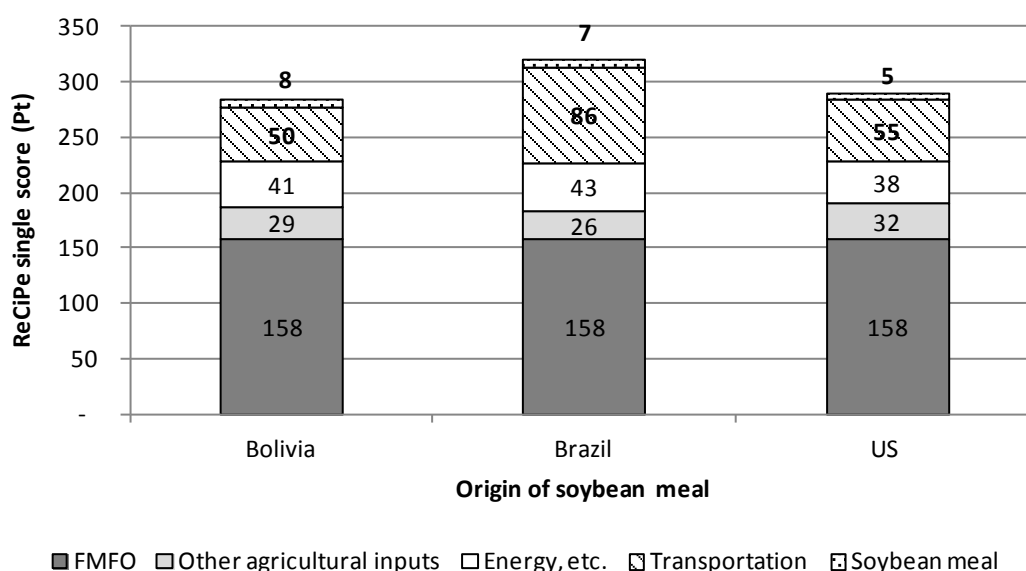
<sup>a</sup> Trout: USDA (2012), Black pacu: Average of values from Bezerra (2002), Torry Research Station (1989) and Machado and Sgarbieri (1991), tilapia: USDA (2012).

**Table C.2** Changes in emissions to water by Peruvian aquaculture systems in response to a  $\pm 20\%$  change in FCRs

| FCR $\Delta$ | FCR | Emissions (kg/t fish) | Trout | Black pacu | Tilapia |
|--------------|-----|-----------------------|-------|------------|---------|
| FCR +20%     | 1.7 | N                     | 86.3  | 37.3       | 48.2    |
|              |     | P                     | 12.6  | 12.1       | 5.4     |
| FCR          | 1.4 | N                     | 66.1  | 25.8       | 34.7    |
|              |     | P                     | 9.6   | 9.7        | 3.0     |
| FCR -20%     | 1.1 | N                     | 45.9  | 14.3       | 21.3    |
|              |     | P                     | 6.6   | 7.3        | 0.6     |



**Fig. C.1** Changes in ReCiPe single scores of Peruvian aquaculture scenarios, per tonne of live weight fish, in response to a  $\pm 20\%$  change in FCRs



**Fig. C.2** Relative performance of the use phase of the reference Peruvian trout scenario TrArtS1 with alternative sourcing for soybean meal in feed (TrArtF1, 15% soybean meal)

### References to SM

Bezerra, A., 2002. Growth and protein digestibility of Tambaqui, *Colossoma macropomum*, Cuvier 1818, fed diets based on fish silage. Masters Diss. Aquaculture Department, Memorial University of Newfoundland.

FAO, 2013. FAOSTAT [WWW Document]. United Nations Food Agric. Organ. Stat. URL <http://faostat.fao.org/site/567/default.aspx#ancor>

Machado, M., Sgarbieri, V., 1991. Partial characterization and nutritive value of proteins from pacu (*Colossoma mitrei*, Berg 1895). *J. Agric. Food Chem.* 39, 1715–1718.

MINAG, 2012. El Arroz: Principales aspectos de la cadena agroproductiva (Rice: main aspects of the agricultural productive chain). Lima: Dirección General de Competitividad Agraria, Ministerio de Agricultura.

MINEM, 2009. Balance Nacional de Energía 2009. Lima: Ministerio de Energía y Minas.

MINEM, 2012. Anuario Estadístico de Electricidad 2010 [WWW Document]. URL <http://www.minem.gob.pe/descripcion.php?idSector=6&idTitular=3903>

Pelletier, N., Tyedmers, P., Sonesson, U., Scholz, A.J., Ziegler, F., Flysjö, A., Kruse, S., Cancino, B., Silverman, H., 2009. Not all salmon are created equal: life cycle assessment (LCA) of global salmon farming systems. *Environ. Sci. Technol.* 43, 8730–6.

Torry Research Station, 1989. Yield and nutritional value of the commercially more important fish species. Rome: Food and Agriculture Organisation of the United Nations.

USDA, 2012. USDA National Nutrient Database for Standard Reference, Release 25 [WWW Document]. U.S. Dep. Agric. Agric. Res. Serv. Nutr. Data Lab. Home Page. URL <http://www.ars.usda.gov/ba/bhnrc/ndl>

#### 4.2.4 Paper 5: Environmental assessment of Peruvian anchoveta food products: is less refined better?

Paper presenting a Life Cycle Assessment-based comparison of Peruvian anchoveta supply chains for direct human consumption products, published in the International Journal of Life Cycle Assessment (Avadí et al., 2014b).

|  |  |
|--|--|
| Paper idea and design                            | Angel Avadí                              |
| Experiment design                                | Angel Avadí                              |
| Data collection                                  | Angel Avadí, Isabel Quispe, Pierre Fréon |
| Data processing, statistical analysis, modelling | Angel Avadí                              |
| Discussion                                       | Angel Avadí, Pierre Fréon                |
| Writing and editorial                            | Angel Avadí, Pierre Fréon                |

#### Environmental assessment of Peruvian anchoveta food products: is less refined better?

Angel Avadí <sup>a,b,\*</sup>, Pierre Fréon <sup>b</sup>, Isabel Quispe <sup>c</sup>

<sup>a</sup> Université Montpellier 2 – Sciences et Techniques, 2 Place Eugène Bataillon, 34095 Montpellier Cedex 5, France.

<sup>b</sup> UMR 212 EME, Institut de recherche pour le développement (IRD). Centre de Recherche Halieutique Méditerranéenne et Tropicale, Avenue Jean Monnet CS 30171, 34203 SETE cedex.

<sup>c</sup> Pontificia Universidad Católica del Perú, Facultad de Ingeniería Industrial, Av. Universitaria 1801, San Miguel, Lima 32, Peru.

\* Corresponding author

#### Abstract

**Purpose.** Life Cycle Assessments (LCAs) of various anchovy (*anchoveta*) direct human consumption products processed in Peru were carried out, in order to evaluate their relative environmental performance as alternative products to enhance nutrition of communities with low access to fish products in the country. **Methods.** LCA was carried out for fresh, frozen, canned, salted and cured anchoveta products, both at plant gate and featuring local and national distribution over non-refrigerated, chilled and fully refrigerated distribution chain. The functional unit used was one kg of fish in final product. **Results.** Results demonstrate that, in environmental terms, more refined products (cured and canned *anchoveta* products) represent a much higher burden than less refined products (fresh, frozen, salted). Although this is a likely result, the magnitude of this difference (4 to 27 times when expressed as an environmental single score) is higher than expected and had not been quantified before for salted and cured products, as far as we know. This difference is mainly due to differences in energy consumption between types of products. Furthermore, cured and salted products feature larger Biotic Resource Use, when calculated based on the whole fish equivalent, due to higher processing losses/discards. The relevance of taking into account the different transportation and storage needs is highlighted. For those products requiring refrigerated transportation and storage, over a national distribution chain, those activities increase the overall environmental impacts of the products by 55% (fresh chilled) to 67% (frozen). Yet, such an increase does not worsen the environmental performance of fresh and frozen products in comparison to the energy-intensive canned and cured products.

**Conclusions.** It is concluded that a more sustainability-oriented analysis, including the social and economic pillars of sustainability, is required towards decision-making involving promotion of either product for addressing nutritional deficiencies in Peru.

Keywords: Cold chain; frozen, canned and cured fish; *Engraulis ringens*; Life Cycle Assessment; Peru

## 1 Introduction

The Peruvian *anchoveta* (*Engraulis ringens*) fishery is one of the most important ones in the world, in terms of landings and its relation with global animal feed industries (SOFIA 2012). The *anchoveta* purse seiner fleet encompasses both an industrial fleet and a small- and medium-scale (SMS) fleet (Avadí et al. 2014; Fréon et al. 2013, 2014a, 2014b). The industrial fleet lands fish for reduction, referred to in Peru as indirect human consumption (IHC), while the SMS fleet lands fish for both IHC (illegally) and food, referred to in Peru as direct human consumption (DHC). Additionally, the SMS fleet has exclusive access to specific fishing grounds, namely the first five nautical miles for the SS fleet and between the first five and ten nautical miles for the MS fleet (Supreme Decree 005-2012-PRODUCE, although a recent Supreme Court Decree declared it unconstitutional). Including all fleets, total landing volumes average 6 to 7 million tonnes per year (PRODUCE 2012a), of which around 98% is destined to the fishmeal and fish oil (FMFO) industry, and the remaining less than 2% is processed into human food products (Fréon et al. 2010; Fréon et al. 2013).

The Peruvian population surpasses 27 million inhabitants, of which more than 70% live in urban areas. Poverty, defined as the incapacity to meet the basic household needs (food, healthcare, education), is roughly equivalent to the lowest quintile of income, expenditures and assets (INEI 2012a). It reaches 60% in the rural areas (especially in the Andean and Amazonian regions) and ~3% in urban areas (INEI 2011, 2012a). Hunger is clearly associated to poverty (FAO 2011). According to FAO and the Global Hunger Index (FAO 2000; IFPRI 2006, 2012), Peru has advanced

in hunger reduction, yet continues being one of the few Latin-American countries featuring moderate hunger. In some Andean regions, where the most economically-depressed communities in Peru are located, indicators such as chronic malnutrition of children under five years old, stunting and undernourishment are still high (FAO 2000, 2011; INEI 2011). Given such situation, Peruvian government policies have historically been, to some extent, oriented to provide vulnerable communities with cheap sources of animal protein and in general improve access to nutritious food. Several voices in Peru have discussed the need for stimulating consumption of *anchoveta* products, and consequently both government and private initiatives have tackled the issue (PRODUCE 2012b), yet without notable results (Sánchez and Gallo 2009). Annual per capita fish consumption average was estimated in ~20 kg in 2005-2011 (INEI 2012b), but less than 12% of this amount is *anchoveta*. Moreover, 9% of fish products consumed in Peru (mainly canned products) are imported (del Carpio and Vila 2010). The estimated national consumption and exports of *anchoveta* products is listed in Table 1. Despite its recent increase, *anchoveta* consumption is still minimal yet it represents in average approximately 70% of *anchoveta* production for DHC. The consumption of fresh *anchoveta*, despite being marginal and displaying a decreasing trend (Table 1), was included for completion and towards consideration of future increased consumption. The consumption of the other *anchoveta* DHC products shows an increasing trend (2006-2010), especially canned products with an average annual increase of 149%.

There is a variety of policy and market interventions that could be deployed to tackle protein deficiency and malnourishment in general

of vulnerable Peruvian communities. Nonetheless, it seems natural that given the huge stock of a cheap source of fish protein and fatty acids available to Peru, scientific, policy and lobbying efforts have focused on promoting the direct human consumption of *anchoveta* (e.g. CSA-UPCH 2012; de la Puente et al. 2011; OANNES 2012; Rokovich 2009). Indeed seafood (including aquaculture products) derived from the *anchoveta* supply chains, has been often suggested as a suitable means to improve nutritional intake of vulnerable communities and consumers at large (Jiménez and Gómez 2005; Rokovich 2009; de la

Puente et al. 2011; Landa 2012; Paredes 2012). The Peruvian population at large would benefit from a greater availability of *anchoveta* DHC products, due to their important nutritional features: high contents of gross energy, protein, fatty acids, vitamins and minerals; in comparison to other fish products available in Peru (Avadí and Fréon 2014). Research efforts should thus address the scientific aspects to evaluate the environmental performance and other sustainability metrics of the different *anchoveta* DHC supply chains.

**Table 1** Estimation of the national consumption of *anchoveta* DHC products, in fresh fish equivalents (2006-2010)

|                                    |               | 2006      | 2007      | 2008      | 2009      | 2010      | Average   | Contribution |
|------------------------------------|---------------|-----------|-----------|-----------|-----------|-----------|-----------|--------------|
| Estimated national consumption (t) | Canned        | 18 700    | 45 844    | 58 051    | 62 557    | 72 634    | 51 557    | 58%          |
|                                    | Frozen        | 68        | 2 486     | 7 332     | 9 517     | 11 693    | 6 219     | 7%           |
|                                    | Fresh         | 538       | 401       | 336       | 293       | 223       | 358       | <1%          |
|                                    | Salted        | 6 058     | 1 459     | 942       | 2 962     | 3 979     | 3 080     | 3.5%         |
|                                    | Subtotal      | 25 363    | 50 190    | 66 660    | 75 329    | 88 529    | 61 214    |              |
| Estimated exports (t)              | Canned        | 12 319    | 16 112    | 20 800    | 22 416    | 21 613    | 18 652    | 21%          |
|                                    | Frozen        | 1 210     | 2 800     | 4 933     | 2 010     | 3 467     | 2 884     | 3%           |
|                                    | Cured, salted | 4 610     | 6 000     | 6 200     | 6 810     | 6 600     | 6 044     | 7%           |
|                                    | Subtotal      | 18 139    | 24 912    | 31 933    | 31 236    | 31 680    | 27 580    |              |
| <i>Anchoveta</i> total for DHC (t) |               | 43 502    | 75 102    | 98 594    | 106 565   | 120 209   | 88 794    | 100%         |
| <i>Anchoveta</i> for IHC (t)       |               | 5 891 800 | 6 084 700 | 6 159 387 | 5 828 600 | 3 330 400 | 5 458 977 |              |

Notes: National consumption was estimated by deducting PROMPERU export statistics from RECIPE landings statistics. The following conversion factors with respect to fresh fish were used: canned = 0.50, frozen = 0.75 and cured = 0.25; the use of these factors reflects the different initial processes displayed in Fig. 1 and Fig. 2. Conversion factors are based on industrial yields of the different industries studied and in personal communication with a Peruvian analyst on *anchoveta* fisheries and industries (J. C. Sueiro, pers. comm., 2012).

Source: PRODUCE statistics (PRODUCE 2012a), PROMPERU (2010)

This study introduces a life cycle assessment of *anchoveta* products for DHC. Due to their relevance in the Peruvian fish processing industry, and the abovementioned intent of promoting national consumption of *anchoveta* products, we focused on the more representative processing industries in Peru: canning, freezing and curing.

*Anchoveta* frozen products are mostly consumed in the country (as opposite to other species frozen products, which are to a large extent exported), while canned products are both exported and

consumed in Peru (del Carpio and Vila 2010; PROMPERU 2011). As of 2011, installed capacities of whole fish by processing plants were roughly as follows, according to official statistics (PRODUCE 2012a; INEI 2012b): freezing - 2.4 million t·a<sup>-1</sup> in 117 plants, curing - 1.3 million t·a<sup>-1</sup> in 18 plants, and canning - 720 000 t·a<sup>-1</sup> in 69 plants.

Fresh *anchoveta* is available almost exclusively at landing points. According to current legislation, vessels landing *anchoveta* for DHC must have a purchase agreement with a processing plant

(Ministerial Resolution 433-2012-PRODUCE). That is to say, fishers cannot sell their catch directly for fresh consumption. Moreover, most landing facilities for DHC fail to fulfil the requirements set by the sanitary standard for fisheries and aquaculture resources (Supreme Decree 040-2001-PE; Rokovich, 2009). The lack of a cold chain for fish in Peru is a major limiting factor for the further development of domestic distribution channels, especially for such a delicate fish as *anchoveta*.

Existing distributions chains for fresh and frozen fish in Peru (cold chain) are clearly insufficient to deliver fresh, chilled and frozen fish and fish products to the national population outside the main coastal urban areas (Sueiro 2006; del Carpio and Vila 2010). Only the coastal, especially urban areas such as Lima and other big cities are well provided of fresh marine fish. The Amazon regions also have a steady supply of (freshwater) fish, as to lesser extent do the highland regions close to water bodies where trout and native fish are cultured and wild caught; as can be discerned from consumption statistics (INEI 2012c). Few studies have analysed the distribution of fish in Peru (e.g. del Carpio and Vila 2010; Rokovich 2009; Sanguinetti 2010a, b, c, d; Sanguinetti 2009; Sueiro 2006). From these reports, the distribution chain for fish can be summarised as a combination of a) wholesaler markets concentrating the distribution of fresh fish, providing retailers, markets and supermarkets, restaurants, etc; b) processing plants and importers of canned, frozen and salted fish products distributing to retailers, markets and supermarkets; and c) distribution chains. Only canned products feature national distribution (non-refrigerated), while other types of products are distributed mainly locally, or in some cases by airfare, in very small amounts.

We performed LCAs of different *anchoveta* products and interpreted the results to suggest directions for further development of those industries, as a tool for contributing to the sustainable development of those industries. We placed emphasis on the potential of the different

products to contribute in an environmentally sound way to improve nutrition of the population.

## 2 Methods

### 2.1 Goal and scope

Life Cycle Assessment (LCA) is an ISO-standardised framework for conducting a detailed account of all resources consumed and emissions associated to a specific product along its whole life cycle (ISO 2006a). LCA has been widely applied to study the environmental performance of fisheries and aquaculture products, both fresh and processed (Hospido et al. 2006; Iribarren et al. 2010; Henriksson et al. 2011; Parker 2012; Vázquez-Rowe et al. 2012a; Avadí and Fréon 2013). LCA consists of a goal and scope definition phase, where the functional unit (FU) and system boundary are defined; a Life Cycle Inventory (LCI) phase, where life cycle data related to the FU is collected; a Life Cycle Impact Assessment (LCIA) phase where a set of characterisation factors are used to calculate environmental impacts on a wide number of impact categories; and an interpretation phase, where conclusions are drawn from the LCI and LCIA results (ISO 2006a, 2006b).

Fig. 1 depicts simplified process flows for three different *anchoveta* DHC product, while a value chain diagram of the *anchoveta* DHC industry in Peru is depicted in Fig. 2. It should be noticed that, in the curing value chain, products from the intermediate step “Salting” are consumed in Peru, while the final cured products (packaged in vacuum bags, cans or glass containers) are currently exported.

The following systems were modelled: an *anchoveta* canning plant, a fish freezing plant and an *anchoveta* curing plant. *Anchoveta* landed for DHC, without processing, was modelled as fresh fish for immediate consumption. System boundaries of the study, as shown in Fig. 3, include the pre-processing of fish (gutting, heading, cleaning), the Peruvian electricity mix, and the fish processing processes. System



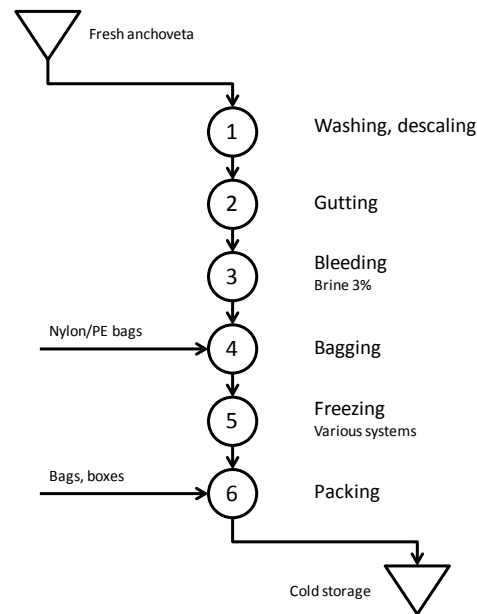
boundaries also include the operations of the SMS wooden fleet landing *anchoveta* for DHC. Detailed analyses of the SMS fleet, in comparison with the industrial fleets, are presented in Fréon et al. (2014b) and Avadí et al. (2014). Transport from plants to retailers and from retailers to consumer, as well as intermediate storage, are usually excluded from the perimeter in sea-to-gate LCAs and no inventory data was collected in this study. Nonetheless, due to the expected large differences in the impacts of transport of the different categories of DHC products, even at national scale, we performed a screening-level LCAs of distribution. We estimated from literature the comparative contribution to impacts of the existing distribution chain for fish in Peru and of a simulated distribution chain, extended to the interior of the country. Such a comparison is aimed at suggesting future directions for the currently marginal market for fresh *anchoveta* (and fresh fish in general). We modelled the existing distribution chain as local (when only serving the coastal region) and national (when serving the whole country), both of which can be non-refrigerated, chilled or fully refrigerated. The extended distribution chain was modelled as national, also non-refrigerated, chilled or fully refrigerated depending on the needs of distributed products.

The functional unit (FU) was defined as one kg (t) of *anchoveta* DHC product, referred to in this study as “one kg of fish in product”. Such a FU was chosen to normalise the differences in discards, process losses and residues, and thus in the ratio final product:raw material among manufacturing processes. The FU includes edible fish (flesh and bones) and accounts for dehydration of the fish carcass during the processing. Residues were assumed to substitute fresh *anchoveta* landed for reduction (duly affected by the conversion ratios residues :fishmeal and fresh anchoveta:fishmeal). Consequently mass allocation was applied between residues and processed fish, given similar gross energy contents and the fact that both whole anchoveta and its residues are used for reduction. The revalorisation of residues (i.e. by

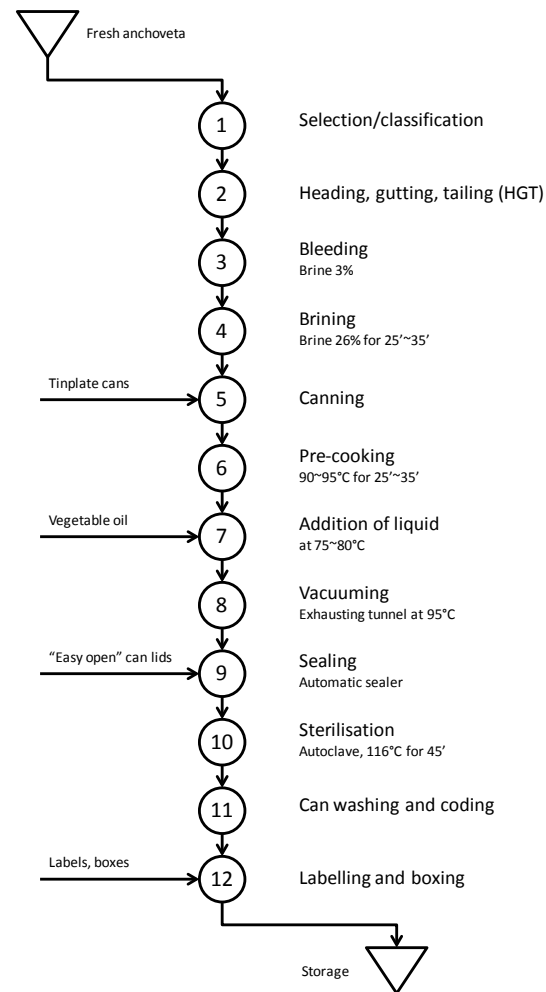
residual fishmeal plants) lowers the overall impacts of DHC products, as a function of the amount of residues generated, which varies considerably among them. Moreover, this selection of FU is consistent with previous research (e.g. Hospido et al. 2006). The reference flow for each DHC process was thus the amount of anchoveta entering each process, including associated discards, processing residues and process losses due to transformation. The FU excludes packaging and other product materials (e.g. vegetable oils).

The reference flow represents the “usable” fraction of catches which is nominally landed for DHC and that actually reaches a DHC process. The usable fraction has been estimated to be 10 to 50% of DHC landings according to the final product, while the balance is diverted to reduction plants. Illegal, unreported and unregulated (IUU) landings have been considered by prorating their estimated fuel consumption into the fuel demand per average landed tonne of *anchoveta* for reduction and for DHC. Estimation of IUU (7% of total landings and 23% of SMS landings) and its associated fuel use demand is detailed in Fréon et al. (2013; 2014b).

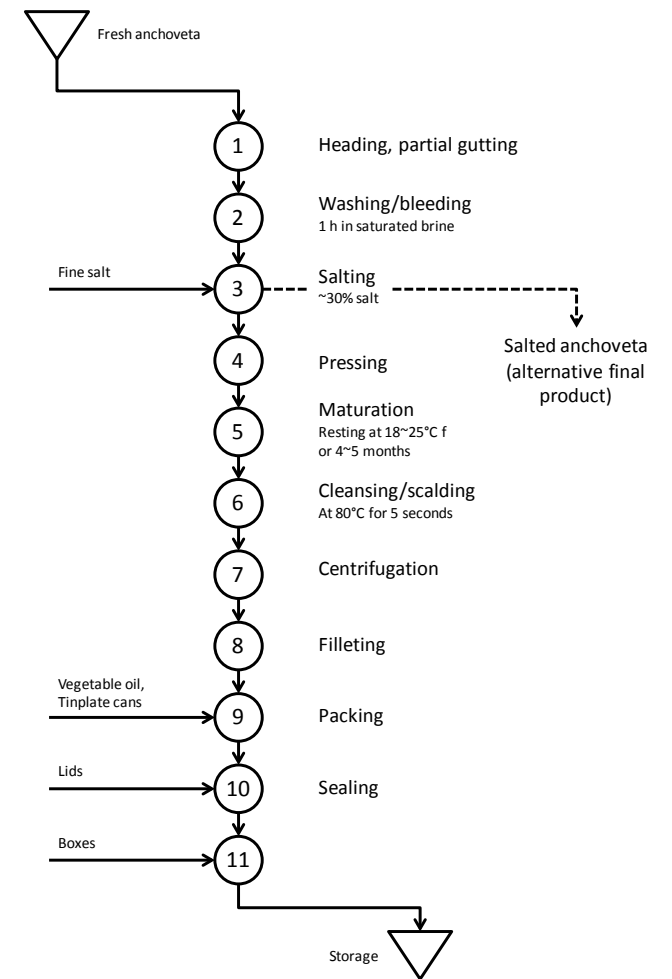
a) Frozen product



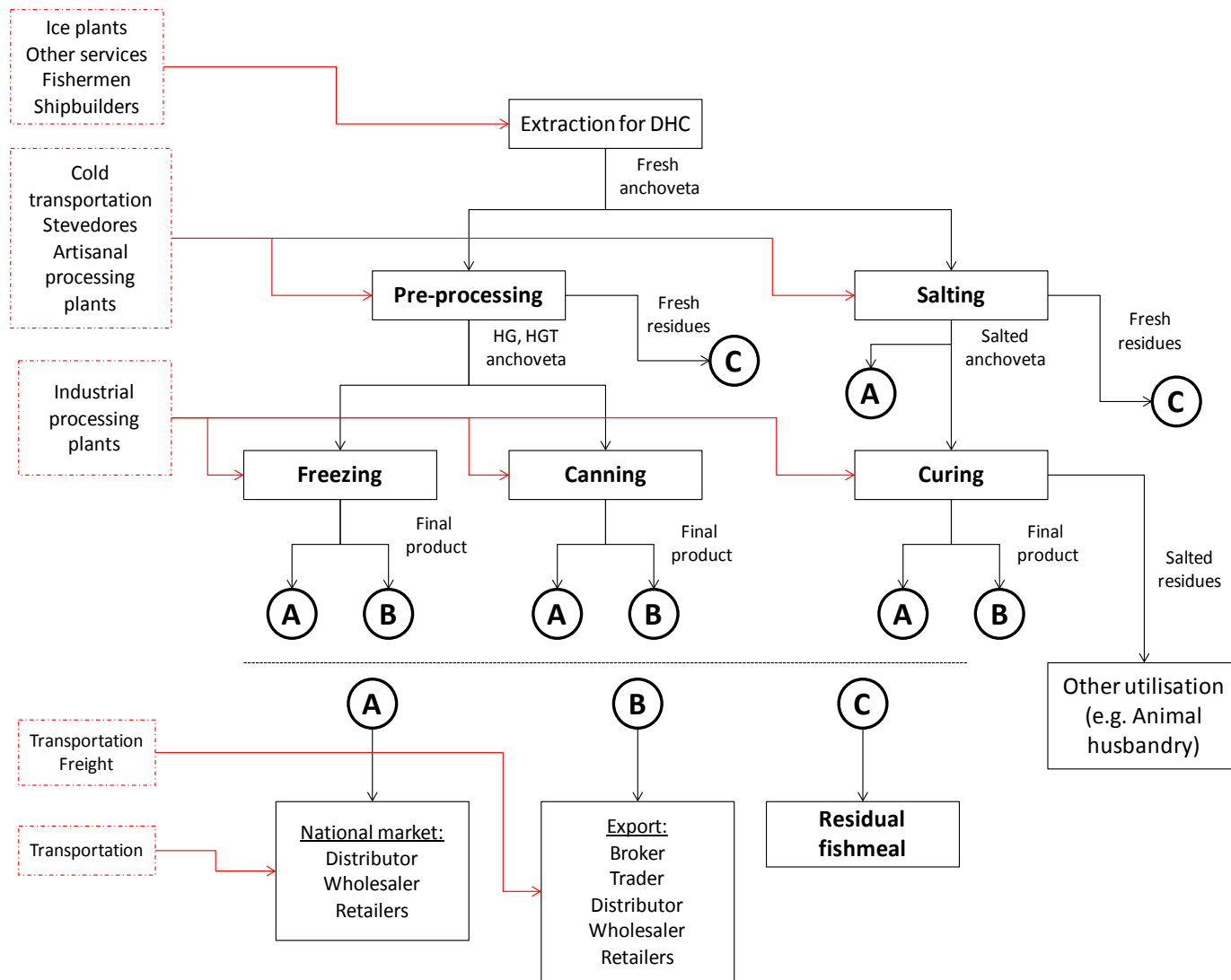
b) Canned product in vegetable oil



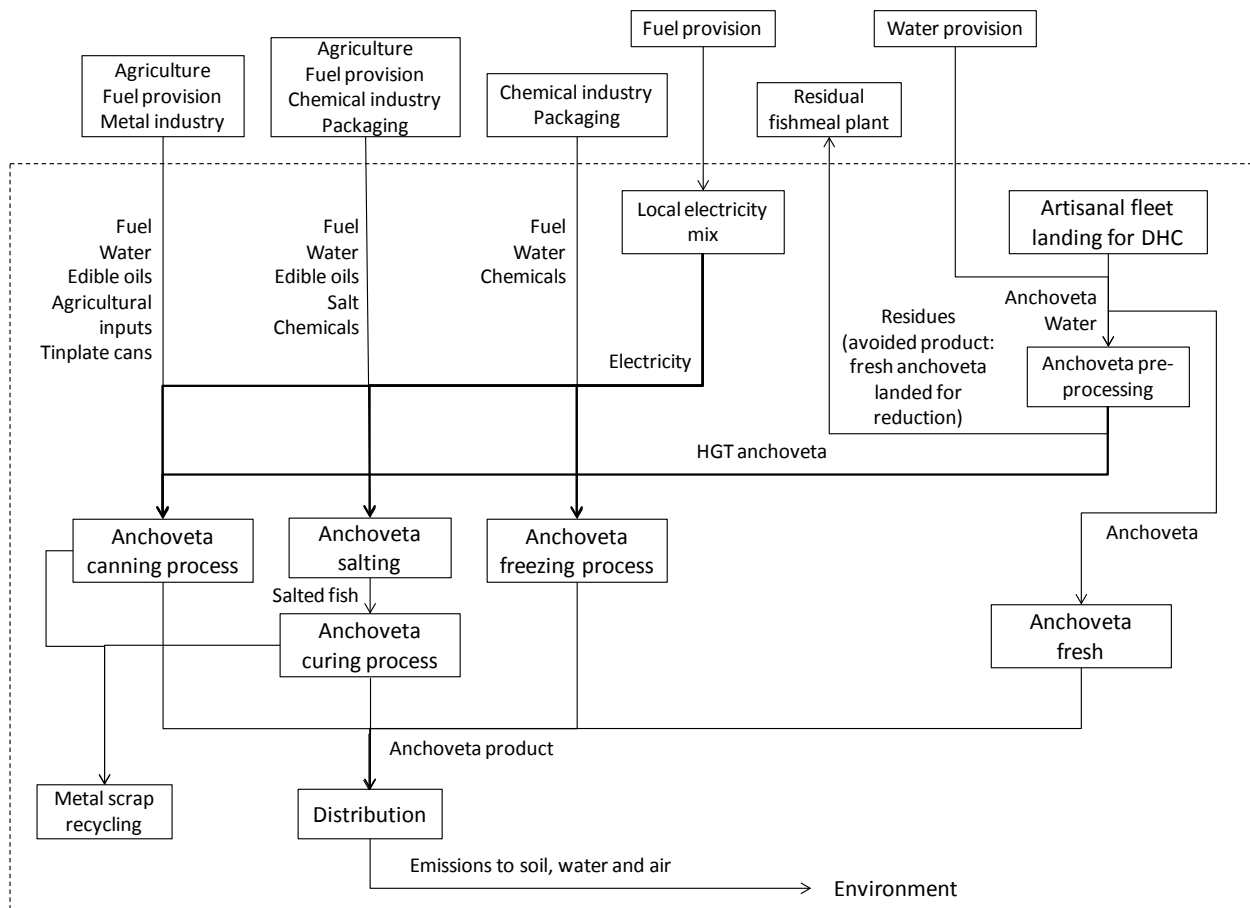
c) Cured product in vegetable oil



**Fig. 1** Simplified flow diagrams of three anchoveta DHC products. Source: based on ITP technical sheets (ITP, 2007), Pablo Echevarría (Compañía Americana de Conservas, pers. comm., 03.2013) and (PENX 2004)



**Fig. 2** The Peruvian *anchoveta* processing industry value chain. Sources: ITP (2007), Pablo Echevarría (Compañía Americana de Conservas, pers. comm., 03.2013), and PENX (2004)



**Fig. 3** System boundary for the LCA of the *anchoveta* DHC industries

## 2.2 Life cycle inventories

Life Cycle Inventories (LCI) were compiled for the three systems under study, in such a way that the modelled *anchoveta* DHC products (canning, freezing and curing) are represented according to current practices. The main inventory items included were: fuel and electricity use, refrigerants, water use, packaging and tinplate cans, emissions to air, releases to water, solid residues, chemicals, edible oils and salt, infrastructure (steel, copper wire, etc.), and heavy equipment (boilers and compressors, including their construction and maintenance). The system boundary proposed (Fig. 3) depicts canning, curing and freezing as black boxes, although processes are very different within each industry, featuring different resource utilisation, timeframes and associated effluents that were modelled. All of them include intensive energy use, especially freezing (for freezing and cold chambers) and canning (for sterilisation and cooking). Curing

generates a large proportion of discards and residues, due to stricter raw material quality requirements.

Primary data collection for fisheries providing the DHC industries is detailed in Fréon et al. (2014b). The most relevant items are fuel consumption, vessel building materials (steel, other metals, wood, etc) and fishing gear. The most impacting items for the DHC manufacturing were energy (fuels, electricity), packaging materials (tinplate, aluminium), and vegetable oils. Key items such as Bolivian soybean oil, electricity (national energy mix), fuel and materials consumed by the fishing fleet, and combustion of fuels in industrial boilers; were modelled specifically for Peru.

Several fish processing plants were visited in Peru, some of them belonging to vertically-integrated fishing companies. The facilities visited were the pilot canning plant ran by the Institute for Fish Technology (ITP) in Lima (ITP 2012), the frozen fish products plant ran by Alimentos Congelados SAC

in Ilo, and the *anchoveta* curing/canning plant ran by Compañía Americana de Conservas SAC (<http://grupoconsorcio.com/>) in Pisco. ITP cooperates with several industrial producers in product development and certification processes. Operational data from ITP was validated and adjusted to represent industry standards (fuel, water and electricity utilisation per production unit is associated to scale) by means of surveys and field visits made to industrial-scale canning companies (anonymous pers. comms.).

Secondary data collected includes industrial average data for liquid effluents from the different fish processing industries (GESTEC 2006; Cristóvão et al. 2012; Bugallo et al. 2013), data for estimating the environmental impacts of refrigerated distribution chains (e.g. Foster et al. 2006; Laguerre et al. 2013; Tassou et al. 2009), energy consumption data for benchmarking of the manufacturing processes (e.g. Hospido et al. 2006) and estimations of the amount of metal scrap generated by the production of tins and aluminium cans (Hospido et al. 2006). Moreover, all background processes were taken from the *Ecoinvent* database v2.3 (Ecoinvent 2012).

### 2.3 Life cycle impact assessment

Among the currently available LCIA methods within the LCA framework, CML baseline 2000 (Guinée et al. 2002) is widely used in fisheries and seafood LCA studies (Parker 2012; Avadí and Fréon 2013), and provides mid-point indicators. The newer ReCiPe method (Goedkoop et al. 2009) integrates and harmonises midpoint and endpoint indicators in a coherent framework. Moreover, ReCiPe extends and complements previous widely used methods (Parker 2012): CML and Ecoindicator 99 (Goedkoop and Spriensma 2001). Thus, ReCiPe was used, complemented with additional indicators and methods when needed:

- ReCiPe is used for midpoint indicators and an endpoint single score, the latter being computed by applying an additional set of characterisation factors to transform midpoints into endpoints, and then a

weighting set to calculate a single score (Goedkoop et al. 2013).

- Toxicity characterisation with ReCiPe offers 50, 100 and infinite years. All toxicity models, for instance USES-LCA toxicity model (van Zelm et al. 2009) used by CML and ReCiPe, and the consensus model USEtox (Rosenbaum et al. 2008); feature high uncertainty. Nonetheless, these methods may be used to establish relative trends in contribution to toxicity. Therefore, percent averages of CML and USEtox results were retained.
- Cumulative Energy Demand (CED) measures the total use of industrial energy (VDI 1997). It is implemented in the homonymous LCIA method (Hischier et al. 2010).
- Biotic Resource Use (BRU), an expression of the primary productivity consumed by an organism given its trophic level, is not currently formalised into LCIA methods. BRU is calculated by the equation

$$BRU = PPR = (catch / 9) \cdot 10^{(TL-1)} \quad (1)$$

were PPR stands for Primary Production Required and TL for trophic level of landed species (Pauly and Christensen 1995). BRU is expressed in  $g C \cdot kg^{-1}$ . BRU-based discard assessment approaches, as described in Hornborg (2012) and Hornborg et al. (2012a, b), consist in calculating primary productivity required by species in the discarded fraction of a fishery, and establishing the proportion of threatened species in the discard. Discard indicators could be later used to calculate an index normalised respect to global discards (Vázquez-Rowe et al. 2012b). BRU including discards was calculated for each DHC process, while other discards indicators were not considered because discards are not a pressing issue in the *anchoveta* fisheries, except during some years.

- Sea use endpoint impact categories, namely the impacts of biomass removal on Biotic Natural Resources (BNR) at the species level ( $I_{BNR,sp}$ ) and at the ecosystem level ( $I_{BNR,eco}$ ), were computed as proposed in Langlois et al. (2014). These indicators express, respectively, the time in years necessary for restoring the biomass uptake of the harvested species, and for regenerating the amount of biomass removed (as an expression of the biotic natural resource depletion in the ecosystem). The indicators are calculated by the following equations:

$$I_{BNR,sp} = \text{reference flow} \cdot 1 / MSY \quad (2)$$

(the 5-year average of the total annual catch can be used in substitution of the maximum sustainable yield (MSY) of the stock, if the stock is over-exploited); and

$$I_{BNR,eco} = BRU / [A \cdot E_{NPP}] \quad (3)$$

where BRU is expressed in  $t \cdot C \cdot t^{-1}$ , A is the ecosystem area in  $km^2$  and  $E_{NPP}$  is the net primary productivity of the ecosystem in  $t \cdot km^{-2} \cdot y^{-1}$ . Both  $I_{BNR,sp}$  and  $I_{BNR,eco}$  are expressed in years.

The software used for computing LCIA was SimaPro v7.3 (PRé 2012). Both main inputs and outputs of the studied systems —excluding landing of fresh anchoveta, described in Fréon et al. (2014b)— are shown in Table 2.

**Table 2** Aggregated life cycle inventory and impact assessment of *anchoveta* DHC products, per kg of pre-processed fresh fish (after in-plant discards and heading, gutting and tailing). The sub-inventory related to raw material (landed fresh fish) is not included

| Inventory items                                    | Unit | Canned<br><i>anchoveta</i> <sup>a</sup> | Frozen<br><i>anchoveta</i> | Salted<br><i>anchoveta</i> | Cured<br><i>anchoveta</i> <sup>a</sup> |
|--|------|---|----------------------------|----------------------------|--|
| <b>Pre-processing</b>                              |      |   |                            |                            |  |
| <b>Inputs</b>                                      |      |   |                            |                            |  |
| Fresh fish   | kg   | 2.00                                    | 1.33                       | 3.47                       | 3.47                                   |
| <b>Outputs</b>                                     |      |   |                            |                            |  |
| Fish discards and residues                         | kg   | 1.00                                    | 0.33                       | 2.47                       | 2.47                                   |
| <b>Manufacturing</b>                               |      |   |                            |                            |  |
| <b>Inputs</b>                                      |      |   |                            |                            |  |
| Pre-processed fish                                 | kg   | 1.00                                    | 1.00                       | 1.00                       | 1.00                                   |
| Tinplate (cans)                                    | kg   | 0.13                                    | N/A                        | N/A                        | 0.19                                   |
| Aluminium (cans)                                   | kg   | N/A                                     | N/A                        | N/A                        | 0.02                                   |
| Vegetable oil                                      | kg   | 0.52                                    | N/A                        | N/A                        | 0.73                                   |
| Salt   | kg   | 0.20                                    | N/A                        | 1.04                       | 1.92                                   |
| Ice  | kg   | 2.00                                    | N/A                        | 3.00                       | 3.00                                   |
| Fuels  | kJ   | 4 323                                   | N/A                        | 0                          | 76                                     |
| Electricity  | kJ   | 360                                     | 911                        | 0                          | 176                                    |
| Water  | L    | 10                                      | 4                          | 3                          | 16                                     |
| <b>Outputs</b>                                     |      |   |                            |                            |  |
| Other fish process losses                          | kg   | 0.71                                    | 0                          | 0.08                       | 0.32                                   |
| Processed fish in product                          | kg   | 0.29                                    | 1.00                       | 0.92                       | 0.68                                   |
| Tinplate scrap                                     | g    | 18.3                                    | N/A                        | N/A                        | 27                                     |
| Aluminium scrap                                    | g    | N/A                                     | N/A                        | N/A                        | 2.5                                    |
| Water emissions, N                                 | g    | 1.22                                    | 0.08                       | 0.06                       | 1.59                                   |
| Water emissions, P                                 | g    | 0.25                                    | 0.04                       | 0.03                       | 0.33                                   |
| <b>National and local distribution<sup>b</sup></b> |      |   |                            |                            |  |
| <b>Inputs</b>                                      |      |   |                            |                            |  |
| Electricity <sup>c</sup>                           | kJ   | 0                                       | 4 216 (90)                 | 0                          | N/A                                    |
| Refrigerant  | mg   | 0                                       | 4.17                       | 0                          | N/A                                    |
| Transportation (trucks <7.5 t) <sup>d</sup>        | tkm  | 0.350                                   | 0.467 (0.067)              | 0.350 (0.050)              | N/A                                    |
| <b>Outputs</b>                                     |      |   |                            |                            |  |
| Refrigerant losses                                 | mg   | 0                                       | 0.41                       | 0                          | N/A                                    |

<sup>a</sup> Production average of different presentations and packaging materials. <sup>b</sup> During distribution, 6 days of storage and 4.5 days of in-store display were assumed (Laguerre et al. 2013). No distribution was modelled for cured products, values presented correspond to salted products. <sup>c</sup> Value in parenthesis corresponds to in-store display of fresh chilled products. <sup>d</sup> A factor +16% was applied to refrigerated transportation to account for additional fuel consumption (Tassou et al. 2009). Values in parenthesis correspond to local distribution.

### 3 Results and discussion

#### 3.1 Key figures and impact assessment

The *anchoveta* DHC produce large volumes of mostly residues, which are commonly revalorised by the residual fishmeal industry. By modelling these dynamics, the contribution of residues to lower overall environmental impacts (i.e. ReCiPe single score) of the different industries (manufacturing) was determined as approximately 2% for canned products, 3% for cured products, 16% for salted products and 8% for frozen products.

Fuel and electricity use are key economic factors in the fish transformation industries (Hospido et al. 2006; Zuffa and Arana 2008; Barros et al. 2009; Thrane et al. 2009). Inventory data (Table 2) is consistent with published figures. For instance, reference literature suggests 200 kWh per tonne of frozen fish products (FAO 1994) and 3 579 MJ of thermal energy plus 498 kWh of electricity per tonne of raw fish processed into a canned product (Hospido et al. 2006). The apparent misbalance regarding thermal and electric consumption for canning, which appears when comparing the Peruvian data to similar data in other countries, is due to the fact that Peruvian processing plants often produce large shares of their electricity requirements with thermal generators during peak hours. Curing consumes more electricity than canning, due to storage needs (the maturation process during curing takes ~5 months under controlled temperatures). In contrast canning requires more thermal energy for cooking and sterilisation than curing because cured products do not require such processes. Residence time (in the processing plant) for frozen products was not explicitly accounted for —literature suggests 3.2 days for meat products (Laguerre et al. 2013)—, but anecdotal data collected from plant visits suggest more than one month for Peruvian frozen fish products. The overall associated energy consumption during a production cycle (manufacture plus in-plant storage) of the studied plants was prorated per tonne of product. Water use for canning and

freezing has been reported in the order of  $\sim 8 \text{ m}^3 \cdot \text{t}^{-1}$  and  $2.5 \text{ m}^3 \cdot \text{t}^{-1}$ , respectively (Hospido et al. 2006; TASA 2010). Literature data on fish salting and curing is not available as far as we know, so freezing and canning data were used for benchmarking.

Regarding packaging, canned and cured products use tins and aluminium cans, which were modelled from *Ecoinvent* metal manufacturing processes assuming a waste production rate of 14% in the can manufacturing, following (Hospido et al. 2006). Those metal scraps we modelled as fully recycled, yet if no recycling would be present, the additional environmental burden would have been marginal. Moreover, coating substances used in the food can industry were excluded, as well as the modelling of specific vegetable oils used in the fish canning and curing industries (other than Bolivian soybean oil, which was assumed to represent all vegetable oils used in Peru). Olive oil imported from Spain is commonly used by the curing industry; yet Bolivian soybean oil was used as proxy due to lack of data. Spanish olive oil features high environmental burdens, as discussed in (Vázquez-Rowe et al. 2014).

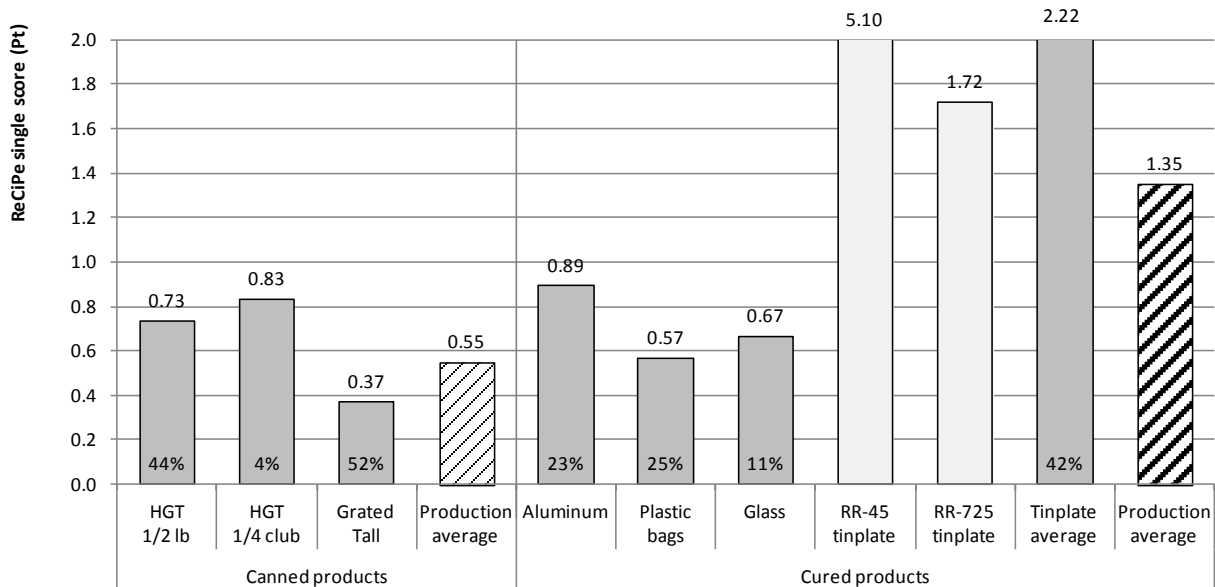
It is noticeable from computed impact categories that freezing products perform orders of magnitude away from canning and curing, which confirm results of other studies performed on other types of food (e.g. Foster et al. 2006). For instance, general environmental impacts and specific toxicity impacts associated to frozen products are lower per functional unit than those of canning (factors 12 and 31) or curing (factors 29 and 82). Nonetheless, losses of the product related to any rupture of the cold chain can generate unexpected additional impacts, likely to occur in a developing country like Peru where electricity supply and some infrastructure are not always adequate. Fresh landed *anchoveta* has obviously the lowest associated impacts, mostly attributable to fuel use by the SMS fleet (Fréon et al. 2014b).

It is worth noting that the environmental impacts of canned and cured products presented here are



based on production averages of the specific production mixes of the studied processing plants, which are believed representative of the national production mix (no national data at such level of detail was available). The ReCiPe single score of

canned products, for instance, ranges from 0.37 to 0.83 Pt·kg<sup>-1</sup>, yielding a weighted average of 0.55; while the single score of cured products ranges from 0.57 to 5.10 Pt·kg<sup>-1</sup>, averaging 1.35 (Fig. 4).



**Fig. 4** Relative impacts of various *anchoveta* canned and cured products at plant gate, based on the ReCiPe single score index; per kg of fish in product. HGT: headed, gutted and tailed fish; percentages indicate contribution to the production mix of ITP and Alimentos Congelados SAC, as representative examples of the Peruvian production mix

LCIA results are summarised in Fig. 5. It is noticeable that, when only manufacturing is considered (Fig. 5a), results for freezing and salting *anchoveta* (the less energy-intensive industries) are between one and two orders of magnitude lower than those of canning and curing (the more energy-intensive industries) in all impact categories. When distribution over the existing refrigerated distribution chain is included through simulation (Fig. 5b), results for climate change and toxicity increase (170% and 216%, respectively) for frozen products, due to the additional demand for refrigerated transportation and storage. The implications of expanding the existing fish distribution change are discussed in the next section.

In the agricultural land occupation category, the contribution of vegetable oils to canned and cured products impacts is visible: the difference in contribution between products using and not

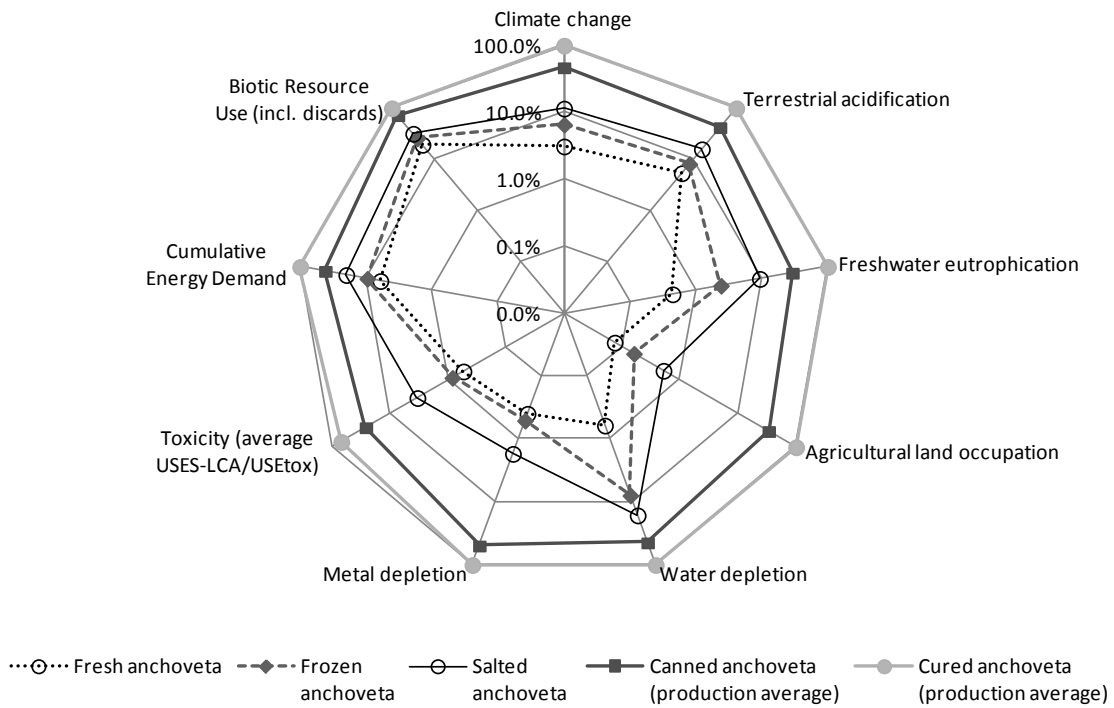
using vegetable oils reaches three orders of magnitude. It is worth noting that “sea use” (in reference to best known “land use”) is not considered in the single score we used (more on this point in the second next section), the same as a few other categories (e.g. water depletion).

Canned products use tinplate cans, while cured products use either tinplate or, aluminium cans; or glass containers. The contribution of packaging materials to overall impacts of these types of products is notable, as depicted in a contribution analysis (Fig. 6a). Such contribution is around 60% of the ReCiPe single score for both systems.

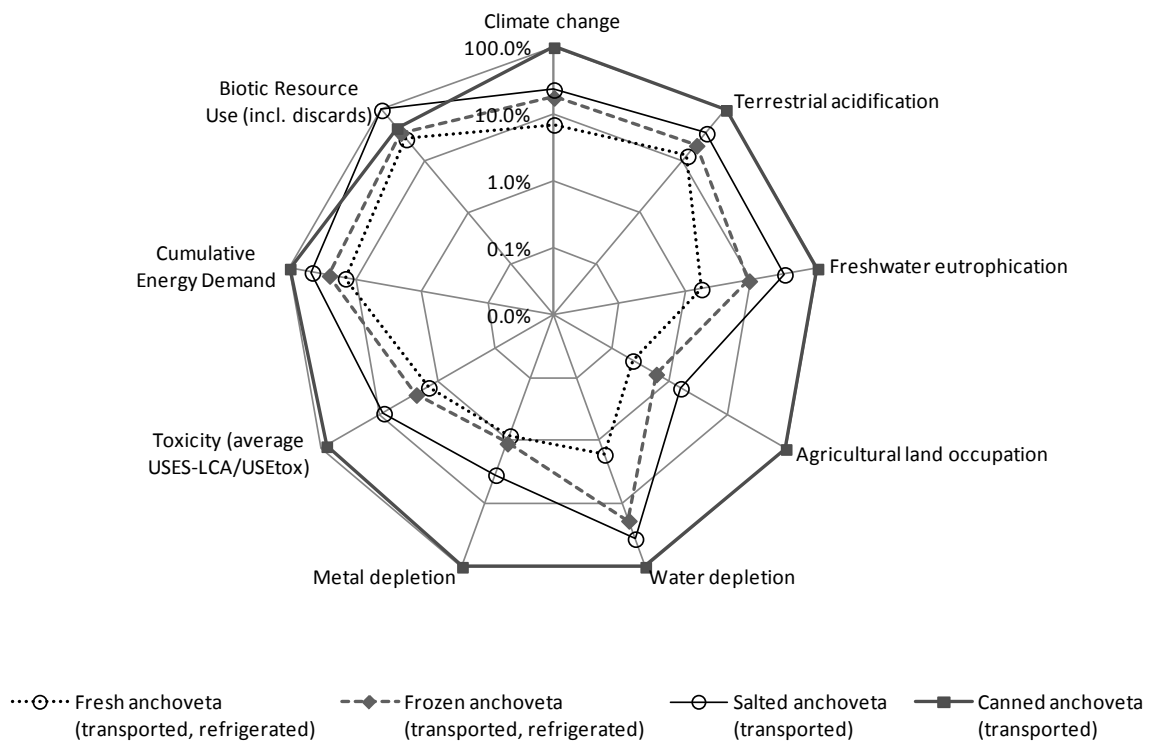
Between canned and cured products there are important differences in several impact categories. Regarding ozone depletion potential, for instance, the reason for this difference is because the canning industry requires powering autoclaves by means of heavy duty boilers powered by either

gas or fuel oils. The curing industry, not entailing sterilisation needs, uses smaller, often gas-powered boilers for other purposes, such as conditioning of cleaning water. Similarly, the differences in the abiotic resource use category are due to the intensive use of oil-powered boilers by the canning industry, unnecessary for the curing industry. Both industries consume tinplate, which contributes with between 40 and 50% of the abiotic resource use impact. Among all products, the main affected impact categories were climate change, human toxicity and fossil depletion, with different levels of contribution to the overall environmental impacts of each product depending on the distribution strategy used (Fig. 7).

a) At plant gate

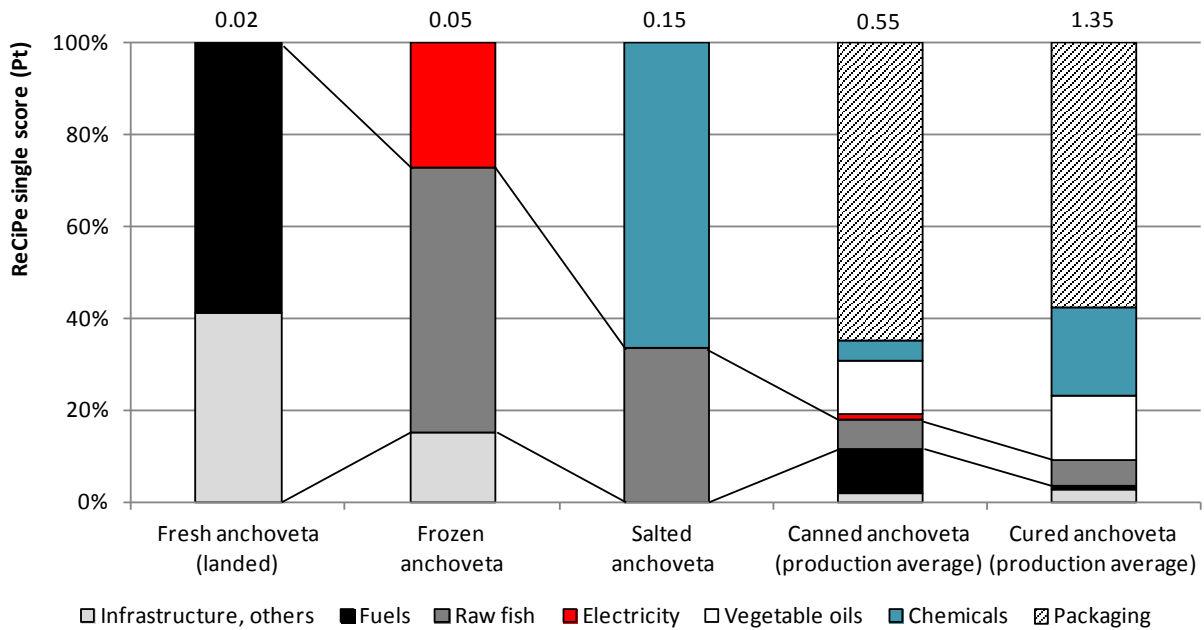


b) Including distribution over the existing chain

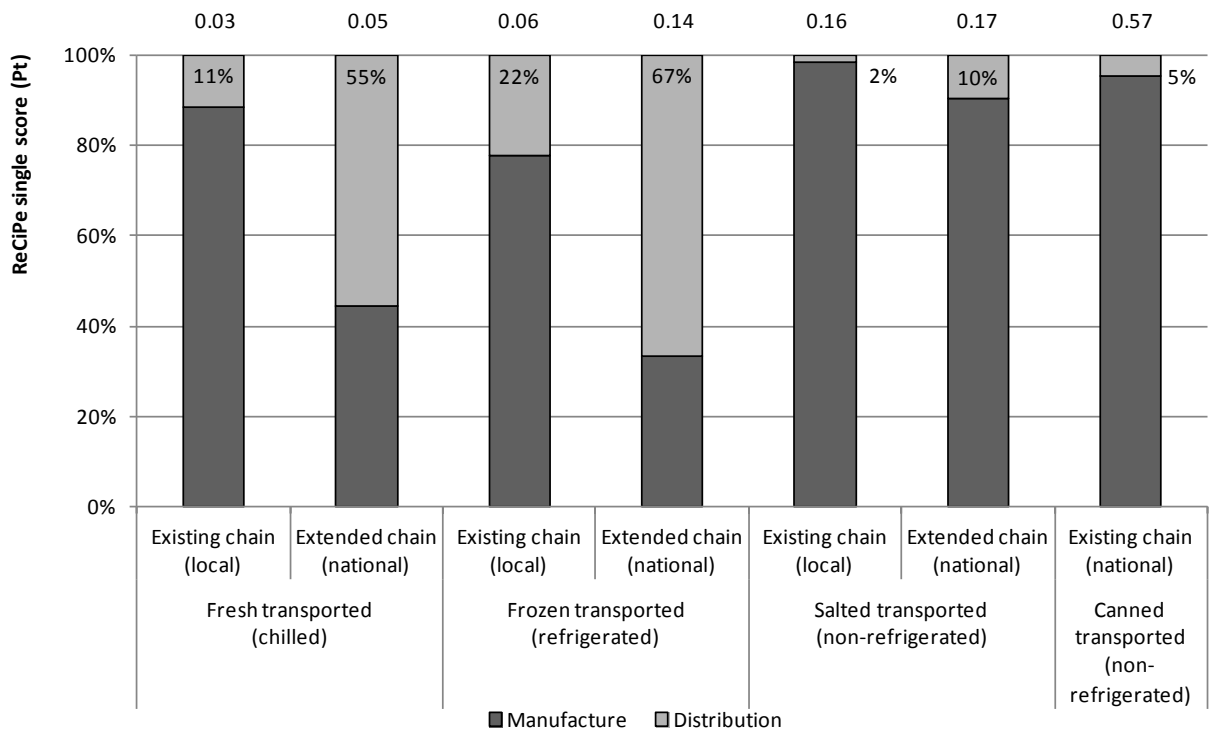


**Fig. 5** Relative environmental performance of the *anchoveta* DHC products based on selected ReCiPe LCIA categories (plus Cumulative Energy Demand and Biotic Resource Use), per kg of fish in product

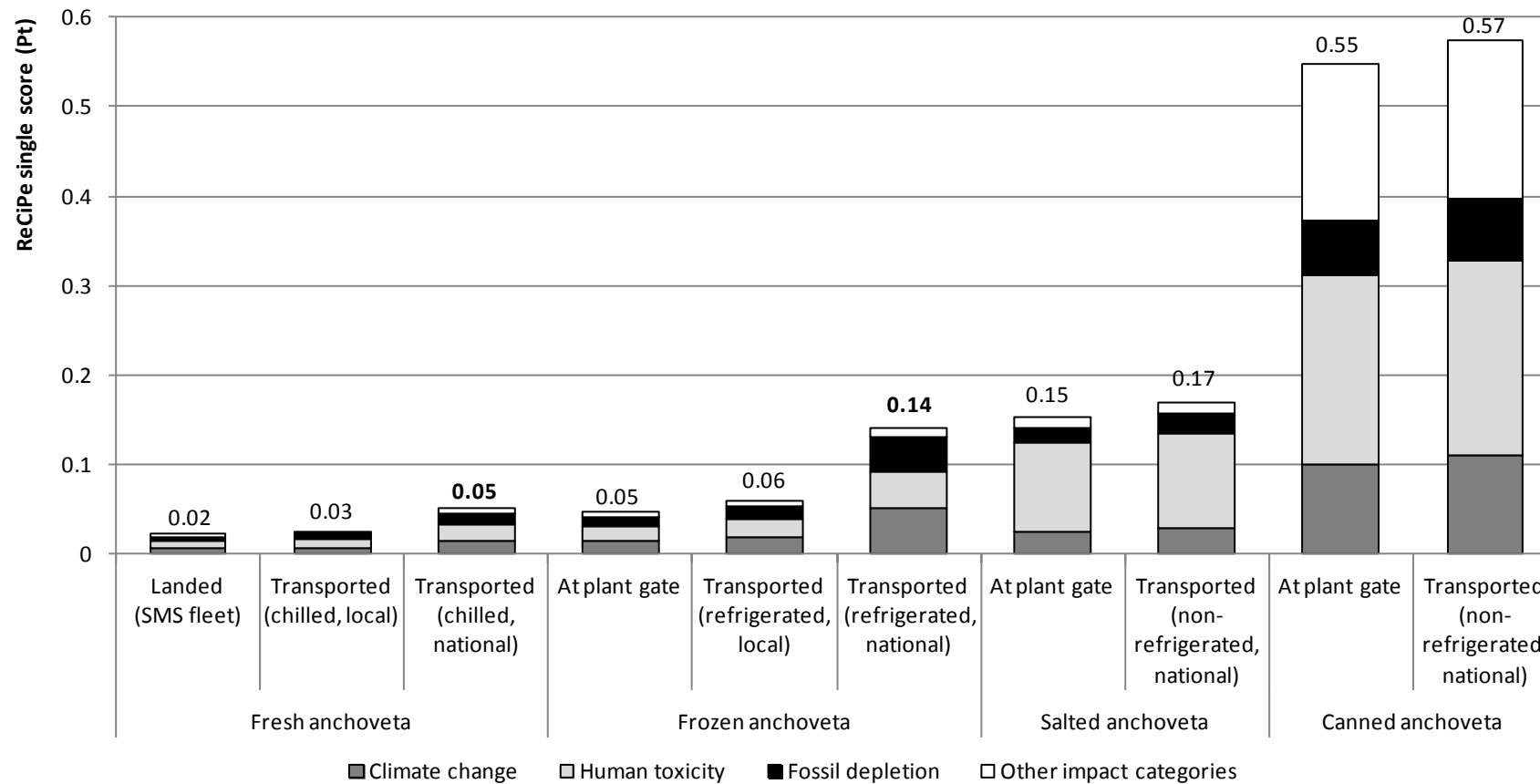
a) At plant gate



b) Including distribution over the existing and the extended cold chain



**Fig. 6** Relative contribution analysis of the *anchoveta* DHC products based on the ReCiPe single score index (on top of each column), per kg of fish in product at plant gate and including distribution. The existing distribution chain services mainly the coastal region, while the extended chain intends to serve at the national level. Distribution of cured products is excluded because they are destined for export, while canned products are already distributed nationally



**Fig. 7** Contribution of distribution of DHC products, within the coastal region (local) and from the coastal to the highland region of Peru (national), to overall environmental impacts, per kg of fish in product. Canned and salted products do not require refrigeration. Cured products are excluded because they are destined mainly for export

### 3.2 Modelling the extended fish distribution chain

In order to distribute fresh and frozen fish (e.g. *anchoveta*) across Peru, and especially to the highland regions, a cold distribution chain should be in place. Such cold chain would imply refrigerated transport and cold chambers, among other infrastructure. Other distribution chains exist in Peru, such as the poultry products one. Nonetheless these chains demand less refrigeration and transportation because the bulk of transportation handles live animals, and production hubs are relatively close to consumption centres (MINAG 2012).

To facilitate estimating the additional impacts on the overall environmental performance of *anchoveta* fresh (chilled) and frozen products that would be caused by a country-wide cold supply chain, we modelled the additional energy demand for transportation and storage and its related emissions, as well as refrigerant leakage from transportation, for both types of products. Infrastructure depreciation was excluded because its contribution was estimated as negligible when prorated by FU. A mean transportation distance between coastal-based producers and target markets in the Andes has been estimated in 350 km (e.g. the average of Lima-Huancayo and Lima-Huánuco), while local transportation within the coastal region was estimated in 50 km.

Results, as presented in Fig. 6b, suggest that distribution of chilled and frozen products over a country-wide cold chain would result in higher overall environmental impacts (factors 2.0 and 2.3, respectively) than the existing coastal distribution patterns. Nonetheless, the environmental impacts of these products (including cold transportation and storage) remain way lower than that of canned products, which are distributed and stored without refrigeration. Distribution over the existing and extended distribution chains represents between 2 and 10% of the overall environmental impacts for non-refrigerated transported products and between 11 and 67% for refrigerated ones. In this later case, the increase in

transport impact related to the extension of the distribution chain is greater for frozen products than for chilled ones. This result is in agreement with a statement in Ziegler et al. (2007), that refrigeration contributed the most to total transport when freezing makes slower transportation possible.

Furthermore, since 52% of the Peruvian population is leaving along the coast (INEI 2011), the overall impact of the extension of transportation and storage at the national scale would remain minor if the cold chain was extended to the interior of the country.

In previous seafood studies, the additional energy demand of retailing and preserving fresh/chilled and frozen fish products has been estimated in the order of 2.5-11% and 3.2-13%, respectively (Foster et al. 2006), while another study on frozen cod suggests that 17% of the impacts can be allocated to the transportation phase (Ziegler et al. 2003). Nonetheless, those fish products have their origin in fuel-intensive fisheries —unlike the Peruvian *anchoveta* fisheries (Fréon et al. 2014a, 2014b)— and related aquacultures, thus higher energy demands were expected and obtained for distribution in the Peruvian case. Moreover, residence time between processing and consumption of chilled/frozen animal protein products has been estimated in between 11.6 and 14.1 days (Laguerre et al. 2013), yet our interactions with Peruvian seafood producers suggested much longer times (>1 month in the plant, plus several days in distribution). For the type of transportation vehicles similar to those used in Peru (namely rigid trucks under 7.5 t) refrigerated transportation increases fuel use by ~16%. Another consequence of refrigerated transportation is the leakage of refrigerant chemicals. Emissions associated with refrigerant leakage have been estimated in the range 17-21% of transportation emissions, in CO<sub>2</sub> equivalents, assuming a 10% annual leakage rate (Tassou et al. 2009). Electricity consumption for doored refrigerated display cabinets used in stores has

been estimated in  $5.6 \text{ kWh}\cdot\text{d}^{-1}\cdot\text{m}^{-1}$  (Fricke and Becker 2010).

In an attempt to provide figures on the Peruvian DHC products that can be compared with other DHC fish products in other countries, we calculated the climate change/global warming potential (GWP) of all studied products per functional unit (kg CO<sub>2</sub>eq per kg fish in product). This midpoint indicator was retained because it is commonly computed and is usually highly correlated with most other midpoint or endpoint indicators. Comparison with results from other studies is at best limited, due to different system boundaries, assumptions and functional units, yet in general terms these indicators provide an easy-to-grasp overview on the environmental performance of Peruvian DHC anchoveta products. GWP figures were calculated for all products except for cured anchoveta, which is not distributed within Peru. Results expressed in kg CO<sub>2</sub>eq at plant gate or including distribution are respectively 0.24 and 0.33 for frozen anchoveta, 0.42 and 0.44 for salted anchoveta, 1.73 and 1.87 for average canned products, and 3.70 for average cured product. The latter value is probably underestimated, as the production and transportation of Spanish olive oil was not modelled, but another vegetable oil used as proxy. Once again it is noticeable that national distribution excluding air freight does not dramatically deteriorate the products' environmental performance, as found by other authors (e.g. Ziegler et al. 2007). Our values of anchoveta GWP at plant gate for frozen Peruvian anchoveta (0.24) are one fold lower than equivalent pelagic fish (the Atlantic herring, *Clupea harengus*) produced in Norway and also caught by purse seiners (Ziegler et al. 2007, Supporting information). This difference is mainly due to lower fuel use in Peru than in Norway, which is mainly due to better catch per unit of effort in relation to a higher abundance of the resource and to its closer proximity to numerous landing points (Fréon et al. 2014a).

### 3.3 Appropriation of net primary productivity and sea use

*Engraulis ringens* features a generally accepted trophic level (TL) of 2.7 (Froese and Pauly 2011). Nonetheless, other authors have suggested and used a different TL of 3.63 (Hückstädt et al. 2007; Boissy et al. 2011). Following the PPR equation and applying TL = 2.7, the BRU of anchoveta is  $5\,569 \text{ g C}\cdot\text{kg}^{-1}$ . The anchoveta, being a low-TL species, appropriates less primary productivity than other commercially caught and consumed fish in Peru such as horse mackerel and jack mackerel (*Scomber japonicus* and *Trachurus murphyi*, both with TL = 3.5 and BRU =  $35\,136 \text{ g C}\cdot\text{kg}^{-1}$ ), Pacific hake (*Merluccius gayi peruanus*, TL = 4.3, BRU =  $221\,696 \text{ g C}\cdot\text{kg}^{-1}$ ), jumbo squid (*Dosidicus gigas*, TL = 4.2, BRU =  $176\,099 \text{ g C}\cdot\text{kg}^{-1}$ ) and "perico" (mahi-mahi, *Coryphaena hippurus*, TL = 4.4, BRU =  $279\,098 \text{ g C}\cdot\text{kg}^{-1}$ ), according to Fishbase (Froese and Pauly 2011).

Regarding the seas use indicators proposed, fishing anchoveta is less detrimental than fishing other species. The estimated times of compensation of the removal of anchoveta biomass at both the species (stock) and the ecosystem levels are one to four orders of magnitude shorter than in the case of biomass removal of other species commonly harvested for DHC in Peru (Table 3). This result by itself advocates for human consumption of low TL species, that is forage fish species rather than piscivorous one. Nonetheless other considerations than sea use indicators and other environmental impact one must be taken into account when discussing such a complex issue, in particular socio-economic factors that are out of the scope of this study. The same applies to the reason of the low availability of anchoveta for DHC that can be attributable to a combination of numerous factors. Those include regulatory limitations (allowed target supply chain for landings), lower or similar price paid to fishers for anchoveta landed for DHC respect to anchoveta landed for IHC, preferences of consumers driven by alimentary habits and prices of products, lack of a

cold chain for fish in Peru (Fréon et al. 2013, 2014a 2014b; Avadí et al. 2014). More generally speaking, there is an ongoing debate regarding the best use of forage fish at global scale because most of these species (including *anchoveta*). They can be either harvested for food or for feed then used for feeding terrestrial or aquatic cultivated species. Although the latter display a better fish-in to fish-out ratio than wild fish, they also rely on agricultural systems for their production (Tacon and Metian 2009; Fréon et al. 2010; Welch et al. 2010; Tacon et al. 2011). Such complex issues are being addressed separately by our team.

### 3.4 Discards

*Engraulis ringens* forms very large schools, with very low percentages of accompanying fauna, the most common being jellyfish (Quiñones et al. 2013). As a result, by-catch in the *anchoveta* SMS fishery, consists mostly of jellyfish and other pelagic species, of which the latter are not discarded (Fréon et al. 2014b). Discards are mostly composed of excess *anchoveta* regular captures or juveniles of this species when their abundance is counter-seasonal, representing in average 3.9% of landings in the period 2005-2011 (Torrejón et al. 2012). Despite the fact legislation demands that the artisanal fleet can only land *anchoveta* for DHC (Supreme Decree 010-2010-PRODUCE), a large percentage of their captures reach the fishmeal industry. This is either because the catch spoils before landing for DHC (*anchoveta* is very fragile, and requires delicate handling onboard) or because it is deliberately and illegally directed for reduction (Fréon et al. 2014a). In contrast, other Peruvian artisanal fisheries for DHC deal with much more scarce stocks of other species than *anchoveta*, and often feature large percentages of by-catch. For instance, by-catches of the Pacific hake fisheries feature up to 20 species of commercial value, although 3 to 6 at time. The main discard in this fishery is the so-called “pescadilla” (hake of non-exportable size, partly sold on local markets). BRU-based discard figures have been computed for the hake and *anchoveta* fisheries, and compared in Table 4.

In the post-fishery stage, according to a recent Peruvian legislative action (Supreme Decree 017-2011-PRODUCE), industries processing fish for DHC are allowed to discard up to 40% of the landings purchased or pre-purchased by the processing plant. Discards by the curing industry are often much higher, even reaching sometimes 100% of a batch (P. Echevarría, pers. comm., 03.2013).

In the post-fishery stage, according to a recent Peruvian legislative action (Supreme Decree 017-2011-PRODUCE), industries processing fish for DHC are allowed to discard up to 40% of the landings purchased or pre-purchased by the processing plant. Discards by the curing industry are often much higher, even reaching sometimes 100% of a batch (P. Echevarría, pers. comm., 03.2013).



**Table 3** Sea use indicators of the impacts of biomass removal at the species and ecosystem levels for the main Peruvian species harvested for DHC (Extreme values are highlighted in bold), including landings and fates of landings for the period 2001-2010, per landed million tonnes

| Common name        | Peruvian name       | Scientific name             | Trophic level | Landings (t) <sup>a</sup> |         | Use of landings <sup>a</sup> |          |        |        | <i>I</i> <sub>BNR,sp</sub> <sup>b</sup><br>years | <i>I</i> <sub>BNR,eco</sub><br>years |
|--------------------|---------------------|-----------------------------|---------------|---------------------------|---------|------------------------------|----------|--------|--------|--|--------------------------------------|
|                    |                     |                             |               | Total                     | DHC     | Canning                      | Freezing | Curing | Fresh  |  |                                      |
| Peruvian anchoveta | Anchoveta           | <i>Engraulis ringens</i>    | 2.7           | 5 547 772                 | 88 775  | 70 197                       | 9 099    | 9 120  | 358    | 0.2  | 21                                   |
| Pacific hake       | Merluza             | <i>Merluccius gayi</i>      | 4.3           | 36 855                    | 36 855  |                              | 28 466   | 95     | 8 294  | 27   | <b>818</b>                           |
| Horse mackerel     | Caballa             | <i>Scomber japonicus</i>    | 3.5           | 77 754                    | 77 754  | 38 655                       | 17 675   | 4 673  | 16 751 | 13   | 130                                  |
| Jack mackerel      | Jurel               | <i>Trachurus picturatus</i> | 3.5           | 158 757                   | 158 757 | 56 948                       | 17 717   | 2 233  | 81 858 | 6  | 130                                  |
| Jumbo squid        | Pota                | <i>Dosidicus gigas</i>      | 4.2           | 435 379                   | 435 379 | 1509                         | 382 424  |        | 51 407 | 2  | <b>650</b>                           |
| Mahi-mahi          | Perico              | <i>Coryphaena hippurus</i>  | 4.4           | 45 815                    | 40 958  |                              | 14 111   |        | 26 847 | 22   | <b>1030</b>                          |
| Bigeye tuna        | Atún ojo grande     | <i>Thunnus obesus</i>       | 4.5           | 206                       | 203     | 177                          | 25       |        |        | <b>4 848</b>                                     | 101                                  |
| Skipjack tuna      | Barrilete           | <i>Katsuwonus pelamis</i>   | 3.8           | 5 020                     | 4 928   | 4 312                        | 617      |        |        | 199  | 20                                   |
| Yellowfin tuna     | Atún aleta amarilla | <i>Thunnus albacares</i>    | 4.3           | 825                       | 810     | 709                          | 101      |        |        | <b>1212</b>                                      | 64                                   |

<sup>a</sup> Average values for 2006-2010, from PRODUCE statistics (PRODUCE 2012a). <sup>b</sup> Average total catch was used for calculation, because maximum sustainable yield (MSY).

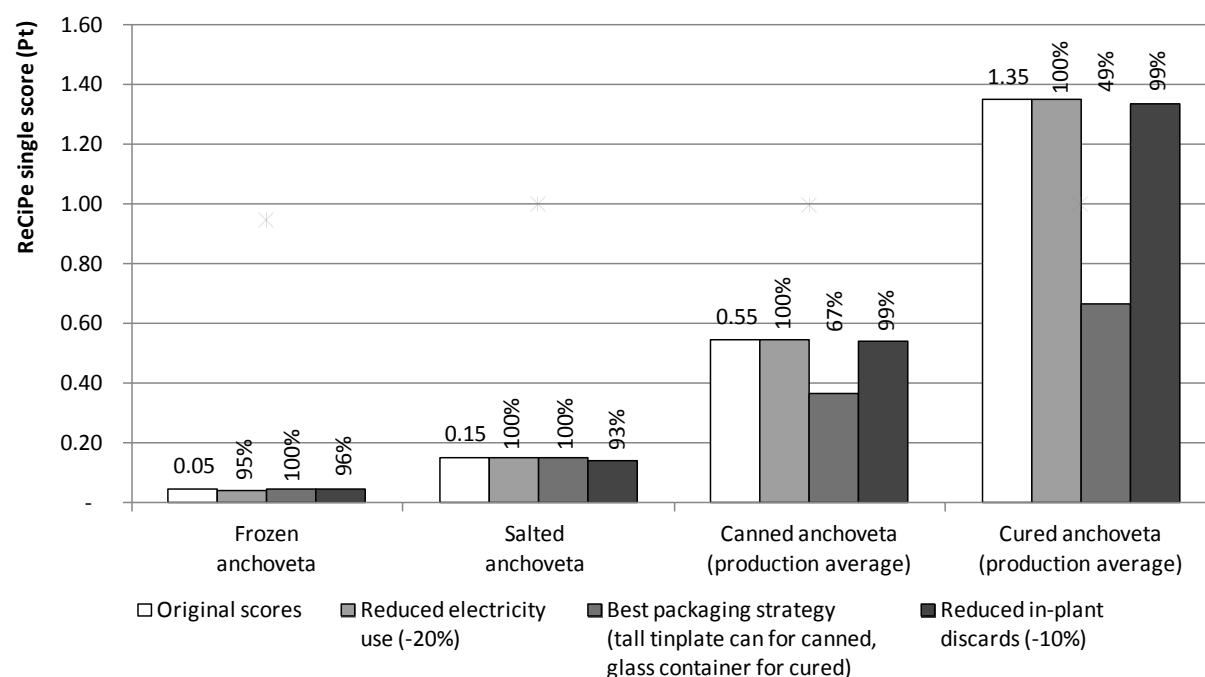
Estimations were not available, and in Peru most stocks are fully or over-exploited (notably hake), landings exceed official quotas and unreported landings are common.

**Supporting data.** Primary productivity: 1643 g C m<sup>-2</sup>yr<sup>-1</sup> for the Northern Humboldt Current System (165 000 km<sup>2</sup>), 1387 g C m<sup>-2</sup>yr<sup>-1</sup> for the Humboldt Current Large Marine Ecosystem (2.5 million km<sup>2</sup>) (Carr and Kearns 2003; Tam et al. 2008).

**Table 4** Biotic Resource Use (BRU) of discards (including by-catch) from the *anchoveta* and other Peruvian DHC fisheries

| Fishery                          | BRU discards              |                           | BRU by-catch              |                           | Composition of by-catch and discards<br>[trophic level <sup>b</sup> of species used for BRU calculation]   | Sources                                       |
|----------------------------------|---------------------------|---------------------------|---------------------------|---------------------------|--|---|
|                                  | (g C/kg, [% of discards]) | (g C/kg, [% of by-catch]) | (g C/kg, [% of by-catch]) | (g C/kg, [% of by-catch]) |  |   |
| Anchoveta for DHC                | 217                       | [3.9%]                    | N/A                       | N/A                       | <i>Engraulis ringens</i> [2.7]   | Torrejón et al. (2012)                        |
| Horse mackerel and Jack mackerel | 562                       | [1.6%]                    | N/A                       | N/A                       | Non-target small pelagics including target species juveniles [3.5], jellyfish, other species juveniles and small quantities of sharks.   | Kelleher (2005)                               |
| Jumbo squid                      | 176                       | [0.1%]                    | N/A                       | N/A                       | Mainly blue shark ( <i>Prionace glauca</i> ) [4.2]   | Kelleher (2005)                               |
| Mahi-mahi                        | 13,207                    | [1%]                      | 82,547                    | [6.3%]                    | Mainly <i>Prionace glauca</i> [4.2]  | Kelleher (2005), Gilman et al. (2008)         |
| Pacific hake <sup>a</sup>        | 30,594                    | [15%]                     | 10,118                    | [6%]                      | 2007-2010: Pacific drum ( <i>Larimus pacificus</i> ) [5.2], jumbo squid ( <i>Dosidicus gigas</i> ) [4.2], Sharptooth smooth-hound ( <i>Mustelus dorsalis</i> ) [5.1], "pescadilla" or hake juveniles [3.5, lower limit of hake's trophic level]. Different species reported in 2012. | CeDePesca (2010), IMARPE (2008), Salas (2012) |
| Tuna (longline)                  | 51,069                    | [29%]                     | N/A                       | N/A                       | Mainly <i>Prionace glauca</i> [4.2]  | Kelleher (2005)                               |
| Tuna (purse seiner)              | 17,920                    | [5.1%]                    | N/A                       | N/A                       | Non-commercial tunas such as bonito ( <i>Sarda chiliensis</i> ) [4.5], dogtooth tuna; rainbow runner, dolphinfish, jacks, shark, billfish, mantas and undersized skipjack and yellowfin, dolphins.   | Kelleher (2005)                               |

<sup>a</sup> Discard percentage includes 20% of the by-catch fraction which consists of non-commercial species and individuals (CeDePesca, 2010; IMARPE, 2008). Average annual by-catch rate for 2005-2012 (IMARPE, unpublished data). <sup>b</sup> All trophic levels taken from Froese and Pauly (2011).



**Fig. 8** Performance changes in response to process changes for all studied products, per kg of fish in product

### 3.5 Alternative scenarios and sensitivity analysis

A number of hotspots in the DHC processing were identified, yet different ones for the various DHC processes (Fig. 6a): raw fish and electricity for frozen products, salt (brine) and raw fish for salted products, packaging for canned products, and packaging and brine for cured products. Therefore sensitivity to those factors was tested, and these scenarios represent alternative productions. By comparing the reference situation with scenarios featuring either a reduced electricity use (for instance as a result of shorter storage in cold and eco-efficiency measures), the best packaging strategy for canned and cured products, and reduced in-plant discards; environmental performance improvements are quantified using ReCiPe single scores (Fig. 8). Performance changes are minor for all cases, except for canned and cured products regarding the best available packaging materials (in agreement with Zufia and Arana (2008) findings) and sizes. Reduction in electricity use and of in-plant discards entail minor overall performance improvements due to the relatively low importance of these factors in environmental performance, which is dominated by packaging (canned and cured products) and fisheries (all other products).

The dominance of packaging impact over fishing in canned product cannot be generalised to other fisheries. For instance Zufia and Arana (2008) found that the fishery impact was always largely dominant (from 67 to 87%) in eight mid-point impact categories of canned tuna with tomato, although the retained system boundary was larger than our due to the inclusion of home cooking and waste disposal. Once more this result is due to the higher fishing performance of the Peruvian *anchoveta* fisheries, here compared with an offshore species or group of species (not indicated), probably by a distant purse seiner fleet. In contrast, Vázquez-Rowe et al. (2014) obtained results similar to ours on another small pelagic species (the sardine *Sardina pilchardus*) caught by the Galician purse seiners. Although the system

boundary of sardine products was larger than ours, including human consumption and excretion, Vázquez-Rowe et al. (2014) found that the contribution of the canning process itself in the LCA of for most of Galician sardine products was dominating in most of the 18 ReCiPe midpoint indicators. When it was not dominating (terrestrial ecotoxicology and water depletion) this was due to the contribution of olive oil used in the product. Furthermore, single score of fried and grilled sardine impacted respectively ~20 and ~12 times more than canned sardine, a result that compares well with our values of ~19 for the single score ratio of canned anchovy to fresh anchovy including existing distribution chains (Galician products were considered transported over a mean distance of 35 km, versus 50 km in our case).

In order to keep *anchoveta* at a DHC quality level, vessels must insulate their holds and carry ice, practically reducing their holding capacity by at least 30%. In practice, only a small percentage of SMS vessels feature insulated holds or carry enough ice as to guarantee fish preservation to DHC quality. A scenario where chilled and frozen anchovy would replace more expensive and less environmentally friendly canned and salted product seems promising. These topics are further analysed in Fréon et al. (2014a; 2014b) and Avadí et al. (2014) and lead to some recommendations expressed below.

## 4 Recommendations

Several aspects of legislation and management could be modified to improve environmental performance of DHC industries, and to promote and support and increase in the consumption of DHC products, especially in the highlands. Some of these aspects are discussed here.

The fact that any DHC industry is allowed to discard up to 40% of the landings purchased by the processing plant is clearly counterproductive. Such a fixed ratio does not represent the operative features of different processing industries. For instance, freezing and canning have much more tolerance than curing to fluctuations

in freshness, individual sizes, and other raw material quality factors (P. Echevarría, pers. comm., 03.2013). Tolerances should be adjusted to the technical realities of the different industries. Moreover, legislation and enforcement should better make sure that vessels legally allowed to land anchoveta for DHC feature the required hull insulation and have access to the volumes of ice required for maintaining DHC quality.

A more radical measure would be to modify the dual regimes governing industrial and SMS fisheries, in which the former may land only for IHC and the latter for DHC. Fréon et al. (2014a) suggested that all vessels should be allowed to land to either IHC or DHC, betting that big companies would not only be able to control the sanitary conditions of fishing and landings, but also would be able and encouraged to develop marketing mechanisms to push forward consumption of DHC products. The SMS fleet, in the other hand, would benefit from legal access to the IHC market. This measure is likely to decrease the proportion of *anchoveta* discards from the DHC industry, and the proportion of anchoveta caught for IHC that ends up in residual fishmeal plants.

A national cold distribution chain for fresh/chilled/frozen fish should be favoured in case it is socio-economically and environmentally positive, and relevant for the communities to be served by it. The potential market for fish in the highland regions must be studied because it is currently underserved or provided by means of heavily environmentally burdened air shipping. Moreover, vulnerable communities should have access to more and cheaper fish products than canned ones to enhance their diets.

## 5 Conclusions

Limitations in the scope of the presented assessment are due to inherent limitations of LCA in relation to fisheries, such as the lack of standardised fisheries-specific impact categories, the lack of characterisation of the impacts of certain substances released to the environment

(oils, some antifouling substances), etc. (Vázquez-Rowe et al. 2012a; Avadí and Fréon 2013). In order to partly overcome the lack of standardised fisheries-specific impact categories we presented here quantitative indices of biotic use, sea use and discard.

For the DHC *anchoveta* industries, it is possible to conclude that less energy-intensive industries (freezing and salting - less refined, plastics-packaged products) are 4 to 27 times less environmentally impacting than the more energy-intensive industries (canning and curing - more refined, metal and glass-packaged products). Yet, given the underlying motivation of distributing nutritious *anchoveta* products to vulnerable and often remote communities without proper cold chain, the transportation and storage needs of all these alternative products must be taken into account. For instance, salted and canned products require no cold storage, while chilled and frozen products do. Refrigerated transportation of fresh and frozen fish over long distances and with long storage produces higher environmental impacts than regular. The additional impacts of those activities do not eliminate the environmental advantage of fresh and frozen products over canned products, yet leaving salted fish as the less environmentally burdened. Moreover, consumer preferences also would play a role in the selection of products to promote (e.g. there is no tradition in Peru of consuming cured fish other than salt-preserved, and that is mainly in the highlands), and relative nutritional value may vary among these products. This issue is addressed in ongoing work by our team.

A possible way to soundly improve the environmental performance of canned and cured products would be to prefer less impacting packaging materials (e.g. glass over metal, tins over aluminium) and larger formats (i.e. more edible product per amount of packaging material). Nonetheless, the impact of such changes on acceptance by customers must be evaluated prior to decision-making regarding alternative packaging. Cleaner production-related measures,

such as diminishing discards and residues, or reducing electricity consumption; only slightly improves the environmental performance of studied products.

In conclusion, an environmental assessment alone does not provide sufficient information for decision makers to decide promoting a subset of alternative products. We suggest a more comprehensive sustainability assessment, including nutritional and socio-economic indicators, should be performed to compare *anchoveta* and other seafood DHC products.

### Acknowledgements

This work, carried out by a member of the Anchoveta Supply Chain (ANCHOVETA-SC) project (<http://anchoveta-sc.wikispaces.com>) is a contribution to the International Joint Laboratory “Dynamics of the Humboldt Current system” (LMI-DISCOH) coordinated by the Institut de Recherche pour le Développement (IRD) and the Instituto del Mar del Peru (IMARPE), and gathering several other institutions. It was carried out under the sponsoring of the Direction des Programmes de Recherche et de la formation au Sud (DPF) of the IRD. We acknowledge Francisco Miro, Alberto Salas (ITP) and Pablo Echevarría (Compañía Americana de Conservas SAC) for their support in data gathering.

### References

Avadí A, Fréon P (2013) Life cycle assessment of fisheries: A review for fisheries scientists and managers. *Fish Res* 143:21–38.

Avadí A, Fréon P (2014) A set of sustainability performance indicators for seafood: direct human consumption products from Peruvian anchoveta fisheries and freshwater aquaculture. *Ecol Indic* (in review).

Avadí A, Vázquez-Rowe I, Fréon P (2014) Eco-efficiency assessment of Peruvian anchoveta steel and wooden fleets using the LCA+DEA framework. *J Clean Prod*. doi:10.1016/j.jclepro.2014.01.047

Barros MC, Magán a., Valiño S, et al. (2009) Identification of best available techniques in the

seafood industry: a case study. *J Clean Prod* 17:391–399.

Boissy J, Aubin J, Drissi A, et al. (2011) Environmental impacts of plant-based salmonid diets at feed and farm scales. *Aquaculture* 321:61–70.

Bugallo PMB, Andrade LC, Iglesias a. M, López RT (2013) Integrated Environmental Permit through Best Available Techniques: evaluation of the fish and seafood canning industry. *J. Clean. Prod.* in press:10.1016/j.jclepro.2012.12.022

Carr M-E, Kearns EJ (2003) Production regimes in four Eastern Boundary Current systems. *Deep Sea Res Part II Top Stud Oceanogr* 50:3199–3221.

CeDePesca (2010) Merluza peruana *Merluccius gayi* peruanus. Ficha Técnica de la Pesquería (Peruvian hake *Merluccius gayi* peruanus. Technical sheet of the fishery). 1–23.

Cristóvão RO, Botelho CMS, Martins RJE, Boaventura R a. R (2012) Chemical and Biological Treatment of Fish Canning Wastewaters. *Int. J. Biosci. Biochem. Bioinforma.* 2:10.7763/IJBBB.2012.V2.108

CSA-UPCH (2012) Come Anchoveta (Eat Anchoveta). <http://www.anchoveta.info/>.

De la Puente O, Sueiro JC, Heck C, et al. (2011) La Pesquería Peruana de Anchoveta - Evaluación de los sistemas de gestión pesquera en el marco de la certificación a cargo del Marine Stewardship Council (The Peruvian anchoveta fishery - Assessment of the fishery management systems in the framework of th. Doc Trab del Cent para la Sostenibilidad Ambient la UPCH 160.

Del Carpio L, Vila B (2010) El mercado de productos pesqueros en la Región Metropolitana de Lima (The market of fish products in the Lima Metropolitan Region). <http://www.infopesca.org/sites/default/files/complemento/publibreacceso/286/informe-lima.pdf>, Montevideo: INFOPESCA

Ecoinvent (2012) The ecoinvent Centre portal. <http://www.ecoinvent.ch/>.

FAO (1994) Informes nacionales y documentos seleccionados presentados en la cuarta reunión del Grupo de Trabajo sobre Tecnología Pesquera. Cartagena, Colombia, 25–31 de mayo de 1992. In: FAO

- Inf. Pesca No. 476, Supl. <http://www.fao.org/docrep/008/t4460s/t4460s00.htm>.
- FAO (2000) FAO - Perfiles nutricionales por países - Peru (FAO - Nutritional profiles by country - Peru). <http://www.bvsde.paho.org/texcom/nutricion/permap.pdf>, Rome: Food and Agriculture Organisation of the United Nations
- FAO (2011) Country Profile: Food Security Indicators. Country: Peru. [http://www.fao.org/fileadmin/templates/ess/documents/food\\_security\\_statistics/country\\_profiles/eng/Peru\\_E.pdf](http://www.fao.org/fileadmin/templates/ess/documents/food_security_statistics/country_profiles/eng/Peru_E.pdf)
- Foster C, Green K, Bleda M, et al. (2006) Environmental Impacts of Food Production and Consumption: A report to the Department for Environment, Food and Rural Affairs. London: Manchester Business School. Defra
- Fréon P, Avadí A, Marín W, Negrón R (2014b) Environmentally-extended comparison table of large- vs. small- and medium-scale fisheries: the case of the Peruvian anchoveta fleet. *Can J of Fish Aquat Sci* (in review).
- Fréon P, Avadí A, Vinatea RA, Iriarte F (2014a) Life cycle assessment of the Peruvian industrial anchoveta fleet: boundary setting in life cycle inventory analyses of complex and plural means of production. *Int J Life Cycle Assess*. doi:10.1007/s11367-014-0716-3
- Fréon P, Bouchon M, Domalain G, et al. (2010) Impacts of the Peruvian anchoveta supply chains: from wild fish in the water to protein on the plate. *GLOBEC Int Newsl* 27–31.
- Fréon, P, Sueiro, JC, Sigbjorn, T, Iriarte, F, Miro, O, Landa, Y, Mittaine, J-F, Bouchón, M (2013) Harvesting for food versus feed: the paradoxical case of the Peruvian fisheries? *Rev Fish Biol Fisheries*. doi: 10.1007/s11160-013-9336-4.
- Fricke B, Becker B (2010) Energy Use of Doored and Open Vertical Refrigerated Display Cases. *Int. Refrig. Air Cond. Conf. Pap.* 1154
- Froese R, Pauly D (2011) FishBase: *Engraulis ringens*. <http://www.fishbase.org/summary/Engraulis-ringens.html>.
- GESTEC (2006) Declaración de impacto ambiental Planta de congelados de pescado SPK Coronel Sur (Environmental Impact Declaration - Frozen fish plant SPK Coronel Sur). 1–49.
- Gilman E, Clarke S, Brothers N, et al. (2008) Shark interactions in pelagic longline fisheries. *Mar Policy* 32:1–18.
- Goedkoop M, Heijungs R, Huijbregts M, et al. (2009) ReCiPe 2008. A life cycle impact assessment method which comprises harmonised category indicators at the midpoint and the endpoint level. Report I: Characterisation. [www.lcia-recipe.info](http://www.lcia-recipe.info), Ministry of Housing, Spatial Planning and Environment (VROM)
- Goedkoop M, Heijungs R, Huijbregts M, et al. (2013) ReCiPe 2008. A life cycle impact assessment method which comprises harmonised category indicators at the midpoint and the endpoint level. Report I: Characterisation. Ministry of Housing, Spatial Planning and Environment (VROM)
- Goedkoop M, Spriensma R (2001) The Eco-indicator 99 - A damage oriented method for Life Cycle Impact Assessment - Methodology Annex. Assessment 144.
- Guinée JB, Gorrée M, Heijungs R, et al. (2002) Handbook on life cycle assessment. Operational guide to the ISO standards. I: LCA in perspective. IIa: Guide. IIb: Operational annex. III: Scientific background. 692.
- Henriksson PJG, Guinée JB, Kleijn R, Snoo GR (2011) Life cycle assessment of aquaculture systems—a review of methodologies. *Int J Life Cycle Assess* 17:304–313.
- Hischier R, Weidema BP, Althaus H, et al. (2010) Implementation of Life Cycle Impact Assessment Methods. *ecoinvent report No. 3 (v2.2)*. Dübendorf: Swiss Centre for Life Cycle Inventories
- Hospido A, Vazquez M, Cuevas A, et al. (2006) Environmental assessment of canned tuna manufacture with a life-cycle perspective. *Resour Conserv Recycl* 47:56–72.
- Hückstädt L a., Rojas CP, Antezana T (2007) Stable isotope analysis reveals pelagic foraging by the Southern sea lion in central Chile. *J Exp Mar Bio Ecol* 347:123–133.
- IFPRI (2006) The Challenge of Hunger. Global Hunger Index: Facts, determinants and trends. [http://www.ifpri.org/sites/default/files/publications/gh\\_i06.pdf](http://www.ifpri.org/sites/default/files/publications/gh_i06.pdf), Bonn / Washington: International Food Policy

- Research Institute (IFPRI) and Deutsche Welthungerhilfe (DWHH)
- IFPRI (2012) 2012 Global hunger index: the challenge of hunger: Ensuring sustainable food security under land, water, and energy stresses. <http://www.ifpri.org/sites/default/files/publications/ghi12.pdf>, Bonn / Washington, DC / Dublin: International Food Policy Research Institute (IFPRI), Concern Worldwide and Welthungerhilfe and Green Scenery
- IMARPE (2008) La pesquería de merluza en el mar peruano: Régimen Provisional de Pesca 2007 (The hake fisheries in the Peruvian sea: Provisional fisheries regime 2007). [http://www.imarpe.gob.pe/imarpe/archivos/informes/imarpe\\_13\\_la\\_pesqueria\\_de\\_la\\_merluza\\_web.pdf](http://www.imarpe.gob.pe/imarpe/archivos/informes/imarpe_13_la_pesqueria_de_la_merluza_web.pdf), Lima: Instituto del Mar del Perú
- INEI (2011) Encuesta Demográfica y de Salud Familiar 2011 (Demographic and family health survey 2011). <http://proyectos.inei.gob.pe/endes/2011/>, Lima: Instituto Nacional de Estadística e Informática (INEI)
- INEI (2012a) Evolución de la pobreza en el Perú al 2011 (Evolution of poverty in Peru until 2011). [http://www.inei.gob.pe/DocumentosPublicos/Pobreza\\_ExposicionJefe.pdf](http://www.inei.gob.pe/DocumentosPublicos/Pobreza_ExposicionJefe.pdf), Lima
- INEI (2012b) Perú: Compendio estadístico 2012. Pesca (Peru: Statistical compendium 2012. Fisheries). 887–916.
- INEI (2012c) Perú: Consumo per cápita de los principales alimentos 2008-2009 (Peru: Per capita consumption of main staple foods 2008-2009). <http://www.inei.gob.pe/biblioineipub/bancopub/Est/Lib1028/index.html>
- International Markets Bureau (2010) The Peruvian Consumer Behaviour - Attitudes and Perceptions toward Food Products. [http://www.gov.mb.ca/agriculture/statistics/agri-food/peru\\_consumer\\_report\\_en.pdf](http://www.gov.mb.ca/agriculture/statistics/agri-food/peru_consumer_report_en.pdf), Agriculture and Agri-Food Canada
- Iribarren D, Moreira MT, Feijoo G (2010) Life Cycle Assessment of fresh and canned mussel processing and consumption in Galicia (NW Spain). *Resour Conserv Recycl* 55:106–117.
- ISO (2006a) Environmental management – Life cycle assessment – Principles and framework (ISO 14040:2006). International Organization for Standardization (ISO)
- ISO (2006b) Environmental management – Life cycle assessment – Requirements and guidelines (ISO 14044:2006). International Organization for Standardization (ISO)
- ITP (2007) Investigación y desarrollo de productos pesqueros: Fichas técnicas (Research and development of fishery products: Technical sheets). <http://www.itp.gob.pe/documentos/fichastecnicas2007.pdf>, Lima: Instituto Tecnológico Pesquero del Perú
- ITP (2012) Instituto Tecnológico Pesquero (Institute for Fish Technology). <http://www.itp.gob.pe/webitp/>.
- Jiménez F, Gómez C (2005) Evaluación nutricional de galletas enriquecidas con diferentes niveles de harina de pescado (Nutritional evaluation of cookies enriched with various levels of fishmeal). <http://www.rpan.org/publicaciones/pv010.pdf>, Lima: Red Peruana de Alimentación y Nutrición (r-PAN)
- Jun S, Cox L, Huang A (2006) Using the flexible retort pouch to add value to agricultural products. *J Food Saf Technol*
- Kelleher K (2005) Discards in the world's marine fisheries. An update. Rome: Food and Agriculture Organisation of the United Nations
- Laguerre O, Hoang HM, Flick D (2013) Experimental investigation and modelling in the food cold chain: Thermal and quality evolution. *Trends Food Sci Technol* 29:87–97.
- Landa Y (2012) La pesca de la anchoveta, el óptimo social y el desarrollo sostenible del sector (Anchoveta fishery, the social optimum and sustainable development of the fishery sector). Universidad Nacional Agrícola La Molina (UNALM) - Universidad Nacional Autónoma de México (UNAM)
- Langlois, J., Fréon, P., Delgenes, J.-P., Steyer, J.-P., & Hélias, A. (2014). New methods for impact assessment of biotic-resource depletion in LCA of fishery: theory and application. *J Clean Prod.* doi: 10.1016/j.jclepro.2014.01.087.
- MINAG (2012) Maíz Amarillo Duro: Principales aspectos de la cadena agroproductiva (Main aspects of the maize agricultural chain). <http://agroaldia.minag.gob.pe/biblioteca/download/pd>

- f/agroeconomia/agroeconomiamazamarillo2.pdf,Lima: Ministerio de Agricultura
- OANNES (2012) Los desafíos para la zona costera peruana en el siglo 21 (Challenges for the coastal zone off Peru in the 21st century). Taller Nac Evaluación los desafíos las Zo costeras en el siglo XXI propuestas para la Cumbre la Tierra Rio+20 1–22.
- Paredes CE (2012) Eficiencia y equidad en la pesca peruana: La reforma y los derechos de pesca (Efficiency and equity in Peruvian fisheries: Reform and fishing rights). Lima: Instituto del Perú
- Paredes CE (2013) ¿Crecer para qué? Gestión
- Parker R (2012) Review of life cycle assessment research on products derived from fisheries and aquaculture: A report for Seafish as part of the collective action to address greenhouse gas emissions in seafood. Final Report. [http://www.seafish.org/media/583639/seafish\\_lca\\_review\\_report\\_final.pdf](http://www.seafish.org/media/583639/seafish_lca_review_report_final.pdf),Edinburgh: Sea Fish Industry Authority
- Pauly D, Christensen V (1995) Primary production required to sustain global fisheries. *Nature* 374:255–257.
- PENX (2004) Perú: Plan Estratégico Nacional Exportador 2003-2013. Plan Operativo Exportador Pesca y Acuicultura. [http://www.mincetur.gob.pe/comercio/OTROS/bid/pdfs/POS\\_Pesca\\_y\\_acuicultura\\_1.pdf](http://www.mincetur.gob.pe/comercio/OTROS/bid/pdfs/POS_Pesca_y_acuicultura_1.pdf),Lima: Ministerio de Comercio Exterior y Turismo
- Poovarodom N (2012) Comparative Carbon Footprint of Packaging Systems for Tuna Products. *Packag Technol Sci* 25:249–257.
- PRé (2012) SimaPro by Pré Consultants. <http://www.pre-sustainability.com/content/simapro-lca-software/>.
- PRODUCE (2012a) Ministry of Production - Fisheries statistics.
- PRODUCE (2012b) PESEM 2012-2016: Plan estratégico sectorial multianual del sector producción. Lima: Ministerio de la Producción
- PROMPERU (2010) Desarrollo del comercio exterior pesquero en el Perú 2010. <http://www.siiicex.gob.pe/siiicex/resources/sectoresproductivos/283857330rad5545C.pdf>,Coordinación de Pesca y Acuicultura de la Subdirección de Promoción Comercial
- PROMPERU (2011) Desarrollo del comercio exterior pesquero en el Perú 2011. *Serv al Export* 1–26.
- Quiñones J, Monroy A, Acha EM, Mianzan H (2013) Jellyfish bycatch diminishes profit in an anchovy fishery off Peru. *Fish Res* 139:47–50.
- Rokovich JA (2009) Estudios para el desarrollo de clusters en la actividad pesquera industrial y artesanal de anchoveta y pota - Informe final. Lima: ICON- INSTITUT GmbH
- Rosenbaum RK, Bachmann TM, Gold LS, et al. (2008) USEtox—the UNEP-SETAC toxicity model: recommended characterisation factors for human toxicity and freshwater ecotoxicity in life cycle impact assessment. *Int J Life Cycle Assess* 13:532–546.
- Salas LAI (2012) Situación del Recurso Merluza al Verano de 2012. Informe Final (Situation of hake as of summer 2012. Final Report). [http://tarwi.lamolina.edu.pe/licochea/merluza/informe\\_merluza\\_4\\_abril\\_2012\\_final.pdf](http://tarwi.lamolina.edu.pe/licochea/merluza/informe_merluza_4_abril_2012_final.pdf),Lima: Universidad Nacional Agraria La Molina
- Sánchez N, Gallo M (2009) Status of and trends in the use of small pelagic fish species for reduction fisheries and for human consumption in Peru. In: Hasan M, Halwart M (eds) *Fish as Feed inputs Aquac. Pract. Sustain. Implic.* FAO Fish. Aquac. Tech. Pap. No. 518. pp 325–369
- Sanguinetti LEC (2009) La comercialización en primera venta de los productos de la pesca marítima artesanal en el Perú: Problemática y plan de mejoras. 1–62.
- Sanguinetti LEC (2010a) Estudio de Mercado de Productos Pesqueros Artesanales en seis regiones del Perú: Lambayeque - San José. [http://compralealperu.gob.pe/RepositorioAPS/3/jer/1/estudios-de-mercado/estudio\\_de\\_Mercado\\_de\\_Productos\\_Pesqueros\\_en\\_seis\\_regiones\\_de.pdf](http://compralealperu.gob.pe/RepositorioAPS/3/jer/1/estudios-de-mercado/estudio_de_Mercado_de_Productos_Pesqueros_en_seis_regiones_de.pdf),CETMAR - PRODUCE - DGPA - PEPA
- Sanguinetti LEC (2010b) Estudio de Mercado de Productos Pesqueros Artesanales en seis regiones del Perú: La Libertad - Salaverry. [http://compralealperu.gob.pe/RepositorioAPS/3/jer/1/estudios-de-mercado/Estudio\\_de\\_Mercado\\_de](http://compralealperu.gob.pe/RepositorioAPS/3/jer/1/estudios-de-mercado/Estudio_de_Mercado_de)

- Productos Pesqueros en seis Regiones d.pdf,CETMAR - PRODUCE - DGPA - PEPA
- Sanguinetti LEC (2010c) Estudio de Mercado de Productos Pesqueros Artesanales en seis regiones del Perú: Lima - Chancay. [http://compralealperu.gob.pe/RepositorioAPS/3/jer/-1/estudios-de-mercado/Estudio de Mercado de Productos Pesqueros en seis Region \(1\).pdf](http://compralealperu.gob.pe/RepositorioAPS/3/jer/-1/estudios-de-mercado/Estudio de Mercado de Productos Pesqueros en seis Region (1).pdf),CETMAR - PRODUCE - DGPA - PEPA
- Sanguinetti LEC (2010d) Estudio de Mercado de Productos Pesqueros Artesanales en seis regiones del Perú: Tumbes - Puerto Pizarro. [http://compralealperu.gob.pe/RepositorioAPS/3/jer/-1/estudios-de-mercado/Estudio de Mercado de Productos Pesqueros en seis Region \(2\).pdf](http://compralealperu.gob.pe/RepositorioAPS/3/jer/-1/estudios-de-mercado/Estudio de Mercado de Productos Pesqueros en seis Region (2).pdf),CETMAR - PRODUCE - DGPA - PEPA
- SOFIA (2012) The State of World Fisheries and Aquaculture 2012. 209.
- Sueiro J (2006) Pesca y seguridad alimentaria: el abastecimiento del pescado fresco en el Perú. <http://www.bvcooperacion.pe/biblioteca/bitstream/123456789/5413/1/BVCI0005186.pdf>,Lima: Colectivo Internacional en Apoyo al Pescador Artesanal (CIAPA)
- Tacon A, Hasan M, Metian M (2011) Demand and supply of feed ingredients for farmed fish and crustaceans: trends and prospects. FAO Fish Aquac Tech Pap No 564 87.
- Tacon A, Metian M (2009) Fishing for Aquaculture: Non-Food Use of Small Pelagic Forage Fish—A Global Perspective. *Rev Fish Sci* 17:305–317. doi: 10.1080/10641260802677074
- Tam J, Taylor MH, Blaskovic V, et al. (2008) Trophic modeling of the Northern Humboldt Current Ecosystem, Part I: Comparing trophic linkages under La Niña and El Niño conditions. *Prog Oceanogr* 79:352–365.
- TASA (2010) Sustainability Report 2010. Lima: Tecnológica de Alimentos S.A.
- Tassou S a., De-Lille G, Ge YT (2009) Food transport refrigeration – Approaches to reduce energy consumption and environmental impacts of road transport. *Appl Therm Eng* 29:1467–1477.
- Thrane M, Nielsen EH, Christensen P (2009) Cleaner production in Danish fish processing – experiences, status and possible future strategies. *J Clean Prod* 17:380–390.
- Torrejón J, Díaz E, Limache J (2012) Descarte por exceso de captura en la pesquería del stock norte-centro de la anchoveta peruana (*Engraulis ringens* J.) entre el 2005 – 2011 (Discard due to excess captures in the North-Center stock of the Peruvian anchoveta fishery between 2005 and 2011). In: Indacochea A (ed) III CONCIMAR Congr. Ciencias del Mar del Perú, Libr. resúmenes Digit. Universidad Científica del Sur, Facultad de Biología Marina y Econegocios, Lima: 25 al 29 de Junio, p 361
- Van Zelm R, Huijbregts M a. J, Meent D (2009) USES-LCA 2.0—a global nested multi-media fate, exposure, and effects model. *Int J Life Cycle Assess* 14:282–284.
- Vázquez-Rowe I, Hospido A, Moreira MT, Feijoo G (2012a) Best practices in life cycle assessment implementation in fisheries. Improving and broadening environmental assessment for seafood production systems. *Trends Food Sci Technol* 28:116–131.
- Vázquez-Rowe I, Moreira MT, Feijoo G (2012b) Inclusion of discard assessment indicators in fisheries life cycle assessment studies. Expanding the use of fishery-specific impact categories. *Int. J. Life Cycle Assess*. 10.1007/s11367-012-0395-x
- Vázquez-Rowe I, Villanueva-Rey P, Hospido A, Moreira M T, & Feijoo G (2014) Life cycle assessment of European pilchard (*Sardina pilchardus*) consumption. A case study for Galicia (NW Spain). *Sci Total Environ*, 475, 48–60. doi:10.1016/j.scitotenv.2013.12.099
- VDI (1997) Cumulative Energy Demand - Terms, Definitions, Methods of Calculation. Düsseldorf: Verein Deutscher Ingenieure
- Welch A, Hoenig R, Stieglitz J, et al. (2010) From Fishing to the Sustainable Farming of Carnivorous Marine Finfish. *Rev Fish Sci* 18:235–247. doi: 10.1080/10641262.2010.504865
- Ziegler F, Nilsson P, Mattsson B, Walther Y (2003) Life cycle assessment of frozen cod fillets including fishery-specific environmental impacts. *Int J Life Cycle Assess* 8:39–47.
- Zufía J, Arana L (2008) Life cycle assessment to eco-design food products: industrial cooked dish case study. *J Clean Prod* 16:1915–1921.



## 4.3 Comprehensive characterisation and sustainability assessment

### 4.3.1 Paper 6: A set of sustainability performance indicators for seafood: direct human consumption products from Peruvian anchoveta fisheries and freshwater aquaculture

Paper proposing a set of sustainability indicators for analysing the Peruvian anchoveta supply chains for direct human consumption products, from anchoveta fisheries and freshwater aquaculture, to be published in Ecological Indicators (Avadí and Fréon, 2014).

|  |                           |
|--|---------------------------|
| Paper idea and design                            | Angel Avadí               |
| Experiment design                                | Angel Avadí, Pierre Fréon |
| Data collection                                  | Angel Avadí, Pierre Fréon |
| Data processing, statistical analysis, modelling | Angel Avadí               |
| Discussion                                       | Angel Avadí, Pierre Fréon |
| Writing and editorial                            | Angel Avadí, Pierre Fréon |

### A set of sustainability performance indicators for seafood: direct human consumption products from Peruvian anchoveta fisheries and freshwater aquaculture

Angel Avadí<sup>a,b,\*</sup>, Pierre Fréon<sup>b</sup>

<sup>a</sup> Université Montpellier 2 – Sciences et Techniques, 2 Place Eugène Bataillon, 34095 Montpellier Cedex 5, France.

<sup>b</sup> UMR 212 EME, Institut de recherche pour le développement (IRD). Centre de Recherche Halieutique Méditerranéenne et Tropicale, Avenue Jean Monnet CS 30171, 34203 SETE cedex. France.

\* Corresponding author

#### Abstract

Different seafood products based on Peruvian *anchoveta* (*Engraulis ringens*) fisheries and freshwater aquaculture of trout (*Oncorhynchus mykiss*), tilapia (*Oreochromis* spp.) and black pacu (*Colossoma macropomum*), contribute at different scales to socio-economic development, environmental degradation and nutrition of the national population. Various indicators have been used in literature to assess performance of those industries regarding different aspects of sustainability, notably regarding socio-economic performance. In this study, a novel set of indicators is proposed to evaluate the sustainability performance of those industries in Peru, based on Life Cycle Assessment (LCA) and nutritional profiling, as well as on energy and socio-economic assessment approaches. The emphasis lies on the potential of different products to contribute in an energy-efficient, environmentally friendly and socio-economically sound way to improve nutrition of the Peruvian population. The indicator set includes Biotic Resource Use (BRU), Cumulative Energy Demand (CED), Energy Return on Investment (EROI), production costs, gross profit generation, added value, and nutritional profile in terms of vitamins, minerals and essential fatty acids; as well as a number of life cycle impact assessment indicators commonly used in seafood studies and recently proposed sea use indicators (measuring the impacts of fish biomass removal at the species and ecosystem levels). Results suggest that, in environmental terms, more energy-intensive/highly processed products (cured and canned *anchoveta*

products) represent a higher burden than less energy-intensive products (salted and frozen *anchoveta* products, semi-intensive aquaculture products). This trend is confirmed when comparing all products regarding their industrial-to-nutritional energy ratio. Regarding the other dimensions analysed, the scoring is opposite (salted and frozen *anchoveta* products generate fewer jobs and lower gross profit than canned and cured) except for aquaculture products, which are the best performing ones. Overall, it was concluded that less energy-intensive industries (*anchoveta* freezing and salting) are the least environmentally impacting but also the least economically interesting products, yet delivering higher nutritional value. Aquaculture products maximise gross profit and job creation, with lower energy efficiency and nutritional values. The proposed sustainability indicator set fulfilled its goal of providing a multi-criteria overview of alternative *anchoveta* direct human consumption and freshwater aquaculture products. As often the case, there is no ideal product and the best trade-off must be sought when making decision regarding fisheries and seafood policy.

Keywords: employment; gross profit; Life Cycle Assessment; nutrition; seafood industry; sustainability assessment

## 1 Introduction

Seafood systems represent an important source of protein and other nutrients, especially to coastal populations worldwide. A variety of processing methods and products has been developed, ranging from fresh fish to energy-intensive canned or cured seafood products. These products exert different pressures on the environment and society, while producing different socio-economic benefits. Sustainability assessment of seafood systems has been addressed by means of certification mechanisms and eco-labels, life cycle approaches, economic and bio-economic analysis and modelling, indicator systems, etc (e.g. Ayer and Tyedmers, 2009; Kruse et al., 2008; Leadbitter and Ward, 2007; McCausland et al., 2006; Samuel-Fitwi et al., 2012). We believe it is necessary to combine approaches and take into consideration the supply chain, management, environmental, energy, socio-economic and nutritional features of the studied systems in order for sustainability to be comprehensively assessed.

Sustainability indicators can be defined as variables or combinations of variables collected/computed and treated with a well-defined analytical or policy goal, and for which certain values are significant in the context of the analysed system. Indicators are expected to

feature certain traits, namely (Pingault and Préault, 2007; Roth, 2002): pertinence, reliability (i.e. scientifically backed), operability (easy to update and communicate), legitimacy (i.e. accepted use, appropriation by stakeholders), interpretability (easy to understand), genericity (i.e. allowing comparison at various spatio-temporal scales), and defined in a finite interval (e.g. 1-5, A-D, etc). Indicators can be organised within an indicator system or dashboard when several of them are required (Halog and Manik, 2011; Shin and Shannon, 2010). For Joerin et al. (2005) and Balestrat et al. (2010) modelling is often necessary to build a system of indicators, for a model allows to organise the indicators into a coherent whole. A number of knowledge and politically-driven indicator development frameworks have been proposed and adopted by leading international organisations (reviews in Bowen and Riley, 2003; Rametsteiner et al., 2011; Singh et al., 2009).

We propose a novel set of sustainability performance indicators (SPIs) addressing the three conventional pillars of sustainability (environment, society and economics). It is mainly based on Life Cycle Assessment (LCA) and additional nutritional, energy and socio-economic assessment approaches to evaluate anchoveta (*Engraulis ringens*) direct human consumption (DHC) and

freshwater aquaculture products in Peru. Finally, we use the results of such assessment to suggest directions for further sustainable development of those industries.

A large percentage of the Peruvian population, notably in remote Andean areas, suffers malnourishment, including iron and vitamin deficiency (FAO, 2011; FAO, 2000; INEI, 2011). Annual per capita edible fish consumption in Peru was estimated in between 4.2 and 11.2 (up to

22.5 kg in whole fish equivalents, in the period 2005-2011), being much higher in the coastal and Amazonian regions than in the Andean region (INEI, 2012a). These mean values rank Peru, according to FAOSTAT, as the 61th country in fish and seafood consumption worldwide, whereas it is the second fishing country (first when only catches in national waters are considered). The main types of fish products consumed in Peru are listed in Table 1.

**Table 1** Consumption patterns of fish products in Peru (2005-2011)

| Product             | Consumption <sup>a</sup><br>(kg·person <sup>-1</sup> ·y <sup>-1</sup> ) |      |      |      | Area of consumption | Main species                                   |
|---------------------|---|------|------|------|---------------------|--|
|                     | 2005  | 2007 | 2009 | 2011 |                     |  |
| Fresh fish          | 11.6  | 13.8 | 13.2 | 11.7 | Coastal areas       | Jack mackerel, Mahi mahi, jumbo squid          |
| Canned fish         | 3.1   | 4.2  | 4.3  | 6.1  | National level      | Jack mackerel, tuna, <i>anchoveta</i>          |
| Frozen fish         | 2.8   | 2.4  | 3.5  | 3.8  | Major cities        | South Pacific hake, jumbo squid                |
| Cured (salted) fish | 1.1   | 1.0  | 1.1  | 0.9  | Provinces           | Chub mackerel, jack mackerel, <i>anchoveta</i> |
| Total               | 18.6  | 21.4 | 22.2 | 22.5 |                     |  |

<sup>a</sup> Figures expressed in whole fish-equivalent volumes (INEI, 2012a; INEI, 2012b). National consumption of freshwater aquaculture products is marginal, and mostly limited to the producing communities and regions.

Most fish consumed in Peru is sourced by fisheries other than anchoveta, and scarcely by freshwater aquaculture. Seafood, especially that derived from the anchoveta supply chains, has been often suggested as a suitable means to improve nutritional intake of vulnerable communities and consumers at large (Jiménez and Gómez, 2005; de la Puente et al., 2011; Landa, 2012; Paredes, 2012; Rokovich, 2009). Analysing the factors limiting such consumption —e.g. prices, availability, preferences, etc. (Olsen, 2004)—, as well as the nutritional-toxicological conflict associated with seafood intake (Sioen et al., 2009; Sioen et al., 2008; Ström et al., 2011) and the particularities of the anchoveta exploitation (Fréon et al., 2013), exceeds the scope of this study. Instead, we focus on the sustainability assessment of those anchoveta and aquaculture products, to inform on their relative sustainability performance and assist in providing information for future popularisation or policy/management measures involving these products. Our emphasis lied on the different products' potential to contribute in an energy-

efficient and socio-economically sound way to improve nutrition of the population.

## 2 Methods

Sustainability assessment of the following products and their comparison was carried out: canned, frozen, salted and cured anchoveta, as well as cultured rainbow trout, black pacu and red hybrid tilapia. The system boundaries include infrastructure, heavy equipment, use of water and chemicals, energy use, agricultural inputs to anchoveta products (e.g. vegetable oils), fish and the whole aquafeed subsystem (including agricultural inputs), and transportation of key inputs. For both anchoveta DHC and aquaculture systems the analysis encompassed cradle to gate and distribution interventions.

### 2.1 Life cycle assessment

Life Cycle Assessment (LCA) is an ISO-standardised framework for conducting a detailed account of all resources consumed and emissions associated to a specific product along its whole life cycle (ISO,

2006a). LCA has been widely applied to study the environmental performance of fisheries (Avadí and Fréon, 2013), seafood including aquaculture products (Aubin, 2013; Henriksson et al., 2011; Parker, 2012) and industrialised seafood products (Hospido et al., 2006; Iribarren et al., 2010). LCA consists of a goal and scope definition phase, where the functional unit (FU) and system boundary are defined; a Life Cycle Inventory (LCI) phase, where life cycle data related to the FU is collected; a Life Cycle Impact Assessment (LCIA) phase where a set of characterisation factors are used to calculate environmental impacts on a wide number of impact categories; and an interpretation phase, where conclusions are drawn from the LCI and LCIA results (ISO, 2006a; ISO, 2006b). The midpoint-based CML methods, baseline 2000 and 2001 (Guinée et al., 2002), are the most commonly used in fisheries and seafood LCA studies (Avadí and Fréon, 2013; Parker, 2012). The newer ReCiPe method (Goedkoop et al., 2009) extends and complements two previous and widely used methods (Parker, 2012): CML and Ecoindicator 99 (Goedkoop and Spriensma, 2001), and combines midpoint and endpoint indicators. The CML method includes characterisation factors for more substances than ReCiPe, and therefore was used for toxicity impact categories, complemented by USEtox (Rosenbaum et al., 2008), a consensus toxicity model.

A combination of LCIA methods is thus proposed, from which some environmental performance indicators are extracted:

- ReCiPe is used for computing midpoints and an endpoint single score, based on the midpoints and a weighting set (Goedkoop et al., 2013). See details on the calculation of the single score in the Supplementary Material.
- CML baseline 2000 and USEtox are used to compute toxicity impact categories, and their respective results are compared. Such a comparison is suggested due to the high uncertainty associated to toxicity models in LCA.

- Cumulative Energy Demand (CED) (Hischier et al., 2010) is used to compute the total use of industrial energy (VDI, 1997).

To complete the inventories upstream, all background processes were taken from the ecoinvent database v2.3 (Ecoinvent, 2012) and the life cycle impact assessments were computed using SimaPro v7.3 (PRé, 2012). Detailed description of the production systems and environmental performance analyses of these products are presented in Avadí et al. (2014b,c).

The FU for which all indicators were computed was defined as one tonne (t) of a) edible fish in a DHC product in the case of anchoveta, and b) fresh fish edible portion for cultured species. Both types of products can be considered as final outputs of the anchoveta-based supply chains. Mass allocation was applied for computing the relative impacts of fish products and their associated processing residues (fish residues are valorised as inputs to the residual fishmeal industry).

Impacts of the seafood consumption phase have been excluded from the analysis. Distribution (transportation, retailing) of fresh and frozen products is limited in Peru, whereas canned products are distributed nationally. Potential impacts of distribution patterns for anchoveta DHC products were compared here with those of aquaculture products, if distributed nationally over an extended land-based refrigerated chain. Exports exceed the scope of this work and were not considered.

## 2.2 Sustainability indicators

A number of indicators were selected from the large indicators pool available in literature, in such a way that all aspects of sustainability (especially the environmental dimension) are addressed (Table 2). Main criteria for such selection were: 1) the abovementioned expected traits, to the largest possible extent; 2) historical, previous use in the seafood research field; and 3) comparability with other food systems (Gerbens-Leenes et al.,

2003; Jones, 2002; Kruse et al., 2008; Ness et al., 2007; Potts, 2006; Singh et al., 2009). Sustainability dimensions addressed by selected indicators were: ecological (sea use indicators), environmental (including energy use, resource use and toxicity-related effects), human nutrition and energy efficiency; and socio-economic aspects.

Indicators of ecosystem impacts of fisheries were chosen from the growing pool of ideas proposed in the literature (e.g. Hornborg et al., 2012a; Langlois et al., 2014; Libralato et al., 2008; Shin et al., 2010). These indicators (described below) are based on ecosystem level indicators such as net primary productivity (NPP), fisheries performance indicators such as maximum sustainable yield (MSY) of a given stock, and the commonly used Biotic Resource Use indicator (Langlois et al., 2014). For completion, the ecological impacts of producing agricultural inputs to aquafeeds used in aquaculture should be also calculated, but it was not due to lack of proper data. Biotic resource use (BRU) is estimated for agricultural materials from the carbon content of the crop, for animal husbandry and aquaculture products from the carbon content of feed compositions; and for fish inputs to aquafeeds, using the Primary Production Required (PPR) equation. This equation was first proposed by Pauly and Christensen (1995) and since widely used since by many fisheries and aquaculture researchers. PPR to sustain catches of a specific fishery is considered an equivalent of the BRU of a fish raw material derived from that fishery (Papathyphon et al., 2004; Tyedmers, 2000). BRU is also useful for rendering comparable the impacts of species removal (catches, by-catches, discards), crops and animal products.

Pauly and Christensen estimated the primary production required for a fishery based upon a 9:1 conversion ratio of wet weight to carbon and a transfer efficiency between trophic levels of 10% (both figures are conservative); by means of the widely used equation 1:

$$BRU = PPR (g C \cdot kg^{-1}) = (catch \cdot g^{-1}) \cdot 10^{(TL-1)} \quad (1)$$

where PPR stands for Primary Production Required and TL for trophic level of landed species. Actual catch data was used for calculations, as recommended by (Hornborg et al., 2013). BRU-based discard assessment approaches, as described in Hornborg (2012) and Hornborg et al. (2012a, b), consist of calculating PPR of species in the discarded fraction of a fishery, and establishing the proportion of threatened species in the discard (VEC).

Sea use endpoint impact categories, namely the impacts of biomass removal on Biotic Natural Resources (BNR) at the species level ( $I_{BNR,sp}$ ) and at the ecosystem level ( $I_{BNR,eco}$ ) were proposed by Langlois et al. (2014). They express the time in years necessary for restoring the biomass uptake of the harvested species, and for regenerating the amount of biomass removed (as an expression of the biotic natural resource depletion in the ecosystem). The indicators are calculated by equations 2 and 3:

$$I_{BNR,sp} (years) = reference\ flow \cdot 1 / MSY \quad (2)$$

where the 5-year average of the total annual catch can be used in substitution of the maximum sustainable yield (MSY) of the stock, if the stock is over-exploited; and

$$I_{BNR,eco} (years) = BRU / [A \cdot E_{NPP}] \quad (3)$$

where BRU is expressed in  $t C \cdot t^{-1}$ , A is the ecosystem area in  $km^2$  and  $E_{NPP}$  is the net primary productivity of the ecosystem in  $t \cdot km^{-2} \cdot y^{-1}$ . These sea use indicators were calculated for different segments of the anchoveta fishery: the small- and medium-segments landing for DHC and the industrial segment landing for reduction into fishmeal and fish oil that are used in aquafeeds. Maximum Sustainable Yield (MSY) for anchoveta has been estimated in over 5 million tonnes (Csirke et al., 1996), but the authors did not offer a fixed number but rather a range. Therefore a 5-year average of total landings were used as proxy (5.5 million t, for 2006-2010), given that anchoveta stock is presently considered as fully exploited and previously as over-exploited

(IMARPE, 2010). MSY of hake has been estimated in ~27 000 t until the stock, considered as over-exploited, fully recovers (Lassen et al., 2009).

LCA-based indicators were included, including specific impact categories and the weighted single score computed by ReCiPe, as detailed above (Table 2).

Cumulative Energy Demand (CED) is a good estimation of the energy embedded in a product. It is also useful for the computation of more sophisticated energy efficiency indicators. Gross Energy Content (GEC), is a good indicator of the nutritional characteristics of an agricultural or seafood material, because it is based on the lipid, protein and carbohydrate contents of the material (by means of an unweighted sum):

$$GEC (MJ \cdot kg^{-1}) = Protein\ content \cdot P_{energy} + Lipid\ content \cdot L_{energy} \quad (4)$$

where  $P_{energy}$  is the energy content of protein ( $23.6 MJ \cdot kg^{-1}$ ) and  $L_{energy}$  is the energy content of lipids ( $39 MJ \cdot kg^{-1}$ ). No relevant carbohydrate content is present in seafood, thus it is excluded from the formula. Used  $P_{energy}$  and  $L_{energy}$  are associated to GEC, which includes energy losses in excretions. An alternative would be to use metabolizable energy rather than gross energy content of protein and lipid (for instance,  $P_{energy} = 16.7 MJ \cdot kg^{-1}$ ).

CED and GEC are also used for computing two different variations of Energy Return On Investment (EROI), by means of equations 5 and 6 (Hall, 2011; Mitchell and Cleveland, 1993; Tyedmers, 2000):

$$Gross\ edible\ EROI\ (\%) = [GEC (MJ \cdot kg^{-1}) \cdot EY (\%)] / CED (MJ \cdot kg^{-1}) \quad (5)$$

where EY represents the fish edible yield; and:

$$Edible\ Protein\ EROI\ (\%) = [P (\%) \cdot P_{energy} (MJ \cdot kg^{-1}) \cdot EY (\%)] / CED (MJ \cdot kg^{-1}) \quad (6)$$

where P is the protein content of fish,  $P_{energy}$  is the energy content of protein ( $23.6 MJ \cdot kg^{-1}$ ), EY represents the edible yield of the fish (often

fillets) and CED represents the total industrial energy input.

BRU and CED complement resource and energy use impact categories included in ReCiPe.

Nutrition information labels for seafood products use standard profiles (Drewnowski and Fulgoni III, 2008). Comparisons of nutritional characteristics of different seafood products have focused on vitamins, minerals, protein, energy content and especially Omega-3 fatty acids. We customised the Nutrient Rich Food index ( $NRF_{n,3}$ ) described in Drewnowski and Fulgoni III (2008) which aggregates values for various beneficial nutrients and nutrients to limit. Positive nutrients are those more relevant to tackle the nutritional deficiencies observed in Peru (see below), and only two nutrient to limit present in damageable quantities in some of the studied seafood products were retained (saturated fat and sodium). The  $NRF_{n,3}$  index is based on nutrient density (Darmon et al., 2005) and the LIM model of nutrients to limit (Maillot et al., 2007). It is calculated for a 100 g portion of seafood and formalised in equations 7 to 9:

$$NRF_{n,3} = NRF_n - LIM \quad (7)$$

where  $NRF$  stands for Nutrient Rich Food,  $n$  is the number of positive nutrients assessed and  $LIM$  is a measure of the Maximum Recommended Values (MRV) of nutrients to limit delivered by the seafood product.

$$NRF_n = (\sum_{1-n} ((Nutrient/DV) \cdot 100/n)) / ED \quad (8)$$

where  $DV$  represents the recommended daily values for each nutrient assessed, and  $ED$  is the energy density of the food item, in kcal. Included nutrients, expressed together with their  $DV$  per 100 g of the food item, are protein, Omega-3 fatty acids (EPA + DHA), other non-saturated lipids (including Omega-6 fatty acids), vitamins A, B-12 and D; calcium, potassium, phosphorus and iron.

$$LIM = (\sum_{1-2} (DA/MRV)/2) \cdot 100/Q \quad (9)$$

where  $DA$  is the daily amount, in g, provided by the seafood item in a portion of  $Q$  g;  $DI$  represents the daily intake of food (in g) and  $Q$  is the quantity of the seafood item consumed. We used  $Q = 100$  g and MRV values are taken from Maillot et al. (2007). The LIM model includes originally three nutrients to limit, namely saturated fat, added sugars and sodium. We simplified the original equation (Maillot et al., 2007) to exclude added sugars, and refer to the 100 g seafood portion rather than to the whole daily food intake.

In order to take better into account the specific nutritional deficiencies occurring in Peru, we also produced a weighted version of the index, applying a weighting set based on the relevance of the studied food products for tapping. Details on those deficiencies, the weighting factors and the weighted ranking of seafood and other protein foods consumed in Peru are presented in the Supplementary Material, where results are contrasted with the canonical  $NRF_{n,3}$  ranking.

Socio-economic indicators are calculated based on statistical data, company data and publications by experts. Notably, the majority of revenue, cost and employment figures for industries other than aquaculture were obtained from literature: we used anchoveta processing-specific data when possible, and otherwise performed a mass allocation of Peruvian seafood industries data from (Christensen et al., 2013). The indicators are defined as follows:

- Employment, the labour associated to producing one functional unit (Kruse et al., 2008), adjusted as full time jobs (including direct and indirect). PRODUCE statistics on fish landings, processing and production corresponding to the year 2009 were used for computations.
- Value added, the monetary value added per functional unit (Kruse et al., 2008). This can be interpreted as the difference between the selling price of a good and the cost of all inputs purchased (Heijungs et al., 2012), especially raw materials (e.g. fresh fish and

agricultural inputs, aquafeed, fry, packaging, fuels and energy, etc).

- Gross profit, the monetary value retained by commercial entities per functional unit, defined in the context of this study as the difference between the selling price and its production cost (and due to the simplification of production costs, excluding taxes, subsidies, rights, depreciation costs and capital costs). Production costs represent the cost of producing one functional unit (Kruse et al., 2008). The cost structure excludes (due to data gaps and for simplicity) certain taxes, subsidies, rights, depreciation costs and capital costs.

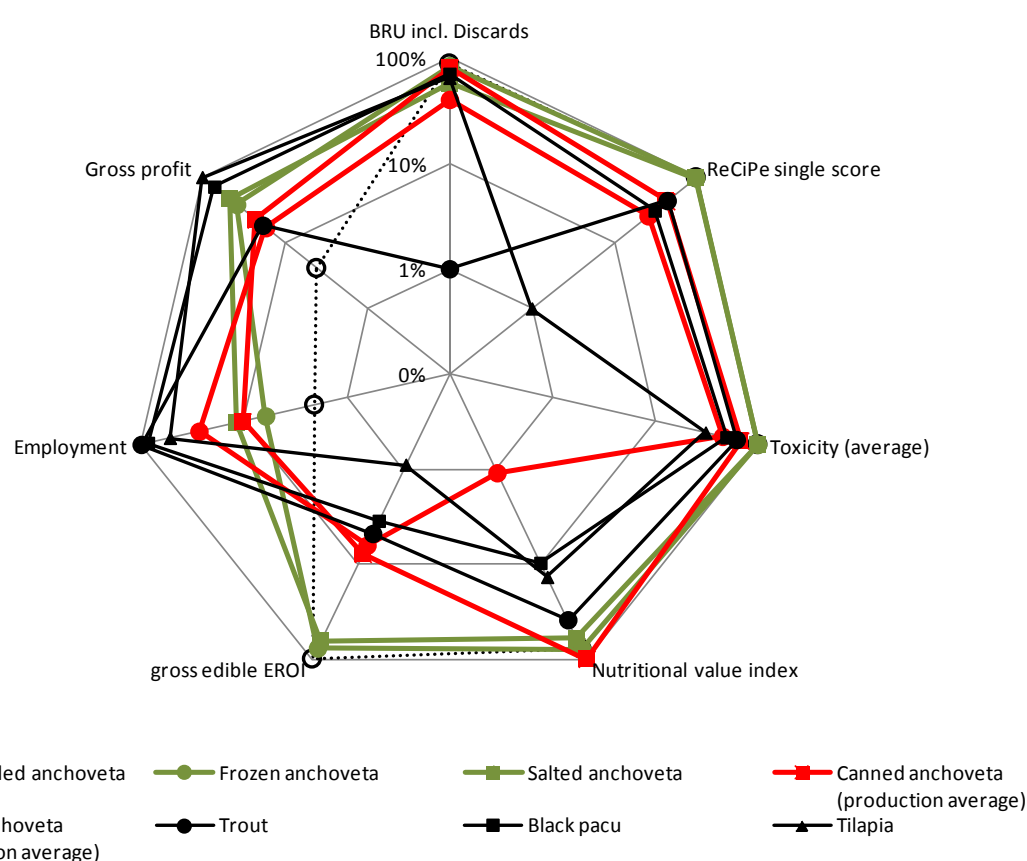
All indicators proposed feature different units, and thus were presented separately by means of a representation device based on a percentage scale relative to the highest observed value, as a means of normalisation. Doing this also addresses the need of a finite interval for all indicators, although at the expense of sensitivity to the range of analysed products. For that reason indicators were presented both for all products and clustered by industry (DHC vs. aquaculture). Table 2 also depicts the compliance of each indicator with the desired criteria. Certain indicators are novel and thus lack legitimacy (e.g. some ecological and socio-economic ones), while others (i.e. nutritional profile), are complex to compute.

**Table 2** Overview of proposed sustainability indicators (including impact categories included in LCIA methods)

| Sustainability dimension | Indicator (unit)  | Reference publications                         | Calculation  | Indicator traits              |                 |   |   |   |   |   |   |
|--------------------------|---|--|--------------|-------------------------------|-----------------|---|---|---|---|---|---|
|                          |   |  |              | P                             | R               | O | L | I | G | D |   |
| Ecological               | $I_{BNR,sp}$ (years)  | Langlois et al. (2014)                         | Manual       | X                             | X               | X |   | X | X | X |   |
|                          | $I_{BNR,eco}$ (years)   |  |              | X                             | X               | X |   | X | X | X |   |
| Environmental            | BRU (g C/kg)  | Pauly and Christensen (1995)                   | Manual       | X                             | X               | X | X | X | X | X |   |
|                          | BRU-based discard assessment  | Hornborg (2012)<br>Hornborg et al. (2012b, a)  |              | X                             | X               | X |   | X | X | X |   |
|                          | LCA/ReCiPe<br>Climate change, Ozone depletion, Terrestrial acidification, Freshwater eutrophication, Marine eutrophication, Photochemical oxidant formation, Particulate matter formation, Ionising radiation, Agricultural land occupation, Urban land occupation, Natural land transformation, Water depletion, Metal depletion, Fossil depletion | Goedkoop et al. (2009)                         | LCIA methods | X                             | X               | X | X | X | X | X |   |
|                          | Single score (Pt)   |  |              |                               |                 |   |   |   |   |   |   |
|                          | LCA/CED (MJ)  | Hischier et al. (2010)                         |              | X                             | X               | X | X | X | X | X |   |
|                          | LCA/CML[USES-LCA]<br>Human toxicity, Fresh water aquatic ecotoxicity, Marine aquatic ecotoxicity, Terrestrial ecotoxicity   | Guinée et al. (2002)<br>van Zelm et al. (2009) |              | X                             | X               | X | X | X | X | X |   |
|                          | LCA/USEtox (CTUe, CTUh <sup>a</sup> )   | Rosenbaum et al. (2008)                        |              | X                             | X               | X | X |   | X | X |   |
|                          | GEC (MJ/kg)   | Tyedmers (2000)                                |              | X                             | X               | X | X | X | X | X |   |
|                          | Nutritional profile (Nutrient Rich Food index)<br>Lipids<br>Protein<br>Vitamins<br>Minerals   | Drewnowski and Fulgoni (2008)                  |              | Manual                        | X               | X |   | X | X |   | X |
|                          | gross edible EROI (%)   |  |              |                               | Tyedmers (2000) | X | X | X | X | X | X |
| edible protein EROI (%)  | Tyedmers et al. (2005)<br>Hall (2011)   | Manual   | X            | X                             | X               | X | X | X | X |   |   |
| Socio-economic           | Production costs (USD)  | Kruse et al. (2008)                            | Manual       | X                             | X               | X | X | X | X | X |   |
|                          | Employment (USD)  |  |              | X                             | X               |   | X | X | X | X |   |
|                          | Value added (USD)   |  |              | X                             | X               | X |   | X | X | X |   |
|                          | Gross profit generation (USD)   |  |              | Accepted accounting indicator | X               | X |   | X | X | X |   |

Abbreviations: BRU: Biotic Resource Use, CED: Cumulative Energy Demand, CTU: comparative toxic units, EROI: Energy Return On Investment, GEC: Gross Energy Content,  $I_{BNR,sp}$ : impacts on Biotic Natural Resources at the species level,  $I_{BNR,eco}$ : impacts on Biotic Natural Resources at the ecosystem level, LCA: Life Cycle Assessment, LCIA: Life Cycle Impact Assessment; P: pertinence, R: reliability, O: operationality, L: legitimacy, I: interpretability, G: genericity, D: defined in a finite interval (all indicators expressed as a percent of the higher value).

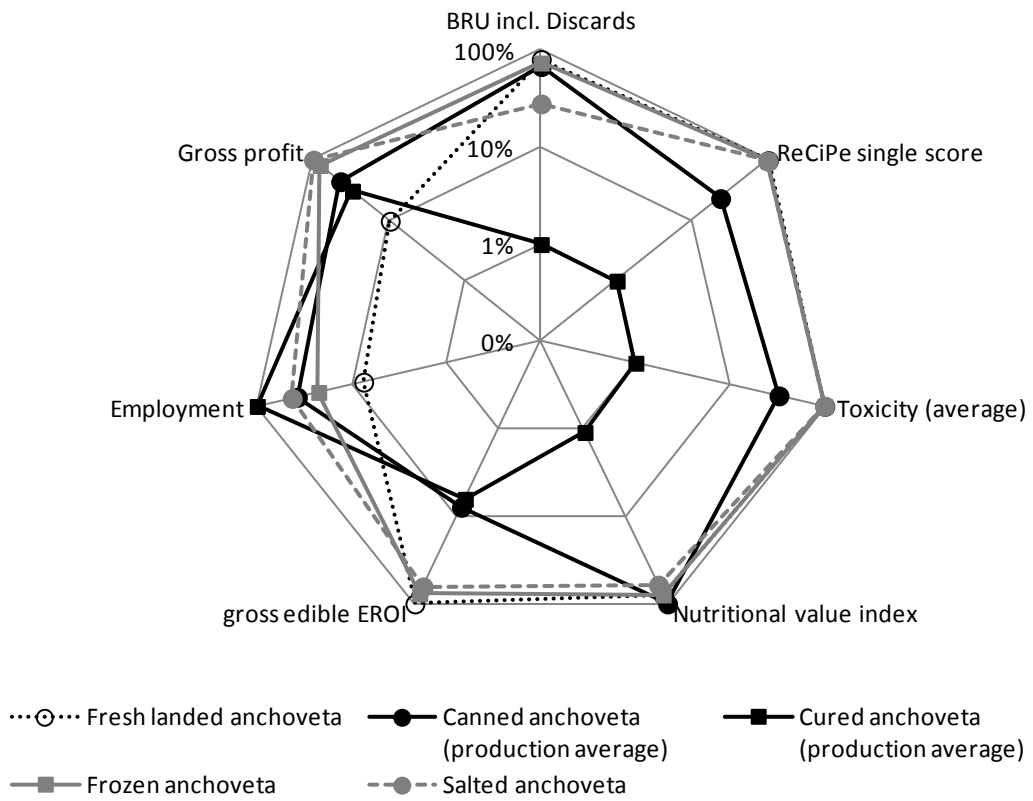
<sup>a</sup> CTUe provides an estimate of the potentially affected fraction of species (PAF) integrated over time and volume per unit mass of a chemical emitted ( $PAF\ m^{-3}\cdot day\cdot kg^{-1}$ ) (Rosenbaum et al., 2008). CTUh provides an estimate of the increase in morbidity in the total human population per unit mass of a chemical emitted (cases per kilogram), assuming equal weighting between cancer and non-cancer due to a lack of more precise insights into this issue (Rosenbaum et al., 2008).



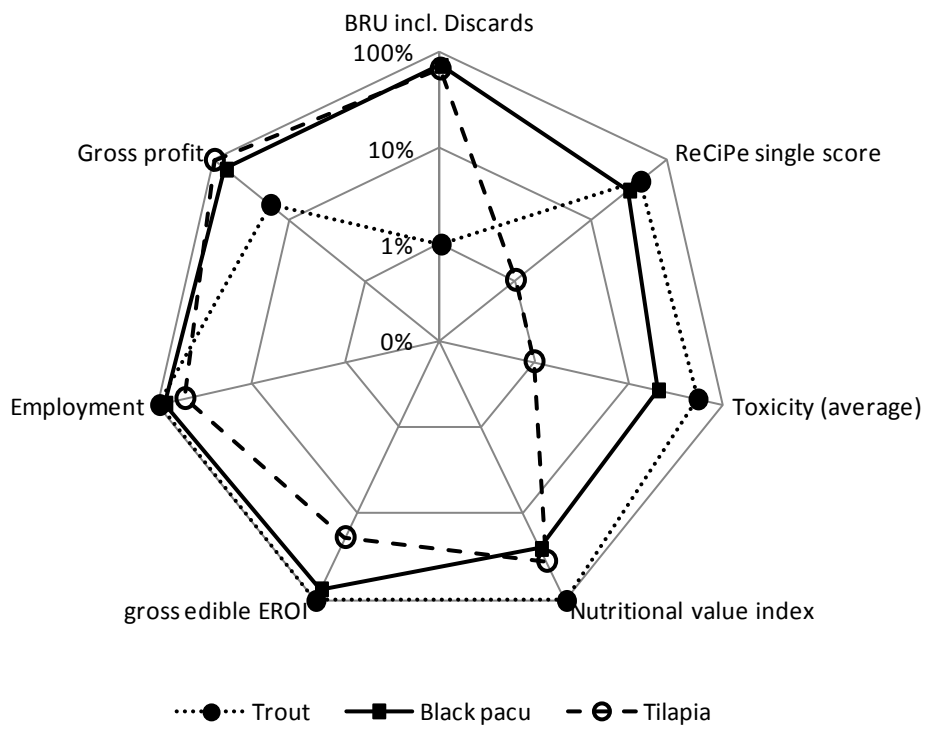
**Fig. 1** Relative sustainability performance of Peruvian *anchoveta* DHC products and aquaculture products (at plant and farm gate, respectively), based on the proposed indicator set, per tonne of fish in product. All axes are in  $\log_{10}$  scale; axes BRU, single score and toxicity have been inverted so that higher values are better



a) Anchoveta DHC products at plant gate



b) Aquaculture products at farm gate



**Fig. 2** Relative sustainability performance of Peruvian seafood products, by industrial cluster (same considerations as in Fig. 1)

### 3 Results and discussion

The indicator set was applied to all products described, and results are presented both aggregated (Fig. 1), and by industrial cluster (anchoveta DHC industry-based in Fig. 2a and aquaculture-based in Fig. 2b), initially without considering distribution, which is discussed later. Results are detailed and discussed in the next sections, by sustainability dimension: ecological/environmental, energy and nutrition, and socio-economic performance.

#### 3.1 Ecological and environmental performance

$I_{\text{BNR,sp}}$  and  $I_{\text{BNR,eco}}$  were estimated at  $1.80\text{E-}07$  and  $2.05\text{E-}05$  years per t of fresh headed-gutted-tailed (HGT) fish, respectively. The effect of the removal of anchoveta biomass associated to the studied

products ranges between  $3.50\text{E-}08$  and  $9.49\text{E-}07$  years. These values represent the time in years necessary to rebuild, at the species level, the production of one tonne of fish in product (anchoveta DHC or aquaculture product whose diet included FMFO). The product ranking according to  $I_{\text{BNR,sp}}$  is presented in Table 3. The ecological BNR ranking was not included in the multi-criteria device depicted in Fig. 1 and Fig. 2. The rationale for this is that we preferred to emphasise direct rather than indirect sustainability impacts of the studied products. Moreover, the BNR ecological impact assessment lacks completion as long as land use impacts — biodiversity, biotic production potential and ecological soil quality (Milà i Canals et al., 2007)— associated to aquafeeds and aquaculture are not included.

**Table 3** Sea use indicators of *anchoveta* DHC and freshwater aquaculture products, per tonne of fish in product

| Product                                | Usable fraction (%) <sup>a</sup> | Fresh fish (t) <sup>b</sup> | Aquafeed (t) | FMFO (t) | $I_{\text{BNR,sp}}$ (years) | Rank (1=best) |
|--|----------------------------------|-----------------------------|--------------|----------|-----------------------------|---------------|
| Fresh anchoveta (HGT, for DHC)         | 75                               | 1.33                        |              |          | $2.40\text{E-}07$           | 5             |
| Fresh anchoveta (whole, for reduction) | 100                              | 1.00                        |              |          | $1.80\text{E-}07$           | 4             |
| Frozen anchoveta (gutted)              | 75                               | 1.33                        |              |          | $2.40\text{E-}07$           | 5             |
| Salted anchoveta (HGT)                 | 27                               | 3.70                        |              |          | $6.68\text{E-}07$           | 8             |
| Canned anchoveta (production average)  | 50                               | 2.00                        |              |          | $3.61\text{E-}07$           | 7             |
| Cured anchoveta (production average)   | 19                               | 5.26                        |              |          | $9.49\text{E-}07$           | 9             |
| Trout, semi-intensive, commercial      | 60                               | 1.67                        | 2.33         | 0.61     | $1.09\text{E-}07$           | 3             |
| Black pacu, semi-intensive, commercial | 42                               | 2.38                        | 3.33         | 0.20     | $3.61\text{E-}08$           | 2             |
| Tilapia, intensive, commercial         | 36                               | 2.78                        | 3.89         | 0.19     | $3.50\text{E-}08$           | 1             |

<sup>a</sup> Usable fraction of whole fresh fish. <sup>b</sup> Tonnes of fresh fish equivalent to 1 tonne of fish in product. For aquaculture products a feed conversion ratio of 1.4 was used, and inclusion ratios of fishmeal and oil (FMFO) into feeds were 26% for trout, 6% for black pacu and 5% for tilapia (Avadí et al., 2014b).

By applying a trophic level (TL) of 2.7 for *Engraulis ringens* (Froese and Pauly, 2011) to equation 1, a BRU of  $5\,569\text{ g C}\cdot\text{kg}^{-1}$  was obtained for fresh landed anchoveta, discards included. In the anchoveta fishery by-catch is minimal, consisting mostly of jellyfish and other pelagic species, of which the latter is not discarded (Fréon et al., 2014b). Discards are mostly composed of anchoveta juveniles, representing in average 3.9%

of landings although higher values can be observed some years (Torrejón et al., 2012). Anchoveta, being a relatively low-TL species (although certain authors suggest a higher average TL, e.g. Espinoza and Bertrand (2008) and Hückstädt et al. (2007)), appropriates less primary productivity than other commercial wild-caught and cultured fish. Much higher values were obtained for anchoveta products, ranging from 7

715 C·kg<sup>-1</sup> for frozen fish to 50 038 C·kg<sup>-1</sup> for cultivated trout (Table 4). Regarding anchoveta products, this difference is due the fact that residues of anchoveta transformation (losses) are considered. Regarding cultured fish, these species are fed with commercial aquafeeds containing anchoveta fishmeal and fish oil, as well as agricultural inputs; all of this ingredients appropriate primary productivity and are subject to a conversion ratios (FCR). FCRs used for all Peruvian aquaculture species was 1.4 (Avadí et al., 2014b), while fishmeal and fish oil yields were ~23% and ~4%, respectively. Cultivated trout shows the largest BRU due to the higher content of animal and fish inputs in feeds (Fig. 2b). Moreover, BRUs of all products are even higher when comparing them on the base of their edible yields.

Both CML baseline 2000 (USES-LCA) and USEtox models yielded very similar results, when expressed as relative percentage contribution. Moreover, in the single score environmental indicators, all products show similar performance (although minimised by the log scale of Fig. 1), except for fresh, frozen and salted anchoveta products, which feature lower associated impacts and thus show a higher performance (Fig. 2a).

LCIA results, upon which environmental indicators are based, are summarised in Table 4 (detailed results are available in the reference publications) and show even more contrasted results than the single score. It is noticeable that in the selected impact categories, results are much higher for the more energy-intensive anchoveta products (canned and cured) than for the less energy-intensive (frozen, salted). Moreover, aquaculture products feature in general higher impacts than industrialised anchoveta products. The overall environmental performance of all products is determined mainly by the industrial energy demand (electricity and heat demand by fish processing industries, including the production of containers, and energy embodied in commercial aquafeeds), as reflected for instance by the impact categories climate change and CED. Another

important driver is the land use effect of using agricultural products (e.g. vegetable oils in canned and cured products, inputs to aquafeeds), as measured by the agricultural land occupation category.

When the distribution (regular or refrigerated transport and storage) of products is considered, important changes in environmental performance take place in the cases of fresh/chilled and frozen anchoveta products (Fig. 3). It remains that the environmental performance is better for anchoveta DHC products than for aquaculture ones, and for less energy-intensive DHC products than for more energy-intensive ones. For aquaculture products, the additional environmental burdens due to refrigerated distribution are in the range of 6 to 11%.

### 3.2 Energy and nutrition

Gross Energy Content of anchoveta is higher than other fish consumed in Peru, due to its relatively larger content of protein and lipids. Moreover, fuel consumption of the anchoveta industrial fisheries impacting aquafeed averages 16 kg per tonne landed (Fréon et al., 2014a), whereas it is 35 kg per tonne landed for the SMS fleet landing for DHC (Fréon et al., 2014b). In the other hand, industrial processing of anchoveta for certain DHC products, namely cured and canned, is energy-intensive in terms of fuels (heavy fuel, diesel and gas) and, to a lower extent, of electricity.

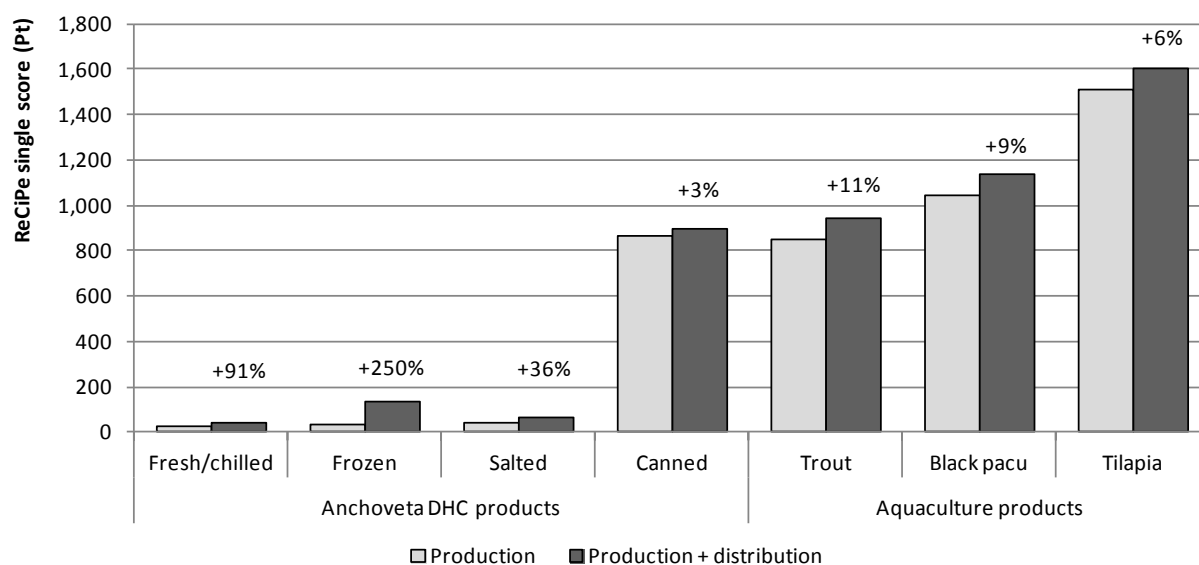
Gross edible and edible protein EROI analyses show that anchoveta products, especially those demanding less industrial energy over their production process, feature better EROI ratios than aquaculture products (Table 5). Among cultured fish, trout performs best because of its high energy content, high edible yield (i.e. the ratio edible part/total weight), and lower energy requirements for its semi-intensive farming phase. Peruvian tilapia, in the other hand, features lower energy efficiency, because of low GEC, low edible yields and high CED (due to a more energy-intensive farming phase).

**Table 4** Selected LCIA results of *anchoveta* DHC and freshwater aquaculture products, per tonne of fish in product at plant gate (*anchoveta*) or at farm gate (aquaculture)

| Impact categories                | Unit                  | Fresh anchoveta | Canned anchoveta <sup>a</sup> | Frozen anchoveta | Salted anchoveta | Cured anchoveta <sup>a</sup> | Rainbow trout <sup>d</sup> | Black pacu <sup>e</sup> | Red tilapia <sup>f</sup> |
|----------------------------------|-----------------------|-----------------|-------------------------------|------------------|------------------|------------------------------|----------------------------|-------------------------|--------------------------|
| <b>ReCiPe</b>                    |                       |                 |                               |                  |                  |                              |                            |                         |                          |
| Climate change                   | kg CO <sub>2</sub> eq | 115.38          | 2 583                         | 193.57           | 126.11           | 2 906                        | 4 672                      | 4 653                   | 9 897                    |
| Terrestrial acidification        | kg SO <sub>2</sub> eq | 1.23            | 14.19                         | 1.47             | 1.08             | 17.00                        | 63.74                      | 65.58                   | 136.09                   |
| Freshwater eutrophication        | kg P eq               | 0.01            | 1.03                          | 0.05             | 0.06             | 1.83                         | 16.68                      | 24.45                   | 11.41                    |
| Agricultural land occupation     | m <sup>2</sup> a      | 2.60            | 1997                          | 4.51             | 5.34             | 3 462                        | 8,084                      | 9,376                   | 7 799                    |
| Water depletion                  | m <sup>3</sup>        | 0.29            | 32.64                         | 3.07             | 2.33             | 31.61                        | 25 402                     | 13 242                  | 4 010                    |
| Single score                     | Pt                    | 22.95           | 798.17                        | 37.68            | 45.52            | 1033                         | 849.52                     | 1045                    | 1573                     |
| <b>CML-toxicity</b>              |                       |                 |                               |                  |                  |                              |                            |                         |                          |
| Human toxicity                   | kg 1,4-DB-e           | 42.98           | 14 356                        | 70.04            | 114.34           | 18 443                       | 2 208                      | 1480                    | 2 258                    |
| Ecotoxicity <sup>b</sup>         | kg 1,4-DB-e           | 38 896          | 2 873 606                     | 60 202           | 103 519          | 3 741 057                    | 1 153 270                  | 1 119 651               | 1 651 079                |
| <b>Others</b>                    |                       |                 |                               |                  |                  |                              |                            |                         |                          |
| Cumulative Energy Demand         | MJ                    | 6 809           | 68 990                        | 8 278            | 6 681            | 79 377                       | 71 912                     | 79 176                  | 146 776                  |
| Biotic Resource Use <sup>c</sup> | kg C                  | 5 786           | 9 489                         | 7 715            | 20 625           | 28 661                       | 50 038                     | 14 555                  | 17 556                   |

<sup>a</sup> Production average. <sup>b</sup> Summarises CML impact categories freshwater aquatic ecotoxicity, marine toxicity and terrestrial ecotoxicity. <sup>c</sup> BRU is calculated for the whole fish equivalent, including discards. <sup>d</sup> Trout systems: semi-intensive, lake-based, commercial feed. <sup>e</sup> Black pacu systems: semi-intensive, pond-based, commercial feed. <sup>f</sup> Tilapia systems: intensive, pond-based, commercial feed.

**Notes.** Efficiencies used for *anchoveta* products, respect to fresh whole fish: canned = 50%, frozen = 75%, salted = 27%, cured = 19%. Edible yields of aquaculture products: trout = 60%, black pacu = 42%, tilapia = 36%.



**Fig. 3** Additional environmental impacts of distribution activities of *anchoveta* DHC and freshwater aquaculture products, per tonne of final product. Absolute values of ReCiPe single score are shown on the vertical axis and percentages express the relative increase in single score when distribution is added. Distribution is national and the same transport distance is used for all products. Storage along a cold chain is also taken into account, except for salted and canned *anchoveta* products

**Table 5** Energy Return on Investment (EROI) of *anchoveta* DHC and freshwater aquaculture products, per tonne of fresh fish input equivalent at plant gate (*anchoveta*) or output at farm gate (aquaculture)

| Fish product  | GEC <sup>i</sup><br>(MJ·kg <sup>-1</sup> ) | CED <sup>ii</sup><br>(MJ·kg <sup>-1</sup> ) | Edible yield <sup>iii</sup><br>(%) | Protein<br>content (%) | Lipid<br>content (%) | gross<br>edible<br>EROI | edible<br>protein<br>EROI |
|---|--|---|------------------------------------|------------------------|----------------------|-------------------------|---------------------------|
| <i>Anchoveta</i> (fillets) <sup>a, iv</sup>                         | 19.5 ±2.2                                  | 5.1   | 57.7 ±9.6                          | 19.1 ±0.1              | 8.8 ±0.8             | 165.1                   | 37.1                      |
| <i>Anchoveta</i> (HGT) <sup>b</sup>                                 | 7.9 ±0.2                                   | 1.7   | 75                                 | 19.1 ±0.1              | 8.8 ±0.8             | 417.2                   | 232.3                     |
| <i>Anchoveta</i> (canned, HGT, with vegetable oils) <sup>c</sup>    | 6.9 ±2.4                                   | 41.4  | 50                                 | 21.3 ±1.8              | 9.0 ±5.7             | 15.6                    | 11.0                      |
| <i>Anchoveta</i> (guttled, fresh/frozen) <sup>a</sup>               | 19.5 ±2.2                                  | 8.5   | 75                                 | 19.1 ±0.1              | 8.8 ±0.8             | 96.1                    | 53.5                      |
| <i>Anchoveta</i> (salted) <sup>c</sup>                              | 5.3  | 6.0   | 27                                 | 18.4                   | 5.9                  | 82.8                    | 66.3                      |
| <i>Anchoveta</i> (cured, fillets, with vegetable oils) <sup>c</sup> | 6.5 ±0.1                                   | 78.7  | 19                                 | 30.0                   | 4.0                  | 8.2                     | 8.7                       |
| Cultured rainbow trout <sup>d</sup>                                 | 7.2 ±1.6                                   | 71.9  | 59.4 ±5.2                          | 18.4 ±1.7              | 7.6 ±3.4             | 5.9                     | 3.5                       |
| Cultured black pacu <sup>e</sup>                                    | 8.2 ±2.0                                   | 75.1  | 41.8 ±3.4                          | 15.0 ±1.9              | 12.4 ±5.4            | 4.6                     | 1.9                       |
| Cultured red tilapia <sup>f</sup>                                   | 4.5 ±0.5                                   | 79.2  | 36.0 ±1.4                          | 18.3 ±1.5              | 1.9 ±0.2             | 4.3                     | 1.8                       |

Notes: <sup>i</sup> Excluding vegetable oil added to canned and cured *anchoveta* products. <sup>ii</sup> CED of canned, salted and cured *anchoveta* calculated for 1 kg of raw fish processed. <sup>iii</sup> Values represent a percentage of the whole fish weight.

When averages are calculated from different reported values, they are accompanied by the calculated standard deviation. <sup>iv</sup> *Anchoveta* fillets is not a product commercialised in Peru, yet it is shown for comparison

Sources: <sup>a</sup> GEC calculated from a study of *anchoveta* muscle (calorimetry measurements, IRD, 2011, unpublished), lipid content is an average of values (IMARPE-ITP, 1996; Torry Research Station, 1989; calorimetry measurements, IRD, 2011, unpublished). <sup>b</sup> IMARPE-ITP (1996), Torry Research Station (1989). <sup>c</sup> ITP (2007). <sup>d</sup> Austreng and Refstie (1979), Celik et al. (2008), Dumas et al. (2007), Fallah et al. (2011), USDA (2012). <sup>e</sup> Almeida et al. (2008), Bezerra (2002), Torry Research Station (1989), Machado and Sgarbieri (1991). <sup>f</sup> Mendieta and Medina (1993), Torry Research Station (1989), USDA (2012).

A nutritional analysis of anchoveta DHC products and aquaculture products is presented in Table 6. Canned anchoveta products feature higher contents of protein, Omega-3 and vitamins B-12 than the other fish products listed. Detailed nutritional data (i.e. vitamin and mineral profile) was not directly available for industrialised Peruvian anchoveta products, but values were approximated from other anchovy and sardine products. Such figures support the conclusion that anchoveta is a very nutritious fish, except for when in the form of cured fillets, because the LIM score exceeds the  $NRF_n$  one (mainly due to the extreme concentration of sodium). Regarding aquaculture products, trout flesh is the most nutritious among the listed species, featuring the highest levels of protein, vitamins and minerals. Black pacu provides more energy per serving, due to larger lipid content. Black pacu is otherwise nutritionally poorer than the other species, due to a high content of saturated fat. Moreover, farmed tilapia has been found to feature a combination of fatty acids less beneficial than that of farmed salmonids (Weaver et al., 2008), yet tilapia is more expensive in Peruvian supermarkets than the other two cultured species.

The ranking of products according to the described nutritional index is as follows (from best to worst): canned, fresh/frozen, salted anchoveta, fresh trout, fresh tilapia, fresh black pacu and cured anchoveta. The counter-intuitive higher score of canned products compared to fresh/frozen one is explained by the nutritional value of ingredients, vegetable oil in particular: canned anchoveta was modelled as featuring soy oil (the most commonly used in Peru), thus the product features high energy, high concentration of non-saturated lipids, as well as high vitamin and Omega-3 contents. The 166 kcal·100<sup>-1</sup> g energy content of canned anchoveta retained in Table 6 represents the average of a range of 125 to 207 166 kcal·100<sup>-1</sup> g (ITP, 2007).

Some of these products compete favourably, when compared with other sources of protein consumed in Peru (Table 7). Indeed, the overall

nutritional ranking is as follows, from best to worst: canned, fresh/frozen and salted anchoveta, fresh trout, hake, eggs, fresh tilapia, fresh black pacu, beef (lean), shrimp, chicken (lean), milk, pork (lean), cured anchoveta and fresh cheese. Nonetheless, the main source of animal protein for the Peruvian population is the relatively less nutritional chicken, with 17.4 kg·person<sup>-1</sup>·y<sup>-1</sup> (INEI, 2012b), due to competitive prices, easier conservation and more efficient distribution than fresh fish (Fréon et al., 2013).

We have not considered the potential content of heavy metals and other harmful substances (PBC, pesticides) in the flesh of fish, especially in cultured ones, due to lack of data. Ideally, those toxicity aspects should be included in nutritional assessments and comparisons of seafood products.

### 3.3 Socio-economic aspects

Anchoveta direct supply chains (fisheries, reduction and processing for DHC) provide the equivalent of about 77 000 jobs (Christensen et al., 2013) for a total production of about 2.3 million t, resulting from the processing of 6.5 million t of fresh fish in 2009. In contrast, aquaculture of the studied species provides ~16 400 direct jobs (Mendoza, 2011a) for a total production of 28 000 t during the same year. Fig. 1 shows that aquaculture products, together with the curing industry, provide more jobs per functional unit than anchoveta fisheries and other processes.

The studied industries feature variable economic performances, being canning and curing more profitable, both in terms of gross profit and added value, than direct landing for fresh DHC, freezing and reduction into fishmeal, on a per tonne basis (Table 8).

According to calculations based on data in Christensen et al. (2013), gross profit per landed tonne is higher for the SMS fleet than for the industrial fleets. Fréon et al. (2013) confirm it and add that for SMS vessels, fishing (illegally) for IHC is more profitable than for DHC because the

higher production costs of the latter are compensated by larger landings per fishing trip.

Among the anchoveta processing industries (IHC, DHC), differences in gross profit per tonne produced are associated with variations in their production costs and cost structure. The DHC industry currently pays a bit more to the SMS fleet per landed tonne than the fishmeal industry to the industrial fleets (third party owned vessels). In past years, nonetheless, it has been reported that fishmeal plants have paid to independent vessels higher prices than the DHC industry, in a successful strategy to ensure raw material, as a consequence to their overcapacity (Fréon et al., 2013).

The reduction industry is by far more profitable than anchoveta canning by volume and also on a per tonne basis. Primary data on the anchoveta curing and salting industry (P. Echevarría, pers. comm., 03.2013), suggest that those industries are more profitable on a per tonne basis.

Regarding the profit generated by reduction products, it is worth repeating that taxes, subsidies, rights, depreciation costs and capital costs were excluded from calculations, in order to simplify and homogenise the basis for comparison among industries, and because their relative importance to the cost structure is rather low (Paredes and Gutiérrez, 2008; Paredes and Letona, 2013).

Due to its size, the fishmeal industry represents the third source of foreign exchange for the Peruvian economy —8% in average during 2000-2011, according to official statistics (SUNAT, 2012)—. Nonetheless, the anchoveta DHC industry shows a promising growth trend (Avadí et al., 2014c) and therefore represents great socio-economic potential.

Aquaculture products feature higher production costs per produced tonne of fish than anchoveta DHC products per processed fish, but generate greater added value and gross profit (except when compared to anchoveta curing and salting).

**Table 6** Nutritional profile of various *anchoveta* DCH and other Peruvian fish products (see text for ranking method)

| Edible portion     | Energy<br>kcal·100 <sup>-1</sup> g  | Protein                                  | Basic profile (%)               |                |      | Vitamins (µg·100 <sup>-1</sup> g) |      |      |      |       | Minerals (mg·100 <sup>-1</sup> g) |       |       |     | Ranking<br>(1=best) |
|--------------------|-------------------------------------|--|---------------------------------|----------------|------|-----------------------------------|------|------|------|-------|-----------------------------------|-------|-------|-----|---------------------|
|                    |                                     |  | Lipids (total,<br>Omega-3, SFA) | Water          | Ash  | A                                 | B-12 | D    | Ca   | Na    | K                                 | P     | Fe    |     |                     |
| Anchoveta products | Fresh/frozen (gutted)               | 465.8 <sup>a</sup><br>188.2 <sup>b</sup> | 19.1                            | 8.8, 2.5, 1.3  | 70.8 | 1.2                               | 15.0 | 0.6  | <0.1 | 77.1  | 78.0                              | 241.4 | 174.0 | 3.0 | 2                   |
|                    | Canned (HGT) <sup>c</sup>           | 166.0                                    | 21.3                            | 9.0, 2.6, 2.7  | 59.8 | 3.5                               | 18.5 | 11.2 | 6.4  | 365.0 | 408.0                             | 380.5 | 400.5 | 2.5 | 1                   |
|                    | Salted (HGT) <sup>c</sup>           | 126.1                                    | 18.4                            | 5.9, 1.7, 2.2  | 43.0 | 6.2                               | 12.0 | 0.9  | 1.7  | 232.0 | 1 223                             | 544.0 | 252.0 | 4.6 | 3                   |
|                    | Cured (fillets) <sup>c</sup>        | 155.8                                    | 30.0                            | 4.0, 1.2, 2.2  | 48.1 | 17.6                              | 12.0 | 0.9  | 1.7  | 232.0 | 3 668                             | 544.0 | 252.0 | 4.6 | 7                   |
| Fresh fish         | Cultured rainbow trout <sup>d</sup> | 171.1                                    | 18.4                            | 7.6, 0.7, 1.4  | 73.8 | 1.2                               | 84.0 | 4.3  | 15.9 | 25.0  | 51.0                              | 377.0 | 226.0 | 0.3 | 4                   |
|                    | Cultured black pacu <sup>e</sup>    | 196.8                                    | 15.0                            | 12.0, 0.4, 4.8 | 71.6 | 2.1                               | 6.0  | 2.2  | 2.9  | 35.0  | 35.3                              | 164.9 | 631.8 | 0.5 | 6                   |
|                    | Cultured red tilapia <sup>f</sup>   | 108.6                                    | 18.3                            | 1.9, 0.1, 0.6  | 80.5 | 1.4                               | 0.0  | 1.6  | 3.1  | 10.0  | 52.0                              | 302.0 | 170.0 | 0.6 | 5                   |

Notes: When alternative values for the same parameter were available, averages were used. For energy calculations, the following conversion factor was used for MJ·kg<sup>-1</sup> to kcal·100<sup>-1</sup> g: 0.1·0.004184<sup>-1</sup>. For the Omega-3 figures, only eicosapentaenoic acid (EPA, 20:5) and docosahexaenoic acid (DHA, 22:6) were considered, and are expressed as percentages of the total product weight, in parenthesis. Due to the variety of data sources, a ±2% error may occur in the total percentage of the basic profiles. Data for cultured species is relative to edible portions.

Sources: <sup>a</sup> Calorimetry measurements for anchoveta muscle/fillets (IMARPE, 2011, unpublished data), <sup>b</sup> Torry Research Station (1989), IMARPE-ITP (1996), Peter Tyedmers (pers. comm., 2012), industry data (<http://www.tasa.com.pe/>), USDA (2012) values for European anchovy. <sup>c</sup> ITP (2007), González et al. (2007), (Reyes et al., 2009), USDA (2012) and <http://www.nutraqua.com/> values for canned sardine and cured European anchovy. <sup>d</sup> Austreng and Refstie (1979), Celik et al. (2007), Dumas et al. (2007), Fallah et al. (2011), Sousa et al. (2002) and USDA (2012). <sup>e</sup> Almeida et al. (2008), Almeida and Bueno Franco (2006), Barua and Chakraborty (2011), Bezerra (2002), González et al. (2007), Melho Filho et al. (2013), Torry Research Station (1989), Machado and Sgarbieri (1991), Oishi et al. (2010), Van der Meer (1997) and <http://www.nutraqua.com/> values for vitamins are averages of *Pangasius hypophthalmus*, *Lates niloticus* and *Oreochromis niloticus niloticus*. <sup>f</sup> Torry Research Station (1989), Mendieta and Medina (1993) and USDA (2012) values for mixed tilapia species.

**Table 7** Nutritional profile of other animal protein sources consumed in Peru

| Edible portion                       | Energy<br>kcal·100 <sup>-1</sup> g | Protein | Basic profile (%)               |       |     | Vitamins (µg·100 <sup>-1</sup> g) |      |     |       |       | Minerals (mg·100 <sup>-1</sup> g) |       |     |   | Ranking<br>(1=best) | Consumption e<br>(kg·person <sup>-1</sup> ·y <sup>-1</sup> ) |
|--------------------------------------|------------------------------------|---------|---------------------------------|-------|-----|-----------------------------------|------|-----|-------|-------|-----------------------------------|-------|-----|---|---------------------|--|
|                                      |                                    |         | Lipids (total,<br>Omega-3, SFA) | Water | Ash | A                                 | B-12 | D   | Ca    | Na    | K                                 | P     | Fe  |   |                     |  |
| Beef (lean) <sup>a,b</sup>           | 105.0                              | 21.3    | 10.0, 0.04, 4.1                 | 75.9  | 1.1 | 0.0                               | 2.7  | 0.0 | 16.0  | 59.0  | 271.0                             | 208.0 | 3.4 | 3 | 5.1                 |  |
| Chicken (lean) <sup>a,b</sup>        | 119.0                              | 21.4    | 9.3, 0, 2.7                     | 75.5  | 1.0 | 16.0                              | 0.3  | 3.3 | 12.0  | 64.0  | 144.0                             | 173.0 | 1.5 | 5 | 17.4                |  |
| Eggs <sup>a,b</sup>                  | 141.0                              | 13.5    | 8.4, 0.6, 3.1                   | 75.4  | 0.9 | 140.0                             | 0.9  | 2.1 | 34.0  | 142.0 | 138.0                             | 194.0 | 1.1 | 2 | 6.6                 |  |
| Fresh cheese <sup>a,b</sup>          | 264.0                              | 17.5    | 20.1, 0.05, 13.7                | 55.0  | 4.1 | 420.0                             | 1.8  | 0.7 | 783.0 | 704.0 | 126.0                             | 375.0 | 1.3 | 8 | 2.4                 |  |
| Hake (edible portion) <sup>c,d</sup> | 102.3                              | 16.6    | 1.2, 0.5, 0.3                   | 82.1  | 1.2 | 7.3                               | 0.5  | 1.0 | 14.7  | 64.0  | 403.7                             | 180.0 | 0.0 | 1 | N/A                 |  |
| Milk <sup>a,b</sup>                  | 63.0                               | 3.1     | 7.6, 0, 4.6                     | 87.8  | 0.7 | 28.0                              | 0.2  | 0.2 | 106.0 | 106.0 | 303.0                             | 94.0  | 1.3 | 6 | 48.1                |  |
| Pork (carcass) <sup>a,b</sup>        | 198.0                              | 14.4    | 15.1, 0.01, 7.9                 | 69.2  | 1.2 | 2.0                               | 0.6  | 0.0 | 12.0  | 42.0  | 253.0                             | 238.0 | 1.3 | 7 | 1.0                 |  |
| Shrimp <sup>a,f</sup>                | 71.0                               | 13.6    | 1.0, 0.1, 0.1                   | 83.0  | 1.9 | 54.0                              | 1.1  | 0.1 | 54.0  | 566.0 | 113.0                             | 244.0 | 0.2 | 4 | N/A                 |  |

Notes: See notes for Table 6.

Sources: <sup>a</sup> USDA (2012), <sup>b</sup> Reyes et al. (2009), <sup>c</sup> IMARPE-ITP (1996), <sup>d</sup> Dias et al. (2003), <sup>e</sup> INEI (2012b), <sup>f</sup> PRODUCE (2012b).

**Table 8** Socio-economic indicators for the *anchoveta* DHC processing industries and comparison with the reduction industry (per tonne of processed whole fish) and aquaculture (per tonne of production), for the reference year 2009 (two other seafood products added for comparison)

| Indicator           | Unit                                  | Landings    |               | Reduction |           |         |        | Direct Human Consumption |          |        | Aquaculture |         |              |                 | Other products |  |
|---------------------|---------------------------------------|-------------|---------------|-----------|-----------|---------|--------|--------------------------|----------|--------|-------------|---------|--------------|-----------------|----------------|--|
|                     |                                       | Steel fleet | Vikinga fleet | SMS fleet | FMFO      | Canning | Curing | Salting (artisanal)      | Freezing | Trout  | Black pacu  | Tilapia | Trawled hake | Cultured shrimp |                |  |
| Production          | t · y <sup>-1</sup>                   | 5 043 916   | 939 588       | 341 476   | 1 617 497 | 95 589  | 9 772  | 3 450                    | 43 985   | 12 817 | 564         | 1261    | 47 162       | 13 425          |                |  |
| Revenues            | 10 <sup>3</sup> USD · y <sup>-1</sup> | 683 444     | 115 356       | 44 392    | 1 675 995 | 101 224 | 24 909 | 13 370                   | 81 006   | 49 146 | 2 153       | 3 331   | 12 734       | 45 810          |                |  |
| Employment (direct) | jobs · y <sup>-1</sup>                | 10 744      | 6 361         | 7 144     | 12 550    | 8 032   | 2 515  | 338                      | 1827     | 13 024 | 492         | 672     | 389          | 2 180           |                |  |
|                     | jobs · t <sup>-3</sup>                | 2           | 7             | 21        | 8         | 84      | 257    | 98                       | 42       | 1016   | 872         | 533     | 8            | 162             |                |  |
| Production costs    | 10 <sup>3</sup> USD · y <sup>-1</sup> | 514 984     | 86 226        | 19 089    | 1 136 332 | 78 955  | 17 492 | 8 815                    | 66 318   | 32 594 | 1132        | 2 232   | 5 985        | 33 563          |                |  |
|                     | USD · t <sup>-1</sup>                 | 102.1       | 91.8          | 55.9      | 702.5     | 826.0   | 1790   | 2 555                    | 1508     | 2 543  | 2 007       | 1770    | 126.9        | 2 500           |                |  |
| Value added         | 10 <sup>3</sup> USD · y <sup>-1</sup> | 120 901     | 20 906        | 39 065    | 491 029   | 60 734  | 14 945 | 4 145                    | 13 365   | 25 695 | 1192        | 1758    | 5 094        | 22 450          |                |  |
|                     | USD · t <sup>-1</sup>                 | 24.0        | 22.3          | 114.4     | 303.6     | 635.4   | 1529   | 1201                     | 303.9    | 2 005  | 2 113       | 1394    | 108.0        | 1672            |                |  |
| Gross profit        | 10 <sup>3</sup> USD · y <sup>-1</sup> | 164 460     | 29 130        | 25 303    | 539 663   | 22 269  | 7 417  | 4 327                    | 14 689   | 16 553 | 1021        | 1099    | 6 749        | 12 247          |                |  |
|                     | USD · t <sup>-1</sup>                 | 33.4        | 31.0          | 74.1      | 333.6     | 233.0   | 759.0  | 1245                     | 334.0    | 1291   | 1811        | 871.7   | 143.1        | 912.3           |                |  |

Notes: Value added = revenues - purchased inputs, Gross profit = revenues - costs. Industry data was available regarding production costs and revenues for curing and salting (P. Echevarría, pers. comm., 03.2013), canning and SMS anchoveta landings for direct human consumption (DHC) (Fréon et al., 2013), and hake landings (Paredes, 2013). For other landings, reduction and DHC, calculations are based on data for the whole Peruvian fisheries and processing industries, including all species (Christensen et al., 2013), adjusted for anchoveta based on contribution rates (by mass): 70% of SMS landings (Fréon et al., 2014b), 50% of canning and 10% of freezing (Peruvian industry experts, personal communications, 2012-2013). Similar adjustments made for hake trawling: 95% (IMARPE, unpublished data). For aquaculture, prices and employment figures are from Mendoza (2011, 2013) and production costs:revenues and purchases:other costs ratios used are from Berger et al. (2005), Maradiague et al. (2005), MAXIMIXE (2010) and Rebaza et al. (2008). All production figures are from PRODUCE statistics, the SMS fleet production figure adjusted for illegal, unreported and unregulated fishing landings.



### 3.4 Limitations and additional comparison devices

A missing aspect of the proposed panel of indicator is the policy and fisheries management dimensions. These dimensions are central within internationally accepted assessment mechanisms such as the Marine Stewardship Council's (MSC, 2010) certification, which in contrast does not make use of the environmental indicators proposed here. A combination of the criteria applied by an eco-label/certification scheme and a sustainability indicator set should cover all sustainability aspects inherent to seafood systems. MSC-related initiatives have been and are being carried out in Peru in relation to anchoveta fisheries and products (de la Puente et al., 2011; P. Echevarría, pers. comm., 03.2013).

Another limitation is the lack of full assessment of direct ecosystem impacts due to species/biomass removal (only addressed here through BRU), which will be addressed in another publication, by means of an ecosystem model depicting the interactions between the marine ecosystem and the fisheries exploiting it.

Further limitations in the scope of the proposed indicator set, especially in the environmental dimension, are due to inherent limitations of LCA in relation to fisheries and aquaculture, such as: destruction of habitats, spread of disease and escapees from aquaculture, impacts of certain substances released to the environment (oils, medicaments, some antifouling substances), etc (Avadí and Fréon, 2013; Samuel-Fitwi et al., 2012; Vázquez-Rowe et al., 2012).

The decision makers should face a dilemma in front of the presented results: should they favour the fish products that are the friendliest to the environment, or the one that generate more employment and gross profit? An additional aid to the decision can be offered by ratio indicators, although such indicators must be used with caution. For instance, one can compute the gross profit generation by single score environmental impact for each tonne of product or the

employment per single score (or a combination of various indicators by single score). Other score ratios could be related to the nutritional value (score) or the embodied energy efficiency (EROI) of each product. Nonetheless, a score ratio can be excellent (or poor) for two different reasons: its numerator its high or its denominator is low. Two of these suggested ratios are presented in the Supplementary Material.

## 4 Conclusions

The suggested sustainability assessment indicator set depicts most of the main aspects of sustainability related to seafood products. The multi-criteria decision tool presented illustrates the relative performance of various supply chains competing for the same basic raw material (anchoveta, either as raw material for processing or for aquafeeds), in a holistic way that allows identification of eco-efficiency and socio-economic hotspots.

Regarding the anchoveta DHC industries, it is possible to conclude that the least energy-intensive industries (freezing and salting; less refined products) are less environmentally impacting and economically interesting, yet providing a similar number of jobs and delivering nutritionally equivalent products than the more energy-intensive industries (canning and curing; more refined products); as synthesised in Fig. 2a. In order to contribute to the nutrition of vulnerable (and often remote) communities in Peru, canned and salted anchoveta products should be preferred for their longer shelf life and simpler transportation and storage requirements. Nonetheless, this advantage is questioned by the consumer preference and retail price of such products (Fréon et al., 2013). Should a cold chain be in place, fresh/frozen anchoveta products would be suitable options. Despite an important increase in overall impacts associated with the operation of a cold distribution chain if it has to be expended to the interior of the country, such an increase does not worsen the environmental performance of fresh and frozen products in comparison to the energy intensive products

canned and cured (Avadí et al., 2014c). Canned products are the more expensive to produce and thus feature a higher retailing price, yet remain a good overall alternative in most dimensions of analysis, except for its environmental performance. Alternative container technology (i.e. tetra pack) would improve environmental performance and lower transportation costs of such products (Labouze et al., 2008).

For Peruvian freshwater aquaculture products, environmental performance is largely related to the composition of aquafeeds (Avadí et al., 2014b), as seem to be the other dimensions of analysis (Fig. 2b). Moreover, aquaculture products display better performance than anchoveta DHC products regarding socio-economic indicators.

Finally, a good option can be encouraged only if it has a reasonable chance of succeeding from a market point of view, which takes into account additional factors such as demand and supply. For instance, in Peru offer (and to a lesser extent demand) favours canned over other anchoveta DHC and freshwater aquaculture products. It is difficult to claim an absolute superior sustainability performance for any product, even after a multi-disciplinary assessment as the one proposed, without taking into account additional socio-economical factors and political issues. The later depends on the priorities of the decision makers, whether they include improving nutrition, employment, gross profit generation, energy use and/or environmental performance. Nonetheless we advocate using this type of analysis as a tool in decision making for competing, alternative or potential food products.

### Acknowledgements

This work, carried out by a member of the Anchoveta Supply Chain (ANCHOVETA-SC) project (<http://anchoveta-sc.wikispaces.com>) is a contribution to the International Join Laboratory “Dynamics of the Humboldt Current system” (LMI-DISCOH) coordinated by the Institut de Recherche pour le Développement (IRD) and the Instituto del Mar del Peru (IMARPE), and gathering several

other institutions. It was carried out under the sponsoring of the Direction des Programmes de Recherche et de la formation au Sud (DPF) of the IRD. The authors benefited from a partial funding of the GEMCH program (Hacia un manejo con enfoque ecosistémico del Gran Ecosistema Marino de la Corriente Humboldt) of UNDP, and from the support from Mariano Gutierrez, Senior Project Officer in this program. We acknowledge Francisco Miro, Alberto Salas (ITP), Pablo Echevarría (Compañía Americana de Conservas SAC) and Santiago de la Puente (CSA-UPCH) for their support in data gathering. Sara Hornborg (SIK) contributed with valuable critiques on ecological indicators, and Pascale Talamond (IRD) with ideas for the nutritional index.

### References

- Almeida NM, Bueno Franco MR (2006) Determination of essential fatty acids in captured and farmed tambaqui (*Colossoma macropomum*) from the Brazilian Amazonian area. *J Am Oil Chem Soc* 83:707–711.
- Almeida NM, Visentainer JV, Franco MRB (2008) Composition of total, neutral and phospholipids in wild and farmed tambaqui (*Colossoma macropomum*) in the Brazilian Amazon area. *J Sci Food Agric* 88:1739–1747.
- Aubin J (2013) Life Cycle Assessment as applied to environmental choices regarding farmed or wild-caught fish. *CAB Rev*
- Austreng E, Refstie T (1979) Effect of varying dietary protein level in different families of rainbow trout. *Aquaculture* 18:145–156.
- Avadí A, Fréon P (2013) Life cycle assessment of fisheries: A review for fisheries scientists and managers. *Fish Res* 143:21–38.
- Avadí A, Fréon P, Quispe I (2014c) Environmental assessment of Peruvian anchoveta direct human consumption products. *Int J Life Cycle Assess* (in review).
- Avadí A, Pelletier N, Aubin J, Ralite S, Núñez J, Fréon P (2014b) Comparative environmental performance of artisanal and commercial feed use in Peruvian freshwater aquaculture. *Aquaculture* (in review).

- Avadí A, Vázquez-Rowe I, Fréon, P (2014a) Eco-efficiency assessment of Peruvian anchoveta steel and wooden fleets using the LCA+DEA framework. *J Clean Prod* (in press).
- Ayer NW, Tyedmers PH (2009) Assessing alternative aquaculture technologies: life cycle assessment of salmonid culture systems in Canada. *J Clean Prod* 17:362–373.
- Balestrat M, Chery JP, Tonneau JP (2010) Onstruction d ' indicateurs spatiaux pour l ' aide a la decision : interet d ' une demarche participative I. ISDA2. Montpellier, pp 28–30
- Barua P, Chakraborty S (2011) Proximate composition of egg, stomach content and body composition of Pacu (*Piaractus brachypomus*) collected from aquatic environment of Bangladesh. *Curr Biot* 5:330–343.
- Berger C, Quispe M, Talavera V (2005) Programa Nacional para la Competitividad de la Acuicultura Langostinera en el Perú 2005-2014. 1–118.
- Bezerra A (2002) Growth and protein digestibility of Tambaqui, *Colossoma macropomum*, Cuvier 1818, fed diets based on fish silage. Aquaculture Department, Memorial University of Newfoundland, Masters Dissertation
- Bowen R, Riley C (2003) Socio-economic indicators and integrated coastal management. *Ocean Coast Manag* 46:299–312.
- Celik M, GÖKÇE M, BASUSTA N, et al. (2008) Nutritional quality of rainbow trout (*Oncorhynchus mykiss*) caught from the Atatürk Dam Lake in Turkey. *J Muscle Foods* 19:50–61.
- Christensen V, de la Puente S, Sueiro JC, et al. (2013) Valuing seafood: the Peruvian fisheries sector. *Mar Policy*
- Csirke, J. 1996. Análisis bioeconómico de la pesquería pelágica peruana dedicada a la producción de harina y aceite de pescado. *Boletín Inst. Mar Perú*. 19:25-68.
- Darmon N, Darmon M, Maillot M, Drewnowski A (2005) A nutrient density standard for vegetables and fruits: nutrients per calorie and nutrients per unit cost. *J Am Diet Assoc* 105:1881–7.
- De la Puente O, Sueiro JC, Heck C, et al. (2011) La Pesquería Peruana de Anchoveta - Evaluación de los sistemas de gestión pesquera en el marco de la certificación a cargo del Marine Stewardship Council (The Peruvian anchoveta fishery - Assessment of the fishery management systems in the framework of th. *Doc Trab del Cent para la Sostenibilidad Ambiental UPCH* 160.
- Dias MG, Sánchez MV, Bártolo H, Oliveira L (2003) Vitamin content of fish and fish products consumed in Portugal. *Electron J Environ Agric Food Chem* 2:510–513.
- Drewnowski A, Fulgoni III V (2008) Nutrient profiling of foods: creating a nutrient-rich food index. *Nutr Rev* 66:23–39.
- Dumas A, de Lange CFM, France J, Bureau DP (2007) Quantitative description of body composition and rates of nutrient deposition in rainbow trout (*Oncorhynchus mykiss*). *Aquaculture* 273:165–181.
- Ecoinvent (2012) The ecoinvent Centre portal. <http://www.ecoinvent.ch/>.
- Esposito P, Bertrand A (2008) Revisiting Peruvian anchovy (*Engraulis ringens*) trophodynamics provides a new vision of the Humboldt Current system. *Prog Oceanogr* 79:215–227.
- Fallah A a., Siavash Saei-Dehkordi S, Nematollahi A (2011) Comparative assessment of proximate composition, physicochemical parameters, fatty acid profile and mineral content in farmed and wild rainbow trout (*Oncorhynchus mykiss*). *Int J Food Sci Technol* 46:767–773.
- FAO (2000) FAO - Perfiles nutricionales por países - Peru (FAO - Nutritional profiles by country - Peru). Rome: Food and Agriculture Organisation of the United Nations <http://www.bvsde.paho.org/texcom/nutricion/permap.pdf>
- FAO (2011) Country Profile: Food Security Indicators. Country: Peru. [http://www.fao.org/fileadmin/templates/ess/documents/food\\_security\\_statistics/country\\_profiles/eng/Peru\\_E.pdf](http://www.fao.org/fileadmin/templates/ess/documents/food_security_statistics/country_profiles/eng/Peru_E.pdf)
- FDA (2013) A Food Labelling Guide. US Department of Health and Human Services, Food and Drug Administration <http://www.fda.gov/downloads/Food/GuidanceRegulation/UCM265446.pdf>

- Fréon P, Avadí A, Marín W, Negrón R (2014b) Environmentally-extended comparison table of the Peruvian anchoveta large-scale vs. the small- and medium-scale fleets. *Can J Fish Aquat Sci* (in review).
- Fréon P, Avadí A, Vinatea RA, Iriarte F (2014a) Life cycle assessment of the Peruvian industrial anchoveta fleet: boundary setting in life cycle inventory analyses of complex and plural means of production. *Int J Life Cycle Assess* (in press).
- Fréon P, Sueiro JC, Iriarte F, et al. (2013) Harvesting for food versus feed: a review of Peruvian fisheries in a global context. *Rev Fish Biol Fisheries*. doi: 10.1007/s11160-013-9336-4
- Froese R, Pauly D (2011) FishBase: *Engraulis ringens*. <http://www.fishbase.org/summary/Engraulis-ringens.html>.
- Gerbens-Leenes P, Moll A, Uiterkamp S (2003) Design and development of a measuring method for environmental sustainability in food production systems. *Ecol Econ* 46:231–248.
- Goedkoop M, Heijungs R, Huijbregts M, et al. (2009) ReCiPe 2008. A life cycle impact assessment method which comprises harmonised category indicators at the midpoint and the endpoint level. Report I: Characterisation. Ministry of Housing, Spatial Planning and Environment (VROM) Ministry of Housing, Spatial Planning and Environment (VROM) [www.lcia-recipe.info](http://www.lcia-recipe.info)
- Goedkoop M, Heijungs R, Huijbregts M, et al. (2013) ReCiPe 2008. A life cycle impact assessment method which comprises harmonised category indicators at the midpoint and the endpoint level. Report I: Characterisation. Ministry of Housing, Spatial Planning and Environment (VROM)
- Goedkoop M, Spriensma R (2001) The Eco-indicator 99 - A damage oriented method for Life Cycle Impact Assessment - Methodology Annex. Assessment 144.
- González Á, Márquez A, Senior W, Martínez G (2007) Constituyentes minerales del Morocoto *Piaractus brachypomus* en el orinoco medio de venezuela (Mineral Constituents of the Morocoto *Piaractus brachypomus* in the Middle Orinoco in Venezuela). *Rev Científica, FCV-LUZ XVII*:325–329.
- Guinée JB, Gorrée M, Heijungs R, et al. (2002) Handbook on life cycle assessment. Operational guide to the ISO standards. I: LCA in perspective. IIa: Guide. IIb: Operational annex. III: Scientific background. 692.
- Hall C a. S (2011) Introduction to Special Issue on New Studies in EROI (Energy Return on Investment). *Sustainability* 3:1773–1777.
- Halog A, Manik Y (2011) Advancing Integrated Systems Modelling Framework for Life Cycle Sustainability Assessment. *Sustainability* 3:469–499.
- Heijungs R, Settanni E, Guinée J (2012) Toward a computational structure for life cycle sustainability analysis: unifying LCA and LCC. *Int J Life Cycle Assess* 18:1722–1733.
- Henriksson PJG, Guinée JB, Kleijn R, Snoo GR (2011) Life cycle assessment of aquaculture systems—a review of methodologies. *Int J Life Cycle Assess* 17:304–313.
- Hischier R, Weidema BP, Althaus H, et al. (2010) Implementation of Life Cycle Impact Assessment Methods. *ecoinvent report No. 3 (v2.2)*. Dübendorf: Swiss Centre for Life Cycle Inventories
- Hofstetter P (1998) Perspectives in life cycle impact assessment: a structured approach to combine models of the technosphere, ecosphere and valuesphere. 484.
- Hornborg S (2012) Evaluating Fisheries Management from a Life Cycle Perspective with New Approaches to By-catch Impacts. University of Gothenburg, Licentiate thesis
- Hornborg S, Belgrano A, Bartolino V, et al. (2013) Trophic indicators in fisheries: a call for re-evaluation. *Biol Lett*
- Hornborg S, Emanuelsson A, Sonesson U, Ziegler F (2012a) D.1.3b: By-catch methods in Life Cycle Assessment of seafood products. Public Consult 1–6.
- Hornborg S, Nilsson P, Valentinsson D, Ziegler F (2012b) Integrated environmental assessment of fisheries management: Swedish Nephrops trawl fisheries evaluated using a life cycle approach. *Mar Policy* 36:1–9.
- Hospido A, Vazquez M, Cuevas A, et al. (2006) Environmental assessment of canned tuna manufacture with a life-cycle perspective. *Resour Conserv Recycl* 47:56–72.
- Hückstädt L a., Rojas CP, Antezana T (2007) Stable isotope analysis reveals pelagic foraging by the

- Southern sea lion in central Chile. *J Exp Mar Bio Ecol* 347:123–133.
- IMARPE (2010) Boletín Instituto del Mar del Perú. Quinto panel internacional de expertos en evaluación de la anchoveta peruana (*Engraulis ringens* Jenyns. Callao, 10 – 14 agosto 2009. Lima: Instituto del Mar del Perú
- IMARPE-ITP (1996) Compendio Biológico-Tecnológico de las principales especies hidrobiológicas comerciales del Perú (Bio-technologic compendium of the main commercial hydrobiological species of Peru). 146.
- INEI (2011) Encuesta Demográfica y de Salud Familiar 2011 (Demographic and family health survey 2011). Lima: Instituto Nacional de Estadística e Informática (INEI)<http://proyectos.inei.gob.pe/endes/2011/>
- INEI (2012a) Perú: Compendio estadístico 2012. Pesca (Peru: Statistical compendium 2012. Fisheries). 887–916.
- INEI (2012b) Perú: Consumo per cápita de los principales alimentos 2008-2009 (Peru: Per capita consumption of main staple foods 2008-2009). <http://www.inei.gob.pe/biblioineipub/bancopub/Est/Lib1028/index.html>
- Iribarren D, Moreira MT, Feijoo G (2010) Life Cycle Assessment of fresh and canned mussel processing and consumption in Galicia (NW Spain). *Resour Conserv Recycl* 55:106–117.
- ISO (2006a) Environmental management – Life cycle assessment – Principles and framework (ISO 14040:2006). International Organization for Standardization (ISO)
- ISO (2006b) Environmental management – Life cycle assessment – Requirements and guidelines (ISO 14044:2006). International Organization for Standardization (ISO)
- ITP (2007) Investigación y desarrollo de productos pesqueros: Fichas técnicas (Research and development of fishery products: Technical sheets). Lima: Instituto Tecnológico Pesquero del Perú <http://www.itp.gob.pe/documentos/fichastecnicas2007.pdf>
- Jiménez F, Gómez C (2005) Evaluación nutricional de galletas enriquecidas con diferentes niveles de harina de pescado (Nutritional evaluation of cookies enriched with various levels of fishmeal). Publicación Virtual 010Lima: Red Peruana de Alimentación y Nutrición (r-PAN)<http://www.rpan.org/publicaciones/pv010.pdf>
- Joerin F, Nembrini A, Billeau S, Desthieux G (2005) Des « géoindicateurs » pour soutenir les processus participatifs en aménagement du territoire. *Rev Int Géomatique* 15:33–61.
- Jones A (2002) An Environmental Assessment of Food Supply Chains: A Case Study on Dessert Apples. *Environ Manage* 30:560–576.
- Kruse S, Flysjö A, Kasperczyk N, Scholz AJ (2008) Socioeconomic indicators as a complement to life cycle assessment—an application to salmon production systems. *Int J Life Cycle Assess* 14:8–18.
- Labouze E, Schultze A, Cruyppenninck H (2008) Analyses de Cycle de Vie des emballages de Tetra Pak. Ivry-sur-Seine: Bio Intelligence Service SAS, Tetra Pak [http://www.tetrapak.com/fr/SiteCollectionDocuments/Analyse\\_du\\_Cycle\\_de\\_Vie\\_ACV/rapport\\_final.pdf](http://www.tetrapak.com/fr/SiteCollectionDocuments/Analyse_du_Cycle_de_Vie_ACV/rapport_final.pdf)
- Landa Y (2012) La pesca de la anchoveta, el óptimo social y el desarrollo sostenible del sector (Anchoveta fishery, the social optimum and sustainable development of the fishery sector). Universidad Nacional Agrícola La Molina (UNALM) - Universidad Nacional Autónoma de México (UNAM), PhD Dissertation
- Langlois J, Fréon P, Delgenes J-P, Steyer J-P, & Hélias A (2014) New methods for impact assessment of biotic-resource depletion in LCA of fishery: theory and application. *J Clean Prod*. doi:10.1016/j.jclepro.2014.01.087
- Lassen, H, Barriga, E, Palacios, J, Vargas, N, Díaz, E, Arguelles, J & Purca, S. 2009. Evaluación del estado del stock de merluza (*Merluccius gayi peruanus* Ginsburg) en el mar peruano. 2008. *Bol. Inst. Mar Perú*. 24:21-26.
- Leadbitter D, Ward T (2007) An evaluation of systems for the integrated assessment of capture fisheries. *Mar Policy* 31:458–469.
- Libralato S, Coll M, Tudela S, et al. (2008) Novel index for quantification of ecosystem effects of fishing as removal of secondary production. *Mar Ecol Prog Ser* 355:107–129.

- Machado M, Sgarbieri V (1991) Partial characterization and nutritive value of proteins from pacu (*Colossoma mitrei*, Berg 1895). *J Agric Food Chem* 39:1715–1718.
- Maillot M, Darmon N, Darmon M, et al. (2007) Nutrient-dense food groups have high energy costs: an econometric approach to nutrient profiling. *J Nutr* 137:1815–20.
- Maradiague R, Farro E, Escala J, Yi D (2005) Planeamiento estratégico para la producción y comercialización de tilapias (Strategic planning for production and commercialisation of tilapia). Masters Thesis, <http://tesis.pucp.edu.pe/repositorio/handle/123456789/1673>
- MAXIMIXE (2010) Elaboración de Estudio de Mercado de la Trucha en Arequipa, Cusco, Lima, Huancayo y Puno - Estudio de Determinación y Especificaciones de la Trucha -. Lima: Ministerio de la Producción [http://crecemype.pe/RepositorioAPS/1/jer/PROPESCA\\_OTRO/difusion-publicaciones/a](http://crecemype.pe/RepositorioAPS/1/jer/PROPESCA_OTRO/difusion-publicaciones/a) DGA Jul10 Especificaciones de la Trucha.pdf
- McCausland WD, Mente E, Pierce GJ, Theodossiou I (2006) A simulation model of sustainability of coastal communities: Aquaculture, fishing, environment and labour markets. *Ecol Modell* 193:271–294.
- Melho Filho A, Oliveira HH de, Santos RC dos (2013) Omega-6/Omega-3 and PUFA/SFA in *Colossoma macropomum* Grown in Roraima, Brazil. *Orbital-The Electron J Chem* 5:30–34.
- Mendieta OW, Medina ML (1993) Salado y secado solar de tilapia (*Oreochromis sp*) en la región de San Martín. Salting and solar drying of tilapia (*Oreochromis sp*) in the San Martin region. *Folia Amaz* 5:117–127.
- Mendoza D (2011a) Panorama de la acuicultura mundial, América Latina y el Caribe y en el Perú (Overview of global aquaculture, Latin America and the Caribbean, and Peru). Lima: Dirección de Acuicultura, Ministerio de la Producción - PRODUCE [http://www.racua.org/uploads/media/informe\\_acuicultura\\_mundo\\_al\\_peru.pdf](http://www.racua.org/uploads/media/informe_acuicultura_mundo_al_peru.pdf)
- Mendoza D (2011b) Estudio sobre la acuicultura de la trucha a nivel mundial, el desenvolvimiento de la importación de ovas, la tendencia de la producción nacional y su comercialización. Lima: Dirección de Acuicultura, Ministerio de la Producción - PRODUCE
- Mendoza D (2013) Situación del extensionismo acuícola en el Perú (Situation of aquacultural extensionism in Peru). Report for Red de Acuicultura de las Américas (RAA) and FAOLima: Dirección de Acuicultura, Ministerio de la Producción - PRODUCE [http://rnia.produce.gob.pe/images/stories/archivos/pdf/publicaciones/informe\\_extensionismo\\_peru.pdf](http://rnia.produce.gob.pe/images/stories/archivos/pdf/publicaciones/informe_extensionismo_peru.pdf)
- Milà i Canals L, Bauer C, Depestele J, et al. (2007) Key Elements in a Framework for Land Use Impact Assessment Within LCA Land Use in LCA. *Int J* 12:5–15.
- Mitchell C, Cleveland CJ (1993) Resource scarcity, energy use and environmental impact: a case study of the New Bedford, Massachusetts, USA, fisheries. *Environ Manage* 17:305–317.
- MSC (2010) MSC Fishery Standard: Principles and Criteria for Sustainable Fishing. 1–8.
- Ness B, Urbel-Piirsalu E, Anderberg S, Olsson L (2007) Categorising tools for sustainability assessment. *Ecol Econ* 60:498–508.
- Oishi CA, Nwanna LC, Pereira Filho M (2010) Optimum dietary protein requirement for Amazonian Tambaqui, *Colossoma macropomum* Cuvier, 1818, fed fish meal free diets. *Acta Amaz* 40:757–762.
- Olsen SO (2004) Antecedents of Seafood Consumption Behavior. *J Aquat Food Prod Technol* 13:79–91.
- Papatryphon E, Petit J, Kaushik SJ, van der Werf HMG (2004) Environmental impact assessment of salmonid feeds using Life Cycle Assessment (LCA). *Ambio* 33:316–23.
- Paredes C, Gutiérrez ME (2008) La industria anchovetera Peruana: Costos y Beneficios. Un Análisis de su Evolución Reciente y de los Retos para el Futuro (The Peruvian anchoveta industry: Costs and benefits. An analysis of recent evolution and challenges for the future). Estudio preparado por encargo del Banco Mundial al Instituto del Perú de la Universidad de San Martín [http://institutodelperu.org.pe/descargas/informe\\_de\\_la\\_industria\\_de\\_anchoveta.pdf](http://institutodelperu.org.pe/descargas/informe_de_la_industria_de_anchoveta.pdf)
- Paredes CE (2012) Eficiencia y equidad en la pesca peruana: La reforma y los derechos de pesca (Efficiency and equity in Peruvian fisheries: Reform and fishing rights). Lima: Instituto del Perú

- Paredes CE (2013) ¿Atrapados en la red? La reforma y el futuro de la pesca en el Perú (Caught in the fishing net? Reform and future of fisheries in Peru). 227.
- Paredes CE, Letona Ú (2013) Contra la corriente: La anchoveta peruana y los retos para su sostenibilidad. 76.
- Parker R (2012) Review of life cycle assessment research on products derived from fisheries and aquaculture: A report for Seafish as part of the collective action to address greenhouse gas emissions in seafood. Final Report. Edinburgh: Sea Fish Industry Authority [http://www.seafish.org/media/583639/seafish\\_lca\\_review\\_report\\_final.pdf](http://www.seafish.org/media/583639/seafish_lca_review_report_final.pdf)
- Pauly D, Christensen V (1995) Primary production required to sustain global fisheries. *Nature* 374:255–257.
- Pingault N, Pr eault B (2007) Indicateurs de d veloppement durable: un outil de diagnostic et d'aide   la d cision (Sustainable development indicators: a diagnostic and decision support tool). Notes et  tudes  conomiques No. 28 Paris: Minist re de l'Agriculture et de la P che
- Plag nyi  E (2007) Models for an ecosystem approach to fisheries. *FAO Fish Tech Pap No 477* 108.
- Potts T (2006) A framework for the analysis of sustainability indicator systems in fisheries. *Ocean Coast Manag* 49:259–280.
- PR e (2012) SimaPro by PR e Consultants. <http://www.pre-sustainability.com/content/simapro-lca-software/>.
- PRODUCE (2012) Especies cultivadas en el Per  (Species cultured in Peru). Lima: Ministerio de la Producci n, Direcci n Nacional de Acuicultura [http://www2.produce.gob.pe/RepositorioAPS/3/jer/ACUISUBMENU4/boletines/FICHAS\\_PRINCIPALES\\_ESPECIES.pdf](http://www2.produce.gob.pe/RepositorioAPS/3/jer/ACUISUBMENU4/boletines/FICHAS_PRINCIPALES_ESPECIES.pdf)
- Rametsteiner E, P lzl H, Alkan-Olsson J, Frederiksen P (2011) Sustainability indicator development—Science or political negotiation? *Ecol Indic* 11:61–70.
- Rebaza C, Valdivieso M, Rebaza M, Chu-Koo F (2008) An lisis econ mico del cultivo de Gamitana (*Colossoma macropomum*) y Paco (*Piaractus brachypomus*) usando una dieta extrusada comercial en Ucayali (Economic analysis of the Gamitana (*Colossoma macropomum*) and Paco (*Piaractus brachypomus*) pond culture using. *Folia Amaz* 17:7–13.
- Reyes M, G mez-S nchez I, Espinoza C, et al. (2009) Tablas peruanas de composici n de alimentos (Peruvian tables of food composition). Lima: Peruvian Ministry of Health, Centro Nacional de Alimentaci n y Nutrici n
- Rokovich JA (2009) Estudios para el desarrollo de clusters en la actividad pesquera industrial y artesanal de anchoveta y pota - Informe final. Proyecto UE-PERU/PENX Lima: ICON-INSTITUT GmbH
- Rosenbaum RK, Bachmann TM, Gold LS, et al. (2008) USEtox—the UNEP-SETAC toxicity model: recommended characterisation factors for human toxicity and freshwater ecotoxicity in life cycle impact assessment. *Int J Life Cycle Assess* 13:532–546.
- Roth I (2002) Mesurer le d veloppement durable (Measuring sustainable development). *Bull ASEP* 8:1–8.
- Samuel-Fitwi B, Wuertz S, Schroeder JP, Schulz C (2012) Sustainability assessment tools to support aquaculture development. *J Clean Prod* 32:183–92.
- Shin YJ, Shannon LJ (2010) Using indicators for evaluating, comparing, and communicating the ecological status of exploited marine ecosystems. 1. The IndiSeas project. *ICES J Mar Sci* 67:686–691.
- Shin Y-J, Shannon LJ, Bundy A, et al. (2010) Using indicators for evaluating, comparing, and communicating the ecological status of exploited marine ecosystems. 2. Setting the scene. *ICES J Mar Sci* 67:692–716.
- Singh R, Murty H, Gupta S, Dikshit A (2009) An overview of sustainability assessment methodologies. *Ecol Indic* 9:189–212.
- Sioen I, De Henauw S, Van Camp J, et al. (2009) Comparison of the nutritional-toxicological conflict related to seafood consumption in different regions worldwide. *Regul Toxicol Pharmacol* 55:219–28.
- Sioen I, Leblanc J-C, Volatier J-L, et al. (2008) Evaluation of the exposure methodology for risk-benefit assessment of seafood consumption. *Chemosphere* 73:1582–8.
- Sousa R, Santos P, Bambirra E, et al. (2002) Nutritional characteristics of amazonian fish fat (*Colossoma*

- macropomum) and its effect on lipid metabolism of rats fed hypercholesterolemic diets. *Food Sci Technol* 22:88–93.
- Ström S, Helmfrid I, Glynn A, Berglund M (2011) Nutritional and toxicological aspects of seafood consumption--an integrated exposure and risk assessment of methylmercury and polyunsaturated fatty acids. *Environ Res* 111:274–80.
- SUNAT (2012) National Customs and Tax Administration. <http://www.sunat.gob.pe/>.
- Torrejón J, Díaz E, Limache J (2012) Descarte por exceso de captura en la pesquería del stock norte-centro de la anchoveta peruana (*Engraulis ringens* J.) entre el 2005 – 2011 (Discard due to excess captures in the North-Center stock of the Peruvian anchoveta fishery between 2005 and 2011). In: Indacochea A (ed) III CONCIMAR Congr. Ciencias del Mar del Perú, Libr. resúmenes Digit. Universidad Científica del Sur, Facultad de Biología Marina y Econgocios, Lima: 25 al 29 de Junio, p 361
- Torry Research Station (1989) Yield and nutritional value of the commercially more important fish species. Rome: Food and Agriculture Organisation of the United Nations
- Tyedmers P (2000) Salmon and Sustainability: The biophysical cost of producing salmon through the commercial salmon fishery and the intensive salmon culture industry. The University of British Columbia, PhD Dissertation, <https://circle.ubc.ca/handle/2429/13201>
- Tyedmers P, Watson R, Pauly D (2005) Fueling global fishing fleets. *Ambio* 34:635–8.
- USDA (2012) USDA National Nutrient Database for Standard Reference, Release 25. In: U.S. Dep. Agric. Agric. Res. Serv. Nutr. Data Lab. Home Page. <http://www.ars.usda.gov/ba/bhnrc/ndl>.
- Van der Meer MB (1997) Feeds and feeding strategies for *Colossoma macropomum* (Cuvier 1818): fish growth as related to dietary protein. Wageningen Institute of Animal Sciences, Wageningen Agricultural University, PhD Dissertation
- Van Zelm R, Huijbregts M a. J, Meent D (2009) USES-LCA 2.0—a global nested multi-media fate, exposure, and effects model. *Int J Life Cycle Assess* 14:282–284.
- Vázquez-Rowe I, Hospido A, Moreira MT, Feijoo G (2012) Best practices in life cycle assessment implementation in fisheries. Improving and broadening environmental assessment for seafood production systems. *Trends Food Sci Technol* 28:116–131.
- VDI (1997) Cumulative Energy Demand - Terms, Definitions, Methods of Calculation. VDI-Richtlinien 4600Düsseldorf: Verein Deutscher Ingenieure
- Weaver KL, Ivester P, Chilton J a, et al. (2008) The content of favorable and unfavorable polyunsaturated fatty acids found in commonly eaten fish. *J Am Diet Assoc* 108:1178–85.



## Supplementary material

### A. Calculation of the ReCiPe single scores

Impact categories included in the single score are as follows, per area of protection (AoP):

- Human health, for which the endpoint indicators is expressed as disability-adjusted life years – DALY (Hofstetter, 1998): Climate change, Ozone depletion, Human toxicity, Photochemical oxidant formation, Ionising radiation, and Particulate matter formation.
- Ecosystems, for which the endpoint is expressed as the potentially disappeared fraction of species (PDF) integrated over area/volume and time (Goedkoop and Spriensma, 2001): Terrestrial ecotoxicity, Terrestrial acidification, Agricultural land occupation, Urban land occupation, Marine ecotoxicity, Freshwater eutrophication, and Freshwater ecotoxicity.
- Resources, for which the endpoint indicators is expressed as the marginal cost increase of extracting a resource (in year 2 000 USD): Metal depletion, Fossil depletion.

In this study, the weighting set used was the Egalitarian/Average one, that is to say, the one where Human health contributes 40% to the single score, Ecosystems 40% and Resources 20%. Within AoPs, ReCiPe applies no weighting set among individual impact categories, but rather account for the contribution of each impact category's value to the unit in which each AoP is expressed.

### B. Calculation of Nutrient Rich Food scores

The Nutrient Rich Food (NRF<sub>n.3</sub>) index (Drewnowski and Fulgoni III, 2008), based on nutrient density (Darmon et al., 2005) and the LIM model of nutrients to limit (Maillot et al., 2007), was calculated for a 100 g portion of seafood. The weighted version was tailored for the Peruvian population's nutritional requirements, considering the following nutritional deficiencies that were identified in previous works: mineral, vitamin and other macro- and microelement deficiencies, especially of vitamin A, iron and calories/protein (Creed-Kanashiro and Uribe, 2000; Romaña, 2005; Sacco et al., 2003).

Therefore we applied the following weighting set on a semi-arbitrary base:

- protein: 25%,
- Omega-3 fatty acids (EPA + DHA): 30%,
- other non-saturated lipids (including Omega-6 fatty acids): 10%,
- vitamin A: 10%,
- vitamins B-12 and D: 5% each;
- calcium, potassium and phosphorus: 5% each,
- iron: 10%,
- sodium: -5%, and
- saturated fatty acids: -5%.

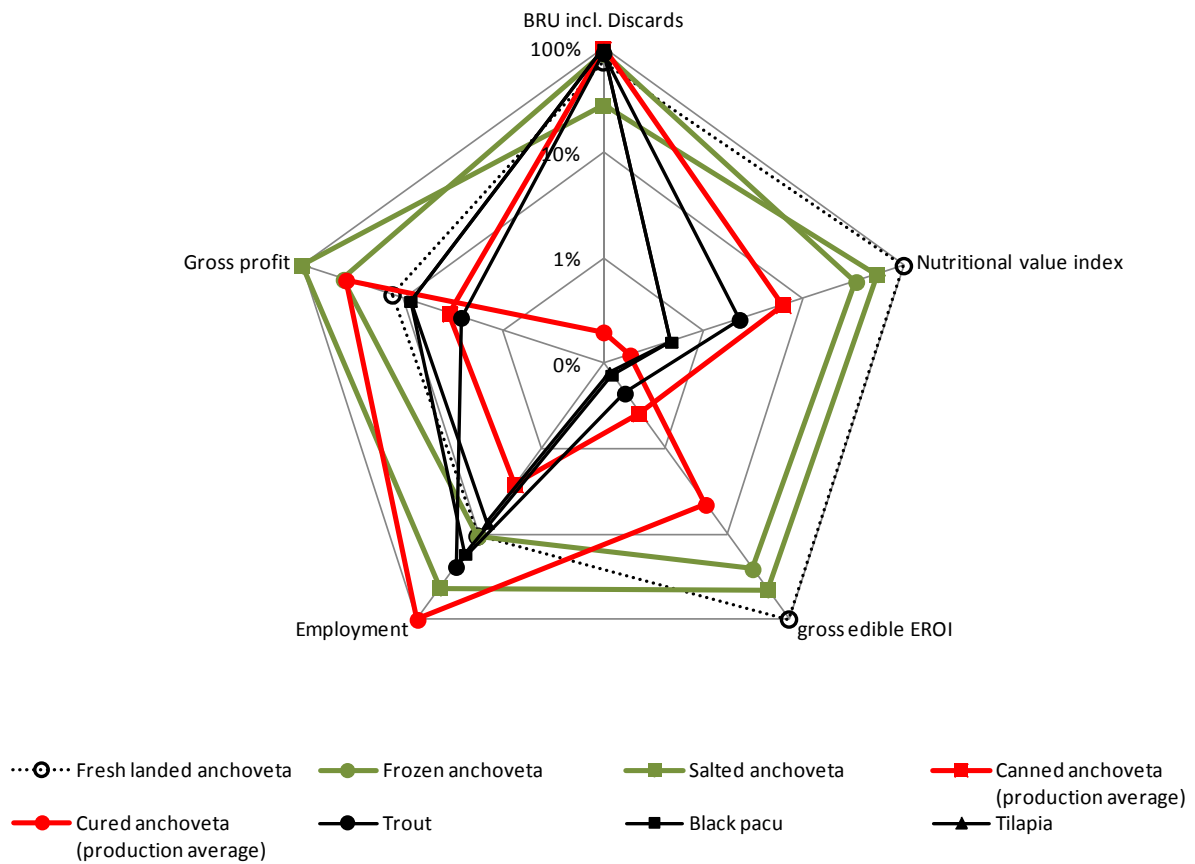
The high weight of Omega-3 fatty acids is justified by the large health benefits to humans, when consumed, attributed to EPA and DHA (Bellows et al., 2010; Bourre, 2005; Pike and Jackson, 2010). The currently inexistent yet potentially interesting product "Anchoveta, fillets" (chilled) was also modelled. See section 2.2 in the paper for methodological details.

**Table B.1** Unweighted and weighted Nutrient Rich Food scores

| Protein products                    | NRF <sub>n</sub><br>original | LIM<br>original | NRF <sub>n.3</sub><br>original | NRF <sub>n</sub><br>weighted | LIM<br>weighted | NRF <sub>n.3</sub><br>weighted | Rank<br>original<br>NRF <sub>n.3</sub> | Rank<br>weighted<br>NRF <sub>n.3</sub> |
|-------------------------------------|------------------------------|-----------------|--------------------------------|------------------------------|-----------------|--------------------------------|--|--|
| Anchoveta, fillets                  | 0.35                         | 0.04            | 0.31                           | 0.10                         | 0.002           | 0.10                           | 6                                      | 5                                      |
| Hake, fillets                       | 0.35                         | 0.02            | 0.34                           | 0.09                         | 0.001           | 0.09                           | 5                                      | 6                                      |
| Trout, fillets                      | 0.45                         | 0.04            | 0.41                           | 0.09                         | 0.002           | 0.09                           | 4                                      | 7                                      |
| Black pacu, fillets                 | 0.20                         | 0.10            | 0.10                           | 0.04                         | 0.005           | 0.04                           | 9                                      | 9                                      |
| Tilapia, fillets                    | 0.17                         | 0.02            | 0.14                           | 0.03                         | 0.001           | 0.03                           | 8                                      | 10                                     |
| Frozen anchoveta (HGT)              | 0.87                         | 0.04            | 0.83                           | 0.25                         | 0.002           | 0.25                           | 2                                      | 2                                      |
| Canned anchoveta                    | 1.19                         | 0.14            | 1.06                           | 0.30                         | 0.007           | 0.30                           | 1                                      | 1                                      |
| Salted anchoveta, gutted (unsalted) | 0.94                         | 0.30            | 0.64                           | 0.26                         | 0.015           | 0.24                           | 3                                      | 3                                      |
| Cured anchoveta, fillets            | 0.57                         | 0.82            | (0.25)                         | 0.15                         | 0.041           | 0.11                           | 15                                     | 4                                      |
| Chicken, lean                       | 0.08                         | 0.07            | 0.02                           | 0.01                         | 0.003           | 0.01                           | 12                                     | 13                                     |
| Pork, lean                          | 0.05                         | 0.17            | (0.11)                         | 0.01                         | 0.008           | (0.00)                         | 14                                     | 15                                     |
| Eggs                                | 0.34                         | 0.09            | 0.25                           | 0.09                         | 0.005           | 0.08                           | 7                                      | 8                                      |
| Beef, lean                          | 0.16                         | 0.10            | 0.07                           | 0.02                         | 0.005           | 0.02                           | 10                                     | 12                                     |
| Milk (no vitamin A added)           | 0.08                         | 0.11            | (0.02)                         | 0.01                         | 0.006           | 0.00                           | 13                                     | 14                                     |
| Fresh white cheese                  | 0.10                         | 0.42            | (0.31)                         | 0.01                         | 0.021           | (0.01)                         | 16                                     | 16                                     |
| Shrimp, edible portion              | 0.17                         | 0.12            | 0.05                           | 0.03                         | 0.006           | 0.02                           | 11                                     | 11                                     |

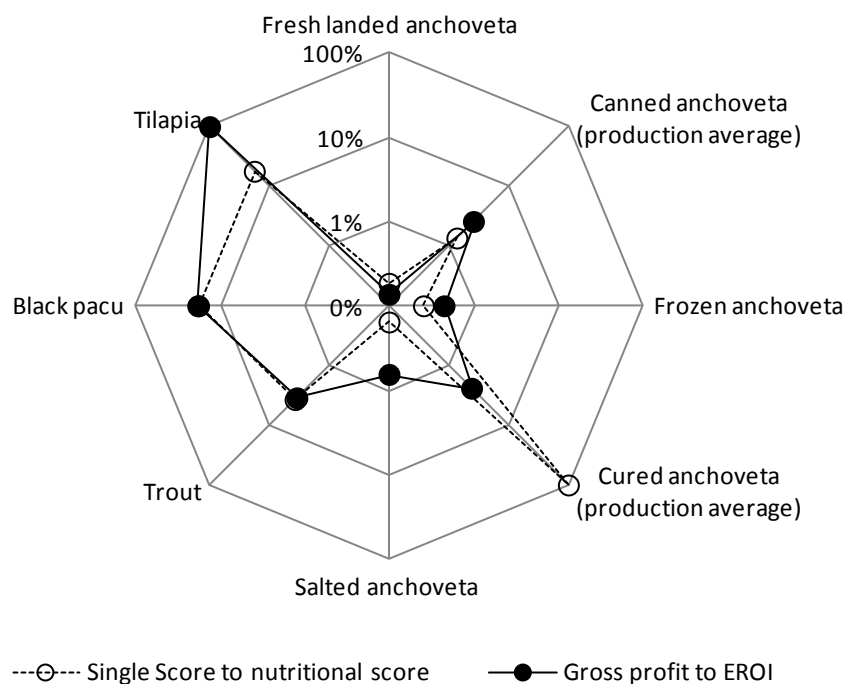
### C. Further comparison devices

Each indicator was compared respect to the single score. This approach shows that the best, most balanced option is salted anchoveta, and the worst canned *anchoveta* and aquaculture products (Fig. C.1).



**Fig. C.1** Relative sustainability performance of Peruvian *anchoveta* DHC products and aquaculture products, based on ratios of each indicator to the ReCiPe single score (per tonne of final product, including national distribution)

The environmental performance of each product was re-scaled in relation to its nutritional value, and its gross profit generation potential to its embodied energy efficiency (EROI) (Fig. C.2). It is noticeable that aquaculture products are better balanced than anchoveta products. Cured *anchoveta* generates much higher gross profit related to their embodied energy than any other *anchoveta* product, followed by canned products. In these ratios, the relation between numerator and denominator does not skew the results, because each product results are scaled respect to all others.



**Fig. C.2** Additional score ratios of the *anchoveta* and aquaculture DHC products: environmental performance to nutritional value and gross profit to embodied energy efficiency (per tonne of final product, including national distribution)

## References

- Goedkoop, M., Heijungs, R., Huijbregts, M., Schryver, A. De, Struijs, J., & Zelm, R. van (2013) ReCiPe 2008. A life cycle impact assessment method which comprises harmonised category indicators at the midpoint and the endpoint level. Report I: Characterisation. Ministry of Housing, Spatial Planning and Environment (VROM).
- Darmon N, Darmon M, Maillot M, Drewnowski A (2005) A nutrient density standard for vegetables and fruits: nutrients per calorie and nutrients per unit cost. *J Am Diet Assoc* 105:1881–7.
- Drewnowski A, Fulgoni III V (2008) Nutrient profiling of foods: creating a nutrient-rich food index. *Nutr Rev* 66:23–39.
- Maillot M, Darmon N, Darmon M, et al. (2007) Nutrient-dense food groups have high energy costs: an econometric approach to nutrient profiling. *J Nutr* 137:1815–20.
- Creed-Kanashiro H, Uribe T (2000) Improving dietary intake to prevent anemia in adolescent girls through community kitchens in a periurban population of Lima, Peru. *J Nutr Supplement*:459–461.
- Romaña G de (2005) Efficacy of multiple micronutrient supplementation for improving anemia, micronutrient status, growth, and morbidity of Peruvian infants. *J Nutr Supplement*:646–652.
- Sacco LM, Caulfield LE, Zavaleta N, Retamozo L (2003) Dietary pattern and usual nutrient intakes of Peruvian women during pregnancy. *Eur J Clin Nutr* 57:1492–7.
- Bellows L, Bunning M, Macdonald M (2010) Omega-3 Fatty Acids. Food and Nutrition Series No. 9.382 Colorado State University Extension
- Bourre JM (2005) Where to find omega-3 fatty acids and how feeding animals with diet enriched in omega-3 fatty acids to increase nutritional value of derived products for human: what is actually useful? *J Nutr Health Aging* 9:232–42.
- Pike IH, Jackson A (2010) Fish oil: production and use now and in the future. *Lipid Technol* 22:59–61.

#### 4.3.2 Paper 7b: Coupled ecosystem/supply chain modelling from sea to plate, Part 2: the Peruvian anchoveta case

Manuscript comparing the sustainability performance of anchoveta supply chains and alternative policy-based scenarios, as well as alternative paths for one landed tonne of Peruvian anchoveta until reaching the retailer's shelf. To be published, fused with Paper 7a, in PlosOne (Avadí et al., 2014d).

|  |  |
|--|--|
| Paper idea and design                            | Angel Avadí, Pierre Fréon  |
| Experiment design                                | Angel Avadí (indicators, LCA, model coupling), Jorge Tam (EwE modelling), Pierre Fréon |
| Data collection                                  | Angel Avadí, Pierre Fréon, Jorge Tam   |
| Data processing, statistical analysis, modelling | Angel Avadí, Pierre Fréon, Jorge Tam   |
| Discussion                                       | Angel Avadí, Pierre Fréon, Jorge Tam   |
| Writing and editorial                            | Angel Avadí, Pierre Fréon, Jorge Tam   |

#### Coupled ecosystem/supply chain modelling from sea to plate, Part 2: the Peruvian anchoveta case

Angel Avadí <sup>a,b,\*</sup>, Pierre Fréon <sup>b</sup>, Jorge Tam <sup>c</sup>

<sup>a</sup> Université Montpellier 2 – Sciences et Techniques, 2 Place Eugène Bataillon, 34095 Montpellier Cedex 5, France.

<sup>b</sup> UMR 212 EME, Institut de recherche pour le développement (IRD). Centre de Recherche Halieutique Méditerranéenne et Tropicale, Avenue Jean Monnet CS 30171, 34203 SETE cedex. France.

<sup>c</sup> Laboratorio de Modelado Oceanográfico, Ecosistémico y de Cambio Climático (LMOECC), Instituto del Mar del Perú (IMARPE), Apdo. 22, Callao, Lima, Perú.

\* Corresponding author

#### Abstract

The sustainability assessment of food supply chains is relevant towards global sustainable development. The Peruvian *anchoveta* fishery is the starting point for various local and global supply chains, especially via reduction of *anchoveta* into fishmeal and oil, used worldwide as a key input to animal and fish feeds. A methodology is proposed in the first part of this work (Avadí et al., 2014; this volume) towards analysing those supply chains, circumscribed to Peru. The second part of the study (this paper) describes the Peruvian anchoveta supply chains, and applies the proposed methodology to model it. Three scenarios were explored: status quo of fish exploitation (Scenario 1), increase of *anchoveta* landings for food (Scenario 2), and radical decrease of total *anchoveta* landings to allow other fish stocks to prosper (Scenario 3). It was found that Scenario 2 brought the best balance of sustainability improvements among the three scenarios, yet further refining of the assessment is recommended. It is noted that, in the long term, the best opportunities for improving the environmental and socio-economic performance of the Peruvian fisheries would be related to sustainability-improving management and policy changes affecting the reduction industry.

Keywords: Life Cycle Assessment, material flow modelling, Peru, scenarios, supply chain modelling, trophic modelling

## 1 Introduction

The sustainability modelling and assessment methodology presented in the first part of this research (Avadí et al. 2014, this volume) is illustrated here, by applying it to the Peruvian anchoveta (*Engraulis ringens*) supply chains. The starting point of these supply chains is one of world's largest fish stock exploited by one of the largest mono-specific fisheries, both in landings and in number of vessels (Chavez et al., 2008; Fréon et al., 2010a,b). The strongest initial links of these Peruvian supply chains (fisheries, reduction) supply important global supply chains (aquaculture, animal husbandry), and thus their sustainability is of paramount interest. Moreover, being Peru a developing country facing nutritional and social challenges, the fact that the bulk of fisheries landings is destined for reduction into fishmeal and fish oil that are mostly exported is subject to discussion and multi-disciplinary analysis (e.g. Christensen et al., 2013; Fréon et al., 2013). By applying the proposed methodology to these supply chains, we compare the relative environmental and socio-economic performance of various products, analyse alternative exploitation scenarios, and ultimately track the fate of one marginal tonne of landed anchoveta channelled through alternative Peruvian supply chains, now and in the future.

Anchoveta is exploited by a large and heterogeneous fleet; a small percentage of the catch is rendered into seafood products for direct human consumption while the majority of the catch is reduced into animal feed ingredients (fishmeal, fish oil), and then exported to feed various aquacultures and animal husbandry supply chains, mainly in Asia and Europe. Several fishfood and agricultural supply chains compete for the anchoveta resources, generating a variety of impacts on the Peruvian ecosystem and society, as well as on the global environment and economy.

The dynamics of those complex supply chains have never been studied in a holistic, sustainability-imbued way. Understanding those dynamics and impacts to the largest extent possible is the motivation of this research, in such a way that decision makers along the chains are informed and actions are taken to improve the sustainability of the anchoveta-based fishfood fisheries and industries. The system under study encompasses the supply chains from the extraction (fisheries and their impact on the Northern Humboldt Current ecosystem), through reduction activities for fishmeal and fish oil, aquafeed production (taking into account other agricultural inputs to aquafeeds), aquaculture and, finally, a fishfood product on the consumer's plate (excluding final transportation and use — household storage, cooking and disposal—). The research topic connects with the wider topic of sustainability assessment of food systems, and its importance derives from the relevance of the Peruvian fishmeal in relation with international food supply chains, as Peru is the first global exporter of fishmeal (SOFIA, 2012).

## 2 The Peruvian anchoveta supply chains

The Peruvian anchoveta fishery has been landing in average 6.5 million tonnes per year in the period 2001-2010, according to statistics from the Ministry of Production of Peru, PRODUCE (PRODUCE, 2012a).

The anchoveta stock is targeted by a large fleet, clustered in two main sub-fleets operating under different legal regimes: the industrial fleet and the small- and medium-scale (SMS) fleet. The industrial fleet (vessels larger than 32.6 m<sup>3</sup> holding capacity) includes steel vessels and wooden vessels nicknamed "Vikingas". The small-scale fleet includes vessels under 10 m<sup>3</sup> holding capacity, while the medium-scale fleet vessels

featuring 10 to 32.6 m<sup>3</sup> holding capacity. Small-scale vessels also differ from medium-scale ones in the level of technification and capture systems used; small-scale vessels are characterised by manual labour and basic technology (Alvarado, 2009).

Catches by the steel fleet represent around 81% of the total anchoveta catches for reduction, while the Vikingas capture 19%, according to statistics by Instituto del Mar del Perú, IMARPE (Marilú Bouchon, unpublished data). The industrial fleet landings for indirect human consumption (reduction) represent more than 99% of total catches, while the SMS fleet landings for direct human consumption (fresh, freezing, canning, curing) represent less than 1% of total catches, according to PRODUCE statistics. Table 1 resumes landing and processing data for anchoveta.

This case study will apply the proposed sustainability assessment framework to the competing fates of anchoveta landings over a complex supply chain, which encompasses fishing, reduction, feed manufacturing, aquaculture, processing for DHC and commercial distribution. Moreover, three scenarios of anchoveta exploitation will be modelled, involving changes in fate (final fishfood product). After the assessment, a good estimation of the sustainability (especially environmental) performance anchoveta industry and related supply chains will be available.

## **2.1 The Humboldt Current System**

The Humboldt Current System (HCS) identifies the tropical ocean area off Peru and north of Chile. The northern HCS is considered as the most productive fishing ground in the world, because it produces more fish per area than any other region. Moreover, a number of singularities characterise the HCS as follows, and determine its productivity (Chavez et al., 2008).

The HCS is extremely sensitive to climatic dynamics. Temperature anomalies associated to El Niño-Southern Oscillation (ENSO), Pacific Ocean regime shifts, etc; have historically produced huge

changes in seabird populations and fluctuations in abundance of anchoveta and sardine (*Sardinops sagax*). Moreover, some strong ENSO events (1972-73, 1982-83, 1997-98 and 2009-10) severely impacted Peruvian fisheries (Talledo, 2010). Additionally, the pressure exerted by industrial fisheries since the 1950s has been claimed to contribute to important impacts on the ecosystem.

The HCS has been extensively researched, from various perspectives such as oceanographic, fisheries and ecosystem dynamics, and impacts of climate change. The two most relevant published bodies of research are The Peruvian upwelling ecosystem: dynamics and interactions (Pauly and Tsukuyama, 1987), an international collaboration report and The Northern Humboldt Current System: Ocean Dynamics, Ecosystem Processes, and Fisheries (Werner et al., 2008), a special issue of the international journal *Progress in Oceanography*. Recent publications by the Institut de Recherche pour le Développement (IRD), presented state of the art research on the impacts of climate change on the HCS dynamics, ecosystems and Peruvian fisheries (Bertrand et al., 2010; Brochier et al., 2013).

**Table 1** Historical statistics for anchoveta landings and processing (2001-2011). Source: PRODUCE data (INEI, 2012a; PRODUCE, 2012a; PRODUCE, 2010)

| <b>Year</b>                      | <b>2001</b> | <b>2002</b> | <b>2003</b> | <b>2004</b> | <b>2005</b> | <b>2006</b> | <b>2007</b> | <b>2008</b> | <b>2009</b> | <b>2010</b> | <b>2011</b> | <b>Average</b>   |
|----------------------------------|-------------|-------------|-------------|-------------|-------------|-------------|-------------|-------------|-------------|-------------|-------------|------------------|
| <i>Anchoveta</i> landings        | 6 358 217   | 8 104 729   | 5 347 187   | 8 808 494   | 8 655,461   | 5 935 302   | 6 159 802   | 6 257 981   | 5 935 165   | 3 450 609   | 7 103 061   | <b>6 556 001</b> |
| <i>Anchoveta</i> for reduction   | 6 347 600   | 8 082 897   | 5 335 500   | 8 797 100   | 8 628 400   | 5 891 800   | 6 084 700   | 6 159 387   | 5 828 600   | 3 330 400   | 6 994 051   | <b>6 498 221</b> |
| Fishmeal production <sup>a</sup> | 2 034 900   | 1 562 116   | 1 416 500   | 1 807 000   | 2 067 900   | 1 367 900   | 1 284 500   | 1 585 600   | 1 584 100   | 1 119 300   | 1 235 674   | <b>1 551 408</b> |
| National consumption             | 91 800      | 46 686      | 43 700      | 53 600      | 66 400      | 25 400      | 20 700      | 20 800      | 36 700      | 33 600      | -           | <b>39 944</b>    |
| Exports                          | 1 943 100   | 1 515 430   | 1 372 800   | 1 753 400   | 2 001 500   | 1 342 500   | 1 263 800   | 1 564 800   | 1 547 400   | 1 085 700   | -           | <b>1 399 130</b> |
| Fish oil production              | 447 200     | 206 150     | 267 508     | 363 000     | 339 400     | 346 773     | 371 600     | 280 400     | 335 000     | 320 800     | 248 637     | <b>320 588</b>   |
| National consumption             | 131 800     | 45 245      | 80 800      | 78 200      | 60 600      | 58 200      | 65 900      | 41 800      | 46 800      | 69 700      | -           | <b>61 731</b>    |
| Exports                          | 315 400     | 160 905     | 186 708     | 284 800     | 278 800     | 288 573     | 305 700     | 238 600     | 288 200     | 251 100     | -           | <b>236 253</b>   |
| <i>Anchoveta</i> for DHC         | 10 617      | 21 832      | 11 687      | 11 394      | 27 061      | 43 502      | 75 102      | 98 594      | 106 565     | 120 209     | 109 010     | <b>57 779</b>    |
| Canning                          | 3 286       | 13 364      | 4 823       | 2 631       | 14 887      | 31 000      | 61 944      | 78 851      | 84 957      | 94 234      | 84 194      | <b>43 106</b>    |
| Freezing                         | 1 137       | 4 326       | 655         | 214         | 1 405       | 1 268       | 5 286       | 12 265      | 11 517      | 15 160      | 14 680      | <b>6 174</b>     |
| Fresh fish                       | 398         | 9           | 392         | 320         | 348         | 538         | 401         | 336         | 293         | 223         | 44          | <b>300</b>       |
| Curing                           | 3 717       | 4 132       | 5 806       | 8 194       | 10 425      | 10 658      | 7 459       | 7 142       | 9 762       | 10 579      | 10 092      | <b>7 997</b>     |

<sup>a</sup> all species, >90% *anchoveta*.



## 2.2 The anchoveta fishery

The modern anchoveta fishery started in Peru around 1955, parallel to the decline of the previously economically relevant guano industry. The 1957-58 ENSO event decimated guano-producing seabird populations, coinciding with further development of the anchoveta fishery. During the 1960s the fleet and the fishery grew continuously until 1970, peaking with the largest historical harvest of 12.3 million tonnes, representing 20% of that year's world catch (Chavez et al., 2008). In 1972, the anchoveta stock collapsed, probably due to a strong ENSO event in combination with high fishing pressure, leading to a slow recovery of the anchoveta stock and catches as well as changes in fisheries management and legislation (Arias, 2012) as shown in the Supplementary Material (SM), Fig. A.1. In the 2000-2009 period catches were stable in comparison with historical landings, averaging 7.1 million tonnes annual. In 2010, an ENSO event and management measures reduced landings to 3.4 million tonnes (SOFIA, 2012; Tveteras et al., 2011).

Currently, Peruvian fisheries are ruled by the currently valid Fisheries Act (Decree Law 25977 of 1992), and its applicable bylaw regulation (Supreme Decree 012-2001-PRODUCE, Supreme Decree 005-2012-PRODUCE). As of 2012, approximately 660 industrial steel vessels (operating directly under regime Decree Law 25977) target anchoveta for reduction. Additionally, almost 700 wooden semi-industrial Vikingas (operating under regime Law No. 26920) target anchoveta for reduction, and about 850 SMS wooden vessels target anchoveta (among other species) for direct human consumption (DHC).

Overcapitalisation/overcapacity affects the anchoveta-targeting fleets and reduction industries, to a great extent due to the existence of a semi-regulated open access system, in place until the 2008 fishing season included, and featuring a global quota (Total Allowable Catch, TAC). Overcapitalisation is still substantial in Peru;

in 2007 the fishing fleet was estimated to be between 2.5 and 4.6 times its optimal size (Paredes, 2010).

The Peruvian anchoveta fishery operates in two well-defined coastal areas in the South Pacific, as determined by the species habitat and behaviour: the north-central area (between parallels 4° and 14°) and the south area (between parallels 15° and 18°, which continues in Chile between parallels 19° and 24°).

More detailed descriptions of the industrial steel fleet and the semi-industrial and SMS fleets, as well as discussions on their environmental performance; are presented in Fréon et al. (2014a,b) and Avadí et al. (2014a), respectively.

## 2.3 The reduction industries

Fishmeal plants produce fishmeal as main product and fish oil as co-product. Fishmeal is used worldwide as an ingredient for cultured animal feeds, in the following proportions: aquaculture 62%, pigs 22%, poultry 8% and other animals 8% (IFFO, 2008). Inclusion of fishmeal and fish oil in aquafeeds is in continuous diminishing (Tacon et al., 2011), to the extent that alternative protein sources become available and its effectiveness is demonstrated. Moreover, use of fish inputs for non-fish animal feeds has also decreased steadily in the last decades: despite the fact that aquafeeds represent only less than 4% of the global production of animal feeds (Alltech, 2012; Tacon et al., 2011), aquafeeds consumed ~49% of all fishmeal produced in 2008 (Silva and Turchini, 2008). Peruvian fishmeal represents 30%-35% of the world's supply (IFFO, 2009).

In Peru, more than 98% of fishmeal produced is derived from anchoveta. Plants can be classified into conventional, high protein and residual, according to the technology used and product quality obtained (Jiménez and Gómez, 2005; Paredes and Gutiérrez, 2008; Peruvian product labels): average quality (FAQ) fishmeal by means of direct heat drying (~64% protein), high protein content (HPC) fishmeal by means of indirect

(steam, hot air) drying (67%-70% protein), and residual fishmeal (processing residues, up to 55% protein) by direct heat drying.

There were 160 industrial fishmeal plants in Peru as of 2012, but not a single registered artisanal fishmeal plant, according to PRODUCE statistics. 50% of plants are concentrated in the northern coastal region, mainly in Chimbote and Chicama (Centrum, 2009).

The reduction industry features great overcapacity: in 2007 the industry was 3 to 9 times its optimal size (Paredes, 2010). The 1992 General Fisheries Act prohibited further expansion in installed capacity of reduction plants, but nonetheless the sector privatisation in the 90s and a large number of mergers and acquisitions between 2006 and 2008 contributed to concentrate the sector and worsen the overcapacity issue (Paredes, 2010). A shift towards better technology, and thus better and more lucrative product, is noticeable in the increase in high protein content processing capacity and production (FAQ: from 37.6% in 2010 to 34% in 2011; prime fishmeal: from 62.4% in 2010 to 66% in 2011) (SNP, 2011; SNP, 2010).

Production and export of fishmeal and fish oil is the main driver for the thriving anchoveta industries. Peruvian fishmeal and oil are exported, among other aquaculture-producing countries, to China, Chile and some European countries. The main users of those imports are shrimp, salmonids, carp, tilapia and other aquaculture systems. It has been suggested that Chinese carp cultures may be the largest single consumer of fishmeal, despite low inclusion rates in feeds, due to the enormous volume of production (Deutsch et al., 2007; SOFIA, 2012). Other authors suggest shrimp farming in China as the main consumer (Patrik Henriksson, SEAT, 03.2012, pers. comm.).

Fish to fishmeal conversion ratios in the Peruvian industry has improved from more than 5:1 in the early 1990s to ~4.2:1 in the last years. Conversion ratios below 4.2 are considered as impossible in the context of Peru (Paredes, 2010). Table 2 compares various reported conversion ratios. Fish oil conversion ratios are very fluctuating because they depend on the lipid content of anchoveta, which varies over the years. The average yield in the period 2001-2011 was 21.3:1, as calculated based on statistics from PRODUCE and the National Institute for Statistics and Informatics, INEI (INEI, 2012a).

**Table 2** Fish to fishmeal and fish oil conversion ratios national averages 2001-2006 in different countries including Peru according to Péron et al. (2010), and comparison with PRODUCE data used in this study for the period 2001-2011

| Countries                            | Landings<br>(1 000 t) | Fishmeal<br>(1 000 t) | Fish oil<br>(1 000 t) | FM ratio    | FO ratio     | Species used for reduction                |
|--------------------------------------|-----------------------|-----------------------|-----------------------|-------------|--------------|---|
| Thailand                             | 475.5                 | 499                   | -                     | 0.95        | -            | Various                                   |
| China                                | 2 041                 | 769                   | -                     | 2.65        | -            | Various                                   |
| Denmark                              | 881.5                 | 327                   | 106                   | 2.70        | 8.32         | Sandeel, sprat, blue whiting, herring     |
| United States                        | 909                   | 258                   | 88                    | 3.52        | 10.33        | Menhaden, Alaska pollock                  |
| Chile                                | 3 161                 | 773                   | 157                   | 4.09        | 20.13        | Jack mackerel, <i>anchoveta</i> , sardine |
| <b>Peru (this study)<sup>a</sup></b> | <b>6 498.2</b>        | <b>1 551.4</b>        | <b>320.6</b>          | <b>4.21</b> | <b>21.30</b> | <b><i>Anchoveta</i></b>                   |
| Peru                                 | 7 561                 | 1 700                 | 270                   | 4.45        | 28.00        | <i>Anchoveta</i>                          |
| Japan                                | 1 141                 | 226                   | 66                    | 5.05        | 17.29        | Sardine, pilchard                         |
| Norway                               | 1 061                 | 203                   | 47.5                  | 5.23        | 22.34        | Blue whiting, capelin, trimmings          |
| Iceland                              | 1 262                 | 221                   | 74                    | 5.71        | 17.05        | Blue whiting, herring, trimmings          |

<sup>a</sup> Based on PRODUCE reported values for 2001-2011 (PRODUCE, 2012a)

A more detailed discussion on the reduction industry is under preparation by our team (ANCHOVETA-SC project).

## 2.4 The processing industry for food

The Peruvian population surpasses 27 million inhabitants, more than 70% of which live in urban areas. Annual per capita fish consumption was estimated in ~19 kg in 2005 and in ~23 kg in 2009. Consumption is notably higher in the coast (seafood) and in the Amazonian areas (river fish), while it is much lower in the highlands (industrialised fish products and Andean aquaculture) (INEI, 2012b).

The amount of fresh anchoveta landed for direct human consumption has increased in the last decade at an average annual rate of 37%, according to PRODUCE statistics. Nonetheless, a 1% rate of landings destined to DHC represents a poor proportion in a country with a large percentage of its population suffering from malnutrition (Fréon et al., 2010a). It has been suggested that an increased use of anchoveta for DHC could contribute to solve some of the nutritional problems in Peru and the region (Sánchez and Gallo, 2009).

National consumption of anchoveta, despite its recent increase, is still minimal, yet it represents in average more than 70% of anchoveta manufactures for DHC. The low availability of anchoveta for DHC can be attributable to a combination of factors, for instance, regulatory limitations (industrial vessels cannot provide DHC industry), preferences of consumers and lack of a cold chain for fish in Peru. Some believe a key factor is the shelf price of anchoveta DHC products. Moreover, the top factor determining that most anchoveta landings are directed or diverted (in case of the SMS captures) to reduction is the difference in prices paid to fishermen per t of landed fish: fishmeal plants pay more than DHC plants. Additionally, in order to keep anchoveta at a DHC quality level, vessels must carry ice, practically reducing their holding

capacity by at least 30%. These topics are further analysed in (Fréon et al., 2013).

A more detailed discussion of Peruvian anchoveta processing for DHC is presented in Avadí et al. (2014c).

## 2.5 Key anchoveta-based aquaculture systems in Peru

In Peru, aquaculture has been and is historically dominated by marine species, namely scallops (*Argopecten purpuratus*) and shrimps (mainly *Litopenaeus vannamei*), and freshwater species such as trout (mainly *Oncorhynchus mykiss*), tilapia (*Oreochromis* spp) and black pacu (*Colossoma macropomum*), locally known as Gamitana (Mendoza, 2013; PRODUCE, 2009). Marine aquaculture contributes to ~81% of Peruvian cultured fishfood production, while freshwater production provides ~19% (Mendoza, 2011).

The Peruvian aquaculture, mostly represented by small scale or artisanal practices (~63% of total production in 2010 according to Mendoza (2011)); has featured continuous growth over the last 20 years. Most trout culturing operations are artisanal yet semi-intensive, especially those in the Puno department (Titicaca lake and nearby water bodies), where most of the national production takes place. Trout farming in the Puno region water bodies consist of artisanal wood- or metal-nylon floating cages (800 kg to 2000 kg carrying capacity) and larger scale metal-nylon floating cages (up to 6 t carrying capacity). Trout is mainly destined for export, despite increasing consumption in the producing areas and larger Peruvian cities such as its capital, Lima. Gamitana farming is carried out mainly in large, semi-intensive artificial pond systems, while tilapia is produced using a variety of methods and operational scales, mostly intensive. Gamitana is almost exclusively cultured in the Amazonia (Loreto and San Martin departments) and tilapia in the Piura region. Gamitana is mostly consumed locally, to a large extent due to the physical isolation of producing Amazonian communities.

Tilapia was historically destined to national markets, but over the last decade increasing shares of production have been exported.

The Peruvian shrimp aquaculture is the main consumers of fishmeal among Peruvian aquacultures, given its high inclusion rates in commercial feeds of 20%-50% (Amaya et al., 2007; Sun, 2009; Tacon et al., 2011; Tacon, 2002). Similarly to other fish farming systems, a key aspect of Peruvian aquaculture is the provision of feed. In Peru, both artisanal and commercial feeds are used, but the latter prevail, especially for trout.

National consumption of aquaculture products in Peru has been estimated in 0.52 kg per capita in 2010, yet a growth pattern in consumption of 22% per year has been recorded (Mendoza, 2011).

A more detailed discussion of Peruvian (freshwater) aquaculture is presented in Avadí et al. (2014b).

## **2.6 Distribution channels**

Distribution channels for fisheries DHC consist of 1) landing in a variety of fishing ports and piers, private and public; 2) transportation of fish in isothermal trucks, often organised by wholesalers; 3) processing in DHC plants; 4) distribution to retailers for national consumption and export to foreign markets (Rokovich, 2009).

Until today, most landing facilities for DHC fail to fulfil the requirements set by the sanitary standard for fisheries and aquaculture resources, as established by the Supreme Decree 040-2001-PRODUCE (Rokovich, 2009). The lack of a cold chain for fish in Peru is a major limiting factor for the further development of domestic distribution channels.

Aquaculture products in Peru are distributed by retailers within Peru and exported by exporting firms or by the producers.

Wholesaler markets concentrate around 29% of total landings destined to fresh fish, of which 3.2% is imported from neighbouring countries (mainly

jack mackerel). In the coastal areas, wholesaler markets provide retailers (e.g. distributors, markets), supermarkets, restaurants and final consumers. Lima alone absorbs 32% of the total national consumption of fish.

Canned fish is largely produced in Peru, and both processing plants and importers (5% of canned fish is either imported as final product or frozen fish is imported to be processed in Peru, mainly tuna from Ecuador) provide wholesalers, which subsequently provide supermarkets and retailers.

Frozen food products are both produced in Peru and imported. Imports, representing ~60% of the frozen fish products consumed in Peru, largely consist of jack mackerel (when national production of this highly fluctuating resource is too low) from Chile and tuna from Ecuador. Producers and importers provide wholesalers, which subsequently provide restaurants and supermarkets across the country (transportation mainly by refrigerated trucks).

Cured and salted products are both produced in Peru and imported, notably anchovy from Argentina (18% of the national consumption of cured products). Producers and importers provide directly to markets across the country.

## **2.7 Fisheries management and policy environment**

The Peruvian Institute of the Sea (Instituto del Mar del Perú, IMARPE) provides the scientific foundation for fisheries management in Peru, which is implemented by PRODUCE (IMARPE, 2012). IMARPE struggles between scientific and political considerations for their recommendations, due to its dependence situation with regard to PRODUCE (e.g. the Chairman of the Board of IMARPE is a political position rather than technical) (de la Puente et al., 2011).

IMARPE evaluates the anchoveta population off Peru and recommends PRODUCE the annual TAC (Sánchez and Gallo, 2009). Such estimation is performed based upon a) hydro-acoustic data

collected since 1975 from 2~3 annual surveys encompassing the whole Peruvian coastline and b) modelling of anchoveta population dynamics estimated from environmental conditions and recruitment levels by means of a Virtual Population Analysis based upon a bio-economic age-structured model (FishSource, 2012). The recommended TAC is related to calculation of the Maximum Sustainable Yield. Spawning biomass is calculated using the Egg-Production Method (a meta-review is available in Bernal et al. (2012)).

Since the north-central stock encompasses >90% of the anchoveta biomass, most regulation and legislation applies only to it, and the south-stock is exploited under an open-access regime (featuring closures related to the juvenile ratio).

Since the early 1990s, a number of legislative pieces were introduced, and regulate fisheries management nowadays with mixed effects. For instance, the drop in catches to 3.4 million tonnes in 2010 was mostly due to management measures applied to protect a large juvenile ratio. Thanks to that management decision, 2011 catches even exceeded 2009 levels (SOFIA, 2012).

Other effects of legislation are still unfolding in the Peruvian anchoveta fishery and reduction industries. For instance, before 2008 legislation introducing individual vessel quotas (IVQ), up to 1200 vessels competed for the TAC in a nicknamed "Olympic race", reducing the annual fishing season to 50 days (Aranda, 2009; Paredes, 2010). A list of key historical legislation governing fisheries in Peru is available in the SM (Table A.1).

Fishing companies have reacted to the IVQ regime in various ways, for instance, large vertically integrated companies encompassing fishing and reduction are using their more efficient vessels to harvest their company-wide quotas (IVQ are transferable within the same company) (Aranda, 2009; Paredes, 2010). This will eventually lead, as intended, to a reduction in fleet overcapacity, but has spawned several other negative consequences (Paredes, 2010; Paredes, 2012).

Most legislation regulates the activities of industrial, large scale vessels, while the SMS fleets are highly unregulated and practically operate in an open-access regime (Alfaro-Shigueto et al., 2010). Regulation for SMS fisheries includes the exclusive use of the sea within 5 nautical miles, holding capacity, length, manual labour, mesh size for nets, prohibition of beach seines, minimum catch sizes for some species, and protection for cetaceans, turtles and seabirds (Alfaro-Shigueto et al., 2010; Estrella and Swartzman, 2010).

In general, it is considered by researchers that Peruvian anchoveta-related legislation is either insufficient, ineffective or poorly enforced (de la Puente et al., 2011; Paredes, 2010; Tveteras et al., 2009). Moreover, a number of issues permeate the enforcement of Peruvian fisheries legislation and management guidelines (based on pers. comm. with various researchers and experts, as well as on journalistic pieces), including: poor information availability for the smaller scale operations (Juan Carlos Sueiro, pers. comm., 01.2013); illegal, under-reported and un-regulated (IUU) landings are common (Paredes, 2012); illegal reduction plants profusely operate partially fed by IUU landings (Pablo Echevarría, pers. comm., 03.2013); illegally produced fishmeal is "washed" by brokers; there is a generalised lack of compliance with regulations mandating proper solid and liquid waste management from fishing vessels and processing plants; there is a concentration of capital and bargaining power in a handful of vertically integrated companies; SMS fisheries do not pay any fishing rights nor have a quota assigned, while fishery rights paid by industrial operations are clearly insignificant compared with their benefits, and insufficient to finance fishery regulation, supervision and control (Paredes, 2013a; Paredes, 2013b; Paredes and Gutiérrez, 2008; Paredes, 2012; Paredes and Letona, 2013; USMP, 2013).

Despite all those problems, Peruvian fisheries are in general considered among the most sustainably managed in the world (Alder and Pauly, 2008; FishSource, 2012; Schreiber and Halliday, 2013),

mostly because of its scientific-based annual quotas and on-demand fishery closures.

## **2.8 Socio-economic dynamics**

Fisheries and seafood products, and especially exports of fishmeal and fish oil, represent the third individual source of foreign exchange for the Peruvian economy (in average, 8% of earnings in the period 2000-2011), according to statistics by the National Customs and Tax Administration, SUNAT (SUNAT, 2012).

China and Germany are the larger importers of Peruvian fishmeal, while Denmark and Chile are the main importers of fish oil. Most of Peruvian fishmeal, which is dominantly of very high quality, is destined to aquafeeds.

In terms of employment, industrial and SMS fisheries, as well as reduction and other fish processing industries, provide a large number of jobs. It is difficult to isolate the jobs associated exclusively to the extraction and processing of anchoveta, other than those in the reduction industries. Nonetheless, (Sueiro, 2008) estimated the number of jobs directly associated to the anchoveta industrial and SMS fleets in 10 000 and 8 000, respectively.

Recently, a more comprehensive estimation of employment for the Peruvian fisheries and processing sector was carried out (Christensen et al., 2013). These and other socio-economic indicators of the anchoveta supply chains (gross profit generation, added value) are presented and discussed in Avadí and Fréon (2014).

## **2.9 Nutritional value of fishfood products of the anchoveta supply chains**

According to FAO and the Global Hunger Index (FAO, 2000; IFPRI, 2012; IFPRI, 2006), Peru has advanced in hunger reduction, yet continues being one of the few Latin-American countries featuring moderate hunger. According to FAO, hunger is associated to poverty (FAO, 2011). Especially in the Andean communities, indicators such as

chronic malnutrition of children under five, stunting and undernourishment are still elevated (FAO, 2011; FAO, 2000; INEI, 2011) and thus government policies should be (and to some extent are being) oriented to provide those communities with cheaper sources of animal protein and in general improve access to nutritious food.

Seafood, especially that derived from the thriving anchoveta supply chains, has been often suggested as a suitable means to improve nutritional intake of vulnerable communities and the people at large. The varied fishfood products of the anchoveta-based supply chains include anchoveta products as well as marine and freshwater aquaculture products.

Anchoveta products are extremely high in beneficial Omega-3 fatty acids, as well as in mineral salts (ash) and essential aminoacids (Sánchez and Gallo, 2009). Further discussion on nutritional value of anchoveta and other Peruvian fishfood products is presented in Avadí and Fréon (2014).

## **2.10 Ecosystem and bio-economic modelling of the Peruvian anchoveta fishery**

Various attempts to model the HCS ecosystem and its sensitivity to environmental condition, often emphasising population dynamics/stock assessment of commercially important species or threatened species have been carried out since the 1970s (Hertlein, 1995; Taylor and Wolff, 2007).

A preliminary Ecopath with Ecosim – EwE (Christensen and Pauly, 1992; Walters et al., 1997) trophic model of the northern HCS was produced by Tam et al. (2005), highlighting that anchoveta faces mortality from a variety of predators, being such pressure more important than mortality due to fisheries. In the other hand, hake's mortality, for instance, is mostly due to fisheries. A more comprehensive EwE-based trophic model was later presented by Tam et al. (2008) and Taylor et al. (2008), which discusses trophic and ecosystem

dynamics under El Niño and La Niña conditions. The Tam et al. (2008) model has been used to apply the ecosystem approach to hake (Tam et al., 2009) and anchoveta (Tam et al., 2010) fisheries, and is currently used in the running project Indiseas (Shin et al., 2012), under an IRD-IMARPE collaboration.

A number of bio-economic models have been also developed for the Peruvian anchoveta fishery (Csirke and Gummy, 1996), some of which have been used for estimating stock biomass and calculating the TAC. In recent years, new age-structured and integrated assessment models by have been used by IMARPE (IMARPE, 2010). In line with Peruvian fisheries legislation, species-specific models are used to estimate biomass and fishing quotas rather than multi-species trophic models. A reason for such choice is that trophic models are considered as under development, due to lack of comprehensive data, therefore fisheries management is carried out on a mono-specific modelling basis.

### 3 Methodology and data sources

The proposed framework, as described in the first companion paper (Avadí et al., 2014, this volume), is based on a one-way coupled model of the ecosystem and its exploiting supply chains, consisting of three phases: 1) characterisation and modelling of the fishfood system under study, 2) definition and calculation of sustainability indicators, and 3) comparison of competing supply chains, and definition and comparison of alternative policy-scenarios for the greater supply chain.

Inventory data for the various LCA studies was the most data-intensive endeavour in this study. Most background processes were defined as previously modelled inecoinvent and reference publications.

Data collection was carried out in Peru during 2008-2013, in the context of the Anchoveta Supply Chain project (ANCHOVETA-SC, <http://anchoveta-sc.wikispaces.com>) in cooperation with PRODUCE, IMARPE, the

Research Institute of the Peruvian Amazonia (IIAP, 2012), a trout development project from the regional Puno government (PETT, 2012), Peruvian universities, various large fishing and reduction enterprises —organised into the National Fisheries Society (SNP, 2011)—, as well as from multiple confidential and anonymous sources. Detailed statistics and operational data pertaining to all key links in the complex anchoveta-based supply chains were gathered. Moreover, experts and analysts of the anchoveta industries were also approached, and historical datasets obtained from them, some including data from a large enterprise no longer in operation, but with its vessels operated by other companies. Surveys were extensively used to obtain data, particularly from industrial and SMS fisheries. Field visits encompassed fish ports, fishmeal plants, fish processing plant, aquaculture farms, shipyards, etc.

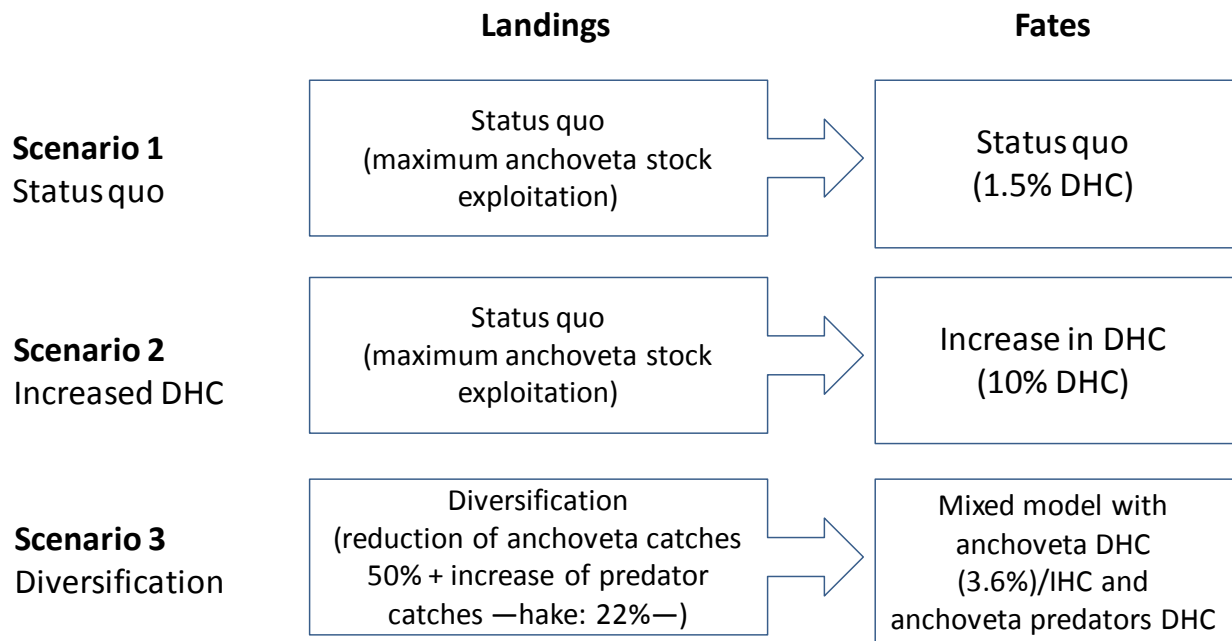
Detailed relations of all data sources used are presented in other publications associated to the ANCHOVETA-SC project.

A screening level LCA (Life Cycle Screening, LCS) of the industrial hake fleet was performed by means of literature data and landings statistics by PRODUCE and IMARPE (R. Castillo, pers. comm., 06.10.13; V. Aramayo, pers. comm. 11.2013; R. Adrien, pers. comm., 12.2013). This screening heavily relies on assumptions, since detailed data on the Peruvian hake fisheries was not available. Based on those uncertain results, sustainability indicators were calculated as to compare this fishery with the anchoveta fisheries, and their respective products.

The ecosystem model used is based on the abovementioned EwE trophic models of the Northern Humboldt Current System (NHCS) by Tam et al. (2008) and Taylor et al. (2008). The model domain extends from 4°S to 16°S, and 60 nm offshore, covering an area of approximately 165 000 km<sup>2</sup>, and including 32 living functional groups. The model was fitted to historical time series data of biomass and catch of main fishery resources from 1995 to 2003. After the historical

period, scenarios simulations were run for the period 2004-2033. A key feature for the EwE scenarios was the behaviour of anchoveta and hake biomasses. Observed and fitted anchoveta biomasses decreased during El Niño 1997-98, then recovered in 2000, and fluctuated until stabilised around 70 t·km<sup>-2</sup>. On the other hand, hake biomasses also decreased during El Niño, but recovered more slowly in 2006 and stabilised around 1 t·km<sup>-2</sup>.

Fig. 1 lists the alternative exploitation scenarios derived from the EwE simulation. These scenarios were foreseen in (Fréon et al., 2013). Two types of scenarios seemed suitable, both policy-induced: a) changes in fish fates (DHC vs. IHC), and b) changes in landings and landing composition. EwE modelling provides the ecosystem perspective of these scenarios, while LCA-derived and other indicators based on a functional unit can easily be scaled up or down to varying production volumes.



**Fig. 1** Alternative exploitation scenarios

Three alternative exploitation scenarios were derived from the EwE model, projecting the reference year (2011) into the future:

- Scenario 1 (S1) - Status quo. This is an extrapolation of the current situation (2011), where the anchoveta fishery is fully developed and the landings oriented to DHC remain low, varying from 1.5% at the reference year 2011 to 3.6% at the scenarios year 2021 (this difference in rates is due to the fact that, due to lack of actualisation of the EwE model until 2011, actual landing statistic were used for 2011 rather than simulated catches). The increase in DHC percentage represents an extrapolation of the current slightly increasing trend. After the historical period, anchoveta

and hake fishing mortality are set constant and equal to the last historical value.

- Scenario 2 (S2) - Increased DHC. The same fully developed anchoveta fishery as in Scenario 1, but 10% of the landings are oriented to DHC. Anchoveta and hake fishing mortalities are handled as in Scenario 1.
- Scenario (S3) 3 - Diversification. In this scenario there is a reduction of anchoveta exploitation and an increase in the exploitation rate of Pacific hake (*Merluccius gayi*), an anchoveta predator. The anchoveta landings are oriented both to DHC and IHC, and hake landings are oriented to DHC. From the end of the historical period onwards, the anchoveta fishing mortality was linearly decreased to 50% during



the next ten years (2013), then hake fishing mortality was linearly increased 22% during the next ten years (2023), afterwards fishing mortalities were kept constant during 10 more years (2033).

The one-way coupling between the EwE model and the material flow model (MFM) built with the modelling tool Umberto (IFU, 2005) is mono-directional, since no economic way for dynamic linking was found. EwE outputs are inputs to the MFM model, but changes in the MFM cannot influence directly the EwE model. Therefore, the one-way coupled model was preserved for modelling the current situation and some alternative fish exploitation scenarios (see section 4.2). Nonetheless, the MFM can be used standalone, as a supply chain modelling tool to explore variations within a defined scenario (e.g. changes in relative production volumes of aquaculture products or anchoveta DHC products).

For the alternative exploitation scenarios, foreseen changes in the proportion of anchoveta landings destined to DHC, as well as changes in aquaculture production, were modelled for future years by extrapolating historical landing and production data (PRODUCE, 2012a; PRODUCE, 2012b) by means of statistically representative trend lines. Operational costs and prices were not extrapolated, due to unavailability of detailed annual data. Eventual changes in captures per unit effort (CPUE), which is accepted to be proportional to changes in biomass and hence of fish catchability (affecting fuel use intensity), were considered, in such a way that all environmental modelling is based on CPUE-adjusted fuel use intensities.

The coupled trophic/supply chain model is fed from a number of models, namely, the EwE trophic model of the Northern HCS, LCAs of each link in the anchoveta supply chain, and various additional sustainability and nutrition indicators. Table 3 summarises the links in the Peruvian anchoveta supply chain that were modelled individually (either by full LCA or by Life Cycle Screening, based on secondary data).

**Table 3** Modelled sub-systems of the Peruvian anchoveta supply chain

| Sub-models →<br><br>SC links ↓   | EWE outputs | Biophysical indicators |     |                                |                             | Socio-economic indicators |
|--|-------------|------------------------|-----|--------------------------------|-----------------------------|---------------------------|
|  |             | LCA                    | LCS | Other environmental indicators | Nutrition/energy indicators |                           |
| <b>Fisheries</b>   |             |                        |     |                                |                             |                           |
| Industrial anchoveta fleet   | X           | X                      |     | X                              | X                           | X                         |
| Vikinga (anchoveta) fleet  | X           | X                      |     | X                              | X                           | X                         |
| Small- and medium-scale anchoveta fleet/average landed anchoveta for IHC                   | X           | X                      |     | X                              | X                           | X                         |
| Average landed anchoveta for reduction (weighted average of industrial and Vikinga fleets) | X           | X                      |     | X                              | X                           | X                         |
| Ice plants providing for SMS fisheries   |             |                        | X   |                                |                             |                           |
| Hake industrial fishery  | X           |                        | X   | X                              | X                           |                           |
| <b>Direct Human Consumption</b>  |             |                        |     |                                |                             |                           |
| Canned anchoveta   |             | X                      |     | X                              | X                           | X                         |
| Frozen anchoveta   |             | X                      |     | X                              | X                           | X                         |
| Salted/cured anchoveta   |             | X                      |     | X                              | X                           | X                         |
| <b>Indirect Human Consumption (reduction)</b>  |             |                        |     |                                |                             |                           |
| Prime fishmeal   |             | X                      |     | X                              | X                           | X                         |
| FAQ fishmeal   |             | X                      |     | X                              | X                           | X                         |
| Residual fishmeal  |             |                        | X   | X                              | X                           | X                         |
| <b>Aquafeeds</b>   |             |                        |     |                                |                             |                           |
| Artisanal feeds PE   |             | X                      |     | X                              | X                           | X                         |
| Commercial feeds PE  |             |                        | X   | X                              | X                           | X                         |
| Commercial feeds international (ingredients and energy use)                                |             |                        | X   | X                              | X                           | X                         |
| <b>Aquaculture</b>   |             |                        |     |                                |                             |                           |
| Tilapia: artisanal/commercial feeds, PE  |             |                        | X   | X                              | X                           | X                         |
| Black pacu: artisanal/commercial feeds, PE   |             | X                      |     | X                              | X                           | X                         |
| Trout: artisanal/commercial feeds, PE  |             | X                      |     | X                              | X                           | X                         |

LCA: Life Cycle Assessment, LCS: Life Cycle Screening, SMS: Small- and medium-scale, PE: Peru

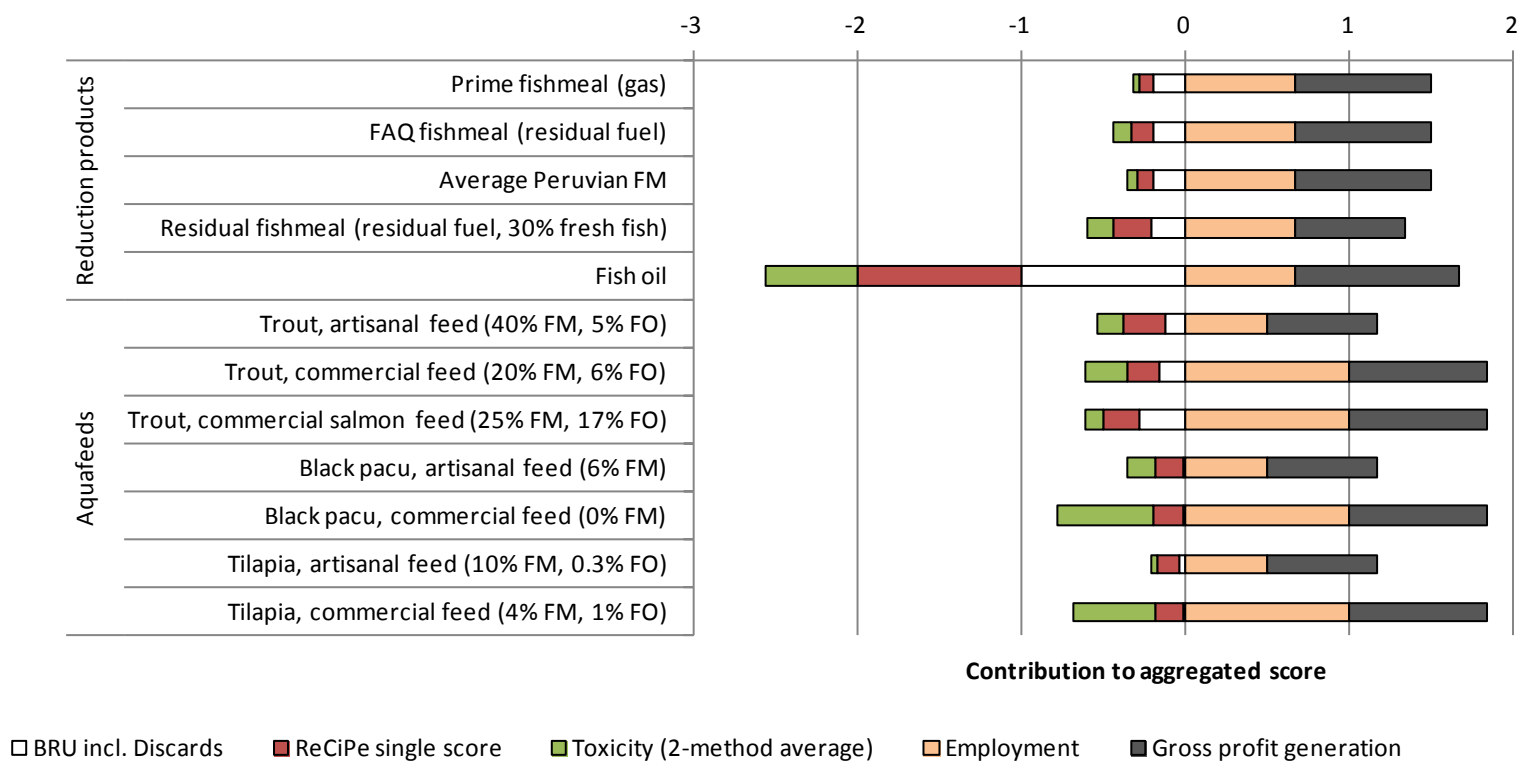
## 4 Results

### 4.1 Comparison of current supply chains

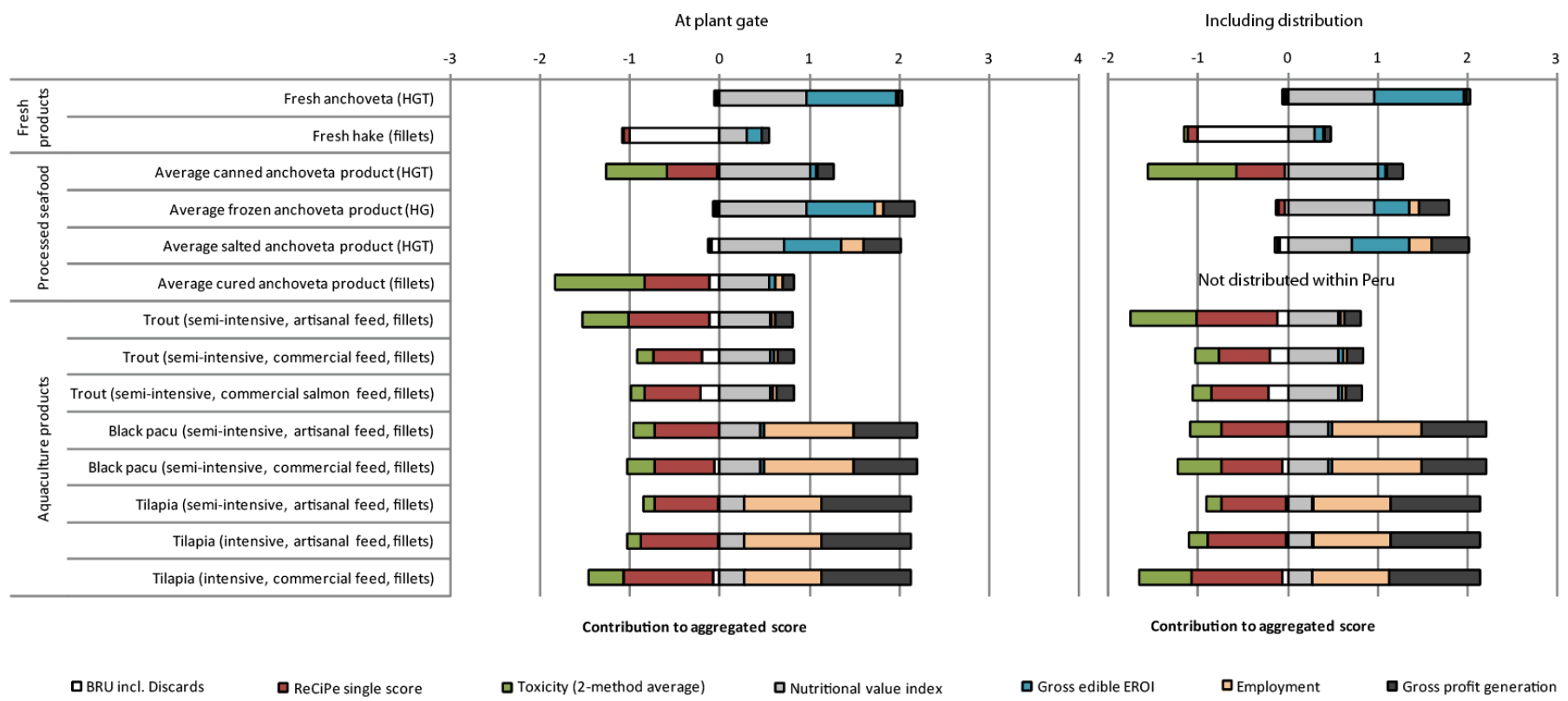
The proposed ecosystem/supply chain model allowed producing an overview of the whole anchoveta supply chain's sustainability performance, based on the indicator set presented in Table 1. The base material flow model is presented in SM, Fig. A.2.

The overall ranking of all studied products is presented in Fig. 2, including distribution at the national level of final fisheries DHC and aquaculture products. Fresh anchoveta and low energy-intensive anchoveta products perform better from a sustainability perspective than other products. A more detailed comparison of anchoveta DHC and aquaculture products, representing the current status of those supply chains, is presented in Avadí and Fréon (2014).

a) Reduction products and aquafeeds (no employment and gross profit generation data was available for aquafeeds, so proxy literature values were used)



b) Fishfood products



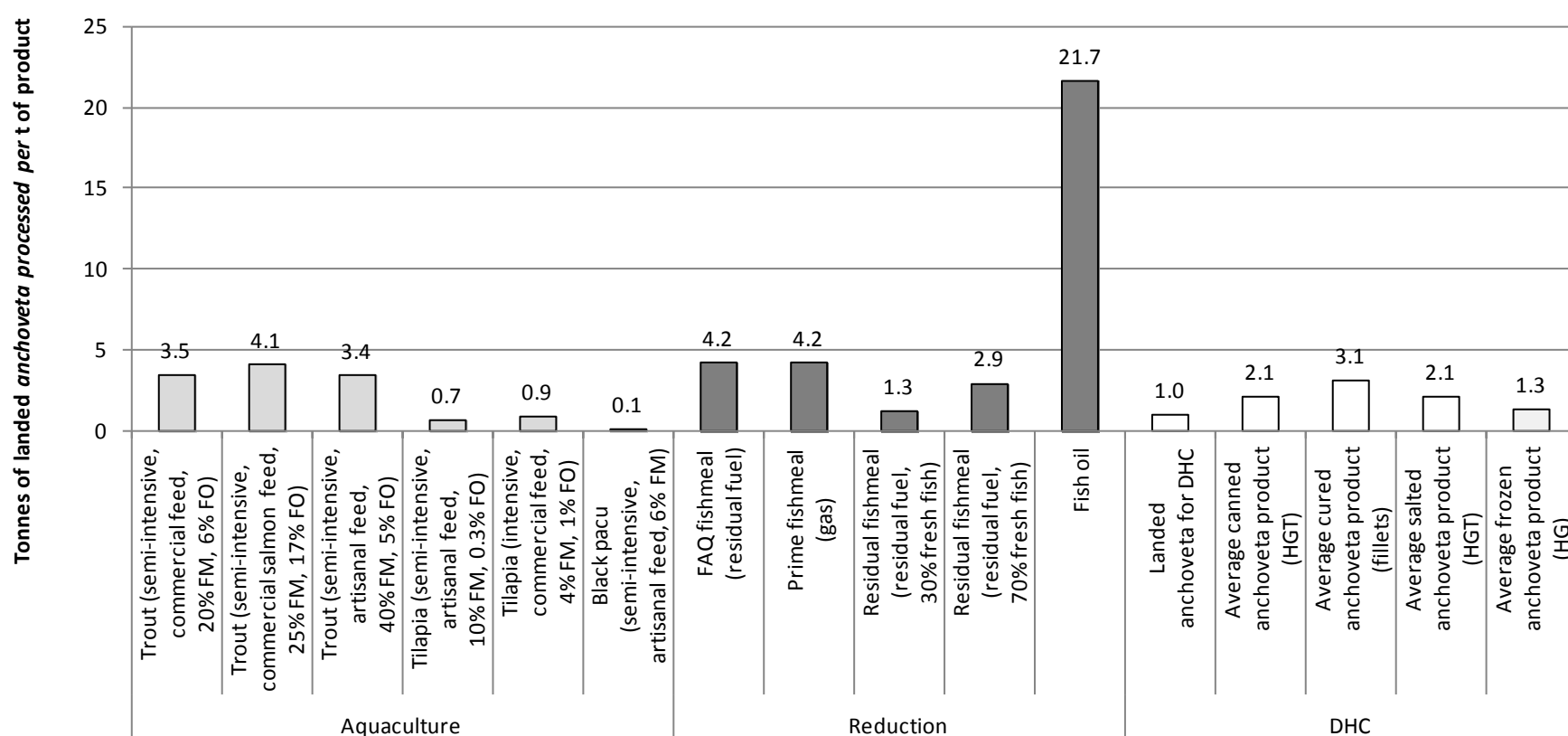
**Fig. 2.** Ranking of all studied DHC products from the anchoveta supply chains. According to the proposed indicator set, per tonne of fish in product. Shorter negative bars and longer positive bars represent better performance). The maximum possible interval in the right hand part of the graph is the same as in the left hand part (-3 to 4) but its display was reduced for convenience

When including national distribution of DHC products (over refrigerated chains when necessary), overall environmental performance as represented by the ReCiPe single score and toxicity indicators increase with a wide range of intensities (from 3% for canned products to 250% for frozen products). Nonetheless, the relative environmental ranking of all studied products does not change significantly because distribution has a minor contribution to total impacts (Table 4).

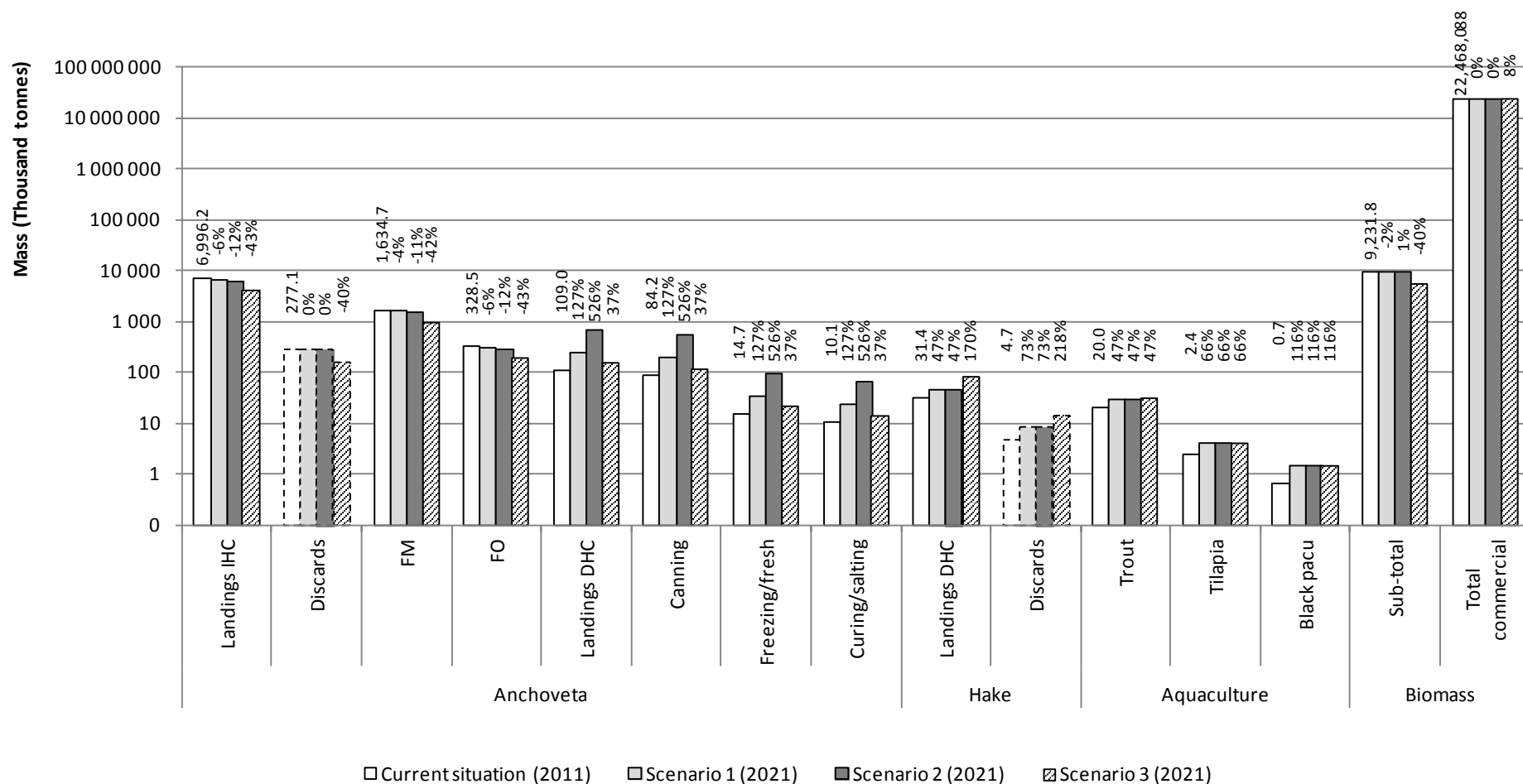
The fate of one tonne of Peruvian anchoveta, from sea to plant or farm gate (and to port gate in the case of fresh anchoveta for DHC) has been computed (Fig. 3). It is noticeable that DHC products feature better yields of products (and directly edible by humans) than reduction products. Aquaculture products are not directly comparable because they demand other agricultural inputs, yet it is shown that herbivore fish require much less fish inputs than carnivore ones.

**Table 4** Comparison of environmental performance of fisheries and aquaculture DHC products, at plant gate and after distribution, per t of fish in product

| Product group        | Products  | At plant gate            |                              |                  | Including distribution   |                              |                  | Change              |                |
|----------------------|---|--------------------------|------------------------------|------------------|--------------------------|------------------------------|------------------|---------------------|----------------|
|                      |   | ReCiPe single score (Pt) | Toxicity (CML, kg 1,4-DB eq) | Ranking (1=best) | ReCiPe single score (Pt) | Toxicity (CML, kg 1,4-DB eq) | Ranking (1=best) | ReCiPe single score | Toxicity (CML) |
| Fresh products       | Fresh <i>anchoveta</i> (HGT)                            | 31                       | 51 918                       | 1                | 51                       | 75 829                       | 1                | 68%                 | 46%            |
|                      | Fresh hake (fillets)                                    | 113                      | 134 066                      | 4                | 207                      | 245 237                      | 4                | 84%                 | 83%            |
| Processed seafood    | Average canned <i>anchoveta</i> product (HGT)           | 866                      | 3 229 195                    | 6                | 893                      | 3,260 146                    | 5                | 3%                  | 1%             |
|                      | Average frozen <i>anchoveta</i> product (HG)            | 38                       | 60 272                       | 2                | 132                      | 171 443                      | 3                | 250%                | 184%           |
|                      | Average salted <i>anchoveta</i> product (HGT)           | 46                       | 103 633                      | 3                | 62                       | 122 566                      | 2                | 36%                 | 18%            |
| Aquaculture products | Trout (semi-intensive, artisanal feed, fillets)         | 1412                     | 3 209 626                    | 12               | 1506                     | 3 320 796                    | 12               | 7%                  | 3%             |
|                      | Trout (semi-intensive, commercial feed, fillets)        | 850                      | 1 155 908                    | 5                | 944                      | 1 267 078                    | 6                | 11%                 | 10%            |
|                      | Trout (semi-intensive, commercial salmon feed, fillets) | 981                      | 1 174 689                    | 7                | 1075                     | 1 285 859                    | 7                | 10%                 | 9%             |
|                      | Black pacu (semi-intensive, artisanal feed, fillets)    | 1126                     | 1 447 070                    | 10               | 1220                     | 1 558 240                    | 10               | 8%                  | 8%             |
|                      | Black pacu (semi-intensive, commercial feed, fillets)   | 1045                     | 1 121 131                    | 8                | 1140                     | 1 232 301                    | 8                | 9%                  | 10%            |
|                      | Tilapia (semi-intensive, artisanal feed, fillets)       | 1105                     | 1 017 474                    | 9                | 1200                     | 1 128 644                    | 9                | 9%                  | 11%            |
|                      | Tilapia (intensive, artisanal feed, fillets)            | 1355                     | 1 178 435                    | 11               | 1450                     | 1 289 605                    | 11               | 7%                  | 9%             |
|                      | Tilapia (intensive, commercial feed, fillets)           | 1573                     | 1 653 337                    | 13               | 1667                     | 1 764 507                    | 13               | 6%                  | 7%             |



**Fig. 3** Alternative fates of 1 tonne of landed *anchoveta* (excluding other agricultural inputs to aquafeeds and DHC products), expressed as tonnes of landed anchoveta processed into 1 tonne of final product; HGT: headed, gutted, tailed; FM: fish oil



**Fig. 4** Mass outputs associated to the alternative exploitation scenarios, per key product, on a log<sub>10</sub> scale (percentages represent variation from the current situation)

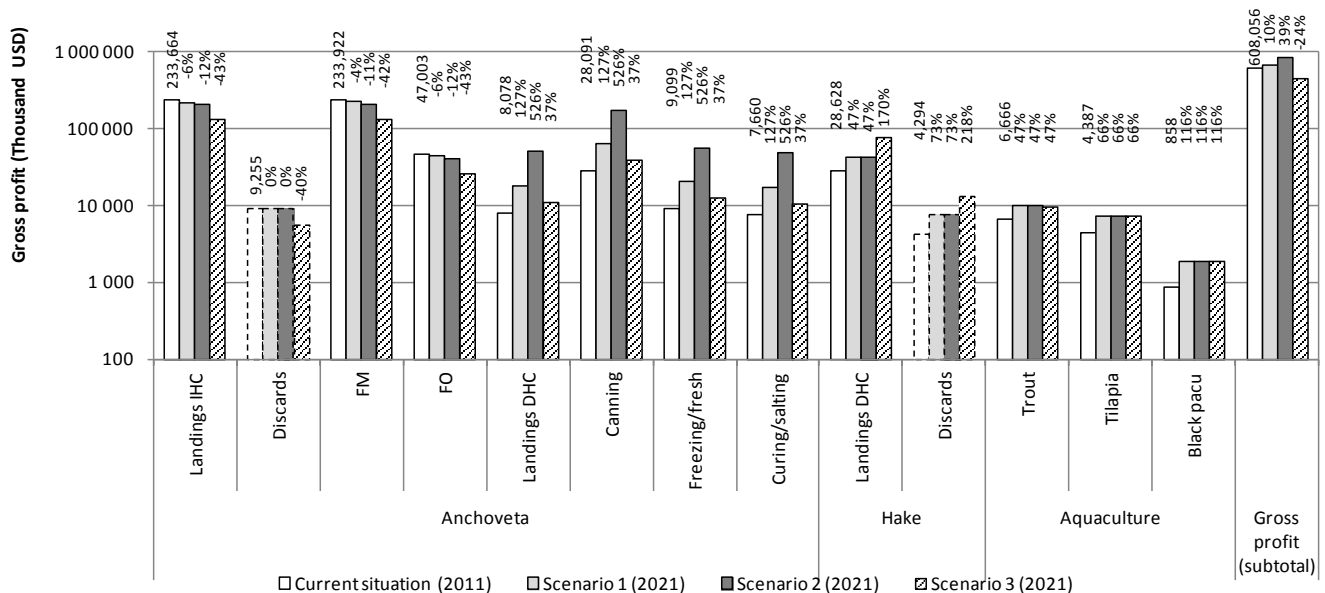
## 4.2 Alternative exploitation scenarios

A preliminary simulation (SM, Fig. B.1) indicated that after a 50% reduction of anchoveta fishing mortality, hake biomass increased 22%. Biomasses of other species also increased (such as bonito biomass, which increased 45%), yet hake is the most commercially interesting species of them (SM, Fig. B.2).

In S1 and S2, anchoveta biomass (SM, Fig. B.3) and hake biomass (SM, Fig. B.4) remained stable in the simulation based on historical values because no further changes were introduced. However, in the diversification scenario (S3), due to the reduction of anchoveta landings; the anchoveta biomass (SM, Fig. B.3) increased 21% and stabilised around 85 t·km<sup>-2</sup>. Consequently, hake biomass (SM, Fig. B.4) increased 18% and stabilised around 1.2 t·km<sup>-2</sup>. It is noteworthy that other predators also increased in this scenario (e.g. seabirds and pinnipeds). EwE outputs for the reference year and simulation scenarios, including fish biomasses, are presented in the SM.

The main product masses associated with the three scenarios (in the reference future year 2021) are depicted in Fig. 4. Conclusions on masses of our target seafood products and biomass of all commercial species in the marine ecosystem can be drawn: the former show a negligible increase of 1% in S2 and an important decrease of 40% in S3, while the latter shows no changes in S2 and a 8% increase in S3. Sankey diagrams (Schmidt, 2008b; Schmidt, 2008a) of the main masses (biomass and other materials) and energy flows were produced for the supply chains in the reference year and for the three scenarios in the reference future year (SM, Fig. A.3 to A.5).

Comparative gross economic benefits, expressed as gross profit (revenues – production costs) are shown in Fig. 5. Gross profit generation associated to the studied fishfood products supply chains increases by 12% in S2, while decreases 36% in S3. Detailed mass and economic balances, as well as detailed data for other dimensions of analysis (environmental impacts, biotic resource use, nutritional value) are shown in SM (Table A.2 and Table A.3).

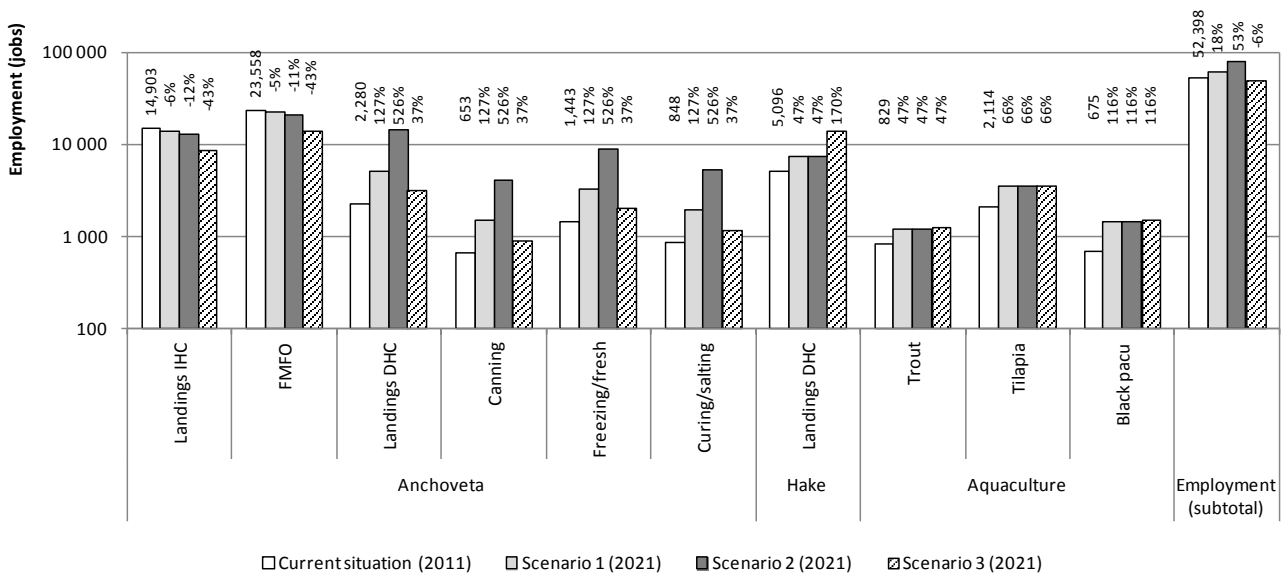


**Fig. 5** Economic outputs (gross profit = revenues – production costs) associated to the alternative exploitation scenarios, per key product, on a log<sub>10</sub> scale (percentages represent variation from the current situation)

Based on a Life Cycle Screening (LCS) performed on the Peruvian hake fishery (ANCHOVETA-SC project, unpublished data), all scenarios incorporate characterisation of that fishery, for the purpose of comparison with the anchoveta fisheries. A key datum for the hake fisheries LCA is the average fuel use intensity, estimated in 84 kg fuel per landed tonne, mass-allocated between hake and by-catch —93% of landings were hake, according to detailed landing records for the hake fleet in 2010 (IMARPE, unpublished data)—.

Graphical comparison of the scenarios, according to other dimensions of analysis, is presented in Fig. 6 to 10. The results depicted in these figures refer to the studied fishfood products only.

Employment related to our target fishfood products supply chains increases naturally by 18% in S1 along with the extrapolated increase in job-intensive production of DHC products. In S2 the increase reaches 53%, while in S3 employment decreases by 6%.



**Fig. 6** Employment associated to the alternative exploitation scenarios, per key product, on a log<sub>10</sub> scale (percentages represent variation from the current situation)

Environmental impacts, as expressed by the ReCiPe single score for our target supply chains, increase by 10% in S1 and by 54% in S2, associated to the increase in the production of energy-intensive processed seafood products. In S3, environmental impacts decrease by 32%, due to the great reduction in anchoveta landings.

BRU subtotal decreases only by 3% in S1 and 4% in S2, while displaying an important decrease of 40% in S3, also associated to the great reduction in anchoveta landings

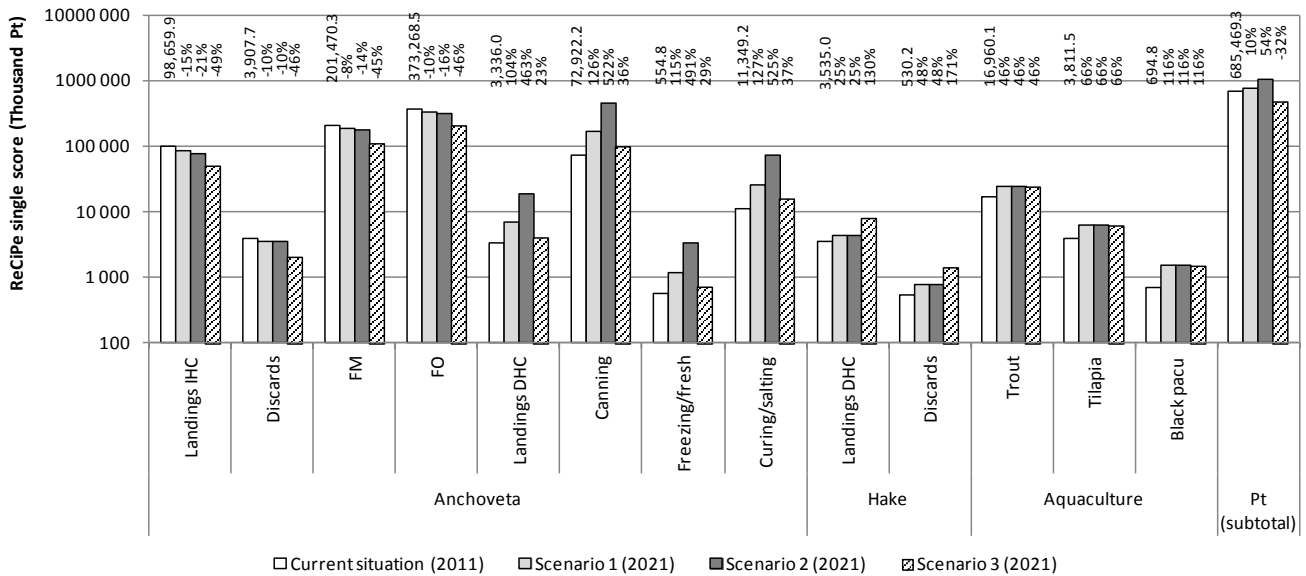
Among the ecosystem level indicators chosen, a higher value for IBNR<sub>sp</sub> symbolises a less preferable ecosystem health status, while all

higher values for IndiSeas indicators represent a healthier ecosystem. Regarding IBNR<sub>sp</sub>, results for all scenarios (the same amount of biomass is extracted in S1 and S2) show progressive improvement for anchoveta and worsening for hake. Applying IndiSeas indicators to EwE outputs of all commercial species results in an increase of trophic level of landings from 2.53 in S1/2 to 2.61 in S3, and to an increase in the inverse fishing pressure from 2.51 to 4.07, whereas the proportion of predators decreases slightly in S3, from 19% to 18%.

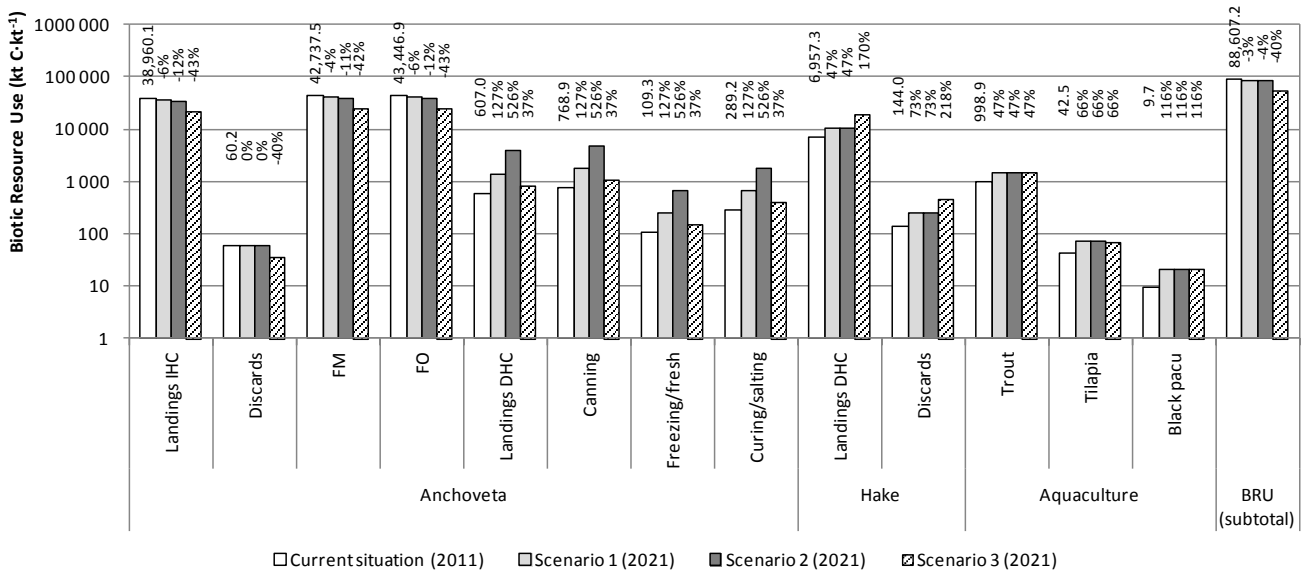
Available protein, as a proxy for the nutritional virtues of each scenario, subtotal for target products increases in all of scenarios when

compared to the 2011 situation. In S1, the 112% increase of the subtotal of our target products is associated to the increasing trend in landings for DHC, while in S2 the increase is a whopping 434%. In S3, the increase appears by comparison very moderate (53%) although substantial, due to the increase of hake landings for DHC. It is worth noting that the subtotal available protein of some other important commercial species such as catfish (*Galeichthys peruvianus*), flatfish

(*Paralichthys adspersus*) and Eastern Pacific bonito (*Sarda chiliensis chiliensis*), display a different pattern from the subtotal for target products, with small decreases of 4% from the reference year to S1 and S2, but a 47% increase in S3. When this increase is expressed in absolute value (2 039 Mt) it overcompensates the lower performance of S3 subtotal when compared to S1 and S2 (-2.2 Mt).

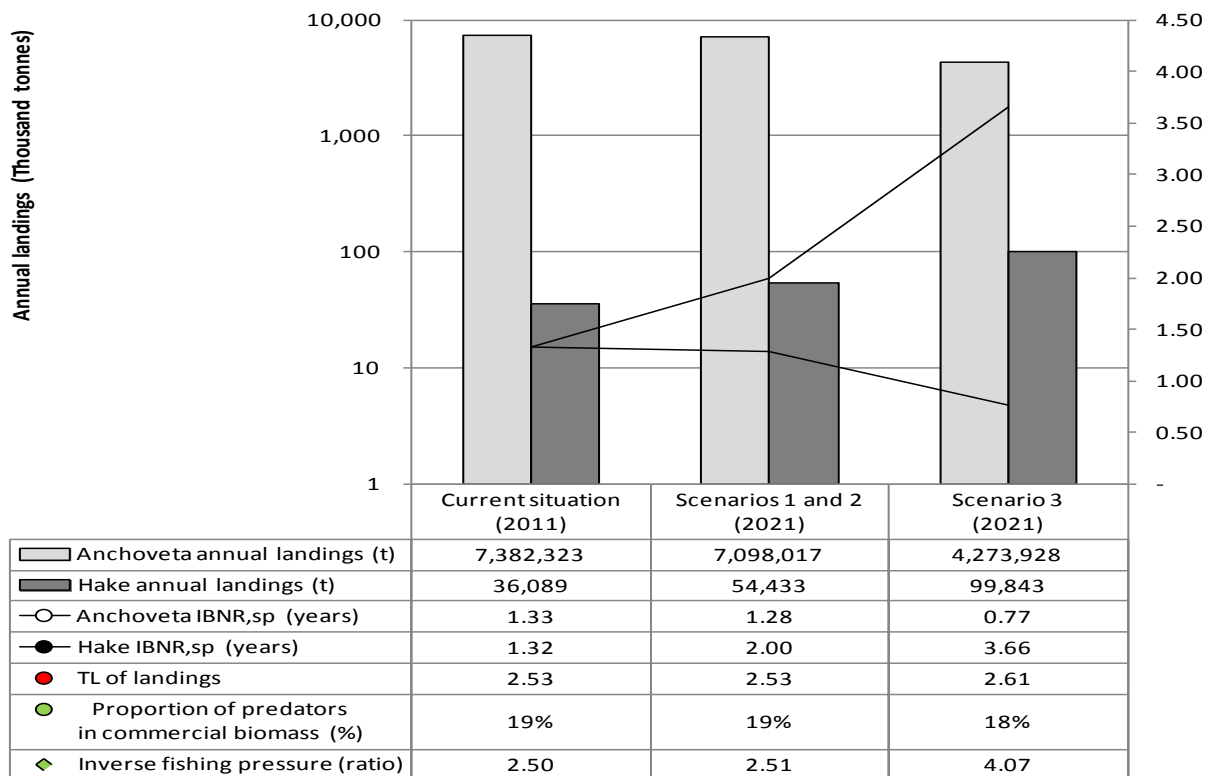


**Fig. 7** Environmental score (ReCiPe single score) associated to the alternative exploitation scenarios, per key product, on a log<sub>10</sub> scale (percentages represent variation from the current situation)

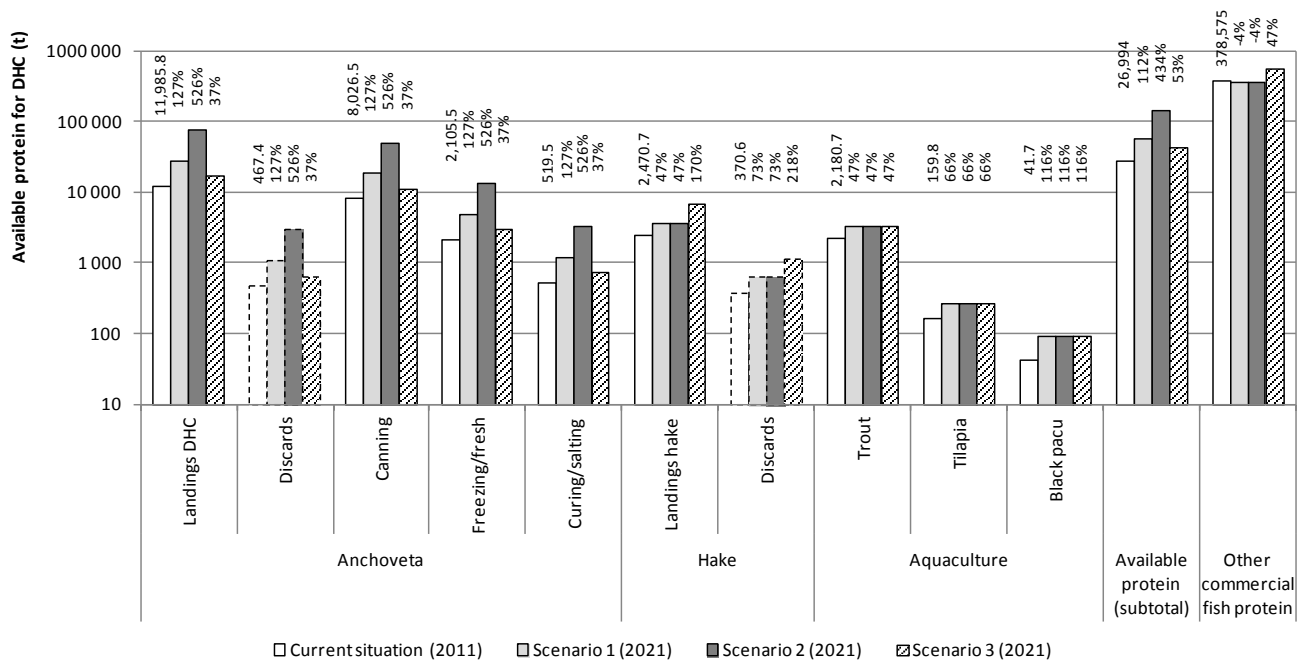


**Fig. 8** Biotic Resource Use associated to the alternative exploitation scenarios, per key product, on a log<sub>10</sub> scale (percentages represent variation from the current situation)





**Fig. 9** Indicators of ecosystem impacts (impacts on Biotic Natural Resources at the species level, mean trophic level of landings, proportion of predators in commercial biomass, and inverse fishing pressure) under the alternative exploitation scenarios. Maximum Sustainable Yield (MSY) for *anchoveta* has been estimated in over 5 million tonnes (Csirke et al., 1996), thus a 5-year average of total landings were used as proxy (5.5 million t). MSY of hake has been estimated in ~27 000 t until the stock fully recovers (Lassen et al., 2009)



**Fig. 10** Human nutritional protein (as a proxy of nutritional benefits) delivered by the alternative exploitation scenarios, per key product, on a log<sub>10</sub> scale (percentages represent variation from the current situation, other commercial fish landed refers to catfish (*Galeichthys peruvianus*), flatfish (*Paralichthys adspersus*) and Eastern Pacific bonito (*Sarda chiliensis chiliensis*))

## 5 Discussion

### 5.1 Methodological choices

Future changes in a) the proportion of anchoveta landings destined to DHC and, b) aquaculture production, were estimated to be positive. That is to say, total DHC and aquaculture production are expected to grow. Complete historical annual data was available until 2011, and both DHC and aquaculture production datasets depicted a growing trend until 2010. In 2011, nonetheless, total anchoveta landings for DHC were lower to those in 2010, yet it was not possible to predict a declining trend based on a single “low” year. Aquaculture output, in the other hand, shows a continuously growing trend since 2001.

In the case that future scenarios would have been built assuming a zero-slope growth trend, relative results would not vary significantly.

Particularly in the case of Scenario 3, where total anchoveta landings are dramatically reduced, we simulated the fate of anchoveta landings in favour of the DHC compared to the reference situation (2011). That is to say, the landing ratios of Scenario 1 (~3.6% for DHC) were kept. The rationale behind this decision is that, given existing overcapacity in both industries (reduction, canning), and the facts that reduction would be severely constrained and that fish processing companies are highly vertically integrated; it is likely that in such shortage situation firms would prioritise their more recent investment: anchoveta DHC means of production, especially those related to canning.

Another fundamental decision for scenario modelling was that the reference situation (the year 2011), was modelled (in the material flow model) using biomasses from PRODUCE statistics rather than from the EwE simulation. Differences are minor, but we preferred the more realistic depiction of the reference situation. For future scenarios, total catches (translated into fishing mortality) for anchoveta and hake were taken from the EwE simulation, as earlier described.

Reduction efficiencies were not altered (we consider the technical optimum has been reached), and neither aquaculture ratios (inter-species production ratios, general trends in feed compositions, etc).

### 5.2 The current situation: could it be better?

Under the current situation, a variety of anchoveta-based products are produced. The fishmeal industry has improved its technical performance over the years, and the current state of the art involves to a large extent the use of natural gas and an indirect drying process. Prime quality fishmeal produced at indirect drying gas-based plants is the best performing reduction product, according to the applied sustainability indicators set. Nonetheless, the production of residual FM remains necessary, not only from a socio-economic standpoint, but also from the environmental perspective to the extent that fish processing resources are valorised.

Regarding DHC products, the sustainability-optimal would be the landing, processing and distribution of fresh/chilled/frozen anchoveta products. Yet, salted and canned products currently provide certain vulnerable communities with fish products. Freshwater aquaculture products could play a better socio-economic role in Peru, given an adequate distribution chain is put into operation and current landing infrastructure for the SMS fleet is improved and enlarged. Among cultured species, black pacu displays better sustainability performance. Moreover, black pacu (and by extension other Amazonian species) seems promising for the country, again, depending on a currently inexistent distribution chain.

Throughout the supply chains, it is necessary to improve controls for better compliance with management measures (satellite monitoring of SMS vessels; diseases, discards, and juveniles control, etc). To improve the quality of fish (especially anchoveta) landed for DHC, it would be advisable to improve awareness of fishermen and

landing points controlling personnel on sanitary issues.

Policy measures should also be undertaken in order to improve the production of anchoveta DHC products, for instance, deploying a quota system for SMS fleets, and/or allowing all fleets to land for either DHC or IHC, as long as minimum requirements for each activity are fulfilled (Fréon et al., 2013).

### **5.3 Scenarios 1 and 2: Anchoveta for reduction or for food?**

S1 represents the status quo, that is to say the management strategy during the year of reference (2011) retained after the beginning of the simulation (2004), and extrapolated into the future. Such state of affairs is sustainable from the anchoveta stock management perspective, yet sub-optimal regarding socio-economic aspects (Fréon et al., 2013). S2 would improve sustainability in a variety of ways. For instance, by extracting nearly the same amount of biomass (without reducing the mean trophic level of landings or the proportion of predators in the ecosystem, Fig. 9), gross profit generation would increase by a factor 1.2 due to the increased activity of DHC processing industries. Similarly, employment would improve by a factor 1.5 and available protein for consumers by 2.5. The environmental costs of those improvements represent 1.4 regarding S1. The implications of S2 are complex: for instance, gross profit would be generated by a larger number of firms than in the current situation, and national distribution chains would have to be developed. Moreover, because it is unlikely that the Peruvian consumers will absorb all the additional anchoveta production (factor 2.8 in whole fish equivalents) export market must be found, which remains uncertain. Nonetheless, S2 would be undoubtedly more sustainable, at the national level, than S1.

### **5.4 Scenario 3: Anchoveta today or hake tomorrow?**

The goal of S3 is tempting: allow overexploited stocks to improve, so that they can be exploited again (hopefully more sustainably than in the past). By decreasing anchoveta fishing mortality by 50% over at least 10 years, other NHCS stocks would improve, notably hake (by 18% in biomass). An associated increase in hake catches (by a factor ~1.44) would thus be possible, and a similar increase is observed for a number of other stocks of predators (e.g. conger, flatfish, horse mackerel, pinnipeds and seabirds) whereas the decrease of a few anchoveta-competitor species (e.g. other small pelagics) and of cetaceans is observed. The implications of such a dramatic change in resource exploitation are diverse, although overestimated due to our incomplete coverage of species: total biomass removed would decrease by a factor 0.4 and biotic resource use by a factor 0.3; total gross profit generated would decrease also by a factor 0.3, employment by a factor 0.2 and environmental impacts by a factor 0.4. Moreover, the mean trophic level of landings shows a slight increase, due to the change in the proportion of anchoveta and hake landed. The proportion of predators in the ecosystem shows a slight decrease (19 to 18%) under this scenario because biomass of anchoveta increases slightly more than that of predators. The inverse fishing pressure increases, due to the drastic reduction on total landings (Fig. 9). Available amount of protein-equivalent of target species anchoveta and hake for Peruvian consumers would also decrease, by a factor 0.3, but could partly be compensated by an increase of some other species caught for DHC (Fig. 10; SM, Fig. B2). Overall, according to these indicators, S3 seems less preferable than S1 and S2, despite some ecological and environmental improvements. Moreover, to achieve the national consensus required for effectively reducing so dramatically the exploitation of the anchoveta stock would be a daunting endeavour, to say the least.

## 6 Conclusions

The proposed framework, as illustrated with the Peruvian case, provides a multi-criteria toolset for decision-making regarding the improvement of fishfood supply chain dynamics. The scenario analysis confirmed previous speculations that an increase in the share of anchoveta destined to DHC products would positively contribute to the country's sustainable development (S2). It also proved that a dramatic reduction in anchoveta landings would not be, in general, as positive for the country (S3). This latter point deserves more in-depth study, varying the exploitation rates and taking into account all species of the ecosystem that are exploited or potentially exploitable, be it by fisheries or for tourism. The preservation of ecosystem services should also be better taken into account.

A final rumination is that, due to the huge size of the reduction industry and its providing fisheries, results per functional unit do not align with absolute results per industry (DHC vs IHC vs aquaculture). In absolute terms, the most impacting activities in Peru are those related to the capture and reduction in FMFO of anchoveta. As a result, the best opportunities for improving the environmental and socio-economic performance of the Peruvian anchoveta supply chains would be related to sustainability-improving management and policy changes affecting the reduction industry and its provisioning. Moreover, future scenario modelling featuring reduction of anchoveta mortality should be explored using a sensitivity analysis to estimate the optimal level of reduction according to the response of all species in the ecosystem, including seabirds and mammals, their usefulness and potential values and uses.

### Acknowledgements

This work, carried out by a member of the Anchoveta Supply Chain (ANCHOVETA-SC) project (<http://anchoveta-sc.wikispaces.com>) is a contribution to the International Joint Laboratory "Dynamics of the Humboldt Current system" (LMI-

DISCOH) coordinated by the Institut de Recherche pour le Développement (IRD) and the Instituto del Mar del Perú (IMARPE), and gathering several other institutions. It was carried out under the sponsoring of the Direction des Programmes de Recherche et de la formation au Sud (DPF) of the IRD.

### References

- Alder J, Pauly D (2008) A comparative assessment of biodiversity, fisheries and aquaculture in 53 countries' Exclusive Economic Zones. Fisheries Centre Research Reports Fisheries Centre, University of British Columbia, Canada
- Alfaro-Shigueto J, Mangel JC, Pajuelo M, et al. (2010) Where small can have a large impact: Structure and characterization of small-scale fisheries in Peru. *Fish Res* 106:8–17.
- Alltech (2012) 2012 Alltech Global Feed Survey Summary. <http://www.ifif.org/uploadImage/2012/2/15/6a6d838117f38df3467726391c947b821329329246.pdf>
- Alvarado F (2009) Diagnóstico social sobre el trabajo y el empleo en el sector pesquero de Ecuador y Perú (Social diagnosis on work and employment in the fisheries sector of Ecuador and Peru). Proyecto para el desarrollo racional y sostenible del sector pesquero Madrid: Organización Internacional del Trabajo (OIT) <http://www.ilo.int/public/spanish/region/eurpro/madrid/download/peruecuador.pdf>
- Aranda M (2009) Developments on fisheries management in Peru: The new individual vessel quota system for the anchoveta fishery. *Fish Res* 96:308–312.
- Arias M (2012) The evolution of legal instruments and the sustainability of the Peruvian anchovy fishery. *Mar Policy* 36:78–89.
- Avadí, A, Fréon, P, Tam, J (2014d) Ecosystem-based supply chain modelling from sea to plate, Part 1: background and framework. Manuscript.
- Avadí A, Fréon P (2014) A set of sustainability performance indicators for seafood: direct human consumption products from Peruvian anchoveta fisheries and freshwater aquaculture. *Ecol Indic* (in review).

- Avadí A, Fréon P, Quispe I (2014c) Environmental assessment of Peruvian anchoveta direct human consumption products. *Int J Life Cycle Assess* (in review).
- Avadí A, Pelletier N, Aubin J, Ralite S, Núñez J, Fréon P (2014b) Comparative environmental performance of artisanal and commercial feed use in Peruvian freshwater aquaculture. *Aquaculture* (in review).
- Bertrand A, Fréon P, Chaigneau A, et al. (2010) Impactos del Cambio Climático en la Dinámica Oceánica, el Funcionamiento de los Ecosistemas y de las Pesquerías en el Perú: Proyección de Escenarios e Impactos Socio Económicos - Resumen Ejecutivo.
- Brochier T, Echevin V, Tam J, et al. (2013) Climate change scenarios experiments predict a future reduction in small pelagic fish recruitment in the Humboldt Current system. *Glob Chang Biol* n/a–n/a.
- Cárdenas-Alayza S (2012) Prey abundance and population dynamics of South American fur seals (*Arctocephalus australis*) in Peru. Vancouver: The University of British Columbia, Masters Dissertation
- Centrum (2009) Reporte Sectorial: Sector Pesca. Reportes Financieros Centrum Católica, Burkenroad Latinoamérica (Perú). Lima: Noviembre 18, 2009.
- Chavez FP, Bertrand A, Guevara-Carrasco R, et al. (2008) The northern Humboldt Current System: Brief history, present status and a view towards the future. *Prog Oceanogr* 79:95–105.
- Christensen V, de la Puente S, Sueiro JC, et al. (2013) Valuing seafood: the Peruvian fisheries sector. *Mar Policy*
- Christensen V, Pauly D (1992) ECOPATH II - a software for balancing steady-state ecosystem models and calculating network characteristics. *Ecol Modell* 61:169–185.
- Csirke, J (1996) Análisis bioeconómico de la pesquería pelágica peruana dedicada a la producción de harina y aceite de pescado. *Boletín Inst. Mar Perú*. 19:25-68.
- Csirke, J, Guevara-Carrasco, R, Cárdenas, G, Ñiquen, M, & Chipollini, A (1996) Situación de los recursos anchoveta (*Engraulis ringens*) y sardina (*Sardinops sagax*) a principios de 1994 y perspectivas para la pesca en el Perú, con particular referencia a las regiones Norte y Centro de la costa peruana. *Bol. Inst. Mar Perú*. 15:1-23.
- De la Puente O, Sueiro JC, Heck C, et al. (2011) La Pesquería Peruana de Anchoveta - Evaluación de los sistemas de gestión pesquera en el marco de la certificación a cargo del Marine Stewardship Council (The Peruvian anchoveta fishery - Assessment of the fishery management systems in the framework of th. *Doc Trab del Cent para la Sostenibilidad Ambient la UPCH* 160.
- Deutsch L, Gräslund S, Folke C, et al. (2007) Feeding aquaculture growth through globalization: Exploitation of marine ecosystems for fishmeal. *Glob Environ Chang* 17:238–249.
- Estrella C, Swartzman G (2010) The Peruvian artisanal fishery: Changes in patterns and distribution over time. *Fish Res* 101:133–145.
- FAO (2000) FAO - Perfiles nutricionales por países - Peru (FAO - Nutritional profiles by country - Peru). Rome: Food and Agriculture Organisation of the United Nations <http://www.bvsde.paho.org/texcom/nutricion/permap.pdf>
- FAO (2011) Country Profile: Food Security Indicators. Country: Peru. [http://www.fao.org/fileadmin/templates/ess/documents/food\\_security\\_statistics/country\\_profiles/eng/Peru\\_E.pdf](http://www.fao.org/fileadmin/templates/ess/documents/food_security_statistics/country_profiles/eng/Peru_E.pdf)
- FishSource (2012) Anchoveta - Peruvian northern-central stock. FishSource report FishSource: Status and environmental performance of fisheries worldwide <http://www.fishsource.com/fishery/identification?fishery=Anchoveta+-+Peruvian+northern-central+stock>
- Fréon P, Avadí A, Marín W, Negrón R (2014b) Environmentally-extended comparison table of large- vs. small- and medium-scale fisheries: the case of the Peruvian anchoveta fleet. *Can J of Fish Aquat Sci* (in review).
- Fréon P, Avadí A, Vinatea RA, Iriarte F (2014a) Life cycle assessment of the Peruvian industrial anchoveta fleet: boundary setting in life cycle inventory analyses of complex and plural means of production. *Int J Life Cycle Assess* (in press).
- Fréon P, Bouchon M, Domalain G, et al. (2010a) Impacts of the Peruvian anchoveta supply chains: from

- wild fish in the water to protein on the plate. *GLOBEC Int Newsl* 27–31.
- Fréon P, Bouchon M, Estrella C (2010b) Comparación de los impactos ambientales y aspectos socioeconómicos de las cadenas de producción de anchoveta (Comparison of environmental impacts and socio-economical aspects of the Peruvian anchovy supply chains). *Boletín Inst del Mar del Perú* 25:63–71.
- Fréon P, Sueiro JC, Iriarte F, et al. (2013) Harvesting for food versus feed: a review of Peruvian fisheries in a global context. *Rev Fish Biol Fisheries*. doi: 10.1007/s11160-013-9336-4
- Hertlein W (1995) A Simulation Model of the Dynamics of Peruvian Anchoveta (*Engraulis ringens*). *NAGA, ICLARM Q* 41–46.
- IFFO (2008) FIN Dossier 2008: Annual Review of the feed grade fish stocks used to produce fishmeal and fish oil for the UK market. 1–77.
- IFFO (2009) The production of fishmeal and fish oil from Peruvian anchovy. datasheet 1–10.
- IFPRI (2006) The Challenge of Hunger. Global Hunger Index: Facts, determinants and trends. Bonn / Washington: International Food Policy Research Institute (IFPRI) and Deutsche Welthungerhilfe (DWHH)<http://www.ifpri.org/sites/default/files/publications/ghi06.pdf>
- IFPRI (2012) 2012 Global hunger index: the challenge of hunger: Ensuring sustainable food security under land, water, and energy stresses. Bonn / Washington, DC / Dublin: International Food Policy Research Institute (IFPRI), Concern Worldwide and Welthungerhilfe and Green Scenery<http://www.ifpri.org/sites/default/files/publications/ghi12.pdf>
- IFU (2005) Umberto – A Software Tool for Life Cycle Assessment and Material Flow Analysis – User Manual. Hamburg: Institut für Umweltinformatik Hamburg GmbH and ifeu – Institut für Energie und Umweltforschung Heidelberg GmbH
- IIAP (2012) Instituto de Investigaciones de la Amazonía Peruana (Research Institute of the Peruvian Amazonia). <http://www.iiap.org.pe/>.
- IMARPE (2009) Boletín Instituto del Mar del Perú. Informe del Tercer Panel Internacional de Expertos de Evaluación de la merluza peruana *Merluccius gayi peruanus* Ginsburg. Manejo Precautorio de la Merluza Peruana. Callao 24 – 28 de marzo 2008. Lima: Instituto del Mar del Perú
- IMARPE (2010) Boletín Instituto del Mar del Perú. Quinto panel internacional de expertos en evaluación de la anchoveta peruana (*Engraulis ringens* Jenyns). Callao, 10 – 14 agosto 2009. Lima: Instituto del Mar del Perú
- IMARPE (2012) Instituto del Mar del Perú (Peruvian Institute of the Sea). [http://www.imarpe.pe/imarpe/index.php?id\\_idioma=EN](http://www.imarpe.pe/imarpe/index.php?id_idioma=EN).
- INEI (2011) Encuesta Demográfica y de Salud Familiar 2011 (Demographic and family health survey 2011). Lima: Instituto Nacional de Estadística e Informática (INEI)<http://proyectos.inei.gob.pe/endes/2011/>
- INEI (2012a) Perú: Compendio estadístico 2012. Pesca (Peru: Statistical compendium 2012. Fisheries). 887–916.
- INEI (2012b) Perú: Consumo per cápita de los principales alimentos 2008-2009 (Peru: Per capita consumption of main staple foods 2008-2009). <http://www.inei.gob.pe/biblioineipub/bancopub/Est/Li b1028/index.html>
- Jiménez F, Gómez C (2005) Evaluación nutricional de galletas enriquecidas con diferentes niveles de harina de pescado (Nutritional evaluation of cookies enriched with various levels of fishmeal). Publicación Virtual 010Lima: Red Peruana de Alimentación y Nutrición (r-PAN)<http://www.rpan.org/publicaciones/pv010.pdf>
- Lassen, H, Barriga, E, Palacios, J, Vargas, N, Díaz, E, Arguelles, J & Purca, S (2009) Evaluación del estado del stock de merluza (*Merluccius gayi peruanus* Ginsburg) en el mar peruano. 2008. *Bol. Inst. Mar Perú*. 24:21-26.
- Mendoza D (2011) Panorama de la acuicultura mundial, América Latina y el Caribe y en el Perú (Overview of global aquaculture, Latin America and the Caribbean, and Peru). Lima: Dirección de Acuicultura, Ministerio de la Producción - PRODUCE[http://www.racua.org/uploads/media/informe\\_acuicultura\\_mundo\\_al\\_peru.pdf](http://www.racua.org/uploads/media/informe_acuicultura_mundo_al_peru.pdf)
- Mendoza D (2013) Situación del extensionismo acuícola en el Perú (Situation of aquacultural extensionism in Peru). Report for Red de Acuicultura de las Américas

- (RAA) and FAOLima: Dirección de Acuicultura, Ministerio de la Producción - PRODUCE [http://rnia.produce.gob.pe/images/stories/archivos/pdf/publicaciones/informe\\_extensionismo\\_peru.pdf](http://rnia.produce.gob.pe/images/stories/archivos/pdf/publicaciones/informe_extensionismo_peru.pdf)
- PAD (2008) Realidad Pesquera de la Flota Industrial de Madera: Mitos y Verdades. Escuela de Dirección, Universidad de Piura
- Paredes C (2010) Reformando el Sector de la Anchoveta Peruana: Progreso Reciente y Desafíos Futuros (Reform of the Peruvian anchoveta sector: Recent progress and challenges for the future). Inst del Perú - Cuad Investig 1–23.
- Paredes C (2013a) Eficiencia y equidad en la pesca local: la reforma y los derechos. El Comer B6.
- Paredes C (2013b) La anchoveta en su laberinto. Gestión 23.
- Paredes C, Gutiérrez ME (2008) La industria anchovetera Peruana: Costos y Beneficios. Un Análisis de su Evolución Reciente y de los Retos para el Futuro (The Peruvian anchoveta industry: Costs and benefits. An analysis of recent evolution and challenges for the future). Estudio preparado por encargo del Banco Mundial al Instituto del Perú de la Universidad de San Martín de Porres [http://institutodelperu.org.pe/descargas/informe\\_de\\_la\\_industria\\_de\\_anchoveta.pdf](http://institutodelperu.org.pe/descargas/informe_de_la_industria_de_anchoveta.pdf)
- Paredes CE (2012) Eficiencia y equidad en la pesca peruana: La reforma y los derechos de pesca (Efficiency and equity in Peruvian fisheries: Reform and fishing rights). Lima: Instituto del Perú
- Paredes CE, Letona Ú (2013) Contra la corriente: La anchoveta peruana y los retos para su sostenibilidad. 76.
- Pauly D, Muck P, Mendo I, Tsukayama J (1989) The Peruvian Upwelling Ecosystem: Dynamics and Interactions. ICLARM Conf. Proc. 18. Instituto del Mar del Perú (IMARPE), Callao, Peru, Deutsche Gesellschaft für Technische Zusammenarbeit (GTZ), GmbH, Eschbom, Federal Republic of Germany; and International Center for Living Aquatic Resources Management (ICLARM), Manila, Philippines, p 438
- Pauly D, Tsukayama I (1987) The Peruvian Anchoveta and Its Upwelling Ecosystem: Three Decades of Change. ICLARM Stud Rev 15 351.
- Péron G, François Mittaine J, Le Gallic B (2010) Where do fishmeal and fish oil products come from? An analysis of the conversion ratios in the global fishmeal industry. *Mar Policy* 34:815–820.
- PETT (2012) Regional Government of Puno, Proyecto Especial Truchas Titicaca (Especial Project Trout Titicaca Lake). <http://pett.regionpuno.gob.pe/>.
- PRODUCE (2009) Plan Nacional de Desarrollo Acuicultura (Aquaculture Development National Plan). 85.
- PRODUCE (2010) Anuario Estadístico 2010 - Sub sector Pesca. Lima: Ministerio de la Producción, Oficina General de Tecnología de la Información y Estadística
- PRODUCE (2012a) Ministry of Production - Fisheries statistics. <http://www.produce.gob.pe/index.php/estadistica/desembarque>
- PRODUCE (2012b) Ministry of Production - Aquaculture statistics. <http://www.produce.gob.pe/index.php/estadistica/acuicultura>.
- Rokovich JA (2009) Estudios para el desarrollo de clusters en la actividad pesquera industrial y artesanal de anchoveta y pota - Informe final. Proyecto UE-PERU/PENX Lima: ICON-INSTITUT GmbH
- Sánchez N, Gallo M (2009) Status of and trends in the use of small pelagic fish species for reduction fisheries and for human consumption in Peru. In: Hasan M, Halwart M (eds) *Fish as Feed inputs Aquac. Pract. Sustain. Implic.* FAO Fish. Aquac. Tech. Pap. No. 518. pp 325–369
- Schmidt M (2008a) The Sankey Diagram in Energy and Material Flow Management. Part I. *J Ind Ecol* 12:82–94.
- Schmidt M (2008b) The Sankey Diagram in Energy and Material Flow Management. Part II. *J Ind Ecol* 12:173–185.
- Schreiber M, Halliday A (2013) Uncommon among the Commons? Disentangling the Sustainability of the Peruvian Anchovy Fishery. *Ecol Soc* 18:15.
- Shin Y-J, Bundy A, Shannon LJ, et al. (2012) Global in scope and regionally rich: an IndiSeas workshop helps shape the future of marine ecosystem indicators. *Rev Fish Biol Fish* 22:835–845.

- Silva SS, Turchini GM (2008) Towards Understanding the Impacts of the Pet Food Industry on World Fish and Seafood Supplies. *J Agric Environ Ethics* 21:459–467.
- SNP (2010) Memoria Anual 2010. Lima: Sociedad Nacional de Pesquería <http://snp.org.pe/wp/?cat=25>
- SNP (2011) Memoria anual 2011. Lima: Sociedad Nacional de Pesquería <http://snp.org.pe/wp/?cat=25>
- SOFIA (2012) The State of World Fisheries and Aquaculture 2012. 209.
- Sueiro JC (2008) La actividad pesquera peruana: Características y retos para su sostenibilidad. Lima: CooperAcción, Acción Solidaria para el Desarrollo <http://www.ibcperu.org/doc/isis/10736.pdf>
- SUNAT (2012) National Customs and Tax Administration. <http://www.sunat.gob.pe/>.
- Tacon A, Hasan M, Metian M (2011) Demand and supply of feed ingredients for farmed fish and crustaceans: trends and prospects. *FAO Fish Aquac Tech Pap* No 564 87.
- Talledo S (2010) Situación y perspectiva de la harina de pescado: Caso peruano de 1980-2007. Lima: Universidad Nacional Mayor de San Marcos, Masters Dissertation, [http://www.cybertesis.edu.pe/sisbib/2010/talledo\\_el/pdf/talledo\\_el.pdf](http://www.cybertesis.edu.pe/sisbib/2010/talledo_el/pdf/talledo_el.pdf)
- Tam J, Taylor MH, Blaskovic V, et al. (2008) Trophic modeling of the Northern Humboldt Current Ecosystem, Part I: Comparing trophic linkages under La Niña and El Niño conditions. *Prog Oceanogr* 79:352–365.
- Tam, J, Blaskovic, V, & Alegre, A. Modelo ecotrófico del ecosistema de afloramiento peruano durante El Niño 1997-98. In Wolff, M., Milessi, A., & Mendo, J. (Eds.) (2005) Modelación ecotrófica multiespecífica e indicadores cuantitativos ecosistémicos para la administración de pesquerías. CURSO INTERNACIONAL. Lima: Universidad Agraria La Molina.
- Tam, J, Jarre, A, Taylor, M, Wosnitza-Mendo, C, Blaskovic, V, Vargas, N, Díaz, E, Arguelles, J & Purca, S (2009) Modelado de la merluza en su ecosistema con interacciones tróficas y forzantes ambientales. *Bol. Inst. Mar Perú*. 24:27-32.
- Tam, J., V. Blaskovic, E. Goya, M. Bouchon, M. Taylor, R. Oliveros-Ramos, R. Guevara-Carrasco, S. Purca (2010) Relación entre anchoveta y otros componentes del ecosistema. *Bol. Inst. Mar Perú*. 25:31-37.
- Taylor MH, Tam J, Blaskovic V, et al. (2008) Trophic modeling of the Northern Humboldt Current Ecosystem, Part II: Elucidating ecosystem dynamics from 1995 to 2004 with a focus on the impact of ENSO. *Prog Oceanogr* 79:366–378.
- Taylor MH, Wolff M (2007) Trophic modeling of Eastern Boundary Current Systems: a review and prospectus for solving the “Peruvian Puzzle.” *Rev peru biol* 14:87–100.
- Tveteras S, Paredes C, Peña-Torres J (2011) Individual Fishing Quotas in Peru: Stopping the Race for Anchovies. *Marine Resource Economics* Marine Resources Foundation <http://fen.uahurtado.cl/wp/wp-content/uploads/2010/07/l263.pdf>
- USMP (2013) MESA REDONDA ¿El marco legal está propiciando la pesquería formal en el país? *Gestión* 15–18.
- Walters C, Christensen V, Pauly D (1997) Structuring dynamic models of exploited ecosystems from trophic mass-balance assessments. *Rev Fish Biol Fish* 7:139–172.
- Werner F, Lough G, Bertrand A, et al. (2008) The Northern Humboldt Current System: Ocean Dynamics, Ecosystem Processes, and Fisheries. *Prog Oceanogr* 79:95–412.



## Supplementary material

### A: Supporting tables and figures

**Table A.1** Chronology of key fisheries legislation in Peru (Arias, 2012; de la Puente et al., 2011; PAD, 2008; Paredes and Letona, 2013)

| Year | Legal instrument  | Issue   |
|------|---|---|
| 1961 | Law No. 13825   | Apply 14% tax on fishmeal exports   |
| 1962 | Decree Law 14195<br>Decree Law 14228  | Regulating instalment of fishmeal factories<br>Fishmeal exports allowed only through cooperatives   |
| 1963 | Supreme Decree 16-63-PE<br>Supreme Decree 18-63-PE<br><br>Supreme Decree 77-63-PE | Setting up the National Fisheries Council<br>Establishing exporting quotas and a new licenses' system for fishmeal processing plants<br>Officially recognizing the Peruvian Fishmeal Consortium                             |
| 1964 | Law No. 15048<br><br>Supreme Decree 07-64-PE                                      | New tax system for fishmeal exports, valid for 10 years (0.22 USD per tonne fishmeal and 0.11 USD per tonne fish oil)<br>Establishment of Peruvian Marine Research Institute  |
| 1965 | Supreme Decree 05-65-PE   | First <i>anchoveta</i> closed season  |
| 1967 | Law No. 16694   | Law for Fisheries Promotion   |
| 1968 | Law No. 17403   | Setting import free taxes for fishmeal equipment  |
| 1969 | Decree Law 180261   | Establishment of Ministry of Fisheries  |
| 1970 | Decree Law 18196<br>Decree Law 18253  | Establishment of Fisheries Development Fund<br>Establishment of State Company for commercialization of fishmeal and fish oil  |
| 1971 | Decree Law 18810  | (First) General Fisheries Act (repealed)  |
| 1988 | Law No. 24790   | (Second) General Fisheries Act (repealed)   |
| 1992 | Decree Law 25977  | (Third) General Fisheries Act (featuring prohibition of fleet enlargement and increasing fishmeal plant capacity)   |
| 1994 | Supreme Decree 01-94-PE   | Regulation for the Fisheries Act (repealed)   |
| 1997 | Supreme Decree 001-97-PE<br>Supreme Decree 781-97-PE                              | Publication of official list of fishing vessels<br>Declaration of <i>anchoveta</i> and sardine as fully-exploited species   |
| 1998 | Law No. 26920   | Law regulating wooden fleet vessels with holding capacity 32.6-110 m <sup>3</sup> (Vikingas, operating illegally before the law). It excludes Vikingas operators from the fleet enlargement limitations of Decree Law 25977 |
| 2001 | Supreme Decree 012-2001-PE<br><br>Supreme Decree 040-2001-PE                      | Regulation for the Fisheries Act, defines artisanal (SMS) vessels as those featuring a holding capacity of up to 32.6 m <sup>3</sup> and 15 m length<br>Sanitary standard for fisheries and aquaculture resources           |
| 2002 | Supreme Decree 001-2002-PE<br><br>Supreme Decree 007-2002-PE                      | Establishes catches of sardine, jack mackerel and chub mackerel can be only dedicated to DHC<br>Fishing permits and vessel decommissioning  |
| 2003 | Supreme Decree 026-2003-PE<br>Supreme Decree 027-2003-PE                          | Regulation for the Vessel Monitoring System<br>Establishment of the Surveillance and Control Program for Fisheries and Landings   |
| 2005 | Ministerial Resolution 043-2005-PRODUCE   | Establishes rules for processing of fish residues from small- and medium-scale landing ports  |
| 2006 | Supreme Decree 024-2006-PRODUCE   | Establishment of "fishing rights" for landings destined for reduction (0.25% of the average monthly FOB value of 1 t of fishmeal, per landed t of <i>anchoveta</i> )  |

|      |   |  |
|------|---|--|
|      | Ministerial Resolution 205-2006-PRODUCE   | Establishes rules for processing of fish residues and discards from processing for direct human consumption  |
| 2007 | Supreme Decree 002-2007-PRODUCE   | Declaration of direct human consumption of <i>anchoveta</i> and jumbo squid to be of strategic and national interest   |
| 2008 | Legislative Decree 1084<br><br>Supreme Decree 021-2008-PRODUCE  | Introduction of individual vessel quotas (to end the race for fish under the total allowable quota)<br>Imposition of a USD 1.95 fee per landed t<br>Regulation for Legislative Decree 1084   |
| 2009 | Supreme Decree 009-2009-PRODUCE   | Establishes the regulations for an individual vessel quota system in the South Zone of Peru  |
| 2010 | Supreme Decree 010-2010-PRODUCE<br><br>Supreme Decree 018-2010-PRODUCE<br>Supreme Resolution 028-2010-PRODUCE         | Regulation for Fisheries Management of <i>Anchoveta</i> for Direct Human Consumption (DHC)<br>Prohibition of building new vessels over 5 m <sup>3</sup> of holding capacity<br>Creation of the National Council for the Promotion of the Resources <i>anchoveta</i> and <i>pota</i> (flying giant squid, <i>Dosidicus gigas</i> )  |
| 2011 | Supreme Decree 005-2011-PRODUCE<br>Supreme Decree 017-2011-PRODUCE  | Regulation for processing of fish residues and discards<br>Modifies the regulation for processing of fish residues and discards  |
| 2012 | Supreme Decree 005-2012-PRODUCE<br><br>Ministerial Resolution 433-2012-PRODUCE<br><br>Supreme Decree 008-2012-PRODUCE | Subdivision of the direct human consumption fleet into small-scale (<10 m <sup>3</sup> ) and medium-scale (10-32.6 m <sup>3</sup> ). Also assigns exclusive fishing rights within the first 5 nautical miles to the former and from 5 to 10 nautical miles to the latter.<br>Complementary regulation establishing that small- and medium-scale vessels landing <i>anchoveta</i> for DHC must have a purchase agreement with fish processing plants.<br>Establishment of the obligation to report fishing grounds where juveniles are present. |
| 2013 | Judgement by the Supreme Court (November)   | The Supreme Court declared unconstitutional the exclusivity of the 5 to 10 nautical miles for the medium-scale fleet as it appears in Supreme Decree 005-2012. Currently under appeal by PRODUCE.  |

**Table A.2** Detailed mass balances, gross profit and employment figures of the modelled scenarios (economy-wide), excluding distribution

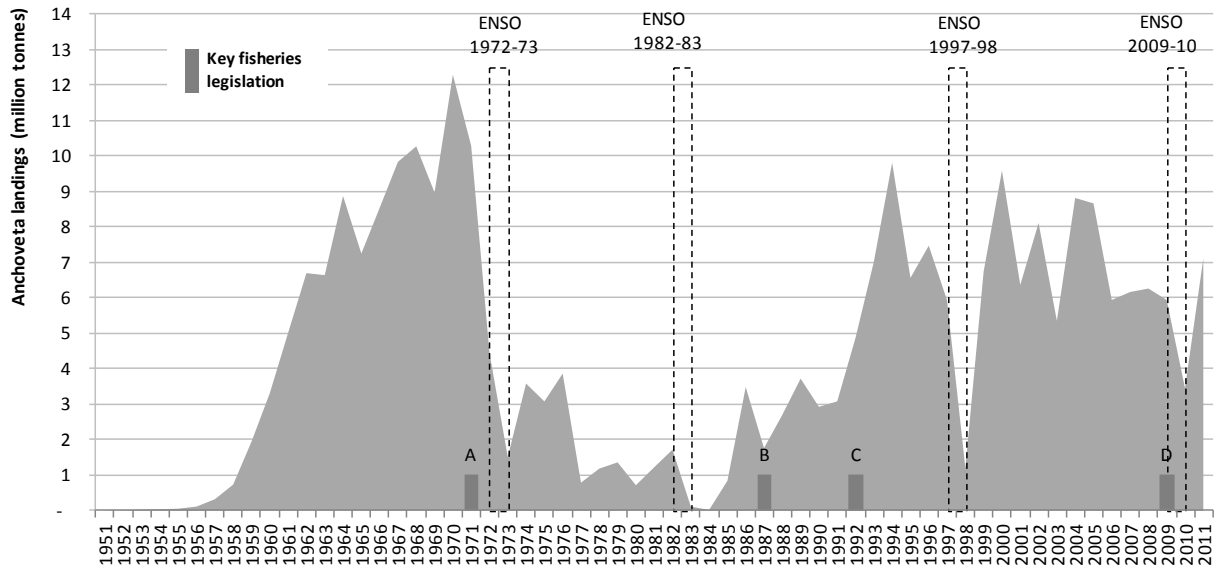
| Products           | Status quo (2011) |                         |                          | Scenario 1 (2021) |                         |                          | Scenario 2 (2021) |                         |                          | Scenario 3 (2021) |                         |                          |        |
|--------------------|-------------------|-------------------------|--------------------------|-------------------|-------------------------|--------------------------|-------------------|-------------------------|--------------------------|-------------------|-------------------------|--------------------------|--------|
|                    | Biomass (kt)      | Gross profit (1000 USD) | Employment (direct jobs) | Biomass (kt)      | Gross profit (1000 USD) | Employment (direct jobs) | Biomass (kt)      | Gross profit (1000 USD) | Employment (direct jobs) | Biomass (kt)      | Gross profit (1000 USD) | Employment (direct jobs) |        |
| <i>Anchoveta</i>   | Landings IHC      | 6 996.2                 | 233,664                  | 14 903            | 6 573.5                 | 219,546                  | 14 002            | 6 139.1                 | 205,037                  | 13 077            | 3 958.1                 | 132,195                  | 8 431  |
|                    | Discards          | 277.1                   | 9,255                    | N/A               | 276.8                   | 9,246                    | N/A               | 276.8                   | 9,246                    | N/A               | 166.7                   | 5,567                    | N/A    |
|                    | FM                | 1634.7                  | 233,922                  | 15 705            | 1561.4                  | 223,437                  | 14 960            | 1458.2                  | 208,670                  | 13 971            | 940.2                   | 134,538                  | 9 008  |
|                    | FO                | 328.5                   | 47,003                   |                   | 308.6                   | 44,163                   |                   | 288.2                   | 41,244                   |                   | 185.8                   | 26,592                   |        |
|                    | Landings DHC      | 109.0                   | 8,078                    | 2 280             | 247.7                   | 18,353                   | 5 181             | 682.1                   | 50,545                   | 14 270            | 149.1                   | 11,051                   | 3 120  |
|                    | Canning           | 84.2                    | 28,091                   | 653               | 191.3                   | 63,825                   | 1484              | 526.8                   | 175,774                  | 4 088             | 115.2                   | 38,431                   | 894    |
|                    | Freezing/fresh    | 14.7                    | 9,099                    | 1443              | 33.5                    | 20,673                   | 3 278             | 92.1                    | 56,934                   | 9 026             | 20.1                    | 12,448                   | 1974   |
|                    | Curing/salting    | 10.1                    | 7,660                    | 848               | 22.9                    | 17,404                   | 1 927             | 63.1                    | 47,932                   | 5 306             | 13.8                    | 10,480                   | 1160   |
| <i>Hake</i>        | Landings hake     | 31.4                    | 28,628                   | 5 096             | 46.3                    | 42,208                   | 7 513             | 46.3                    | 42,208                   | 7 513             | 84.9                    | 77,420                   | 13 781 |
|                    | Discards          | 4.7                     | 4,294                    | N/A               | 8.2                     | 7,448                    | N/A               | 8.2                     | 7,448                    | N/A               | 15.0                    | 13,662                   | N/A    |
| <i>Aquaculture</i> | Trout             | 20.0                    | 6,666                    | 829               | 29.4                    | 9,809                    | 1 220             | 29.4                    | 9,809                    | 1 220             | 29.4                    | 9,809                    | 1220   |
|                    | Tilapia           | 2.4                     | 4,387                    | 2 114             | 4.0                     | 7,275                    | 3 504             | 4.0                     | 7,275                    | 3 504             | 4.0                     | 7,275                    | 3 504  |
|                    | Black pacu        | 0.7                     | 858                      | 675               | 1.4                     | 1,852                    | 1 457             | 1.4                     | 1,852                    | 1457              | 1.4                     | 1,852                    | 1457   |
| <b>Totals</b>      | <b>9 231.8</b>    | <b>608 065</b>          | <b>44 546</b>            | <b>9 020.0</b>    | <b>668 545</b>          | <b>54 527</b>            | <b>9 330.8</b>    | <b>847 279</b>          | <b>73 433</b>            | <b>5 502.1</b>    | <b>462 090</b>          | <b>44 549</b>            |        |

**Notes.** Gross profit = Revenues – Production costs. IHC: Indirect Human Consumption, DHC: Direct Human Consumption, FM: Fishmeal, FO: Fish oil.

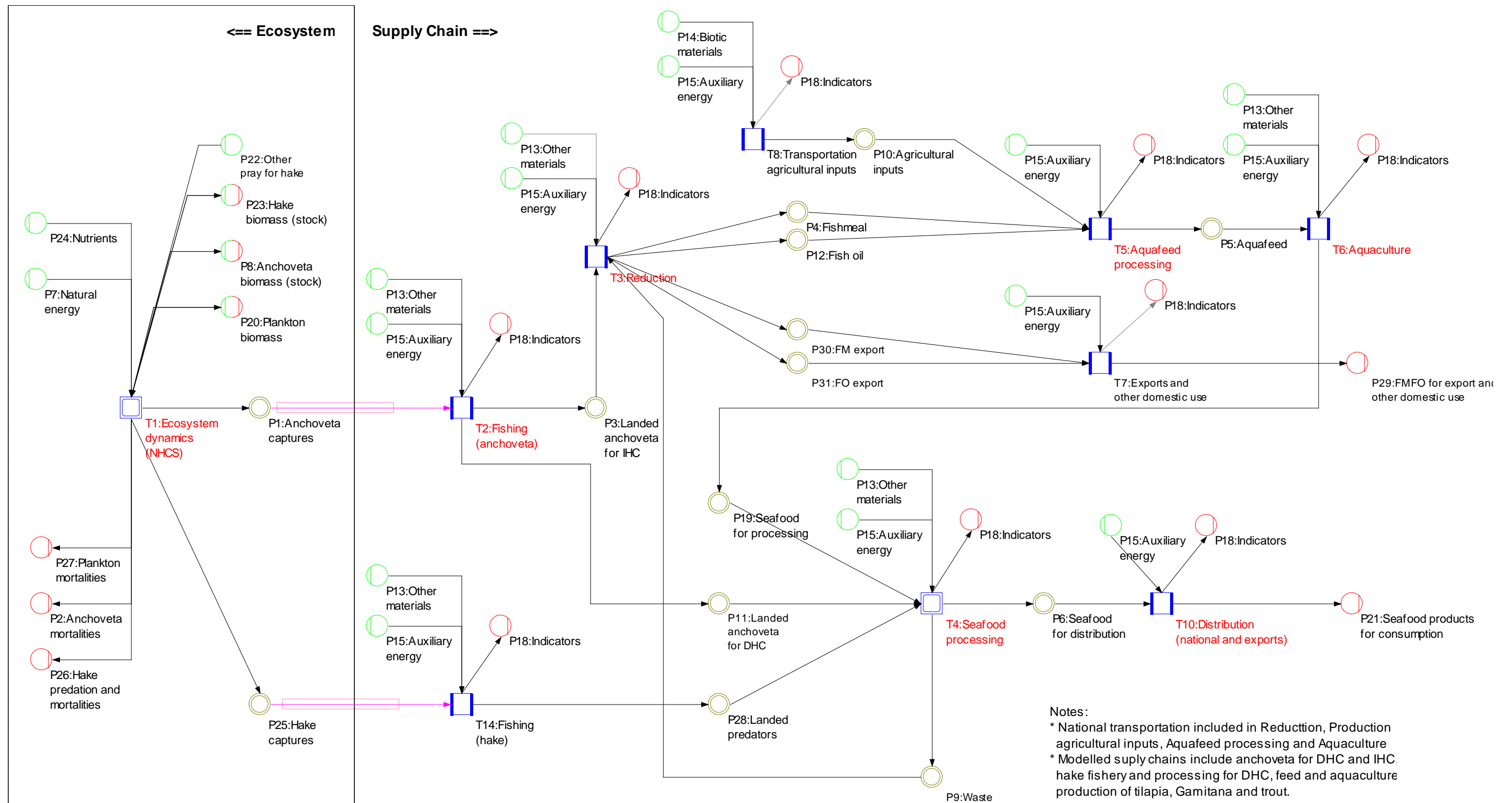
**Table A.3** Detailed environmental, nutritional, and energy efficiency scores of the modelled scenarios (economy-wide), excluding distribution

| Products         | Status quo (2011)        |                              |                               | Scenario 1 (2021)        |                              |                               | Scenario 2 (2021)        |                              |                               | Scenario 3 (2021)        |                              |                               |          |
|------------------|--------------------------|------------------------------|-------------------------------|--------------------------|------------------------------|-------------------------------|--------------------------|------------------------------|-------------------------------|--------------------------|------------------------------|-------------------------------|----------|
|                  | ReCiPe single score (Pt) | BRU (kt C·kt <sup>-1</sup> ) | Available protein for DHC (t) | ReCiPe single score (Pt) | BRU (kt C·kt <sup>-1</sup> ) | Available protein for DHC (t) | ReCiPe single score (Pt) | BRU (kt C·kt <sup>-1</sup> ) | Available protein for DHC (t) | ReCiPe single score (Pt) | BRU (kt C·kt <sup>-1</sup> ) | Available protein for DHC (t) |          |
| <i>Anchoveta</i> | Landings IHC             | 98 659.9                     | 38 960.1                      | N/A                      | 92 699.1                     | 36 606.2                      | N/A                      | 86 572.7                     | 34 187.0                      | N/A                      | 55 816.9                     | 22 041.7                      | N/A      |
|                  | Discards                 | 3 907.7                      | 60.2                          | 810.6                    | 3 903.7                      | 60.1                          | 1841.8                   | 3 903.7                      | 60.1                          | 5 072.2                  | 2 350.6                      | 36.2                          | 1109.0   |
|                  | FM                       | 201 470.3                    | 42 737.5                      | N/A                      | 192 439.7                    | 40 821.9                      | N/A                      | 179 721.5                    | 38 124.0                      | N/A                      | 115 873.7                    | 24 580.1                      | N/A      |
|                  | FO                       | 373 268.5                    | 43 446.9                      | N/A                      | 350 716.4                    | 40 821.9                      | N/A                      | 327 537.9                    | 38 124.0                      | N/A                      | 211 176.8                    | 24 580.1                      | N/A      |
|                  | Landings DHC             | 2 502.0                      | 607.0                         | 20 784.6                 | 5 684.7                      | 1379.3                        | 47 224.7                 | 15 655.8                     | 3 798.6                       | 130 057.4                | 3 423.0                      | 830.5                         | 28 435.4 |
|                  | Canning                  | 72 922.2                     | 768.9                         | 17 891.2                 | 165 686.8                    | 1747.1                        | 40 650.7                 | 456 303.7                    | 4 811.5                       | 111 952.6                | 99 765.0                     | 1052.0                        | 24 477.0 |
|                  | Freezing/fresh           | 554.8                        | 109.3                         | 2 807.4                  | 1260.7                       | 248.4                         | 6 378.6                  | 3 471.9                      | 684.1                         | 17 566.9                 | 759.1                        | 149.6                         | 3 840.8  |
|                  | Curing/salting           | 11 349.2                     | 289.2                         | 1852.9                   | 25 786.6                     | 657.2                         | 4 210.0                  | 71 016.6                     | 1809.9                        | 11 594.3                 | 15 526.9                     | 395.7                         | 2 534.9  |
| <i>Hake</i>      | Landings hake            | 3 535.0                      | 6 957.3                       | 5 219.9                  | 5 211.8                      | 10 257.4                      | 7 695.9                  | 5 211.8                      | 10 257.4                      | 7 695.9                  | 9 559.7                      | 18 814.6                      | 14 116.2 |
|                  | Discards                 | 530.2                        | 144.0                         | 783.0                    | 919.7                        | 249.8                         | 1358.1                   | 919.7                        | 249.8                         | 1358.1                   | 1687.0                       | 458.2                         | 2 491.1  |
| Aquaculture      | Trout                    | 16 960.1                     | 998.9                         | 3 669.1                  | 24 955.5                     | 1469.8                        | 5 398.8                  | 24 955.5                     | 1469.8                        | 5 398.8                  | 24 955.5                     | 1469.8                        | 5 398.8  |
|                  | Tilapia                  | 3 811.5                      | 42.5                          | 444.0                    | 6 319.9                      | 70.5                          | 736.2                    | 6 319.9                      | 70.5                          | 736.2                    | 6 319.9                      | 70.5                          | 736.2    |
|                  | Black pacu               | 694.8                        | 9.7                           | 99.7                     | 1498.9                       | 20.9                          | 215.1                    | 1498.9                       | 20.9                          | 215.1                    | 1498.9                       | 20.9                          | 215.1    |
| <b>Totals</b>    | <b>685 469.3</b>         | <b>135 131.6</b>             | <b>54 362</b>                 | <b>773 497.9</b>         | <b>134 410.4</b>             | <b>115 710</b>                | <b>1 075 649.3</b>       | <b>133 667.5</b>             | <b>291 647</b>                | <b>479 913.2</b>         | <b>94 499.8</b>              | <b>83 354</b>                 |          |

**Notes.** IHC: Indirect Human Consumption, DHC: Direct Human Consumption, FM: Fishmeal, FO: Fish oil.

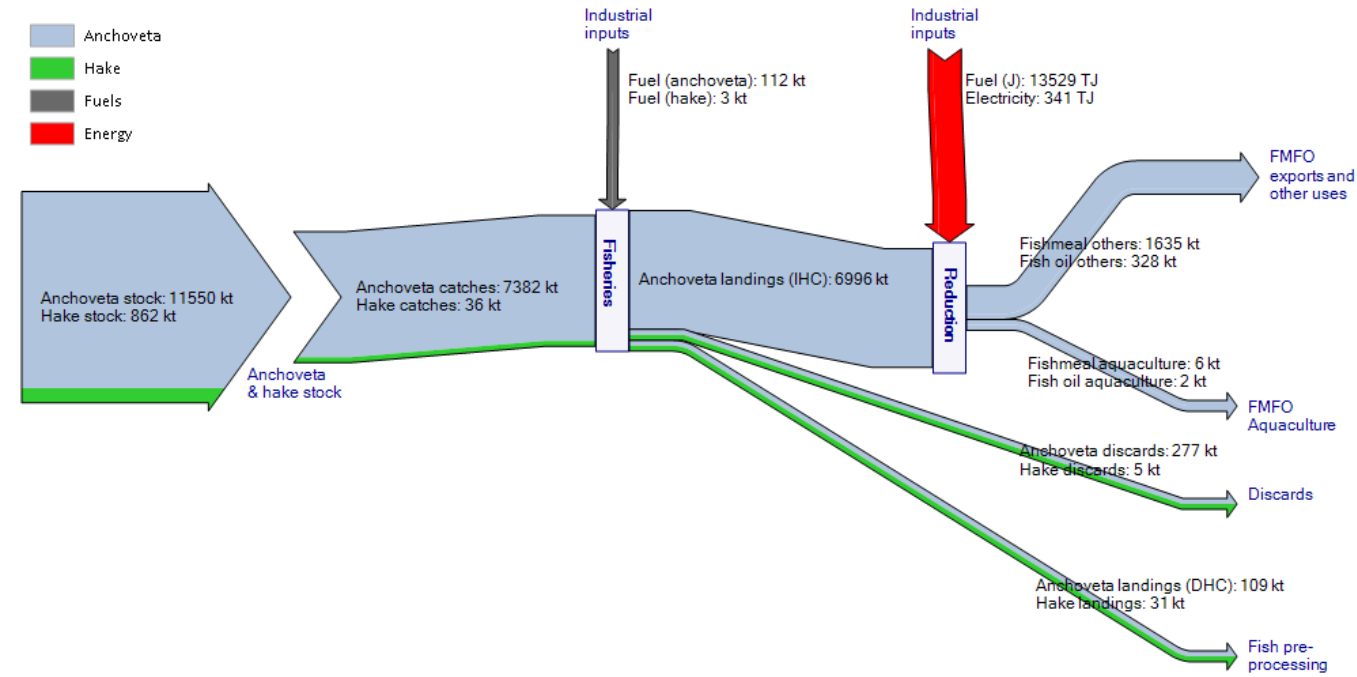


**Fig. A.1** Historical annual *anchoveta* landings and critical El Niño (ENSO) and policy events (1951-2011): A - (First) General Fisheries Act, B - (Second) General Fisheries Act, C - (Third) General Fisheries Act, D - Legislative Decree 1084 (individual vessel quota system). Source: statistics from FishStatJ and PRODUCE. Inspired from Fig. 2 in (Arias, 2012)

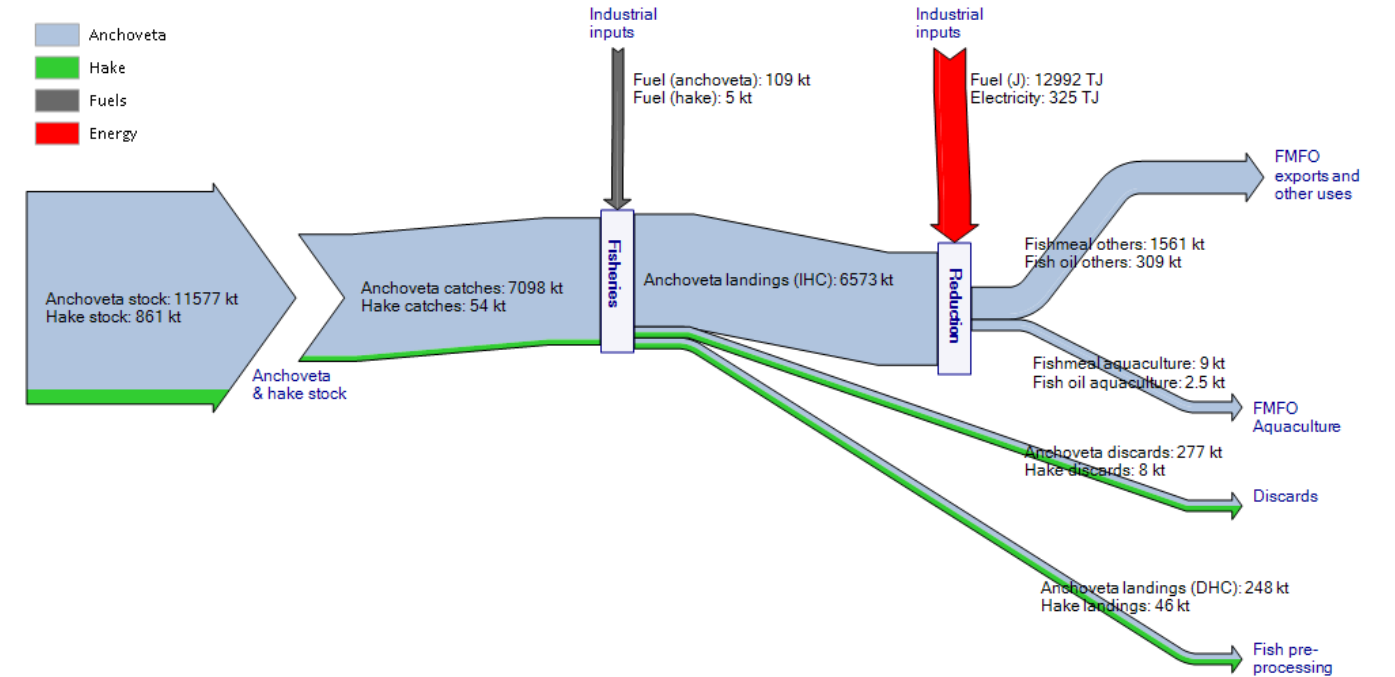


**Fig. A.2** Material flow model of the Peruvian *anchoveta* supply chains, featuring interactions with the Northern Humboldt Current System (NHCS). The “Supply Chain” part of the model can be used separately to generate mass balances of alternative exploitation/production mixes (every arrow can be modified manually and the rest of the system would be recalculated for such intervention)

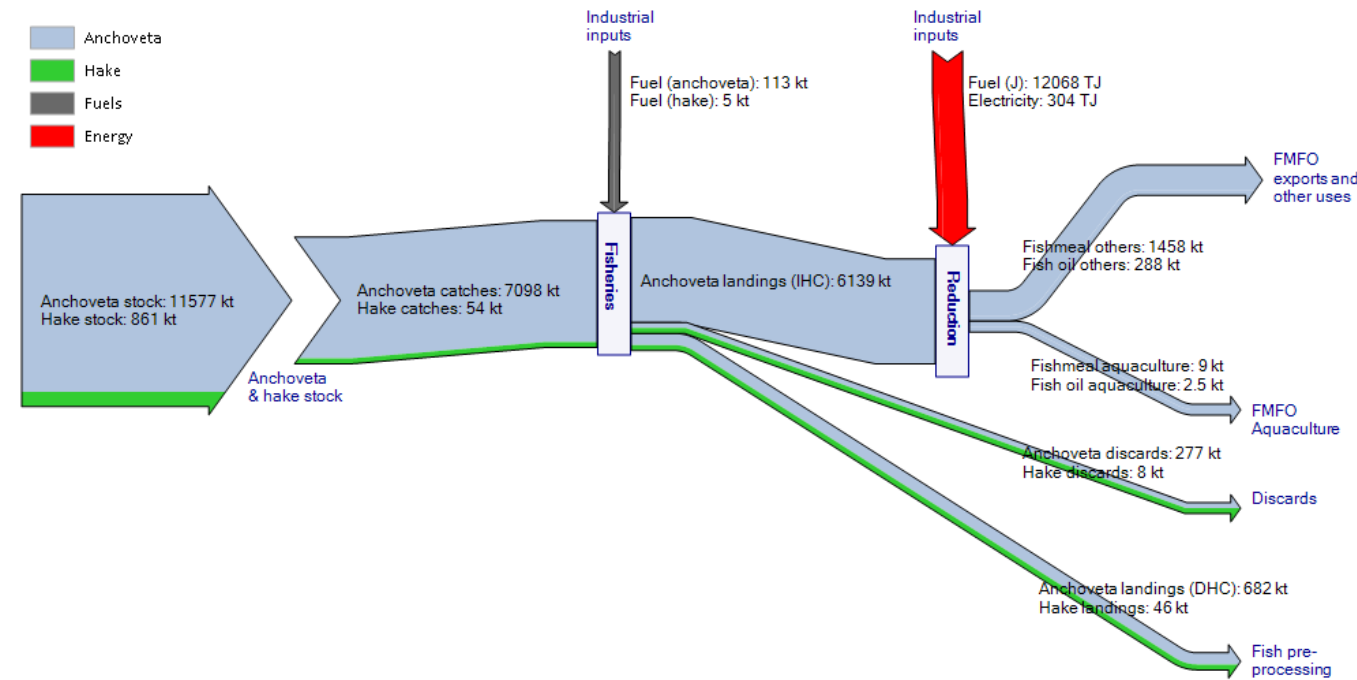
Fisheries, current situation



Fisheries, S1



Fisheries, S2



Fisheries, S3

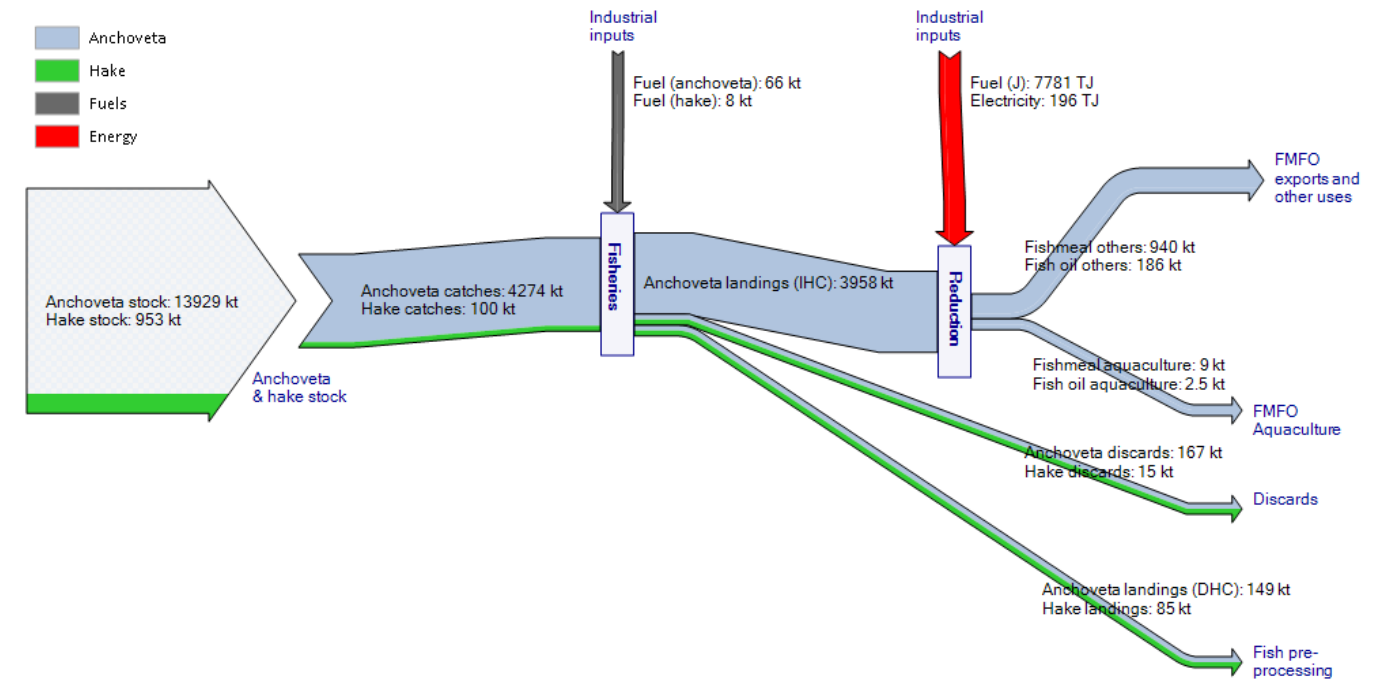
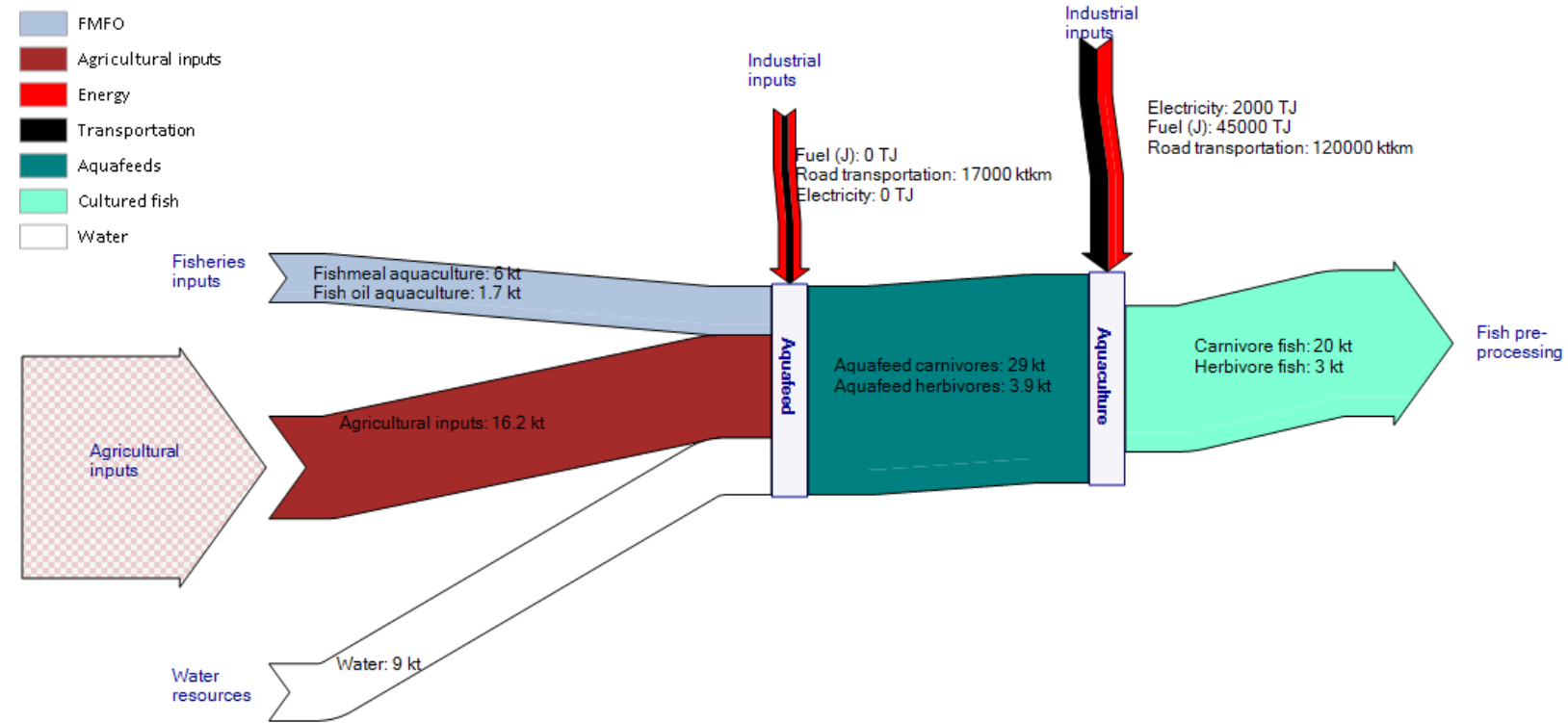


Fig. A.3 Mass and energy Sankey diagrams for fisheries across scenarios

Aquaculture, current situation



Aquaculture, S1, S2 and S3

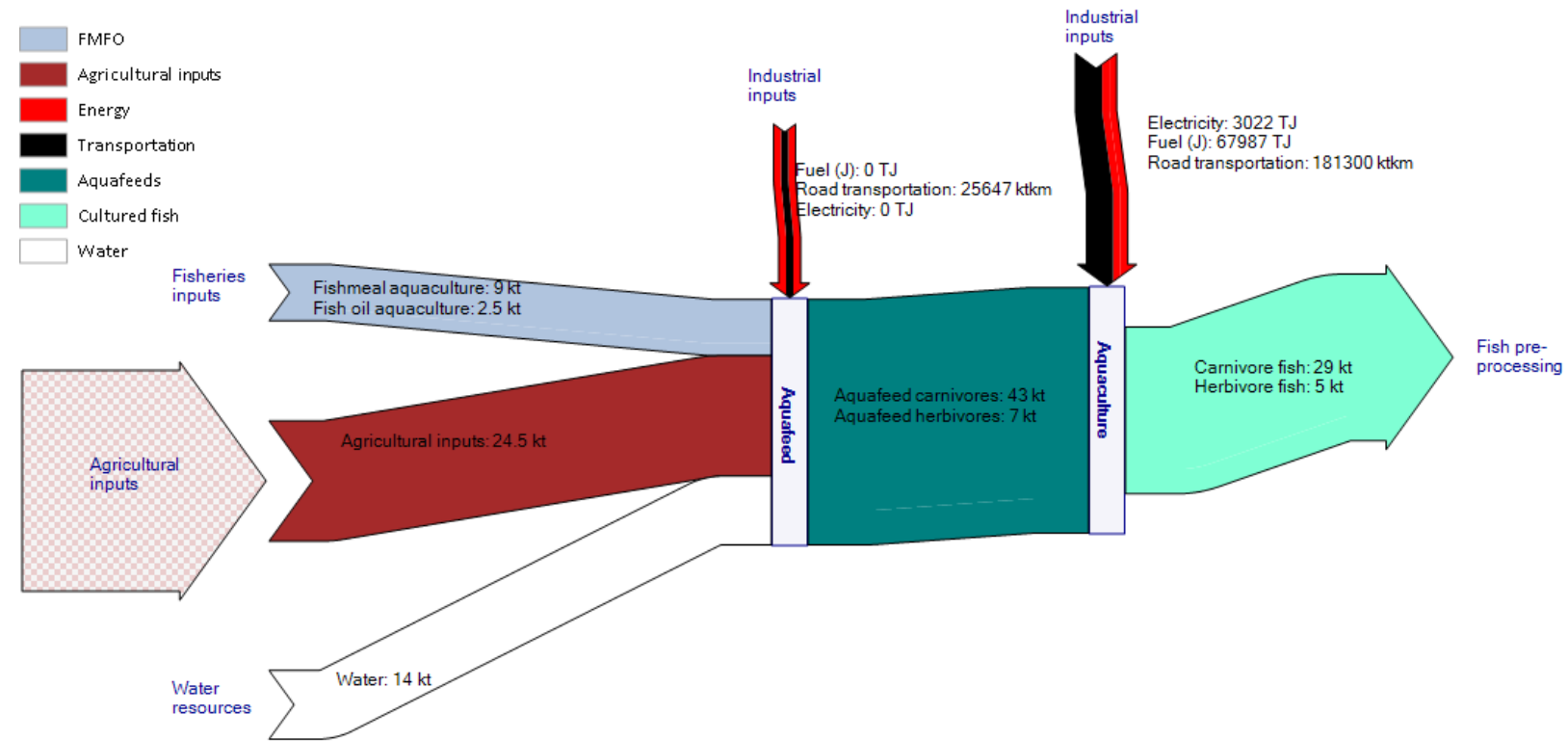
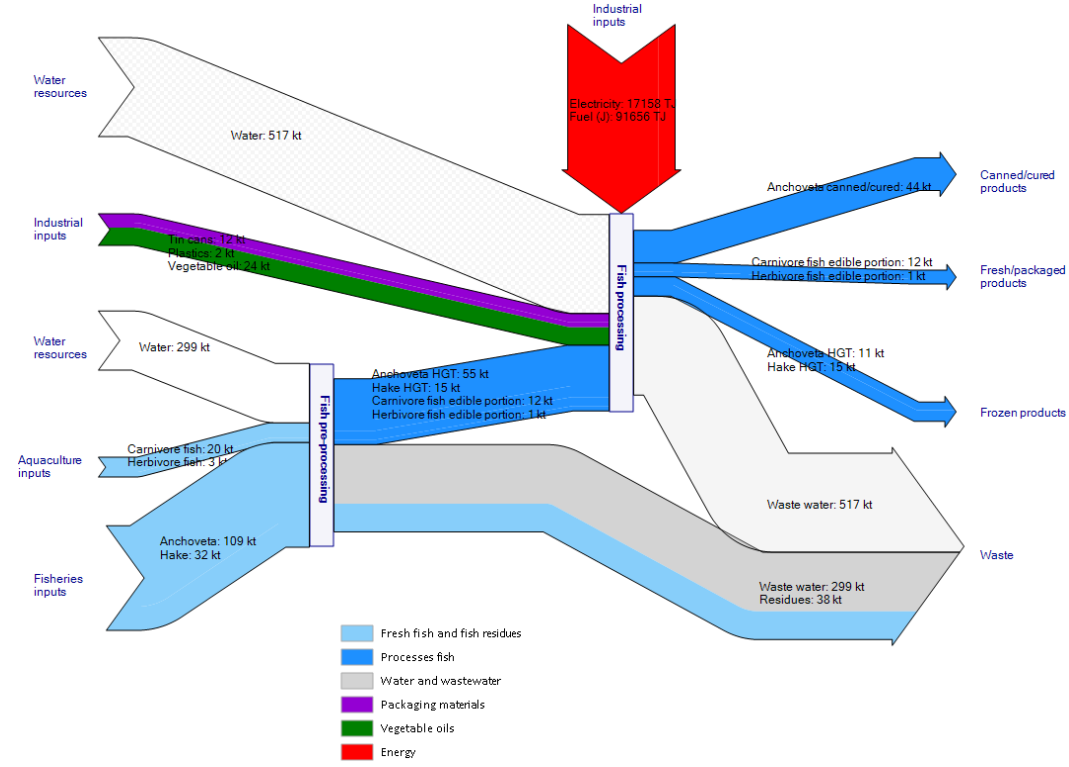


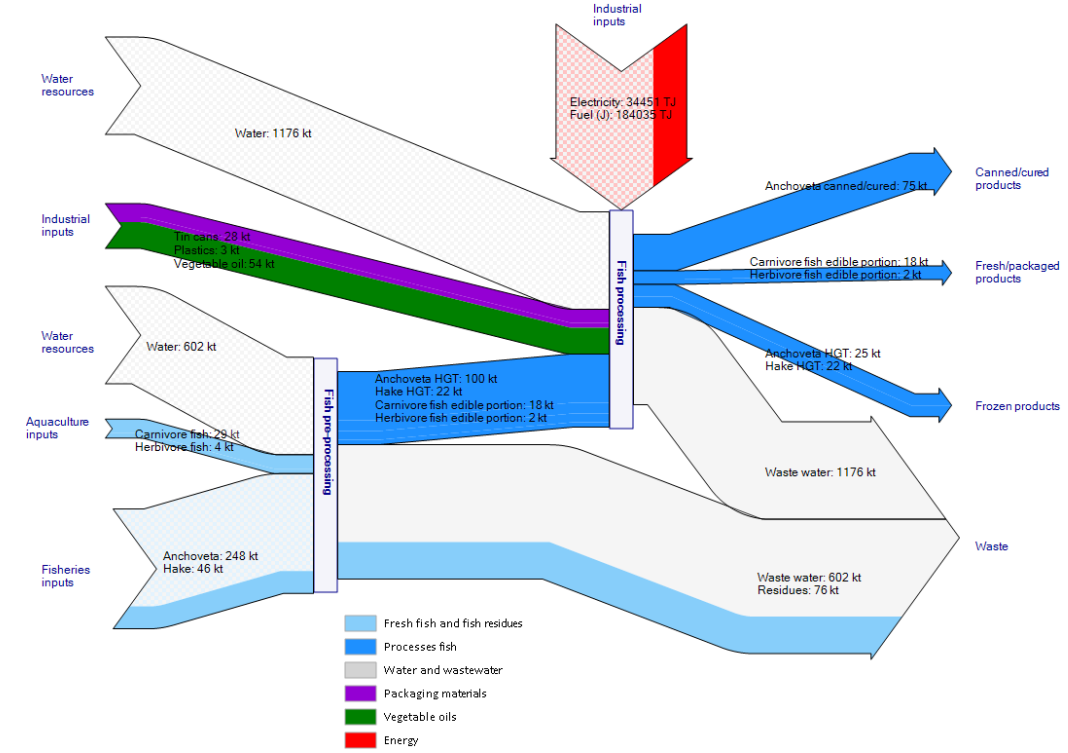
Fig. A.4 Mass and energy Sankey diagrams for aquaculture across scenarios



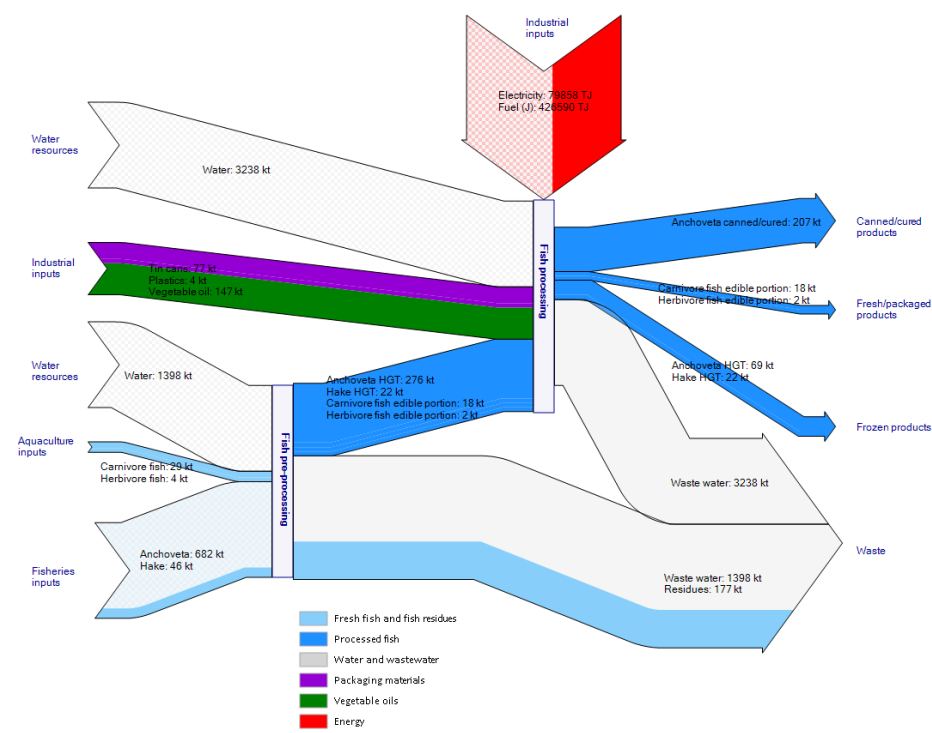
Fishfood processing, current situation



Fishfood processing, S1



Fishfood processing, S2



Fishfood processing, S3

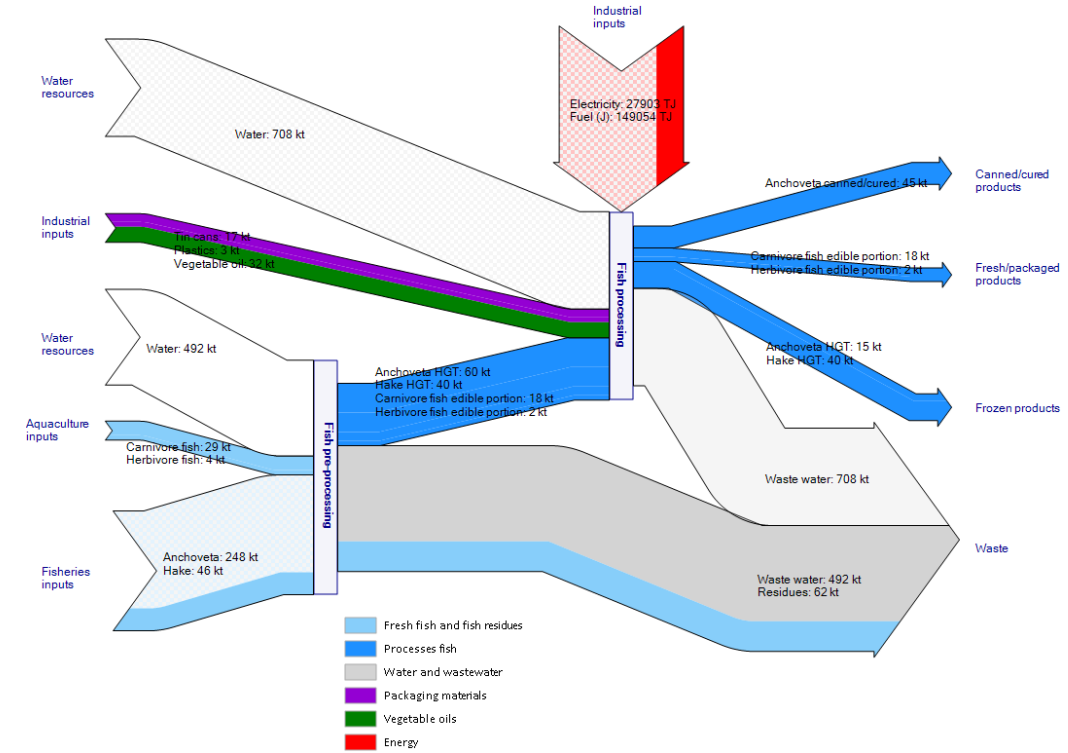


Fig. A.5 Mass and energy Sankey diagrams for fishfood processing across scenarios

**B: EwE outputs for simulation scenarios.**

**Table B.1** EwE outputs for reference year 2011 (actual *anchoveta* and hake catches, according to PRODUCE statistics, were 7 382 323 and 36 089, respectively)

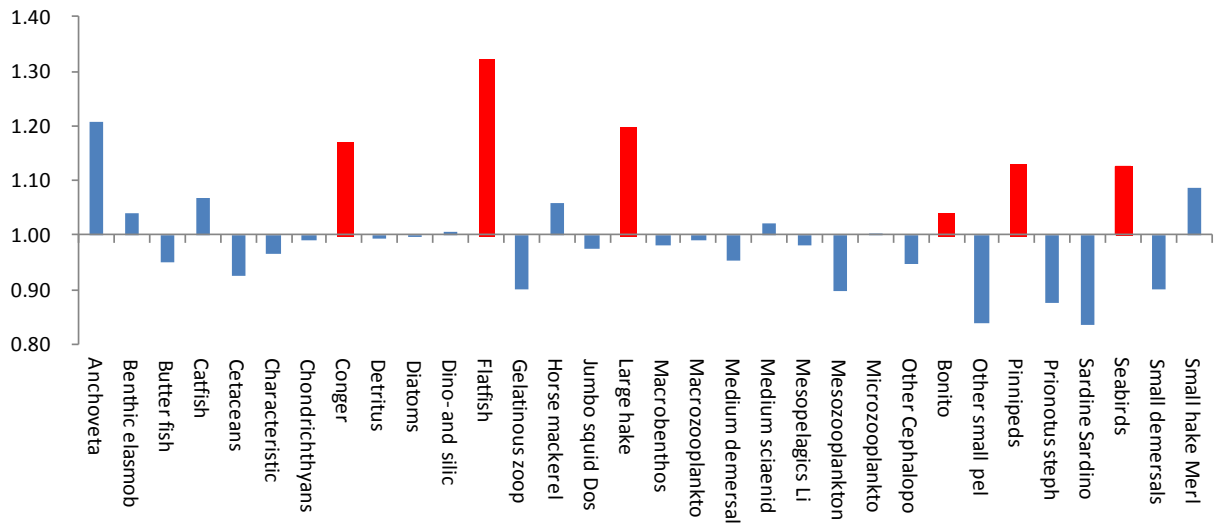
| Species                      | Inputs (t)  |   | Outputs (t)   |
|------------------------------|-------------|---|---------------|
| <b>Plankton</b>              |             |   |               |
| Solar irradiation (MW)       | 165,000,000 | Plankton consumption ( <i>anchoveta</i> ) | 239,429,062   |
| Nutrients                    | 155,000,000 | Plankton mortalities                      | 3,657,878,172 |
| Plankton biomass             | 23,049,347  | Plankton biomass                          | 23,049,347    |
| <b>Anchoveta</b>             |             |   |               |
| Plankton consumption         | 239,429,062 | <i>Anchoveta</i> consumption (hake)       | 1,706,090     |
|                              |             | <i>Anchoveta</i> respiration              | 151,182,174   |
|                              |             | <i>Anchoveta</i> mortalities              | 14,335,670    |
|                              |             | <i>Anchoveta</i> catches                  | 7,081,409     |
|                              |             | <i>Anchoveta</i> un-assimilation          | 83,800,171.81 |
| <i>Anchoveta</i> biomass     | 11,550,170  | <i>Anchoveta</i> biomass                  | 11,550,170    |
| <b>Hake</b>                  |             |   |               |
| <i>Anchoveta</i> consumption | 1,706,090   | Hake consumption (predators)              | 316,953.69    |
| Other prey consumption       | 4,359,887   | Hake respiration                          | 1,948,507     |
|                              |             | Hake un-assimilation                      | 1,859,288     |
|                              |             | Hake mortalities                          | 538,552       |
|                              |             | Hake catches                              | 54,345        |
| Hake biomass                 | 861,822     | Hake biomass                              | 861,822.41    |

**Table B.2** EwE outputs for Scenarios 1 and 2 (2021)

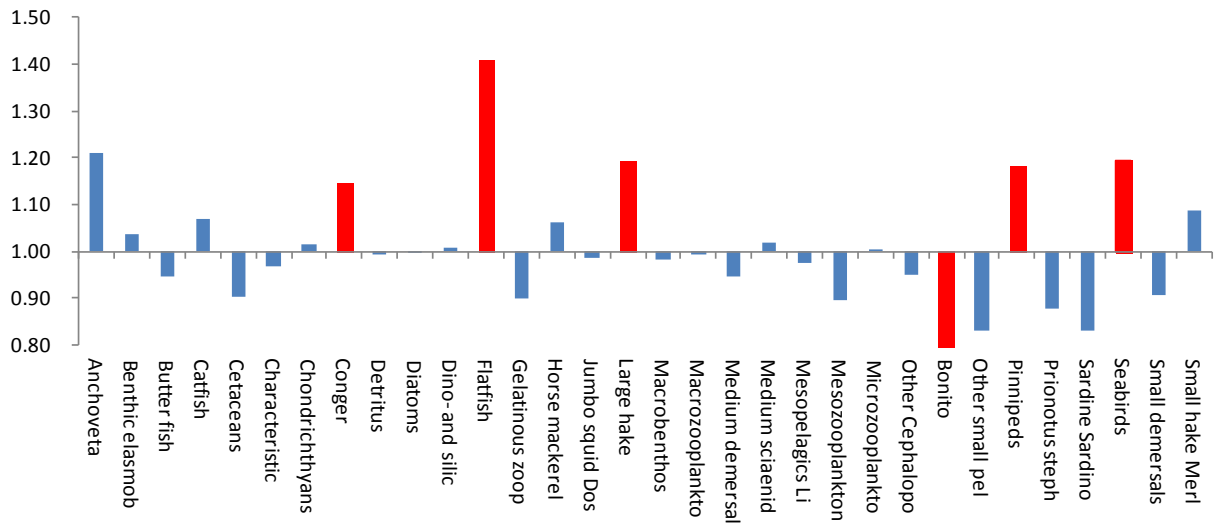
| Species                      | Inputs (t)  |   | Outputs (t)   |
|------------------------------|-------------|---|---------------|
| <b>Plankton</b>              |             |   |               |
| Solar irradiation (MW)       | 165,000,000 | Plankton consumption ( <i>anchoveta</i> ) | 239,809,340   |
| Nutrients                    | 155,000,000 | Plankton mortalities                      | 3,665,525,401 |
| Plankton biomass             | 23,045,504  | Plankton biomass                          | 23,045,504    |
| <b>Anchoveta</b>             |             |   |               |
| Plankton consumption         | 239,809,340 | <i>Anchoveta</i> consumption (hake)       | 1,716,384     |
|                              |             | <i>Anchoveta</i> respiration              | 151,182,174   |
|                              |             | <i>Anchoveta</i> mortalities              | 14,340,117    |
|                              |             | <i>Anchoveta</i> catches                  | 7,098,017     |
|                              |             | <i>Anchoveta</i> un-assimilation          | 83,933,268.98 |
| <i>Anchoveta</i> biomass     | 11,577,259  | <i>Anchoveta</i> biomass                  | 11,577,259    |
| <b>Hake</b>                  |             |   |               |
| <i>Anchoveta</i> consumption | 1,716,384   | Hake consumption (predators)              | 316,206       |
| Other prey consumption       | 4,346,013   | Hake respiration                          | 1,948,507     |
|                              |             | Hake un-assimilation                      | 1,856,457     |
|                              |             | Hake mortalities                          | 538,721       |
|                              |             | Hake catches                              | 54,433        |
| Hake biomass                 | 860,534     | Hake biomass                              | 860,534       |

**Table B.3** EwE outputs for Scenario 3 (2021)

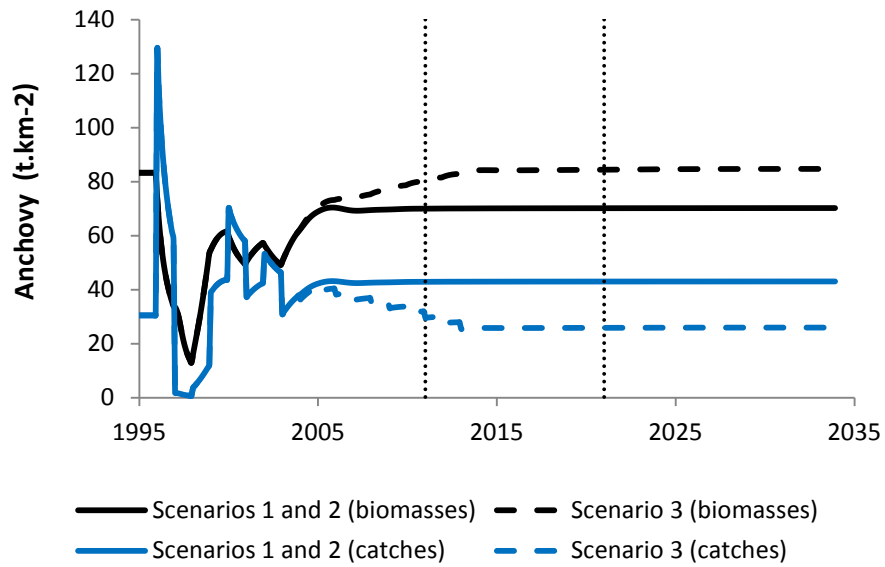
| Species                      | Inputs (t)  |   | Outputs (t)   |
|------------------------------|-------------|---|---------------|
| <b>Plankton</b>              |             |   |               |
| Solar irradiation (MW)       | 165,000,000 | Plankton consumption ( <i>anchoveta</i> ) | 278,270,010   |
| Nutrients                    | 155,000,000 | Plankton mortalities                      | 3,602,995,052 |
| Plankton biomass             | 22,437,949  | Plankton biomass                          | 22,437,949    |
| <b>Anchoveta</b>             |             |   |               |
| Plankton consumption         | 278,270,010 | <i>Anchoveta</i> consumption (hake)       | 2,397,941     |
|                              |             | <i>Anchoveta</i> respiration              | 151,182,174   |
|                              |             | <i>Anchoveta</i> mortalities              | 21,185,411    |
|                              |             | <i>Anchoveta</i> catches                  | 4,273,928     |
|                              |             | <i>Anchoveta</i> un-assimilation          | 97,394,503.44 |
| <i>Anchoveta</i> biomass     | 13,928,640  | <i>Anchoveta</i> biomass                  | 13,928,640    |
| <b>Hake</b>                  |             |   |               |
| <i>Anchoveta</i> consumption | 2,397,941   | Hake consumption (predators)              | 341,653.69    |
| Other prey consumption       | 4,379,889   | Hake respiration                          | 1,948,507     |
|                              |             | Hake un-assimilation                      | 2,054,765     |
|                              |             | Hake mortalities                          | 575,177       |
|                              |             | Hake catches                              | 99,843        |
| Hake biomass                 | 952,741     | Hake biomass                              | 952,741       |



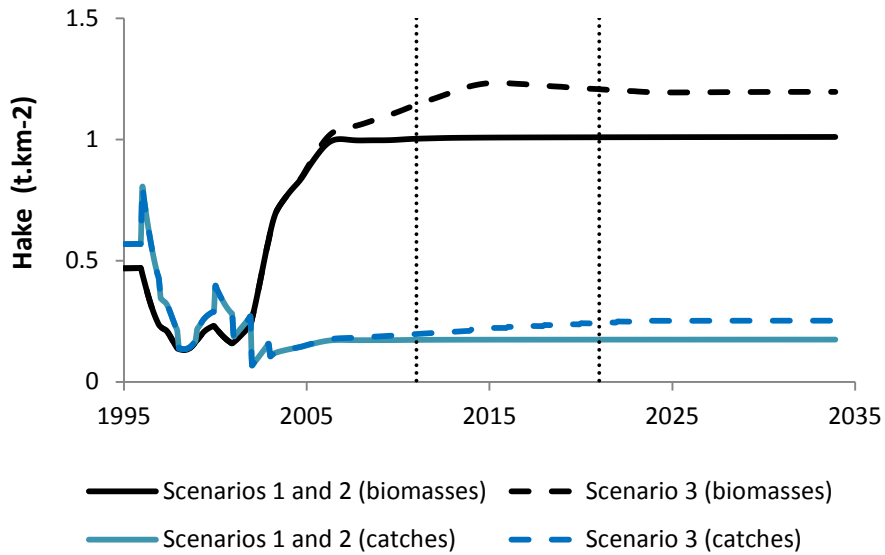
**Fig. B.1** Changes in biomasses of all modelled species from 2004 to 2031, after a 50% reduction of *anchoveta* fishing mortality



**Fig. B.2** Changes in biomasses of all modelled species from 2004 to 2031, Scenario 3 (fishing mortality of hake increased in 22% and of bonito in 45%, proportional to the biomass increase in Fig. B.1)



**Fig. B.3** Comparison of *anchoveta* biomasses and catches among scenarios



**Fig. B.4** Comparison of hake biomasses and catches among scenarios

# Chapter 5

---

Discussion on the various sources of uncertainty, as well as uncertainty management in the context of the research, especially regarding ecosystem modelling and life cycle assessment.

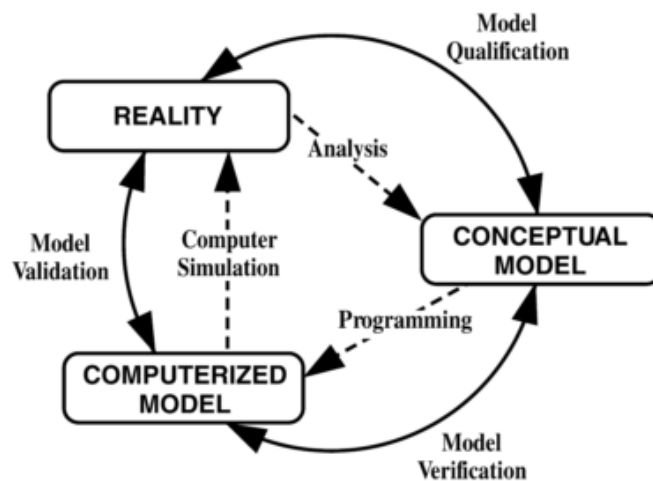
---

## 5 Management of uncertainty

### 5.1 Uncertainty in modelling

Many authors agree that uncertainty and sensitivity analyses and management are essential when analysing and modelling complex systems (Helton et al., 2006; Oberkampf et al., 2002), especially when natural systems (e.g. Refsgaard et al., 2007) or the interaction between natural and anthropogenic systems is studied. This is particularly the case for the development of bio-economic models of marine exploitation (e.g. Seijo and Caddy, 2000). A growing body of literature has addressed uncertainty, among others, in the fields of marine ecosystems modelling (e.g. Morissette, 2005), material flow analysis (e.g. Danus, 2002) and life cycle assessment (e.g. Citroth, 2004).

The very definition of uncertainty adapts to the study field in which it is investigated: in the general realm of modelling, it can be understood as the lack of knowledge about a specific value used in an analysis (epistemic uncertainty, also referred to as subjective, reducible and type B uncertainty), or as the inherent behavioural randomness of the studied system (random uncertainty, also referred to as variability, as well as stochastic, irreducible and type A uncertainty) (Helton et al., 2006). The so-called uncertainty analysis deals with epistemic uncertainty, that is to say, with uncertainty of analysis inputs. Sensitivity analysis, in the other hand, assesses the contribution of individual uncertainty of analysis inputs to the overall uncertainty of the analysis results (Helton et al., 2006). Analysis inputs subject to uncertainty may include data, relationships and choices (Heijungs and Huijbregts, 2004). Epistemic uncertainty implies inadequate information, due to either inexactness, unreliability, or simple ignorance (Walker et al., 2003). Moreover, epistemic uncertainty and variability may arise at various stages/constituencies of a model, namely (Walker et al., 2003; Roy and Oberkampf, 2011): system boundaries (context, exclusions), model uncertainty (conceptual model or computer implementation, e.g. numerical approximations and transformations), inputs, parameters and model outcome uncertainties (accumulated uncertainty). Model uncertainty in particular is a consequence of the simplifications and exclusions associated to attempting to represent reality as a computable model (Figure 7).



**Figure 7: From reality to modelling**  
 Reproduced from Oberkamp et al. (2002).

A variety of approaches have been developed to deal with uncertainty and sensitivity analyses, including mathematical methods (deterministic, statistical), “social” methods (consensus, guidelines and standards) and, the most onerous way, scientific methods involving research aiming to solve the uncertainties (Helton et al., 2006; Heijungs and Huijbregts, 2004).

### 5.1.1 Uncertainty in marine ecosystem modelling in general and EwE in particular

Models are often built to study complex systems which are difficult to be directly investigated, such as marine ecosystems. Uncertainty and variability are inherent to ecosystem modelling, thus it is essential to manage it (Morissette, 2005). Some of the sources of uncertainty when modelling marine ecosystems include lack of knowledge of the ecosystem dynamics, the need for simplification (e.g. regarding number of species modelled, species structure (e.g. age), trophic relationships, interactions with abiotic, ecological and anthropogenic systems, etc.), and data quality. Especially regarding the interaction with anthropogenic systems (i.e. fisheries), the use of bio-economic indicators poses additional sources of uncertainty (Seijo and Caddy, 2000).

Ecopath with Ecosim (EwE) is a trophic modelling environment widely used for studying the dynamics of exploited marine ecosystems. EwE starts with steady-state representations of the ecosystem in terms of production (including fishery-related mortalities) and energy balances, and allows for dynamic modelling in time and space. Some strategies to manage uncertainty in EwE models have been discussed (Christensen and Walters, 2004), yet have been allegedly seldom applied in practice (Morissette, 2005). EwE includes for instance a routine for re-sampling (to assign probability distributions to input parameters), a pedigree index for input parameters (ranking the parameters’ reliability), auto mass-balancing capabilities based on an iterative routine, as well as a number of indices to add robustness (Christensen and Walters, 2004; Kavanagh et al., 2004). Additional sources of uncertainty in EwE include the use of functional groups clustering various species (5 to 10 for fish, more for plankton); the challenging mass-balancing process, which often requires very subjective decisions to be made by the modeller; and the utilisation of primary productivity and detritus as adjustment variables.

### 5.1.2 Uncertainty in material flow analysis and modelling

When modelling material and energy flows of complex systems, for instance with the support of Material Flow Analysis tools, data uncertainties are likely to occur within the dataset constructed,

especially regarding process losses and emissions, as well as historical data (Daniuš, 2002). The latter is one of the main reasons for the advent of life cycle assessment. Moreover, modelling transfer coefficient between processes might be a source of uncertainty, as well as process dynamics: transformations tend to be non-linear, yet modelling flows implies certain degree of linearization, simplification of system boundaries, cut-offs, level of accuracy, etc (Avadí, 2010). Time-related uncertainties arise when material flow models are used to predict future dynamics of the studied system, for instance production and use of materials (Bertram et al., 2009).

### 5.1.3 Uncertainty in LCA

The process of modelling a real world system and producing LCA outcomes produces uncertainty and variability (Huijbregts, 1998a). As LCA reaches maturity, addressing uncertainty is becoming more and more a key issue in LCA, as reflected in increasing instances of uncertainty discussion in literature (Ciroth, 2004, Lloyd and Ries, 2007). When life cycle-based methods such as LCA are used for decision support, uncertainty is a key subject to be taken into consideration (Geisler et al., 2005; Lloyd and Ries, 2007).

Uncertainty in LCA is associated to data quality and availability, model assumptions and other design choices, while variability streams from real world variability. A relation of such sources of variability was proposed by Huijbregts (1998a) and extended in later works (e.g. Bjrklund, 2002; Lloyd and Ries, 2007), as shown in Table 10.

**Table 10: Examples of sources of uncertainty in LCA, and tools to reduce and/or illustrate it towards improving reliability in LCA results**

Adapted from Bjrklund (2002).

| Type<br>→ Tools to address uncertainty      | LCA phase  |   |                                |  |
|---|--|---|--------------------------------|--|
|   | Goal and scope                                       | Inventory   | Choice of impact categories    | Classification and characterisation  |
| Data inaccuracy<br>→ 3, 4, 7, 10-16, 18     |  | Emission measurements   |                                | Life times of substances and relative contribution to impacts (e.g. regarding toxicity)  |
| Data gaps<br>→ 2, 6, 7, 9                   |  | Lack or incompleteness of inventory data  |                                | Lack of impact data  |
| Unrepresentative data<br>→ 2-4, 7, 9-11, 17 |  | Lack of representative inventory data   |                                |  |
| Model uncertainty<br>→ 8, 10, 11, 17        |  | Static modelling, linearization   |                                | Static modelling, linearization, simplification or partiality of characterisation models |
| Uncertainty due to choices<br>→ 1, 9-11, 17 | Functional unit, system boundaries, cut-off criteria | Subjective judgement, allocation strategy, technology level, average/marginal data (e.g. ALCA vs. CLCA) | Exclusion of impact categories | Choice of characterisation methods   |
| Spatial variability<br>→ 8, 10-13, 17       |  | Regional differences in emission inventories  |                                | Regional differences in environmental sensitivity  |
| Temporal variability<br>→ 8, 10-13, 17      |  | Differences in annual emission inventories  |                                | Choice of time horizon, changes in environmental features over time                      |
| Variability between objects/sources         |  | Performance differences between equivalent  |                                | Differences between environmental and human  |



|                                     |   |                                    |                                |  |
|-------------------------------------|---|------------------------------------|--------------------------------|--|
| → 7, 10-13, 16-17                   |   | processes                          |                                | characteristics  |
| Epistemological uncertainty<br>→ 9  | Ignorance of relevant aspects of the studied system | Ignorance about modelled processes | Ignorance of impact categories | Unknown contribution to impact categories and characterisation factors |
| Mistakes<br>→ 1, 5, 9               | Any   | Any                                | Any                            | Any  |
| Estimation of uncertainty<br>→ 2, 9 |   | Inventory parameters               |                                | Characterisation parameters  |

**Tools identification:** 1. Standardisation, 2. Data bases, 3. Data quality goals, 4. Data quality indicators, 5. Validation of data, 6. Parameter estimation, 7. Additional measurements, 8. Higher resolution models, 9. Critical review, 10. Sensitivity analysis, 11. Uncertainty importance analysis, 12. Classical statistical analysis (i.e. stochastic methods), 13. Bayesian statistical analysis, 14. Interval arithmetic, 15. Vague error intervals, 16. Probabilistic simulation, 17. Scenario modelling, 18. Rules of thumb

Stochastic and scenario modelling are among the most commonly used methods for addressing uncertainty in published LCAs (Lloyd and Ries, 2007). Among stochastic methods, the most popular tool is Monte Carlo simulation, usually applied to quantify the sensitivity of the outcomes to uncertainty and variability in the inventory data (Hung and Ma, 2008).

## 5.2 Uncertainty management in the modelling of anchoveta supply chains

Additional uncertainty arises when models are (one or two-way) coupled, because uncertainty propagates and accumulates. Uncertainty issues associated to the ecosystem/supply chain coupled model proposed in this work are identified and solutions for reducing them suggested in Table 11.

**Table 11: Sensitivity and uncertainty issues of the ecosystem-supply chain coupled model and treatments**  
Self elaboration.

| Issues category     | Description  | Treatment   |
|---------------------|--|---|
| LCA related issues* | Data issues associated to cut-off criteria and multiple data sources.  | The use of weighted averages to harmonise multiple data sources may reduce deviations in results due to uncertainty.<br>Sensitivity analyses of input data should be applied to various ranges of key contributors to environmental impacts (e.g. fuel use).<br>→ Both treatments were applied  |
|                     | Toxicity calculation issues arise from diverse implementations featured in existing toxicity methods.  | Comparing various toxicity methods, for instance ReCiPe/USES-LCA vs. USEtox (scientific consensus method), would clarify toxicity contribution of studied systems. Relevant LCIA methods are described in <b>Appendix C: A comparison of current Life Cycle Impact Assessment methods</b> .<br>→ This treatments was applied                          |
|                     | Allocation issues occur in multi-species fisheries and multi-function fishfood processes, as extensively discussed in fishfood LCA literature. | Contrasting diverse allocation methods, as practiced in literature, would highlight sensitivity of results to allocation. A specific approach for allocation in fisheries LCA studies is described in section <b>2.4.1</b> .<br>→ For fishfood co-products, energy-based allocation was practiced, and other allocation criteria for other situations |

|  |  |  |
|--|--|--|
|  | Impact assessment issues due to the fact that fishfood-specific categories are not implemented in LCIA methods, namely species removal and seafloor damage (for fisheries) and biotic resource use (for fishfood products in general).   | Calculation of those impact categories contributes to more complete and relevant LCA studies. Moreover, additional impact categories and LCIA methods should be included, when relevant, to offer a more multi-criteria comparison (i.e. BRU including discards, complemented with energy efficiency and nutritional indicators).<br>→ A variety of fishfood-specific impact categories were computed  |
|  | Differences in system boundary setting and cut-off criteria among LCA studies make difficult the nesting of studies to cover large segments of a fishfood supply chain (e.g. integration of studies on fisheries and reduction industries). Other methodological sources of uncertainty include the inclusion of capital goods and land use considerations.  | System boundaries and cut-off criteria must be clearly described and justified. All life cycle stages of the system under study should be included, despite any perceived negligibility in contribution to environmental impacts (e.g. in fisheries, both construction and end of life of vessels should be included).<br>→ Whole cradle to gate LCAs were modelled, as well as distribution/retailing for final products  |
| Trophic model related issues   | The EwE model features data issues due to availability and pedigree levels.  | → No treatment, uncertainties in the EwE model are discussed only  |
|  | Oversimplification is inherent to population modelling, for instance, regarding number and interaction among trophic groups (species).   | → No treatment, uncertainties in the EwE model are discussed only  |
|  | Additional omissions and simplification in the model such as the exclusion of climatic dynamics.   | → The model features both ENSO and non-ENSO years as steady states   |
| Supply chain modelling   | Simulation results are sensitive to scenario design parameters, such as DHC:IHC ratio, changes in fishing mortality and Capture Per Unit Effort (CPUE) over time, etc.   | → Due to time constraints, the selection of DHC:IHC ratios and fishing mortality was subjective, to represent expected/desired future exploitation strategies. Alternative EwE simulations featuring variations in fishing mortality for anchoveta and hake were produced, yet excluded from results due to undesired effects (e.g. collapse of other commercial species stocks). CPUE was adjusted over time and expressed as adjusted fuel use intensities proportional to changes in biomass. |
| Model-coupling related issues  | Challenges arising from the proposed model coupling (one-way forcing) approach are due mostly to the complex nature of the EwE model. The base model is static, which is later dynamically modelled over time. The material flow model is static, so steady states of the dynamic EwE model are required for coupling steady state instances. Thus, the coupled model cannot directly recalculate the ecosystem changes, but those need to be modelled in EwE alone. | To fully overcome this model linking constraint would be possible by developing a software interface, which exceeds the scope of this research.<br>→ “Snapshots” in specific time periods were obtained from the EwE model to be connected to scenarios of the material flow model set in different time periods   |
| * Adapted from Henriksson et al. (2011), Thrane (2004b) and Parker and Tyedmers (2011). Detailed discussion in sections 2.4.1 and 2.4.2. |  |  |

# Chapter 6

---

Conclusions and discussion of a number of management and policy measures inspired by the supply chain and alternative exploitation scenario analyses. The chapter analyses the lessons learned from designing and applying the framework to the studied system, and proposes ways to advance further sustainable development of the Peruvian anchoveta-based supply chains and Peruvian fisheries in general.

---

## 6 Conclusions and portents for the future

As discussed in **Chapter 5**, there are varied levels of uncertainty associated with the results of this research. Nonetheless, results have identified trends of the environmental and socio-economic performance of the anchoveta supply chains, in such a way that justified conclusions were drawn and advice towards sustainability improvements can be offered.

The relative environmental performance of SMS, Vikinga and steel industrial fleets favours the industrial fleet, per functional unit, although to a magnitude lower than expected from the large difference in scale of the different segments. The industrial steel fleet moreover lands a dominant share of all landed anchoveta, and such a situation is unlikely to change. It is thus a solid conclusion that the best opportunities for improving the sustainability performance of the anchoveta fisheries lie on the improvement of that specific fleet. Of course, the other fleets cannot be neglected, and certain researchers have suggested a number of improving measures such as increased technification (e.g. acoustic and other electronic equipment) and alternative construction materials. Regarding the latter, Rokovich (2009) encourages the use of fibre glass as hull construction materials for SMS fleets, because of reduced friction, lesser maintenance needs, reduced fouling, etc (yet such idea is subject to controversy).

Regarding the reduction industry, it has reached its technical peak according to current technical advances, and further improvements would refer to the increased utilisation of alternative fuels such as natural gas instead of heavy oils.

The processing industries for DHC would also benefit from better energy use, but also the treatment of effluents remain an issue to be dealt with. In order to improve nutrition of the Peruvian population, by means of increased fish consumption (especially anchoveta), it is clear that a national refrigerated distribution chain needs to be established. The additional negative impacts of such chain would not notably increase existing impacts of DHC products, in relative terms. Moreover, canned products fulfil needs and address the particular circumstances of the country, due to easiness of distribution and storage, long shelf life, etc. It is thus difficult to choose a “best” product to promote, yet it is clear that anchoveta DHC consumption must be increased in Peru. The scenario analysis carried out favours the further increase of DHC production and consumption. Nonetheless, the size of the Peruvian market must be taken into consideration, because it could absorb a limited additional amount of DCH anchoveta products due to economic and cultural limiting factors. It has been claimed that the best way

to address nutritional and other socio-economic needs of vulnerable communities in Peru is indeed the reduction industry (to generate foreign exchange) and local aquaculture (to produce fishfood) rather than a growing anchoveta DHC industry, because large excesses would have to be exported (Natale et al., 2012; Wijkström, 2010). Such statement overlooks the fact that the reduction industry does not adequately distributes the rent it generates, and that Peru lacks sufficient distribution infrastructure for fresh fish, including cultured.

Peruvian freshwater aquaculture is relatively small, compared with its seawater aquaculture (23 000 vs. 69 000 t, respectively, in 2011). Nonetheless, it increasingly provides fish products especially to the producing regions. Trout in particular delivers important benefits to both the culturing and consuming communities. Improvements for the aquaculture industry would arise especially from better feed formulations, featuring less energy-intensive inputs. Peruvian aquaculture competes well, regarding environmental and energy performances, with key foreign culturing systems; yet straightforward comparisons are challenging due to differences in system boundaries and cut-off criteria among published aquaculture LCAs. We have estimated similar environmental performances among Peruvian and foreign aquaculture from published energy use figures and feed compositions (e.g. Boissy et al., 2011; Pelletier and Tyedmers, 2010; Pelletier et al., 2009). Moreover, comparison of anchoveta supply chains EROI values with EROI values for a number of international aquaculture and fisheries products (Table 12) show that Peruvian semi-intensive cage trout shows similar performance than intensive cage cultured Atlantic salmon. Peruvian tilapia, mainly from semi-intensive and intensive aquaculture, shows lower performance than Indonesian extensive cultured tilapia. Black pacu under semi-intensive culturing compares with tilapia rather than with extensively cultured carps. Cultured salmonids show higher edible protein EROI (epEROI) than wild caught salmon, while the Peruvian hake trawling fishery shows better performance than other demersal fisheries.

**Table 12 Comparison of Peruvian and international fisheries and aquaculture products in terms of their edible protein Energy Return On Investment (epEROI)**

Self elaboration.

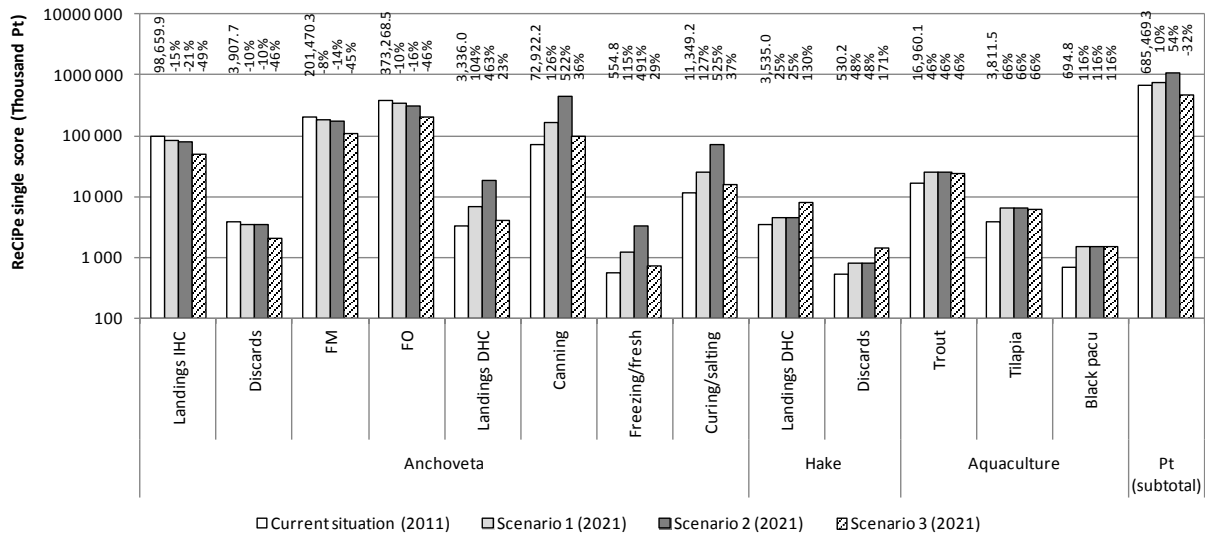
| Species/product   | Location           | epEROI (%) | Source                        |
|---|--------------------|------------|-------------------------------|
| Atlantic mackerel (trawl)                                     | Spain-Galicia      | 7.3        | Vázquez-Rowe et al. (2013)    |
| Atlantic salmon, intensive cage                               | Sweden             | 2.0        | Tyedmers et al. (2005)        |
| Atlantic salmon, intensive cage                               | Canada             | 2.5        | Tyedmers et al. (2005)        |
| Black pacu, semi-intensive, artisanal feed                    | Peru               | 1.9        | This research                 |
| Black pacu, semi-intensive, commercial feed                   | Peru               | 1.8        | This research                 |
| Canned anchoveta (from purse seine)                           | Peru               | 6.9        | This research                 |
| Cultured Atlantic salmon<br>(various feeds including organic) | Canada             | 7.8 - 17.8 | Pelletier and Tyedmers (2007) |
| Cultured carp   | Global             | 94         | Pelletier and Tyedmers (2007) |
| Cultured shrimp   | Global             | 1.4        | Pelletier and Tyedmers (2007) |
| Cured anchoveta (from purse seine)                            | Peru               | 8.3        | This research                 |
| European hake (trawl)   | Spain-Galicia      | 5.6        | Vázquez-Rowe et al. (2013)    |
| Frozen anchoveta (from purse seine)                           | Peru               | 54         | This research                 |
| Global fisheries  | Global             | 8.0        | Pelletier and Tyedmers (2007) |
| Horse mackerel (trawl)  | Spain-Galicia      | 6.1        | Vázquez-Rowe et al. (2013)    |
| North Atlantic cod (trawl, longline, Danish seine)            | Canada,<br>Iceland | 0.08 - 0.1 | Tyedmers (2004)               |
| North East pacific salmon (purse seine)                       | Canada             | 0.2        | Tyedmers (2004)               |
| Pacific hake (trawl)  | Peru               | 21         | This research                 |

|   |           |     |                        |
|---|-----------|-----|------------------------|
| Salted anchoveta (from purse seine)           | Peru      | 65  | This research          |
| Shrimp, semi-intensive                        | Ecuador   | 2.5 | Tyedmers et al. (2005) |
| Tilapia, extensive                            | Indonesia | 13  | Tyedmers et al. (2005) |
| Tilapia, intensive, artisanal feed            | Peru      | 1.4 | This research          |
| Tilapia, intensive, commercial feed           | Peru      | 1.0 | This research          |
| Tilapia, semi-intensive, artisanal feed       | Peru      | 1.3 | This research          |
| Trout, semi-intensive, artisanal feed         | Peru      | 1.7 | This research          |
| Trout, semi-intensive, commercial salmon feed | Peru      | 2.6 | This research          |
| Trout, semi-intensive, commercial feed        | Peru      | 3.5 | This research          |

A fundamental research question in the thesis referred to the trade-off between the heavy exploitation of anchoveta for feeding cultured fish (especially carnivorous), or reduced anchoveta harvest in order for wild predator stocks to prosper and be exploited. This question, and the related question of limited forage fish resource to feed a growing aquaculture sector, has been widely researched for global fisheries and aquaculture<sup>17</sup>. Pro-aquaculture arguments include the differences in FIFO ratios for wild and cultured fish (which favours the latter to the point that some salmon cultures have been suggested as net fish protein and oil producers), as well as the type of fish used by reduction industries, which very often lacks commercial value as food fish. Counter arguments often refer to the additional agricultural inputs required to feed cultured fish, as well as a number of negative environmental and socio-economic impacts associated to aquaculture. For the Peruvian case, it is clear that the anchoveta fisheries could sustainably fulfil all fishfood needs of Peru's population, not considering of course consumer's preferences, which lean towards higher trophic level species. The multi-disciplinary analysis of alternative products suggests that it is more convenient from a sustainability and nutritional point of view to consume fresh anchoveta than fresh hake or cultured trout (see section 4.3.2). Anchoveta features better EROI and nutritional value than the other species, while hake features a very high BRU and cultured trout features higher environmental impacts mainly due to aquafeed demand.

From the scenario comparison it arises that among all dimensions of analysis, harvesting anchoveta and processing it into FMFO and DHC products (scenarios 1 and 2) is a preferable alternative than dramatically reducing anchoveta exploitation for hake and other predators stocks to prosper and be harvested (scenario 3). This scenario modelling did consider eventual changes in captures per unit effort (CPUE), which is accepted to be proportional to changes in biomass and hence of fish catchability (affecting fuel use intensity). A CPUE-adjusted environmental comparison of the scenarios is presented in Figure 8.

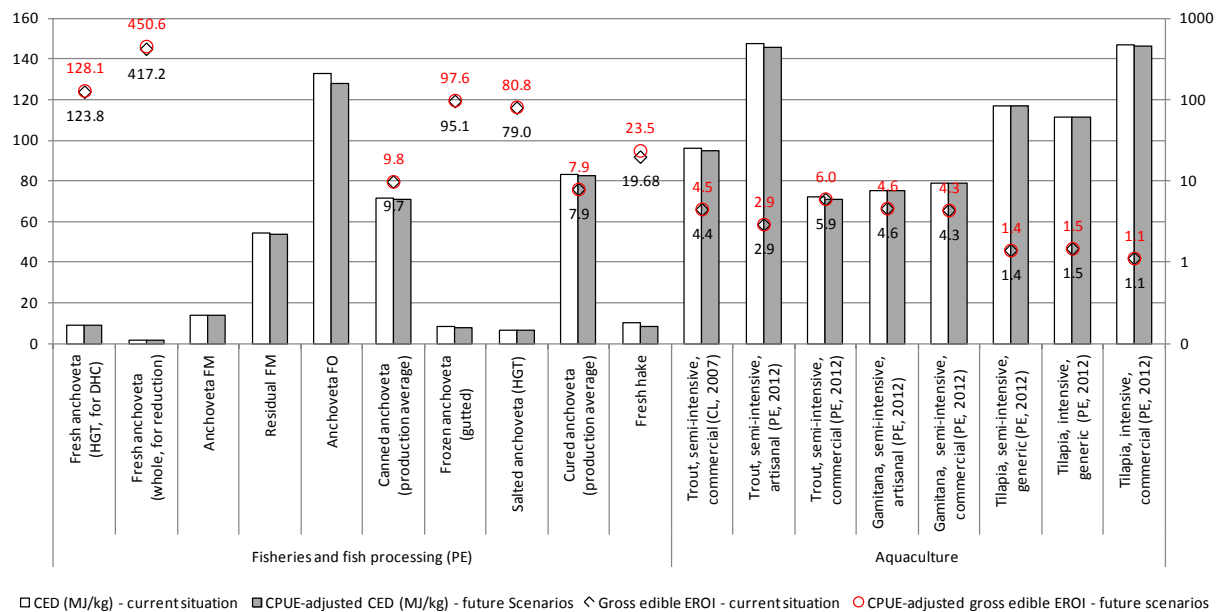
<sup>17</sup> For instance, see discussions on this topic in Crampton et al. (2010), Fréon et al. (2013), Natale et al. (2012), Tacon et al. (2010) and Wijkström (2010).



**Figure 8: CPUE-adjusted environmental score (ReCiPe single score) associated to the alternative exploitation scenarios, per key product, edible portions, at plant gate; on a log<sub>10</sub> scale**

Self elaboration, based on IMARPE and PRODUCE statistics and primary data on fuel use. Percentages represent variation from the current situation.

The total annual fuel consumption by the anchoveta and hake fleets together is calculated in 61 kt for scenario 3 when CPUE is modelled as linearly proportional to biomass; while total fuel use for scenarios 1 and 2 reaches 113 and 117 kt, respectively. The CPUE-driven underlying variations in fuel use intensity affect CED and thus EROI ratios, yet only slightly, as shown in Figure 9.



**Figure 9 Comparison of energy efficiency ratios for fisheries and aquaculture products, with adjusted CPUE, for future scenarios**

Self elaboration. Cumulative Energy Demand of products (including reduction) was included.

Despite further improvements in environmental performance, other dimensions of analysis such as employment and rent continue penalising scenario 3 respect to scenario 2 (see section 4.3.2). Nonetheless scenario 3 is extreme and a less drastic reduction in anchoveta and hake mortality deserves further exploration.

## 6.1 Management and policy suggestions towards a more sustainable future

Management and policy suggestions for the anchoveta fisheries and processing industries have been suggested in a large number of publications (e.g. Bertrand et al., 2010; Caillaux et al., 2013; Fréon et al., 2013; Paredes, 2010; Paredes and Letona, 2013; Rokovich, 2009; Salvattecchi and Mendo, 2005; Sueiro, 2008). Based on literature and the results of this research, a number of management and policy suggestions are presented below.

Key suggestions for management measures for fisheries and fresh fish handling:

- Improve insulation of holds and enforce ice use (or alternative preservation techniques) for vessels landing fish for DHC. This measure would improve the quality and increase the amount of anchoveta landed for DHC which actually reaches DHC processing. It would moreover improve general sanitary conditions.
- Build/optimize landing infrastructure and public wharfs for small- and medium-scale fisheries. Such initiative would undoubtedly improve sanitary conditions of fish handling and stimulate the production and consumption of DHC products.
- Develop refrigerated distribution chains for fishfood products. This is an essential measure to be undertaken towards improving fish consumption in Peru, especially in the highlands and remote communities.

Key suggestions for policy measures towards rationalisation of anchoveta exploitation:

- Assign flexible tolerances for discards from different DHC processes, based upon their inherent quality requirements. The currently fixed rate of 40% for all DHC-destined landings is arbitrary, because the various DHC industries feature different levels of tolerance to quality variations. The measure would also contribute to downsize the illegal fishmeal production industry.
- Allow the development of fresh anchoveta supply chain. Currently, SMS vessels landing for DHC are required by law to deliver fish to DHC processing plants only, therefore a legal update is required (on top of infrastructure and distribution improvements) for anchoveta to be commercialised and consumed in fresh/chilled condition.

Additional management/policy suggestions inspired by literature and discussions with Peruvian stakeholders:

- Improve awareness of fishermen and landing points controlling personnel on sanitary issues. Sanitary conditions of fish handling are still a problem in many landing points in Peru, thus an improvement of that situation would much likely increase the consumption of fresh fish, including anchoveta.
- Deploy a quota system for SMS fleets. This policy measure would democratise the exploitation of the anchoveta resource, by regulating the amount of fish landed by these fleets (whose combined accumulated holding capacity is substantial and fast growing). It would moreover spawn additional policy/management measures such as satellite tracking of all fishing vessels, which would reduce illegal, unreported and unregulated (IUU) fishing activities, and ultimately improve the anchoveta stock management. Individual vessel quotas would not be recommendable due to the administrative, monitoring and enforcement challenge.

- Apply several measures for reducing overcapacity in fisheries and reduction industry, for instance, the abovementioned quota system for the SMS fleet, by enforcing the prohibition of new vessels entering anchoveta fisheries, and eventually by making IVQ fully transferrable.
- Allow all fleets to land for either DHC or IHC, as long as minimum requirements for each activity are fulfilled. This democratisation of the access to fish resources would undoubtedly improve overall efficiencies and economic performance of the anchoveta fleets. Under such scheme, all vessels in a region would land (according to their fulfilment of sanitary requirements) anchoveta for the type of processing featured in the region (reduction, DHC processing). It would allow for a better management of the ecosystem and stock exploited by the anchoveta fishery, since decisions would be applicable to the whole set of resource and production means. The measure would contribute to downsize the illegal fishmeal production industry (often masked as valorisation of fish residues, even off the fishing season), especially if combined with a quota system for the fishmeal industry.
- Improve calculation of fishing rights and generalise the requirement of paying the state for the right of fishing to all fleets. It has been amply discussed in Peru, specially by Paredes (e.g. Paredes, 2010; Paredes, 2013; Paredes and Letona, 2013), that fishing rights currently paid by the reduction industry (usually vertically-integrated) are inferior to those paid in other countries and do not even cover the costs of monitoring, research and stock management. It has been suggested those rights should be redefined, and spread to all fleets.

These measures would contribute to build a more sustainable future for the Peruvian anchoveta supply chains. That means several things: apolitical scientific fisheries management (well financed by taxes paid by fishing companies as fishing rights); improved processing technologies which consume less fossil fuels and produce less emissions to water, air and soil; increased production and consumption of DHC products, which involves a national distribution chain; expanding yet better managed aquaculture; and a clear and shared vision and strategy towards sustainable exploitation of marine resources.

Peru does not escape the laws of the international, globalised markets, and as a key exporter of fish reduction products cannot isolate its resource management from the world. Therefore, as it is foreseen that the reduction industry will continue developing; eco-efficiency of reduction fisheries and industries should be further streamlined, by means of technology, management and policy improvements.

A truly scientific fisheries management should be implemented, not influenced by politic or special economic interests, but aiming solely towards the sustainable management of fisheries resources. This aspect is of utmost importance for the sustainable development for the Peruvian fishfood supply chains, especially those based on the anchoveta resource.

## **6.2 Framework limitations and transfer potential**

From the development and application of the proposed sustainability assessment framework, its limitations and weaknesses became apparent, as initially discussed in chapter 5. For instance:

- The attributional approach to LCA, as well as allocation and system boundary/cut-off decisions, allow by design to reach different conclusions than consequential or hybrid LCA approaches. Moreover, despite being a mature methodology, LCA impact categories and associated characterisation factors are often insufficient, subject to uncertainty and prone to under or



overestimations. LCA is, moreover, very data intensive, and hence the frequent use of proxies may also contribute to under or overestimation of environmental impacts.

- Most sustainability indicators are subjective by their very nature, therefore a different set of indicators could offer a different view of the studied systems. This is particularly true for ecosystem and nutrition indicators, as discussed in Papers 6 and 7a,b.
- Ecosystem models are very simplified representations of complex ecosystem dynamics, thus future trends on biomasses are highly approximate. Any error at this early stage of the modelling chain will propagate along the whole model.
- Whole supply chain material and energy flow models are also very simplified and generalise individual value chain behaviours and trends (deemed representative enough) towards representing sector-wide dynamics. Moreover, the combination of ecosystem and economic models might multiply and propagate errors.

Despite these shortcomings, the framework proposed and illustrated in this research provided with adequate high level understanding of the studied supply chains, as well as with identification of environmental and socio-economic hotspots. It explored the policy environment to a lesser extent, and that is indeed a dimension of assessment that should be integrated in further research. The framework is general enough as to be transferrable, that is to say, applied to study other economically important fisheries-based supply chain systems. When doing so, particular attention would have to be given to the subset of ecological indicators, because the exploited marine ecosystem would be undoubtedly very different from the one in the case study, the Northern Humboldt Current System. Even other Eastern Boundary Upwelling Ecosystems (Canary, California and Benguela currents) feature different traits in terms of productivity, complexity of the trophic web, exploitation, etc.

### **6.3 Directions for further research**

A number of directions for further research can be proposed, based on lessons learned from the development and application of the framework. For instance, it is clear that the best opportunities for improving the sustainability performance of the anchoveta fisheries lie on the improvement of the reduction-oriented steel industrial fleet. Such an improvement would be related to policy, management, fishing strategies, technology, etc. Moreover, despite the dominant economic importance of the reduction industry; fisheries, reduction and DHC industries are so tightly interlinked that a coherent policy environment must address them as a whole rather than separately as until now. Decision-making stakeholders need to set priorities for the stimulation of specific DHC products, because their relative benefits (according to all the dimensions of analysis explored) are varied and there is no “best” product. On this regard, the establishment of a national refrigerated distribution chain, to improve nutrition, seems of high priority and therefore demands comprehensive research. In the context of freshwater aquaculture, research should focus on better farm management and feed formulations (featuring less energy-intensive inputs). In order to facilitate future scenario modelling and scenario-based information, more detailed (e.g. modelling CPUE changes; considering all commercial species; exploring other scenarios, being either intermediate to the three ones proposed here or totally different ones) and up-to-date policy-based scenarios need to be explored, including dynamic linking between ecosystem and material flow models.

Additionally, the relationships and dynamics between Peruvian fishfood and (especially) reduction products with international food supply chains require to be thoroughly studied. Although the

importance of Peruvian reduction products in international animal husbandry and aquaculture is well known, yet it has not been accounted for nor characterised in detail. For instance, which one is the main cultured species consuming Peruvian fishmeal in Asia, shrimp or carps? Which impact will have on the Peruvian reduction industry the upcoming ban of discards in European fisheries? How resilient would be an alternative anchoveta exploitation scenario, in terms of markets, stock, socio-economics, etc? How can Peru exploit the competitive advantages, if any, of being the main global producer of fish reduction products towards further developing its aquaculture? How to effectively increase the national consumption of anchoveta DHC products in Peru? What is the extent of losses along the anchoveta supply chains and how to curb them? These questions and others, which allow understanding the socio-economic, trade and environmental impacts of Peruvian fish products in international food supply chains; claim for further research.

## Bibliography

- Acar, Y., Kadipasaoglu, S., & Schipperijn, P. (2010). A decision support framework for global supply chain modelling: an assessment of the impact of demand, supply and lead-time uncertainties on performance. *International Journal of Production Research*, 48(11), 3245-3268. doi:10.1080/00207540902791769
- Adelle, C., & Pallemarts, M. (2009). Sustainable Development Indicators. An Overview of relevant Framework Programme funded research and identification of further needs in view of EU and international activities. European Commission. Directorate-General for Research, Directorate I – Environment, Unit I.2 – Sustainable Development.
- ADEME (2007). Bilan Carbone Companies and Local Authorities Version. Methodological Guide Version 5.0: objectives and principles for the counting of greenhouse gas emissions. French Agency for the Environment and Energy Management, Paris.
- Ahumada, O., & Villalobos, J. (2009). Application of planning models in the agri-food supply chain: A review. *European Journal of Operational Research*, 196(1), 1-20. doi:10.1016/j.ejor.2008.02.014
- Allen, J. I., & Fulton, E. (2010). Top-down, bottom-up or middle-out? Avoiding extraneous detail and over-generality in marine ecosystem models. *Progress In Oceanography*, 84(1-2), 129-133. doi:10.1016/j.pocean.2009.09.016
- Almeida, N. M., & Bueno Franco, M. R. (2006). Determination of essential fatty acids in captured and farmed tambaqui (*Colossoma macropomum*) from the Brazilian Amazonian area. *Journal of the American Oil Chemists' Society*, 83(8), 707–711. doi:10.1007/s11746-006-5027-9
- Almeida, N. M., Visentainer, J. V., & Franco, M. R. B. (2008). Composition of total, neutral and phospholipids in wild and farmed tambaqui (*Colossoma macropomum*) in the Brazilian Amazon area. *Journal of the Science of Food and Agriculture*, 88(10), 1739–1747. doi:10.1002/jsfa
- Alvarado, F. (2009). Diagnóstico social sobre el trabajo y el empleo en el sector pesquero de Ecuador y Perú. Proyecto para el desarrollo racional y sostenible del sector pesquero. Madrid: Organización Internacional del Trabajo.
- Apaiah, R., Linnemann, A., & Vanderkooi, H. (2006). Exergy analysis: A tool to study the sustainability of food supply chains. *Food Research International*, 39(1), 1-11. doi:10.1016/j.foodres.2005.04.006
- APOYO. (2008). Aplicación de un sistema de LMCE en la pesquería de anchoveta en el Perú y propuesta de programa de reestructuración laboral. Lima: APOYO Consulting, Ministry of Production of Peru.
- Aramyan, L. (2007). Measuring Supply Chain Performance in the Agri-Food Sector. PhD Dissertation. Wageningen University. Retrieved from <http://library.wur.nl/WebQuery/edepot/121904>
- Aranda, M. (2009). Evolution and state of the art of fishing capacity management in Peru: The case of the anchoveta fishery. *Pan-American Journal of Aquatic Sciences*, 4, 146–153. Retrieved from [http://www.panamjas.org/pdf\\_artigos/PANAMJAS\\_4\(2\)\\_146-153.pdf](http://www.panamjas.org/pdf_artigos/PANAMJAS_4(2)_146-153.pdf)
- Ardente, F., & Cellura, M. (2012). Economic Allocation in Life Cycle Assessment. *Journal of Industrial Ecology*, 00(0), no-no. doi:10.1111/j.1530-9290.2011.00434.x
- Arias Schreiber, M. (2011). The evolution of legal instruments and the sustainability of the Peruvian anchovy fishery. *Marine Policy*, 36(1), 78–89. doi:10.1016/j.marpol.2011.03.010

- ART. (2008). Proceedings of the 6th International Conference on LCA in the Agri-Food Sector – Towards a sustainable management of the Food chain. In T. Nemecek & G. Gaillard (Eds.), 6th International Conference on Life Cycle Assessment in the Agri-Food Sector. Zurich: Agroscope Reckenholz-Tänikon Research Station ART.
- Aubin, J., Papatryphon, E., Van der Werf, H. M. G., & Chatzifotis, S. (2009). Assessment of the environmental impact of carnivorous finfish production systems using life cycle assessment. *Journal of Cleaner Production*, 17(3), 354–361. doi:10.1016/j.jclepro.2008.08.008
- Austreng & Refstie. (1979) Effect of varying dietary protein level in different families of rainbow trout. *Aquaculture*, 18(2), 145-156
- Avadí, A, Fréon, P, Tam, J (2014d) Coupled ecosystem/supply chain modelling of fishfood products from sea to shelf: the Peruvian anchoveta case. *PlosOne* (in review).
- Avadí, A. (2010). Integrated regional material flow modelling and GHG inventorying: implications for regional sustainable development. Masters Thesis. Birkenfeld: University of Applied Sciences Trier – Environmental Campus Birkenfeld, Master of Engineering in International Material Flow Management. Retrieved from [http://www.bod.com/index.php?id=3435&objk\\_id=892192](http://www.bod.com/index.php?id=3435&objk_id=892192)
- Avadí, A., & Fréon, P. (2013). Life cycle assessment of fisheries: A review for fisheries scientists and managers. *Fisheries Research*, 143, 21–38. doi:10.1016/j.fishres.2013.01.006
- Avadí, A., & Fréon, P. (2014). A set of sustainability performance indicators for seafood: direct human consumption products from Peruvian anchoveta fisheries and freshwater aquaculture. *Ecological Indicators*, in review.
- Avadí, A., Fréon, P., & Quispe, I. (2014b). Environmental assessment of Peruvian anchoveta food products: is less refined better? *The International Journal of Life Cycle Assessment*, in press. doi:10.1007/s11367-014-0737-y
- Avadí, A., Pelletier, N., Aubin, J., Ralite, S., Núñez, J., & Fréon, P. (2014c). Comparative environmental performance of artisanal and commercial feed use in Peruvian freshwater aquaculture. *Aquaculture*, in review.
- Avadí, A., Vázquez-Rowe, I., & Fréon, P. (2014a). Eco-efficiency assessment of the Peruvian anchoveta steel and wooden fleets using the LCA+DEA framework. *Journal of Cleaner Production*, in press. doi:10.1016/j.jclepro.2014.01.047
- Ayer, N., Cote, R., Tyedmers, P., & Martinwillison, J. (2009). Sustainability of seafood production and consumption: an introduction to the special issue. *Journal of Cleaner Production*, 17(3), 321-324. doi:10.1016/j.jclepro.2008.09.003
- Ayer, N., Tyedmers, P., Pelletier, N., Sonesson, U., & Scholz, A. J. (2007). Co-product allocation in life cycle assessments of seafood production systems: Review of problems and strategies. *The International Journal of Life Cycle Assessment*, 12(7), 480–487. doi:10.1065/lca2006.11.284
- Ayres, R.U., Simonis, U.E., (1994). *Industrial Metabolism, Restructuring for Sustainable Development*. United Nations University Press, Tokyo, New York, Paris.
- Baes, C. F., Sharp, R. D., Sjoeren, A. L., & Shor, R. W. (1984). A review and analysis of parameters for assessing transport and environmentally released radionuclides through agriculture. ORNL-5786. Oak Ridge National Laboratory. Retrieved from <http://homer.ornl.gov/baes/documents/ornl5786.pdf>
- Baitz, M., Albrecht, S., Brauner, E., Broadbent, C., Castellan, G., Conrath, P., Fava, J., et al. (2012). LCA's theory and practice: like ebony and ivory living in perfect harmony? *The International Journal of Life Cycle Assessment*. doi:10.1007/s11367-012-0476-x

- Baltazar, P. (2009). Situación actual de la tilapia en el Perú (Current situation of tilapia in Peru). Segunda Jornada de Actualización en Tilapia. Puerto Vallarta, México, 11-15 setiembre del 2009. Retrieved from [http://www.cebem.org/cmsfiles/articulos/situacion\\_tilapia\\_peru.pdf](http://www.cebem.org/cmsfiles/articulos/situacion_tilapia_peru.pdf)
- Baltazar, P., & Palomino, A. (2004). Manual de cultivo de tilapia (Handbook of tilapia husbandry). Lima: Ministerio de la Producción y Fondo Nacional de Desarrollo Pesquero - FONDEPES. Retrieved from [http://www2.produce.gob.pe/RepositorioAPS/3/jer/ACUISUBMENU4/manual\\_tilapia.pdf](http://www2.produce.gob.pe/RepositorioAPS/3/jer/ACUISUBMENU4/manual_tilapia.pdf)
- Bandura, R. (2008). A Survey of Composite Indices Measuring Country Performance: 2008 Update. A UNDP/ODS Working Paper. New York: Office of Development Studies, United Nations Development Programme.
- Bare, J. (2000). Midpoints versus endpoints: The sacrifices and benefits. *The International Journal of Life Cycle Assessment*, 3(4), 97-326. doi:10.1007/BF02978665
- Barrett, J., Vallack, H., Jones, A., & Haq, G. (2002). A Material Flow Analysis and Ecological Footprint of York. Technical Report. Stockholm Environment Institute.
- Beamon, B. (1998). Supply chain design and analysis: Models and methods. *International Journal of Production Economics*, 55(3), 281-294. Retrieved from <http://www.sciencedirect.com/science/article/pii/S0925527398000796>
- Bellows, L., Bunning, M., & Macdonald, M. (2010). Omega-3 Fatty Acids. Food and Nutrition Series No. 9.382. Colorado State University Extension.
- Bertram, M., Martchek, K. J., & Rombach, G. (2009). Material Flow Analysis in the Aluminum Industry. *Journal of Industrial Ecology*, 13(5), 650–654. doi:10.1111/j.1530-9290.2009.00158.x
- Bertrand, A., Fréon, P., Chaigneau, A., Echevin, V., Estrella, C., Demarq, H., Gutiérrez, D., et al. (2010). Impactos del Cambio Climático en la Dinámica Oceánica, el Funcionamiento de los Ecosistemas y de las Pesquerías en el Perú: Proyección de Escenarios e Impactos Socio Económicos (Impacts of Climate Change on oceanic dynamics, ecosystem functioning and Peruvian fisheries: Projection of scenarios and socio-economic impacts). Lima: Institut de Recherche pour le Développement (IRD) for British Embassy Lima.
- Bezerra, A. (2002). Growth and protein digestibility of Tambaqui, *Colossoma macropomum*, Cuvier 1818, fed diets based on fish silage. Masters Thesis. Aquaculture Department, Memorial University of Newfoundland.
- Bidault, F. (1988). Le champ stratégique de l'entreprise. *Economica*.
- Bjørndal, T., Lane, D. E., & Weintraub, A. (2004). Operational research models and the management of fisheries and aquaculture: A review. *European Journal of Operational Research*, 156(3), 533-540. doi:10.1016/S0377-2217(03)00107-3
- Bjorklund, A. E. (2002). Survey of Approaches to Improve Reliability in LCA. *The International Journal of Life Cycle Assessment*, 7(2), 64–72.
- Boissy, J., Aubin, J., Drissi, A., Van der Werf, H. M. G., Bell, G. J., & Kaushik, S. (2011). Environmental impacts of plant-based salmonid diets at feed and farm scales. *Aquaculture*, 321, 61–70. doi:10.1016/j.aquaculture.2011.08.033
- Booth, M. a, Allan, G. L., & Anderson, A. J. (2005). Investigation of the nutritional requirements of Australian snapper *Pagrus auratus* (Bloch & Schneider, 1801): apparent digestibility of protein and energy sources. *Aquaculture Research*, 36(4), 378–390. doi:10.1111/j.1365-2109.2005.01219.x
- Börjeson, L., Höjer, M., Dreborg, K.-H., Ekvall, T., & Finnveden, G. (2006). Scenario types and techniques: Towards a user's guide. *Futures*, 38(7), 723–739. doi:10.1016/j.futures.2005.12.002

- Bösch, M. E., Hellweg, S., Huijbregts, M. A. J., & Frischknecht, R. (2007). Applying cumulative exergy demand (CExD) indicators to the ecoinvent database. *The International Journal of Life Cycle Assessment*, 12(3), 181–190.
- Bosma, R., Anh, P. T., & Potting, J. (2011). Life cycle assessment of intensive striped catfish farming in the Mekong Delta for screening hotspots as input to environmental policy and research agenda. *The International Journal of Life Cycle Assessment*, 903-915. doi:10.1007/s11367-011-0324-4
- Boulding, K. (1966). The economics of the coming spaceship earth. In H. Jarrett (ed.) 1966. *Environmental Quality in a Growing Economy*, pp. 3-14. Baltimore, MD: Resources for the Future/Johns Hopkins University Press.
- Bowen, R., & Riley, C. (2003). Socio-economic indicators and integrated coastal management. *Ocean & Coastal Management*, 46(3-4), 299-312. doi:10.1016/S0964-5691(03)00008-5
- Brandenburger, A. M., & Nalebuff, B. J. (1996). *Co-Opetition : A Revolution Mindset That Combines Competition and Cooperation : The Game Theory Strategy That's Changing the Game of Business*. Industrial Marketing Management (p. 304). Currency Doubleday.
- Brander, M., Tipper, R., Hutchison, C., & Davis, G. (2008). Consequential and attributional approaches to LCA: a guide to policy makers with specific reference to greenhouse gas LCA of biofuels. *Ecometrica*, Edinburgh (p. 14). Retrieved from [http://d3u3pjcknor73l.cloudfront.net/assets/media/pdf/approachesto\\_LCA3\\_technical.pdf](http://d3u3pjcknor73l.cloudfront.net/assets/media/pdf/approachesto_LCA3_technical.pdf)
- Brown, D. (2000). A review of bio-economic models. Cornell University, Cornell African Food Security and Natural Resource Management (CAFSNRM) Program. Retrieved from <http://citeseerx.ist.psu.edu/viewdoc/download?doi=10.1.1.200.8771&rep=rep1&type=pdf>
- Brunner, P. and Rechberger, H. (2003). *Practical Handbook of Material Flow Analysis*. Lewis Publishers. Boca Raton, FL, USA.
- BSi. (2011). PAS 2050:2011 Specification for the assessment of the life cycle greenhouse gas emissions of goods and services. London: British Standards Institution, Crown and Carbon Trust.
- Caillaux, M., Mangin, T., Fuller, J., Kirschner, Y., & Thornton, S. (2013). *Assessing Management Strategies for the Artisanal Sector of the Peruvian Anchoveta Fishery*. Bren School of Environmental Science & Management, University of California.
- Cappell, R., Wright, S., and Nimmo, F. (2007). *Sustainable Production and Consumption of fish and shellfish - Environmental Impact Analysis*. DEFRA LCA.
- Carbon Trust. (2007). *Carbon Footprint Measurement Methodology*. Version 1.3 (pp. 1–26). London. Retrieved from [http://rpm-solutions.ca/CSR/CarbonFootprint\\_methodology\\_full.pdf](http://rpm-solutions.ca/CSR/CarbonFootprint_methodology_full.pdf)
- Casado, P., Rodríguez, L., Alcántara, F., & Chu-Koo, F. (2009). Evaluación del trigo regional (*Coix lacryma-jobi*, Poaceae) como insumo alimenticio para gamitana (*Colossoma macropomum*). Evaluation of Job's Tear meal (*Coix lacryma-jobi*, Poaceae) as feedstuff for black- finned pacu (*Colossoma macropomum*). *Folia Amazónica*, 18(1-2), 89–96.
- Casanova\_Flores, R., & Chu-Koo, F. (2008). Evaluación del polvillo de malta de cebada (*Hordeum vulgare*) como insumo alimenticio para gamitana (*Colossoma macropomum*). Evaluation of barley bran (*Hordeum vulgare*) as feedstuff for gamitana (*Colossoma macropomum*). *Folia Amazónica*, 17(1-2), 15–22.
- Celik, M., GÖKÇE, M., BASUSTA, N., KÜÇÜKGÜLMEZ, A., TASBOZAN, O., & TABAKOGLU, S. (2008). Nutritional quality of rainbow trout (*Oncorhynchus mykiss*) caught from the Atatürk Dam Lake in Turkey. *Journal of Muscle Foods*, 19(1), 50–61. Retrieved from <http://onlinelibrary.wiley.com/doi/10.1111/j.1745-4573.2007.00099.x/full>
- Chang, Y., & Makatsoris, H. (2001). Supply chain modeling using simulation. *International Journal of Simulation*, 2(1), 24-30.

- Chertow, M. R. (2007). "Uncovering" Industrial Symbiosis. *Journal of Industrial Ecology*, 11(1), 11-30. Retrieved from <http://cie.research.yale.edu/sites/default/files/uncovering IE.pdf>
- Christensen, V., & Pauly, D. (1992). ECOPATH II - A software for balancing steady-state ecosystem models and calculating network characteristics. *Ecological Modelling*, 61(681), 169-185.
- Christensen, V., & Walters, C. (2004). Ecopath with Ecosim: methods, capabilities and limitations. *Ecological Modelling*, 172(2-4), 109–139. doi:10.1016/j.ecolmodel.2003.09.003
- Christensen, V., de la Puente, S., Sueiro, J. C., Steenbeek, J., & Majluf, P. (2013). Valuing seafood: the Peruvian fisheries sector. *Marine Policy*. doi:10.1016/j.marpol.2013.09.022
- Christensen, V., Steenbeek, J., & Failler, P. (2011). A combined ecosystem and value chain modeling approach for evaluating societal cost and benefit of fishing. *Ecological Modelling*, 222(3), 857-864. Elsevier B.V. doi:10.1016/j.ecolmodel.2010.09.030
- Ciroth, A. (2004). Uncertainties in life cycle assessment. *The International Journal of Life Cycle Assessment*, 9(3), 141–142.
- Coll, M., Shannon, L., Moloney, C. L., Palomera, I., & Tudela, S. (2006). Comparing trophic flows and fishing impacts of a NW Mediterranean ecosystem with coastal upwelling systems by means of standardized models and indicators. *Ecological Modelling*, 198(1-2), 53-70. doi:10.1016/j.ecolmodel.2006.04.009
- Cooper, A. (2006). A guide to fisheries stock assessment: from data to recommendations. Durham: National Sea Grant College Program of the US Department of Commerce's National Oceanic and Atmospheric Administration under NOAA grant #NA16RG1035. Retrieved from <http://www.sefsc.noaa.gov/sedar/download/stockassessmentguide.pdf?id=DOCUMENT>
- Cooper, J. S. (2003). Specifying functional units and reference flows for comparable alternatives. *The International Journal of Life Cycle Assessment*, 8(6), 337-349. doi:10.1065/Ica2003.09.1344
- Cooper, J. S., & Kahn, E. (2012). Commentary on issues in data quality analysis in life cycle assessment. *The International Journal of Life Cycle Assessment*, 17(4), 499–503. doi:10.1007/s11367-011-0371-x
- Cooper, J. S., Noon, M., & Kahn, E. (2012). Parameterization in Life Cycle Assessment inventory data: review of current use and the representation of uncertainty. *The International Journal of Life Cycle Assessment*, 17(6), 689–695. doi:10.1007/s11367-012-0411-1
- Côté, A., & McCollough, D. (2007). Comparative Analysis of Indicator Systems for Sustainable Development. Québec: Bureau de coordination du développement durable of the Ministère du Développement durable, de l'Environnement et des Parcs.
- Cote, R. (2008). Industrial ecology, industrial symbiosis and eco-industrial parks. In Rankin, J. Summary and Proceedings of the Asia-Pacific International Workshop on Industrial Ecology. Kawasaki: International Society for Industrial Ecology (Tsinghua University) and National Institute for Environmental Studies, Japan (NIES).
- Crampton VO, Nanton D a., Ruohonen K, et al. (2010) Demonstration of salmon farming as a net producer of fish protein and oil. *Aquaculture Nutrition* 16:437–446.
- CSCP/GTZ. (2006). Policy Instruments for Resource Efficiency Towards Sustainable Consumption and Production. Deutsche Gesellschaft für Technische Zusammenarbeit (GTZ) and UNEP/Wuppertal Institute Collaborating Centre on Sustainable Consumption and Production (CSCP). Retrieved from [http://www.uns.ethz.ch/edu/teach/bachelor/energymob/GTZ\\_et\\_al\\_2006\\_policy-instruments\\_resource\\_efficiency.pdf](http://www.uns.ethz.ch/edu/teach/bachelor/energymob/GTZ_et_al_2006_policy-instruments_resource_efficiency.pdf)

- Curran, M. A. (2007). Co-product and input allocation approaches for creating life cycle inventory data: a literature review. *INT J LIFE CYCLE ASS*, 12(Special Issue 1):65–78. doi:10.1065/lca2006.08.268
- Curran, M. A., Notten, P., Chayer, J. A., & Cicas, G. (2006). Summary of global life cycle inventory data resources. Task Force 1: Database Registry (Vol. 1). SETAC/UNEP Life Cycle Initiative, US Environmental Protection Agency, National Risk Management Research Laboratory. Retrieved from [http://www.epa.gov/ORD/NRMRL/lcaccess/pdfs/summary\\_of\\_global\\_lci\\_data\\_resources.pdf](http://www.epa.gov/ORD/NRMRL/lcaccess/pdfs/summary_of_global_lci_data_resources.pdf)
- Dabbene, F., Gay, P., & Sacco, N. (2008). Optimisation of fresh-food supply chains in uncertain environments, Part I: Background and methodology. *Biosystems Engineering*, 99(3), 348-359. doi:10.1016/j.biosystemseng.2007.11.011
- Dahl, A. L. (2012). Achievements and gaps in indicators for sustainability. *Ecological Indicators*, 17, 14-19. doi:10.1016/j.ecolind.2011.04.032
- Danius, L. (2002). Data uncertainties in material flow analysis. Local case study and literature survey. Licentiate thesis. Stockholm: Industrial Ecology, Dept of Chemical Engineering & Technology, Royal Institute of Technology.
- Deep, A., & Dani, S. (2009). Managing Global Food Supply Chain Risks: A Scenario Planning Perspective. POMS 20th Annual Conference (pp. 1-21). Orlando: Production and Operation Management Society. Retrieved from <http://www.pomsmeetings.org/confproceedings/011/fullpapers/011-0371.pdf>
- DEFRA (2009). Guidance on how to measure and report your greenhouse gas emissions. Department for Environment, Food and Rural Affairs, London.
- Deutz, P., & Gibbs, D. (2008). Industrial Ecology and Regional Development: Eco-Industrial Development as Cluster Policy. *Regional Studies*, 42(10), 1313-1328. doi:10.1080/00343400802195121
- Dewulf, J., Van Langenhove, H., Muys, B., Bruers, S., Bakshi, B.R., Grubb, G.F., Paulus, D.M., and Sciubba, E., 2008. Exergy: Its Potential and Limitations in Environmental Science and Technology. *Environmental Science & Technology* 42, 2221-2232.
- Dias, J., Yúfera, M., Valente, L. M. P., & Rema, P. (2010). Feed transit and apparent protein, phosphorus and energy digestibility of practical feed ingredients by Senegalese sole (*Solea senegalensis*). *Aquaculture*, 302(1-2), 94–99. doi:10.1016/j.aquaculture.2010.02.013
- Drakeford, B., & Pascoe, S. (2010). Substitution of fishmeal in salmon diets: Can it be cost effective? *World Aquaculture Magazine*, 6-8.
- Drewnowski, A., & Fulgoni, V. (2008). Nutrient profiling of foods: creating a nutrient-rich food index. *Nutrition reviews*, 66(1), 23–39. doi:10.1111/j.1753-4887.2007.00003.x
- Dreyer, L., Hauschild, M., & Schierbeck, J. (2006). A framework for social life cycle impact assessment. *Int J LCA*, 11(2), 88–97. doi:10.1065/lca2005.08.223
- Dumas, A., De Lange, C. F. M., France, J., & Bureau, D. P. (2007). Quantitative description of body composition and rates of nutrient deposition in rainbow trout (*Oncorhynchus mykiss*). *Aquaculture*, 273(1), 165–181. doi:10.1016/j.aquaculture.2007.09.026
- Earles, J. M., & Halog, A. (2011). Consequential life cycle assessment: a review. *The International Journal of Life Cycle Assessment*, 16(5), 445–453. doi:10.1007/s11367-011-0275-9
- Ehrenfeld, J., & Gertler, N. (1997). Industrial ecology in practice: the evolution of interdependence at Kalundborg. *Journal of industrial Ecology*, 1(1). Retrieved from <http://onlinelibrary.wiley.com/doi/10.1162/jiec.1997.1.1.67/abstract>



- Ekvall, T., & Finnveden, G. (2001). Allocation in ISO 14041 — a critical review. *Journal of Cleaner Production*, 9, 197-208. Retrieved from <http://www.sciencedirect.com/science/article/pii/S0959652600000524>
- Emanuelsson, A., Ziegler, F., Hornborg, S., & Sonesson, U. (2012). Target catch methods in Life Cycle Assessment of seafood products: Accounting for overfishing in a Wasted Potential Yield framework. Public consultation. LC-IMPACT. Retrieved from [http://lc-impact.eu/userfiles/D\\_1\\_3a\\_marine\\_resources\\_use.pdf](http://lc-impact.eu/userfiles/D_1_3a_marine_resources_use.pdf)
- Emanuelsson, A., Ziegler, F., Pihl, L., Sköld, M., & Sonesson, U. (2013). Accounting for overfishing in life cycle assessment : new impact categories for biotic resource use. *The International Journal of Life Cycle Assessment* (in press). doi:10.1007/s11367-013-0684-z
- Estrella, C., & Swartzman, G. (2010). The Peruvian artisanal fishery: Changes in patterns and distribution over time. *Fisheries Research*, 101(3), 133–145. doi:10.1016/j.fishres.2009.08.007
- EU. (2012). Facts and figures on the Common Fisheries Policy. Basic statistical data. Luxembourg: Publications Office of the European Union. doi:10.2771/18990
- European Commission. (2013). Commission Recommendation of 9 April 2013 on the use of common methods to measure and communicate the life cycle environmental performance of products and organisations. *Official Journal of the European Union* (Vol. 56, p. 209). Retrieved from <http://eur-lex.europa.eu/LexUriServ/LexUriServ.do?uri=OJ:L:2013:124:FULL:EN:PDF>
- Evans, Y., & Tvetaras, S. (2011). Status of fisheries and aquaculture development in Peru: case studies of Peruvian anchovy fishery, shrimp aquaculture, trout aquaculture and scallop aquaculture. Background Report. Lima.
- Fallah, A. a., Siavash Saei-Dehkordi, S., & Nematollahi, A. (2011). Comparative assessment of proximate composition, physicochemical parameters, fatty acid profile and mineral content in farmed and wild rainbow trout (*Oncorhynchus mykiss*). *International Journal of Food Science & Technology*, 46(4), 767–773. doi:10.1111/j.1365-2621.2011.02554.x
- FAO. (1995). Code of Conduct for Responsible Fisheries (p. 41). Rome: Food and Agriculture Organization of the United Nations (FAO).
- FAO. (2003). Fisheries Management 2. The ecosystem approach to fisheries. FAO Technical Guidelines for Responsible Fisheries (Vol. 4, p. 112). Rome: Food and Agriculture Organisation of the United Nations, Fisheries Department.
- FAO. (2010). NATIONAL FISHERY SECTOR OVERVIEW. PERU. Fishery and Aquaculture Country Profiles (p. 21). Retrieved from <http://scholar.google.com/scholar?hl=en&btnG=Search&q=intitle:NATIONAL+FISHERIES+SECTOR+OVERVIEW#0>
- Finkbeiner, M. (Ed). (2011). Towards Life Cycle Sustainability Management. Springer Science+Business Media. doi:10.1007/978-94-007-1899-9
- Finnveden, G., & Moberg, Å. (2005). Environmental systems analysis tools - an overview. *Journal of Cleaner Production*, 13(12), 1165-1173. doi:10.1016/j.jclepro.2004.06.004
- Finnveden, G., Hauschild, M. Z., Ekvall, T., Guinée, J., Heijungs, R., Hellweg, S., Koehler, A., et al. (2009). Recent developments in Life Cycle Assessment. *Journal of Environmental Management*, 91(1), 1-21. doi:10.1016/j.jenvman.2009.06.018
- Flachowsky, G., & Kamphues, J. (2012). Carbon Footprints for Food of Animal Origin: What are the Most Preferable Criteria to Measure Animal Yields? *Animals*, 2(2), 108–126. doi:10.3390/ani2020108

- Food Policy. (2011). The challenge of global food sustainability (Editorial). *Food Policy*, 36(Supplement 1), S1-S2. doi:10.1016/j.foodpol.2011.01.001
- Ford, J. S., Pelletier, N. L., Ziegler, F., Scholz, A. J., Tyedmers, P., Sonesson, U., Kruse, S. a., et al. (2012). Proposed Local Ecological Impact Categories and Indicators for Life Cycle Assessment of Aquaculture. *Journal of Industrial Ecology*, 16(2), 245–265. doi:10.1111/j.1530-9290.2011.00410.x
- Fox, J.M., Lawrence, A.L. and Smith, F. (2004). Development of a Low-fish Meal Feed Formulation for Commercial Production of *Litopenaeus vannamei*. In: Cruz Suárez, L.E., Ricque Marie, D., Nieto López, M.G., Villareal, D., Scholz, U. and González, M. 2004. Avatración Acuícola. 16-19 Noviembre, 2004. Hermosillo, Mexico.
- Freibauer, A., Mathijs, E., Brunori, G., Damianova, Z., Faroult, E., Gomis, J. G. i, O'Brien, L., et al. (2011). Sustainable food consumption and production in a resource-constrained world. The 3rd SCAR Foresight Exercise (pp. 0-147). Luxembourg, Publications Office of the European Union.
- Freidberg, S. (2013). Calculating sustainability in supply chain capitalism. *Economy and Society*, 00(00), 1–26. doi:10.1080/03085147.2012.760349
- Fréon, P., Avadí, A., Amelia, R., & Chavez, V. (2014a). Life cycle assessment of the Peruvian industrial anchoveta fleet: boundary setting in life cycle inventory analyses of complex and plural means of production. *The International Journal of Life Cycle Assessment*, in press. doi:10.1007/s11367-014-0716-3
- Fréon, P., Avadí, A., Marín, W., & Negrón, R. (2014b). Environmentally-extended comparison table of large- vs. small- and medium-scale fisheries: the case of the Peruvian anchoveta fleet. *Canadian Journal of Fisheries and Aquatic Sciences*, in review.
- Fréon, P., Bouchon, M., Domalain, G., Estrella, C., Iriarte, F., Lazard, J., Legendre, M., et al. (2010). Impacts of the Peruvian anchoveta supply chains: from wild fish in the water to protein on the plate. *GLOBEC International Newsletter*, (April), 27–31.
- Fréon, P., Drapeau, L., David, J., Fernández Moreno, A., Leslie, R., Oosthuizen, H., Shannon, L.J., van der Lingen, C.D., (2005b). Spatialised ecosystem indicators in the Southern Benguela. *ICES J. Mar. Sci.*, 62, 459-468.
- Fréon, P., Sueiro, J. C., Iriarte, F., Miro Evar, O. F., Landa, Y., Mittaine, J.-F., & Bouchon, M. (2013). Harvesting for food versus feed: a review of Peruvian fisheries in a global context. *Reviews in Fish Biology and Fisheries*. doi:10.1007/s11160-013-9336-4
- Frischknecht, R., Jungbluth, N., Althaus, H., Bauer, C., Doka, G., Dones, R., Hischier, R., et al. (2007). Implementation of Life Cycle Impact Assessment Methods. ecoinvent report No. 3 (v2.0). Dübendorf: Swiss Centre for Life Cycle Inventories.
- Frischknecht, R., Jungbluth, N., Althaus, H.-J., Doka, G., Heck, T., Hellweg, S., Hischier, R., et al. (2007). Overview and Methodology. ecoinvent report No. 1. Dübendorf: Swiss Centre for Life Cycle Inventories.
- Frosch, R. A., & Gallopoulos, N. E. (1989). Strategies for Manufacturing. *Scientific American*, 189(3), 144-152.
- Fulton, E. (2010). Approaches to end-to-end ecosystem models. *Journal of Marine Systems*, 81(1-2), 171-183. doi:10.1016/j.jmarsys.2009.12.012
- Fulton, E. a, Smith, A. D., & Johnson, C. R. (2004). Biogeochemical marine ecosystem models I: IGBEM—a model of marine bay ecosystems. *Ecological Modelling*, 174(3), 267-307. doi:10.1016/j.ecolmodel.2003.09.027
- Fulton, E., Fuller, M., & Smith, A. (2004). Ecological indicators of the ecosystem effects of fishing: final report. Report Number R99/1546. Australian Fisheries Management Authority. Retrieved from [http://www.sainsolutions.net/Ecol Ind\\_simulation\\_testing.pdf](http://www.sainsolutions.net/Ecol%20Ind_simulation_testing.pdf)

- Fulton, E., Smith, A., & Punt, A. (2005). Which ecological indicators can robustly detect effects of fishing? *ICES Journal of Marine Science*, 62(3), 540–551. doi:10.1016/j.icesjms.2004.12.012
- Gascuel, D., & Pauly, D. (2009). EcoTroph: Modelling marine ecosystem functioning and impact of fishing. *Ecological Modelling*, 220(21), 2885-2898. doi:10.1016/j.ecolmodel.2009.07.031
- Geisler, G., Hellweg, S., & Hungerbühler, K. (2005). Uncertainty analysis in life cycle assessment (LCA): Case study on plant-protection products and implications for decision making (9 pp+ 3 pp). *The International Journal of Life Cycle Assessment*, 3, 192–194. Retrieved from <http://link.springer.com/article/10.1065/lca2004.09.178>
- Gerbens-Leenes, P. (2003). Design and development of a measuring method for environmental sustainability in food production systems. *Ecological Economics*, 46(2), 231-248. doi:10.1016/S0921-8009(03)00140-X
- Gereff, G., Humphrey, J., Kaplinsky, R., & Sturgeon, T. J. (2001). Introduction: Globalisation, Value Chains and Development. *Institute of Development Studies Bulletin*, 32(3), 1-8. doi:10.1111/j.1759-5436.2001.mp32003001.x
- GFN. (2009). *Ecological Footprint Standards 2009*. Oakland: Global Footprint Network.
- Glencross, B. D., Booth, M., & Allan, G. L. (2007). A feed is only as good as its ingredients – a review of ingredient evaluation strategies for aquaculture feeds. *Aquaculture Nutrition*, 13, 17–34.
- Gluch, P. (2004). The life cycle costing (LCC) approach: a conceptual discussion of its usefulness for environmental decision-making. *Building and Environment*, 39(5), 571-580. doi:10.1016/j.buildenv.2003.10.008
- Goedkoop, M., Hofstetter, P., Müller-Wenk, R., & Spriensma, R. (1998). The Eco-indicator 98 explained. *The International Journal of Life Cycle Assessment*, 3(6), 352–360. Retrieved from <http://link.springer.com/article/10.1007/BF02979347>
- Goedkoop, M., Heijungs, R., Huijbregts, M., Schryver, A. D., Struijs, J., & Zelm, R. V. (2009). ReCiPe 2008. A life cycle impact assessment method which comprises harmonised category indicators at the midpoint and the endpoint level. Report I: Characterisation. Ministry of Housing, Spatial Planning and Environment (VROM). Retrieved from [www.lcia-recipe.info](http://www.lcia-recipe.info)
- Goedkoop, Mark, & Spriensma, R. (2001). The Eco-indicator 99 - A damage oriented method for Life Cycle Impact Assessment - Methodology Annex. Assessment (p. 144). Amersfoort, NL.
- Gold, S., Seuring, S., & Beske, P. (2010). Sustainable Supply Chain Management and Inter-Organizational Resources: A Literature Review. *Corporate Social Responsibility and Environmental Management*, 245(July 2009), 230-245. doi:10.1002/csr
- GRI. (2006). *Sustainability Reporting Guidelines Version 3.0*. Global Reporting Initiative.
- Guinée, J. B., Gorrée, M., Heijungs, R., Huppes, G., Kleijn, R., Koning, A. de, ... Huijbregts, M. A. J. (2002). *Handbook on life cycle assessment. Operational guide to the ISO standards. I: LCA in perspective. IIa: Guide. IIb: Operational annex. III: Scientific background* (p. 692). Dordrecht: Kluwer Academic Publishers.
- Guinée, J. B., Heijungs, R., Kleijn, R., Voet, E. van der, Koning, A. de, Oers, L. van, Elshkaki, A., et al. (2006). Human and ecological life cycle tools for the integrated assessment of systems (HELIAS). *The International Journal of Life Cycle Assessment*, 11(Special Issue 1), 19-28. doi:10.1065/lca2006.04.008
- Guinée, J., Heijungs, R., Huppes, G., Zamagni, A., Masoni, P., Buonamici, R., Ekvall, T., et al. (2011). Life cycle assessment: past, present, and future. *Environmental science & technology*, 45(1), 90-6. doi:10.1021/es101316v

- Guttormsdóttir, A. B. (2009). Life Cycle Assessment on Icelandic cod product based on two different fishing methods. Environmental impacts from fisheries. Masters Thesis. University of Iceland. Retrieved from <http://www.matis.is/media/utgafa/krokur/Adalbjorg-Birna-Vistferilgreining-LCA.pdf>
- Haberl, H., Fischer-Kowalski, M., Krausmann, F., Weisz, H., & Winiwarter, V. (2004a). Progress towards sustainability? What the conceptual framework of material and energy flow accounting (MEFA) can offer. *Land Use Policy*, 21(3), 199–213. doi:10.1016/j.landusepol.2003.10.013
- Haberl, H., Wackernagel, M., Krausmann, F., Erb, K.-H., & Monfreda, C. (2004b). Ecological footprints and human appropriation of net primary production: a comparison. *Land Use Policy*, 21(3), 279–288. doi:10.1016/j.landusepol.2003.10.008
- Hajen, W. E., D. A. Higgs, R. M. Beames, and B. S. Dosanjh. 1993. Digestibility of various feedstuffs by post-juvenile chinook salmon (*Oncorhynchus tshawytscha*) in sea water. 2. Measurement of digestibility. *Aquaculture* 112:333-348.
- Hák, T., Moldan, B., Dahl, A.L. (Eds). (2007). Sustainability Indicators: A Scientific Assessment. SCOPE 67. Island Press, Washington, DC.
- Hall, C. a. S. (2011). Introduction to Special Issue on New Studies in EROI (Energy Return on Investment). *Sustainability*, 3(12), 1773–1777. doi:10.3390/su3101773
- Hall, G. M., & Howe, J. (2012). Energy from waste and the Food Processing Industry. *Process Safety and Environmental Protection*, 90(3), 203-212. Institution of Chemical Engineers. doi:10.1016/j.psep.2011.09.005
- Halog, A., & Manik, Y. (2011). Advancing Integrated Systems Modelling Framework for Life Cycle Sustainability Assessment. *Sustainability*, 3(2), 469-499. doi:10.3390/su3020469
- Handal, J. (2006). Estudio Técnico y Económico de los dos sistemas de producción de Tilapia Roja (*Oreochromis sp.*) en la costa norte de Honduras (Technical and economic study of two production systems for red hybrid tilapia (*Oreochromis sp.*) in the northern coast of Hondura. Licentiate thesis. Retrieved from <http://bdigital.zamorano.edu/bitstream/11036/1019/1/T2253.pdf>
- Hardy, R. W. (2006). Worldwide Fish Meal Production Outlook and the Use of Alternative Protein Meals for Aquaculture. In (Eds.) Suárez, LEC, Marie, DR, Salazar, MT, López, MGN, Cavazos, DAV, Cruz, ACPC and Ortega, AG. *Advances in Aquaculture Nutrition VIII. VIII International Symposium on Aquaculture Nutrition*. 15 - 17 November. Universidad Autónoma de Nuevo León, Monterrey, Nuevo León, Mexico. ISBN 970-694-333-5.
- Hasan, M., & Halwart, M. (2009). Fish as feed inputs for aquaculture: practices, sustainability and implications. FAO Fisheries and Aquaculture Technical Paper No. 518. Retrieved from <http://www.cabdirect.org/abstracts/20113010913.html>
- Hasan, M., Hecht, T., De Silva, S., & Tacon, A. (2007). Study and analysis of feeds and fertilizers for sustainable aquaculture development. FAO Fisheries Technical Paper No. 497 (p. 510). Rome. Retrieved from <http://agris.fao.org/agris-search/search/display.do?f=2008/XF/XF0804.xml;XF2008434301>
- Hau, J. L., & Bakshi, B. R. (2004). Promise and problems of emergy analysis. *Ecological Modelling*, 178(1-2), 215-225. doi:10.1016/j.ecolmodel.2003.12.016
- Heck, P. (2006). Circular Economy related international practices and policy trends: Current situation and practices on sustainable production and consumption and international Circular Economy development policy summary and analysis. Environmental Campus Birkenfeld, Institute for Applied Material Flow Manage (IfaS). Retrieved from [http://siteresources.worldbank.org/INTEAPREGTOPENVIRONMENT/Resources/CircularEconomy\\_Policy\\_FinalDraft\\_EN.pdf](http://siteresources.worldbank.org/INTEAPREGTOPENVIRONMENT/Resources/CircularEconomy_Policy_FinalDraft_EN.pdf)

- Heijungs, R., & Huijbregts, M. A. J. (2004). A Review of Approaches to Treat Uncertainty in LCA. In C. Pahl-Wostl, S. Schmidt, A. E. Rizzoli, & A. J. Jakeman (Eds.), *Complexity and Integrated Resources Management*. Transactions of the 2nd Biennial Meeting of the International Environmental Modelling and Software Society, Volume 1 (pp. 332–339). Osnabrück.
- Heijungs, R., Guinée, J., Kleijn, R., & Rovers, V. (2007). Bias in normalization: causes, consequences, detection and remedies. *The International Journal of Life Cycle Assessment*, 12(4), 211–216.  
doi:<http://dx.doi.org/10.1065/lca2006.07.260>
- Heijungs, R., Huppel, G., & Guinée, J. (2010). Life cycle assessment and sustainability analysis of products, materials and technologies. Toward a scientific framework for sustainability life cycle analysis. *Polymer Degradation and Stability*, 95(3), 422–428. doi:10.1016/j.polymdegradstab.2009.11.010
- Heller, M. C., & Keoleian, G. A. (2000). Life Cycle-Based Sustainability Indicators for Assessment of the U.S. Food System. Report No. CSS00-04 (p. 59). Ann Arbor: University of Michigan, Center for Sustainable Systems. Retrieved from <http://www.umich.edu/~css>
- Helling, K., Blim, M., & O'Regan, B. (2005). An appraisal of virtual networks in the environmental sector. *Management of Environmental Quality: An International Journal*, 16(4), 327–337.  
doi:10.1108/14777830510601208
- Helton, J. C., Johnson, J. D., Sallaberry, C. J., & Storlie, C. B. (2006). Survey of sampling-based methods for uncertainty and sensitivity analysis. *Reliability Engineering & System Safety*, 91(10–11), 1175–1209.  
doi:10.1016/j.res.2005.11.017
- Henriksson PJG, Guinée JB, Heijungs R, et al. (2013) A protocol for horizontal averaging of unit process data— including estimates for uncertainty. *Int. J. Life Cycle Assess.* 10.1007/s11367-013-0647-4
- Henriksson, P., Guinée, J. B., Kleijn, R., & Snoo, G. R. de. (2011). Life cycle assessment of aquaculture systems — a review of methodologies. *The International Journal of Life Cycle Assessment*. doi:10.1007/s11367-011-0369-4
- Hertwich, E. (2005). Consumption and the rebound effect: An industrial ecology perspective. *Journal of Industrial Ecology*, 9(1), 85–98. Retrieved from <http://onlinelibrary.wiley.com/doi/10.1162/1088198054084635/abstract>
- Higgs, D.A., B.S. Dosanjh, A.F. Prendergast, R.M. Beames, R.W. Hardy, W. Riley, and G. Deacon. (1995). Chapter 11. Use of rapeseed/canola protein products in finfish diets. In: D. Sessa and C. Lim (Eds.) AOCs monograph entitled "Nutrition and utilization technology in aquaculture", pg.130-156.
- Hischier, R., Weidema, B., Althaus, H.-jörg, Bauer, C., Doka, G., Dones, R., Frischknecht, R., et al. (2010). Implementation of Life Cycle Impact Assessment Methods. *ecoinvent report No. 3*. Dübendorf.
- Hoekstra, A. Y., Chapagain, A. K., Aldaya, M. M., & Mekonnen, M. M. (2011). *The Water Footprint Assessment Manual*. London: Earthscan. Water Footprint Network. Retrieved from <http://www.waterfootprint.org/downloads/TheWaterFootprintAssessmentManual.pdf>
- Horan, R. D., Fenichel, E. P., Drury, K. L. S., & Lodge, D. M. (2011). Managing ecological thresholds in coupled environmental-human systems. *Proceedings of the National Academy of Sciences of the United States of America*, 108(18), 7333–8. doi:10.1073/pnas.1005431108
- Hornborg, S., Emanuelsson, A., Sonesson, U., & Ziegler, F. (2012b). D.1.3b: By-catch methods in Life Cycle Assessment of seafood products. Public consultation (pp. 1–6). LC-IMPACT.
- Hornborg, S. (2012). Evaluating Fisheries Management from a Life Cycle Perspective with New Approaches to By-catch Impacts. Licentiate thesis. University of Gothenburg.

- Hornborg, S., Belgrano, A., Bartolino, V., Valentinsson, D., & Ziegler, F. (2013). Trophic indicators in fisheries: a call for re-evaluation. *Biology Letters*, 9(20121050). doi:<http://dx.doi.org/10.1098/rsbl.2012.1050>
- Hornborg, S., Nilsson, P., Valentinsson, D., & Ziegler, F., (2012a). Integrated environmental assessment of fisheries management: Swedish Nephrops trawl fisheries evaluated using a life cycle approach. *Mar. Pol.*, 36(6), 1–9.
- Howieson, J., & Lawley, M. (2010). Implementing Whole of Chain Analyses for the Seafood Industry: A Toolbox Approach. In P. Ballantine & J. Finsterwalder (Eds.), *Australian and New Zealand Marketing Academy (ANZMAC) Annual Conference 2010*, Nov 29 2010 (pp. 1-8). Christchurch, New Zealand: University of Canterbury.
- Huijbregts, M. A. J. (1998a). Application of Uncertainty and Variability in LCA Part II: Dealing with Parameter Uncertainty and Uncertainty due to Choices in Life Cycle Assessment. *The International Journal of Life Cycle Assessment*, 3(1), 343–351.
- Huijbregts, M. A. J. (1998b). Uncertainty in LCA LCA Methodology Application of Uncertainty and Variability in LCA Part I: A General Framework for the Analysis of Uncertainty and Variability in Life Cycle Assessment. *The International Journal of Life Cycle Assessment*, 3(5), 273–280.
- Huijbregts, M. a. J., Hellweg, S., Frischknecht, R., Hungerbühler, K., & Hendriks, a. J. (2008). Ecological footprint accounting in the life cycle assessment of products. *Ecological Economics*, 64(4), 798–807. doi:10.1016/j.ecolecon.2007.04.017
- Hung, M.-L., & Ma, H. (2008). Quantifying system uncertainty of life cycle assessment based on Monte Carlo simulation. *The International Journal of Life Cycle Assessment*, 14(1), 19–27. doi:10.1007/s11367-008-0034-8
- Hunkeler, D., Swarr, T., Klöpffer, W., Pesonen, H-L., Citroth, A., Brent, A., Pagan, B. (Eds). (2011). *Environmental life-cycle costing: a SETAC code of practice*. Society of Environmental Chemistry and Toxicology. SETAC Press.
- Huppes, G., van Rooijen, M., Kleijn, R., Heijungs, R., de Koning, A., & van Oers, L. (2004). Life cycle costing and the environment. CML, Leiden University. Retrieved from [http://www.rivm.nl/milieuportaal/images/Report\\_LCC\\_April\\_2004\\_final.pdf](http://www.rivm.nl/milieuportaal/images/Report_LCC_April_2004_final.pdf)
- Hurtado, N. (2005a). La tilapia en el Perú (Tilapia in Peru) (p. 25). Lima: NH Ingenieros Consultores. Retrieved from [http://www.revistaaquatic.com/documentos/docs/nh\\_tilapiaperu.pdf](http://www.revistaaquatic.com/documentos/docs/nh_tilapiaperu.pdf)
- Hurtado, N. (2005b). Tilapia: La alternativa social y económica del tercer milenio (Tilapia: The social and economic alternative of the third millenium) (pp. 1–127). Retrieved from <http://www.revistaaquatic.com/documentos/doc.asp?c=23>
- Huysveld, S., Schaubroeck, T., De Meester, S., Sorgeloos, P., Van Langenhove, H., Van linden, V., & Dewulf, J. (2013). Resource use analysis of Pangasius aquaculture in the Mekong Delta in Vietnam using Exergetic Life Cycle Assessment. *Journal of Cleaner Production*. doi:10.1016/j.jclepro.2013.01.024
- ICHEM. (2002). *The Sustainability Metrics. Sustainable Development Progress Metrics recommended for use in the Process Industries*. Sustainable Development Working Group of The Institution of Chemical Engineers.
- IEA. (2007). *Biomass for Power Generation and CHP*, International Energy Agency, IEA Energy Technology Essentials.
- IFFO. (2009). *The production of fishmeal and fish oil from Peruvian anchovy. datasheet* (pp. 1–10). International Fishmeal and Fish Oil Organisation.
- IFFO. (2012). International Fishmeal and Fish Oil Organisation. Retrieved from <http://www.iffonet/>

- IFPRI. (2006). The Challenge of Hunger. Global Hunger Index: Facts, determinants and trends. Bonn / Washington: International Food Policy Research Institute (IFPRI) and Deutsche Welthungerhilfe (DWHH). Retrieved from <http://www.ifpri.org/sites/default/files/publications/ghi06.pdf>
- IFPRI. (2012). 2012 Global hunger index: the challenge of hunger: Ensuring sustainable food security under land, water, and energy stresses. Bonn / Washington, DC / Dublin: International Food Policy Research Institute (IFPRI), Concern Worldwide and Welthungerhilfe and Green Scenery. Retrieved from <http://www.ifpri.org/sites/default/files/publications/ghi12.pdf>
- li, G., & Zhang, R. (2008). The Formation of Ecological Supply Chain Based on By-Product Exchange. IEEE International Conference on Service Operations and Logistics, and Informatics, 2008. (Vol. 1, pp. 1433-1438). Beijing: Institute of Electrical and Electronics Engineers. Retrieved from [http://ieeexplore.ieee.org/xpls/abs\\_all.jsp?arnumber=4686626](http://ieeexplore.ieee.org/xpls/abs_all.jsp?arnumber=4686626)
- ILCD. (2010). ILCD Handbook: Analysing of existing Environmental Impact Assessment methodologies for use in Life Cycle Assessment. European Commission, Joint Research Centre, Institute for Environment and Sustainability.
- ILCD. (2010). International Reference Life Cycle Data System (ILCD) Handbook: General guide for Life Cycle Assessment - Detailed guidance. European Commission - Joint Research Centre. Luxembourg, Publications Office of the European Union.
- Iles, A. (2007). Making the seafood industry more sustainable: creating production chain transparency and accountability. *Journal of Cleaner Production*, 15(6), 577-589. doi:10.1016/j.jclepro.2006.06.001
- IMARPE. (2009). Boletín Instituto del Mar del Perú. Informe del Tercer Panel Internacional de Expertos de Evaluación de la merluza peruana *Merluccius gayi peruanus* Ginsburg. Manejo Precautorio de la Merluza Peruana. Callao 24 – 28 de marzo 2008 (Vol. 24).
- IMARPE. (2010). Boletín Instituto del Mar del Perú. Quinto panel internacional de expertos en evaluación de la anchoveta peruana (*Engraulis ringens* Jenyns. Callao, 10 – 14 agosto 2009 (Vol. 25).
- IMARPE-ITP. (1996). Compendio Biológico-Tecnológico de las principales especies hidrobiológicas comerciales del Perú (Bio-technologic compendium of the main commercial hydrobiological species of Peru) (p. 146). Lima: Instituto del Mar del Perú and Instituto Tecnológico Pesquero del Perú.
- Indacochea, A. (Ed.). (2012). Libro de resúmenes digital. III CONCIMAR Congreso de Ciencias del Mar del Perú (p. 361). Retrieved from <http://concimarperu2012.com/>
- Ingram, J., Ericksen, P., & Liverman, D. (Eds.). (2010). Food security and global environmental change. London: earthscan. Retrieved from <http://www.publish.csiro.au/nid/21/pid/6702.htm>
- Ingwersen, W. W., & Stevenson, M. J. (2012). Can we compare the environmental performance of this product to that one? An update on the development of product category rules and future challenges toward alignment. *Journal of Cleaner Production*, 24, 102–108. doi:10.1016/j.jclepro.2011.10.040
- International Database of food composition. (2012). Retrieved from <http://composicionnutricional.com/alimentos/buscar.php>
- IPCC. (2006). 2006 IPCC Guidelines for National Greenhouse Gas Inventories, The Intergovernmental Panel on Climate Change (IPCC)
- ISO (2006d). ISO14064–1.Greenhouse gases—Part 1: Specificationwith guidance at the organization level for quantification and reporting of greenhouse gas emissions and removals. International Organization for Standardization, Geneva

- ISO (2006e). ISO 14064–3. Greenhouse gases—Part 3: Specification with guidance at the validation and verification of greenhouse gas assertions. International Organization for Standardization, Geneva
- ISO. (2006a). Environmental management - Life Cycle Assessment – Principles and Framework. EN ISO 14040. International Organisation for Standardisation.
- ISO. (2006b). Environmental management - Life Cycle Assessment - Requirements and Guidelines. EN ISO 14044.
- ISO. (2006c). Environmental labelling and declarations – Type III environmental declarations – Principles and procedures (ISO 14025:2006). International Organisation for Standardisation.
- ISO/WD (2010). TR 14069 working draft 2: Greenhouse gases (GHG)—Quantification and reporting of GHG emissions for organizations (Carbon footprint of organization)—Guidance for the application of ISO 14064–1, under development.
- ITP. (2007). Investigación y desarrollo de productos pesqueros: Fichas técnicas (Research and development of fishery products: Technical sheets). Lima: Instituto Tecnológico Pesquero del Perú. Retrieved from <http://www.itp.gob.pe/documentos/fichastecnicas2007.pdf>
- Jackson, A. (2009). Fish In-Fish Out Ratios explained. *Aquaculture Europe*, 34(3), 5-10. Retrieved from <http://www.iffonet.net/downloads/100.pdf>
- Jain, J., Dangayach, G., & Agarwal, G. (2010). Supply Chain Management: Literature Review and Some Issues. *Journal of Studies on Manufacturing*, 1(1), 11-25. Retrieved from <http://www.hypersciences.org/JSM/lss.1-2010/JSM-2-1-2010.pdf>
- Janssen, M., & van den Bergh, J. (1999). SIMBIOSES: Modelling industrial metabolism in a multi-regional economic system. *Materials Use and Spatial Scales in Industrial Metabolism*. Amsterdam: Department of Spatial Economics, Free University Amsterdam. Retrieved from <http://www.tinbergen.nl/discussionpapers/99060.pdf>
- Jensen, T. K., Nielsen, J., Larsen, E. P., & Clausen, J. (2010). The Fish Industry—Toward Supply Chain Modeling. *Journal of Aquatic Food Product Technology*, 19(3-4), 214-226. doi:10.1080/10498850.2010.508964
- Jeong, H. C., Kim, G. Y., Lee, J. T., Roh, K. A., Shim, K. M., & Lee, D. B. (2009). Estimation of Carbon Fixation Capacity in Major Crops of Korea. *The 9th International Conference of The East and Southeast Asia Federation of Soil Science Societies* (pp. 669–670).
- Jeswani, H. K., Azapagic, A., Schepelmann, P., & Ritthoff, M. (2010). Options for broadening and deepening the LCA approaches. *Journal of Cleaner Production*, 18(2), 120-127. Elsevier Ltd. doi:10.1016/j.jclepro.2009.09.023
- Jiménez-Montealegre, R., Avnimelech, Y., Verreth, J. A. J., & Verdegem, M. C. J. (2005). Nitrogen budget and fluxes in *Colossoma macropomum* ponds. *Aquaculture Research*, 36(1), 8–15. Retrieved from <http://onlinelibrary.wiley.com/doi/10.1111/j.1365-2109.2004.01174.x/full>
- Jørgensen, A., Le Bocq, A., Nazarkina, L., & Hauschild, M. (2008). Methodologies for social life cycle assessment. *The International Journal of Life Cycle Assessment*, 13(2), 96–103. doi:10.1065/lca2007.11.367
- Jungbluth, N., Chudacoff, M., Dauriat, A., Dinkel, F., Doka, G., Emmenegger, M. F., Gnansounou, E., et al. (2007). *Life Cycle Inventories of Bioenergy*.ecoinvent report No. 17. Dübendorf.
- Kaiser, M.J. and Jennings S. (2002). Ecosystem effects of fishing. In J. D. Reynolds and P. J. B. Hart (Eds.), *Handbook of Fish Biology and Fisheries - Volume 2 Fisheries*. Blackwell Publishing.
- Kasi, V. (2005). Systemic Assessment of SCOR for Modeling Supply Chains. *Proceedings of the 38th Annual Hawaii International Conference on System Sciences* (p. 87b-87b). doi:10.1109/HICSS.2005.574



- Kaushik, S., & Troell, M. (2010). Taking the fish-in fish-out ratio a step further. *Aquaculture Europe*, 35(March), 15-17.
- Kavanagh, P., Newlands, N., Christensen, V., & Pauly, D. (2004). Automated parameter optimization for Ecopath ecosystem models. *Ecological Modelling*, 172(2-4), 141–149. doi:10.1016/j.ecolmodel.2003.09.004
- Keeble, J. J., Topiol, S., & Berkeley, S. (2003). Using Indicators to Measure Sustainability Performance at a Corporate and Project Level. *Journal of Business Ethics*, (44), 149-158.
- Keramati, A. A. (2010). Supply chain integration: A modelling classification. Eighth Annual International Symposium on Supply Chain Management. SCMP - Supply Chain Management Professional. Retrieved from <http://amir-keramati.com/so/SympoCanadfinal version.pdf>
- Keramati, A. A., & Eldabi, T. (2011). Supply Chain Integration : Modelling Approach. In A. Ghoneim, M. Themistocleous, D. Koufopoulos, & M. Kamal (Eds.), *Online Proceedings of the 8th European, Mediterranean & Middle Eastern Conference on Information Systems (EMCIS)* (Vol. 2011, pp. 75-85). Athens. Retrieved from <http://www.iseing.org/emcis/EMCISWebsite/EMCIS2011 Proceedings/SCM8.pdf>
- Khan, A. (2009). A fish chain analysis of Northern Gulf Cod recovery options: exploring EwE modeling approaches for policy scenarios. In: Palomares, M. L. D., Morissette, L., Cisneros-Montemayor, A., Varkey, D., Coll, M., & Piroddi, C. (Eds.). *Ecopath 25 Years Conference Proceedings: Extended Abstracts*. Fisheries Centre Research Reports (Vol. 17). Vancouver: Fisheries Centre, University of British Columbia.
- Kim, C.-seop, Tannock, J., Byrne, M., Farr, R., Cao, B., & Er, M. (2004). State of the art review: Techniques to model supply chain in an extended enterprise. VIVACE WP2.5/UNOTT/T/04021-1.0 (pp. 1-69).
- Kim, Y., Mosier, N. S., Hendrickson, R., Ezeji, T., Blaschek, H., Dien, B., Cotta, M., et al. (2008). Composition of corn dry-grind ethanol by-products: DDGS, wet cake, and thin stillage. *Bioresource technology*, 99(12), 5165–76. doi:10.1016/j.biortech.2007.09.028
- Kleijnen, J. (2005). Supply chain simulation tools and techniques: a survey. *International Journal of Simulation and Process*, 1(1/2), 82-89. Retrieved from <http://inderscience.metapress.com/index/NAR9RN3062RQ7A30.pdf>
- Klöpffer, W. (2008). Life cycle sustainability assessment of products. *The International Journal of Life Cycle Assessment*, 13(2), 89-95. doi:10.1065/lca2008.02.376
- Klöpffer, W., & Ciroth, A. (2011). Is LCC relevant in a sustainability assessment? *The International Journal of Life Cycle Assessment*, 16(2), 99-101. doi:10.1007/s11367-011-0249-y
- Korhonen, J. (2004). Industrial ecology in the strategic sustainable development model: strategic applications of industrial ecology. *Journal of Cleaner Production*, 12(8-10), 809-823. doi:10.1016/j.jclepro.2004.02.026
- Kristófersson, D., & Anderson, J. (2006). Is there a relationship between fisheries and farming? Interdependence of fisheries, animal production and aquaculture. *Marine Policy*, 30(6), 721-725. doi:10.1016/j.marpol.2005.11.004
- Kruse, S., Flysjö, A., Kasperczyk, N., & Scholz, A. J. (2008). Socioeconomic indicators as a complement to life cycle assessment—an application to salmon production systems. *The International Journal of Life Cycle Assessment*, 14(1), 8-18. doi:10.1007/s11367-008-0040-x
- Kytzia, S., Faist, M., & Baccini, P. (2004). Economically extended—MFA: a material flow approach for a better understanding of food production chain. *Journal of Cleaner Production*, 12(8-10), 877–889. doi:10.1016/j.jclepro.2004.02.004
- Labuschagne, C., Brent, A. C., & van Erck, R. P. G. (2005). Assessing the sustainability performances of industries. *Journal of Cleaner Production*, 13(4), 373-385. doi:10.1016/j.jclepro.2003.10.007

- Lagarde, V., & Macombe, C. (2011). Taking into account the social effects of competition between products— example of Croatian pig industries (Presentation). In Macombe, C., Feschet, P., Garrabé, M., & Loeillet, D. (2011). 2nd International Seminar in Social Life Cycle Assessment—recent developments in assessing the social impacts of product life cycles. *The International Journal of Life Cycle Assessment*, 16(9), 940-943. doi:10.1007/s11367-011-0331-5
- Landa, Y. (2012). La pesca de la anchoveta, el óptimo social y el desarrollo sostenible del sector (Anchoveta fishery, the social optimum and sustainable development of the fishery sector). PhD Dissertation. Universidad Nacional Agrícola La Molina (UNALM) - Universidad Nacional Autónoma de México (UNAM).
- Langlois J, Fréon P, Delgenes J-P, Steyer J-P, & Hélias A (2014) New methods for impact assessment of biotic-resource depletion in LCA of fishery: theory and application. *J Clean Prod*. doi:10.1016/j.jclepro.2014.01.087
- Langlois, J., Fréon P., Delgenes, J-P, Steyer, J-P, Hélias, A. (2012). Biotic resources extraction impact assessment in LCA of fisheries. in: Corson, M.S., van der Werf, H.M.G. (Eds.), *Proceedings of the 8th International Conference on Life Cycle Assessment in the Agri-Food Sector (LCA Food 2012)*, 1-4 October 2012, Saint Malo, France. INRA, Rennes, France, p. 517-523.
- Langlois, J., Hélias, A., Delgenes, J.-P., Steyer, J.-P., (2011). Review on land use considerations in life cycle assessment: methodological perspectives for marine ecosystems, in: Finkbeiner, M. (Ed.), *Towards Life Cycle Sustainability Management*, Chapter 9, Springer, Dordrecht, 85-96.
- Larkin, S. L., Alvarez, S., Sylvia, G., & Harte, M. (2011). *Practical Considerations in Using Bio-economic Modelling for Rebuilding Fisheries*. OECD Food, Agriculture and Fisheries Working Papers, No. 38. OECD Publishing.
- Lavassani, K. M., & Movahedi, B. (2010). Critical Analysis of the Supply Chain Management Theories: Toward the Stakeholder Theory. POMS 21st Annual Conference. Vancouver: Production and Operation Management Society. Retrieved from <http://www.pomsmeetings.org/ConfProceedings/015/FullPapers/015-0545.pdf>
- Lehodey, P., Chai, F. E. I., & Hampton, J. (2003). Modelling climate-related variability of tuna populations from a coupled ocean – biogeochemical-populations dynamics model, (November 2002), 483-494.
- Leroy, Y., & Lasvaux, S. (2013). De la gestion des incertitudes en analyse de cycle de vie. *Marché et organisations*, 17(1), 65. doi:10.3917/maorg.017.0065
- Levin, S. (1992). The problem of pattern and scale in ecology. *Ecology*, 6(73), 1943–1967.
- Libralato, Coll, M., Tudela, S., Palomera, I. Pranovi, F., (2008). Novel index for quantification of Ecosystem Effects of Fishing as removal of secondary production. *Marine Ecology Progress Series* 355, 107–129.
- Link, J. (2002). Ecological considerations in fisheries management: when does it matter? *Fisheries*, 27(4).
- Linnane, A., Ball, B., Munday, B., van Marlen, B., Bergman, M., Fonteyne, R., et al., (2000). A review of potential techniques to reduce the environmental impact of demersal trawls. *Irish Fisheries Investigations. Series B (Marine)*, 7, 39 pp.
- Lloyd, S., & Ries, R. (2007). Characterizing, Propagating, and Analyzing Uncertainty in Life-Cycle Assessment: A Survey of Quantitative Approaches. *Journal of Industrial Ecology*, 11(1), 161–179.
- Lochmann, R., Chen, R., Chu-Koo, F., Camargo, W., & Kohler, C. (2009). Effects of Carbohydrate-Rich Alternative Feedstuffs on Growth, Survival, Body Composition, Hematology, and Nonspecific Immune Response of Black Pacu, *Colossoma macropomum*, and Red Pacu, *Piaractus brachipomus*. *Journal of the World Aquaculture Society*, 40(1), 33–44. Retrieved from <http://ukpmc.ac.uk/abstract/AGR/IND44153309>

- Luna, M. (2008). Instalación de una piscigranja en Tocache, San Martín (Setting up of a pond farm in Tocache, San Martín). Licentiate thesis. Universidad Nacional Agraria La Molina, Lima (Perú). Facultad de Zootecnia. Departamento de Producción Animal.
- Mai, N., Bogason, S. G., Arason, S., Árnason, S. V., & Matthíasson, T. G. (2010). Benefits of traceability in fish supply chains – case studies. *British Food Journal*, 112(9), 976-1002. doi:10.1108/00070701011074354
- Mancini, L., Lettenmeier, M., Rohn, H., & Liedtke, C. (2012). Application of the MIPS method for assessing the sustainability of production–consumption systems of food. *Journal of Economic Behavior & Organization*, (81), 779-793. doi:10.1016/j.jebo.2010.12.023
- Maradiague, R., Farro, E., Escala, J., & Yi, D. (2005). Planeamiento estratégico para la producción y comercialización de tilapias (Strategic planning for production and commercialisation of tilapia). Masters Thesis. Retrieved from <http://tesis.pucp.edu.pe/repositorio/handle/123456789/1673>
- McKinsey & Company. (2012). TOWARDS THE CIRCULAR ECONOMY. Economic and business rationale for an accelerated transition. The Ellen MacArthur Foundation. Retrieved from <http://www.thecirculareconomy.org/>
- McMichael, P. (2011). Food system sustainability: Questions of environmental governance in the new world (dis)order. *Global Environmental Change*, 21(3), 804-812. doi:10.1016/j.gloenvcha.2011.03.016
- Meisterling, K. W. (2011). Climate implications of biomass appropriation: Integrating bioenergy and animal feeding systems. PhD Dissertation. Carnegie Mellon University. Retrieved from <http://repository.cmu.edu/dissertations/27>
- Mendieta, O. W., & Medina, M. L. (1993). Salado y secado solar de tilapia (*Oreochromis sp*) en la región de San Martín. Salting and solar drying of tilapia (*Oreochromis sp*) in the San Martín region. *Folia Amazónica*, 5(1-2), 117–127.
- Mendoza, D. (2011). Panorama de la acuicultura mundial, América Latina y el Caribe y en el Perú. Lima: Dirección de Acuicultura, Ministerio de la Producción - PRODUCE. Retrieved from [http://www.racua.org/uploads/media/informe\\_acuicultura\\_mundo\\_al\\_peru.pdf](http://www.racua.org/uploads/media/informe_acuicultura_mundo_al_peru.pdf)
- Mendoza, D. (2013). Situación del extensionismo acuícola en el Perú (Situation of aquacultural extensionism in Peru). Report for Red de Acuicultura de las Américas (RAA) and FAO. Lima: Dirección de Acuicultura, Ministerio de la Producción - PRODUCE.
- Milà i Canals, L., Romanya, J., Cowell, S., (2007). Method for assessing impacts on life support functions (LSF) related to the use of “fertile land” in Life Cycle Assessment (LCA). *J. Clean. Prod.*, 15(15), 1426–1440.
- Min, H., & Zhou, G. (2002). Supply chain modeling: past, present and future. *Computers & Industrial Engineering*, 43(1-2), 231-249. doi:10.1016/S0360-8352(02)00066-9
- Miro, O., Jiménez, R., & Alarcón, J. (2009). Acondicionamiento tecnológico de embarcaciones pesqueras artesanales sobre la captura y manipuleo de la anchoveta peruana (*Engraulis ringens*) para el consumo humano directo en la zona de El Callao. Congreso Nacional de Ingeniería Pesquera - CONIP 2009 (pp. 1–47). Callao.
- Mitchell, C., & Cleveland, C. J. (1993). Resource scarcity, energy use and environmental impact: a case study of the New Bedford, Massachusetts, USA, fisheries. *Environmental management*, 17(3), 305–317. Springer. Retrieved from <http://www.springerlink.com/index/730q152563511305.pdf>
- Mogensen, L., Hermansen, J. E., Halberg, N., Dalgaard, R., Vis, J. C., & Smith, B. G. (2009). Life cycle assessment across the food supply chain. In C. J. Baldwin (Ed.), *Sustainability in the food industry* (pp. 115-144). IFT Press. Wiley-Blackwell. Retrieved from <http://orgprints.org/15610/>

- Morissette, L. (2005). Addressing uncertainty in marine ecosystems modelling. In E. Levner, I. Linkov, & J.-M. Proth (Eds.), *Strategic Management of Marine Ecosystems* (pp. 127–142). Nice: Proceedings of the NATO Advanced Study Institute on Strategic Management of Marine Ecosystems: NATO Science Series.
- MSC. (2010). *MSC Fishery Standard: Principles and Criteria for Sustainable Fishing* (pp. 1–8). Marine Stewardship Council.
- MUFV. (2008). *The Circular Economy State of Rhineland-Palatinate*. Ministry of the Environment, Forests and Consumer Protection Rhineland-Palatinate (MUFV), Mainz and Ministry for the Economy, Commerce, Agriculture and Viticulture (MWVLW), Rhineland-Palatinate. Mainz, January 2008. Retrieved from [http://www.mulewf.rlp.de/fileadmin/mufv/publikationen/Kreislaufwirtschaftsland\\_englisch.pdf](http://www.mulewf.rlp.de/fileadmin/mufv/publikationen/Kreislaufwirtschaftsland_englisch.pdf)
- Muir, J. F. (2013). Fish, feeds, and food security. *Animal Frontiers*, 3(1), 28–34. doi:10.2527/af.2013-0005
- Müller, K., & Sturm, A. (2001). Standardized Eco-Efficiency Indicators. Ellipson A.G. Retrieved from [http://www.ellipson.com/files/studies/EcoEfficiency\\_Indicators\\_e.pdf](http://www.ellipson.com/files/studies/EcoEfficiency_Indicators_e.pdf)
- Nakagawa, H., Harada, T., & Ichinose, T. (2008). Biomethanol Production from Various Forms of Biomass: Utilization of Forage Grasses, Trees, and Crop Residues. *International Workshop on Sustainable Utilization of Biomass and other Organic Wastes as Renewable Energy Sources and for Agricultural and Industrial Uses in the ASPAC Region* (pp. 1–11). Tagaytay, Philippines. Retrieved from [http://en.fftc.org.tw/htmlarea\\_file/library/20110725161023/eb618.pdf](http://en.fftc.org.tw/htmlarea_file/library/20110725161023/eb618.pdf)
- Nankervis, L., Matthews, S. J., & Appleford, P. (2000). Effect of dietary non-protein energy source on growth, nutrient retention and circulating insulin-like growth factor I and triiodothyronine levels in juvenile barramundi, *Lates calcarifer*. *Marine Biology*, 323–335.
- Natale, F., Hofherr, J., Fiore, G., & Virtanen, J. (2012). Interactions between aquaculture and fisheries. *Marine Policy*, 1–9. doi:10.1016/j.marpol.2012.05.037
- Naylor, R., & Burke, M. (2005). Aquaculture and ocean resources: Raising Tigers of the Sea. *Annual Review of Environment and Resources*, 30(1), 185-218. doi:10.1146/annurev.energy.30.081804.121034
- Naylor, R., Goldberg, R. J., Primavera, J. H., Kautsky, N., Beveridge, M., Clay, J., Folke, C., et al. (2000). Effect of aquaculture on world fish supplies. *Nature*, 405(6790), 1017-24. doi:10.1038/35016500
- Naylor, R., Hardy, R. W., Bureau, D. P., Chiu, A., Elliott, M., Farrell, A. P., Forster, I., et al. (2009). Feeding aquaculture in an era of finite resources. *Proceedings of the National Academy of Sciences of the United States of America*, 106(36), 15103-10. doi:10.1073/pnas.0905235106
- Nellemann, C., MacDevette, M., Manders, T., Eickhout, B., Svihus, B., Prins, A. G., Kaltenborn, B. P. (Eds.). (2009). *The environmental food crisis: the environment's role in averting future food crises: a UNEP rapid response assessment*. Retrieved from <http://www.grida.no/publications/rr/food-crisis/>
- Ness, B., Urbel-Piirsalu, E., Anderberg, S., & Olsson, L. (2007). Categorising tools for sustainability assessment. *Ecological Economics*, 60(3), 498-508. doi:10.1016/j.ecolecon.2006.07.023
- Nijdam, D., Rood, T., & Westhoek, H. (2012). The price of protein: Review of land use and carbon footprints from life cycle assessments of animal food products and their substitutes. *Food Policy*, 37(6), 760–770. doi:10.1016/j.foodpol.2012.08.002
- Nilsson, M., Nykvist, B., Varnäs, A., Siebert, C. K., & Ericsson, K. (2009). *A European Eco-Efficient Economy Governing climate, energy and competitiveness*. Report for the 2009 Swedish Presidency of the Council of the European Union. Stockholm Environment Institute.

- Nilsson, P., & Ziegler, F. (2007). Spatial distribution of fishing effort in relation to seafloor habitats in the Kattegat, a GIS analysis. *Aquatic Conservation: Marine and Freshwater Ecosystems*, 440(August 2006), 421-440. doi:10.1002/aqc.792
- Nordahl, P. G. (2011). Is the Aquaculture Industry Caught In a Fishmeal Trap? Masters Thesis. Norwegian School of Economics and Business Administration. Retrieved from [http://www.globefish.org/upl/Publications/Nordahl - Is the Aquaculture Industry Caught In a Fishmeal Trap \(internet\)\[1\].pdf](http://www.globefish.org/upl/Publications/Nordahl-Is%20the%20Aquaculture%20Industry%20Caught%20In%20a%20Fishmeal%20Trap%20(internet)[1].pdf)
- Norris, G. A. (2001). The requirement for congruence in normalization. *The International Journal of Life Cycle Assessment*, 6(2), 85–88. Retrieved from <http://www.springerlink.com/index/MG88513216M62538.pdf>
- NRC. (1993). *Nutrient Requirements of Fish*. Committee on Animal Nutrition, Board of Agriculture, National Research Council. National Academy Press, Washington D.C., USA.
- Oberkampf, W. L., DeLand, S. M., Rutherford, B. M., Diegert, K. V., & Alvin, K. F. (2002). Error and uncertainty in modeling and simulation. *Reliability Engineering & System Safety*, 75(3), 333–357. doi:10.1016/S0951-8320(01)00120-X
- Odum, H.T. (1996). *Environmental Accounting: EMERGY and Environmental Decision Making*. Wiley, New York, 370 pp.
- OECD. (2001). *OECD Environmental Indicators - Towards Sustainable Development*. Organisation for Economic Co-operation and Development.
- OECD. (2010). *The Economics of Adapting Fisheries to Climate Change*. Organisation for Economic Co-operation and Development. doi:10.1787/9789264090415-en
- Oishi, C. A., Nwanna, L. C., & Pereira Filho, M. (2010). Optimum dietary protein requirement for Amazonian Tambaqui, *Colossoma macropomum* Cuvier, 1818, fed fish meal free diets. *Acta Amazonica*, 40(4), 757–762. Retrieved from [http://www.scielo.br/scielo.php?pid=S0044-59672010000400017&script=sci\\_arttext](http://www.scielo.br/scielo.php?pid=S0044-59672010000400017&script=sci_arttext)
- Österblom, H., Merrie, A., Metian, M., Boonstra, W. J., Watson, J. R., Rykaczewski, R. R., ... Blenckner, T. (2013). Modeling Social–Ecological Scenarios in Marine Systems. *BioScience*, 63(9), 735–744. doi:10.1525/bio.2013.63.9.9
- Papatryphon, E., Petit, J., Kaushik, S., & van der Werf, H. M. G. (2004). Environmental impact assessment of salmonid feeds using Life Cycle Assessment (LCA). *Ambio*, 33(6), 316-23. Retrieved from <http://www.ncbi.nlm.nih.gov/pubmed/17526885>
- Paredes, C. (2010). Reformando el Sector de la Anchoveta Peruana: Progreso Reciente y Desafíos Futuros (Reform of the Peruvian anchoveta sector: Recent progress and challenges for the future). Instituto del Perú - Cuadernos de Investigación (pp. 1–23). Retrieved from [http://www.institutodelperu.org.pe/descargas/Publicaciones/DelInstitutedelPeru/DOC/contenido\\_carlos\\_paredes - reforma de la presqueria anchoveta peru.pdf](http://www.institutodelperu.org.pe/descargas/Publicaciones/DelInstitutedelPeru/DOC/contenido_carlos_paredes_-_reforma_de_la_presqueria_anchoveta_peru.pdf)
- Paredes, C. E., & Letona, Ú. (2013). Contra la corriente: La anchoveta peruana y los retos para su sostenibilidad (p. 76). Lima: World Wildlife Fund (WWF) and Universidad de San Martín de Porres (USMP). Retrieved from [http://awsassets.panda.org/downloads/anchoveta\\_version\\_final.pdf](http://awsassets.panda.org/downloads/anchoveta_version_final.pdf)
- Paredes, C., & Gutiérrez, M. E. (2008). La industria anchovetera Peruana: Costos y Beneficios. Un Análisis de su Evolución Reciente y de los Retos para el Futuro. Estudio preparado por encargo del Banco Mundial al Instituto del Perú de la Universidad de San Martín de Porres. Retrieved from [http://institutodelperu.org.pe/descargas/informe de la industria de anchoveta.pdf](http://institutodelperu.org.pe/descargas/informe_de_la_industria_de_anchoveta.pdf)

- Parfitt, J., Barthel, M., & Macnaughton, S. (2010). Food waste within food supply chains: quantification and potential for change to 2050. *Philosophical transactions of the Royal Society of London. Series B, Biological sciences*, 365(1554), 3065-81. doi:10.1098/rstb.2010.0126
- Parker, R. (2012). Review of life cycle assessment research on products derived from fisheries and aquaculture: A report for Seafish as part of the collective action to address greenhouse gas emissions in seafood. Final Report. Edinburgh: Sea Fish Industry Authority. Retrieved from [http://www.seafish.org/media/583639/seafish\\_lca\\_review\\_report\\_final.pdf](http://www.seafish.org/media/583639/seafish_lca_review_report_final.pdf)
- Parker, R. W. R., & Tyedmers, P. (2011). Uncertainty and natural variability in the ecological footprint of fisheries: A case study of reduction fisheries for meal and oil. *Ecological Indicators*, 16, 76–83. doi:10.1016/j.ecolind.2011.06.015
- Parkes, G., Young, J., Walmsley, S., Abel, R., Harman, J., Horvat, P., Lem, A., et al. (2010). Behind the Signs—A Global Review of Fish Sustainability Information Schemes. *Reviews in Fisheries Science*, 18(4), 344-356. doi:10.1080/10641262.2010.516374
- Pauly, D., & Christensen, V. (1995). Primary production required to sustain global fisheries. *NATURE*, 374(6519), 255-257.
- Pauly, D., Christensen, V., & Walters, C. (2000). Ecopath, Ecosim, and Ecospace as tools for evaluating ecosystem impact of fisheries. *ICES Journal of Marine Science*, 57(3), 697-706. doi:10.1006/jmsc.2000.0726
- Peacock, N., Camillis, C., Pennington, D., Aichinger, H., Parenti, A., Rennaud, J.-P., Raggi, A., et al. (2011). Towards a harmonised framework methodology for the environmental assessment of food and drink products. *The International Journal of Life Cycle Assessment*, 16(3), 189-197. doi:10.1007/s11367-011-0250-5
- Pelletier, N. (2006). Life cycle measures of biophysical sustainability in feed production for conventional and organic salmon aquaculture in the northeast Pacific. Masters Thesis. Dalhousie University. Retrieved from [http://www.fcrn.org.uk/researchLib/theses/Pelletier\\_LCAofSalmonFeed\\_Thesis.pdf](http://www.fcrn.org.uk/researchLib/theses/Pelletier_LCAofSalmonFeed_Thesis.pdf)
- Pelletier, N., & Tyedmers, P. (2008). Life cycle considerations for improving sustainability assessments in seafood awareness campaigns. *Environmental Management*, 42(5), 918-31. doi:10.1007/s00267-008-9148-9
- Pelletier, N., & Tyedmers, P. (2010). Life Cycle Assessment of Frozen Tilapia Fillets From Indonesian Lake-Based and Pond-Based Intensive Aquaculture Systems. *Journal of Industrial Ecology*, 14(3), 467–481. doi:10.1111/j.1530-9290.2010.00244.x
- Pelletier, N., & Tyedmers, P. (2011). An Ecological Economic Critique of the Use of Market Information in Life Cycle Assessment Research. *Journal of Industrial Ecology*, 15(3), 342–354. doi:10.1111/j.1530-9290.2011.00337.x
- Pelletier, N., Allacker, K., Pant, R., & Manfredi, S. (2013). The European Commission Organisation Environmental Footprint method: comparison with other methods, and rationales for key requirements. *The International Journal of Life Cycle Assessment*. doi:10.1007/s11367-013-0609-x
- Pelletier, N., Ayer, N., Tyedmers, P., Kruse, S., Flysjö, A., Robillard, G., Ziegler, F., et al., (2007). Impact categories for life cycle assessment research of seafood production systems: Review and prospectus. *Int. J. Life Cycle Ass.*, 8(1), 39-421.
- Pelletier, N., Tyedmers, P., Sonesson, U., Scholz, A. J., Ziegler, F., Flysjö, A., Kruse, S., et al. (2009). Not all salmon are created equal: life cycle assessment (LCA) of global salmon farming systems. *Environmental science & technology*, 43(23), 8730–6. doi:10.1021/es9010114
- Phillips, M. J., Enyuan, F., Gavine, F., Hooi, T. K., Kutty, M. N., Lopez, N. A., Mungkung, R., et al. (2009). Review of environmental impact assessment and monitoring in aquaculture in Asia-Pacific. In FAO. Environmental impact

- assessment and monitoring in aquaculture. FAO Fisheries and Aquaculture Technical Paper. No. 527 (pp. 153-283). Rome. Retrieved from <ftp://ftp.fao.org/docrep/fao/012/i0970e/i0970e01b.pdf>
- Pike, I. H., & Jackson, A. (2010). Fish oil: production and use now and in the future. *Lipid Technology*, 22(3), 59–61. doi:10.1002/lite.201000003
- Plagányi, É. E. (2007). Models for an ecosystem approach to fisheries. FAO Fisheries Technical Paper No. 477 (p. 108). Retrieved from <ftp://ftp.fao.org/docrep/fao/010/a1149e/a1149e.pdf>
- Porter, M. E. (1985). *Competitive Advantage: Creating and Sustaining Superior Performance*. Free Press.
- Power, A. (1999). Linking ecological sustainability and world food needs. *Environment, Development and Sustainability*, 1, 185-196. Retrieved from <http://www.springerlink.com/index/H6211R3816488154.pdf>
- Prellezo, R., Accadia, P., Andersen, J. L., Little, A., Nielsen, R., Andersen, B. S., Röckmann, C., et al. (2009). Survey of existing bioeconomic models. Final report. Studies and Pilot Projects for Carrying Out the Common Fisheries Policy No FISH/2007/07 Lot 5 (p. 283). Sukarrieta: AZTI-Tecnalia.
- PRODUCE. (2009). Plan Nacional de Desarrollo Acuícola (Aquaculture Development National Plan) (p. 85). Lima: Ministerio de la Producción. Retrieved from [http://portal.andina.com.pe/EDPFiles/EDPWEBPAGE\\_plan-acuicola.pdf](http://portal.andina.com.pe/EDPFiles/EDPWEBPAGE_plan-acuicola.pdf)
- PRODUCE. (2010). Anuario Estadístico 2010 - Sub sector Pesca. Lima: Ministerio de la Producción, Oficina General de Tecnología de la Información y Estadística.
- PRODUCE. (2012). Ministry of Production - Aquaculture statistics. Lima: Ministerio de la Producción. Retrieved from <http://www.produce.gob.pe/index.php/estadistica/acuicultura>
- PromAmazonia. (2009). Tecnología para la acuicultura amazonica (Technology for Amazonian aquaculture). Retrieved from <http://www.iiap.org.pe/promamazonia/SBiocomercio/Upload/Lineas/Documentos/528.pdf>
- PROMPERU. (2011). Desarrollo del comercio exterior pesquero en el peru 2011. Servicios al Exportador (pp. 1–26). Coordinación de Pesca y Acuicultura de la Subdirección de Promoción Comercial.
- Qiu, H., Zhu, W., Wang, H., & Cheng, X. (2007). Analysis and Design of Agricultural Sustainability Indicators System. *Agricultural Sciences in China*, 6(4), 475-486. doi:10.1016/S1671-2927(07)60072-8
- Raikes, P., Jensen, M. F., & Ponte, S. (2000). Global Commodity Chain Analysis and the French Filière Approach: Comparison and Critique. CDR Working Paper 00.3. Copenhagen: Centre for Development Research. Retrieved from <http://www.tandfonline.com/doi/abs/10.1080/03085140050084589>
- Rametsteiner, E., Pülzl, H., Alkan-Olsson, J., & Frederiksen, P. (2011). Sustainability indicator development— Science or political negotiation? *Ecological Indicators*, 11(1), 61-70. doi:10.1016/j.ecolind.2009.06.009
- Rana, K. J., Siriwardena, S., & Hasan, M. (2009). Impact of rising feed ingredient prices on aquafeeds and aquaculture production. FAO Fisheries and Aquaculture Technical Paper No. 541. Retrieved from <http://www.cabdirect.org/abstracts/20103269836.html>
- Reap, J., Roman, F., Duncan, S., & Bras, B. (2008a). A survey of unresolved problems in life cycle assessment - Part 1: goal and scope and inventory analysis. *The International Journal of Life Cycle Assessment*, 13(4), 290-300. doi:10.1007/s11367-008-0008-x
- Reap, J., Roman, F., Duncan, S., & Bras, B. (2008b). A survey of unresolved problems in life cycle assessment - Part 2: impact assessment and interpretation. *The International Journal of Life Cycle Assessment*, 13(5), 374-388. doi:10.1007/s11367-008-0009-9

- Rebaza, C., Valdivieso, M., Rebaza, M., & Chu-Koo, F. (2008). Análisis económico del cultivo de Gamitana (*Colossoma macropomum*) y Paco (*Piaractus brachyomus*) usando una dieta extrusada comercial en Ucayali (Economic analysis of the Gamitana (*Colossoma macropomum*) and Paco (*Piaractus brachyomus*) pond culture using. *Folia Amazónica*, 17(1-2), 7–13.
- Refsgaard, J. C., van der Sluijs, J. P., Højberg, A. L., & Vanrolleghem, P. a. (2007). Uncertainty in the environmental modelling process – A framework and guidance. *Environmental Modelling & Software*, 22(11), 1543–1556. doi:10.1016/j.envsoft.2007.02.004
- Reitinger, C., Dumke, M., Barosevic, M., & Hillerbrand, R. (2011). A conceptual framework for impact assessment within SLCA. *The International Journal of Life Cycle Assessment*, 16(4), 380-388. doi:10.1007/s11367-011-0265-y
- Rey-Valette, H., Clément, O., Aubin, J., Mathé, S., Chia, E., Legendre, M., Caruso, D., et al. (2008). Guide to the co-construction of sustainable development indicators in aquaculture. EVAD - Evaluation of aquaculture system sustainability - 2005-2008. Retrieved from [http://publications.cirad.fr/une\\_notice.php?dk=548450](http://publications.cirad.fr/une_notice.php?dk=548450)
- Rochat, D. (2004). Assessment of end-of-life scenarios for PET in Tunja, Colombia, using Material Flow Analysis (MFA), Life Cycle Assessment (LCA) and Multi-Attribute Utility Theory (MAUT). Licentiate thesis. École Polytechnique Fédérale de Lausanne, ETH-Zurich, UniBoyacá. Retrieved from [http://www.empa.ch/plugin/template/empa/\\*/59251/---/l=2](http://www.empa.ch/plugin/template/empa/*/59251/---/l=2)
- Rodríguez, D. A., Sulabo, R. C., González-Vega, J. C., & Stein, H. H. (2012). Energy concentration in canola, cottonseed, and sunflower products fed to growing pigs. Monogastric Nutrition Laboratory (unpublished data). Retrieved from <http://nutrition.ansci.illinois.edu/node/660>
- Rokovich, J. A. (2009). Estudios para el desarrollo de clusters en la actividad pesquera industrial y artesanal de anchoveta y pota - Informe final (Studies for cluster development for the industrial and artisanal fisheries for anchoveta and jumbo squid – Final report). Proyecto UE-PERU/PENX. Lima: ICON-INSTITUT GmbH.
- Rose, K. A., Allen, J. I., Artioli, Y., Barange, M., Blackford, J., Carlotti, F., Cropp, R., et al. (2010). End-To-End Models for the Analysis of Marine Ecosystems: Challenges, Issues, and Next Steps. *Marine and Coastal Fisheries: Dynamics, Management, and Ecosystem Science*, 2, 115-130. doi:10.1577/C09-059.1
- Rosenbaum, R. K., Bachmann, T. M., Gold, L. S., Huijbregts, M. a. J., Jolliet, O., Juraske, R., Koehler, A., et al. (2008). USEtox—the UNEP-SETAC toxicity model: recommended characterisation factors for human toxicity and freshwater ecotoxicity in life cycle impact assessment. *The International Journal of Life Cycle Assessment*, 13(7), 532-546. doi:10.1007/s11367-008-0038-4
- Rosillo Callé, F.(Ed.) (2007). *The biomass assessment handbook: bioenergy for a sustainable environment*. London: Earthscan.
- Rothschild, W.E. (1984). Surprise and the competitive advantage. *Journal of Business Strategy*, Vol. 4 Iss: 3, pp.10–18. doi: 10.1108/eb039028
- Roy, C. J., & Oberkampf, W. L. (2011). A comprehensive framework for verification, validation, and uncertainty quantification in scientific computing. *Computer Methods in Applied Mechanics and Engineering*, 200(25-28), 2131–2144. doi:10.1016/j.cma.2011.03.016
- Roy, P., Nei, D., Orikasa, T., Xu, Q., Okadome, H., Nakamura, N., & Shiina, T. (2009). A review of life cycle assessment (LCA) on some food products. *Journal of Food Engineering*, 90(1), 1-10. doi:10.1016/j.jfoodeng.2008.06.016
- RSPB. (2004). Assessment of the sustainability of industrial fisheries producing fish meal and fish oil. Final report to the Royal Society for the Protection of Birds (RSPB) by Poseidon Aquatic Resource Management Ltd and The



- University of Newcastle-upon-Tyne. Retrieved from [http://www.rspb.org.uk/Images/fishmeal\\_tcm9-132911.pdf](http://www.rspb.org.uk/Images/fishmeal_tcm9-132911.pdf)
- Rugani, B., Panasiuk, D., & Benetto, E. (2012). An input–output based framework to evaluate human labour in life cycle assessment. *The International Journal of Life Cycle Assessment*, 17(6), 795–812. doi:10.1007/s11367-012-0403-1
- Ruiz, L. (2013). Estado de la acuicultura en el Perú (Status of aquaculture in Peru). *Revista AquaTIC*, (37), 99–106. Retrieved from <http://www.revistaaquatic.com/aquatic/art.asp?t=p&c=280>
- Salvatteci, R., & Mendo, J. (2005). Estimación de las pérdidas bio-económicas causadas por la captura de juveniles de anchoveta (*Engraulis ringens*, J.) en la costa peruana (Estimation of bio-economic losses caused by the capture of juvenile anchovy (*Engraulis ringens*, J.) in the Peruvian co. *Ecología Aplicada*, 4(12), 2–9. Retrieved from <http://www.scielo.org.pe/pdf/ecol/v4n1-2/a15v4n1-2.pdf>
- Samuel-Fitwi, B., Wuertz, S., Schroeder, J. P., & Schulz, C. (2012). Sustainability assessment tools to support aquaculture development. *Journal of Cleaner Production*. doi:10.1016/j.jclepro.2012.03.037
- Sauvant, D., Perez J.M. and Tran G. (2004). Tables of composition and nutritional value of feed materials: pigs, poultry, cattle, sheep, goats, rabbits, horses, fish. Wageningen Academic Publishers, Wageningen and INRA Editions, Versailles.
- SCC. (2010). Supply Chain Operations Reference (SCOR<sup>®</sup>) model - Overview - Version 10.0 (pp. 0-23). Supply Chain Council.
- Schau, E. M. (2006). Product Category Rules (PCR) for preparing an Environmental Product Declaration (EPD) for Product Group Wild caught fish - Draft. ISO/DIS 14025 Environmental Declarations Type III (pp. 1–8). Oslo, EPD Foundation Norway. Retrieved from <http://pcr-library.edf.org.tw/data/norway/NPCR07FishEN.pdf>
- Schau, E. M. (2012). Environmental life cycle assessments of fish food products with emphasis on the fish catch process. PhD Dissertation. Norwegian University of Science and Technology. Retrieved from <http://ntnu.diva-portal.org/smash/get/diva2:490795/FULLTEXT02>
- Schau, E., & Fet, A. (2008). LCA studies of food products as background for environmental product declarations. *The International Journal of Life Cycle Assessment*, 13(3), 255–264. Retrieved from <http://www.springerlink.com/index/816220076U1V8555.pdf>
- Schepelmann, P., Ritthoff, M., Jeswani, H., Azapagic, A., & Suomalainen, K. (2009). Options for Deepened and Broadened LCA. CALCAS: Co-ordination Action for innovation in Life-Cycle Analysis for Sustainability.
- Schlüter, M., Mcallister, R., Arlinghaus, R., Bunnefeld, N., Eisenack, K., Hölker, F., Milner-Gulland, E., et al. (2012). New horizons for managing the environment: A review of coupled social-ecological systems modeling. *Natural Resource Modeling*, 25(1), 219–272. doi:10.1111/j.1939-7445.2011.00108.x
- Schmidheiny, S. with the Business Council for Sustainable Development. (1992). *Changing Course: A Global Business Perspective on Development and the Environment*. Cambridge: MIT Press.
- Schmidt, J. H. (2008). System delimitation in agricultural consequential LCA. *The International Journal of Life Cycle Assessment*, 13(4), 350–364. doi:10.1007/s11367-008-0016-x
- Schneider, O., Amirkolaie, A. K., Vera-Cartas, J., Eding, E. H., Schrama, J. W., & Verreth, J. a J. (2004). Digestibility, faeces recovery, and related carbon, nitrogen and phosphorus balances of five feed ingredients evaluated as fishmeal alternatives in Nile tilapia, *Oreochromis niloticus* L. *Aquaculture Research*, 35(14), 1370–1379. doi:10.1111/j.1365-2109.2004.01179.x

- Searcy, C. (2009). *The Role of Sustainable Development Indicators in Corporate Decision-making* (Vol. 1). Winnipeg: International Institute for Sustainable Development.
- Seijo, J., & Caddy, J. (2000). Uncertainty in bio-economic reference points and indicators of marine fisheries. *Marine and Freshwater Research*, 51, 477–483.
- Seung, C., & Zhang, C. I. (2011). Developing socioeconomic indicators for fisheries off Alaska: A multi-attribute utility function approach. *Fisheries Research*. Elsevier B.V. doi:10.1016/j.fishres.2011.04.004
- Seuring, S. (2011). Supply Chain Management for Sustainable Products – Insights From Research Applying Mixed Methodologies. *Business Strategy and the Environment*, 20(7), 471–484. doi:10.1002/bse.702
- Shapiro, J. F. (2000). Supply chain management, integrated planning, and models. *Modelling the supply chain* (pp. 1-42). Cengage Learning.
- Shin, Y.-J., & Cury, P. (2001). Exploring fish community dynamics through size-dependent trophic interactions using a spatialized individual-based model. *Aquatic Living Resources*, 14(2), 65–80. Elsevier. Retrieved from <http://linkinghub.elsevier.com/retrieve/pii/S0990744001011068>
- Shin, Y.-J., Shannon, L. J., Bundy, A., Coll, M., Aydin, K., Bez, N., ... Cury, P. M. (2010). Using indicators for evaluating, comparing, and communicating the ecological status of exploited marine ecosystems. 2. Setting the scene. *ICES Journal of Marine Science*, 67(4), 692–716. doi:10.1093/icesjms/fsp294
- Singh, R., Murty, H., Gupta, S., & Dikshit, A. (2009). An overview of sustainability assessment methodologies. *Ecological Indicators*, 9(2), 189-212. doi:10.1016/j.ecolind.2008.05.011
- Sklan, D., Prag, T., & Lupatsch, I. (2004). Apparent digestibility coefficients of feed ingredients and their prediction in diets for tilapia *Oreochromis niloticus* x *Oreochromis aureus* (Teleostei, Cichlidae). *Aquaculture Research*, 35(1993), 358–364.
- Sleeswijk, A. W. (2010, July). *Regional LCA in a global perspective. A basis for spatially differentiated environmental life cycle assessment*. PhD Dissertation. Leiden University. Retrieved from <http://www.ncbi.nlm.nih.gov/pubmed/21612904>
- Sleeswijk, A. W., van Oers, L., Guinée, J., Struijs, J., & Huijbregts, M. (2008). Normalisation in product life cycle assessment: an LCA of the global and European economic systems in the year 2000. *Science of the Total Environment*, 390(1), 227-40. doi:10.1016/j.scitotenv.2007.09.040
- Smeets, E., & Weterings, R. (1999). *Environmental indicators: Typology and overview*. Technical report No 25. Copenhagen: European Environment Agency. Retrieved from [http://www.geogr.uni-jena.de/fileadmin/Geoinformatik/projekte/brahmatwinn/Workshops/FEEM/Indicators/EEA\\_tech\\_rep\\_25\\_Env\\_Ind.pdf](http://www.geogr.uni-jena.de/fileadmin/Geoinformatik/projekte/brahmatwinn/Workshops/FEEM/Indicators/EEA_tech_rep_25_Env_Ind.pdf)
- Smith, K. G., Grimm, C. & Gannon, M. (1992). *Dynamics of competitive strategy*. London, Sage Publications.
- Smith, K., Ferrier, W., & Ndofor, H. (2001). Competitive dynamics research: Critique and future directions. In M. Hitt, R. E. Freeman, & J. Harrison (Eds.), *Handbook of Strategic Management*. London: Blackwell Publishers.
- Smith, M. D., Roheim, C., Crowder, L. B., Halpern, B. S., Turnipseed, M., Anderson, J., Asche, F., et al. (2010). Sustainability and global seafood. *Science*, 327(5967), 784. American Association for the Advancement of Science. doi:10.1126/science.1185345
- SNP. (2010). *Memoria Anual 2010*. Lima: Sociedad Nacional de Pesquería. Retrieved from <http://snp.org.pe/wp/?cat=25>

- SNP. (2011). Memoria anual 2011. Lima: Sociedad Nacional de Pesquería. Retrieved from <http://snp.org.pe/wp/?cat=25>
- SOFA. (2011). The state of food and agriculture 2010-11. Rome: Food and Agriculture Organization of the United Nations (FAO). Retrieved from <http://www.fao.org/docrep/013/i2050e/i2050e.pdf>
- SOFIA. (2010). The state of world fisheries and aquaculture 2010. Rome: FAO Fisheries and Aquaculture Department. Retrieved from <http://www.fao.org/docrep/013/i1820e/i1820e.pdf>
- SOFIA. (2012). The State of World Fisheries and Aquaculture 2012 (p. 209). Rome: FAO Fisheries and Aquaculture Department. Retrieved from <http://www.fao.org/docrep/016/i2727e/i2727e.pdf>
- Spangenberg, J. H., & Bonniot, O. (1998). Sustainability Indicators - A Compass on the Road Towards Sustainability. Wuppertal Paper No. 81 (pp. 1-34). Sustainable Societies Program, Division for Material Flows and Structural Change Wuppertal Institute for Climate, Environment, Energy.
- Spiertz, H. (2010). Food production, crops and sustainability: restoring confidence in science and technology. *Current Opinion in Environmental Sustainability*, 2(5-6), 439-443. doi:10.1016/j.cosust.2010.10.006
- Stein, H. H. (2006). DDGS: Energy and nutrient content and digestibility. *Proc. Midwest Swine Nutr. Conf.* (pp. 58-65). Indianapolis.
- Štreimikienė, D., Girdzijauskas, S., & Stoškus, L. (2009). Sustainability Assessment Methods and Their Application to Harmonization of Policies and Sustainability Monitoring. *Environmental Research, Engineering and Management = Aplinkos tyrimai, inžinerija ir vadyba*, 48(2), 51-62.
- Sueiro, J. C. (2008). La actividad pesquera peruana: Características y retos para su sostenibilidad. Lima: CooperAcción, Acción Solidaria para el Desarrollo. Retrieved from <http://www.ibcperu.org/doc/isis/10736.pdf>
- Suh, S. (2005). Theory of materials and energy flow analysis in ecology and economics. *Ecological Modelling*, 189(3-4), 251-269. doi:10.1016/j.ecolmodel.2005.03.011
- Suh, S., Weidema, B., Schmidt, J., & Heijungs, R. (2010). Generalized Make and Use Framework for Allocation in Life Cycle Assessment. *Journal of Industrial Ecology*, 14(2), 335-353. doi:10.1111/j.1530-9290.2010.00235.x
- Sun, W. (2009). Life Cycle Assessment of Indoor Recirculating Shrimp Aquaculture System. Masters Thesis. University of Michigan Ann Arbor. Retrieved from <http://deepblue.lib.umich.edu/handle/2027.42/63582>
- Swarr, T. E., Hunkeler, D., Klöpffer, W., Pesonen, H.-L., Citroth, A., Brent, A. C., & Pagan, R. (2011). Environmental life-cycle costing: a code of practice (Editorial). *The International Journal of Life Cycle Assessment*, 16(5), 389-391. doi:10.1007/s11367-011-0287-5
- Tacon, A., & Metian, M. (2008). Global overview on the use of fish meal and fish oil in industrially compounded aquafeeds: Trends and future prospects. *Aquaculture*, 285(1-4), 146-158. doi:10.1016/j.aquaculture.2008.08.015
- Tacon, A., & Metian, M. (2009). Fishing for feed or fishing for food: increasing global competition for small pelagic forage fish. *Ambio*, 38(6), 294-302. Retrieved from <http://www.ncbi.nlm.nih.gov/pubmed/19860152>
- Tacon, A., Hasan, M., & Metian, M. (2011). Demand and supply of feed ingredients for farmed fish and crustaceans: trends and prospects. *FAO Fisheries and Aquaculture Technical Paper No. 564* (p. 87). Retrieved from <http://www.fao.org/docrep/015/ba0002e/ba0002e.pdf>
- Tacon, A., Metian, M., Turchini, G., & De Silva, S. (2010). Responsible Aquaculture and Trophic Level Implications to Global Fish Supply. *Reviews in Fisheries Science*, 18(1), 94-105. doi:10.1080/10641260903325680

- Tam, J., Taylor, M. H., Blaskovic, V., Espinoza, P., Michael Ballón, R., Díaz, E., Wosnitza-Mendo, C., et al. (2008). Trophic modeling of the Northern Humboldt Current Ecosystem, Part I: Comparing trophic linkages under La Niña and El Niño conditions. *Progress In Oceanography*, 79(2-4), 352–365. doi:10.1016/j.pocean.2008.10.007
- Tarabella, A., & Burchi, B. (2011). Sustainability of Food Products Applying Integrated Life Cycle Tools. *International Journal of Economic Practices and Theories*, 1(1), 28-33. Retrieved from <http://www.ijept.org/index.php/ijept/article/view/4>
- Thomassen, M. a., Dalgaard, R., Heijungs, R., & Boer, I. (2008). Attributional and consequential LCA of milk production. *The International Journal of Life Cycle Assessment*, 13(4), 339–349. doi:10.1007/s11367-008-0007-y
- Thrane, M. (2004a). Energy Consumption in the Danish Fishery: Identification of Key Factors. *Journal of Industrial Ecology*, 8(1), 39–239. doi:10.1162/1088198041269427
- Thrane, M. (2004b). Environmental Impacts from Danish Fish Products – Hot spots and environmental policies. PhD Dissertation. Aalborg University, Denmark. Retrieved from <http://vbn.aau.dk/files/114956/MikkelThrane.pdf>
- Tidwell, J. H., & Allan, G. L. (2001). Fish as food: aquaculture’s contribution. *Ecological and economic impacts and contributions of fish farming and capture fisheries. EMBO reports*, 2(11), 958–63. doi:10.1093/embo-reports/kve236
- Torry Research Station. (1989). Yield and nutritional value of the commercially more important fish species. Rome: Food and Agriculture Organisation of the United Nations. Retrieved from <http://www.fao.org/docrep/003/T0219E/T0219E00.htm>
- Travers, M., Shin, Y.-J., Jennings, S., & Cury, P. (2007). Towards end-to-end models for investigating the effects of climate and fishing in marine ecosystems. *Progress In Oceanography*, 75(4), 751-770. doi:10.1016/j.pocean.2007.08.001
- Travers, M., Shin, Y.-J., Jennings, S., Machu, E., Huggett, J. a., Field, J. G., & Cury, P. (2009). Two-way coupling versus one-way forcing of plankton and fish models to predict ecosystem changes in the Benguela. *Ecological Modelling*, 220(21), 3089-3099. doi:10.1016/j.ecolmodel.2009.08.016
- Tukker, A., & Jansen, B. (2006). Environmental Impacts of Products: A Detailed Review of Studies. *Journal of Industrial Ecology*, 10(3), 159–182. doi:10.1162/jiec.2006.10.3.159
- Tukker, A., Goldbohm, R. A., de Koning, A., Verheijden, M., Kleijn, R., Wolf, O., Pérez-Domínguez, I., et al. (2011). Environmental impacts of changes to healthier diets in Europe. *Ecological Economics*, 1-13. doi:10.1016/j.ecolecon.2011.05.001
- Tukker, A., Huppes, G., Guinée, J., & Heijungs, R. (2006). Environmental Impact of Products (EIPRO) Analysis of the life cycle environmental impacts related to the final consumption of the EU-25. Technical Report Series. Technical Report EUR 22284 EN. European Commission, Joint Research Centre (DG JRC), Institute for Prospective Technological Studies. Retrieved from <https://openaccess.leidenuniv.nl/handle/1887/11434>
- Tusche, K., Wuertz, S., Susenbeth, a., & Schulz, C. (2011). Feeding fish according to organic aquaculture guidelines EC 710/2009: Influence of potato protein concentrates containing various glycoalkaloid levels on health status and growth performance of rainbow trout (*Oncorhynchus mykiss*). *Aquaculture*, 319(1-2), 122–131. doi:10.1016/j.aquaculture.2011.06.035
- Tveteras, S., Paredes, C., & Peña-Torres, J. (2009). Individual Fishing Quotas in Peru: Stopping the Race for Anchovies. Retrieved from <http://fen.uahurtado.cl/wp/wp-content/uploads/2010/07/l263.pdf>

- Tyedmers, P. (2000). Salmon and Sustainability: The biophysical cost of producing salmon through the commercial salmon fishery and the intensive salmon culture industry. PhD Dissertation. The University of British Columbia. Retrieved from <https://circle.ubc.ca/handle/2429/13201>
- Tyedmers, P. (2004). Fisheries and energy use. In Encyclopedia of energy (Vol. 2, pp. 683–693). Retrieved from [http://www.fcrn.org.uk/sites/default/files/Fishing\\_and\\_Energy\\_Use.pdf](http://www.fcrn.org.uk/sites/default/files/Fishing_and_Energy_Use.pdf)
- Tyedmers, P., & Ayer, N. (2011). Assessing the environmental performance of finfish culture in Canada: Review of potential methodological frameworks. Fisheries and Oceans Canada. Dalhousie University, School for Resource & Environmental Studies.
- Tyedmers, P., Watson, R., & Pauly, D. (2005). Fueling global fishing fleets. *Ambio*, 34(8), 635–8. Retrieved from <http://www.ncbi.nlm.nih.gov/pubmed/16521840>
- UN. (2012). The Future we Want. RIO+20 United Nations Conference on Sustainable Development (pp. 1–19). Rio de Janeiro.
- UNALM. (2012). Investigación en nutrición y alimentación de especies de acuicultura. Lima: Universidad Nacional Agraria La Molina, Programa de Investigación y Proyección Social en Alimentos. Retrieved from [http://www.lamolina.edu.pe/facultad/Zootecnia/PIPS/Prog\\_Alimentos/peces.htm](http://www.lamolina.edu.pe/facultad/Zootecnia/PIPS/Prog_Alimentos/peces.htm)
- UNCSD. (2001). Indicators of sustainable development: Guidelines and methodologies. United Nations Commission on Sustainable Development. Dept. of Economic and Social Affairs. Retrieved from <http://www.un.org/esa/sustdev/natlinfo/indicators/indisd/indisd-mg2001.pdf>
- UNCTAD. (2004). A Manual for the Preparers and Users of Eco-efficiency Indicators Version 1.1. UNCTAD/ITE/IPC/2003/7. New York and Geneva: United Nations Conference on Trade and Development.
- UNCTAD/ISAR. (2006). 2006 Review of the Reporting Status of Corporate Responsibility Indicators. TD/B/COM.2/ISAR/CRP.4. United Nations Conference on Trade and Development, Intergovernmental Working Group of Experts on International Standards of Accounting and Reporting.
- UNCTAD/ISAR. (2008). Guidance on Corporate Responsibility Indicators in Annual Reports. UNCTAD/ITE/TEB/2007/6. New York and Geneva: United Nations Conference on Trade and Development, Intergovernmental Working Group of Experts on International Standards of Accounting and Reporting.
- UNEP. (2009). The Role of Supply Chains in Addressing the Global Seafood Crisis. United Nations Environment Programme. Retrieved from [http://www.unep.ch/etb/publications/Fish\\_Supply\\_Chains/UNEP\\_fish\\_supply\\_chains\\_report.pdf](http://www.unep.ch/etb/publications/Fish_Supply_Chains/UNEP_fish_supply_chains_report.pdf)
- UNEP/SETAC. (2006). Background Report for a UNEP Guide to Life Cycle Management: A guide to sustainable products. UNEP/SETAC Life Cycle Initiative: United Nations Environment Programme.
- UNEP/SETAC. (2007). Life Cycle Management: A Business Guide to Sustainability. UNEP/SETAC Life Cycle Initiative: United Nations Environment Programme.
- UNEP/SETAC. (2009). Guidelines for social life cycle assessment of products. (C. Benoit & B. Mazijn, Eds.). UNEP/SETAC Life Cycle Initiative: United Nations Environment Programme. Retrieved from <http://biblio.ugent.be/record/624820>
- USDA. (2012). USDA National Nutrient Database for Standard Reference, Release 25. U.S. Department of Agriculture, Agricultural Research Service. Nutrient Data Laboratory Home Page, <http://www.ars.usda.gov/ba/bhnrc/ndl>
- Utne, I. (2009). Life cycle cost (LCC) as a tool for improving sustainability in the Norwegian fishing fleet. *Journal of Cleaner Production*, 17(3), 335–344. doi:10.1016/j.jclepro.2008.08.009

- Valdivia, S., Ciroth, A., Sonnemann, G., Ugaya, C. M. L., Lu, B., & Alvarado, C. (2011). Toolbox for Life Cycle Sustainability Assessment of Products. Life Cycle Management Conference LCM 2011. Berlin. Retrieved from <http://www.lcm2011.org/papers.html>
- van Berkel, R. (2002). Application of Cleaner Production Principles and Tools for Eco-Efficient Minerals Processing. In Rankin, J. et al. (Eds). Proceedings Green Processing Conference 2002. Clayton: Australasian Institute of Mining and Metallurgy (AusIMM).
- van Berkel, R. (2006). Regional Resource Synergies for Sustainable Development in Heavy Industrial Areas: an overview of opportunities and experiences (p. 139). Perth: Centre of Excellence in Cleaner Production, Curtin University of Technology. Retrieved from <http://seg.curtin.edu.au/local/docs/publications/2007/arcbulletin1.pdf>
- van Berkel, R. (2007). Eco-efficiency in the Australian minerals processing sector. *Journal of Cleaner Production*, 15(8-9), 772-781. doi:10.1016/j.jclepro.2006.06.017
- van der Vorst, J., & Beulens, A. (1999). A Research Model for the Redesign of Food Supply Chains. *International Journal of Logistics: Research and Applications*, 2(2), 161-174. doi:10.1080/13675569908901579
- van der Vorst, J., Tromp, S., & van der Zee, D.-J. (2009). Simulation modelling for food supply chain redesign; integrated decision making on product quality, sustainability and logistics. *International Journal of Production Research*, 47(23), 6611-6631. doi:10.1080/00207540802356747
- Van Zelm, R., Huijbregts, M. a. J., & Meent, D. (2009). USES-LCA 2.0—a global nested multi-media fate, exposure, and effects model. *The International Journal of Life Cycle Assessment*, 14(3), 282–284. doi:10.1007/s11367-009-0066-8
- Vázquez-Rowe, I., Moreira, M. T., & Feijoo, G. (2011b). Environmental assessment of frozen common octopus (*Octopus vulgaris*) captured by Spanish fishing vessels in the Mauritanian EEZ. *Marine Policy*, 36(1), 180-188. doi:10.1016/j.marpol.2011.05.002
- Vázquez-Rowe, I., Moreira, M. T., Feijoo, G., (2012b). Inclusion of discard assessment indicators in fisheries life cycle assessment studies. Expanding the use of fishery-specific impact categories. *Int. J. Life Cycle Ass.*, 17(5), 535-549.
- Vázquez-Rowe, I., Villanueva-Rey, P., Moreira, M. T., & Feijoo, G. (2013). Edible protein energy return on investment ratio (ep-EROI) for Spanish seafood products. *AMBIO, A journal of the Human Environment*. doi:10.1007/s13280-013-0426-2
- VDI. (1997). Cumulative Energy Demand - Terms, Definitions, Methods of Calculation. In: VDI-Richtlinien 4600. Verein Deutscher Ingenieure, Düsseldorf.
- VDI. (2005). Cleaner production (PIUS): Basic principles and area of application. VDI Verein Deutscher Ingenieure (The Association of Engineers). Berlin: Beuth Verlag GmbH.
- Veleva, V., & Ellenbecker, M. (2001). Indicators of sustainable production: framework and methodology. *Journal of Cleaner Production*, 9(6), 519-549. doi:10.1016/S0959-6526(01)00010-5
- Venkatesh, G., Hammervold, J. and Brattebø, H. (2009), Combined MFA-LCA for Analysis of Wastewater Pipeline Networks. *Journal of Industrial Ecology*, 13: 532–550. doi: 10.1111/j.1530-9290.2009.00143.x
- Verdouw, C. N., Beulens, A. J. M., Trienekens, J. H., & Wolfert, S. (2010). Business Process Modelling in Demand-Driven Agri-Food Supply Chains. Proceedings of the 4th International European Forum on System Dynamics and Innovation in Food Networks (pp. 307-323). Innsbruck-Igls, Austria: International Center for Food Chain and

- Network Research, University of Bonn, Germany. Retrieved from [http://centmapress.ilb.uni-bonn.de/ojs/index.php/proceedings/issue/view/ISBN 978-3-941766-03-7](http://centmapress.ilb.uni-bonn.de/ojs/index.php/proceedings/issue/view/ISBN%20978-3-941766-03-7)
- Verfaillie, H. A., & Bidwell, R. (2000). Measuring eco-efficiency, a guide to reporting company performance. World Business Council for Sustainable Development. Retrieved from [http://www.wbcsd.org/web/publications/measuring\\_eco\\_efficiency.pdf](http://www.wbcsd.org/web/publications/measuring_eco_efficiency.pdf)
- Vergara, J., Lopez-Calero, G., & Robaina, L. (1999). Growth, feed utilization and body lipid content of gilthead seabream (*Sparus aurata*) fed increasing lipid levels and fish meals of different quality. *Aquaculture*, (179), 35–44. Retrieved from <http://www.sciencedirect.com/science/article/pii/S0044848699001507>
- Villasante, S., Rodríguez, D., Antelo, M., Quaas, M., & Österblom, H. (2011). The Global Seafood Market Performance Index: A theoretical proposal and potential empirical applications. *Marine Policy*. doi:10.1016/j.marpol.2011.04.007
- Wagner, B., & Enzler, S. (Eds.). (2006). *Material flow management: Improving cost efficiency and environmental performance*. Heidelberg: Physica-Verlag. Retrieved from <http://library.wur.nl/WebQuery/clc/1234857>
- Wahlström, B. (1994). Models, modelling and modellers: an application to risk analysis. *European Journal of Operational Research*, 75, 477-487. Retrieved from <http://www.sciencedirect.com/science/article/pii/0377221794902909>
- Walker, W. E., Harremoës, P., Rotmans, J., van der Sluijs, J. P., van Asselt, M. B. A., Janssen, P., & von Krauss, M. P. K. (2003). Defining Uncertainty: A Conceptual Basis for Uncertainty Management. *Integrated Assessment*, 4(1), 5–17.
- Walters, C., Christensen, V., & Pauly, D. (1997). Structuring dynamic models of exploited ecosystems from trophic mass-balance assessments. *Reviews in Fish Biology and Fisheries*, 7(2), 139-172.
- Walters, C., Pauly, D., & Christensen, V. (1999). Ecospace: prediction of mesoscale spatial patterns in trophic relationships of exploited ecosystems, with emphasis on the impacts of marine protected areas. *Ecosystems*, 2(6), 539-554.
- WBCSD. (2000). *A Corporate Accounting and Reporting Standard. The Greenhouse Gas Protocol*. World Business Council for Sustainable Development.
- WBCSD. (2006). *Eco-efficiency Learning Module* (p. 225). World Business Council for Sustainable Development. Retrieved from <http://www.wbcsd.org/pages/EDocument/EDocumentDetails.aspx?ID=13593&NoSearchContextKey=true>
- WBCSD. (2011a). *Corporate Value Chain (Scope 3) Accounting and Reporting Standard*. World Resources Institute and World Business Council for Sustainable Development.
- WBCSD. (2011b). *Product Life Cycle Accounting and Reporting Standard*. World Resources Institute and World Business Council for Sustainable Development.
- Weidema, B. (2000). Avoiding Co-Product Allocation in Life-Cycle Assessment. *Journal of Industrial Ecology*, 4(3). Retrieved from <http://www.springerlink.com/index/v40016052g125178.pdf>
- Weidema, B. P. (2003). *Market information in life cycle assessment*. Danish Environmental Protection Agency. Environmental Project. Retrieved from <http://www.norlca.org/resources/780.pdf>
- Welch, A., Hoenig, R., Stieglitz, J., Benetti, D., Tacon, A., Sims, N., & O’Hanlon, B. (2010). From Fishing to the Sustainable Farming of Carnivorous Marine Finfish. *Reviews in Fisheries Science*, 18(3), 235-247. doi:10.1080/10641262.2010.504865

- Werner, F., Lough, G., Bertrand, A., Guevara-Carrasco, R., Soler, P., Csirke, J., & Chavez, F. P. (2008). The Northern Humboldt Current System: Ocean Dynamics, Ecosystem Processes, and Fisheries. *Progress in Oceanography*, 79, 95–412. doi:10.1016/j.pocean.2008.10.012
- Wijkström, U.N. (2009). The use of wild fish as aquaculture feed and its effects on income and food for the poor and the undernourished. In Hasan, M.R. and Halwart, M. (eds). *Fish as feed inputs for aquaculture: practices, sustainability and implications*. FAO Fisheries and Aquaculture Technical Paper No. 518. Rome, FAO. pp. 371–407
- Wijkström, U.N. (2010). Is feeding fish with fish a viable practice? In R. P. Subasinghe, J. R. Arthur, D. M. Bartley, S. S. De Silva, M. Halwart, N. Hishamunda, C. V. Mohan, et al. (Eds.), *Farming the Waters for People and Food*. Proceedings of the Global Conference on Aquaculture 2010, Phuket, Thailand. 22–25 September 2010. pp. (pp. 31–56). FAO, Rome and NACA, Bangkok.
- Wognum, P. M., Bremmers, H., Trienekens, J. H., van der Vorst, J. G. a. J., & Bloemhof, J. M. (2011). Systems for sustainability and transparency of food supply chains – Current status and challenges. *Advanced Engineering Informatics*, 25(1), 65-76. doi: 10.1016/j.aei.2010.06.001
- Wood, S. M., & Layzell, D. B. (2003). *A Canadian Biomass Inventory: Feedstocks for a Bio-based Economy*. BIOCAP Canada Foundation.
- World Commission on Environment and Development (WCED). (1987). *Our common Future*. Brundtlandt-Report), Gen. Ass. A. Oxford.
- WRI and WBCSD (2004). *GHG Protocol Corporate Accounting and Reporting Standard*. World Resources Institute, Washington, DC.
- Zamagni, A., Guinée, J., Heijungs, R., Masoni, P., & Raggi, A. (2012). Lights and shadows in consequential LCA. *The International Journal of Life Cycle Assessment*, 17(7), 904–918. doi:10.1007/s11367-012-0423-x
- Zamagni, A., Pesonen, H.-L., & Swarr, T. (2013). From LCA to Life Cycle Sustainability Assessment: concept, practice and future directions. *The International Journal of Life Cycle Assessment*, 18(9), 1637–1641. doi:10.1007/s11367-013-0648-3
- Ziegler, F., & Valentinsson, D. (2008). Environmental life cycle assessment of Norway lobster (*Nephrops norvegicus*) caught along the Swedish west coast by creels and conventional trawls—LCA methodology with case study. *The International Journal of Life Cycle Assessment*, 13(6), 487-497. doi:10.1007/s11367-008-0024-x



# Appendices

---

- Appendix A: The EwE modelling approach
  - Appendix B: The Umberto modelling approach
  - Appendix C: A comparison of current Life Cycle Impact Assessment methods
  - Appendix D: The ReCiPe LCIA method
  - Appendix E: Extended introduction to the case study - the Peruvian anchoveta supply chains
  - Appendix F: Posters
  - Appendix G: Institutions, labs, projects
- 

## Appendices

### Appendix A: The EwE modelling approach

The Ecopath with Ecosim mass-balance modelling system is an end-to-end ecosystem modelling toolset aimed to develop trophic models of (mainly) marine ecosystems. The base Ecopath model generates a static food web, while available sub-models and plug-ins allow for dynamic modelling (temporal and spatial), value chain integration, etc (Christensen et al., 2008). EwE is amply applied worldwide, and over 200 publications have used it (Palomares et al., 2009).

“The Ecopath system is built on an approach presented by Polovina (1984a; 1984b) for the estimation of the biomass of the various elements (species or groups of species) of an aquatic ecosystem. It was subsequently combined with various approaches from theoretical ecology, notably those proposed by R.E. Ulanowicz (1986), for the analysis of flows between the elements of ecosystems. In many cases, the period considered will be a given year, but the state and rate estimates used for model construction may pertain to different years. Models may represent a decade or more, during which little changes have occurred. When ecosystems have undergone massive changes, two or more models may be needed, representing the ecosystem before, during, and after the changes. This can be illustrated by an array of models of the Peruvian upwelling ecosystem representing periods before and after the collapse of the anchoveta fishing there (Jarre et al., 1991b).

Once a model of the type discussed here has been built it can be used directly for simulation modelling using Ecosim. This approach is fully integrated with Ecopath, and is a complex simulation model for evaluating the impact of different fishing regimes on the biological components of ecosystems.

The foundation of the EwE suite is an Ecopath model (Christensen and Pauly, 1992; Pauly et al., 2000), which creates a static mass-balanced snapshot of the resources in an ecosystem and their interactions, represented by trophically linked biomass ‘pools’. The biomass pools consist of a single species, or species groups representing ecological guilds. Pools may be

further split into ontogenetic linked groups; a group may as an example be split in larvae, juvenile, age 1-2, and spawners (age 3+). Ecopath data requirements are relatively simple, and generally already available from stock assessment, ecological studies, or the literature: biomass estimates, total mortality estimates, consumption estimates, diet compositions, and fishery catches. “

Christensen et al. (2008, pp.9-10)

The EwE model is based on a few basic concepts. Mortality for a prey is considered as consumption for a predator, and such is the foundation of the food web. Ecopath defines models on the base of two master equations for production and energy balance, as well as complementary relations:

- The production components equation states that Production = catches + predation mortality + biomass accumulation + net migration + other mortality. Formally:

$$P_i = Y_i + B_i * M2_i + E_i + BA_i + P_i * (1 - EE_i) \quad (\text{Eq. 1})$$

where  $P_i$  rate for group (i),  $B_i$  is the total production rate of (i),  $Y_i$  is the total fishery catch rate of (i),  $M2_i$  is the total predation the biomass of the group,  $E_i$  the net migration rate (emigration – immigration;  $NM_i$  being the net migration),  $BA_i$  is the biomass accumulation rate for (i), and  $M0_i = P_i * (1-EE_i)$  is the non-predatory mortality rate for (i).  $EE_i$  is the proportion of the production that is utilized in the system and is defined as

$$EE_i = (B_i * M2_i + C_i + NM_i + BA_i)/P_i \quad (\text{Eq. 1a})$$

- The energy balance equation states that Consumption = production + respiration + unassimilated food. Formally:

$$Q_i = P_i + R_i + UF_i \quad (\text{Eq. 2})$$

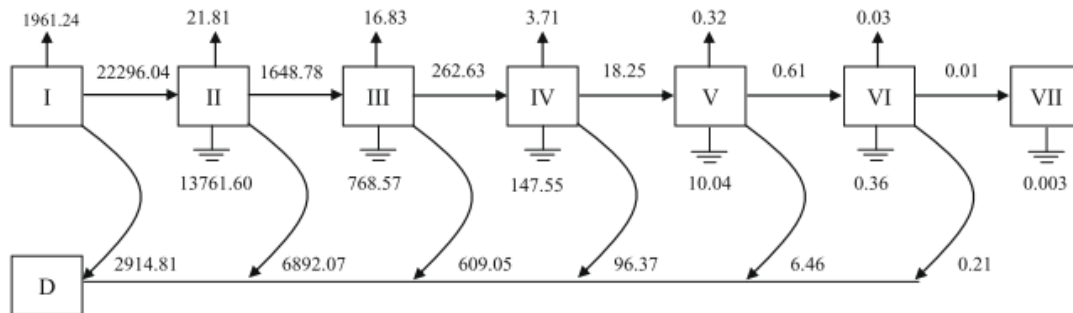
where  $Q_i$  = prey consumption,  $P_i$  = production,  $R_i$  = respiration,  $UF_i$  = unassimilated food (including excretion and egestion).

- Regarding fisheries, fishing mortality equals yield/biomass.
- A system of linear equations is produced, with at least as many equations as groups defined.
- The linear systems can complete missing values when complementary parameters are known. It also estimates additional parameters per group, such as gross food conversion efficiency and trophic level.

Thus, for each functional group (pool) required input data is: wet weight biomass ( $B$ , t/km<sup>2</sup>), production/biomass ratio ( $P/B$ , 1/y), consumption/biomass ratio ( $Q/B$ , 1/y), catch ( $C$ , t/km<sup>2</sup>/y) and diet composition ( $DC$ ). One unknown parameter (either  $B$ ,  $P/B$ ,  $Q/B$  or  $EE$ ) can be estimated when solving the system of linear equations (Tam et al., 2008).

Once the base static Ecopath model is defined and balanced, Ecosim applies time-differential equations based on Eq. 1 to produce a dynamic model of the static parameterisation. EwE features auto mass-balancing capabilities based on an iterative routine, as well as a number of indices to add robustness (Christensen and Walters, 2004; Kavanagh et al., 2004). Nonetheless, the mass-balancing process is challenging, often requiring very subjective decisions to be made by the modeller; and the utilisation of primary productivity and detritus as adjustment variables.

Finally, EwE produces simulated future states of the trophic web under study. Steady states of the trophic web are often depicted as Lindeman spine graphs (see Figure 10 for an example). The Lindeman spine illustrates the net amount each trophic level receives from the preceding one, as well as the amounts it creates through respiration, exports, detritus for recycling, and net production for transport to the next level. It also allows the calculation of the trophic efficiency of each level and for the food web as a whole (Baird and Ulanowicz, 1993).



**Figure 10: Lindeman spine of the Humboldt Current System on a La Niña year**  
Reproduced from Tam et al. (2008).

## References

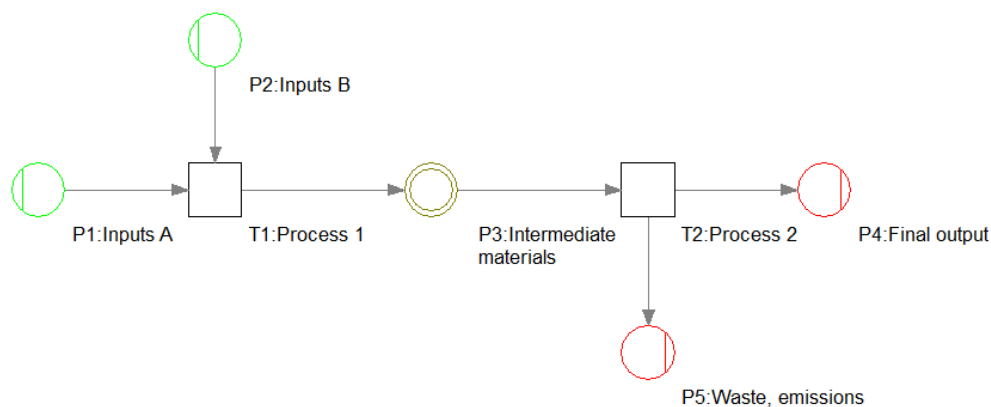
- Baird, D., & Ulanowicz, R. E. (1993). Comparative study on the trophic structure, cycling and ecosystem properties of four tidal estuaries. *Marine Ecology Progress Series*, 99, 221–237.
- Christensen, V., & Pauly, D. (1992). ECOPATH II - a software for balancing steady-state ecosystem models and calculating network characteristics. *Ecological modelling*, 61(681), 169–185. Retrieved from <http://www.sciencedirect.com/science/article/pii/0304380092900168>
- Christensen, V., & Walters, C. (2004). Ecopath with Ecosim: methods, capabilities and limitations. *Ecological Modelling*, 172(2-4), 109–139. doi:10.1016/j.ecolmodel.2003.09.003
- Christensen, V., Walters, C., Pauly, D., & Forrest, R. (2008). Ecopath with Ecosim version 6 User Guide. Lenfest Ocean Futures Project (pp. 1–235).
- Kavanagh, P., Newlands, N., Christensen, V., & Pauly, D. (2004). Automated parameter optimization for Ecopath ecosystem models. *Ecological Modelling*, 172(2-4), 141–149. doi:10.1016/j.ecolmodel.2003.09.004
- Palomares, M. L. D., Morissette, L., Cisneros-Montemayor, A., Varkey, D., Coll, M., & Piroddi, C. (Eds.). (2009). *Ecopath 25 Years Conference Proceedings: Extended Abstracts*. Fisheries Centre Research Reports Volume 17 Number 3. Vancouver: Fisheries Centre, University of British Columbia.
- Pauly, D., Christensen, V., & Walters, C. (2000). Ecopath, Ecosim, and Ecospace as tools for evaluating ecosystem impact of fisheries. *ICES Journal of Marine Science*, 57(3), 697–706. doi:10.1006/jmsc.2000.0726
- Tam, J., Taylor, M. H., Blaskovic, V., Espinoza, P., Michael Ballón, R., Díaz, E., Wosnitza-Mendo, C., et al. (2008). Trophic modeling of the Northern Humboldt Current Ecosystem, Part I: Comparing trophic linkages under La Niña and El Niño conditions. *Progress In Oceanography*, 79(2-4), 352–365. doi:10.1016/j.pocean.2008.10.007

## Appendix B: The Umberto modelling approach

Material flow networks (MFN) are anthropogenic systems, mainly productive, that can be used as a base for calculating input/output balances of productive systems as well as LCIs of products. Thus, MFNs can be used to model the material and energy flows within complex systems such as productive processes, factories and, eventually, regions.

Umberto (<http://www.umberto.de/en/>) uses Petri (place/transition) nets to represent MFNs, featuring three types of components as follows (see Figure 11):

- **Transitions** (symbolised by squares), or locations in the network where transformation processes occur. Within transitions, which are connected to places (elements representing materials in motion or storage), the transformation processes can be specified in a variety of ways, ranging from simple input/output ratios to complex non-linear transformations (programming).
- **Places** (symbolised by circles) represent input, output and storage of materials, as well as connection dynamics between transitions. Umberto uses four types (input, output, storage and connection). Connection places cannot store materials.
- **Arrows**, representing links with direction and sense that determine the flow (like a Euclidean vector) among places and transitions.



**Figure 11: Example Umberto network showing basic element types**

Self elaboration.

A MFN is composed of places and transitions interconnected by arrows. In Umberto, such net can be built in a WYSIWYG<sup>18</sup> fashion.

Nesting of nets is possible in Umberto, generally used to represent portions of a MFN in deeper detail. Nested nets are called *subnets*. There are no limitations for the number of nested subnets. Each Umberto project can encompass several *scenarios* (MFNs with its subnets), and each scenario can encompass different *periods* (time-based analysis unit, i.e. accounting periods).

Materials (substances), products and energy have to be defined as a comprehensive list prior to be used in a net or subnet, and identified by a unique name. A consistent material notation is required to simplify material identification. Materials can be clustered in categories and must be assigned a material

<sup>18</sup> WYSIWYG is an acronym used in information technology to describe graphic/visual programming or design interfaces, or “What you see is what you get”.

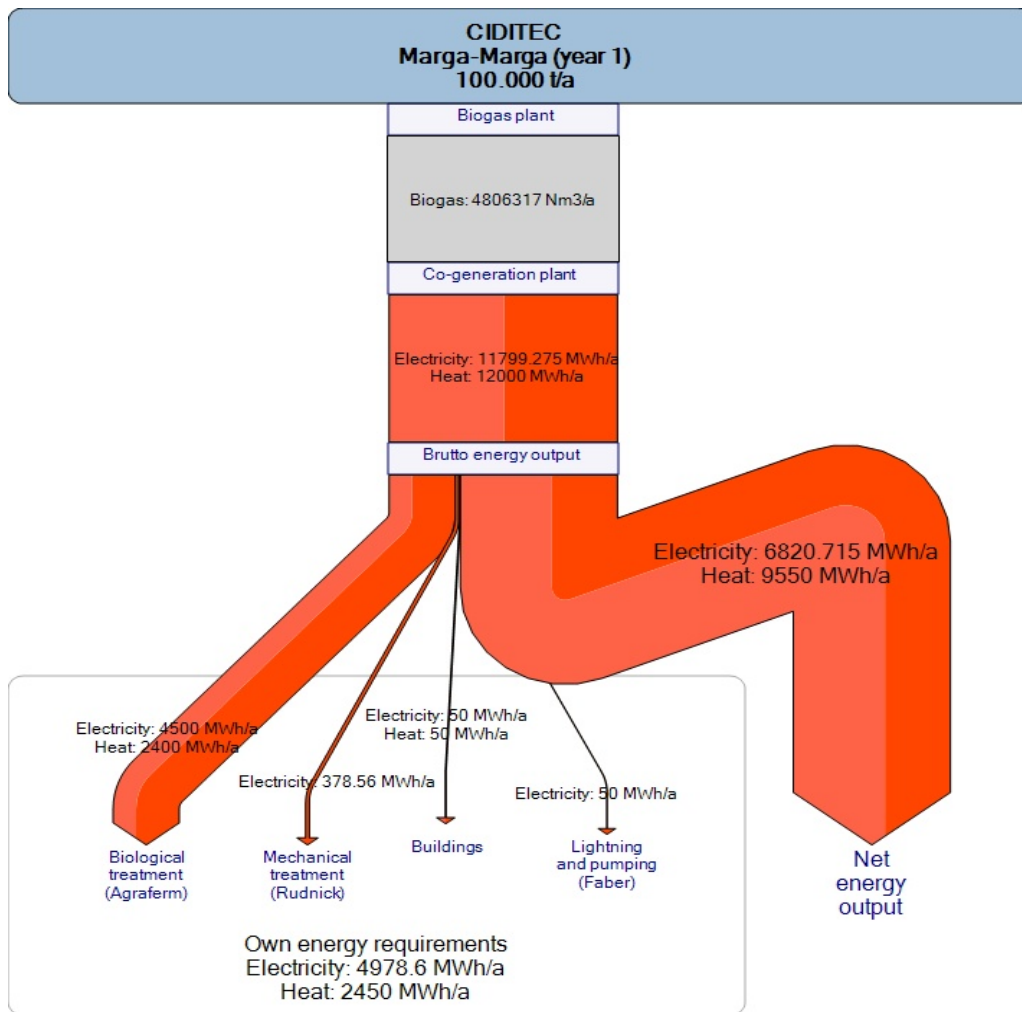
*type (good, neutral or bad)* and a measurement *unit* (kg for mass and kJ for energy). A *market price*, expressed in a definable currency unit, can also be assigned to each material definition. Materials can also be assigned *properties*, or descriptions of their ecological, economic and technical implications.

In general, all types of units can be customised in Umberto: mass, energy, currency, etc.

Once a network representing a system is completed with behaviour specifications, it can be “calculated”, that is to say, to run a static simulation of the MFN to obtain a balance (inventory) of materials and energy. Such inventory can be extended by means of cost-accounting mechanisms (included in Umberto) as to express the materials balance in monetary terms.

Umberto features additional functionalities for MFN design, data processing and presentation:

- Valuation systems, or the possibility to qualify quantitative inventory data under different sets of criteria/indicators (user-defined sustainability indicators such as kWh consumed per kg of product, or kg of water consumed per kg of product, etc).
- Sankey diagrams, graphical representations of MFNs which depicts weighted arrows whose width is consequent with its associated value (kg of material, kJ of energy) (Schmidt, 2008a). See Figure 12 for an example.
- Life Cycle Inventories, the possibility of calculating production costs (in terms of materials, energy, emissions, money) of a product against a reference flow (i.e. one unit of the product).
- Module Library, a library of industrial processes modelled in detail, suitable to be imported into new MFNs. The library can also be fed with new customer-built modules, in compliance with the philosophy of object programming (reutilisation of functional pieces of logic with or without embedded data). Currently industrial processes depicted in the library include: conventional energy generation, chemicals manufacturing, metal works, plastics manufacturing, paper and cardboard manufacturing, transportation, wood pulping and waste management.



**Figure 12: Example of Sankey diagram (waste sorting with cogeneration)**

Source: Institute for Applied Material Flow Management (IfaS, <http://www.stoffstrom.org/en/>).

Umberto, as a solid yet flexible material and energy flows modelling tool, is used in Europe and the world by industrial, commercial, research and consulting companies, as well as by academic institutions, as described in the Umberto Reference List (see appendix references).

The current stable release of Umberto is version 5.5, being further versions currently under development. Currently, two companion tools are available: Umberto for Carbon Footprint and eSankey (<http://www.ifu.com/en/products/>).

## References

- IFU. (2005). Umberto – A Software Tool for Life Cycle Assessment and Material Flow Analysis – User Manual, Version 5, May 2005, ifu – Institut für Umwelthinformatik Hamburg GmbH and ifeu – Institut für Energie und Umweltforschung Heidelberg GmbH
- Schmidt, M. (2008a). The Sankey Diagram in Energy and Material Flow Management. Part I. Journal of Industrial Ecology, 12(1), 82–94. doi:10.1111/j.1530-9290.2008.00004.x

Umberto Reference List:

[http://www.umberto.de/system/galleries/download/umberto\\_en/umberto\\_referencelist\\_en.pdf](http://www.umberto.de/system/galleries/download/umberto_en/umberto_referencelist_en.pdf)

## Appendix C: A comparison of current Life Cycle Impact Assessment methods

Selection of LCIA methods implemented in the ecoinvent database (v 2.2, 2010).

| Major methods →<br>Criteria ↓     | CML 2001<br>CML 2002  | Eco-indicator 99  | EDIP 97<br>EDIP 2003   | ReCiPe  |
|-----------------------------------|---|---|--|---|
| <b>Background publication</b>     | Guinée et al. (2001a, b, c)<br>Guinée et al. (2002)   | Goedkoop and Spriensma (2000a,b)  | Wenzel et al. (1997)<br>Hauschild and Potting (2005)   | Goedkoop et al. (2009)  |
| <b>Origin</b>                     | Netherlands: Centre of Environmental Science - Leiden University (CML)  | Netherlands: Pré Consultants  | Denmark: Technical University of Denmark, Danish Environmental Protection Agency<br><b>EDIP 2003 is an alternative to EDIP 97, not an update</b> | Netherlands: National Institute for Public Health and the Environment (RIVM), Radboud University, CML, Pré Consultants, CE Delft<br><b>This method integrates CML 2002 and Eco-indicator 99</b> |
| <b>Regional validity</b>          | Global (except for acidification and photo-oxidant formation: Europe)   | Global for climate change, ozone depletion and resources; Europe for other categories | EDIP 97: Global<br>EDIP 2003: Europe   | Global for climate change, ozone depletion and resources; Europe for other categories   |
| <b>Midpoint impact categories</b> | Climate change  | Climate change  | Global warming   | Climate change (IPCC 2007 factors)  |
|                                   | Acidification potential   | Acidification and eutrophication  | Acidification  | Terrestrial acidification   |
|                                   | Eutrophication potential  |   | Nutrient enrichment<br>Stored nutrient enrichment  | Freshwater eutrophication<br>Marine eutrophication  |
|                                   | Human toxicity<br>Malodours air   | Carcinogenics<br>Stored carcinogenics<br>Respiratory effects                          | Human toxicity<br>Stored human toxicity  | Human toxicity<br>Particulate matter formation  |
|                                   | Freshwater aquatic ecotoxicity<br>Marine aquatic ecotoxicity<br>Terrestrial ecotoxicity<br>Freshwater sediment ecotoxicity<br>Marine sediment ecotoxicity | Ecotoxicity<br>Stored ecotoxicity   | Ecotoxicity, acute<br>Ecotoxicity, chronic<br>Stored ecotoxicity   | Terrestrial ecotoxicity<br>Freshwater ecotoxicity<br>Marine ecotoxicity   |
|                                   | Photochemical oxidation   |   | Photochemical ozone formation  | Photochemical oxidant formation   |
|                                   | Stratospheric ozone depletion   | Ozone layer depletion   | Stratospheric ozone depletion  | Ozone depletion   |
|                                   | Ionising radiation  | Ionising radiation<br>Stored ionising radiation                                       |  | Ionising radiation  |

|  |   |  |   |   |
|--|---|--|---|---|
|  | Land use  | Land occupation  | Land filling  | Agricultural land occupation<br>Urban land occupation<br>Natural land transformation  |
|  | Resources   | Fossil fuels<br>Mineral extraction   | Non-renewable resources<br>Renewable resources  | Water depletion<br>Metal depletion<br>Fossil depletion  |
| <b>Endpoint impact categories</b>                  | None  | Human health<br>Ecosystem quality<br>Resources   | None  | Human health<br>Ecosystem<br>Resources  |
| <b>Remarks on implementation in ecoinvent v2.2</b> | Multiple characterisation methods implemented.<br>Normalisation factors not implemented.<br>Explicit handling of long-term emissions. | Three weighting sets (cultural perspectives) included: Hierarchist, Individualist and Egalitarian.<br>Normalisation and weighting implemented for each perspective.<br>Explicit handling of long-term emissions. | Spatially differentiated characterisation models implemented in EDIP 2003, for 40+ European regions.<br>Normalisation and weighting factors not implemented.<br>Explicit handling of long-term emissions. | Three weighting sets (cultural perspectives) included: Hierarchist, Individualist and Egalitarian.<br>Normalisation and weighting implemented for each perspective (except for land transformation and fresh water depletion).<br>Explicit handling of long-term emissions. |

| Single issue methods →<br>Criteria ↓ | Cumulative Energy Demand (CED) | Ecological footprint                                   | IPCC 2007                            | USEtox   | USES-LCA 2.0   |
|--------------------------------------|--------------------------------|--|--------------------------------------|--|--|
| <b>Background publication</b>        | VDI (1997)                     | Wackernagel et al. (2005);<br>Huijbregts et al. (2008) | Fourth Assessment Report (IPCC 2007) | Rosenbaum et al. (2008);<br>Hauschild et al. (2008)  | van Zelm et al. (2009)   |
| <b>Issue</b>                         | Energy                         | Land use   | GWP                                  | Toxicity (3000 substances)   | Toxicity   |
| <b>Units</b>                         | MJ                             | Ha   | t CO <sub>2</sub> eq                 | Human: CTUh, increase in morbidity in the total human population per unit mass of a chemical emitted (cases per kg)<br>Other: CTUe, potentially affected fraction of species | Human: DALY, life years lost or disabled by diseases, which are influenced by impacts.<br>Other: species.yr, potentially disappeared fraction of species over area per year. |



|                          |  |  |   |  |  |
|--------------------------|--|--|---|--|--|
|                          |  |  |   | (PAF) integrated over time and volume per unit mass of a chemical emitted (PAF m <sup>3</sup> day kg <sup>-1</sup> )   |  |
| <b>Definition</b>        | Determination of the primary energy use along the life cycle of a product.   | Determination of the sum of time integrated direct land occupation and indirect land occupation, related to nuclear energy use and to CO2 emissions from fossil energy use and clinker production.                             | Characterisation of different gaseous emissions according to their global warming potential and the aggregation of different emissions in the impact category climate change. | Characterisation of human and ecotoxicological impacts. USEtox is a scientific consensus model based upon a list of previous widely used toxicity models: CalTOX, IMPACT 2002, USES-LCA, BETR, EDIP, WATSON, and EcoSense. | Characterisation of human and ecotoxicological impacts. Implemented in the ReCiPe LCIA method, but not standalone in ecoinvent.  |
| <b>Impact categories</b> | Non-renewable resources (fossil, nuclear, primary forest)<br>Renewable resources (biomass, wind, solar, geothermal, water) | Carbon dioxide, fossil Nuclear (uranium, in ground)<br>Land occupation (arable, construction site, dump site, forest, industrial area, benthos, industrial area, pastures and meadows, permanent crop, sea and ocean, unknown) | Climate change (GWP 100a, 20a, 500a)  | Human toxicity, cancer<br>Human toxicity, non-cancer<br>Ecotoxicity  | Extra features, compared to USEtox:<br>Endpoint characterization factors are calculated.<br>Marine and terrestrial ecotoxicity are also addressed.<br>Various scenario assumptions can be tested by changing settings. |

The following methods were used in the research:

- CML baseline 2000 (Guinée et al., 2002) is widely used in fisheries and fishfood LCA studies (Avadí and Fréon, 2013). It provides mid-point indicators. Typical categories include climate change (global warming potential), acidification, eutrophication, toxicity, and resources depletion (fossil fuels, minerals, freshwater).
- ReCiPe, which extends CML, will be used for the most typical mid-point impact categories. It will also be used for endpoint indicators (human health, ecosystems and resources), calculated from CML-compatible midpoints, and computed into a single score. ReCiPe applies an additional set of characterisation factors to transform midpoints into endpoints, and then a weighting set to calculate a single score (Goedkoop et al., 2013).
- All toxicity models used by CML, ReCiPe and USEtox feature high uncertainty. Nonetheless, toxicity characterisation with CML was preserved because it includes characterisation factors for more substances than the other methods. CML baseline 2000 applies an infinite timeframe for characterisation of toxicity; CML 2001 and ReCiPe offer 50, 100 and infinite years. CML and ReCiPe methods implement the USES-LCA toxicity model (van Zelm et al., 2009).
- Additional methods widely used in fishfood LCA studies are suggested to complement ReCiPe results, namely Cumulative Energy Demand (CED) and Ecological Footprint (EF), which measure the total use of industrial energy (VDI, 1997) and the total time-integrated direct land occupation and indirect land occupation (Huijbregts et al., 2008), respectively.
- Additional indicators not formalised into LCIA methods yet are also recommended: Biotic Resource Use (BRU) and sea use indicators (see **Chapter 2** for details).

## References

- Avadí, A., & Fréon, P. (2013). Life cycle assessment of fisheries: A review for fisheries scientists and managers. *Fisheries Research*, 143, 21–38. doi:10.1016/j.fishres.2013.01.006
- Goedkoop, M., Heijungs, R., Huijbregts, M., Schryver, A. De, Struijs, J., & Zelm, R. van. (2013). ReCiPe 2008. A life cycle impact assessment method which comprises harmonised category indicators at the midpoint and the endpoint level. Report I: Characterisation. Ministry of Housing, Spatial Planning and Environment (VROM).
- Guinée, J. B., Gorrée, M., Heijungs, R., Huppes, G., Kleijn, R., Koning, A. de, ... Huijbregts, M. A. J. (2002). Handbook on life cycle assessment. Operational guide to the ISO standards. I: LCA in perspective. IIa: Guide. IIb: Operational annex. III: Scientific background (p. 692). Dordrecht: Kluwer Academic Publishers.
- Hischier, R., Weidema, B., Althaus, H.-jörg, Bauer, C., Doka, G., Dones, R., Frischknecht, R., et al. (2010). Implementation of Life Cycle Impact Assessment Methods. ecoinvent report No. 3. Dübendorf.
- Huijbregts, M. a. J., Hellweg, S., Frischknecht, R., Hungerbühler, K., & Hendriks, a. J. (2008). Ecological footprint accounting in the life cycle assessment of products. *Ecological Economics*, 64(4), 798–807. doi:10.1016/j.ecolecon.2007.04.017
- ILCD. (2010). International Reference Life Cycle Data System (ILCD) Handbook: Analysing of existing Environmental Impact Assessment methodologies for use in Life Cycle Assessment. European Commission, Joint Research Centre, Institute for Environment and Sustainability.
- Rosenbaum, R. K., Bachmann, T. M., Gold, L. S., Huijbregts, M. a. J., Jolliet, O., Juraske, R., Koehler, A., et al. (2008). USEtox—the UNEP-SETAC toxicity model: recommended characterisation factors for human toxicity and

freshwater ecotoxicity in life cycle impact assessment. *The International Journal of Life Cycle Assessment*, 13(7), 532–546. doi:10.1007/s11367-008-0038-4

van Zelm, R., Huijbregts, M. a. J., & Meent, D. (2009). USES-LCA 2.0—a global nested multi-media fate, exposure, and effects model. *The International Journal of Life Cycle Assessment*, 14(3), 282-284. doi:10.1007/s11367-009-0066-8

VDI. (1997). Cumulative Energy Demand - Terms, Definitions, Methods of Calculation. In: VDI-Richtlinien 4600. Verein Deutscher Ingenieure, Düsseldorf.

## Appendix D: The ReCiPe LCIA method

The ReCiPe LCIA method combines and extends previous methods, namely CML and Ecoindicator 99. It is almost fully implemented in ecoinvent (2.0 onwards).

Main features of ReCiPe include (Goedkoop, 2009; Hischier et al., 2010; ILCD, 2010):

- Three cultural perspectives, reflecting different sets of subjective choices regarding time horizons, uncertainty, etc; have been implemented:
  - Individualist (I), focusing on short term interest, using established impact categories and featuring technological optimism (e.g. time horizon for climate change and terrestrial acidification of 20 years; full adaptation to climate change; land restoration time is 100 years).
  - Hierarchist (H), focusing on the most common policy principles (e.g. time horizon for climate change and terrestrial acidification of 100 years; mean adaptation to climate change; mean land restoration times).
  - Egalitarian (E), focusing on most precautionary choices and including not fully established yet identified and explored impact categories (e.g. time horizon for climate change and terrestrial acidification of 500 years; no adaptation to climate change; maximum land restoration times)
- Regional validity is global for climate change, ozone depletion and resources, and Europe for other categories.
- Endpoint categories (areas of protection) are:
  - Human health, expressed in “disability-adjusted life years” (DALY), a figure derived from health statistics on life years lost or disabled by a wide range of diseases, which are themselves triggered or worsened by environmental conditions.
  - Ecosystem quality, expressed in “potentially disappeared fraction of species” (PDF) over area (or volume, in the case of aquatic eutrophication) and time. Such approach assumes the diversity of species properly represents the quality of ecosystems.
  - Resources, expressed in economic terms (currency), assuming the cost of resources is correlated to its availability, thus rendering a money ratio a good measure of the depletion of a specific resource providing specific functions to humans.
- The USES-LCA toxicity model is implemented in ReCiPe for characterisation of human toxicity (expressed as DALYs) and ecotoxicity (expressed as species.yr).

ReCiPe integrates and harmonises midpoint and endpoint indicators in a coherent framework, as depicted in Figure 13.

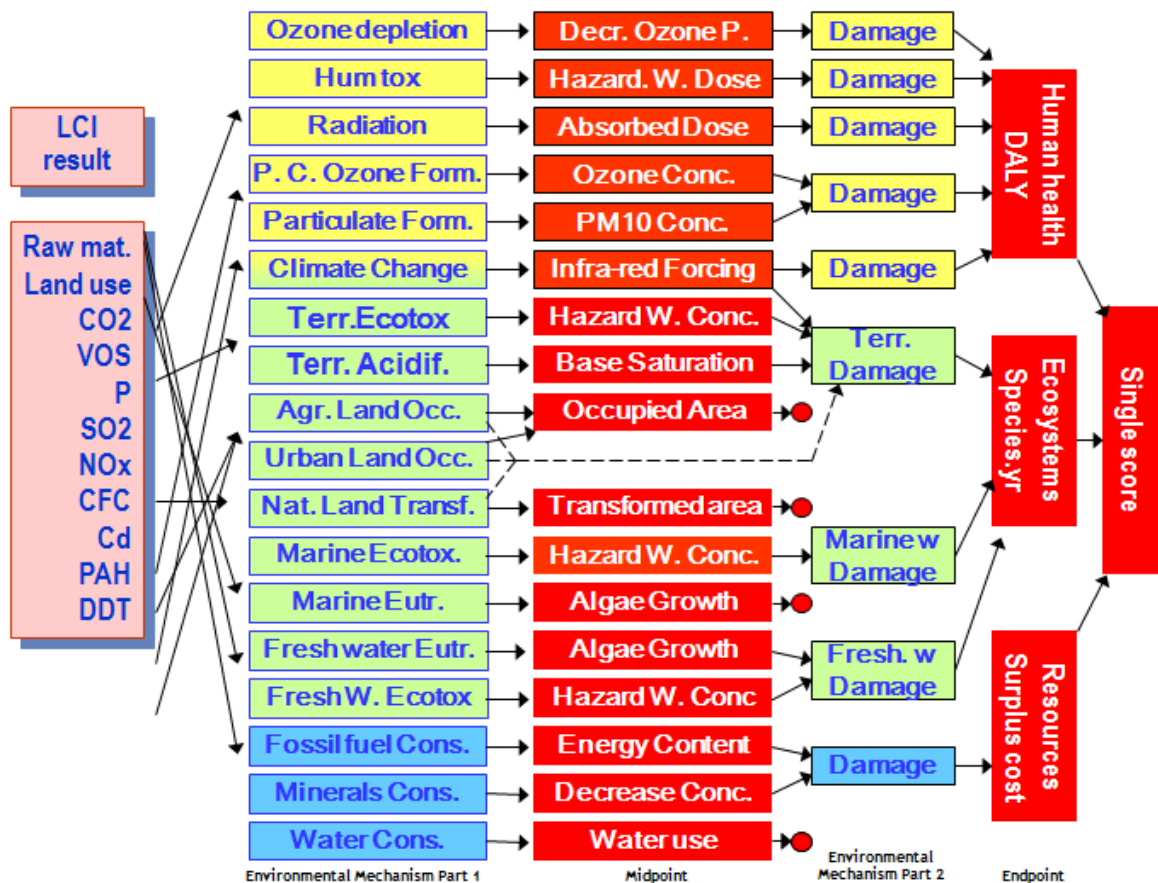


Figure 13: Midpoint and endpoint indicators used in ReCiPe

Reproduced from Hischier et al., (2010).

## References

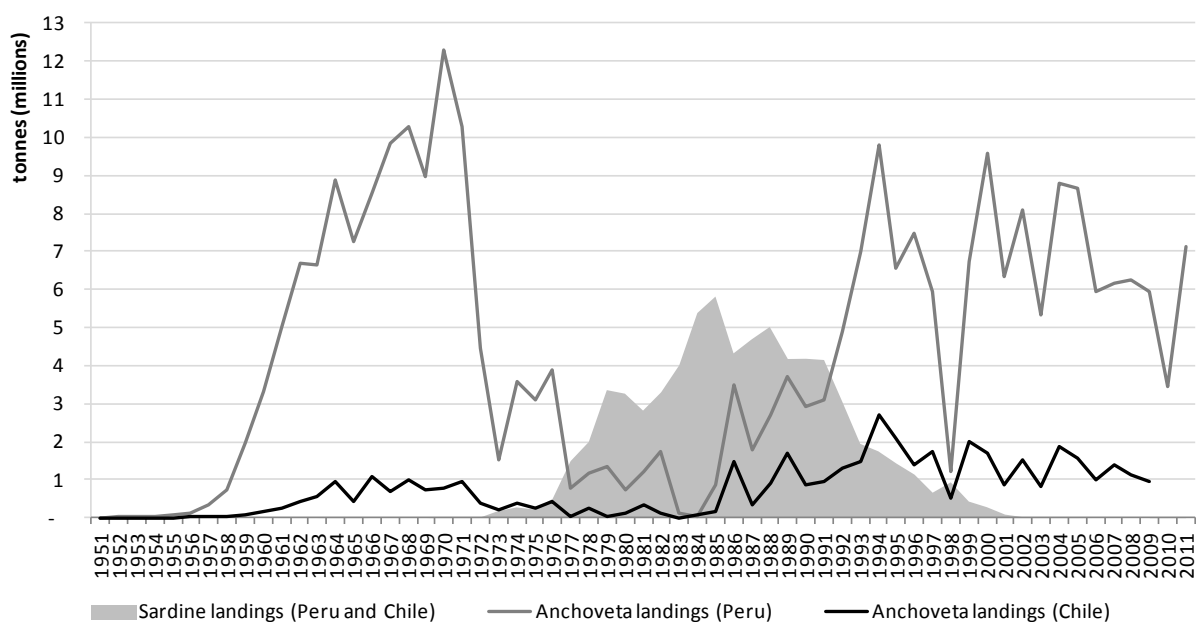
- Goedkoop, M., Heijungs, R., Huijbregts, M., Schryver, A. D., Struijs, J., & Zelm, R. V. (2009). ReCiPe 2008. A life cycle impact assessment method which comprises harmonised category indicators at the midpoint and the endpoint level. Report I: Characterisation. Ministry of Housing, Spatial Planning and Environment (VROM). Retrieved from [www.lcia-recipe.info](http://www.lcia-recipe.info)
- Hischier, R., Weidema, B., Althaus, H.-jörg, Bauer, C., Doka, G., Dones, R., Frischknecht, R., et al. (2010). Implementation of Life Cycle Impact Assessment Methods. ecoinvent report No. 3. Dübendorf.
- ILCD. (2010). ILCD Handbook: Analysing of existing Environmental Impact Assessment methodologies for use in Life Cycle Assessment. European Commission, Joint Research Centre, Institute for Environment and Sustainability.

## Appendix E: Extended introduction to the case study - the Peruvian *anchoveta* supply chains

### 1 The Humboldt Current System

The Humboldt Current System (HCS) identifies the tropical ocean area off Peru and north of Chile. The northern HCS is considered as the most productive fishing ground in the world, because it produces more fish per area than any other region. Moreover, a number of singularities characterise the HCS as follows, and determine its productivity (Chávez et al., 2008):

- It is unusually cold for its latitude, and features upwelling of cold waters which bring to the surface large volumes of nutrients for phytoplankton<sup>19</sup>, which is a critical factor for primary productivity.
- The oxygen minimum zone (OMZ) is extremely shallow, concentrating living resources close to the surface.
- The northern HCS is very sensitive to equatorial Pacific dynamics such as El Niño-Southern Oscillation (ENSO), Kelvin waves, etc; and thus is vulnerable to interannual and interdecadal climatic and ecosystem fluctuations. For instance, it has been suggested an important interdecadal variability in anchoveta abundance in the HCS, alternating abundance periods with another small pelagic: sardine (*Sardinops sagax*) (Alheit and Niquen, 2004; Fréon et al., 2008). Figure 14 depicts this phenomenon.



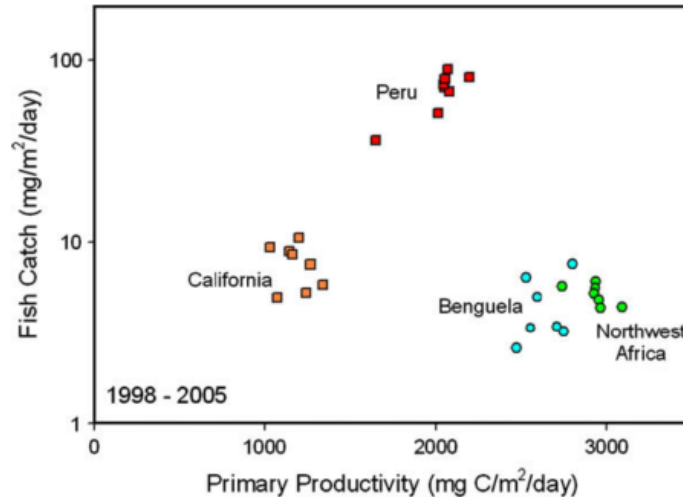
**Figure 14: Relative abundance of anchoveta and sardine in the HCS, as illustrated by annual catches (historical, 1951-2011)**

Self elaboration, based on Klyashtorin (2001) and Alheit and Niquen(2004). Statistics from FishStatJ<sup>20</sup> and PRODUCE.

<sup>19</sup> Chávez et al (1989) mentions a volume of upwelled water of  $1E+14$  m<sup>3</sup>/y and a nitrate concentration of 25 µg-at/L, yielding a flow of upwelled nitrate of  $2.50E+18$  µg-at/y (Jorge Tam, personal communication, 2012).

<sup>20</sup> FishStatJ, a tool for fishery statistics analysis. Release: 1.0.1. FAO - Fisheries and Aquaculture Department, FIPS - Statistics and information. Peruvian landings data from FishStatJ corresponds to PRODUCE.

The abovementioned combination of factors, especially due to the influence of a shallower and wider OMZ, determines the greater productivity of the northern HCS when compared with other Eastern Boundary Upwelling Ecosystems (EBUE), such as Benguela, California and Northwest Africa (Fréon et al., 2009), as depicted in Figure 15.



**Figure 15: Fish catches vs. primary productivity for the four main EBUEs (1998-2005)**

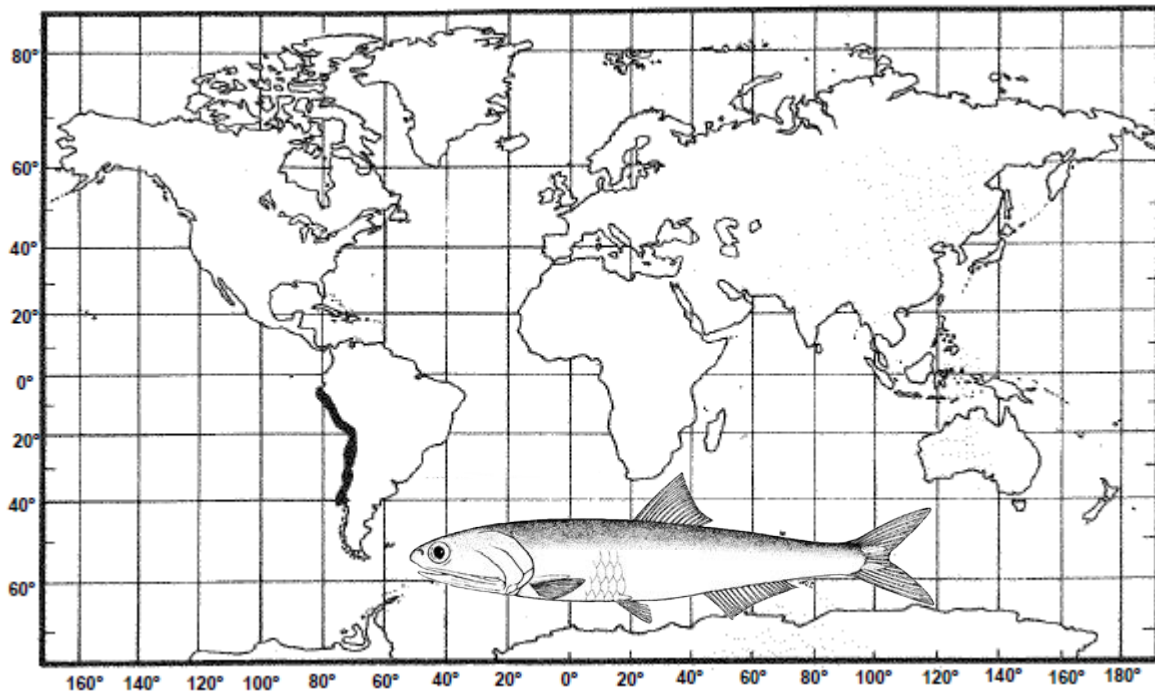
Reproduced from Chávez et al. (2008).

The HCS is extremely sensitive to climatic dynamics. Temperature anomalies associated to ENSO, Pacific regime shifts, etc; have historically produced huge changes in seabird populations and fluctuations in abundance of anchoveta and sardine<sup>21</sup>. Additionally, the pressure exerted by industrial fisheries since the 1950s has been claimed to contribute to important impacts on the ecosystem.

## 2 Engraulis ringens

*Engraulis ringens*, known in Peru as *anchoveta* (FAO name: Peruvian anchoveta) is a small pelagic fish (~20 cm long) distributed along the Eastern South Pacific, off the costas of Peru and Chile (Whitehead et al., 1988). See Figure 16.

<sup>21</sup> Recorded ENSO events in the 1950-2010 period include (\* denotes high impact on fisheries off Peru): 1953, 1957-58, 1963-62, 1965-66, 1972-73\*, 1976-77, 1977-78, 1982-83\*, 1986-88, 1991-92, 1993, 1994-95, 1997-98\*, 2002-2003, 2004-2005, 2009-2010\* (Talledo, 2010).



**Figure 16: Geographical distribution of anchoveta**

Reproduced and adapted from Whitehead et al. (1988).

Anchoveta dwells in very large schools within the continental platform, mainly up to 80 km off the coast. Anchoveta feed on plankton by filter-feeding, and migrates vertically between the surface (at night) and up to 50 m (in daytime) (Whitehead et al., 1988). The species is very sensitive to the OMZ and to ENSO events (Bertrand et al., 2010). Anchoveta is a key species in the Humboldt Current System, being consumed by multiple predators, namely fish, cephalopods, birds, mammals and fisheries (Werner et al., 2008).

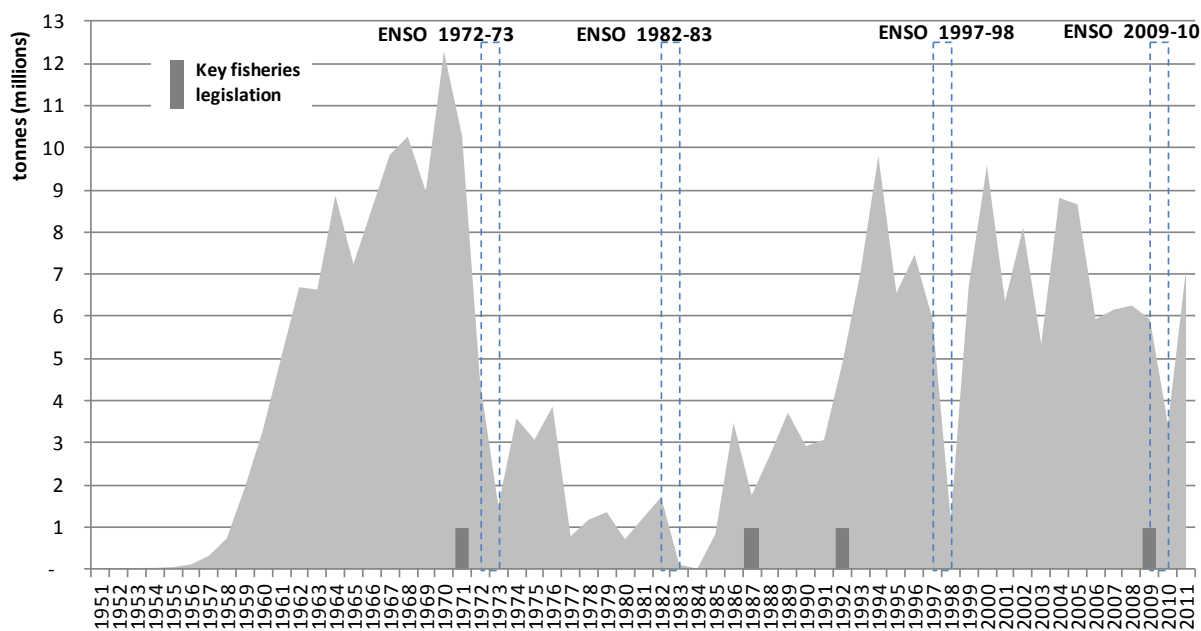
### 3 Institutions

The main institutions governing and researching fisheries and fishfood industries in Peru are the Peruvian Ministry of Production (PRODUCE, <http://www.produce.gob.pe/>), the Peruvian Institute of the Sea (IMARPE, <http://www.imarpe.pe/imarpe/>), the Technological Institute for Production (formerly Technological Institute for Fisheries, ITP, <http://www.itp.gob.pe/webitp/>), and FONDEPES (National Fisheries Development Fund, <http://www.fondepes.gob.pe/>).

### 4 The anchoveta fishery

The modern anchoveta fishery started in Peru around 1955, parallel to the decline of the previously economically relevant guano industry. The 1957-58 ENSO event decimated guano-producing seabird populations, coinciding with further development of the anchoveta fishery. During the 1960s the fleet and the fishery grew continuously until 1970, peaking with the largest historical harvest of 12.3 million tonnes, representing 20% of that year's world catch (Chávez et al., 2008). In 1972, the anchoveta stock collapsed, probably due to a strong ENSO event in combination with high fishing pressure, leading to a slow recovery of the anchoveta stock and catches as well as changes in fisheries management and legislation (Arias, 2011) as shown in Figure 17. In the 2000-2009 period catches were stable in comparison with historical landings, averaging 7.1 million tonnes annual. In 2010, an ENSO event and management measures reduced landings to 3.4 million tonnes (Tveteras et al., 2009, SOFIA, 2012).





**Figure 17: Historical annual anchoveta landings and critical ENSO and policy events (1951-2011)**

Self elaboration, based on Arias (2011) and statistics from FishStatJ<sup>22</sup> and PRODUCE.

Table 13 depicts an abridged history of the Peruvian anchoveta fishery.

**Table 13: Brief history of the Peruvian anchoveta fishery**

Adapted from IFFO (2009).

| Decade | Key events  |
|--------|---|
| 1950s  | <ul style="list-style-type: none"> <li>Private firms begin to specialise in processing anchoveta to produce fishmeal and fish oil. Improved fishing technology and increased demand for livestock feed propel fishmeal as a valuable global commodity.</li> <li>Peruvian fishing fleet became equipped with sonar equipment to locate fish shoals. Lightweight nylon nets introduced to fishing industry to replace less efficient cotton nets. Anchoveta accounted for about half of the world's fishmeal production.</li> </ul>   |
| 1960s  | <ul style="list-style-type: none"> <li>Peru becomes the world's leading fishing nation in terms of volume. Fishmeal processing plants peak at 154 plants.</li> <li>In 1964, Peru harvests 18% of total world fish catch, and produced about 40% of total world supply of fishmeal.</li> <li>Fish products account for 25 to 30% of total export earnings, and become leading export sector. Anchoveta accounts for 99% of fishmeal production.</li> <li>Signs of overfishing on north and central coasts appear in the mid 60s. Fishing fleets begin to explore untapped fishing grounds of the south coast.</li> <li>Fishing companies try to remain competitive by increasing investment in new, larger fishing boats. Industry now able to process 16 million tonnes of anchoveta annually.</li> </ul> |
| 1970s  | <ul style="list-style-type: none"> <li>1970: FAO and the precursor of IMARPE warn that maximum sustainable yield for anchovies could not exceed 9.5 million tonnes annually.</li> <li>Anchoveta catches rise above 12 million tonnes in 1970, and 10 million in 1971, and then fall to 4 million in 1972 and 1.3 million in 1973.</li> <li>Numbers of seabirds also greatly reduces.</li> </ul>   |

<sup>22</sup> FishStatJ, a tool for fishery statistics analysis. Release: 1.0.1. FAO - Fisheries and Aquaculture Department, FIPS - Statistics and information. Peruvian landings data from FishStatJ corresponds to PRODUCE.

|       |  |
|-------|--|
|       | <ul style="list-style-type: none"> <li>• The Peruvian anchoveta industry struggles economically.</li> <li>• The military dictatorship nationalised the fishing and reduction industries, which was later sold to the private sector with huge losses for the state.</li> </ul>   |
| 1980s | <ul style="list-style-type: none"> <li>• The anchoveta stock remains low for most of the decade.</li> <li>• The biomass of other pelagic species such as sardines increases.</li> <li>• Anchoveta catches drop further at the start of the decade, with an all time low of only 22 000 metric tonnes in 1984 following a strong ENSO event.</li> <li>• Government and Industry work together to bring about a recovery of the stocks to provide a viable fishery.</li> </ul>   |
| 1990s | <ul style="list-style-type: none"> <li>• Extensive research is conducted into the Anchoveta population and strict quotas introduced, as well as closed seasons to allow for spawning.</li> <li>• Reduction in the numbers of juveniles caught.</li> <li>• Stocks begin to recover.</li> <li>• 1997-98 brings one of the strongest ENSO events ever recorded resulting in a sharp decline in the biomass.</li> <li>• Control measures ensured a rapid recovery.</li> </ul>  |
| 2000s | <ul style="list-style-type: none"> <li>• Despite another ENSO event in 2002-03 the biomass remains healthy.</li> <li>• Independent surveillance of landings.</li> <li>• Maximum Catch Limits per Vessel (individual vessel quotas) introduced.</li> <li>• Improved protection of artisanal fishing and the environment.</li> <li>• Parachute payments and pensions for those who retire from fishing.</li> <li>• Government tackles corruption and abuses of rules to protect fishery and crews. Higher fines. Illegal licences revoked.</li> <li>• Ecosystem based approach to stock management initiated.</li> </ul> |

Peruvian fisheries are ruled by the currently valid Fisheries Act (Decree Law 25977 of 1992), and its applicable bylaw regulation (Supreme Decree 12 of 2001, Supreme Decree 5 of 2012; among others). According to such legislation, the Peruvian fishing fleet is divided as follows (de la Puente et al., 2011):

- Small-scale<sup>23</sup>, which includes vessels with up to 10 m<sup>3</sup> of holding capacity and featuring equipment and fishing systems considered as “artisanal”, that is to say, with pre-eminence of manual work. Most of those vessels are wooden.
- Medium-scale, which encompasses vessels with more than 10 m<sup>3</sup> and up to 32.6 m<sup>3</sup> of holding capacity and up to 15 m length, yet featuring modern equipment and fishing systems. The segregation between artisanal and minor scale can be blurry due to discrepancies between the official, authorised holding capacity and the actual one.
- Large-scale, or industrial, which encompasses vessels with a holding capacity over 32.6 m<sup>3</sup>. Those vessels are either wooden (with holding capacity of up to 110 m<sup>3</sup>, nicknamed “Vikingas”, and mostly targeting anchoveta) or steel hulled (higher limit for holding capacity over 800 m<sup>3</sup>). The wording “industrial fleet” normally refers to both the industrial steel fleet and the Vikinga fleet. More than 60% of steel industrial vessels feature a holding capacity between 155 and 395 m<sup>3</sup>.

As of 2012, approximately 660 industrial steel vessels (operating directly under regime Decree Law 25977) target anchoveta for reduction. Additionally, almost 700 wooden semi-industrial Vikingas (operating under regime Law No. 26920) target anchoveta for reduction, and ~1400 small- and medium-

<sup>23</sup> A discussion on literature definitions of small-scale and medium-scale is available in section 4.2.2.

scale (SMS) wooden vessels target anchoveta (among other species) for direct human consumption (DHC)<sup>24</sup> and ~9 000 industrial vessels target other species (medium-size pelagic species and demersal ones). There is no single trustable inventory of the extensive artisanal/smaller scale wooden fleet, including a 2012 INEI census (INEI, 2012), which was methodologically flawed. The SMS fleet encompasses between ~10 400 vessels, according to IMARPE statistics (PRODUCE official statistics are highly incomplete, reporting between 5 000 and 6 000 vessels). This later fleet is largely multi-gear and multi-target species. Table 14 shows key indicators of the anchoveta fleets.

**Table 14: Size of the Peruvian anchoveta fleet (2012)**

Self elaboration, based on PRODUCE and IMARPE statistics. There is no comprehensive inventory of the total artisanal fleet; figures are based on estimations, sampling and partial surveys by IMARPE and PRODUCE.

| Fleet                              | Destination | Number of fishing units (2012) | Holding capacity range in m <sup>3</sup> | Holding capacity in m <sup>3</sup> (2012) | Historical annual landings in tonnes (2005-2010) |
|------------------------------------|-------------|--------------------------------|--|---|--|
| Industrial steel                   | IHC         | 661                            | 47 – 870                                 | 192 489                                   | 4 189 494  |
| Industrial wooden (Vikingas)       | IHC         | 696                            | 32.6 – 110                               | 44 672                                    | 976 334  |
| Artisanal and smaller scale wooden | DHC         | ~1 400                         | <1 – 32.6                                | ~16 500                                   | 140 307  |
|                                    | IHC (IUU)*  |                                |  |   | 331 788  |
| Total:                             |             |                                |  |   | 5 637 923  |

\* Anonymous personal communications with Peruvian fisheries experts, 2011-2013; and journalistic notes.

Overcapitalisation/overcapacity affects the anchoveta-targeting fleets and reduction industries. It is largely due to the existence of a semi-regulated open access system, in place until the 2008 fishing season included, and featuring a global quota (Total Allowable Catch, TAC). Overcapitalisation is still substantial in Peru; in 2007 the fishing fleet was estimated to be between 2.5 and 4.6 times its optimal size (Fréon et al., 2008; Paredes, 2010), while in 2011 it was between 2 and 3 times its optimal size (Paredes, 2012).

The Peruvian anchoveta fishery operates in two well-defined coastal areas in the South Pacific: the north-central area (between parallels 4°S and 14°S) and the south area (between parallels 15°S and 18°S, which continues in Chile between parallels 19°S and 24°S). The proportion of the Peruvian catches in the south area varies between ~8 to 15% of the national catches. The 14°S limit is believed to separate two anchoveta stocks (or sub-stocks) inhabiting the north-central and south areas respectively (Serra, 1983) although this limit is fluctuating according to environmental conditions (in particular during ENSO events), to the extent that the present concept of stock structure for this species is controversial by part of the scientific community.

Two papers were produced analysing environmental performance of various segments of the anchoveta fishery, using LCA, and are presented in sections 4.2.1 and 4.2.2.

## 5 The reduction industries

Fishmeal plants produce fishmeal as main product and fish oil as co-product. Fishmeal is used worldwide as an ingredient for cultured animal feeds, in the following proportions: aquaculture 62%, pigs 22%, poultry 8% and other animals 8% (IFFO, 2008). Inclusion of fishmeal and fish oil in aquafeeds is in

<sup>24</sup> PRODUCE listing of fishing vessels (<http://www.produce.gob.pe/index.php/embarcaciones-pesqueras/consulta-en-linea-de-embarcaciones-pesqueras>).

continuous diminishing (Tacon et al., 2011), to the extent that alternative protein sources become available and its effectiveness is demonstrated. Despite this decrease, the absolute and relative shares of fishmeal and fish oil in aquaculture are increasing, due to the large increase of this sector. From the fishmeal used for aquaculture, in 2008, the top three consuming species were shrimps (~27%), marine fish (~19%) and salmon (~14%); while the three top consumers of fish oil were salmon (~37%), marine fish (~25%) and trout (~17%) (Tacon et al., 2011; SOFIA, 2012). Use of fish inputs for non-fish animal feeds has decreased steadily in the last decades: despite the fact that aquafeeds represent only less than 4% of the global production of animal feeds (Alltech, 2012; Tacon et al., 2011), aquafeeds consumed ~49% of all fishmeal produced in 2008 (Silva and Turchini, 2008). Peruvian fishmeal represents 30%-35% of the world's supply (IFFO, 2009).

In Peru, more than 98% of fishmeal produced is derived from anchoveta. Plants can be classified into three categories, according to the technology used and product quality obtained (Jiménez and Gómez, 2005; Paredes and Gutiérrez, 2008; Peruvian product labels):

- Conventional plants, producing fair average quality (FAQ) fishmeal by means of direct heat drying. FAQ fishmeal features ~64% protein and up to 12% lipid content.
- High protein content (HPC) fishmeal producing plants, by means of indirect (steam, hot air) drying; produce high quality, prime and super-prime fishmeals with higher protein content (67%-70%) and digestibility, as well as lower lipid content (up to 10%).
- Residual plants process fish residues, and produce lower grade fishmeal (up to 55% protein).

There were 160 industrial fishmeal plants in Peru as of 2012, but not a single registered artisanal fishmeal plant, according to PRODUCE statistics (which does not consider low quality fishmeal dried by direct sun exposure, still practiced in Peru). Geographical distribution of plants is as follows: 50% is concentrated in the northern coastal region (mainly in Chimbote and Chicama), 35% in the central region (Lima, Ica) and the remaining 15% in the southern region (Arequipa and Moquegua) (Centrum, 2009).

The reduction industry features great overcapacity: in 2007 the industry was 3 to 9 times its optimal size (Fréon et al., 2008; Paredes, 2010). The 1992 General Fisheries Act prohibited further expansion in installed capacity of reduction plants, nonetheless the sector privatisation in the 90s and a large number of mergers and acquisitions between 2006 and 2008 contributed to concentrate<sup>25</sup> the sector and worsen the overcapacity issue (Paredes, 2010), as shown in Table 15. A shift towards better technology, and thus better and more lucrative product, is noticeable in the increase in high protein content processing capacity and production (FAQ: from 37.6% in 2010 to 34% in 2011; prime fishmeal: from 62.4% in 2010 to 66% in 2011) (SNP, 2010, 2011).

**Table 15: Changes in industrial fishmeal plant capacity in Peru (2000-2012)**

Self elaboration, based on PRODUCE statistics<sup>26</sup> and Juan Carlos Sueiro (personal communication, 2012).

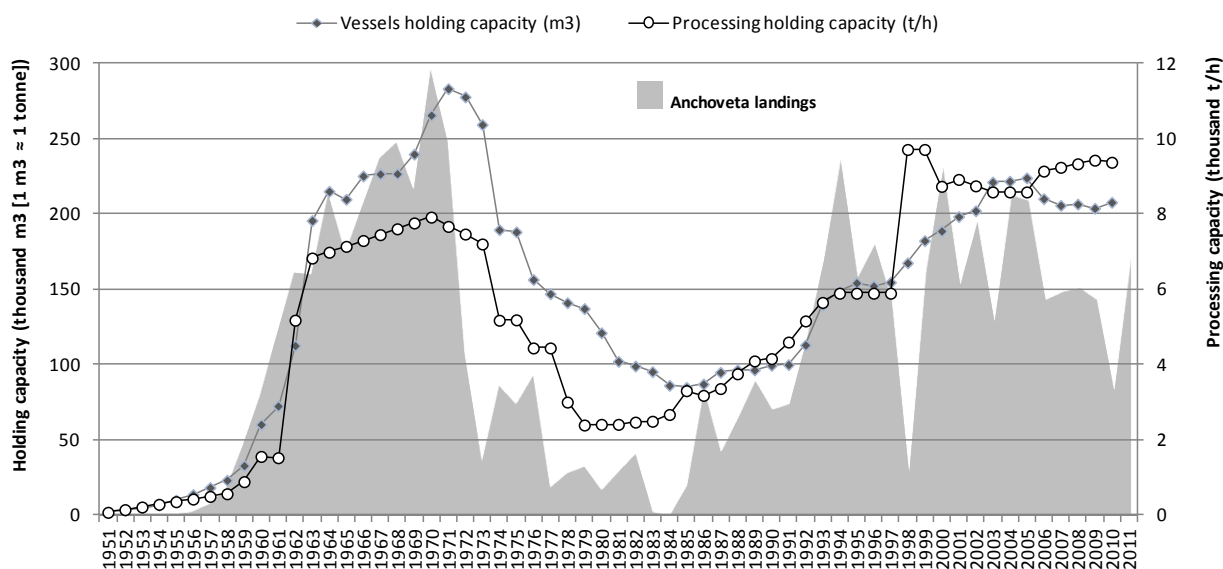
---

<sup>25</sup> By 2009, the larger seven fishing/processing companies (Austral, CFG, COPEINCA, Diamante, Exalmar, Hayduk and TASA) concentrated 70% of the national production of fishmeal and fish oil, and over 50% of fish-related exports (Centrum, 2009; Paredes, 2010).

<sup>26</sup> PRODUCE list of reduction and other fish processing plants (<http://www.produce.gob.pe/index.php/plantas-pesqueras/consulta-en-linea-de-plantas-pesqueras>)

| Plants               | 2000       |                     |                          | 2003       |                     |                          | 2006       |                     |                          | 2009       |                     |                          | 2012       |                     |                          |
|----------------------|------------|---------------------|--------------------------|------------|---------------------|--------------------------|------------|---------------------|--------------------------|------------|---------------------|--------------------------|------------|---------------------|--------------------------|
|                      | No.        | Capacity (tonnes/h) | Contribution to capacity | No.        | Capacity (tonnes/h) | Contribution to capacity | No.        | Capacity (tonnes/h) | Contribution to capacity | No.        | Capacity (tonnes/h) | Contribution to capacity | No.        | Capacity (tonnes/h) | Contribution to capacity |
| Conventional (FAQ)   | 85         | 6,310               | 72%                      | 81         | 6,052               | 69%                      | 76         | 5,463               | 60%                      | 70         | 4,989               | 53%                      | 43         | 2,569               | 28%                      |
| High protein content | 33         | 2,286               | 26%                      | 38         | 2,621               | 30%                      | 50         | 3,554               | 39%                      | 60         | 4,253               | 45%                      | 74         | 6,497               | 70%                      |
| Residual             | 21         | 142                 | 2%                       | 23         | 147                 | 2%                       | 20         | 126                 | 1%                       | 30         | 191                 | 2%                       | 43         | 274                 | 3%                       |
| <b>Total</b>         | <b>139</b> | <b>8,738</b>        | <b>100%</b>              | <b>142</b> | <b>8,820</b>        | <b>100%</b>              | <b>146</b> | <b>9,143</b>        | <b>100%</b>              | <b>160</b> | <b>9,433</b>        | <b>100%</b>              | <b>160</b> | <b>9,341</b>        | <b>100%</b>              |

Moreover, overcapacity in reduction capacity is historically associated to the fleet overcapacity and the landings of anchoveta (see Figure 18). Legislation forbidding the increase of both capacities has proven ineffective.

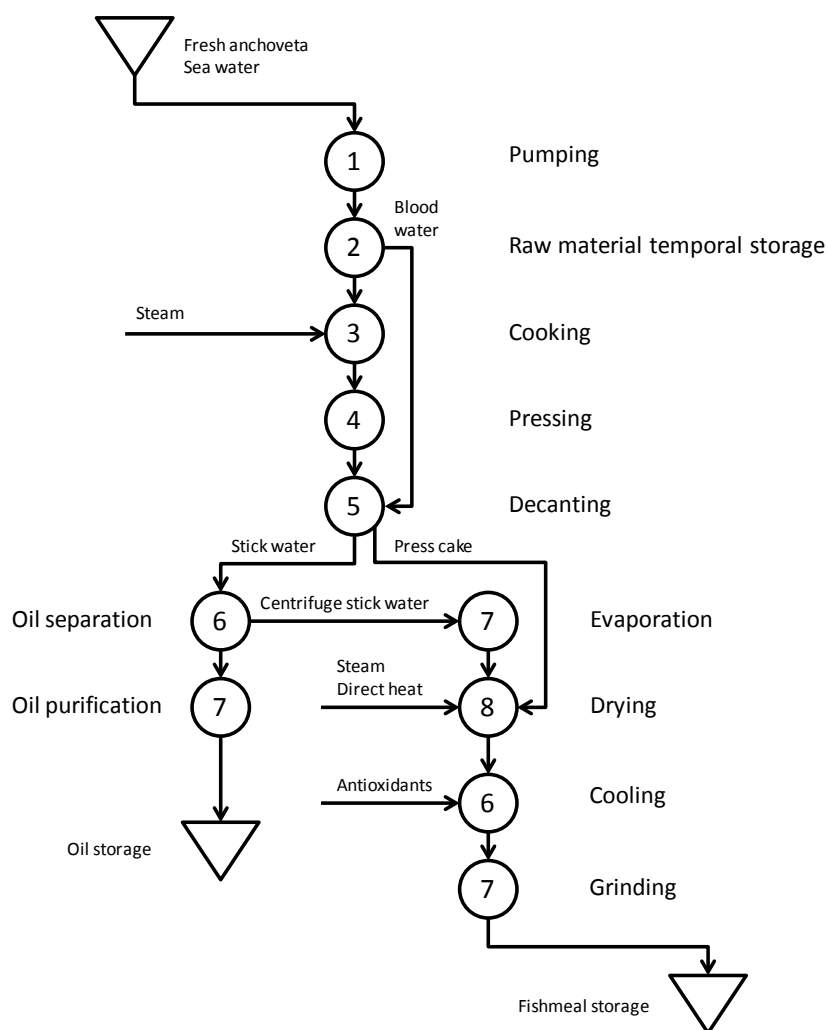


**Figure 18: Historical relation between fleet holding capacity and processing capacity (1951-2011)**

Self elaboration, based on PRODUCE and IMARPE statistics and Arias (2011).

Waste flows by the reduction industry include wastewaters with high organic load and fish oil (Jayasinghe and Hawboldt, 2011; Vidal et al., 1997). Nowadays most Peruvian plants feature a solids recovery system for their output streams.

The fishmeal and oil production process is depicted in Figure 19.



**Figure 19: Simplified flow diagram of fishmeal and oil production**

Self elaboration based on field observation and various sources (Bimbo, 2011; FAO, 1986; IFFO, 2009).

Production and export of fishmeal and fish oil is the main driver for the thriving anchoveta industries, as shown in Table 16.

**Table 16: Anchoveta landings for IHC and export figures (2001-2011)**

Self elaboration, based on INEI<sup>27</sup> and PRODUCE statistics

| Year                    | 2001      | 2002      | 2003      | 2004      | 2005      | 2006      | 2007      | 2008      | 2009      | 2010      | 2011      | Average          |
|-------------------------|-----------|-----------|-----------|-----------|-----------|-----------|-----------|-----------|-----------|-----------|-----------|------------------|
| Anchoveta landings      | 6,358,217 | 8,104,729 | 5,347,187 | 8,808,494 | 8,655,461 | 5,935,302 | 6,159,802 | 6,257,981 | 5,935,165 | 3,450,609 | 7,103,061 | <b>6,556,001</b> |
| Anchoveta for reduction | 6,347,600 | 8,082,897 | 5,335,500 | 8,797,100 | 8,628,400 | 5,891,800 | 6,084,700 | 6,159,387 | 5,828,600 | 3,330,400 | 6,994,051 | <b>6,498,221</b> |
| Fishmeal production *   | 2,034,900 | 1,562,116 | 1,416,500 | 1,807,000 | 2,067,900 | 1,367,900 | 1,284,500 | 1,585,600 | 1,584,100 | 1,119,300 | 1,235,674 | <b>1,551,408</b> |
| National consumption    | 91,800    | 46,686    | 43,700    | 53,600    | 66,400    | 25,400    | 20,700    | 20,800    | 36,700    | 33,600    | -         | <b>39,944</b>    |
| Exports                 | 1,943,100 | 1,515,430 | 1,372,800 | 1,753,400 | 2,001,500 | 1,342,500 | 1,263,800 | 1,564,800 | 1,547,400 | 1,085,700 | -         | <b>1,399,130</b> |
| Fish oil production     | 447,200   | 206,150   | 267,508   | 363,000   | 339,400   | 346,773   | 371,600   | 280,400   | 335,000   | 320,800   | 248,637   | <b>320,588</b>   |
| National consumption    | 131,800   | 45,245    | 80,800    | 78,200    | 60,600    | 58,200    | 65,900    | 41,800    | 46,800    | 69,700    | -         | <b>61,731</b>    |
| Exports                 | 315,400   | 160,905   | 186,708   | 284,800   | 278,800   | 288,573   | 305,700   | 238,600   | 288,200   | 251,100   | -         | <b>236,253</b>   |

\* all species, around 90% anchoveta

Fish to fishmeal conversion ratios in the Peruvian industry has improved from more than 5:1 in the early 1990s to 4.2:1 in the last years. Conversion ratios below 4.2 are considered as impossible in the context of Peru, although in recent years lower values were obtained from a retrocalculation of this ratio using

<sup>27</sup> Instituto Nacional de Estadística e Informática (National Institute of Statistics and Informatics, INEI), statistical compendia (<http://www.inei.gob.pe/Biblioinei4.asp>).

national total catches and national total fishmeal production; these values reflect IUU fishing activities (Paredes, 2010). Table 17 compares various national conversion ratios.

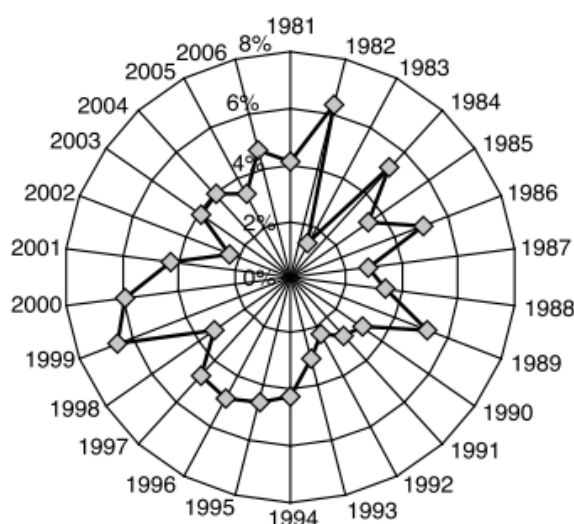
**Table 17: Fish to fishmeal and fish oil conversion ratios (2001-2006), various national averages**

Adapted from Péron et al. (2010) and PRODUCE data.

| Countries                  | Landings (t)     | Fishmeal (t)     | Fish oil (t)   | FM ratio    | FO ratio     | Species used for reduction            |
|----------------------------|------------------|------------------|----------------|-------------|--------------|---------------------------------------|
| Thailand                   | 475,500          | 499,000          | -              | 0.95        | -            | Various                               |
| China                      | 2,041,000        | 769,000          | -              | 2.65        | -            | Various                               |
| Denmark                    | 881,500          | 327,000          | 106,000        | 2.70        | 8.32         | Sandeel, sprat, blue whiting, herring |
| United States              | 909,000          | 258,000          | 88,000         | 3.52        | 10.33        | Menhaden, Alaska pollock              |
| Chile                      | 3,161,000        | 773,000          | 157,000        | 4.09        | 20.13        | Jack mackerel, anchoveta, sardine     |
| <b>Peru (this study) *</b> | <b>6,498,240</b> | <b>1,551,408</b> | <b>320,588</b> | <b>4.21</b> | <b>21.30</b> | Anchoveta                             |
| Peru                       | 7,561,000        | 1,700,000        | 270,000        | 4.45        | 28.00        | Anchoveta                             |
| Japan                      | 1,141,000        | 226,000          | 66,000         | 5.05        | 17.29        | Sardine, pilchard                     |
| Norway                     | 1,061,000        | 203,000          | 47,500         | 5.23        | 22.34        | Blue whiting, capelin, trimmings      |
| Iceland                    | 1,262,000        | 221,000          | 74,000         | 5.71        | 17.05        | Blue whiting, herring, trimmings      |

\* Based on PRODUCE reported values for 2001-2011

Fish oil conversion ratios are very fluctuating because they depend on the lipid content of anchoveta, which varies over the years, as shown in Figure 20. The average yield in the period 2001-2011 has been 21.3:1, as calculated based on INEI and PRODUCE statistics.



**Figure 20: Changes in fish oil yields as a percentage of processed raw material (1981-2006)**

Reproduced from Sueiro (2008).

Peruvian fishmeal and oil are exported, among other aquaculture-producing countries, to China, Chile and some European countries; as detailed below. The main users of those imports are shrimp, salmonids, carp, tilapia and other aquaculture systems. China is the largest consumer of FMFO for aquaculture, the bulk of the demand concentrated in tilapia and carp feeds (Chiu et al., 2013).

## 6 The processing industry for DHC

The amount of fresh anchoveta landed for direct human consumption has increased in the last decade at an average annual rate of 37%, according to PRODUCE statistics (see Table 18). Nonetheless, still only ~1% of landings are destined to DHC, which represents a poor proportion in a country with a large percentage of its population suffering from malnutrition (Fréon et al., 2010). It has been suggested that an increased use of anchoveta for DHC could contribute to solve some of the nutritional problems in

Peru and the region (Sánchez and Gallo, 2009). The topic of nutrition and anchoveta DHC is further explored in below.

**Table 18: Anchoveta landings for DHC and processing volumes (2001-2011)**

Self elaboration, based on INEI and PRODUCE statistics.

| Year                    | 2001      | 2002      | 2003      | 2004      | 2005      | 2006      | 2007      | 2008      | 2009      | 2010      | 2011      | Average          |
|-------------------------|-----------|-----------|-----------|-----------|-----------|-----------|-----------|-----------|-----------|-----------|-----------|------------------|
| Anchoveta landings      | 6,358,217 | 8,104,729 | 5,347,187 | 8,808,494 | 8,655,461 | 5,935,302 | 6,159,802 | 6,257,981 | 5,935,165 | 3,450,609 | 7,103,061 | <b>6,556,001</b> |
| Anchoveta for reduction | 6,347,600 | 8,082,897 | 5,335,500 | 8,797,100 | 8,628,400 | 5,891,800 | 6,084,700 | 6,159,387 | 5,828,600 | 3,330,400 | 6,994,051 | <b>6,498,221</b> |
| Anchoveta for DHC       | 10,617    | 21,832    | 11,687    | 11,394    | 27,061    | 43,502    | 75,102    | 98,594    | 106,565   | 120,209   | 109,010   | <b>57,779</b>    |
| % of total landings     | 0.2%      | 0.3%      | 0.2%      | 0.1%      | 0.3%      | 0.7%      | 1.2%      | 1.6%      | 1.8%      | 3.5%      | 1.5%      | <b>1.0%</b>      |
| Growth rate             |           | 106%      | -46%      | -3%       | 138%      | 61%       | 73%       | 31%       | 8%        | 13%       | -9%       | <b>37%</b>       |
| Canning                 | 3,286     | 13,364    | 4,823     | 2,631     | 14,887    | 31,000    | 61,944    | 78,851    | 84,957    | 94,234    | 84,194    | <b>43,106</b>    |
| Freezing                | 1,137     | 4,326     | 655       | 214       | 1,405     | 1,268     | 5,286     | 12,265    | 11,517    | 15,160    | 14,680    | <b>6,174</b>     |
| Fresh fish              | 398       | 9         | 392       | 320       | 348       | 538       | 401       | 336       | 293       | 223       | 44        | <b>300</b>       |
| Curing                  | 3,717     | 4,132     | 5,806     | 8,194     | 10,425    | 10,658    | 7,459     | 7,142     | 9,762     | 10,579    | 10,092    | <b>7,997</b>     |

There are three main landing centres for DHC: Paita (Piura region), Coishco and Chimbote (Ancash region), and Pisco and Tambo de Mora (Ica region). Landings in the Ica region are mostly destined to curing (salted, anchovy), while the other two regions focus on canning. Most processing plants are located in Paita and Ancash (Rokovich, 2009).

A number of issues affecting the availability of fish for DHC have been described (Clemente, 2009; Fréon et al., 2013), including:

- Bargaining power of buyers (traders, wholesalers) in comparison to fishermen's.
- Low beach prices and low beach demand.
- Poor infrastructure for landing, manipulation and preservation (cold chain).
- In some areas, competition with Chilean or Peruvian fresh/frozen fish, either legally imported or smuggled. Also, competition with industrial fleet for fresh fish.
- Lack of access to credit, informality.

Processing capacity for DHC and number of plants have varied over the years, as depicted in Table 19. Processing capacity is in general growing, yet the number of individual plants has decreased.

**Table 19: Changes in industrial DHC plant capacity in Peru (2005-2011)**

Self elaboration, based on INEI and PRODUCE statistics.

| Production type |                        | 2005    | 2007    | 2009    | 2011    |
|-----------------|------------------------|---------|---------|---------|---------|
| Canning         | No.                    | 87      | 75      | 67      | 69      |
|                 | Capacity (boxes/shift) | 191 840 | 177 650 | 174 232 | 180 733 |
| Freezing        | No.                    | 95      | 106     | 108     | 117     |
|                 | Capacity (t/day)       | 3 557   | 4 644   | 5 536   | 6 630   |
| Curing          | No.                    | 17      | 16      | 15      | 18      |
|                 | Capacity (t/day)       | 1 592   | 2 777   | 2 864   | 3 571   |

Further details on the Peruvian DHC industries and processing processes are provided in section **4.2.4**.

## 7 Distribution channels

Distribution channels for DHC function as follows (Rokovich, 2009):

- Landing in fishing ports/piers/quays, either private or state-owned (in general, lacking adequate facilities for primary processing/proper handling). Anchoveta for DHC is stored in plastic boxes



or big 1000 l plastic containers (nicknamed “dinos”), with plenty of ice; in order to be transported in isothermal trucks. A minimum amount of fresh anchoveta (0.2%; Fréon et al., 2013) is diverted to popular markets.

- Wholesalers obtain anchoveta directly from the fishing vessels, accumulate it in piers and quays and then transport it to processing plants or to distribution centres, to be further distributed by retailers.
- Processing plants for DHC normally process anchoveta into canned and cured (salted, classical “anchovy”) presentations. Many plants own private landing piers.
- Retailers distribute anchoveta products to markets, supermarkets, small shops and popular canteens.
- Export markets, mainly Europe, Central and North America, receive anchovy and canned anchoveta products.

Until today, most landing facilities for DHC fail to fulfil the requirements set by the sanitary standard for fisheries and aquaculture resources, as established by the Supreme Decree 40, 2001 (Rokovich, 2009). The lack of a cold chain for fish in Peru is a major limiting factor for the further development of domestic distribution channels.

Aquaculture products in Peru are distributed by retailers within Peru and handled by exporting firms or by the producers when exported.

## **8 Key anchoveta-based aquaculture systems**

In Peru, aquaculture has been and is historically dominated by marine species, namely scallops (*Argopecten purpuratus*) and shrimps (mainly *Litopenaeus vannamei*), and freshwater species such as trout (mainly *Oncorhynchus mykiss*), tilapia (*Oreochromis spp*) and black pacu (*Colossoma macropomum*), locally known as Gamitana (Mendoza, 2013; PRODUCE, 2009). Marine aquaculture contributes to ~81% of Peruvian cultured fishfood production, while freshwater production provides ~19% (Mendoza, 2011). A detailed description of these systems and their environmental performance is available in section 4.2.3.

Exploring the Peruvian shrimp aquaculture exceeds the scope of this work, but it is worth noticing that shrimps are the main consumers of fishmeal in Peruvian aquaculture, given its high inclusion rates in commercial feeds of 20%-50% (Amaya et al., 2007; Sun, 2009; Tacon et al., 2011; Tacon, 2002). Similarly to other fish farming systems, a key aspect of Peruvian aquaculture is the provision of feed. In Peru, both artisanal and commercial feeds are used, but the latter prevail, especially for trout.

National consumption of aquaculture products in Peru has been estimated in 0.52 kg/*per capita* in 2010, yet a growth pattern in consumption of 22% per year has been recorded (Mendoza, 2011).

## **9 Fisheries management and policy environment**

The Instituto del Mar del Perú, IMARPE, provides the scientific foundation for fisheries management in Peru, which is finally implemented by PRODUCE. IMARPE struggles between scientific and political considerations for their recommendations, due to its dependence situation with regard to PRODUCE (e.g. the Chairman of the Board of IMARPE is a political rather than technical position) (de la Puente et

al., 2011). The following specificities define management of anchoveta fisheries in Peru (de la Puente et al., 2011; FishSource, 2012; Fréon et al., 2008; Landa, 2012; Sánchez and Gallo, 2009):

- IMARPE evaluates the anchoveta population off Peru and recommends PRODUCE the annual TAC. Such estimation is performed based upon a) hydro-acoustic data collected since 1975 from 2~3 annual surveys encompassing the whole Peruvian coastline and b) modelling of anchoveta population dynamics estimated from environmental conditions and recruitment levels by means of a Virtual Population Analysis based upon the bio-economic age-structured model by Csirke and Gummy (1996)<sup>28</sup>. The recommended TAC is based on Minimum Spawning Biomass and other biological reference points (listed below), yet it is not rigorous as there is no fully documented operational management procedure. Spawning biomass is calculated using the Egg-Production Method (a meta-review is available in Bernal et al. (2012)).
- Since the north-central stock encompasses >90% of the anchoveta biomass, most regulation and legislation applies only to it, and the south-stock is exploited under an open-access regime (featuring closures related to the juvenile ratio in catches).
- The biological reference points considered for the anchoveta fishery management include the following:
  - Given that anchoveta produces two cohorts per annum, the fishing season is divided accordingly: sub-seasons start in April and October, and two closures take place in February and August.
  - Juvenile ratio should not exceed 10% of captures in any vessel (otherwise non-scheduled closures are imposed).
  - Fishing Mortality should never exceed the Natural Mortality rate (0.8).
  - Minimum Spawning Biomass must be kept to 5 million tonnes.
  - TAC for a period should not exceed 40% of the estimated biomass for the same period, being used in practice a precautionary limit of 33%. TAC has been kept in the last years between 5 and 8.5 million tonnes.
- Entry of new industrial fishing vessels is restricted.

---

<sup>28</sup> “Csirke and Gummy model simulates population dynamics for Peruvian anchovy of the Northern-central stock and its interaction with Peruvian pelagic industrial fishery, incorporating environmental variability at stock-recruitment levels, negative compensation changes in the capturability coefficient ( $q$ ), interactions with sardine populations (*Sardinops sagax*), and impacts caused by possible changes in fishing mortality and fishing regulations over anchovy populations and the fishery’s economical profit. This model reproduces population’s and fishery’s main indicators, such as recruitment, biomass and total catch observed between 1950 and 1995. It is used to simulate scenarios under different management strategies by modifying fleet size, total capacity of processing plants, fishing effort, fishing mortality and TAC. Based on its results, recommendations are made to ensure resource conservation, fishery sustainability and higher profits along mid and long-terms taking into account observed environmental variability. IMARPE updates this model continuously.” FishSource (2012). Population dynamics and bio-economic models applied in Peru successfully explain environmental effects on biomass. It seems that surplus production models alone would not suffice for setting a TAC, but IMARPE uses Catch Per Unit Effort (CPUE) and the Schaefer surplus production model for projecting biomass estimations, in addition to hydro-acoustic surveys and the age-structured model (Landa, 2012).

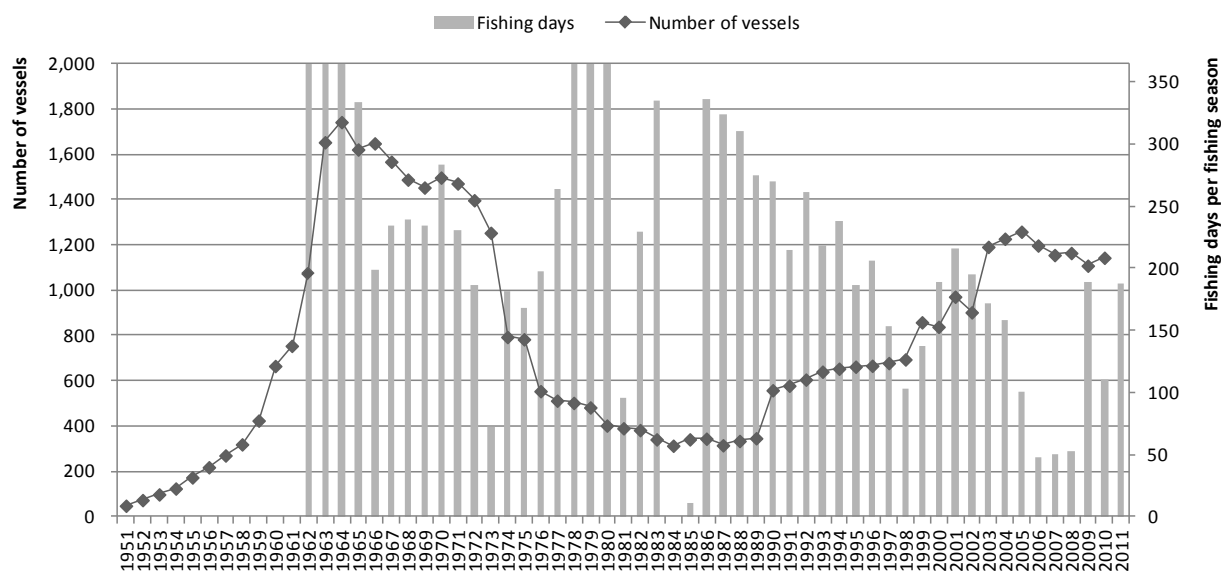
- Licensing is required to operate within the 200 nautical miles limit, and vessels operating outside the 5-mile limit (reserved for spawning protection and artisanal fleet) must be fitted with a satellite tracking system.

Current Peruvian management and policy environment, especially regarding anchoveta fisheries and processing; aim for establishing an Ecosystem Approach to Fisheries (EAF). Thus, policies are (in theory) based on the principles of protection of ecosystems, implementation of clean technologies, preservation of biodiversity, social justice, and sustainable use of marine resources (IFFO, 2009).

Variations in anchoveta landings (as depicted in Figure 17), are due in part to ENSO events and other natural variability, but also to fishery management and policy. Poor management contributed to a large extent to the anchoveta collapse of 1972 (along with a regime shift and an ENSO event) and subsequent period of 15 years of low catches. Moreover, Peru experienced between the 1960s and 1990s a variety of political regimes<sup>29</sup>, which determined important changes in the policy environment and economic conditions for the anchoveta industries. Such succession of regimes did not foster solid fisheries management neither the strengthening of meso-institutions (Tveteras et al., 2009).

Since the early 1990s, a number of legislative pieces were introduced and regulate fisheries management nowadays, with mixed effects. For instance, the drop in catches to 3.4 million tonnes in 2010 was mostly due to management measures applied to protect a large juvenile ratio (direct consequence of a La Niña event followed by an ENSO event, as depicted in Figure 17). Thanks to that management decision, 2011 catches even exceeded 2009 levels (SOFIA, 2012).

Other effects of legislation are still unfolding in the Peruvian anchoveta fishery and reduction industries. For instance, before 2008 legislation introducing individual vessel quotas (IVQ), up to 1200 vessels competed for the TAC in a nicknamed “Olympic race”, reducing the annual fishing season to 50 days (Aranda, 2009; Paredes, 2010) as shown in Figure 21.



**Figure 21: Fleet size vs. duration of the anchoveta fishing season (historical, 1951-2011)**  
Self elaboration, based on PRODUCE statistics, Aranda (2009) and Paredes (2010).

<sup>29</sup> A military populist regime, democratic periods, and a civil right-wing dictatorship.

Fishing companies have reacted to the IVQ regime in various ways, for instance, large vertically integrated companies encompassing fishing and reduction are using their more efficient vessels to harvest their company-wide quotas (IVQ are transferable within the same company) (Aranda, 2009; Paredes, 2010). This will eventually lead, as intended, to a reduction in fleet overcapacity, but has spawned several other consequences (Paredes, 2010):

- Because overcapacity in the reduction industry is larger than in the fleet, and that legislation has not addressed that issue; larger companies with fleet and plants have better opportunities to hoard anchoveta. Those reduction companies without their own fleet purchase fresh anchoveta from independent fleet operators, and must compete with vertically integrated companies<sup>30</sup> for those resources at increasing prices (prices for fresh anchoveta are now disconnected from the international fishmeal prices).
- The rising prices of “independent” fleet anchoveta have increased the incentives for “black fishing” and under-reporting.

Most legislation regulates the activities of industrial, large scale vessels, while the SMS fleet (defined as featuring a holding capacity under 32.6 m<sup>3</sup>, and consisting mostly of wooden ships) is highly unregulated and practically operates in an open-access regime (Alfaro-Shigueto et al., 2010). Regulation for artisanal fisheries includes the exclusive use of the sea within 5<sup>31</sup> nautical miles (NM), holding capacity, length, manual labour, mesh size for nets, prohibition of beach seines, minimum catch sizes for some species, and protection for cetaceans, turtles and seabirds (Alfaro-Shigueto et al., 2010, Estrella and Swartzman, 2010).

In general, it is considered by researchers that Peruvian anchoveta-related legislation is either insufficient, ineffective or poorly enforced (de la Puente et al., 2011; Paredes, 2010; Tveteras et al., 2009). Moreover, a number of issues permeate the enforcement of Peruvian fisheries legislation and management guidelines, including (Paredes, 2012; personal communication with various researchers and experts):

- The scale of information availability in the whole Peruvian fisheries and fishfood processing industry decreases dramatically in the following order: IHC, DHC, artisanal operations, transport and commercialisation (Juan Carlos Sueiro, personal communication, 01.2013).
- There is a significant level of “cloned” and other illegal fishing vessels, and in general the number of vessels and fishermen continue growing despite the limiting nature of legislation. Despite it is forbidden by legislation that new artisanal fishing vessels are built, yet the Navy continues authorising new vessels (and charging a fee for the construction inspections). Moreover, illegal vessel construction continues highly unmolested by the authorities.
- Unreported, under-reported and “black” fishing (illegal catches) are common. For instance, small scale artisanal fishing vessels, which are not allowed to fish anchoveta for reduction, are

---

<sup>30</sup> The six larger vertically-integrated fishing/processing companies (Austral, CFG, COPEINCA, Diamante, Hayduk and TASA) harvested in average 48% of the national landings between 2008 and 2010, and the ongoing trend is that such share of captures for those companies will much likely increase (Federico Iriarte, personal communication, 2012). The seventh larger company, Exalmar, was excluded from this analysis due to lack of access to data.

<sup>31</sup> The medium-scale fleet (10 to 32.6 m<sup>3</sup> vessels) has exclusivity to the area between 5 and 10 NM, while the industrial fleet is allowed to fish beyond the 10th NM. Recently (late 2013), a decisión by the Peruvian Supreme Court deemed such exclusions unconstitutional.

commonly providing residual fishmeal plants, which are not allowed to use fresh fish as raw material, but should only use residues from fish processing. Moreover, some artisanal vessels use insufficient amount of ice or deliberately delay landing, so that captures spoil to the point that are not suitable for DHC and are then deviated to reduction plants. Additionally, there is no match between DHC installed capacity and holding capacity of the artisanal fleet for DHC.

- There are illegal and unregulated fishmeal plants in operation. Moreover, it has been suggested that in many cases, combined processing for DHC and residual fishmeal processing, the latter justified as a solution for residues management; are in fact oriented to Prime fishmeal production, thus deviating large percentages of raw material (Pablo Echevarría, personal communication, 03.2013). Both legal and illegal theoretically residual fishmeal plants often commission artisanal vessels to illegally catch anchoveta for them.
- Illegally produced high quality fishmeal is “washed” by brokers, who combine it with legally produced high quality fishmeal and commercialise it together as larger production batches (hence affecting, as previously mentioned, the *post facto* calculated conversion rates).
- There is a generalised lack of compliance with regulations mandating proper solid and liquid waste management from fishing vessels and processing plants. For instance, used lubricating oils from marine engines are often disposed at sea, as well as process waters from reduction and fish processing plants (some plants lack solids recovery systems for their process waters, despite the fact it is required by legislation).
- It has been suggested that large vertically-integrated reduction companies overpay independent fishermen targeting anchoveta for IHC, in such a way that they monopolise their offer thus preventing smaller, non vertically-integrated companies from obtaining a sufficient share of the TAC. Indeed prices for raw anchoveta destined to reduction have risen since the individual quota system entered into force in 2009.

Other challenges to coastal and fisheries management in the country have been discussed by Peruvian experts, and recently summarised in a consensus report (OANNES, 2012):

- Low level of resources devoted to scientific and technological research.
- Professional profile of marine biologists and fisheries engineers is outdated and requires modernisation and resources.
- Multi-sector research and management of the economy is required, taking into account socio-economic factors.
- Better support (e.g. meso institutions, better supply chain and value chain infrastructure such as landing quays and cold storage, legislation changes, etc) for the artisanal fisheries is needed.
- Better governmental and corporate social responsibility, as well as improved environmental education and awareness are required.
- Fishfood certifications are needed.
- A comprehensive legal reform for the fisheries sector is required.

Despite all those problems, Peruvian fisheries are in general considered among the most sustainably managed ones in the world (Alder and Pauly, 2008; FishSource, 2012).

## 10 Impacts of climate change on fisheries and related industries

Actual and potential impacts of climate change in world fisheries and related industries have been discussed in literature (e.g. Sumaila et al., 2011; Barange et al., 2014), and the generalised conclusion is that climate change, on top of the effects of overfishing, pollution and habitat degradation; is likely to affect primary productivity, species and stocks distribution and catchability. Regarding the Humboldt Current System off Peru, it has been suggested that climate change would alter the upwelling conditions (volume of nutrients, turbulence, oxygen levels) which currently determine primary productivity on which anchoveta and all other species of the HCS trophic web rely (Bertrand et al., 2010; Gutiérrez et al., 2011; Brochier et al., 2013). Changes reducing abundance and catchability would have moderate to strong negative socio-economic consequences for Peru.

## 11 Socio-economics of the anchoveta supply chains

Fisheries and fishfood products, and especially exports of fishmeal and fish oil, represent the third individual source of foreign exchange for the Peruvian economy (in average, 8% of earnings in the period 2000-2011), as shown in Table 20.

**Table 20: Top sectors contributing to the Peruvian economy**  
Self elaboration, based on SUNAT<sup>32</sup> statistics.

| Exports                        | 2000         | 2001         | 2002         | 2003         | 2004          | 2005          | 2006          | 2007          | 2008          | 2009          | 2010          | 2011          | Contribution |
|--------------------------------|--------------|--------------|--------------|--------------|---------------|---------------|---------------|---------------|---------------|---------------|---------------|---------------|--------------|
| Mining products                | 3,267        | 3,263        | 3,877        | 4,763        | 7,218         | 9,790         | 14,707        | 17,604        | 18,556        | 16,629        | 22,155        | 27,518        | 59%          |
| Oil and gas products           | 381          | 391          | 451          | 621          | 646           | 1,526         | 1,760         | 2,306         | 2,681         | 1,921         | 3,088         | 4,705         | 8%           |
| Fisheries products *           | 1,131        | 1,123        | 1,056        | 1,026        | 1,381         | 1,626         | 1,767         | 1,964         | 2,425         | 2,210         | 2,535         | 3,151         | 8%           |
| Agricultural (animal products) | 394          | 437          | 550          | 624          | 801           | 1,008         | 1,216         | 1,512         | 1,917         | 1,827         | 2,202         | 2,843         | 6%           |
| Textiles                       | 701          | 664          | 667          | 823          | 1,092         | 1,275         | 1,471         | 1,736         | 2,025         | 1,495         | 1,561         | 1,991         | 6%           |
| Agricultural (crops)           | 249          | 207          | 216          | 224          | 325           | 331           | 573           | 460           | 686           | 637           | 975           | 1,684         | 3%           |
| Others                         | 832          | 940          | 887          | 1,009        | 1,347         | 1,812         | 2,306         | 2,502         | 2,999         | 2,356         | 3,293         | 4,109         | 10%          |
| <b>Total</b>                   | <b>6,955</b> | <b>7,025</b> | <b>7,704</b> | <b>9,090</b> | <b>12,810</b> | <b>17,368</b> | <b>23,800</b> | <b>28,084</b> | <b>31,289</b> | <b>27,074</b> | <b>35,807</b> | <b>46,001</b> | <b>100%</b>  |

All figures are FOB values in USD Mio. \* Only fishmeal and fish oil, excluding national consumption (33,600 t and 69,700 t in 2010, respectively, according to INEI statistics).

China and Germany are the larger importers of Peruvian fishmeal, while Denmark and Chile are the main importers of fish oil. Most of Peruvian fishmeal, which is dominantly of very high quality, is destined to aquafeeds. Peruvian fishmeal and oil trade is presented in Table 21.

<sup>32</sup> SUNAT, Superintendencia Nacional de Aduanas y de Administración Tributaria, Peruvian government authority for customs and taxes, <http://www.sunat.gob.pe/estadisticasestudios/index.html>.

**Table 21: Peruvian exports of fishmeal (tariff group 2301) and fish oil (tariff group 150420), per destination (2007-2011)**

Self elaboration, based on TradeMap<sup>33</sup> data.

|                 | 2007      | 2008      | 2009      | 2010      | 2011      | Average   | Contribution | Primary use *          |
|-----------------|-----------|-----------|-----------|-----------|-----------|-----------|--------------|------------------------|
| <b>Fishmeal</b> |           |           |           |           |           |           |              |                        |
| World           | 1,225,483 | 1,428,186 | 1,440,431 | 1,623,029 | 1,781,684 | 1,499,763 | 100%         | ?                      |
| China           | 507,652   | 740,841   | 677,152   | 846,031   | 1,042,229 | 762,781   | 51%          | Shrimp, carps, tilapia |
| Germany         | 161,825   | 170,377   | 266,179   | 183,315   | 157,675   | 187,874   | 13%          | Trout                  |
| Japan           | 160,611   | 140,801   | 112,715   | 174,383   | 135,625   | 144,827   | 10%          | ?                      |
| Chile           | 10,649    | 29,226    | 5,667     | 60,287    | 74,868    | 36,139    | 2%           | ?                      |
| Viet Nam        | 44,089    | 57,707    | 59,531    | 58,252    | 64,905    | 56,897    | 4%           | ?                      |
| Others          |           |           |           |           |           | 311,244   | 21%          |                        |
| <b>Fish oil</b> |           |           |           |           |           |           |              |                        |
| Denmark         | 62,153    | 46,055    | 48,645    | 38,541    | 76,272    | 54,333    | 18%          | Trout                  |
| Chile           | 68,465    | 70,467    | 14,937    | 54,738    | 53,314    | 52,384    | 17%          | Salmon                 |
| Belgium         | 38,266    | 78,141    | 46,162    | 36,330    | 46,148    | 49,009    | 16%          | ?                      |
| Canada          | 17,968    | 44,321    | 33,848    | 30,210    | 39,654    | 33,200    | 11%          | Salmonids              |
| China           | 4,160     | 8,512     | 30,397    | 26,469    | 26,871    | 19,282    | 6%           | ?                      |
| Others          |           |           |           |           |           | 91,534    | 31%          |                        |
| World           | 249,202   | 384,863   | 257,802   | 274,245   | 332,600   | 299,742   | 100%         |                        |

All figures expressed in thousand USD. \* Primary intended usage determined from Tacon and Metian (2008) and expert opinions.

In terms of employment, both industrial and artisanal fisheries, as well as reduction and other fish processing industries, provide a large number of jobs. Various sources put the number of direct and indirect jobs associated to the fisheries and fishfood processing sector in the order of 90 000 to 110 000 (Sudameris, 2002; Centrum, 2009). From those jobs, 35 000 have been recorded as directly related to fishing (MINTRA, 2011), while 26 500 have been estimated as directly related to fisheries for reduction and processing for fishmeal and oil (Paredes and Gutiérrez, 2008).

It is difficult to isolate the jobs associated exclusively to the extraction and processing of anchoveta, other than those in the reduction industries. Nonetheless, Sueiro (2008) estimated the number of jobs directly associated to the anchoveta industrial and artisanal fleets in 10 000 and 8 000, respectively. Based on a detailed study of the jobs in the fishfood sector (Alvarado, 2009), the number of jobs attributable to anchoveta alone was estimated (Table 22).

<sup>33</sup> TradeMap, Trade statistics for international business development, <http://www.trademap.org/>. Accessed 02.2013.

**Table 22: Manpower employed by the Peruvian seafood sector with emphasis on anchoveta (2000-2007)**

Self elaboration, based on Alvarado (2009), and INEI and PRODUCE statistics.

| Activity           | 2000           | 2001           | 2002           | 2003           | 2004           | 2005           | 2006           | 2007           | Average        |
|--------------------|----------------|----------------|----------------|----------------|----------------|----------------|----------------|----------------|----------------|
| <b>Extraction</b>  | <b>76,200</b>  | <b>73,290</b>  | <b>74,285</b>  | <b>77,108</b>  | <b>78,245</b>  | <b>80,900</b>  | <b>82,949</b>  | <b>84,255</b>  | <b>78,404</b>  |
| Industrial         | 19,400         | 16,490         | 17,485         | 17,585         | 18,750         | 18,900         | 19,089         | 19,853         | <b>18,444</b>  |
| Anchoveta          | -              | 13,115         | 16,150         | 15,421         | 17,171         | 17,402         | 16,122         | 16,913         | <b>14,037</b>  |
| Artisanal          | 56,800         | 56,800         | 56,800         | 59,523         | 59,495         | 62,000         | 63,860         | 64,402         | <b>59,960</b>  |
| Anchoveta          | -              | 7,616          | 2,008          | 926            | 836            | 2,175          | 2,452          | 4,225          | <b>2,530</b>   |
| <b>Processing</b>  | <b>20,614</b>  | <b>17,949</b>  | <b>19,465</b>  | <b>20,767</b>  | <b>21,789</b>  | <b>24,834</b>  | <b>26,510</b>  | <b>28,003</b>  | <b>22,491</b>  |
| IHC                | 7,584          | 7,215          | 8,361          | 7,346          | 8,644          | 8,973          | 9,063          | 9,335          | <b>8,315</b>   |
| Anchoveta          | -              | 6,354          | 8,285          | 7,330          | 8,631          | 8,973          | 9,057          | 9,333          | <b>7,245</b>   |
| DHC                | 13,030         | 10,734         | 11,104         | 13,421         | 13,145         | 15,861         | 17,447         | 18,668         | <b>14,176</b>  |
| Anchoveta          | -              | 1,439          | 392            | 209            | 185            | 556            | 670            | 1,225          | <b>585</b>     |
| Canning            | -              | 448            | 240            | 86             | 43             | 306            | 478            | 1,010          | <b>326</b>     |
| Freezing           | -              | 155            | 78             | 12             | 3              | 29             | 20             | 86             | <b>48</b>      |
| Fresh              | -              | 54             | -              | 7              | 5              | 7              | 8              | 7              | <b>11</b>      |
| Curing             | -              | 507            | 74             | 104            | 133            | 214            | 164            | 122            | <b>165</b>     |
| <b>Aquaculture</b> | <b>6,315</b>   | <b>6,400</b>   | <b>7,100</b>   | <b>6,521</b>   | <b>7,311</b>   | <b>8,671</b>   | <b>8,844</b>   | <b>8,938</b>   | <b>7,513</b>   |
| <b>Secondary</b>   | <b>18,500</b>  | <b>17,750</b>  | <b>18,800</b>  | <b>18,695</b>  | <b>19,880</b>  | <b>22,710</b>  | <b>23,846</b>  | <b>24,036</b>  | <b>20,527</b>  |
| Anchoveta          | -              | 14,117         | 17,365         | 16,395         | 18,206         | 20,911         | 20,139         | 20,476         | <b>15,951</b>  |
| <b>TOTAL</b>       | <b>121,629</b> | <b>115,389</b> | <b>119,650</b> | <b>123,091</b> | <b>127,225</b> | <b>137,115</b> | <b>142,149</b> | <b>145,232</b> | <b>128,935</b> |

All figures represent number of workers.

Employment figures for the various anchoveta fleets, calculated based on IMARPE records and surveys are presented in section 4.2.2. Recently, another estimation of employment in the anchoveta fisheries and processing sector was carried out, where direct and indirect jobs were presented in terms of full-time jobs equivalents (Christensen et al., 2013.). Those figures, in combination with estimations of other socio-economic indicators, are presented in section 4.3.1.

Regarding taxes and other income source for the state from fisheries, it has been argued that the fishing rights the state charges to fishing companies are way below the economic benefit those companies obtain from their activities (de la Puente et al., 2011; Paredes, 2010, 2012; Paredes and Letona, 2013).

## 12 Nutritional value of fishfood products of the anchoveta supply chains

According to FAO and the Global Hunger Index (FAO, 2000; IFPRI, 2006, 2012), Peru has advanced in hunger reduction, yet continues being one of the few Latin-American countries featuring moderate hunger. According to FAO, hunger is associated to poverty (FAO, 2011). Especially in the Andean communities, indicators such as chronic malnutrition of children under five, stunting and undernourishment are still elevated (FAO, 2000, 2011; INEI, 2011) and thus government policies should be (and to some extent are being) oriented to provide those communities with cheaper sources of animal protein and in general improve access to nutritious food.

Seafood, especially that derived from the thriving anchoveta supply chains, has been often suggested as a suitable means to improve nutritional intake of vulnerable communities and the people at large (de la Puente et al., 2011; Jiménez and Gómez, 2005; Landa, 2012; Rokovich, 2009; Paredes, 2012). The varied fishfood products of the anchoveta-based supply chains include anchoveta products as well as marine and freshwater aquaculture products. A rudimentary nutritional profile of the main products studied is discussed in section 4.3.1.



### 13 Ecosystem and bio-economic modelling of the Peruvian anchoveta fishery

Various attempts to model the HCS ecosystem and its sensitivity to environmental condition, often emphasising population dynamics/stock assessment of commercially important species<sup>34</sup> or threatened species<sup>35</sup> have been carried out since the 1970s (Hertlein, 1995; Taylor and Wolff, 2007).

A preliminary EwE-based trophic model of the northern HCS was produced by Tam et al. (2005), highlighting that while anchoveta faces mortality from a variety of predators, being such pressure more important than mortality due to fisheries; hake's mortality is mostly due to fisheries. A more comprehensive EwE-based trophic model was later presented by Tam et al. (2008) and Taylor et al. (2008), which discusses trophic and ecosystem dynamics under El Niño and La Niña conditions. The base model (Tam et al., 2008) features:

- A high pedigree index ( $0 < 0.638 < 1$ ), denoting a good model with parameters mostly based on local data.
- It lacks biomass accumulation and migrations, and the adapted models do not include all the original 33 trophic groups originally identified, but only those of immediate interest, namely plankton and target species.
- Predation effect of *anchoveta* over eggs and larvae of predators is not accounted for.

Various models were prepared using OSMOSE (an individual based model) in 2009 for eight major species in the HCS, in order to simulate their trophic relations (Marzloff et al., 2009).

A number of bio-economic models have been also developed for the Peruvian anchoveta fishery (as listed in Table 23), some of which have been used for estimating stock biomass and calculating the TAC.

**Table 23: Bio-economic models of the Peruvian anchoveta fishery**

Self elaboration, based on Landa (2012), IMARPE and Jorge Tam, personal communication (2012).

| Authors→<br>Criteria↓             | Aguero (1987)                    | Fréon and Yáñez (1995)                           | Csirke and Gumy (1996)*       | Palomares (2005)                         | Fréon et al. (2008)   |
|-----------------------------------|----------------------------------|--|-------------------------------|--|---|
| <b>Study timeframe</b>            | 1950-1983                        | 1957-1977  | 1950-1995                     | 1960-2003                                | 1950-2003   |
| <b>Goal</b>                       | Economic analysis of the fishery | Environmental impacts on the fishery             | Anchoveta population dynamics | Optimal capture level                    | Holding and processing overcapacity in relation with biomass variations |
| <b>Mathematical analysis tool</b> | Lineal programming optimisation  | Non-linear regression via expert system CLIMPROD | Linear regression             | Linear regression                        | No real data modelling  |
| <b>Biological model</b>           | None                             | Static production surplus                        | Age-structured                | Dynamic production surplus (Smith, 1968) | Dynamic production surplus (Smith, 1968)                                |
| <b>Dependent variable</b>         | Utility function                 | Capture per Unit Effort (CPUE)                   | Anchoveta population          | Captures                                 | Fishing capacity  |

<sup>34</sup> E.g.: anchoveta (Pauly et al., 1989; IMARPE, 2010) and hake (IMARPE, 2009).

<sup>35</sup> E.g.: fur seals (Cárdenas-Alayza, 2012).

| <b>Explanatory variables</b>  | Income, costs, biomass | Biological variables and fishing capacity | Biological variables, fishing capacity and processing capacity | Biological variables and fishing capacity            | Biological variables, captures, benefits and regulation |
|-------------------------------|------------------------|---|--|--|---|
| <b>Environmental variable</b> | None                   | Seawater surface temperature              | None   | Seawater surface temperature and precipitation level | Interdecadal variability of anchoveta abundance         |

\* Model until recently in use by IMARPE for stock biomass estimation and TAC calculation. More recent models have been used in recent years by IMARPE (Oliveros-Ramos et al., 2010; Díaz et al., 2010).

In line with Peruvian fisheries legislation, bio-economic species-specific models are used to confirm that biomass estimations and the TAC (estimated based on biological reference points) are within the acceptable range rather than trophic models. A reason for such choice is that trophic models are considered as less reliable, due to lack of comprehensive data, therefore fisheries management is carried out on a per-species basis (Jorge Tam, personal communication, 2012).

## References

- Aguero, M. (1987). A bio-economic model of the Peruvian pelagic fishery, p. 307-324. In D. Pauly, P. Muck, J. Mendo and L Tsukayama (eds.) *The Peruvian upwelling ecosystem: dynamics and interactions*.
- Alder, J., & Pauly, D. (Eds.). (2008). *A comparative assessment of biodiversity, fisheries and aquaculture in 53 countries' Exclusive Economic Zones*. Fisheries Centre Research Reports (Vol. 16). Fisheries Centre, University of British Columbia, Canada.
- Alfaro-Shigueto, J., Mangel, J. C., Pajuelo, M., Dutton, P. H., Seminoff, J. a., & Godley, B. J. (2010). Where small can have a large impact: Structure and characterization of small-scale fisheries in Peru. *Fisheries Research*, 106(1), 8–17. doi:10.1016/j.fishres.2010.06.004
- Alheit, J., & Niquen, M. (2004). Regime shifts in the Humboldt Current ecosystem. *Progress In Oceanography*, 60(2-4), 201–222. doi:10.1016/j.pocean.2004.02.006
- Alltech. (2012). 2012 Alltech Global Feed Survey Summary. Retrieved from <http://www.ifif.org/uploadImage/2012/2/15/6a6d838117f38df3467726391c947b821329329246.pdf>
- Alvarado, F. (2009). *Diagnóstico social sobre el trabajo y el empleo en el sector pesquero de Ecuador y Perú. Proyecto para el desarrollo racional y sostenible del sector pesquero*. Madrid: Organización Internacional del Trabajo.
- Amaya, E. a., Davis, D. A., & Rouse, D. B. (2007). Replacement of fish meal in practical diets for the Pacific white shrimp (*Litopenaeus vannamei*) reared under pond conditions. *Aquaculture*, 262(2-4), 393–401. doi:10.1016/j.aquaculture.2006.11.015
- Aranda, M. (2009). Evolution and state of the art of fishing capacity management in Peru: The case of the anchoveta fishery. *Pan-American Journal of Aquatic Sciences*, 4, 146–153. Retrieved from [http://www.panamjas.org/pdf\\_artigos/PANAMJAS\\_4\(2\)\\_146-153.pdf](http://www.panamjas.org/pdf_artigos/PANAMJAS_4(2)_146-153.pdf)
- Arias Schreiber, M. (2011). The evolution of legal instruments and the sustainability of the Peruvian anchovy fishery. *Marine Policy*, 36(1), 78–89. doi:10.1016/j.marpol.2011.03.010
- Barange, M., Merino, G., Blanchard, J. L., Scholtens, J., Harle, J., Allison, E. H., ... Jennings, S. (2014). Impacts of climate change on marine ecosystem production in societies dependent on fisheries. *Nature Climate Change*, 4(February), 211–216. doi:10.1038/NCLIMATE2119

- Bernal, M., Somarakis, S., Witthames, P. R., van Damme, C. J. G., Uriarte, A., Lo, N. C. H., & Dickey-Collas, M. (2012). Egg production methods in marine fisheries: An introduction. *Fisheries Research*, 117-118, 1–5. doi:10.1016/j.fishres.2012.01.001
- Bertrand, A., Fréon, P., Chaigneau, A., Echevin, V., Estrella, C., Demarq, H., Gutiérrez, D., et al. (2010). Impactos del Cambio Climático en la Dinámica Oceánica, el Funcionamiento de los Ecosistemas y de las Pesquerías en el Perú: Proyección de Escenarios e Impactos Socio Económicos (Impacts of Climate Change on oceanic dynamics, ecosystem functioning and Peruvian fisheries: Projection of scenarios and socio-economic impacts). Lima: Institut de Recherche pour le Développement (IRD) for British Embassy Lima.
- Bimbo, A. P. (2011). The production and processing of marine oils. Retrieved February 2, 2013, from <http://lipidlibrary.aocs.org/processing/marine/index.htm>
- Brochier, T., Echevin, V., Tam, J., Chaigneau, A., Goubanova, K., & Bertrand, A. (2013). Climate change scenarios experiments predict a future reduction in small pelagic fish recruitment in the Humboldt Current system. *Global Change Biology*, 19, 1841–1853. doi:10.1111/gcb.12184
- Cárdenas-Alayza, S. (2012). Prey abundance and population dynamics of South American fur seals (*Arctocephalus australis*) in Peru. Masters Thesis. Vancouver: The University of British Columbia.
- Centrum. (2009). Reporte Sectorial: Sector Pesca. Reportes Financieros Centrum Católica, Burkenroad Latinoamérica (Perú). Lima: Noviembre 18, 2009.
- Chávez, F., Bertrand, A., Guevara-Carrasco, R. Soler, P. and Csirke, J. (2008). Editorial: The Northern Humboldt Current System: brief history, present status and a view towards the future. In Werner, F., Lough, G., Bertrand, A., Guevara-Carrasco, R., Soler, P., Csirke, J., & Chavez, F. P. (Eds). *The Northern Humboldt Current System: Ocean Dynamics, Ecosystem Processes, and Fisheries*.
- Chiu, A., Li, L., Guo, S., Bai, J., Fedor, C., & Naylor, R. L. (2013). Feed and fishmeal use in the production of carp and tilapia in China. *Aquaculture*, 414-415, 127–134. doi:10.1016/j.aquaculture.2013.07.049
- Christensen, V., de la Puente, S., Sueiro, J. C., Steenbeek, J., & Majluf, P. (2013). Valuing seafood: the Peruvian fisheries sector. *Marine Policy*. doi:10.1016/j.marpol.2013.09.022
- Clemente Sanguinetti, L. E. (2009). La comercialización en primera venta de los productos de la pesca marítima artesanal en el Perú: Problemática y plan de mejoras (pp. 1–62). Lima: Centro Tecnológico del Mar- Fundación CETMAR and PRODUCE. Retrieved from <http://www2.produce.gob.pe/RepositorioAPS/3/jer/-1/COMERC%20PESC%20ART%20PROBLEMATICA%20Y%20PLAN%20DE%20MEJORAS%20final%20Ok.pdf>
- Csirke, J.; Gumy, A. A. (1996). Análisis bioeconómico de la pesquería pelágica peruana dedicada a la producción de harina y aceite de pescado (Bio-economic analysis of the Peruvian pelagic fisheries for the production of fishmeal and fish oil). *Bol. Inst. Mar, Peru*, 15(2):25-68.
- de la Puente, O., Sueiro, J. C., Heck, C., Soldi, G., & Puente, S. de la. (2011). La Pesquería Peruana de Anchoveta - Evaluación de los sistemas de gestión pesquera en el marco de la certificación a cargo del Marine Stewardship Council. Documentos de Trabajo del Centro para la Sostenibilidad Ambiental de la UPCH (p. 160). Universidad Peruana Cayetano Heredia, Centro para la Sostenibilidad Ambiental. Retrieved from <http://www.csa-upch.org/pdf/lapesqueriaperuana.pdf>
- Díaz E, García C, Espinoza D, Guevara-Carrasco R, Csirke J, Ñiquen M, Vargas N, Argüelles J. 2010.- Assessment of the north–center stock of Peruvian anchoveta (*Engraulis ringens* Jenyns) using an age - structured model. *Bol. Inst. Mar Perú*. 25(1-2):57-61.
- Estrella, C., & Swartzman, G. (2010). The Peruvian artisanal fishery: Changes in patterns and distribution over time. *Fisheries Research*, 101(3), 133–145. doi:10.1016/j.fishres.2009.08.007

- FAO. (1986). The production of fish meal and oil. FAO Fisheries Technical Paper No. 142. Rome.
- FAO. (2000). FAO - Perfiles nutricionales por países - Peru (FAO - Nutritional profiles by country - Peru). Rome: Food and Agriculture Organisation of the United Nations. Retrieved from <http://www.bvsde.paho.org/texcom/nutricion/permap.pdf>
- FAO. (2003). Fisheries Management 2. The ecosystem approach to fisheries. FAO Technical Guidelines for Responsible Fisheries (Vol. 4, p. 112). Rome: Food and Agriculture Organisation of the United Nations, Fisheries Department.
- FAO. (2011). Country Profile: Food Security Indicators. Country: Peru. Retrieved from [http://www.fao.org/fileadmin/templates/ess/documents/food\\_security\\_statistics/country\\_profiles/eng/Peru\\_E.pdf](http://www.fao.org/fileadmin/templates/ess/documents/food_security_statistics/country_profiles/eng/Peru_E.pdf)
- FishSource. (2012). Anchoveta - Peruvian northern-central stock. FishSource: Status and environmental performance of fisheries worldwide. Retrieved from <http://www.fishsource.com/fishery/identification?fishery=Anchoveta+-+Peruvian+northern-central+stock>
- Fréon, P., & Yáñez R, E. (1995). Influencia del medio ambiente en evaluación de stock: una aproximación con modelos globales de producción (Influence of the environment on stock assessment: an approximation with global production models). *Investigaciones Marinas, Valparaíso*, 23, 25–47. doi:10.4067/S0717-71781995002300002
- Fréon, P., Barange, M., & Arístegui, J. (2009). Eastern Boundary Upwelling Ecosystems: Integrative and comparative approaches. *Progress In Oceanography*, 83(1-4), 1–14. doi:10.1016/j.pocean.2009.08.001
- Fréon, P., Bouchon, M., Mullon, C., Garcia, C., & Niquen, M. (2008). Interdecadal variability of anchoveta abundance and overcapacity of the fishery in Peru. *Progress In Oceanography*, 79(2-4), 401–412. doi:10.1016/j.pocean.2008.10.011
- Fréon, P., Sueiro, J. C., Iriarte, F., Miro Evar, O. F., Landa, Y., Mittaine, J.-F., & Bouchon, M. (2013). Harvesting for food versus feed: a review of Peruvian fisheries in a global context. *Reviews in Fish Biology and Fisheries*. doi:10.1007/s11160-013-9336-4
- Gutiérrez, D., Bertrand, A., Wosnitza-mendo, C., Dewitte, B., Purca, S., Peña, C., ... Guevara-carrasco, R. (2011). Sensibilidad del sistema de afloramiento costero del Perú al cambio climático e implicancias ecológicas. *Revista Peruana Geo-atmosférica*.
- Hertlein, W. (1995). A Simulation Model of the Dynamics of Peruvian Anchoveta (*Engraulis ringens*). *NAGA, The ICLARM Quarterly*, (July), 41–46. Retrieved from [http://worldfish.catalog.cgiar.org/naga/na\\_2236.pdf](http://worldfish.catalog.cgiar.org/naga/na_2236.pdf)
- IFFO. (2008). FIN Dossier 2008: Annual Review of the feed grade fish stocks used to produce fishmeal and fish oil for the UK market (pp. 1–77). Fishmeal Information Network. Retrieved from <http://www.iffonet.net/downloads/79.pdf>
- IFFO. (2009). The production of fishmeal and fish oil from Peruvian anchovy. datasheet (pp. 1–10). International Fishmeal and Fish Oil Organisation.
- IFPRI. (2006). The Challenge of Hunger. Global Hunger Index: Facts, determinants and trends. Bonn / Washington: International Food Policy Research Institute (IFPRI) and Deutsche Welthungerhilfe (DWHH). Retrieved from <http://www.ifpri.org/sites/default/files/publications/ghi06.pdf>
- IFPRI. (2012). 2012 Global hunger index: the challenge of hunger: Ensuring sustainable food security under land, water, and energy stresses. Bonn / Washington, DC / Dublin: International Food Policy Research Institute

- (IFPRI), Concern Worldwide and Welthungerhilfe and Green Scenery. Retrieved from <http://www.ifpri.org/sites/default/files/publications/ghi12.pdf>
- IMARPE. (2009). Boletín Instituto del Mar del Perú. Informe del Tercer Panel Internacional de Expertos de Evaluación de la merluza peruana *Merluccius gayi peruanus* Ginsburg. Manejo Precautorio de la Merluza Peruana. Callao 24 – 28 de marzo 2008 (Vol. 24).
- IMARPE. (2010). Boletín Instituto del Mar del Perú. Quinto panel internacional de expertos en evaluación de la anchoveta peruana (*Engraulis ringens* Jenyns. Callao, 10 – 14 agosto 2009 (Vol. 25).
- INEI. (2011). Encuesta Demográfica y de Salud Familiar 2011 (Demographic and family health survey 2011). Lima: Instituto Nacional de Estadística e Informática (INEI). Retrieved from <http://proyectos.inei.gob.pe/endes/2011/>
- INEI. (2012). I Censo Nacional de la Pesca Artesanal del Ámbito Marítimo 2012 - Resultados generales. Lima: Instituto Nacional de Estadística e Informática (INEI), Ministerio de la Producción (PRODUCE).
- Jayasinghe, P., & Hawboldt, K. (2011). A review of bio-oils from waste biomass: Focus on fish processing waste. *Renewable and Sustainable Energy Reviews*, 1–24. doi:10.1016/j.rser.2011.09.005
- Jiménez, F., & Gómez, C. (2005). Evaluación nutricional de galletas enriquecidas con diferentes niveles de harina de pescado. Publicación Virtual 010. Lima: Red Peruana de Alimentación y Nutrición (r-PAN). Retrieved from <http://www.rpan.org/publicaciones/pv010.pdf>
- Klyashtorin, L. (2001) Climate Change and Long-Term Fluctuations of Commercial Catches - The Possibility of Forecasting. FAO Fisheries Technical Paper 410. Rome: Food and Agriculture Organisation of the United Nations. Retrieved from <http://www.fao.org/docrep/005/y2787e/y2787e00.htm>
- Landa, Y. (2012). La pesca de la anchoveta, el óptimo social y el desarrollo sostenible del sector (Anchoveta fishery, the social optimum and sustainable development of the fishery sector). PhD Dissertation. Universidad Nacional Agrícola La Molina (UNALM) - Universidad Nacional Autónoma de México (UNAM).
- Marzloff, M., Shin, Y., Tam, J., & Bertrand, M. T. A. (2009). Trophic structure of the Peruvian marine ecosystem in 2000–2006: Insights on the effects of management scenarios for the hake fishery using the IBM trophic model Osmose. *Journal of Marine ...*, 75(1-2), 290–304. doi:10.1016/j.jmarsys.2008.10.009
- Mendieta, O. W., & Medina, M. L. (1993). Salado y secado solar de tilapia (*Oreochromis* sp) en la región de San Martín. Salting and solar drying of tilapia (*Oreochromis* sp) in the San Martin region. *Folia Amazónica*, 5(1-2), 117–127.
- Mendoza, D. (2011). Panorama de la acuicultura mundial, América Latina y el Caribe y en el Perú. Lima: Dirección de Acuicultura, Ministerio de la Producción - PRODUCE. Retrieved from [http://www.racua.org/uploads/media/informe\\_acuicultura\\_mundo\\_al\\_peru.pdf](http://www.racua.org/uploads/media/informe_acuicultura_mundo_al_peru.pdf)
- Mendoza, D. (2013). Situación del extensionismo acuícola en el Perú (Situation of aquacultural extensionism in Peru). Report for Red de Acuicultura de las Américas (RAA) and FAO. Lima: Dirección de Acuicultura, Ministerio de la Producción - PRODUCE.
- MINTRA. (2011). Anuario estadístico sectorial 2011. Serie Histórica /18. Lima: Ministerio de Trabajo y Promoción del Empleo.
- OANNES. (2012). Los desafíos para la zona costera peruana en el siglo 21. Taller Nacional Evaluación de los desafíos de las zonas costeras en el siglo XXI: propuestas para la Cumbre de la Tierra Rio+20. (pp. 1–22). Lima, 7 al 11 de Mayo de 2012.

- Oliveros-Ramos R, Guevara-Carrasco R, Simmonds J, Csirke J, Gerlotto F, Peña C, Tam J. 2010. Integrated assessment model for the north-central stock of Peruvian anchoveta *Engraulis ringens* Jenyns. *Bol. Inst. Mar Perú* 25(1-2):49-55.
- Palomares, C. (2005). La optimización de la explotación pesquera de anchoveta y sardina en el Perú, en presencia del Fenómeno del Niño (ENSO) (Optimisation of the exploitation of anchoveta and sardine in Peru, in presence of the El Niño phenomenon (ENSO)). Masters Thesis. Universidad de los Andes. Facultad de Economía.
- Paredes, C. (2010). Reformando el Sector de la Anchoveta Peruana Progreso Reciente y Desafíos Futuros. Instituto del Perú - Cuadernos de Investigación (pp. 1–23). Retrieved from [http://www.institutodelperu.org.pe/descargas/Publicaciones/DelInstitutodelPeru/DOC/contenido\\_carlos\\_paredes\\_-\\_reforma\\_de\\_la\\_presqueria\\_anchoveta\\_peru.pdf](http://www.institutodelperu.org.pe/descargas/Publicaciones/DelInstitutodelPeru/DOC/contenido_carlos_paredes_-_reforma_de_la_presqueria_anchoveta_peru.pdf)
- Paredes, C. E. (2012). Eficiencia y equidad en la pesca peruana: La reforma y los derechos de pesca (Efficiency and equity in Peruvian fisheries: Reform and fishing rights). Lima: Instituto del Perú.
- Paredes, C., & Gutiérrez, M. E. (2008). La industria anchovetera Peruana: Costos y Beneficios. Un Análisis de su Evolución Reciente y de los Retos para el Futuro. Estudio preparado por encargo del Banco Mundial al Instituto del Perú de la Universidad de San Martín de Porres. Retrieved from [http://institutodelperu.org.pe/descargas/informe\\_de\\_la\\_industria\\_de\\_anchoveta.pdf](http://institutodelperu.org.pe/descargas/informe_de_la_industria_de_anchoveta.pdf)
- Pauly, D., Muck, P., Mendo, J., and Tsukayama, L. (1989). The Peruvian upwelling ecosystem: dynamics and interactions. ICLARM Conference Proceedings 18, 438 p. Instituto del Mar del Perú (IMARPE) Callao, Perú; Deutsche Gesellschaft für Technische Zusammenarbeit (GTZ) GmbH, Eschborn, Federal Republic of Germany; and International Center for Living Aquatic Resources Management (ICLARM), Manila. Philippines.
- PRODUCE. (2009). Plan Nacional de Desarrollo Acuícola (Aquaculture Development National Plan) (p. 85). Lima: Ministerio de la Producción. Retrieved from [http://portal.andina.com.pe/EDPFiles/EDPWEBPAGE\\_plan-acuicola.pdf](http://portal.andina.com.pe/EDPFiles/EDPWEBPAGE_plan-acuicola.pdf)
- Rokovich, J. A. (2009). Estudios para el desarrollo de clusters en la actividad pesquera industrial y artesanal de anchoveta y pota - Informe final (Studies for cluster development for the industrial and artisanal fisheries for anchoveta and jumbo squid – Final report). Proyecto UE-PERU/PENX. Lima: ICON-INSTITUT GmbH.
- Sánchez, N. and Gallo, M. (2009). Status of and trends in the use of small pelagic fish species for reduction fisheries and for human consumption in Peru. In M.R. Hasan and M. Halwart (eds). *Fish as feed inputs for aquaculture: practices, sustainability and implications*. FAO Fisheries and Aquaculture Technical Paper. No. 518. Rome, FAO. pp. 325–369.
- Serra R. (1983). Changes in the abundance of pelagic resources along the Chilean coast. *FAO Fish. Rep.* 291, pp. 255-284.
- Silva, S. S., & Turchini, G. M. (2008). Towards Understanding the Impacts of the Pet Food Industry on World Fish and Seafood Supplies. *Journal of Agricultural and Environmental Ethics*, 21(5), 459–467. doi:10.1007/s10806-008-9109-6
- Smith, V. L. (1968). Economics of Production from Natural Resources. *The American Economic Review*, 58(3), 409–431. Retrieved from <http://www.jstor.org/stable/1813767>
- SNP. (2010). Memoria Anual 2010. Lima: Sociedad Nacional de Pesquería. Retrieved from <http://snp.org.pe/wp/?cat=25>
- SNP. (2011). Memoria anual 2011. Lima: Sociedad Nacional de Pesquería. Retrieved from <http://snp.org.pe/wp/?cat=25>

- SOFIA. (2012). The State of World Fisheries and Aquaculture 2012 (p. 209). Rome: FAO Fisheries and Aquaculture Department. Retrieved from <http://www.fao.org/docrep/016/i2727e/i2727e.pdf>
- Sudameris. (2002). Reporte Sectorial: Harina y aceite de pescado: Perspectivas fundamentales positivas. Lima: Banco Wiese Sudameris, Departamento de Estudios Económicos. Noviembre, 2002.
- Sueiro, J. C. (2008). La actividad pesquera peruana: Características y retos para su sostenibilidad. Lima: CooperAcción, Acción Solidaria para el Desarrollo. Retrieved from <http://www.ibcperu.org/doc/isis/10736.pdf>
- Sumaila, R., Cheung, W. W. L., Lam, V. W. Y., Pauly, D., & Herrick, S. (2011). Climate change impacts on the biophysics and economics of world fisheries. *Nature Climate Change*, 1(9), 449–456. doi:10.1038/nclimate1301
- Sun, W. (2009). Life Cycle Assessment of Indoor Recirculating Shrimp Aquaculture System. Masters Thesis. University of Michigan Ann Arbor. Retrieved from <http://deepblue.lib.umich.edu/handle/2027.42/63582>
- Tacon, A. (2002). Thematic review of feeds and feed management practices in shrimp aquaculture. Report prepared under the World Bank, NACA, WWF and FAO Consortium Program on Shrimp Farming and the Environment. Work in Progress for Public Discussion. Published by the Consortium. (p. 69). Retrieved from <http://library.enaca.org/Shrimp/Case/Thematic/FinalFeed.pdf>
- Tacon, A., & Metian, M. (2008). Global overview on the use of fish meal and fish oil in industrially compounded aquafeeds: Trends and future prospects. *Aquaculture*, 285(1-4), 146–158. doi:10.1016/j.aquaculture.2008.08.015
- Tacon, A., Hasan, M., & Metian, M. (2011). Demand and supply of feed ingredients for farmed fish and crustaceans: trends and prospects. FAO Fisheries and Aquaculture Technical Paper. No. 564 (p. 87). Rome. Retrieved from <http://www.fao.org/docrep/015/ba0002e/ba0002e.pdf>
- Talledo, S. (2010). Situación y perspectiva de la harina de pescado: Caso peruano de 1980-2007. Masters Thesis. Lima: Universidad Nacional Mayor de San Marcos. Retrieved from [http://www.cybertesis.edu.pe/sisbib/2010/talledo\\_el/pdf/talledo\\_el.pdf](http://www.cybertesis.edu.pe/sisbib/2010/talledo_el/pdf/talledo_el.pdf)
- Tam, J., Blaskovic, V., & Alegre, A., Modelo ecotrófico del ecosistema de afloramiento peruano durante El Niño 1997-98. In Wolff, M., Milessi, A., & Mendo, J. (Eds.). (2005). Modelación ecotrófica multiespecífica e indicadores cuantitativos ecosistémicos para la administración de pesquerías. CURSO INTERNACIONAL. Lima: Universidad Agraria La Molina.
- Tam, J., Taylor, M. H., Blaskovic, V., Espinoza, P., Michael Ballón, R., Díaz, E., Wosnitza-Mendo, C., et al. (2008). Trophic modeling of the Northern Humboldt Current Ecosystem, Part I: Comparing trophic linkages under La Niña and El Niño conditions. *Progress In Oceanography*, 79(2-4), 352–365. doi:10.1016/j.pocean.2008.10.007
- Taylor, M. H., & Wolff, M. (2007). Trophic modeling of Eastern Boundary Current Systems: a review and prospectus for solving the “Peruvian Puzzle”. *Rev. peru. biol.*, 14(1), 87–100.
- Taylor, M. H., Tam, J., Blaskovic, V., Espinoza, P., Michael Ballón, R., Wosnitza-Mendo, C., Argüelles, J., et al. (2008). Trophic modeling of the Northern Humboldt Current Ecosystem, Part II: Elucidating ecosystem dynamics from 1995 to 2004 with a focus on the impact of ENSO. *Progress In Oceanography*, 79(2-4), 366–378. doi:10.1016/j.pocean.2008.10.008
- Tveteras, S., Paredes, C., & Peña-Torres, J. (2009). Individual Fishing Quotas in Peru: Stopping the Race for Anchovies. Retrieved from <http://fen.uahurtado.cl/wp/wp-content/uploads/2010/07/i263.pdf>
- Vidal, G., & Marti, M. (1997). Treatment of recycled wastewaters from fishmeal factory by an anaerobic filter. *Biotechnology letters*, 19(2), 117–121. Retrieved from <http://www.springerlink.com/index/XL284543H70102G3.pdf>

Werner, F., Lough, G., Bertrand, A., Guevara-carrasco, R., Soler, P., Csirke, J., & Chavez, F. P. (2008). The Northern Humboldt Current System: Ocean Dynamics, Ecosystem Processes, and Fisheries. *Progress in Oceanography*, 79, 95–412. doi:10.1016/j.pocean.2008.10.012

Whitehead, P.J.P., G.J. Nelson and T. Wongratana, 1988. *FAO Species Catalogue*. Vol. 7. Clupeoid fishes of the world (Suborder Clupeoidei). An annotated and illustrated catalogue of the herrings, sardines, pilchards, sprats, shads, anchovies and wolf-herrings. *FAO Fish. Synop.* 125(7/2):305-579. Rome: FAO.



# Appendix F: Posters

Presented at LCA Food 2012: Life Cycle Assessment in the Agri-Food Sector, 1-4 October 2012, Saint-Malo, France. <https://colloque4.inra.fr/lcafood2012>



## LCA of locally produced feeds for Peruvian aquaculture

### Aquafeed for omnivorous and carnivorous fish



**Goal and scope definition:**

- Assess the contribution of various feed ingredients to the environmental impacts associated to aquafeed production.
- Investigate the specific contribution of Peruvian fishmeal to feeds for omnivorous and carnivorous cultured species.

**1 tonne of aquafeed:**

- Suitable basis for comparison with other studies
- Reference flow: amount of ingredients and energy required to provide 1 functional unit

**LCA impact categories**

**Typical:**

- ReCiPe (midpoints and endpoints)

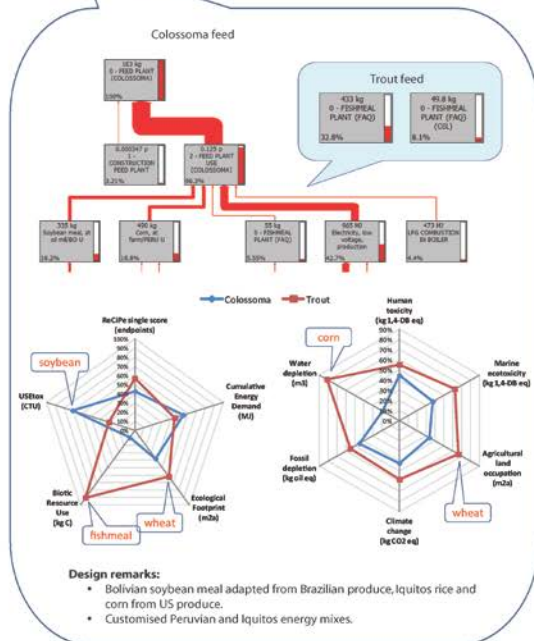
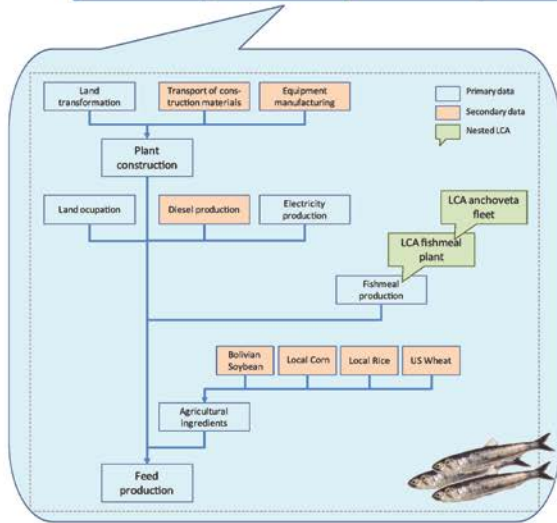
**Additional:**

- Cumulative Energy Demand (CED)
- Biotic Resource Use (BRU), as Net Primary Production Appropriation

$BRU = (Mass/g) \cdot 10^{(TL-1)}$

**Sensitivity analysis:**

- Comparison of various sources of soybean meal was performed, showing similar environmental performance between US and Bolivian soy, very different from Brazilian soy's important environmental impacts due to clear-cutting of rain forest.
- The contribution of Peruvian fishmeal makes a great difference (impacts wise) between omnivorous and carnivorous feed compositions.



- Conclusions:**
- Fuel use is the main contributor to impacts in all activities (fishing, reduction, feed processing)
  - Feed provision is the main contributor to impacts in intensive Peruvian aquaculture
  - The sourcing of feed ingredients is a critical factor for associated environmental impacts of feeds
  - Use of fish products for trout feed leads to major differences in BRU
  - Construction and maintenance of reduction and feed plants (unlike fisheries) contribute negligibly to overall impacts.
  - Comparison with published LCAs of feeds, using ReCiPe single scores:
 

|                                 |                        |
|---------------------------------|------------------------|
| Peru (trout) = 100% (reference) | Peru (Colossoma) = 75% |
| Canada (salmon) = 123%          | Norway (salmon) = 125% |



**REFERENCES**

- Avadi, A. and Fréon, P. 2012. A framework for sustainability comparison of seafood supply chains. This Conference.
- Dros, J.M. 2004. Managing the Soy Boom: Two scenarios of soy production expansion in South America. WWF Forest Conversion Initiative. AID/Environment. Amsterdam.
- Goedkoop, M., Heijungs, R., Huijbregts, M., et al. 2009. ReCiPe 2008. Ministry of Housing, Spatial Planning and Environment (VROM).
- Pelletier, N., Tyedmers, P., Sonesson, U., Scholz, A. J., Ziegler, F., Flysjö, A., Kruse, S., et al. 2009. SUPPORTING INFORMATION. Not all salmon are created equal: life cycle assessment (LCA) of global salmon farming systems. Environmental science & technology. 43(23), 8730-6.
- Tyedmers, P. 2000. Salmon and Sustainability: The biophysical cost of producing salmon through the commercial salmon fishery and the intensive salmon culture industry. PhD Dissertation. The University of British Columbia.

**Angel Avadi**  
angel.avadi@ird.fr  
UMR 212 EME, IRD, Centre de Recherche pour le Développement (IRD), Université Montpellier II, CRH, BP 171, 34203, Sète, France.

**Dr. Pierre Fréon**  
UMR 212 EME, IRD, Centre de Recherche Halieutique Méditerranéenne et Tropicale (CRH), BP 171, 34203, Sète, France

**Dr. Jesús Núñez**  
IRD, UMR 226 ISEM, LMI EDIA, Institut des Sciences de l'Évolution de Montpellier, CS 19519, 34960 Montpellier cedex 2, France

**Camilo Cuba**  
Universidad N. Federico Villarreal, Facultad de Oceanografía, Pesquería y Ciencias Alimentarias, 350 calle Roma, Lima, Perú

**The ANCHOVETA-SC project**  
<http://anchoveta-sc.wikispaces.com>



# A framework for sustainability comparison of seafood supply chains

## Case study: The Peruvian anchoveta industries

### Project goals

- 1) Model impacts of changes in Peruvian fishery strategies on the Northern Humboldt Current System trophic web.
- 2) Characterise and compare key supply chains for direct and indirect human consumption based upon anchoveta (*Engraulis ringens*) as key input material.

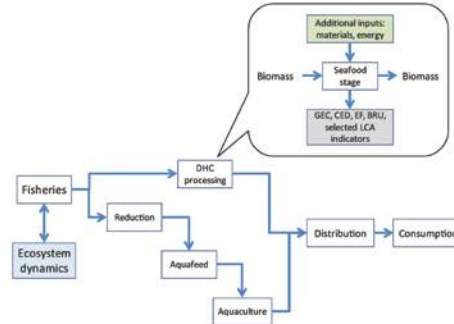
### LCA work carried out in Peru

- A conventional fishmeal plant running on heavy oil
- A modern fishmeal plant running mainly on natural gas
- The industrial steel anchoveta fleet (preliminary LCI of wooden fleet)
- Two aquafeed plants servicing omnivore and carnivore cultures
- An aquaculture farm producing omnivore indigenous fish

### Work in progress

- Definition of exploitation scenarios
- Integration of trophic and material flow models
- Selection of data gathering for socio-economic indicators
- Gathering and adaptation of supply chain data for agricultural feed ingredients
- Performing further LCAs of supply chain components

### Simplified diagram of the anchoveta-based supply chains



### Characterisation of biophysical flows:

- Life Cycle Assessment of fisheries, transformation/reduction, aquafeed production, and aquaculture activities.
- Secondary data of aquaculture activities and feed ingredients.

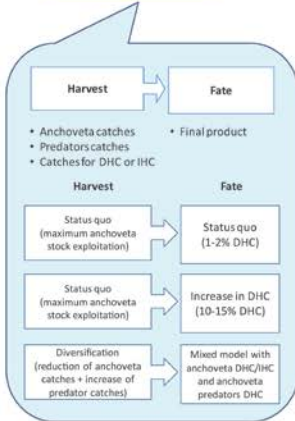
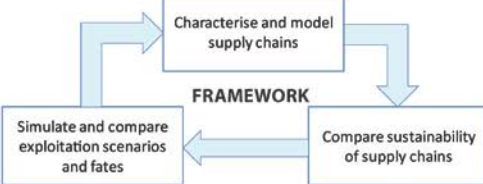
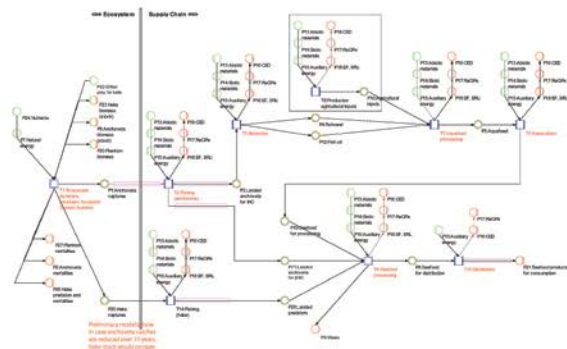
### Modelling of ecosystem-fishery interactions:

- Integration of a trophic model of the Humboldt Current System with the general supply chain model (material and energy flows).

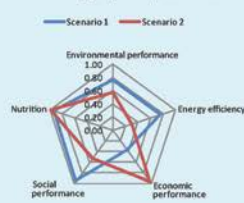
### Characterisation of socio-economic dynamics:

- Compilation of socio-economic data of the studied supply chains.

### Coupled material and energy flows / ecosystem model for anchoveta



### Representation device for Sustainability performance of seafood supply chains/scenarios



### Rationale for sustainability indicators

- Gross energy content (MJ/kg) Based on crude protein and lipid content (g/kg) to compare feed ingredients and formulations
- Edible protein EROI (%) to compare seafood products
- BRU (g C/kg) and Ecological Footprint (ha/t) to compare feed ingredients, feed formulations and seafood products
- LCA impact categories to compare intermediate and final seafood products, and competing supply chains
- Socio-economic indicators (e.g. value added, employment) to compare competing supply chains/scenarios

### REFERENCES

- Christensen, V., Steenbeek, J., & Failler, P., 2011. A combined ecosystem and value chain modeling approach for evaluating societal cost and benefit of fishing. *Ecological Modelling*, 222(3), 857-864.
- Fréon, P., Bouchon, M., Domalain, G., Estrella, C., Iriarte, F., Lazard, J., et al. (2010). Impacts of the Peruvian anchoveta supply chains: from wild fish in the water to protein on the plate. *GLOBEC International Newsletter*, (April), 27-31.
- Tyedmers, P. 2000. Salmon and Sustainability: The biophysical cost of producing salmon through the commercial salmon fishery and the intensive salmon culture industry. PhD Dissertation. The University of British Columbia.
- <http://www.ecopath.org/>
- <http://www.umberto.de/en/>



umberto  
know the flow

### Angel Avadi

angel.avadi@ird.fr  
UMR 212 EME, Institut de Recherche pour le Développement (IRD),  
Université Montpellier II, CRH, BP 171, 34203, Sète, France

### Dr. Pierre Fréon

UMR 212 EME, IRD, Centre de Recherche Halieutique Méditerranéenne et Tropicale (CRH), BP 171, 34203, Sète, France

### Dr. Jorge Tam

Instituto del Mar del Perú (IMARPE), Apdo. 22, Callao, Peru

The ANCHOVETA-SC project  
<http://anchoveta-sc.wikispaces.com>



## Appendix G: Institutions, labs, projects



<http://anchoveta-sc.wikispaces.com>



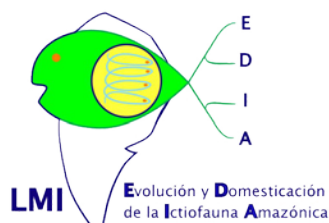
[www.ird.fr](http://www.ird.fr)



[www.univ-montp2.fr](http://www.univ-montp2.fr)



[www.discoh.ird.fr](http://www.discoh.ird.fr)



[www.perou.ird.fr/la-recherche/lmi/edia](http://www.perou.ird.fr/la-recherche/lmi/edia)



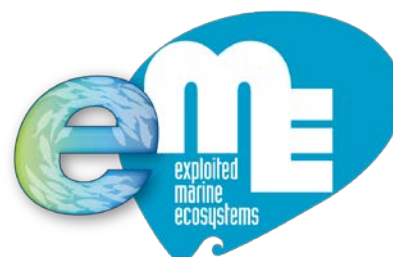
<http://humboldt.iwlearn.org/en>



[www.itp.gob.pe/webitp/](http://www.itp.gob.pe/webitp/)



[www.dal.ca/faculty/management/res.html](http://www.dal.ca/faculty/management/res.html)



[www.umar-eme.org](http://www.umar-eme.org)



<http://wwwz.ifremer.fr>



[www.imarpe.pe/imarpe/](http://www.imarpe.pe/imarpe/)



<http://red.pucp.edu.pe/ciclodevida>

## List of publications as of April 2014

Avadí A., & Fréon P. (2013) Life cycle assessment of fisheries: A review for fisheries scientists and managers. *Fisheries Research*, 143:21–38.

Avadí, A., & Fréon, P. (2014). A set of sustainability performance indicators for seafood: direct human consumption products from Peruvian anchoveta fisheries and freshwater aquaculture. *Ecological Indicators*, in review.

Avadí, A., Fréon, P., & Quispe, I. (2014b). Environmental assessment of Peruvian anchoveta food products: is less refined better? *The International Journal of Life Cycle Assessment*, in press. doi:10.1007/s11367-014-0737-y

Avadí, A., Fréon, P., & Tam, J. (2014). Coupled ecosystem/supply chain modelling of fishfood products from sea to shelf: the Peruvian anchoveta case. *PlosOne*, submitted.

Avadí, A., Pelletier, N., Aubin, J., Ralite, S., Núñez, J., & Fréon, P. (2014). Comparative environmental performance of artisanal and commercial feed use in Peruvian freshwater aquaculture. *Aquaculture*, in review.

Avadí, A., Vázquez-Rowe, I., & Fréon, P. (2014a). Eco-efficiency assessment of the Peruvian anchoveta steel and wooden fleets using the LCA+DEA framework. *Journal of Cleaner Production*, in press. doi:10.1016/j.jclepro.2014.01.047

Fréon, P., Avadí, A., Amelia, R., & Chavez, V. (2014). Life cycle assessment of the Peruvian industrial anchoveta fleet: boundary setting in life cycle inventory analyses of complex and plural means of production. *The International Journal of Life Cycle Assessment*, in press. doi:10.1007/s11367-014-0716-3

Fréon, P., Avadí, A., Marín, W., & Negrón, R. (2014). Environmentally-extended comparison table of large- vs. small- and medium-scale fisheries: the case of the Peruvian anchoveta fleet. *Canadian Journal of Fisheries and Aquatic Sciences*, in review.