



ACHILLON®

Minimal invasive Achilles tendon suture system



Surgical technique

DETAILS

Low invasive Achilles tendon suture system

Precise order and direction for introduction of the sutures.



Needle driver.
Suture size: 0 USP (3.5 metric).



4° angle to conform to the anatomy.

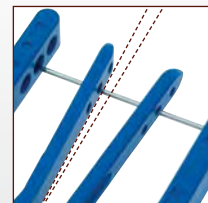

Materials:

- polycarbonate
- Stainless steel 316 L.



Adjustment screw for appropriate adaptation to the tendon stump.



DESCRIPTION

The ACHILLON[®] System[™] is an elegant method to treat acute Achilles tendon ruptures. It is a mini-invasive procedure that allows direct visual control of the repair, as well as percutaneous introduction of the sutures. The surrounding soft tissues and the tendon itself are always treated with the utmost care to avoid any local trauma.

INDICATIONS

- Acute rupture (< 10 days).
- Rupture located between 2 and 8 cm above calcaneum.
- Open or closed rupture

CONTRAINDICATIONS

- Previous local surgery.
- Chronic or neglected rupture.

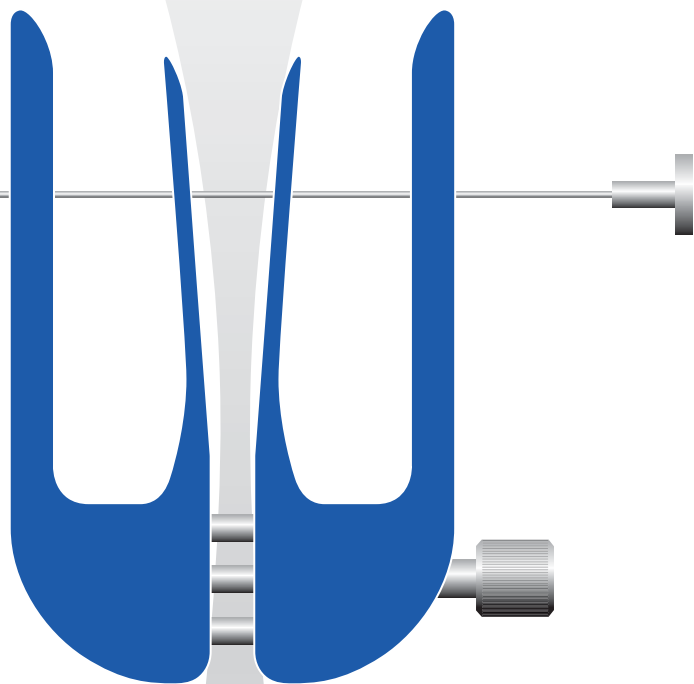

DESIGN RATIONALE

Still with the aim to improve the repair of the ruptured tendon, a new technique has been developed. It links a percutaneous surgery with a mini open approach. Thanks to a specific dedicated instrument, the settlement of sutures is reproducible. The matching of the ends of the tendon can be checked thanks to the mini-open approach. Ideally, sutures should be bioresorbable, but it is possible to use standard threads taking into account that they must be removed as the tendon is healed. The post-operative protocol is the same as the for percutaneous surgery.

ADVANTAGES

- No necrosis or sepsis problem in the published studies.
- No injury caused to the sural nerve.
- Solid fixation.
- Precise matching of the ends of the tendon.
- Fast mobilization.
- Earlier return to a sport activity.
- Easy suturing.
- Reliable and reproducible technique.

Surgical technique



NEWDEAL[®] as the manufacturer of this device, does not practice medicine and does not recommend this or any other surgical technique for use on a specific patient. The surgeon who performs any implant procedure is responsible for determining and using the appropriate techniques for implanting the device in each patient.

Patient positioning •

The patient is placed prone on the surgical table with standard protection on the various pressure points. Both ankles are elevated and a tourniquet is applied (except if contraindicated).

Preparation of the surfaces •

- Antibiotic prophylaxis pre-op.
- Do not use plastic drape (percutaneous technique).
- Inflate tourniquet.

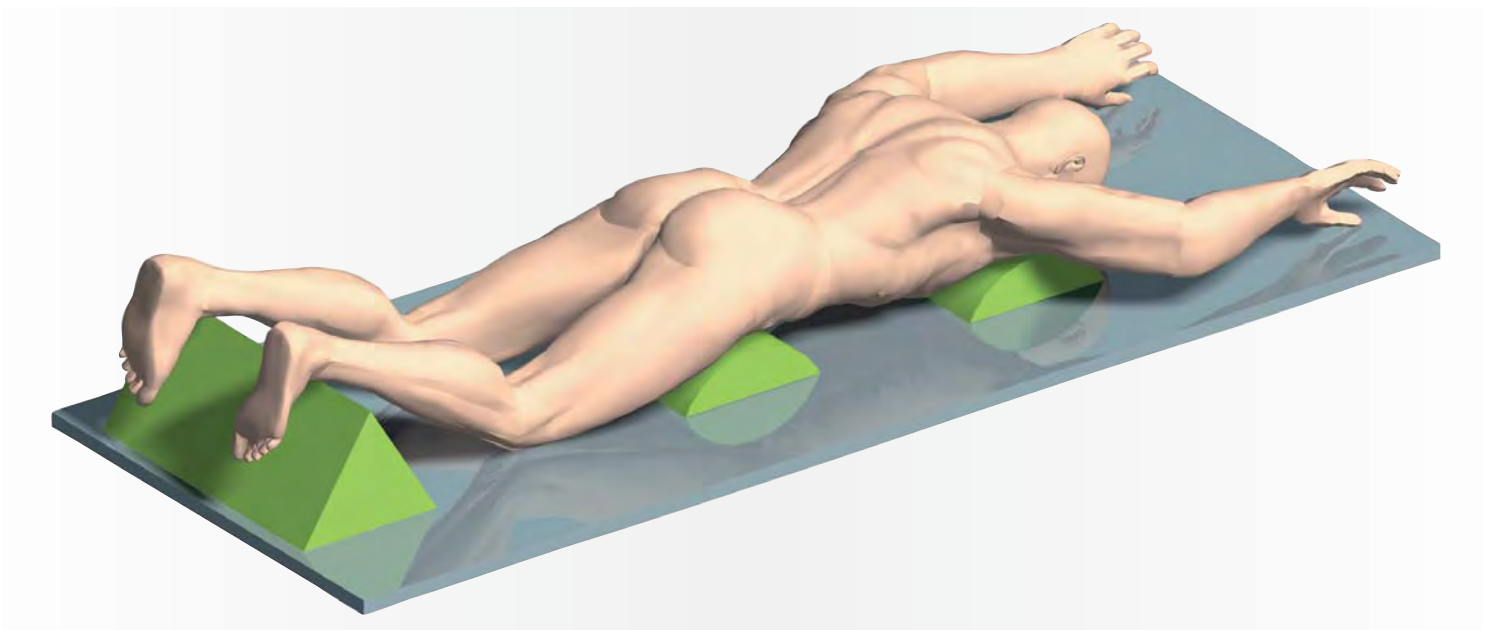

Step 1 • FEEL THE GAP

Accurately feel the gap (soft spot) corresponding to the rupture site.

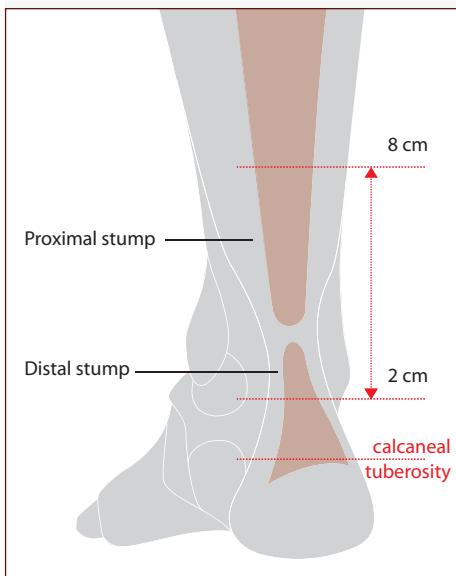

TIP

In more than 90% of cases, rupture is located 4 cm above calcaneal tuberosity.

The ACHILLON® is intended to be used for ruptures occurring between 2 and 8 cm proximal to the calcaneal tuberosity.

Step 2 • FIRST INCISION

- Vertical and medial to the tendon.
- 1.5 to 2 cm in length, proximally from the soft spot.
- With scalpel blade N°15 (smallest size), delicately dissect the thin subcutaneous tissue.

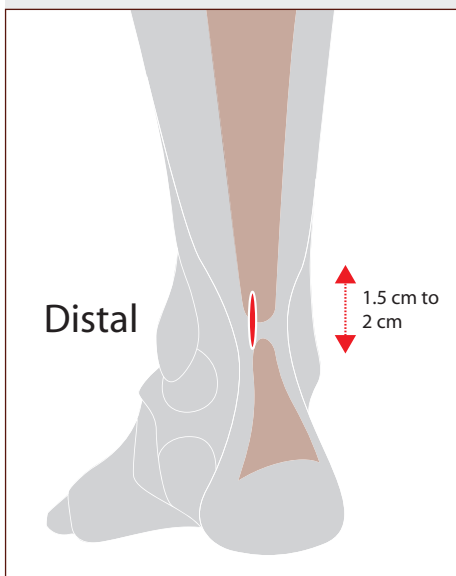

Step 3 • PARATENON INCISION

- Retract the skin layer with 2 small hook retractors (Guillis type).
- Carefully identify the paratenon.
- Make a 2 cm vertical incision in the paratenon.

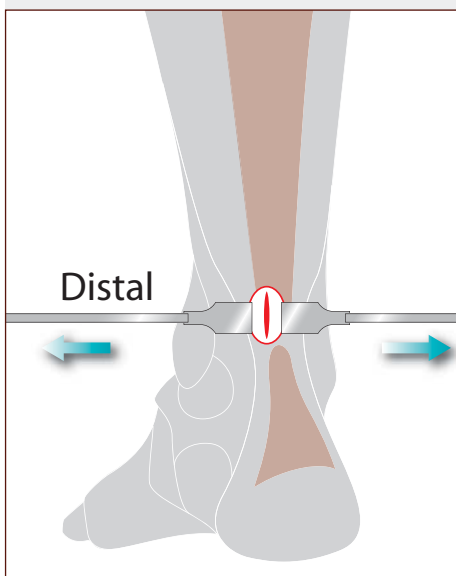

Step 4 • STAY SUTURES

- Place a stay suture in each edge of the paratenon.
- The space under the paratenon has to be cleared proximally and distally in order to visualize its “tunnel shape”.

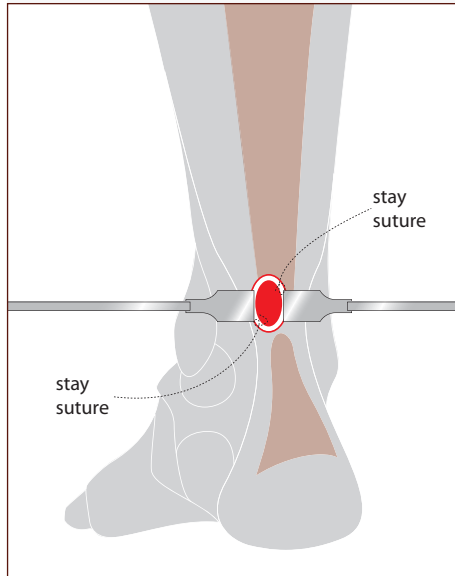

TIP

This maneuver will facilitate the introduction of the ACHILLON®.

Step 5 • IDENTIFY STUMPS

- Identify both proximal and distal tendon stumps.
- On the medial side, the plantaris tendon may be visualized.

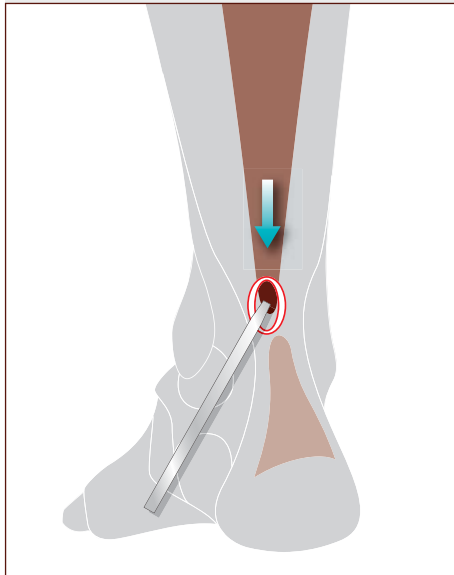

TIP

In most cases the tendon stumps have become frayed. If the rupture spot is particularly difficult to locate, the skin incision can easily be extended proximally or distally.

Step 6 • INTRODUCTION

- Introduce the ACHILLON® in the closed position (= minimal width) under the paratenon proximally.
- The tendon stump comes in between the two internal branches.

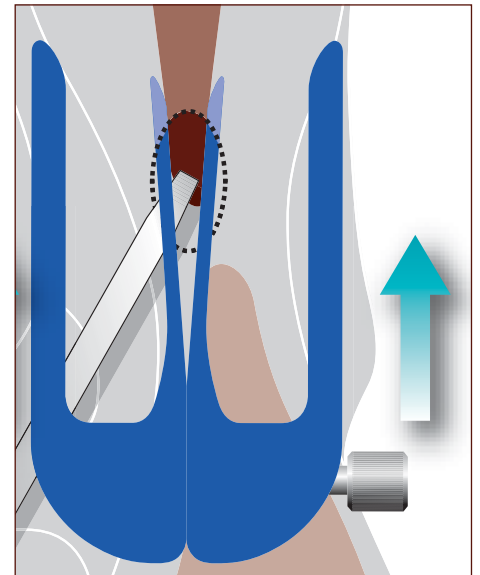
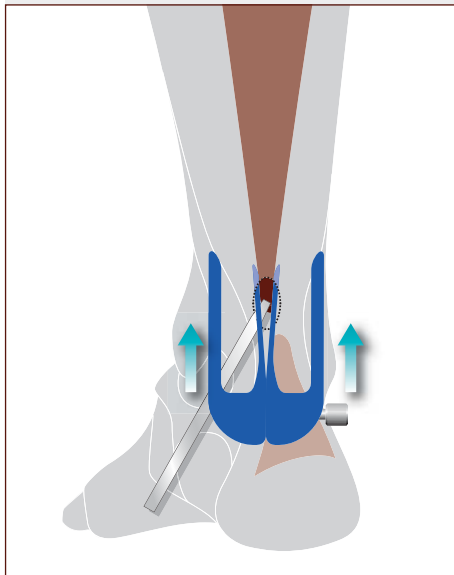

Step 7 • WIDENING

- As soon as the ACHILLON® is introduced, it is progressively widened.
- The tendon stump is held with a fine forceps or clamp passed under the ACHILLON® (Kocher or Mosquito).

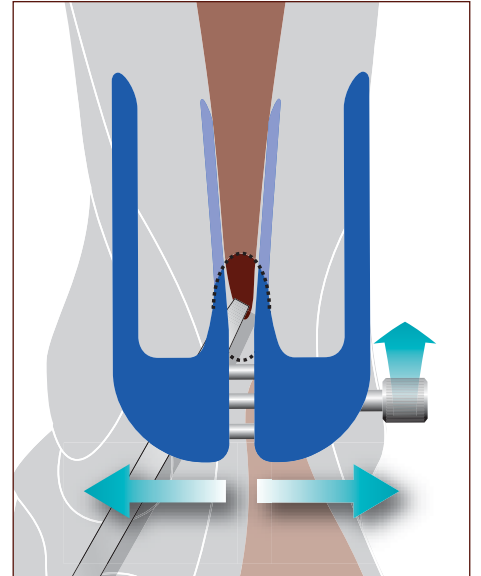
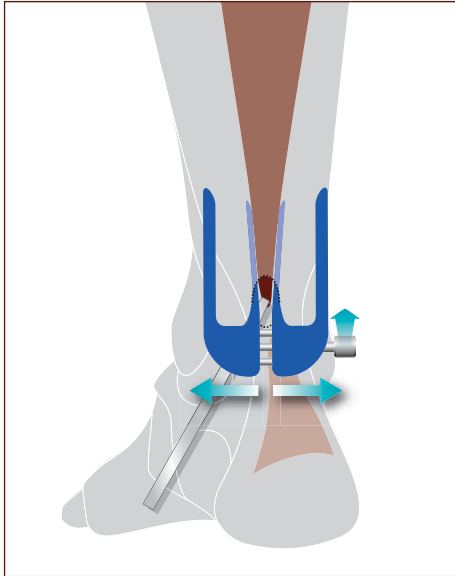

Step 8 • POSITIONING

Before introducing the sutures, the appropriate position and angulation of the ACHILLON® is confirmed by external digital palpation.

- The tendon should fall between the two central branches of the instrument.
- Using the needle driver, the first needle is introduced according to arrows and numbers printed on the instrument.

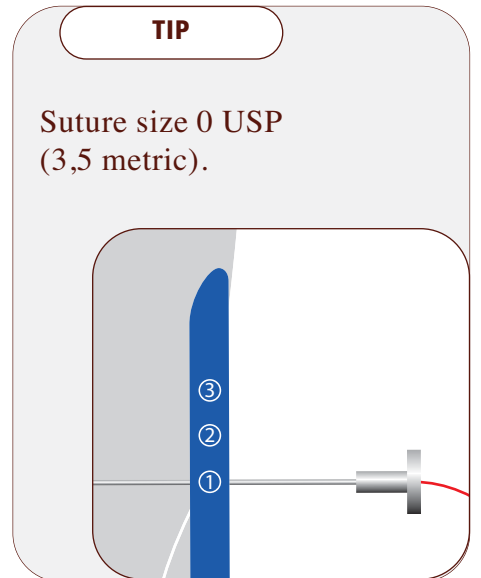
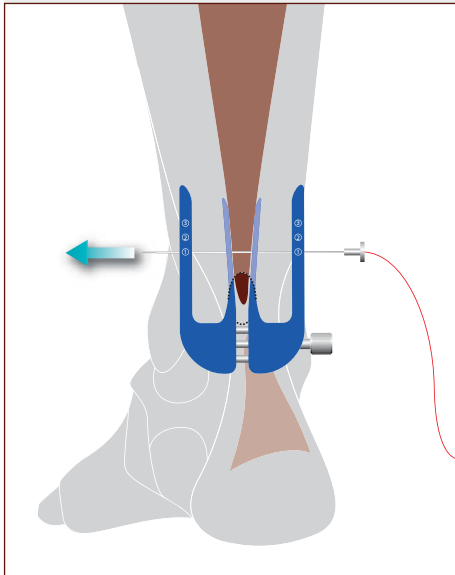

Step 9 • SUTURES

- Three sutures are passed and left outside.

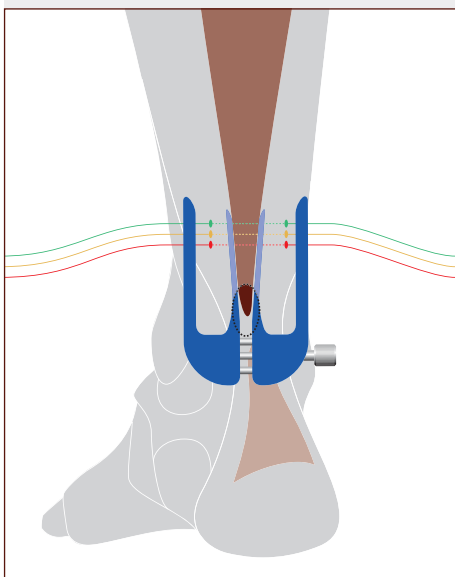

Step 10 • REMOVE ACHILLON®

The ACHILLON® is withdrawn gently in order to prevent any suture or soft tissue damage.

- As it is being withdrawn, the ACHILLON® is progressively closed.

TIP

From an extracutaneous position, the sutures become subperitendinous. Thus, the tendon itself becomes the only site of tissue attachment for the suture.

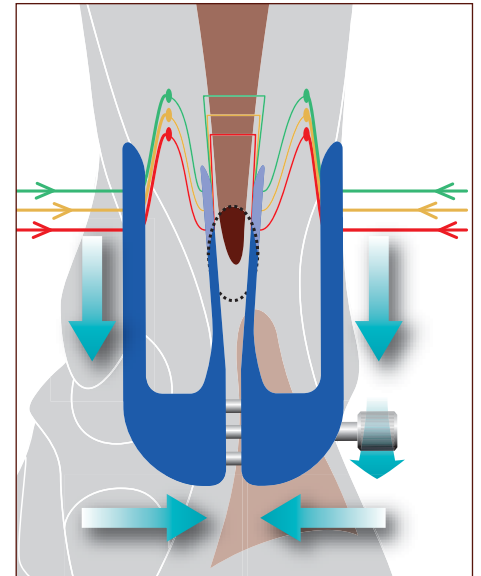
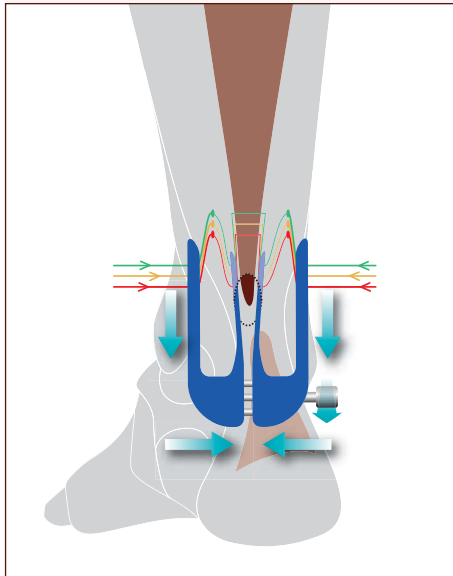

Step 11 • CLAMP

- Another clamp is placed on the 3 sutures coming out medially.
- Each clamp must remain on its respective side. In this way sutures will not cross the midline.

TIP

If any suture fails, it has to be replaced by repeating the previous technique.

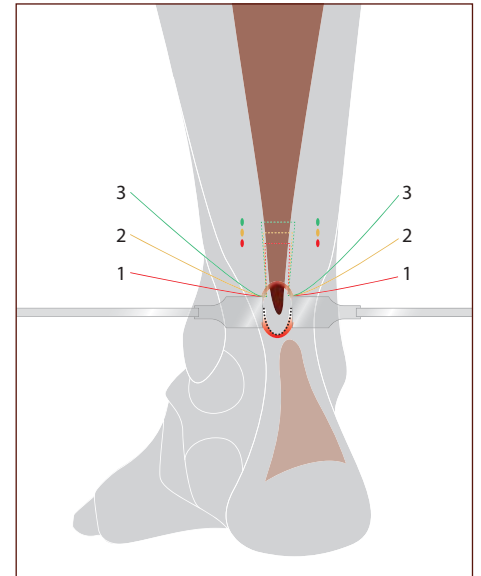
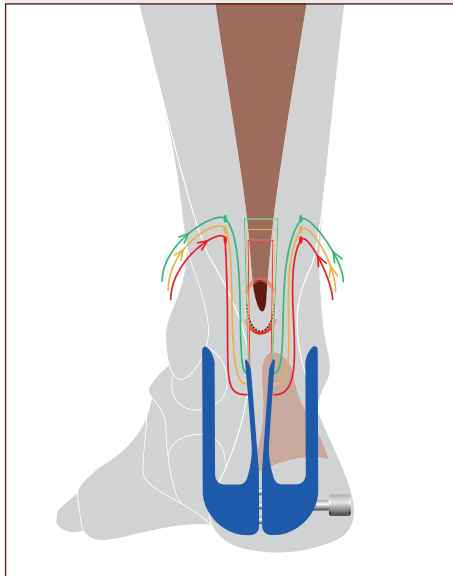

Step 12 • DISTAL STUMP

- The same sequence is performed on the distal stump.
- The ACHILLON® is introduced under the paratenon and pushed until it touches the calcaneum.
- Again 3 sutures are placed.

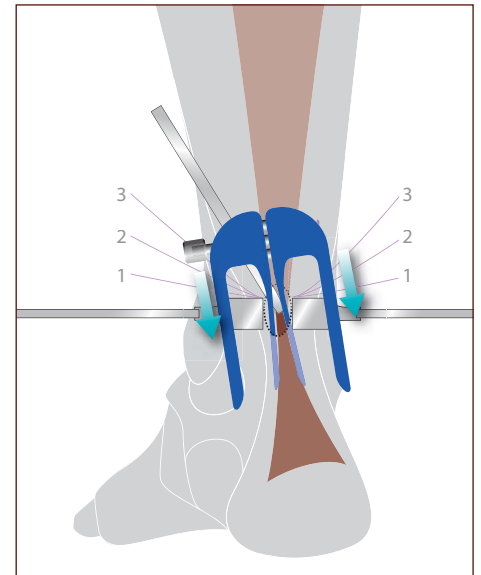
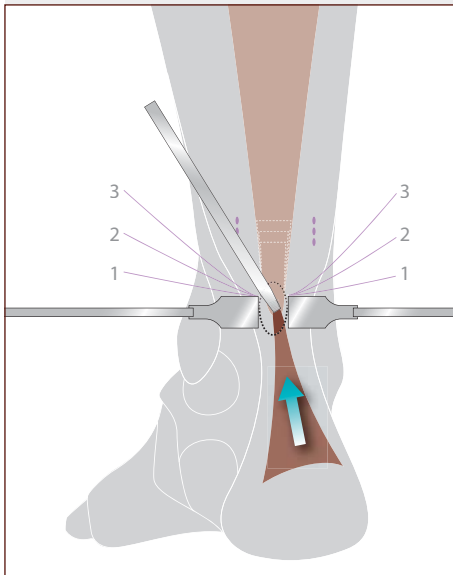

Step 13 • ORGANIZE

- Correctly organize the suture pairs.
- They must not cross the midline: the sutures coming out on the lateral side have to remain lateral and those on the medial side have to remain medial.

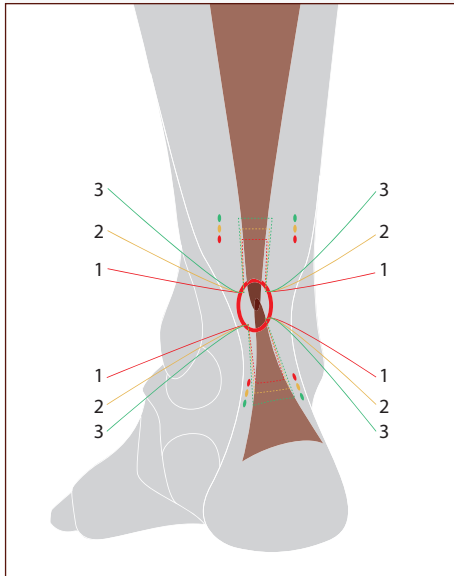

Step 14 • TENDON SUTURES

- The sutures are tied by corresponding pairs.
- The tendon reduction is controlled under direct vision.

TIP

If the tendon is so frayed that it prevents any landmark for control of length, then the tendon tension should be compared to the opposite leg.

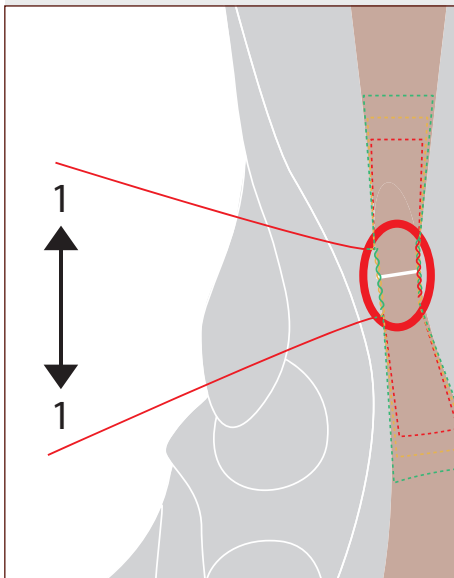

Step 15 • SUTURING

Careful closure of paratenon and skin.

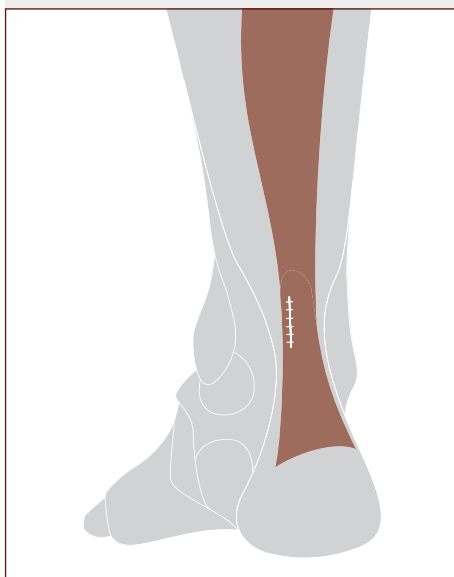

POSTOPERATIVE CARE

- The ankle is maintained in 30° of plantarflexion with a splint, during the first three weeks.
- It is then progressively brought to the neutral position over the following five weeks. Always be sure of patient compliance.

Instructions for use

STERILE INSTRUMENT FOR FOOT SURGERY SINGLE USE

In accordance with EEC directive 93/42 relative to medical devices, this product must be handled by WELL-TRAINED, QUALIFIED PERSONS, AWARE OF THESE DIRECTIONS FOR USE.

1 - Description of the medical devices:

The instruments - delivered sterile - are:

- ACHILLON® System
- 1 needle driver
- 2 surgical needles

2 - Indications:

- Acute (less than 10 days) closed ruptures of the Achilles tendon.
- Open ruptures (less than 6 hours) without skin defect.
- Rupture located between 2 cm and 8 cm above the tuberosity of the calcaneum.

3 - Contraindications:

the instrument should not be used in a patient who has currently, or who has history of:

- Chronic rupture.
- previous local surgery.
- patient under steroids
- Open ruptures (more than 6 hours)
- Complex open ruptures with skin defect.
- Pediatric age
- Rupture located between 0 and 2 cm above the tuberosity of the calcaneum and higher then 8 cm above the tuberosity of the calcaneum.
- Non collaborating patient
- Patient unable to walk with crutches.

Each patient must be evaluated by the surgeon to determine the specific risk/benefit relationship in light of the patient's condition and the surgeon's practice, training, experience, and knowledge of the related medical literature.

Complications with the use of similar surgical technic have been reported in the medical literature. Any patient undergoing a surgical procedure is subject to intra-operative and post-operative complications. Each patient's tolerance to surgery, medication, and implantation of a foreign object may be different.

Possible risks, adverse reactions, and complications associated with surgery and the use of this surgical technique should be discussed with and understood by the patient prior to surgery. The patient should not be led to unrealistic expectations as to the performance or results that the surgery can provide. The patient should be informed that successful results cannot be guaranteed. It is the responsibility of the surgeon to provide the patient with information prior to surgery

Complications may include but are not limited to :

- Pain, discomfort, or abnormal sensations;
- Risk of additional injury from post-operative trauma .

Side effects may include but are not limited to:

- Infections
- Hematoma
- Allergy
- Skin necrosis
- Venous Thrombosis

Adverse effects may necessitate re-operation.

4 - Precautions for use:

Knowledge of surgical techniques, proper reduction , and post-operative patient management are considerations essential to a successful outcome. This product is sold sterile. Check packaging and labelling integrity before use. The sterility is guaranteed as long as the packaging has not been damaged (film scratched, label missing, questionable packaging, ...etc) and before the end of the sterility validity. Do not use any instrument for which the packaging has been opened or damaged outside the operating theater.

5 - Use of the instrument:

The surgeon must use the instrumentations recommended in accordance with the operative technique available from the manufacturer. The medical device must be used in compliance with the use of the profession and the art standards. Do not attempt a surgical procedure with faulty, damaged or suspect instruments. Inspect all components preoperatively to assure utility. Alternate surgical technics should be available intraoperatively. Opening of the instruments set must be done according to aseptic condition. When handling the instrument, avoid any contact with other material or tools which may damage the instrument surface. Under no circumstances the instrument should be modified .

6 - Re-use of the instrument:

ACHILLON® instrument must never be re-used. The company accepts no responsibility for such a use.

7 - Re-sterilization of non used instrument:

Re-sterilization is not allowed.

8 - Preventing actions for the patient to avoid post-operative complications:

- Avoid extreme position like flexion-extension
- wear post operative shoes, splints, braces, plaster etc according to the surgeon's prescription
- recieve prompt medical attention for any infection that could occur, whether at the operated-member level or elsewhere in the body.
- Immobilize in plantar flexion immediatly after surgery, before patient's recovery from anesthesia.
- follow the complete guidelines for post operative treatment as indicated by the surgeon.
- No weight bearing total or partial until surgeon's instructions.

9 - Storage:

Store in dry place

10 - Product information disclosure / Liability:

Newdeal, an Integra LifeSciences Company, has exercised reasonable care in the selection of materials and the manufacture of these products. Newdeal excludes all warranties, whether expressed or implied, including but not limited to, any implied warranties of merchantability or fitness for a particular purpose. Newdeal shall not be liable for any incidental or consequential loss, damage, or expense, directly or indirectly arising from use of this product. Newdeal neither assumes nor authorizes any person to assume for it any other or additional liability or responsibility in connection with these products. Newdeal intends that this device should be used only by physicians having received proper training in orthopedic surgery technique for use of the device.

INFORMATIONS:

Should any information regarding the products or their uses be required, please contact your representative or distributor or directly contact the manufacturer.

WARNING: Federal law (USA) restricts this device to sale by or on the order of a physician.

INSTRUMENTATION SET (scale 1/1)

ACHILLON® system is available sterile for single use only.

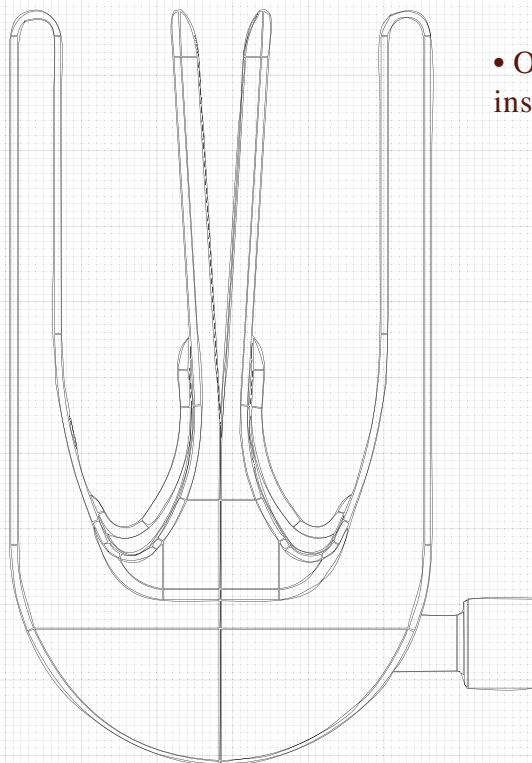

- One ACHILLON® instrument.

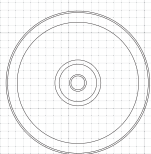

- One needle drive.

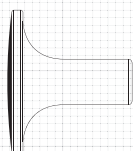

- Two surgical needles of 1.6 mm diameter.



ACHILLON®



Winner of the
AFCP 99
&
ESSKA 98 prizes



ACHILLON®

REFERENCE
119 700

DESCRIPTION

- ONE ACHILLON® INSTRUMENT
- ONE NEEDLE DRIVE
- TWO SURGICAL NEEDLES OF 1.6 MM DIAMETER.

- The products are manufactured and referenced within the frame of the standards in force.
- Implantation procedures are described in the surgical technique.
- Non contractual document. The manufacturer reserves the right, without prior notice, to modify the products in order to improve their quality.
- WARNING : Federal law (USA) restricts this device to sale by or on the order of a physician.

Distributed by

CE 0120

• See instructions for use



• Single use



• Sterile

STERILE

EO



INTEGRA LIFESCIENCES CORPORATION
311 Enterprise Drive • Plainsboro NJ 08536
t 800-654-2873 • 609-275-0500
f 609-275-5363 • www.integra-ls.com

NEWDEAL SAS
10, place d'Helvetie • 69006 Lyon • FRANCE
t +33 (0)4 37 47 51 51 • f +33 (0)4 37 47 51 52
newdeal@newdeal.info • www.newdeal.info

