

Jan.
1927



35
CENTS

RADIO BROADCAST



F. J. Edgus.

HOW TO BUILD THE TWO-TUBE "LAB." CIRCUIT WITH A. C. SUPPLY

[[The Cathode Ray Tube—The New Grimes Inverse Duplex System—How Crystals Are Used in Radio—A Plea for Proper Radio Regulation—What Do Listeners Really Like in Programs?—Data Sheets for the Experimenter]]

Doubleday, Page & Company, Garden City, New York

Cunningham

RADIO TUBES



Between You and The Microphone

there can be no factor more vitally important to true tone quality in your receiver than Cunningham Radio Tubes. Ever alert—always on duty—these tubes are the sentinels that guard radio reception from distortion and insure tone quality of the highest order. Install them today in every socket of your receiver. Cunningham Radio Tubes are sold by reliable dealers everywhere in the United States.

All Types in the Orange and Blue Carton

Since 1915—Standard for All Sets



New York

E. J. Cunningham Inc.

Chicago

San Francisco

Manufactured and sold under rights, patents and inventions owned and / or controlled by Radio Corporation of America

★ Examined and approved by RADIO BROADCAST ★

Build Your Set With KARAS PARTS

They will make it work better—look finer—last longer

GET the very utmost efficiency out of the radio set you build by using Karas Parts. Have it as fine in appearance as any factory-built set ever made. Build it of parts that will give years of trouble-free service. To accomplish this three-fold aim USE KARAS PARTS. No matter what circuit you use, Karas Parts will improve the results you may expect from your receiver. Thousands of enthusiastic Karas users have told us what these famous parts accomplished for them. Use these parts in your set and they will give YOU the same gratifying results.

All Good Dealers Everywhere Handle Karas Parts

We have made it possible for every radio set builder to secure Karas Parts easily and quickly. These parts have national distribution. They may be secured from all good radio dealers everywhere. However, there are times when the demand for Karas parts for popular circuits depletes some dealers' stocks, with the result that your particular dealer may be out of certain items you need. If you are in a hurry and do not wish to wait until your dealer secures a new stock from his jobber you may order direct from us, if you wish to do so. Simply fill out and mail the coupon below, telling us which parts you need, and we will send these to you by mail. SEND NO MONEY. Just hand the postman the price of the parts plus a few cents postage.

KARAS MICROMETRIC VERNIER DIALS



Oscillatory circuits require Karas Micrometric Vernier Dials for best results in tuning. Micrometrics tune to within 1-1000th of an inch—have 63 to 1 gear ratio—never falter or slip—have large convenient knobs which do not tire the hand—are made of Bakelite—have gold inlay precision markings—smooth, velvety action—and are absolutely free from backlash. They enable super owners to tune their sets as fine as a split hair. No other vernier dials do this. Micrometrics come in 180 and 360 degree types, are easy to attach—no panel holes to drill. Order Micrometrics for your super to-day and listen to stations you never heard before. Price, \$3.50 each.

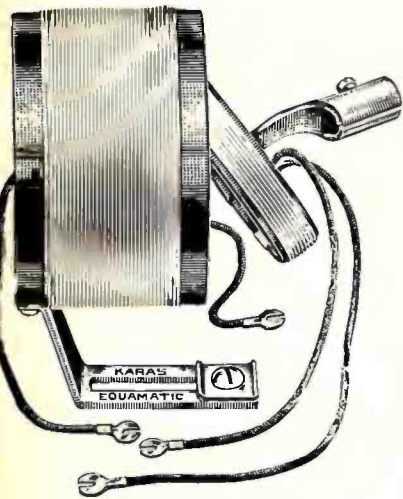

KARAS EQUAMATIC INDUCTANCE COILS

A revolutionary development in the design of a scientific inductance that was perfected by Karas especially for the Equamatic System. When these coils are used with the Karas Special 17 plate Variable Condenser in the Equamatic Receiver the radio frequency tubes operate at their highest possible peak of efficiency—just below the oscillation point—because there is an absolutely constant and equal transfer of energy between the primary and secondary inductances at every wave length setting of the dials. **THIS HAD NEVER BEFORE BEEN ACCOMPLISHED.** No other receiver does it to-day. *The Equamatic System is the only circuit in existence which gives this remarkable efficiency.*

Karas Equamatic Inductance Coils are made of Bakelite. The 2 1/2 inch secondary has a slotted bracket which is mounted on the subpanel and which may be adjusted for tight or loose coupling or turned about the spring clip to give any desired rate of coupling. The 2 inch primary coil is designed to mount on the extended shaft of the Special Karas Condenser, and it too may be adjusted to the precise angle for most efficient operation. These two coils are entirely separated from each other.

The Equamatic System does away with all lossy methods—is wonderfully selective—has tremendous volume—and great clearness.

Three Karas Equamatic Inductance Coils are packed in a box with a complete manual of simple diagrams and full instructions for building the Karas Equamatic 5-tube Sensation. Included with the coils are all necessary nuts, screws and binding posts for assembling the entire receiver. Price, set of three coils, \$12.00.



Karas Equamatic Retard Coils

So efficient is the Karas Equamatic Circuit that when used with present-day radio tubes it becomes necessary to place a small retard coil in the grid circuit. This compact coil contains 50 turns of No. 36 wire on a 1/4 inch laminated iron core housed in a brass shield. Two of these coils are required in the Equamatic System. Price, each, \$1.00.



Karas Equamatic Sub Panel Brackets

These brackets make it possible to center the primary coils exactly within the secondary coils in the Equamatic Receiver inductances, and also to have the pivot of the adjustable primary directly above the spring clip of the secondary—two important details in the construction of the Equamatic. Three of these brackets are required. Price, set of three brackets, 70c.



KARAS HARMONIK ALL STAGE RADIO AUDIO TRANSFORMERS

Every tone—every shade of tone—every vital harmonic—every overtone—is amplified with greatest volume and unvarying clearness by Karas Harmonik Audio Frequency Transformers. We designed these transformers to combine the greatest possible VOLUME with maximum clearness. Result: When Karas Harmoniks are used there is no muffling of words or sounds—no distorted tones—just clear, pure, sweet, natural reproduction with surpassing volume. Karas Harmoniks are all stage radio transformers. They have extremely low losses, high impedance and minimum distributed capacity. Many thousands of turns of wire finer than a human hair is wound on the large, iron core to insure high inductance and ample magnetic field for influencing the secondary windings. Karas Harmoniks have a controlled air gap which gives an extremely high amplification of low frequency fundamental harmonics. They are scientifically shielded, perfectly matched, and will outperform any other audio transformers ever made. Price, each, \$7.00.

KARAS ORTHOMETRIC STRAIGHT FREQUENCY LINE VARIABLE CONDENSERS

Called by experts the most perfect variable condensers ever produced. They possess features you will recognize as vital in condenser design. First, Karas Orthometrics have no measurable losses. Their resistance cannot even be ascertained by the most delicate instruments. As Karas dielectrics are made of hard rubber and placed well outside of the effective electrostatic field, absorption losses are done away with. Second, Karas Orthometrics are absolutely straight frequency line condensers. The "curve" of a Karas Condenser is a perfectly straight line at every wave length setting of the dial. This result is accomplished by the scientific eccentric form and position of Karas Orthometric Rotor Plates. There is a uniform separation of all adjoining wavelengths by equal distances on the dial. Every station is equally separated from its nearest neighbor in either direction by a ten kilocycle spacing—one division of the dial. Result: NO CROWDING whatever of stations at ANY part of the broadcast waveband. Karas Orthometrics are of highest possible efficiency both electrically and mechanically. Die-stamped high quality brass frames and plates are used, both rotor and stator plates being soldered at every point of contact. Rotor plates and frame are grounded, eliminating body capacity effect. Scientific cone bearings allow rotor plates to turn easily and smoothly, yet hold the shaft firmly and in perfect alignment.

Sizes and Prices	
23 plate .0005 mfd. capacity\$7.00
17 plates .00037 mfd. capacity 6.75
Special 17 plate for Equamatic 7.00
11 plates .00025 mfd. capacity 6.50
7 plates .00014 mfd. capacity 6.50
5 plates .0001 mfd. capacity 6.50

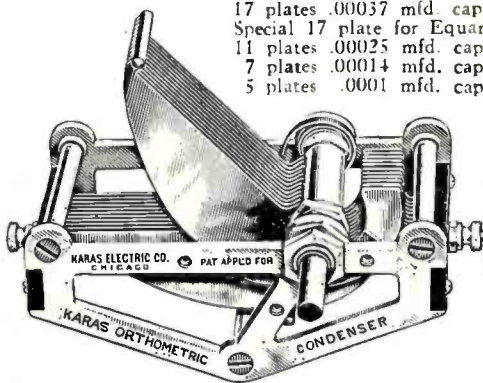

KARAS ORTHOMETRIC VARIABLE CONDENSERS

KARAS ELECTRIC CO.,
1061 Association Bldg., CHICAGO

Please send me the following Karas Products, for which I agree to pay postman \$..... upon delivery, plus postage.

() Set of 3 Karas Equamatic Inductance Coils, \$12.00.
 () Karas Audio Frequency Transformers, each, \$7.00.
 Karas Orthometric Condensers, as follows:
 () 23 plate () 17 Plate () Special 17 plate
 () 11 Plate () 7 Plate () 5 Plate
 Karas Equamatic Retard Coils, each, \$1.00.
 Karas Equamatic Subpanel Brackets, set of three, 70c.

Name

Address

City State

(If cash accompanies order we will ship postpaid.)

KARAS ELECTRIC CO.
1061 Association Bldg.
CHICAGO ★

★ Examined and approved by RADIO BROADCAST ★

The new Balkite Combination— with your “A” battery



U. S. PATENT, OCT. 12, 1926

*it supplies all radio power automatically
from the light socket*



A New Balkite “B” at \$27.50
Eliminates “B” batteries and supplies “B” current from the light socket. Three new models. Balkite “B”-W at \$27.50 for sets of 5 tubes or less requiring 67 to 90 volts. Balkite “B”-X for sets of 8 tubes or less; capacity 30 milliamperes at 135 volts — \$42. Balkite “B”-Y for any radio set; capacity 40 milliamperes at 150 volts — \$69. (In Canada: “B”-W \$39; “B”-X \$59.50; “B”-Y \$96.)



The New Balkite Charger
MODEL J. Has two rates. A low trickle charge rate and a high rate for rapid charging. Can thus be used either as a trickle or as a high rate charger. Noiseless. Rates: with 6-volt battery, 2.5 and .5 amperes; with 4-volt battery, .8 and .2 ampere. Price \$19.50. West of Rockies \$20. (In Canada \$27.50.)



Balkite Trickle Charger, \$10
MODEL K. With 6-volt “A” batteries can be left on continuous charge thus automatically keeping the battery at full power. With 4-volt batteries can be used as an intermittent charger. Or as a trickle charger if a resistance is added. Rate .5 ampere. Price \$10. West of Rockies \$10.50. (In Canada \$15.)

All Balkite Units operate from 110-120 volt, 50-60 cycle AC. The Balkite Charger is also made in 25-40 cycle model.

Now you can operate your radio set from the light socket. Merely by adding the new Balkite Combination Radio Power Unit. Once connected to your “A” battery and set and plugged into the light socket, it supplies automatic power to both circuits. You need not even turn it off and on, for it is controlled by the filament switch already on your set and is entirely automatic in operation. It will give you a constant quality of reception that cannot be secured in any other way.

Balkite Combination can be installed in a few minutes, either near the set or in a remote location. Like all Balkite Radio Power

Units it has no tubes, nothing to replace or renew, is a permanent piece of equipment, and is built to conform with the standards of the Underwriters’ Laboratories. It is noiseless in operation. It will serve any set now using either 4 or 6-volt “A” batteries and requiring up to 30 milliamperes at 135 volts of “B” current — any set of 8 tubes or less, including power tubes.

Add Balkite Combination to your radioset and know the pleasure and convenience of owning a receiver always ready to operate at full power. Price \$59.50. [\$83 in Canada.] Ask your dealer. Fansteel Products Company, Inc., North Chicago, Illinois.

Listen to the Balkite Radio Symphony Concerts with Walter Damrosch and the New York Symphony Balkite Hour Saturday Nights 9 P. M. Eastern (8 P. M. Central) Standard Time, over WEAJ, WEEL, WGR, WFI, WCAE, WSAI, WTAM, WWJ, WGN, WCCO, KSD, WDAF, WOC.

Balkite ★ Radio Power Units

THE BALKITE LINE OF ELECTROLYTIC DEVICES IS PROTECTED BY EDGAR



W. ENGLE U. S. REISSUE PATENT NO. 16,438; DATED OCT. 12, 1926

★ Examined and approved by RADIO BROADCAST ★



STATION WOC DAVENPORT

HERE'S WORK THAT IS ALMOST ROMANCE!



These Instruments Given FREE of Extra Cost

All instruments shown here and others sent to all my students free of extra cost under short time special offer. Clip coupon now—find out all about this big unequalled offer while you still have time to take advantage of it. This training is intensely practical—these instruments help you do the practical work.

My Radio Training is the "Famous Course That Pays for Itself"

Make more money quick when you take up this practical course.



\$70 in one Day for T. M. Wilcox

"I am in business for myself and recently made \$70 in one day. I was an electrician of rich experience and was occupying a splendid position as telephone superintendent when I enrolled with your course believing it would open up greater opportunities—have not been disappointed. Estimate that Radio will be worth tens of thousands of dollars to me in the next few years." T. M. Wilcox, Belle Island, Newfoundland.

I show you how to increase your earnings almost from the start of your course through practical pointers I give you.

Howard B. Luce of Friedens, Pa., made \$320 in 7 weeks during his spare time. D. H. Suitt of Newport, Ark., writes "While taking the course I earned in spare time work approximately \$900." Earl Wright of Omaha reports making \$400 in a short time while taking his course—working at Radio in his spare time only! Sylvester Senso, 207 Elm St., Kaukana, Wis., made \$500. These records not unusual—these men are a few of hundreds.

And when you graduate, my big Free Employment Department helps you get the job. You get just the same preparation and assistance toward success we gave C. C. Gielow, Chief Operator of the Great Lakes Radio Telegraph Co., E. W. Novy, Chief Operator of Station WRNY, Erle Chambers, Radio Engineer for Stewart-Warner, J. E. Fetzer, Chief Engineer of Station WEMC. The National Radio Institute, established 1914, today offers you the same opportunity these men had under a bond that guarantees you full satisfaction or money refunded. It's your big chance to get into the great Radio field—mail coupon TODAY for my big Free Book and proof!

Originators of Radio Home-Study Training

Kimball With WMAQ Chicago

"Accepted a position with the Chicago Daily News Station WMAQ. My income practically doubled, thanks to your fine course. I handle all consultation also do operating." Keith Kimball, Station WMAQ, Chicago, Ill.



Now Owns a Radio Store

"The Radio business is rushing just now. Building many Super Heterodynes, also doing installation and repairing. To your course I owe all my success in the Radio profession." A. J. Ommodt, Bowman, N. Dak.



Controls First Car by Radio

"I operate the portable broadcasting station in rear car, driving front car by Radio control. Will operate this car from New York to Frisco—13 months trip. Then we take the car around the world—a three years' tour. I owe it all to you." Leo Paul, New York City.



You Can Do What These Men Did!

I Will Train You at Home to Fill a Big-Pay Radio Job

Get into the great new Big-pay Industry—Radio. If you're earning a penny less than \$50 a week, clip coupon now. Send for AMAZING FREE BOOK, "Rich Rewards in Radio." Why go along at \$25 or \$35 or \$45 a week, when you could earn \$50 to \$250 in the same six days, as a Radio Expert? Hundreds of N. R. I. trained men are doing it—why can't you? I'll train you just as I trained them—just as I trained the men whose letters you see on this page. I'll teach you quickly at home in your spare time to be a Radio Expert, and draw down big money for the easiest and most fascinating work in the world.

\$50 to \$250 a Week as a RADIO EXPERT

It's the trained man, the Radio Expert, who gets the big jobs of this profession—paying \$75, \$100, \$200 a week and up. Free book gives all the facts. Every day N.R.I. trained men are taking good places in the Radio field—men like you—men like those whose stories I show you here. You can prepare just as they did by new practical methods, learn right at home in your spare time. Lack of experience no drawback—common schooling all you need. Our tested clear methods make it easy for you. We guarantee to train you successfully. Big Free Book contains all the proof.

Clip Coupon Now for FREE BOOK

Most amazing book on Radio ever written—full of facts and pictures—tells all about the great Radio field, how we prepare you and help you start. You can do what others have done—GET THIS BOOK. Send coupon today—no obligation.

J. E. Smith, Pres. NATIONAL RADIO INSTITUTE Dept. A-94 Washington, D. C.



Read the true stories printed in this border of men who got out of the rut



Chief Engineer Station WEMC

"Please communicate with my two junior operators here who want to increase their knowledge of Radio. Being a graduate of your course I know they could do nothing better for themselves than study it for it is the way to success in this profession." John E. Fetzer, Chief Engineer, Station WEMC, Berrien Springs, Michigan.



Photo shows Graduate E. F. Spadoni in his own Radio store at Chicago, Ill. "Your course gets the credit," says Spadoni.



J. E. Smith, President NATIONAL RADIO INSTITUTE Dept. A-94 Washington, D. C.

Dear Mr. Smith: Without obligating me in anyway, send me your free book "Rich Rewards in Radio" and all information about your practical, home-study Radio course.

Name.....Age.....

Street Address.....

Town.....State.....

Promoted to Big Job

"Just been made Sales Manager of this Radio firm—received a very good increase in pay. Up to present have been getting salary which in 3 months enabled me to purchase a new car." R. Jones Bay City Mich.



KINGSTON

B Battery Eliminator

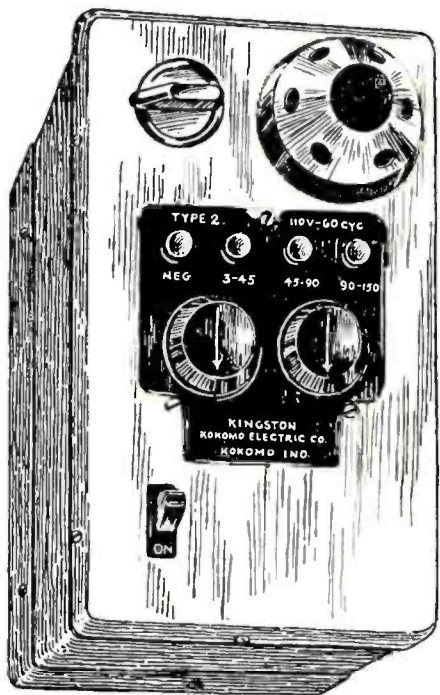

Complete
with
Raytheon Tube

TYPE 2
For 110-120 Volt A C
60 Cycle Current
\$35.00

TYPE 2A
Higher Powered Eliminator
for extremely large sets
\$42.50

TYPE 2C
For 110-120 Volt A C
25 or 30 Cycle Current
\$47.50

No Fixed Voltage Taps
with the Kingston, three different voltages and obtainable at the same time.

Extreme Flexibility
Each tap is adjustable over a wide range, making any voltage from 5 to 150 possible.

The Raytheon Tube
The Raytheon Tube is used as a rectifier only the highest quality is admitted to the Kingston.

Is Without Noise
The Kingston operates with extreme quietness and without vibration and will not heat.

No Acid or Solution
No trouble to operate and operation cost is extremely low. Will not get out of order.

THE KINGSTON B BATTERY ELIMINATOR means clear, full reception *always* richer, finer tone quality, and release from most of your radio problems.

Do away with troublesome, expensive, bulky batteries, with a dead radio set just when you want it most, with acids, with the danger of stained rugs.

The Kingston B Eliminator is compact, handsomely finished in black and nickel, and guaranteed not only to remove battery nuisance, but to deliver increased volume. A trial will convince you.

★ *At Your Dealer's*



KINGSTON

★ Examined and approved by RADIO BROADCAST ★

WESTON

for Radio Performance

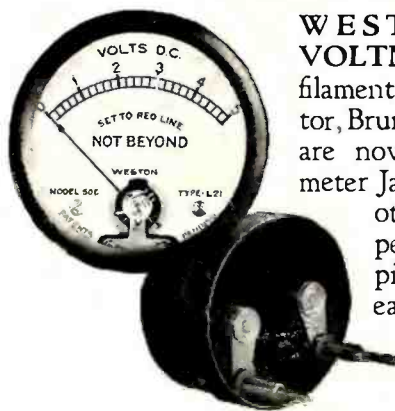

WESTON "PIN-JACK" VOLTMETER for plugging into filament pin-jacks—Radiola, Victor, Brunswick-Balke or Bosch sets are now provided with Voltmeter Jacks for its reception. All other sets can be so equipped by simply installing the pin-jacks which accompany each instrument. It is only necessary to plug the Voltmeter into the jacks and turn the rheostat until the proper tube voltage is indicated—eliminating 90% of the troubles of radio reception and giving longer tube life with the best possible reproduction.

WESTON RADIO INSTRUMENTS

will reveal the true conditions under which your set is operated and make it possible—simply by watching the dial—to get the best out of any receiver. The manufacturers mentioned above already provide pin-jacks on their sets for the use of these voltmeters. Dealers who have sold them know that they cut their servicing overhead on every set to which applied and bring satisfied customers, insured against unnecessary disappointment, failure and expense.



THE WESTON CONVERTIBLE TYPE OF "PIN-JACK" VOLTMETER not only has the advantages of the pin-jack instrument, but in addition is arranged for battery testing. With this unique device the operator can regulate his filament voltage—then remove the voltmeter and plug it into the High Range Stand to measure battery voltages and locate circuit troubles. Ask your radio dealer or write us for complete information.

**WESTON ELECTRICAL ★
INSTRUMENT CORPORATION**

179 Weston Avenue

Newark, N. J.



STANDARD THE WORLD OVER

WESTON

Pioneers since 1888



Supreme ⁱⁿ MUSICAL PERFORMANCE!

Tschaikowsky, Bee thoven, Brahms — would you listen with rapture to the rendition of their master pieces by the "hungry six" corner band? You would not!

Then why distort the masterful programs of the better broadcasting stations to the "hungry six" type of reception when Thordarson transformers are available at every dealer's?

Thordarson transformers are found in the majority of quality receivers, where musical performance is the first consideration — A conclusive proof of the musical supremacy of Thordarson amplification.

THORDARSON RADIO TRANSFORMERS



THORDARSON ELECTRIC MANUFACTURING CO.
Transformer Specialists Since 1895
WORLD'S OLDEST AND LARGEST EXCLUSIVE TRANSFORMER MAKERS
Huron and Kingsbury Streets — Chicago, Ill. U.S.A.



R-200
Amplifying Transformer

The transformer for the musical epicure. Has unusually faithful reproductive powers. Specified on such quality receivers as Zenith, Kennedy and Howard... **\$8.00**



Standard
Amplifying Transformer

A good reproducing transformer suitable for the requirements of the average ear.
2 to 1 ratio.....\$5.00
3½ to 1 ratio..... 4.00
6 to 1 ratio..... 4.50



Autoformer
All Frequency
Impedance Amplifier

Amplifies every note in the musical scale. An impedance with a step-up ratio, giving the even amplification of the impedance with the amplification increase **\$5.00** of the transformer.....



R-210
Power Compact

A complete foundation unit for power amplification and B-supply. Contains a power supply transformer and two chokes for power amplifier using UX-210 **\$20.00** power tube.....



R-171
Power Compact

Similar to the R-210 type but designed for UX-171 power tube and Raytheon rectifier. Contains buffer condensers as well as power supply transformer and **\$15.00** chokes.....



R-197
Power Supply
Transformer

A Power Supply Transformer designed for B-supply using the R. C. A. UX-213 type full wave rectifying tube. Will **\$7.00** supply up to 180 volts B.....



R-196
30 Henry Choke

Designed either as a filter or an output choke. Completely shielded. Current carrying capacity 80 MA. Inductance 30 henries. D. C. resistance 280 **\$5.00** ohms.....



R-76
Speaker Coupling
Transformer

An output transformer designed as a protective device to keep the high direct current voltage of power amplification out **\$6.00** of the speaker unit.....

ZENITH
SPARTON
Neutrowound
Pfanstiel
KENNEDY
MURAD
OZARKA
Valleytone
Radiadyne
Howard
Murdoch
Deresnadyne
EAGLE
RADIO ARGUS
AUDIO MASTER
HARTMAN
Buckingham
ALADDIN
Perlesz
Signola
Herald
and many others

Standard
on the
Finest

The UNIVERSAL

TWO NEW COMPANIONS

Transoceanic "New Phantom"

Seven Tubes--100% Shielding--Tunes 35 Meters to 3600 Meters

\$220.00 (No Accessories)

"On the Air to

Compare These Features With Any Radio

* Indicates Original Golden-Leutz Feature as Applied to Broadcast Receivers † Exclusive Feature

		Golden Leutz Transoceanic	Any Other Radio
1.	100% shielding—Interstage shielding—Complete external shielding against extraneous disturbances* - - - - -	✓	
2.	Totally shielded low loss variable condensers to prevent interaction between condenser and transformer fields* † - - - - -	✓	
3.	Complete shielding between stators (grid circuit) of multiple condensers scientifically determined* - - - - -	✓	
4.	Use of Indicating Meters and special switch to read "A," "B" and "C" battery voltages, total of 8 different readings* - - - - -	✓	
5.	Licensed under Hogan Patent 1,014,002 for single control (first licensee)* - - - - -	✓	
6.	Optional individual control or simultaneous control of all tuning controls, instantly changeable* - - - - -	✓	
7.	Use of interchangeable tuned radio frequency transformers to tune all broadcast wavelengths in the world, viz, 35 to 3600 meters* † - - - - -	✓	
8.	A special filter circuit in the output to exclude detrimental plate current from the Loud Speaker, Power Audio Amplifier included - - - - -	✓	
9.	Use of Resistance Coupling in the Audio Amplifier, combined with impedance and transformer coupling for perfect reproduction* † - - - - -	✓	
10.	Adjustable Antennae Coupling to adapt set to all various types and sizes of broadcast antennae* † - - - - -	✓	
11.	Antennae Series Condenser for Extreme Selectivity in congested districts, distant reception through locals possible* † - - - - -	✓	
12.	Sealed Chassis to exclude moisture and dust, design equally suited to any climate in the world* † - - - - -	✓	
13.	Last stage, power audio, adaptable to 201A, 112, 171 or 210 tubes, 550 volts maximum capacity for great volume* † - - - - -	✓	
14.	Separate B Voltage Taps for Detector, Radio Amplifiers, Audio Amplifiers and Power Amplifiers, adjustable for all tubes* - - - - -	✓	
15.	Separate Bias Voltage Taps for Radio Amplifier, Audio Amplifiers and Power Amplifiers, adjustable for all tubes* - - - - -	✓	
16.	Power Audio Tube Filament arranged for heating by either battery or alternating current* - - - - -	✓	
17.	No rivets to corrode, all connections soldered in accordance with Navy Specifications, all wires heavily insulated* - - - - -	✓	
18.	Only piece of steel used is in condenser shafts, detrimental steel supports purposely omitted, all other material non-magnetic - - - - -	✓	
19.	Metallized heavy current carrying, permanent value grid leaks and resistors. Fixed condensers made to special order - - - - -	✓	
20.	Direct Disc Vernier Adjustments: Etched Black Brass Dials, Silver Graduations 0 to 100 - - - - -	✓	
21.	Indicating rotors upon which calibrations can be recorded for reference: all calibrations are permanent - - - - -	✓	
22.	All insulating material Genuine Bakelite include sub-panels—coil bases—coil forms; sockets, new UX type positive contact - - - - -	✓	
23.	All Screws, Bolts and Nuts securely fastened by bronze lock washers and non-magnetic rust proof material* † - - - - -	✓	
24.	Most Compact Multiple Tube Sets made, 9 tube less than 2 cubic feet; 7 tube less than 1 cubic foot. Dimensions 27 $\frac{1}{2}$ x 13 $\frac{1}{8}$ x 8 inches. - - - - -	✓	
25.	Scientifically determined distance between transformers and shield, not detrimentally close, practically no shield losses* † - - - - -	✓	
26.	Volume Control device to regulate volume to any desired value without affecting quality, musical reproduction finest possible - - - - -	✓	
27.	Can be used with "B" and "C" Eliminators, special Golden-Leutz Eliminator made to match which supplies up to 450 volts - - - - -	✓	
28.	Practically all parts, except the meter and a few small parts, are manufactured in our factory and laboratory tested - - - - -	✓	
29.	Each receiver tested at night and calibrated to a station at least 2000 miles distant, guaranteeing long range performance - - - - -	✓	
30.	Adaptable to Electric Socket Operation using Golden-Leutz A-B-C Eliminator - - - - -	✓	

GOLDEN-LEUTZ, INC.

"Manufacturers of the Highest Class Radio Apparatus in the World"

MAIN OFFICE AND WORKS:

SIXTH AND WASHINGTON AVES., LONG ISLAND CITY, NEW YORK, U. S. A.

Cables: "Experinfo" New York—All Codes

DEALERS OR JOBBERS WIRE OR WRITE FOR SAMPLE TODAY

TRANSOCEANIC

TO THE "SILVER GHOST"

Transoceanic "Phantom"

Nine Tubes--100% Shielding--Tunes 35 Meters to 3600 Meters

\$250.00 (No Accessories)

Everywhere"

Phantom Models are already in use on the U. S. S. VEGA and U. S. S. UTAH

"MOST POWERFUL IN THE WORLD"

With respect to Receiving Range, Selectivity, Simplicity of Operation, Electrical Design, Mechanical Construction, Total Amplification and Quality of Musical Reproduction, we believe this Phantom Model easily exceeds all present designs.

9 TUBE TRANSOCEANIC "PHANTOM"

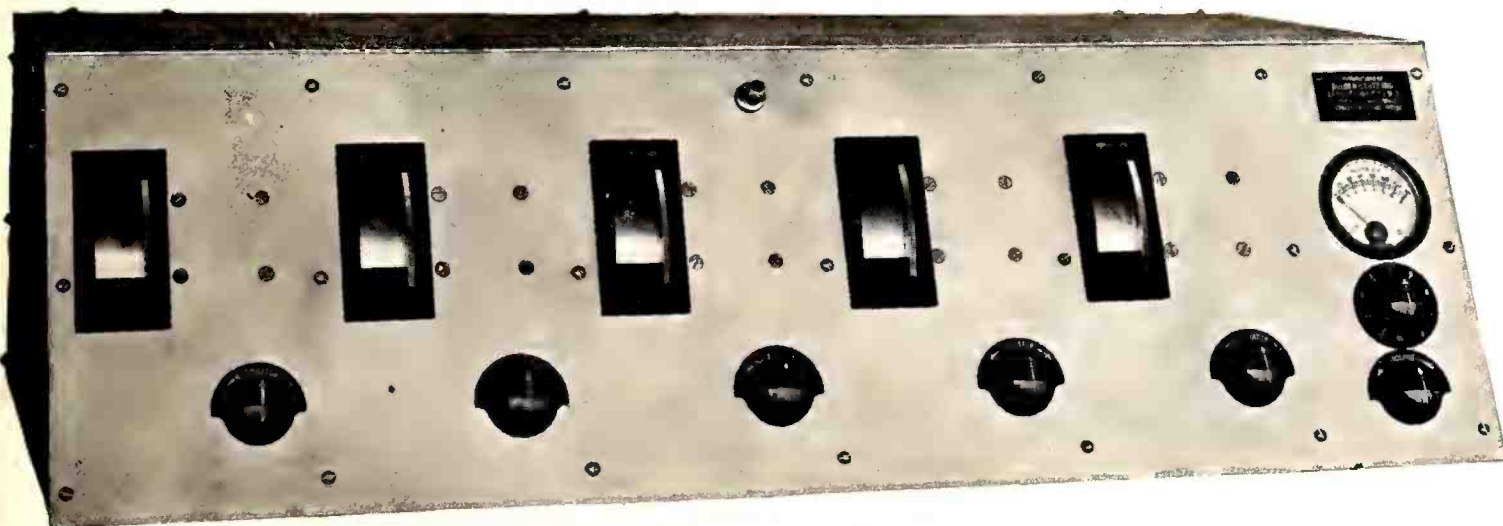

UNIVERSAL TRANSOCEANIC "NEW PHANTOM"

Item	Quan.	DESCRIPTION	Price
1	1	Universal Transoceanic "New Phantom" Broadcast Receiver, 7 tubes, 2 tuned radio, detector, three audio and power audio amplifier. Including "A" Transformers for 200 to 560 meters tuning range. (No accessories included.)	\$220.00
EXTRAS			
2	1	Set selected tubes including detector and 210 power tube	21.50
3	1	Set "B" Transformers for tuning 80 to 210 meters	15.00
4	1	Set "C" Transformers for tuning 35 to 90 meters	15.00
5	1	Set "AA" Transformers for tuning 500 to 1500 meters	15.00
6	1	Set "BB" Transformers for tuning 1200 to 3600 meters	15.00
7	1	6 volt 120 A.H. Storage Battery	24.00
8	1	New Type Farrand Senior Loud Speaker, Cone Type	32.50
9	1	Golden-Leutz Special Current Supply for 110 volts 50/60 cycle A.C.	135.00
10	1	Antennae Equipment	4.00
Total all accessories			\$497.00
11	1	Complete Knocked down Kit of all Transoceanic "New Phantom" Parts ready for assembly including constructional Drawings (no accessories) "A" Type transformers for 200 to 560 meters included	\$190.00
12	1	Complete set of Constructional Drawings and Operating Data on Transoceanic "New Phantom" only	2.00

Special Quotation for Dry "B" Battery Operation Will Be Made On Request

UNIVERSAL TRANSOCEANIC "PHANTOM"

Item	Quan.	DESCRIPTION	Price
1	1	Universal Transoceanic "Phantom" Broadcast Receiver, 9 tubes 4 tuned radio, detector, three audio and power audio amplifier. Including "A" Transformers for 200 to 560 meters tuning range. (No accessories included.)	\$250.00
EXTRAS			
2	1	Set selected tubes including detector and 210 power amplifier	25.50
3	1	Set "B" Transformers for tuning 80 to 210 meters	25.00
4	1	Set "C" Transformers for tuning 35 to 90 meters	25.00
5	1	Set "AA" Transformers for tuning 500 to 1500 meters	25.00
6	1	Set "BB" Transformers for tuning 1200 to 3600 meters	25.00
7	1	6 volt 120 A.H. Storage Battery	24.00
8	1	New Type Farrand Senior Loud Speaker, Cone Type	32.50
9	1	Golden-Leutz Special Current Supply for 110 volts 50/60 cycle A.C.	135.00
10	1	Antennae Equipment	4.00
Total all accessories			\$571.00
11	1	Complete Knocked down Kit of all Transoceanic "Phantom" Parts, ready for assembly including constructional drawings (no accessories.) "A" Transformers for 200 to 560 meters included.	\$220.00
12	1	Complete set of Constructional Drawings and Operating Data for Transoceanic "Phantom" only	2.00

Special Quotation for Dry "B" Battery Operation Will Be Made On Request

INDIVIDUALS MAY ORDER DIRECT FROM FACTORY IF DESIRED



SM

'Ever heard a real receiver?



630

Silver Shielded Six

YOU can buy every part needed for the Shielded Six solidly packed in a wooden kit-box—everything necessary except cabinet and accessories. Just ask for the 630 kit—it costs \$95.00—and it will build a set you can't duplicate for \$200, factory built. Or if you have some parts, you can get the Essential Kit, No. 633, for \$45.00.

And remember—when you build a Shielded Six you're getting a set with years of research work behind its design, with every part laboratory tested. You're getting a guarantee that its tone quality is beyond compare. *Radio Broadcast, Radio Age, Radio News, The Citizen's Radio Call Book*, all and more, have verified these claims—have endorsed the Shielded Six unqualifiedly.

HAVE YOU ever heard a real receiver? That's a simple question, but not one person in one hundred can say "yes."

Have YOU ever heard a radio set that made you lie back, light up your favorite pipe, and say, "This is the life"? When you've listened to a symphony over the radio, haven't you always felt that it would be just a bit clearer if you were in the concert hall?

Have you ever wanted just a little more volume on that distant station—just a bit more selectivity to cut out the interfering locals? And haven't you wished but two dials would tune the whole contraption instead of lots and lots of little knobs?

Have you ever heard a Silver-Marshall Shielded Six "doing its stuff"? It is guaranteed to give you better reproduction than you've ever heard. With the Six, you actually feel the vibration when you hear a cello or an organ—the timbre of a violin is true—a piano sounds as it should. And on a full orchestra—well, just ask the man who's built one about tone quality—he'll probably overwhelm you with enthusiasm.

For selectivity, for bringing in distance, the Shielded Six is right there beside the best. You can put it together on the living-room table with three tools in three hours, and the same evening bring in stations local and distant with uncanny ease—with only two dials.

220 and 221 Audio Transformers



DO you know that a large manufacturer building reproducing equipment for new theatres standardized on 220s and 221s after going over the entire market? Do you know that the maker of the finest electrically cut phonograph records stopped looking for reproducing equipment when his laboratory reported on the 220s and 221s? Do you know that the unofficial report of the largest telephone manufacturing company in the world set S-M 220s up as the very finest they had ever tested? Do you know that every important magazine has recommended them—that they are outselling all other makes? Finally, do you know that, guaranteed to give better quality than any others available, not a single user has ever asked the factory for his money back?

Can you think of any better recommendation for *your* audio transformers?

S-M type 220 audio transformer is designed for all stage use in ordinary or power amplifiers, with all standard tubes. S-M 221 is an output transformer, to be used between your power tube and loud speaker. It's guaranteed to improve quality and handling power—unconditionally, with any set or speaker. Both types are priced at \$6.00.

Prices 10% higher West of the Rockies

Do You Know the Secret of Quality Reproduction?

HAVE you your copy of "The Secret of Quality"? This book tells you simply and concisely how to get the most out of your audio amplifier—how to get real quality. It contains laboratory data never before available even to many manufacturers. It is the only authoritative treatise on all types of audio amplification written in non-technical language ever published.

It's free! Ask your dealer for a copy.

SILVER-MARSHALL, Inc.

838 W. JACKSON BLVD.

CHICAGO, U. S. A. ★

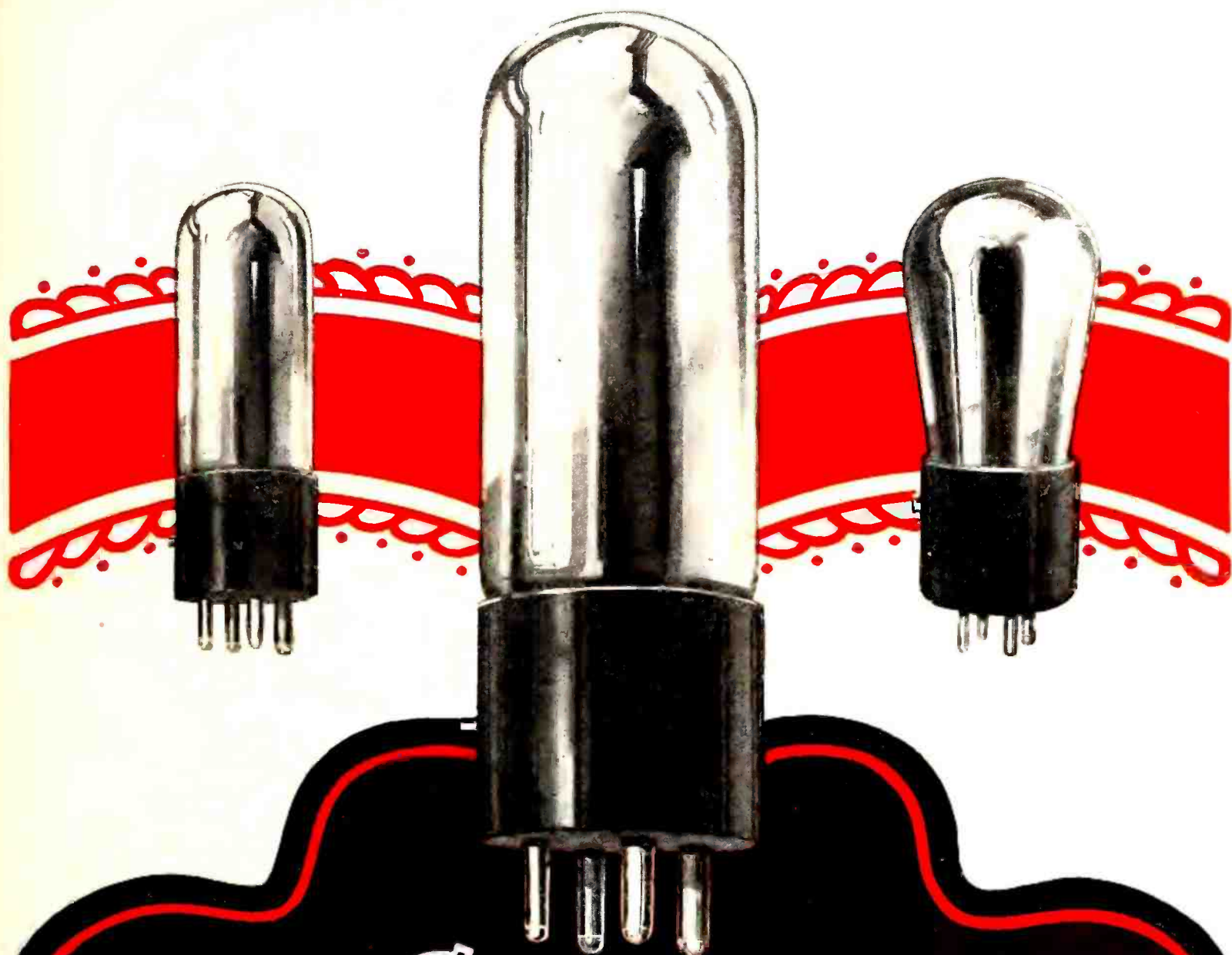

Sylvania TUBES

Sylvania Tubes are preferred by the most critical radio users everywhere.

Radio experts with ears that are trained to catch the most minute flaw in radio reception, like the clearer tone and the keener selectivity of Sylvania Tubes.

Sylvania Tubes are made better, yet they cost no more than the ordinary tubes. ★

For real radio enjoyment, place a Sylvania Tube in every socket of your set and tune in. The result will reveal to you new possibilities in your set.

**SYLVANIA PRODUCTS COMPANY
EMPORIUM, PENNA.**

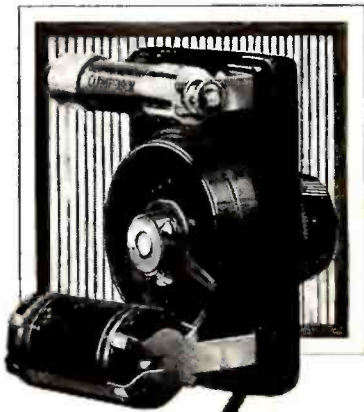

\$3.50 IN
U.S.A.
WITHOUT
DRY CELL

Featuring

CARBORUNDUM

REG. U. S. PAT. OFF.

STABILIZING DETECTOR UNIT

They say that even hardened laboratory engineers are enthused over the new Carborundum Eight-Tube Super Set.

It is an absolute revelation and one of its great features is the Carborundum Stabilizing Detector Unit employed as a second detector.

With this marvelous set you will get crystal clear tones at super-hot volume to spare—greater distance—increased sensitivity.

And one of the great reasons for its remarkable success is the

Send for
Constructional
Details of the
Carborundum
Eight-Tube
Super Set and
new Hook-Up
Book D-2

CARBORUNDUM STABILIZING DETECTOR UNIT

Improves Any Set

CARBORUNDUM GRID LEAKS ~ CARBORUNDUM COUPLING RESISTORS

THE CARBORUNDUM COMPANY, NIAGARA FALLS, N. Y. ★

SALES OFFICES AND WAREHOUSES IN

New York : Chicago : Boston : Philadelphia : Cleveland : Detroit : Cincinnati : Pittsburgh : Milwaukee : Grand Rapids
The Carborundum Co., Ltd., Manchester, Eng.

THE *Simplicity* of tuning
THE *Efficiency* of the Bakelite Shaft Condensers
and the *Beauty* of the Bronze Front Plate
and the *Quartzite Coils*

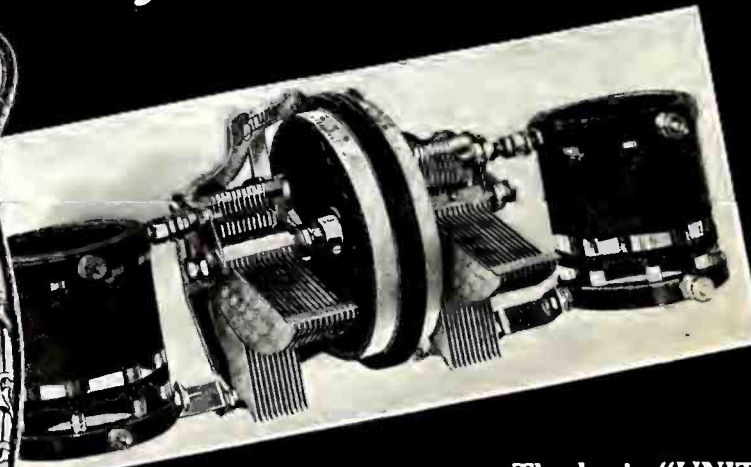

Makes the
"UNITUNE" the most
desirable tuning device
ever designed.

ALL BRUNO
"UNITUNES"
may be mounted on a
panel with only two
screws.

The basic "UNITUNE" consists of a frame upon which are mounted two condensers operated independently by two bakelite drums projecting thru a beautiful bronze plate. It may be obtained in all standard capacities. Completely assembled it lists at \$11.00.

Other "UNITUNES" assembled with one or more Quartzite Coils for all popular circuits range from \$12.00 to \$21.00.

Booklet of Instruction and Blue Prints—25c

BRUNO RADIO CORP., LONG ISLAND CITY, N. Y. ★

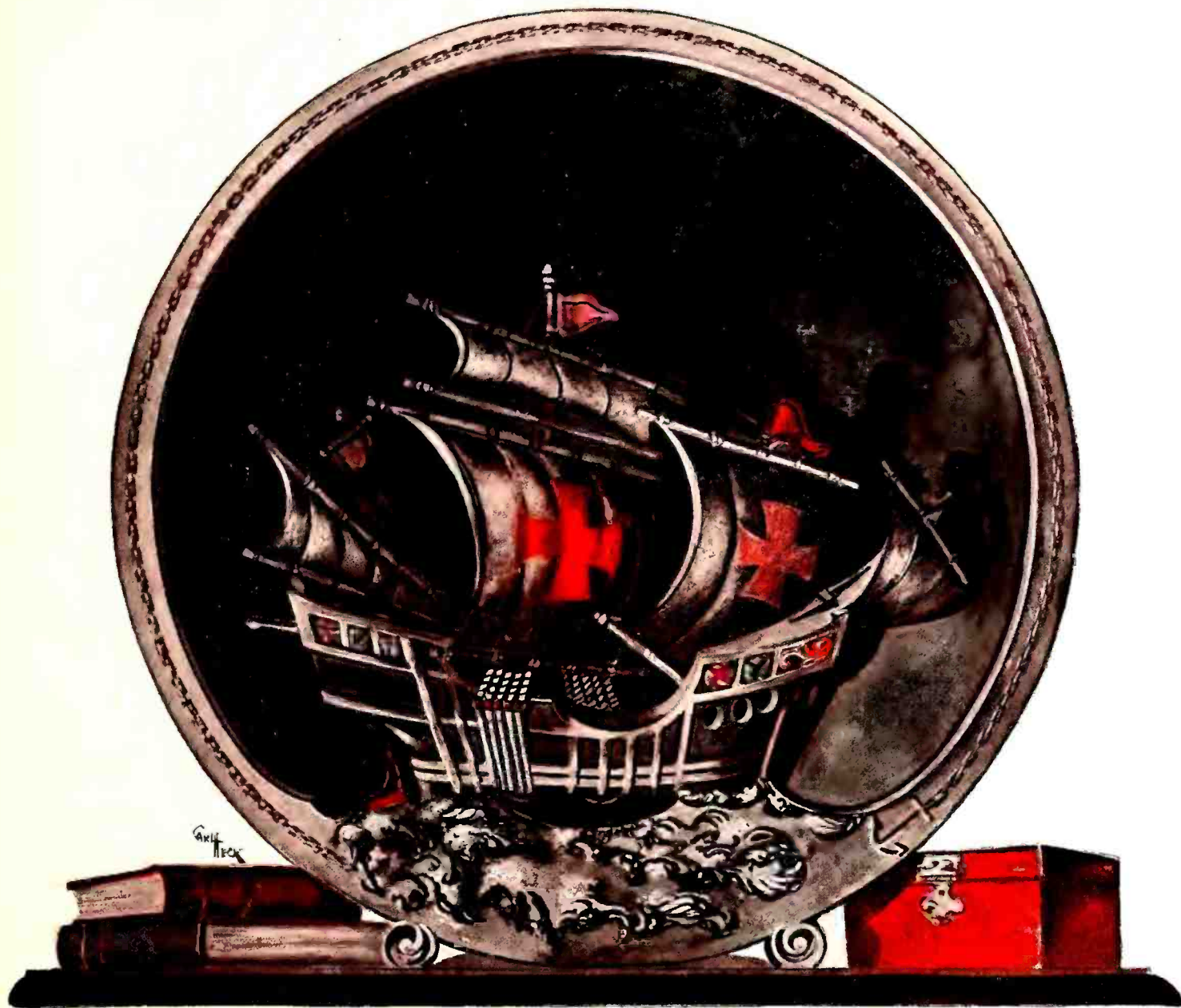

The New Ship Model VITALITONE

BEAUTY and quality are completely harmonized in this new ship model VITALITONE loudspeaker. It adds a decorative note to your room whether placed on a table or hung on the wall.

The frame and stand, which support a standard size cone, are executed in bas relief and finished in antique polychrome coloring.

The VITALITONE is powerful, responsive, sensitive, and non-buzzing. It is adjustable and of sturdy construction and will take 350 volts power input.

Satisfactory results unqualifiedly guaranteed.

[[Price \$12.50]]



Write Dept. B for Literature.

VITALITONE RADIO CORPORATION
88 University Place - New York

★ Examined and approved by RADIO BROADCAST ★

D' y' know what **HOMMEL** does for Dealers?

"Why, Mack, you ought to tie up with Hommel—the wholesaler who never retails," says a Hommel Dealer to his friend who had been facing the competition of his own jobber.

"I've dealt with Hommel for years," he continued, "Hommel has given me the fairest and squarest of dealer co-operation, has advertised consistently for years and has referred hundreds of inquiries to me direct. Hommel's Repair and Inspection Department saves me a lot of factory red tape and I've never been delayed yet on a rush order. The prices are always right.

"Yes, Mack, my advice is—Tie up with Hommel for real jobbing service."



"MY ADVICE IS—TIE UP WITH HOMMEL!"

Hommel's Catalogue No. 27-B is free. Ask for it.

WHOLESALE

EXCLUSIVELY

LUDWIG HOMMEL & CO

929 PENN AVENUE



PITTSBURGH, PA.

Hoyt CELLCHEK

If you are trying to think of an acceptable, useful Christmas present for a friend with a Radio, give him one of these new and more accurate instruments, for testing his storage battery. The electrical meter indicates instantly whether the battery needs re-charging, is low or in good condition. And the CELLCHEK operates without the withdrawal of a drop of acid, keeps hands clean and protects rugs and furniture.

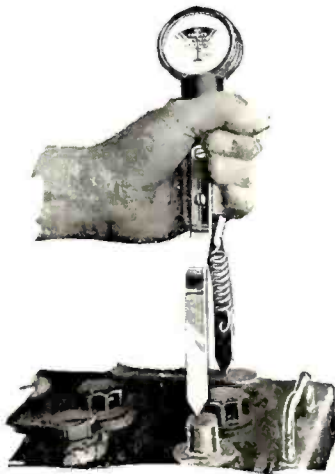

Price - - \$2.50 ★

BURTON-ROGERS COMPANY
 Boston Mass.
 Sales Dept. for Hoyt Electrical Instrument Co.

Recommended by
Leading Authorities
 and Specified by
ARTHUR H. LYNCH
 for the
Lynch Power Amplifier

CECO
A Tube for Every Radio Need

Use Two CECO Type "G" High Mu Tubes and One CECO Type J71 Power Amplifier

Write for Complete Data Sheet

C. E. MFG. CO., Inc., PROVIDENCE, R. I.

Self-Shielded With Copper

This Tube Eliminates
Squeals, Howls and Scraping,
Rasping, Microphonic Noises

Now comes the Strongson Self-Shielded Copper Plated Radio Tube. It isolates and holds within the tube those microphonic noises, originating within it and prevents that electrical and magnetic inter-action between the tube stages, by drawing off all inter-tube coupling through a ground to the negative "A" Terminal. The results are more power per tube stage, decreased consumption of power, whether from batteries or light socket, and flawless, perfectly toned reproduction of voice or music. Low wave stations come in without those accompanying squeals and howls. You can feed your set all the power necessary to get distance and desired volume without disturbing noises. With concentration of power per tube stage, the selectivity is sharper as stations come in on a much more restricted dial area.

WRITE FOR CIRCULAR

giving full particulars regarding this revolutionary tube development. Better still—send money order with your dealer's name and address for a set of tubes. Satisfaction guaranteed or money refunded.

DEALERS AND DISTRIBUTORS

Write or wire today for full particulars



PATS. PEND.



NONE GENUINE WITHOUT SEAL

\$3.50

HIGHEST TEST, HIGHEST GRADE TUBES

In the construction of Strongson Self-Shielded Copper Plated Tubes extreme care is taken from start to finish. Only the highest test, highest grade tubes are offered to the public. The tube characteristics are tested twice as many times as any other tube now on the market.

FOR CHRISTMAS

A useful gift for your radio friend. A set of five or six matched Strongson Self-Shielded Copper Plated Tubes. Attractively packed and shipped postpaid to any address, upon receipt of price \$3.50 per tube.

Shielding Grounded

The copper shielding is grounded to the negative "A" Terminal which in turn connects to the ground of your set.

Self-Shielded
Note in the illustration below, that the copper shield is an integral part of the tube itself.

**SELF-SHIELDED
STRONGSON
COPPER-PLATED**

RADIO TUBES

MOULDED PRODUCTS CORPORATION

LICENSEE

549 to 551 WEST 52nd STREET

New York City

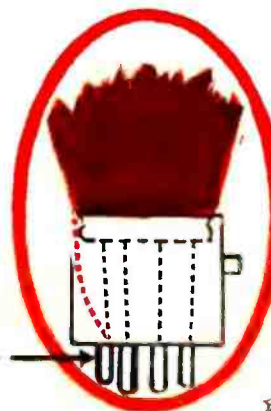

Faradon

CAPACITORS

“UNIVERSAL” FILTER CAPACITOR BLOCK



Model WS-3750
\$10.50

This new FARADON “Universal” Filter Capacitor Block, of 14.2 Mfds. in one container, is for operation in connection with the most generally used Battery Eliminator circuits. It contains important features not heretofore found in grouped filter condensers.

The total capacitance is connected to fixed terminals in convenient units, permitting ready wiring as desired. Units to be connected in the circuit where possible high potential surges may occur are constructed to withstand a higher voltage than is usually required. Convenience, safety and continued satisfactory operation are combined in the FARADON Filter Block.

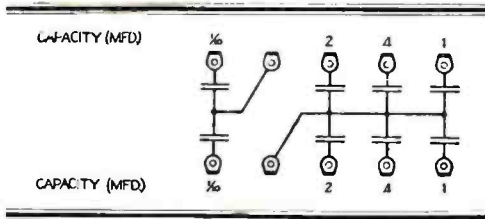

BY-PASS CAPACITORS

MODELS

Capacity MFD	Operating DC	Flash Test DC	Model No.	Price
1/2	150	500	WS3713	\$.90
1	150	500	WS3714	1.20
2	150	500	WS3715	1.90



RELIABILITY *Is Essential to Satisfaction in By-Pass and Filter Capacitors*

Not until a product has successfully passed exacting final electrical and mechanical tests is it considered worthy of the “FARADON” trade mark and ready for commercial use. Dependable, efficient products are the result.

U. S. Army, U. S. Navy, Bureau of Standards, General Electric Co., Radio Corp. of America, Tropical Radio Telegraph Co., Westinghouse Electric & Mfg. Co., and Western Electric Co., are some of the large Faradon users.

Thus secure the reliable Faradon Capacitors from your Dealer's



WIRELESS SPECIALTY APPARATUS CO.

Jamaica Plain :: Established 1907 :: Boston, Mass., U. S. A.



Your program starts with a snap-

It does if your "snap" judgment is good! Because good reception demands lively batteries. And that's what you get when you snap on your Rectigon to do your charging. The time to start bringing in tomorrow's snappy program is tonight—after the last station signs off. You just plug into the light socket and attach the terminals. That keeps your batteries at their peppy best. That saves service station bother. And you'll never be caught with batteries run down, or absent for charging when the week's best program is on the air.

when you charge 'em at home with

The Westinghouse Rectigon Battery Charger

©, 1927, W. E. & M. Co.

No noise as it charges—not a bit of fuss. Not even a murmur that would disturb the mildest slumber.



No acids, no chemicals—no moving parts—nothing to spill or burn. No muss, no worry. You'll have no spoiled rugs, no ruined clothing.



Saves its cost in short order—Count the dollars spent in a few trips to the service station and you'll hotfoot it for a Rectigon, for the good it does your pocketbook as well as your batteries.



Charges both "A" and "B" batteries—Keeps both packed with power. Bulb is used for "B" battery charging and is enclosed, like all other parts, in metal, safe from accident. (Rectigon charges automobile batteries, too.)



Perfect safety for your set—If you tune in while you're charging there'll be no harm either to set or batteries. Nor will batteries be discharged if anything happens to the current while your Rectigon's attached.



No Storage Battery Radio is Complete Without a Rectigon



THE RECTIGON is a superb Westinghouse product. Things you *can't* see, like extra heavy insulation, things you *can* see, like the durably enameled case—all are of highest quality. Westinghouse also manufactures a complete line of radio instruments, and Micarta panels and tubes.

WESTINGHOUSE ELECTRIC & MANUFACTURING CO.
Tune in on KDKA - KYW - WBZ - KFKX

★ Examined and approved by RADIO BROADCAST ★

RADIO BROADCAST

JANUARY, 1927

WILLIS K. WING, Editor

KEITH HENNEY
Director of the Laboratory

JOHN B. BRENNAN
Technical Editor

Vol. X, No. 3

EDGAR H. FELIX, Contributing Editor

CONTENTS

Cover Design	From a Painting by Fred J. Edgars	
Frontispiece	Three Great Research Engineers	250
The Hundred-Billion-Dollar Vacuum Tube	James Stokley	251
The March of Radio	An Editorial Interpretation	255
Why the Department of Commerce Should Control Radio	Another Triumph for Short Waves—The Beam System	The Marvels of the Coolidge Cathode Ray Tube
Additional "Talking Movies"	Ways of Reducing Interference in the Ether	Who Can Tell What Is the "Best Radio Set?"
	Radio Leads to Another Technical Advance	The Course of Patents in Dispute
	Who Will Endow Broadcasting?	The Month in Radio
	Interesting Things Said Interestingly	
A Six-Tube Super-Heterodyne	Kendall Clough	260
Piezo-Electric Crystals	M. Thornton Dow	263
The New Inverse Duplex System	David Grimes	266
The Listeners' Point of View	John Wallace	269
Radio Speakers Should Be Forbidden to Read from Manuscript	What Does the Listener Like in Radio Programs?	The Banquet Broadcast Nuisance
		The Log of a Listener
		Communications
		Broadcast Miscellany
The "Hi-Q" Receiver	Leslie G. Biles	274
As the Broadcaster Sees It	Carl Dreher	277
Why Censorship of Programs Is Unfortunate	Deterioration of a Word	Concerning B. C. Operators
Technical Notes of Interest to Broadcasters	Radio and Swinging Fists	The Lightning Jerker
		Abstract of Technical Article
		Latest Scientific Marvel of the AP
		Technique of Field Operation
		Memoirs of a Radio Engineer
New Equipment		282
A Combined Amplifier and A. C. Operated Power-Supply Unit	James Millen	284
How to Construct a Two-Tube Shielded "Lab" Receiver	John B. Brennan	289
Letters From Readers		296
RADIO BROADCAST's Laboratory Information Sheets		298
No. 57 What Is Resonance?	No. 58 The UX-171 and UX-210	No. 59 What Are Harmonics?
No. 60 Filter Circuit Data	No. 61 The Intermediate-Frequency Amplifier	No. 62 Antenna Power Dissipation
	No. 63 Line Power-Supply Devices	No. 64 The Gang Condenser
"Now, I Have Found"		304
A Key to Recent Radio Articles	E. G. Shalkhauser	310
The RADIO BROADCAST Technical Information Service		318
How the Radio Trade-Mark Is Protected	Leo T. Parker	320
Manufacturers' Booklets Available		322
Book Reviews		324
Practical Physics, Black and Davis.	Reviewed by Edgar Felix	The American Announcer and Radio Log

BEHIND EDITORIAL SCENES

ALTHOUGH this January, 1927, RADIO BROADCAST is not decked out with red holly and demure Santa Clauses in appropriate poses, it is nevertheless a Christmas issue, and contains a greater quantity than usual of interesting material. In this issue, we have a description of a very interesting super-heterodyne which a large number of readers have been pleading for, ever since Kendall Clough's article on super-heterodyne operation appeared in our September number. We present Thornton Dow's first article on the crystal and its use in radio, the first of a series of articles by David Grimes, describing his remarkable new inverse duplex circuit, a description of the new Hammarlund-Roberts "Hi-Q" receiver, and last, the two-tube R. B. "Lab." circuit receiver with the National Amplifier and B Supply. That is an array of technical and constructional material of which we are quite proud. For our Christmas presentation to our readers, we have omitted the seasonal decorations and have supplied as many fine technical articles as we could. Even so, the article by Howard Rhodes, of the RADIO BROADCAST Laboratory, telling of J. H. Hallberg's work on very short waves had to be held over for our February number.

FOR those who have been wondering about the details of the cathode ray tube developed by Doctor Coolidge of the General Electric Company, James Stokley's leading article supplies the information and, what is more, not a little of the impression created by actually seeing the tube in operation. The tube is now more than a laboratory fact and the medical application lies with that profession. That step, we understand, has already been taken. . . . There is a paragraph on page 258 in the "March of Radio" directly under the heading "The Month in Radio," which is more than usually prophetic, as announcements about the time this magazine appears will well show.

WE, like the aural Mr. Wallace, who each month interprets "The Listeners' Point of View," have a strong aversion to the average questionnaire. . . . But so much nonsense has been uttered, and worse, written, about what the radio listener likes, that we have decided to give those listeners who read this magazine an opportunity to tell something of their habits and preferences. We hope that every reader will tear out page 270 and fill out the answers.

THE tabulation of advertising volume in general and class magazines in *Printers' Ink* shows that for November magazines, RADIO BROADCAST had a total of 29,504 lines, being exceeded by *Radio News* with 35,506, and followed by *Popular Radio* with 29,315, *Radio* with 19,706, and *Radio Age* with 8834.

RADIO BROADCAST for February will contain another article on the R. B. "Lab." Circuit, this time with especial reference to the four-tube model. We are beginning to hear from the provinces on this set and as Mr. Harvey Merwin of Florida phrased it, "the circuit is so much better than you said it was that I cannot understand why you did not shout louder, but perhaps it is wiser to let the user discover that for himself." The first of two articles by B. F. Miessner on electrically operated receivers will appear in February. Keith Henney is working on another of his popular tube articles which will soon appear.

—WILLIS K. WING.

<p>Doubleday, Page & Co. MAGAZINES</p> <p>COUNTRY LIFE WORLD'S WORK GARDEN & HOME BUILDER RADIO BROADCAST SHORT STORIES EDUCATIONAL REVIEW LE PETIT JOURNAL L'ÉCO FRONTIER STORIES WEST</p>	<p>Doubleday, Page & Co. BOOK SHOPS (Books of all Publishers)</p> <p>NEW YORK { LORD & TAYLOR PENNSYLVANIA TERMINAL (2 SHOPS) GRAND CENTRAL TERMINAL 38 WALL ST. and 526 LEXINGTON AVE. 848 MADISON AVE. and 166 WEST 32ND ST.</p> <p>ST. LOUIS: 223 N. 8TH ST. and 4914 MARYLAND AVE. KANSAS CITY: 620 GRAND AVE. and 206 W. 47TH ST. CLEVELAND: HIGBEE CO. SPRINGFIELD, MASS.: MEEKINS, PACKARD & WHEAT</p>	<p>Doubleday, Page & Co. OFFICES</p> <p>GARDEN CITY, N. Y. NEW YORK: 285 MADISON AVE. BOSTON: PARK SQUARE BUILDING CHICAGO: PEOPLES GAS BUILDING SANTA BARBARA, CAL. LONDON: WM. HEINEMANN LTD. TORONTO: OXFORD UNIVERSITY PRESS</p>	<p>Doubleday, Page & Co. OFFICERS</p> <p>F. N. DOUBLEDAY, President A. W. PAGE, Vice-President NELSON DOUBLEDAY, Vice-President RUSSELL DOUBLEDAY, Secretary S. A. EVERITT, Treasurer JOHN J. HESSIAN, Asst. Treasurer</p>
---	---	--	--

DOUBLEDAY, PAGE & COMPANY, Garden City, New York

Copyright, 1926, in the United States, Newfoundland, Great Britain, Canada, and other countries by Doubleday, Page & Company. All rights reserved.
TERMS: \$4.00 a year; single copies 35 cents.



look inside that Christmas Radio Set

THE *equipment* is as important as the set. The distance reach of a set depends a great deal on the tube in the detector socket. The over-all performance of a set depends very much on the tubes in every socket. The volume and tone quality you will get are dependent upon the tube in the last audio stage. In every point, the tubes are as important as the set. And everyone who realizes this insists on genuine RCA Radiotrons.

The research laboratories of RCA, General Electric and Westinghouse have developed Radiotrons to new accomplishment, year by year. And the manufacturing skill of these same companies keeps RCA Radiotrons far in the lead in accurate making.

Be sure, when you buy a Christmas radio set, that you are getting genuine RCA Radiotrons with it. You can tell by the RCA mark inside the glass at the top. Or take out the tube, and look at its base.

Extra! Extra! Gift Ideas for Radio fans

A "spare" Radiotron—genuine RCA Radiotron, of course—of the type he uses.

A *power* Radiotron UX-112, UX-171 or UX-210 for bigger volume and finer tone.

A special *detector* Radiotron UX-200-A for storage battery sets—for longer distance reach.

Ask any dealer all about these Radiotrons—he'll tell you which to get. But be sure it's a genuine RCA Radiotron, if it's to be worthy of gift giving.

RADIO CORPORATION
OF AMERICA
New York Chicago
San Francisco

RCA Radiotron

MADE BY THE MAKERS OF THE RADIOLA

★ Examined and approved by RADIO BROADCAST ★



THREE GREAT RESEARCH ENGINEERS

Dr. Irving Langmuir, Dr. Willis R. Whitney, and Dr. W. D. Coolidge. Doctor Langmuir has contributed much to the development of the vacuum tube. Doctor Whitney is chief of the research laboratories of the General Electric Company, and Doctor Coolidge is the assistant director of the Laboratory. The remarkable new cathode ray tube is due to the experiments of Doctor Coolidge

RADIO BROADCAST

VOLUME X /



NUMBER 3

JANUARY, 1927

The Hundred-Billion-Dollar Vacuum Tube

New Cathode Ray Tube Has Greater Electronic Emission Than all Available Radium in the World—How the Rays Are Caused to Pass Through a Nickel "Window"—Their Effect Is to Cause Calcite Crystals to Glow, Glass to Change Color, Wax to Become Electrified, Acetylene Gas to Solidify

By JAMES STOKLEY

Science Service

IT HAS been estimated that the number of electrons given out by the new Coolidge cathode ray tube would be equal to that given out in the same time by a ton of radium, were it possible to obtain so much of this precious material. A hundred billion dollars would be the cost of so much radium, but the fact is that there is less than a pound of radium available in the whole world!

The cathode ray tube is essentially a vacuum tube put to a new use. It differs somewhat in form from the conventional tube, and the voltages applied to it border upon the 350,000-volt figure instead of the requisite 90 or 180 volts which we use on the plates of our vacuum tubes in a radio receiver. The source of electrons in the Coolidge cathode ray tube is the same as in the ordinary radio tube—a heated filament in a vacuum. In the radio tube, the electrons are emitted from the filament and are utilized for carrying electricity from the filament to the plate, under control of the grid. In the cathode ray tube, the electrons are emitted in a similar manner but are attracted to the plate by means of a very high voltage, and are caused to pass outside the tube through a thin nickel window, where their behavior upon various materials may be studied.

As early as November 30, 1878, a paper was presented to the Royal Society in London by Professor (later Sir) William Crookes, which gave some particulars of the phenomena which takes place when an electrical discharge is sent through a highly evacuated tube. Since then many men have taken up the study.

On October 20, 1926, Dr. William D.

Coolidge, assistant director of the General Electric Company's Research Laboratory at Schenectady, New York, gave a public demonstration of the latest type of Crookes' tube which is capable of producing *large*

quantities of electrons or cathode rays outside of the tube itself.

In the ordinary cathode ray tube, the electrodes are of aluminum, consisting, like all forms of matter, of atoms, which, in turn, consist of electrons. When the electrodes are connected with an induction coil, or some other apparatus to produce a high voltage, the small amount of gas left within (for the vacuum, though high, is not perfect) is ionized. That is, the atoms of which the gas consists are broken up into smaller units called ions, which are of two kinds, one bearing a positive charge and the other a negative.

When these positive ions hit the cathode, they knock out electrons from the aluminum atoms, and it is these electrons, moving with a speed comparable with that of light itself, that form the cathode rays.

In the Coolidge tube, however, the electrons are emitted from a heated filament in the same manner as they are in the ordinary vacuum tube. This filament may be heated by means of an ordinary storage battery and gives off quantities of electrons. Then, when a high positive potential is applied to the cylindrical anode, the electrons are drawn with great velocity from the cathode toward and through the anode to the window, even though the vacuum is so great that, when the filament is cold, the highest voltage will not cause a discharge in the tube.

For many years it was known that there were electrons inside the tube but that they were not coming outside. Crookes referred to them as the "Fourth State of Matter," for they were obviously not solid, liquid, or gas, the three states of matter then

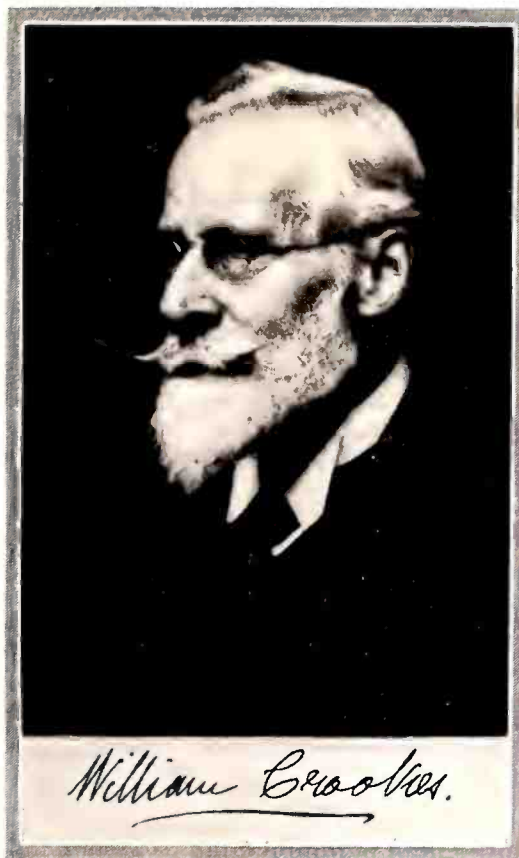

SIR WILLIAM CROOKES

Famous English physicist, whose early experiments with electrical discharges within evacuated glass bulbs led to the discovery of X-rays, and, later, to the invention of the cathode ray tube by Dr. W. D. Coolidge

known. Neither were they wave motions, like light, or radio waves. At that time the opinion was justified that the cathode rays, or electrons, could never be obtained outside of the tube.

Later, however, a German physicist, P. E. A. Lenard, made a tube which allowed a few scattering electrons to come outside the tube through a small aluminum window.

In the Coolidge X-ray tube (not to be confused with the cathode ray tube) the electrons from the hot filament are driven against a heavy tungsten target thus causing a secondary radiation from the target called X-rays. In the cathode ray tube the electrons, or cathode rays, are driven against a thin nickel window which they penetrate to get outside the tube.

It is this nickel window which replaces the aluminum window of Lenard. Though it might seem strange that these tiny particles could pass through an apparently solid piece of metal, it is not so strange if we realize that the most solid substance consists of atoms, according to the modern ideas of the constitution of matter. The atom, which not many years ago was supposed to be a solid and indivisible unit, is now believed to be built something like the solar system, with a charge of positive electricity in the center, called the proton, and a varying number of particles of negative electricity, or electrons, revolving around it. It is the number of the orbital electrons, and the extent of the electrical charge on the proton, that determines what element the atom makes.

Thus, in the cathode ray tube, the cathode rays, which may travel as fast as 150,000 miles in a second, or about eight tenths the velocity of light, pass between

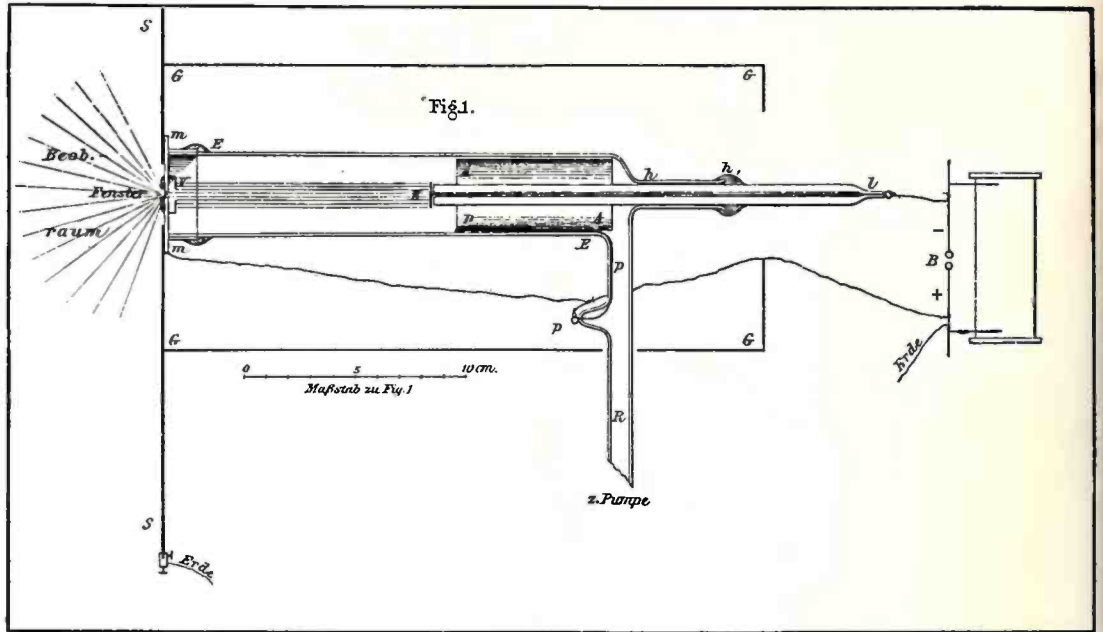

LENARD'S CATHODE RAY TUBE

The first apparatus for producing cathode rays in air. Small quantities of the rays came through a tiny aluminum window shown at the left of the diagram. As this window could never be made completely airtight, it was necessary to keep the tube constantly connected to an air pump while in operation, a difficulty which Doctor Coolidge has surmounted.

the parts of the nickel atoms of the window, and out into the open air. But the air can't get into the tube, because the oxygen and nitrogen atoms are about the same size as those of the window, and so are too big to crawl through the cracks.

Theoretically, says Doctor Coolidge, the element with the lowest atomic number, which is its number in a list of all the elements in order of atomic weights, would be best for the window, because such an atom would have the smallest number of parts to obstruct the rays. Beryllium is No. 4, but practically, nickel, which is No. 28, works best. It is strong, and does not have

to be cemented to the tube, and a cemented joint is the most vulnerable spot for leakage of air.

To fasten a piece of nickel, three inches in diameter, and five ten-thousandths of an inch thick to a glass tube so that no air will leak around it, seems, and is, a rather difficult procedure, but Doctor Coolidge has succeeded. The seal is even more airtight than it was in Lenard's $\frac{1}{8}$ -inch window, for he had to keep his tube connected to a vacuum pump in order to keep the vacuum sufficiently high, but Doctor Coolidge is now able to seal his tube off from the pump after it has been exhausted. This has the advantage that the tube can be easily transported and used in any position.

The method of sealing the window makes use of invar, an alloy of nickel and steel, which has the peculiar property that it expands and contracts with changes in temperature by nearly the same amount as does the glass which is sealed to it. The nickel window is soldered on to a ring of invar, and the invar is sealed to the glass. Metals in general could not be sealed to the glass, because, when the glass and metal cooled, after the seal was made, the metal would contract at a different rate from the glass. In addition, in order that the thin nickel may not be broken by the air pressure over its surface, amounting to more than a hundred pounds, a honeycomb-shaped grid of molybdenum, a very strong metal, with a very low coefficient of expansion, is placed behind the window.

Connected with the window, and, with it, forming the anode, is a copper tube, shown in the diagram. This extends to within an inch of the cathode, and serves to protect the glass walls from the bombardment of the electrons. Otherwise, at the high voltages used, the glass would soon be punctured.

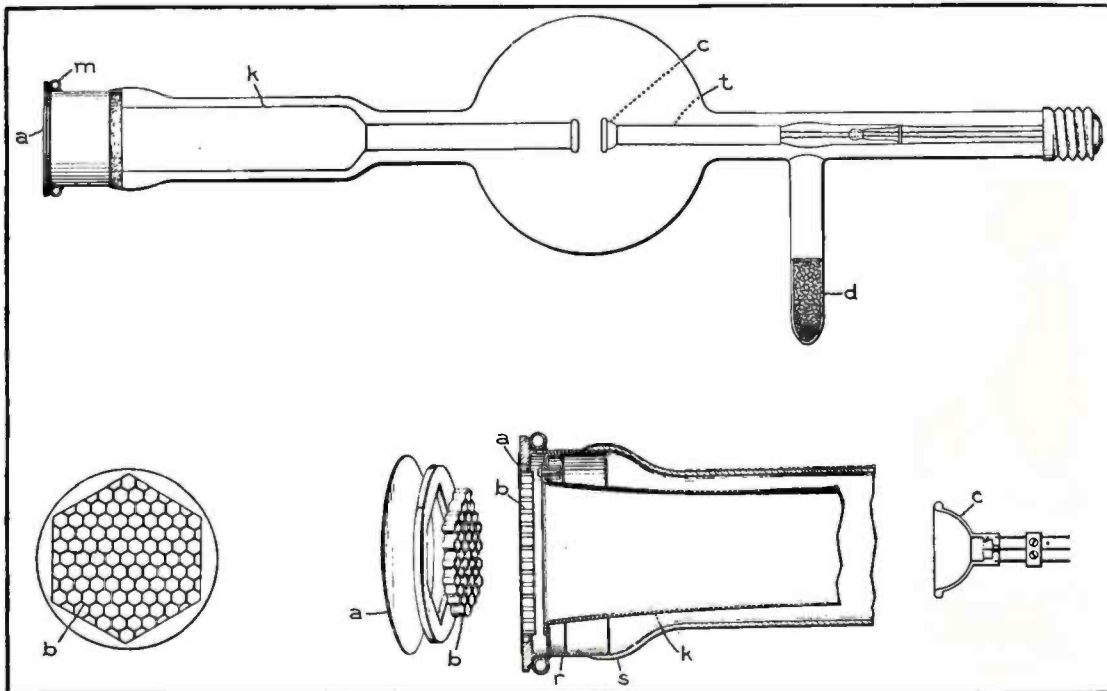

A PICTURE DIAGRAM OF THE COOLIDGE CATHODE RAY TUBE

The diagram shows the complete tube and component parts in detail. (a) Anode window, a very thin piece of nickel foil, through which the electrons pass. (b) A molybdenum hexagonal grid to reinforce the window against the pressure of the atmosphere. (c) Hemispherical cathode cup, focussing the electrons released by the tungsten filament within the cup. (d) Charcoal trap for residual gases. When immersed in liquid air, the charcoal removes all traces of gas within the tube. (k) Copper shield, preventing the electrons from striking the glass tube. (m) Water-cooling tube, to prevent the window from becoming over-heated. (r) Sleeve of invar to which the window is soldered. (s) Glass to invar seal. (t) Cathode shield

THE TUBE IN OPERATION

BUT now let us see the tube in operation. The room is darkened, and the dim figure of the scientist is seen moving a switch. Suddenly there is visible a large ball of purple light, with its center just in front of the window. This is the luminosity of the air, excited by the cathode rays, and the scattering of the rays causes the glow to extend even behind the window.

Air is not the only thing that glows in the path of the rays. In some of the tubes with which Crookes experimented he placed various minerals, and the rays caused them to glow with vari-colored lights. The same effects are observed when such substances are placed in front of the new tube. For instance, a crystal of calcite, a very pure form of marble, is placed in front of the window, and it glows with a bright orange light. If the current is turned off, the crystal continues to glow, as if red-hot, but it can be handled without danger, for it is as cool as it was at first, though the glow continues for many hours.

But the mere glowing is not the only remarkable effect of the cathode rays on the calcite crystal, for, after it has been exposed to them, it may show bluish white scintillations for a minute or more after the current has been turned off. And even then, until as much as an hour after raying, scintillations can be made to occur by scratching the crystal with a sharp point. Another way of prolonging the state in which scintillations may occur is by the use of low temperature, for if the crystal is plunged into liquid air just after it has been rayed, and kept there for even a week, it starts to glow and scintillate again when it is restored to normal temperature.

Five other substances that have been tried show these scintillations at ordinary temperature; these are amber, rosin, and the crystals of the chlorates of barium, potassium, and calcium. A large number of other substances, celluloid among them, show the scintillations also if they are cooled to liquid air temperature while being rayed.

If the spot where these scintillations have occurred is examined with a microscope, there is found a tiny crater with canals leading into it. These canals are straight in the calcite, but curved in celluloid. Apparently, this sparkling is due to the fact that the negative electrons driven into the surface of the crystal produce a potential gradient in the crystal, or celluloid, and when this becomes great enough, the discharge takes place, with a miniature eruption, which leaves the crater.

Another effect of the electrons is to produce a permanent electrical charge in certain substances. Everyone knows how a fountain pen, or other piece of hard rubber,



THE EQUIVALENT OF A TON OF RADIUM

A man can hold it easily. In the center of the round glass bulb can be seen the hemispherical shield containing the filament which forms the cathode of the tube. The anode is a hollow cylinder located to the left and extending from within an inch of the cathode toward the window at the extreme left, from which the rays are projected. The thin nickel sheet is on the outside and under it may be seen the form of the molybdenum grid which prevents it from breaking under the pressure of the air

may be charged by rubbing on one's sleeve, for example. But the charge finally dispels itself. However, a few years ago, a Japanese physicist, Eguchi, made what he called a permanent electret, analogous to the permanent magnet. A flat pan was filled with a melted mixture of rosin and carnauba wax, and this mixture was allowed to solidify between two large electrodes

connected with a source of high voltage. When it hardened and was removed, it had an electrical charge which persisted in spite of rough treatment.

When the cathode rays are made to impinge on a similar wax disc, it has been found that they produce a negative charge extending in to a depth corresponding to their penetrating power in this material. As in Eguchi's electret, this charge appears to be very permanent.

Visible changes are produced in some chemical substances; for example, the water clear crystals of cane sugar are turned white by a short exposure to the rays, while white crystals of potassium chloride are turned purple. Glass, likewise, is turned to a lavender color with an exposure of about a second—an effect that has been observed in windows of old houses that have been exposed to sunlight for a century or more.

ACETYLENE GAS SOLIDIFIED

ANOTHER curious chemical effect is that on acetylene gas. When the rays are turned into a glass chamber of the gas, and this glass chamber is surrounded by a metal vessel connected to the nickel window, a yellowish brown powder falls

to the bottom. Previously a similar appearing substance has been obtained in much smaller quantities by the action of the rays from radium-like substances, but it is unique because no chemical has yet been found which will dissolve it. A possible use for this substance would seem to be as a varnish, because it would be impervious to everything, but the difficulty is

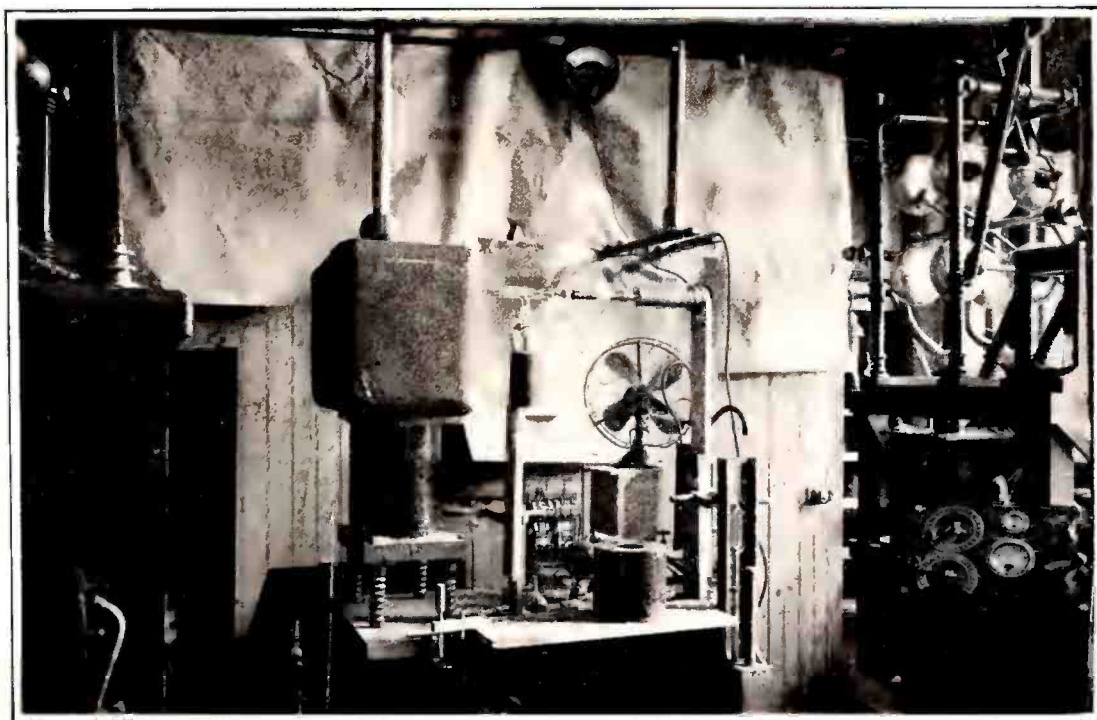

APPARATUS FOR PRODUCING CATHODE RAYS IN AIR

The tube is seen in the center of the picture, the window from which the electrons emerge being pointed to the right. The electric fan is used in keeping the tube cool while in operation. The high voltage (350,000 volts) necessary for operation is produced by the transformer at the left



A LIVE RABBIT'S EAR

Was exposed to the cathode rays for a second with a current of a milliamperere within the tube. This caused a scab to form over the rayed area

The leaf of a rubber plant was placed in front of the tube while operating, and it was found that the rayed area almost instantly became covered with a white latex, as if thousands of holes had been pricked in the surface and the sap allowed to ooze out. The effect is seen on only the side of the leaf toward the tube. The rays are not very penetrating.

Bacteria and insects are killed very quickly with the rays, while their effect on higher forms of life are very striking. For these experiments, rabbits were used, but despite the treatment, when the work with them was finished, there were more rabbits than when they first arrived!

A circular area on the rabbit's ear about the size of a dime was exposed to the rays for a tenth of a second with a current in the tube a milliamperere. The skin became dark, as if sunburned, and a few days later the hair fell out, not to reappear for seven weeks. Then another similar area was rayed for a second with the same current, and this caused a scab to form over the rayed area, but two weeks later a profuse growth of snow-white hair began which finally became longer than the



AGAIN THE RABBIT'S EAR

Only two weeks after the appearance of the scab on the ear caused by the one-second exposure, a profuse growth of white hair covered the bare part

in applying it. Ordinary varnish, such as shellac, requires some medium which will dissolve it, alcohol, for example, before it can be applied. However, if no metal vessel is used around the glass chamber containing the acetylene, the solid substance resulting from the cathode ray bombardment deposits as a hard yellowish lacquer on any object placed within the chamber.

It is the effects of the cathode rays on living tissue, however, that excite the most interest, for they are similar to that from a large amount of radium. One of the chief radiations from radio-active substances, the so-called "beta" rays, are nothing but rapidly moving electrons, just like the cathode rays, except that they move somewhat faster. Doctor Coolidge estimates, as stated elsewhere, that the number of electrons given out by the new tube is the same as that given out in the same time by a ton of radium. If such a vast amount of radium could be obtained, it would be worth something like a hundred billion dollars, but the fact is that there is less than a pound of radium available in the world.



IN THE DARK ROOM

The front of a cathode ray tube is here shown projecting into a dark room during operation, the luminosity of the surrounding air being clearly indicated

original gray hair. Finally, a third area was rayed for fifty seconds, also with one milliamperere. Scabs formed on both sides of the ear and when they dropped off, a hole was left, the edge of which was finally covered with the snow-white hair.

The possibilities of the tube have only begun to be investigated. However, with the 350,000 volts, the highest power that has yet been used on the tube, the range of the rays is only about two feet from the window. With still higher voltages this could be increased, but the highest possible voltage could scarcely give a range of more than a few yards, which automatically precludes its use as a weapon of offense in warfare.

But to the scientist, a new instrument for study has been provided, and the relatively few effects of the

tube already observed show that it will doubtless lead to many other interesting discoveries. A new field of research is opened in the study of the effect of cathode rays on all sorts of materials, many of which could not hitherto be brought into vacuum tubes. Even Dr. Coolidge himself hesitates to make predictions.

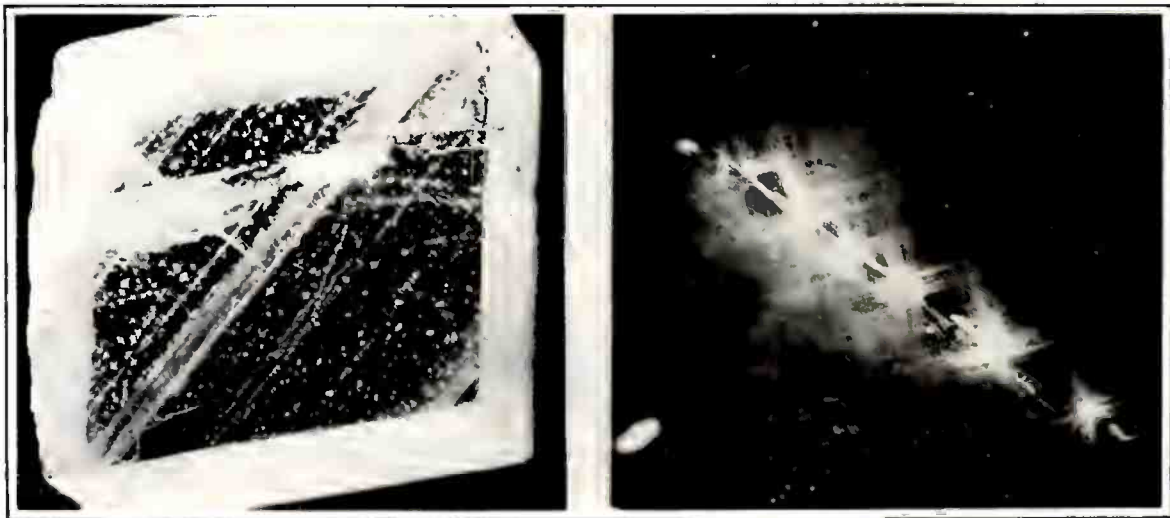

CRYSTAL OF CALCITE AFTER EXPOSURE TO CATHODE RAYS

The picture to the left shows a crystal glowing with "cold light" after exposure to the rays. To the right is a magnified view of scintillations produced on calcite crystal by similar exposure to the rays

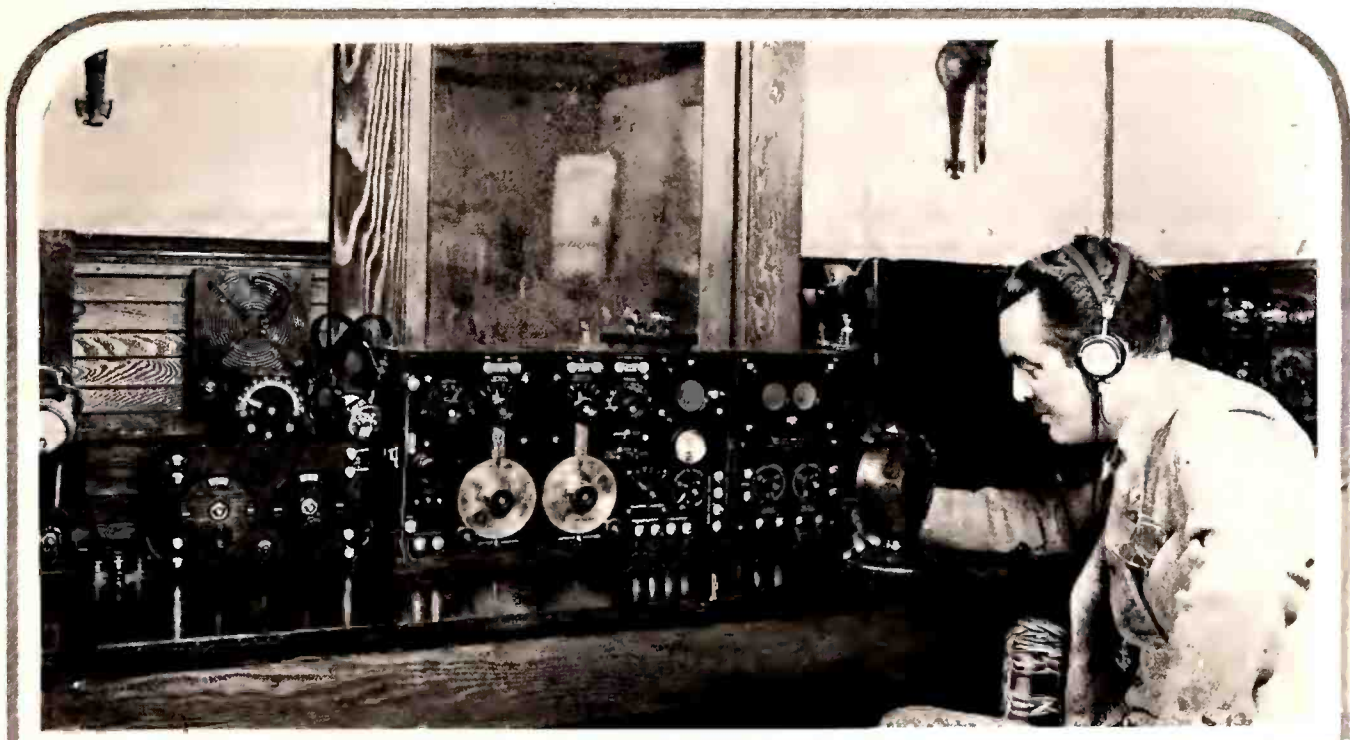

THE MARCH OF RADIO

News and Interpretation of Current Radio Events

Why the Department of Commerce Should Control Radio

ONE fine day in December, out of a bustling committee room in the national capital, where, for a period of weeks, Congressmen have whispered, Senators orated, and self-appointed experts expounded, perhaps will come forth the compromise radio bill. Presented on the floor of both Houses, there will be questions, speeches, and amendments and, little altered, the bill will be sent to the President for signature.

More than likely, the bill will provide for a radio commission which will cost taxpayers probably a quarter of a million a year in salaries and expenses. Being far better than no regulation at all, the creation of the commission will not be a calamity. It is simply a wasteful and inefficient means of accomplishing the regulation of radio. Perhaps some candidates, defeated for reelection on November 2, will find a berth on the commission a great help in tiding over what might be a period of unemployment.

Broadcasting managements will have to be more polite to politicians than in the past. Occasionally program managers will sidetrack meritorious program features in favor of a speech by a friend of a member

of the commission. Pussyfooting in Washington for wavelengths will become the established profession of a new breed of lobbyists—men who can “handle” the radio commission.

The radio industry, through its coordinating committee, representing various trade organizations, including the National Association of Broadcasters and the Radio Manufacturers' Association, is maintaining headquarters in Washington in order to assist the conference of Representatives and Senators with expert advice. Just what kind of advice they will give is not certain. A statement from one of the organizations represented in the coordinating committee is to the effect that they believe the White and Dill Bills can be satisfactorily combined. Apparently they will not raise their voices too loudly against the formation of the commission.

The National Association of Broadcasters says: “We are not spending our time worrying about chaos any more, for that is a matter of history.” Similar reassuring statements come from various sources, leading one to believe that the doctrines of Coué are evidently the guiding spirit of the radio industry. Possibly, when the doors of the committee room are closed and plain-clothes men stationed in the hall outside, representatives of the industry may be

willing to whisper to the conference committee that the present wavelength tangle is intolerable. But they will be careful not to raise their voices when they say it, lest some broadcast listener overhear. Then the secret would be out! Those who dare to cry out against the ridiculous wavelength congestion are accused of being calamity howlers and spreading false information. But we admit publicly that there are too many broadcasting stations. And we are not calamity howlers.

The prosperity and popularity of radio has not been affected by the chaotic situation (yes, we said chaotic) because DX listening is a minor and unimportant phase of radio entertainment. The æsthetic enjoyment of radio is a matter of listening to high-grade local stations. The fact that, for example, WODA, WLWL, and WRNY have, by their choice of wavelength, at various times excluded WGY from New York listeners is a minor loss as long as WHN, WAAF, and WJZ are undisturbed. The little fellows have stepped on each other's feet with utter abandon so that listening to them is as pleasant as a cat fight at midnight. But who cares? There are good, high-power local stations to listen to, offering a tremendously improved brand of broadcast entertainment.

We make our last plea for the formation

The photograph forming the heading shows the excellently arranged amateur phone transmitting station of George C. Tichenor at Los Angeles, operating on 2499, and 1666 kc. (84.5, 120, and 180 meters) using the calls 6AQA and 6XX

of a Bureau of Radio Communication in the Department of Commerce on the grounds of economy and efficiency. We hope for a law which provides unequivocally that there shall not be more than two stations of 500 watts power operating on the same channel, separated by at least 2000 miles; that stations of more than 500 watts be assigned exclusive channels; that not more than two thirds of the available frequencies be assigned to this high-grade service; that smaller stations, not covering large areas, be limited to 250 watts power; that they be given a free and clear channel by a separation of at least 500 miles from the nearest partner in their channel. This plan provides for 256 small stations and 75 large stations.

If service to the listener is the object of legislators, they will give him a clear, uncongested ether. If political expediency rules, they will provide soft berths for "lame ducks" by creating a cumbersome radio control commission and they will lack the courage necessary to reduce the number of broadcasting stations by some 40 per cent., an essential process to securing enjoyable and clear broadcasting.

At one fourth the cost of the proposed commission, a Bureau of Radio Communication can be maintained with a chief at \$12,500 a year, an assistant chief at \$6000 a year, nine deputy supervisors, one for each of the nine radio districts at \$4000 a year, the latter to work with the local radio inspectors in handling broadcasting problems in each district. Eligibility to serve in the Bureau should be subject to passing a civil-service examination. The membership of the bureau should be entirely independent of the fortunes of politics and politicians.

If broadcasting must be saddled with the radio commission, we may hope that it be quickly appointed and that it proceeds with courage to its job of decimating the ranks of broadcasters.

President Coolidge has frequently expressed his opposition to the formation of unnecessary boards and commissions. A Radio Commission is unnecessary. The presidential veto power may be exercised to defeat the Commission. It is regrettable that no body representing the radio industry has given forth a single,



©Bachrach

GEORGE S. DAVIS

Mr. Davis died on October 8, 1926, and was vice-president and general manager of the Tropical Radio Company, president of the Wireless Specialty Apparatus Company, and a director of the Radio Corporation. Mr. Davis, regarded as one of the most able men in commercial radio, worked up to his important position from a start as a ship wireless operator. The Tropical Radio Company is the company which manages the radio activities of the United Fruit Company, and the Wireless Specialty Apparatus Company is one of the chief manufacturing organizations for the Radio Corporation

united expression of what is good for radio.

Another Triumph for Short Waves —The Beam System

THE extraordinary results achieved by the new short-wave beam transmitter, used for communication between Montreal and London, has en-

which it has not been possible to dissolve or analyze; it has changed castor oil to a solid; transparent rock crystal salt into a black substance; killed fruit flies exposed to it for the fraction of a second; profoundly altered the characteristics of living cells, and has caused many minerals, after brief exposure, to become luminescent. When the technique of using the electron shower is fully understood, it will be capable of producing entirely new substances with uses and properties never before conceived. In the hands of the medical profession, it is likely to rout many heretofore incurable diseases. Within a generation, man will be able to construct any substance he pleases synthetically.



© Bachrach



© Harris & Ewing

TWENTY-FIVE YEARS OF WORK BY THE BUREAU OF STANDARDS

On December 4th, the Bureau of Standards celebrated its twenty-fifth anniversary. Its remarkable achievements in scientific research applied closely to the problems of industry have made the Bureau known and respected the world over. In no field have its activities been more helpful than in radio. The illustrations show Dr. J. H. Dellinger, past president of the Institute of Radio Engineers and director of the radio laboratory, and Dr. George K. Burgess, director of the Bureau

couraged Guglielmo Marconi to predict that "some day electric waves may be used for the transmission of power over moderate distances, if we succeed in perfecting devices for projecting the waves in parallel beams in such a manner as to minimize dispersion and diffusion of energy into space."

Transmission of power need not be efficient to be highly useful. For example, if we could transmit electric power to aircraft, even at a loss of 75 per cent. of the energy transmitted, the commercial value of aircraft would be tremendously enhanced, relieved of carrying fuel supply as a part of the load.

Marconi's short-wave beam transmission link between London and Montreal has a capacity of 200 words per minute, rivalling the maximum capacity of the best submarine cables. Radiating its energy in one direction, it is highly economical of power.

The Marvels of the Coolidge Cathode Ray Tube

DR. W. D. COOLIDGE'S new cathode tube, which projects a stream of electrons in the open air, makes available to science a tool of research destined to become fully as important as the X-ray. Already the electron bombardment has been used to change acetylene gas into a solid—a mysterious yellow powder

Additional "Talking Movies"

THE Radio Corporation of America reports substantial improvement in its earnings for the quarter ending September 30, as com-

pared with the same period last year. Increased summer sales is said to account for the gain in part. Instead of a deficit of \$358,275 for the quarter, as in 1925, there is a surplus of \$2,116,090. It is also reported that, in collaboration with the Fox Film Corporation, the Radio Corporation will market a talking movie device, suitable not only for use in theatres but also in small auditoriums of schools, colleges, and churches. The device will be a combination of the Pallophotophone and the conventional motion picture projector.

Ways of Reducing Interference in the Ether

SINGLE side-band transmission on a frequency of 214.2 kilocycles (1400 meters) is being used by station 2 XAH of the General Electric Company for relaying its programs to WCAD, Canton, New York, for rebroadcasting. The reception of programs from single side-band transmitters requires special and delicate receiving apparatus but has the advantage of greater stability and economy of power. It utilizes less than half the frequency space required by the two side-band method ordinarily used.

Who Can Tell What is the "Best Radio Set"?

A LETTER, signed "Up in the Air," which we ought to disregard because of its anonymity, complains that the average radio fan is much confused by reading radio publications. They do not tell him plainly and definitely which radio receiver is the best. The radio fan, he says, is a thousand times more puzzled than the prospective purchaser of an automobile or a watch or gun. Automobile manufacturers, he continues, have races and tests which demonstrate the quality of their products. Why not contests for radio sets for ferreting out the best receiver in each class?

Although we have studied the automo-

bile technically for more than ten years, we do not know which is the "best" in each price class. Winning automobile races is as much a matter of good luck and driving skill as it is the result of quality inherent in the car. Exceptional performance of a radio set is as much the outcome of good location and skillful operation as it is inherent quality. There is no "best radio set" any more than there is a "best" anything else.

Radio Leads to Another Technical Advance

IN A report to the American Mining Congress, William A. Sharp of Denver, Colorado, describes his radio camera-
phone which detects the presence of solid rock, liquids, gases, and minerals in the ground. A giant meteor which buried itself years ago in Arizona but has never been unearthed, despite countless drillings and borings, was discovered by the device to be buried to a depth of 1410 feet. At another point, eighteen new veins of a mine were located and three ancient mining tunnels abandoned and sealed up years ago.

A crude predecessor of this device was used in France, after the War, to locate buried shells.

The Course of Patents in Dispute

THE Crosley Radio Corporation is defending a suit filed in Ohio by the Westinghouse Electric & Manufacturing Company under Armstrong Patent 1,113,149; A. I. Gancher, for the Gancher Service Company, accepted a consent decree obtained by the Lectophone Corporation under several Hopkins patents; the Morrison Electric Supply Company, Inc., submitted to a consent decree in favor of the Westinghouse Electric & Manufacturing Company, under Fessenden and Armstrong patents; the Westinghouse Company also brought suit against the Stewart Warner Speedometer Company under Armstrong's patent 1,113,149; the Patent

Electric Company and the Carter Radio Company are at odds over the matter of connecting plugs, while an appeal is being brought which will bring the DeForest Company and the Radio Corporation of America into another battle over Patent 879,532; an injunction was granted the Westinghouse Electric Company in its suit against C. A. Branston, Inc., under Armstrong and Fessenden patents. The



AN HEROIC RADIO OPERATOR

H. T. Bruck, radio operator attached to the S.S. *New Britain*, who stuck to his post until he summoned aid for this vessel, which had caught fire when well out to sea. The ship was taken to a pier in Charleston and the fire put out

Shepherd Stores, however, advertised in the Boston *Globe*, with impunity and without patent difficulties, a sale of "437 women's summer dresses at \$3.75 each, all of standard manufacture, panels, dials, switches, sockets, rheostats, coils, condensers, transformers, panel shields, resistances, micadons, etc. The reductions are enormous."

We hope for the sake of modesty that the transformers were of the closed core type and the coils did not have spaced windings.

Who Will Endow Broadcasting?

FREEMAN HOPWOOD, in a letter to the New York *Times*, decries the increasing proportion of commercial programs on the air. He would enjoy an evening with his radio if it would bring to him "the thoughts of Voltaire, the rare philosophy of Schopenhauer, the jests of Mark Twain, a discourse on psychoanalysis, selections from John Stuart Mills, the wisdom of Confucius, a verse of two from Shelley or Keats" and a few other similar appeals to highbrow tastes.

Fortunately, or unfortunately, these preferences are those of a very limited proportion of the radio audience and all of them are of a type which is ill suited to the microphone. The thoughts of Voltaire are best appreciated by reading. The ear of the individual with average education does not perceive and assimilate nearly as readily as the eye. Broadcasting is primarily a disseminator of music. The greatest stimulus to improved standards has been the very commercial programs which he decries, such as the Atwater Kent hour, the recent Balkite Hour (to mention only a few) as well as such familiar standbys as the Philharmonic concerts.

Mr. Hopwood does not suggest meeting his share of the cost of broadcasting as a means of eliminating the commercial pro-



BEFORE THE DAYS OF THE RADIO COMPASS
SKIPPER OF TRAMP SHIP (endeavoring to locate his position on an old and dirty chart): "If that's a fly-mark, Bill, we're orl right, but if it's Sable Island 'eaven 'elp us!"

(Reproduced from *Radio: Beam and Broadcast*, by A. H. Morse)



CHARLES W. BURTON

Boston

Superintendent of Broadcasting, WEEL, Boston, Massachusetts. Especially written for RADIO BROADCAST:

"When WEEL broadcast the famous Boston Symphony Orchestra for the first time, the novelty of the thing attracted to our wavelength an audience that most nearly reached our maximum coverage. We know, from a check-up of tube and battery sales in our territory, that WEEL can be heard by 1,500,000 persons. We believe our potential audience was with us that night. Here is another way we arrive at that conclusion: We are convinced that only one person in every 500 tuned-in on a program will write a letter to the station about it. Three thousand letters followed the initial symphony broadcast.

"Most stations and program sponsors exaggerate the importance of fan mail. It cannot reflect the attitude of the audience in general; it rarely offers any intelligent criticism, and its requests, if complied with, add to the deadly similitude of programs. Many program sponsors, in order to stimulate letter writing, are offering samples, radio logs, and other articles as an inducement. Of what value to radio, or their campaign, is this? It merely indicates that people like to get something for nothing. It doesn't show whether the program has a popular appeal. Indeed, I have seen letters something like this: 'Your tenor ought to have his throat cut, and obviously your orchestra was organized 15 minutes before the program opened. Please send me one of your handy bottle openers.'

"A great many kind listeners do write fine letters to WEEL, and we love them for it. We hope their numbers will increase. But we do not hold with the old tradition that fan mail is the very life blood of the broadcasting industry."

gram, but instead hopes for an emulator of Andrew Carnegie to do it for him. To endow radio upon a satisfactory standard, such as is being rapidly attained through improvement in commercial broadcasting, would cost, through only fifty stations, not less than twenty million dollars a year. Commercial broadcasting can accomplish equally good results at half the cost be-

cause the difficult problem of collecting from the radio audience does not have to be met. There being no established source of revenue, broadcasting is able to present numerous high-grade features which would otherwise demand high payment.

Commercial broadcasters have learned that annoying the audience with persistent reference to themselves destroys the goodwill which they may gain. As a consequence, good features through high-grade stations are not rendered obnoxious because they are sponsored by commercial organizations. Even though the Royal Typewriter Company spent, it is rumored, \$35,000 to make the Dempsey-Tunney fight available to the audience, the references to the company during the broadcast were laudably restrained.

The Month In Radio

CAPT. R. H. RANGER of the Radio Corporation of America announces a marked improvement in the transmission of radio photographs by utilizing a minute stream of hot air which largely eliminates the dots and "freckles" characteristic of the pictures so far transmitted.

With the possibility of working with the transmission of photographs and the well-developed and fascinating field of short-wave experiment at their disposal, thousands of set constructors are directing their energies to new channels. The development of photographic transmission is approaching the point that the broadcasting of pictures is bound to be undertaken soon. It will have the same significance as the opening of wjv and KDKA as public broadcasting stations. A few devoted experimenters will obtain the complex apparatus necessary to decipher radio pictures; gradually they will win public attention and eventually picture reception will spread, as did broadcasting, to all parts of the world. Whether this will take place in one year or five years is as difficult to predict as was the radio enthusiasm in 1920.

EXPERIMENTS conducted at the Indiana Harbor Belt Railroad classification yards at Gibson, Indiana, have demonstrated the superiority of radio over the usual system of signals by means of lights and whistles. Obscuring of signals by mist and strong sunlight is eliminated. Since only low power is required, this communication does not add seriously to ether congestion. It eliminates much tooting and whistling which would otherwise annoy those in the vicinity of the freight yards.

THE Radio Manufacturers' Association is contributing a valuable service to the industry by gathering statistics which are being issued by J. B. Hawley, Chairman of its Statistical Committee. It is interesting to note the progress of the art by the increasing volume of sales and the varying ratio of purchases in sets, parts and accessories. The figures are millions of dollars:

Year	Sets	Parts	Accessories	Total
1922	5	40	1.5	46.5
1923	15	75	30	120
1924	100	100	150	350
1925	175	74	200	449
1926	225	75	230	520

THE Tri-State Telephone & Telegraph Company is trying out a plan in St. Paul, Minnesota, to furnish telephone subscribers with radio broadcast programs picked up by a central receiving station. The company installs loud speakers in the residences of 'phone subscribers, using a special pair of cables independent of the regular telephone circuit. The listener is freed of all maintenance and tuning difficulties but must content himself with the program selected by the company. In addition, he, of course, pays a monthly fee for the service.

THE Bureau of Standards celebrates its twenty-fifth anniversary on Saturday, December 4. The efficient coöperation of the Bureau with industry marks it as one of the Government's most successful and constructive scientific agencies.

THE production of multi-tube radio sets for 1925 was 2,180,622, an increase of 1045 per cent over 1923 when 190,374 were produced. In that same period, tube production increased from 4,687,400 to 23,934,658, an increase of 410 per cent. and loud speakers from 623,146 to 2,606,866, an increase of 318 per cent. The value of radio products in 1925 increased 215 per cent. over 1923. The largest manufacturer to give out his production figures is A. Atwater Kent, who is, at this time, turning out 5200 sets a day.

THE Radio Manufacturers' Association reports an increase of membership from 63 in August, 1925, to 184 in the middle of September, 1926.

THE Radio Trade Association of Michigan conducts a school for radio service men. Students are put out on practical jobs in repair and construction work during their training. The radio industry suffers from lack of competent service men and the establishment of radio trade schools is a step in the right direction.

FRANCIS R. HOYT has obtained allowances on a patent application covering magnetic switches for the control of A battery charger, A battery and B battery substitute, through the receiving set switch.

QST *Français Radio Électricité* blossoms forth in a new and larger form with a recent issue, in which *QST Français*, combines with *Radio Électricité*. We wish our authoritative contemporary every success.

BOLSHEVIST propoganda, intended for the British miners, has been picked up by radio listeners in England. The use of an international medium such as radio for propoganda, regardless of whether destructive or not, is a practice indulged in only by shortsighted governments which do not mind making themselves unpopular in the eyes of the world. It is a veiled way of making war. Imagine our feelings if a station in Canada engaged in fomenting labor troubles in the United States!

THE Olympia Exhibition, which corresponds in England to our Radio World's Fair, in the first showing of new lines, is featuring sets with simplified control and more convenient accessories. Some receivers are equipped with only an on-and-off switch, with means of permanently adjusting the circuits to the favorite local, high-power station. Others give a choice of two stations through a two-point switch.

A DISPATCH to the New York *Times* from Strassbourg announces that agents for a German radio firm are selling radio sets in Alsace-Lorraine at the extraordinarily low price of forty francs. These sets are built so that only the wavelength of Freiburg, a German broadcasting station sending out special programs for Alsace-Lorraine, may be heard. Something will have to be done to curb the international abuse of radio.

CORRESPONDENCE in British radio magazines indicates that WGY, WJZ, and WPG are the three American stations most frequently heard on the other side. The reports indicate that receiving conditions are much better this year than last year for hearing American stations in Europe.

CANADA has been most capable in regulating radio by assigning broadcasting licenses on a sound and simple basis. Each district of the country is given one channel exclusively, there being duplication only between Montreal and Vancouver, separated by 2000 miles and four hours of time difference. Stations operating in the same locality divide the time. In Toronto, for example, there are ten stations sharing one wavelength. Until American broadcasters began abusing the gentlemen's agreement to keep off the fourteen Canadian channels, Canada's 67 stations operated entirely without interference. Of course, it could not be expected that the ruthless American ether vandals would regard international agreements worthy of consideration. When an American broadcaster interferes with a Canadian frequency, he injures radio for an entire district.

WHEN Danish musicians broadcast as members of bands and orchestras, they are to receive an extra 50 per cent. over their regular pay. Not that broadcasting involves the slightest extra work on the part of such musicians. When the usefulness of a service performed is increased, certainly its remuneration should be increased, but the increase should bear some relation to the increased value of the service and to the additional skill and effort required. A 50 per cent. increase for broadcasting seems like extortion.

A SUBSCRIPTION is being collected for Charles Clavier, victim of the wreck of the New York-Paris plane at Mineola. Clavier began his career as a radio operator in 1907 and served with distinction during the War aboard the French destroyer *Coutelas*. He took part in the Gallipoli campaign. He leaves a family of three. Subscriptions to the fund are being received by *La T. S. F. Moderne*, 9 Rue Castex (4me), Paris, France.

BEGINNING with a talk by former Lieut. Governor George G. Lunn, through WGY, in April, 1922, educational work in behalf of forestation has been extended until the U. S. Department of Agriculture is now sending information to farmers on the subject of forestation through 100 broadcasting stations. There are more than 550,000 radio sets on farms and, in some states, one farmer out of four has a radio receiver.

A DECREE of the French Government requires that all commercial airplanes, carrying at least ten passengers and traveling more than 160 kilometers, and those flying over the sea for a distance of more than 12½ kilometers from the coast shall be equipped with radio telegraph apparatus.

When the London-Paris airplane, carrying ten

passengers, six of them Americans, on October 21 fell to the sea, there was time to send an SOS. It resulted in the rescue of all concerned. A fishing smack drew alongside, but not until after most of the plane was already under water and the passengers and crew were clinging precariously to the tail, waist deep in water. An eloquent proof of the wisdom of the French decree.

THE dove of peace hovers in the copyright controversy, according to a statement from E. C. Mills, Chairman of the Administrative Committee of the American Society of Authors, Composers, and Publishers. Soon we may expect photographs in the rotogravure sections of Mr. Mills embracing Mr. Klugh, the spokesman of the National Association of Broadcasters. The placid horizon is the result of a more reasonable view on the part of both parties. The musicians have realized that broadcasting is not making them penniless by destroying all their accustomed sources of revenue and the broadcasters have realized that some compensation is due to the composer for his share in making radio enjoyable. All that remains to be settled is the establishment of a definite, uniform, and reasonable scale of charges on the part of the society and the universal acceptance of that scale by the broadcasters. Both of these objectives are yet to be attained.

THE National Better Business Bureau has issued a booklet on radio advertising which should form the bible of every one concerned in the advertising of radio products, including publications in the field. It defines a code of ethics in connection with distance, selectivity, tone quality, and volume claims and defines the permissible practice in the use of such terms as "static eliminators," "list price," and "complete equipment." It is a valuable contribution to radio advertising literature.

Interesting Things Said Interestingly

GUNTER DOBERZINSKY (a director of the Central German broadcasting station at Leipzig, during a visit to study radio conditions in the United States):

"American radio sets first of all are attractive to the eye and are finished with a care quite unequaled abroad. The beauty and variety of the designs render them attractive in any home. In Germany we still build sets with four or five dials, which require considerable technical skill to manipulate. The American sets, I find, tend toward greater simplicity and are controlled by a single dial, which renders them largely fool proof. Your sets are controlled by a turn of a finger, while German sets require both hands.

"There is but a single broadcasting station to each of the large cities of Germany, but these are well supplied with money. In many cases they support fine orchestras and even opera companies. They also broadcast operas from Berlin and concerts by famous orchestras."

ARTHUR G. BURROWS (Director General of the Union Internationale de Radiophone in an interview with Eric Palmer):

"The first fruits of the many conferences toward coöperation that have been held will be noticed the middle of October when the voluntarily prepared repartition program of European wavelengths with the object of elimination of interference will be applied.

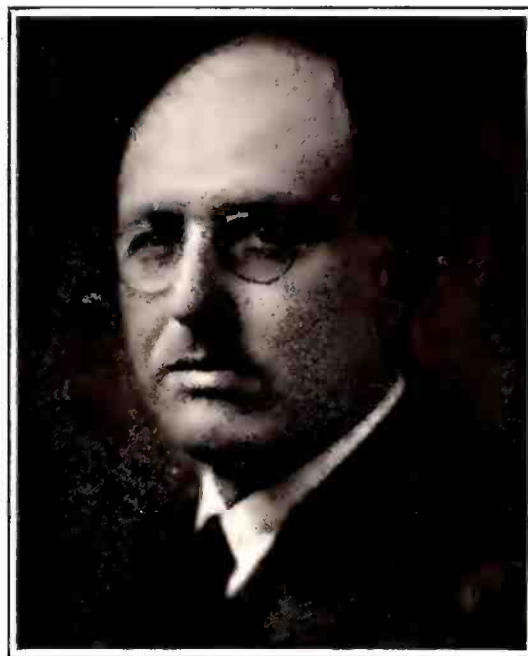

WILLIAM S. HEDGES

Chicago

Radio Editor, the *Chicago Daily News*. Especially written for RADIO BROADCAST:

"There are two classes of broadcasters. First, the class which maintains the viewpoint of service to the public and second, that class which is attempting to use the new medium of communication as a means of drawing attention to its firm or its products. The first class includes newspapers and radio manufacturers. The radio manufacturers as a whole recognize that they have a duty to perform, that the sale of a receiving set is not complete until there is entertainment to be picked up by the set. In the second class there are many firms to which the radio public is indebted for exceptionally high-grade programs but that group unfortunately also includes many organizations which have neither the conception of, concern for, nor the funds to adequately furnish programs, nor the ability to produce suitable programs. In the clearing of the ether, this second group will bear the closest scrutiny.

"A tabulation made by the American Newspaper Publishers Association last fall showed 67 stations owned in whole or in part by newspapers, in addition to which there were 18 newspapers which maintained studios and 37 which sponsored programs from stations in which they had no financial interest. It is logical that such a large number of newspapers deem it a function of public service to engage actively in broadcasting. The newspaper is a quasi-public institution. Its business relations are with so great a number of people in the community that the newspaper must always be mindful of public interest in its broadcasts, as well as other public appearances. Furthermore, its contacts put the newspaper in a preëminent position to serve the public as a broadcaster."

"This new plan should increase the chances of European stations being heard in America. Many existing stations are increasing their power and also, new higher power long-wave stations are under construction, notably, a Swedish station which is to use 40,000 watts on 1350 meters and a station in Holland which is to use 20,000 watts antenna power. There is a marked growth in experimental short-wave stations."

A Six-Tube Super-Heterodyne



A FRONT VIEW

Of the completed super-heterodyne. The jack at the right is used to read the plate current of the oscillator

By KENDALL CLOUGH

INASMUCH as the writer's September RADIO BROADCAST article on super-heterodynes received such a large number of requests for tangible constructional information, a receiver has been prepared for description in this article. It is hoped that the design presented will not be accepted as a hard-and-fast application of the principles laid down in the September article, but rather, that the individual constructor will recognize the possibilities of a certain amount of flexibility in the construction of the receiver without radical departure from the design principles previously presented.

The September RADIO BROADCAST article went into considerable detail regarding the question of what intermediate frequency should be used, and the conclusion was reached that the best operating frequencies are those of 45, 55, and 65 kilocycles.

Preference is given to these frequencies so as to mitigate the possibility of a resultant beat note of two heterodyning stations being of such frequency as to enable its easy passage through the intermediate amplifier. Granting that all broadcasting stations are separated from each other by ten kilocycles, it will readily be seen that a resultant beat note caused by two stations heterodyning must be of a number of kilocycles divisible by ten. Thus, such a note would always be at least five kilocycles "out of phase" with that of the intermediate amplifier providing this latter figure is divisible by five but not by ten, as would be the case if any of the above-suggested intermediate frequencies were used.

The fallacy in this idea lies in the fact that many broadcasters no longer recognize the ten-kilocycle separation law, and it is now possible for two heterodyning stations to produce a beat note that is the equivalent of either 45, 55, or 65 kc. (the frequency of the intermediate amplifier) and thus the selectivity of the super-heterodyne is somewhat impaired. No super-heterodyne can successfully cope with conditions as they are today, but, as an early reversion to law and order, when the necessary ten-kilocycle separation will be universally adopted, is likely soon to come, there is no hesitation on the writer's part in recommending the super-heterodyne

as representing the utmost in selectivity and all-round efficiency.

In order to simplify the construction as much as possible, and also in order to keep the receiver in a compact form, the second stage of audio amplification has been omitted, it being anticipated that the more ardent fans already have or are intending to build power amplifiers for operation with various receivers of their construction.

The receiver as described, with a single stage of audio amplification, will be found to give signals of satisfactory volume at the loud speaker for local station reception. However, the use of a second audio stage—preferably in the form of a separate unit power amplifier—is to be recommended where really loud signals are required.

The completed receiver, as seen from the front, is shown in the photograph at the top of the page. The front panel is of $\frac{1}{8}$ " bakelite, 7" x 18". From left to right may be seen the intermediate amplifier potentiometer, with the filament on and off switch just below, the antenna condenser dial, the oscillator control dial, and the filament rheostat, with a jack below. This jack is for use in adjustment of the oscillator harmonics control, and will be described more fully later. Phones, or a loud speaker, are inserted by means of pin jacks on the sub-panel. Between the two tuning controls, and at the lower edge of the panel, is the knob for the midget condenser controlling the regeneration of the first detector.

Fig. 1 shows the wiring diagram of the complete receiver, and is simply a correlation of the individual circuit diagrams shown in the Sep-

Constructional Data on an Economical Super-Heterodyne with Its Oscillator and First Detector Circuits Shielded—One Stage of Audio Is Sufficient for Locals—Smooth Regeneration Control and Oscillator Harmonic Control Are Features

tember article. A slight change has been made in the first detector in the connection of the short-wave choke to the plate circuit. A connection in this manner causes the midget condenser, C₂, to take the character of a throttle device for control of oscillation in the first detector and, with the particular apparatus described, seems to operate as an approximate constant regenerator, very little adjustment being required in order to keep the tube in a high state of regeneration over the entire wave band. The apparatus constituting the first detector is better shown in the right-hand stage shield in the photograph taken from above and reproduced on page 261. The variable condenser, C₁, next to the panel, is of 0.00035-mfd. capacity in this case, although it is perfectly feasible to use a condenser of 0.0005-mfd. capacity if available. Immediately behind the condenser is the coil socket and antenna coupler coil of a standard make. In case the constructor desires to build his own coils, they may be made in accordance with the drawing of Fig. 2, on which winding specifications are given for both sizes of condensers mentioned. The number of turns on the plate coil of Fig. 2 may have to be altered to meet individual conditions, and this may be done as outlined later on. The antenna coupling, as provided in this sketch, is made by means of a coil wound on a short length of tubing which can be slid along the principal coil form.

At the rear of the first detector shield is the tube socket with its separate grid leak and condenser mounted on either side, and a short-wave choke, L₇, to aid in obtaining oscillation of the first detector. Several chokes of this character are available on the market, but instructions for making this item are shown in Fig. 3. A pair of leads from the grid circuit of the first detector run down through the sub-panel to the oscillator pick-up coil, L₄, in the stage shield at the left of the first detector.

THE OSCILLATOR CIRCUIT SHIELD

THIS shield contains a condenser, C₃, of the same size and make as the first detector, and an identical coil. This coil also may be purchased or constructed along the lines of the one shown in Fig. 2. Behind the coil is the oscillator tube socket and two 1-mfd.

The Facts About This Receiver

Name of Receiver	Kendall Clough Super-Heterodyne
Type of Circuit	Super-Heterodyne
Number of Tubes	SIX 201-A tubes

This receiver was designed for RADIO BROADCAST by Mr. Kendall Clough in response to many requests which were received for constructional data on a super-heterodyne incorporating the design features outlined by him in the September, 1926, issue. The first detector and oscillator are both shielded so as to give very stable operation. Two stages of intermediate-frequency amplification are used instead of three, as is customary. The set is designed for operation on a short indoor antenna. The plate-current drain is about 30 milliamperes.

bypass condensers, one of which completes the plate circuit of the oscillator and the other bypasses the grid bias applied for the elimination of harmonics. A small r. f. choke, L_8 , of similar construction to the one used in the first detector, is soldered to one of the lugs of the B-battery bypass condenser. Through this choke the connection is made from the oscillator to the B battery, thus isolating the oscillator—from a radio-frequency standpoint. The use of the two bypass condensers and the choke makes certain that all radio-frequency currents generated by the oscillator are contained within the shield except what energy is fed out through the pick-up coil to the first detector. In view of this fact, it is perfectly feasible to put a jack in the B line to the oscillator without danger of "hand capacity effect" to the jack. This jack permits the use of a milliammeter provided with a cord and plug for checking the space current of the oscillator at any time. It is very important that it be possible to read the oscillator plate current in order to properly adjust the C battery for elimination of harmonics. Just behind the oscillator shield is mounted a 200-ohm potentiometer, P_1 , connected across the A-battery terminals. In series with this device and the grid circuit of the oscillator are a pair of binding posts marked "plus C" and "minus C" for the insertion of a positive bias on the oscillator.

At the extreme right of the sub-panel are the two stages of intermediate amplification terminating in the second detector, which is the cushioned socket at the rear. The transformers, T_1 , T_2 , T_3 , used in the receiver described, peak at 54 kilocycles, and have proven very satisfactory for use in the congested districts of Chicago. These transformers have been very carefully peaked, and it should be noted that liberal space has been allowed between them in order to keep stray coupling at a minimum. The three bypass condensers shown in the wiring diagram are placed directly to the right of the long-wave transformers and, while they are sufficiently close to permit one-inch leads to their respective connecting points, they are at the same time spaced sufficiently so that the transformer fields cannot set up eddy cur-

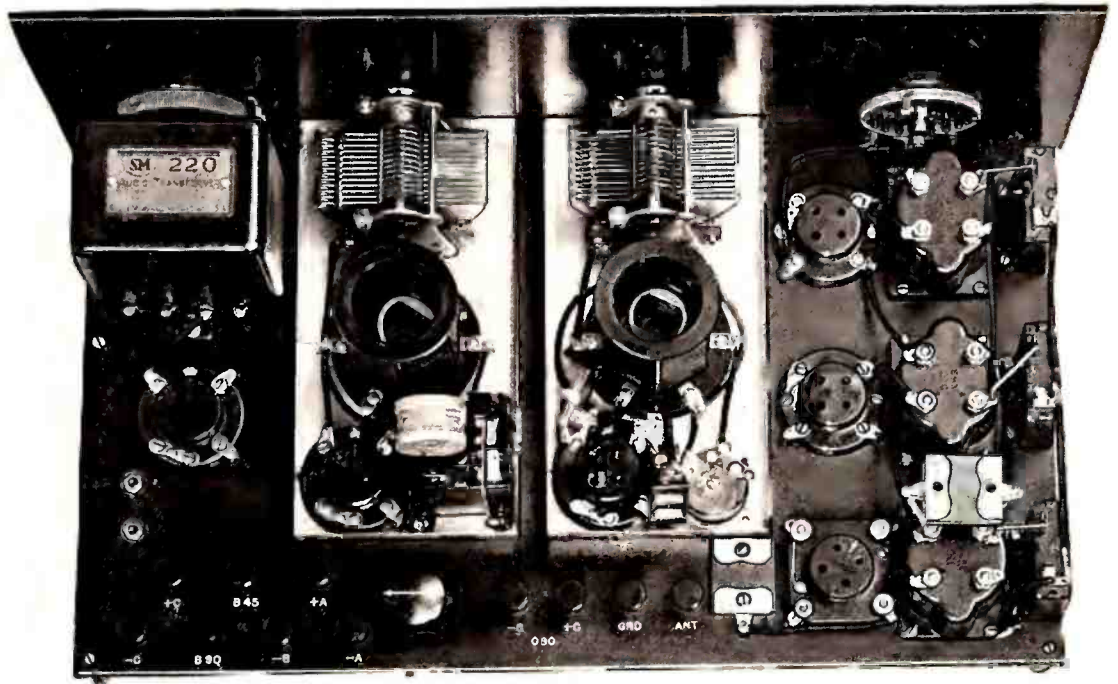

A WELL-DESIGNED SUPER-HETERODYNE

The intermediate-frequency amplifier is located at the right in this picture and the single audio stage is at the extreme left. The first detector is in the right-hand stage shield and the oscillator is in the left-hand shield

rents in the shells of the condensers. At the left of the second detector tube socket is a 0.002-mfd. condenser across the detector output, and one of the screws which holds this condenser also holds a long-wave choke, L_9 , on the panel below. This choke may be better seen in the photographic under-side view of the sub-panel. It may be purchased, or wound as described in Fig. 3 on the same type of spool as the short-wave chokes previously mentioned, but with a greater number of turns. From this choke a lead goes over to the audio transformer at the left (looking from behind the panel) of the set, and the remainder of the construction is simply a one-stage amplifier terminating in two tip jacks as shown at the left-hand rear portion of the sub-panel.

In the particular receiver described, the sub-panel measures 10" x 17", and is $\frac{1}{4}$ " thick in view of the considerable weight of the parts it must support. Throughout the wiring on the sub-panel, a scheme has been kept in mind which

may prove valuable to the home constructor. Insofar as possible all leads carrying radio-frequency currents are kept above the sub-panel. This applies to all leads inside of the shields, of course, and to the plate and grid leads of the long-wave transformers, and also the low-potential leads from the long-wave transformers to the bypass condensers. Wherever feasible, low-potential and battery leads are brought from the upper to the lower side of the sub-panel by means of the screws that are used in holding down the various pieces of equipment.

THE HARMONIC CONTROL

THE adjustment of the harmonic control on the oscillator should be made after the receiver has been completed and operated, in order to assure one that the whole assembly is operating satisfactorily. After this, the top of the oscillator stage shield may be removed and the condenser rotated to or near maximum capacity. At this point, a trial bias of 8 to 10

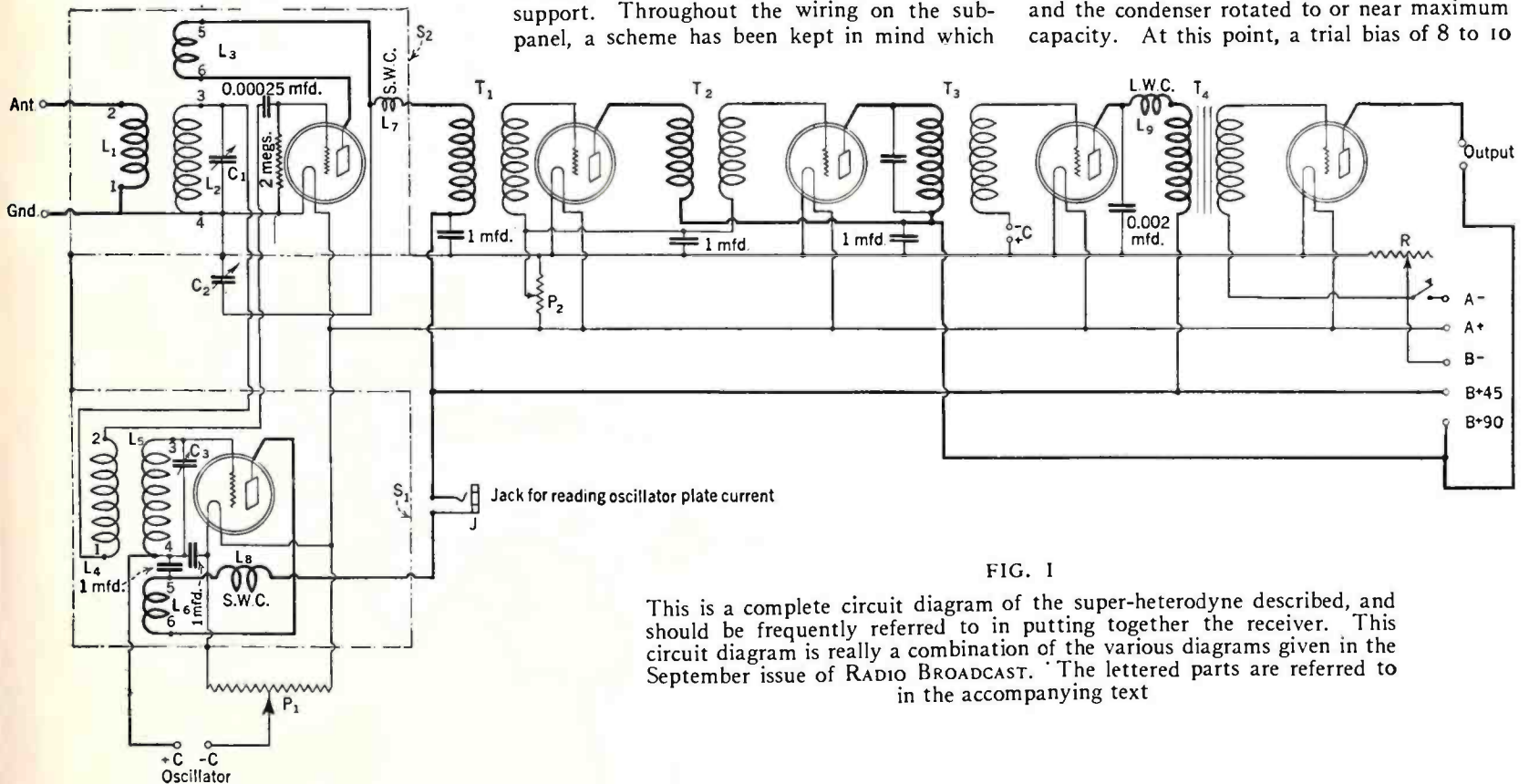

FIG. 1

This is a complete circuit diagram of the super-heterodyne described, and should be frequently referred to in putting together the receiver. This circuit diagram is really a combination of the various diagrams given in the September issue of RADIO BROADCAST. The lettered parts are referred to in the accompanying text

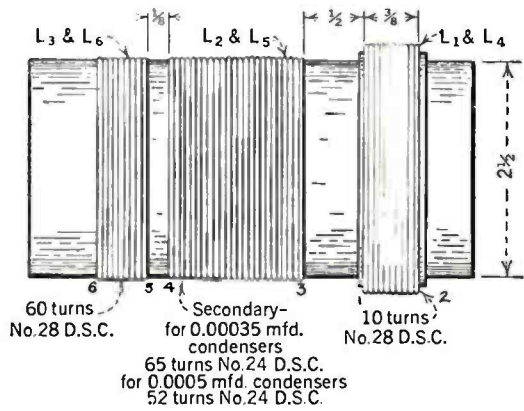
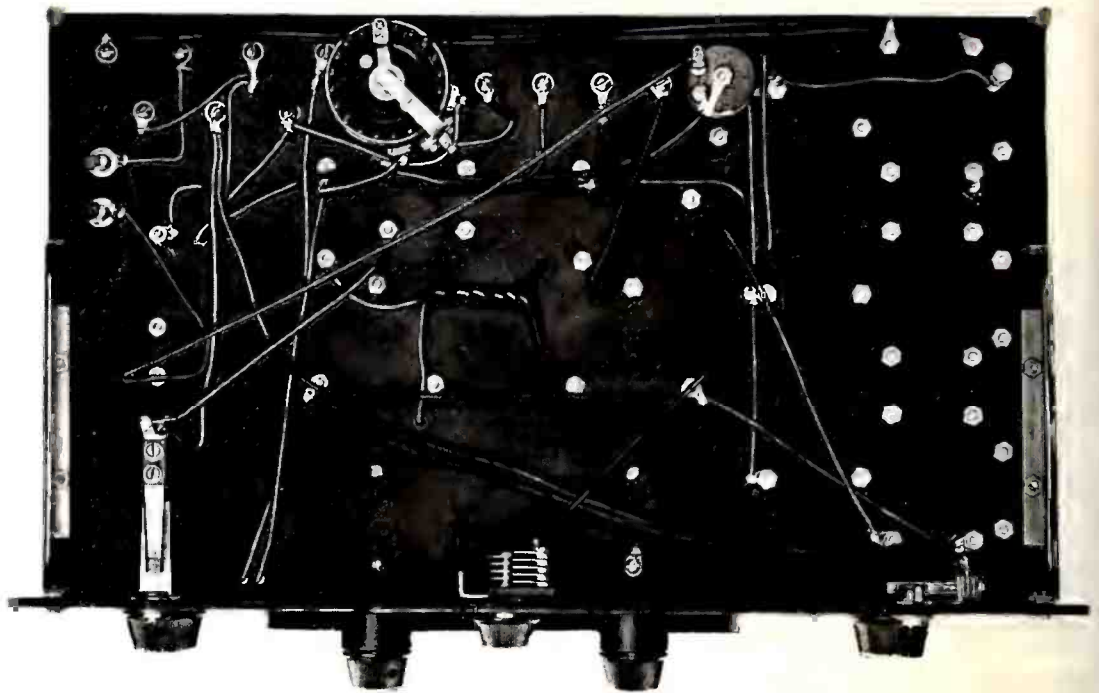

FIG. 2

Both the oscillator and antenna coupler are made exactly the same. L_1 in the drawing is wound on a cylindrical form slightly larger than $2\frac{1}{2}$ " in diameter so that it can slide over the main coil form, and the coupling be varied in this way. In the oscillator circuit L_1 becomes L_4 (see Fig. 1) and acts as a pickup coil

volts is connected to the C posts marked "Osc." in the photograph, and a 0-25 millimeter with cord and plug is inserted in the jack on the face of the panel. The plate current is noted and the oscillator coil, L_3 , is now short circuited. If the plate current now reads lower than it did previously, the potentiometer should be rotated toward the positive end until the plate current is approximately equal to the value previously obtained. If this cannot be done, then more C battery should be inserted. The conductor used for the short circuit is now removed from the coil and the plate current again noted. In case the tube has stopped oscillating with this bias it is good evidence that more plate turns are required on the oscillator coupler. If the tube is still oscillating, or has been made to oscillate, the adjustment proceeds as above, always noting the current with



HOW THE RECEIVER IS WIRED

Flexible wire is used and most of the wiring is done under the sub-base. The various pieces of apparatus under the sub-base are the potentiometer for controlling the bias on the oscillator, the regeneration condenser, the jack in the oscillator plate circuit, the filament switch, and the long-wave choke coil

the tube oscillating, and then placing the short circuit on the coil and adjusting the bias to obtain the same current. This will require a number of trials but should be continued until short circuiting the coil causes no change in the oscillator plate current. The plate current consumption of the entire receiver is approximately thirty milliamperes so that good batteries must be used to operate it. The receiver's operation in one of the most congested districts of Chicago has been exceedingly gratify-

ing—eight distant stations being received in a short evening's work through a barrage of local interference which is almost impenetrable with other receivers tried in the same location.

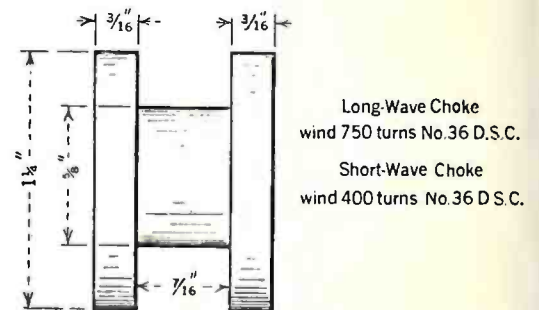
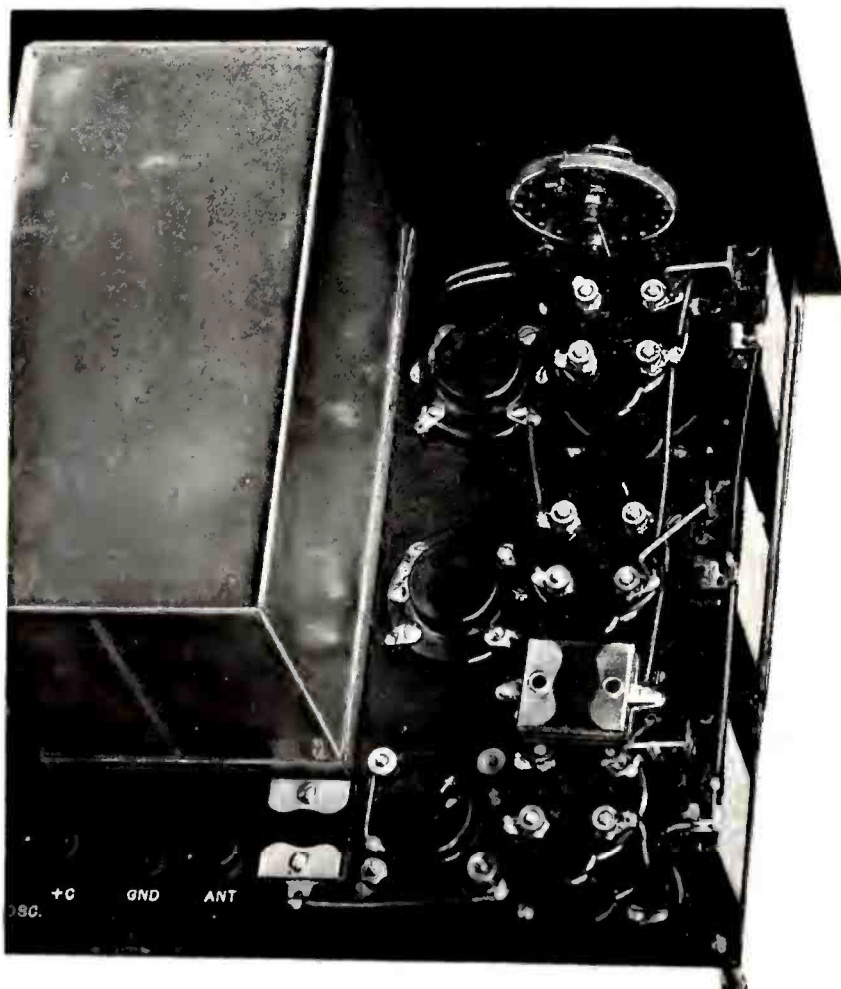

FIG. 3

Winding data for the various choke coils used in the super-heterodyne are given in this diagram. Two short-wave chokes should be made up, one for the first detector and the other for the oscillator. Only one long-wave choke is needed, this for the plate circuit of the second detector tube



(Left) this is a view of the intermediate amplifier. The transformer nearest the potentiometer is the first of the intermediate-frequency amplifiers

THE PARTS FOR THIS RECEIVER

L_1, L_2, L_3 —Silver-Marshall Antenna Coil . . .	2.50
L_4, L_5, L_6 —Silver-Marshall Oscillator Coil . . .	2.50
C_1, C_3 —Two Silver-Marshall 0.00035-Mfd. Variable Condensers . . .	9.00
C_2 —Silver-Marshall Midget Condenser . . .	1.50
T_1, T_2, T_3 —Silver-Marshall Long-Wave Matched Transformers with Filter . . .	18.00
T_4 —Silver-Marshall Type 220 Transformer . . .	6.00
P_1, P_2 —Two Yaxley 200-Ohm Potentiometers . . .	3.50
R—Yaxley 2-Ohm Rheostat . . .	1.35
Y—Yaxley Closing Circuit Jack, Type No. 260
S_1, S_2 —Two Silver-Marshall Stage Shields . . .	4.00
5 1-Mfd. Dubilier Bypass Condensers . . .	6.25
1 0.002-Mfd. Polymet Fixed Condenser35
1 0.001-Mfd. Fixed Polymet Condenser35
1 0.00025-Mfd. Polymet Fixed Condenser30
1 2-Meg. grid leak30
1 Yaxley Battery Switch, No. 10 Midget50
2 Carter Pin Jacks60
6 Silver-Marshall Sockets . . .	3.00
1 Coil Burton-Rodgers Flexible Wire . . .	1.00
TOTAL . . .	\$61.60

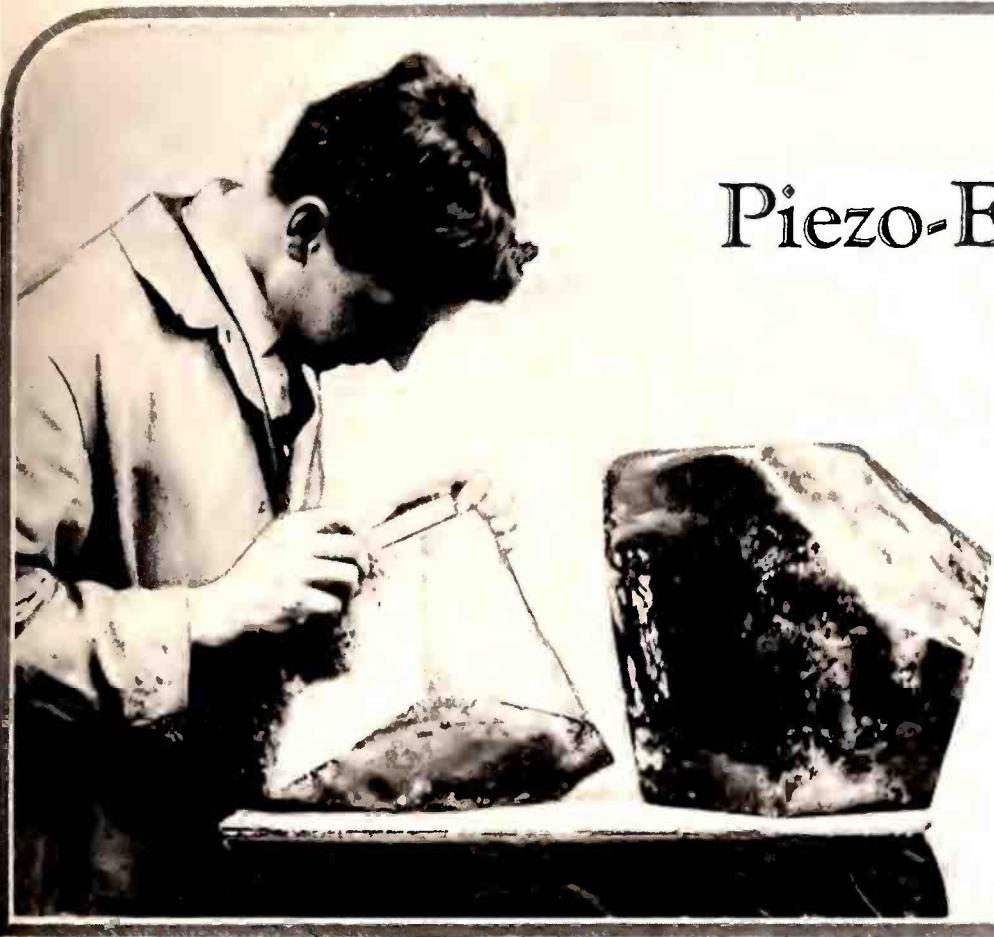

Piezo-Electric Crystals

*How Quartz Crystals Are Used
to Maintain Constant Frequencies
Accurate to Within One
Fiftieth of One Per Cent.*

By
M. THORNTON DOW

ABOUT sixty years ago, when P. and J. Curie, two scientists in France, discovered that certain natural crystals have piezo-electric properties, they could scarcely have foreseen in those days before radio the many useful applications to which their scientifically gathered facts were so soon to be put. Yet they must have recognized that possibilities lay ahead, for they found a very practical use for their discovery in a type of voltmeter which they developed.

Many crystals are piezo-electric; that is to say, they have the interesting property of giving rise to an electric voltage when they are mechanically squeezed. This characteristic action also works in the reverse sense: When a voltage is properly applied, a piezo-electric crystal elongates or contracts in certain directions.

These curious and fascinating properties, first discovered by the scientists already mentioned, have ever since that time challenged the desire for knowledge of many more investigators. Everyone should know the names of some of them—such men as, Langevin, Cady, Pierce, Morecroft, Nicolson, Pupin, and Wills. These men, and also scientists in the United States Navy and at the Bureau of Standards in Washington, have all applied their ingenuity to problems the solutions of which have opened up wide fields of usefulness for crystals of this kind.

Of the many crystals which are piezo-electric, quartz crystals are most commonly in use because of their rugged mechanical, and stable chemical, properties. Some natural crystals of quartz are shown in Fig. 2, and in the photograph at the top of this page. Such crystals are found as natural deposits, and they may range in weight from a small fraction of an ounce to several hundred pounds. They are six-sided and have ends shaped like a six-sided pyramid except that alternate edges near the base of the pyramid have been flattened off by nature. With these ends cut off, the remaining part would look somewhat like the hexagonal box schematic-

ally shown in Fig. 3. If light passes through the crystal lengthwise, in the direction shown by the arrow O, it is acted upon in an extraordinary and very interesting way. But of more interest just here is the fact that along this axis the crystal is quite unresponsive to electric voltage while in the direction of the arrow E, the quartz is electrically readily excitable. A voltage applied between two pieces of tin foil pasted at opposite corners of such a crystal causes the distance between these two corners to decrease (by a small

amount, depending upon the magnitude of the voltage), while the distance between two faces marked by the arrow B, perpendicular to them, may at the same time increase. Reversing the polarity of the voltage reverses these effects. On the other hand, if by any mechanical or electrical means the crystal is compressed or elongated, it spontaneously sets up a voltage in the direction of the axis E.

The fact that stressing a piezo-electric crystal causes it to develop voltage has been useful in the development of an electrical reproducer for the phonograph. By use of a needle, or by other means, the impressions on a phonographic record produce variations in pressure on a crystal. A voltage of correspondingly varying intensity is set up by the crystal and electrically operates a device such as a loud speaker or telephone receiver.

A slab of crystal, such as is shown and illustrated in Figs. 5 and 6, may be cut to take advantage of these peculiar pressure-electric properties for giving rise to electrical and mechanical oscillations. If the polarity of a rather high voltage, applied to a smaller but similar crystal, is reversed with sufficient rapidity, the crystal, due to mechanical vibration, may actually creep out from between two brass plates (See Fig. 4). To keep an oscillating crystal in its place, its mounting usually takes the form of a box arranged to carry an upper and a lower brass plate to serve as electrodes. The crystal may rest upon the lower electrode but it does not necessarily need to come in contact with either electrode. Various kinds of mountings used with piezo-electric crystals are shown in Figs. 1 and 7. Some of these, in their experimental form, have adjustable electrodes, but in practical use this feature is not necessary.

In common with so many of the developments in radio, the recent rapid rise to popularity of the piezo-electric crystal waited upon the evolution of the vacuum tube. These two children of the laboratory, the crystal and the tube, grew up independently, only to be lately introduced to

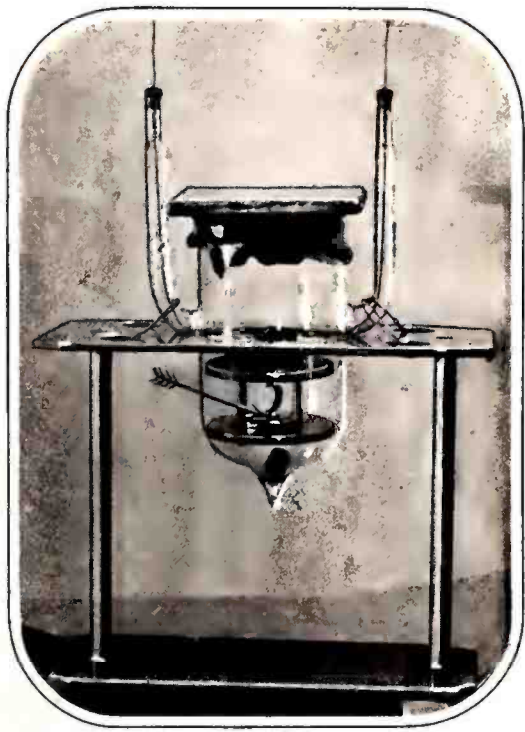

FIG. 1

The crystal on the glass-enclosed mounting will oscillate at nearly six million cycles per second. In order to keep the temperature constant, the container, from which air has been pumped may be submerged in a water bath



FIG. 2

Several quartz crystals and pieces sawed from larger crystals. The pyramid ends of the large crystal in the picture forming the heading to this article are shown among them

each other by scientists. The useful pair now cooperate in many ways to promote improvements in radio communication and explorations into various dark corners of the world of science. For instance, the fact that an oscillating crystal gives rise to a system of sound waves in the surrounding air has made it possible to measure with great precision the velocity of sound at frequencies far beyond the range audible to the human ear. With suitable apparatus, moreover, such an inaudible sound can be transmitted through water, between, for example, two submerged submarines, and can be made intelligible by electrical devices at chosen receiving posts.

APPLICATIONS TO BROADCASTING

TODAY, crystals find their widest applicability in the radio field due to the fact that, in combination with a vacuum tube oscillator, they act as stabilizers of frequency. There are two principal ways in which radio requires the steadying influence on frequency of the piezo-electric crystal. In the first place, for satisfactory operation of a broadcasting station, the transmitted carrier frequency must be held very nearly constant. And, in order to avoid confusion, every frequency assigned and used must be accurately known in terms of a standard. In either case the requirement is met by the quartz crystal when combined with a vacuum tube circuit, such as shown by the diagram in Fig. 8, which will produce sustained oscillations at a frequency determined by the crystal.

Now in many respects, a crystal is like a piece of any other solid. Take a bar of steel, strike it in one way and, due to its mechanical vibrations, it will give out a sound of a certain pitch; strike the same piece of steel in some other way and another pitch may become audibly more pronounced. The crystal, as we have already seen, can be excited to mechanical vibration by alternating voltage; furthermore, it can in this way be vibrated at any frequency whatever,

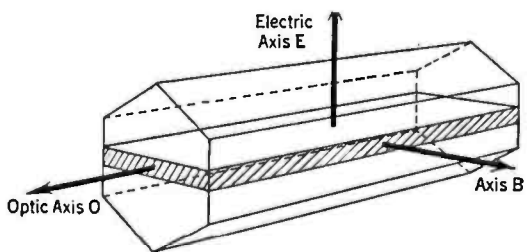

FIG. 3

Certain properties of a quartz crystal differ in the various directions indicated by arrows

throughout a very wide range, depending upon the frequency of alternation of the voltage, but at any one of a number of different frequencies its readiness to vibrate is especially marked. A somewhat similar characteristic is found in the ordinary tuning fork. One can force the prongs to vibrate at any reasonable frequency, but at some characteristic frequency they will vibrate with large amplitude by very little outside help. A second fork in vibration at this same frequency, across the table from the first, may be all that the latter requires to keep it going.

For the present it is best to get acquainted

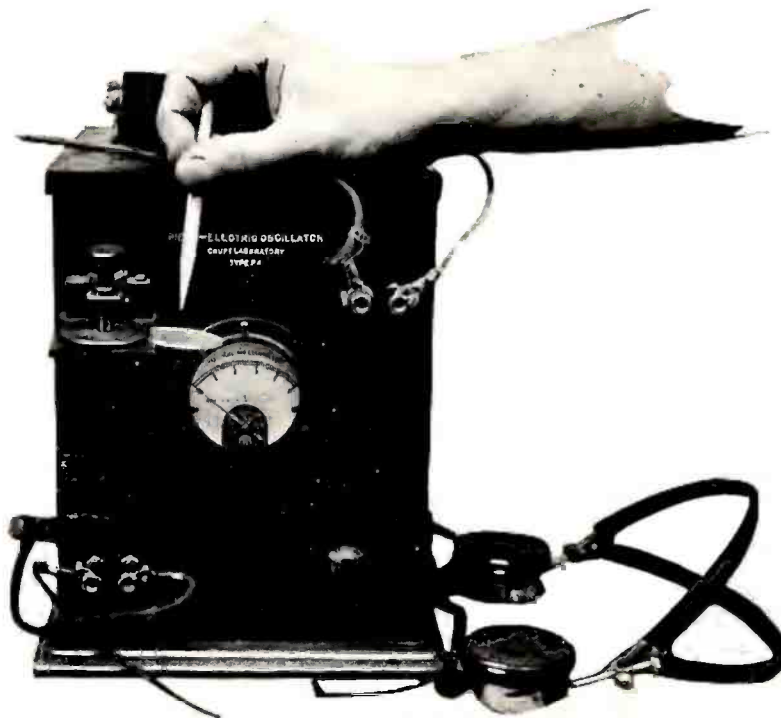

FIG. 4

Unless this small convex crystal is completely enclosed when an alternating voltage is applied, it shoots out from between its electrodes, as here illustrated. A natural frequency for this crystal is about one and a half million oscillations per second

with some of the more general facts about crystals that oscillate so that, later on, in dealing with a particular application of the crystal, we can feel more at home in following specific directions. An impedance (that is, a coil combined with a condenser) is shown in the plate circuit of Fig. 8. From the point of view of an electric circuit, a piezo-electric crystal is also a coil combined with a condenser, since, to the circuit, it acts as an impedance. Now such an arrangement of impedances may cause oscillations of current and voltage to start in the tube circuits. Thereby an oscillating voltage is set up at the electrodes of the crystal which is here shown connected between grid and filament. Such a voltage, as before described, excites the crystal to mechanical vibration. If the frequency of this excitation is even only approximately one of those values at which the crystal strongly prefers to go, the counter electric potentials set up by the

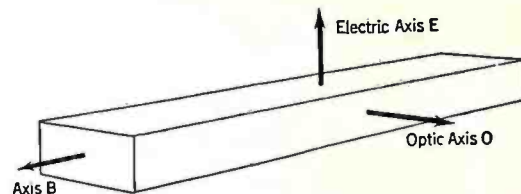

FIG. 5

A diagram of the crystal shown in Fig. 6. Arrows indicate directions similarly shown in the original crystal of Fig. 3. The natural frequency of this crystal is about 28,000 oscillations per second

elongations and contractions of the crystal so influence the action of the tube by way of the grid as to force the oscillations to the frequency chosen by the crystal. The tube drives the crystal but *the crystal dictates the frequency*. Because of the strong preferences, just mentioned, which the crystal shows for certain frequencies, such an oscillator operates with remarkable constancy of frequency.

In order to start the oscillator at some frequency preferred by the crystal, the coil and condenser must have values within rather liberal limits. In most cases, however, the condenser can be dispensed with altogether by choosing a suitable coil. Surprisingly large changes can be made in the inductance of the coil and in the plate voltage or filament current to the tube without affecting the output frequency seriously for ordinary purposes.

A tuned circuit, such as a wave-meter, coupled closely to the crystal oscillator, will cause small changes in frequency; but it would be very difficult to produce changes as large as one cycle in a thousand per second without "killing" the oscillator by doing so. It is usual also to find that the frequency of a crystal oscillator is affected somewhat by changes in temperature; but for one degree change in temperature a change of one cycle in thirty thousand per second would be unusually large. If special care is taken to keep a crystal at constant temperature, and to avoid undue coupling to other circuits, the frequency of a crystal oscillator may be made to hold as constant as any conceivable need can ever demand. In ordinary usage, without exercising any unusual precautions, crystals are found to hold frequencies at

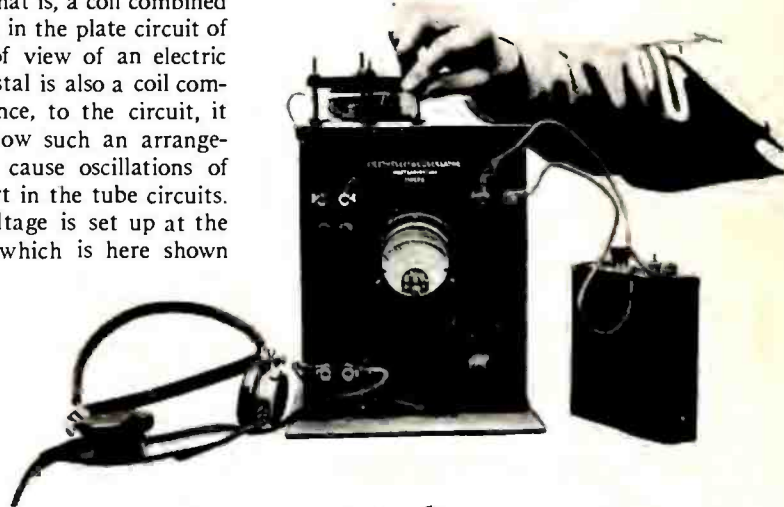

FIG. 6

A shudder runs through a quartz crystal when an alternating voltage is applied between its upper and lower sides



FIG. 7

Several experimental and commercial types of crystal mountings

a given value within approximately one or two cycles in ten thousand per second.

Accruing to the advantages of the quartz crystal as a unique controller of frequency in radio, is the multiplicity of frequencies to be found associated with one individual crystal. And in the constancy of its control, the crystal plays no favorites. Although all crystals are not equally ready to respond to the call to oscillate, nearly every crystal can easily be made to operate as an oscillator at either one of two different frequencies by using Professor Pierce's circuits, which are shown combined in Fig. 9. This circuit is simplified to the last degree; a crystal, a tube, and a coil are the main parts in it; a plate milliammeter is very useful but not absolutely essential. With the switch S at position H, the crystal oscillates at some high frequency; with the switch at L the frequency is much lower.

of its frequencies there are, simultaneously, many other frequencies available. Though crystals can be ground to give as high as 10,000,000 or as low as 25,000 (or less) cycles per second, it is too laborious to get these extreme frequencies in this way. If a frequency of 10,000,000 cycles is needed it is simpler to use that frequency as found in the circuit of, say, a 2,000,000 cycle crystal. By great good fortune electric oscillation frequencies in vacuum tube circuits, both with and without associated crystals, usually appear in crowds. Where the leader goes the others follow. The leader in this case is called the fundamental. The various individuals of the whole crowd are called harmonics. The fundamental frequency may be called harmonic number 1; it is the predominant frequency at which the oscillations take place.

But such oscillations as these produce effects equivalent to having other frequencies present at the same time, and these other frequencies are always whole number multiples of the fun-

damental frequency. Harmonic number 2 always has exactly twice the frequency of the fundamental, harmonic number 3 always has exactly three times the frequency of the fundamental, and so on. The fundamental is the more powerful, the other harmonics less powerful. Roughly speaking, the higher the number of a given harmonic, the less powerful it usually is. Ordinarily it is easy to find at least fifteen such frequencies and often it is possible to find more than a hundred, and every one of these frequencies will be remarkably constant and simply related to the fundamental.

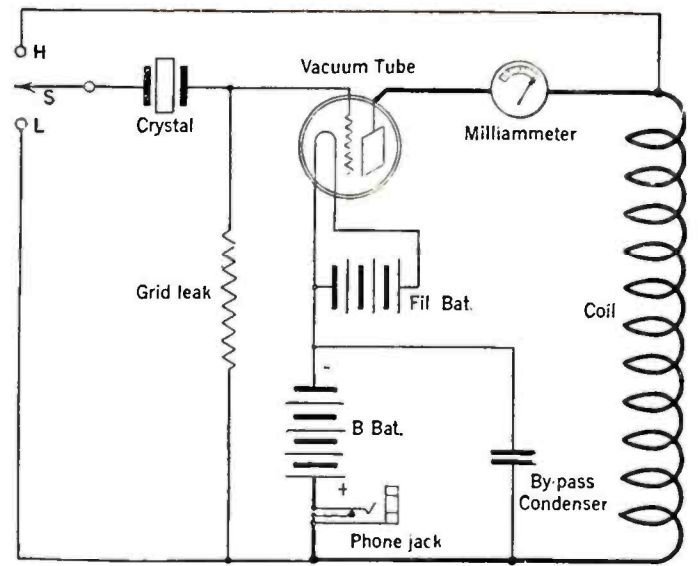

FIG. 9

A very convenient form of crystal oscillator circuit which is a combination of two circuits due to Professor Pierce, of Harvard. The General Radio Company, of Cambridge, Massachusetts, manufactures such an oscillator

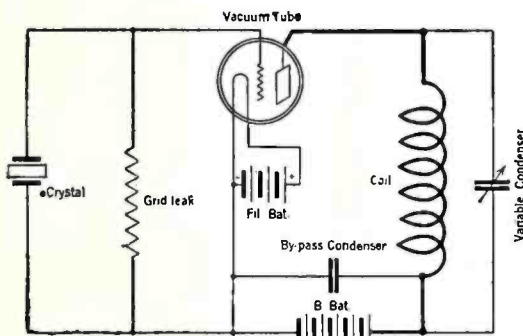

FIG. 8

One scheme of circuit which will oscillate at the frequency of the crystal. Apparatus wired to give crystal-controlled oscillations is collectively called a Crystal Oscillator

The values of frequency depend on the size of the crystal. A crystal about the size of a small spectacle lens, for instance, would give possibly 1,500,000 and 150,000 cycles per second for the two frequencies. Sometimes two different coils are needed for operation, one for each of the two switch positions. When oscillations begin, there is a sudden, or in some cases, a rather leisurely, reduction in the reading of the plate meter. If we care to add a condenser and tune the circuit, as already suggested by Fig. 8, there is usually at least one other frequency at which the crystal will be found to oscillate readily.

The various frequencies, at each of which the crystal may be made to oscillate at will, are related in value in accordance with complicated laws. The value for each frequency so obtained from a crystal must be separately determined by calibration in a laboratory equipped for the purpose. When these calibrations are at hand, a wide range of standardized frequencies become available to the experimenter when he makes use of the additional facts briefly described below.

HARMONICS ARE UTILIZED

TO SPEAK of two or three (or more) of these preferred frequencies does not tell the whole story, for when the crystal oscillates at any one



A COMMERCIAL PIEZO-ELECTRIC OSCILLATOR

This instrument has been on the market for more than five years. All the batteries are included, which makes the unit readily portable

The New Inverse Duplex System

The New Inverse Duplex Circuit Embodying Some Fundamentally New Principles and Surpassing the Old System on all Counts—Excellent Selectivity, Meeting Modern Needs, Is Featured—Audio Transformers Should Have “Rising” Characteristics to Compensate Sharpness of R. F. Circuit

By DAVID GRIMES

THIS article constitutes the first of a special series written for RADIO BROADCAST to acquaint its readers with the latest fundamental improvements in a most fascinating circuit arrangement—the Inverse Duplex System. When the Inverse Duplex System was first introduced to the broadcast enthusiast, many of the present circuit refinements were unknown. In fact, at the time when the first Inverse Duplex System articles appeared in this magazine, in 1923, little else but regeneration and untuned radio frequency amplification were considered.

Since those far-off days in radio, many things have occurred, changing the entire character of the industry. Problems which then seemed insurmountable now no longer exist—solved as the occasion necessitated. Almost before these early Inverse Duplex System articles were off the press, things started popping! New tubes! New wavelengths! More stations! And didn't this raise havoc with design!

For instance, the original Inverse Duplex System circuits featured in these pages were exceptionally efficient, picking up stations 1300 miles away on a one-foot loop with only three tubes. But the set employed untuned radio frequency transformers designed to function well on 360 (833 kc.) and 400 (750 kc.) meters. Furthermore, the various constants used were specified

for the UV-201 tube, which was promptly replaced by the UV-201-A type. Meanwhile many additional broadcasting stations were going on the air with wavelength assignments running from 240 (1250 kc.) up to 550 (545 kc.) meters. What else could be expected of the innocent untuned radio frequency transformers but inferior results on other wavelengths than those for which they were designed? The number of stations alone created a problem in selectivity that could not be taken lightly, and, whatever fixed or untuned radio frequency may or may not be, it is certainly not selective.

There still seem to be many radioexperimenters who associate these circuit limitations with the basic principle of Inverse Duplexing. Of course many multi-tube reflex circuits were notoriously inefficient but the Inverse Duplex System and reflexing should not be confused for one single instant. It is true that both use the tubes twice for amplification. Their methods of doing this, however, are entirely distinct and separate. Extensive investigation on reflex action was conducted during the war by the Government with the conclusion that reflexing had many limitations. Out of this work was born the Inverse Duplex System, specially conceived to make the double operation of vacuum tubes perform as it should.

The first step after broadcasting conditions changed, was to incorporate into the Inverse Duplex System new and better circuits to meet the new commercial requirements. Tuned radio frequency was introduced about this time and several receivers employing tuned radio frequency amplification carried everything before them. It obviously remained for tuned radio frequency to be adapted to the Inverse Duplex System. This procedure sounded very simple, but neither this change nor the one necessary before the new tubes could be used was, in any sense of the word, easy. Too many complications arose and before any one circuit change could be made, it was important to determine all the effects on the overall amplification and efficiency.

Since 1923, concentrated effort has been exerted by those closest to the Inverse Duplex System, consisting of thousands of tests conducted under actual field conditions as well as in the laboratories. One by one, the various constituent circuits were whipped into shape and one by one applied to the Duplex principle. The progress was so steady and the results so gratifying that merely applying tuned radio frequency and ordinary audio amplification to the system no longer appealed. Nothing short of fundamentally new associated circuits would be considered!

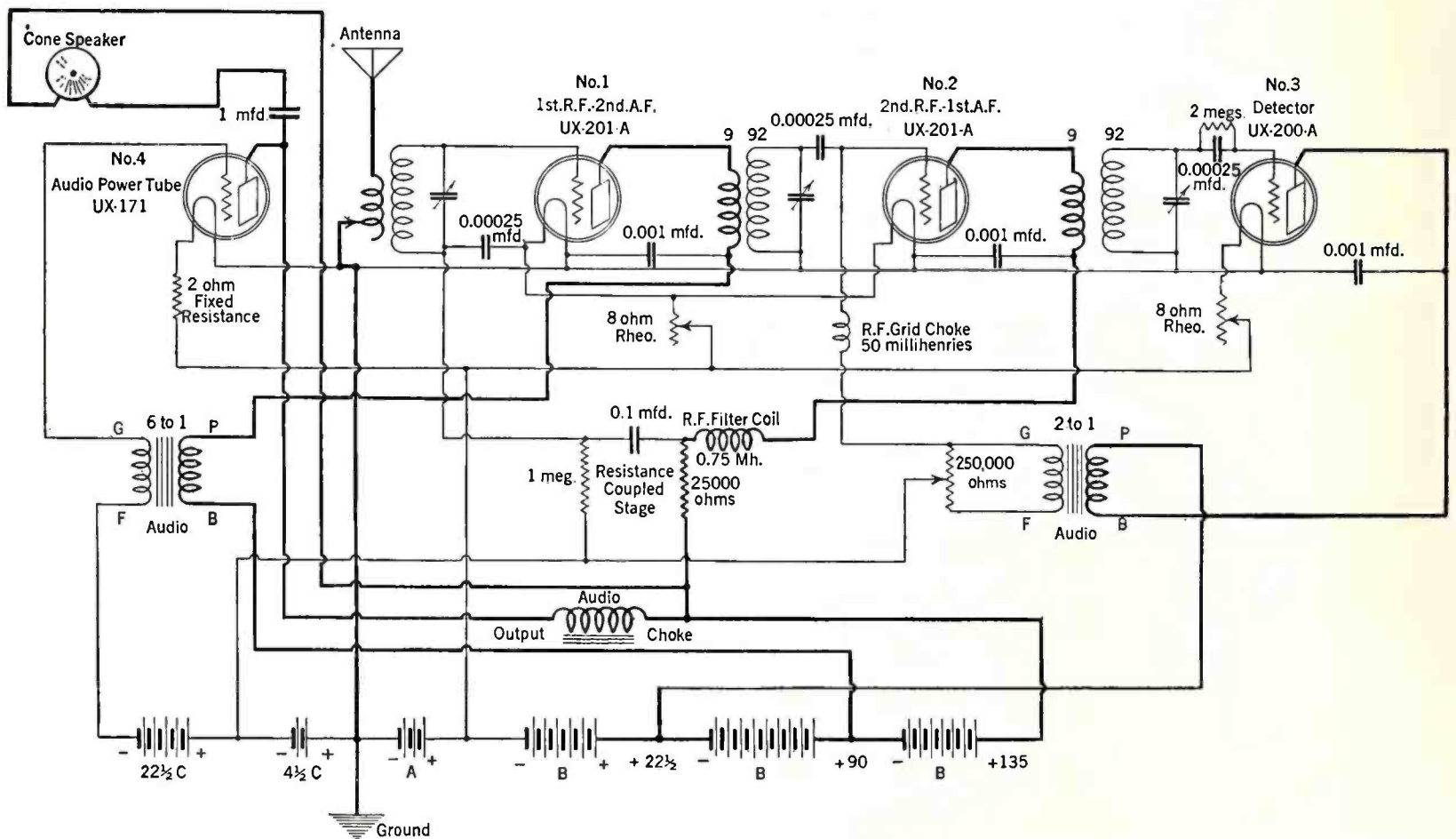

FIG. 1

FEATURES OF THE NEW SYSTEM

NOW, after three years of real engineering effort, the new Inverse Duplex System is presented as one of the most efficient circuits of the year.

Some of the outstanding features to be considered are listed below, and they will be discussed in detail as the series of articles progresses:

1. Excellent radio frequency selectivity at all wavelengths.
2. Substantially equal radio frequency amplification at all wavelengths.
3. Several special arrangements to secure real tone quality in the audio amplifying circuit.
4. Means for preventing detector-tube overload, thus retaining the bass notes on local stations.
5. Elimination of direct current from loud speaker windings, reducing burn-out tendencies.
6. Straight line volume control for smooth gradual adjustment from a whisper up to the choking point of the tubes.
7. Long length of tube life because of negative C battery bias on all amplifying tubes, radio frequency as well as audio frequency.
8. Small B battery drain due to the reasonable number of tubes used and the fact that all amplifying tubes are operated with the standard negative C bias on the grids.
9. Unique audio grid arrangement on first audio tube to overcome hand hum, prohibit the audio whistling caused by the A type tubes, and to permit the second and third condensers to be run on the same grounded shaft, if desired.
10. Certain circuit designs to permit the use of the new UX-171 power amplifying tube and the new UX-200-A detector.
11. Determination of audio phases for reduced radio frequency modulating effect on excessive signal strengths.

It was soon realized during the tests on tuned radio frequency that the circuit was inherently more efficient on the short waves than on the long waves. The fixed radio coupling between the primary and secondary windings of the tuned transformers made this so, and the actual results completely verified the theory. Efforts were made during the Inverse Duplex System adoption to remedy this fault but it was something that required an entirely new tuned radio frequency circuit. Other engineers were working on this problem of unequal radio frequency amplification as it almost offset the selectivity advantage the tuned radio frequency system possessed. Almost a dozen solutions have been offered as a result. In nearly every case, the difficulty has been overcome—the long-wave amplification being made equal to the short-wave amplification! But one very important thing has been overlooked and that one thing is selectivity—the very thing that gave tuned radio frequency its standing! All the systems based on increased coupling arrangements at long waves or increased "loss" methods at short waves, were broad either at one end or the other of the tuning dials.

The new Inverse Duplex System investigations finally disclosed the complete answer to this apparent enigma. The System made use of the inherent tendency of the audio circuit to feed back radio energy—a previous detriment turned into a great asset. A simple explanation will make this plain. Referring to Fig. 1, it will be seen that the radio frequency energy passes from the antenna to the detector through tube No. 1 and tube No. 2, constituting the first and second stages of radio frequency amplification respectively. The audio currents originating in the detector tube No. 3 then pass back through these tubes in the inverse sequence, going through the No. 2 tube as the first audio and the No. 1 tube

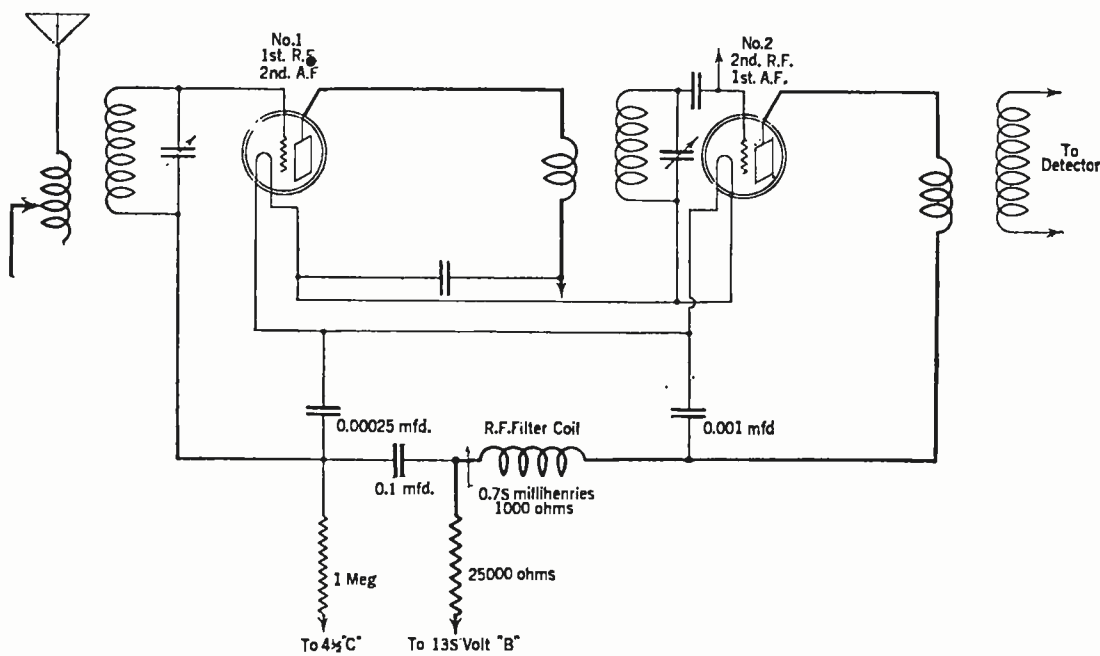

FIG. 2

as the second audio amplifying stage. The audio currents thus travel from No. 2 to No. 1 while the radio currents are passing through from No. 1 to No. 2 tube. Certain precautions must be taken to prevent the currents from passing through the wrong paths in view of these reversed sequence arrangements.

A little reflection will reveal that the radio frequency currents in the output of the No. 2 tube might easily leak back through the resistance coupling (which passes the audio currents from this No. 2 tube to the No. 1 tube) into the input of the first radio amplifier—the No. 1 tube. This would constitute a first-class feed-back that would be either aiding or opposing according to the phase polarity of the primary connections on the middle interstage radio frequency tuning transformer. The first thought in the research laboratories was to insert a large radio frequency choke coil in this resistance coupling to prevent all radio frequency leakage here without deter-

plate and grid bypass condensers that the entire arrangement would constitute a filtered feed-back circuit affecting the long waves more than the short. Having hit upon the theory, it was worked out in practice quite simply. The constants of the coil were found to be 0.75 millihenries and 1000 ohms resistance. These values are not at all critical but, on the contrary, are subject to considerable latitude because the filter circuit is *not* a tuned or resonant device. It is, as its name implies, a filter.

FILTERING ACTION

FOR those readers who do not see this filtering action clearly, a brief description of its operation is here given. Assume, as a starting point, that the circuit has been tuned to a short-wave station of about 200 meters. The high-frequency currents flowing as a result in the plate circuit of the No. 2 tube are readily passed back to the filament by the 0.001-mfd. bypass condenser. The filter choke coil offers great impediment to the passage of these short-wavelength, high-frequency currents, really forcing the currents to take the path of least resistance through the 0.001-mfd. bypass. However, as the longer wavelengths are tuned-in, the lower frequencies of these longer waves encounter more and more difficulty in passing through the 0.001-mfd. bypass condenser and at the same time, pass more easily through the filter coil, which offers less impedance to the lower frequencies. Feed-back thus occurs at the long waves in an ever-increasing amount as the 550-meter setting is finally reached.

This feed-back, or reënforcement, is just sufficient to compensate the drop in long-wave amplification due to the fixed radio frequency coupling, so that an overall amplification is obtained as shown in Fig. 4, on page 268. The dotted line indicates the efficiency curve of the average tuned radio frequency circuit over the wavelength band used in broadcasting. The solid line at the top of the graph shows the amplification as obtained from the circuit combination just described. The amplification is shown to be practically constant over the entire range.

The excellent selectivity feature of this circuit at all wavelengths is next to be considered. This is a very important factor. Curves A and B in Fig. 4 show the resonance peaks of the tuned radio frequency and the Inverse Duplex System layouts respectively. It will be noted that the sharpness of tuning is about the same in the two cases at the short wavelengths. The straight

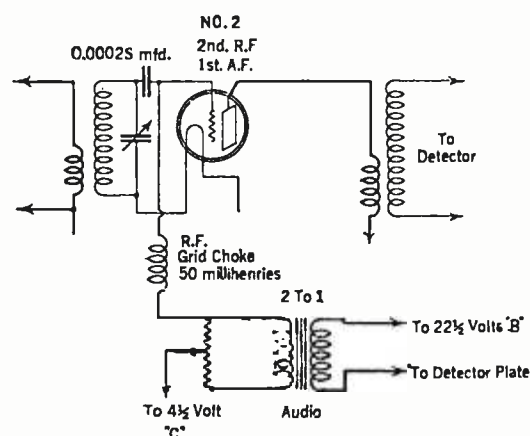

FIG. 3

ring the audio currents which were traveling their legitimate path. This worked perfectly, whereupon different values of chokes were tried in order to determine how small a choke could be relied upon. Then a discovery was made!

By properly poling the primary of the tuned radio frequency transformer between the No. 1 and No. 2 tubes, the feed-back could be made to reënforce the original signal in tube No. 1 and could be made to reënforce it progressively as the longer wavelengths were tuned-in on the antenna. Reference is here made to Fig. 2 which shows only that portion of the circuit with which we are now concerned. This radio-frequency choke coil could be so designed in combination with the

tuned radio-frequency circuits have long been noted for their selectivity at these settings. On the other hand, curves C and D on the same diagram tell a different story. Not only is the height of the resonance curve greater, which means greater amplification, but the sharpness is much more pronounced in the new Inverse Duplex System as compared with tuned radio-frequency circuits. Other systems employed for boosting the height of the tuned radio frequency curve at the long waves still further broaden or reduce the sharpness of resonance—or selectivity!

It almost appears to be paradoxical—greater amplification with greater selectivity! It is as if you had suddenly transported your receiver much nearer the transmitting stations and then found to your surprise that they could be tuned out more easily than before. The explanation is simple, of course. This newly acquired gain in amplification has been the result of a reënforcing action which is equivalent to a decided reduction in the resistances of the several tuned circuits. Now the sharpness of resonance depends entirely on the resistances of the tuned circuits. Having, in effect, then, reduced these resistances, the sharpness of tuning, or selectivity, increases tremendously. This action of reënforcement is well known among engineers and is often referred to as “negative resistance,” although in reality there is no such thing.

PREVENTING “HAND HUM”

ONE of the many obstinate difficulties encountered when tuned radio frequency was applied to the Inverse Duplex circuit was the tendency for the middle tuning dial to pick up audio induction hum and to squeal when the operator’s hand was brought near it. The trouble was not anticipated but, when once it occurred, it was easily diagnosed, and a remedy prescribed. The variable condensers used in tuning constitute a fairly large amount of metal, particularly in area. These condensers were naturally located in the grid circuits of the audio transformers, as the grid circuits of the amplifying tubes were common to both radio and audio currents. Now any large capacity hanging on the grid post of the first audio transformer is apt to cause no end of trouble. Placing the hand near this condenser was practically equivalent to touching the audio grid post with the finger, and the unearthly squeal resulting hardly bears de-

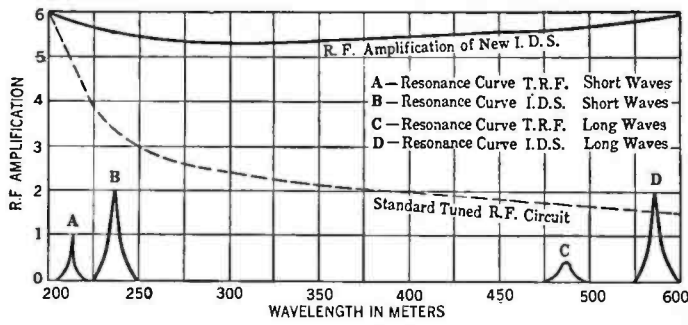

FIG. 4

scription. Incidentally, as any electric lamp or power circuit was brought near the set, this “grid collector” variable condenser would start to perform. The 60-cycle hum always resulting was very pronounced.

Fig. 3 on the previous page shows in a clear manner just how this trouble was overcome. The audio currents were kept entirely out of the radio circuit and the variable tuning condenser, by a multiple connection instead of a series one. The

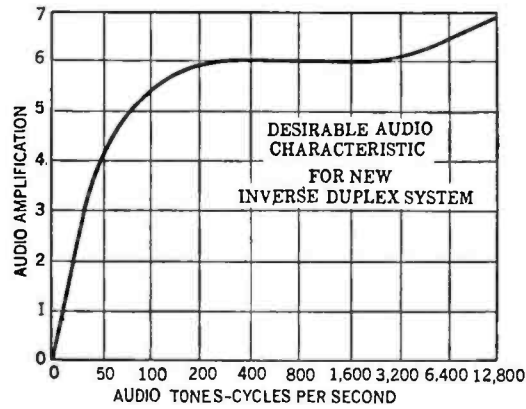

FIG. 5

grid post of the first audio transformer connects directly to the grid of the No. 2 tube through a radio frequency grid choke coil. This coil passes the audio energy without any objection, but becomes an open circuit for any frequencies encountered in the broadcast wave band. The blocking condenser, 0.00025 mfd., passes the radio energy through to the grid but prevents the audio currents from running down through the radio circuit to the filament. This variable condenser is thus grounded for audio currents without effect-

ing its tuning operation for radio currents. Of course, the third tuning condenser works into the grid of the detector so no difficulty is experienced here, there being no audio currents in this circuit. The left-hand or first condenser is not so susceptible to this hand whistle since it is in the grid circuit of the second audio tube. This audio stage is a resistance-coupled one anyway, which overcomes the situation just discussed. Inasmuch as the grid bias is supplied to the No. 2 tube through the audio circuit and radio frequency choke, the filament return from the tuning condenser may be connected to either side, and may therefore be combined with the detector filament return. Thus the rotors of the second and third condensers may be common and connected together for simplified control.

The various developments in the audio circuit are quite separate and distinct from anything so far described. For best tone quality, the audio transformers should have a certain characteristic when employed in this new Inverse Duplex System. They, of course, should have good low-note amplification in order to give that timbre which cannot be present when the bass notes are not amplified efficiently. But the transformers should have a “rising” characteristic, *i. e.*, they should exaggerate the higher tones slightly. There are two reasons for this, both of them easily appreciated when pointed out.

In the first place, the 0.00025-mfd. blocking condenser in the grid of the tube in Fig. 3 is, in reality, across the secondary winding of the first audio transformer, as far as audio currents are concerned. This condenser reduces the high tones somewhat, and this has to be compensated.

In the second place, the more sharply tuned a radio frequency circuit is, the more it tends to cut off the high audio tones coming through. As previously brought out, the radio circuit used in the new Inverse Duplex System is exceedingly selective, and this tends to cut out some of the higher audio tones. Employing an audio transformer with a “rising” characteristic compensates this, and permits the selectivity without sacrificing the tone quality. This is an important point. Fig. 5 shows an ideal curve for this purpose.

The next article in the series will give further details on the development of the Inverse Duplex Receiver and will also offer constructional information.

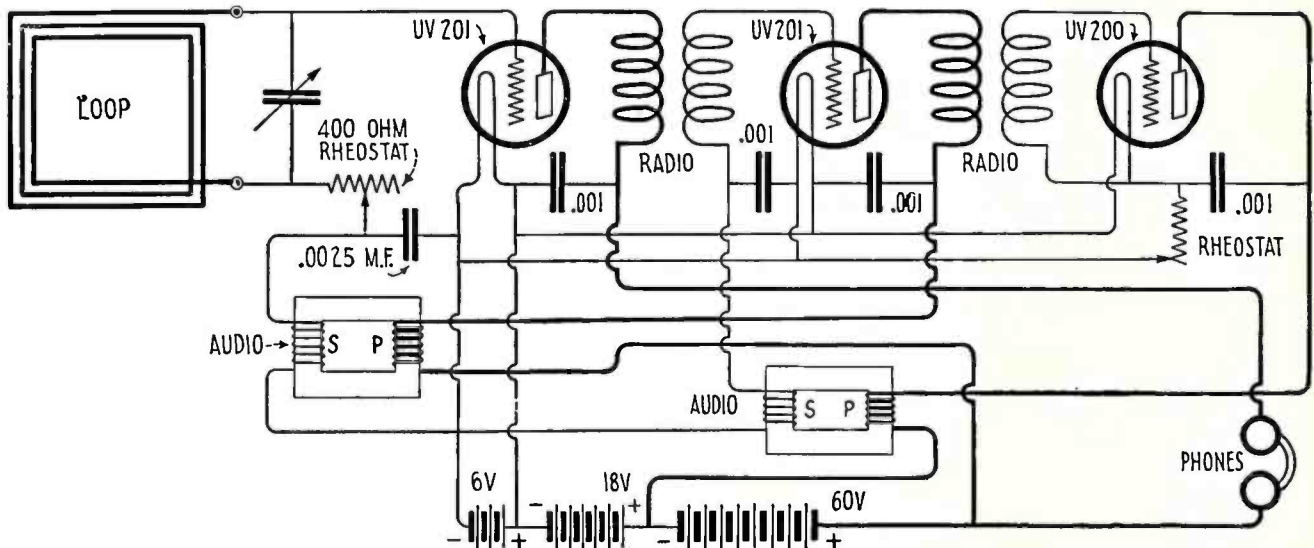

“1300 MILES ON A ONE-FOOT LOOP”

Such was the title of an article describing the then ultra-modern Inverse Duplex System, which appeared in the April, 1923, RADIO BROADCAST. Above is the circuit, a three-tube affair, which created quite a sensation at the time of its original presentation. Woe betide the fan who constructs a set from this old circuit in these modern days, when selectivity is an essential and primary requirement

THE LISTENERS' POINT OF VIEW

Conducted by John Wallace

Radio Speakers Should Be Forbidden to Read from Manuscripts

WE HAVE a copy of a list of regulations and suggestions for radio entertainers prepared by Program Director L. J. Johnen of WLW. The list is a long one, but since it is probably typical of the requirements of most broadcasting stations you may be interested in reading a few of the paragraphs:

"The performer should always submit his program, written in advance so that the announcer may be prepared to present it in a dignified manner without having to word his announcements extemporaneously. No performer should essay a selection with which he is not entirely familiar. In this way he will save himself and please the radio audience.

"All addresses must be submitted by speakers for approval before being broadcast.

"No requests for money may be made.

"It should be remembered that the announcer has full charge of the studio. The performer should accept any suggested changes in his program, or in his position before the microphone, in the spirit in which they are given.

"It is, of course, understood that nothing offensive or suggestive of bad taste will be permitted.

"It is against the rules of WLW to permit direct advertising.

"Speakers should talk in an ordinary conversational tone, about two feet from the microphone, and directly into it. The face must never be turned away. A speaker should not speak into the microphone as if he were addressing a large audience.

"The distance from the microphone for singers and instrumentalists varies—the higher the pitch and the greater the volume, the greater should be the distance.

"Very loud singing or playing is objectionable as it detracts from successful broadcasting, often producing a shattered effect. The best choral effects are obtained when each person sings in a subdued manner.

"Pianists are cautioned to make very sparing use of the pedals—it is best not to use the sustaining pedal at all—and not to accentuate the

bass notes, in order that the broadcast may be clear and distinct.

"Selections should be chosen with a view to pleasing the maximum number of listeners. The average audience likes familiar compositions, simple in melody, and universal in appeal. It is suggested that strange exotic selections be omitted from the program.

"Speakers are urged not to speak extemporaneously. They should always use manuscript, in order to prevent halting in their utterances. A page of typewritten copy, double spaced, usually takes about three minutes to read slowly and distinctly."

With these last two rules we are not in sympathy. Perhaps they are inevitable, certainly they obtain at every station, but still we think they should be thrown out. The admonishment is to speakers particularly. There is little enough excuse for radio speeches anyway, and what small justification there is is that the spoken word may be more interesting than the written one. In fact, in this day of cheap printing, there is little excuse for any speechifying. We concede just two situations in which a speech is more logically called for than a printed message: first, when an audience is made up of illiterates; second, when the speaker is endowed with an

ability to put his stuff across better orally than he can in writing. A memorized speech, or one read from manuscript, is no improvement on one set up in type; the fact that someone other than one's self is reading it adds little to the interest. It is every bit as dry in the reading as it is when it appears in the newspaper the next day.

It is the existence and observation of the rule quoted above that has made radio speeches what they are to-day—about the dulllest thing on the air. The very "halts" which the rule quoted seeks to eliminate are, in fact, an essential element in a good speech—just as legitimate as the words themselves. They indicate, in the case of a competent speaker, that that speaker is thinking. And what more could you ask? When a man is making a good speech he is *thinking out loud*. That's why a good speech is effective: the audience enters into the speaker's stream of thought and thinks with him. Some of his thoughts are inevitably new thoughts, thoughts that never occurred to him before that very instant. It is this fact, that the speech is developing, actually originating, before them, that gives it life for the audience. Not one speaker in a thousand can, while reading a speech, convey the impression that he is also thinking

about it. The result is a colorless, dead thing. And, read over the radio, the same speech becomes even deader than dead.

Not long ago, we listened (briefly) to a speech by George Palmer Putnam delivered for the Eveready Hour and purporting to deal with explorations in Greenland. It is a matter of record that Mr. Putnam did engage in explorations in Greenland but it never would have been guessed from his speech. The talk was about as convincing and personal as if it had been culled from the "G" volume of an encyclopedia. True, Mr. Putnam made no stammering pauses, his words were carefully chosen, his rhetoric was irreproachable, the mechanism of the whole dissertation was faultless—and its net value was nil.



© Henry Miller

WHAT HAPPENED TO THE TOWERS OF PWX, AT HAVANA

The recent hurricane played havoc with radio towers. During the Florida hurricane, radio towers of broadcasting stations were partly destroyed, although repairs were quickly made

TELL US WHAT YOU LIKE IN RADIO PROGRAMS

WHAT say, O constituents, to a questionnaire?

Radio has been blessed with more than its share of questionnaires, and we have hesitated for a long time about using such a method of gathering information about what readers of RADIO BROADCAST think of radio programs. But we feel, and not without reason, that the readers of RADIO BROADCAST constitute a distinct class of radio listeners, and may be justifiably considered the upper strata.

And aside from the amusement to be had from phrasing your replies to these four questions, you may be helping to influence the character of programs. Every program director is always keen about knowing how his efforts are being received,

and he can not always tell from his letters, for how does he know that they represent a true cross-section of his listeners.

The questions below are few, and some of them have the special virtue that they have never been asked before. Please use the space provided for your answers. Tear this sheet from the magazine, and if possible typewrite your replies. If the space provided is not sufficient, attach an additional sheet to this with your remarks. If you are interested in reading the replies—contribute some yourself. Address all questionnaires to

JOHN WALLACE,
RADIO BROADCAST,
Garden City, New York.

Please Answer These Questions

1. Do you listen to your radio evenings as you would to a regular show, or do you simply turn it on and use it as a background to other activities?

(This question may seem silly, but we ask it because we have a growing suspicion that radio programs aren't as reverently listened to as the broadcasters suppose.)

2. Do you regularly tune-in on distant stations or do you regularly rely on your local stations?

(They tell us that the DX hound is a fast-disappearing breed. Is he?)

3. If you had a hundred minutes to listen to all, or any part of the following broadcasts, how would you apportion your time? (Answer in spaces provided in the next column.)

Instrumental Music	} <i>Serious</i> — minutes <i>Light</i> — minutes <i>Popular</i> — minutes	
Vocal Music		— minutes
Radio Play		— minutes
Speech	— minutes	
Educational Lecture	— minutes	
Miscellaneous Novelties	— minutes	
TOTAL	100 minutes	

(In answering this question, assume that each of the offerings is the best of its kind, say Coon-Sanders Nighthawks for the jazz, the New York Symphony for classical music, Ford and Glenn for the novelties, and so on.)

4. What are the six best broadcasts you have heard?

(We could refresh your memory with some notable broadcasts, but that might influence your choice. Anything is eligible, from an especially good dog fight broadcast, to a high-powered soprano solo, heard four years ago.)

Please answer these questions briefly and mail them at once to Mr. Wallace, at the editorial offices of RADIO BROADCAST, Garden City, New York. We prefer to have you write your replies on this page. The results of the questionnaire will be announced just as soon as it is possible to compile them.

We do not mean that a radio speaker, or any speaker, need improvise his speech entirely. Let him fret over it as many nights in advance as he likes, provided, always, that he can, in the final rendition, eliminate any suggestion that it has been prepared. If he is sufficiently full of his subject and has an outline before him to keep him from going too far astray he can deliver just as fluent a speech as he could from a manuscript, and a far livelier one.

Whatever else may have been thought of William Jennings Bryan he was unquestionably a speaker, than whom there was no thanwhomer. As a reporter, we once had an opportunity to "cover" a speech by him. Before he commenced we obtained from him a copy of the outline he was to follow. It was just ten lines long. From it he talked for two hours. Never for an instant did his manner of speaking suggest that he had the faintest idea what he was going to say next; it seemed absolutely extemporaneous. Yet the whole thing was a perfect piece of fluent prose. We learned later that he had given that same speech some ten times before. The secret of its freshness, its seeming like a first performance, lay in the fact that the ideas he had expounded so many times before were couched that evening in an entirely new set of words and phrases. Had he followed a manuscript he never would have fooled anyone into thinking he was delivering a fresh speech—nor would he have kept his audience spellbound, as he did, for two hours.

Every radio speaker evidently cannot be a William Jennings Bryan, but any one of them can afford to emulate his methods with great profit. That is, they can follow his method, providing the broadcasting stations throw out the silly requirement of a manuscript. We much prefer a radio speaker who is flustered, stammering, incoherent, and ungrammatical and still sounds like a human being to one who is polished and suave and sounds like a stock-market announcer.

The studio rule which we would suggest anent this subject, and which we would urge posting conspicuously on all walls of the broadcasting station, would read as follows:

SPEAKERS ARE ENJOINED not to deliver memorized speeches, and are *positively forbidden* to speak from manuscript. Speakers who are possessed of burning messages in manuscript form are cordially invited to have them set up in type and distributed as pamphlets or take a jump for themselves in the lake.

As for the other rule, tactfully worded as a suggestion—"The average audience likes familiar compositions, simple in melody, and universal in appeal. It is suggested that strange exotic selections be omitted from the program"—what can be done about that? The answer is,



ALMA PETERSON AND KATHRYN BROWNE

Two artists of the Chicago Civic Opera Company who are being featured in a series of Wednesday night programs through the Chicago Evening *American* studio of KYW, Chicago. Miss Peterson is a dramatic soprano and Miss Browne a contralto. They are heard through KYW from 7 to 8, Chicago time

probably, nothing. We may rant and protest, scream and tear our hair but, alas, the doleful fact remains that the *average* audience *does* like familiar compositions. Of course we may call it an idiot, which it is, but due to its numbers it is a very influential idiot. And we shall have to continue to look elsewhere than to radio for serious compositions executed subsequent to the reign of good Queen Victoria. "Exotic" composers of the ilk of Strawinsky will, we grant, not be heard via radio for another twenty years; not until they are as commonplace and acceptable as the once bizarre Debussy.

in appeal" as the few to which you have given your OK. And how can a piece help but be "familiar" if it is played often enough, and furthermore how, oh how, can a piece ever hope to gain that cherished goal of being "familiar" if it's never given a chance? It is a dreadful *impasse!*

The Banquet Broadcast Nuisance

IN THE November department you may remember, we had remarks to make concerning the extraordinary badness of the printed publicity emanating from radio stations. None of it, with about three or four exceptions, is worth the paper it is printed—or mimeographed—on. One of these exceptions is *The Gold Medal Station News*, a monthly publication of WCCO which is mailed to that station's listeners as well as to radio editors. The sheet is edited by H. A. Bellows, WCCO's manager, and he can invariably be counted on to make interesting comment on current radio affairs. We have long been bored by the broadcasting of banquets—the which still persists in the hinterlands—and Mr. Bellows decisively sets forth their shortcomings in the current number of the above-mentioned *News*:

"Almost every day we receive one or more requests to broadcast banquets or similar meetings. Two or three years ago, when broadcasting schedules were hard to fill, there was a good deal to be said for sending out programs of this sort, but to-day, except in the rare instances in which banquets or meetings are arranged primarily for radio purposes, the listeners are properly indignant when they are asked to tune-in on broadcasting of this sort.

"If the sponsors of the average banquet could but realize the unfavorable reaction of the average listener to such broadcasting, they would never again ask for the privileges of the air. They do not hear the clatter of dishes, the insistent noise of the crowd, the lamentable waits, the uneven transmission, the echoes and the disturbances which irritate the radio listener; they do not stop to think that a thirty-minute speech, which may be only mildly dull while one is comfortably digesting a too large meal, is



THE TOLLEFSEN TRIO AT WEAF

These artists are heard as a part of the "Vikings" broadcast through WEAF and associated stations on Tuesday evenings from 8 to 8:30 eastern time. In the illustration: Mme. Augusta Tollefsen, pianist; Carl H. Tollefsen, violinist, and Paulo Gruppe, 'cellist

simply intolerable when it comes out of the loud speaker.

"Furthermore, the attempt to broadcast a banquet often spoils the affair itself. The speakers cannot freely address the people before them; they must talk steadily at the microphone. Much of the spontaneity which is the life of any banquet must be deliberately killed if the broadcasting is to progress with any approach to smoothness. The army of waiters must be silenced at the very moment when people want their empty coffee cups removed. Something of the deadened (why not frankly call it funeral?) atmosphere of the broadcasting studio must be introduced into the banquet hall, to the immense discomfort of everyone concerned.

"Of course there are rare exceptions. A banquet, like the huge affair of the radio industries in New York on September 15, may be definitely built around the idea of broadcasting. But if those responsible for the ordinary banquet could have attended one of the executive committee meetings preparatory to this radio dinner, and could have noted how every detail was resolutely subordinated to the requirements of good broadcasting, they would realize how far the usual affair falls short of these essentials.

"Luckily, more and more people are coming to realize that broadcasting a complete banquet is just as dull as printing in the newspapers verbatim copies of all the speeches, from 'Unaccustomed as I am to public speaking' down to the last tremulous 'I thank you.' They are learning that such broadcasting stirs up definite illwill, and so is undesirable publicity. There are, however, many who have not yet discovered this fact, and until all the banquet committees in the Northwest have found it out for themselves, there will be times when the manager of the Gold Medal Station would gladly sell his job for thirty cents in cash and a hiding place out of reach of the telephone."

The Log of a Listener

RANDOM discoveries while running around the dials the other night:

woc, Davenport, Iowa—a report on the direction of flight of a flock of ducks sighted over Davenport, which must have been of valuable information to sportsmen, though it strikes us as a dirty trick on the ducks.

wSBT, South Bend, Indiana—"Well, folks, we want anybody who can do anything, play a mouth organ or something, to just please drop around here at the studio and . . ." So that's where they get their material!

wJAX, Jacksonville, Florida—" . . . and this number is dedicated to . . ." But that's as far as we listened.

koA, Denver—A talk by William H. Crawford, for twenty-five years confidential representative of the *New York Times*. Reminiscences of personal contacts with Pope Pius XI, Warren Harding, Calvin Coolidge, King Albert of Belgium, and the Prince of Wales. An interesting talk in spite of an obvious flavor of the manuscript in the speaker's phraseology.

kFQB, Fort Worth—Two of our pet abominations: a reading of telegrams and then a "for our next selection we will play for you . . ."

wSMB, New Orleans—Two knock-out dispensers of jazz-as-we-like-it. The Liberty Theater Syncopators playing some marvellous variations on the good old tune "Valencia," and then Buck

Jones and his "Radio Revellers" in a fine demonstration of well-orchestrated dance music.

Communication

MR. JOHN WALLACE, Conductor,
The Listeners' Point of View.
SIR,

I read with great interest your article in the September RADIO BROADCAST entitled "The Curious Jargon of the Broadcasting Industry." I share your respect for these venerable terms "sign off" and "stand by"; but, after all, the latter has always seemed to me rather incongruous. Whenever I hear an announcer say "Please stand by," this always suggests to me a mental picture of a vast concourse of people, obediently rising to their feet, and "standing by," as though band were playing our National Anthem, or the home team were about to begin the seventh inning, which seems more probable.

Apropos of all this, hark you to the following.



A GROUP OF LISTENERS IN SAMOA

Natives of Pango-Pango, Samoa, listening-in on a Fada outfit supplied by Phil A. La Brie, who is touring the Far East introducing radio where it has not yet been generally accepted

During the recent fistic combat in Philadelphia, one of our local stations, while giving a detailed account of the affair from telegraphic reports, was responsible for the following gem of perfect politeness and precision: "Please sit by for the next round." Please sit by! The very term suggests solid comfort and relaxation, does it not? May not sitting be considered as the natural position of the great majority of listeners? But be that as it may. My object in writing was merely to call to your attention this unique example of the ever-changing terminology of radio.

Sittingly yours,
LEWIS G. PRAHL
Milwaukee, Wisconsin.

Broadcast Miscellany

TWO Canadian stations, CNRM, Montreal, and CNRO, Ottawa, are now being hooked up for a simultaneous broadcast on one night of each week. Of the four programs thus given in November two originated in Ottawa and two in Montreal. It is expected that the "chain" will soon be extended to include CNRT.

ON SUNDAY nights at 8 o'clock (EST) is being heard from wjz a series of recitals by John DeBueris, a leading performer on the clarinet and basset horn. The clarinet is especially well adapted to radio reproduction and Mr. DeBueris' programs are well selected. The soloist has been a member of the Victor Herbert Orchestra, the Metropolitan Opera House orchestra, and, most recently, the Goldman Band.

FOLLOWING a tour of Europe H. V. Kaltenborn of the Brooklyn Daily *Eagle* has resumed his series of weekly talks on "Current Topics" via wor Monday evenings at 8:30 (EST), the which we recommend to you. Commenting on letters from listeners, Mr. Kaltenborn, who has received a fair share of them, says:

"Applause letters are going out of fashion. More's the pity. Everyone who speaks, sings, or plays over the air needs the reaction that can only come from unknown listeners. When we face an audience its applause, interest, laughter, or its listlessness, restlessness, or frowns tell us what it likes or does not like. We know when it agrees and when it dissents. We can fight it when we must, coddle it when necessary, or wake it up by extra effort. But when we have done our bit over the air we don't know what the wild ether waves have been saying until the mailman brings the cheers and the knocks.

"Although I have been giving weekly talks over the radio for three years, I never got rid of a sneaking suspicion that I was wasting my oratorical fragrance on the studio air until I got my first reaction from someone who actually heard my talk."

WEAFF has arranged a program especially designed to please the Saturday night listener entitled "The WEAFF Revue." As its name suggests it is sixty minutes of rapidly changing events and to a degree serves to sum up all that has passed over WEAFF's waves in the days of the week preceding it. The program includes old-time songs, hits and bits of comic opera selections, vocal and instrumental selections from grand opera, a little modern jazz and comedy, both musical and otherwise. In other words: a radio variety show for them as likes variety shows.

ALSO on wor's program is an excellent quartette composed of Messrs. Christie, Gannon, Barnett, and Seebach. They are to be heard at 8:00 p. m. (EST) on Sundays. A typical program will run something like this: "Dinah," "Stars of the Summer Night," "Deep River," "Banjo Song," "Can't You Hear Me Calling, Caroline," "I'll Take You Home Again," etc.

IF, WHEN the Atwater Kent Sunday evening concert draws to a close, you feel like more music in kind, you have only to tune-in on wjz, WRC, WGY, WBZ, or KDKA and listen to the Maxwell House Coffee Hour, which begins at 10:15 p. m. (EST). There are to be ten concerts in all, sponsored by this manufacturer, of a nature and quality much the same as the venerable Atwater Kent hour.

The artists who have signed contracts to appear in this series include among others, Efram Zimbalist, violinist, who has been released for this broadcast through the courtesy of the Victor

Talking Machine Company; Marie Sundelius, soprano; Johana Gadski, soprano; Sophie Braslau, contralto; Toscha Seidel, violinist; May Peterson, coloratura soprano; Moriz Rosenthal; Isa Kremer, the Russian lyric soprano; also the Fisk Jubilee Singers and the noted Ukranian Chorus. Throughout the entire series the solo artists will be supported by a twenty-two-piece symphony orchestra under the direction of Nathaniel Schilkret.

WGY is proving a valuable training school for radio announcers. A few months ago George Markham, formerly in charge of the agricultural hour at wgy, left to become general manager of wdbo, at Winter Park, Florida. Now Witter T. Cook, a graduate of Massachusetts Institute of Technology, more recently an announcer of wgy and one of the wgy players, has accepted a position with the air forces of wdae at Tampa, Florida.

THE Eveready Hour's broadcast of *Show Boat* a month or so ago proved to be one of the best of the novelties they have yet offered. An abbreviated version of the Edna Ferber story was arranged and Lionel Atwill read the narrative. When the progress of the tale called for one or another of the characters to speak, a different voice was heard and the rôle was carried much the same as in a regular radio "play." A background of music was provided throughout with occasional interludes of straight music, such as the variety show on the boat or the crooning singing of the darkies on the levee. The whole job evinced thorough preparation and was distinctly one of the two or three best novelties we have yet heard. In fact, we enjoyed it more than the book.

BY FAR the best of the radio book reviewers is Oliver M. Saylor. For a long time he has been giving a weekly review of plays and books through wgs in what is called the "Footlight and Lamplight" broadcast. Mr. Saylor is the author of several valuable books on the theater. The plays he reviews are, of course, those current in New York. And each week he comments on three or four of the recently published books. These comments combine sound criticism with an entertaining



THE STAFF OF WBAL, AT BALTIMORE

This broadcaster has established a strong place in its first year of operation because it has followed a policy which amounts to specialization. From left to right, seated: John Wilbourn, assistant studio manager and tenor ballad singer; George Bolek, program supervisor and staff pianist; Stanley W. Barnett, studio manager and announcer; Frederick R. Huber, director of broadcasting; standing: Gustav Klemm, program supervisor and director of WBAL concert orchestra; James Wilkinson, announcer and baritone

manner of presentation. An idea of his style of speaking can best be given by a random quotation from a recent broadcast:

"... The *Silver Stallion*, on the other hand, carries you so far back into the past that I for one doubt whether it ever did exist except in the strange mind of its author, James Branch Cabell. Without a word of warning you are whisked away into a land of ogres and miracles, a land of gay, sardonic men and rather helpless but beguiling women. Five times I tried to get started on this book and stopped. I gritted my teeth and went at it. Fifty or so pages and I was so wrapped up in the thing that you couldn't have torn it from me. And so, if you are awarded *The Silver Stallion* at your next bridge party, don't get discouraged. Break down the wall and enjoy the pageant the author has prepared for you.

"That pageant is misunderstood if you think of it only as a fairy story or as an attempt to imi-

tate the old French legends. It is merely Cabell's way of saying things about life to-day that few would heed if he said them in common dress. Most of these things are iconoclastic. In this book you will find the bitterest, most devastating and scornful attack on woman that has been penned in modern times. And a thorough drubbing for the whole notion of heroes and hero-worship. If some woman writer doesn't rise to the challenge of *The Silver Stallion* I'll begin to think the things Cabell says of the sex are true!"

"Footlight and Lamplight" is broadcast Thursday evenings at 8:30 (EST)

THE advance program of wgs, thanks to the inspiration or maliciousness of some compositor, recently carried a headline reading:

NANCY WILSON? 'CELLIST? ON AIR TUESDAY EVENING

As a matter of fact, Nancy Wilson is both Nancy Wilson and a 'cellist. But the typesetter's error (and our listening experience) suggests that the dubious mark might often and honestly be used in connection with a radio performer's alleged talent. For instance:
 Waldo Slithers.....Radio Humorist?
 Olga Schlitz.....Lyric? Soprano?
 Thomas Peep.....Famous? Piccolo Player?

FOR the first time, we take occasion to felicitate a broadcasting station on its birthday. WBAL celebrated its first anniversary November 1. WBAL set out with the intention of being a distinct personality among broadcasting stations, and in the space of one year has well achieved this purpose. For a year it has been broadcasting evening programs ninety-nine per cent. of which have been purely musical. In addition to a "no-jazz" policy to which it has steadily clung, WBAL has also sought to distinguish itself by maintaining entirely its own staff of broadcasting features and refusing to depend on outside hook-ups to put over its programs. In short, the station has specialized, and concentrated its attention on a particular class of listeners, which is what we would have every station do regardless of what class it chooses to please.



WGN'S DRAKE HOTEL CONCERT ENSEMBLE

This excellent hotel orchestra is heard each day and evening playing during the station's luncheon and dinner concerts. Left to right: Leon Benditzsky, pianist; Armand Buisseret, violinist; Henry Selinger, violinist and director; Frederick Meinken, organist; Leon Lichtenfeld, 'cellist; Edward Karstens, bass 'cello

The "Hi-Q" Receiver

By LESLIE G. BILES

The Latest Development of the Popular Hammarlund-Roberts Receiver, with Shielded R. F. and Detector Stages



Automatic Coupling Between Primary and Secondary Tuned Coils Is Attained as Condenser Dials Are Turned

READY FOR SERVICE

Resplendent in a polished cabinet, the "Hi-Q" is—to use the vernacular—"all set" for action

IT WAS in November, 1925, that RADIO BROADCAST described the first Hammarlund-Roberts Receiver. Since then, new design features have come into common use and many of these recent advances have been combined in the new Hammarlund-Roberts "Hi-Q" Receiver illustrated in this article.

The original Hammarlund-Roberts receiver consisted of a stage of tuned neutralized tuned r. f. amplification, a regenerative detector, and a two-stage transformer-coupled audio frequency amplifier. The "Hi-Q" receiver consists essentially of two stages of neutralized, tuned r. f. amplification, a non-regenerative detector and a two-stage transformer-coupled audio amplifier. Because of the additional stage of r. f. amplification, the use of a new type detector tube, and several other improvements, in sensitivity and selectivity this new receiver represents a considerable advance over the original model. In bettering the receiver, the designers have kept in mind the advisability of simplicity of control and, therefore, we find this receiver with only two main tuning dials. The only other apparatus visible on the front panel is a tapped antenna switch, a volume control, and an output jack.

The new and interesting features in this receiver make the editor of RADIO BROADCAST feel that it is well worth while to outline these features in a general way, and also to give some information concerning the arrangement of the apparatus. It is not intended to give complete constructional data in this article but rather to acquaint home constructors with the general features of the receiver. Even so, the experienced home constructor will find sufficient information in the various pictures and diagrams to build the set.

Briefly, this receiver incorporates the following features:

FIRST: Dual tuning whereby three tuned radio frequency circuits are controlled by only two dials, making the tuning quite simple.

SECOND: Complete shielding of the radio frequency circuits so as to prevent direct pickup by the coils of the receiver, and unwanted interstage coupling.

THIRD: Automatic variation of the coupling between the primary and secondary coils of the radio frequency transformers so as to obtain high efficiency.

FOURTH: A high efficiency detector circuit which permits the use of the new type 200-A detector tube.

FIFTH: Arrangement of the circuit so as to permit the use of a semi-power tube in the output.

These various features are taken up in more detail in the following paragraphs.

As mentioned above, the receiver incorporates three tuned circuits. The antenna stage is controlled by the left-hand dial which operates a single variable condenser. The two tuned radio frequency circuits are controlled by the right-hand dial through the use of a gang condenser. A small variable condenser is in parallel across one of the condensers of the gang unit and is used to compensate any small differences in capacity of the second and third tuned circuits. Once this small compensating condenser is adjusted, it need never be touched again.

The stage shielding around the r.f. amplifiers is very important, and makes possible the use of efficiently constructed coils in carefully designed circuits without any danger of interstage coupling through the magnetic fields of the coils. The antenna stage is not shielded but the apparatus is so laid out that shielding may be incorporated if it is desired.

AUTOMATIC COUPLING VARIATION

AUTOMATIC coupling variation is becoming more commonly used, and, in the "Hi-Q" receiver, this coupling variation is accomplished automatically by mounting the primary coils on movable supports. On the rear of the variable condensers there are placed small cams, and, when the condensers are turned out, these cams function to push the primary coil further and further away from the secondary coil. The coupling between the two circuits is loosest when the variable condensers are set to receive the high frequency, or short wavelength, stations.

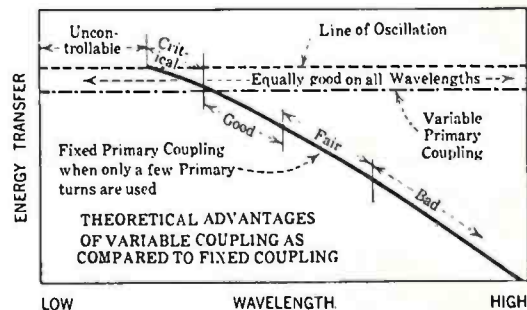

FIXED VERSUS VARIABLE COUPLING

This diagram clearly shows the advantages which accrue from the use of some form of variable coupling between the primary and secondary tuned coils

The reason why this coupling variation is necessary is that in most tuned radio frequency receivers the amplification on the long wavelengths is very poor in comparison to the amplification on the shorter wavelengths. This disadvantage of uneven amplification can be overcome by increasing the number of turns on the primary of the radio frequency transformers. Generally, however, when this is done, the receiver will break into oscillation on the shorter wavelengths, hence the problem is to obtain high gain on the longer wavelengths by the use of large primaries, but to arrange the circuits so that oscillations do not occur when short wavelength stations are being received.

Loosening the coupling between the primary and secondary coils has practically the same effect as decreasing the number of primary turns. The designers of this receiver have made it possible to obtain the essential variation in coupling without the use of any extra controls. The coupling is loosened just sufficiently to prevent oscillation on all wavelengths as they are received, and, as a result, the radio frequency circuits are always working at a point slightly below maximum amplification.

The detector circuit, as mentioned above, has been arranged for the use of a 200-A detector tube. When this tube is used the detector circuit must be slightly different than when a 201-A is to be the detector, in that the grid leak return must then connect to the positive filament. For a 200-A, it must connect to the negative filament. The 200-A detector tube is quite sensitive and will give considerably greater signal strength than can be obtained when using a 201-A although there is some attendant tube hiss with the more sensitive tube.

The output has separate B and C battery terminals so that any type of tube may be used in the second stage of audio. If a 112 tube is used the C battery voltage should be 0 for 135 volts of B battery and 10½ for a plate voltage of 157½. A 171 tube may also be used, providing a special arrangement in the output circuit is incorporated.

All types of tubes may be used in the receiver. The circuit arrangement is such as to make this easily possible. The two r.f. tubes have a fixed resistance in series with the volume control so that, for different types of tubes, fixed resistances may be used so as to obtain the correct filament voltage. The detector, and first and second audio stages, have separate filament control resistances so that changing these will permit the use of any type of tube. The designers recommend the following tube combinations:

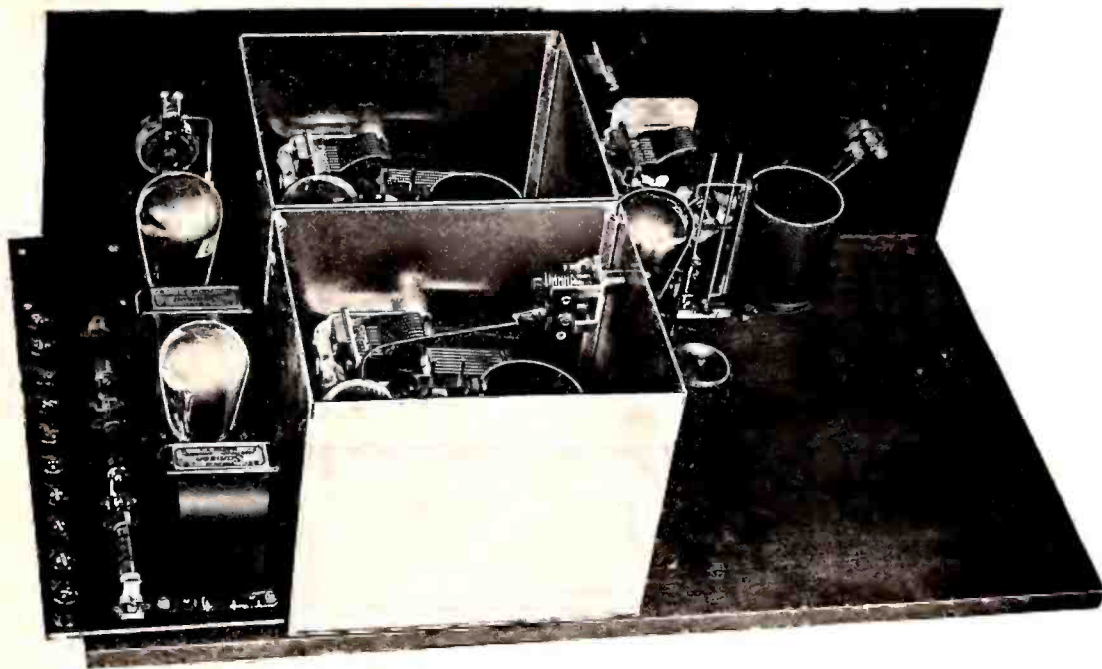

A DIFFERENT ANGLE

Of the same receiver shown below, but photographed before it was placed in a cabinet

COMBINATION No. 1

UX-201-A or CX-301-A in sockets No. 1, 2, 3, and 4
 UX-112 or CX-312 in Socket No. 5.
 1—6-Volt Storage A Battery.
 3—45-Volt B Batteries.
 2—4½-Volt C Batteries.

COMBINATION No. 2

UX-201-A or CX-301-A throughout.
 1—6-Volt Storage A Battery.
 2 or 3—45-Volt B Batteries.
 1 or 2—4½-Volt C Battery.

NOTE: If only 2 45-volt B batteries are used, only one 4½-volt C battery is necessary, and the two negative C battery binding posts should be

connected together. The + 90-volt and + 135-volt binding posts should also be connected together.

COMBINATION No. 3

UX-12 or CX-12 throughout.
 1—1½-Volt Dry Cell A Battery.
 2—45-Volt B Batteries.
 1—4½-Volt C Battery.

COMBINATION No. 4

UX-199 or CX-299 throughout.
 1—4½-Volt Dry Cell A Battery
 2—45-Volt B Batteries
 1—4½-Volt C Battery.

COMBINATION No. 5

UX-199 or CX-299 in Sockets Nos. 1, 2, 3, and 4
 UX-120 or CX-220 in Socket No. 5.
 1—4½-Volt Dry Cell A Battery.
 3—45-Volt B Batteries.
 1—22½-Volt C Battery.
 1—4½-Volt C Battery.

In combination No. 1, a 171 or 371 may be substituted for the 112 or 312. If a 171 is used, it will require a 40-volt C battery and four 45-volt units for the B battery. The 40-volt C battery should have its minus connected to the terminal marked—C. The plate current of this type tube is quite large, and it cannot be safely passed through the windings of the average loud speaker. It is recommended that if this tube is used, a choke coil, such as is used in B line power-supply devices, be placed directly across the terminals of the loud speaker jack. As the resistance of the loud speaker winding is considerably higher than the resistance of such a choke, practically all the plate current will pass through the choke coil and so prevent the loud speaker windings from being damaged. At the same time, the impedance of the choke coil to the voice currents is very high, so that all of the signal energy will pass through the loud speaker, and no loss of volume will be noticed.

ROBERTS NEUTRALIZATION

THERE are a few more notes concerning this receiver which should be of interest. In the first place, both of the r.f. stages are neutralized by the well-known Roberts method of neutralization. By equalizing or neutralizing the r.f. stages in this way, the electrostatic feed-back through the capacity of the element of the tubes is eliminated, and oscillations of the r.f. amplifier are prevented. The equalizing condensers are conveniently located so that they can be adjusted with

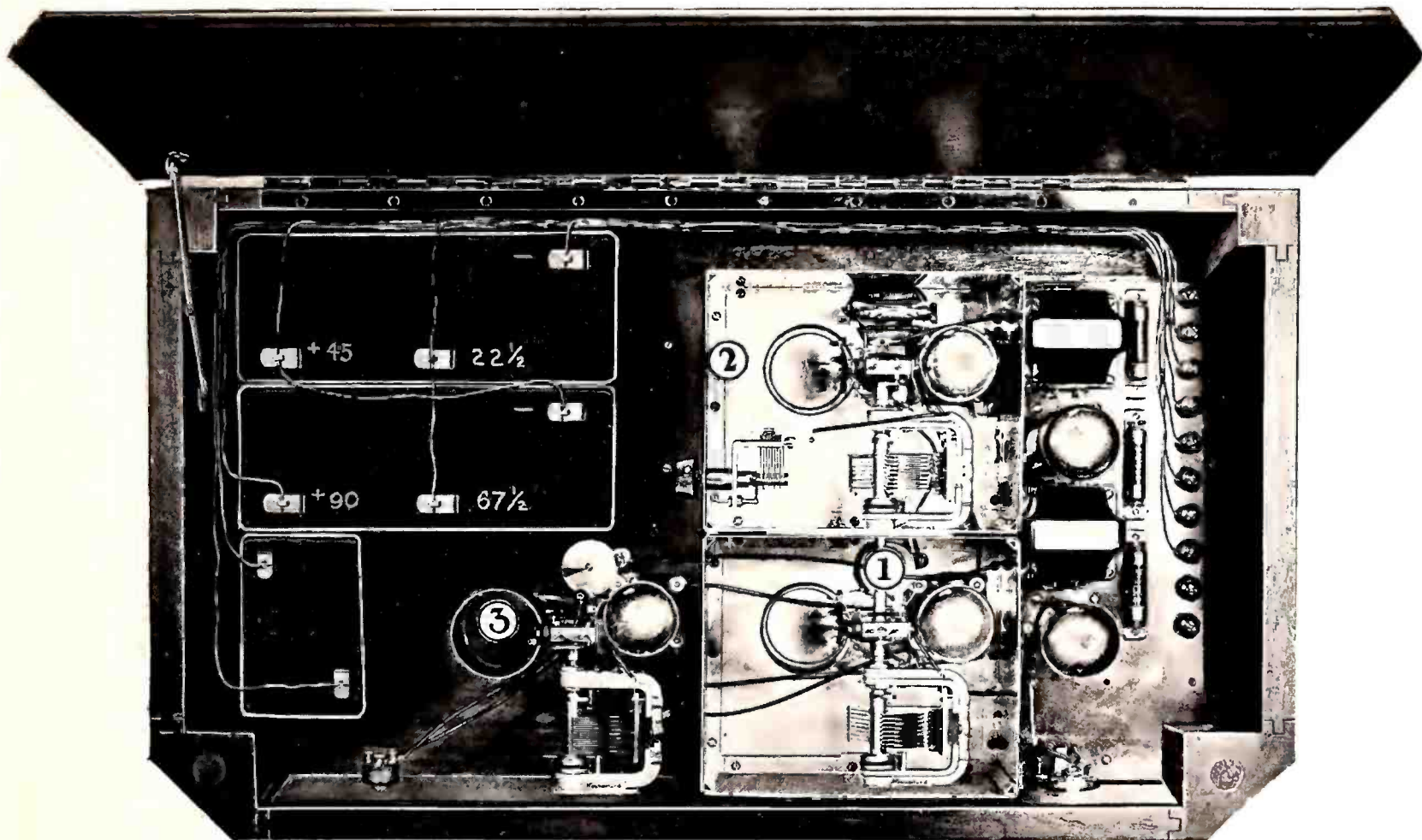

BENEATH THE LID OF THE HAMMARLUND-ROBERTS "HI-Q" RECEIVER

The layout of the apparatus has been carefully thought out, and every unit has been placed to best advantage. The numbered sections are the second r.f. stage, detector stage, and first r.f. stage respectively

the aid of a long stick sharpened like a screw driver at one end. The use of a metal screw driver is apt to affect the setting or, in slipping, might very easily cause a serious short circuit, and should never be employed for this purpose. The antenna circuit is equipped with a tap switch so that either a long or short antenna may be used.

The photographs and circuit diagrams in this article illustrate the arrangement of parts. The list of parts used in this receiver is given below:

2—Samson Transformers, Type HW-A3 (3-1 ratio)	\$10.00
3—Hammarlund 0.00035-Mfd. Midline Condensers	14.25
3—Hammarlund Auto-Couple Coils (Set of 3 Coils)	10.00
1—Hammarlund Jr. Condenser, 9 plates, 32 Mmfd.	1.80
2—Mar-Co No. 192 Vernier Dials	5.00
3—Benjamin No. 9040 Sockets (With Bases)	2.25
2—Benjamin No. 9049 Sockets (Without Bases)	1.00
2—Amperites, No. 1A (With Mountings)	2.30
1—Amperite, No. 112 (With Mounting)	1.10
1—Carter No. M-10-S Combined Rheostat & Filament Switch, 10-Ohm	1.00
1—Carter No. 1 "Short" Jack	.25
1—Carter No. 12 "Imp" Aerial Switch	.70
1—Sangamo 0.00025-Mfd. Fixed Condenser	.40
1—Sangamo 0.001-Mfd. Fixed Condenser	.50

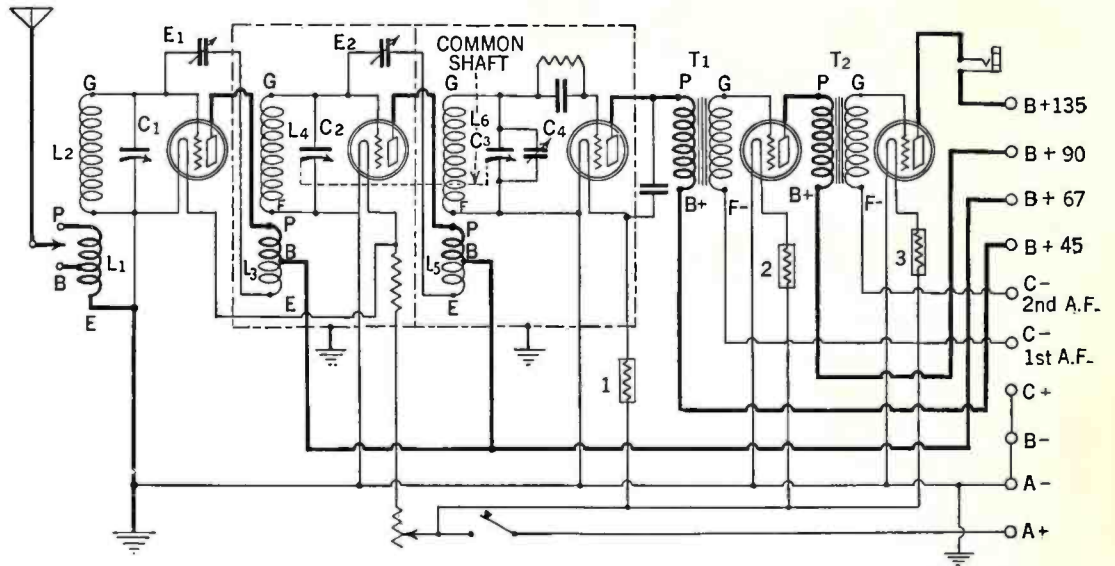

THE CIRCUIT DIAGRAM

Note that the grid return of the detector tube connects to the negative filament post. This is for a 200-A tube

1—Pair Sangamo Grid-Leak Clips	.10
1—Durham Metallized Resistor, 3 Megohms	.50
10—Eby Engraved Binding Posts	1.50
1—Hammarlund-Roberts Hi-Q Foundation Unit (Containing drilled and engraved Westinghouse Micarta panel, drilled Micarta sub-panel, two complete shields, two equalizers, extension shaft, resistance unit, wire, screws, nuts,	

and all special hardware required to complete receiver).	10.50
TOTAL	\$63.05

The above set of parts have been placed on the market in complete kit form at the price indicated at the foot of column of individual prices. A booklet, giving point to point connections, and many other useful data, has been published by Hammarlund-Roberts, Incorporated.

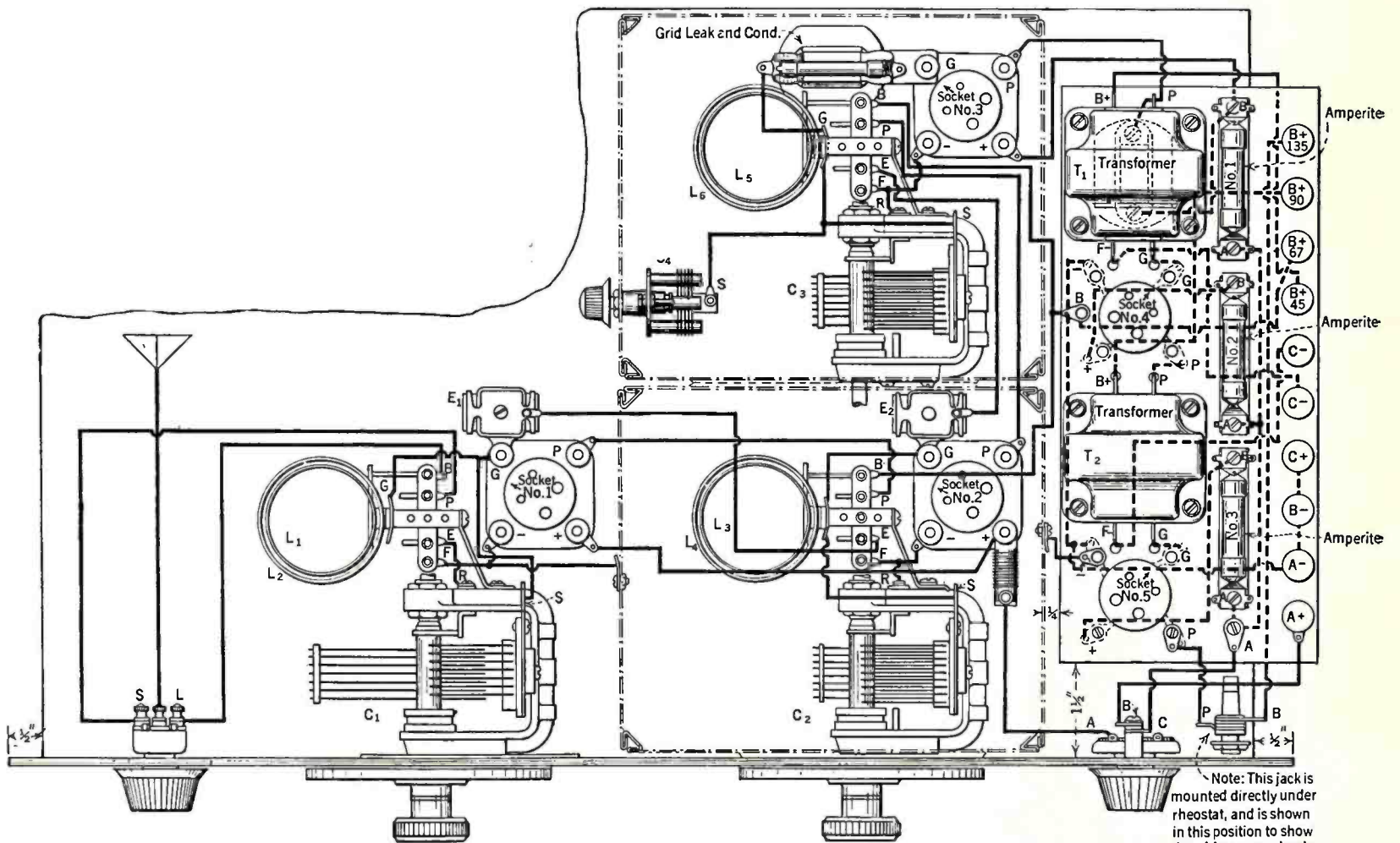

A PICTURE DIAGRAM OF THE THEORETICAL CIRCUIT SHOWN ABOVE

The dotted lines clearly show the position and arrangement of the two shields in both diagrams. The lettering on the coil units corresponds to that which will be found on the commercial units

AS THE BROADCASTER SEES IT

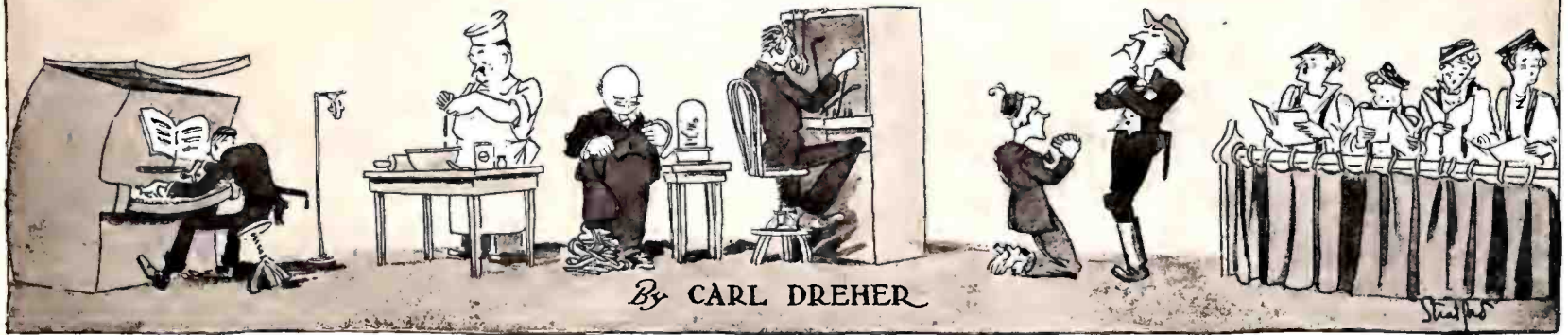

Why Censorship of Programs Is Unfortunate

IN 1923, the *New York Times* expressed the then-prevalent attitude of broadcasters toward controversial material in the following words:

"The radio audience is so large and represents such a varied interest that the censor must eliminate anything which might injure the sensibilities of those listening."

Of course if this idea were strictly followed nothing verbal could be broadcast, except the alphabet, market reports, and bedtime stories for children. If anything has been definitely established it is that some people can manage to be offended, no matter what precautions are taken to keep them happy. The lengths to which they will go, in an effort to find something to become sore about, are almost incredible. One such sufferer recently wrote to a newspaper protesting against the exhibition, in the New York Aquarium, of a jewfish and a porkfish, as a slur against the race of Israel. Maybe some humorist on the staff of the paper wrote the letter, but, if so, he did not carry the idea to a more absurd extreme than one sometimes finds in practice.

Since 1923 we have been getting away, to a great extent, from the idea of complete, meticulous inoffensiveness in broadcasting. It will take only a few more universal pannings like the one recently received by the British Broadcasting Company when it refused to broadcast George Bernard Shaw's birthday speech unless the author refrained from saying anything controversial, to bring about a sane attitude toward this problem.

The time of a broadcasting station is worth money, and not everyone can be allowed to broadcast. But when a man of admittedly distinguished sapience and eminent position is refused the privilege of talking to several hundred thousand people eager to hear him, simply on the ground that some listeners may not like his opinions, the situation becomes so absurd that all sensible people must feel the impulse to throw their radio sets out of the window.

Are robust, adult individuals, who want grown-up intellectual fare and can stand seeing others eat something they may not care for themselves, to be left out of consideration altogether? The timorous broadcasters who raise their hands in horror when some Brann of the ether wants to call a spade a spade make me, for one, rather tired. Is life worth living at all if one is always in a sweat about "adverse criticism" and a possible brick heaved through the window? It may be to the infirm and the aged, but surely broadcasting is not exclusively in the hands of valetudinarians. And, from the business standpoint, is there not as much danger in boring everyone with a respectable intelligence quotient, by radiating only what is dull and safe, as in taking a chance with the "Old Subscriber" and "Pro Bono Publico" class?

The present trend toward freer expression on the air will continue, I believe, until one can say in a broadcasting studio whatever is written by the editors of newspapers, or spoken by publicists, or printed in books. Those who do not like what is said by some speaker at some station will have to listen and make the best of it, or tune-in elsewhere, or retire to the Aleutian Islands, where the seals will not offend them with unwelcome ideas. Whatever problems are raised by a reasonable progress toward freedom of expression, whatever difficulties crop up, whatever the cost of that development, it is better to proceed resolutely than to be reduced to the ultimate absurdity of trying to please everyone in a world full of contention, competition, and diverse opinions. If broadcasting is to reflect life it must accept life.

Deterioration of a Word

IN THE popular lingo, the word "static" has come to mean simply "noise." Originally the term had a specific meaning in the radio field: disturbance in reception caused by natural electrical discharges. That was when radio still occupied her secluded niche in the temple of

technology. Then the saint was dragged forth into the market place, and worshipped the many in place of the few. The motley crowd that now pressed against her lacked the feeling for niceties in definition which had characterized the priests, and "static" came to be applied to any racket issuing from a loud speaker. Under this heading were crowded indiscriminately all the rich varieties of noises, natural and artificial, which radio is capable of producing. Finally, as a figure of speech, "static" was lifted out of radio altogether; the word is now mouthed along Broadway by every vaudeville comedian out of a job (or in the job when he has one), and his wit is copied by all the door-openers, taxi-drivers, and waitresses. Once a chaste and restricted expression, it now means anything and belongs to everybody. Once a problem which haunted the sleepless nights of great engineers, it now provides a derisive epithet for the countless thousands whose brains are never awake.

Concerning B. C. Operators

IF I may be permitted to intone an exhortation to my fellow knob-turners of the broadcast control rooms, it will be in the direction of urging them, one and all, to learn something about the quantitative side of what they are doing. Too many broadcast technicians, when asked how they would accomplish something or other in their business, answer in such phrases as the following: "You connect the line to a 77-Z amplifier and the output of that goes to a pad and from the pad you connect to a 23-X equalizer. Then you also have a 46-PQ monitoring amplifier and 199538-TT loud speaker." And they go on and on, telling how units are connected according to blueprints, without really knowing why and wherefore. The actual essential relations of the equipment, the operating boys tend to leave to the design engineers.

This is all wrong in a number of ways. Intricate equipment of the sort used in

broadcasting can only be intelligently operated by men who know the design background. They need not be conversant with all the factors which agitate and perplex the design man, but they must know something about the quantitative conditions of the final product, or they might as well yield their places to stenographers. Many an intelligent girl who serves industry for \$30 per week could be trained to operate a broadcast station when it is running right, quite as well as some of the operators who think in terms of type numbers and add a smattering of badly sent Morse to this talent. In science and technology, you know nothing unless your knowledge is in quantitative form. Those individuals who stop with clamping wires under nuts will keep right on doing so until they become too old to read the inscriptions next to the binding posts. Progress is limited to those who know a little more than they must know in order to keep the station on the air. The robots aforementioned may be usable in some industries, but I predict that their days in broadcasting are numbered. Twice a year enterprising young men swarm forth out of the high schools and colleges, and some of them head for the broadcasting stations. They radiate question marks, and think in terms of TU's, rotating vectors, and integrals. What chance has a poor wireless operator against them? A lot, I venture to answer, if . . . if he spends a few hours a week reading the proceedings of the engineering societies, the technical telephone reviews, and the like. None at all, if he devotes those hours to rolling the bones and perusing the fifteen-cent fiction weeklies. Let the boys think it over before they find themselves back in the mess-rooms of 3000-ton freighters, with the bright lights and liberty far, far away across a tossing horizon.

Technical Notes of Interest to Broadcasters

WORLD RADIO for July 30, 1926, contains a brief description of "A New Microphone," forwarded by the Riga correspondent of the publication. It is the invention of a Russian professor, M. Bonch-Bruievich, who explains that it consists of "an extremely fine membrane between two perforated condenser plates. The plates are charged with a constant high-tension current, and the membrane is connected to the grid of the valve. In order to secure the best results, it is necessary to have a special amplifier which amplifies the highest notes more than the low ones." This is, of course, a characteristic of electrostatic transmitters in general, of which this is a special form. From an accompanying photograph it appears that this condenser transmitter is three or four times as large as American types. Presumably the object of placing the dia-

phragm between two plates, instead of adjacent to one only, is to secure a greater variation in capacity and to generate a higher audio e.m.f., by utilizing a push-pull principle. As the diaphragm withdraws from one plate, it approaches the other, decreasing the capacity in the first space and increasing it in the other; both of these changes may be used to generate an audio potential, and by suitable connections these potentials may be added. This theory of operation is not part of the short article in *World Radio*, and may be far from the mark. In any case, the constructional complications of Prof. Bonch-Bruievich's double condenser transmitter must be serious, and only very marked electrical advantages could outweigh this fault in actual broadcast service.

A NEW BOOK ON SOUND

WITHOUT having seen a copy, I venture to say that I. B. Crandall's new book, *Vibrating Systems and Sound* (Van Nostrand & Co.), will contain much material of interest to technical broadcasters. The author is a well-known investigator in the field of electrical sound measurements, and some of his results in the Bell Telephone Laboratories have attracted wide attention among physicists and telephone engineers.

J. E. JENKINS and S. E. Adair, of 1500 N. Dearborn Parkway, Chicago, issue a *Bulletin No. 1*, describing audio frequency apparatus in the line of microphone, output, input, and interstage transformers, as well as choke coils for audio circuits. The diagrams shown are of interest to broadcast operators.

TO BE PASTED ON THE WALL

HANDY figures to remember in telephone calculations:

The average power of speech is 125 ergs per second. Inasmuch as 10^7 ergs per second correspond to one watt, 10 ergs per second are equivalent to one microwatt, and the energy of speech is of the order of 12.5 microwatts

Inasmuch as even with close talking only a portion of the total energy emitted by a speaker is absorbed by the microphone, the speech input to a telephone system is of the order of 1-10 microwatts.

A commercial telephone transmitter, being resonant to the mean speech frequency, amplifies the sound input by about 1000 times, corresponding to a gain of 30 TU's. The electrical output is therefore 1000-10,000 microwatts, or 0.001 to 0.01 watt (zero level).

A high quality carbon transmitter, with its vibrating system tuned to a frequency well above the ordinary speech band, lacks the amplifying qualities of the commercial microphone. It is about one one-thousandth as sensitive as the latter, corresponding to a level 30 TU's "down" (below zero level).

A normal high-quality condenser transmitter is down another 30 TU's approximately, and its energy output is therefore of the order of 0.01 microwatt with normal speech inputs.

In converting power ratios to gain or loss in TU's, it follows from the formula.

$$TU = 10 \log_{10} P$$

where P is the power ratio, that a TU of 10 corresponds to a power ratio of 10, a TU of 20 to a power ratio of 100, a TU of 30 to a power ratio of 1000, etc., since the logarithm to the base 10 of 10 is 1, that of 100 is 2, that of 1000 is 3, etc. Multiplying the power by 10 always indicates an addition of 10 TU's to the level; dividing the power by 10 requires subtracting 10 TU's. Since the voltage amplification ratio (if the impedance remains unchanged) is the square root of the power ratio, TU's corresponding to various voltage amplifications are also readily calculated mentally. For example, a TU of 20 corresponds to a voltage amplification of 10, a TU of 40 corresponds to a voltage amplification of 100, etc. Various other relationships may be worked out; some of these have been given in the "Technical Operation of Broadcasting Stations" articles in this department.

The usual gain of a telephone repeater is of the order of 25 TU's.

Broadcast telephone circuits are limited to inputs varying from zero level to plus 8 TU's to avoid crosstalk into parallel circuits.

Radio and Swinging Fists

BEFORE the government took charge of radio, back in 1912, resorts to the manly art, as a means of settling QRM disputes, were not uncommon. Insults and challenges were conveniently dispatched through the air, and actual hostilities sometimes followed. In other cases the prospective candidates for slaughter met as agreed, after threatening each other in astounding terms via Continental Morse, only to find, face to face, that they were both pretty decent fellows. The pro-

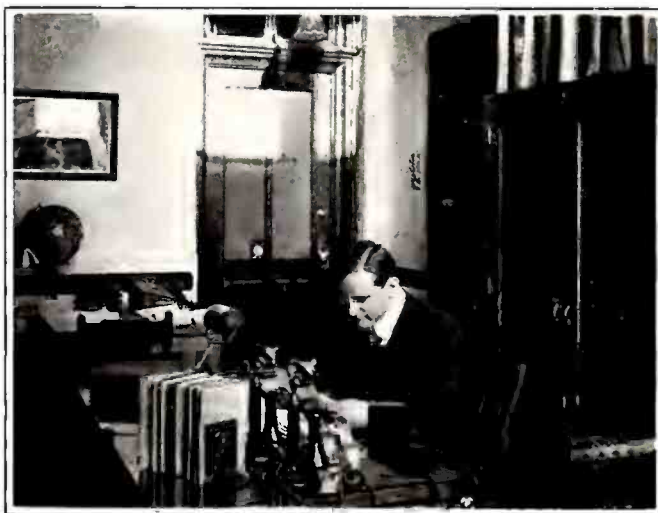

DR. ALFRED N. GOLDSMITH

Who gave a radio course at the College of the City of New York during the period from 1913 to 1918. He is now chief broadcast engineer of the Radio Corporation of America

cedure was then to adjourn to the nearest saloon (there were saloons in those days) and to swap radio lies over the bar. Nevertheless, some eyes were blackened, and a certain amount of blood-letting undoubtedly occurred, in the primitive days of radio. The general opinion among the old-timers sucked into the whirlpool of broadcasting has been that the latter is an effete art, and many of them bewail the passing of the day when sopranos were unknown on the air and nothing could be heard but curt masculine dots and dashes.

This notion must now be revised. Reports come from Dortmund, in Westphalia, Prussia, that some months ago an altercation occurred at the local broadcast studio, as a result of which the director thereof was fined three hundred marks and costs. It seems that a humorist holding forth before the microphone included in his repertory an anecdote calculated to imperil the morals of the devout Westphalians. The program director of the station, his hair on fire, rushed into the studio and remonstrated with the artist, if we may call him such. He remonstrated, apparently, with his fists. It would have saved him some money if he had directed his fleet footsteps toward the control room and persuaded the operator to pull the switch and take the offending monologist off the air.

Clearly, however, fights are still possible in radio, and the old-timers should not despair. If they live long enough they may see a few homicides under the antennas yet.

The "Lightning Jerker"

THE *Lightning Jerker* is a magazine devoted entirely to the interests of the professional radio operator. The editor is R. E. Nelson, and the office of publication 1110 Capitol Bldg., Chicago, Illinois. As far as size goes, the *Lightning Jerker* is nothing more than a pamphlet, but what it lacks in thickness it makes up in lucid, enlightening discussion of the professional radio operator's problems. These problems are concrete enough, and there is nothing pedantic or windy about the solutions of the operator-editors of the paper. Mainly devoted to marine radio at present, it is desirous of including B.C. men on its subscription list. They would do a lot better reading it than poring over the columns of *Hot Hound* or *Stupid Stories*.

Abstract of Technical Article

ABSTRACT OF "ANALYSIS OF THE ENERGY DISTRIBUTION IN SPEECH," by I. B. Crandall

and D. MacKenzie, *Physical Review*, Series 2, Vol. XIX, No. 3, March, 1922.

THIS paper is of interest to broadcasters, not only because of the practical significance of its conclusions, but as an illustration of the type of acoustic research on which the technique of modern broadcasting rests to a great extent.

The object of the research in this case was to determine the energy distribution of speech with respect to frequency, to find out, that is, whether high or low tones carried the energy, and to what extent. The method used is shown in Fig. 1. Here we have a condenser transmitter of the type described by Wente in the *Physical Review*, Vol. XIX, No. 5, May, 1922. (See "Technical Operation of Broadcasting Stations—No. 13." The Condenser Transmitter, RADIO BROADCAST, December, 1926), feeding into its associated amplifier, which in this case has three resistance-coupled stages. The output of this amplifier is divided between the halves of a special "twin amplifier"—but the twins in this instance are not alike; the functioning of the apparatus, in fact, depends on the difference between them. The lower stage is untuned and therefore transmits the full electrical response of the system, through an 11:1 stepdown transformer to a thermocouple and microammeter. The upper stage is tunable to any frequency within the speech range by variation of the condenser and inductometer in the circuit, and passes only a narrow band of frequencies, the energy of which may be measured on an identical thermocouple-microammeter combination. It is therefore possible to determine what percentage of the full energy of the voice of an observer speaking to the condenser transmitter resides in any particular band of audio frequencies.

The method used by Crandall and MacKenzie involved noting the deflections of the two instruments for a 50-syllable sentence of connected speech, and also for a list of 50 disconnected syllables. There were six speakers, four men and two women. The total number of observations was 13,800. The successive syllables were

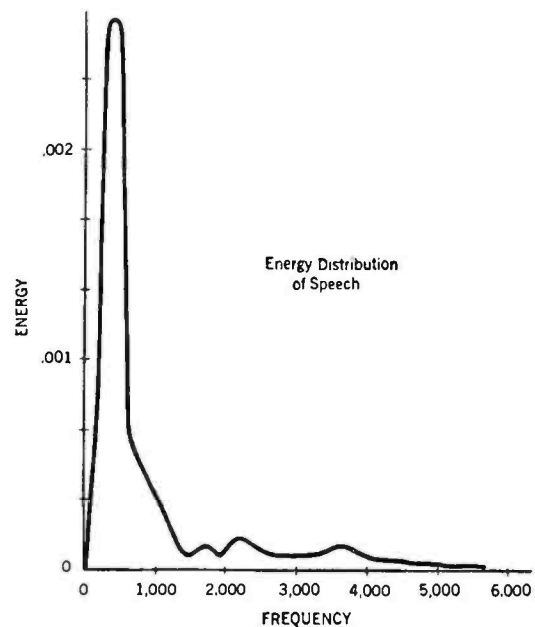

FIG. 2

pronounced slowly, and the microammeter deflection read in each case.

Numerous secondary measurements were made for the purpose of calibration, and to correct for the internal characteristics of portions of the apparatus. The relation of the unmodified output of the untuned half of the twin amplifier, to the initial input, was known in all portions of the speech range. The damping of the series resonant circuit was chosen for sufficient resolving power and energy-sensitiveness over the speech range. The centers of the frequency bands measured were at 75, 100, 200, 300, 400 to 3200 by steps of 200; 3500, 4000, 4500, 5000 cycles per second. Beyond 5000 cycles, the energy was too low to be measured. There were 23 frequency settings in all. With corrections for varying volume, varying area of tuned circuit response curves, and varying frequency sensitivity of the equipment, the over-all error of the measurements was estimated as about 5 per cent.

The result of the 13,800 measurements is shown in Fig. 2, which is a composite curve of energy distribution against frequency, for all the voices tested. This curve shows that the energy of speech is concentrated at the lower frequencies, with a peak at about 200 cycles. The peak for male voices is about 100 cycles below that of female voices; the shape of the curves is similar. Most of the energy of the voice is below 1000 cycles, and, it may be added, most of it is carried by the vowel sounds. When it comes to articulation, however, the higher frequencies are exceedingly important. This field was not entered by the au-

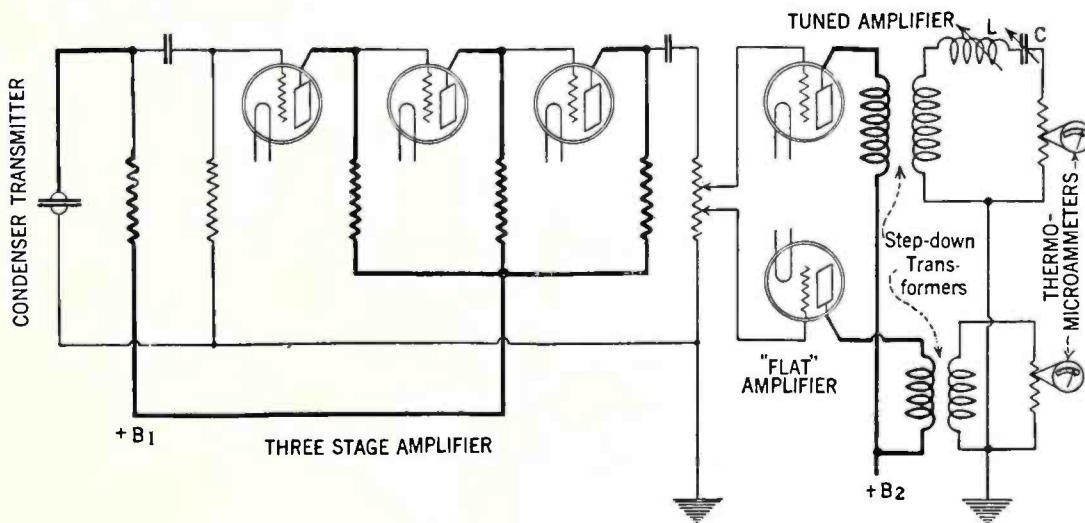

FIG. 1

thors of the paper now under discussion, and may best be reserved for a later abstract.

It should be noted that these results hold for the "frequency distribution of energy in speech in terms of the mechanical energy of a more or less ideal transmitter diaphragm." This follows from the fact that one source of error in the experiment cannot be eliminated. At audio frequencies, the wavelength is short and comparable with the diameter of the transmitter, with consequent inequalities in reflection at the various frequencies. There are standing wave effects in the space between the speaker's mouth and the transmitter. Thus the work of Crandall and MacKenzie is only roughly valid for the absolute energy distribution of the voice; it is strictly true (within the known limits of error of the tests) rather for the voice considered as a part of a telephone system. Since the telephone system used in the work described was substantially that of a broadcast station of the present day, the results hold closely for broadcast systems, although the tests and publication antedated the main development of broadcasting and the job was done by men connected with the wire telephone business.

The judicious broadcast technician will not require much interpretation of the conclusion to be drawn from the curve of Fig. 1. He already knows that amplifier overloading is most apt to occur at the low frequencies.

Latest Scientific Marvel of the A. P.

THE heading of a boxed article in the *New York Times* for September 20, 1926, is "Dancers Are 'Receiving Sets'; No One Else Hears Radio Music." The text reads as follows:

BERKHAMPTSTEAD, ENGLAND, Sept. 19 (AP).—At a hotel dance here last evening twenty couples danced to radio music which could not be heard by the spectators. The dancers were all their own receiving sets and wore inconspicuous headphones.

The sight of the folks dancing looked almost mad to all who did not know of the experiment being tested by scientists who had worked on the problem for three years.

If this stunt is an invention, then the production of fireproof chewing gum would be an invention. If it takes a scientist three years to evolve a capacitive pick-up for forty pairs of headphones, then my iceman is a scientist. If it is news, then Mr. Hugo Gernsback's demonstration of the same magic (See *Radio News* for February, 1926) should have been headlined in 60-point type at the very least.

Technique of Field Operation

GRAPHIC description of prompt action to meet an emergency in field broadcasting, culled from the log of Mr. James Foreman at wjz:

Clipped one announcement of Olsen's off air when a stew made a dive for mic to greet his beloved.



MR. JULIUS WEINBERGER

A graduate of Doctor Goldsmith's course of 1913, who later became associated with him in conducting the radio course at the College of the City of New York, Mr. Weinberg is now a development engineer in the Radio Corporation

This, incidentally, is not altogether funny. The fact is that out of three or four dance hours broadcast by a metropolitan station, at least one will show such an experience. One of the merrymakers, generally with more cubic centimeters of al-

cohol under his belt than he was built to hold in a seemly manner, approaches the microphone in his cavortings and, suddenly, there bursts on his whirling brain the effulgent idea of talking to his dear ones far away. Why not, especially as the service is free? What else is radio for? So he yells his message, usually something on the order of "Hello, Shylvia!" into the transmitter. Unless the field operator happens to see him make his approach, the clown gets away with this much, for even the best radio man's reaction time is slightly more than two words in length. But further communications are lost to the world, for the operator throws the line key off, while his assistant rushes out from behind the palms, sometimes taking one with him as a suitable weapon, designed for this purpose by nature, if not by the hotel management. With the retreat of the impromptu broadcaster, the engagement generally ends, and the amplifier goes back on the air. The gap remains, and must be explained, as the sample above shows.

Memoirs of a Radio Engineer

XVI

I HAVE mentioned previously, in this series, the radio course given at the College of the City of New York by Prof. Alfred N. Goldsmith, during the years 1913-1918. My turn to take this



RIGHT
The printing telegraph set-up at the College of the City of New York

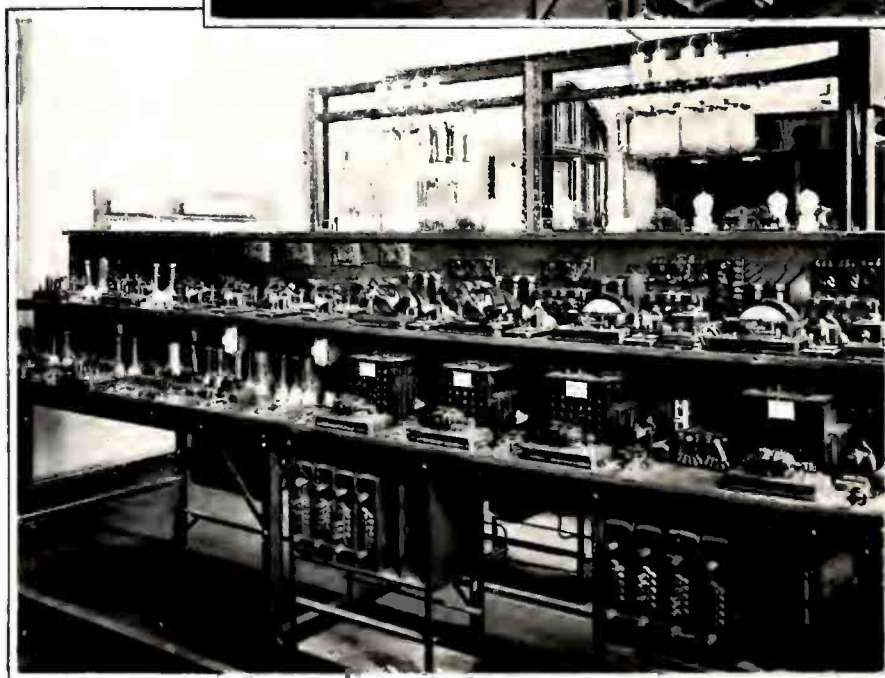

LEFT
The telegraph and telephone laboratory of the College of the City of New York in 1917

course came in 1917. My classmates were Maurice Buchbinder, Jesse Martsten, Herbert Kayser, and Joseph D. R. Freed.

In the same year, before the college sessions began, Julius Weinberger, a graduate of the course and the College in 1913, became associated with Doctor Goldsmith. Mr. Weinberger spent about a year, after his graduation, in civil engineering, followed by three years in the radio laboratory of the Bureau of Standards in Washington. The radio course (Physics 90-91) as given in 1917, included a Saturday morning laboratory period, under the supervision of Mr. Weinberger. Both Doctor Goldsmith and Mr. Weinberger corrected the students' reports, which were quite voluminous, some of my own running to twenty closely written pages. Doctor Goldsmith gave two lecture hours a week to the class of five men, and devoted as much time as he could to the laboratory work. The apparatus consisted of regulation commercial transmitting and receiving equipment, measuring instruments, both domestic and foreign, and the necessary electric power machinery, switchboards, etc. Before starting on the experiment, the students, who generally worked in squads of two, had considerable reading and theoretical preparation to go through with. The report normally started with a dissertation on theory, then a description of the apparatus, connection diagrams, and procedure; tables of observations; computations; and final numerical results.

A sample page of one of my reports is shown herewith. It shows the diagram of connections of a Bergmann Electricitäts Werke arc. But by far the best reports in the class were those of Joseph Freed. The calligraphy, arrangement, and lucidity of description were incomparable. All of us spent a great deal of time on these write-ups. I know I devoted as much time to my radio work as to all my other courses combined, and I believe this was the general rule among the small groups of students who elected the radio course.

The corrections of Doctor Goldsmith and Mr. Weinberger were made in red ink, frequently mixed with a justified quantity of scientific venom. These were the final polishing touches of engineering instruction, after the rough cuts had been made by Professor Parmly and the other instructors in previous technological courses. When a portion of a diagram was not clearly marked, a question, like "Range?" was sure to be found appended in red ink when the report once more reached the student's hands. Excess significant figures were stricken out. Various qualifying phrases and corrections of dubious reasoning were inserted. At times I dragged into my reports various *obiter dicta* and slightly facetious remarks, which were frowned upon by Doctor Goldsmith when they occurred in formal reports. In a report on "Detectors; Operating and Electrical Characteristics," I remarked, "One of Austin's early combinations was tellurium-silicon, and it is rediscovered every year, if not

every month, by amateur investigators, the discovery being made public in a magazine on each occasion." In the margin, in Doctor Goldsmith's handwriting, there appears the remark, "A sad truth of *no scientific interest.*" In the same folder I wrote about a detector stand whose construction did not meet my august approval, "With the removal of the crystal it might, however, make a good spark gap." To this wise crack the Doctor appended a "No," underlined three times, indicating a degree of irritation. This squelched me for a while, but in a later experiment I said of a Rendahl variometer, "Its operation is readily understood if sufficient diagrams, with arrows, be drawn." This witticism Professor Goldsmith deleted, adding a marginal rebuke, "Draw them, or else eliminate the statement. Be more businesslike in the general tone of reports." Weinberger also paddled me occasionally, generally in the form of flat

contradictions of my most assured statements. I wrote, "The calibration curve of this condenser is linear, *of course . . .*" The underlining was Mr. Weinberger's, and he added dryly, "Usually a rare occurrence." When I complained piteously, "owing to the difficulty of handling the cubic equation, Eccles' formula was not used in calculating," J. W., with characteristic directness and practicality, advised me, "Look up, on page 100 of *Machinery's Handbook* methods of solving cubic equations."

There was nothing academic about that radio course, and most of the things we learned there remain applicable ten years later. There is the case in which I reported, "The measured capacity of the small mica condenser does not accord with the marked capacity by over 10,000 cms. Which is wrong?" Doctor Goldsmith answered, "Measured values *always* take precedence over manufacturer's labels."

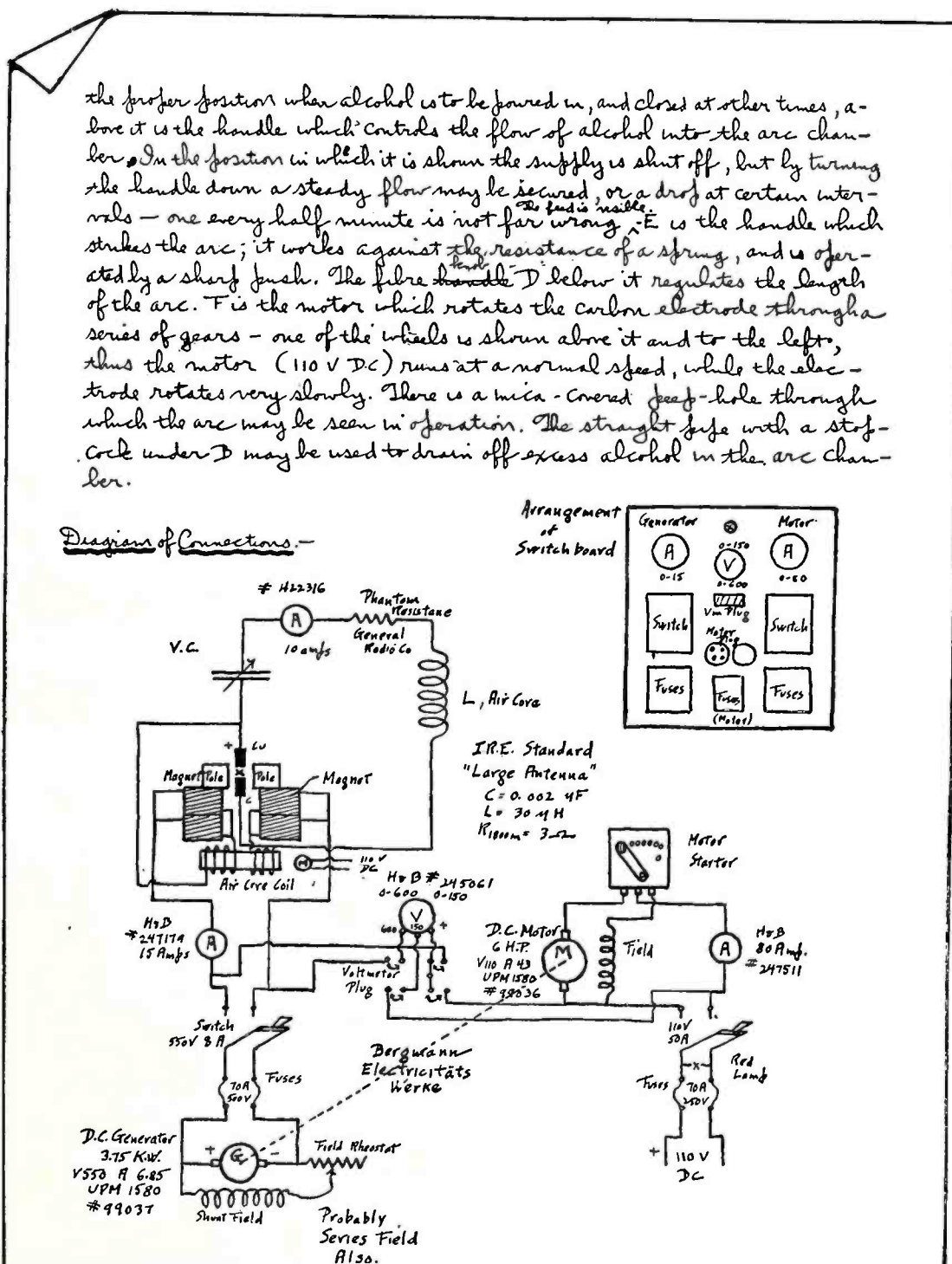

A PAGE FROM MR. DREHER'S LABORATORY NOTEBOOK—A. D. 1917



1

NEW APPARATUS

Equipment of the Radio Industry
Submitted to the Radio Broadcast
Laboratory for Test and Inspection

RADIO BROADCAST Photographs



2



4



3

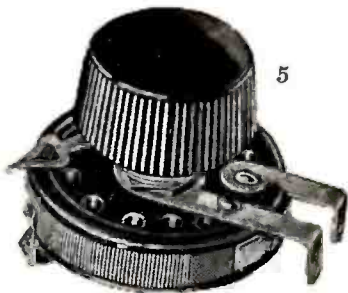

5



7



8



9

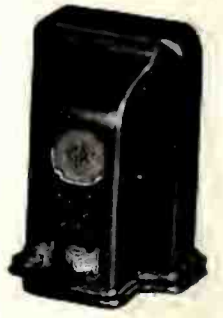

10

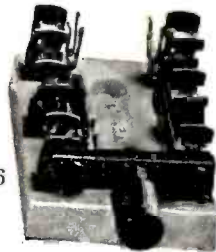

6

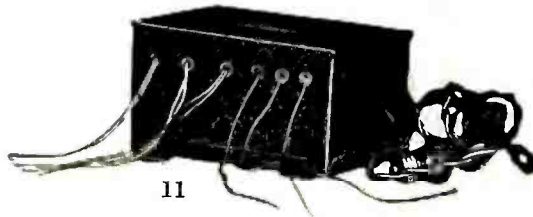

11



12

No.	NAME OF APPARATUS	MANUFACTURER	USE OF PRODUCT	PRICE	REMARKS
1.	Marie Louise Console Cabinet	Knickerbocker Talking Machine Co., 831 B'way, N. Y. C.	Decorative housing for radio receiver and accessory equipment.	\$275.00	A beautiful <i>objet d'art</i> from an excellent cabinet maker. Will accommodate such receivers as the Atwater Kent Nos. 20, 30, and 32.
2.	"Metrodyne" Receiver	Metro Elec. Co., 2161 North California Ave., Chicago, Ill.	Broadcast reception.	\$48.50	A six-tube receiver producing good quality.
3.	Loop, "Volumax"	Weber Elec., 4527 Broadview Rd., Cleveland, Ohio.	Signal pick-up device.	\$14.50	An unusual loop that has proved a very efficient collector.
4.	Resistor Unit	Amsco Products Inc., 416 Broome St., N. Y. C.	For use in voltage supply devices, etc.	\$0.65	Guaranteed accurately rated within five per cent. on either side of rated value.
5.	Rheostat	Amsco Products Inc., 416 Broome St., N. Y. C.	Regulates current and voltage supplied to filaments of tubes.	\$0.75	A compact rheostat having an air-cooled resistance unit.
6.	Double-Pole Double-Throw Switch	Fahnestock Elec. Co., East Ave. and 8th St., Long Island City	General use in battery charging and other circuits.	\$0.75	A throw-over switch provided with Fahnestock clip connectors.
7.	Audio Transformer, "Symphonic"	Samson Elec. Co., Canton, Mass.	Amplifier of audio frequencies.	\$9.00	Turns ratio 3.25 to 1.
8.	Audio Transformer, No. R200	Thordarson Elec. Mfg. Co., 500 W. Huron St., Chicago, Ill.	Amplifier of audio frequencies.	\$8.00	Turns ratio 2.3 to 1.
9.	Line Protector	Precise Mfg. Corp., 254 Mill St., Rochester, N. Y.	Automatic overload relay for use in A-battery circuits.	\$3.75	Opens battery circuit in case of accidental short circuits.
10.	Output Transformer	General Radio Co., Cambridge, Mass.	Coupling device between last audio stage and loud speaker.	\$5.00	Same physical dimension as regular G. R. audio transformer. Turns ratio 1 to 1.
11.	B-Power Unit	Dongan Elec. Co., 2991 Franklin St., Detroit, Mich.	Supplies plate potential to all tubes of the radio receiver.	\$17.50	Combined line transformer, condenser block, and filter choke for use in power supply circuit, employing a 216-B tube.
12.	Wall Plug Units	Yaxley Mfg. Co., 9 S. Clinton St., Chicago, Ill.	Wall outlets for connecting batteries, etc., to the receiver.	\$1.00 \$2.50 \$4.50	(1) Antenna and ground connections; (2) Battery plug and receptacle; (3) Antenna and ground jacks, and battery plug and receptacle.



13



14

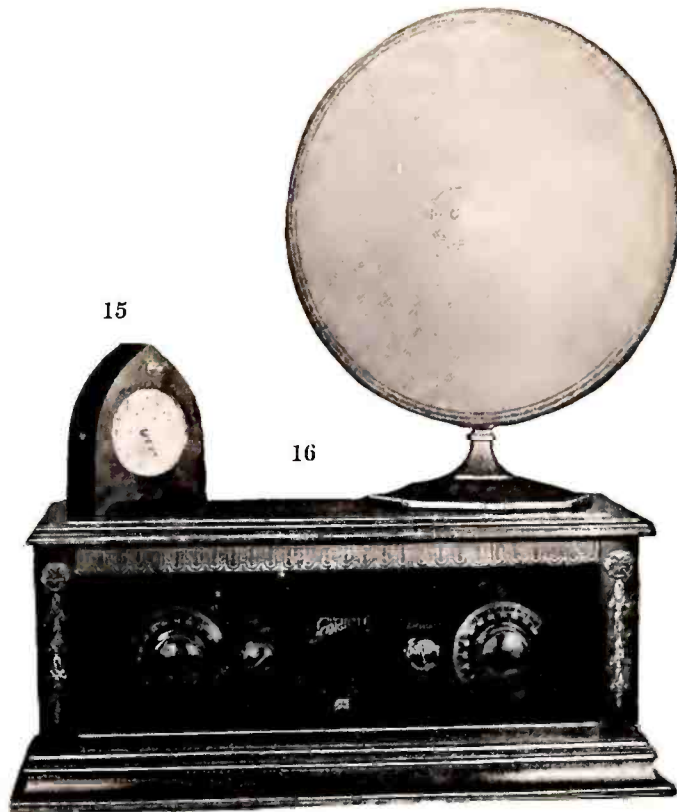

15

16

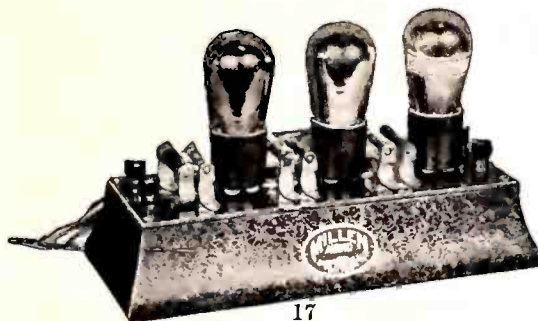

17



19



20

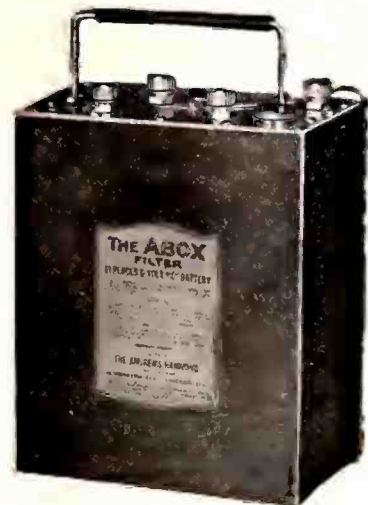

18

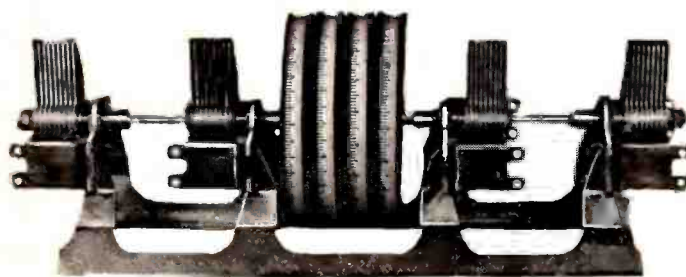

21



22

NO.	NAME OF APPARATUS	MANUFACTURER	USE OF PRODUCT	PRICE	REMARKS
13.	Voltage Supply Device	Cornell Mfg. Co., Lawson and Annabelle Sts., Long Island City, N. Y.	Supplies voltage to all tubes of the radio receiver.	\$39.50 \$49.00	Type B (\$39.50) supplies only B potential while type CB (\$49.00) supplies B and C voltages. A Raytheon tube is employed.
14.	Dual Condenser	Bruno Radio Corp., 23rd and 4th Ave., Long Island City, N. Y.	Capacity element for tuning circuit of receiver.	\$11.00	Consists of a pair of "ganged" condensers for the simultaneous tuning of two matched circuits.
15.	"Radiolarm" Clock	Herbert M. Hill, 117 Highwood Ave., Leonia, N. J.	Combined clock and filament switch for turning on and off receiver at prearranged times.	\$9.00	Gets you up for the early morning gymnastics!
16.	"Oriole" Radio Receiver	W-K Elec. Co., Kenosha, Wisc.	Broadcast reception.	\$125.00	A high class Six-tube receiver employing the "Tri-num" circuit.
17.	Unit Audio Amplifier	Jas. Millen, Inc., 105 Fifth Ave., N. Y. C.	Complete audio unit for attachment to output of detector circuit for reproduction of broadcast programs.	\$25.00	Resistance-impedance-coupled amplifier with tone filter.
18.	A Battery Filter	The Abox Co., 215 North Michigan Ave., Chicago, Ill.	Filter device, for use with an A-battery charger.	\$19.50	Does away with the A battery, furnishing A current directly from the charger.
19.	Audio Transformer, AF3	Ferranti Ltd., 130 W. 42nd St., N. Y. C.	Amplifier of audio frequencies.	\$12.00	Turns ratio, 3.5-1.
20.	Tuner Coils	Aero Products, Inc., 1772 Wilson Ave., Chicago, Ill.	Inductance units for use in short-wave tuning circuits.	\$12.50 a set	Low loss inductances for short-wave sets. The coils are also obtainable for use in tuned radio frequency sets for use on the broadcast band.
21.	Gang Condenser	Alden Mfg. Co., 52 Willow St., Springfield, Mass.	"Gang" capacity element for use in multiple tuner circuit.	\$15.00	The four condensers may be turned simultaneously by the pressure of three fingers on the milled edges of the dials.
22.	Radio Receiver	J. B. Ferguson, Inc., 532 Pierce Ave., Long Island City, N. Y.	For broadcast reception.	\$75.00	A six-tube shielded receiver of excellent sensitivity and good quality output.

The Rola Pedestal Reproducer, listed as item 15 on page 49 of the New Apparatus pages of RADIO BROADCAST for November, 1926, now sells for \$36 instead of \$45 as listed then

A Combined Amplifier and A.C. Operated Power-Supply Unit

A Unit Comprising a High-Quality Three-Stage Amplifier with Power Tube, Using the Mains as a Source of B Power Supply—A and C Potentials for the Output Tube Also Obtained from the Same Source

By JAMES MILLEN



FIG. 1

This is the two-tube R. B. "Lab" Receiver. Used in conjunction with the line power-supply device described in this article, very excellent results are obtainable. The receiver may be connected to the power supply by a cable, such as that shown tapering off to the left of this page, which indicates connection to the unit at the bottom of the page. The loud speaker is one of the large size Western Electric cones. Compare this photographic layout with Fig. 7 on page 288

ONE of the essentials for good quality in audio frequency amplification is the use of a power or semi-power tube in the output stage. The use of such a tube, in turn, requires high B and C voltages. While such voltages may readily be obtained from B batteries, it is more economical, due to the high plate current drawn by the power tube, to employ a device which supplies these voltages from the house lighting system. A unit of this type, in addition to supplying the necessary B potentials for all the tubes of the receiver, may be combined with an audio amplifier and can be designed to supply A and C potentials for an incorporated output stage power tube.

The tendency in modern radio receiver design is to separate the r.f. and detector end of a radio receiving set from the audio amplifier end. There are several very excellent reasons for such practice, but perhaps one of the most outstanding is that, having a good audio amplifier, a number of different sets and circuits may be built and experimented with, without the necessity of duplicating the rather expensive audio amplifier. Then, again, the audio amplifier, if a separate unit, may be located down in the cellar or some other out of the way place, along with the associated power supply, whether of the battery or lamp socket variety, while only a small and compact unit, comprising the r. f. and detector circuits, need be placed on the living room table.

A third reason, which is rapidly becoming

important, is the use to which a separate audio amplifier may be put in connection with the "rejuvenation" of the old type phonograph and its "Panatrop" variety. More will be said of this latter use in RADIO BROADCAST in the very near future.

It is the purpose of this article to describe a combined power-supply device, powered by the a. c. house lighting system and high quality audio amplifier which may be wired by the most inexpert from an assembled kit of parts now available on the market. The audio amplifier part of this unit is designed for connection to the output of a detector tube. The majority of commercial units of this type have included merely a single stage (a power stage) of audio amplification, it being necessary to utilize the first stage of audio in the receiver proper in combination with the unit.

Many fans possessing old sets, overlooking the fact that even the first stage of audio frequency amplification in a receiver is capable of delivering quite distorted signals, have looked upon a power amplifier unit as a panacea for the poor quality signals they are receiving, and after purchasing an expensive unit, have been disappointed with the result obtained by connecting it to the output of an existing single stage of audio amplification.

The assembly described here, and designed by the author, is connected directly in the plate

circuit of a detector tube, which may be preceded by the usual stage, or stages, of r. f. amplification.

Three stages of audio amplification are incorporated in this unit. The first is impedance-coupled; the second and third, resistance-coupled. The fourth socket in the amplifier-power supply device is for the Raytheon rectifier tube. The output power tube, preferably an UX-171, has a plate potential of approximately 200 volts, which is supplied through the transformer, and a grid bias of about fifty volts.

Though there are any number of different ways in which an amplifier and B power unit may be mounted, one of the most practical, and

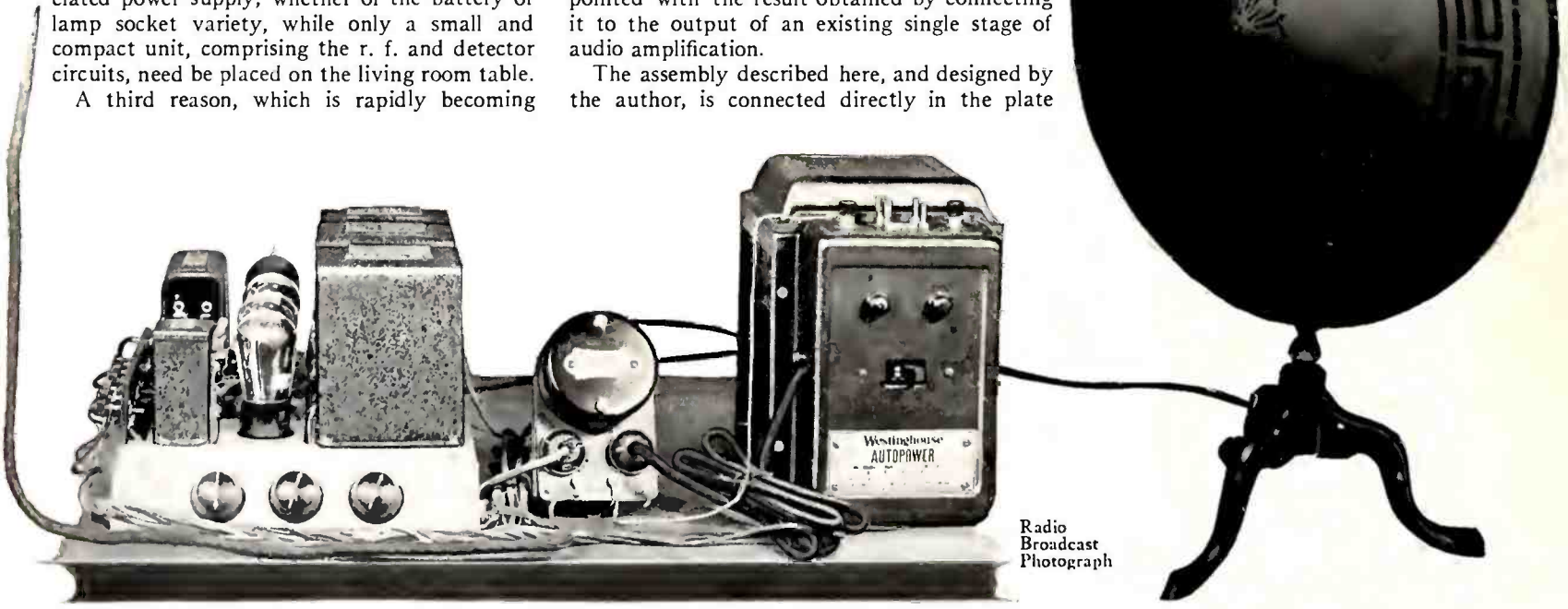

Radio Broadcast Photograph

at the same time the neatest and least expensive, when a kit of parts is to be purchased, is on a cast iron hollow base, such as is used in the unit shown in the lower picture of Fig. 1 and elsewhere. All the wiring may be run under the base so as to enhance the appearance of the completed unit. The controls may be mounted on one of the sides, and a number of the small parts, such as bypass condensers and fixed resistors, can be placed out of sight. Mechanically, the cast metal base is a substantial piece of apparatus which will withstand a great deal of abuse, while, electrically, the all-metal construction results in the effective shielding of the various parts as well as the complete unit.

THE POWER AMPLIFIER

THE last stage of amplification in the modern high quality amplifier must be of the so-called power or semi-power type. It takes energy to bring out the low notes, and only an amplifier that is capable of feeding some real energy into a loud speaker is capable of properly reproducing the low notes.

Tube overloading is the most common cause of distortion, and the only practical way to prevent tube overloading is to use a semi-power tube with a high C voltage and the corresponding B voltage.

Of all the different power and semi-power tubes available to the radio public at this time, the UX-171 is by far the most sensible tube for use in obtaining quality amplification in connection with the home radio set.

This tube does not require the very high plate voltages needed for the UX-210, and at the same time, due to its lower plate impedance, results in better tone quality when used with speakers of the Western Electric 540 AW type. It is not possible to get anywhere near as much volume, without distortion due to overloading, from the 112 as with the 171.

As an UX-171 tube is employed in the final or power stage, an output device is essential for the protection of the loud speaker. In the unit described, a tone filter is employed in the output. It consists of a 30-henry inductance and a 4-mfd. condenser mounted in a compact container with suitable terminals. Aside from serving as a protective device, the output filter results in improved tone quality and more stable operation of the amplifier in bypassing the audio frequency current in the plate circuit of the last tube around the otherwise common plate impedance (the 8-mfd. filter condenser) of the power supply device.

THE AMPLIFIER

IN THE amplifier, by which is meant those two tubes preceding the power stage, at least two good reasons are responsible for the use of the impedance-coupled first stage rather than a resistance-coupled one. The first reason for using the Impedaformer in place of a resistance input unit, is so that provision is made for the use of one of the new detector tubes recently placed on the radio market, if the constructor so desires. These tubes draw considerably more plate current than the UX-201-A tubes. In fact when operated at 90 volts, as recommended by some tube manufacturers, the plate current of a special detector tube may be as much as six milliamperes. The normal plate current of a UX-201-A type tube, when used as a detector, is nearer one milliampere. Even the new metallized filament coupling resistors (0.1 meg.) will not safely carry over two milliamperes. The Impedaformer will, however, safely

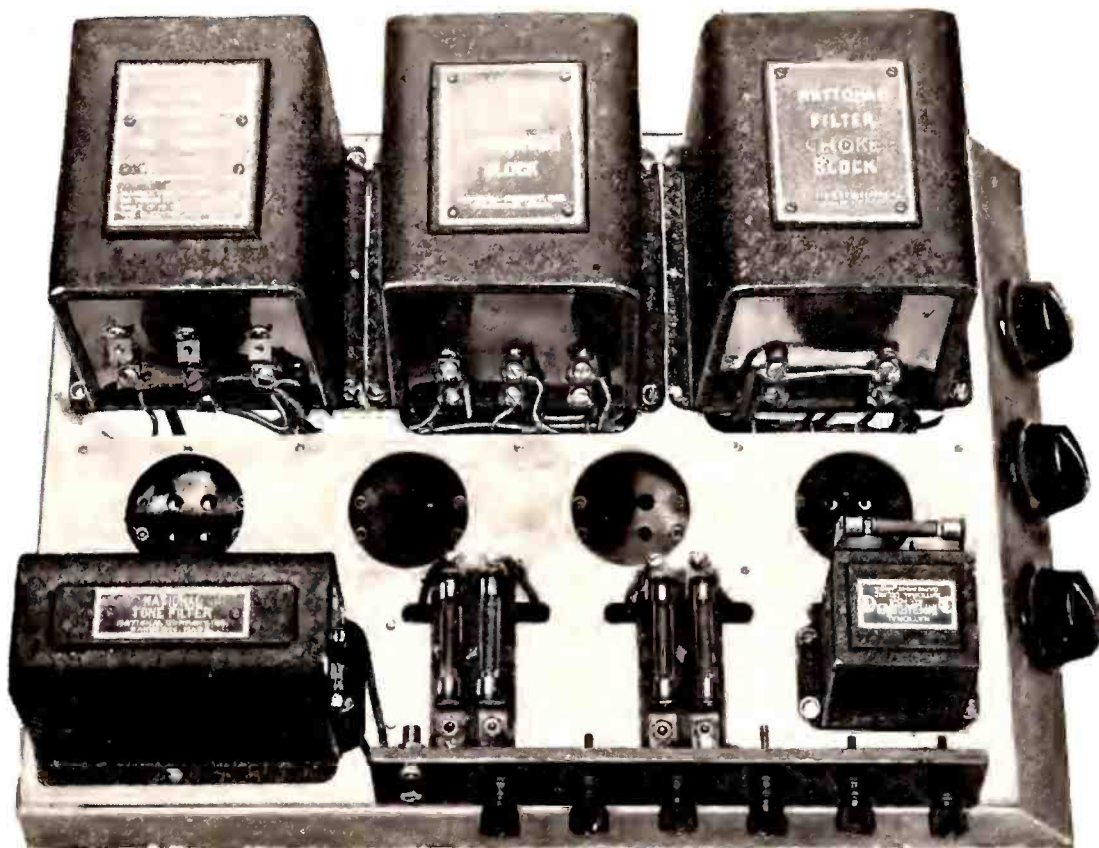

FIG. 2 RADIO BROADCAST Photograph
Top view of the completed unit. The condenser block is placed between the power transformer and the choke coils in order to reduce any possibility of the choke coils picking up stray magnetic flux from the transformer

and continuously carry considerably more than six milliamperes, so that its use in place of a resistance coupling unit will prevent any possibility of trouble from this source. Another reason is that the National Impedaformer specified, contains, in addition to the impedance, coupling condenser, and grid resistor, an r.f. choke coil which serves to keep the r.f. currents in the detector plate circuit from getting into the audio amplifier where it would cause distortion. The use of a radio frequency choke coil also results in much smoother regeneration when the detector circuit employed is of the regenerative type.

There was a time, not so long ago, when there were several worth-while objections to resistance-coupled amplification. Fortunately, all of these objections have been eliminated, so that this economical and certain method of securing exceptionally fine audio quality may now be unhesitatingly employed in the better types of amplifiers.

The first of these former disadvantages to the

use of resistance-coupled amplification was the necessity of securing from dry B batteries the high voltage—180 volts or so—required for the optimum performance of this system of amplification. The advent of devices supplying these high-voltages settled that question.

A second former objection was the fact that a two-stage transformer-coupled amplifier produced greater volume than a three-stage resistance-coupled amplifier. High-mu tubes did much to settle that question.

It is only within the last few months that resistors entirely satisfactory for resistance-coupled amplifiers have been available. The impregnated paper type formerly used for this purpose were neither noiseless nor permanent in value. After a few months' use, amplifiers employing such resistors frequently showed bad signs of distortion. Metallized resistors proved the cure for this.

The power supply apparatus consists of a transformer, double choke, Raytheon tube, condenser block, and the necessary resistors.

The transformer was designed to be universally adaptable to any B power or amplifier circuit, and consists of a 500-volt secondary with mid tap, a 5.5-volt secondary for the filament of either an UX-171 power tube or an UX-213 rectifier, and a 7.5-volt secondary for use with either the UX-216-B or UX-210 tubes. When used in this amplifier, the 5.5-volt secondary is used to light the filament of the UX-171 amplifier tube. As the 7.5-volt secondary is located between the 110-volt winding and the high-voltage secondary, it serves most excellently as an electrostatic shield to prevent the introduction of power line noises into the radio set, by the simple expedient of grounding the mid tap.

The two 0.1-mfd. buffer condensers, so essential for the smooth operation of the Raytheon rectifier tube, are con-



FIG. 3 RADIO BROADCAST Photograph
The apparatus is mounted on a substantial cast iron base. The greater part of the wiring is run under this base

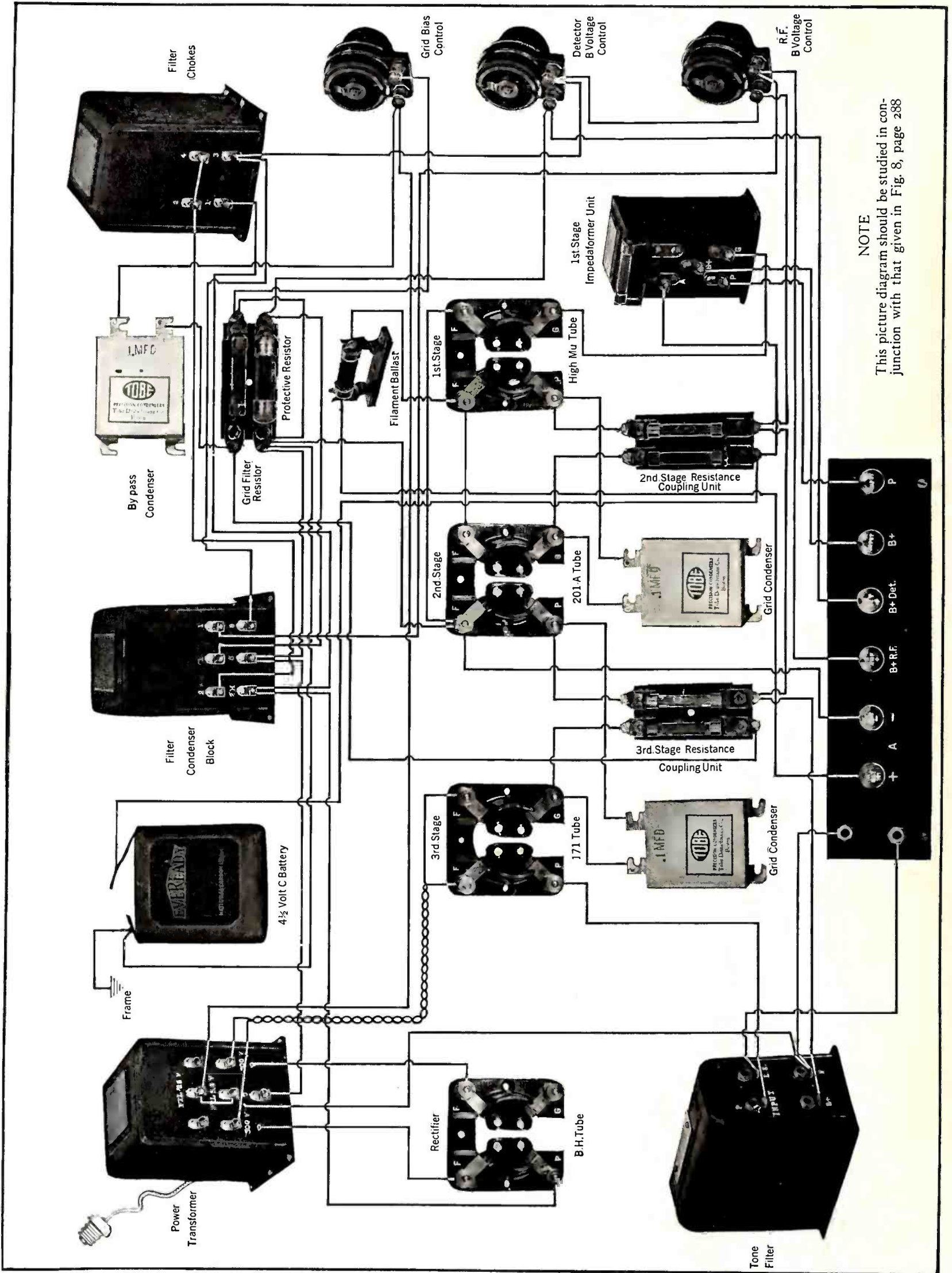

NOTE
This picture diagram should be studied in conjunction with that given in Fig. 8, page 288

tained within the transformer case and are properly connected to the transformer windings.

As a safety measure, the two high-voltage secondary leads are not connected to terminals on the transformer case, but are brought out in the form of long insulated flexible leads which may be run directly to the protected terminals on the Raytheon rectifier socket. Thus, the possibility of shock, due to carelessness in touching an exposed metal terminal, is eliminated.

WIRING THE AMPLIFIER

AS SUPPLIED in kit form, all of the different components of the amplifier are securely mounted on the metal base ready to be wired.

The wire used should be of a well insulated flexible type.

First wire the power section. The two flexible leads on the transformer are run directly to the two protected filament terminals of the Raytheon socket and soldered in place. Care must be exercised in soldering connections to the sockets to see that no soldering paste or flux gets between the contacts, or an arc will result when the amplifier is put in operation. The grid terminal of the Raytheon socket is not used.

Now connect the two a.c. filament leads to the 171 tube, twisting them together, as indicated in Fig. 8 and in the illustration on page 286.

The rest of the connections of the power supply apparatus are perfectly straightforward, and, after all of the apparatus in this unit has been connected together the amplifier proper may be wired. The two leads from each of the grid condensers (in the grid circuits of the second and last audio tube) should be run directly to the grid and plate terminals of the proper sockets, as shown. While wiring, keep in mind the fact that the wires are finally to be grouped together and bound into cables as mentioned above. Ordinary grocer's string is quite satisfactory for this purpose and, if given a coat of shellac when finished, the string will be firmly held in place.

The soldering lug visible on the bakelite socket strip in Fig. 5 between the second and third tube sockets, screws through the cast iron base and casings of the individual units, and is for the purpose of grounding the metal base. It is connected to the negative filament lead at the adjacent tube negative filament prong.

The negative terminal of the C battery is the long strip. The short strip is the positive. The positive C terminal may either be connected to the metal clamp that holds it in place or to the ground lug previously referred to. Both of these points are grounded. This battery supplies the grid biasing voltage to the first two audio tubes. The grid bias for the last tube (the ux-171) is obtained by taking the voltage drop across resistor R₃.

INSTALLING THE AMPLIFIER

WHEN the amplifier has been finished, it may be connected to either a set especially designed for the purpose, such as the two-tube R. B. "Lab." circuit receiver described in this issue of RADIO BROADCAST by John B. Brennan, or else may be used in place of the audio amplifier in any set the builder may happen to have.

The A supply required for the first two tubes of the amplifier, and the tubes in the main set, may be obtained from a storage battery. In order to simplify matters, an A power unit, such as the Westinghouse "Autopower," shown in the layout of Fig. 1, may be utilized.

The Westinghouse unit consists of a fairly low capacity storage battery which is kept charged by means of a trickle charger of the dry contact rectifier type. Its use makes the set entirely operated from the mains and results in



Radio Broadcast Photographs

FIG. 4

The three variable resistors mounted on the end of the base are adjusted to meet local conditions when the amplifier is installed. They then require no further attention

a receiver the batteries of which require a minimum of attention. Replacement of the small grid battery in the amplifier unit will be necessary only about once yearly.

The most convenient way of controlling the amplifier-power supply unit set, and A-power unit, is by means of one of the automatic relay switches. Fig. 7 shows just how the equipment is connected together. Where the set and amplifier are not too far apart—and it is recommended where possible that they be placed not over 10 feet apart—the use of a cable, such as the Yaxley, will be found a very convenient and neat method of connecting the various units together.

The input to the amplifier is in most cases, except for some types of regenerative receivers, secured by connecting the input post which on the amplifier unit is marked "B" to the adjacent +B det. post in the same unit. A wire is then

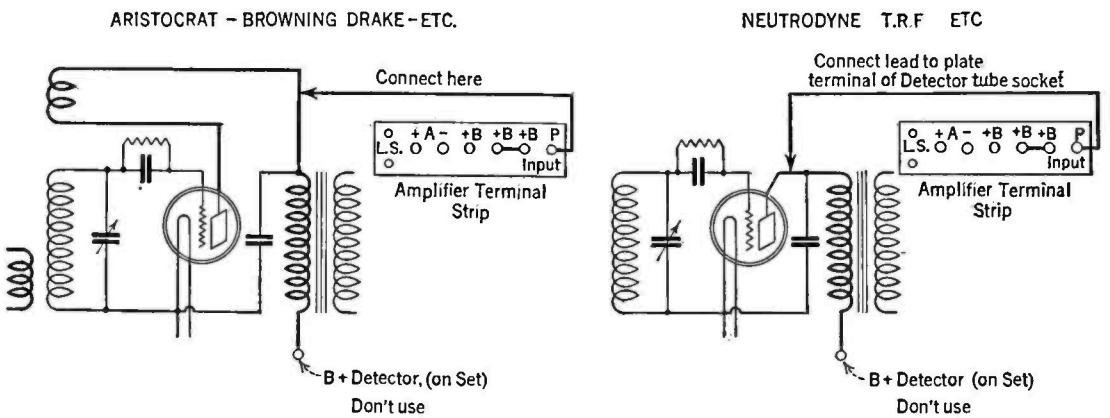
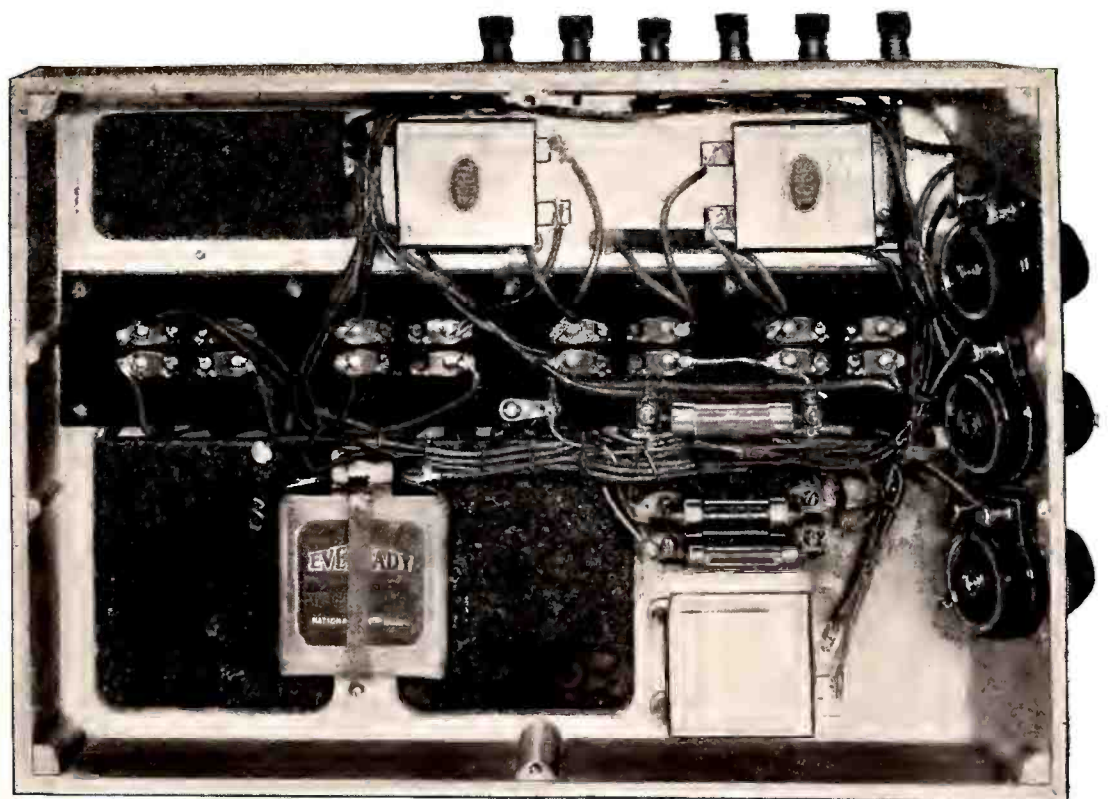

FIG. 5

Showing how the line power-supply device may be connected to either the regenerative or non-regenerative form of receiver



Radio Broadcast Photographs

FIG. 6

A neat wiring job is secured by cabling the various leads, as shown in this illustration taken beneath the cast iron base

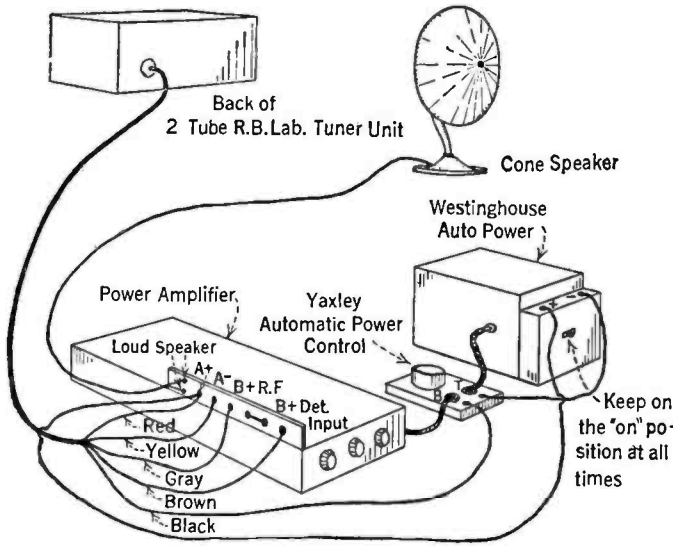

FIG. 7
The wiring of the photographic layout shown on the first page of this article, whereby the R. B. "Lab" Receiver may be used in conjunction with the power-supply device described here. Mr. Brennan's article starting, on page 280, explains the colors indicated in this diagram

run from the other input terminal (marked "P" on the amplifier) to the plate terminal of the detector tube socket on the main receiving set.

No connection is made to the plus B detector post on the set.

In the case of the two-tube R. B. "Lab" circuit receiver, the lead from the input (P) post on the amplifier is run to the output post on the set (See Fig. 7).

In the case of some other sets, such as the "Aristocrat" and Browning-Drake, the input (P) lead should be connected to either the opposite side of the tickler coil from the detector tube plate lead or else to the plate post of the audio coupling unit. This is necessary in order not to interfere with regeneration. The "plus B det." post on the set is not used. See Fig. 5.

OPERATING THE AMPLIFIER

THE first step in operating the amplifier is to insert the various tubes. Generally a high-mu tube in the first stage, a UX-201-A in the second, and a UX-171 in the output will be found most

satisfactory, although it may be better, under some conditions, to use high-mu tubes in both the first and second audio stages. The reason why a UX-201-A is preferable in the second stage at times is due to the possibility of the second high-mu tube being overloaded on strong signals. The proper places for the different resistors specified in the table on this page are indicated in Fig. 8.

When all is ready, turn the three variable resistors to their highest value of resistance and turn on the power. If all the wiring has been carefully and accurately done, and the set tuned to a local station, reception will be had. The three variable resistors may then be adjusted for best results. Generally the use of the full value of resistance will be found most satisfactory. Under no condition should all the resistance be "cut out." Stops are provided on the

resistances specified in the list of parts so that excessive currents cannot be passed.

No matter how good an amplifier one has, unless a good speaker, such as the Western Electric 540 AW or 548 AW, is used, the best of quality cannot be realized. Furthermore, the cone should not be placed too close to the set, but preferably in another corner of the room.

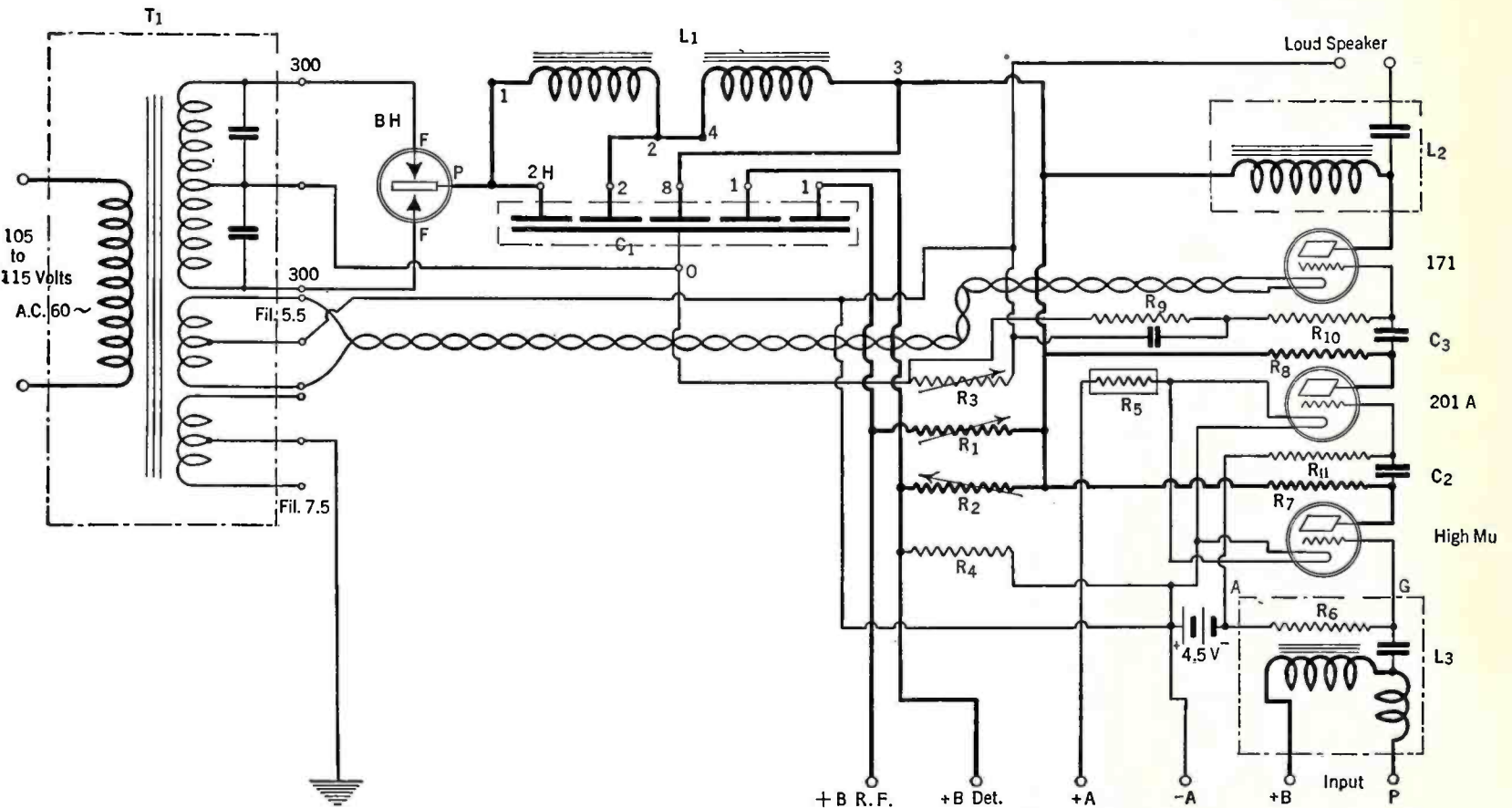

FIG. 8

The wiring diagram of the power-supply device described in the article. The 7.5-volt filament winding is grounded to form an electrostatic shield between the 110-volt winding and the high-voltage secondary winding on the power transformer

LIST OF PARTS

National Three-Stage Amplifier Kit	\$84.00
The prices of the individual parts in this kit are as follows:	
T ₁ —1 Power Transformer	\$16.50
C ₁ —1 Filter Condenser Block	17.50
L ₁ —1 Filter Choke Unit, Type 80	10.00
L ₂ —1 Tone Filter	7.50
L ₃ —1 Impedaformer	5.50
1 Terminal Strip	—
1 Cast-Iron Base	—
1 4-Gang Socket	3.00
C ₂ , C ₃ —2 Tobe 0.1-Mfd. Condensers	1.20
C ₄ —1 Tobe 1.0-Mfd. Condenser	.70
R ₁ , R ₂ , R ₃ —3 Electrad Variable Resistors	4.50
R ₄ —1 10,000-Ohm Fixed Resistor	.65
3 Lynch Double Resistor Mounts	1.50
R ₅ —1 Lynch No. 2 Filament Ballast	1.00
R ₆ , R ₇ , R ₈ , R ₉ —4 Lynch 0.1-Meg. Metalized Filament Resistors	3.00
R ₁₀ —1 Lynch 0.25-Meg. Metalized Filament Resistor	.50
R ₁₁ —1 Lynch 0.5-Meg. Metalized Filament Resistor	.50
1 Eveready No. 703 4½-Volt C Battery	.35
BH—1 Raytheon Tube	6.00
1 Coil Flexible Wire	.50
ACCESSORIES	
1 High-Mu Tube	\$2.50
1 201-A Tube	1.75
1 171 Tube	4.50
1 Yaxley Automatic Control Switch	5.00
1 Westinghouse Autopower, 6 Volts	30.00
1 Loud Speaker, Western Electric 540 AW	32.00
1 Corbett type S-25 console	32.50

How to Construct a Two-Tube Shielded "Lab" Receiver

An Amplifier—Detector Unit for Use in Conjunction with a Separate Audio-Frequency Amplifier—A Loading Coil Permits Greater Transfer of Energy—Complete Shielding is Easy of Accomplishment and Aids Materially the Selectivity in Congested Districts

By JOHN B. BRENNAN

Technical Editor



RADIO BROADCAST Photograph

THE COMPLETE RECEIVER INSTALLATION

Consisting of the two-tube tuner unit, power audio amplifier, loud speaker, trickle charger A battery, and automatic control, is shown housed in a Corbett cabinet

WHEN radio broadcasting made its bow, some six or seven years ago, the types of receivers then in vogue closely followed the orthodox designs of the day—queer to us now in comparison to the fine pieces of radio furniture which may be purchased to-day.

He considered himself high and mighty who boasted of a little box housing a tuner circuit plus another box on whose front dangled the precious audiotron with its double filament. Those were the days when the neighborhood hardware store was sorely pressed to supply the demand for flashlight cells with which the high and mighty one built up his B-battery.

The art has progressed. But a strange coincidence is the fact that, to-day, designers of radio receivers are swinging around the circle, so to speak, and the more important receiver developments are crowding closely the styles of yesterday.

Then it was that receivers were built up on the unit principle. That is, first one would obtain the tuner coil box and connect to it the crystal detector and phones. Graduating from this stage on to the next the experimenter would follow with the annexation of a vacuum tube detector and unit amplifier of some sort.

To-day that system—to be sure, in slightly altered form—is coming into its own again, and rightly so, for it has many points in its favor.

Much has been said about the ability of the tuner coils and the wiring of a receiver to pick up unwanted signals without the aid of the antenna. To many this has manifested itself as broadness of tuning and lack of sensitivity. To overcome this undesirable property, the tuner unit must incorporate some means for excluding the unwanted signals or at least to make all the signals enter the receiver through the antenna. Building the tuner unit in a metal cabinet, as described in this paper, very definitely overcomes this difficulty.

In selecting a circuit suitable for the tuner unit, the R. B. "Lab" circuit has been chosen, since it has all the meritorious qualities of a desirable circuit. In no way does this supersede the R. B. "Lab" circuit receiver which was fully described in the November, 1926, RADIO BROADCAST. That was a complete receiver in itself, audio channel

and all, and the description in that issue resulted from the natural desire on the part of experimenters of the "Lab" circuit to have before them a suitable receiver design embodying the fine points of the circuit.

Unquestionably, to shield the coils within a receiver is highly beneficial, providing it is done correctly, and because of these beneficial qualities, the receiver described here has been shielded practically completely.

Slight variations in the R. B. "Lab" circuit, as outlined in the November, 1926, issue, have been made in the circuit used here, to suit the mechanical and electrical requirements set for this model.

To obtain maximum transfer of energy from the antenna to the receiver, involves the use of some sort of antenna tuning device. The antenna loading coil employed in the tuner unit described here furnishes exceptionally well the means to this end.

Four taps have been provided in this coil so that the circuit is resonant at approximately 1200, 857, 666, and 600 kc. (250, 350, 450 and 500 meters) successively as the switch arm is turned from left to right. The value of this loading coil is most apparent when it is desired to

shift tuning from a short-wave station to one operating on a longer wavelength.

Shielding makes possible the use of a type of coil such as a solenoid, in the radio frequency stage input circuit which is more efficient than one of the confined electromagnetic field type, and, further this shielding aids in preventing the wiring of the circuit itself in picking up unwanted signals.

A separate audio channel for this two-tube unit may employ the same parts as the receiver described in November, and doubtless this point will find favor with those who already have that material on hand or for those constructors of the November R. B. "Lab" circuit who wish to convert their receiver into the two-tube tuner circuit with its separate amplifier.

The amplifier itself presents no very great problem of construction and, when completed, may be stowed away in some remote part of the console cabinet or perhaps in the basement with the storage A battery and its attendant charger, etc. Elsewhere in this magazine is described a combined audio power amplifier and plate power supply device which is very well adapted for use with the tuner unit described here.

THE ALUMINUM SHEET FOR SHIELDING

BEFORE collecting the various parts necessary for the construction of the tuner unit, it is well for the prospective builder to read over the description thoroughly and acquaint himself with the various sketches and construction lay-outs. In this same connection, the reader should not fail to review what has been published on the "Lab" circuit in the June, September, and November, 1926, issues of RADIO BROADCAST. This will serve to familiar-

The Facts About This Receiver

Name of Receiver
Type of Circuit

R. B. "Lab" Two-Tube Receiver
R. B. "Lab" Circuit; one stage tuned neutralized radio frequency amplification plus regenerative detector.

Number of Tubes

Two, r.f., 201-A type, detector, special detector such as 200-A, or ordinary 201-A tube.

Frequency Range
Novel Features

1500-545 kc. (200 to 550 meters).
Tapped antenna loading coil, C battery detector; complete metal housing.

The receiver described here is essentially a tuner unit in which is incorporated an r.f. and a detector tube. To it must be connected some sort of audio amplifying device of quality to reproduce with fidelity the sounds entering the microphone of the transmitter. The tuner unit has been intentionally housed in a metal cabinet which affords the advantage of shielding the circuit wiring from undesirable signal pickup.

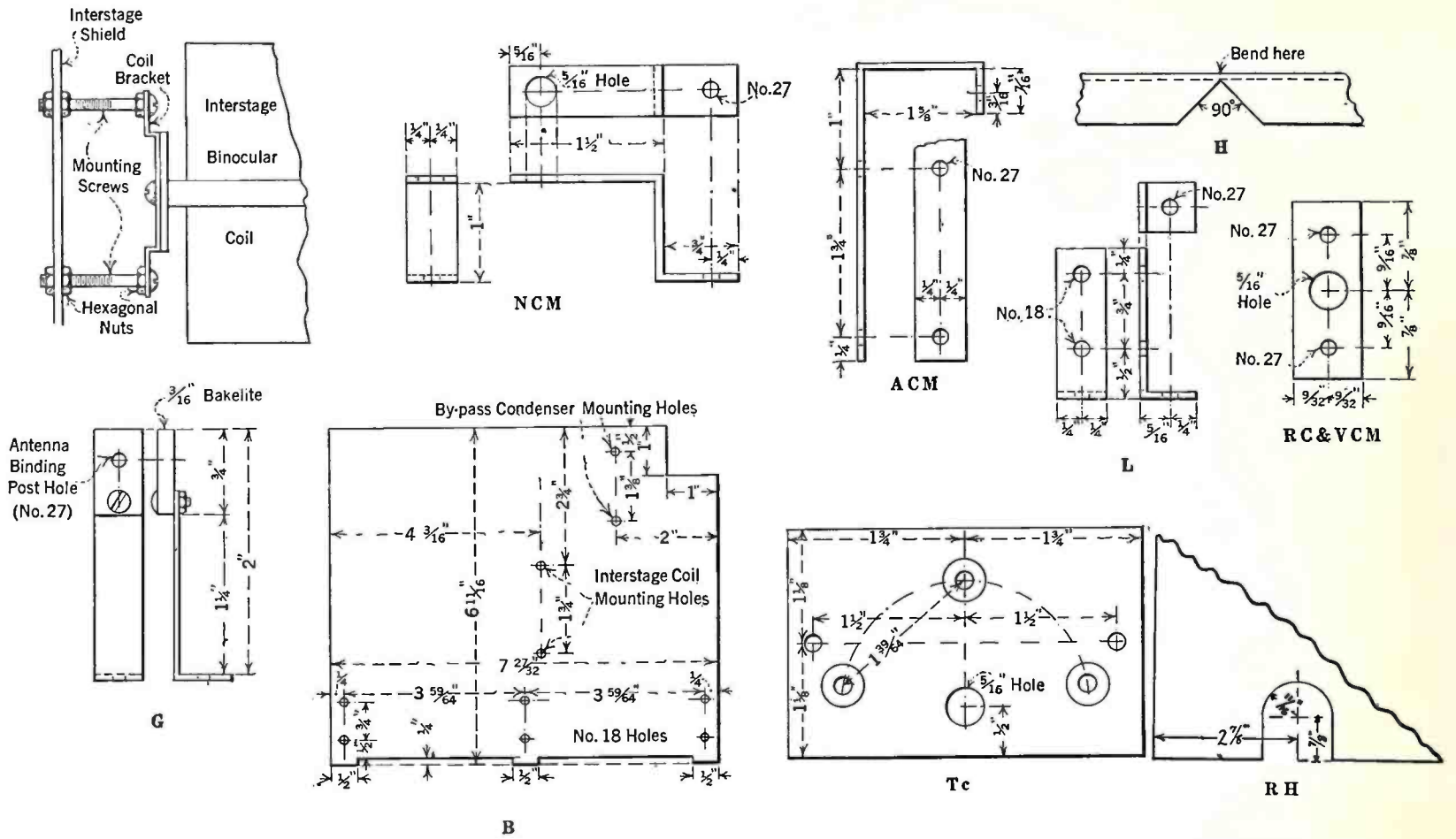
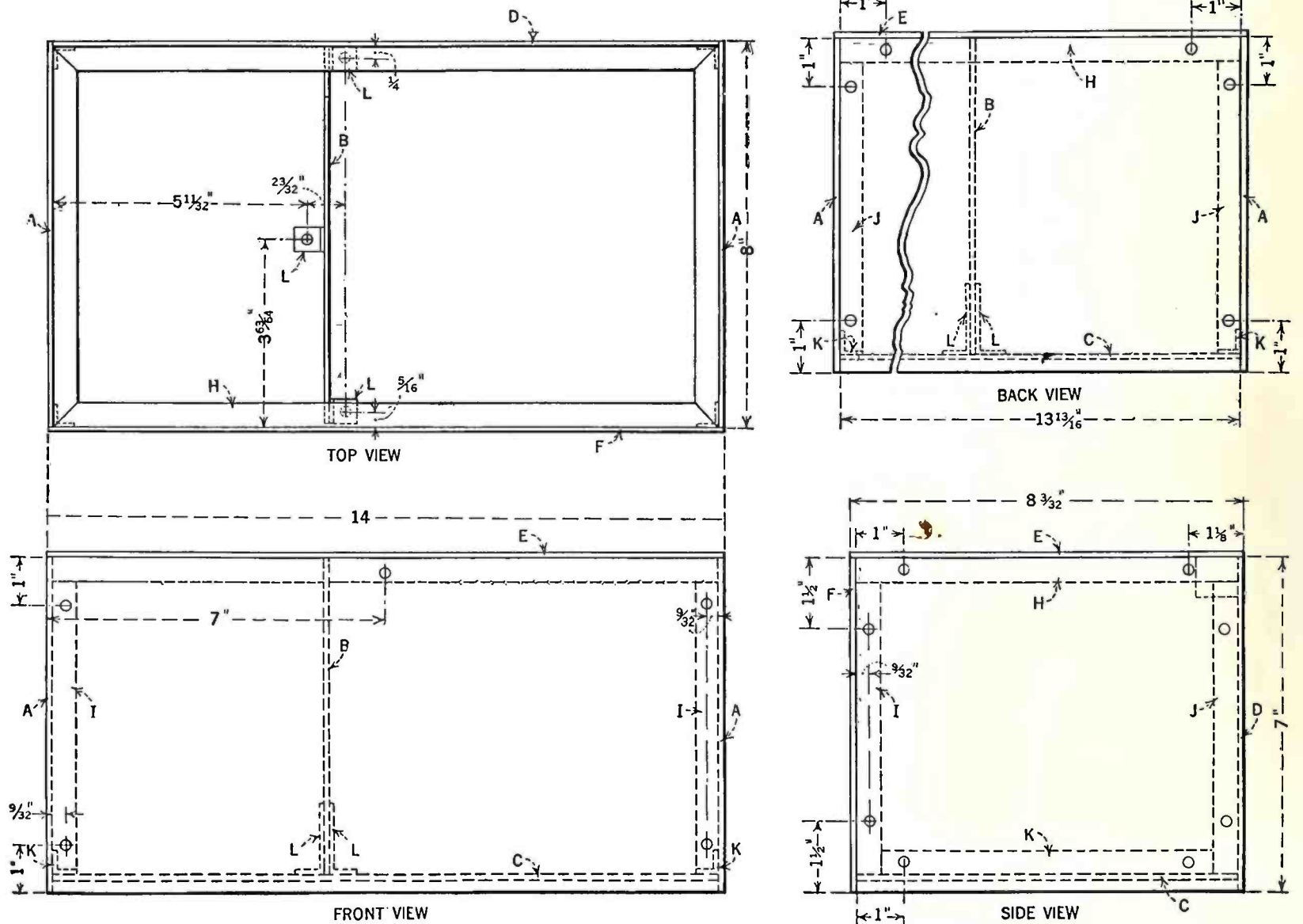

FIG. 1 AND 2

Prepare the various mounts and other brackets, etc. from the sketches shown above. Identification of these parts may be made by referring to the material list shown on page 291. The assembly details of the metal box are fully outlined in the diagram below (Fig. 2). The top view shows the method of fastening the walls, the lid being removed. R H, above, indicates the dimensions for the receptacle hole to be made in the back wall for admitting the cable plug



ize the builder with his problems, and guard against error.

With regard to the aluminum sheet necessary for the cabinet material, it is well to obtain a large sheet of standard size, which usually comes 18 inches wide and about six feet long. When purchased this way, the price per pound is less by about 25 per cent. than if only a part of the sheet be purchased, and the surplus may be used by the constructor in other ways.

The various pieces of cabinet material may be cut out roughly with a hack saw and then filed to size, or if one is so disposed, the services of the local tinsmith or machine shop may be employed to produce a more finished workmanlike job. This procedure will tend toward greater accuracy than when the job is filed down to size by hand. So, too, the brass angle strip may be laid out, center punched, and then drilled at the local machinist's. Unless one is used to drilling metal with a hand drill, the worth of having as much of this kind of work done outside cannot be fully appreciated.

Much care must be exercised in center punching the various hole marks—especially so on the main panel—because the use of a dull center punch will often result in incorrectly spaced holes. If you are attempting the drilling of the holes

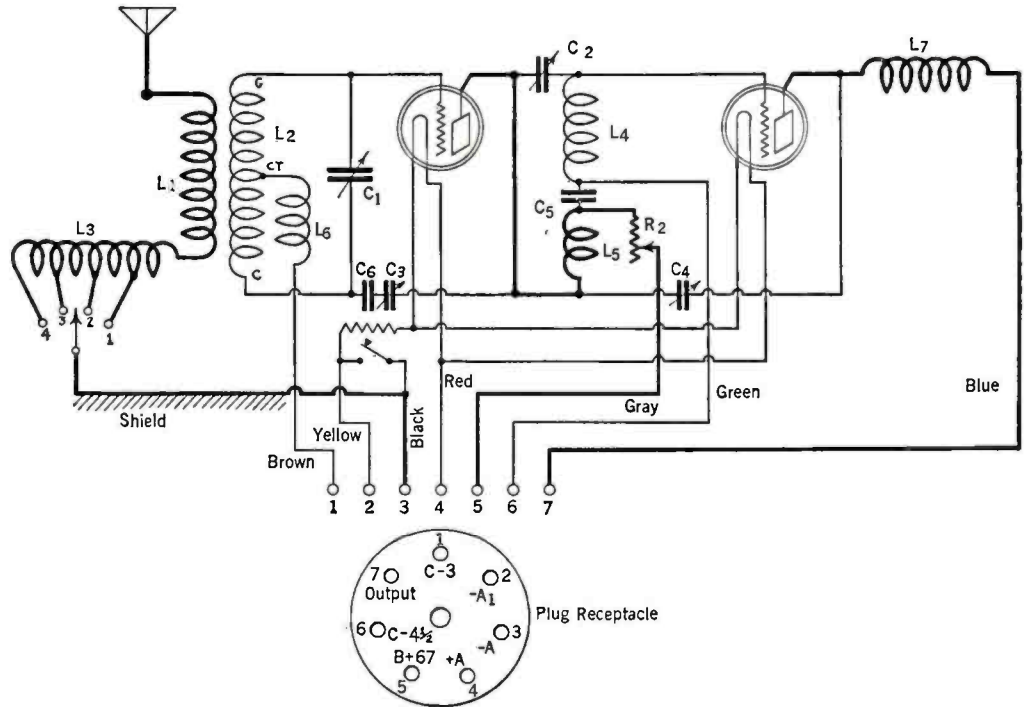

THE CIRCUIT OF THE TWO-TUBE TUNER UNIT

Is quite similar to that of the "Lab" receiver described in the November, 1926, RADIO BROADCAST. Comparison between the two will show that the circuit shown here differs from the other in that first an antenna loading coil has been added, secondly the C battery method of detection has been substituted and, thirdly, the volume control has been placed in the radio-frequency amplifier circuit. By placing the volume control in this position, the operator is able to prevent overloading of the detector, especially on strong local signals. The condenser C6, in series with the neutralizing condenser C3, is employed as a protective device in case the plates of C3 become shorted. While not shown in the several photographs, this condenser is mounted directly on the back plate of the tuning condenser C1

PARTS REQUIRED FOR METAL CABINET

THE table presented here serves not only as a parts list of the material necessary to the assembly of the metal box, but furnishes a key to the various lettered parts appearing in the sketches accompanying this article, Figs. 1 and 2 in particular.

PART LETTER	NAME	SIZE	No. Req'd.
A	Side Walls	8" x 7" x 3/8"	2
B	Compartment Wall	6 1/8" x 7 3/8" x 3/8"	1
C	Base	13 1/8" x 7 3/8" x 3/8"	1
D	Back Wall	13 1/8" x 7" x 3/8"	1
E	Lid	14" x 8 3/8" x 3/8"	1
F	Front Panel	14" x 7" x 3/8"	1
G	Antenna Binding Post Bracket	1/2" x 2" x 1/8"	1
H	Top Bracket	1/2" Angle Brass	1
I	Front-Side Brackets	" " "	2
J	Side-Back Brackets	" " "	2
K	Side-Base Brackets	" " "	2
L	Compartment Brackets	1/2" Brackets	3
Rc	Insulator Mount For Regen. Cond.	1 3/8" x 1 1/2" x 3/8"	1
Tc	Insulator Mount For Tuning Cond.	2 1/4" x 3 1/2" x 3/8"	2
ACM	Antenna Loading Coil Mount	1/2" Flat Brass	1
NCM	Neutralizing Cond. Mount	1/2" Flat Brass	1
VCM	Volume Control Mount	1 3/8" x 1 1/2" x 3/8"	1

yourself, first drill them with a small sharp drill,—say a No. 33 or 35. Then, it is a simple matter to enlarge the holes with the correct size drill to the specified size. In doing this work, the Stevens tapered reamers are of inestimable value.

After all the panels, etc., have been laid out and drilled in accordance with the drawings they may be set aside for the moment and the various insulated mountings drilled in accordance with the instructions in the diagrams on

page 290. These mountings are necessary to the construction of the tuner unit in preventing the tuning condensers, regeneration condenser, and volume control from coming in contact with the main metal panel, which is at ground potential.

As noted in the parts list, the builder must obtain approximately 96 inches of angle brass and 36 inches of 1/2-inch flat brass strip.

The angle brass is cut up and drilled to form the connecting pieces for the cabinet. Reference to Fig. 1 will show the location of the various holes and also the several sizes of bracket lengths. The bracket H, that one which is formed into a rectangle to fit to the four sides

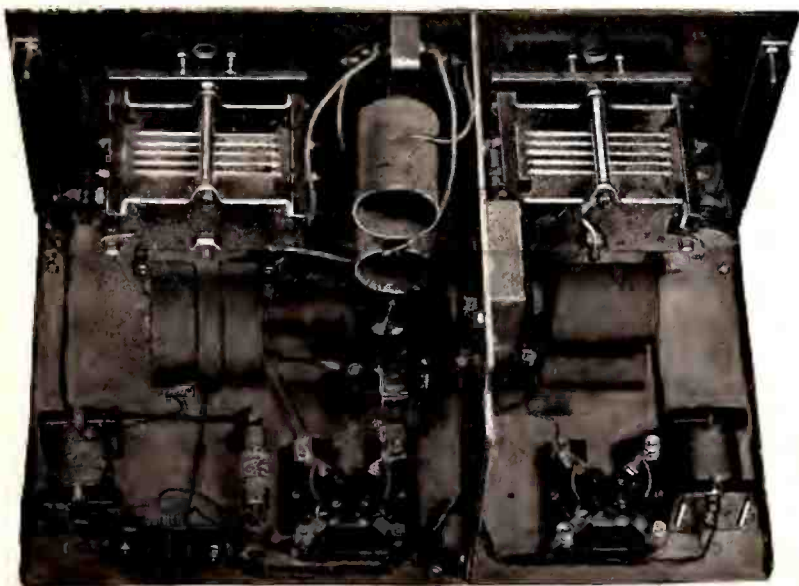

RADIO BROADCAST Photograph

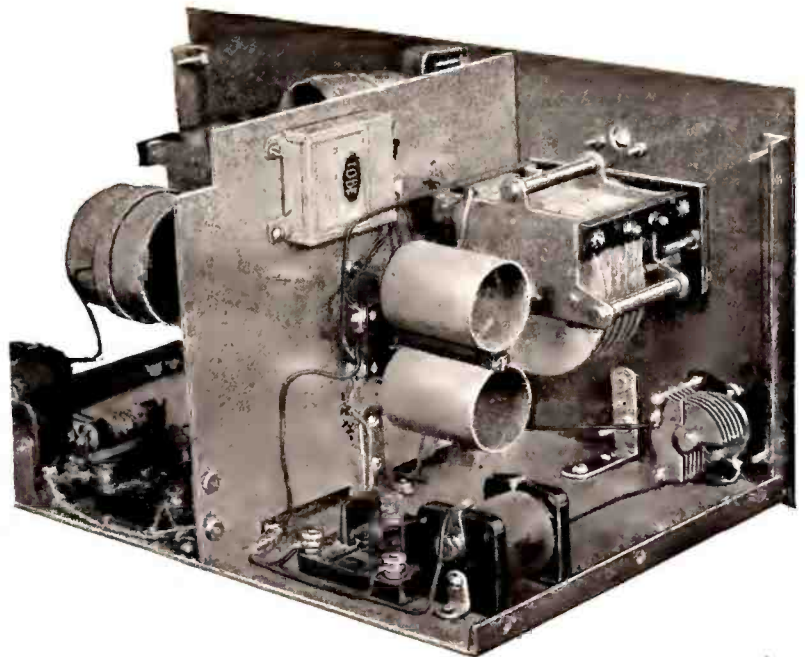

RADIO BROADCAST Photograph

LOOKING AT THE INSIDE

Of the receiver reveals the simplicity of assembly of the metal box and also the parts employed in the circuit. These views indicate quite clearly the method employed in mounting the tuning condensers on bakelite mounts which are then fastened to the back of the main panel

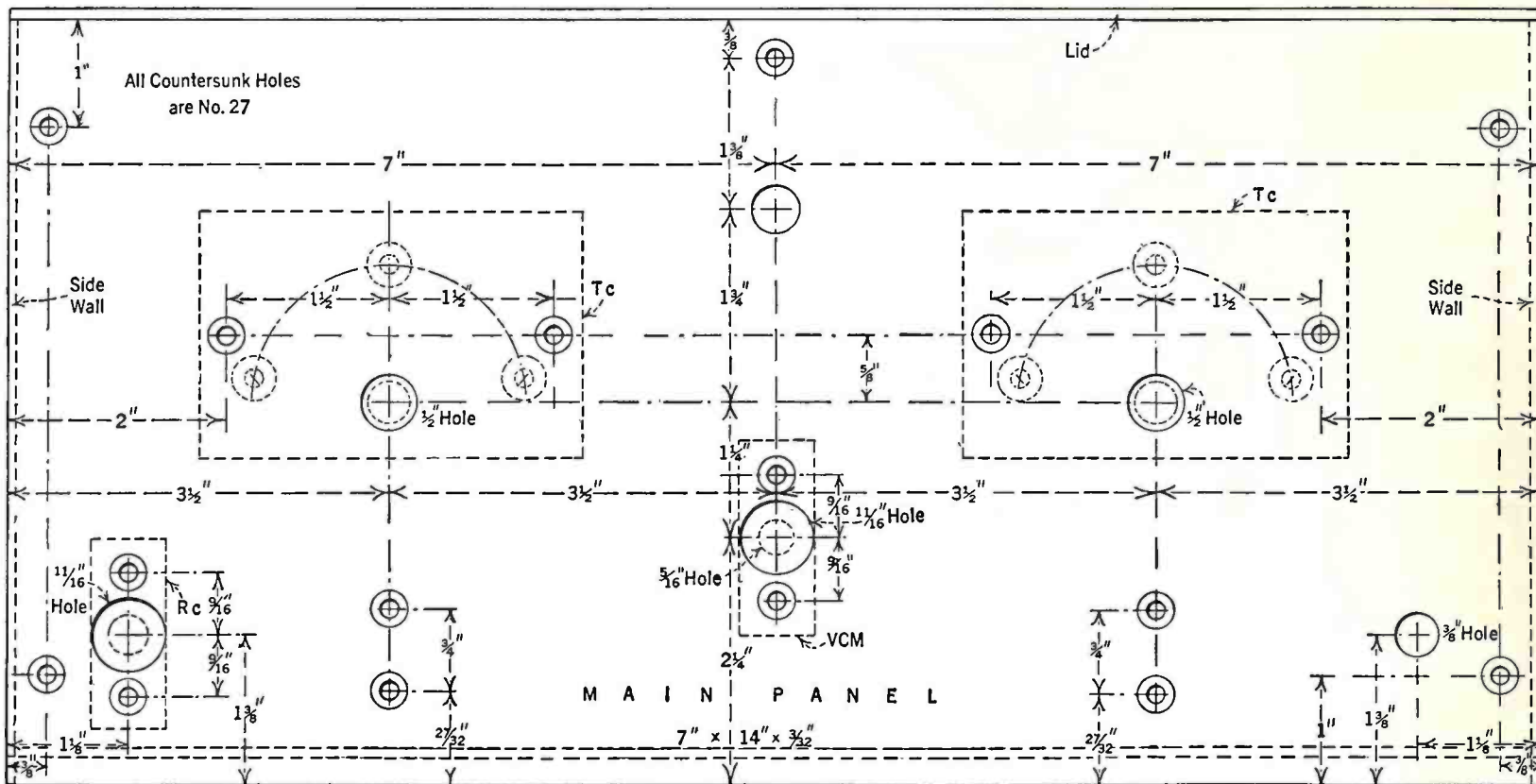

FIG. 3

All the dimensions necessary for locating the holes on the main panel are shown here. In spotting the center-marks of these holes, do not scribe heavily the lines to form the intersection at which a hole is located. A light pencil line will suffice, for such may be rubbed off later. Drill all the holes with a small drill first, then enlarge with larger drills, or with Stevens tapered reamers, to the size specified

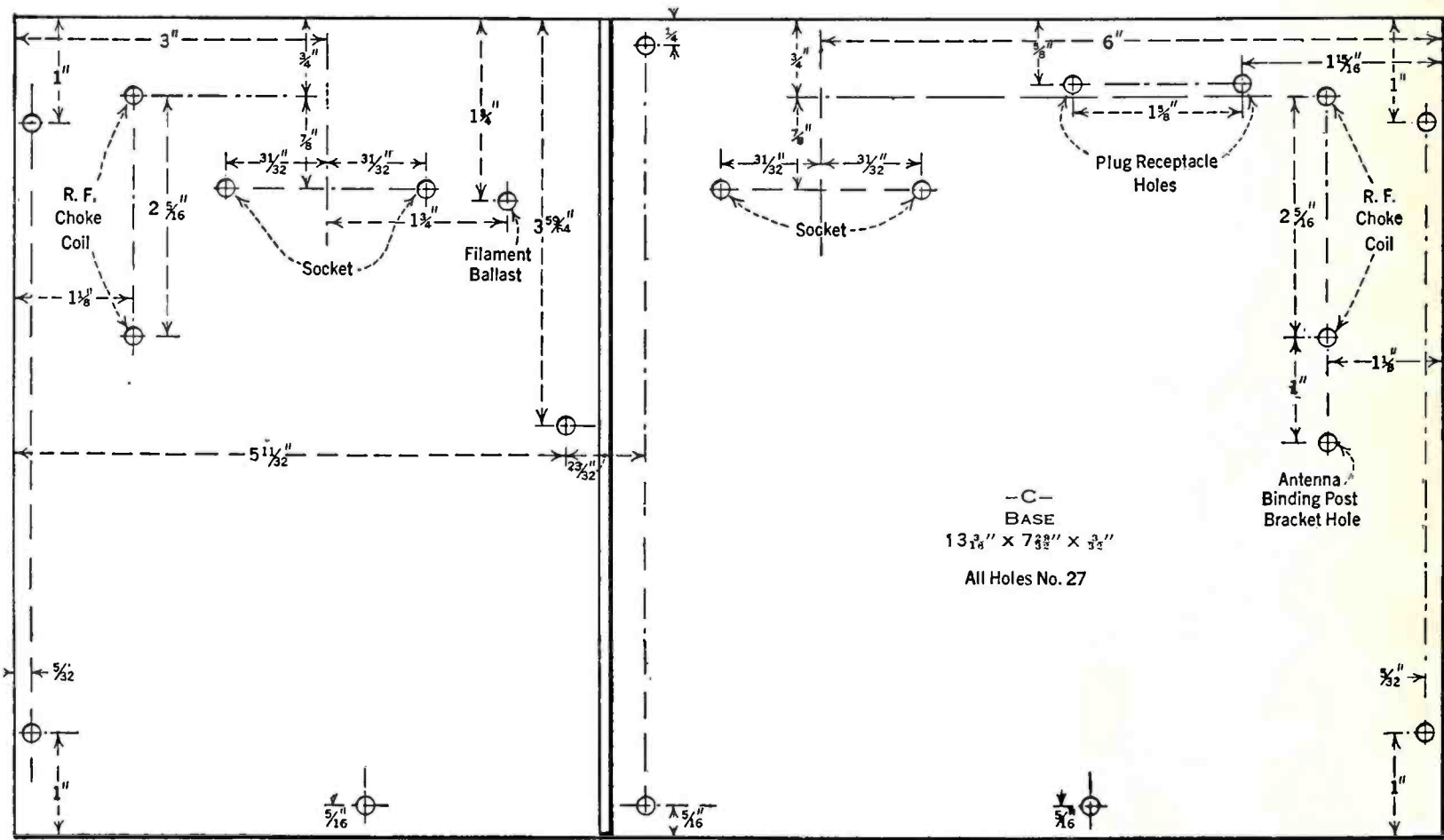
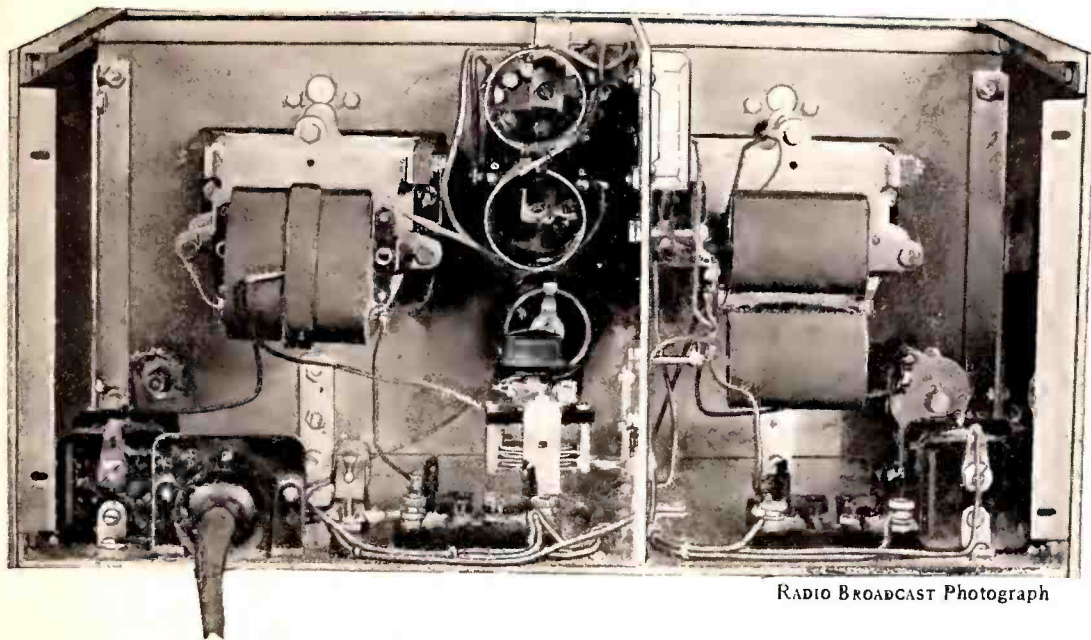

FIG. 4

This diagram shows the placement of the holes in the base for mounting such parts as sockets, choke coils, etc. Note that the antenna binding post bracket is located at the right, directly forward of the r. f. choke coil for the antenna circuit. The post, unfortunately, is not shown in the illustrations which accompany this article



RADIO BROADCAST Photograph

THIS BACK VIEW

Indicates how completely the interstage shield isolates the antenna circuit from the interstage circuit. Behind the binocular coil located in the center of the picture may be seen the 4-point tap switch. The filament and other leads to the connector plug are cabled and bound, as may be observed

of the metal cabinet at the top, requires approximately 44 inches of angle brass. It is bent and cut in the manner indicated in H Fig. 1.

It is to be noted by reference to Fig. 3 that the tuning condensers are mounted on their respective rectangles of bakelite in such a manner as to prevent the heads of mounting screws from coming in contact with the metal panel. This is accomplished by deeply countersinking these mounting screw holes so that the heads of the screws are well below the surface of the bakelite. The hole in the metal panel is sufficiently large enough so that the shaft, when properly mounted in its center, does not touch the panel.

MOUNTING THE APPARATUS

AFTER this work is done, the condensers, on their insulated mounts, may be fastened to the main panel as may be the filament switch, tap switch, regeneration condenser, and volume control. The filament switch and antenna tap switch may be mounted directly on the metal panel without the aid of insulation, as these units have their mountings at ground potential. The volume control and regeneration condenser are insulated from the panel by means of the bakelite strip VCM and RC, details of which are shown in Fig. 1.

On the metal base may be mounted the two sockets, two radio frequency choke coils, the filament ballast, antenna binding post bracket, terminal receptacle, and interstage shield. The sockets should be raised off the metal base by means of several washers placed under the socket at the mounting holes. This is so that the ux type tubes do not have their prongs shorted by contact with the base.

At this point the dials may be mounted at the front of the main panel, and then the base and main panel are fastened together by means of the brackets provided for this purpose. The neutralizing condenser is fastened by means of its bracket to the "p" post of the radio frequency stage socket. The protective condenser C₆ in series with the neutralizing condenser C₃, is mounted on the back plate of the tuning condenser, C₁ by means of a 3/8 brass machine screw which passes through the threaded hole at the

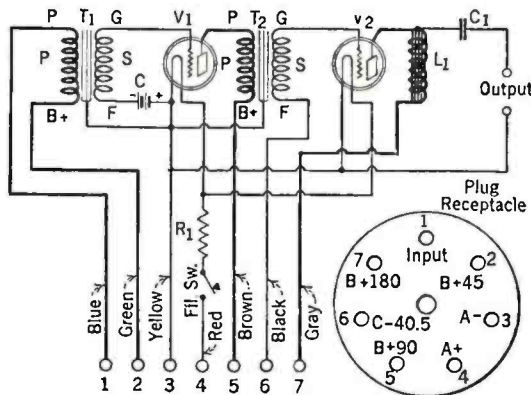

THE AUDIO AMPLIFIER

Shown on page 294 is wired in accordance with the circuit diagram which appears above

end of the condenser C₆. The other terminal of this condenser connects by wire to the neutralizing condenser.

The Gen Win coil units, or, if desired, home-made coils made in accordance with the specifications outlined in Fig. 5, are then located at their respective positions in the receiver. The solenoid coil (the antenna coil), is mounted by means of its brackets directly under the screw heads of the spacer rods of the Cardwell condenser which tunes the secondary circuit of the radio-frequency amplifier stage.

The tapped binocular coil (the antenna loading coil) is mounted on a specially prepared bracket, ACM, details of which are shown in Fig. 1, and fastened to the top center screw hole on the main panel. The other binocular coil—the interstage coil—is mounted on the interstage shield by means of two 1-inch round-head brass machine screws. First the screws are passed through the shield and secured with nuts. Then another set of nuts are screwed on the screws for about 1/16 of an inch from their ends; the coil is placed on the screw ends and finally fastened with a third set of nuts which firmly hold the coil bracket between the second and third sets of nuts. This mounting is clearly illustrated in Fig. 1. The bypass condenser is also mounted on the interstage shield at the holes provided.

Having accomplished all this, the next step is to wire the receiver. First the filament circuit for both tubes is completed from the Yaxley connector plug receptacle to the sockets, switch, and filament ballast. It is only necessary to connect the minus A terminal of the receptacle to some point on the metal base to complete the circuit to the filament switch and tap switch. In making the other connections from these two units, be sure that the ungrounded terminals are employed since connection has already been made to the side which is common to the mount-

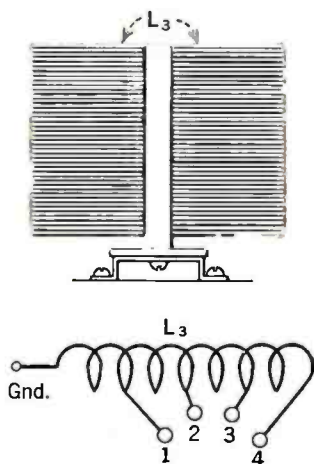

- 1= 26th Turn
- 2= 59th "
- 3= 89th "
- 4= 118th "

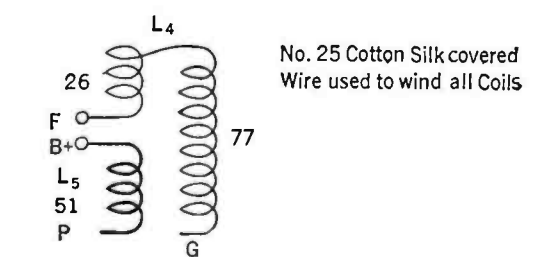
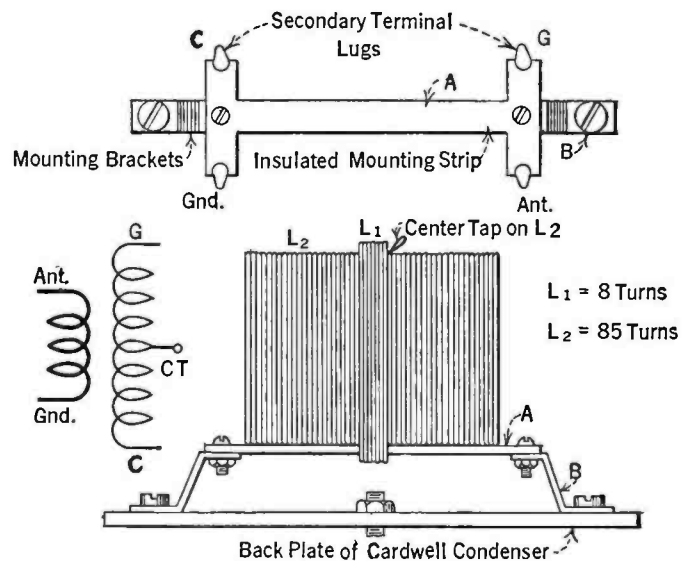
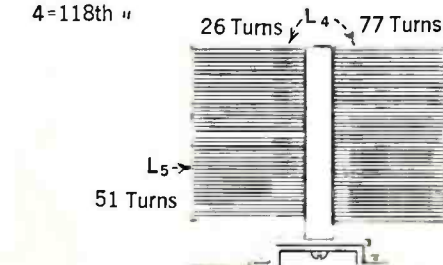

No. 25 Cotton Silk covered Wire used to wind all Coils

FIG. 5

The sketches above will aid those who desire to make their own coils. The coils are of the type known as self-supporting, that is, they are wound on a celluloid form. Much information relative to the winding of coils may be obtained from the article on coil winding appearing in the March, 1926, RADIO BROADCAST. On the terminal strip of some of the manufactured solenoids, that post marked "F—" should be the C post. The sketch above shows the correct connections

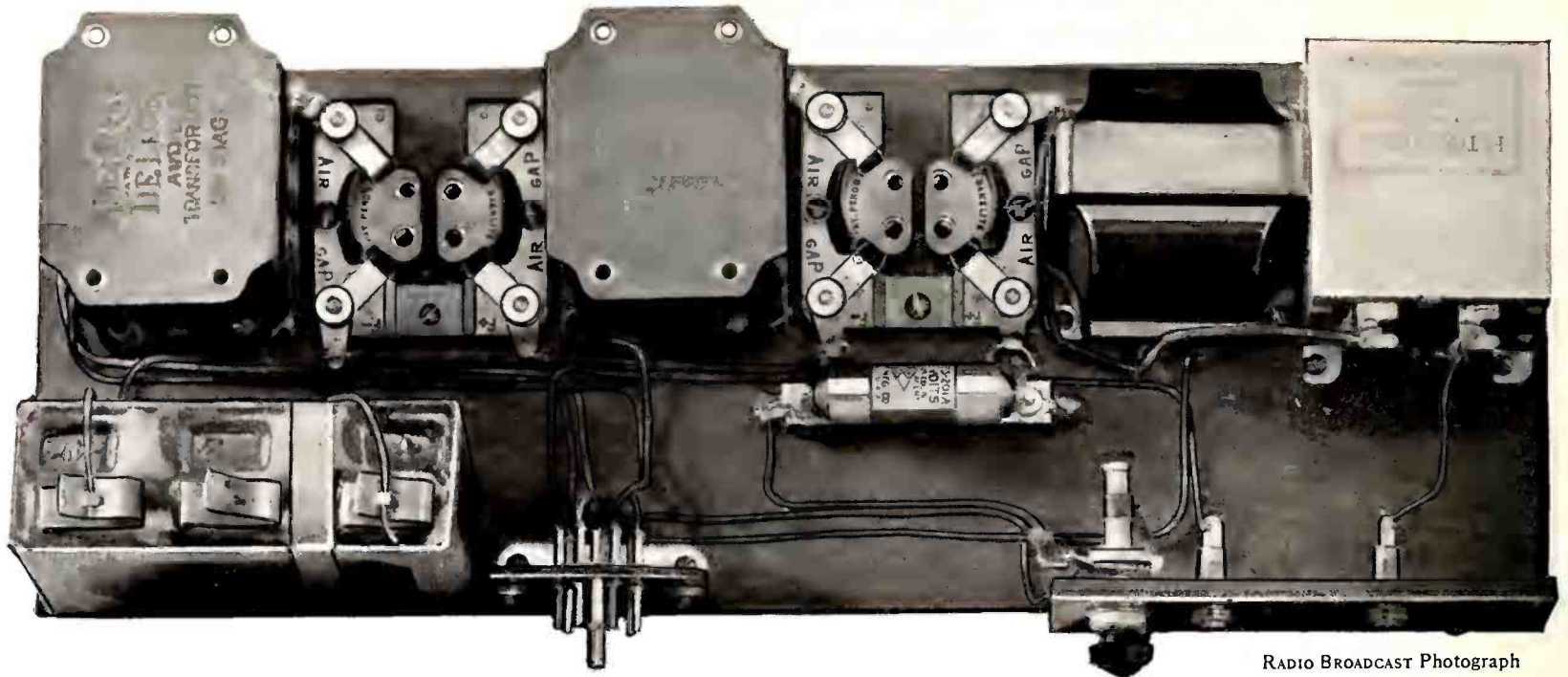

RADIO BROADCAST Photograph

A COMPLETE AUDIO AMPLIFIER

Consisting of Amertran transformers, Airgap sockets, Samson output impedance, Tobe condenser, Yaxley plug, together with the necessary 4½-volt C battery, etc., may be assembled on a base board and stowed away in the cellar or in the lower compartment of a cabinet, as illustrated in the photographs appearing on pages 289 and 295

ing bushing by virtue of connection being made from minus A to the base. The several filament wires may be bound by means of cord to form a cable.

After the filament circuit is completed, the rest of the wiring may be made as direct as possible, that is, from point to point without the usual care of making right angle turns.

Now the antenna loading coil may be unfastened from the back of the main panel, the angle brass, H, put in place, and the antenna coil remounted over the angle brass. From this point on it is only a matter of fastening the sides, back, and top to the angle brass. As an aid in this, it will be well to frequently refer to the numerous illustrations and sketches accompanying the article.

The builder must, even under the most favorable circumstances, employ his own ingenuity in duplicating the construction described because he has not the opportunity to have before him a model but rather the scale drawings and other sketches that enter into the building of this tuner unit.

Constructors of this two-tube tuner unit will find much that is new and intriguing in departing from the accepted paths of receiver design wherein the audio amplifier is an integral part of the receiver itself. The audio amplifier illustrated above is very simply laid out on a board and, if it is so desired, may be housed in a metal or other box. It works very well with the two-tube R. B. "Lab" receiver.

To operate the two-tube tuner unit, connect it to an audio amplifier as shown here-with or to any combined power supply and audio amplifier such as the one described elsewhere in this issue by James Millen.

When all the connections have been completed and the antenna is attached to its binding post, turn on the filament switch and rotate the dials, turning them somewhat in unison. For a long wavelength station, the antenna loading coil tap switch should be turned so as to include the entire loading coil, and for a short wavelength station, this coil should be adjusted to one of the lower taps. Turn the regeneration condenser so that the rotating plates mesh completely with the stationary plates. If a station is broad-

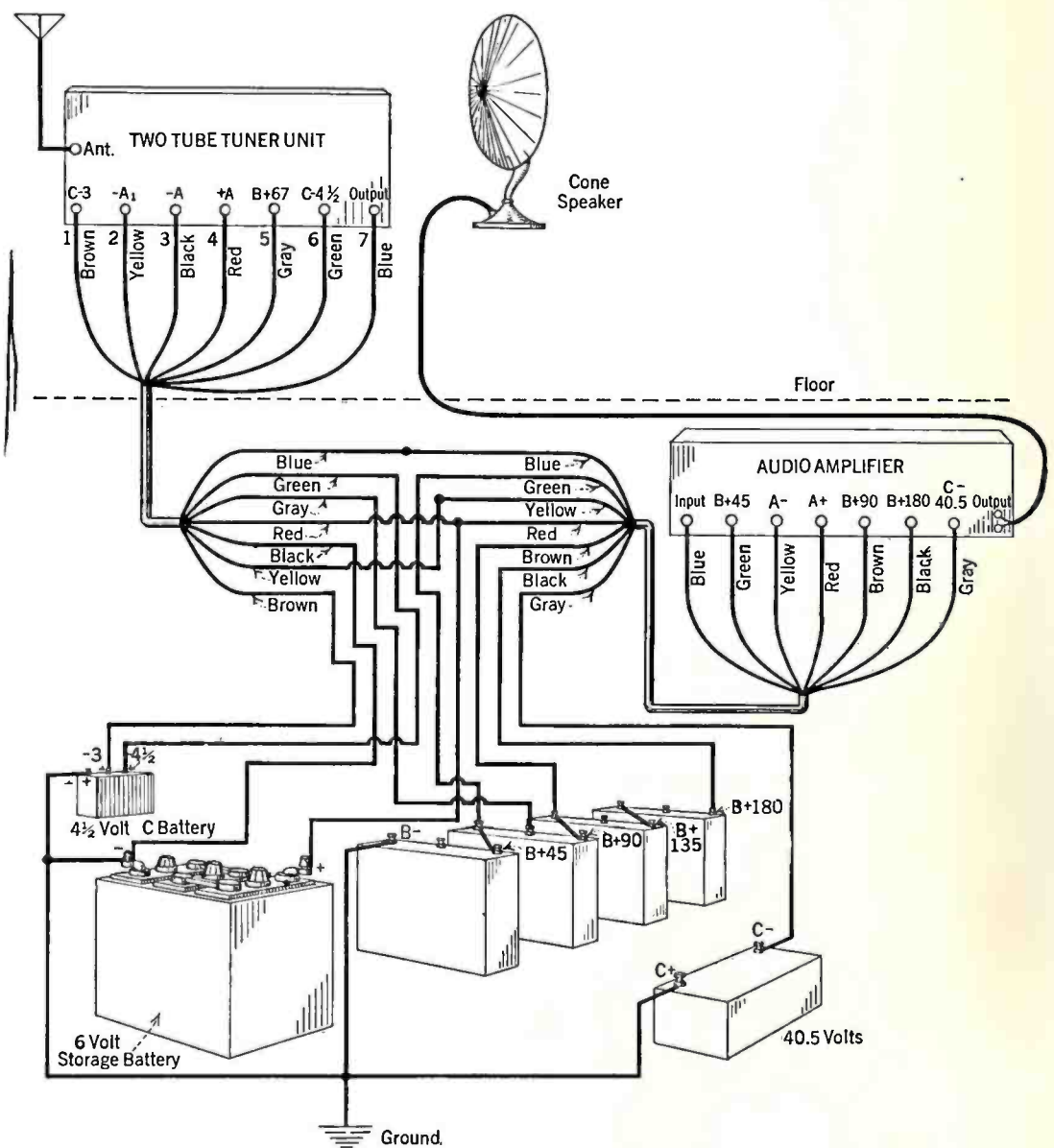

THE ACTUAL HOOK-UP

Of the two-tube tuner unit, the loud speaker, the batteries, and the audio amplifier is easily accomplished by following the circuit shown above. Two Yaxley 7-wire cables aid materially in making this job a simple one

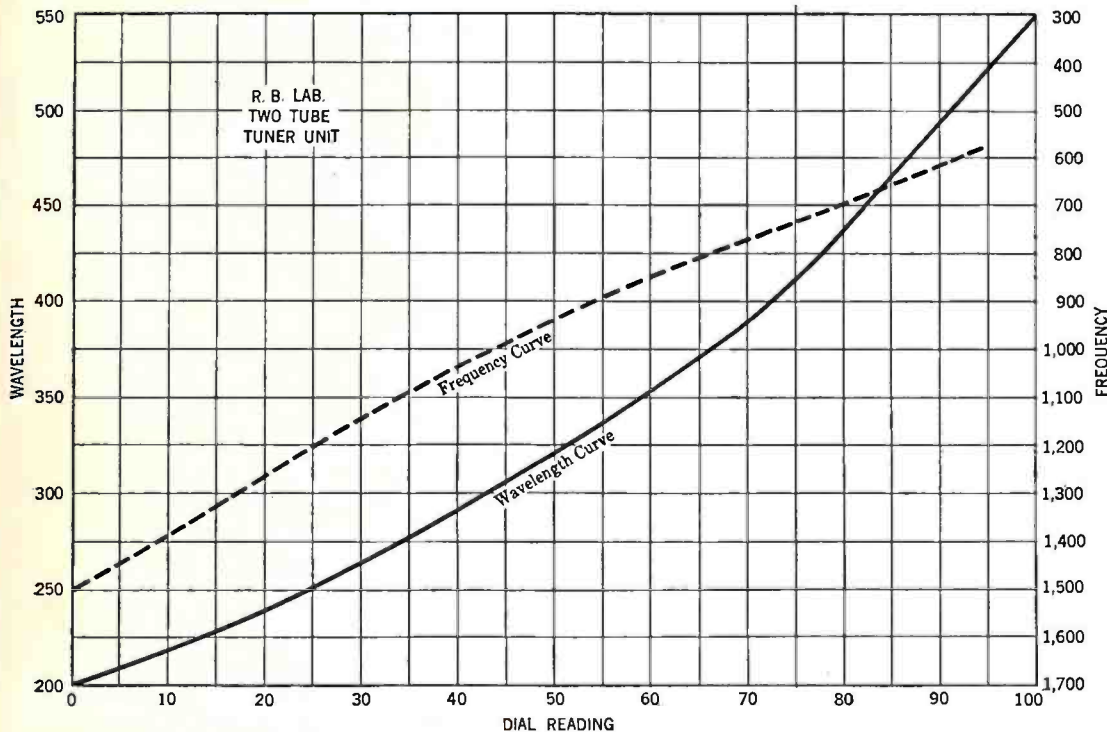

AN APPROXIMATE TUNING CHART

Which will aid constructors in locating dial positions for the stations they are in the habit of listening to

casting, reception will be manifest by a loud squeal. Adjust both tuning dials until the squeal is loudest, back off the regeneration control until the squeal ceases, and in its place will be heard the signals. The volume control enables one to adjust the volume to the desired intensity. With the receiver connected to the amplifier in the manner indicated, the switch on the tuner unit will also control the operation of the audio amplifier.

To neutralize the receiver, take a stick about 1 inch wide and cut a wedge at one end which will engage with the knurled surface of the knob on the neutralizing condenser. The procedure is outlined on page 42 of Radio Broadcast for November, 1926. Another method is as follows: remove the plus A filament connection to the radio frequency stage socket after a station has been tuned-in and then adjust the neutralizing condenser until the signal received is either entirely eliminated or at a minimum. The receiver is then neutralized and the filament wire may be

replaced. It will be necessary to retune the two main condensers with each new adjustment of the neutralizing condenser until a final setting has been obtained.

The first part of this list of parts embraces only those employed in the actual circuit itself and does not include the hardware and metal material necessary for the construction of the metal cabinet, these parts being given in the second half of this list.

- L1, L2, L3, L4, L5—1 Kit Gen-Win R. B. "Lab" Circuit Coils. \$8.50
- L6, L7—2 Radio Frequency Choke Coils, Samson No. 85 \$6.00
- C1, C2—2 Tuning Condensers, Cardwell Taper Plate, Type 169E. 9.50
- 2 National Dials. 5.00
- C3—1 Neutralizing Condenser,

- Precise Type 940, 10-Mmfd. \$1.25
- C4—1 Regeneration, Condenser, Precise Type 940, 50-Mmfd. 1.50
- C5—1 Isolating Condenser, Tobe Deut-schmann, 1-Mfd.90
- C6—1 Protective Condenser, Sangamo, 0.001-Mfd.35
- R1—1 Filament Ballast, Brach 1/2-Amp. 1.00
- R2—1 Volume Control, Electrad Roy-alty Variable Resistance, 0-500,000 Ohms, Type L. 1.50
- 1 Tap Switch, 4-Point, Yaxley Type 44. 1.00
- 1 Cable Connector and Plug, Yaxley No. 660. 3.50

MATERIAL FOR THE METAL CABINET

- 7-1/2" x 3/8" Oval-Head Nickel-Plated Machine Screws, with Hex Nuts (for Front Panel Mounting).14
 - 1/2 Doz. 1/2" x 3/8" Round-Head Brass Machine Screws with Hex Nuts (for Parts Mounting).12
 - 2-1" x 3/8" Round-Head Brass Machine Screws with Hex Nuts (for Coil Mounting).04
 - 1 Gross 1/4" x 3/8" Round-Head Nickel-Plated Machine Screws with Hex Nuts (for Cabinet Assembly). 1.50
 - 36 Inches 1/2" x 1/16" Flat Brass Strip.40
 - 96 Inches 1/2" x 1/16" Angle Brass. 1.00
 - 1 Walnut Grained Aluminum Panel 7" x 14" x 3/8". 1.25
 - 1 Sheet, Aluminum Box Material 18" wide x 48" long x 3/32" thick. 3.00
- Total \$47.45

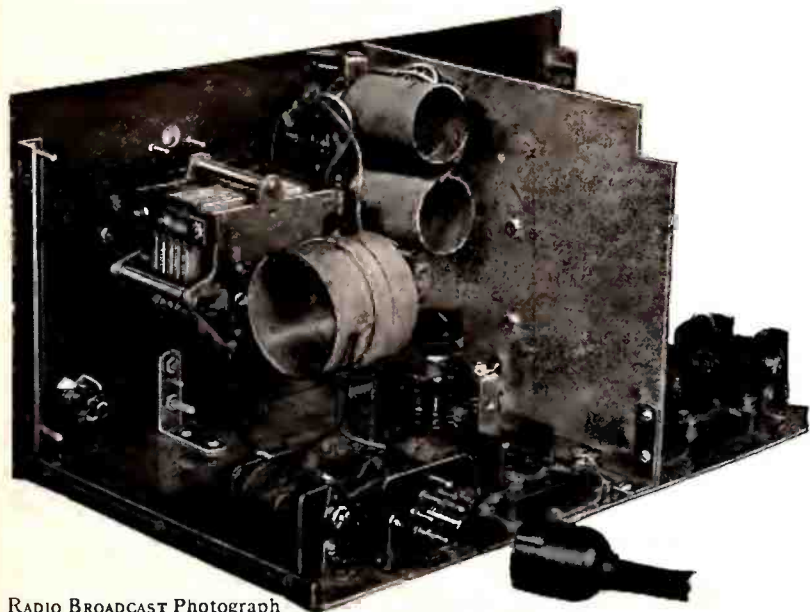

RADIO BROADCAST Photograph

THE ANTENNA STAGE COMPARTMENT

Is shown here with its associated apparatus. Note that only one wire connection is made to the filament switch. The frame of the switch is fastened directly to the panel which is at ground potential and, since the battery is connected to the minus A terminal of the connector plug, which is also grounded, the circuit is completed



RADIO BROADCAST Photograph

THE CORBETT TABLE CABINET

Houses the audio amplifier and power-supply unit, A battery, and trickle charger, presenting to view only the two-tube tuner unit and loud speaker

LETTERS FROM READERS

Contributions from Readers on Various Subjects
of Radio Interest—An Open Forum for All

No Thistles in This Bouquet!

RADIO BROADCAST receives many letters from its readers—both of commendation and condemnation. Either are welcome. Mr. Goddard's credentials, we feel, qualify him to wax verbose should the cause arise, so we feel particularly complimented by his "straight from the shoulder" remarks in his letter of recent date:

Editor, RADIO BROADCAST,
Doubleday, Page & Company,
Garden City, New York.

SIR:

RADIO BROADCAST seems to cover every possible phase of the radio subject in a manner that shows splendid editorial work, and presents a great contrast to the many radio magazines with which the newsstands are flooded. Being in the printing game myself, I can also appreciate the really remarkable way in which the magazine is gotten up. Honestly, words fail me when I try to describe my feelings—and this is not applesauce, either.

I have been very busy for some weeks, and fear that I will have but little time in the near future, but you may rest assured that I shall keep an ear cocked for 2 CY (the experimental station of RADIO BROADCAST) on 7500 kc. (40 meters), and will surely be glad to report the signals. I hear you are using 250 watts now; that should pack a lusty clout out here on that wavelength!

Very truly yours,
H. J. GODDARD (9 EE),
Ellendale, North Dakota.

The Short-Wave Super-Heterodyne

RADIO BROADCAST is always glad to hear from any one who has been helped out by articles which have appeared in the magazine. The thought that the regenerative set (when used with short waves on c. w. work) is in reality a super-heterodyne, is one which may lead eventually to further study of the peculiar problems of the amateur:

Editor, RADIO BROADCAST,
Doubleday, Page & Company,
Garden City, New York.

SIR:

The article in the November RADIO BROADCAST by Mr. George J. Eltz, Jr., with its frank discussion of the disadvantages as well as the merits of the short-wave "super," has helped me to straighten out my ideas with regard to what is and what is not needed in a short-wave receiver.

The fact that the usual "ham" receiver has always been called "regenerative" has been misleading. When used for phone reception, of course, such a receiver is a regenerator, but, when used for c.w., the ordinary "ham" receiver is a super-heterodyne of the sort best adapted to present-day conditions. The first detector and oscillator are in the form of an autodyne, eliminating a tuning control so that we are able to add a control (regeneration control) for regulating the strength of the heterodyne. This increases

the sensitivity of the receiver and decreases radiation.

The intermediate frequency happens to be so low that it is audible, which has three distinct advantages: The autodyne is more efficient because we can tune closer to the signal frequency. The necessity for a second detector and another heterodyne is removed because we can listen to the intermediate frequency itself. We get no long-wave QRM.

Audio amplification simply consists of further amplifying the intermediate frequency—already audible.

Is it a super-heterodyne? I believe it is.

Mr. Eltz's receiver is more sensitive and produces louder signals than the "ham" variety, but the latter could be made to give the same results if it were desirable!

Any signal too weak to operate the first detector is, of course, lost to either kind of receiver. A signal which operates the first detector, but is too weak to make an impression on the untuned, non-regenerative transformer of the "ham" receiver, may be picked up and amplified by Mr. Eltz's tuned, regenerative transformers.

Here is the point: Tuned, regenerative, audio frequency transformers can be used in our "ham" receivers, but we do not want to use them at present. There are hundreds of wobbly notes on the air at present on the 7500-kc. (40-meter) band which would not stand for a peaked transformer. When the great majority of amateur stations are using crystal control (or its equivalent), we can and shall use tuned regenerative audio stages. The result will be a receiver which is even more sensitive than Mr. Eltz's super-heterodyne.

To produce louder signals, more audio stages can be added, the limit being the noise level at the location in question. In my own case, any signal which is above the very high noise level is a good loud signal with only one stage of audio.

It might be better if the attention of the experimenters be devoted to more pressing problems such as non-radiating short-wave receivers, five-meter (60,000 kc.) work, steadier signals, etc.

Very truly yours,
JAMES T. McCORMICK (9 BHR),
Topeka, Kansas.

More About "Pirating"

IT IS a far cry from the pirates of olden days to the modern pirates who are providing chaos in the air by promiscuous broadcasting on whatever wavelength they may happen to choose. There was a certain amount of glamour attached to the old pirates, while the modern ones on the other hand remind one of the mischievous pranks of the small boy who destroys other peoples' pleasure with a total disregard for their feelings. The whole procedure is rather childish when you stop to think of it, and those stations who are causing annoyance are merely cooking up a dish which they will have to eat later, and without relish. Readers in various parts of the country continue to send in complaints regarding the matter. Heterodyning between stations is more than frequent, and is not confined to isolated communities. RADIO BROADCAST

has always taken a rather firm stand on this question, and we are glad that our readers agree with us. Here are two letters which express unmistakably the feelings of the writers:

Editor, RADIO BROADCAST,
Doubleday, Page & Company,
Garden City, New York.

SIR:

I read all of the radio magazines more or less regularly and find some good features in all, but it seems to me that RADIO BROADCAST is far and away the superior in the field, both in the standard maintained by the advertising department (which is truly appreciated) and in the interest of the reading matter.

I should like to air my views about the switching of wavelengths by broadcasters without Secretary Hoover's permission. The average listener with a sensitive set has had enough interference between stations in the past without suffering any further increase.

Some contend that all should have equal rights in the broadcast field and make watchwords of "monopoly" and "censorship." My notion is that the pioneer developers of radio broadcasting, such as the Radio Corporation, Westinghouse, Western Electric, and others, have as much right to their wavelength as the man who discovers a gold field and gets first choice of claims there. These companies risked their money when the returns were uncertain, and they should be protected now that others are rushing in to obtain some of the benefits of their pioneering.

As to censorship, the second catchword, as long as stations, such as WVEF, WJZ, KDKA, WLW, WSAI, and certain others continue the type of program they have been giving, let there be that kind of censorship. Whenever the censorship fails to give the people what they want, you will hear from the people, rather than from other broadcast stations and reformers.

Very truly yours,
JAMES B. TANEY,
Salem, Virginia.

And here, is the other one:

Editor, RADIO BROADCAST,
Doubleday, Page & Company,
Garden City, New York.

SIR:

If last night (October 30, 1926) was a criterion of the coming winter in radio, God help the poor radio fan. Talk about interference!

We have three stations in Boston, and our favorite, WEEI, was broadcasting the Balkite Hour, with Mr. Damrosch conducting. At 9:15 another station started up, possibly WLS, Chicago, and we had the joyous combination of Mr. Damrosch, a sweet heterodyne whistle, and a background of distorted but audible jazz.

About the other stations: WNAO heterodynes beautifully with WSB. Broadcaster WBZA has three stations which heterodyne it, two in Chicago, and one somewhere else. There were eleven cases of heterodyning on the short-wave band below WPG, Atlantic City, not counting the locals.

Does the radio industry need laws to save itself? No one needs a radio receiver to listen to whistles, and if that is all we are to hear, the set might as well be in the ash heap.

Very truly yours,
HAROLD A. STURGES,
South Hamilton, Massachusetts.

NATIONAL

POWER AMPLIFIER

Makes any Radio Set the last word in Fidelity of Reproduction and Eliminates all B and C Batteries.



PERFECTION OF QUALITY OF REPRODUCTION, AND ELIMINATION OF B AND C BATTERIES—are the two requirements of the discriminating Radio owner of today. Both are met in the NATIONAL Power Amplifier, now announced for the first time.

The NATIONAL Power Amplifier supplies a new and thoroughly modern audio amplifier for any Radio set. It incorporates in the same unit a complete B-Supply and C voltage for the power-tube. Once adjusted, it requires no further attention and may be placed in the cabinet beneath the Radio set.

It is designed to operate directly from the detector tube of any present Radio Receiver. The audio tubes in the receiver are removed and no longer used in that place. In their stead, the audio tubes of the power amplifier pass on the detected signal to the loud-speaker at any desired volume, which may be sufficient to fill a large hall, still without any impairment of tone or quality.

The NATIONAL Power Amplifier has been developed on sound engineering lines in collaboration with ARTHUR H. LYNCH and JAMES MILLEN, Mr. Lynch having contributed especially to the Amplifier and Mr. Millen to the Power-Unit design. Its three-tube audio-amplifier contains one stage of NATIONAL Impedaformer and two stages of Lynch resistance-coupled amplification, using TOBE Coupling Condensers. The first two tubes are high-mu tubes of Ceco make, the semi-power tube a UX-171 or CX-371, out-putting through a NATIONAL Tone Filter for protection of the speaker windings and improvement of quality. The constants used in the audio circuit are such as to give a reality of speaker output, which is limited only by the quality of broadcasting being received. In other words, this amplifier is so nearly perfect that the responsibility for quality when using it is up to the broadcasting station rather than the set.

Examined and approved by RADIO BROADCAST

B-POWER SUPPLY KITS **NATIONAL** **POWER AMPLIFIER KITS**

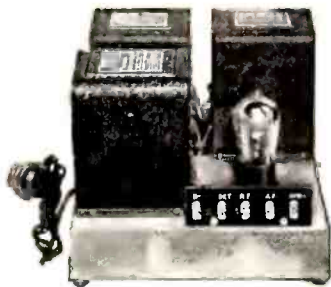

NATIONAL B-Power Unit
Type M

The Power Units are mounted on a cored and drilled cast metal base with the amplifier. The NATIONAL Power-Transformer carries windings suitable for use either with the new Raytheon BH 80-mil tube or the Rectron UX-213. It also carries a winding for lighting the filament of the power-tube direct from A.C. The Special NATIONAL TOBE B-BLOCK employs extra high-voltage short-path condensers, necessary when so much voltage is being handled. The Filter-Chokes are wound with large wire,—much larger than usual, and the iron cores are exceptionally heavy. These power units will carry 80 mils continuously without heating or damage,—a very high rating. TOBE Buffer Condensers are used. Variable C-voltage for the power tube bias and variable B-voltage for detector and R.F. tubes is supplied at the terminal strip, through Electrad Royalty and Clarostat Variable Resistances. There is a solidity and excellence of appearance in these B-Supply Units which is a true reflection of the careful engineering design and quality of materials packed within them.

NATIONAL Power Amplifier Kit (Type L-3)

The NATIONAL Power Amplifier is put up in complete kit form by the National Company, except audio tubes, which will in most cases be already in the possession of Radio owners. Even the wire is included in the kit and full instructions for assembling. The whole unit may be easily assembled in one evening.

Price—NATIONAL Power Amplifier Kit, Type L-3
complete with Raytheon BH Tube..... \$84.00

Price of kit as above but completely assembled, ready to run....\$95.00

The NATIONAL B Power-Unit Kit (Type M)

To meet the large demand for a reliable and rugged B Power Supply unit, free from difficulties associated in so many minds with such devices, National Company also offers a complete kit with Raytheon BH Tube. This is also provided with a cored and drilled metal base, all necessary wire, and can be assembled in a few hours. It employs the same fine units as the NATIONAL Power Amplifier,—Power Transformer, NATIONAL Special TOBE B BLOCK and Filter Chokes.

Price—NATIONAL B Supply Unit Kit, Type M....\$60.00

NATIONAL One-Stage Amplifier Kit (Type E-1)

In many cases the Radio owner desires a combined B Eliminator and one-stage power amplifier which can be plugged directly into the output of his present set. The NATIONAL one-stage Power Amplifier meets this need. It contains the same NATIONAL Power-Transformer, NATIONAL SPECIAL TOBE B BLOCK and Filter-Chokes as the other two units described, and in addition, one stage of NATIONAL Impedaformer Power Amplification for use with Type 171 Semi-Power Tube,—an adjustable C bias is also included (using an Electrad Royalty Variable Resistance) and a NATIONAL Tone Filter.

Price—NATIONAL One-Stage Power Amplifier
Kit, Type E-1, complete, with Raytheon BH
Tube, but without power tube.....\$74.00

National Company also sells separately the units used in its B-Supply units and Power Amplifiers.

NATIONAL Equipment for B-Eliminators and Power Amplifiers
NATIONAL Power Transformer

This new unit, for the construction of Power Units, is designed for use with either Raytheon or Rectron Tubes. The secondary carries sufficient voltage to operate the new Raytheon BH 80-mil Tube and the wire is of sufficient size to permit continuous operation for long periods without heating or damage. The transformer has center-tapped 7.5 volt and 5.5 volt secondaries, for heating the filaments of rectifier tubes or of power tubes, whether of the UX-210, UX-112, or UX-171 type. This makes the transformer adaptable without change to a number of different rectifier and amplifier circuits.

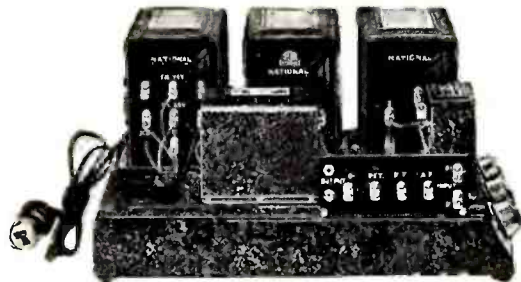

NATIONAL One-Stage
Amplifier
Type E-1



NATIONAL Power-Amplifier
Type L-3

NATIONAL
B-POWER AND AMPLIFIER KITS

Examined and approved by RADIO BROADCAST

B-POWER SUPPLY KITS

POWER AMPLIFIER KITS



The unit is cased in a heavy pressed metal box, attractively finished in black crackle. The terminal panel is of Bakelite with special NATIONAL screw-type terminals.

Dimensions: 4 1/8" wide x 4" deep x 4 3/4" high. Built to NATIONAL standards.

Price—with Raytheon BH Tube..... \$22.50 each

Price—without Raytheon BH Tube..... 16.50 each

NATIONAL Filter Chokes (Types No. 35 and No. 80)

These Filter Chokes are made for use in Filter Circuits of plate-supply units.

Type No. 35 contains two iron core inductances and is designed for a maximum continuous output of 35 mils. This is sufficient for the average 5 tube set, with or without one power-tube.

Dimensions: 2 5/8" x 4" x 3 1/4", finish and type of case to match the NATIONAL Power Transformer.

Price—Type No. 35..... \$7.00

The NATIONAL Filter Choke Type No. 80 is a larger unit containing two iron core inductances wound with larger wire than the Type No. 35 and with larger cores, and capable of handling up to 80 mils continuously, as with the new Raytheon BH Tube.

Dimensions: 4 1/8" x 4" x 4 3/4". Cased to match the NATIONAL Power Transformer.

Price—NATIONAL Filter Choke No. 80..... \$10.00

Tope Special B Block

built for use with NATIONAL B Eliminators and Amplifiers

This Special TOBE B BLOCK, designed expressly for the NATIONAL B Eliminators and Amplifiers, contains TOBE High-Voltage short-path Type Condensers, suitable for working voltages up to 400-volts D.C. The case matches that of the Power Transformer in shape and size. This condenser block is not guaranteed for use with UX-216-B tube when more than 400 volts is being rectified with it (a higher voltage condenser block is required for this purpose; prices sent on request).

Dimensions: NATIONAL 4 1/8" x 4" x 4 3/4".

Price—TOBE SPECIAL B BLOCK..... \$17.50 each

NATIONAL Tone Filter

The plate voltages now required with either the UX-171, UX-112 or UX-210 Power Tubes, for fine quality of reproduction, range from 180 volts upward. The makers of the tubes recommend passing the output to the loud speaker through a Tone Filter. The NATIONAL Tone Filter is designed for this purpose. It contains an impedance of the proper value through which the plate of the Power Tube is supplied, and which will carry as high as 35 mils continuously without heating or deterioration. Also cased in the Tone Filter is a 2 Mfd. TOBE Filter Condenser, through which the A.C. component of the power tube output passes to the speaker. With this NATIONAL Tone Filter all D.C. is kept out of the speaker windings, thus preventing them from burning out, and at the same time the quality of the output is greatly improved, because no force is exerted on the speaker armature, except that due to the signal. Cased to match the other NATIONAL B-Power units, supplied with 5-foot phone cord, for instant attachment to any existing set.

To install put the tips on the end of the phone-cord plug in speaker jack on the set and insert speaker cord into the two tip-jacks marked LS on the panel of the Tone Filter.

Dimensions: 2 5/8" x 4" x 3 1/4" high.

Price—NATIONAL Tone Filter..... \$8.00 each

NATIONAL products are built to engineering standards of excellence. Anyone who has ever built a set using NATIONAL BROWNING-DRAKE Coils and Transformers knows what that means. Send for Bulletin 116-RB.



National Co., Inc., Engineers and Manufacturers—W. A. Ready, Pres., Cambridge, Mass. Makers of NATIONAL BROWNING-DRAKE Coils and R. F. Transformers, Impedance Transformers, Condensers, Power Transformers, etc., for Radio.



NATIONAL Power Transformer



NATIONAL Filter-Chokes



NATIONAL Special Tope B Block



NATIONAL Tone Filter

NATIONAL

B-POWER AND AMPLIFIER UNITS

Examined and approved by RADIO BROADCAST

B-POWER SUPPLY

NATIONAL

PARTS AND KITS

The
Tube
of
Longer
Life

Recommended by
Leading Authorities
and Specified by
ARTHUR H. LYNCH
for the
**Lynch Power
Amplifier**



CECO

A Type for Every Radio Need



Use Two C_FCo Type "G"
High Mu Tubes
and One CECO Type J71
Power Amplifier



Write for Complete Data Sheet

C. E. MFG. CO., Inc., PROVIDENCE, R. I.

TOBE ★

A Special TOBE B-BLOCK with hi-voltage condensers was chosen for use in the NATIONAL POWER AMPLIFIER. TOBE Buffer Condensers are used in the B-Supply Units also, and each audio-coupling condenser is a 0.1 Mfd. TOBE. The NATIONAL Tone-Filter uses a big TOBE, too.

TOBE Condensers are used because they are good condensers. Ask your dealer for TOBES and TOBE B-BLOCKS.

Tobe Deutschmann Co.

Engineers, Manufacturers,
Importers of Technical Apparatus
CAMBRIDGE MASS.

THE NATIONAL
POWER AMPLIFIER Calls for the



**ROYALTY VARIABLE
RESISTANCE KIT**

Do not confuse the resistances in this kit with other types or values. No others will do. In order to handle the energy in the National Power Amplifier, it was necessary to develop a special resistance of an exceptionally rugged type. When building this amplifier therefore, be sure you ask for the NATIONAL POWER AMPLIFIER

ROYALTY VARIABLE RESISTANCE KIT

Licensed exclusive by Technidyne Corporation
under U. S. Patent 1593685, July 27, 1926.

This kit contains three special Royalty Variable Resistances, packed in an attractive carton. A complete kit, list price \$4.50

Accept no substitutes—insist on the genuine!

ELECTRAD, Inc. 428 Broadway,
New York, N. Y.

Chosen by EXPERTS

GLENN H. BROWNING, Laurence M. Cockaday, Gerald M. Best and many other eminent radio designers use the Lynch Metallized Resistor in their experimental circuits and receivers. These men know radio; they have laboratory and testing equipment with which quickly to make accurate comparisons. There could be no better proof of the true merit of the Lynch Metallized Resistor than the endorsement of these experts.

Comprising a concentrated metallized deposit one-thousandth of an inch thick upon a rigid core, sealed forever within a glass tube, the Lynch Metallized Resistor gives conductive, non-arcing resistance that remains silent, accurate!

Guaranteed accuracy—10%; in production they average 5%. .25; 5: 1; 2; 3; 4; 5; 6; 7; 8; 9; 10 Meg., 50c. .025; .09; .1 Meg., 75c. Single mounting 35c; Double, 50c. If your dealer cannot supply you, send stamps, check or money order. We ship postpaid same day order is received.

PRICES:
.25 to 10 Megohms .50. above .01 to .24 Megohms .75
.001 to .01 Megohms \$1.00.

Write us for complete list of ranges

Dealers all over the country and abroad are concentrating on dependable Lynch Metallized Resistors—"the line of least resistance," no "grief," and steady turnover—due to adequate advertising. Get on our mailing list; we keep you posted on new developments. Write us to-day!

ARTHUR H. LYNCH, Inc. Fisk Bldg., Broadway &
57th Street, New York

LYNCH
METALLIZED

MEMBER
RMA

FIXED RESISTORS ★

POWER AMPLIFIER

NATIONAL

PARTS AND KITS

CONSTRUCTIONAL DIAGRAM OF THE R.B.' LAB RECEIVER

DEVELOPED AND DESIGNED BY

RADIO BROADCAST LABORATORY STAFF

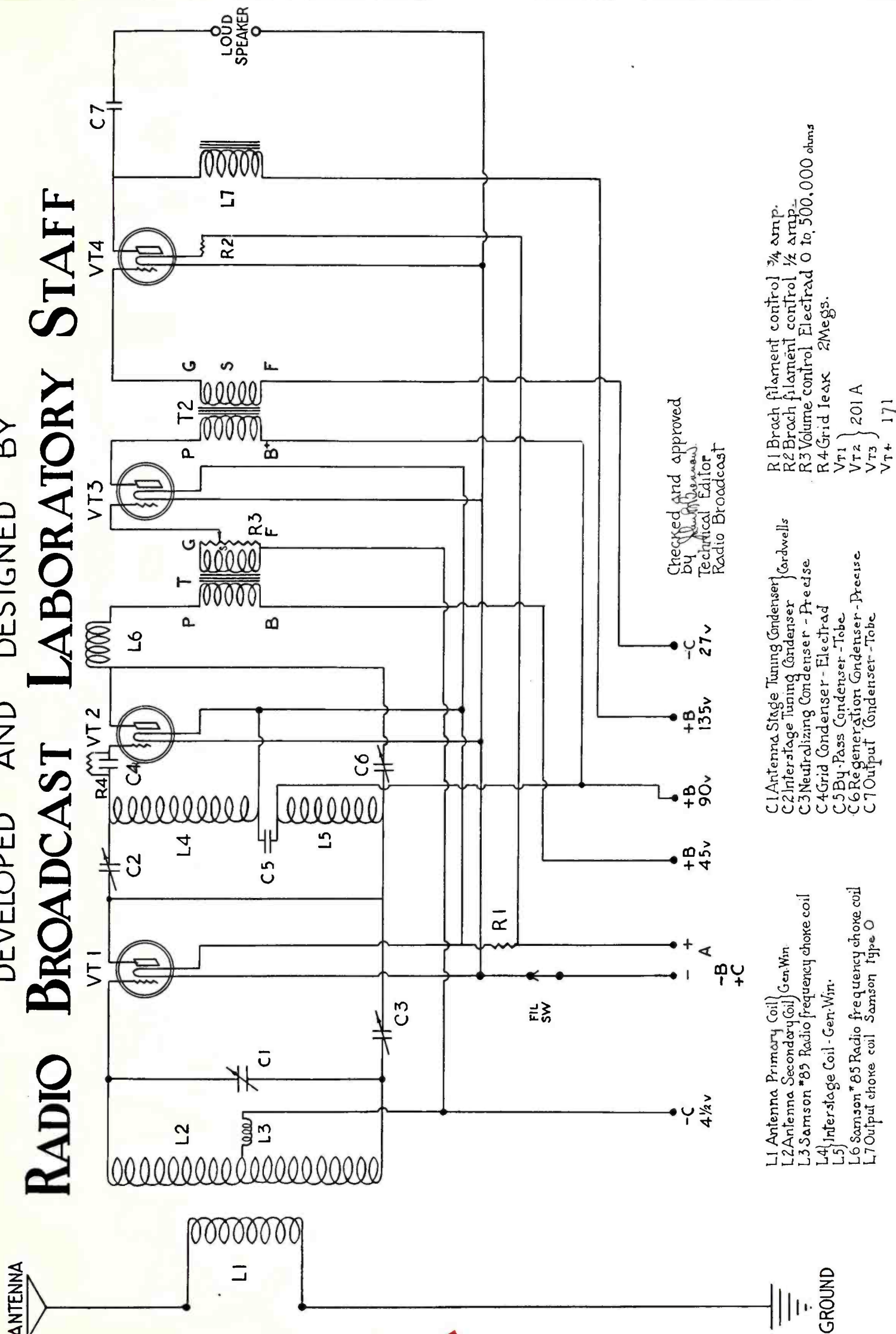

Checked and approved
by *W. H. Newman*
Technical Editor
Radio Broadcast

- R1 Brach filament control 3/4 amp.
- R2 Brach filament control 1/2 amp.
- R3 Volume control Electrad 0 to 500,000 ohms
- R4 Grid leak 2Megs.
- VT1 } 201 A
- VT2 } 201 A
- VT3 } 201 A
- VT4 } 171

- C1 Antenna Stage Tuning Condenser } Cardwells
- C2 Interstage tuning Condenser } Cardwells
- C3 Neutralizing Condenser - Precise
- C4 Grid Condenser - Electrad
- C5 By-Pass Condenser - Tobe.
- C6 Regeneration Condenser - Precise
- C7 Output Condenser - Tobe

- L1 Antenna Primary Coil } Gen-Win
- L2 Antenna Secondary Coil } Gen-Win
- L3 Samson #85 Radio frequency choke coil
- L4 Interstage Coil - Gen-Win
- L5 } 85 Radio frequency choke coil
- L6 Samson #85 Radio frequency choke coil
- L7 Output choke coil Samson type O

CARDWELL-ELECTRAD-PRECISE
GEN-WIN-MARCO-AMERTRAN-BRACH



TOBE DEUTSCHMANN-SAMSON
WESTINGHOUSE-MICARTA-AIRGAP

The 'Lab'

Developed and designed by



Amertran

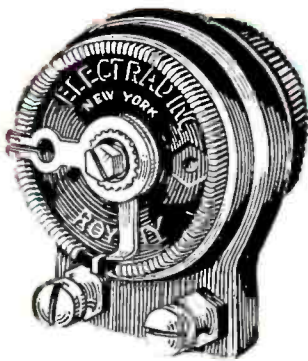

Electrad



Airgap

The Radio Broadcast Laboratory Receiver or as it is popularly called, the R.B. 'Lab' Receiver is not offered as a revolutionary one because everyone who is at all conversant, knows better. It is, nevertheless, a particularly efficient receiver that offers to the constructor and the individual who is desirous of owning a good receiver, as much, if not more, as Radio Broadcast's famous Roberts.

The 'Lab' Receiver is an efficient one—the term “efficient” is not used lightly, by the way—and one in which the owner may depend upon the selectivity that is so imperative in these days of crowded ether land, sensitivity, the requisite of distance reception, is insured; the amplification is not perfect but it is as good as you'll hear anywhere. In short, you'll have some difficulty in finding a home constructed receiver that will even tie it; certainly, you will have no occasion to apologize to anyone for it.

The 'Lab' Receiver will prove worthy of your skill. It is the result of over two years' experimental work on the part of Keith Henney, Director of Radio Broadcast Laboratories. His work was in turn founded upon the original work of Dr. Hull, Bills and others of the Western Electric Company and has been known and used in various fragmentary forms by a number of investigators. The 'Lab' Receiver employs an unusually well designed radio frequency amplifier circuit and is, in addition, perfectly neutralized. Several innovations in design are more satisfactory in practise than the conventional methods. From rather elaborate experiments and tests, it would appear that the four-tube 'Lab' Receiver delivers a stronger quality signal than many receivers employing many more than four tubes. It is, too, an inexpensive receiver, both from a constructional and operation standpoint.

This Receiver has much to recommend it:—it is expertly engineered from an electrical and mechanical standpoint because in design it is predicated on sound premises; it is inherently selective; it insures distance reception; and it delivers a signal of high quality. It is extremely simple to construct; comparatively inexpensive; presents a neat appearance; is but four tubes; and to the individual who wishes to have not only a good receiver but who also has an insatiable desire to experiment, the 'Lab' Receiver offers a plethora of possibilities.

Aside from the fact that the 'Lab' Receiver has much to recommend it, it is unqualifiedly recommended by Radio Broadcast Magazine and Laboratories. A group of nationally known radio manufacturers who are recog-

Write for Constructional Booklet

CARDWELL-ELECTRAD-PRECISE
GEN·WIN·-MARCO-AMERTRAN-BRACH

These names
your guarantee
Quality Products

TOBE DEUTSCHMANN-SAMSON
WESTINGHOUSE-MICARTA-AIRGAP

Receiver

Radio Broadcast Laboratory Staff

nized as leaders whenever radio is discussed recommend it. Even the laboratories of several of these manufacturers have been experimenting and working on the original papers and results achieved. This work wasn't done in collaboration with Radio Broadcast Laboratories but it is significant that the decisions reached regarding the finished receiver were the same; namely; that the 'Lab' Receiver as it stands is a darned good receiver.

The different pieces of apparatus used in the laboratory models of the 'Lab' Receiver are the result of careful selection and much experimentation and testing. As a result any deviation from the list of specified parts will tend to diminish the effectiveness, efficiency and results of which the receiver is capable. Insist on these parts. If your dealer can't supply you write directly to the manufacturer or to the business office of Radio Broadcast.

These major parts were used in the experimental models of the 'Lab' Receiver:

- 2 Cardwell 0.00035 mfd. Variable Condensers, type 169E.
- 3 "Lab" Circuit Tuning Coils, General Winding.
- 2 Marco Illuminated Dials.
- 4 Sockets, Airgap.
- 2 Amertran Audio Frequency Transformers, 1st and 2nd stages.
- 1 X L Neutralizing Condenser, type N.
- 2 Samson Choke Coils—85 millihenries.
- 1 Samson Output Impedance, type 0.
- 1 Tobe Deutschmann By Pass Condenser, 1 mfd.
- 1 Tobe Deutschmann Output Condenser, 4 mfd.
- 1 Electrad Royalty Variable Resistance, 500,000 ohms.
- 1 Electrad Filament Switch.
- 1 Electrad Grid Condenser, 0.00025 mfd.
- 1 Electrad Fused Metallic Grid Leak, 4 megohms.
- 2 Brachstats, 1/2 ampere and 3/4 ampere.
- 1 Precise Microdenser, type 940, 50mmf.
- 9 X L Binding Posts.
- 1 Binding Post Strip.
- 1 Panel 7 x 21 x 3/16 inches.
- 1 5-wire fused Belden Battery Cable Cord.
- 1 Fritz Cabinet.

Write for Constructional Booklet



Samson



Gen-Win



Tobe



Cardwell

CARDWELL-ELECTRAD-PRECISE
GEN-WIN-MARCO-AMERTRAN-BRACH



TOBE DEUTSCHMANN-SAMSON
WESTINGHOUSE-MICARTA-AIRGAP

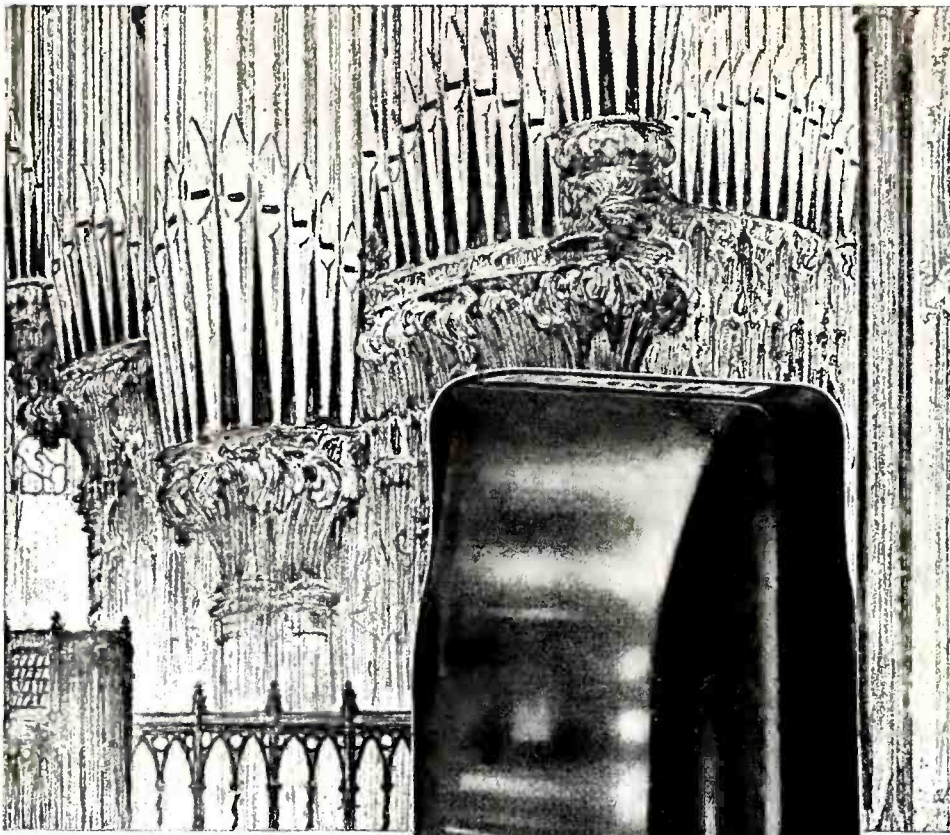

Majestic Melody

"to cheat thee of a sigh or charm thee to a'tear"
is easily yours if your set has a

Samson Output Impedance

and other Samson Audio Units which give the most satisfying results to those who are particular and critical of music.

The Samson Output Impedance is used in the output of an amplifier with a condenser to keep the direct current out of the "speaker". Greater volume is handled without distortion and the "speaker" is protected from demagnetization or having its coils burnt out even though power tubes such as the UX-210 are used.

Other Samson Audio Units insure Majestic Melody through keeping radio and audio frequency currents separate and out of the "B" battery, and by insuring the amplification of rich deep bass and high treble notes that are usually muffled or lost.

Symphonic Transformers		\$9.00
Push-Pull Input Transformer	Type X	5.50
Standard Transformers	Type HW-A3 Ratios, 2-1, 3-1, 6-1	5.00
Dual Impedance	Type D, Donle Design	5.00
Output Impedance	Type O	5.00
Push-Pull Output Impedance	Type Z	5.00
Plate Impedance	Type P	4.50
Grid Impedance	Type G	4.50
Audio Frequency Choke	Type No. 3	3.25
Radio Frequency Choke	No. 85	2.00
Radio Frequency Choke	No. 125	2.25

Our book—"Audio Amplification"—already accepted as a manual of audio design by many radio engineers, contains much original information of greatest practical value to those interested in bettering the quality of their reproduction. Sent upon receipt of 25 cents.



Samson Electric Company

Manufacturers since 1882

MAIN OFFICE — CANTON, MASS.

To build the same set — use the same coils



Patent Pending

Specially designed for the RB'LAB' Receiver

The latest and finest achievement by the Radio Broadcast Engineers is here — The R. B. Laboratory Shielded Receiver. To build this marvelous receiver use GEN-WIN coils shown above. They are designed and built to the specifications of Radio Broadcast engineers; therefore, they are the correct coils, no others will or can get you the same result. Daily we receive testimonial letters acclaiming these coils for their most perfect performance. Like all GEN-WIN products these coils are unconditionally guaranteed.

\$8.50 Kit of 3 Coils

At Your Dealers or Postpaid

General Winding Co.

Incorporated

214 Fulton St., New York, N. Y.

CARDWELL-ELECTRAD-PRECISE
GEN-WIN-MARCO-AMERTRAN-BRACH



TOBE DEUTSCHMANN-SAMSON
WESTINGHOUSE-MICARTA-AIRGAP

Examined and approved by RADIO BROADCAST

ALUMINUM IS A NECESSITY IN RADIO



The R. B. Lab. 2-Tube Receiver—is an example of advanced design, with its aluminum cabinet. The aluminum panel combines practical shielding with the beauty of the finest walnut



Today the crowding of the air by broadcasters and local interference from thousands of receivers make shielding essential. Radio Experts, Manufacturers, Designers, Enthusiasts, have turned to aluminum for shielding because its properties permit the effective elimination of many of the hazards to perfect reproduction. By using aluminum for top, base, sides and center inter-stage shield the designer of the R. B. Lab. 2 Tube Receiver has created an effective combination of strength and lightness achieving complete shielding. The $\frac{3}{8}$ " sheet aluminum panel is a photographic reproduction of a rare piece of walnut. Other 1927 receivers such as the Hammarlund-Roberts, Silver-Marshall, L. C. 27 and A. C. Varion specify aluminum for shielding. Alcoa Wing-type Aluminum Shields prevent interstate interference and give the set-builder an effective and economical method to shield his hook-up. Can-type Shields made of aluminum are fully effective—individually protecting the various stages. The unique shielding value of Alcoa Aluminum is due to its uniform purity and the corresponding low electrical resistance. Used for cabinet, and panels Alcoa Aluminum also is extremely light, is easily worked and may be finished in the most beautiful wood effects in graining and color.

ALUMINUM COMPANY of AMERICA, Pittsburgh, Pa.

Here are some of the Applications

Aluminum Sheet for

- Alcoa Shields
- Box Shields
- Cabinets
- Chassis
- Diaphragms and Loud Speaker Parts
- Panels
- Stampings
- Variable Condensers

Aluminum High-purity Rods for Chemical Rectifiers

Aluminum Sand and Die-Castings for

- Variable Condensers and Plates
- Frames
- Loud Speaker Parts

Aluminum Screw Machine Products

Aluminum Foil for Fixed Condensers

ALCOA



TRADE-MARK

Only the genuine bears this mark

ALUMINUM—THE BEST IN RADIO

A L C O A

—THE BEST IN ALUMINUM

Booklet

"Aluminum Radio Shields"

A treatise by Cockaday and Free on Radio Shielding

ALUMINUM COMPANY OF AMERICA
Room 2319, Oliver Building, Pittsburgh, Pa.

Gentlemen:

Please send me a complimentary copy of the booklet checked on this coupon.

Name

Street

City

Circuit I now use

Circuit I will build next

Booklet

"Aluminum for Radio"

Describes the general application of Aluminum to radio.

Check the square for one, or both, of the booklets you wish.

★ Examined and approved by RADIO BROADCAST ★

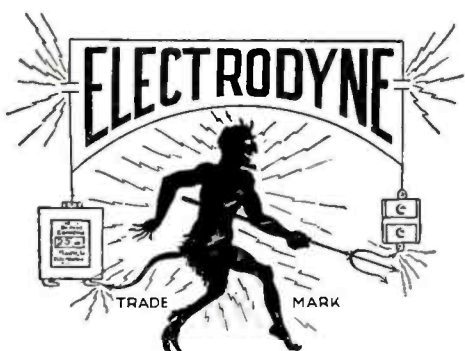

The Heart of a Good "B" Eliminator

ELECTRODYNE "B" BLOCK

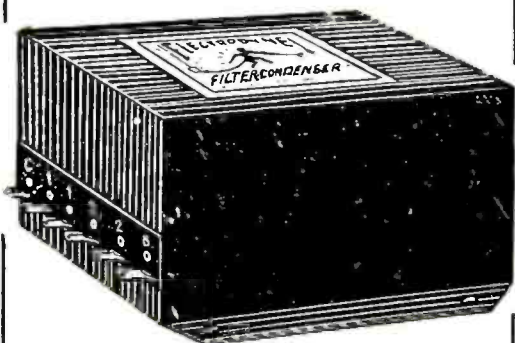

Get This Point

Electrodyne engineers have contributed a new "B" Block for "B" Eliminators. Utmost care is taken to drive out every particle of moisture, thus making it "moisture-proof." The condensers are rugged and made with the greatest precision which gives the "B" Block long life.

Engineers and many other satisfied users have endorsed it because it is technically right, because it makes a "B" Eliminator operate with steady power. Radio fans like it because it satisfied their requirements and makes a telling effect on the tone quality of their sets.

They vary in capacity and price from \$9.00—\$11.00

Electrodyne By-Pass and Filter Condensers

Guaranteed to stand 600 and 1000 volts respectively according to our laboratory standard. Electrodyne condensers are guaranteed to hold their charge for days. Prices according to capacity from 60c to \$7.50



★ Electrodyne Fixed Mica Condensers



Electrodyne fixed mica condensers are sealed in a moisture-proof insulating compound which guarantees absolute freedom from moisture. This means clarity in reception. Prices according to capacity vary from 25c to 95c.

If your nearest dealer cannot supply you write to us direct

Manufacturers write us for our special offer

ELECTRODYNE CO., Inc.
2378 Third Ave., N. Y. C.

The Radio Broadcast LABORATORY INFORMATION SHEETS

INQUIRIES sent to the Questions and Answers department of RADIO BROADCAST have until recently been answered either by letter or in "The Grid." The latter department has been discontinued, and all questions addressed to our technical service department are now answered by mail. In place of "The Grid," appears this series of Laboratory Information Sheets. These sheets contain much the same type of information as formerly appeared in "The Grid," but we believe that the change in the method of presentation and the wider scope of the information in the sheets, will make this section of RADIO BROADCAST of much greater interest to our readers.

The Laboratory Information Sheets cover a wide range of information of value to the experimenter, and they are so arranged that they may be cut from the magazine and preserved for constant reference. We suggest that the series of Sheets appearing in each issue be cut out with a razor blade and pasted on filing cards, or in a note book. The cards should be arranged in numerical order. Several times during the year, an index to all sheets previously printed will appear in this department. The first index appeared in November.

Those who wish to avail themselves of the service formerly supplied by "The Grid," are requested to send their questions to the Technical Information Service of the Laboratory, using the coupon which appears on page 318 of this issue. Some of the former issues of RADIO BROADCAST, in which appeared the first sets of Laboratory Sheets, may still be obtained from the Subscription Department of Doubleday, Page & Company at Garden City, New York.

No. 57

RADIO BROADCAST Laboratory Information Sheet

January, 1927

What is Resonance?

A ELECTRICAL ANALYSIS

IT HAS frequently been said that, in order to receive any particular station, we must tune the various circuits of our receiver to resonance with the incoming frequency. We shall endeavor, in this sheet, to explain what is meant by resonance.

In the accompanying sketch, first refer to "A." Diagram No. 1 is a simple circuit consisting of some source of alternating voltage, marked E, in series with a condenser. The reactance or impedance offered by the condenser to the flow of current depends upon the frequency, and, if we plot a curve showing the change of reactance with frequency, we will get a curve similar to that marked C, in "B." As the frequency increases, the reactance of the condenser decreases, and the curve approaches the zero line. Capacitive reactance is usually considered negative, as shown, in order to indicate that it is opposite in effect to the inductive reactance.

If the condenser in the circuit is replaced by a coil of wire, or inductance, as shown in No. 2, "A," we find that the inductive reactance increases with an increase in frequency which is shown by the curve marked L on "B."

Now, if we connect both a condenser and an inductance in a circuit as shown in No. 3, "A," we will have a combination of the effects produced by both of them. Remembering that the effective resistances or impedances

are opposite in sign, we may add the two curves together and the result will be a curve, such as that marked "Total Reactance" in "B." At one point we notice that the line passes through zero, this point being indicated by the dotted line marked R. In other words, at this point, the total reactance in the circuit is zero, the reactance which is due to the condenser cancelling out the reactance due to the inductance.

When a circuit is tuned to resonance, the capacity and inductance are so proportioned that their effect in the circuit are nullified, and, as more current will flow in a circuit of least resistance or reactance, the combination will offer very little opposition to the currents having a frequency of R in the diagram but will offer considerable resistance to any other currents having a different frequency

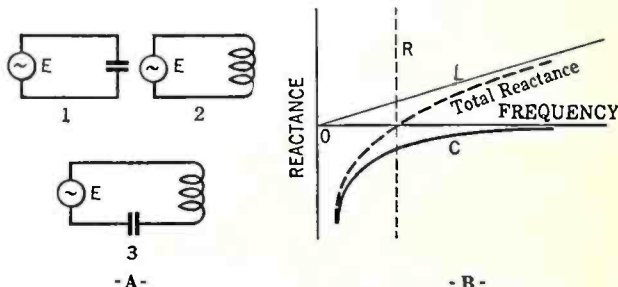

No. 58

RADIO BROADCAST Laboratory Information Sheet

January, 1927

The UX-171 and UX-210

A COMPARISON

BOTH of these tubes are suitable for use in the last stage of audio amplification, but under certain conditions one tube is to be preferred over the other.

By glancing at the table, it will be seen that the output resistance is lower for the 171 than the 210 for all values of plate voltage. The greatest transfer of energy occurs between a tube and a speaker when their impedances are matched. As most loud speakers have very little impedance at low frequencies, it is advantageous to use a tube such as the 171 which has a very low plate impedance.

This compensates to some extent the low amplification factor of 3. From the figures given for the maximum undistorted output, it can be seen that, with 180 volts on the plate, the 171 will deliver to the load 700 milliwatts of power. This is about the same power as can be obtained from a 210 with about 300 volts on the plate. However, at 425 volts, the 210 is capable of delivering more than twice the undistorted power of a 171. It is quite evident then, that the 171 is somewhat to be preferred for ordinary signal strength such as is needed in the home, and that for unusual volume, such as concert work in large halls, the 210 would prove more satisfactory.

TUBE	GRID VOLTS	PLATE VOLTS	OUTPUT RESISTANCE	MAXIMUM UNDISTORTED OUTPUT (MILLIWATTS)	AMPLIFICATION FACTOR	PLATE CURRENT
UX-171	16.5	90	2500	130	3	10
	27	135	2200	330	3	16
	40	180	2000	700	3	20
UX-210	4.5	90	9200	18	7.5	3
	9	135	8000	65	7.5	4.5
	10.5	157.5	7400	90	7.5	6
	18	250	5600	340	7.5	12
	27	350	5100	925	7.6	18
	35	425	5000	1540	7.7	22

Father Time Says:



Westinghouse manufactures, also, a complete line of radio instruments and the Rectigon Battery Charger.

You're Sure with **MICARTA** REG U S PAT OFF **RADIO PANELS**

It was back in 1904 that Micarta first appeared upon the scene as an insulating material far superior to anything heretofore available.

In November, 1920, when KDKA broadcasted its first program, Micarta helped make this epochal event possible.

Since then Micarta has consistently demonstrated its superiority for radio use. It is the real backbone of the set, being used for front panels, sub-panels, terminal strips, tubing, and in many other places where unusual insulating results are called for.

Drill or saw Micarta without a worry. It will not chip or break out. Its deep, permanent finish, in mahogany, black, walnut grain, or walnut burl, adds charm and beauty to the very finest set.

Micarta is used by leading radio manufacturers and has back of it a record dating from the very dawn of the radio era. Ask for Micarta by name.

WESTINGHOUSE ELECTRIC & MANUFACTURING COMPANY
Offices in Principal Cities Representatives Everywhere
Tune in sometime with KDKA—KYW—WBZ—KFKX

Westinghouse

© 1927 W. E. & M. Co.



MICARTA FABRICATORS, Inc.
OF NEW YORK
309 Canal Street
New York City

Fabricators of Micarta
for the Radio Trade

MICARTA FABRICATORS, Inc.
OF ILLINOIS
500 South Peoria Street
Chicago, Ill.

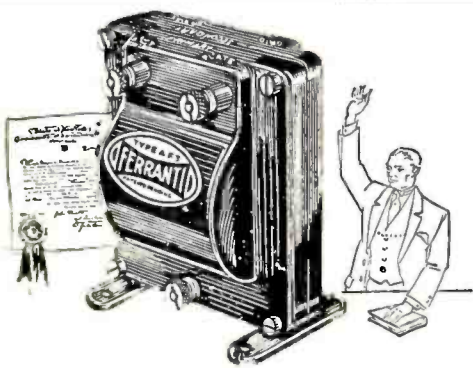

All the Truth and nothing but the Truth!

If your set gives you poor quality, it is telling lies about the sending station. If it fails to transmit those low base notes, it is concealing part of the truth.

You want true reception. You are entitled to it. So is your family. There is a way to get the truth in radio:—

FERRANTI

Ferranti Transformers can probably modernize that old set of yours or improve the reception of even a new one. Your dealer can help you install one or two.

If you want to make the best of the power tube feeding the loud speaker, use Ferranti. If your dealer does not carry Ferranti, write us and we shall tell you where you can get one.

HIGHSPOTS

High amplification ratio with flat curve.

Ferranti brings out the fundamental frequency of low tones—none are heard merely by inference from higher harmonics.

Every transformer tested ten times—all short-circuit turns eliminated.

Windings have high impedance.

Built by an established manufacturing company with forty years' experience in the winding of coils of fine wire for electrical instruments and meters. Primary shunted with built-in condensers of correct capacity.

Tested to 1000 volts between primary and secondary and between primary and secondary and ground.

For the best available transformer results—Ferranti Audio Frequency Transformer A.F. 3—ratio 3½ to 1—\$12.

For a transformer far superior to the average, use Ferranti A.F. 4—ratio 3½ to 1—\$8.50.

FERRANTI, Inc.

130 W. 42nd Street

New York, N. Y. ★

No Better Transformer Is Available At Any Price

No. 59

RADIO BROADCAST Laboratory Information Sheet

January, 1927

What are Harmonics?

THEIR ELECTRICAL CHARACTERISTICS

PRACTICALLY none of the sounds that we hear can be said to be pure, in the sense that they contain only one frequency. Several different persons could all sing the same note and yet the different voices would be easily distinguishable. A violin and a flute might play the same note, but they would sound entirely different.

The factor which causes this difference is the existence in practically all sounds of various harmonics, or overtones, about which something has been said in Laboratory Sheet No. 51. In the present Sheet, we will explain, from an electrical standpoint, what harmonics are.

Acoustically, the difference between a fundamental note and, say, its fifth harmonic is that the pitch of the harmonic is five times as high as the pitch of the fundamental. Electrically, the difference is that, for every time that the fundamental note goes through one cycle, the fifth harmonic goes through 5 cycles. This relation between a fundamental and any of its harmonics always is true, *i. e.*, while the fundamental passes through one cycle, a harmonic passes through a number of cycles, depending upon what harmonic it is; the second harmonic passes through two cycles, the third harmonic passes through three, the fourth through four, and so on.

A cycle comprises one complete alternation of the wave and, therefore, to produce one cycle the wave must start at zero, rise to a positive maximum, decrease to zero, rise to a negative maximum and again decrease to zero.

The sounds created by instruments are practically always very complicated and contain many harmonics. The violin, as an example, produces a very complex note containing a very prominent third harmonic, and many other harmonics as well, while some of the notes produced by a flute are perhaps the purest of any sounds that are generated by musical instruments.

Many amplifying systems are not capable of amplifying the low notes but fortunately a considerable decrease in amplitude in these low frequencies is hardly noticeable to the ear. It is also generally true that the harmonics of these low notes will have the same effect on the ear as the fundamental note. Consequently, if an organ sounded a chord which contained a 30-cycle note and only the second harmonic, 60 cycles, of this note was heard, it would give the same effect to the ear as the fundamental note of 30 cycles. This characteristic, combined with the fact that these low notes are very seldom used, makes it hardly worthwhile to go to any great expense to set up apparatus capable of giving exact amplification of these low frequencies.

No. 60

RADIO BROADCAST Laboratory Information Sheet

January, 1927

Filter Circuit Data

CONDENSER VALUES

SOME interesting data were given in the General Radio *Experimenter* of July, 1926, regarding the characteristics of filter circuits for use with B current-supply devices.

In the diagram, the condenser marked C₁ may be called a reservoir condenser as its function is to store up energy during the peak of the wave and feed it back into the circuit at the lower values of the wave. This condenser is especially valuable in keeping the voltage more nearly constant with varying loads. A small condenser at this point will cause the voltage to drop off very readily with increasing load.

The condenser marked C₂ is placed across the output, and is especially valuable in eliminating any ripple. The curves given on this sheet indicate the effect obtained with different values of condensers in the two positions. It should be noted that an increase in either one of these condensers improves the regulation (curve B and C both showing a decrease over A in voltage drop), due to increasing the size of the load. Curve C shows the best regulation where C₁ is the larger. This indicates that an increase in C₁ is more effective in improving the voltage regulation than C₂. An oscillograph would show that an increase in either condenser would tend to eliminate the ripple, but that less ripple would be obtained by increasing C₂ rather than C₁.

Both experiment and theory seem to indicate that, with a certain total capacity in the current, the best regulation and the least ripple are obtained by making both of the condensers of the same value.

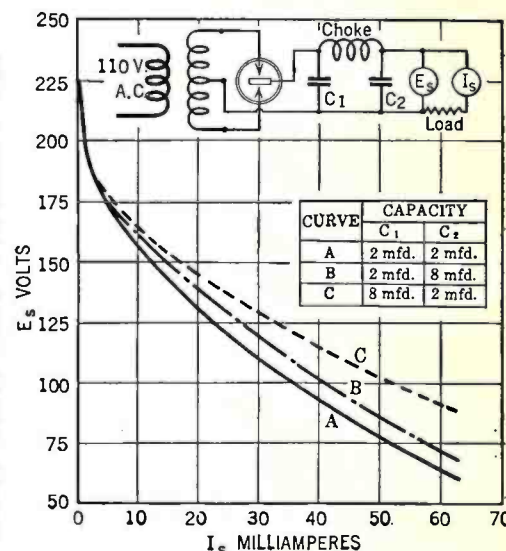

The curves shown are for a single section filter using the Raytheon tube as a rectifier. A multi-section filter would, however, give the same type of curves.

No. 61

RADIO BROADCAST Laboratory Information Sheet

January, 1927

The Intermediate Frequency Amplifier

CHOOSING THE BEST FREQUENCY

THE best operating frequencies for intermediate-frequency amplifiers are 45, 55, 65, etc. rather than 40, 50, or 60. kc.

At the present time, broadcasting stations are supposed to be separated by a frequency of 10 kilocycles. Consequently, it is quite possible for any two stations to be separated, by, say, 40 kilocycles. If two stations, one strong and the other weak, are separated by this amount, it may be quite difficult to completely separate them by means of a single tuned circuit such as a loop. Therefore, both of these frequencies will be present in the loop circuit, and will beat with each other to produce a frequency equal to the difference between their respective frequencies. That is, a station on 500 kilocycles would heterodyne a station on 460 kilocycles to produce a 40-kilocycle note.

Should the intermediate-frequency amplifier happen to be tuned to this frequency, both stations will be heard in the output, even though the oscillator is removed from the circuit. If, on the other hand, the intermediate frequency amplifier is tuned to 45 kilocycles, only the heterodyne beat between the station wanted and the oscillator would be amplified.

We have endeavored to show this idea in the diagram where a 40-kc. intermediate amplifier is used: "A" is the interfering station, "B" is the station desired, and "C" is the wave produced by the oscillator. C is tuned to 540 kilocycles and produces a 40-kc. beat note or heterodyne with the desired signal B which is fed to the intermediate-frequency amplifier. However, at the same time, we will suppose that there is a powerful local station operating on 460 kilocycles (indicated at A), and

the interaction between A and B also produces a 40-kilocycle beat note. The result is, that the station broadcasting on 460 kilocycles will also be heard through the amplifier. When stations whose frequencies are multiples of 10 heterodyne, they naturally produce a beat note which also is a multiple of 10. By designing the intermediate amplifier for a frequency which is not divisible by 10, it will, therefore, exclude beat notes of two heterodyning stations if such are divisible by 10. Hence the desirability of a 45-, 55-, or 65-kc. intermediate amplifier.

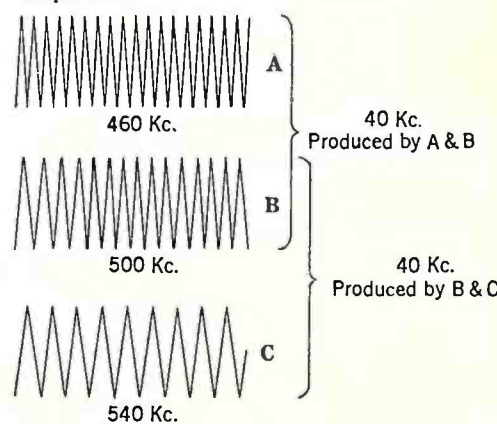

APPROVED BY 18 MONTHS OF PUBLIC USE
NO OTHER BATTERY IS LIKE IT



No. 486
EVEREADY
RADIO "B" BATTERY
45 VOLTS
Layerbilt
NATIONAL CARBON CO. INC.
NEW YORK SAN FRANCISCO
MADE IN U.S.A.

The Layerbilt patented construction revealed. Each layer is an electrical cell, making automatic contact with its neighbors, and filling all available space inside the battery case.

Eveready Layerbilt "B" Battery No. 486, the Heavy-Duty battery that should be specified for all loud-speaker sets.



Practical tests have shown this to be the most economical of "B" Batteries

IN DAILY use in the home, Eveready Layerbilt "B" Battery No. 486 has fulfilled the promises made for it in laboratory tests. More than a year's study of the performance of this battery in the hands of the public has shown that it is the most satisfactory and most economical "B" battery ever developed. All loud-speaker sets require Heavy-Duty batteries—and the Layerbilt has proved itself absolutely the best of them all.

If you are now using the smaller, Light-Duty batteries, the Eveready Layerbilts will give you twice the service though they do not cost anything like twice as much. If you are already using Heavy-Duties, the Layerbilt, the longest lasting Heavy-Duty ever built, will run your set at least 25% longer, and again you will save money. Unless Eveready Layerbilts now are

connected to your set, you spend more on "B" batteries than you should, and you can have no idea how good a "B" battery can be. The Layerbilt holds a surprise in store for you.

Eveready Layerbilt's unequalled service is due to its unique construction. All other dry cell "B" batteries are made of cylindrical cells, with many soldered connections, and a great deal of space is wasted between the cells. The Layerbilt is built up of layers of flat current-producing elements, that make connection with each other automatically, and that fill all available space inside the battery case. It is every inch a battery. In it you get more active materials than in any other battery and the Layerbilt construction makes those materials much more efficient current producers.

Those are the convincing reasons why

the Eveready Layerbilt has proved itself the longest lasting, most economical and reliable "B" battery ever built.

Just remember this about "B" batteries—Heavy-Duty batteries are more economical than the smaller Light-Duty batteries on all loud-speaker sets, and the patented exclusive Eveready Layerbilt No. 486 is the most economical of all.

Manufactured and guaranteed by
NATIONAL CARBON CO., INC.
New York San Francisco
Canadian National Carbon Co., Limited
Toronto, Ontario

Tuesday night is Eveready Hour Night—9 P. M., Eastern Standard Time, through the following stations:

- | | |
|------------------|------------------|
| WEAF—New York | WTAM—Cleveland |
| WJAR—Providence | WWJ—Detroit |
| WEEL—Boston | WGN—Chicago |
| WTAG—Worcester | WOC—Davenport |
| WFI—Philadelphia | WCCO—Minneapolis |
| WGR—Buffalo | WCAE—St. Paul |
| WCAE—Pittsburgh | KSD—St. Louis |
| WSAI—Cincinnati | WRC—Washington |

★ Examined and approved by RADIO BROADCAST ★

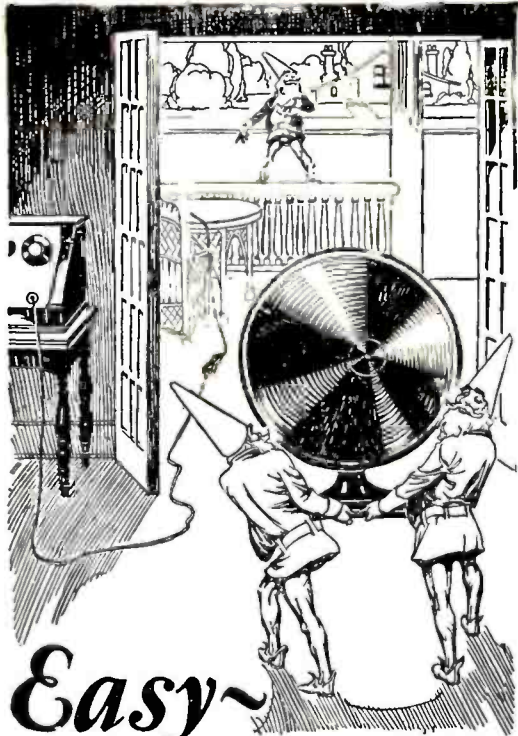

Easy with the E-Z

Now you can have radio entertainment in any room, porch or lawn without disturbing your set! The E-Z Extension Connector hooks up to your set easily and quickly, enabling you to carry the loud speaker anywhere. Exclusive tension slot construction assures positive contact.



Connector only - 35c
 with 20 ft. cord - \$1.25 with 35 ft. cord - \$1.75
 " 25 ft. cord - 1.50 " 50 ft. cord - 2.00

Raytheon Block Condensers

Guaranteed 1000 volt breakdown test. Finest materials and special impregnating compounds embodied in Polymet Block Condensers assure the lasting success of your construction job. Specify Polymet Condensers!

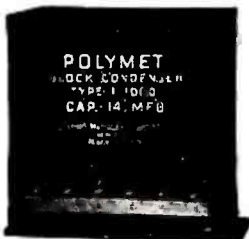

Type 1000-14 Mfd. tapped at 1, 1, 2, 2, 8 . . . \$9.50
 Type 1001-1-C-1 Mfd. . . 2.00

Poly Claro-Plug

Every set deserves one—turns old set into new—improves tone—broadens the range—eliminates scrapes, rasps, hissing. Reduces static.

Over 125 manufacturers of receivers and power units use Polymet Products. THEY KNOW. Follow their lead—specify Polymet Products for best results. At all good dealers everywhere or send direct. Send for illustrated descriptions of all products. FREE on request.

Polymet Manufacturing Corporation
 599 B Broadway - New York City

"World's Largest Manufacturers of Radio Essentials"

POLYMET PRODUCTS

No. 62

RADIO BROADCAST Laboratory Information Sheet

January, 1927

Antenna Power Dissipation

DISTRIBUTION OF ENERGY

THE power supplied by an oscillator to a transmitting antenna, is dissipated in three ways: First, in the form of radiation; second, in the form of heat due to resistance of the wires in the circuit; third, in the form of heat due to dielectric absorption.

Only the first of these factors represents a useful dissipation. This radiation is the power which travels out from the antenna in the form of electromagnetic waves (as signals). Curve A in the accompanying drawing shows how the radiated power varies with the wavelength, it being proportional to the square of the antenna current, and inversely proportional to the square of the wavelength.

Curve B represents the power used up in the resistance of the wires. This is a straight line and does not vary with the wavelength. In actual practice, the eddy current loss and skin effect might be slightly greater at the lower wavelengths, but the variation is so small that it may be neglected.

Curve C illustrates the variation with wavelength of the power absorbed in the dielectric, and, since this absorption is proportional to wavelength, the curve is a straight line. This loss is due to trees, buildings, masts, or other objects in the vicinity of the antenna which absorb power.

Curve D represents the total power in the antenna, and is equal to the sum of the three separate curves. In taking curves such as this on an antenna, it is quite possible to obtain humps at certain wavelengths. This generally indicates the presence of some circuit in the vicinity of the antenna with a natural period of oscillation at that wavelength.

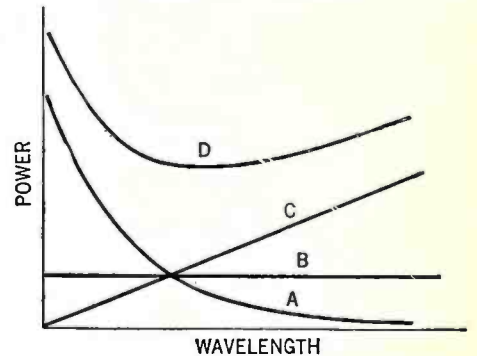

No. 63

RADIO BROADCAST Laboratory Information Sheet

January, 1927

Line Power-Supply Devices

CALCULATION OF RESISTANCE VALUES

IN ORDER to obtain four output voltages from a line power-supply device we will place four resistances, R_1, R_2, R_3, R_4 , in series across the total output of the device. One end of R_1 will connect to the negative B and one end of R_4 will connect to the maximum voltage terminal of the device.

The positive voltage tap, E, for the detector ($22\frac{1}{2}$ or 45 volts) will be taken off between R_1 and R_2 . The voltage, E_2 (generally 90 volts), for an r.f. amplifier, will be taken off between R_2 and R_3 . Voltage E_3 , with a value of, say, 135 volts, will be obtained from a tap connected between R_3 and R_4 . E_4 is the maximum voltage of the unit.

In order to calculate these resistance values, we must assume that a certain amount of current flows through the resistance R_1 . An average value that can be assumed is 5 milliamperes, or 0.005 amperes. If we assume this current to flow through R_1 , and that we desire $22\frac{1}{2}$ volts for the detector, then $R_1 = 22.5 \div 0.005 = 4500$ ohms. If the voltage required is to be 45, then $R_1 = 45 \div 0.005 = 9000$ ohms.

The voltage across R_2 is $90 - 22\frac{1}{2} = 67\frac{1}{2}$, and as the detector plate current at $22\frac{1}{2}$ volts is usually about 0.0005 amperes, this current, plus the 0.005 amperes loss current, flows in R_2 , hence $R_2 = 67.5 \div 0.0055 = 12,300$ ohms approximately. In the case of 45 volts on the detector, the R_2 voltage would be 45 ($90 - 45$) but the detector plate current at 45 volts is now about 0.001 amperes, hence $R_2 = 45 \div 0.006 = 7500$ ohms.

To determine the current in R_3 , we must know the plate current taken by all the tubes operating at 90 volts. Assuming there are two r.f. tubes (UV-201-A) only, the current taken by each when biased at 4.5 volts is 0.002, or 0.004 for both. The voltage across R_3 is $135 - 90 = 45$, and the current flowing in R_3 is $0.005 + 0.0005 + 0.004$ (for a detector plate voltage of $22\frac{1}{2}$), therefore $R_3 = 45 \div 0.0095 = 4750$ ohms approximately. In the case of 45 volts on the detector plate, with 0.001 amperes flowing, we have $R_3 = 45 \div 0.01 = 4500$ ohms.

The current in R_4 is the sum of all the currents plus the current in the plate of the first audio tube (UV-201-A). The plate current in an UV-201-A at 135 volts with 9 volts negative bias is 0.0025 amperes and, in the case of $22\frac{1}{2}$ volts detector, the total current in R_4 is $0.0005 + 0.005 + 0.004 + 0.0025$ or 0.012 total. The voltage across R_4 is $400 - 135 = 265$. Hence, $R_4 = 265 \div 0.012 = 22,000$ ohms approximately.

CASE 1.

- 1 UV-201-A Detector, $22\frac{1}{2}$ volts.
- 2 UV-201-A R. F. 50 volts, Neg. bias $4\frac{1}{2}$.
- 1 UV-201-A A. F. 135 volts, Neg. bias 9.
- 1 UX-210 A. F. 400 volts, Neg. bias 30.
- $R_1 = 4500, R_2 = 12,300, R_3 = 4750, R_4 = 22,000$

CASE 2.

- Same as above except 45-Volt Detector.
- $R_1 = 9000, R_2 = 7500, R_3 = 4500, R_4 = 21,200$

No. 64

RADIO BROADCAST Laboratory Information Sheet

January, 1927

The Gang Condenser

CORRECT CONNECTIONS

SINCE the appearance on the market of gang condensers, that is, condensers having a common shaft and working in unison, many readers have requested information as to how they should be connected. The difficulty in connecting them usually arises from the fact that all of the rotor plates are connected together, thus making it impossible to get a positive return lead for the detector tube, while the radio frequency tubes of necessity must be negatively biased.

By looking at the diagram, it will be noticed that the filament return of the detector tube coil does not connect to the variable condenser but to the positive filament lead. A path for the radio frequency current is provided through the bypass condenser, as shown, to the tuning condenser. An alternative way of connecting is to allow the coil to be connected to the condenser, making the grid positive by connecting the grid lead directly between the grid of the tube and the positive filament. The grid condenser prevents the short circuiting of the batteries.

When a gang condenser is used, the coils must be carefully matched in order to minimize any inequalities between them. In spite of careful matching,

there are bound to be some discrepancies, and it is frequently necessary to use a separate condenser in the antenna circuit, as outlined in Laboratory Sheet No. 33. Some gang condensers are provided with small condensers in parallel with the main condensers, which may be used to bring each circuit into exact resonance.

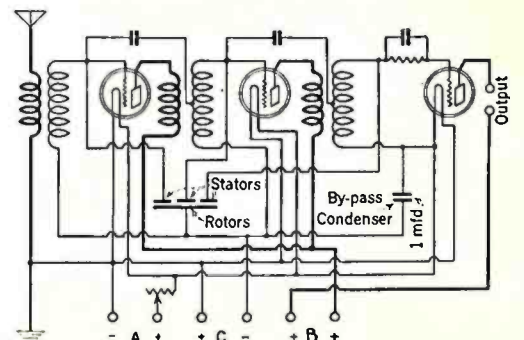

YOU CAN BUILD THE NEW SHIELDED HI-Q*



The Hammarlund-Roberts Board of Engineers

The Hammarlund-Roberts Hi-Q Receiver is the joint creation of ten leading engineers. A wealth of experience plus highest reputation for quality parts guarantee unexcelled performance.

- | | |
|----------------------------|----------------------------|
| Benjamin Electric Mfg. Co. | Martin-Copeland Co. |
| Carter Radio Company | Radiall Company (Amperite) |
| Durham Resistors | Samson Electric Co. |
| Eby Manufacturing Co. | Sangamo Electric Co. |
| Hammarlund Mfg. Company | Westinghouse Micarta |

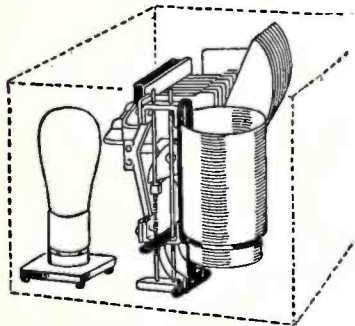

Automatic Variable Coupling

A wonderful new feature. Same control operates both tuning condenser and primary coil coupling. This gives maximum and equal amplification and selectivity over entire tuning range.

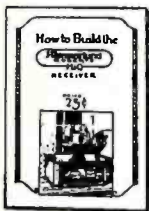

"How to Build It" Book

Written by the Hammarlund Roberts Board of Engineers in very simple A B C language. Every detail described, numbered and diagrammed so that you can easily understand it. Send 25¢ for your copy.

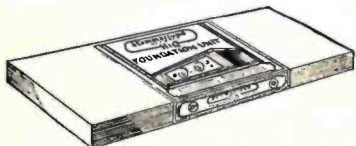

The Hi-Q Foundation Set

The Key to this wonderful receiver. Includes drilled and engraved panel, and sub panel and all the essentials required to start building. Price \$10.50.



*Over 57,000 Built at Home
You Can Do It Too*

LAST year 57,453 radio lovers had the fun of building the Hammarlund-Roberts Receiver at home—a wonderful tribute to the genius of America's ten leading engineers who designed this remarkable instrument.

The new Hi-Q Receiver is even more wonderful than our set of last year. A study of its modern features will disclose simple dual tuning, Complete Shielding, Automatic Variable Coupling, high detection efficiency, high power output and utter absence of oscillation.

An inspection of any home-built Hi-Q Receiver will prove that here for the first time 5 tubes equal 8. Actual test will prove a sensitivity equal to that of expensive "Supers." Reception is startling both in distance and power; volume is full and all signals have those rich, undistorted tones which fall like a caress on the most sensitive ear.

Save \$50 to \$100—Build it Yourself

When over 57,000 novices have built successful Hammarlund-Roberts Receivers, you can build one, too. Send 25c for the "How to Build It" Book or get a copy from your dealer. Follow the simple directions, solder a few connections and in a few hours you, too, will have the satisfaction of having built one of the world's finest receivers at half the price of factory-made sets not nearly so good.

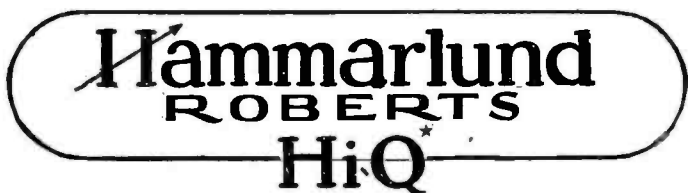

*High ratio of reactance to resistance. High ratio—Great Selectivity—Long Signals
HAMMARLUND-ROBERTS, Inc., 1182-A Broadway, New York

ASK . . . ANY . . . RADIO . . . ENGINEER



The Crowning Adventure of Burgess Radio Batteries

*They Flew Over the North
Pole with Byrd*

ON May 9, history was made . . . American history . . . World history . . . undying history.

Lieut. Commander Byrd, in his fearless 1500-mile flight across the top of the world, adds another thrilling triumph to the long, proud list of American achievements.

Radio went along, for radio has become vital to the lives and success of explorers and adventurers. Burgess Batteries went along, sharing the fate—sharing the hardships and the glory of Commander Byrd, the Detroit Arctic Expedition, and Capt. Donald MacMillan.

It is eminently significant that in these glorious triumphs of American courage and American equipment where the test of men and their tools was the test of the survival of the fittest, that the standard products of the Burgess Battery Company were selected, used and "carried on" under extreme and unprecedented conditions.

BURGESS BATTERY COMPANY
GENERAL SALES OFFICES: CHICAGO
Canadian Factories and Offices:
Niagara Falls and Winnipeg

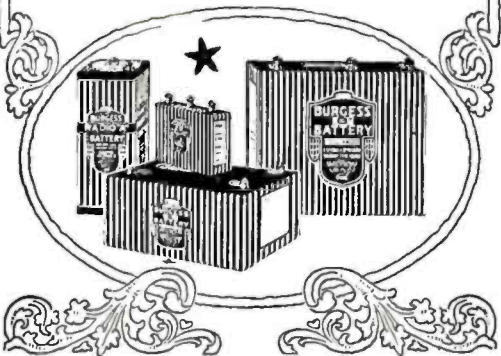

BURGESS RADIO BATTERIES

"NOW, I HAVE FOUND . . ."

A Department for the Exchange of Ideas and Suggestions of Value to the Radio Constructor and Operator

CONTRIBUTIONS to this department are welcome and those used will be paid for at the usual rates, that is, from two to ten dollars each. Manuscripts intended for this department should not exceed about three hundred words in length, and should be typewritten. Little consideration can be given to manuscripts not typewritten. Envelopes should be addressed to this department, RADIO BROADCAST, Garden City, New York.

FILTER SYSTEM FOR CONE SPEAKER

I HAVE been reading with much interest, the various ways of revamping Western Electric cone speakers. I have seen several articles in RADIO BROADCAST and quite a number of methods have been described in other magazines, but none have worked satisfactorily for me.

The Western Electric cone and RCA cone are somewhat alike, being made under the same patents and having the same mechanism. I borrowed an RCA impedance transformer, such as is used in a model 100 loud speaker, and put it in a Western Electric cone, and the results were wonderful.

The way to build this transformer is very simple and cheap. Make an iron core with haywire, the size of a lead pencil, and cut the core $2\frac{1}{2}$ inches long. Wind on this core a coil $\frac{7}{8}$ inches in diameter, using No. 30 silk enameled wire. Connect this coil in series with the speaker and put a Dubilier condenser, capacity 0.01 mfd., across the speaker terminals, and one condenser of the same capacity across the input to the speaker.

The diagram Fig. 1, shows clearly the method of wiring. This device, I have found, will match a Western Electric cone speaker perfectly, with an UX-120 tube, and give very good results with other tubes.

The device is used by the Radio Corporation in all Model 100 speakers, and if properly made, will reproduce low and high notes perfectly with plenty of volume.

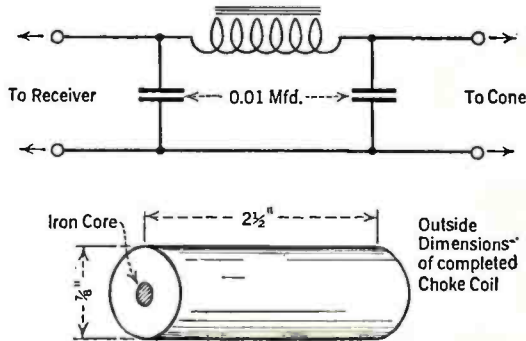

FIG. 1

W. C. GRASEL,
St. Louis, Missouri.

TESTING FIXED CONDENSERS

THE testing of small fixed condensers can best be accomplished by connecting an ordinary six-volt battery across them. If there is a "short" in the condenser, a good spark will be obtained whenever the connections are completed to the two terminals of the battery. The use of ear phones in series with a small battery for testing by the clicks heard is more or less deceptive unless the operator is thoroughly familiar with this type of testing. There is a distinct click, due to the discharge of the condenser, when there is no short present, which may easily be taken to indicate a short. In testing the larger sized fixed condensers, from 0.5 microfarad up, the best method for testing is to apply about 90 volts to the terminals. Then take the connections off and short the terminals with a screw driver or short piece of wire. A good strong spark indicates that the condenser is O. K. If the charge leaks off very rapidly after the battery voltage is removed, it indicates that there is a leak present whether it shows up

or not. A shorted condenser will give no spark after the potential has been removed. A defective condenser may sometimes be repaired by connecting the terminals to a storage battery and allowing enough current to flow so that the short is burned out.

K. BLAINE,
Brooklyn, New York.

PLATE CURRENT BURNS OUT TUBES

SEVERAL users of Browning-Drake receivers have reported that they are unable to make the 199 tube in the radio frequency stage last more than a few days before burning out. In a test run on one of them, the writer found that four tubes lasted a total of nine days, although a careful check-up showed that the tube was getting proper filament voltage and that there was no leakage through the neutralizing condenser.

The trouble was found to lie not in the set, but in the diagram from which it was wired.

This particular blue print (and a survey shows that many like it are in circulation) has the r.f. tube working on the same B voltage as the first audio tubes, which usually is 90 volts, or even more. Since the 199 is not biased with C battery, it is, therefore, being seriously overloaded.

Inspection of the burned-out tubes showed that in every

case the filament parted right at its base. It then became apparent that the plate current, which is added to the filament current on the side of the filament to which the B negative is connected, overloaded the filament and caused the trouble. The addition of, say, 12 milliamperes to the filament circuit of a large tube, makes little difference. In the case of the 199, with a normal filament current of 60 milliamperes, it represents a 20 per cent. overload.

That this diagnosis is correct is attested by operation of the set in question for several months without trouble after the voltage on the radio frequency tube was lowered.

In existing sets, to save adding binding posts, it is advisable to connect the r.f. tube plate circuit to the detector B tap and then run this, feeding both detector and r.f. tube, at 40 to 50 volts. No drop in volume is experienced, changes are easily made, and neutralization is simple.

R. P. WORDEN,
Cleveland, Ohio.

GETTING THE MOST FROM YOUR MILLIAMMETER

A DIRECT-current milliammeter is a very desirable instrument to have about the home laboratory. It may be used for checking resistance units, testing tubes, adjusting the grid bias of an amplifier, testing battery elim-

Which do you want Radio or Music?

WHEN you have read this advertisement you will realize that an important forward stride has been made in radio reproduction and you will be glad to have learned that, *no matter what kind, make or age of set you have*, you can now convert it in a few minutes time and at small expense into the *most perfect reproduction known to radio*. In test after test under all conditions, before laboratory experts, set manufacturers, broadcasting artists of national fame, musical critics, and in test by the radio public itself, the new Truphonic amplifying principle has definitely proved itself to be superior to all other methods of reproduction—barring none. And the Truphonic furthermore has the unique feature that it can be instantly attached to any set.



What the Truphonic is

The Truphonic is simply this: A compact instrument containing three stages of Truphonic coupling and an output unit to protect the loudspeaker from the powerful Truphonic output. A 6 foot battery cord contains all wires to the "A" and "B" batteries (including wires for "C" battery and additional "B" battery if power tube is used). A single wire with clip attached slips over the plate prong of the detector tube which is then reinserted in the socket of the set. It is as simple as ABC and can be attached by anyone in less than 5 minutes without any knowledge of radio.

Used in commercial sets

Although Truphonic amplification has been on the market only a short time it is now used in the sets of 22 radio manufacturers. Unfortunately it was not perfected in time for general use by manufacturers of large production this year. Next year the trend will be toward Truphonic amplification.

But if you want the most beautiful reproduction of music and speech in your home *right now*, get the Truphonic at your dealer's, attach it, and *know* that you have the finest reproduction obtainable—no matter how much you can afford to pay.

If your dealer has not stocked the Truphonic we will send you one C. O. D. on 5-day money back trial. No Truphonic sent unless you give your dealer's name and address.

ALDEN MANUFACTURING COMPANY
Dept. B-21 Springfield, Mass.

TRUPHONIC

Power Amplifier

Reg. U. S. Pat. Off.

\$20

Ready to Attach



Your set



Truphonic



Your loudspeaker

★ Examined and approved by RADIO BROADCAST ★

Speed

**SUPER-EMISSION
RADIO TUBES**

are the most perfectly
balanced tubes produced



X 200 A
**Super-Sensitive
Power Detector**

Other Types

- 201 A 5 volt detector-amplifier
- X 112 5 " power amplifier
- 199 3 " detector-amplifier
- X 120 3 " power amplifier
- 12 1½ " detector-amplifier

and

SPEED

FULL WAVE
GAS FILLED

RECTIFIER

FOR USE IN STANDARD "B"
BATTERY ELIMINATORS

A FEW FRANCHISES
STILL OPEN FOR FIRST
CLASS DISTRIBUTORS

**Cable
Supply Company
INC.**

Executive Offices

**31 Union Square
New York**

inators, shooting trouble, and so on. Since the field of application of the milliammeter is so large, several different ranges are desirable. Manufacturers supply voltmeters with high and low ranges, but multi-range milliammeters are not available, and the demands upon one's purse usually preclude the luxury of several meters.

In electrical laboratories where large currents are often measured, ammeters of low current-carrying capacity are adapted to this purpose by means of an "external shunt." This is nothing more than a resistance unit of such a value as to bypass a known portion of the current around the meter. This practice may be conveniently adopted by the home experimenter in making external multipliers for his milliammeter. As an example, suppose a current estimated at about 50 milliamperes is about to be measured with a 0-10 mil. meter. If the meter resistance is 4 ohms, a shunt resistance of 1 ohm connected across its terminals will cause the current to divide inversely proportional to the resistances, 40 mils. going through the shunt, and 10 mils. going through the meter and registering on the scale as such. The meter with its shunt is then said to have a scale factor of 5, since the reading must be multiplied by 5 to obtain the value of the total current flowing.

Scale multipliers are easily made without the necessity of measuring either their own resistance or that of the milliammeter. Connect the meter in series with any high resistance unit and sufficient B battery voltage to give about a full scale deflection of the needle. A No. 10 Bradleyohm

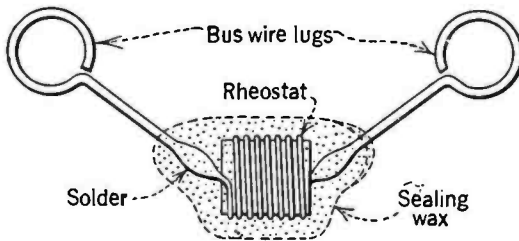

FIG. 2

is ideal for this purpose, as it may be adjusted to give exactly full-scale deflection. The resistance wire to be shunted across the meter may be obtained from an old rheostat, preferably of 30-ohm size. The "dime store" variety is satisfactory. After removing the winding from the frame, cut off about two dozen turns from the end, including the strip. When this wire is connected across the two terminals of the meter, less deflection of the needle will be noted. The length of the resistance wire should be gradually reduced until the needle shows the desired fraction of the original reading, as one-half, or one-fifth, etc. For these trials the ends of the wire should be well tinned as for soldering; if this is not done until last, the final reading will be spoiled. It is best to solder the terminal lugs in place just before the correct length is reached; further reduction may then be accurately accomplished by carefully tinning a small portion of the wire at a time.

This should be accurately done, as any error here will multiply as the scale factor increases. Factors of 10 or more are hardly practicable; in such cases it is better to take the meter with its shunt to a neighboring transmitting amateur, who will gladly check it against his high-range meter.

The unit may be made rigid by coating it with sealing wax, as shown in the diagram, Fig. 2. Place it in position on the meter terminals and, with the aid of a small alcohol blow torch, work the melted wax around it. The scale factor may then be marked on the wax. In using, the meter reading should be multiplied by this

factor to obtain the value of the total measured current.

HOMER S. DAVIS,
Memphis, Tennessee.

A HANDY REFERENCE BOOK

THOSE who have been subscribers to RADIO BROADCAST from the first issue have by this time acquired a rather large fund of useful information. It is a great aid to the experimenter if he has this information instantly available. The Reference Book described here, will eliminate the necessity of looking through perhaps a dozen volumes for some elusive article.

With a razor blade, cut the "Contents" page from each volume. Though RADIO BROADCAST

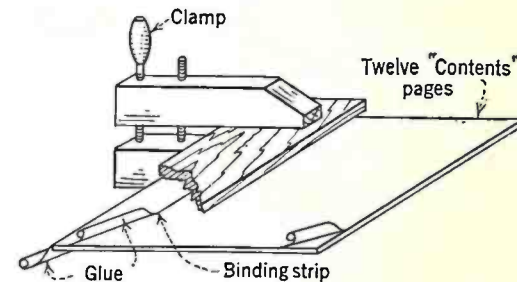

FIG. 3

has been issued in various sizes, it will be found that each "Contents" page can be cut to about seven by nine and one-half inches without destroying the table desired. All the sheets should be cut to this size. Take the sheets of the first twelve issues and lay the last of these on a table, face up. Apply glue to a strip one half inch wide up the left edge. Then lay the second last sheet on this, and apply glue as before. Do this with the ten remaining sheets. Then bind the folios with heavy paper, as shown in Fig. 3, and clamp the booklet in a vise till the glue hardens. Then remove it and drill two holes through the bound edge as shown in Fig. 4.

When folios for each year have been built up in this manner, place them one on top of the other and trim them with a razor blade to a uniform size. Make a cover of black oilcloth, faced with cardboard, and cut holes in it corresponding to those through the bound edges of the folios. (See Fig. 4.)

Assemble the book as shown, by means of

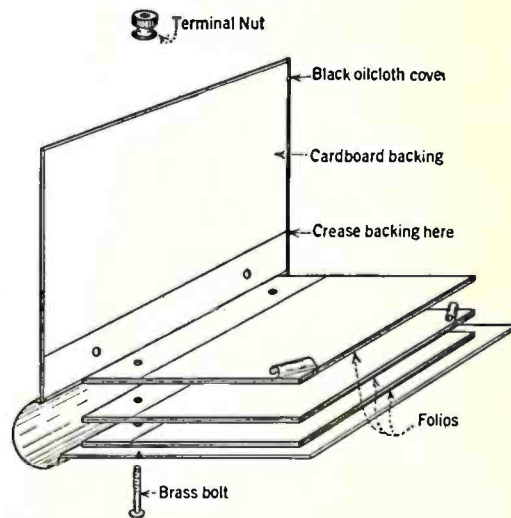

FIG. 4

brass bolts and battery terminals. This method of assembly permits the addition of folios from time to time, but eliminates the possibility of tearing the sheets from the book.

RONALD W. KLINCK,
Vancouver, British Columbia.

GENERAL RADIO

Parts and Accessories have a Laboratory Background of more than a decade

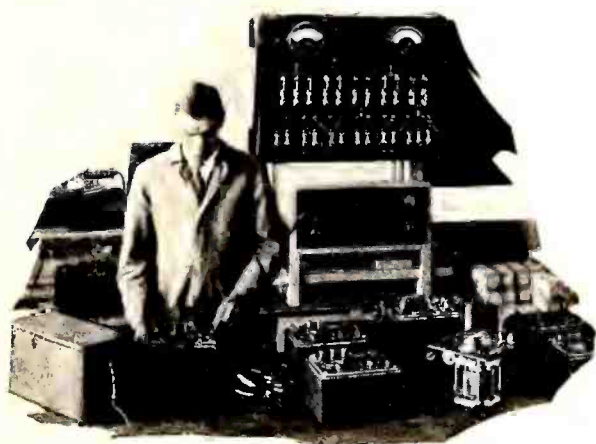
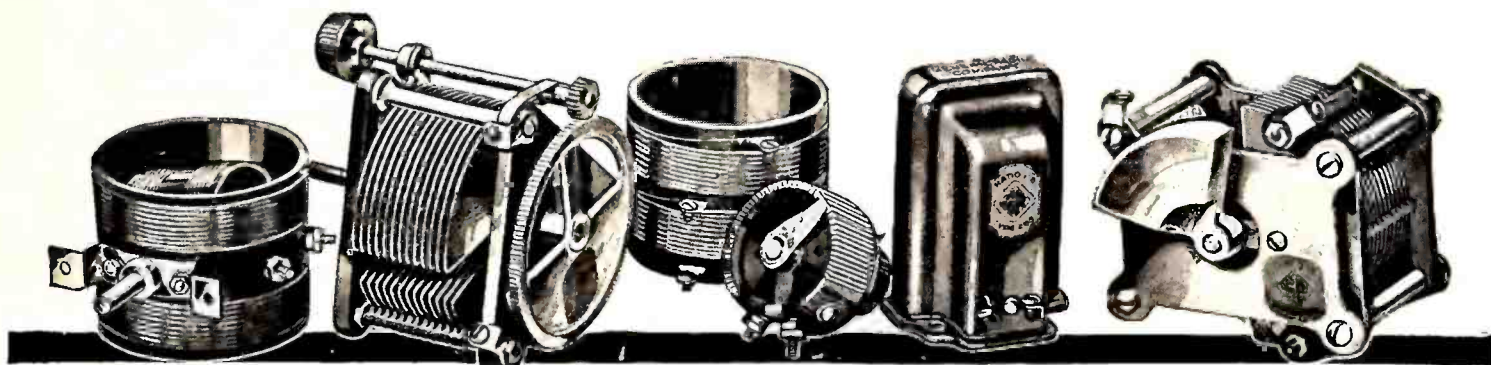

FOR more than a decade the General Radio Company has been manufacturing radio laboratory instruments and parts—the outstanding feature of which is PRECISION. These instruments have been supplied in ever increasing quantities to many well known radio laboratories of the country, including the General Electric Company, Westinghouse Electric Manufacturing Company, Bell Telephone Laboratories, Bureau of Standards, U. S. Navy, U. S. Signal Corps, as well as the leading engineering colleges.

Today, General Radio precision instruments are standard equipment in nearly all the radio laboratories throughout this and many foreign countries.

Through the merits of design, performance, and price, General Radio instruments for the scientist or set-builder are universally recognized as the Standards of Quality.

SINCE the early days of radio, amateur operators and set-builders have looked upon the General Radio Company as a time-tried producer of dependable apparatus.

The conservative buyer of radio parts looks first to the reputation of the manufacturer. He knows from his own experience and those of others whether this reputation warrants his confidence. It is this self-same confidence upon which the popular preference for General Radio parts and accessories is based.

In building a radio receiver, remember that its performance depends primarily upon two things; an efficient circuit and the use of good parts.

Wherever you find a popular circuit you will invariably find General Radio parts.

Ask your dealer or write for our latest parts bulletin No. 926.

GENERAL RADIO CO.

Cambridge

Massachusetts



NEW

PREEMINENT among fine radio receiving units is the Nathaniel Baldwin line.

PREEMINENT in this line of units is Nathaniel Baldwin's latest triumph—now available in

THE BALDWIN "99" LOUD SPEAKER

\$28.50 LIST



Attached to any receiver whether a three tube set employing forty volts or a ten tube set employing four hundred volts. It will correctly and euphoniously render all tones—low or high—to the utmost pleasure and satisfaction of the trained or untrained musical ear.

ORDER TODAY

DEALERS AND JOBBERS

Can secure detailed information regarding territory and distribution available by writing today.

★ J. W. and W. L. WOOLF
Eastern Distributors, Exporters for
NATHANIEL BALDWIN, Inc.
227 Fulton St., New York City
Tel. Cortlandt 6519

B SUPPLY DEVICE RELAY

UPON installing a B supply device in my home it was most convenient to place it in the basement where the wet B batteries had formerly been. This necessitated either going into the basement to turn the unit on and off or installing a switch for the 110-volt current near the set.

I went both of these alternatives one better

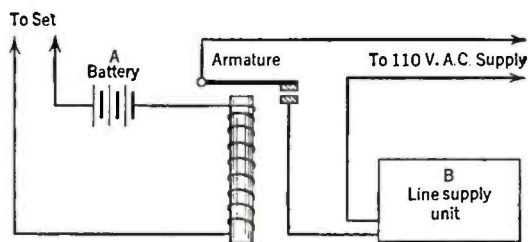

FIG. 5

by constructing from an old automobile reverse current generator relay an automatic switch for the supply unit. Now all I have to do is to pull the A-battery switch on the set and the B supply device cuts in with no further attention.

The sketch, Fig. 5, shows the schematic wiring. The core was stripped of both its original series and shunt windings and was rewound with No. 18 d.c.c. (the number of turns will be governed by the number of tubes and current consumed by the set). I used about 30 turns for a set pulling 2 amps. The armature was insulated from the frame with sheet mica. There is practically no arc at the points, and no condenser is needed.

H. N. STREIT,
Boone, Iowa.

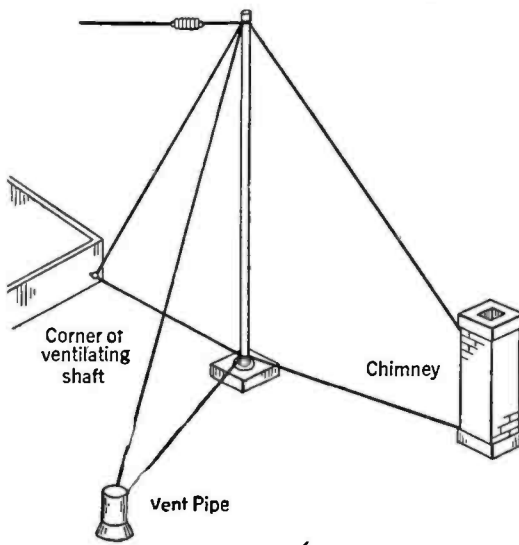

FIG. 6

ANTENNA MAST INSTALLATION

HAVING occasion recently to install a 15-foot antenna mast on the flat roof of an apartment building, I devised a method of securing the mast without having to fasten the lower end with screws. The roof was the usual combination of tar and gravel, and, as it was impossible to fasten the mast to a chimney or other projection from the surface of the roof, I finally decided to guy the mast both top and bottom. After getting the mast in position and securing the guy wires from the top, I simply ran additional guy wires from the lower end of the pole to such points as I could find, three in all, thereby securing both ends of the pole and making it impossible for it to work loose in a high wind. The sketch, Fig. 6, illustrates the method used. The pole (in this case 1 inch iron pipe was used) should be screwed to a wooden block about 8 inches or 10 inches square, so that its end will not wear a hole in the tar of the roof.

W. T. MITHOFF,
Detroit, Michigan.

KEEPING RADIO FREQUENCY CURRENTS FROM THE AUDIO CIRCUIT

THE statement is often made that the primary of a good audio transformer has such a high impedance to radio frequency currents that they must use the bypass condenser or be blocked. It is the writer's experience, however, that a healthy radio frequency impulse can somehow get through such a rough passage and cause distortion.

The author has hit on the scheme, not of trying to choke off these impulses, but of balancing them out. From Fig. 7 it is apparent that there are present in the audio transformer intentional or parasitic capacities, C_p across the primary, C_s across the secondary, and C_c between the primary and secondary. The transformer is drawn in the usual fashion to call attention to the fact that one end of the primary is nearer the

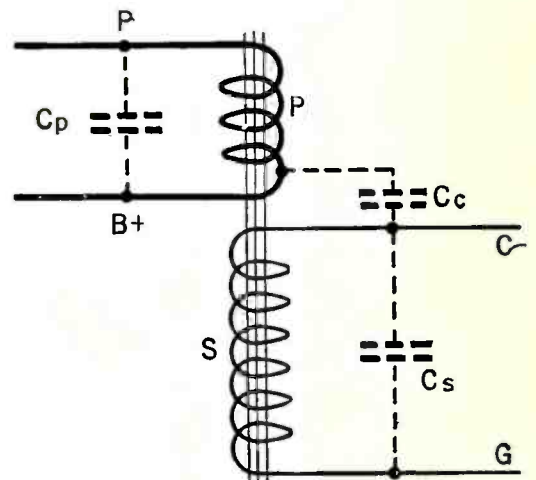

FIG. 7

filament end of the secondary than the grid end. In a good transformer, the secondary capacity is kept small but, compared with the inter-coil capacity, it is larger.

Fig. 8 shows how, by the addition of a plate-grid capacity C_n , a balanced or Wheatstone Bridge effect is obtained. The value of this condenser must be found by trial and is not very large. The author found one of 0.0002 mfd. was best with an Amertran De Luxe. Remember, if you have two condensers of say 0.0001 and 0.00025 mfd., that in series they have a value of 0.00007 mfd. and in parallel a value of 0.00035 mfd., so that two condensers make four values available for trial. Connect the end of a condenser to the grid of the first audio tube and listen with the wire to the other end of the condenser alternately on and off the "P" terminal of the first transformer. It will no doubt be noticed that quality is unmistakably improved.

H. D. HATCH,
Boston, Massachusetts.

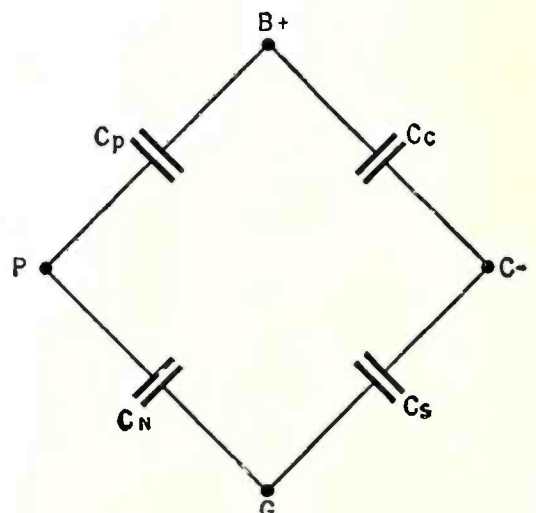

FIG. 8

Mass Production

methods and tremendous purchasing power brought to Amrad and applied to building Neutrodyne a year ago by Powel Crosley, Jr. make available to the Public a 5 tube Neutrodyne at \$60

In this 5 tube battery type Neutrodyne at \$60 great engineering skill is manifest in the splendid performance of the set. Cabinet and trimmings are all any purchaser could ask—beautifully finished and appointed. Recessed dials behind windows and delicately adjusted vernier controls are distinctive features.



Cone Table for table models S-522 and AC-5 with Crosley Musicone built in. Ample room for batteries or power unit. . \$32.

—and a light socket operated Neutrodyne at \$150

This is Amrad's crowning achievement. A power unit, using current direct from your light socket on wall or from table lamp furnishes A, B and C current direct to the 5 tube Neutrodyne pictured at the right. This power unit is pictured directly behind the set.

No batteries—nothing to charge. An entirely new development in power supply. Amazing Mershon Condensers contribute to its great efficiency and compactness. TESTED BY CONSTANT USE IN HOMES FOR OVER A YEAR. Price of receiver \$65. Price of power unit separately \$85.



Model AC-5-C

Light Socket Operated 5 tube console



A beautiful cabinet in two tone finish mahogany. Stands 40 inches high. Genuine Crosley Musicone built in. Equipped with 5 tube battery type set \$110—with lamp socket set and power unit \$200.

Add a Mershon Condenser to your B eliminator for Super-B Current supply

30 MFD DUOTYPE



Filtering out light socket current hum is but part of the job. Eliminators must have STORAGE capacity to prevent "chopping off" of loud or sustained notes. The Mershon Condenser acts as a reservoir and STORES energy for sudden heavy drains on plate current. Does the work of expensive storage battery electrically rather than chemically. B eliminator connected with this condenser gives the excellent tone reproduction of fresh B batteries.

Mershon Electric Condenser 15 mfd capacity each half. 30 mfd total capacity. Type D-15-30. Maximum rating 300 volts D. C. If punctured can be reformed and need not be thrown away.

\$8

AMRAD

AMRAD CORPORATION

Medford Hillside, Mass.

Harold J. Power, Pres.

Write Dept. 2 A 7 for Catalog.

NEUTRODYNES

★ Examined and approved by RADIO BROADCAST ★

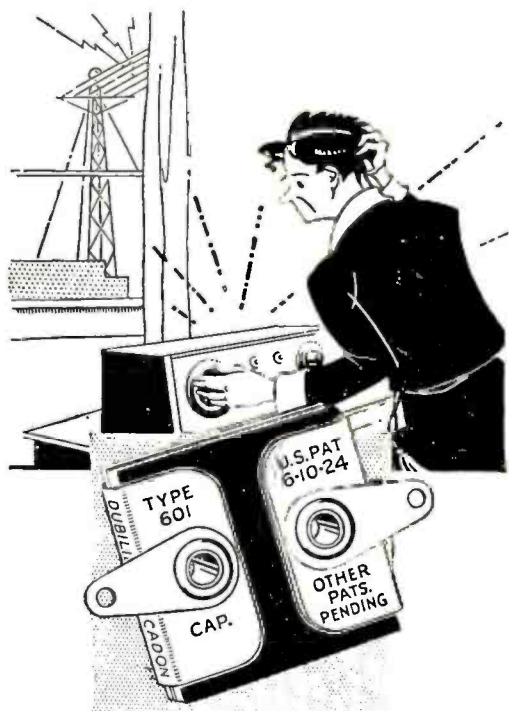

Can't
tune 'em
out?

TRY a Micadon 601 in series with the antenna of your set, if you find it hard to "tune out" nearby stations.

The Micadon will have the same effect as "loose coupling," and the selectivity of your set will be greatly improved. Capacities from .0001 to .0005 mfd. may be used—you will find a full explanation in our 32-page booklet, "Seventeen Ways to Improve Your Set."

Micadons, because of the patented principles of low-loss insulation and protection against variation in capacity which they embody, are a vital element in the improved reception of thousands of radio sets. The tone, the efficiency, and the satisfactory operation of your set depend on the quality of the fixed condensers used.

If you want to be sure that your set will do all it was meant to do, be sure that the fixed condensers bear the name of Dubilier.

Send 10c in stamps or coin for your copy of "Seventeen Ways to Improve Your Set."

Dubilier ★
CONDENSER AND RADIO CORPORATION

4377 Bronx Blvd., New York, N. Y.

THE BEST IN CURRENT RADIO PERIODICALS

The Fifteenth Installment of a Useful Classified Survey of Material Appearing in the Radio Press

By E. G. SHALKHAUSER

How This Survey Can Help You

HOW often have you looked for information contained in some article which you recall having read months ago—the description of the Browning-Drake receiver, or the measurement of losses in inductance coils, for example? After looking through probably several issues of a dozen different publications, you either give up or become interested in something altogether different.

When data is wanted on some particular subject, a systematic file of subjects and titles becomes a real radio encyclopedia. Instead of having merely the title of an article given, which often is misleading, a summary of the contents gives all the information. These surveys cover the radio field as gleaned from material in to-day's periodicals. They will always serve as a future reference-guide to all who are interested in the science of radio, whether engineer, manufacturer, dealer, experimenter, or listener.

To be of practical value and easily accessible, these surveys should either be pasted in a scrap book, or, better still, be pasted on individual cards and filed according to numbers, or alphabetically. In the matter of classification of articles, the Bureau of Standards circular No. 138 has been followed. This may be obtained from the Government Printing Office, Washington, District of Columbia, for ten cents. In addition, each abstract has certain key-words placed at the upper right, which may be used for the purpose of filing articles alphabetically.

With this series of surveys we hope to aid our readers and help them through many difficulties which they no doubt have often experienced. The writer is prepared to give information and references to articles previously surveyed upon receipt of a stamped and self-addressed envelope.

Following is the series of headings, made up according to the Dewey Decimal System used in the Bureau of Standards circular No. 138:



R000 RADIO COMMUNICATION IN GENERAL.

Under this heading will appear all subject matter pertaining to laws, regulations, history, publications, etc., which deal with radio in a general way.

R100 PRINCIPLES UNDERLYING RADIO COMMUNICATION.

Here will be given the phenomena of radio waves, their underlying theory of propagation, the principle of antenna and counterpoise, design and characteristics of vacuum tubes and their behavior in circuits, types of circuits, transmitting and receiving apparatus and their principles of operation.

R200 RADIO MEASUREMENTS AND STANDARDIZATION METHODS.

The various known methods which have been used in measuring frequency, wavelength, resonance, capacity, inductance, resistance current, voltage, dielectric constants, and properties of materials, will be mentioned here.

R300 RADIO APPARATUS AND EQUIPMENT.

A description of various types of antennas and their properties, the use of the electron tube in various types of receiving and transmitting sets, other methods of transmission of signals, various detecting devices used in reception, instruments and parts of circuits, come under this heading.

R400 RADIO COMMUNICATION SYSTEMS.

The spark, modulated wave and continuous wave systems in transmission, beat and other methods of reception, wired wireless, automatic printing, the buzzerphone and Fullerphone, will be given here.

R500 APPLICATIONS OF RADIO—

To aviation, navigation, commerce, military, private and broadcasting, and the specific information under their headings, are referred to here.

R600 RADIO STATIONS.

The operation, equipment, and management of radio installations, both transmitting and receiving, the testing, the rules and regulations concerning stations, the reports and bulletins issued, will follow under this heading.

R700 RADIO MANUFACTURING.

Data relative to costs and contracts of radio equipment from raw material to finished product including factories, tools, equipment, management, sales and advertising, follow here.

R800 NON-RADIO SUBJECTS.

The matter of patents in general; the mathematics and physics, including chemistry, geology and geography; meters of various kinds; all information not strictly pertaining to radio but correlated to this subject, will be found under this heading.

R900 MISCELLANEOUS MATERIAL.

A Key to Recent Radio Articles

R800 (539). MOLECULAR PHYSICS. ATOMS.
Popular Radio. Oct., 1926. Pp. 517-519.
"Will Science Succeed in Releasing the Power of the Atom?" T. F. Wall.

Evidence concerning the nature of magnetism, based on some very startling experimental phenomena, leads the writer to believe that an actual disturbance of the electronic structure has been obtained by the application of intense magnetic fields. Some of this evidence is brought out in the two curves presented, which show the relation of B to H for steel before and after having undergone an intense magnetizing process.

R534. AGRICULTURE, APPLICATIONS OF FARMERS RADIO TO. AND RADIO.
Popular Radio. Oct., 1926. Pp. 525-ff.
"Sets That Earn Incomes," H. R. Kibler.

It is shown how the introduction of the radio receiver into rural communities has changed the habits and methods of farmers in many ways. They now market by radio, farm by radio, are entertained by radio, and conduct their business by radio. In the charts shown, which are the results of a nation-wide survey conducted by the National Farm Radio Council, many outstanding disclosures concerning the effects of radio on farm life and community are made.

R343. ELECTRON-TUBE RECEIVING SETS. RECEIVER, LC-27.
Popular Radio. Oct., 1926. Pp. 511-ff.
"How to Build the New LC-27 Receiver," L. M. Cockaday.

A new 5-tube receiver, called the LC-27, is outlined. It is claimed to have all the ideal characteristics looked for in a modern set. These include splendid quality of reproduction, simple tuning control, selectivity, shielding, and non-regeneration. Blue prints, photographs, a list of parts, and constructional details, are presented.

R113.1. FADING. FADING.
Popular Radio. Oct., 1926. Pp. 531-ff.

"Why Signals Fade," Charles C. Bidwell.
In the writer's opinion, the under surface of the Heaviside Layer is not a smooth surface. Through the recent studies of Breit, Hurlburt, and others in America, and of Appleton, Smith-Rose, and others in England, it has been shown that this lower surface is corrugated, or billowed, like waves on the sea, or like an irregular cloud layer in the sky. The author shows in this article how his experiments point to the same conclusions arrived at by the other scientists. Charts are presented indicating the variations of signal strength from stations KNKA and WGY at various longer periods of time.

See that Screw

A screw-driver adjusts an X-L in crowded places



X-L VARIO DENSER

RESULTS in easier tuning, more distance, volume and clarity—greater stability. Indorsed by leading authorities.

Model "N" A slight turn obtains correct tube oscillation on all tuned radio frequency circuits. Neutrodyne, Roberts two tube Browning-Drake, McMurdo Silver's Knockout, etc. capacity range 1.8 to 20 micro-micro farads. Price \$1.00

Model "G" With grid clips obtains the proper grid capacity on Cockaday circuits, filter and intermediate frequency tuning in heterodyne and positive grid bias in all sets. Capacity range.

Model G-1—.00002 to .0001 MFD
Model G-5—.0001 to .0005 MFD
Model G-10—.0003 to .001 MFD

Price \$1.50

X-L Push Post. Push it down with your thumb, insert wire, remove pressure and wire is firmly held. Releases instantly. Price 15c.

Push Post Panel permanently marked in white on black rubber. In box including soldering lugs, raising bushings and screws for mounting, etc. Price \$1.50



X-L Radio Laboratories 2424 Lincoln Ave. CHICAGO, ILL.

Yale GROUND HOG
The Perfect Ground
DOUBLES POWER AND DISTANCE

Marvelous newly-invented ground gives incredibly improved reception. Doubles power and distance users say. Reduces leakage. Stops jangling even in mid-summer. Results never before equaled. Satisfaction guaranteed or money back at once. Approved by Highest Radio authorities after exhaustive tests. Proven absolutely essential to clear, powerful distance reception. Draws and holds moisture indefinitely. Highly sensitive to radio energy. SEND NO MONEY—To introduce, we offer to those who act at once, regular \$5.00 size for only \$2.00. Send name today and pay \$2.00 plus 17c postage on delivery. Or send only \$2.00 with order and save postage.

FREE—Full description of Ground Hog and details of amazing special offer on request—write today.

Yale Specialty Supply Co. 133 W. 5th St. Kansas City



Order your copy of Radio Broadcast from your news dealer or radio store. Make sure that he reserves a copy for you each month. If your favorite radio store does not stock the magazine write us giving name of radio dealer and address.

AMSCO METALOID

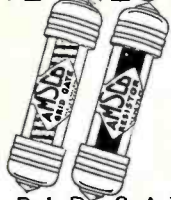

GRID GATE & RESISTOR

There's no thunder in these Metaloids—no crackle or noise of any kind. They're Quiet!

The resistance element is colloidal and smooth—not crystalline, ragged and noisy.

Adopted by leading set makers. They're perfect!

Ask your dealer or write for leaflet

AMSCO PRODUCTS, INC. Broome and Lafayette Streets New York City

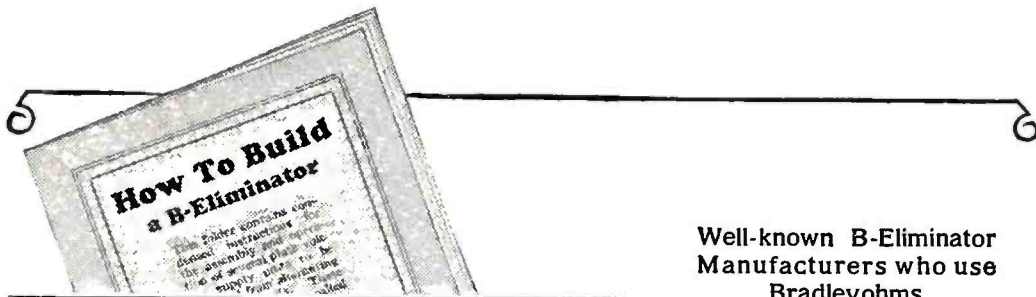

SEND FOR THIS RADIO FOLDER

Contains seven hookups for B-Eliminators published in a prominent radio magazine.



Well-known B-Eliminator Manufacturers who use Bradleyohms

Acme, All-American, American Bosch, Brown & Green, DeWitt-LaFrance, Farrand, Forest Unitron, Grigsby-Grunow Hinds (Majestic), Kellogg, Philadelphia Storage Battery (Philco), Precision, Radio Receptor, R. A. Rothermel, London; Spartana, Valley, Willard, Wilson.

When You Build a B-Eliminator

Use Bradleyohm-E for the Variable Resistors and Bradleyunit-A for the Fixed Resistors



Bradleyohm-E

For B-eliminator service requiring wide voltage control, Bradleyohm-E is essential. It is an oversize Bradleyohm with sufficient capacity to handle all normal B-eliminator requirements. Be sure to ask for Bradleyohm-E in the checkered carton. Your dealer can get them for you.

ALWAYS insist that Bradleyohm-E and Bradleyunit-A are included with your B-Eliminator kit, if you want to be assured of perfect voltage control. The leading manufacturers of B-Eliminators have long since adopted these Allen-Bradley variable and fixed resistors as standard equipment for their B-Eliminators. In fact, Bradleyohm-E is used almost as universally as the Raytheon tube, itself.

You cannot afford to risk the use of inferior substitutes for the scientifically treated discs used in Bradleyohm-E. This remarkable variable resistor handles the strenuous requirements of B-Eliminator service without the slightest strain. Ask your dealer for Allen-Bradley Perfect Radio Devices, today.



Bradleyunit-A

This solid, molded, fixed resistor has no glass or hermetic sealing in its construction. It is a solid unit with silver-plated end caps and is not affected by temperature, moisture and age. By all means, use Bradleyunit-A when you need a fixed resistor.



MAIL THE HANDY COUPON

Allen-Bradley Company 278 Greenfield Avenue Milwaukee, Wisconsin

Please send me, FREE, your radio folder with seven B-Eliminator hook-ups.

Name.....

Address.....



Throw a switch and charge your batteries

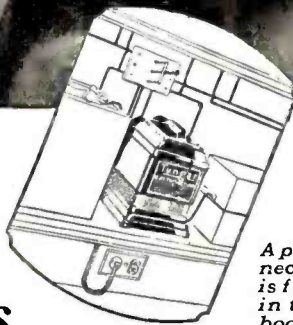

A permanent connection hook-up is fully illustrated in the instruction book accompanying each Tungar.

Nowadays, charging a battery with a Tungar has become as easy as turning on a light. Just throw a switch—and charge your batteries. That's all there is to it if you have a Tungar permanently installed.

The batteries themselves may be placed in a cabinet, or down in the cellar. And, at night, when you sign off, all you have to do is throw a switch—to the right for "A" batteries, to the left for "B." It's no more bother than switching on a light.



Tungar—a registered trademark—is found only on the genuine. Look for it on the name plate.

GENERAL ELECTRIC

Tungar causes no radio interference.

It cannot blow out Radiotrons.

An overnight charge costs about a dime.

Tungar is the original bulb charger. It is a G-E product developed in the Research Laboratories of General Electric.

The 2 or 5 ampere Tungars charge 2, 4 and 6 volt "A" batteries, 24 to 96 volt "B" batteries in series; and auto batteries, too. No extra attachments needed.

East of the Rockies
2 ampere Tungar, \$18
5 ampere Tungar, \$28
Trickle Charger, \$12
(60 cycles—110 volts)

Merchandise Department
General Electric Company
Bridgeport, Connecticut

A Two Year Subscription Saves You Two Dollars

It saves you the bother of renewing next year.

It is the most economical way to subscribe. You simply write six dollars instead of four when sending your check or money order. Try it for two years. Form the habit!

RADIO BROADCAST

Garden City, N. Y.

FANS! BUILD YOUR SETS RIGHT! Plan now, before you go too far, to put the best insulating material into every part. I.C.A. Products of Insuline and Bakelite alone give you the high dielectric strength so necessary for full, clear reception.

EVERY SET BUILDER SHOULD HAVE OUR NEW FREE BOOKLET, giving descriptions and prices of over 70 drilled and engraved panels for popular circuits; sub-panels; knobs; switches; aerial insulators, sockets, etc. From your dealer or write us direct for Free Booklet B-1. Don't take substitutes for genuine I.C.A. Products.

Insulating Company of America, Inc.
59 Warren St., New York City

I.C.A.

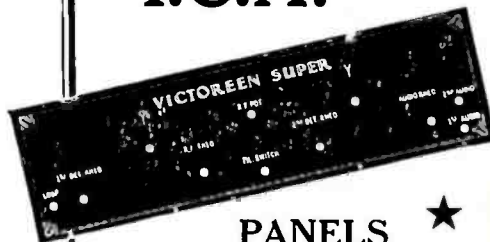

PANELS AND INSULATING PARTS

R343. ELECTRON-TUBE RECEIVING SETS. RECEIVERS. Popular Radio. Oct., 1926. Pp. 528-ff. Bosch, Grebe, "Inside Information on New Radio Receivers," S. G. Taylor.

The new Bosch "Amborola," the latest Grebe "Synchrophase," and the new Freed-Eisemann "800" receivers are discussed in detail, with data being given on care, operation, and installation.

R550. BROADCASTING. BROADCASTING. RADIO BROADCAST. Nov., 1926. Pp. 62-ff. Technical "The Technical and Scientific Aspects of Broadcasting," R. Bown.

An article reprinted from the new *Encyclopædia Britannica* explains the art of broadcast transmission and reception under the following titles:

- | | |
|--------------------------|------------------------|
| 1. Transmitting Systems. | 5. Loud Speakers. |
| 2. Receiving Systems. | 6. Power Supply. |
| 3. Forms of Antennas. | 7. Interference. |
| 4. Tuning Circuits: | 8. Fading. |
| (a) Regenerative Sets, | 9. Interconnection of |
| (b) R. F. Amplifiers, | Broadcasting Stations. |
| (c) Super-Heterodynes. | |

R329. SPECIAL TYPES OF ANTENNAS. ANTENNAS. QST. Oct., 1926. Pp. 16. Hertz, "The Length of the Hertz Antenna," G. Wm. Lang.

In operating a Hertzian antenna the matter of length is usually a guess with most of the folks who put them up. In a table presented, nine different forms of antennas are listed, with measurements concerning wire length, fundamental wavelength, etc.

R114. STRAYS. AURORA, QST. Oct., 1926. Pp. 23-24. EFFECTS. "Aurora and Its Effects Upon Radio Signals," W. M. Sutton.

It is the writer's opinion, borne out by actual experience, that the Aurora Borealis has a decided effect on radio signals of certain frequencies. The Aurora tends to lower the Heaviside Layer, thus reducing the skip-distance and often making nearby stations, which are often inaudible, easily heard. It is stated that strong Aurora kills signals on all waves from 35 meters (8566 kc.) up to 500 meters (600 kc.), that moderate Aurora materially changes the skip distance of 40-meter (7496 kc.) signals, and that slight Aurora changes the skip distance a little on the 40-meter band and causes fading on medium-distance broadcast stations, but distant-station signals remain constant.

R343. ELECTRON-TUBE RECEIVING SETS. RECEIVERS. QST. Oct., 1926. Pp. 34-35. Short-Wave. "Short-Wave Tuner Kits," J. M. Clayton.

Three short-wave tuner kits, the Cross receiver, the REL tuner, and the Silver-Marshall, are shown. These are described and the method of construction pictured.

R344.3 and 343. TRANSMITTER AND "TRANSCIEVER," RECEIVER. PORTABLE. QST. Oct., 1926. Pp. 36-ff.

"A Portable 'Transciever,'" F. A. Gunther. The portable transmitter-receiver here analyzed and shown in diagram form, uses three UX-109 tubes for receiving and one UX-210 tube for transmitting. A dynamotor is used to supply the plate input energy.

R070. EDUCATION; TRAINING. EDUCATION, Radio. Oct., 1926. Pp. 16-ff. Engineering. "Dollars from Radio Inventions," V. G. Mathison.

In the writer's opinion, a thorough knowledge of the fundamental laws of electricity, magnetism, and chemistry are essential in order that one succeed as a radio research engineer or inventor. Most of the research in radio is being carried on behind closed doors at corporation laboratories, and are for monetary purposes solely. This biases the genius of the inventor, who does not receive due reward for his invention. The opportunities, however, are present, providing the "mental equipment" is first obtained.

R343.5. SUPER-HETERODYNE SETS. SUPER-HETERODYNE. Radio. Oct., 1926. Pp. 19-ff.

"An Improved, Shielded Super-Heterodyne," H. W. Armstrong. An improvement, through the addition of one stage of tuned r.f. amplification and one stage of power tube a.f. amplification, to the 50 to 600 meter (5,996-500 kc.) super-heterodyne, found in the August, 1925, *Radio*, is described. With separate shielding, plug-in coil arrangement, and loop reception, the best possible results are said to be obtainable.

R230. INDUCTANCE, MEASUREMENT OF. INDUCTANCE. Radio. Oct., 1926. P. 22.

A Kullmann inductance chart, showing how a single-layer solenoid of a given number of turns and size wire on a coil of given diameter will yield a definite inductance value, is pictured and explained.

R134. DETECTOR ACTION. DETECTION. Radio. Oct., 1926. Pp. 32-34.

"The Siamese Twins of Radio: Detection and Distortion," R. B. Thorpe. The principle of detection involves "distortion," for without distortion there would be no detection, the proof being evident from an analysis of the equation of the detector action in a radio circuit. A simple mathematical discussion of these principles found in detector action is presented, as also is the effect that good and poor modulated energy from the transmitter would have when passing through the detector tube.

R470. WIRED RADIO. WIRED RADIO. Radio News. Oct., 1926. Pp. 324-ff.

"Wired Radio and Its Applications," M. L. Muhleman. The principle of "wired radio" consists in transmitting over the same two wires several radio frequency currents without any intermingling of these currents. The system, as tried in the East, from the transmitting as well as the receiving end, has shown that the problem can be carried out successfully. Several difficulties have been encountered. One of these is to efficiently couple the carrier current lines and power lines used for transmission. Another, the effect of variations in the line itself due to the great difference in current consumption during the 24 hours. In the case of telephone and telegraph lines, these difficulties are not encountered to such a degree.

Potter Condensers

Build the best—

- Socket Power Devices
- A and B Supply Devices
- Power Amplifiers
- Impedance Amplifiers

And are best—

- For Filter Uses
- Rectifiers
- By Pass
- Blocking D. C.

American made of best of materials to full capacity. All sizes and types. ★

POTTER MFG. CO.
North Chicago, Ill.

Bradley Leak

THE PERFECT GRID LEAK

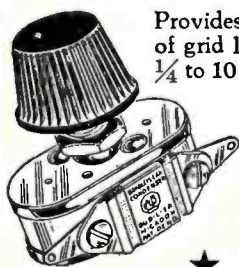

Provides a noiseless range of grid leak resistance from 1/4 to 10 megohms. Assures most effective grid leak resistance value for all tubes. Small grid condenser (0.00025) is separate. Metal parts nickel plated. One hole mounting.

★ Allen-Bradley Co.

Electric Controlling Apparatus
278 Greenfield Avenue Milwaukee, Wis.

2 Automatic Switches Which do you want?

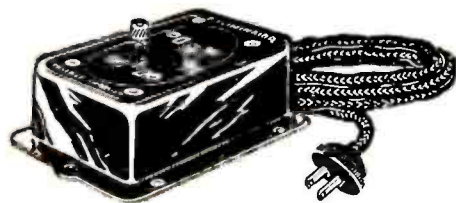
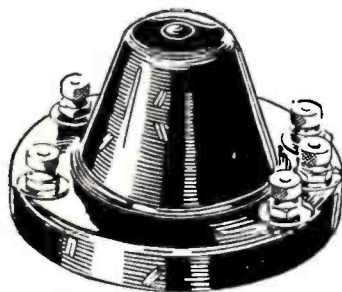

Low Cost

Electrically identical with higher priced models. Five minutes work installing this Utility Type Switch saves you at least \$1.50. Complete instructions make it easy to connect to binding posts. Only one installation is necessary. Requires no attention again.

Retails at \$2.00 to \$2.50

Model 13—This model, shown above is identical electrically with Model 23 but is without cord and plug or receptacles for Charger and Eliminator cords. For use with sets using from 3 to 8 Type 201-A tubes or their equivalent in amperage drain. Retails at \$2.00.

Model 14—Identical electrically with Model 24 except that it is without cord and plug and receptacles for Charger and Eliminator cords. For use with sets using from 5 to 10 Type 199 tubes or their equivalent. Retails at \$2.50.

Convenience

For the man who doesn't like to "tinker", the convenience Models have plug Connections for B Eliminator and Trickle Charger with cord and plug for light socket. Connections are as easily made as plugging in an electric light.

Retails at \$3.50 to \$3.75

Model 23—This model illustrated above, is complete with cord and plug and receptacles for connection with Trickle Charger and B Eliminator Cords. This model is for receiving sets using 3 to 8 Type 201-A tubes or their equivalent in amperage drain. Retails at \$3.50.

Model 24—Same construction as Model 23 but is intended for use with sets using from 5 to 10 Type 199 tubes or their equivalent in amperage drain. Retails at \$3.75.

Either Type Switch will make the A Battery switch on your receiving set, automatically turn on and off, either or both the Trickle Charger and B Eliminator as required.

Ask the nearest radio dealer to show you these newest necessities of radio, or if he cannot take care of you, ★ order direct, giving dealer's name on the coupon below.

THE RELIABLE PARTS MANUFACTURING CO.
2831 Prospect Avenue Cleveland, Ohio

Reliable Automatic Power Control Switch

Reliable Parts Mfg. Co.
Cleveland, Ohio

I would like to have one of your Reliable Automatic Switches.

\$2.00	\$2.50	\$3.50	\$3.75
<input type="checkbox"/>	<input type="checkbox"/>	<input type="checkbox"/>	<input type="checkbox"/>
No. 13	No. 14	No. 23	No. 24

My Dealer is _____

My Name _____ My Address _____

Fully guaranteed. Money returned if unsatisfactory for any reason. Sent C. O. D. if desired.

—used in the LC-27



AEROVOX

"Built Better"

FIXED CONDENSERS

are Specified in

- LC ~ 27 by L. M. Cockaday
- Diamond of the Air " Herman Bernard
- To be announced soon(?) " John Rider
- Raytheon "B" Eliminator " Raytheon Mfg. Co.
- Ultradyn " R. E. Lacault
- To be announced soon(?) " R. E. Lacault

AEROVOX fixed condensers have been approved by M. I. T. and Yale Universities.

AEROVOX WIRELESS CORP.
489-491-493 Broome Street, New York

The New

HAMMARLUND-ROBERTS

"Hi-Q" Receiver
Embodies the Latest
Hammarlund Developments

The coils and variable condensers specified by the twelve nationally-known designer-engineers of the remarkable Hammarlund-Roberts "Hi-Q" Receiver are typical of Hammarlund advanced design and precision manufacturing methods.

These instruments are of standard design and may be used with assurance of satisfaction in any other circuit of similar characteristics.

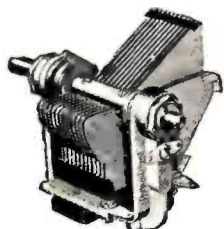

The "MIDLINE" Condenser

Gives better separation of wave lengths than previous types. Has a full-floating rotor with removable shaft, adaptable to any scheme of single control, multiple condenser operation.



"HAMMARLUND, JR."

A high ratio, shielded midget condenser for use wherever small variable capacities and fine tuning are required. Base-board or one-hole panel mounting. Knob included.

Some Other New Circuits
in Which Hammarlund
Products are Officially
Specified

- COCKADAY "LC27"
- SARGENT "INTRADYNE"
- LACAULT "LR4"
- HENRY-LYFORD
- ST. JAMES SUPER
- VICTOREEN SUPER
- MORRISON "VARION"
- NEW HARKNESS
- CARBORUNDUM
- PACENT "ULTIMAX"
- BROWNING-DRAKE
- POPULAR SCIENCE
- MONTHLY "POWERFUL"
- LOFTIN & WHITE

We shall be glad to refer to the proper authorities any inquiries regarding the above receivers

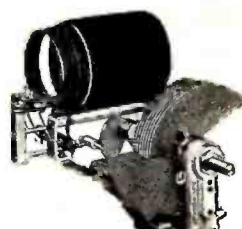

The "AUTO-COUPLE"

A scientifically correct tuned radio frequency assembly of Space-Wound Coil, "Mid-line" Condenser and Aluminum Shield, providing automatic graduated primary coupling at every condenser setting.



EQUALIZER

A compact, efficient variable condenser of small capacity, for neutralizing or balancing radio frequency circuits against undesirable oscillations on the low wave-lengths.

HAMMARLUND MANUFACTURING CO.

424-438 W. 33d Street, New York



For Better Radio
Hammarlund
PRECISION
PRODUCTS



R343. ELECTRON-TUBE RECEIVING SETS. RECEIVER RADIO BROADCAST. Nov., 1926. Pp. 35-42. R. B. Lab. "Constructing the R. B. 'Lab.' Receiver," J. B. Brennan.

A four-tube receiver, employing the Rice method of neutralization, is described. The volume is said to be sufficient to operate a loud speaker. The entire panel layout, and the method of assembly, are so planned as to give the shortest possible leads. The latest parts are incorporated throughout.

R210. FREQUENCY; WAVELENGTH. FREQUENCY, WAVELENGTH. Popular Radio. Oct., 1926. Pp. 534-ff. WAVELENGTH. "Wavelengths to Frequencies," J. O. Perrine.

The writer discusses at some length the advisability of using the term *frequency* instead of *wavelength* when speaking of the ether vibrations and the oscillations in radio circuits. It is brought out that, in using frequency, an equal division is always obtainable, which is not the case when speaking of wavelength. Charts for converting from frequency to wavelength, or vice versa, are given.

R800(347.7). PATENT PRACTICE. PATENTS, RADIO BROADCAST. Nov., 1926. Pp. 19-22. Radio. "The Radio Patent Structure and What It Means," F. Strother.

It is stated that the radio industry at present is tied up with over 2400 patents, interlocking and meshing in a way which only extended patent litigation can untangle. Materials, ideas, methods, combinations of ideas and methods, are all subjects of patents. Of all of these probably the vacuum tube is in the greatest difficulty. Also the neutralization patents are a bone of contention at present. The belief is prevalent that, with the rapid advance of the art, the control of a basic idea does not rest in the basic patent, but rests in the patent upon some more recent refinement of the basic patent, or upon some new method of manufacturing the device.

R900. HISTORY. RADIO BROADCAST. Nov., 1926. Pp. 28-31. Radio. "Looking Back Over Thirty Years of Radio," G. Marconi.

Senatore Marconi gives a résumé of the history of wireless from the time of his early pioneering and experimenting in the commercial wireless field, to the present day when short-wave low-power beam transmitters are replacing those of longer waves and higher power. His discoveries in 1895 led to the erection of larger and larger stations which finally transmitted with enough power to consistently reach across the Atlantic Ocean. The importance of the discoveries of Fleming, DeForest, Langmuir, Armstrong, and others, have brought radio to its present high standing.

R351. SIMPLE OSCILLATOR TRANSMITTERS. TRANSMITTERS, RADIO BROADCAST. Nov., 1926. Pp. 32-34. B Battery.

"High Efficiency B-Battery Transmitters," K. Henney. This article supplements the one appearing in the April issue of RADIO BROADCAST for 1926 (pp. 678 ff.) and shows some of the transmitters which have been built by readers of RADIO BROADCAST. Each set is described, with comments on construction and operation. In tuning the set, a variety of curves are presented which aid greatly in determining what to look for when desiring maximum results.

R343.5. HETERODYNE RECEIVERS. SUPER-HETERODYNE, RADIO BROADCAST. Nov., 1926. Pp. 54-56. Short-Wave. "A short-Wave Super-Heterodyne Receiver," Wace G. J. Eitz, Jr.

A short-wave receiver is described, which does not use the common regenerative method of reception, but the super-heterodyne principle. Since c.w. is supposed to be received with this set, the problem of distortion is not considered of paramount importance. An intermediate frequency of 22 kilocycles is used. The action of the receiver, which is a five-tube set, is summarized as follows:

1. Approximate tuning to the incoming frequency by the first detector tube (which is also an oscillator) and the creation of a 22-kilocycle note.
 2. Amplification of the 22-kilocycle note.
 3. Detection of the beat note with: (a) Straight detector for telephone; (b) Oscillating detector for c.w.
 4. Amplification at audio frequency.
 5. One-dial control for the entire action.
- A description of the entire set is given with comments on construction and operation.

R550. BROADCASTING. BROADCASTING, RADIO BROADCAST. Nov., 1926. Regulation of. Pp. 57-59.

"A New Plan to Regulate Radio Broadcasting," C. Dreher.

A solution of the problem of broadcast-wave allotments is suggested. The opinion is expressed that competition for the much-desired licenses be the method used in rationing them out. The question of merit, when a license to broadcast is desired, shall be decided by a check-up on program, power, and quality of transmission.

- In summary, the points to be considered are as follows:
1. Establishment of a suitable commission with power to rate broadcasting stations as to public service value or capacity, and facilities for determining the same.
 2. Allocation of wavelengths on a population basis and with due regard for technical limitations.
 3. Evaluation of hours of each day as to relative importance for broadcasting.
 4. Distribution of available time and wavelengths to applying stations according to individual ratings and values assigned to hours, exchange of hours to be permitted, subject to ratification by the commission.
 5. Modification as necessary to secure flexibility and aptimum service to listeners.
 6. Provision for judicial review of major decisions.

R343. ELECTRON-TUBE RECEIVING SETS. RECEIVER, QST. Oct., 1923. Pp. 9-15. All-Wave.

"Covering All Wavelengths," John M. Clayton. In an attempt to do away with a multitude of receivers to cover all the radio frequencies from the 15 = to the 20,000-kc. band, Mr. Clayton has designed a receiver using plug-in coils in the Weagant circuit, with two stages of audio amplification. In order to take care of the variable capacity at this wide range of frequencies, a double condenser is used. The complete layout and data concerning the plug-in coils are given.

Why not subscribe to *Radio Broadcast*? By the year only \$4.00; or two years \$6.00, saving \$2.40. Send direct to Doubleday, Page & Company, Garden City, New York.

F. D. PITTS COMPANY

INCORPORATED

219-C Columbus Avenue, Boston, Mass., U. S. A.

"Pioneers in the Distribution of Radio"

DEALERS—Send for large and profusely illustrated catalog on the products of nationally advertised radio manufacturers.

Wholesale Exclusively
MERCHANDISING RADIO SINCE 1919

Centralab

Non-Inductive, Variable-
High Resistances

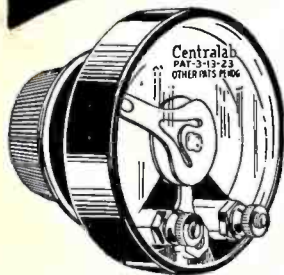

Centralab Radiohms with two terminals, and Modulators or Potentiometers with three terminals, provide gradual Noiseless control of oscillation or volume in any circuit. Specified for the Infradyne S-C, Samson T-C, Henry Lyford, Universal and many other circuits. Used as standard equipment on a large number of commercial receivers, and by

both the U. S. Navy and Signal Corps. There is a resistance and correct taper for every circuit. At your dealer, \$2.00. Write for circuit hook-ups.

CENTRAL RADIO LABORATORIES

22 Keefe Ave.

Milwaukee, Wis.

Makers of variable resistances for 69 makers of leading standard sets. ★

Centralab

AUDIO FREE AMPLIFICATION

The four types thoroughly explained in a fully illustrated booklet 9 x 12".

This booklet will be sent to you absolutely FREE if you will send me six cents in stamps to cover cost of handling and postage.

W. McMANN

64 Church St. Dept. R.B. New York City

\$75 A WEEK BUILDING RADIO SETS

In Your Spare Time

Join the Radio Association of America. Learn how to build and repair sets. The Association will train you—start you out in business, if you wish. Be the radio "doctor" of your community. \$3 an hour upwards easily made.

EARN \$500 IN SPARE HOURS

"I have at last found myself," writes Lyle Follick, Lansing, Mich. "I have already made over \$500." Werner Eichler, Rochester, N. Y., writes, "... have made over \$50 a week in my spare time." Our members are starting radio stores, increasing their salaries, securing better positions, passing radio operator examinations, earning big money in spare time.

JOIN ASSOCIATION NOW!

Are you interested in radio for pleasure or profit? Join now because we have a Special Plan whereby your membership need not cost you a cent. Only limited number of these memberships acceptable. Write now for details—before it is too late.

MAIL THIS COUPON

Radio Association of America,
Dept. R B-1, 4513 Ravenswood Ave., Chicago.
Send me details of your Special Radio Association Membership Plan.
Name.....
Address.....
City..... State.....

AMERTRAN RADIO PRODUCTS

Sold Only by Authorized AmerTran Dealers

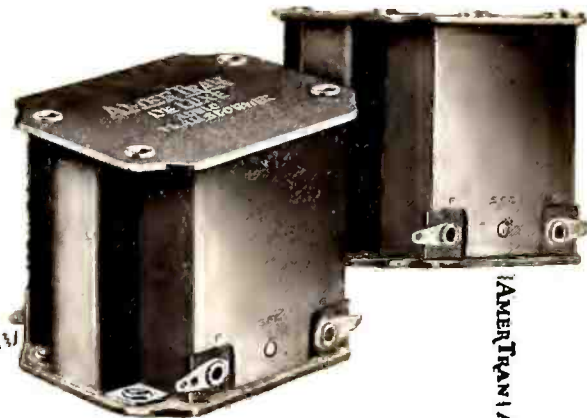

The AmerTran De Luxe Audio Transformer. Made in 2 Types. \$10.00 Each

Those Who Know in Radio

Those who take their radio seriously such as experienced engineers and experimenters use AmerTran De Luxe Audio Transformers. And the reasons are true tone quality and realistic reproduction which result from ideal amplification.

These men know by test and comparison that the AmerTran De Luxe makes a transformer coupled amplifier excelling all other forms of amplifiers. They know, too, how well the AmerTran De Luxe performs in Power Supply Developments. Used with other AmerTran Products, it will make a power unit capable of dependable, satisfactory service.

Every AmerTran De Luxe is manufactured to maintain a high laboratory standard. Its improved performance recommends it especially to those seeking "better than the average" radio reception.

Write for free booklet, "Improving the Audio Amplifier." It contains valuable technical data.

American Transformer Company
178 Emmet St. Newark, N. J.

"Transformer Builders for over Twenty-Six Years"



The AmerTran Power Transformer Type PF-52

Type PF-52 is intended for use in the better type of power supply developments. It will convert the standard 110 volt, 60 cycle alternating house lighting current to a higher voltage for the plate and lower voltage for filament supply.

Price \$18.00 Each



The AmerChoke Type 854

This is a scientifically designed impedance or choke coil of general utility, designed primarily for use in filter circuits. As an output impedance for by-passing direct current from the loud speaker it is both efficient and economical.

Price \$6.00 Each



AmerTran Types AF-7 and AF-6

AmerTran Audio Transformers, types AF-7 and AF-6, have been considered for years among the leaders in audio amplification. These popular and efficient models are made in two types—AF-7 (ratio 3 1/2:1)—AF-6 (ratio 5:1).

Price \$5.00 Each

At **WGN**
SANGAMO
 Mica Condensers
 Prevent
 Shifting of Frequency Bands



BECAUSE the Sangamo condenser is solidly molded in bakelite, mechanical movement of dielectric or plates is impossible. This is one important factor in the permanent accuracy of the Sangamo.

No one has greater need for condenser accuracy than a great broadcasting station like WGN. Read Mr. Leverett's comment:

"Last June I used Sangamo Mica Condensers in a multiple band pass filter. This has been in use for some time, and has given the best of results, showing no shifting of the frequency band. This permanency I believe is due entirely to the consistency of these condensers, there being no apparent change in capacity nor leakage across them. I cheerfully recommend them wherever a constant capacity is required.

(Signed) Geo. H. Leverett, Asst. Engineer
 Station WGN Chicago

Sangamo Condenser Blocks

American-made condensers, wound under uniform tension to eliminate air or ozone bubbles that cause breakdowns.

- Handy sizes:
 12 mfd. tapped 8, 2, 2 mfd.
 14 mfd. tapped 8, 2, 2, 1, 1 mfd.
 14 mfd. tapped 4 (high voltage), 4, 2, 1, 1, 1, 1 mfd.

Also separate condensers; special capacity blocks to order.

Sangamo Electric Company

6332-11 Springfield, Illinois ★

RADIO DIVISION, 50 Church Street, New York

SALES OFFICES—PRINCIPAL CITIES

R800(621.313.73). MERCURY VAPOR RECTIFIERS. MERCURY-ARC RECTIFIERS.

Radio. Oct., 1926. Pp. 40-41.
 "An Amateur's Mercury Arc Rectifier," Don C. Wallace.

In order to supply plate current to the larger tubes used for transmitting purposes, a mercury arc rectifier can be used. A suitable one is sold by the General Electric Company. It supplies voltages anywhere from 500 to 5000 with practically no internal drop. The circuit arrangement and the layout and construction of parts necessary for such a transmitter are described.

R343. ELECTRON-TUBE RECEIVING SET. RECEIVER, Radio. Oct., 1926. Pp. 29-ff. "Equamatic."

"The 'Equamatic' Tuned R. F. Receiver," G. M. Best. Of the various methods used in tuned radio frequency sets to overcome the tendency to oscillate at the higher frequencies and still have a high efficiency, the "Equamatic" system is said to bring about a stable condition more uniform than any other. The principle involved consists in automatically varying the coupling between primary and secondary coils through direct connection with the condenser shaft. The method of constructing and operating a receiver employing the "Equamatic" system is outlined.

R344.5. ALTERNATING CURRENT SUPPLY. ELIMINATORS, Radio News. Oct., 1926. Pp. 322-ff. B Battery.

"B Battery Eliminators," M. L. Muhleman. The various forms of B battery eliminators now on the market are presented and discussed. Their circuit diagrams, and the principle upon which they operate, is brought out in detail for every instrument shown.

R387. SHIELDS. SHIELDING. Radio News. Oct., 1926. Pp. 336-337.

"A Perfect Static Shield," V. G. Mathison. The use of solid metal shielding is considered to be out of the question when looking for amplification of weak signals in receivers, according to the author. Too much energy is lost. In this article, the use of copper rods or copper wires is substituted for the solid shields, with the result that no energy is absorbed from the set, but the set is totally shielded nevertheless. Coils may also be shielded by this method with considerable success.

R132. AMPLIFYING ACTION. AMPLIFICATION, Radio News. Oct., 1926. Pp. 342-ff. Radio Frequency.

"Radio-Frequency Amplification," E. T. Flewelling. Attention is called to some common errors frequently made in the construction and the connections of tuned radio-frequency amplifier sets. Parts must be balanced and wires so placed that they do not cause disturbances in neighboring parts. Every measurement from stage to stage should be made with precision in order to be able to tell what to expect of a set before it is assembled.

R375. DETECTORS AND RECTIFIERS. RECTIFIER, Radio News. Oct., 1926. Pp. 343-ff. Raytheon BH.

"A New Rectifier for A, B, C, Power Units." A new Raytheon tube, capable of delivering enough current and voltage to replace A, B, and C batteries in a set equipped with 190 tubes and a power amplifier, has been developed. A circuit diagram showing how this new tube may be used for the above-mentioned purposes is presented, and discussed at some length. Variations from 10 to 85 milliampere are possible, the tube having a very good regulation over this range.

R342. AMPLIFIERS. AMPLIFIERS, Radio News. Oct., 1926. Pp. 353-ff. Audio Frequency.

"A New Amplifier and B Supply Unit," A. H. Lynch and R. R. Mayo. The requirements for good audio output are said to rest with the following:
 1. An r. f. amplifier which does not cut off side bands.
 2. An r. f. amplifier which does not produce excessive gain and bring in local disturbances.
 3. An i. f. amplifier which does not overload the detector.
 4. A straight frequency-line characteristic for the audio amplifier whether under- or over-loaded.
 5. A loud speaker with good reproducing qualities. An audio frequency amplifier, operated from the lamp socket, and giving exceptional reproduction, is described, and the method of construction outlined. It is a resistance-coupled instrument with a B line power-supply device.

R343. ELECTRON-TUBE RECEIVING SETS. RECEIVERS, Radio News. Oct., 1926. Pp. 362-363. Loewe Tube

"A Five-In-Two Receiver," C. J. Fitch. The writer presents a receiving set built around the new multiple tubes made by Loewe of Germany. The internal construction and arrangement of these new tubes, and the apparatus necessary to assemble a neat and compact receiver, are points discussed and presented.

R210. FREQUENCY MEASUREMENT. FREQUENCY MEASUREMENT, Bureau of Standards. Letter Circular LC-171.

"Methods and Apparatus for Measurement of the Frequencies of Distant Radio Transmitting Stations."

It is the purpose of this circular to outline several methods of measuring frequencies and to describe the apparatus needed for this purpose. A schedule of standard frequency transmissions from wv and 6 xbm, is printed, the range of frequencies covered being from 125 to 6000 kilocycles. The zero beat method and the resonance click method may be used, the former being the more accurate, as stated. Both methods are discussed at some length.

In constructing a frequency meter, of fundamental importance is said to be its mechanical ruggedness. The condenser should meet with certain requirements its range being covered through small variations. It should be shielded and have a low i. f. resistance. As for the resonance indicator, it may consist of several devices, the thermo-galvanometer being preferred. The testing of this frequency meter is accomplished most satisfactorily with a low-power generator described here. In an accompanying table (No. 1) are given the coil sizes of various frequency ranges. A 5-watt generator for setting up the i. f. currents is outlined, with diagrams of hook-ups appended. The method of procedure in making all the measurements is explained in great detail.

Turn 1 Dial-get stations everywhere:-30 Days Free!



SEND COUPON FOR AMAZING SPECIAL OFFER!
 NOTE: This offer is made to prospective buyers by famous big Radio Corporation, one of America's oldest reliable manufacturers of fine sets—seventh successful year. Many satisfied users in every state. Postal or coupon brings testimony of near-by users and proof Miraco's outperform sets costing up to 4 times as much. Very easy to operate

BEAUTIFUL • BIG • POWERFUL
 Ultra Selective **MIRACO** Unitone 5

Built to look like and perform like a \$200 set. Users report:
MIRACO RADIO GETS EM COAST TO COAST

ONE DIAL CONTROL
 Only One Dial to turn for all programs.

Spot on 30 Days Free Trial. Enormous demand for Miraco 5's makes possible best of costly new refinements and improvements at lower prices than ever! Genuine installation atoping panels, dials beautifully finished in walnut to match cabinets; Connect B-Z Battery Cabinet; features too numerous to mention of high-priced sets. Send for Amazing Low "Unitone" Price!

SPECIAL WHOLESALE PRICES
 to user-agents who show the set to friends.
DEALERS WRITE!

Our Factory Prices Save You Up to 1/2!
SEND NO MONEY! Save or make much money \$49.75 Ultra-5
 on notes, speakers, tubes, batteries—write for AMAZING OFFER. Ultra-5 (not illus.) is marvelous value in a big Guaranteed 5-tube, 3-dial set. Retail List \$75

MIDWEST RADIO CORPORATION, Pioneer Builders of Sets
 408-G Miraco Bldg., Cincinnati, Ohio
 WITHOUT OBLIGATION, send free literature, AMAZING SPECIAL OFFER, testimony of users, etc.

NAME:
 ADDRESS:

Fahnestock Clips

RADIO'S GREATEST CONVENIENCE

Used by Manufacturers of Standard Sets and Parts—and by Manufacturers of High Grade Wet and Dry Batteries.



ALL GENUINE FAHNESTOCK CLIPS

bear our imprint on the thumb piece of the clip.

WORLD'S LARGEST MAKER OF CLIP TERMINALS

48 different sizes and styles to meet all requirements.

Send for Catalog and Samples

FAHNESTOCK ELECT. CO.
L. I. City New York

Bradleystat

PERFECT FILAMENT CONTROL

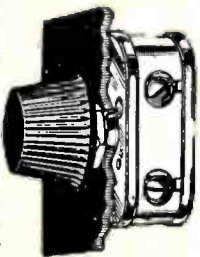

Provides complete noiseless filament control for all radio tubes without change of connections. Metal parts are nickel plated. One hole mounting. Self contained switch opens battery circuit when desired.

Allen-Bradley Co.

Electric Controlling Apparatus

278 Greenfield Avenue Milwaukee, Wis.

Make Your Own Three Foot Cone Speaker In Less Than An Hour

WORLD'S FINEST LOUD SPEAKER

GENUINE "ENSCO" 3" CONE KIT

ONLY \$10
Can be Assembled in Less Than an HOUR



ONLY \$10
The Original Three Foot Cone Speaker KIT

NO DISTORTION THE SOLUTION OF THE LOUD-SPEAKER PROBLEM PERFECT FIDELITY
The Choice of Leading Engineers

Complete parts furnished in kit form. We guarantee this speaker the equal of any manufactured cone speaker at any price. With this **THREE FOOT CONE SPEAKER** you hear all the tones. It brings out the true depth and beauty of orchestral and instrumental music. Can be operated softly for living room music or full volume for dancing, and without trace of distortion. Kit includes famous "ENSCO" cone unit, the only direct-drive, distortionless unit for large cones; Alhambra Ponotex for big cone, with brass apex, two Sepia Prints showing cabinet or simple stand construction. All necessary instructions. Buy this wonderful speaker under our absolute guarantee. *Your money back* if you are not convinced that it is the finest reproducing medium obtainable at any price. It works on any set, with ordinary Tubes or with Power Output.

SEND NO MONEY!

Write your name plainly as indicated below, then mail and complete kit will be forwarded to you. Just pay postman \$10.00 upon delivery.

Name.....
Address.....

ENGINEERS' SERVICE CO.
25 Church St. Desk X New York City

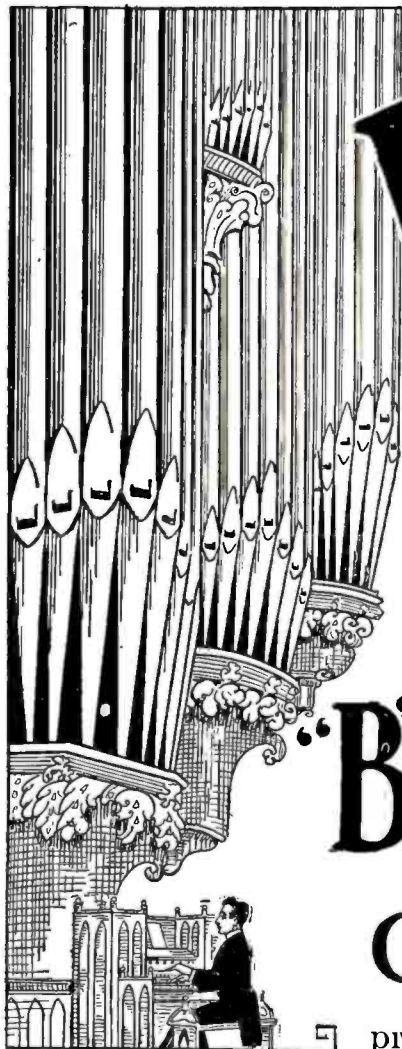

Power
for
the deep
tones
PLUS a
"B" Eliminator

COMPLETE realism in radio reproduction requires that the deep bass tones as well as the high notes be prominently brought out. Only a UX 210 (or CX 310) tube, using up to 400

volts in your last audio stage, has sufficient power to do this. To use this tube directly in your set, rewiring would be required to take care of the increased voltage. Now by merely attaching a **POWERIZER** and eliminating your present last tube, you can not only use this real power tube without rewiring, but eliminate "B" batteries as well.

POWERIZER operates from the lamp socket, using two power tubes—one the 210 or Super-Amplifier giving such marvelous tone that it has come to be known as the "Tonifier", the other a UX 210 (or CX 316) rectifying tube, making the **POWERIZER** a heavy duty super "B" eliminator

You cannot **KNOW** what really perfect tone quality is until you hear **POWERIZER**. **POWERIZER** can be attached to any set in a few minutes with no technical knowledge whatever. Ask the nearest **POWERIZER** dealer to demonstrate it to you today.

Our new descriptive leaflet, "New Tone for Old", will gladly be sent upon request. Write for it.

POWERIZER

REG.

TESTED and APPROVED by ALL
Leading Laboratories

Power Amplifier and "B" Eliminator combined—
at cost of good "B" Eliminator alone.

\$49⁵⁰



RADIO RECEPTOR CO.

106 Seventh Avenue

New York

Sterling

“HOME SERVICE”
Your Radio Tubes and Batteries
... and save money



Test Tubes with a
Sterling Tube Tester
\$7.50



Test Batteries with a
Sterling Pocket Meter
\$1.25 to \$4.00
—or mount one on your panel \$3.00 to \$5.00



Does the Storage “A” Battery need recharging?
Find out with a Sterling Charge Indicator.
\$2.00
The clean, sure, external test.



Renew run down tubes with a
Sterling Reactivator
\$12.50 (meter-equipped) \$3.75 (non-metered)

GOOD radio can't long continue on mere luck. Tubes and batteries do deteriorate from the moment they are placed in use. Falling-off of first quality reception is sure to come sooner or later.

Neglecting to test tubes and batteries often and to replenish them, as and when they need building up, results not only in poor reception, but unnecessary expense.

You can now make your home servicing of tubes and batteries a pleasure by the simple and sure Sterling Radio Inspectors and Care-takers. Any one of these devices will pay for itself this season.

You can't afford to guess your reception is good.

See your nearest radio dealer or write us for our interesting 32-page booklet on the care and up-keep of radio.

The Sterling Mfg. Company
 CLEVELAND, OHIO



Now is a good time to subscribe for

RADIO BROADCAST

Through your dealer or direct, by the year only \$4.00

Doubleday, Page & Company

Garden City, New York



Guarantee

This WHEELAN SUPER-CONE is guaranteed to be as good as any other of its kind in the world. If you are not satisfied, we will refund your money or replace it with a new one. If you are not satisfied, we will refund your money or replace it with a new one. If you are not satisfied, we will refund your money or replace it with a new one.

R. B. J.

\$10

Wheelan Super-Cone

A full size 17 inch free-edge cone guaranteed to be as good in tone and volume as cones selling at \$25. Insist on seeing guarantee tag. ★

If your dealer can't supply you send us his name and your order will be filled. Wheelan Mfg. Co., 254 W. 34th St., New York

“PHASATROL”

Coming-Coming

A True Balancing Device for All Radio Frequency Sets

A Revolutionary Innovation

ELECTRAD, Inc.

RADIO FANS, a one-year's subscription to Radio Broadcast will cost you four dollars, two years six dollars. Consider this expenditure as being a necessary investment on your part for the future development of your own knowledge of Radio.

★ Examined and approved by RADIO BROADCAST ★

THE “RADIO BROADCAST” INFORMATION SERVICE

How to Write for Technical Information—The Scope of This Service

AS WAS announced in the June RADIO BROADCAST, all questions which were formerly sent to “The Grid” will now be handled by the Technical Information Service, RADIO BROADCAST Laboratory. That service is maintained under the following rules:

1. All questions from subscribers to RADIO BROADCAST will be answered free of charge.
 2. Non-subscribers to RADIO BROADCAST will be charged a fee of One Dollar for the Laboratory Technical Service.
 3. All questions will be answered by mail and none will be published in RADIO BROADCAST.
- The Technical Information Service of the Laboratory feels that it is important to define the scope of its service to readers. Although the Service is of very general help to our readers, there are certain demands which can not be met.

The Technical Information Service:

1. Cannot make comparisons between various kinds of receivers or manufactured apparatus.
2. Wiring diagrams of manufactured receivers cannot be supplied. This information can be secured from the various manufacturers.
3. Complete information cannot be given about sets described in other publications, but in all cases (wherever possible), inquirers will be referred to a source of information where the data can be obtained. In this connection, the monthly department in RADIO BROADCAST “The Best in Current Radio Publications” should be of great help, and should be consulted. That department records the most important constructional, technical, and general radio articles which appear.
4. Special receivers or circuits cannot be designed by the Technical Service.
5. Those who ask questions which cannot be answered in the scope of a letter will be referred, if possible, to sources where the information can be obtained.

TECHNICAL INFORMATION INQUIRY BLANK

Technical Service,
 RADIO BROADCAST Laboratory,
 Garden City, New York

GENTLEMEN:

Please give me fullest information on the attached questions. I enclose a stamped addressed envelope.

I am a subscriber to RADIO BROADCAST, and therefore will receive this information free of charge.

I am not a subscriber and enclose \$1 to cover cost of the answer.

Name

Address

R. B. J.

\$625 In Prizes

A BOOKLET recently received from the advertising department of the Benjamin Electric Manufacturing Company, of 120-128 S. Sangamon Street, Chicago, Illinois, announces a series of prizes for radio fans who enter a competition which closes on January 31st, 1927. The prizes, totalling \$625, are offered for new and original circuits, ideas for improvements and modifications of circuits, the best description of a home-made radio set, and for trade names and slogans for Benjamin products.

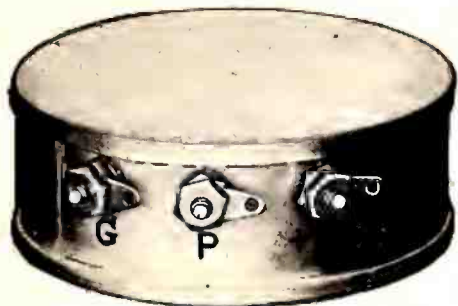

Shielded Tuned Radio Transformer, No. 30

SICKLES Diamond-Weave Coils

THE new Sickles Shielded Tuned Radio Transformer prevents both outside and local interference. It is remarkably compact, sharp tuning, sturdy. Sickles Diamond-weave coils have established an enviable reputation for low distributed capacity, low dielectric losses, and large range of frequency with small variable capacity.

The ideal coil for the Naald Localized Control Tuning Unit and for the Tru-phonie Catacomb Assembly.

There are Sickles Diamond Weave Coils for all Leading Circuits.

The F. W. Sickles Co.
132 Union Street ★
SPRINGFIELD, MASS.

COIL PRICES

- No. 30 Shielded Transformer... \$2.00 each
- No. 24 Browning-Drake..... 7.50 Set
- No. 18A Roberts Circuit..... 8.00 "
- No. 25 Aristocrat Circuit..... 8.00 "

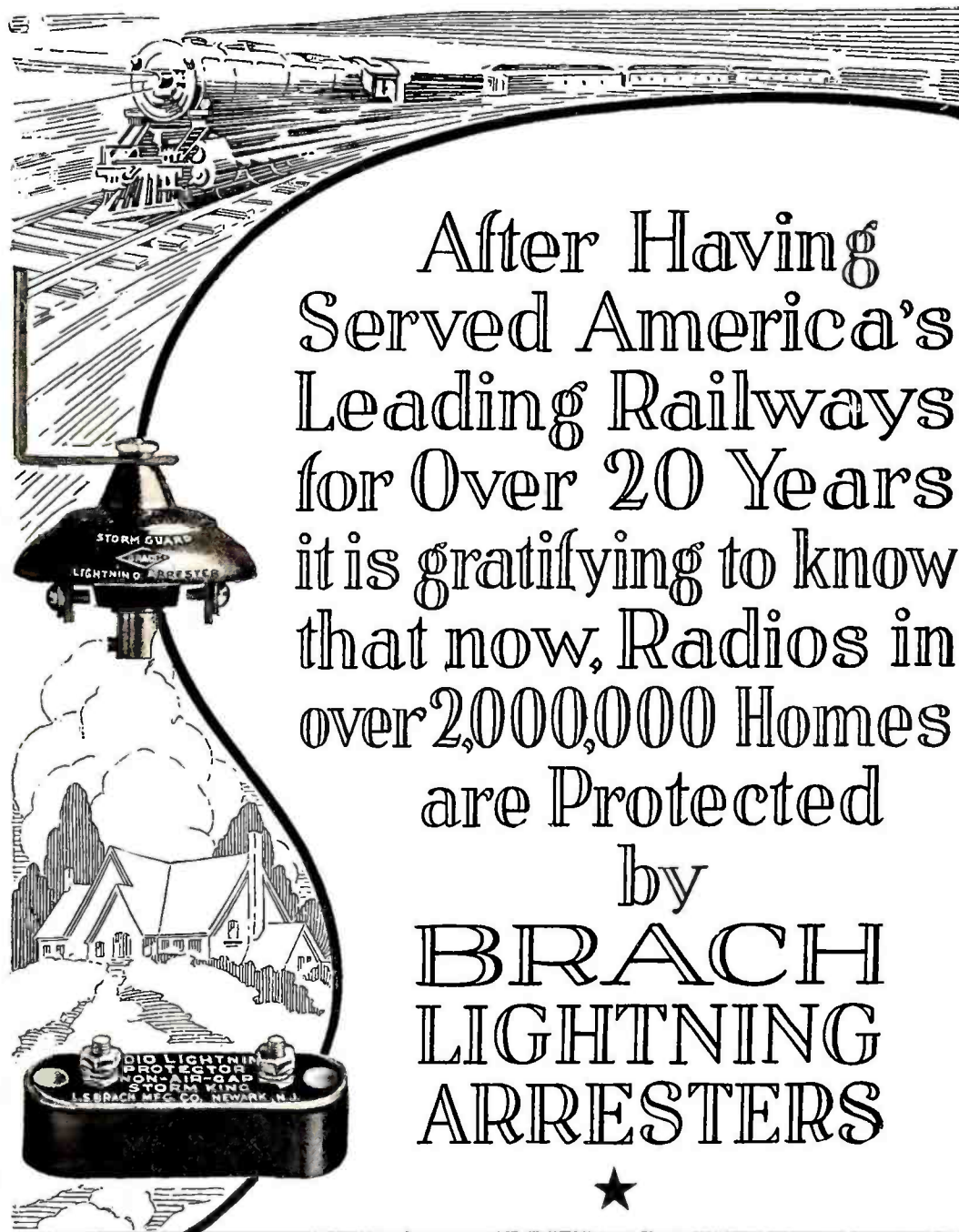

After Having Served America's Leading Railways for Over 20 Years it is gratifying to know that now, Radios in over 2,000,000 Homes are Protected by **BRACH LIGHTNING ARRESTERS**

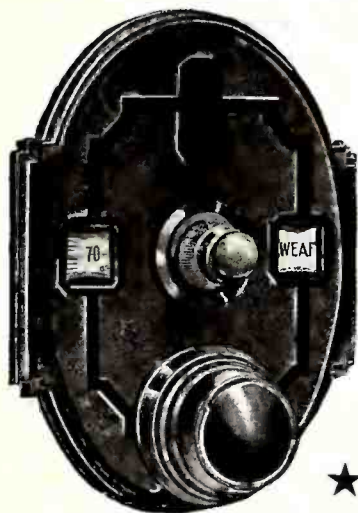

ACCURATUNE Illuminated Dial

Its simplicity and efficiency has overwhelmed the real radio fans.

Its positive friction grip insures absolute smooth action.

Graduated from 0 to 100 or reverse. Sold in three ways.

Recording Dial.....\$2.00 (Ratio 10 to 1)

With Micrometer control 2.75 (Coarse ratio and 200 to 1)

Illuminated extra50

Sent direct if your Dealer cannot supply you

MYDAR RADIO COMPANY

3 Campbell St. Newark, N. J.

"Pioneer Mfrs. of Micrometer Dials"

BRACH CONTROLIT



Gives the SET SWITCH Control of Trickle Charger and "B" Substitute—AUTOMATICALLY.

No need, now, to operate three switches every time you turn on or off your set. The Brach CONTROLIT makes this unnecessary by eliminating all extra switches and placing complete control of your power plant and set in the set switch. At the same time it makes any Radio a light socket power-operated set.

Anyone can install a CONTROLIT—no extra wiring or altering is necessary.

PRICE \$6 in U. S. A.

Brach Radio Products

20
years
in the
lead

L. S. BRACH MFG. CO.

Newark, N. J., U. S. A.

Toronto, Canada

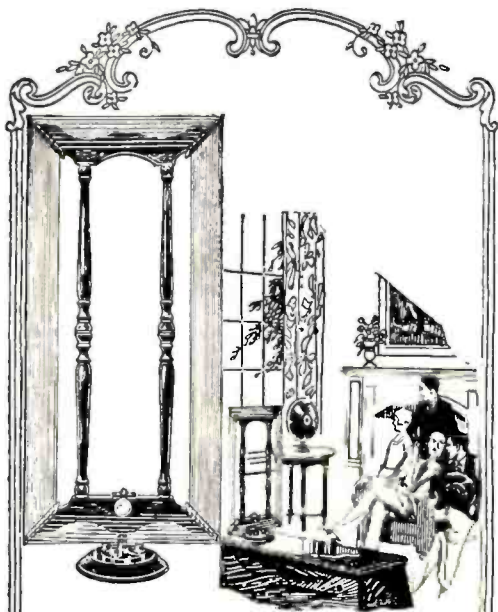

An Efficient Loop of Surpassing Beauty

The Bodine De Luxe Loop fulfills perfectly the long felt need for a compact beautiful loop—outstandingly efficient. The symmetrical frame of solid walnut, handrubbed to a beautiful finish, black bakelite mountings, and attractive silk covered windings combine in producing a loop of outstanding beauty.

Despite its compact size the De Luxe Loop brings in stations with amazing power. Sharper selectivity due to directional tuning improves tone quality.

Designed for standard loop sets but can be used effectively with most aerial sets. Write for free illustrated booklet that tells how. Price, Bodine De Luxe Loop, all models, \$12.00.

Bodine Folding Loop

Exceptionally directional, remarkably efficient. Because of the Basket-weave method of winding the Bodine Folding Loop brings in the long distance stations. Sliding sleeves

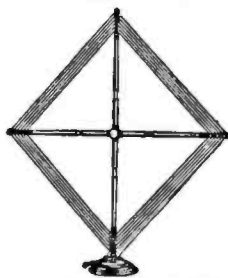

conceal the hinges of the English Mahogany frame in operation. Folded it fits a box only 3 1/2" x 6" x 18". Ideal for camping too! Holds shape under long service. Price, Bodine Folding Loop, \$8.50 to \$10.00.

Bodine Twin-Eight R. F. Transformers



Greater amplification, less interference with other parts, sharper selectivity, are features of these improved coils that amaze manufacturers and set builders alike.

No type of toroidal or doughnut coil can compare with Twin-Eights. Improves all tuned radio frequency hookups. Compact and small, easy to install. The boon of a amateur set builders. Write for hookup of the Bodine Twin-Eight Receiver which uses Twin-Eight Coils. Buy Twin-Eight Coils from your dealer today. Price \$2.00 per coil, three matched coils \$6.00.

Mail the Coupon

BODINE ELECTRIC COMPANY
2246 West Ohio Street
Chicago, Illinois

Kindly mail FREE circular describing:
Bodine Radio Loops.
How to use a loop with aerial receiver.
How to build the Bodine Twin-Eight Receiver.

Name _____
Address _____

How the Radio Trade-mark is Protected

ORDINARILY it is considered legitimate for any person or firm to adopt and use a well-known and popular trade-mark, provided its use is confined to goods or merchandise of an entirely different class from those sold by the original user. With such protection the public is not likely to purchase the goods of the later user of the trade-mark, believing them to be the product of the former user. For example, if "Eata" is recognized as a trade-mark for bread there is nothing to prevent its use by another firm as a trade-mark for automobiles or other products not of the same or kindred class of goods. This is true, because no one is likely to be deceived into purchasing an automobile thinking it is made in a bread-maker's factory, and therefore, no harm usually can come to the original user of the mark "Eata."

A recent higher United States Court trade name case that is particularly interesting from the viewpoint of the restricted use of a trade-mark adopted for use on a somewhat different class of merchandise is that of "Rolls-Royce" for radio tubes.

The Rolls-Royce Company of America, manufacturers of high-priced automobiles and aeroplane engines, instituted legal proceedings against Howard Wall, doing business under the name of the Rolls-Royce Tube Company, to prevent the use of the name "Rolls-Royce" in carrying on his regular business.

In this specific case, irrespective of the remarks in the foregoing paragraphs, the court restrained the use of the name "Rolls-Royce" as a trade-mark for radio tubes, and also as a part of the name of the company that was selling them. It appeared that the Rolls-Royce Tube Company had met with considerable success in selling Rolls-Royce radio tubes by mail. The tubes were simply marked "Rolls-Royce" without other indications to show where or by whom they were manufactured. Also, in advertising the tubes, the words "Rolls-Royce" were used alone in quotation marks with the statement following "Like Their Name, Significant of Quality." The advertisement directed correspondence to be sent to "Dept. A. of the Rolls-Royce Tube Company," thus giving the suggestion that the business comprised this and other departments.

The court decided that, inasmuch as the tubes bore only the name Rolls-Royce, with nothing else to indicate their origin, and as electricity is a vital element in automobiles, purchasers of the tubes might suppose the original Rolls-Royce Company had extended its high-grade products to include radio tubes. If the Rolls-Royce radio tubes proved unsatisfactory, it would tend to destroy, in the minds of the purchasers, the excellence of the product for which the words "Rolls-Royce" heretofore stood.

The court further said, in effect, that it is quite possible the use of the name "Rolls-Royce" might lead uninformed persons to believe the original Rolls-Royce Company stands financially behind the Rolls-Royce Tube Company, which impression, in the event that the radio tube business was not carried on successfully, might cause the name "Rolls-Royce" to suffer accordingly.

The use of the words "Rolls-Royce" in connection with radio tubes was, therefore, enjoined.
LEO. T. PARKER.

Improve Your Set 100%

FERI Lo-LOSS



SHIELDED
TUNED
RADIO
TRANS-
FORMERS

Features [SELECTIVITY] \$5.00
[VOLUME] Per Set
[QUALITY]
[DISTANCE]

Feri Lo-Loss Shielded Coils—Low distributed capacity, low dielectric losses and many other features insure unequalled results. Can be mounted either above or below sub-base Panel. Wiring Diagram and instructions supplied with each set of three.

Send for Description matter on other Feri Products

FERI RADIO MFG. CO.
1167 Bedford Ave. Brooklyn, N. Y.

RADIO PANELS

OF GENUINE BAKELITE

Cut, drilled and engraved to order. Send rough sketch for estimate. Our New Catalog on Panels, Tubes and Rods—all of genuine Bakelite—mailed on request.

STARRETT MFG. CO. ★
521 S. Green Street Chicago, Ill.

WE ESTABLISH YOU

Co-operative membership in EIA is establishing an honest and industrious man in each locality, regardless of his handicaps or present occupation, in a successful radio industry of his own. Young married men preferred. Apply by confidential letter to EQUITABLE INDUSTRIES ASSOCIATION, Dept. B-17, Tribune Bldg., New York

HAMMARLUND-ROBERTS

All Parts in Stock Exactly as Specified \$63.10
Also complete stock of Silver-Marshall parts as well as most of the better circuits.
Shipments made same day order is received.
Professional Set Builders try our discounts.
52-page Catalog Free

SHURE RADIO CO. 19E-21 S. Wells St. Chicago.



World Radio Storage "B" Battery
12 Cell—24 Volt



Proved value. Thousands of users find reception almost magical. Clear, true power—instantly and unendingly. Wise economy. Sturdy construction—Solid Rubber Case protection. Recharged for almost nothing. Endorsed and listed as standard by famous Radio institutions including Pop. Radio Laboratories, Pop. Sci. Inst. Standards, Radio News Lab., Lefax, Inc., and other Radio authorities. What more need be said? Extra Offer: 4 Batteries in series (96 volts) \$10.50. Send No Money Just state number wanted and we will ship same day order is received, by express C. O. D. Pay expressman after examining batteries. 5% discount for cash with order. Remember—you save 50% on World Batteries

★ WORLD BATTERY COMPANY
1219 So. Wabash Ave. Dept. 78 Chicago, Ill.

Makers of the Famous World Radio "A" Storage Battery
Prices: 6-volt, 100 Amp. \$10.00; 120 Amp. \$12.00; 140 Amp. \$15.00
All equipped with Solid Rubber Case.

Set your radio dial at 288.3 meters for the World Storage Battery Station WSHG. Variety—New Talent—Always interesting: JERRY SULLIVAN—Director and Announcer—"Chi-CAW-ko"



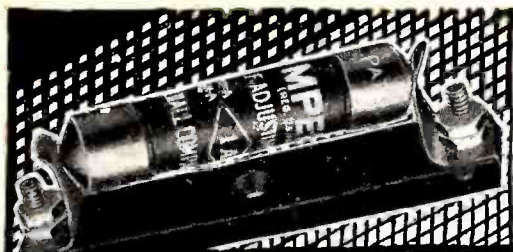

In Your Set

Tube life and efficiency, tone clarity and accurate tuning—all depend on filament control.

AMPERITE, the only self-adjusting filament control, regulates the tube current that governs these vital points. Eliminates hand-rheostats, simplifies set-wiring.

Accepted as standard equipment by every leading engineer, AMPERITE is specified in all popular construction sets.

FREE—Write for "The Radiall Book," containing the latest popular hook-ups and construction data, to Dept. R. B.-1.

Radiall Company ★

50 FRANKLIN ST., NEW YORK

AMPERITE

REG. U.S. PAT. OFF.

The "SELF-ADJUSTING" Rheostat

FIVE TUBE RADIO

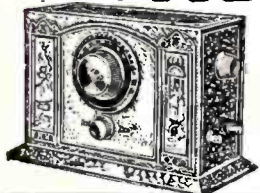

\$25.00

**AGENTS WANTED
BIG COMMISSION**

Demonstrating agent wanted; every county. Exclusive to right man. Sell what public wants—five tube, long distance, loud speaker radio with single dial control. Price within reach of all, \$25.00 retail; liberal discount to agents. Sell in spare time—evenings. No selling or radio experience necessary. Territory going fast. 100 page Radio Book FREE. Write today—don't delay. C. P. FISCHER, 122 W. Austin Ave., Chicago

HOME BUILT B SUPPLY

In the February *Radio Broadcast* appears the first of a series of articles by James Millen describing in great detail many different types of B supplies and amplifiers combined. On the Newsstands. January 15th.

Build Your Own

YOU must have a good 36 inch cone speaker to really enjoy your radio. *Build it yourself!* You can easily—in one evening—and save 4/5 the retail cost.

With this DOUBLE CONE speaker, exactly like highest price factory-made, and PENN C. S. Unit the low bass notes are clear and musical; the high treble notes are rich and mellow. Every instrument in an entire symphony orchestra is distinct and resonant.

Tone quality depends on

3 ft. Cone

the unit. The PENN is made especially for 3 ft. cone speaker; operates with any set; adjustable to audio output of set with which it is used.

Penn CONE SPEAKER UNIT

has full 16 oz. cyanide hardened magnet fully magnetized and completely electrolyzed to prevent rust. Ask your dealer for PENN C. S. Unit. Price, \$9.50.

Complete parts only \$14.15; include unit, 2 sheets Alhambra Fonotex, pr. Back Rings, Unit

Mountings and spc. Ambroid Cement. We'll supply you if your dealer can't or won't. Add \$1 for packing and shipping. Pamphlet, "How to Build a Giant 3 ft. Cone Speaker" mailed for 10c, coin or stamps. Send for it today.

PENN RADIO SALES CO.

104 Fifth Ave., Suite 2103, New York City
Exclusive Sales Agents for G. R. Penn Mfg. Co., New York

ELECTRAD

New Model!

Say "ROYALTY" When in Need of Variable High Resistance!

Dissipates Three Watts

Licensed by Technidyne Corporation under U. S. Patent 1593685, July 27, 1926

From these 11 types you can select the range of resistance exactly adapted to your set. Note these important features of superiority:

- 1—Resistance element is not exposed to any mechanical operation.
- 2—Electrical contact is made positive by metallic arm on wirewound strip.
- 3—The same resistance is always obtained at the same point.
- 4—Resistance value is under control in process of manufacture and does not change in use.
- 5—Entire range of resistance is covered with less than a single turn of the knob.
- 6—There is no mechanical binding, and shaft is turned smoothly over entire range.

Ask your dealer for the genuine ELECTRAD Royalty High Resistances and insure satisfactory results.

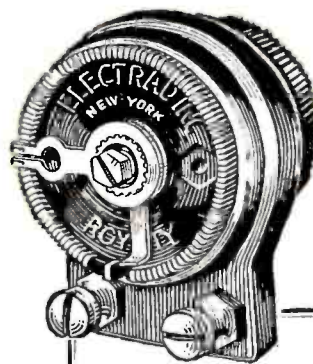

A Range for Every Purpose

- Type A—1/10 to 7 megohms.
- Type B—1500 to 100,000 ohms.
- Type C—500 to 50,000 ohms.
- Type D—10,000 to 700,000 ohms (Detector control for B Eliminator)
- Type E—Compensator, 500,000 ohms. Potentiometer.
- Type F—0 to 2,000 ohms.
- Type G—0 to 10,000 ohms.
- Type H—0 to 25,000 ohms.
- Type J—0 to 200,000 ohms.
- Type K—0 to 5,000 ohms.
- Type L—0 to 500,000 ohms.
- Type E—\$2.00—All other types \$1.50.

ELECTRAD CERTIFIED JACKS

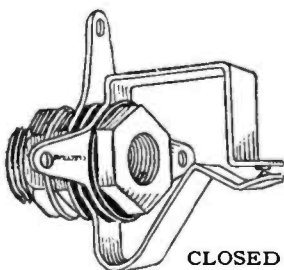

CLOSED

You have never seen the equal of the new Electrad Certified Single Circuit Jacks both open and closed. Requires less than 1" behind panel. Positive acting spring of phosphor bronze. Sterling silver contact points. Insulation of hard rubber. Tinned soldering lugs, so placed that good connections can easily be made. Any good radio store has these jacks or can easily get them for you. Certified and guaranteed electrically



OPEN

and mechanically. U. S. Prices, Open 25c., Closed 35c. Canada Prices, Open 35c., Closed 50c.

ELECTRAD CERTIFIED SWITCHES

—Hear Them Click

No doubt whether you are on or off when you equip your set with the Electrad Certified Switch. You hear it click. Requires less than 1" behind panel. Solid brass construction. Tinned soldering lugs so placed to make easy connections. Neatly designed. Genuine Bakelite knobs. Adds to the appearance of your set. Certified and guaranteed electrically and mechanically. Price U. S. 40c. Canada 60c.

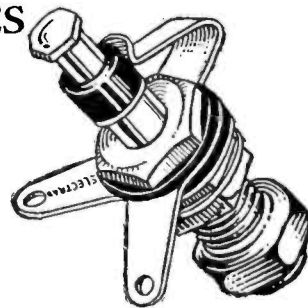

For perfect control of tone and volume use the Electrad 500,000 ohm compensator. For free hook-up write 428 Broadway, New York City.



ELECTRAD Inc.

FROST-RADIO

Parts and Accessories

As important as the tubes, batteries or loud speaker used in your set, are the parts and accessories you select for building your receiver. There will be no doubt about the quality of these parts or their dependability if you go to your dealer and ask for **FROST-RADIO** parts and accessories.

FROST-RADIO

Super-Variable Resistances

For controlling volume, tone and regeneration. Non-inductive, smooth and noiseless in operation. Provide stepless variation from zero to maximum.



List Price, \$1.25

Type 880, two terminals, and Type 890, three terminals, either type, \$1.25, in all resistances.

FROST-RADIO

Metal Frame Rheostats

A simple, sturdy rheostat for little money, that has all of the electrical qualities of our Bakelite type. Metal frame cannot bend or warp, and shaft alignment is permanent. Single hole mounting. Supplied in resistances from 2½ to 75 ohms—50c.



List Price, 50c

FROST-RADIO Bakelite Rheostats

Their cast frames of genuine Bakelite permit free circulation of air around windings. Oversize current carrying capacity prevents overheating. Operation is smooth and noiseless. The finest rheostats money can buy, yet is not high priced.

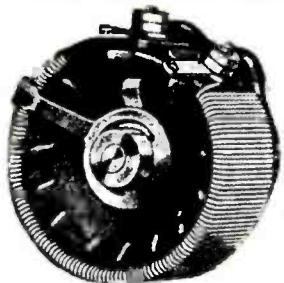

List Price, 75c

Any resistance, 2½ to 75 ohms, 75c.

FROST-RADIO
No. 141
Automatic
2-Fone
Plug
List Price,
75c



HERBERT H. FROST, Inc.

160 North La Salle Street
CHICAGO

New York

Los Angeles

Bradley-Amplifier

Resistance-Coupled
PERFECT AUDIO AMPLIFIER



Provides audio amplification with minimum distortion. Bridgley unit molded resistors used in the Bradley-Amplifier do not vary with age and are not affected by atmospheric conditions. Can be used to replace transformer amplifiers in standard radio sets with decided increase in tone quality.

Allen-Bradley Co.

Electric Controlling Apparatus

278 Greenfield Avenue Milwaukee, Wis.

Manufacturers' Booklets Available

A Varied List of Books Pertaining to Radio and Allied Subjects Which May Be Obtained Free by Using the Accompanying Coupon

AS AN additional service to RADIO BROADCAST readers, we print below a list of booklets on radio subjects issued by various manufacturers. Already, a regular feature of this magazine is an analysis of the best material in current radio publications, and a series of Laboratory Data Sheets, both of which present concise and accurate information in such a form as to be readily used. The publications listed below cover a wide range of subjects, and offer interesting reading to the radio enthusiast. The manufacturers issuing these publications have made great effort to collect interesting and accurate information. RADIO BROADCAST hopes, by listing these publications regularly, to keep its readers in touch with what the manufacturers are doing. Every publication listed below is supplied free. In ordering, the coupon printed on page 324 may be used. Order by number only.—THE EDITOR.



PARTS

1. HOOK-UPS—Problems of filament supply, voltage, regulation, and effect on various circuits. RADIAL COMPANY.
2. HARD RUBBER PANELS—Characteristics and properties of hard rubber as used in radio, with suggestions on how to "work" it. B. F. GOODRICH RUBBER COMPANY.
3. AUDIO TRANSFORMERS—A booklet giving data on input and output transformers. PACENT ELECTRIC COMPANY.
4. RESISTANCE-COUPLED AMPLIFIERS—A general discussion of resistance coupling with curves and circuit diagrams. COLE RADIO MANUFACTURING COMPANY.
5. CARBORUNDUM IN RADIO—A book giving pertinent data on the crystal as used for detection, with hook-ups, and a section giving information on the use of resistors. THE CARBORUNDUM COMPANY.
6. B-ELIMINATOR CONSTRUCTION—Complete constructional data on how to build. AMERICAN ELECTRIC COMPANY.
7. TRANSFORMER AND CHOKE-COUPLED AMPLIFICATION—Circuit diagrams and discussion. ALL-AMERICAN RADIO CORPORATION.
8. RESISTANCE UNITS—A data sheet of resistance units and their application. WARD-LEONARD ELECTRIC COMPANY.
9. VOLUME CONTROL—A leaflet showing circuits for distortionless control of volume. CENTRAL RADIO LABORATORIES.
10. VARIABLE RESISTANCES—As used in various circuits. CENTRAL RADIO LABORATORIES.
11. RESISTANCE COUPLING—Resistors and their application to audio amplification with circuit diagrams. DEJUR PRODUCTS COMPANY.
12. DISTORTION AND WHAT CAUSES IT—Hook-ups of resistance-coupled amplifiers with standard circuits. ALLEN-BRADLEY COMPANY.
13. MATERIALS FOR SCREW MACHINE PRODUCTS—Comparative costs of steel and brass with data and actual examples of how to specify. BRIDGEPORT BRASS COMPANY.
14. ORDERING THE RIGHT KIND OF SHEET BRASS—How to specify the proper grades for various purposes. BRIDGEPORT BRASS COMPANY.
15. B-ELIMINATOR AND POWER AMPLIFIER—Instructions for assembly and operation using Raytheon tube. GENERAL RADIO COMPANY.
- 15a. B-ELIMINATOR AND POWER AMPLIFIER—Instructions for assembly and operation using an R. C. A. rectifier. GENERAL RADIO COMPANY.

16. VARIABLE CONDENSERS—An ambitious description of the functions and characteristics of variable condensers with curves and specifications for their application to complete receivers. ALLEN D. CARDWELL MANUFACTURING COMPANY.
17. BAKELITE—A description of various uses of bakelite in radio, its manufacture, and its properties. BAKELITE CORPORATION.
18. BRASS RODS—Details of manufacture together with tests and specifications. BRIDGEPORT BRASS COMPANY.
19. POWER SUPPLY—A discussion on power supply with particular reference to lamp-socket operation. Theory and constructional data for building power supply devices. ACME APPARATUS COMPANY.
20. AUDIO AMPLIFICATION—A booklet containing data on audio amplification together with hints to the constructor; also some general radio information. ALL-AMERICAN RADIO CORPORATION.
21. HIGH-FREQUENCY DRIVER AND SHORT-WAVE WAVEMETER—Constructional data and application. BURGESS BATTERY COMPANY.

ACCESSORIES

22. A PRIMER OF ELECTRICITY—Fundamentals of electricity with special reference to the application of dry cells to radio and other uses. Constructional data on buzzers, automatic switches, alarms, etc. NATIONAL CARBON COMPANY.
23. AUTOMATIC RELAY CONNECTIONS—A data sheet showing how a relay may be used to control A and B circuits. YAXLEY MANUFACTURING COMPANY.
24. DETECTOR TUBES—A brief outline of tube operation. C. E. MANUFACTURING COMPANY.
25. ELECTROLYTIC RECTIFIER—Technical data on a new type of rectifier with operating curves. KODEL RADIO CORPORATION.
26. DRY CELLS FOR TRANSMITTERS—Actual tests given, well illustrated with curves showing exactly what may be expected of this type of B power. BURGESS BATTERY COMPANY.
27. DRY-CELL BATTERY CAPACITIES FOR RADIO TRANSMITTERS—Characteristic curves and data on discharge tests. BURGESS BATTERY COMPANY.
28. B BATTERY LIFE—Battery life curves with general curves on tube characteristics. BURGESS BATTERY COMPANY.
29. HOW TO MAKE YOUR SET WORK BETTER—A non-technical discussion of general radio subjects with hints on how reception may be bettered. UNITED RADIO AND ELECTRIC CORPORATION.
30. TUBE CHARACTERISTICS—A data sheet giving constants of tubes. C. E. MANUFACTURING COMPANY.
31. FUNCTIONS OF THE LOUD SPEAKER—A short, non-technical general article on loud speakers. AMPLION CORPORATION OF AMERICA.
32. METERS FOR RADIO—A catalogue of meters used in radio with connecting diagrams. BURTON-ROGERS COMPANY.
33. SWITCHBOARD AND PORTABLE METERS—A booklet giving dimensions, specifications, and shunts used with various meters. BURTON-ROGERS COMPANY.
34. COST OF B BATTERIES—An interesting discussion of the relative merits of various sources of B supply. HARTFORD BATTERY MANUFACTURING COMPANY.
35. STORAGE BATTERY OPERATION—An illustrated booklet on the care and operation of

GEORGE ELECTRIC COMPANY
"B POWER UNIT"

TYPE "M"



★
Complete with Tube \$29.50

Our patented filter circuit is most efficient, delivering absolutely pure direct current, free from any hum or distortion. The Type M Unit is sturdily constructed, and will last as long as the best receiving set.

Variable resistances permit the selection of voltages to make your set work efficiently at all times. You can bring in distant stations with more volume, and your locals with purer tone.

This unit operates on 110 volt, 60 cycle A. C. It will deliver 180 volts, with plenty of current for a ten tube set or sets equipped with power tubes.

FULLY GUARANTEED

Our dealer will be glad to give you a demonstration. Write for further information.

GEORGE ELECTRIC COMPANY

751 Carleton Ave.

St. Paul, Minn.

Dealers and Agents!—Write today for attractive agency proposition

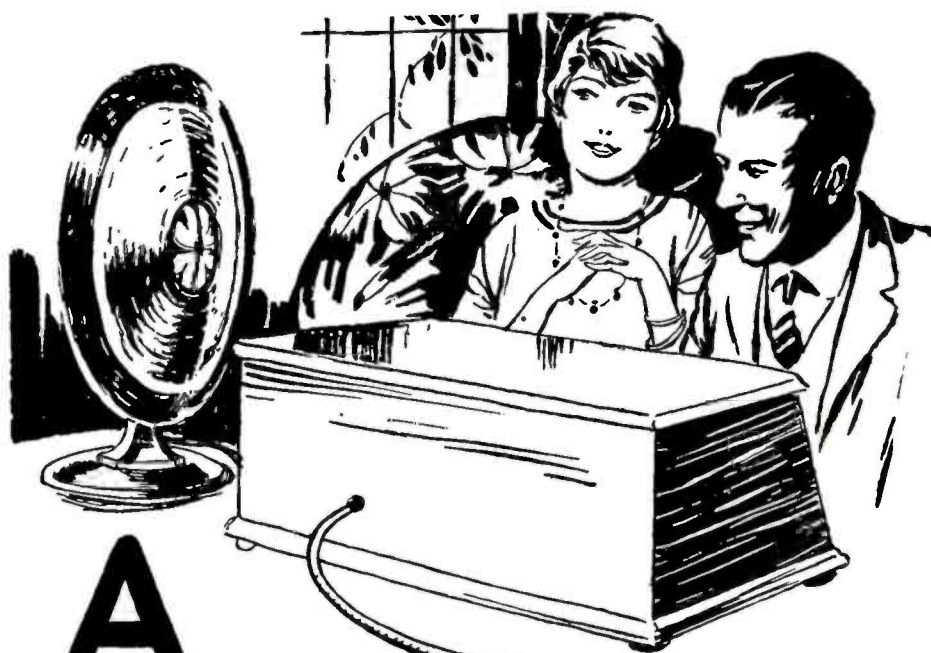

A Safety Valve for Your Radio

SUPPOSE the battery wires to your radio set became crossed, accidentally, what would happen? Almost anything from a serious fire, due to overheated wires, to a ruined B-Battery or a burned-out tube. The consequences are serious enough to warrant some careful thought right now!

The cheapest insurance against the dangers of crossed wires is to protect your radio set with a Belden Fused Radio Battery Cord. It provides

- 1—An A-battery fuse.
- 2—A B-battery fuse.
- 3—A polished bakelite cover for the battery fuses.
- 4—A compact connecting cable that dispenses with loose wires.
- 5—A color-code on each wire for identifying each circuit.
- 6—A time-saver, because the cord is quickly connected and easily concealed.

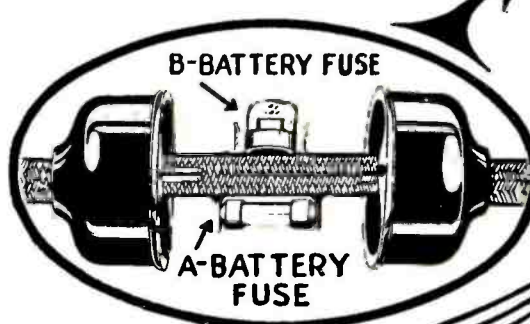

Eliminate fire hazard, ruined or discharged batteries, and burned-out tubes. Ask your nearest dealer for a Belden Fused Radio Battery Cord, today!

Belden Manufacturing Co.
 2312A South Western Avenue.
 Chicago, Illinois

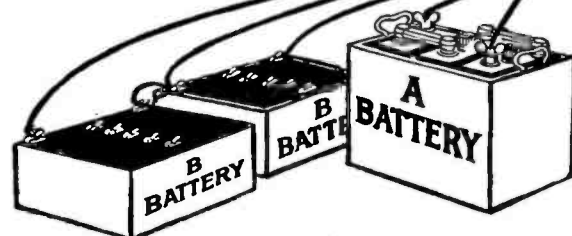

use a ★

Belden Fused Radio Battery Cord



Licensed Under Hiler Pat. No. 1,589,692

FMC DOUBLE IMPEDANCE AUDIO UNITS

Amplify all notes and all frequencies evenly and faithfully, assuring more volume and perfect tone. Use them in place of transformers or resistance units.

Sold by all Dealers

FREE—"The Story of Amplification"
 Write for a Copy;

Ford Radio & Mica Corp.,
 111 Bleecker St. New York City

USE THESE COILS AND IMPROVE ANY RADIO RECEIVER!

AERO COIL SUPER-SENSITIVE INDUCTANCE UNITS



Tuned Radio Frequency Kit \$12.00

The Aero Coil Tuned Radio Frequency Kit illustrated above will positively improve the performance of any receiver. Patented Aero Coil construction eliminates radio frequency losses and brings tremendous improvement in volume, tone and selectivity. Kit consists of three matched units. The antenna coupler has variable primary. Uses .00035 condenser. 8 page color circuit, layout and instruction sheet for building the supersensitive 5 tube Aero-Dyne receiver packed FREE with each kit. Extra copies, 75c each. Instructions include insert showing how to wire up for a power tube if desired.

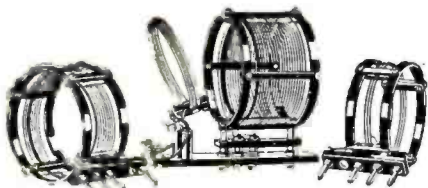

Low Wave Tuner Kit \$12.50

Completely interchangeable. Adapted by experts and amateurs. Range 15 to 130 meters. Includes three coils and base mounting, covering U. S. bands, 20, 40 and 80 meters. You can increase the range of this short wave tuner by securing coils No. 4 and 5. Combined range of 15 to 550 meters. Both interchangeable coils fit same base supplied with short wave kit and use the same condensers. Coil No. 4, price \$4.00; Coil No. 5 price \$4.00.

Get these coils from your nearest dealer. If he should be out of stock order direct from the factory

AERO PRODUCTS, Inc.

Dept. 109

1772 Wilson Ave.

Chicago, Ill.

Famous MARWOOD Now Sold on



Easy Terms

1 Dial 6 Tube \$43.85

Get Agents Price... Save 50% Great news! Now own a famous Marwood at the world's lowest price for real quality—and pay on easy terms. The only radio sold direct on easy terms—proof that the Marwood MUST be a wonder. A year ahead with 4 big exclusive improvements—Super-Selectivity, Power-Tube Volume, Now Easy-Tuning Principle, New Tone Quality. Save half—and get a radio that can't be beat at ANY price.

Both Models Shipped Complete With All Accessories

30 Days Free Trial We trust you. Prove the Marwood the best buy in America. Don't buy a radio till you get our Easy Terms. 30 Days Free Trial. Agent's Confidential Low Prices. Free Radio plan, new Catalog. Agents—Write quick for territory—Make big money.

6 Tube 3 Dial \$36.85

MARWOOD RADIO CORPORATION 1747-110 Morse Avenue, Chicago, Ill.

the storage battery. GENERAL LEAD BATTERIES COMPANY.

36. CHARGING A AND B BATTERIES—Various ways of connecting up batteries for charging purposes. WESTINGHOUSE UNION BATTERY COMPANY.

37. CHOOSING THE RIGHT RADIO BATTERY—Advice on what dry cell battery to use; their application to radio, with wiring diagrams. NATIONAL CARBON COMPANY.

MISCELLANEOUS

38. LOG SHEET—A list of broadcasting stations with columns for marking down dial settings. U. S. L. RADIO, INCORPORATED.

39. BEHIND THE SCENES IN A BROADCASTING STATION—Operation in general, and specific facts about WKRC. KODEL RADIO CORPORATION.

40. STATIC—A brief discussion of the disturbances which may cause trouble in a receiver. SUN MANUFACTURING COMPANY.

41. BABY RADIO TRANSMITTER OF 9XH-9EK—Description and circuit diagrams of dry-cell operated transmitter. BURGESS BATTERY COMPANY.

42. ARCTIC RADIO EQUIPMENT—Description and circuit details of short-wave receiver and transmitter used in Arctic exploration. BURGESS BATTERY COMPANY.

43. SHORT-WAVE RECEIVER OF 9XH-9EK—Complete directions for assembly and operation of the receiver. BURGESS BATTERY COMPANY.

44. ALUMINUM FOR RADIO—A booklet containing much radio information with hook-ups of basic circuits, with inductance-capacity tables and other pertinent data. ALUMINUM COMPANY OF AMERICA.

45. SHIELDING—A discussion on the application of shielding in radio circuits with special data on aluminum shields. ALUMINUM COMPANY OF AMERICA.

46. AUDIO FREQUENCY CHOKES—A pamph-

let showing positions in the circuit where audio frequency chokes may be used. SAMSON ELECTRIC COMPANY.

47. RADIO FREQUENCY CHOKES—Circuit diagrams illustrating the use of chokes to keep out radio frequency currents from definite points. SAMSON ELECTRIC COMPANY.

48. TRANSFORMER AND IMPEDANCE DATA—Tables giving the mechanical and electrical characteristics of transformers and impedances, together with a short description of their use in the circuit. SAMSON ELECTRIC COMPANY.

USE THIS COUPON

RADIO BROADCAST SERVICE DEPARTMENT RADIO BROADCAST, Garden City, New York. Please send me (at no expense) the following booklets indicated by numbers in the published list

Form with dotted lines for Name, Address (Number, Street, City, State) and checkboxes for booklet numbers.

ORDER BY NUMBER ONLY This coupon must accompany every order. RB 127

Book Reviews

Physics for the Radio Man

PRACTICAL PHYSICS. By Black and Davis. Published by the Macmillan Co. Revised edition, 1925. 572 pages, including supplementary pamphlet, 1926, on "Radio Broadcasting." 580 illustrations. Price, \$1.68.

THE original meaning of "physics" was "the study of natural philosophy, the science of the principles operative in inorganic nature." The lever, the arch, the windlass, the pulley, and the flow of liquids were the foundations of a branch of human knowledge which to-day has acquired endless ramifications. To-day we cannot think of physics either as "natural philosophy" or as a thing so abstract as "the principles operative in inorganic nature." It is a study of principles, the operation of which surround us at every moment.

The authors of "Practical Physics" have been diligent in bringing home to their readers the practical application of physics in the things of daily life. They have not contented themselves with statements of laws, formulas, and principles. There is hardly a page which does not illustrate some familiar device in general use as examples of the principles expounded in the text. For example, by turning only a few pages, we found clear-cut diagrams of a vacuum cleaner, phonograph, door check, carbon transmitter, automobile speedometer, dry cell and voltmeter, water tap, lawn sprinkler, electric iron, and a steam radiator vent. By this means, its writers have made their comprehensive volume interesting reading, a quality usually lacking in reference books and school texts.

The problem of writing a physics text book is largely one of elimination. To attain conciseness without undue length, yet completeness

sufficient to be useful, ease of reference, and questions and problems for study purposes, in a mere 572 pages, is indeed no small problem. Good arrangement has contributed liberally in making the attainment of these objectives possible. Every section is numbered and headed in bold face for easy reference; questions and problems are distributed in convenient grouping, not only at the end of each of the twenty-four chapters but at each logical point throughout the text, permitting of easy assignment for study; at the end of each chapter is a summary expounding crisply the laws, principles, and conclusions of the entire chapter.

To the radio enthusiast, ease of reference is of great importance, for he consults a physics book solely to refresh his mind on some particular fact or principle. He finds a knowledge of many branches of physics enters into his radio problems. A vernier dial is not a radio device nearly so much as it is a mechanical contrivance; the physics of sound contributes its share to attaining good tonal quality; a knowledge of electrical engineering is essential when the storage battery, power-supply device, fuses, chargers, power transformers, and numerous other parts of radio equipment are being considered. A textbook on physics is indeed no intruder in the radio enthusiast's library.

In fact, more often than not, the radio devotee is quite unfamiliar with the principles outlined in Chapter XIII, dealing with Magnetism; XIV, Static Electricity; XV, Electric Currents (i. e., units, resistance, its application to series and parallel circuits, battery connections, and numerous practical points in constant use about the radio laboratory); XVI, Effects of Electric Current (describing relations of electricity and magnetism, bells, telegraphs, meters, fuses, circuit breakers, lamps, storage batteries, arcs, etc.);

Sheet Copper for Shielding

Shielding

Prevents aerial radiation and feedback.

Insulates against interference from adjoining circuits.

Improves efficiency, selectivity and tone quality.

USE SHEET COPPER because it combines low resistance with easy working qualities.

COPPER & BRASS
RESEARCH ASSOCIATION
25 Broadway — New York

RAYTHEON For Reliable Reception



American RADIO Now—
50% DISCOUNT ON RADIO!

BIG NEW 1927 CATALOG-FREE

Dealers, Agents, Set Builders—get our big 1927 Catalog—225 nationally advertised lines. Lowest prices in America! Largest, most complete stock. Radio's latest developments. It's FREE—send for your copy now.

AMERICAN AUTO & RADIO MFG. CO., Inc.
36 McGee Street, Kansas City, Mo.

Stop It!



\$15
Complete with tube

Last quarter—eight minutes to play—score tied—your favorite has the ball on opponent's twenty yard line—first down—ten yards to go—looks like a touchdown —

Broadcasting coming in fine—play by play—and then,—it fades away. Tubes are not lit—"A" Battery is out—rundown.

This cannot happen to those who use the

FRESHMAN AUTOMATIC CHARGER

This device keeps the "A" Battery fully charged at all times

An absolute necessity—fool proof and dependable in every respect. Equipped with a Tungar Rectifying Tube which supplies a steady charging current to the "A" Battery when the set is not in use. When the radio is in operation the charger is disconnected by means of an automatic relay.

No LIQUIDS USED "B" ELIMINATOR CONNECTION

Sold by Authorized Freshman Dealers Only ★

Write for our new 48-page book illustrating and describing the entire line of Freshman Masterpiece Receivers and other apparatus

CHAS. FRESHMAN CO., Inc.

Freshman Bldg., NEW YORK—2626 W. Washington Bldg., Chicago

Send for Latest RADIO CATALOG and GUIDE

Get Your Complete Parts for All the Newest Circuits Here

In every issue of Popular Radio and other radio magazines you will find the newest circuits of the world's greatest radio engineers. You will want to build these sets from the parts specified. BARAWIK service keeps up to date on all the new wrinkles. We have the specified parts for all these new circuits, complete, ready to ship you the instant your order arrives. Take advantage of this unequalled service. Get what you want—quick—at a big saving. No order too large or too small for us. 300,000 fans swear by BARAWIK service. We can please you, too.

Short Wave Equipment—Special Amateur Section

The Barawik line features this season a special Amateur Department in charge of F. J. Marco, owner of station 9ZA, a nationally famous radio engineer and an authority on amateur work. It presents the latest in short wave equipment, transmitting and receiving supplies and everything necessary for the amateur and experimenter. Special attention has been given to short-wave kits including the B-T, Aero Coil, Silver-Marshall R.E.L., etc. It will pay you to get our new Guide at once.

Radio's Newest at Rock-Bottom Prices

The new 1927 edition of the Barawik Catalog and Guide gives a comprehensive listing of the radio sets, parts, kits, supplies and accessories necessary in radio. This new guide contains over 6,000 items of radio's newest developments, everything that a real fan will need from the complete factory-built set to the smallest screw, including labor-saving devices, tools, power supply units, amplifier equipment, etc. Standard equipment of the best known manufacturers at tremendous savings.

Besides the complete radio and amateur line there is shown a selection of electrical goods, household appliances, auto accessories and articles necessary in the home—all at a big saving in price.

Write to-day for your free copy of the 164-page guide. Also please include name of other fans. Mail the handy coupon NOW.



BARAWIK CO.

540-549 Monroe St. Chicago, U. S. A.

Mail This Coupon Now! For Free Copy

Name

Address

.....

Fan

Address

Bradleyometer

THE PERFECT POTENTIOMETER

Uses graphite disc resistors which are noiseless and not affected by atmospheric conditions. Metal parts are nickel plated. One hole mounting. Finish and knob match Bradleystat. Made in 200 and 400 ohm ratings.



Allen-Bradley Co. ★

Electric Controlling Apparatus

278 Greenfield Avenue Milwaukee, Wis.

XVII, Induced Currents (with generators, commutators, series, shunt and compound windings, starting resistances, induction coils, telephones, featured in the text); Chapter XVIII, Alternating Currents; Chapter XIX, Sound (wave motion, musical tone, pitch, timbre); Chapter XXIII, Electric Waves (oscillatory discharge, vacuum tube detectors); and Chapter XXIV, Radio Broadcasting.

Favorable as our comment is as to the value of this book to the radio enthusiast, we warn him that it is not a radio book. Just as the authors have confined themselves to basic principles in every branch of mechanics, optics, and acoustics, so also have they dealt with our beloved subject of radio. For example, we challenge you to understand the functioning of a vacuum tube clearly from a reading of the author's description. Everything there is true. But the student may ask after reading it, "What is the B battery for?" Perhaps the diligent reader may remember a statement, earlier in the book, that "electric current flows downhill from plus to minus in outside circuit." That would only confuse him, however, because the explanation says "the filament, when glowing, emits electrons" and they flow "from the filament to the plate." In the next chapter, it says that the B battery always keeps the plate positive. It would not be impossible to conclude from these statements that the B battery opposes the flow of electrons from the filament to the plate. The real error does not lie in the text; it is the fact that plus and minus signs were arbitrarily placed on dry cells long before anything was known about flow of electrons through vacuums. Early investigators simply got the signs the wrong way around.

Nevertheless, these are minor points which do not detract seriously from the value of this comprehensive textbook of physics.

EDGAR H. FELIX.

Announcers' Biographies

THE AMERICAN ANNOUNCER AND RADIO LOG: *Published by the American Announcer, Buffalo, New York, 76 pages, 112 portraits. Price \$2.50.*

ACCORDING to the publisher, it is intended that the purpose of *The American Announcer and Radio Log* be to bring the various fine broadcasting stations of the country nearer to the hearts and homes of the listener. The book is a fairly complete compilation of the biographies of some of the leading station announcers in the country. While perhaps all of the announcers can never be listed, the publishers are fully aware of the fact, but have made provision for the insertion of new pages when these are warranted.

A photograph of each announcer is given, together with a brief sketch of his life and history before he became an announcer. To those who are interested in tracing back the influence which made their favorite announcers take up the profession, this information would be of particular interest. The station call letters, the owner, the power, and wavelength of the station are also given. With the physical dimensions, color of eyes, and hair, any ardent announcer-worshipper can certainly get a pretty good idea of his favorite idol.

The latter pages of this book offer a list of stations, accurate at the time of publication with room for additions as the need may arise. The log gives the call letters, the owner, the location, the wavelength, the power, and three columns for marking down the dial settings. To supplement this list, the stations are regrouped according to their locality, and ready reference maps are provided for locating the stations. Cuban and Canadian stations are also listed.



YAXLEY
APPROVED RADIO PRODUCTS

Cable Connector Plug

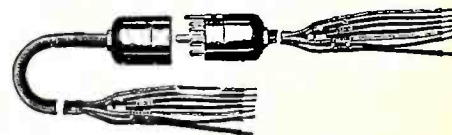

for Binding Posts

You will get some real satisfaction and pleasure, too, with the Yaxley Cable Connector Plug. It does away with a mass of unsightly wires and concentrates them in one neat, compact unit. Cable Connector consists of plug and receptacle. The plug is provided with seven 15-inch strands (RMA Standard Colors) which connect directly to the binding posts. The receptacle is provided with 5-foot seven-strand cable for connecting to the batteries.

Plug and receptacle are of Bakelite, with phosphor bronze contact springs and brass pins. A sure, positive contact is assured, and because of the guide pin it is impossible to put the Connector together incorrectly.

Increase the pleasures of your radio hours by getting one to-day.

No. 670—Cable Connector Plug...\$4.00

At your dealer's. If he cannot supply you send his name with your order to

YAXLEY MFG. CO

Dept. B, 9 So. Clinton St.

Chicago, Ill. ★



This is a good time to subscribe for

RADIO BROADCAST

Through your dealer or direct, by the year only \$4.00

DOUBLEDAY, PAGE & CO. GARDEN CITY, NEW YORK

Mayolian
"B" SUPPLY

Type 612—\$42.50

The "B" Without a Buzz

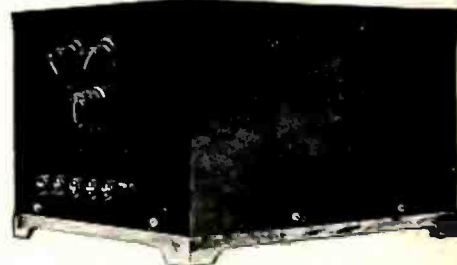

Also—Complete set of parts for home-builders at reasonable prices. Write us.

MAYOLIAN
RADIO CORPORATION
1668 Webster Ave., New York, N. Y.

Pioneers in Battery Elimination



The Power of Niagara—
The Quiet of an Arctic Night



Volume
With
Clarity

DOUBLE ENJOYMENT
From Any Set With

★ **Burns**
LOUD SPEAKER

Why sacrifice the excellent reproducing qualities of a set by the use of an inferior speaker. With a BURNS it is possible to reproduce with amazing exactness every note of music and inflection of voice that the set can pick up. A trial will convince.

AT YOUR DEALER'S OR WRITE DIRECT

American Electric
COMPANY

State and 64th Sts. Chicago, U. S. A.

Ask About BURNS B-Eliminator



Beautiful Jacobean design by Conner
Finished in Warm Walnut



Put Your Set in a Conner Cabinet ★

THE MOST interesting—the most noticed piece of furniture in your home is your Radio Set—House it in a Conner Convenient Cabinet and it will then be the most attractive. Even the best set, with a makeshift mounting, exposed wiring and batteries, misses much in giving you and your friends the pleasure and satisfaction which it should. A Conner Cabinet lends added class and tone to the finest equipment.

A Conner Cabinet assembles every detail of your receiving set, including batteries and tools in a scientifically convenient arrangement and encloses everything in an exceptionally beautiful piece of period furniture. Radio builders know the name "Conner" means Quality. Leading Radio dealers show Conner Cabinets.

Write today for illustrations of the entire line of Conner Convenient Cabinets and learn how easily you may own and enjoy one of these beautiful cases.

A Period Design for every plan of Decoration

\$35 to \$99.50

Jacobean
Renaissance
Sheraton, etc.

Write today for illustrations and details.

We specialize on Cabinets for Radio Builders.

Get our interesting offer to Radio Dealers in open territory. Write today.

CONNER RADIO CABINET COMPANY ☞ New Albany, Indiana

ELKAY
TRADE MARK REG.
TUBE
EQUALIZER
SYSTEM

Eliminates
Rheostats

Elkay Equalizers replace variable rheostat, delivering correct voltage to any type of tube automatically. To use any combination of tubes in same set, merely insert correct value of Equalizer, there is one for every tube made. Before building your set, write for folder to The

Langbein-Kaufman
Radio Co. (Dept. R)
62 Franklin St.
New Haven, Conn.

★
50c
Each
75c
Mounted



Glowing spots
of light
in place of dials



Specified for the R. B. Lab receiver . . . MAR-CO controls add searching tuning action, as well as stylish appearance. \$3.50 complete with Mazda lamp, bezel and drilling template. For mounting on metal panels, sets of insulated bushings are available at 25¢ a set.

MARTIN COPELAND CO.
Providence, R. I.

MAR-CO
Illuminated Controls ★

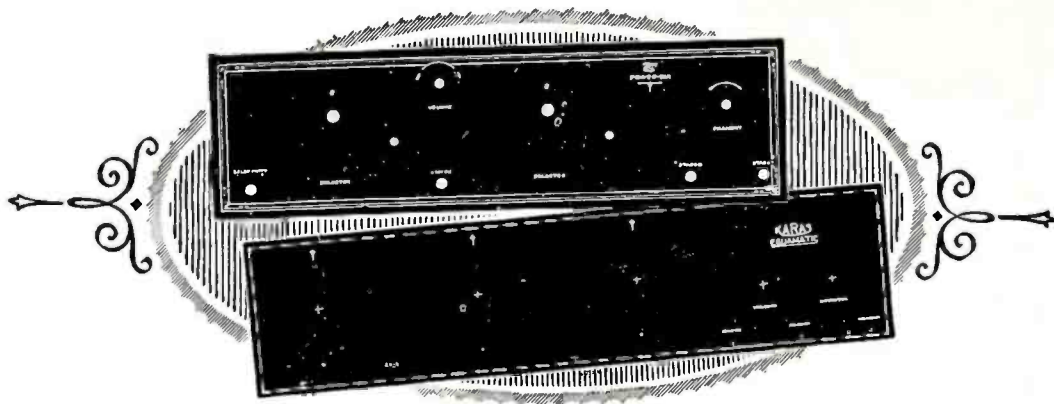

POWER SIX, KARAS, H. F. L.

ADDED to the list of handsomely Veri Chromed Formica kit panels are now the Bremer Tully Power Six, Karas Equamatic front and sub panels, H. F. L. Nine in Line Superheterodyne with sub panel, Victoreen Universal single dial control. There are also Infrazyne 7 x 28, and 7 x 30 Aerodyne, St. James 8 Tube, Bremer Tully Counterphase, Browning Drake National, Madison Moore Superheterodyne, Canfield Duoformer. They are sold by leading jobbers and dealers.

Special panels cut to size and Formica tubing are also available for Amateurs

The FORMICA INSULATION COMPANY

4628 SPRING GROVE AVENUE

CINCINNATI, OHIO

Hear the FORMICA Orchestra Tuesday 9 to 10 over WLW



Formica has a Complete Service on Insulating Material for Radio Manufacturers

LEARN THE CODE AT HOME with the OMNIGRAPH

"Just Listen—The Omnigraph will do the teaching"



THE OMNIGRAPH Automatic Transmitter will teach you both the Wireless and Morse Codes—right in your own home—quickly, easily and inexpensively. Connected with Buzzer, Buzzer and Phone or to Sounder, it will send you unlimited messages. At any speed, from 5 to 50 words a minute.

THE OMNIGRAPH is not an experiment. For more than 15 years, it has been sold all over the world with a money back guarantee. The OMNIGRAPH is used by several Depts. of the U. S. Govt.—in fact, the Dept. of Commerce uses the OMNIGRAPH to test all applicants applying for a Radio license. The OMNIGRAPH has been successfully adopted by the leading Universities, Colleges and Radio Schools.

Send for FREE Catalogue describing three models. DO IT TO-DAY.

THE OMNIGRAPH MFG. CO., 13K Hudson St., New York City

If you own a Radio Phone set and don't know the code—you are missing most of the fun



Modernize Your Set—

with a Jewell A-B Relay. It relieves you of the job of switching the B-eliminator and trickle charger. It does the switching automatically with the snap of your filament switch.

When the filament is turned on it disconnects the charger and connects the B-Eliminator to the electric light circuit. Turning the filaments off reverses the operation. It is very convenient.

Send for Descriptive Form No. 1023

JEWELL ELECTRICAL INSTRUMENT CO.
1650 Walnut Street Chicago
"26 Years Making Good Instruments"



A-B Relay—It will not interfere with the normal operation of any set. Smooth—Positive—Reliable.

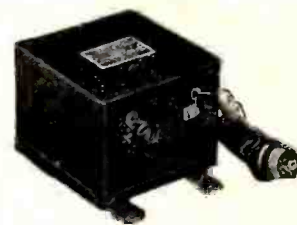

No. 1582 List \$11.00

A Conspicuously Successful B-Eliminator

incorporates Dongan Radio-Power Unit No. 1582

for use with the Raytheon Tube

THOUSANDS of these B-Eliminators have been built and are giving 100 per cent satisfaction. Dongan No. 1582 consists of 1 Transformer and 2 Chokes, designed in conjunction with Raytheon engineers. The Radio-Power supply is quiet, smooth and consistent all the time.

Built into handsome black metal case—very durable. Complete instructions for building. Send check or money order at once.

No. 147 Transformer, designed for use in connection with the output circuit, avoids the loss of B voltage due to the high resistance of the loud speaker and eliminates all risk of damage to the speaker. List \$4.50

DONGAN ELECTRIC MFG. CO.
2991-3001 Franklin St. Detroit, Mich.

TRANSFORMERS of MERIT for FIFTEEN YEARS



FLEXIBLE CELATSITE

Flexible, stranded wire for point-to-point and sub-panel wiring. Non-inflammable "spaghetti" covering. In black, yellow, green, red and brown; a color for each circuit. Put up in 25-foot coils.



The Original Celatsite

—a tinned, copper bus bar wire with non-inflammable "spaghetti" covering, for hook-ups. 5 colors; 30-inch lengths.

Celatsite Battery Cable

—a silk-covered cable of vari-covered Flexible Celatsite wires for connecting batteries to set.



Prevents "blowing" of tubes; gives your set an orderly appearance.

We also offer the highest grade of "spaghetti" tubing for Nos. 10 to 18 wires. 5 colors; 30-inch lengths.

Stranded Enameled Antenna

Best outdoor antenna you can buy. 7 strands of enameled copper wire; maximum surface for reception. Prevents corrosion and consequent weak signals.



Send for folder

THE ACME WIRE CO., DEPT. B
NEW HAVEN, CONN.



Fits All Tubes

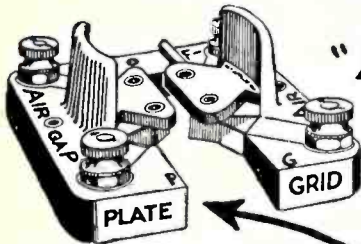

"It gets that last mile"

The AIRGAP SOCKET

Mr. Keith Henney, director of Broadcast Laboratory and developer of R. B. Lab. Circuit, and Mr. John B. Brennan, technical editor, recommend Airgaps for that circuit (November issue page 36) because, as there stated, they introduce a minimum of gridplate capacity and aid in preventing objectionable feedback.

At all dealers or direct postpaid 60c. each ★

AIRGAP PRODUCTS COMPANY Mfr.
11 Campbell Street
Newark, N. J.

SEE THAT GAP?

IF you like this magazine with its coated paper and enlarged size—then why not subscribe and get it regularly—by the year, \$4.00, Six months, \$2.00.

Doubleday, Page & Co.
Garden City New York

DESIGNED to OUTLAST
World
Storage 'A' Battery



Two-Year Guarantee Bond in Writing

NEW LOW PRICES

Famous the world over for reliable, enduring performance. Solid Rubber Case lasting protection against acid or leakage.

Approved and Listed as Standard by Leading Authorities

including Radio News Laboratories, Popular Sci. Inst. Standards, Pop. Radio Laboratories, Radio Broadcast Laboratories, Radio in the Home and Lefax, Inc.

Send No Money

Just state number wanted and we will ship same day order is received, by express C.O.D. Pay expressman after examining batteries. 5% discount for cash with order. Remember, you save 50% on World Batteries—so send your order today.

WORLD BATTERY COMPANY
Dept. 24
1219 S. Wabash Ave., Chicago, Ill.

Solid Rubber Case Radio Batteries
6-Volt, 100-Amperes \$10.00
6-Volt, 120-Amperes \$12.00
6-Volt, 140-Amperes \$13.00
Solid Rubber Case Auto Batteries
6 - Volt, 11 - Plate \$10.00
6 - Volt, 13 - Plate \$12.00
12 - Volt, 7 - Plate \$14.60

Set your radiolists at 288.3 meters for the World Storage Battery Station W5BC. Variety—new talent—always interesting. Jerry Sullivan, Dir. and Announcer "Chl-CAW-go"

W5BC WEAF KYW

A Striking Example of Radio's Real Prowess



Listen to

MU-RAD
The SUPER-SIX-RECEIVER

Ask Your Dealer for Demonstration or Write to

MU-RAD RADIO CORP. ★

DEPT. B., ASBURY PARK, N. J.

goodbye
mister **howl!**

Once this little jacket of live rubber slips over the howling tube—you're through!

All over in less than one second! You can get it in sizes to fit *every* tube. Just ask for the

Mc DONALD HOWL ARRESTER ★

"It Stops that Howl"
(TRADE MARK)

Sole Selling Agents for the U. S. A.
SPARTAN ELECTRIC CORPORATION
350 West 34th Street, New York City

Licensed and Manufactured by the
Scientific Products Canada, Ltd.
MADE IN U. S. A.



PATENT PENDING

75¢ each

At all dealers

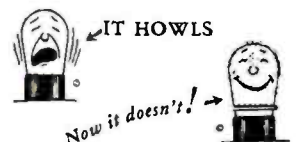

IT HOWLS

Now it doesn't!



**A New and Advanced Model—
Norden-Hauck Super-10
Highest Class Receiver in the World**

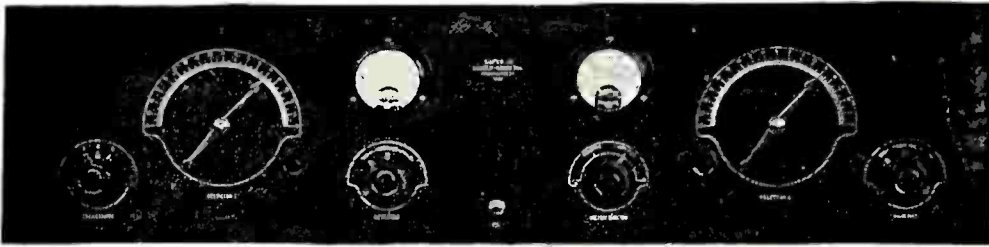

Panel Size: 36" x 9" x 1-1/4"

Weight: 55 lbs.

THE NORDEN-HAUCK SUPER-10 is an entirely new and advanced design of Receiver, representing what we believe to be the finest expression of Modern Radio Research Engineering. It is the product of years of experience devoted exclusively to the attainment of an ideal Broadcast Receiver—regardless of cost. Results obtained in every respect will upset all your previous ideas of good radio reception. Here are only a few of the host of features that place the NORDEN-HAUCK SUPER-10 far in advance of competition:

- 10 tubes employed to give perfect reproduction with unlimited range and volume power.
- Super selectivity on all wave lengths.
- Built to Navy Standards.
- Wide wave length range without change of coils, etc. (Adaptable 35 meters to 3600 meters if desired.)
- Use Loop or Antenna.
- Simple to operate, having only two major tuning controls.
- No Harmonics. Signals are received only at one point.
- Special Power Audio Amplifier, operating any loudspeaker and eliminates necessity of external amplifier.

The NORDEN-HAUCK SUPER-10 is available completely constructed and laboratory tested, or we shall be glad to supply the complete engineering data, construction blue prints, etc., for those desiring to build their own receiver.

Upon Request A complete catalog attractively illustrated, will be gladly mailed without charge, or full size constructional blue prints, showing all electrical and mechanical data, will be promptly mailed postpaid upon receipt of \$2.00

Write, Telegraph or Cable Direct to

**NORDEN-HAUCK
Incorporated
ENGINEERS—MARINE BUILDING
Philadelphia, U. S. A.**

TEAR OFF AND MAIL TODAY

NORDEN-HAUCK, Inc., Philadelphia, U. S. A.

Gentlemen:—

- Please send me without cost or obligation on my part, attractive illustrated literature describing the new Norden-Hauck Super-10.
- I enclose \$2.00 for which please send me, postpaid, complete full size constructional drawings and all data for building the Super-10.

Name

Address

This is a good time to subscribe for

RADIO BROADCAST

Through your dealer or direct by the year, only \$4.00

DOUBLEDAY, PAGE & CO.

GARDEN CITY, NEW YORK



**The "RADIGON" for
ample, dependable
"B"-POWER**

You can depend on the Radigon B Power Supply. It does more than take the place of B-Batteries. The Radigon is the most efficient B Power Unit embodying the full wave non-filament tube principle. It is absolutely guaranteed to give you not only good reception, but clearer tone, wider range and greater selectivity without any hum whatever. Expert and careful workmanship combined with materials of the highest quality insure 100% efficiency at all times.

GUARANTEED

By actual test you will find that the Radigon B will compare favorably with and give you results you would expect from eliminators selling at more than twice its price. To convince you that this is a fact we allow you ten days to prove it to yourself, and if after a ten-day test you are not satisfied in every respect you can return the Radigon at our expense for an immediate refund. Every Radigon product is guaranteed against electrical and mechanical defects for one year. The Radigon will operate any radio set up to twelve tubes, on 105 to 120 volts 50 to 60 cycle A C Current. Terminals are negative, detector and intermediate. Also a high voltage tap which will supply constant current up to 200 volts. Dimensions: 14" deep, 7 1/2" high, 6" wide. Finished in tasteful crystal brown.

PRICE COMPLETE WITH TUBE \$23.75 F. O. B. CHICAGO

24 Hour Delivery

If your dealer cannot supply you send money order for full or part of the amount and we will ship the Radigon immediately upon receipt of order (balance C.O.D.)

The Ideal Xmas Gift—a "RADIGON"

American Radigon Laboratories

557 W. Monroe St., Chicago, Ill.

**All Radio Broadcast
Circuits Are Familiar
To Our Experts**

OUR expert laboratory men are familiar with all problems that arise in the course of construction of receivers described in the pages of Radio Broadcast, as we are their sole service representatives.

For \$2.50 we will inspect and test any radio receiver sent to us by Express Prepaid, and furnish a written report describing the faults we find, together with an estimate of the cost of remedying them. For a Superheterodyne or other highly complicated receiver, a similar service will be rendered for \$5.00.

Our business is to permanently remedy the faults in radio receivers, either by repairs or revision. We have helped hundreds of people to really enjoy their radio sets, and can help you.

Telephone REctor 2538

Rossiter,
Tyler & McDonell, Inc.
Consulting Radio Engineers
136 Liberty St., New York

RTM RADIO SERVICE



MODEL "C" CHEST,

Cabinets in stock—have piano hinge and are 10" deep—grooved front top rail being removable. Illustration shows gold line wood panel to match.

Sizes	Walnut Only	Panel to Match
7x18-10	\$15.00	\$1.26
7x21-10	17.00	1.47
7x24-10	19.00	1.68
*7x26-10	21.00	1.82
7x30-10	23.00	2.10
*7x28-11	23.00	1.96

*For Madison Moore Receiver.
*For Victoreen Receiver.

**Walnut Infradyne Cabinet
\$30⁰⁰**

LC-27 Cabinets

Mahogany or Walnut with Baseboard

\$18⁰⁰

The LC-27 cabinets have 25° slope and take 8 x 26 panel. They are full 10" deep back of the panel.

WRITE FOR folder showing complete LC-27 Line and other Radio Furniture.

**CORBETT CABINET
MFG. COMPANY**
St. Marys - - Pennsylvania

The flux is everything in radio soldering says this Radio Engineer

"In our laboratory we made a thorough analysis of the two groups of fluxes (natural and chemical). We found the natural flux, rosin, the only safe one to use on radio work.

Pure rosin, as in Kester Radio Solder, will not fume, sputter, or creep over large areas, and being a hard, dense substance, rosin will not attract and collect dust (carbon particles), which makes an excellent path for leakages. These are the faults of fluxes containing chloride, be it either in paste, liquid or compound form. Any flux containing chloride will eventually cause heavy leakage. Hence they should be strictly avoided.

We find Kester Radio Solder the most convenient way to solder on radio work, for it has the proper amount of pure rosin right inside the solder itself. In fact, we used it exclusively on all of our work."

There's your guide, radio fans—the approval of an expert radio engineer. Surely there can be no doubt as to what you should use on YOUR SET.



A free Sample write for it now

KESTER Radio SOLDER

the safe solder for radio, requires only heat

CHICAGO SOLDER CO. 4222 Wrightwood Ave. Chicago, U. S. A.

Originators and the World's Largest Manufacturers of Self-fluxing Solder

LYNCH METALLIZED

WARRANTED FIXED RESISTORS

THE vital importance of a silent, accurate resistor cannot be over-estimated. Comprising a concentrated metallized deposit one-thousandth of an inch thick, upon a glass core and sealed forever within the tube, each Lynch Resistor is warranted absolutely noiseless, permanently accurate, dependable! Guaranteed accuracy—10%; in production they average 5%. .25; .5; 1; 2; 3; 4; 5; 6; 7; 8; 9; 10 Meg., 50c. .025; .09; .1 Meg., 75c. Single mounting 35c; Double, 50c. If your dealer cannot supply you, send stamps, check or money order. We ship postpaid same day order is received.

Dealers—Get on our mailing list; we keep you posted on new developments. Write us today!

ARTHUR H. LYNCH, INC. MEMBER RMA 426-B 250 W. 57th St. New York, N. Y.



Do you hear All of the Orchestra—or only part?



WHEN famous orchestras broadcast, do you clearly hear all the musicians? Or—through inability of your transformers to amplify low and high notes as evenly as middle tones—are you really only listening to a few of the instruments? Put Jefferson "Concertones" in your set and enjoy the whole orchestra!

Specified in latest circuits because they do not lose, distort or "blast" any audible notes from the lowest (30 cycles) to the highest (10,000 cycles). Ideal for safe, continuous use with power tubes. At your dealer's, \$6 each.

JEFFERSON ELECTRIC MFG. CO. Largest manufacturers of small transformers 507 So. Green St., Chicago, Ill.

Jefferson Concertone Transformers





AC 12 - \$30

From the highest musical note in nature, to the deepest—

Amplion reproduces the whole range—perfectly

TO the world-famous Amplion line of radio reproducers is added the Amplion Cone—time-perfected—clear and mel-

low in tone—strikingly distinct in the enunciation of the spoken word. In a graceful, two-tone mahogany cabinet, 14" x 14" x 9".

AMPLION Reproducers, \$12 to \$45

Ask your dealer for a demonstration or write to us for interesting Amplion Booklet





THE AMPLION CORPORATION OF AMERICA
Suite L - 280 Madison Ave., New York City

CROSLLEY

BETTER... COSTS LESS

RADIO

CROSLLEY RADIO INSTRUMENTS
Each item the utmost in radio at its price. All prices slightly higher west of the Rocky Mountains. Prices without accessories.



THE "PUP" \$9.75
This little double-circuit one-tube set has brought happiness to thousands and made records for long distance receiving.



THE "4-29" \$29
A 4-tube receiver of amazing efficiency, Crescendon equipped! Everywhere considered marvellous at its price.



THE "PORTABLE" \$33.00
The 4-29 in portable form, handy, compact, efficient.



THE "5-38" \$38
A five-tube tuned radio frequency set, with two stages of non-oscillating radio frequency amplification, Crescendon controlled two stages of audio frequency amplification.

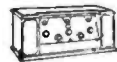

"RFL-75" \$65
5-tubes. True cascade amplification, non-oscillating, non-radiating even under any mis-handling. Its perfect balancing achieved by Wheatstone bridge in each stage of amplification. Exceptional selectivity and tone.



THE "MUSICONE" \$32.00
Embodies the Musicone in a beautiful console of two-tone mahogany finish and provides room for batteries and accessories, 21 1/2 inches long inside.



6-TUBE "RFL-90" CONSOLE \$90
Introducing the double drum station selector! Includes Musicone in exquisite console. Room for batteries and all accessories, 40 inches high by 30 1/2 inches wide.

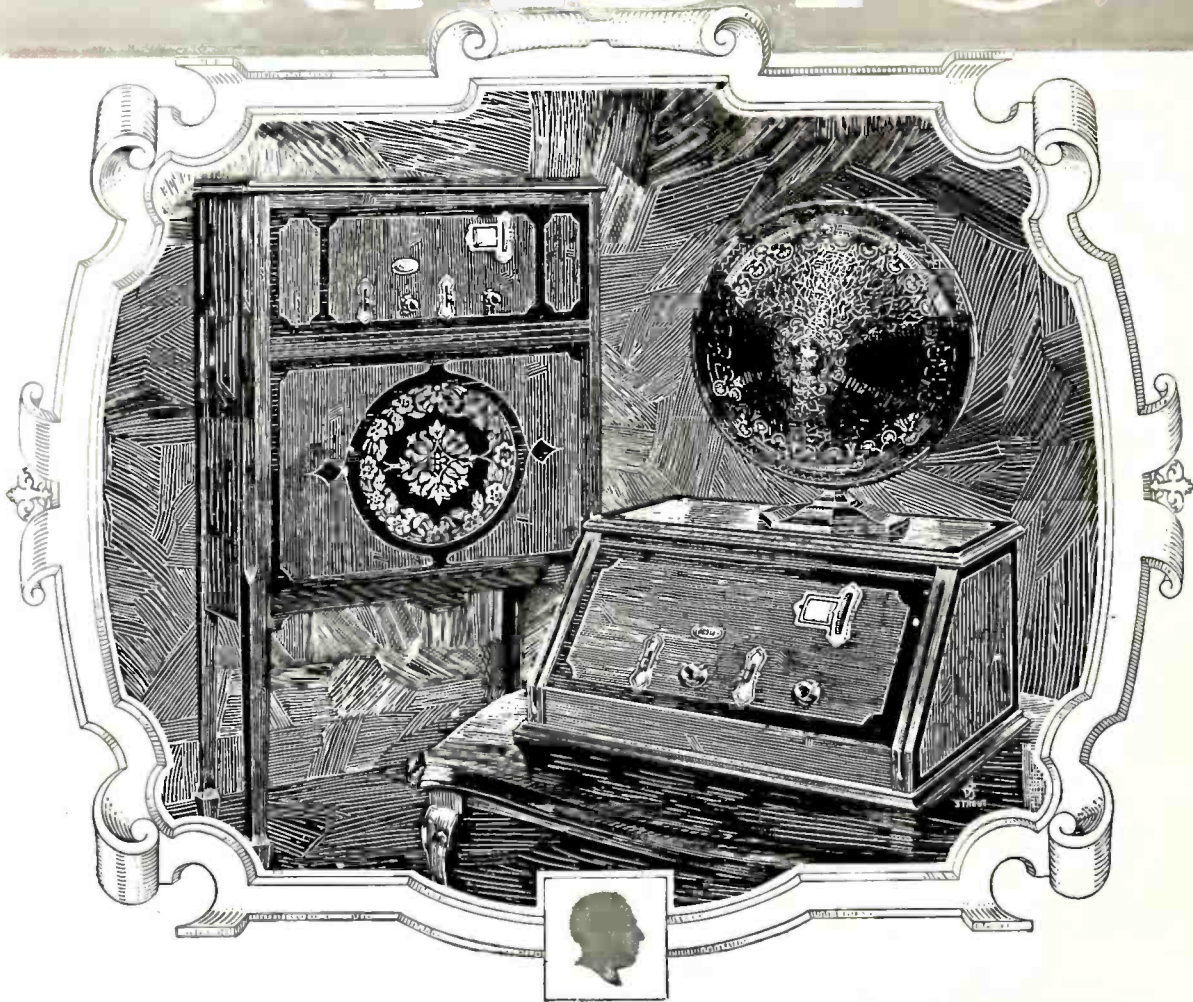

CROSLLEY 1927 FEATURES
Many exclusive—others found only in highest priced radios.

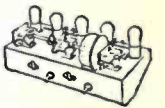

ALL-METAL SHIELDED CHASSIS
This truly great radio achievement, found in several Crosley sets, furnishes a substantial frame for mounting elements, produces excellent alignment of condensers, shields the units from each other, prevents interstage, improves the stability of the circuit, increases selectivity and saves costs by standardizing this phase of manufacture.



"THE ACUMINATORS"
Crosley Acuminators permit tuning in—loud and clear—weak stations passed over and entirely missed by ordinary single dial radios. In tuning high powered and local stations they are not used. They are an exclusive Crosley feature.



THE "CRESCENDON"
When, on ordinary radios, ears must strain to catch a station miles away, a turn of the Crescendon on Crosley radios instantly swells reception to room-filling volume. An exclusive Crosley feature.

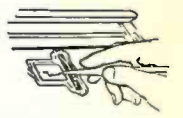

THE SINGLE DIAL STATION SELECTOR
Nothing in radio equals the joy or the convenience of single dial control. Crosley's single drum control enables you to find the stations sought without log book or "tuning."



POWER TUBES
Power tube adaptability marks the Crosley "5-50", "5-75" and "RFL" sets. This feature typifies Crosley provision for best radio reception at moderate cost.

Amazing single dial control and reproduction

THE 5 tube 5-50 THE SUPERMUSICONE THE 5-75 CONSOLE

Such a success! Enthusiastic owners report amazing performance—a drum dial delivering stations loud, clear, sharp; each an almost imperceptible turn of the drum apart. Write station letters on the drum; return to them at will. This marvelous receiver containing these advanced ideas in radio (some of them exclusive to Crosley), including metal shielding and power tube adaptability indicates Power Crosley, Jr.'s genius in lowering prices by mass production methods.

Listen to this wonder reproducer of broadcasting! Then you'll understand why it is the biggest selling loud speaker on the market EVERYWHERE, and the most imitated. Its shape, however, is NOT the secret of its wonderful performance. Its delightful tone and the fidelity of its reproduction is achieved solely through the Crosley patented actuating unit. Avoid imitations. There is only one genuine MUSICONE. Smaller model, 12-inch cone, \$12.50.

This set includes ideas for radio reception perfection NOT found in any other radio. Marvelous exclusive Crosley "Crescendon" and "Acuminators" increase volume on distant stations and bring in programs entirely passed by and missed on ordinary one dial control radios. Console is 40 inches high with ample room for batteries and a genuine Crosley Musicone is built in. Radio chassis same as in the 5-50 receiver. Beautifully finished two-tone mahogany cabinet, rose gold fittings.

\$50.

\$14.75

\$75.

Prices slightly higher west of the Rocky Mountains Write Department 20 for Illustrative Literature

THE CROSLLEY RADIO CORPORATION

CINCINNATI, OHIO. POWEL CROSLLEY, Jr., President

★ Examined and approved by RADIO BROADCAST ★

**Windsor Wall or Table
Type Cone Speaker
Amazes Radio World**



Model 210
(Pat. Applied For)

The latest model Windsor Cone Loudspeaker has astonished the world of radio. In convenience, quality of reception, and extremely low price, it far surpasses anything yet offered. The cone is 22 inches in diameter and is mounted on a sounding board which, in turn, is supported by an easel back. It can be hung up on the wall, as in the picture above, or stood upon any flat surface as shown in the picture below. It contains the famous Windsor loudspeaker unit noted for the extreme clarity and fidelity of reproduction.



Model 210
22-inch Cone Loudspeaker with sounding board and easel back.

\$15.00

(West of Rockies \$18)
(Pat. Applied For)

Model 302 (Shown below)
With Moulded Composition Horn Loudspeaker and 18-inch Cone Loudspeaker.



(Pat. Applied For)

In this Windsor Console is combined both the Windsor Moulded Composition Horn Loudspeaker and the 18-in. Windsor Cone Loudspeaker. The top is 30 in. x 17 in. and stands 29 in. high. Plenty of battery and equipment space is provided by large shelf in rear. Price, finished in Mahogany or Walnut **\$48.00**
(West of Rockies, \$55)

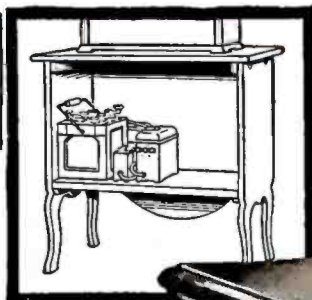

Rear view at left shows large compartment with ample space for batteries, battery charger, or battery eliminator, which are entirely concealed from view. Back is open for ventilation of batteries.

At right is shown the Cone Loudspeaker, with its sounding board, which is quickly and easily removable, allowing instant access to all batteries, battery charger, battery eliminator or other equipment and wiring.

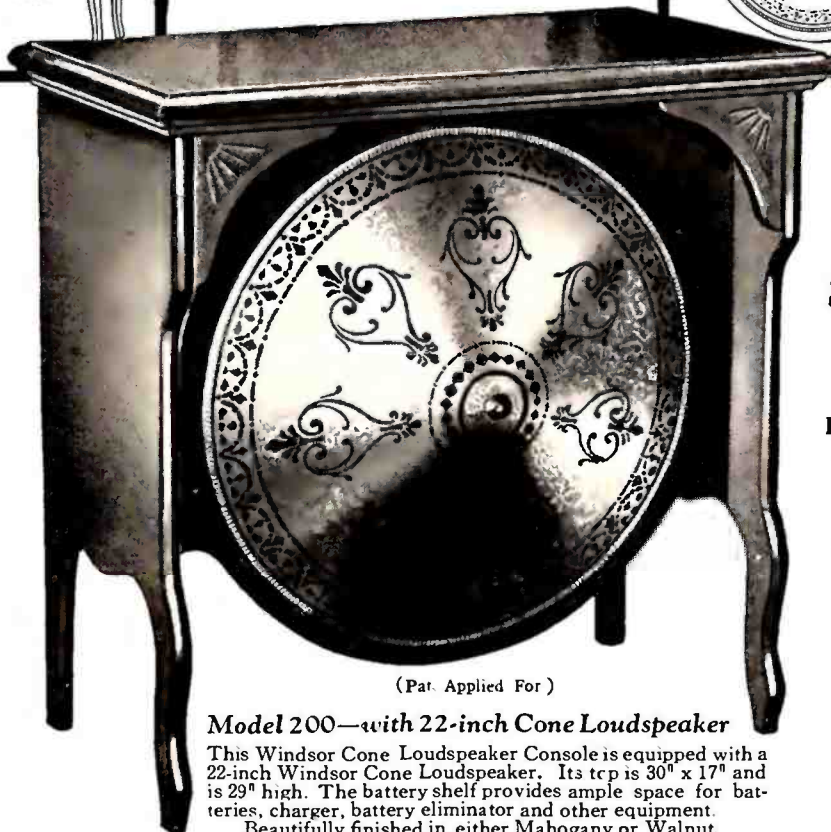
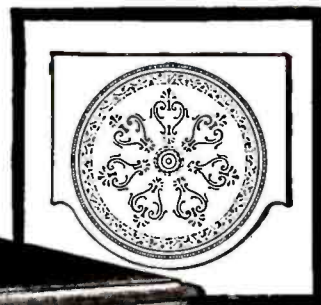

(Pat. Applied For)

Model 200—with 22-inch Cone Loudspeaker

This Windsor Cone Loudspeaker Console is equipped with a 22-inch Windsor Cone Loudspeaker. Its top is 30" x 17" and is 29" high. The battery shelf provides ample space for batteries, charger, battery eliminator and other equipment. Beautifully finished in either Mahogany or Walnut.

Model 200

\$29

Console with Cone Loudspeaker Ready for Set and Batteries (West of Rockies, \$35)

This is the Fastest Selling Line of Loudspeakers and Loudspeaker Consoles in the Radio World Today

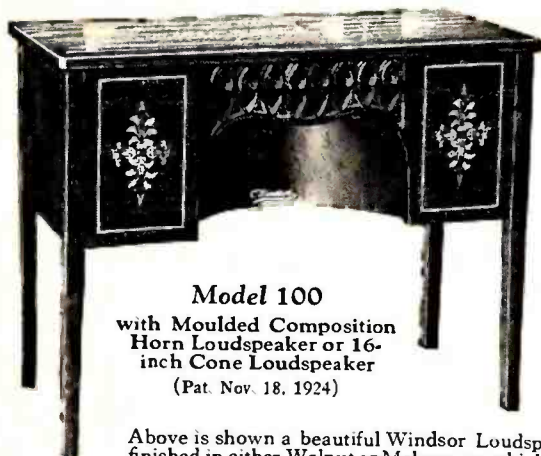

Model 100
with Moulded Composition Horn Loudspeaker or 16-inch Cone Loudspeaker
(Pat. Nov. 18, 1924)

Above is shown a beautiful Windsor Loudspeaker Console, finished in either Walnut or Mahogany, which provides ample space on top for any radio set. The battery shelf beneath will accommodate all necessary equipment. Equipped with either Moulded Composition Horn or 16-inch Cone Loudspeaker. Size: 38 in. x 18 in., and 29 in. high. Price **\$40.00**
(West of Rockies, \$42.50)

To the right is shown the newest Windsor Loudspeaker Console. It is equipped with a 22-inch Cone Loudspeaker and cabinet suitable for 7-inch radio panels up to 26 inches in length. Battery shelf provides ample space for all equipment. Beautifully finished in either Walnut or Mahogany. Price (without receiving set) **\$44.00**
(West of Rockies, \$52.00)

The quality of radio reception made possible by Windsor Cone and Horn Loudspeakers and Loudspeaker Consoles so far surpasses anything heard heretofore that it amazes and delights every radio enthusiast. The Windsor Line is so complete that everyone can find in it a loudspeaker, loudspeaker table, or loudspeaker console exactly to fit their particular needs.



(Pat. Applied For)

Model 1000
with 22-inch Cone Loudspeaker

Note to Dealers: Write or wire today for details of the highly profitable Windsor line.

Electrical Department
WINDSOR FURNITURE COMPANY
1412 Carroll Avenue • CHICAGO, ILLINOIS
Los Angeles Branch—917 Maple Avenue

New!

THE TRANSFORMER THAT INSURES RECEPTION AT ONE POINT ONLY ON THE DIAL. THIS HAS NEVER BEEN DONE BEFORE.

**THE MADISON-MOORE
One-Spot
TRANSFORMER
JUST OUT!**

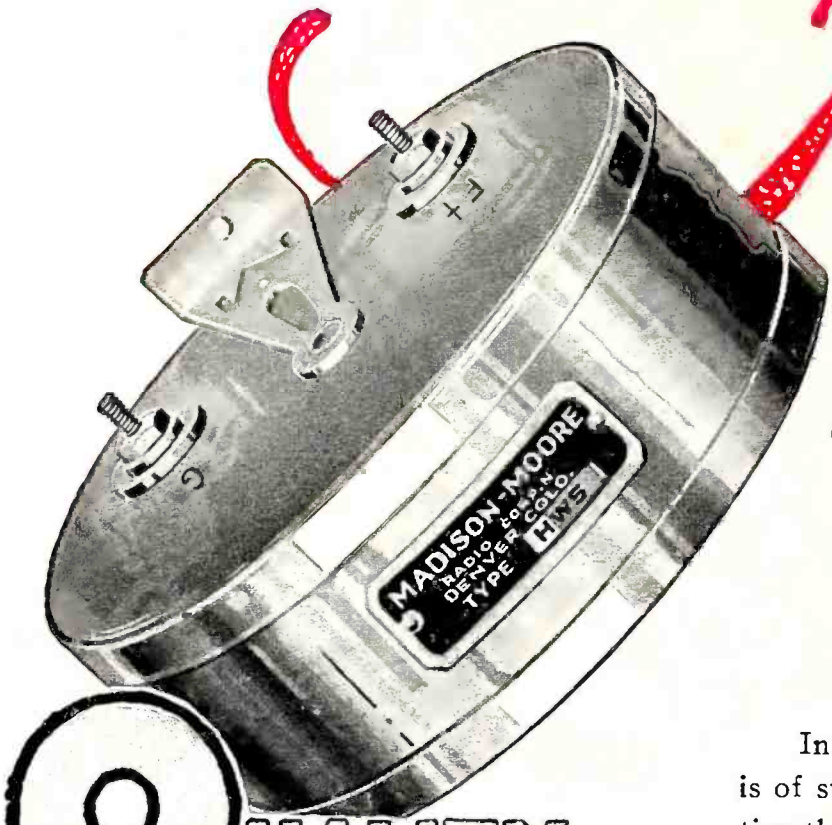

QUANTITY
SELECTIVITY
DISTANCE

In this new instrument, the intermediate frequency is of such high value that the reappearance of any station throughout the entire broadcast range is eliminated. Reception at more than one point on the dial, the feature that has annoyed every owner of a set, has been completely conquered by this latest radio engineering achievement.

This new MADISON-MOORE ONE-SPOT TRANSFORMER is even more wonderful than its predecessor, because it gives POSITIVE SELECTIVITY, HIGHER QUALITY, and GREATER DISTANCE. Yet, owing to increased production, the price for the new instrument is lower than for the former model.

Surpassing radio satisfaction is yours if you install MADISON-MOORE ONE-SPOT TRANSFORMERS. They are supreme in the realm of Radio.

[Ask your dealer. If he can't supply you, write us.]

MADISON-MOORE RADIO CORPORATION
2524 C Federal Boulevard
Denver, Colorado—U. S. A.



MADISON-MOORE
The Finest RADIO APPARATUS in the World!

★ Examined and approved by RADIO BROADCAST ★

THE COUNTRY LIFE PRESS, GARDEN CITY, NEW YORK