

Hands-on Electronics

\$2.50 U.S.
\$2.95 CANADA
MARCH
1988



THE MAGAZINE FOR THE ELECTRONICS ACTIVIST!

COMPU-THROTTLE

THE COMPUTER-AGE MODEL-RAILROAD LOCOMOTIVE SPEED CONTROLLER

You can build it!
See page 32

THYRISTORS

The magic of a 4-layer diode that controls the power of our projects

HEADPHONE INTERFACE

Hands-free conversation with total privacy

POLARITY TESTER

A winning Science Fair project

RAD HOUND

Sniff out radiation in and around home



A GERNSBACK PUBLICATION



NATIONAL SEMICONDUCTOR • PANASONIC
OK MACHINE • EWC, INC. • INTERSIL • AD
EAC, INC. • J. W. MILLER • AAVI ENGINEER
E. F. JOHNSON • ATLANTIC SEMICONDUCTOR

256K (262,144 x 1) DRAM 150NS \$5.70/1; \$39.95/9
Factory Firsts

JODES • DIAMOND TOOL • UNGAR
ES • CW INDUSTRIES • AMDEK • G.E.
YAGAR • YAGAR • J. W. MILLER • JUE
SC CHEMICALS • ARIES • PLESLEY

INTEGRATED CIRCUITS

Part No.	Description	Price
7400 TTL	74A07N	1.18
7401	74A01N	1.18
7402	74A02N	1.18
7403	74A03N	1.18
7404	74A04N	1.18
7405	74A05N	1.18
7406	74A06N	1.18
7407	74A07N	1.18
7408	74A08N	1.18
7409	74A09N	1.18
7410	74A10N	1.18
7411	74A11N	1.18
7412	74A12N	1.18
7413	74A13N	1.18
7414	74A14N	1.18
7415	74A15N	1.18
7416	74A16N	1.18
7417	74A17N	1.18
7418	74A18N	1.18
7419	74A19N	1.18
7420	74A20N	1.18
7421	74A21N	1.18
7422	74A22N	1.18
7423	74A23N	1.18
7424	74A24N	1.18
7425	74A25N	1.18
7426	74A26N	1.18
7427	74A27N	1.18
7428	74A28N	1.18
7429	74A29N	1.18
7430	74A30N	1.18
7431	74A31N	1.18
7432	74A32N	1.18
7433	74A33N	1.18
7434	74A34N	1.18
7435	74A35N	1.18
7436	74A36N	1.18
7437	74A37N	1.18
7438	74A38N	1.18
7439	74A39N	1.18
7440	74A40N	1.18
7441	74A41N	1.18
7442	74A42N	1.18
7443	74A43N	1.18
7444	74A44N	1.18
7445	74A45N	1.18
7446	74A46N	1.18
7447	74A47N	1.18
7448	74A48N	1.18
7449	74A49N	1.18
7450	74A50N	1.18
7451	74A51N	1.18
7452	74A52N	1.18
7453	74A53N	1.18
7454	74A54N	1.18
7455	74A55N	1.18
7456	74A56N	1.18
7457	74A57N	1.18
7458	74A58N	1.18
7459	74A59N	1.18
7460	74A60N	1.18
7461	74A61N	1.18
7462	74A62N	1.18
7463	74A63N	1.18
7464	74A64N	1.18
7465	74A65N	1.18
7466	74A66N	1.18
7467	74A67N	1.18
7468	74A68N	1.18
7469	74A69N	1.18
7470	74A70N	1.18
7471	74A71N	1.18
7472	74A72N	1.18
7473	74A73N	1.18
7474	74A74N	1.18
7475	74A75N	1.18
7476	74A76N	1.18
7477	74A77N	1.18
7478	74A78N	1.18
7479	74A79N	1.18
7480	74A80N	1.18
7481	74A81N	1.18
7482	74A82N	1.18
7483	74A83N	1.18
7484	74A84N	1.18
7485	74A85N	1.18
7486	74A86N	1.18
7487	74A87N	1.18
7488	74A88N	1.18
7489	74A89N	1.18
7490	74A90N	1.18
7491	74A91N	1.18
7492	74A92N	1.18
7493	74A93N	1.18
7494	74A94N	1.18
7495	74A95N	1.18
7496	74A96N	1.18
7497	74A97N	1.18
7498	74A98N	1.18
7499	74A99N	1.18
7500	74A00N	1.18

T 1 IC SOCKETS

SOLDER TAIL DIP SOCKETS

Single height
Low profile
YOUR CHOICE: TIN OR GOLD*
TIN PLATED SOLDER TAIL
*See our website for more details.

Part No. Description Price

256K	256K (262,144 x 1) DRAM 150NS	\$5.70/1; \$39.95/9
------	-------------------------------	---------------------

Carbon Film Resistors

Assorted in 16, 168, 512 Watt

Part No. Description Price

R510	1% Metal Film Disc Resistors	50 3.00 30.00
------	------------------------------	---------------

DISC CAPACITORS

Part No. Description Price

PANASONIC	PANASONIC	
-----------	-----------	--

TANTALUM CAPACITORS

Part No. Description Price

TANALUM	TANALUM	
---------	---------	--

7400 TTL

Part No. Description Price

7400	74A00N	1.18
------	--------	------

WIRE WRAP DIP SOCKETS

Standard profile
Universal mounting and packaging capabilities
Compliant with JEDEC specifications

Part No. Description Price

WWS	WWS	
-----	-----	--

1% Metal Film Disc Resistors

Assorted in 16, 168, 512 Watt

Part No. Description Price

R510	1% Metal Film Disc Resistors	50 3.00 30.00
------	------------------------------	---------------

PANASONIC LS SERIES

Disc Capacitors

Part No. Description Price

PANASONIC	PANASONIC	
-----------	-----------	--

Metalized Polyester Capacitors

Part No. Description Price

MPC	MPC	
-----	-----	--

7400 TTL

Part No. Description Price

7400	74A00N	1.18
------	--------	------

SILICON TRANSISTORS

Part No. Description Price

2N	2N	
----	----	--

1% Metal Film Disc Resistors

Assorted in 16, 168, 512 Watt

Part No. Description Price

R510	1% Metal Film Disc Resistors	50 3.00 30.00
------	------------------------------	---------------

PANASONIC VS SERIES

Disc Capacitors

Part No. Description Price

PANASONIC	PANASONIC	
-----------	-----------	--

Metalized Polyester Capacitors

Part No. Description Price

MPC	MPC	
-----	-----	--

7400 TTL

Part No. Description Price

7400	74A00N	1.18
------	--------	------

SILICON TRANSISTORS

Part No. Description Price

2N	2N	
----	----	--

1% Metal Film Disc Resistors

Assorted in 16, 168, 512 Watt

Part No. Description Price

R510	1% Metal Film Disc Resistors	50 3.00 30.00
------	------------------------------	---------------

PANASONIC VS SERIES

Disc Capacitors

Part No. Description Price

PANASONIC	PANASONIC	
-----------	-----------	--

Metalized Polyester Capacitors

Part No. Description Price

MPC	MPC	
-----	-----	--

7400 TTL

Part No. Description Price

7400	74A00N	1.18
------	--------	------

SILICON TRANSISTORS

Part No. Description Price

2N	2N	
----	----	--

1% Metal Film Disc Resistors

Assorted in 16, 168, 512 Watt

Part No. Description Price

R510	1% Metal Film Disc Resistors	50 3.00 30.00
------	------------------------------	---------------

PANASONIC VS SERIES

Disc Capacitors

Part No. Description Price

PANASONIC	PANASONIC	
-----------	-----------	--

Metalized Polyester Capacitors

Part No. Description Price

MPC	MPC	
-----	-----	--

7400 TTL

Part No. Description Price

7400	74A00N	1.18
------	--------	------

SILICON TRANSISTORS

Part No. Description Price

2N	2N	
----	----	--

1% Metal Film Disc Resistors

Assorted in 16, 168, 512 Watt

Part No. Description Price

R510	1% Metal Film Disc Resistors	50 3.00 30.00
------	------------------------------	---------------

PANASONIC VS SERIES

Disc Capacitors

Part No. Description Price

PANASONIC	PANASONIC	
-----------	-----------	--

Metalized Polyester Capacitors

Part No. Description Price

MPC	MPC	
-----	-----	--

7400 TTL

Part No. Description Price

7400	74A00N	1.18
------	--------	------

SILICON TRANSISTORS

Part No. Description Price

2N	2N	
----	----	--

1% Metal Film Disc Resistors

Assorted in 16, 168, 512 Watt

Part No. Description Price

R510	1% Metal Film Disc Resistors	50 3.00 30.00
------	------------------------------	---------------

PANASONIC VS SERIES

Disc Capacitors

Part No. Description Price

PANASONIC	PANASONIC	
-----------	-----------	--

Metalized Polyester Capacitors

Part No. Description Price

MPC	MPC	
-----	-----	--

7400 TTL

Part No. Description Price

7400	74A00N	1.18
------	--------	------

SILICON TRANSISTORS

Part No. Description Price

2N	2N	
----	----	--

1% Metal Film Disc Resistors

Assorted in 16, 168, 512 Watt

Part No. Description Price

R510	1% Metal Film Disc Resistors	50 3.00 30.00
------	------------------------------	---------------

PANASONIC VS SERIES

Disc Capacitors

Part No. Description Price

PANASONIC	PANASONIC	
-----------	-----------	--

Metalized Polyester Capacitors

Part No. Description Price

MPC	MPC	
-----	-----	--

The Digi Key volume discount and service charges are simple to apply. Most items sold by Digi Key may be combined for a volume discount. Items that are not discountable are identified by the suffix "ND". Following the part number, after writing your order, total all of the discountable items and apply the appropriate discount. To this subtotal, add the non-discountable items. Then the service charge. We pay all shipping and insurance to addresses in the U.S., Canada and Mexico when check or money order accompanies order. Dig-Key only ships orders within the continental U.S., Alaska, Hawaii, and Guam.

WHEN ORDERING BY PHONE CALL 1-800-344-5399 (call 218-681-6674). BY MAIL, SEND YOUR ORDER TO: DIGI-KEY, P.O. Box 677, Thief River Falls, MN 56781.

You may pay by check, money order, MasterCard, VISA or C.O.D. **DIGI-KEY GUARANTEE:** Any parts or products purchased from Digi-Key that prove to be defective will be replaced or refunded if returned within 90 days from receipt with a copy of your invoice. **NEVER SUBJECT TO CHANGE WITHOUT NOTICE.**

CONSTRUCTION

- 32 **Compu-Throttle**—makes model-train sets act like the real thing
- 42 **Delivery Indicator**—alerts you to the arrival of your mail or newspaper
- 46 **Rad Hound**—a radiation contamination early-warning system
- 59 **Headphone Interface**—hands-free conversation with total privacy

FEATURES

- 41 **Chemical Polarity Experiment**—electronics is a science and science is fast-becoming all electronic
- 65 **Thyristors**—everything you should know to use this family of devices
- 71 **E-Z Math**—triangles and vectors for fun and profit

HANDS-ON REPORTS

- 45 **UKI OKI Printer Switch**—lets your printer accept both IBM and Okidata character sets

SPECIAL COLUMNS

- 80 **Ellis On Antique Radio**—learning Morse code in the 1940's
- 82 **Circuit Circus**—simple circuits that can make life a bit easier
- 84 **Carr's Ham Shack**—reduce RFI with an adjustable, active bandpass filter
- 86 **Friedman On Computers**—get a universal monitor driver
- 88 **Jensen On DX'ing**—why listen to shortwave programming?
- 90 **Saxon On Scanners**—a completely miniaturized 100-channel scanner with electronic digital tuning
- 94 **Wels' Think Tank**—transistors were bad enough, but what are those boxes with the numbers all around them?

DEPARTMENTS

- 2 **Editorial**—who's out there?
- 4 **Letter Box**—here is where your input is appreciated
- 8 **New Products Showcase**—spotlighting the latest in electronic hardware
- 17 **Bookshelf**—prepare for tomorrow's electronic gadgets by getting a handle on what's available today
- 39 **FactCards**—they contain what's needed to get that project humming
- 49 **GIZMO SPECIAL SECTION**—what's good to get that gets you good!
Minolta Master Series VHS Camcorder: Sharp Multi-Play Compact-Disc Changer: Canon Personal Typewriter: Phone-Mate Performance Series 7000 Answering Machine: J.C. Penney Video-Cassette Recorder: Teac Stereo Double-Cassette Deck
GIZMO/BYTES—Blaupunkt Dallas Car Stereo: Panasonic VHS Camcorder: Shinton VCRs: Polaroid PhotoMagic System: Canon VM-E2N 8-mm Camcorder: Panasonic Bread Bakery: Healthcheck Blood Pressure Monitor: Sonin Ultrasonic Measuring Device: UPS Shutdown/Electronic Specialists, Inc: Oster Four-cup Coffeemaker: Hewlett-Packard Business Consultant II: Nakamichi CA-5A II Control Amplifier: Adjustable Exercise-Bike Reading Stand: Olympia USA, Inc. Paper Shredders: Career Navigator: Zenith Home Satellite-Receiving Systems: Canon Cat Work Processor: Plus U.S.A. Halftime-Scissors: Onkyo CD Player with Changer
- 73 **Free Information Card**—up-to-date information on the latest products



Compu-Throttle—page 32



Chemical Polarity—page 41



Rad Hound—page 46

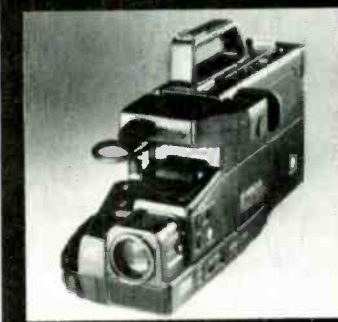

GIZMO—page 49



Headphone Interface—page 59



Saxon On Scanners—page 90

Hands-on Electronics®

The Magazine for the Electronics Activist!

Cover Photograph

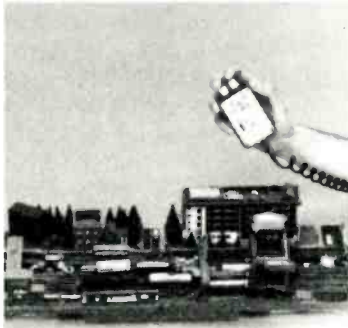

Who is out there?

Every editor flatters himself by pretending to know everything there is to know about his field of interest. Therefore, if electronics is used to make yogurt, I should know about it! So, to get to the point of this editorial; I received a very interesting article in the mail on a computerized model-railroad track power-supply. Now I know that some project builders will use 20 ICs to dim a light, and thus, I thought, using a microprocessor chip to control a model-railroad engine was too much!

But, I liked the idea and the article was prepared in excellent style. I asked the staff to read the manuscript and rave notices came from them. In fact, one staff member was into model railroading and thought that the project in question was the best to come down the track in a long time (to coin a phrase). I purchased it with some reservations.

The very next day I was in the hands of my chiropractor and he was chatting as I was grunting. I discovered he was into model railroading. In fact, he made very complex layouts that he bragged about. I let him test the power supply and he gave it rave notices. To make the story short, a section of his track layout appears on the cover.

At the photo studio I barely got past the front desk when a model-railroad fan stopped me as I was carrying the props to the studio area. And I could go on with a few other stories about instances where model-railroad buffs identified themselves once they knew that I was involved with their hobby.

My unofficial census tells me that there must be 50-million people in North America who are into model railroading. You see, now I know everything about model railroading and that the Compu-Throttle project in this issue is the best power supply a model railroader can build.

That's all for this month. For the next 30 days I may be looking into yogurt and electronics.

Julian S. Martin, KA2GUN
Editor

STAFF

Volume 5, No. 3

March 1988

Larry Steckler, EHF, CET
Editor-In-Chief & Publisher
Art Kleiman, editorial director
Julian S. Martin, KA2GUN, editor
Robert A. Young, associate editor
Herb Friedman, W2ZLF, associate editor
John J. Yacono, associate editor
Brian C. Fenton, associate editor
Carl Laron, WB2SLR, associate editor
Byron G. Wels, K2AVB, associate editor
M. Harvey Gernsback, contributing editor
Doris Kelly, editorial assistant
Teri Scaduto, editorial assistant
Ruby M. Yee, production director
Karen S. Tucker, production manager
Robert A. W. Lowndes, editorial associate
Marcella Amoroso, production assistant
Jacqueline P. Cheeseboro, circulation director
Arline R. Fishman, advertising director

BUSINESS AND EDITORIAL OFFICES

Gernsback Publications, Inc.
500-B Bi-County Boulevard
Farmingdale, NY 11735.
516/293-3000
President: Larry Steckler
Vice-president: Cathy Steckler

NATIONAL ADVERTISING SALES

(For Advertising Inquiries Only)
Joe Shere **MIDWEST/PACIFIC**
1507 Bonnie Doone Terrace
Corona Del Mar, CA 92625
714/760-8697

The Pattis Group
310 Madison Ave. Suite 1804
New York, NY 10017
212-/953-2121

Composition by
Mates Graphics

Model trains courtesy of
Dr. Sam Haas



Hands-on Electronics, (ISSN 0743-2968) Published monthly by Gernsback Publications, Inc., 500-B Bi-County Boulevard, Farmingdale, NY 11735. Second-Class postage paid at Farmingdale, NY and at additional mailing offices. One-year, twelve issues, subscription rate U.S. and possessions \$28.00, Canada \$33.00, all other countries \$35.50. Subscription orders payable in U.S. funds only. International Postal Money Order or check drawn on a U.S. bank. U.S. single copy price \$2.50. © 1988 by Gernsback Publications, Inc. All rights reserved. Trademark registered in U.S. and Canada. Printed in U.S.A.

Postmaster: Please send address changes to Hands-On Electronics, Subscription Dept., P.O. Box 338, Mount Morris, IL 61054-9932.

A stamped self-addressed envelope must accompany all submitted manuscripts and/or artwork or photographs if their return is desired should they be rejected. We disclaim any responsibility for the loss or damage of manuscripts and/or artwork or photographs while in our possession or otherwise.

As a service to readers, Hands-on Electronics publishes available plans or information relating to newsworthy products, techniques and scientific and technological developments. Because of possible variances in the quality and condition of materials and workmanship used by readers, Hands-on Electronics disclaims any responsibility for the safe and proper functioning of reader-built projects based upon or from plans or information published in this magazine.

SELECT 5 BOOKS for only \$3.95

(values to \$127.70)

and get a Free Gift!

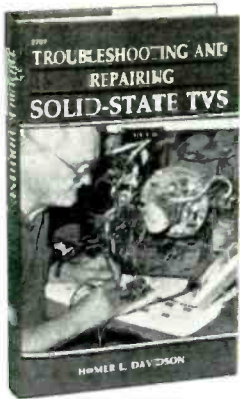

2707 \$26.95
Counts as 2



2733 \$14.95



1218P \$14.95

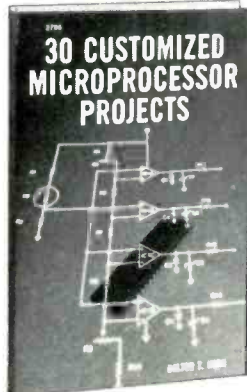

2705H \$22.95



1195P \$16.95



1503P \$15.95



2635 \$19.95



2936 \$14.95



2660P \$17.95



1586 \$17.95



1599P \$16.95

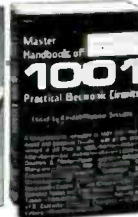

800P \$19.95



2781 \$18.95



1593P \$8.95

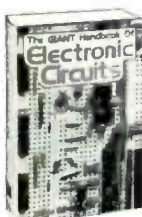

1300P \$24.95



2750 \$25.95
Counts as 2



1498P \$11.95



2832 \$23.95



2922 \$24.95



1663P \$17.95

Electronics projects . . . ideas . . . the latest technology
all at up to 50% off publishers' prices

Membership Benefits • Big Savings. In addition to this introductory offer, you keep saving substantially with members' prices of up to 50% off the publishers' prices. • **Bonus Books.** Starting immediately, you will be eligible for our Bonus Book Plan, with savings of up to 80% off publishers' prices. • **Club News Bulletins.** 14 times per year you will receive the Book Club News, describing all the current selections—mains, alternates, extras—plus bonus offers and special sales, with hundreds of titles to choose from. • **Automatic Order.** If you want the Main Selection, do nothing and it will be sent to you automatically. If you prefer another selection, or no books at all, simply indicate your choice on the reply form provided. As a member, you agree to purchase at least 3 books within the next 12 months and may resign at any time thereafter. • **Ironclad No-Risk Guarantee.** If not satisfied with your books, return them within 10 days without obligation! • **Exceptional Quality.** All books are quality publishers' editions especially selected by our Editorial Board. (Publishers' Prices Shown)

FREE when you join!

Reference Guide to Electronics
Manufacturers' Publications

A time- and money-saving list
of product literature from all
the major electronics suppliers.
(a \$6.95 value)

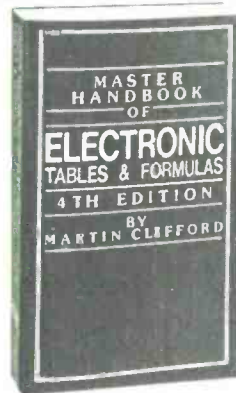
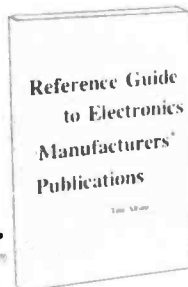

1625P \$14.95



1160P \$10.95



1583P \$13.50

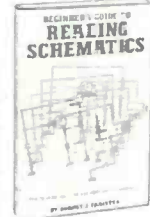

1536P \$8.95

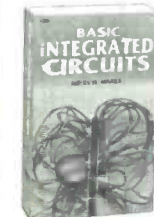

2609P \$16.95



2795 \$29.95
Counts as 2



2800 \$23.95

ELECTRONICS BOOK CLUB®
Blue Ridge Summit, PA 17294-0810

Please accept my membership in the Electronics Book Club® and send the 5 volumes listed below, plus my FREE copy of Reference Guide to Electronics Manufacturers' Publications (2683P), billing me \$3.95 plus shipping and handling charges. If not satisfied, I may return the books within ten days without obligation and have my membership canceled. I agree to purchase at least 3 books at regular Club prices (plus shipping/handling) during the next 12 months, and may resign any time thereafter.

Name _____
Address _____
City _____
State/Zip _____ Phone _____

Valid for new members only. Foreign applicants will receive special ordering instructions. Canada must remit in U.S. currency. This order subject to acceptance by the Electronics Book Club®. All books are hardcover unless numbers are followed by a "P" for paperback. RESP 388

LETTER BOX



Hands-on Electronics, 500-B Bi-County Boulevard, Farmingdale, New York 11735

Communications Break Down

I never miss your magazine, I have found your articles very informative, but unfortunately, I have not seen much in the area of communications. Your last issue touched frequency modulation as well as AM. Would you help we readers understand Pulse Modulation Techniques (PPM, PWM)?

Thank you for your help and keep up the good work.

—B.D., West Haven, CT

If you look back a little ways, you'll find an article on modems in the September 1987 issue. In it is some information on phase modulation, but unfortunately nothing on pulse-width modulation techniques. (You experts get your keyboards out.)

Are You Board

This letter is in reference to your June 1987 issue to the person who wanted to build a musical doorbell, and others like him. We are a company that designs PC boards. We are small, but do have several boards available for the hobby-minded. Our list includes musical-doorbell boards and speech-synthesiser boards.

Each kit has a PC board; double sided, silk screened, solder masked, of excellent quality. It also comes with manual parts placement and schematic diagrams (full size). All parts are easily obtained from local electronics stores.

We take orders by mail or phone and accept MC or Visa. Write to RFJ Engineering, PO Box 4166, Sanford, FL 32771; Tel. 305/323-9039.

—RFJ, Sanford, FL

Our readers are happy to know about you. One thing comes to mind though, assuming you don't want to remain a small company, why don't you advertise with us? Your competition does. (That goes for the rest of you in the hobby market place reading this, face it—you bought the mag.)

Good Reception

In reply to D.K., Waldorf, MD in the January 1988 issue on building a short-

wave receiver. I would refer him to a book distributed by Electronics Technology Today. Their ads are carried by **Hands-On Electronics**.

From the book "How to Build Advanced Short Wave Receivers," I have built two receivers and they perform very well. You can use many junk box parts if you have them. The book is easily understood and construction could be carried out by any average experimenter.

—G.W.T., Peoria, IL

That's a good one for the Bookshelf column. We'll review it in an upcoming issue. Thanks for your friendly advice.

Hooked, Not Hooked Up

I am writing this letter in the hopes you can help me with a problem I haven't been able to resolve up to this time.

My hobby is music, and I'm interested in home-brewing an amplifier for an electric guitar. Unfortunately, I have seen nothing which would give instructions for constructing one. I'm not interested in a toy but a reasonably-powered guitar amp which I could use with a small group. Can you advise where I might get the plans? Is there a particular publication which might deal with this, or do you have any construction plans? I'd be glad to pay you if you have!

The other question is: in the event I can't locate plans to build an amp, can I use a regular stereo amp to play the guitar through, using a "Y-adaptor" to play through both channels simultaneously. If so, do I need a preamp or any other equipment to adapt the guitar for playing through the stereo system?

Thanks very much for your help! This is the first time I've read Hands-On Electronics, and it looks like I very well might be hooked.

—S.D.C., Walton, KY

Checking the classifieds in the back pages is a good way to dig up suppliers for almost anything. I saw an advertisement for a company dealing only in amplifier kits with the address Amplifiers Unlimited, Rt. 2 Box 139, Highmore, SD 57345. Give them a try.

If that doesn't work out, you can hook

your guitar though a stereo as you say, but there are two things worthy of note: The phono input has a preamp, but adjusts the frequency equalization distorting your guitar; an auxiliary input may not have preamplification. Using a tape deck input on your amp is therefore the best way to go.

Be sure that you have speakers that can handle the power, especially if you use fuzz boxes or other distortion-creating techniques.

Tech Trek

I have bought the last several issues of Hands-On Electronics and have found it more informative than most comparable magazines. The educational quality of your special columns are great. Also, you publish some very interesting circuit projects. (I've built a few and of course, they work fine).

There is one thing I would like help with. I have been trying to locate information on where I can find a schematic or other circuit diagram (photofact, etc.) for either a dual—or single—trace oscilloscope.

If you should have any information or suggestions on such a schematic, please respond.

—M.H.R., Minneapolis, MN

The best you can do is go straight to the horses mouth: check with the manufacturer. Look for a mailing address of the manufacturer in question in one of their ads and send them a request for info. If they are uncooperative try asking a repairman what text he would use.

No Energy

The other day I picked up a copy of the December 1987 issue of Hands-On Electronics. What caught my eye was your article on replacing rechargeable batteries. I am an avid photo buff and recently I was given two Honeywell 770 strobes, two AC charger/adapters and four NiCd packs. What a bargain! But the NiCds in one of the packs was starting to leak a little. I immediately took them out and checked the other NiCds out. No damage to the flash units or the NiCd clusters whatsoever. Whew!!

Electronics Paperback Books

GREAT PAPERBACKS AT SPECIAL PRICES

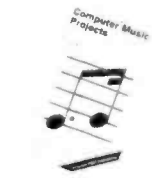

BP173—COMPUTER MUSIC PROJECTS \$6.95. Shows how to use your home computer to produce electronic music. Many circuits. Mostly Jargon free.



BP176—TV DXING FOR THE ENTHUSIAST \$6.95. Practical, authoritative intro to this unusual aspect of electronics. 812 x 11 in. 144 pp.



27051—CUSTOMIZED MICRO-PROCESSOR PROJECTS \$14.95. Building instructions, detailed schematics and application programs for intriguing and useful dedicated CPU projects.

Linear IC Equivalents and Pin Connections



BP141—LINEAR IC EQUIVALENTS AND PIN CONNECTIONS \$12.50. 247 pages. 7 x 10 in. Shows equi vs. pin connections for popular user-oriented ICs.

Digital IC Equivalents and Pin Connections



BP140—DIGITAL IC EQUIVALENTS AND PIN CONNECTIONS \$12.50. 312 pages. 7 x 10 in. Shows equi vs. pin connections for popular user-oriented ICs.



BP187—REFERENCE GUIDE TO AMSTRAD WORD PROCESSING \$14.95. Everything you need to know about using these machines.



BP146—THE PRE-BASIC BOOK \$6.95. A book on the BASIC programming for those who have not yet bought a computer as well as those who have trouble learning how to program.



BP108—INTERNATIONAL DIODE EQUIVALENTS GUIDE \$5.75. Full interchangeability data and characteristics for diodes including Zeners, LEDs, Diacs, Triacs and more.

Secrets of the Commodore 64



BP135—SECRETS OF THE COMMODORE 64 \$5.00. Masses of useful info and programming tips not found in any user's manual.

An Introduction to Programming the Atari 600/800 XL



BP143—INTRO TO PROGRAMMING THE ATARI 600/800 XL \$5.00. Perfect complement to the Atari user's manual. Even shows how to use animated graphics.

Computer Terminology Explained



BP131—MICRO INTERFACING CIRCUITS—BOOK 2 \$5.75. Interfacing sound and speech generators, temperature and optical sensors, motor controllers, and more.

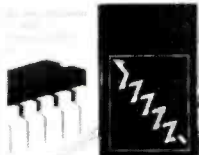

BP148—COMPUTER TECHNOLOGY EXPLAINED \$5.00. Explanations for computer terms often encountered. A dictionary for computer lingo.

Micro Interfacing Circuits Book 2



BP152—INTRO TO Z-80 MACHINE CODE \$5.95. Speed up your programs. They may be harder to write, but it's worth learning how. Some demo programs are included.

An Introduction to Antenna Theory



BP105—ANTENNA PROJECTS \$5.00. Practical radio antenna designs that deliver good performance and are relatively simple and inexpensive to build.

Further Practical Electronics—Calculations and Formulae



BP198—AN INTRODUCTION TO ANTENNA THEORY \$6.95. Basic concepts relevant to receiving and transmitting antennas.

25 Simple Amateur Band Antennas



BP125—25 SIMPLE AMATEUR BAND ANTENNAS \$5.00. All kinds of antennas for all kinds of amateur radio reception.

Electronic Circuits for the Computer Control of Robots



BP179—ELECTRONIC CIRCUITS FOR THE COMPUTER CONTROL OF ROBOTS \$5.00. Data and circuits for interfacing the computer to the robot's motors and sensors.

Easy Add-on Projects for Commodore 64, VIC-20, BBC Micro & Acorn Electron



BP134—EASY ADD-ON PROJECTS FOR COMMODORE 64, VIC-20, BBC MICRO & ACORN ELECTRON \$6.95. Picture digitizer, light pen, model controller and more.

Quality Paperbacks



BP183—AN INTRODUCTION TO CP/M \$5.75. To run and use programs operations under CP/M you need this book.



BP127—HOW TO DESIGN ELECTRONIC PROJECTS \$5.75. How to use standard circuit elements to make custom electronic projects.



BP110—HOW TO GET YOUR ELECTRONIC PROJECTS WORKING \$5.00. How to find the faults in your projects, repair them and get them working.



BP121—DESIGN & MAKE YOUR OWN PC BOARDS \$5.75. Everything you need to know before you make printed-circuit boards for your projects.



BP95—INTERNATIONAL TRANSISTOR EQUIVALENTS \$7.50. Locates possible substitutes for a popular user-oriented selection of modern transistors. Japanese, European and American types.



BP117—PRACTICAL ELECTRONIC BUILDING BLOCKS, Book 1 \$5.75. Build the blocks, and then combine them to form almost any custom project of your choice.



BP77—MICRO-PROCESSING SYSTEMS AND CIRCUITS \$5.95. Guide to the elements of micro-processing systems. Teaches all the fundamentals.



BP118—PRACTICAL ELECTRONIC BUILDING BLOCKS, Book 2 \$5.75. Amplifiers for all kinds to add to the circuits from Book 1 of this series.



BP169—HOW TO GET YOUR COMPUTER PROGRAMS RUNNING \$5.95. Have you ever written your own programs only to find that they do not work? This book shows you how to find errors.



BP128—20 PROGRAMS FOR THE ZX SPECTRUM & 16K ZX81 \$5.75. All programs run on both machines. Include flow charts and info on how to modify to run on other computers.



BP106—MODERN OP-AMP PROJECTS \$5.00. Includes a Slide Timer, AF Signal Gen, Misc Pre-amp, Scratch Filter, and much more.



BP59—SECOND BOOK FOR CMOS IC PROJECTS \$5.00. Multivibrators, amplifiers, triggers & gates, special devices including reaction timer, simple electronic organ, and more.

Affordable Prices

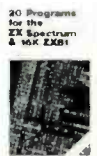

BP128—20 PROGRAMS FOR THE ZX SPECTRUM & 16K ZX81 \$5.75. All programs run on both machines. Include flow charts and info on how to modify to run on other computers.



BP106—MODERN OP-AMP PROJECTS \$5.00. Includes a Slide Timer, AF Signal Gen, Misc Pre-amp, Scratch Filter, and much more.



BP185—ELECTRONIC SYNTHESIZER CONSTRUCTION \$5.95. Shows how to build a monophonic synthesizer, section by section. Replaces BP81.



BP182—MIDI PROJECTS \$6.95. Details of how to interface many popular home computers with MIDI music systems.



BP65—SINGLE IC PROJECTS \$4.95. All projects in this book are based on one IC and are simple to construct. Great way to get started with ICs.



BP49—POPULAR ELECTRONIC PROJECTS \$5.50. A collection of a wide range of electronic projects and circuits for the experimenter.



BP97—IC PROJECTS FOR BEGINNERS \$5.00. Written especially for the less-experienced experimenter. Complete parts layouts and wiring diagrams.



BP80—POPULAR ELECTRONIC CIRCUITS, Book 1 \$5.00. More circuits for hobbyists. Audio, radio, test, music, household and more.



BP98—POPULAR ELECTRONIC CIRCUITS, Book 2 \$5.75. More useful circuits. None of these projects duplicate those in Book 1 of this series.



BP161—INTO THE QL ARCHIVE \$5.95. Presents the powerful database for the Sinclair QL. Step-by-step approach includes practical examples.



BP80—POPULAR ELECTRONIC CIRCUITS, Book 2 \$5.75. More useful circuits. None of these projects duplicate those in Book 1 of this series.

CHECK OFF THE BOOKS YOU WANT

ELECTRONIC TECHNOLOGY TODAY INC.
P.O. Box 240, Massapequa Park, NY 11762-0240

Name _____
Address _____
City _____ State _____ Zip _____

SHIPPING CHARGES IN USA & CANADA
\$0.01 to \$5.00 \$1.00
\$5.01 to \$10.00 \$1.75
\$10.01 to 20.00 \$2.75
\$20.01 to 30.00 \$3.75
\$30.01 to 40.00 \$4.75
\$40.01 to 50.00 \$5.75
\$50.01 and above \$7.00

OUTSIDE USA & CANADA
Multiply Shipping by 2 for sea mail
Multiply Shipping by 4 for air mail
Total price of merchandise \$ _____
Sales Tax (New York State Residents only) \$ _____
Shipping (see chart) \$ _____

Number of books ordered _____
All payments must be in U.S. funds
Total Enclosed \$ _____

H388

But the problem is finding the NiCds. I checked around and found a wholesale electronics place in town that has the sub-C NiCds with the clips. They are \$6.75 apiece plus tax. Right now I need four cells. As I stated before, I checked the other NiCds out and they were not leaking, but they had dates on them of the late 70's, 1977, 1978, and 1979. I checked with the source that I got them from and found out that the dates were the replacement dates of the cells. So they are old but they still seem to charge pretty well.

I read your article and was somewhat confused. The pictures showed Radio Shack NiCds. At the end of your article you stated "Also, I discovered a few surplus mail order houses that sold odd size NiCd cells" but you never did mention names or addresses. Would you give them to me? I would appreciate it greatly. I am shopping for the best prices as I would like to replace all 16 cells. Kind of an expensive proposition if you know what I mean.

—S.M.L., Ames, IA

There are some C and sub-C cells for \$4.25 available from All Electronics, PO Box 567, Van Nuys, CA 91408; Tel. 800/826-5432. Tell them we mentioned them in the letters column.

Colorless letter

My article in the December issue turned out great especially with the addition of color photos of the targets. However, there are errors in the captions of Figs. 4 and 5.

In Fig. 4, the signal Y is not "yellow" as printed, but denotes the luminance signal "Y" as detailed in the text. In Fig. 5, the word "yellow" should of course, be changed to "Y."

I am certain that you will get a few letters from the readership, so I thought I'd give them the answer to their letters ahead of time.

—Adolph A. Mangieri

Thanks for the correction, and you're right about the letters. One thing's for sure our readers are really on the ball. A Pat on the back to those of you who wrote in.

Giving 150 Percent

I have been an electronics experimenter since I was about 12 (1939). In the **Hands-on Electronics**, December 1987, about the article on modulation on page 80—I have had a different theory of what causes modulation.

What it amounts to is, on negative audio modulation the plate or collector RF final voltage is reduced to zero, therefore turning off the source of the carrier. On positive audio modulation positive voltage is added to the plate or collector,

therefore turning off the source of the carrier.

Further, on positive audio modulation, positive voltage is added to the plate or collector, therefore increasing RF power, the only limit here is the amount of power the final can handle without burning out. Thanks for your fine magazine.

—F.J.S., Elcerrito, CA

You're absolutely right. That view of modulation was used to create Taylor super modulators. The idea being that you can actually get over 100% modulation out of a transmitter.

However, there is a legal limit on a super modulator's modulation capacity. That is because their sidebands can have large amplitudes causing them to interfere with the side bands of other stations close to them on the dial.

Rights and Lefts

Concerning the Pirate Radio article in the December 1987 issue: It seems that if the operators of RNI were arrested in international waters, they have a good cause to sue the government and that their rights have been violated. The FCC nor the U.S. government should have jurisdiction in international waters.

It also seems that the FCC should allow the usage of some of "their" unused air space for small local operators with a music format, and low wattage.

Pirate radio changed the whole radio system of Europe, especially France who finally gave in and deregulated and allowed the pirate operators some leeway. In our country of controlled commercial format, I find it appalling, as well as pathetic, that the FCC is so afraid of private broadcast. With a little regulation to keep the psycho-factions from starting a propaganda wave, we, the intellectuals with good taste, could really have something nice. Besides that, if something doesn't give, those hardcore punk broadcasts to Russia might start again. Long live the 1st Amendment. Good luck RAI.

—A.A., Cincinnati, OH

It is interesting to note that the FCC

exists for much the same reason as the maritime services do: traffic control. I think the FCC's job is to set up and police broadcasting standards, not programming ones. If I'm not mistaken they have done just that.

Cars are great, but would you want to drive without stop lights, or the qualifications the Motor Vehicle Department demands of drivers? I wouldn't like to have to listen to a radio station whose sidebands could possibly interfere with all other programming.

If you want to go into a business (and Radio is just that) then why not do it by the book? Surely all intellectuals appreciate order; to wit, is it permissible to yell fire in a crowded movie theater?

Picture Imperfect

We were pleased to find coverage of our color Video Printer in the November issue of **Hands-On Electronics**. However, the Freeze Frame article in the Gadget section mentioned several points which need to be clarified for your readers.

The article incorrectly mentioned a cost per print of \$5, based on the accessory Paper/Ink (20 print) set which is included at no charge with the printer. The standard Paper/Ink set (VY-S100A, Retail \$99.95) makes 100 prints at a cost of less than \$1 per print. The Transparency Paper/Ink set (VY-T50A, Retail \$99.95) makes 50 prints at a cost of less than \$2 per print.

The picture memory noted was incorrect, but that was probably due to an error in a press release. Actual picture memory in the VY-100A is equal to 1,008,000 bytes consisting of 36 RAM ICs of 224,000 bits each. In the VY-50A, 15 RAM ICs are used (about 420,000 bytes), since it memorizes and prints a single field. Composite video input from the Video Output of a camera, VCR, or other video source, is separated into red, green and blue, and converted to a 6 bit (5 bit, VY-50A) digital signal for red, green and blue. The six bits represent 64 levels of each color, so that 262,144 dif-

FREE

HANDS-ON ELECTRONICS 1987 EDITORIAL INDEX FREE COUPON

Return this FREE coupon together with a No. 10 (business-size) envelope on which your name and address appear and to which you have affixed a 22-cent postage stamp and we will send you a copy of the HANDS-ON ELECTRONICS 1987 EDITORIAL INDEX. This is a limited offer so act today!

**THIS FREE OFFER EXPIRES APRIL 30, 1988
AFTER APRIL 30, 1988 THERE WILL BE
A \$1.00 CHARGE.**

FREE

ferent colors can be represented in memory for each pixel (picture element). The digital signals representing each pixel are then stored in RAM. During printing, the RAM is read to make the print. When the memory button is pressed to store a new picture or the power is turned off, prior pictures are cleared.

—Tom Rocoe, Technical Support Manager, Hitachi.

Thanks for the corrections and extra information. It would appear as though even photography will soon be all electronic (which is upsetting to some of our staff). While we're on the subject of Gadget, we hope the readers will like the new Gizmo column replacing it. Please write in and let us know what you think.

A Bit More

I got in on the computer craze when it was in its infancy, upgrading to new and better systems as they came along. Now I've got this great big IBM compatible computer, with multiple hard disks and floppys, controlling nearly every repetitive operation that you could imagine. I've even installed the Voice Synthesizer project that was presented in your December 1986 issue. However, I now wish to add a voice recognition system to my hookup. I've searched high and low, but thus far have been unable to locate a schematic diagram for such a circuit. Have you ever printed or plan to print such a project, or do you know of any other publication that has.

—Louis A. Sullivan, National City, MI

You got a good question there Louis, and you're not alone. I too am interested in a voice recognition system for my computer, but, much to my dismay, simply can't afford such a high-priced toy. Anyway, Louis, the answer to your question is no! But stay tuned, something may turn up in the future. Until then, why not try some of the other computer re-

lated projects that so often appear in these pages.

Hats Off to Hands-On

I never trusted product reports in magazines, because advertisers pay a part of your expenses. It was with a bit of apprehension that I decided to try the ByteSize Calculator software that you raved about in the February, 1987 issue. Gee, it was good. Thanks for an honest report.

—D.C., Cherry Hill, NJ

The Editor re-read the article and the "raving" part was actually removed when the two-page story was assembled. We ran out of space for the "raving" paragraph at the end. Nevertheless, we talked about what the program can do, and the features we found in ByteSize Calculator did all the selling. When a product is good, we take our hats off to it!

Help!

Having read the Electronic Dazer article, which appeared in your November 1987 issue, I decided to put one together for a lady friend of mine, to waylay her fears about traveling the streets of New York late at night. However, as I began collecting the necessary parts, I found it impossible to get a hold of the MJE731 transistor (Q2 in the schematic). Would you please tell where I can get one of the little monsters, or at least an ECG replacement.

—Alton Ripley, Fleetwood, NC

Well Alton, first off let me say that the problem you've been having in locating that transistor was brought about by a typographical error. The part number should have read MJE371. The MJE371 is available from Jameco Electronics, 1355 Shoreway Road, Belmont, CA 94002; 415/592-8097. And there is also an Sylvania replacement for it, the ECG185. Sorry for any inconvenience that the error may have caused you.■

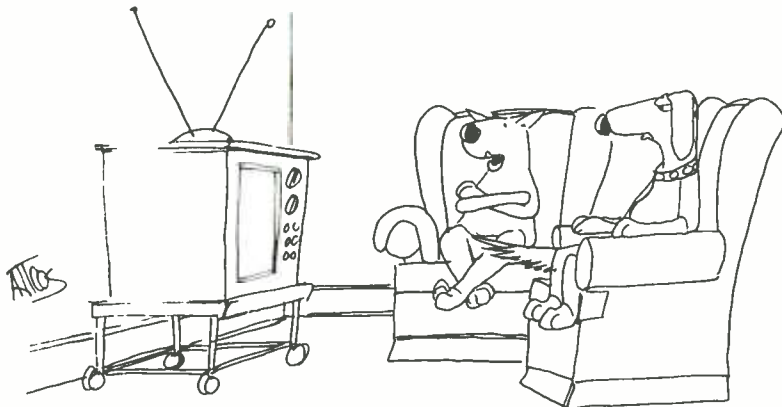

"By the way, I hate it when you change the channels with your tail."

Free Famous hi-tech catalog



A very special guide to what the exciting world of computer and electronics kit-building can do for you.

The informative Heathkit Catalog shows you more than 450 exciting electronic products that will challenge, instruct, and entertain you. You'll find countless kits that you can build and enjoy, from computers and robots to color tv's and a variety of home products. And each is backed by our years of experience and our promise, "We won't let you fail!"



IBM-PC Compatible Expandable Computers



HERO® 2000 Educational Robot and Courseware



Precision Test Instruments

Electronic Keyless Doorlock



PackKit Multi-Mode TNC



Send NOW for your FREE Heathkit Catalog.

Send to: Heath Company, Dept. 107-612
Benton Harbor, Michigan 49022

Name _____

Address _____

City _____ State _____ Zip _____

A subsidiary of Zenith Electronics Corporation CL-784R3

Heathkit
Heath
Company

NEW PRODUCTS

Tinner/Cleaner

The Multicore TTC1 Tip Tinner/Cleaner is a small block of electronics-grade solder powder and chemicals compacted into the shape of a thick disc. It is packaged in a metal container complete with lid and self-adhesive pad on the underside so that it can be easily attached to any convenient surface.

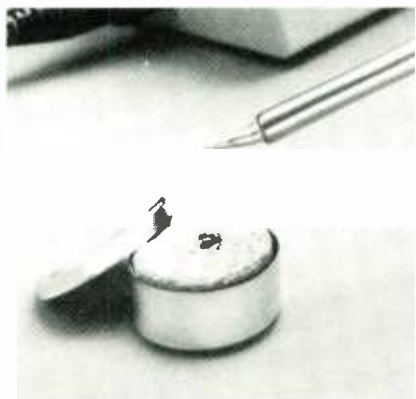

CIRCLE 79 ON FREE INFORMATION CARD

A single wipe of the iron tip across the TTC1 block immediately cleans, wets and tins the tip. It will remove even the stubborn tin/iron intermetallic layer that forms on iron plated tips and resists rosin-based fluxes. The chemicals it contains are non-corrosive and have a low evaporation point so that nothing except solder remains on the tip after tinning.

The price is \$3.95, available off-the-shelf from authorized distributors. For complete information write, Multicore Solders, Cantiague Rock Road, Westbury, NY 11590; Tel. 516/334-7997.

Freewheeler Cordless Moto-Tool

Dremel's new Freewheeler cordless Moto-Tool frees do-it-yourselfers to use the versatile Moto-Tool for even more home, auto and outdoor projects.

The cordless Moto-Tool can use all the accessories and attachments available for the 120V corded Moto-Tool. The two-speed tool uses a 6.0-volt high-torque motor powered by five NiCad batteries. Operating speeds are 15,000 and 20,000 RPM. An LED indicates when the tool is charging.

Dremel's Freewheeler cordless Moto-tool is available in tool-only and kit forms.



CIRCLE 82 ON FREE INFORMATION CARD

The model #850 includes the Freewheeler Cordless Moto-Tool and charger. The model #8500 includes the tool, charger stand and 30 accessories. A keyless chuck is included with the #850 as a special introductory offer—a \$5.00 retail value—and is available as standard with the #8500 kit.

Suggested retail price for the #850 Freewheeler will be \$59.99; suggested price for the #8500 Freewheeler kit will be \$79.99.

For more information contact Dremel, 4915 Twenty-first Street, Racine, WI 53406.

Panel Meter Catalog

Simpson Electric company released a 28-page distributor stock catalog. It's an ideal reference tool for the design engineer selecting panel meter components. Both analog and digital instruments are featured in a multitude of styles, sizes, and ranges to meet most applications, and they are available for delivery from stock.

The catalog designed for easy use and



CIRCLE 49 ON FREE INFORMATION CARD

readability, contains complete specifications and line illustrations. The Simpson panel meter catalog is free for the asking from electronic distributors or by writing the Simpson Electric Company, 853 Dundee Avenue, Elgin, Illinois, 60120-3090; Tel. 312/697-2260.

Collector's Edition Radio

The cathedral-styled, old-fashioned Collector's AM/FM Radio offers yesterday's memories with modern, up-to-date technology. You won't believe the sound!

The hand crafted wood and wood veneer cabinet features the traditional handloom grill cloth, antiqued rotary tuning dial, cast metal dial plates and the finish is a rich, high-gloss brown. Cushioned feet protect furniture.



CIRCLE 86 ON FREE INFORMATION CARD

Other plus features include built-in AM/FM antennas and a side insertion cassette deck (mono) that has a single dual-function cassette control button for fast forward and eject. Powerful 4-in. speaker. UL approved. 11-3/4-in. wide, 8-1/2-in. deep, 12-1/2-in. high.

Only \$79.95 plus \$6.00 each for shipping and handling. Send check or money order to: Collectors Corner, Suite 120, Blake Building, P.O. Box 1378, Gilroy, CA 95021-1378.

Soldering Iron Tips

A broad line of iron-plated tips for use with their line of Antex soldering irons to prevent the copper deteriorating under heavy electronic production applications

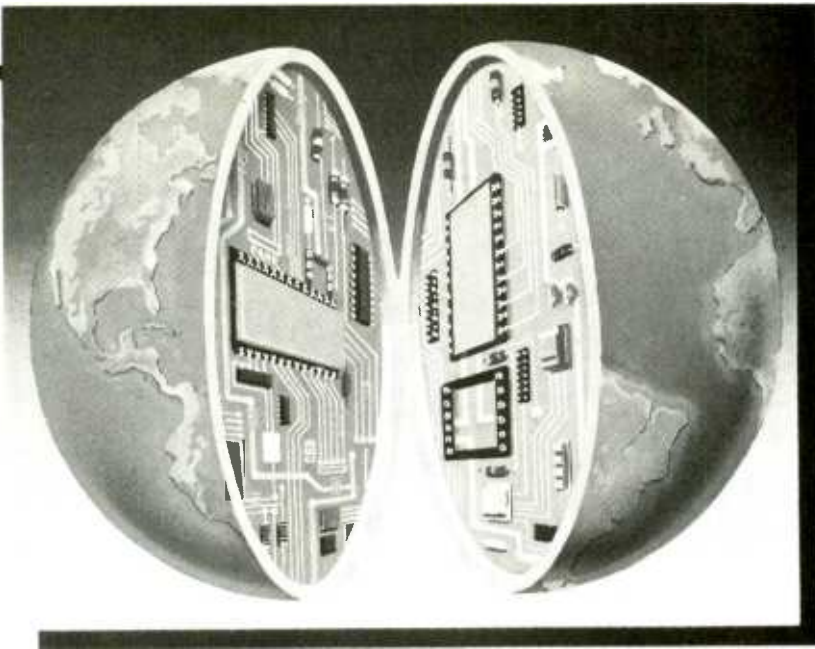

can even earn your Associate in Applied Science Degree in Electronics Engineering Technology. Of course, you set your own pace, and, if you ever have questions or problems, our instructors are only a toll-free phone call away.

The first step is yours.

To find out more, mail in the coupon below. Or, if you prefer, call toll-free 1-800-321-2155 (in Ohio, 1-800-523-9109). We'll send you a copy of CIE's school catalog and a complete package of enrollment information. For your convenience, we'll try to have a representative contact you to answer your questions.

CIE MAKES THE WORLD OF ELECTRONICS YOURS.

Today's world is the world of electronics. But to be a part of it, you need the right kind of training, the kind you get from CIE, the kind that can take you to a fast growing career in business, medicine, science, government, aerospace, communications, and more.

Specialized training.

You learn best from a specialist, and that's CIE. We're the leader in teaching electronics through independent study, we teach only electronics and we've been doing it for over 50 years. You can put that experience to work for you just like more than 25,000 CIE students are currently doing all around the world.

Practical training.

You learn best with practical training, so CIE's Auto-Programmed® lessons are designed to take you step-by-step, principle-by-principle. You also get valuable hands-on experience at every stage with sophisticated electronics tools CIE-designed for teaching. Our

4K RAM Microprocessor Training Laboratory, for example, trains you to work with a broad range of computers in a way that working with a single, stock computer simply can't.

Personalized training.

You learn best with flexible training, so we let you choose from a broad range of courses. You start with what you know, a little or a lot, and you go wherever you want, as far as you want. With CIE, you



AHO-77

CIE Cleveland Institute of Electronics

1776 East 17th St., Cleveland, Ohio 44114

YES! I want to get started. Send me my CIE school catalog including details about the Associate Degree Program. I am most interested in:

- | | |
|--|---|
| <input type="checkbox"/> computer repair | <input type="checkbox"/> television/high fidelity service |
| <input type="checkbox"/> telecommunications | <input type="checkbox"/> medical electronics |
| <input type="checkbox"/> robotics/automation | <input type="checkbox"/> broadcast engineering |
| <input type="checkbox"/> other _____ | |

Print Name _____

Address _____ Apt. _____

City _____ State _____ Zip _____

Age _____ Area Code/Phone No. _____

Check box for G.I. Bulletin on Educational Benefits

- Veteran Active Duty

MAIL TODAY!

CIRCLE 10 ON FREE INFORMATION CARD

AMAZING SCIENTIFIC & ELECTRONIC PRODUCTS

PLANS—Build Yourself—All Parts Available In Stock

- LC7—BURNING CUTTING CO₂ LASER \$ 20 00
- RUB4—PORTABLE LASER RAY PISTOL 20 00
- TCC1—3 SEPARATE TESLA COIL

PLANS TO 1.5 MEV 20 00

- IOG1—ION RAY GUN 10 00
- GRA1—GRAVITY GENERATOR 10 00
- EML1—ELECTRO MAGNET COIL GUN/LAUNCHER 6 00

KITS

- MFT1K—FM VOICE TRANSMITTER 3 MI RANGE 49 50
- VMPMSK—TELEPHONE TRANSMITTER 3 MI RANGE 39 50
- BTC3K—250.00 VOLT 10-14" SPARK TESLA COIL 199 50
- LHC2K—SIMULATED MULTICOLOR LASER 39 50
- BLS1K—100,000 WATT BLASTER DEFENSE DEVICE 69 50
- ITM1K—100,000 VOLT 20" AFFECTIVE RANGE INTIMIDATOR 69 50
- PSP4K—TIME VARIANT SHOCK WAVE PISTOL 59 50
- PTG1K—SPECTACULAR PLASMA TORNADO GENERATOR 149 50
- MVIK SEE IN DARK KIT 199 50

ASSEMBLED

- PG70H—MULTICOLOR VARIABLE MODE PLASMA GLOBE 7 199 50
- BTC10—50,000 VOLT—WORLD'S SMALLEST TESLA COIL 44 50
- LGU40—1MW HIGH VOLT RED LASER GUN 199 50
- TAT20 AUTO TELEPHONE RECORDING DEVICE 24 50
- GPV10—SEE IN TOTAL DARKNESS IR VIEWER 349 50
- LIST10—SNOOPER PHONE INFINITY TRANSMITTER 169 50
- IPG70—VISIBLE PAIN FIELD GENERATOR—MULTI MODE 74 50

* CATALOG CONTAINING DESCRIPTIONS OF ABOVE PLUS HUNDREDS MORE AVAILABLE FOR \$1.00 OR INCLUDED FREE WITH ALL ABOVE ORDERS

PLEASE INCLUDE \$3.00 PH ON ALL KITS AND PRODUCTS PLANS ARE POSTAGE PAID. SEND CHECK, MO, VISA, MC IN US FUNDS

INFORMATION UNLIMITED
P.O. BOX 716 DEPT. HO AMHERST, NH 03031



CIRCLE 44 ON FREE INFORMATION CARD

are available from M.M. Newman Corporation of Marblehead, Massachusetts.

Antex Iron Plated Slide-On Tips feature a .005-in. thick smooth, nonporous iron coating to prevent the highly conductive copper from breaking down after repeated soldering. The entire tip is then nickel plated for easy wetting and protection against rust.

Available in over 40 different shapes and sizes including various spades, chisels, needles, cones, pyramids, and blanks, Antex Iron Plated Slide-On Tips fit directly over the heating element; there are no threads to bind or screws to freeze.

Antex Iron Plated Slide-On Tips are priced from \$1.20 (list) each and will only fit the Antex line of precision miniature soldering irons. Literature is available on request.

For more information contact M.M. Newman Corporation, Charles F. Loutrel, Sales Manager, 24 Tioga Way, P.O. Box 615, Marblehead, MA 01945; Tel. 617/631-7100.

24-Bit Digital I/O Interface

MetraByte's uCPIO-12 24-bit parallel digital I/O board provides a simple and inexpensive means of interfacing an IBM PS/2 Model 50, 60 or 80 in a wide variety of digital-I/O applications. In addition to the 24 TTL/NMOS/CMOS compatible data lines, the uCPIO-12 offers full access to the PS/2's interrupt lines, and allows external connection to the computer's power supplies. For applications with other than logic-level signals, Metra-Byte offers the following signal conditioning boards: SRA-01 8-channel Solid-State I/O module board; ERA-01 8-channel electro-mechanical relay board; ERB-24 24-channel electro-mechanical relay board. The uCPIO-12 can also be easily interfaced to industry standard PB-16A and MSS-16 solid-state I/O module racks.

The 24 Digital I/O lines are provided by an Intel 8255 programmable peripheral interface. The 8255 divides the 24 bits into three separate 8-bit ports (PA, PE, and PC), which may be set independently as inputs or outputs. In addition to operating as a standard 8-bit data port, the third

port (PC) can be subdivided into two 4-bit ports, or can be set to provide handshaking signals for the other two 8-bit ports.

In keeping with the design specifications for the PS/2 adapter cards, there are no dip switches or user adjustments on the uCPIO-12. Base address and interrupt level selection are performed by the PS/2 set-up program.

Along with the uCPIO-12, MetraByte supplies a complete users manual, and a 3-1/2-in. disk with all required installation and operation software. The board has been designed to plug into any available Micro-Channel expansion slot within the computer.



CIRCLE 45 ON FREE INFORMATION CARD

The uCPIO-12 can easily be configured to interface to BCD equipment, Monitor switches and contact closures, control relays, etc. Applications for the board include equipment control, key-pad scanning, printer interface, motor control, intruder alarms, energy management, interface to custom circuitry plus many, many more.

Pricing is as follows: uCPIO-12 \$299.00; SRA-01 \$109.00; ERA-01 \$135.00; ERB-24 \$395.00; STA-U, Screw terminal board \$115.00.

For more information contact Metra Byte, 440 Myles Standish Blvd., Taunton, MA 02780.

Economical Multi-Outlet Protectors

Now you can have economical surge protection for your computers and other valuable electronics equipment by simply retrofitting any of your existing duplex wall outlet.

Model SP-300 upgrades your standard

CABLE-TV



signal remover
50dB NOTCH FILTER

Any* signal coming in on your cable can be completely "removed" with this powerful filter. Particularly useful on "pay" channels. Also can be used to eliminate any over-the-air signal which prevents normal reception. The filter's external adjustments allow precise tuning to any frequency required.

*AVAILABLE FOR THE FOLLOWING CHANNELS:
MODEL 26 - For any channel between 2 and 6 (Tuning range 54 - 108 Mhz)
MODEL 713 - For any channel between 7 and 13 (Tuning range 174 - 216 Mhz)
MODEL 1422 - For any channel between 14(A) and 22(I) (Tuning range 120 - 174 Mhz)

★ ONLY \$30 EACH ★ 30 DAY FREE TRIAL ★
To order, send \$30 check or money order. Specify Model. If not completely satisfied, simply return within 30 days for a full and speedy refund.

★ All models in stock ★ One year warranty
★ Fast, free delivery ★ Quantity discounts to 50%

STAR CIRCUITS/DEPT. H
P.O. BOX 8332, PEMBROKE PINES, FL 33084

COMPUTER
MART



"This micro-computer has an excellent memory and only costs peanuts to run!"

EIA/CEG AUGMENTS DIGITAL AND MICROPROCESSOR COURSE HIGH TECH PARTS KITS NOW AVAILABLE

The members of the Electronic Industries Association Consumer Electronics Group (EIA/CEG) through the Product Services Committee, has marketed the illustrated parts kit for vocational schools, educators and technicians. This is the same material used in the Digital and Microprocessor Course during EIA's summer workshop programs. These workshops are organized by the Consumer Electronics Group and co-sponsored by national service organizations and state departments of vocational education.

Parts and components are contained in a lightweight tool box with individual compartments. It includes a breadboard, power supply, pre-dressed jumpers, resistors,

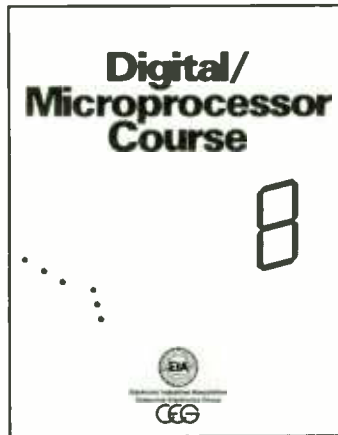

capacitors, and integrated circuits to perform all digital exercises 1 through 25 of the Digital/Microprocessor course book listed in the table of contents. Some parts have been included for the microprocessor section but other components will have to be acquired (as listed in the Introduction to Exercises 26-31).

Individual and classroom size quantities are available at the following cost: quantities 1-9, \$69.95 each, quantities 10-19, \$67.95 each, and for quantities 20 or more, \$64.95 each (cost includes shipping and handling). The kits will also include the Digital and Microprocessor Course book. Additional books are available at the cost of \$2.00 per copy.

PLEASE COMPLETE ORDER FORM FOR PARTS KITS AND BOOKS

Send to: EIA/CEG, Department PS, P.O. Box 19100, Washington, D.C. 20036

ORDER FORM

Parts Kit	Quantity	Amount	Total
1-9	_____	\$69.95 each	_____
10-19	_____	\$67.95 each	_____
20 or more	_____	\$64.95 each	_____
Additional Digital/Microprocessor Course Books		\$2.00 per copy	_____
Total Amount Enclosed			_____

Name																								
Title																								
Firm																								
Address																								
City													State			Zip								

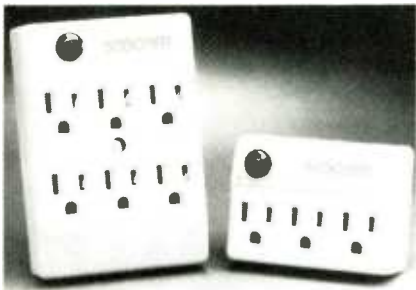

CIRCLE 42 ON FREE INFORMATION CARD

wall outlet to three protected outlets and guards against voltage spikes up to 6000 volts, with a fast clamping time of less than 5 nanoseconds. Model SP-600 upgrades your standard duplex wall outlet to six protected outlets and guards against voltage spikes up to 4500 volts, with a fast clamping time of less than 10 nanoseconds. Installation is fast and easy. Model SP-300 simply plugs into any wall outlet. Model SP-600 simply replaces the cover plate on any standard duplex wall outlet.

Because voltage spikes occur daily, from the power company or your own internal appliances, fluorescent lights or other electrical equipment, valuable stored data can be wiped out unless properly protected. These destructive power surges, spikes and brownouts also shorten the useful life of your electronics equipment. Model SP-300 and Model SP-600 Surge Protectors suppress these damaging fluctuations without interfering with normal current flow. And, an indicator lamp lets you know that the internal filter network is operational.

Suggested retail price for the three-outlet Model SP-300 Surge Protector is \$15.95. Model SP-600 Surge Protector, with its six outlets, is slightly higher in cost at \$19.95.

For additional information, call or write Scooter Products, Ohm Electronics, Inc., 746 Vermont St., Palatine, IL 60067; Tel. 800/323-2727. In Illinois Tel. 312/359-6040.

Multitasking Computer

Professional System/One (Pro/One) Model 35 is the ideal flexible choice for the home or small business.

Model 35 gives you across-the-board IBM-compatibility. Its integrated functions design means you can use telecommunications facilities, share information, and print out reports and data without sacrificing quality or capability—and without spending extra for optional or adaptive features. With Pro/One Model 35, you can just plug in your peripheral devices, turn on your power and begin work.

Pro/One Model 35 also includes a variety of features that cannot be found in any other computer in its class—or even in PCs selling at much higher price levels.

Chief among them is a dual speed capability that allows you to run both the new higher speed 3.5-inch disks and existing 5.25-inch software that may require slower speeds. You also have the option of built-in drives for both 5.25-inch disks and 3.5-inch disks in any configuration you want.

Additionally, Model 35 has six full-size expansion slots, giving you more than twice the capacity for add-on features than you'll find in competing and even higher priced computers. And it offers you more speed than other comparable computers and more than twice the data storage capacity.



CIRCLE 98 ON FREE INFORMATION CARD

Model 35 includes enhanced state-of-the-art graphic capabilities. Your color displays will be clean and brilliant. Two hundred and fifty-six colors can be seen on the screen at any one time, from a palette of more than 256,000 shades. Monochrome displays are equally sharp with a range of up to 64 shades or gray. And Pro/One Model 35 comes fully equipped with built-in surge protection and EMI filters, so your protection is already provided.

Model 35 also offers you what no other computer can. As a special feature, it comes with Profit Technology's exclusive BreakThrough Mentor software, a real-time multi-tasking package that enables you to display five or more programs on the screen simultaneously, and to perform interrelated tasks.

Mentor also serves as a unique information delivery-system that can flash up key points of information from its self-contained business library and display them in sequential order in up to five windows on the screen.

Profit Technology backs its commitment with nationwide service and a two-year Warranty that exceeds industry standards. Extended Maintenance Agreements are available from authorized representatives in more than 500 locations nationwide. You're assured of having your service requirements met on-site and

at recognized centers.

For more information contact Profit Technology Inc., 17 Battery Plaza, 14th Floor, New York, NY 10004.

Fast ATE Multimeter

Speed plus Mate capability make the Solartron 7061 a strong contender for military ATE applications, such as the ADINTS (Air Defense Initial Navigation Test System) for which it has just been selected. The new version of the 7061 fully implements the CITL language specified by the Mate standard and does not require the use of any external hardware adapters.

The 7061 can capture 1500 readings-per-second into an internal memory of 8000 readings, output 300 readings per second over the IEEE bus, respond within 3 ms to an external trigger, and signal an alarm condition in 1 ms. Measurements may be tracked until a defined input level is detected and tracking continues until a specified number of results have been collected. Memory then contains a record of measurements, before and after the desired event. An extensive math and statistics program can then process the output results in any desired format.

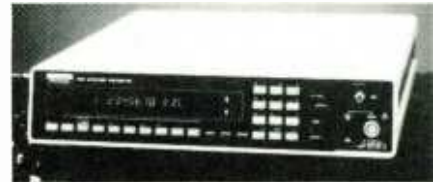

CIRCLE 96 ON FREE INFORMATION CARD

A built-in scanner option adds 16 channels in addition to the main and reference channels. Each channel can be set to any of six measurement functions, with specified delay, resolution, and set-measurement processing. All channels may be scanned in any sequence at a rate of 300 channels per second.

The price of the model 7061 with Mate option is \$3990. For further information, please contact Solartron Instruments at their new location: Solartron Instruments, 20 North Avenue, Burlington, MA 01803; Tel. 617-229-4825.

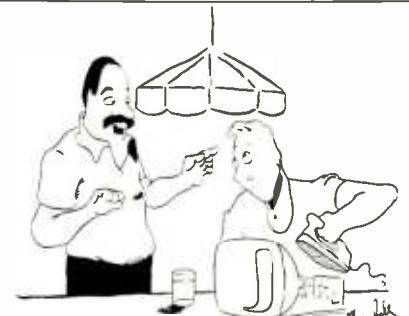

"Just a thought; try a soldering iron."

Tracking Generator

This unit allows swept RF measurements to be made directly, thereby eliminating the need for an external RF detector. The Tracking Generator's span width is selectable from 20 kHz to 10 MHz in a 1-2-5 sequence at output levels of -50 dBm or -15 dBm. That allows the test set to make measurements with a dynamic range up to 90 dB.



CIRCLE 94 ON FREE INFORMATION CARD

The standard features for the FM/AM-1200S include: FM/AM Signal Generator; 2- μ V Receiver for FM/AM/SSB; Duplex Generator; RF and Audio Frequency Error Meter; Modulation Meter; RF Wattmeter; SINAD and Distortion Meter; 1 kHz and Variable Frequency Audio Sources; Oscilloscope; Spectrum Analyzer; 0.2 PPM TCXO; and Internal Rechargeable Battery.

For more information, contact IFR Systems, Inc., 10200 West York Street, Wichita, KS 67215-8935; Tel. 316/522-4981.

Voice Recognition System

Having a talking and listening computer is now an affordable dream. A low-cost version of the original Voice Master, the Covox Voice Master Junior, is a self-contained micro-sized speech digitizer and voice recognition hardware device that plugs into the joystick port of popular 8-bit computers.

The custom style case with built-in microphone allows for either hands-free desk-top use, or hand held, whichever is convenient. Speech or other sounds are recorded into memory which can be saved to disk. Digitized speech can be incorporated in Basic programs and played back without the Voice Master Junior attached.

For word recognition, recognition templates are made. Up to 32 words or phrases can be utilized at a time with others accessible from disk. Wedged into Basic are new command statements which make the Voice Master Junior easy to use. Bonus software includes the Covox Composer program, which lets the user write and compose music by merely whistling a tune. The score can be edited, saved, or printed out.



CIRCLE 92 ON FREE INFORMATION CARD

If Voice Master Junior itself isn't amazing enough, then its suggested retail price of \$39.95 should be, which includes software and manual. Available for Apple II+, IIc, IIe IIgs (DOS 3.3 only), Commodore 64, 128 (in 64 mode), and Atari 800, 800XL, 65XE, 130XE. Contact Covox Inc., 675 Conger Street, Eugene, OR 97402; Tel. 503/342-1271.

Cleaner and Burnisher Kit

The Superbrush Kit is a handy tool for home, office, workshop or camp. It contains one superbrush holder with a coarse grade FybRglass refill installed, and two extra refills made of stainless steel wire and fine grade FybRglass. The refills are all interchangeable in the holder and each gives a different cleaning action, ranging from a fine polish to a coarse, sandpaper finish.

The Superbrush may be used to clean, burnish or polish a variety of surfaces. Some of its many uses include removing



CIRCLE 100 ON FREE INFORMATION CARD

Put Professional Knowledge and a COLLEGE DEGREE in your Technical Career through HOME STUDY

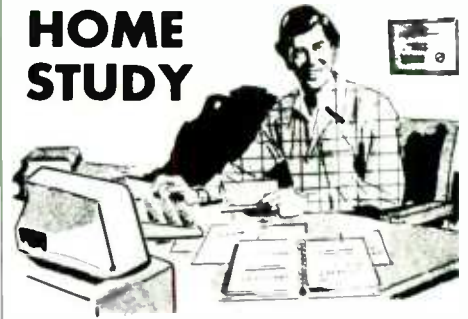

Add prestige and earning power to your technical career by earning your Associate or Bachelor degree through directed home study.

No commuting to class. Study at your own pace, while continuing on your present job. Learn from easy-to-understand lessons, with help from your Grantham instructors when you need it.

Grantham College of Engineering is a specialized institution catering to adults who are employed in electronics and allied fields such as computers. These fields are so enormous that opportunity to *move up* is always present. Promotions and natural turn-over make desirable positions available.

An important part of being prepared to *move up* is holding the proper college degree, but the essential part is *really knowing your field*. Grantham offers two B.S. degree programs — one with major emphasis in *electronics* and the other with major emphasis in *computers*. Both programs are offered by correspondence.

Write for our free catalog (see address below) or telephone us at (213) 493-4421 (no collect calls) and ask for our "degree catalog."

Accredited by
the Accrediting Commission of the
National Home Study Council

GRANTHAM
College of Engineering
10570 Humbolt Street
Los Alamitos, CA 90720

MARCH 1988

rust spots, cleaning electrical contacts, roughing surfaces before using epoxy or glue, cleaning lead in stained glass, deburring small metal parts, cleaning stains off pots and pans, and a number of other household and office uses.

The tool has a twist tip control so that the entire length of the refill can be used, and replacement refills are available in packs of two.

For more information contact The Eraser Company Inc., PO Box 4961, Oliva Drive, Syracuse, NY 13221; Tel. 315/454-3237.

Hi-Capacity Batteries

The Excell Hi-Capacity AA rechargeable battery is a major technological breakthrough. It is the first AA NiCad rechargeable battery to provide up to 50% higher capacity than other cells on the market.

Battery users will find the Excell AA Rechargeable batteries run up to 50% longer between charges, and last up to 50% longer than the rechargeables they are currently using. Many users of photographic, portable electronic, and toy equipment will find the Excell rechargeable batteries perform as well as some disposable batteries.

Excell AA rechargeable batteries provide up to 50% more flashes, more music, more play time, yet are priced approximately the same as lower capacity batteries currently on the market. Other AA Rechargeables are only 450 to 500MAH. Excell AA's are 750MAH. Excell Batteries are backed by a 5 year/1000 charge warranty.



CIRCLE 84 ON FREE INFORMATION CARD

The Excell Quick Charger completes the high-performance line. It charges 2 or AA or AAA batteries in only 5 hours, 2 or 4 AA Hi-Capacity in 7.5 hours, 2-9V in 15 hours. The entire Excell Battery line is packaged for quick sell-through in high-impact gold foil blister packs, which stand out and tell the Excell story.

For further information, write or call:

Al Hyman, Argraph Corporation, 111 Asia Place, Carlstadt, NJ 07072; Tel. 201/939-7722.

Series-5 Control Amplifier

The new preamp, designated the CA-5AII, features defeatable tone controls, two-way tape-dubbing facilities and a selectable-gain MC input as well as refined circuitry.

Thanks to elegantly simple topology, the CA-5AII's phono preamplifier/equalizer and line amplifiers produce good sound before the application of feedback. The modest amount of feedback that is then applied only serves to further enhance the circuit's sound quality and overall gain.



CIRCLE 88 ON FREE INFORMATION CARD

In the phono equalizer and line amplifiers, low-noise field-effect transistors form a balanced input that provides stable gain and an unusually high overload point. The differential FET input is followed by a pair of bipolar transistors that complete the gain stage.

The output circuit uses Nakamichi's Complementary-Symmetry Emitter-Follower with Current Bootstrap. With this approach, the signal passes through only one set of base-emitter junctions (rather than two) so distortion is less and dynamic range is enhanced.

Furthermore, Nakamichi's configuration has lower output impedance and higher output current than conventional emitter followers and it is stable regardless of load impedance. That permits the stage to drive the equalization and tone-control networks at all frequencies and levels with negligible distortion for the human ear.

The moving-coil (MC) preamplifier handles extremely small signals. Here the problem is not input overload, but input noise so they used a single-ended configuration with parallel-connected Super Hgm Ultra-low-noise FETs. Theoretically, a single-ended configuration has 3-dB less noise than a differential input, and parallel connecting a pair of transistors further improves the noise figure.

MC preamplifier gain can be set at 36, 30 or 24 dB by a rear panel switch—a feature not provided on the original CA-5. MC input impedance is 100 ohms; precision resistors supplied with each preamp can be installed on the circuit board to reduce the input impedance to 50, 30, 20, 10, or 3 ohms to match any special cartridges you may have.

The moving-magnet (MM) input impedance is 50k ohms and the switch that adjusts MC preamplifier gain serves to

change the capacitive load on an MM cartridge to 100, 200 or 300 pF. The Nakamichi CA-5AII Control Amplifier carries a suggested retail price of \$995. In Canada, the CA-5AII is available at a suggested retail price of \$1,695.

For more information, in the United States, contact Nakamichi America Corporation, Marketing Dept., 19701 S. Vermont Ave., Torrance, CA 90502.

Four Channel RS-232 to RS-422 Converter

The four-channel Model 422CFC converts Transmit Data and Request-to-Send from RS-232 to the RS-422 standard.

The RS-232 connection is a female DB25S connector which also conforms to the new RS-530 interface standard.

This unit requires 12 volts DC at about 100 ma., and an optional power supply is also available.



CIRCLE 90 ON FREE INFORMATION CARD

The Four Channel RS-422 converter retails at \$69.95. The Model 422PS Power Supply is \$14.95.

Also available from B & B Electronics is a version of the RS-422 Converter with a female DB25S connector for the RS-232C interface, and a male DB25P connector for the RS-422 interface. The Model 422FCR a Reversed RS-422 converter sells for \$69.95.

For more information, send for Catalog #10, B & B Electronics, 1500P Boyce Memorial Drive, PO Box 1040, Ottawa, IL 61350. Tel. 815/434-0846. ■



"It's the plan kit you ordered from Japan."

BOOKSHELF

Compact-Disc Troubleshooting and Repair Guide By Neil R. Helen and Thomas Bentz

This book discusses much more than how to repair a compact disc, it is a concise and complete introduction to the field of digital signal processing and compact disc players. The book describes in detail the hardware and technology involved in this expanding field.

The book clearly explains the audio signal and its problems, discusses basic digital theory, and presents hardware, lasers, circuits, adjustments, tracking and more. Its 208 pages include charts, tables and illustrations useful for beginning and experienced audio/video technicians



CIRCLE 97 ON FREE INFORMATION CARD

and hobbyists.

Topics covered include: the audio signal and signal processing; basic digital theory, the CD modulation system, construction of the compact disc, the laser pickup, detailed CD circuit descriptions, adjustments and

troubleshooting, the CD-ROM, glossary of terms.

Compact Disc Troubleshooting & Repair Guide, No. 22521, retails for \$19.95 and is available at bookstores, electronics distributors or direct from the publisher by calling 800/428-SAMS or by writing to Sams, 4300 West 62nd Street, Indianapolis, IN 298-5400.

Using Microsoft Works By Ron Mansfield

Microsoft Works, the popular integrated program for the Apple Macintosh, combines word processing, database, spreadsheet, and communications into one easy-to-use package. *Using Microsoft Works*, makes this program easy to learn and

MCM Electronics

Quality is not an idle term at MCM! Every incoming shipment is checked and re-checked by our QC Department to see to it that you never receive a defective part.

Service is something you can always count on, too. Our experienced Sales Representatives and Electronic Technicians are standing by to take your orders and answer your questions quickly and courteously.

Selection helps us stand heads above the competition with nearly 10,000 in-stock items (including many hard-to-find products) that can be shipped to you immediately.

Discover the MCM difference! Order your copy of MCM's new Catalog today. It's a decision you'll never regret!

**For your FREE copy, call TOLL-FREE!
1-800-543-4330**

In Ohio, call 1-800-762-4315

In Alaska or Hawaii, call 1-800-858-1849



MCM ELECTRONICS
856 E. CONGRESS PARK DR.
CENTERVILLE, OH 45439
A PREMIER Company

SOURCE NO. HO-12

MCM ELECTRONICS

CIRCLE 11 ON FREE INFORMATION CARD

easier to use.

Combining Quick Start tutorials with more advanced tips and techniques, *Using Microsoft Works* explains both basic and advanced features of Works' four applications. This book also contains a review of basic Macintosh techniques, a hardware and software troubleshooting guide, and information on exchanging data between applications. Readers will learn to use all four Works modules: Word Processing—open word-processing windows, use

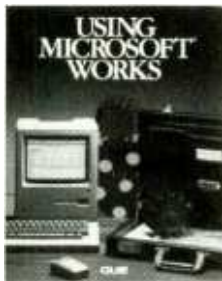

CIRCLE 95 ON FREE INFORMATION CARD

different formats and fonts, work with multiple documents, and integrate graphics with text; Spreadsheet—create spreadsheets, select printing setups, manipulate cells, and produce effective graphs; Database—set up a database, enter and save data, search for data, and create and print reports; Communications—send and receive text, store and print complex files, and automate log-on procedures.

This book is available for \$18.95 in most bookstores and computer stores. To order directly from Que, call 800/428-5331 and ask for a sales representative.

44 Power Supplies for Your Electronic Projects By Robert J. Traister and Jonathan L. Mayo

This is a sourcebook that will make a valuable addition to any electronics library. For the novice looking for a practical introduction to power-supply technology, an advanced hobbyist in search of power supply designs for specific applications, or a technician in need of a quick reference to power supply circuitry, *44 Power Supplies For Your Electronic Projects* is a first-rate do-it-yourself reference.

The book contains a complete introduction to power supply theory and design. The directions are clear and concise as are the illustrations. Covered are all necessary instructions needed to build power-supply circuits using breadboards, perfboards, and even printed circuits of individual



CIRCLE 99 ON FREE INFORMATION CARD

design. The authors provide full details on all of the popular types of power supplies currently in use; transformers—an integral and often overlooked part of a power supply; voltage regulators—a key element in power supply design; affordable sources for power supply components as well as methods for cross-referencing and storing components; a practical perspective on project construction including suggestions on parts substitution and safety; up-to-date information on integrated circuits covering their composition and suggestions for handling them during circuit construction; designs for voltage multipliers; instructions for building variable-voltage supplies that can be adjusted to provide a variety of voltages; easy-to-use listings of schematic symbols, wire sizes and current ratings; and resistor color codes.

The projects range from the very simple—a half-wave supply and a Zener-diode regulator—to advanced digital designs including a 12-volt tracking regulator, and three-terminal regulator supply.

44 Power Supplies For Your Electronic Projects, Order No. 2922, contains 256 pages, costing \$15.60 in paperback, available from Tab Books Inc., PO Box 40, Blue Ridge Summit, PA 17214; Tel. 717/794-2191.

WordPerfect Advanced Techniques By Daniel Rosenbaum

WordPerfect is one of the most versatile, powerful word-processing programs available. Many of its advanced features were essentially inaccessible to most users until the release of Que's latest book, *WordPerfect Advanced Techniques*. This easy-to-follow text shows WordPerfect users how to do all the things they couldn't do before.

WordPerfect Advanced Techniques reviews WordPerfect basics, provides troubleshooting tips, and explores the program's advanced features. The timesaving techniques and special applications presented in this book, including comprehensive coverage of

the WordPerfect Library, turn WordPerfect into one of the most versatile word-processing programs available.

WordPerfect Advanced Techniques will show readers how to alter the program's default settings and choose from a number of start-up options, manipulate individual columns of text, create macros to automate complicated procedures, efficiently select, sort, and merge data, exchange data with 1-2-3 dBASE III Plus, and other popular



CIRCLE 95 ON FREE INFORMATION CARD

programs, configure and customize WordPerfect for various printers, including PostScript supported printers and the Hewlett-Packard LaserJet line, exploit WordPerfect's desktop publishing capabilities, use WordPerfect with many of the more popular memory-resident programs.

The book contains 400 pages for \$19.95 and is available from Que Corporation, 11711 N. College Ave., Carmel, IN 46032; Tel. 800/428-5331.

Hard Disk Management Techniques

By Joseph David Carrabis

This 250-page tutorial highlights installation of utilities, hardware, software and its applications for the experienced business professional working with a hard disk drive.

The book is software-oriented for the serious user as opposed to sophisticated programmer or developer. Each fundamental technique, based on the author's own consulting experience with Fortune 500 companies, is emphasized and explained in detail.

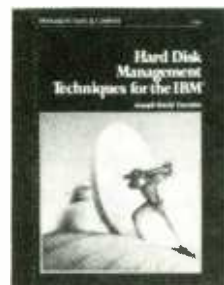

CIRCLE 97 ON FREE INFORMATION CARD

GET THE KNOW-HOW TO SERVICE EVERY COMPUTER ON THIS PAGE

Learn the Basics the NRI Way—and Earn Good Money Troubleshooting Any Brand of Computer

The biggest growth in jobs between now and 1995, according to Department of Labor estimates, will occur in the computer service and repair business, where demand for trained technicians will actually double.

You can cash in on this opportunity—either as a full-time corporate technician or an independent service-person—once you've learned all the basics of computers the NRI way. NRI's practical combination of "reason-why" theory and "hands-on" building skills starts you with the fundamentals of electronics, then guides you through advanced electronic circuitry and on into computer electronics. You also learn to program in BASIC and machine language, the essential languages for troubleshooting and repair.

Total Computer Systems Training, Only From NRI

No computer stands alone. . . it's part of a total system. To really service computers, you have to understand computer systems. And only NRI includes a powerful computer system as part of your training, centered around the new fully IBM compatible Sanyo 880 Series computer.

You start with the step-by-step assembly of the new, highly rated fully IBM compatible Sanyo 880 Series computer. You install and troubleshoot the "intelligent" keyboard. Then you assemble the power supply, install the disk drive, and add extra memory to give you a powerful 256K RAM system. The new 880 computer has two operating speeds: standard IBM speed of 4.77 MHz and a remarkable turbo speed of 8 MHz, making it almost twice as fast as the IBM PC. Next, you'll interface the high-resolution monitor and begin to use the valuable software also included with your complete computer system.

IBM is a Registered Trademark of IBM Corporation.

Epson is a Registered Trademark of Epson America, Inc.

Apple and the Apple logo are Registered Trademarks of Apple Computer, Inc.

Compaq is a Registered Trademark of COMPAQ Computer Corporation.

© 1985 AT&T Technologies, Inc.



AND MORE!

It all adds up to confidence-building, real-world experience that includes training in programming, circuit design, and peripheral maintenance. You'll be learning about, working with, servicing, and troubleshooting an entire computer system—monitor, keyboard, computer, disk drive, power supply—to ensure that you have all the essential skills you need to succeed as a professional computer service technician.

No Experience Needed, NRI Builds It In

This is the kind of practical, hands-on experience that makes you uniquely prepared, with the skills and confidence you need for success. You learn at your own convenience in your own home. No classroom pressures, no night school,

no need to quit your present job until you're ready to make your move. Your training is backed up by your personal NRI instructor and the NRI technical staff, ready to answer your questions and help you when you need it. You get it all with NRI at-home training.

100-Page Free Catalog Tells More

Send the postage-paid reply card today for NRI's big, 100-page, color catalog on NRI's electronics training, which gives you all the facts about NRI courses in Micro-computers, Robotics, Data Communications, TV/Audio/Video Servicing, and other growing high-tech career fields. If the reply card is missing, write to the address below.



- Your NRI total systems training includes:
- NRI Discovery Lab® to design and modify circuits
 - Your four-function digital multimeter with walk-you-through instructions on audio tape
 - Digital logic probe for visual examination of keyboard circuits
 - The newest Sanyo 880 Series Computer with "intelligent" keyboard and 360K double-density, double-sided disk drive
 - High resolution monochrome monitor
 - 8K ROM, 256K RAM
 - Bundled software including GW BASIC, MS-DOS, WordStar, CalcStar
 - Reference manuals, schematics, and bite-sized lessons.

NRI SCHOOLS
McGraw-Hill Continuing Education Center
3939 Wisconsin Avenue, NW
Washington, DC 20016

We'll Give You Tomorrow.



BOOKSHELF

Topics covered include introduction to hard disks and DOS, servicing and maintenance, setting up and organizing a hard disk, hard disk managers, maintenance, file, and security utilities.

Hard Disk Management Techniques, No. 22580, retails for \$19.95 and is available at bookstores, electronics distributors or direct from the publisher by calling 800/428-SAMS or by writing Sams, 4300 West 62nd Street, Indianapolis, IN 46268.

Microprocessors in Industrial Measurement and Control By Marvin D. Weiss

The microprocessor revolution has made tremendous impact on process measurement and control. It has made control systems more compatible with the plant environment and more sympathetic with the operator's needs. At the same time, it has meant a reduction in control equipment costs, start-up costs, and installation time. Now, Marvin D. Weiss provides engineers and managers with practical insight into control requirements for specific processes and shows how the microprocessor uniquely fills those needs.

Starting with a look at the roots of digital systems—including the relay, the tube, the transistor and diode—Weiss traces the evolution of control and automation in the process industries. He then shows how to determine where microprocessors can yield maximum dollar dividends for the process industry by improving quality measurement and control at any level of automation—from pneumatic and analog systems to

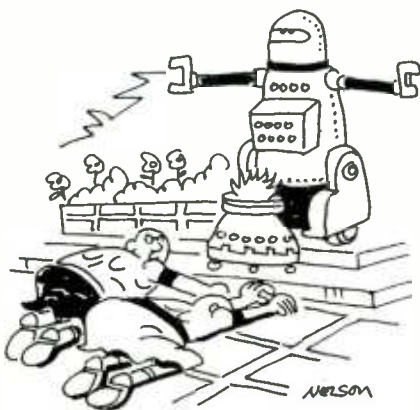

"Who died and made him King"



CIRCLE 99 ON FREE INFORMATION CARD

microcomputer-based distributed systems and expert systems. Also covered is the development of control hardware and control software with a preview of what's in hardware and software technology.

Microprocessors In Industrial Measurement and Control provides insight into how the newest microtechnologies and trends are affecting the automation of processes in industry. Other topics highlighted include classification of levels of automation with examples of how microprocessors can aid automation at each level; measurement techniques and standards; distributed control systems; descriptions and examples of unit control; control methods for coal gasification and energy management; the use of micro systems for selecting or designing safety systems; micro-based pollution control systems...and much more.

Microprocessors In Industrial Measurement and Control is order No. 2818, has 622 pages, available from Tab Professional and Reference Books, PO Box 40, Blue Ridge Summit, PA 17214; Tel. 717/794-2191.

Understanding Expert Systems By Louis E. Frenzel

Louis E. Frenzel, Jr. uses a self-instructional format to lead the reader to an understanding of expert systems, and how they work, where they are used, and how to develop them. Readers will learn how an expert system can act as an intelligent consultant to answer questions, solve problems, and help make decisions.

Ideally suited for the technical professional or manager interested in artificial intelligence, the material is completely illustrated, clear, concise, and application-oriented with marginal notes and review questions and answers.

Topics covered include types of expert systems and their applications; knowledge representation and search; how expert systems work; expert

system development tools; expert system tool vendors; and AI language vendors.



CIRCLE 97 ON FREE INFORMATION CARD

Understanding Expert Systems, No. 27065, is 288 pages, and retails for \$16.95. It is available at bookstores, electronics distributors or direct from the publisher by calling 800/428-SAMS, or you can write to them at Sams, 4300 W. 62nd Street, Indianapolis, IN 46268.

The Benchtop Electronics Reference Manual By Victor F.C. Veley

The real strength of this huge reference lies in its unique format, which divides each of 160 topics into a three-stage exploration: Basic Principles—a simple discussion of the basic concepts that gives newcomers to electronics a solid foundation in theory; Mathematical Derivations—in modern SI metric units—relevant equations that help more advanced electronics practitioners to gain a deeper understanding of the subject; and Practical examples—giving interested readers concrete illustrations of each topic. The result of this format is an easy-to-use reference for electronics and communications technicians now working in industry and a valuable learning aid to high school and college-level students and hobbyists.

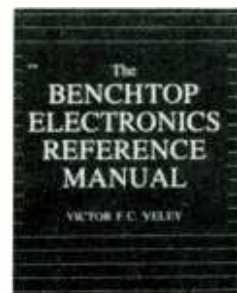

CIRCLE 99 ON FREE INFORMATION CARD

Topics are drawn from the most common subjects in electronics, including direct-current principles, alternating current principles, solid-state devices, tube circuits, and principles of radio communications;

each of which is treated separately. Since 100 of the 160 topics are devoted to the all-important direct and alternating currents, this book would make an ideal text for introductory electronics courses. And all the topics together cover most of the requirements for the FCC Commercial or General Class Radiotelephone Operator's License. Anyone who needs a reliable reference to the principles of electronics will find this volume to be the most comprehensive and authoritative book available.

The Benchtop Electronics Reference Manual, order No. 2785, has 620 pages for \$24.60 in paperback, available from Tab Books, PO Box 40, Blue Ridge Summit, PA 17214; Tel. 717/794-2191.

Small Engines: Operation, Maintenance and Repair By the American Association of Vocational Instructional Materials

With an estimated seventy million small engines in use in the United States today, small gas engines have definitely been established as the power source for everything from lawn mowers and chain saws to pumps and generators. And repair of these engines is a very profitable and booming business. Now, with this complete guide, anyone can learn how to service, operate, maintain, and repair these air-cooled, spark-ignition, 1/2-15 hp engines, to obtain maximum power and efficiency—and to save money.



CIRCLE 99 ON FREE INFORMATION CARD

The book begins with general information on how small gas engines work, describing the distinguishing features of small engines and presenting practical techniques for servicing, starting, operating, and storing these engines. Proper operation, maintenance, and attention to minor repairs are the keys to prolonging the life of a small engine, allowing it to run safely at its top productivity level. All of the routine maintenance procedures so necessary to smooth operation—such as

lubrication and refueling—are described in complete detail. Readers then learn why certain accessories such as carburetor air cleaners, crankcase breathers, spark plugs, and storage batteries require frequent servicing, and they learn how to care for these items.

As an added bonus, this handbook is also a complete engine systems reference, explaining in step-by-step detail the operating principles, maintenance and repair procedures for starters; cylinders; fuel, piston-and-rod, and camshaft assemblies; ignition and lubrication systems; and valves. With the expert advice and detailed instructions in this useful guide, readers can solve almost any small engine problem—from minor adjustments and maintenance to complete overhauls.

Small Engines: Operation, Maintenance and Repair, order No. 2813, contains 288 pages, costing \$14.60 paperback. Available from TAB Books, Inc., PO Box 40, Blue Ridge Summit, PA 17214; Tel. 717/794-2191.

Using DisplayWrite 4 By David Busch

Display Write 4 is the latest version of IBM's popular Display Write word-processing program. Destined to be extremely popular in the corporate environment, DisplayWrite 4 offers a number of new features, including a streamlined series of pop-up menus and command key functions. *Using DisplayWrite 4* promises to be a valuable guide for users of this new program.

The book is designed for both novices and users of previous DisplayWrite programs. It will teach readers how to create and edit documents, increase efficiency with helpful tips and tricks, make the transition from DisplayWrite 3 to DisplayWrite 4, program powerful keyboard macros, use DisplayWrite 4's innovative *Voice Annotation* feature.

The book contains 450 pages costing \$19.95. To order directly from Que, call 800/428-5331 and ask for a sales representative.

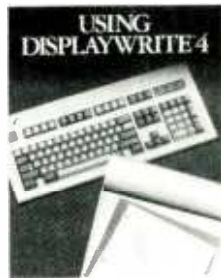

CIRCLE 95 ON FREE INFORMATION CARD

ATTENTION! ELECTRONICS TECHNICIANS



EARN YOUR
**B.S.E.E.
DEGREE**

THROUGH HOME STUDY

Our New and Highly Effective Advanced-Placement Program for experienced Electronic Technicians grants credit for previous Schooling and Professional Experience, and can greatly reduce the time required to complete Program and reach graduation. No residence schooling required for qualified Electronic Technicians. Through this Special Program you can pull all of the loose ends of your electronics background together and earn your B.S.E.E. Degree. Upgrade your status and pay to the Engineering Level. Advance Rapidly! Many finish in 12 months or less. Students and graduates in all 50 States and throughout the World. Established Over 40 Years! Write for free Descriptive Literature.

COOK'S INSTITUTE
OF ELECTRONICS ENGINEERING



347 RAYMOND ROAD
P.O. BOX 20345
JACKSON, MISSISSIPPI 39209

CIRCLE 7 ON FREE INFORMATION CARD

BRIEF CASE RECORDERS



NEW
12 HOUR
MODEL

USES
D-120
TAPE

\$359.00 **

Modified Panasonic recorder installed in top quality 3 inch Samsonite™ Attache Case. Has built in electret condenser mike. Recorder is activated by combination lock on brief case. Unit provides complete portable recoding capability. Fold down work table conceals recorder. TDK DC 120 Casette furnished.

OTHER AMC ITEMS

12 hour modified Panasonic recorders, \$105.00**. Also Telephone Recording Adaptors \$24.50*, VOX SWITCHES \$24.95*, Micro recorders with tie clip microphone, VOX activated micros, Wired mikes, Transmitter detectors, etc. Send for FREE data. **Add \$4.00 each shipping and handling. *Add \$1.50 shipping and handling. Calif. residents add sales tax. Mail Order.

AMC Sales Inc., Dept. (213) 869-8519
9335 Lubec St., Box 928, Downey, Calif. 90241

CIRCLE 6 ON FREE INFORMATION CARD

BOOKSHELF

IBM Peripheral Troubleshooting & Repair Guide By Charles J. Brooks

With this book in the Troubleshooting & Repair Series, personal computer owners, service technicians, students, and hobbyists can learn to service and repair computer peripherals with this step-by-step procedures manual.



CIRCLE 97 ON FREE INFORMATION CARD

Using a cookbook approach, this book presents the basic theory of operation, hardware descriptions, preventive maintenance, and troubleshooting and repair techniques for all major peripherals compatible with the IBM personal computer. Schematics, flowcharts, illustrations, and references to Sams computerfacts technical service data combine to make basic repair instructions clear and easy-to-follow.

Topics covered include basic computer organization, troubleshooting basics, disk drives, monitors, input devices, printers, and modems.

IBM PC Peripheral Troubleshooting & Repair Guide retails for \$21.95 and is available at bookstores, electronics distributors or direct from the publisher by calling 800/428-SAMS or

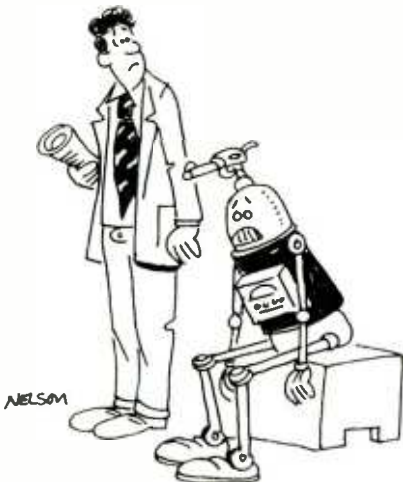

"I'm so depressed. My artificial intelligence is the only thing about me that's real."

by writing Sams, 4300 West 62nd St., Indianapolis, IN 46268.

Using WordPerfect Workbook and Disk

Learning to use WordPerfect is now easier! Que Corporation's latest release, the *Using WordPerfect Workbook and Disk*, will help novice users quickly learn the features and functions of the WordPerfect word-processing program.

Based on WordPerfect version 4.2, the workbook is intended for use with Que's *Using WordPerfect, 3rd Edition*. Utilizing a series of lessons and hands-on exercises, the using WordPerfect Workbook and Disk will help users master the powerful features of this word-processing program. The versatile design of the workbook

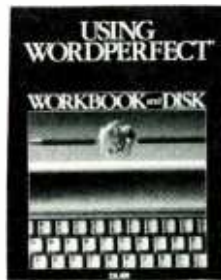

CIRCLE 95 ON FREE INFORMATION CARD

enables it to be used either individually or as part of a training class. Included with the workbook in an IBM-format data disk, filled with sample WordPerfect documents.

The book contains 350 pages costing \$29.95 with the disk. To order it contact Que Corporation, 11711 N. College Ave., Carmel, IN 46032. Tel. 800/428-5331.

Electrostatic Loudspeaker Design and Construction By Ronald Wagner

For many true audiophiles, electrostatic loudspeakers are the Porsches of the speaker world. The units produce the ultimate in sound reproduction, but the cost of a unit can run anywhere from \$3,000 and up. Now, with publication of *Ronald Wagner's Electrostatic Loudspeaker Design and Construction*, even budget-minded music enthusiasts can afford to own and enjoy their own custom-designed electrostatic sound.

The first book-length treatment of electrostatic speaker design and construction for the serious hobbyist, this volume leads off with an overview of the history and development of electrostatic speakers. Wagner explains operational principles, mechanical and electrical properties of these speakers,

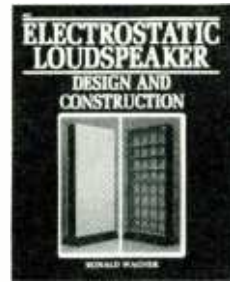

CIRCLE 99 ON FREE INFORMATION CARD

and then proceeds to show how these units can be built at home for as little as one-tenth of the commercial cost. Wagner first shows how to build an electrostatic tweeter and then moves on to construction of a full-scale electrostatic unit. Information on needed materials and equipment, stretching frames, building high-voltage power supplies, wiring speaker panels, making frames to hold the speaker panels, doing preliminary performance tests—it's all here. Wagner has even included instructions for building a supporting cabinet for the finished speaker.

Electrostatic Loudspeaker Design and Construction, order No. 2832, containing 256 pages, sells for \$14.60 in paperback. It is available from TAB Books, Inc., PO Box 40, Blue Ridge Summit, PA 17214; Tel. 717/794-2191.

Lotus 1-2-3 Financial Models By Elna Tymes and Tony Dowden

This book shows Lotus 1-2-3 (Version 2.0) users how to create models for calculating and solving personal or business financial problems.

This revised edition, formerly titled *1-2-3 from A to Z*, includes numerous templates for the Lotus user, each preceded by a brief explanation about how it works and how it can be altered to fit specific analysis needs. More



CIRCLE 97 ON FREE INFORMATION CARD

advanced business models, an increased emphasis on macros, and the inclusion of Version 2.0 make this book ideally suited to the business oriented user.

The book's 300 pages contain

personal and business financial models, with some models for the advanced business user needing complex calculations and formulas. Whether calculating a complicated statistical analysis or a simple home heating analysis, this book can be a one-stop source for the guidance and tools needed to do the spreadsheet calculations in the most efficient manner possible.

Lotus 1-2-3 Financial Models, retails for \$19.95 and is available at bookstores, electronics distributors or direct from the publisher by calling 800/428-SAMS, or writing Sams, 4300 West 62nd Street, Indianapolis, IN 46268.

Oscillators Simplified, With 61 Projects
By Delton T. Horn

An excellent learn-by-doing book that includes just about everything there is to know about oscillators in one compact volume.

Although oscillator circuits are covered to some degree in virtually every text on basic electronics, materials beyond the basic level are often difficult to find. This book is a totally comprehensive guide on the subject, covering both theory and practical applications, at an intermediate level. Horn discusses not

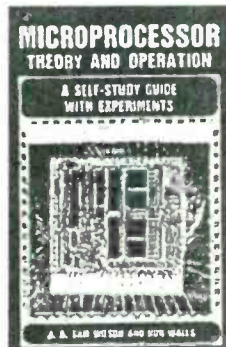

CIRCLE 99 ON FREE INFORMATION CARD

only sine, rectangle, and square waves, but also sawtooth, spike, triangle, and staircase waves. And he explains how to generate those waves with many active devices.

More than 60 projects provide readers with the designs for many different signal generator circuits, such as the Hartley oscillator, the Colpitts oscillator, a complex signal generator, a pulsed signal generator, a basic 555 astable multivibrator, a tone decoder demonstrator, a musical tone generator, and many others. Tips for adapting these basic circuits are also given to encourage readers to experiment with new designs on their own.

Other important subjects rarely given in-depth treatment in other texts include dedicated integrated circuits, digital waveform synthesis, troubleshooting signal generator circuits, and practical uses for phase-locked loops.

This book gathers into one volume information that had to be picked up in bits and pieces before. At once an excellent text on oscillator theory and applications for hobbyists or students, this book is also a handy reference on the subject for professionals in the electronics field.

Oscillators Simplified, With 61 Projects, order no. 2875 has 252 pages, sells for \$11.60 in paperback. Available from TAB Books Inc., PO Box 40, Blue Ridge Summit, PA 17214; Tel. 717/794-2191.

The C Trilogy: A Complete Library For C Programmers
By Eric Bloom

Far more than just another programming tutorial or collection of subroutines and functions, this is a complete, single-volume C reference library. It gives instant access to the full range of information needed by both novice and more experienced programmers. Just some of the highlights include C language rules, syntax, and standard functions, a discussion of C within the MS-DOS video, cursor placement, and more: PC printer control—with details on the double strike, compressed print, and other special printing requirements, structured programming techniques, data manipulation techniques, accounting and financial calculating techniques, plus array manipulation techniques.

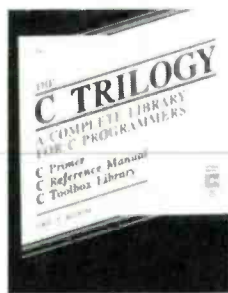

CIRCLE 99 ON FREE INFORMATION CARD

Arranged in three basic sections, this book includes a C-language primer that explains all data types and operators, control statements, arrays and character strings, structures, pointers, functions, input and output, the C compiler, and compiler directives.

The second section is designed to function as a C language reference

manual giving quick access to listings of the most frequently used C statements and functions as well as language operators, storage classes and data types, and compiler directives.

The final section with its C-toolbox library, however, will probably prove most useful to all levels of C programmers from novice to experienced. Here is a total of 196 ready-to-run functions and subroutines for such diverse uses as printer control, string manipulation, data input, array manipulation, measurement conversion, data functions, screen output functions, and mathematical functions.

The C Trilogy: A Complete Library For C Programmers order No. 2890, contains 600 pages for \$22.60. It's available from TAB Books, Inc., PO Box 40, Blue Ridge Summit, PA 17214; Tel. 717/794-2191.

Secrets of 123 Classic Science Tricks and Experiments
By Edi Lanners

This fact-and-fun-filled book reveals the secrets and scientific principles of mind-teasing tricks and experiments sure to please any age group. A dancing egg, an electric walnut, a coin suspended in midair, drawing with fire, These are but just a few of the amazing "impossibilities" explained in *Secrets of 123 Classic Science Tricks and Experiments*.

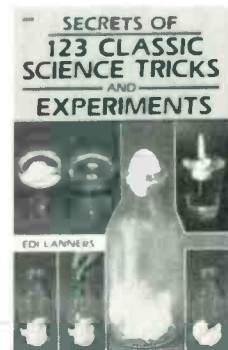

CIRCLE 99 ON FREE INFORMATION CARD

A respect for and interest in science can be cultivated through these entertaining projects. Step-by-step directions and illustrations make mastering these feats as simple as pulling a rabbit from a hat! No special skill or experience is required to perform the tricks in this collection.

Only ordinary household items are needed for the experiments and games that demonstrate such phenomenon as card tricks, centrifugal force, gravity, a hovering ladle, turning water into wine, coin tricks, inertia, mirror

BOOKSHELF

images, optical illusions, and a tower of matches.

Parents and teachers will find this a handy source of school and science-fair projects—principles of electricity, physics, chemistry and physiology are the basics for all of these fascinating—and educational tricks, experiments and games.

From first page to last, this book of easy-to-perform tricks and illusions will provide hours, even years of delightful fun!

Secrets of 123 classic Science Tricks and Experiments, order No. 2821, has 192 pages \$7.70 in paperback. Available from TAB Books Inc., PO Box 40, Blue Ridge Summit, PA 17214; Tel. 717/794-2191.

Introduction To Telecommunications System By P.H. Smale

This guide will make the process of transmitting data electronically over long distances amazingly easy to understand—from the history, theory, and basic principles to performance characteristics, uses, current research, and the most recent technological developments.

Detailed information that is technical enough for electronics hobbyists, students, and those working in telecommunications, yet clear, practical, and useful enough for business and management students and professionals. Smale covers the whole range of telecommunication principles, beginning with a basic discussion of wave theory and continuing with the principles behind radio, television, telephone, and telegraph networks. Other highlighted and digital networks for national and

international telecommunications systems.



CIRCLE 99 ON FREE INFORMATION CARD

Along with necessary background information on each subject, the author explains how each emerging technology has changed human communications and how telecommunications systems have evolved to accommodate the rapidly changing business, commercial, and industrial requirements of users.

Introduction to Telecommunications Systems, order No. 2924, having 160 pages, for \$14.60 in paperback, is available from TAB Books, Inc., PO Box 40, Blue Ridge Summit, PA 17214; Tel. 717/794-2191.

Microprocessor Theory and Operation—A Self-Study Guide with Experiments By J.A. Sam Wilson and Ron Walls

Here is a long-needed sourcebook that effectively bridges the gap between digital electronics theory and microprocessor technology. Beginning with the heart of the computer, this guide explains bit-by-bit exactly how microprocessors and their circuitry work, and then examines the power supply and peripherals.

Wilson and Walls provide a detailed picture of the whole microprocessor system and how it functions, with specific information on busses, clocks, memories, and interfaces. Dedicated microprocessors, 6802 microprocessors, microprocessor instruction sets, and some special features of microprocessors are also fully examined—as are specific microprocessor systems: the 74181 ALU (arithmetic logic unit), the PLA (programmed logic array), and more. Finally, the authors look at the many different uses for microprocessors, how information is obtained, and what the microprocessor does with that information.

To provide readers with hands-on familiarity with microprocessors and their circuitry, 15 easy-to-build, inexpensive projects are included. These innovative designs range from a

bounceless switch and a counter to more advanced projects that explore ROM, RAM, and interfacing elements. Full instructions are included for all 15 projects, and for the power supplies they require.

A review section is provided at the end of each chapter, assuring that readers will master all of the material in the book, and an appendix and index make reference easy. Since understanding microprocessors involves more than just learning how the hardware is put together, a simple program is provided which



CIRCLE 99 ON FREE INFORMATION CARD

demonstrates how each part of the microprocessor is used. Finally, Wilson and Walls include some useful programming tips and provide pointers on how to troubleshoot microprocessor systems.

Microprocessor Theory and Operation—A Self-Study Guide with Experiments, order No. 2791 contains, 224 pages, costing \$14.60 in paperback. It's available from TAB Books, Inc., PO Box 40, Blue Ridge Summit, PA 17214; Tel. 717/794-2191.

80386—A Programming and Design Handbook By Penn Brumm and Don Brumm

Exciting new standards in microcomputer power, speed, and versatility have been established by the revolutionary 80386—Intel Corporation's new 32-bit processor. In *80386—A Programming and Design Handbook*, computer experts Penn Brumm and Don Brumm examine the impact of this advanced hardware on desktop computing, and detail information about the microprocessor's architecture, capabilities, and operation.

This handbook to the 80386 provides the facts prospective users will want to know before making a purchasing decision. The authors worked side by side with 80386 designers in producing this sourcebook



"But, I'm a pacifist."

to make certain the information and explanations included are complete and accurate.

The book covers 80386 design concepts and development history; 80386 architecture—block diagram, functional description, hardware/software compatibility, operational modes, pipelining, clock speeds, advanced features, and execution rates; memory organization and management overview, multitasking, multiple



CIRCLE 99 ON FREE INFORMATION CARD

execution and concurrent operating system; performance tests/ratings overview; hardware protection mechanism, plus many more features are reviewed.

80386—A Programming and Design Handbook, scrutinizes every design and operating parameter of the microprocessor. To the fullest extent possible, programmers and designers' questions have been anticipated and answered.

80386—A Programming and Design Handbook, order No. 2937 has 464 pages, \$19.60 in paperback, available from TAB Professional and Reference Books, Division of TAB Books, Inc., PO Box 40, Blue Ridge Summit, PA 17214; Tel. 717/794-2191.

Transmitter Hunting: Radio Direction Finding Simplified

By Joseph D. Moell, and Thomas N. Curlee

Radio direction finding has been an important technology since its inception during World War I. But until recently most practitioners were scientists and engineers, who were primarily interested in esoteric studies of antenna theory and signal processing—little of which is readily understandable to the average hobbyist. Now that amateur radio operators have discovered this fascinating science, a great need has emerged for one comprehensive beginner's guide. This book is designed to fill that gap.

In the first chapters, Moell and Curlee review the important role radio direction finding has played during this century, and describe the many

opportunities for fun and satisfaction that T-hunting provides. Then readers are guided through the beginning steps of setting up for the hunt, including an overview of mobile hunting techniques and the kinds of hardware now available. The authors even include complete plans for constructing inexpensive, easy-to-build antennas and Doppler units.



CIRCLE 99 ON FREE INFORMATION CARD

Readers receive practical guidance for involving other area hams in T-hunting, with ideas for rules, scoring, and some unusual types of hunts. Special topics include T-hunting in Europe and Asia; search and rescue hunting; commercial and military direction finding systems; and other

uses for radio direction finding skills, such as wildlife preservation, cable TV interference searching, and finding power line interference. The authors also describe how a programmable calculator can be used to do accurate triangulation calculations in the field—and they include complete program listings, with explanations. Finally, the book takes a look ahead at what the future holds for transmitter hunting. A bibliography for further information and a complete list of manufacturers round out this all-inclusive reference.

There is a whole lot more to T-hunting than meets the eye—it is a public service, a technical challenge, a club builder, and a lot of fun. With this comprehensive and easy-to-understand guide and just one afternoon's work, anyone with an amateur radio license can begin locating downed aircraft, searching out radio frequency jammers, and enjoying the fascinating hobby of radio direction finding.

Transmitter Hunting: Radio Direction Finding Simplified, order No. 2701, 336 pages \$17.60 paperback. Available from TAB Books Inc., 40 Blue Ridge Summit, PA 17214; Tel. 717/794-2191.

(Continued on page 105)

THIS SPACE CONTRIBUTED AS A PUBLIC SERVICE

A defense against cancer can be cooked up in your kitchen.

There is evidence that diet and cancer are related. Follow these modifications in your daily diet to reduce chances of getting cancer.

1. Eat more high fiber foods such as fruits and vegetables and whole grain cereals.
2. Include dark green and deep yellow fruits and vegetables rich in vitamins A and C.
3. Include cabbage, broccoli, brussels sprouts, kohlrabi and cauliflower.
4. Be moderate in consumption of salt-cured, smoked, and nitrite-cured foods.
5. Cut down on total fat in take from animal sources and fats and oils.
6. Avoid obesity.
7. Be moderate in consumption of alcoholic beverages.

No one factor causes cancer alone.
AMERICAN CANCER SOCIETY

SEND FOR FREE 1987 CATALOG 48 PAGES!

*QUALITY PARTS *DISCOUNT PRICES *FAST SHIPPING!

ALL ELECTRONICS CORP.

<p>BLACKLIGHT ASSEMBLY</p> <p>Complete, functioning assembly includes ballast, on-off switch, power cord, sockets and F4T5-BL blacklight. Mounted on a 7 1/8" X 3 1/8" metal plate. Use for special effects lighting or erasing EPROMs. CAT# BLTA \$10.00 EACH</p>	<p>1mA METER</p> <p>Modutec 0-1 mA signal strength meter with KLM logo. 1/4" X 1 3/4" X 7/8" deep. CAT# MET-2 \$2.00 each</p>	<p>VIC 20 MOTHERBOARD</p> <p>26 IC's including 6502A and 6560. Not guaranteed but great for replacement parts or experimentation. CAT # VIC-20 \$15.00 each</p>	<p>XEON FLASH TUBE</p> <p>3/4" X 1/8" dia. CAT# FLT-1 2 for \$1.00</p>												
<p>SWITCHING POWER SUPPLY</p> <p>Compact, well regulated switching power supply designed to power Texas Instruments computer equipment. INPUT: 14-25 vac @ 1 amp OUTPUT: +12 vdc @ 350 ma +5 vdc @ 1.2 amp -5 vdc @ 200 ma. SIZE: 4 3/4" square. CAT# PS-30 \$3.50 each</p>	<p>LED'S</p> <p>Jumbo T 1-3/4 (5 mm)</p> <p>RED CAT# LED-1 10 for \$1.50</p> <p>GREEN CAT# LED-2 10 for \$2.00</p> <p>YELLOW CAT# LED-3 10 for \$2.00</p>	<p>MINI PUSH BUTTON</p> <p>1 P.S.T. momentary. Push to make. CAT# MPB-1 10 for \$3.25</p> <p>NI-CAD CHARGER/TESTER</p> <p>Will charge most every size Ni-Cad battery available. CAT# UNCC-N \$15.00</p>	<p>TELEPHONE COUPLING TRANSFORMER</p> <p>Stancor TTCP-8</p> <p>600 ohms C.T. to 600 ohms C.T. P.C. board mount. 3/4" X 5/8" X 3/4"</p> <p>CAT# TCTXS \$2.50</p>												
<p>THIRD TAIL LIGHT</p> <p>Sleek high-tech lamp assembly. Could be used as a third auto tail light, emergency warning light, or special-effects lamp. Red reflective lens is 2 3/4" X 5 1/2" is mounted on a 4" high pedestal with up-down swivel adjustment. Includes 12 V replaceable bulb CAT# TLB \$3.95 each</p>	<p>TWO PIECE HOLDERS FOR ABOVE L.E.D.S</p> <p>CAT# HLED 10 for 65c 100 for \$5.00</p>	<p>RECHARGEABLE NI-CAD BATTERIES</p> <table style="width: 100%; border-collapse: collapse;"> <tr> <td>AAA SIZE 1.25V 180mAh</td> <td>\$2.25</td> </tr> <tr> <td>AA SIZE 1.25V 500mAh</td> <td>\$2.00</td> </tr> <tr> <td>AA WITH SOLDER TABS</td> <td>\$2.20</td> </tr> <tr> <td>C SIZE 1.2V 1200mAh</td> <td>\$4.25</td> </tr> <tr> <td>SUB-C SIZE SOLDER TABS</td> <td>\$4.25</td> </tr> <tr> <td>D SIZE 1.2V 1200mAh</td> <td>\$4.25</td> </tr> </table>		AAA SIZE 1.25V 180mAh	\$2.25	AA SIZE 1.25V 500mAh	\$2.00	AA WITH SOLDER TABS	\$2.20	C SIZE 1.2V 1200mAh	\$4.25	SUB-C SIZE SOLDER TABS	\$4.25	D SIZE 1.2V 1200mAh	\$4.25
AAA SIZE 1.25V 180mAh	\$2.25														
AA SIZE 1.25V 500mAh	\$2.00														
AA WITH SOLDER TABS	\$2.20														
C SIZE 1.2V 1200mAh	\$4.25														
SUB-C SIZE SOLDER TABS	\$4.25														
D SIZE 1.2V 1200mAh	\$4.25														
<p>TOLL FREE ORDERS 800-826-5432 INFO • (818) 904-0524 FAX • (818) 781-2653</p>		<p>OUR NEW ADDRESS IS: P.O. BOX 567 VAN NUYS, CA 91408</p>													

QUANTITIES LIMITED. MINIMUM ORDERS \$10.00 CALIF. ADD SALES TAX USA. \$10.00 SHIPPING. NO C.O.D. FOREIGN ORDERS INCLUDE SUFFICIENT SHIPPING

CIRCLE 5 ON FREE INFORMATION CARD

Join
the

Electronics and Control Engineers' Book Club®

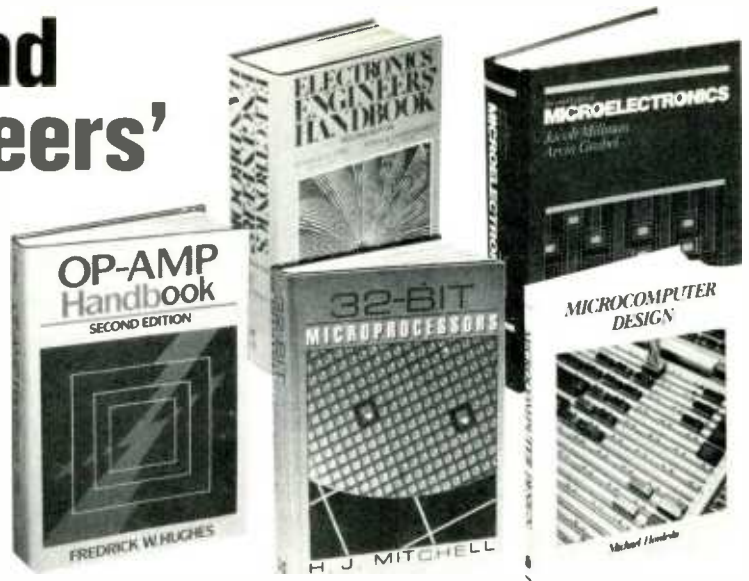

ADVANCED DIGITAL COMMUNICATIONS: Systems and Signal Processing. Edited by K. Feher. 768 pp., 436 illus. Emphasizes the newest advances and developments in telecommunications systems and networks. Chapters on subjects such as ISDN, speech coding algorithms, digital speech interpolation systems and interference are all written by international authorities to give you on-the-job expertise.
583801-X Pub. Pr., \$59.95 Club Pr., \$42.50

ELECTRONICS ENGINEERS' HANDBOOK, Second Ed. Edited by D. G. Fink & D. Christiansen. 2,272 pp., 2,189 illus. This updated and enlarged edition covers all the latest knowledge in the field, including new advances in integrated circuits, pulsed and logic circuits, laser technology, telecommunication, and much more.
209/812 Pub. Pr., \$89.00 Club Pr., \$61.50

32-BIT MICROPROCESSORS. Edited by H. J. Mitchell. 248 pp., 104 illus. and tables. A complete survey of the architecture, operation, and applications of today's most important new devices from AT&T, Immos, Intel, and Motorola.
425/85X Pub. Pr., \$39.95 Club Pr., \$29.50

MICROWAVE AMPLIFIERS AND OSCILLATORS. By C. Gentili. 150 pp., 79 illus. A thorough, practical introduction to the theory and design of microwave amplifiers and oscillators, with coverage of the scattering matrix, the gallium arsenide field-effect transistor, and microstrip technology.
229/953 Pub. Pr., \$31.95 Club Pr., \$24.95

TROUBLESHOOTING ELECTRONIC EQUIPMENT WITHOUT SERVICE DATA By R. G. Middleton. 303 pp., 162 illus. and tables. Packed with charts, diagrams, and case histories, this practical handbook shows you how to pinpoint defective electronic circuitry when no service data is available.
583134-1 Pub. Pr., \$27.95 Club Pr., \$22.50

- your one source for engineering books from over 100 different publishers
- the latest and best information in your field
- discounts of up to 40% off publishers' list prices

New Members!
Take any one of these great professional books for only **\$289** as a premium with your first selection!

Spectacular values up to **\$98.50**

ENGINEERING FUNDAMENTALS FOR THE PROFESSIONAL ENGINEERS' EXAM, Third Ed. By L. M. Polentz. 432 pp., 170 illus. Features worked out solutions and full explanations for all sample problems so you can learn how to solve them. It's a dependable way to prepare for the exam or a perfect on-the-job reference.
503/931 Pub. Pr., \$36.50 Club Pr., \$27.95

AUTOMATIC CONTROL SYSTEMS, Fifth Ed. By B. C. Kuo. 736 pp., illus. Provides an overview of automatic control systems, including in-depth coverage of classical control techniques, optimal control theory, and analog and digital control system design. This updated edition discusses the latest ideas on the use of computers to design control systems and as components of such systems.
583706-4 Pub. Pr., \$48.00 Club Pr., \$36.95

OP-AMP HANDBOOK, Second Ed. By F. W. Hughes. 320 pp., 231 illus. Organized for on-the-job reference, this handbook covers all facets of op-amps, from stability and protection to signal processing using op-amps. Includes a collection of over 60 practical circuits for a variety of applications, procedures, and experiments.
583651-3 Pub. Pr., \$36.33 Club Pr., \$27.50

THE LINEAR IC HANDBOOK. By M. S. Morley. 614 pp., 163 illus. The one-stop sourcebook that helps you find — quickly and easily — the lowest-cost linear IC that will meet your needs. Includes specs, applications data, and prices of linear ICs from all major manufacturers, as well as design and fabrication techniques.
583784-6 Pub. Pr., \$49.50 Club Pr., \$36.25

MCGRAW-HILL CONCISE ENCYCLOPEDIA OF SCIENCE AND TECHNOLOGY. Editor-in-Chief S. P. Parker and the Staff of the McGraw-Hill Encyclopedia of Science and Technology. 2,065 pp., 1,600 illus. This volume serves every need for understanding today's science and technology. Written by over 3,000 of the world's topmost experts, including 19 Nobel Prize winners, it covers 75 disciplines from Acoustics to Zoology.
454/825 Pub. Pr., \$98.50 Club Pr., \$63.99

CIRCUIT DESIGN FOR ELECTRONIC INSTRUMENTATION: Analog and Digital Devices from Sensor to Display, Second Ed. By D. Wobschall. 400 pp., 365 illus. Brings you the entire process of circuit design in a comprehensive, easy-to-follow format. This new edition reflects the latest in IC technology, including CMOS and ECL devices.
712/31X Pub. Pr., \$49.50 Club Pr., \$36.95

AMERICAN ELECTRICIANS' HANDBOOK, Eleventh Ed. By T. Croft and W. Summers. 1,824 pp., 1,560 illus. This newly updated handbook shows you how to select, install, maintain, and operate all the latest electrical equipment and wiring. It includes the most recent code requirements, basic formulas, and a wealth of circuit diagrams and illustrations.
139/326 Pub. Pr., \$64.50 Club Pr., \$49.50

MICROELECTRONICS, Second Ed. By J. Millman and A. Grabel. 1,001 pp., 646 illus. Takes you from the basics of semiconductor properties to an understanding of the operation of solid-state devices, and then to more advanced topics. Its up-to-date coverage, real-life examples, and practical data make this an ideal reference for the working engineer.
423/30X Pub. Pr., \$49.95 Club Pr., \$36.50

ENGINEERING MATHEMATICS HANDBOOK, Third Ed. By J. J. Tuma. 512 pp., illus. This best-selling handbook gives you the essential mathematical tools—formulas, definitions, theorems, tables, and models for computer programming — that you need for your day-to-day engineering calculations.
654/433 Pub. Pr., \$44.50 Club Pr., \$34.50

HANDBOOK OF ELECTRONIC TABLES AND FORMULAS Sixth Edition

256 pages, illustrated. 583804-4
Up-to-date mathematical tables and electronic formulas in a convenient desk reference that you'll find indispensable. Included are basic formulas, constants, government industry standards, symbols and codes, service data, and more. The handbook also has new sections describing how to do your calculations on a computer, and complete computer programs

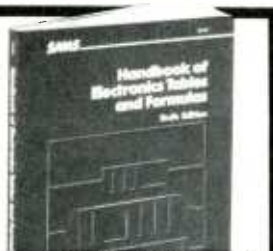

**A \$19.95
Value — Yours
ABSOLUTELY
FREE
when you join!**

PRINCIPLES OF PARALLEL AND MULTI-PROCESSING. By G. R. Desrochers. 500 pp., illus. A highly practical guide to the best techniques in parallel problem-solving. Discusses parallel system design, architecture, implementation, software, and performance analysis.
165/793 Pub. Pr., \$49.50 Club Pr., \$36.95

ANALOG ELECTRONIC CIRCUITS. By G. M. Glasford. 480 pp., 350 illus. Gives you the detailed information and equations you need to create and analyze top quality circuit designs or effectively utilize the designs of others.
583768-4 Pub. Pr., \$52.33 Club Pr., \$37.95

HANDBOOK OF ELECTRONIC NOISE MEASUREMENT AND TECHNOLOGY, Second Ed. By C. A. Vergers. 440 pp., 213 illus. Provides answers to all your questions about noise origins, causes, effects. Also shows you how to predict and measure noise, and how to design low-noise circuits.
583947-4 Pub. Pr., \$39.95 Club Pr., \$29.95

SWITCHGEAR AND CONTROL HANDBOOK, Second Ed. Edited by R. W. Smeaton. 1,056 pp., 789 illus. The only handbook that treats all aspects of switchgear control, including design, applications, safety, and maintenance. Updated to reflect the changes brought about by the use of computers, solid-state devices, and programmable controls.
584/494 Pub. Pr., \$75.00 Club Pr., \$56.95

ANTENNA APPLICATIONS REFERENCE GUIDE. Edited by R. C. Johnson and H. Jaski. 496 pp., 368 illus. and tables. Covers the major applications of antenna technology in all areas of communications and their design methods. Emphasizes important new applications such as earth station, satellite, seeker, aircraft, and microwave-relay antennas.
322/848 Pub. Pr., \$49.50 Club Pr., \$36.50

MICROCOMPUTER DESIGN. By M. Hordeski. 406 pp., illus. Emphasizes the most current, cost effective methods for developing, debugging and testing all types of microprocessor products, including software and hardware.
583683-1 Pub. Pr., \$42.67 Club Pr., \$29.95

DESIGNING ELECTRONIC CIRCUITS. By R. G. Middleton. 351 pp., 192 illus. Covers virtually every category of circuits commonly used. This practical manual provides the basic design procedures, tables and formulas vital to effective electronic circuit design. Plus over 60 start-to-finish procedures are featured along with scores of computer programs to help you design and analyze electronic circuits.
583673-4 Pub. Pr., \$36.95 Club Pr., \$27.50

Be sure to consider these important titles as well!

INTRODUCTION TO RADAR SYSTEMS, Second Ed. By M. I. Skolnik. 579/891 Pub. Pr., \$51.95 Club Pr., \$38.95

MICROPROCESSORS IN INSTRUMENTATION AND CONTROL. By S. A. Money. 427/878 Pub. Pr., \$39.50 Club Pr., \$29.50

OPERATIONAL AMPLIFIERS AND LINEAR INTEGRATED CIRCUITS, Third Ed. By R. F. Coughlin and F. F. Driscoll. 583754-4 Pub. Pr., \$34.95 Club Pr., \$25.95

McGraw-Hill's NATIONAL ELECTRICAL CODE HANDBOOK, 19th Ed. By J. F. McPartland. 457/877 Pub. Pr., \$42.50 Club Pr., \$31.95

ELEMENTS OF ENGINEERING ELECTROMAGNETICS, Second Ed. By N. N. Rao. 583774-9 Pub. Pr., \$49.00 Club Pr., \$35.50

PROBABILITY, SIGNALS, NOISE. By J. Dupraz. 183/389 Pub. Pr., \$39.95 Club Pr., \$29.95

POWER GENERATION CALCULATIONS REFERENCE GUIDE. By T. G. Hicks. 288/883 Pub. Pr., \$36.50 Club Pr., \$27.50

HUMAN FACTORS REFERENCE GUIDE FOR ELECTRONICS AND COMPUTER PROFESSIONALS. By W. E. Woodson. 717/664 Pub. Pr., \$32.50 Club Pr., \$23.75

THE FOURIER TRANSFORM AND ITS APPLICATIONS, Second Ed., Revised. By R. N. Bracewell. 070/156 Pub. Pr., \$49.95 Club Pr., \$38.95

THE LASER GUIDEBOOK. By J. Hecht. 217/338 Pub. Pr., \$49.50 Club Pr., \$37.50



68000 MICROPROCESSOR: ARCHITECTURE, SOFTWARE & INTERFACE TECHNIQUES. By W. A. Triebel & A. Singh. 583613-8 Pub. Pr., \$42.67 Club Pr., \$29.95

FOR FASTER SERVICE IN ENROLLING CALL TOLL-FREE 1-800-2-MCGRAW MAIL THIS COUPON TODAY

Why YOU should join now!

- **BEST AND NEWEST BOOKS IN YOUR FIELD** — Books are selected from a wide range of publishers by expert editors and consultants to give you continuing access to the best and latest books in your field.
- **BIG SAVINGS** — Build your library and save money too! Savings ranging up to 40% or more off publishers' list prices.

BONUS BOOKS—You will immediately begin to participate in our Bonus Book Plan that allows you savings up to 70% off the publishers' prices of many professional and general interest books!

- **CONVENIENCE**—12-14 times a year (about once every 3-4 weeks) you receive the Club Bulletin FREE. It fully describes the Main Selection and Alternate Selections. A dated Reply Card is included. If you want the Main Selection, you simply do nothing—it will be shipped automatically. If you want an Alternate Selection—or no book at all—you simply indicate it on the Reply Card and return it by the date specified. You will have at least 10 days to decide. If, because of late delivery of the Bulletin you receive a Main Selection you do not want, you may return it for credit at the Club's expense.

As a Club member you agree only to the purchase of three books (including your first selection) during your first year of membership. Membership may be discontinued by either you or the Club at any time after you have purchased the first selection plus two additional books.

Other McGraw-Hill Book Clubs:
Architects' Book Club • Byte Book Club • Chemical Engineers' Book Club
• Civil Engineers' Book Club • Mechanical Engineers' Book Club

For more information, write to:
McGraw-Hill Book Clubs, P.O. Box 582, Hightstown, New Jersey 08520-9959

McGraw-Hill Book Clubs Electronics and Control Engineers' Book Club[®]

P.O. Box 582, Hightstown, NJ 08520-9959

Please enroll me as a member and send me the two books indicated, plus the HANDBOOK OF ELECTRONIC TABLES AND FORMULAS. I am to receive one book for just \$2.89, the other at the discounted member's price, plus local tax, shipping and handling charges. I agree to purchase a minimum of two additional books during my first year of membership as outlined under the Club plan described in this ad. I understand that a shipping and handling charge is added to all shipments.

Your FREE Handbook	
583804-4	
Write Code No. of the \$2.89 selection here	Write Code No. for the First selection here
<input type="text"/>	<input type="text"/>

Signature _____

Name _____

Address Apt. # _____

City _____

State _____ Zip _____

This order subject to acceptance by McGraw-Hill. All prices subject to change without notice. Offer good only to new members. Foreign member acceptance subject to special conditions. **E33937**

EVER WISH YOUR CHEAP PLASTIC-MODEL LOCOMOTIVE would run as smoothly as those expensive brass engines? Do your brass engines run poorly, because you have a budget power pack? Does your model railroad run like an inexpensive toy? Do your trains go from standstill to 60 miles-per-hour instantly when the throttle is opened? Do they skid to a halt when you brake or power down from 50 mph?

Well, Bucky, hold your head up high for here is a project that will help coax better running out of any locomotive. Now you will get *Ooohs* and *Aaahs* from visitors the instant that you throttle up!

That performance is made possible by using a model train speed-control unit ("throttle" or "power pack") based on a Motorola MC68705P3 Micro Computer Unit (MCU). You build it from the plans in this article. It is called the *Compu-Throttle*.

Having a microcomputer in the track circuit allows the operator to enjoy locomotive response to the throttle that duplicates the real thing. Now, the power output to the tracks using Compu-Throttle will be controlled precisely for optimum performance.

The author has been experimenting with the power control system for several years. The Compu-Throttle includes the *Handheld Control Box* with two pushbutton switches and a three position slide switch, plus the *Power Unit* with the remaining circuitry. The two units are connected by a four-wire cable. Hook-up to the track is via two wires, the same as

done with a regular power pack. The electronic circuit of Compu-Throttle has three major circuit divisions: Power supply, control circuitry, and power output. Each is discussed separately.

Power Supply Circuit

The primary purpose of the power-supply circuit for the Compu-Throttle is to provide a source of 16- to 24-volts DC for the output section to shape into controlled power that is supplied to the locomotive. The power-supply circuit also supplies +5-volt DC to run the computer and associated circuitry, and a +1.4-volt DC reference level. Refer to Fig. 1A. (Note: Figure 1 comes in three parts; 1A, 1B, and 1C. This was done for ease in preparing the text for circuit discussion.)

Bridge rectifier BR1 converts AC from transformer T1 (18 to 24-volt AC) to full-wave rectified DC, which is smoothed by capacitor C8. The electrolytic capacitor C8, is divided into two 1000- μ F units for physical-size reason only. A small amount of ripple on the 18-volt DC output signal does not matter, but the +5-volt DC regulated supply to the computer circuit must be clean. Resistor R13 and capacitor C5 provide additional filtering and isolation from any possible motor noise that may be coupled back into the regulated supply. Resistor R13 also helps reduce the amount of heating of chip U5. Voltage regulator U5 provides regulated +5-volt DC. Capacitor C6 helps reduce noise on the +5-volt DC supply bus. Resistors R11 and R12 form a voltage divider to provide a

PLAYING ON THE RAILROAD WITH COMPU-THROTTLE

A single-chip microcomputer assists in procuring maximum performance from your model railroad locomotives.

By Eric W. Brom

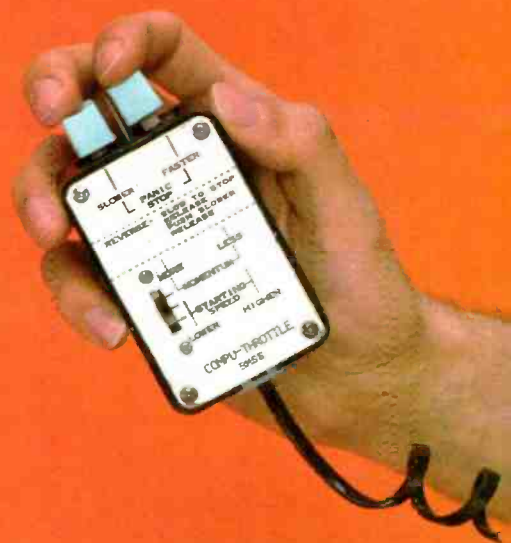

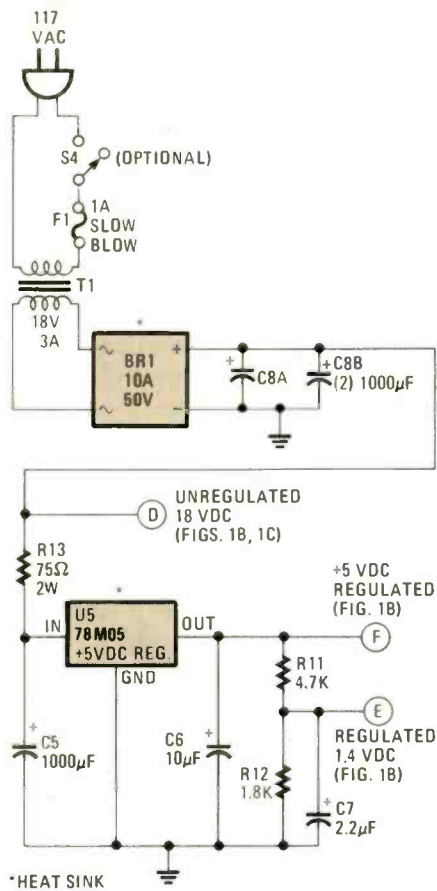

Fig. 1A—The Compu-Throttle's schematic diagram is served up in three functional parts. The circuit shown above is for the power-supply circuit that powers the other two sections.

+1.4-volt DC reference for U2, and capacitor C7 helps stabilize it. C1, C2, and C3, located near U1, U2, and U3, respectively, provide supply decoupling from noise spikes generated in each IC chip—U1 through U4.

Control Circuitry

The control circuit for the Compu-Throttle (refer to Fig. 1B) consists primarily of the Motorola MC68705P3 micro-computer unit, U1 (MCU). It reads the inputs from the control switches through U3, and provides output signals which are amplified and shaped by U2 and U4. To keep the number of wires between the Power Unit and the Handheld Control Box switches to a minimum, they are scanned.

Wires 1 and 2 are outputs, while 3 and 4 are inputs. The wires are part of a telephone cable that normally connects between the telephone main housing and the handset. The cable has four wires that are color coded. You can select a coiled-cord version that can stretch up to 20 feet or more. This cable can be purchased almost anywhere—even food supermarkets carry them.

There are two parts to the scan cycle. First, wire 1 is set high and wire 2 is set low (U1: pin 22-low, pin 23-high). The inputs (wires 3 and 4) are held low by resistors R5 and R6. The MOMENTUM switch, S3, is a two position switch with a center-off return position. If the MOMENTUM switch, S3, is pushed, D2 will be forward biased, making U1 pin 20 low. Similarly, if the UP switch is pushed, D3 conducts, making U1 pin 21 low. Since wire 2 is low, D4 cannot be forward biased, even if the Down switch is pushed. When the computer has read the inputs, it makes wire 1 low and 2 high. Now the STARTING SPEED and DOWN switches can forward bias D2 and D4, so the computer can read them. Resistors R3 and R4 ensure that the input levels to U3 are high enough.

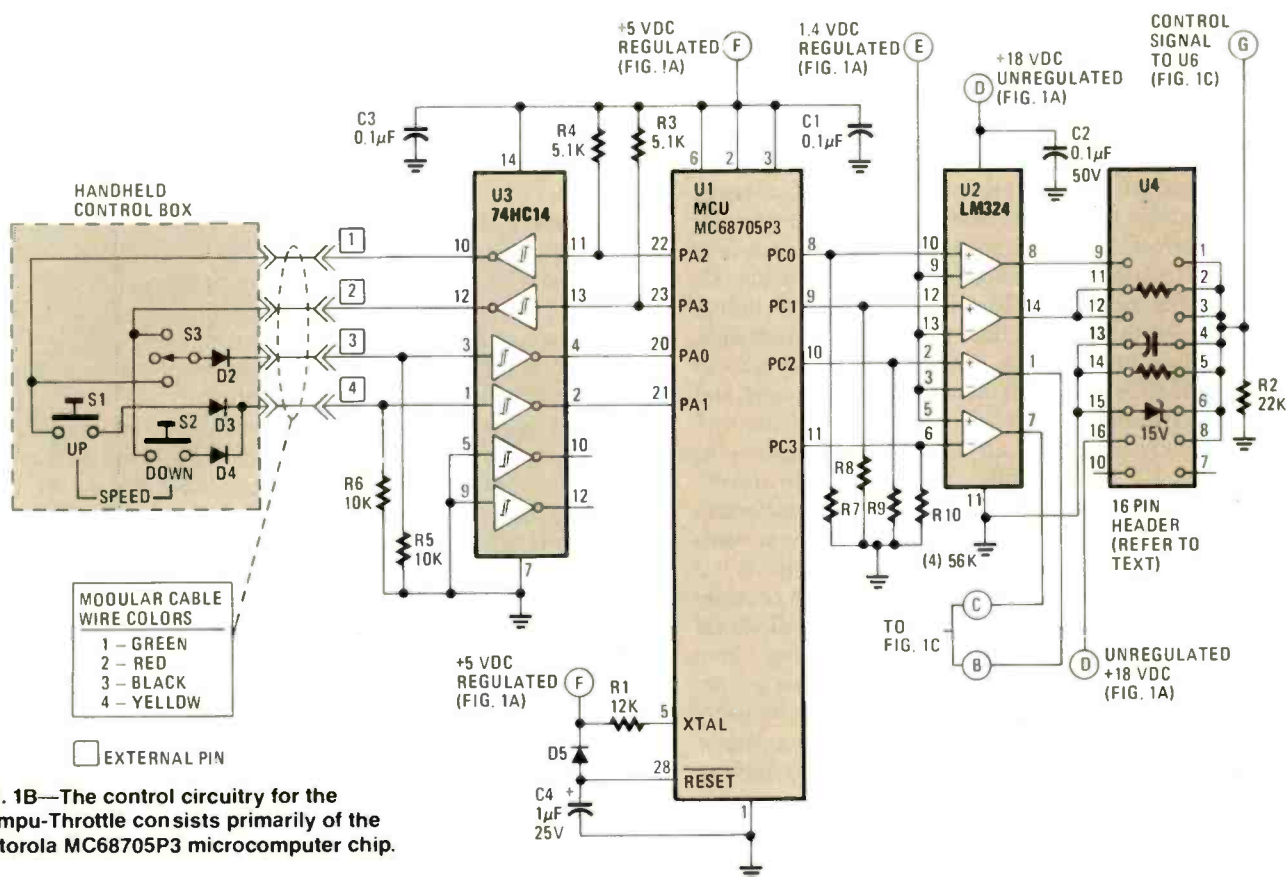

Fig. 1B—The control circuitry for the Compu-Throttle consists primarily of the Motorola MC68705P3 microcomputer chip.

circuit complexity and cost. Semiconductors U6, U5, BR1, and Q1 through Q4 dissipate enough heat to need heatsinking. If you are using the printed-circuit board (refer to the Parts List and Figs. 9 and 10.) specified in this article, these components are all along one edge so they can be mounted on a common heatsink. They must be electrically isolated from each other, so insulation must be used. The leads may have to be bent to provide an offset if the bodies do not extend far enough to reach the heatsink. There are several ways to handle BR1: It could be mounted on the printed-circuit board with its own heatsink or an angle bracket to the main heatsink; it could be mounted flat against the heatsink and the leads bent and soldered into the board; or it could be mounted off-board on another heatsink and the rectified output connected to the + and - pads on the board. If bridge rectifier BR1 is mounted flat on the board, a hole may have to be drilled in the printed-circuit board for a mounting screw to pass through.

If you are using the printed-circuit board and make it either from scratch or the template supplied in this article, inspect it carefully for shorted and broken traces before starting on the assembly.

Some components cover others, so the order of assembly is important: 1. Jumper wires (four). 2. IC's or IC sockets, 3. resistors, 4. diodes and bridge rectifier, 5. capacitors, and 6. transistors and voltage-regulator chips.

If you decide to use modular telephone cables as suggested, be careful: Modular telephone cords contain two pairs of wires, the first is the red and green wires, the second

is the black and yellow wires. For a reason unknown to the author, most cords reverse the two wires of each pair. This can lead to some confusion when using them in non-telephone applications. Although the actual choice of wire colors is not important, wiring it as suggested will maintain compatibility between all units built. One sure technique is to ring out the telephone cable and number each of the corresponding ends 1 through 4.

Installing the program in an MC68705P3 requires either a Motorola EVM board (about \$500) or a small board which copies the program from a 2764 EPROM. Since most readers probably do not have this equipment, the microcomputer chip U1 is offered pre-programmed (See Parts List). If you do have the equipment and wish to program the chip yourself, please contact the author.

Handheld Control Box

The Handheld Control Box is the *user interface* for the Compu-Throttle. Each builder will probably prefer something a little different, so only general notes are presented here. Several factors must be considered:

1. Size and shape factor of box. Because of the small number of components, almost any size box can be used.

2. Button feel! Since the buttons are pushed frequently, light touch, reliable buttons should be used. The author prefers the computer keyboard type which actually have several sets of contacts that come together when the key is pushed (bifurcated).

3. Since pushing both buttons (S1 and S2) activates the

PARTS LIST FOR THE COMPU-THROTTLE

SEMICONDUCTORS

- BR1—10-A, 100-PIV, silicon, bridge rectifier
 D1—5-A, 200-PIV, silicon diode
 D2—D5—1N914 silicon, small-signal diode (or equivalent)
 LED1—Light-emitting diode, tri-color
 Q1—Q3—TIP126 5-A, 80-volt, PNP, Darlington power transistor (or equivalent)
 Q2—Q4—TIP121 5-A, 80-volt, NPN, Darlington power transistor (or equivalent)
 U1—Motorola MC68705P3 MCU integrated circuit with program installed. See text and ordering information below.
 U2—LM324 quad op-amp integrated circuit
 U3—74HC14 or 74C14 CMOS hex Schmidt trigger inverter integrated circuit
 U4—16-pin DIP header with wave-shaping circuit components (see text)
 U5—7805 or 78M05 +5-volt, fixed, voltage regulator integrated circuit
 U6—LM350T 3-ampere, adjustable, voltage regulator integrated circuit

RESISTORS

- (All fixed resistors are 1/4-watt, 5% or 10% units except as noted)
 R1—12,000-ohm (See note in Initial Checkout and Testing text section)
 R2—2000-ohm
 R3, R4, R14, R17, R18, R21—5100-ohm
 R5, R6—10,000-ohm
 R7—R10—56,000-ohm
 R11—4700-ohm
 R12, R15, R16, R19, R20—1800-ohm
 R13—75-ohm, 2-watt, 10%

R23—1000-ohm

R24—470-ohm

CAPACITORS

- C1, C2, C3—0.1- μ F, 100-WVDC, miniature ceramic disc
 C4—1- μ F, 50-WVDC, Tantalum
 C5—1000- μ F, 35-WVDC, electrolytic
 C6—10- μ F, 50-WVDC, electrolytic
 C7—2.2- μ F, 35-WVDC, electrolytic
 C8A, C8B—1000- μ F, 50-WVDC, electrolytic
 NOTE on C5 and C8: The published circuit board layout is designed for Panasonic SU Series with axial leads.

ADDITIONAL PARTS AND MATERIALS

- F1—Fuse, 1-A, 250-volt, slow blow and holder
 J1, J2—RJ11 4-conductor, modular, telephone jack (line cord size)
 S1, S2—Keyboard-type pushbutton switch
 S3—Single-pole, double-throw, center-off toggle or slide switch
 T1—Power transformer, miniature: 117-volt AC primary winding; 18- to 24-volt, 3-A secondary winding
 AC line cord, modular phone cord, printed-circuit board materials, IC sockets (if desired), suitable enclosures for Power Unit and Handheld Control Box, hardware, decals, wire, solder, etc.

The following parts are available from Brom Microsystems Engineering, Box 616, Winona, MN 55987. VISA/MC accepted.

High-quality etched and drilled printed-circuit board with silk-screened parts placement diagrams—\$7.00; MC68705P3 microcomputer chip U1 with program installed in EPROM—\$23.00; kit of above plus all parts on PC board, IC sockets, LED1, and R24—\$75.00. Please add \$1.00 per order for shipping.

panic stop function, some provision should be made to keep **one finger** from accidentally pushing both. Wide spacing, or a piece of plastic between the buttons can prevent this.

4. Since the Handheld Control Box may be dropped occasionally, durable switches should be used.

5. Durability is also a factor in selecting the slide switch. A "Bat handle" toggle switch takes quite a beating. A slide switch with well defined detents works well.

6. A piece of self adhesive "Velcro" on the back makes a convenient way of hanging the Handheld Control Unit on the edge of the layout. The Handheld Control Unit does not have to be handheld, the same buttons could be mounted in a panel attached to the layout. When the Handheld Control Box is hanging on the side of the layout, it can be used without detaching it.

Initial Checkout and Testing

Since the most common problems will probably be short circuits between traces of the printed-circuit board wiring; and improperly installed components, check everything over carefully. This will save much time later. The author prefers to perform initial checkout in stages. The entire circuit should be built up, but the three IC's left out. Power can now be

applied for the *smoke test*. With power applied, check to see that the +5-volt (4.75- to 5.25-volt) and +1.4-volt (1.2- to 1.6-volt) power supplies are operating correctly.

The output to the tracks may be slightly turned on due to the lack of drive. Resistor R2 helps keep U6 off when the header or U2 are out.

Now remove power and install U2 and the header, then apply power again. The output should now be off. The output circuit can be tested, if desired, by pulling pins of U2 high. See Table 1. Chip U3 and the Handheld Control Box can be tested by applying various levels to U2. See Table 2.

If all is satisfactory thus far, then remove power, install U1, and reapply power. The first test of the CPU is to put a voltmeter or logic probe on U1 pin 27, which is a squarewave with a period of 10 seconds (high for 5 seconds, then low for 5 seconds). This signal can be probed with a voltmeter. If it is present, the CPU is running. The period will be exactly 10

TABLE 1—OUTPUT LOGIC

Conditions				Output	
				Test Point	
US Pin 12	U2 Pin 10	U2 Pin 5	U2 Pin 2	5	6
+ Volts DC				Signal Level	
0	0	X	X	Low	Low
X	X	5	0	Low	Low
5	5	0	0	Low	High
5	5	5	5	High	Low
5	5	0	5	High	High

Connect a 1000-ohm, 1/2-Watt resistor across the output terminals. A Low level will be 3 volts or less, a High level will be approximately the Zener (on the header) voltage. X indicates either a Low or a High.

COMPU-THROTTLE FEATURES

Easy to use: The locomotive engineer does not have to be an electrical engineer, too.

Easy to set up: Small enough so that it is easy to carry to a show, hooks up just like a regular power pack.

Economical to build: The cost does not outweigh the features.

Walk-around hand control: The Handheld Control Box that the operator uses is a small box with 2 pushbuttons and a slide switch, connected to the main unit with a 4-wire modular telephone cable.

Memory: If the Handheld Control Box is unplugged from the Power Unit for any reason, the train continues at the same speed. *half Momentum:* An adjustable amount of momentum is provided to simulate different length trains.

Starting speed adjust: Since most engines will not start until approximately 5-volts DC is applied to the track and each locomotive is different, the system allows the starting voltage to be adjusted.

Choice of pulse power, pure DC, or any combination: The output waveform can be changed from pure pulse power to pure DC, or any combination in between, just by changing a few parts, which are mounted on a DIP header. When pulse is used, it is low frequency at low speeds, providing very smooth starts and stops, but a higher frequency at higher speeds reducing unnecessary heating.

Reliable operation: The fewer components in the circuit, the better. The single-chip computer design helps this. The voltage regulator that controls the output contains internal protection that makes it almost impossible to destroy. LM350 regulators have been used from the beginning and one has yet to burn out in operation.

Usable with all model scales: Almost any electrically powered model train can be operated, from Z gauge to HO to G gauge (LGB), as long as the Compu-Throttle's ratings are not exceeded. Even older "toy" trains that normally run on AC can be run, except that reversing them may be different than with DC powered trains. (Minor adjustments to the output wave-shaping circuit may be needed for optimum operation).

TABLE 2—KEYBOARD SCAN LOGIC

Conditions	Switches				Outputs	
	U3 Pin 11	U3 Pin 13	UP	DOWN	Momentum	St. Spd.
U3 Pin 11	5	0	0	0	0	0
U3 Pin 13	5	5	5	5	5	5
UP	X	0	0	0	0	0
DOWN	X	X	X	X	0	0
Momentum	X	0	0	0	0	0
St. Spd.	X	X	X	X	0	0
U3 Pin 11	5	0	0	0	0	0
U3 Pin 13	5	5	5	5	5	5
UP	X	0	0	0	0	0
DOWN	X	X	X	X	0	0
Momentum	X	0	0	0	0	0
St. Spd.	X	X	X	X	0	0
U3 Pin 11	5	0	0	0	0	0
U3 Pin 13	5	5	5	5	5	5
UP	X	0	0	0	0	0
DOWN	X	X	X	X	0	0
Momentum	X	0	0	0	0	0
St. Spd.	X	X	X	X	0	0

Note: O = Open, C = Closed, X = Either

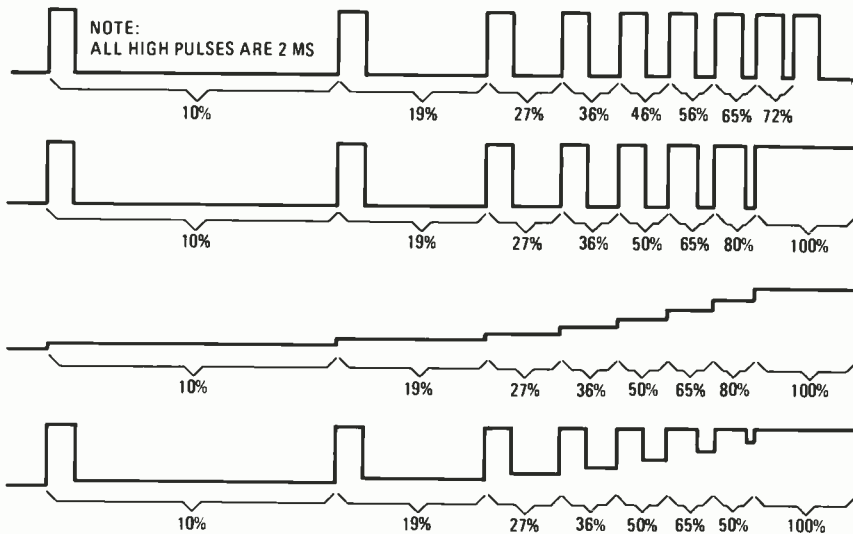

Fig. 2—Several waveforms can be generated by reconfiguring the components on the DIP header referred to as U4 in Fig. 1C. Above, a pure pulse output using just the main pulse output. For the header circuit, refer to Fig. 6.

Fig. 3—In the above graph, a pure pulse output using just the average pulse output derived from the circuit in Fig. 6.

Fig. 4—Either pulse output (in Figs. 2 and 3) may be filtered with a resistor and capacitor (see Fig. 7) into a pure DC voltage. This is similar to many "transistor throttles" that are currently on the market.

Fig. 5—The circuit shown in Fig. 8 provides a combination of pulse and DC power shown above. The main-pulse output is used to provide a full-voltage pulse while the average-pulse output is used to provide the DC component.

seconds if the CPU clock frequency is 4 MHz, so even a voltmeter can be used to determine the exact operating frequency of the CPU. The value of R1 needed to produce 4 MHz varies from resistor to resistor. If the value is too low, the oscillator may not run. If this is the case, the value of R1 may need to be changed. Start by substituting about a 22,000-ohm resistor in place of the 12,000-ohm unit. This will probably result in too low a clock frequency. The resistance value can then be lowered until the correct frequency is obtained. The actual operating frequency is not critical, so anything close to 10 seconds will do. If the frequency is too high (squarewave period less than 10 second) with the 12,000-ohm resistor, the CPU might run erratically, so it would be wise to increase the resistance value.

Pin 19 of the CPU presents the results of the checksum test of the EPROM. If no error is found, this pin will be low. If an error is found, it will be high. If an error is indicated, the output pin could be bad, or one or more bytes of EPROM may have the wrong values. Do not be afraid to try using the chip anyway, as the error may not cause a problem.

Since the keyboard is scanned, it is difficult to test that area of the circuitry with the MCU installed. Instead, 4 output bits



The compu throttle's control cord plugs into the front of the unit using a normal modular telephone cord.

contain the results of the scanning. Each bit will be high if the corresponding switch is pushed; low, if not pushed:

(Continued on page 98)

OPERATOR INSTRUCTIONS

SPEED UP

1. Make sure the slide switch (S3) is in the center position. 2. Push the Up button (S1). 3. As long as the Up button is held, speed will increase until maximum speed is reached.

SLOW DOWN

1. Make sure the slide switch (S3) is in the center position. 2. Push the Down button (S2). 3. As long as the Down button is held, speed will decrease until the train has stopped.

PANIC STOP

1. Make sure the slide switch (S3) is in the center position. 2. Push the Up and Down buttons (S1 and S2, respectively) simultaneously. 3. The train will stop immediately. 4. Release both buttons.

CHANGING DIRECTION

1. Make sure the slide switch (S3) is in the center position. 2. Bring the train to a stop. 3. Release all buttons. 4. Push, then release, Down button (S2).

NOTE: The train may stop before the output is completely off, which will prevent reversing. In this case, hit PANIC STOP (both Up and Down buttons) once the train has stopped, then reverse.

ADJUSTING STARTING SPEED

1. Set the slide switch (S3) to the STARTING SPEED position. 2. Using the Up and Down buttons (S1 and S2, respectively), adjust the speed so the train is just about to start. 3. Set the slide switch back to the center position. 4. This speed is now the lowest speed above stop.

ADJUSTING MOMENTUM

1. Set the slide switch (S3) to the MOMENTUM position. 2. To increase the momentum (slower rate of acceleration/deceleration) hold the Down button (S2) for a few seconds. 3. To decrease the momentum (faster rate of acceleration/deceleration) hold the Up button (S1) for a few seconds. 4. Set the slide switch to the center position. 5. Operate the train. 6. Repeat the above steps until the desired amount of momentum is reached.

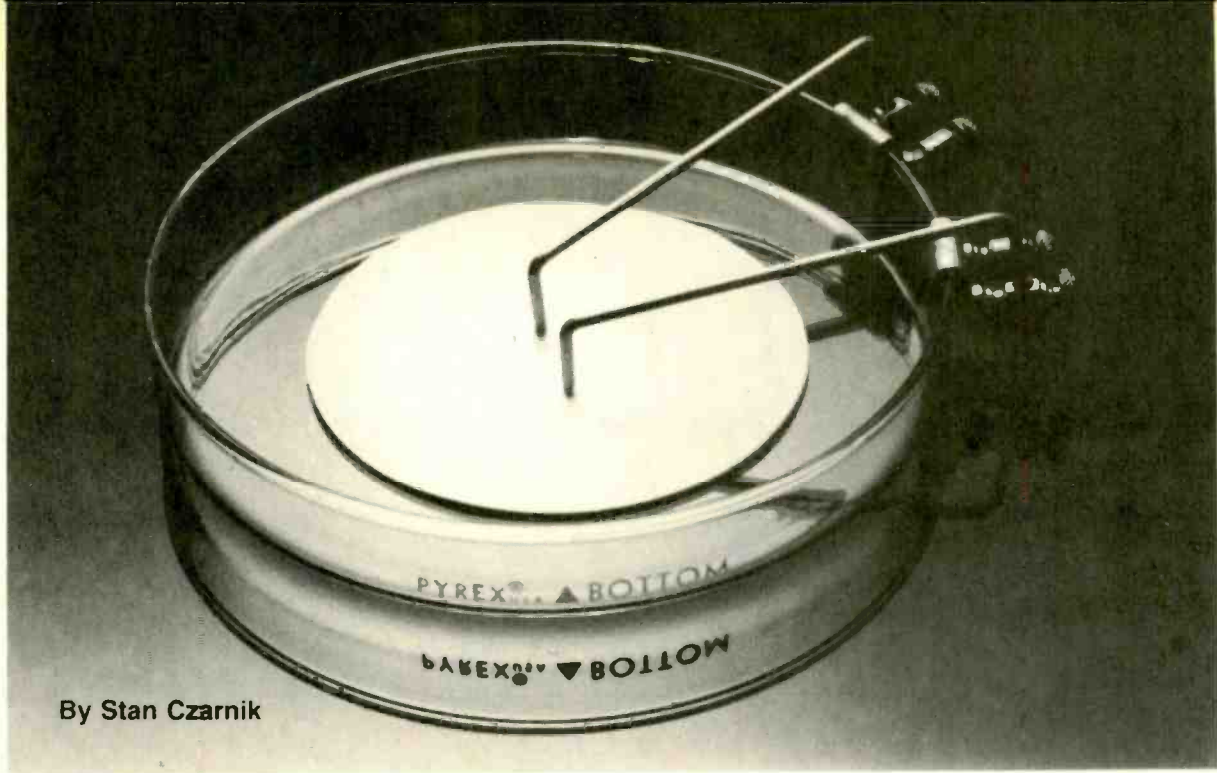

By Stan Czarnik

CHEMICAL POLARITY EXPERIMENT

Lets face it, electronics is a science and science is becoming all electronic. To prove it, try this simple multimeter test to determine chemical properties

☐ PHENOLPHTHALEIN IS A MEMBER OF A LARGE CLASS OF substances known as indicators. Indicators signal the presence, absence, or concentration of other materials by means of some detectable change, often a change in color. Phenolphthalein is colorless in the presence of neutral or acid solutions but turns a bright pinkish red in the presence of an alkali (basic) solution.

With some phenolphthalein, some alcohol, some salt, a dish, and a few odds and ends from the junkbox you can build a simple polarity meter and learn something about electrochemistry besides. Where will the phenolphthalein come from? That's easy. It's the active ingredient in Ex-Lax.

Obtain a small glass dish or bowl with steep sides. The piece of hardware in the photograph is a laboratory culture

dish; but any sort of dish will do fine. Place a circle of filter paper or paper towel in the center of the plate. Run two lengths of stiff wire or narrow metal rod from the surface of the towel to a couple of binding posts. A couple more terminals may be added to facilitate wiring (Photo 2). The ends of the contact rods should be approximately one inch apart. It is not necessary to attach the terminals to the dish; they can be located elsewhere, on a block of wood, for example.

Now crush a single Ex-Lax tablet with the round end of a large screwdriver or something similar. Dissolve the powder in one ounce of solvent alcohol. Be careful, solvent alcohol is very flammable. In another container, dissolve one-half tea-

(Continued on page 108)

PARTS LIST FOR THE CHEMICAL POLARITY EXPERIMENT

- Glass dish
- Ex-Lax tablets (Phenolphthalein)
- Filter paper or paper towel
- Solvent alcohol
- Table salt (Sodium Chloride)

Two short lengths of stiff wire or narrow metal rod, binding posts, hook-up wire, and low voltage DC power source.

For those of you who may want to use genuine laboratory chemicals and glassware, the author recommends: Hagenow Laboratories, 1302 Washington, Manitowoc, Wisconsin (catalog \$1.00) and Chem-Lab, 13814 Inglewood, Hawthorne, California 90250 (chemical catalog \$3.00, equipment catalog \$4.00, both for \$5.00).

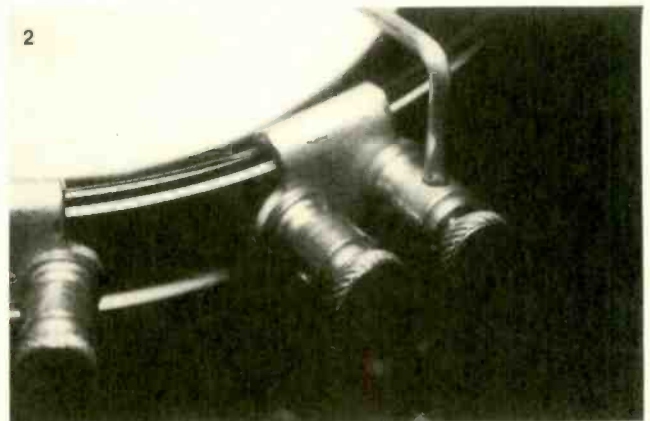

In this version of the device small metal brackets support two binding posts, one to hold the contact rod, the other for connection to DC power source. These neat vintage terminals were found at a flea market.

DELIVERY INDICATOR

Know at a glance that your mail or daily newspaper has been delivered with this simple tilt-triggered circuit.

By Dennis Eichenberg

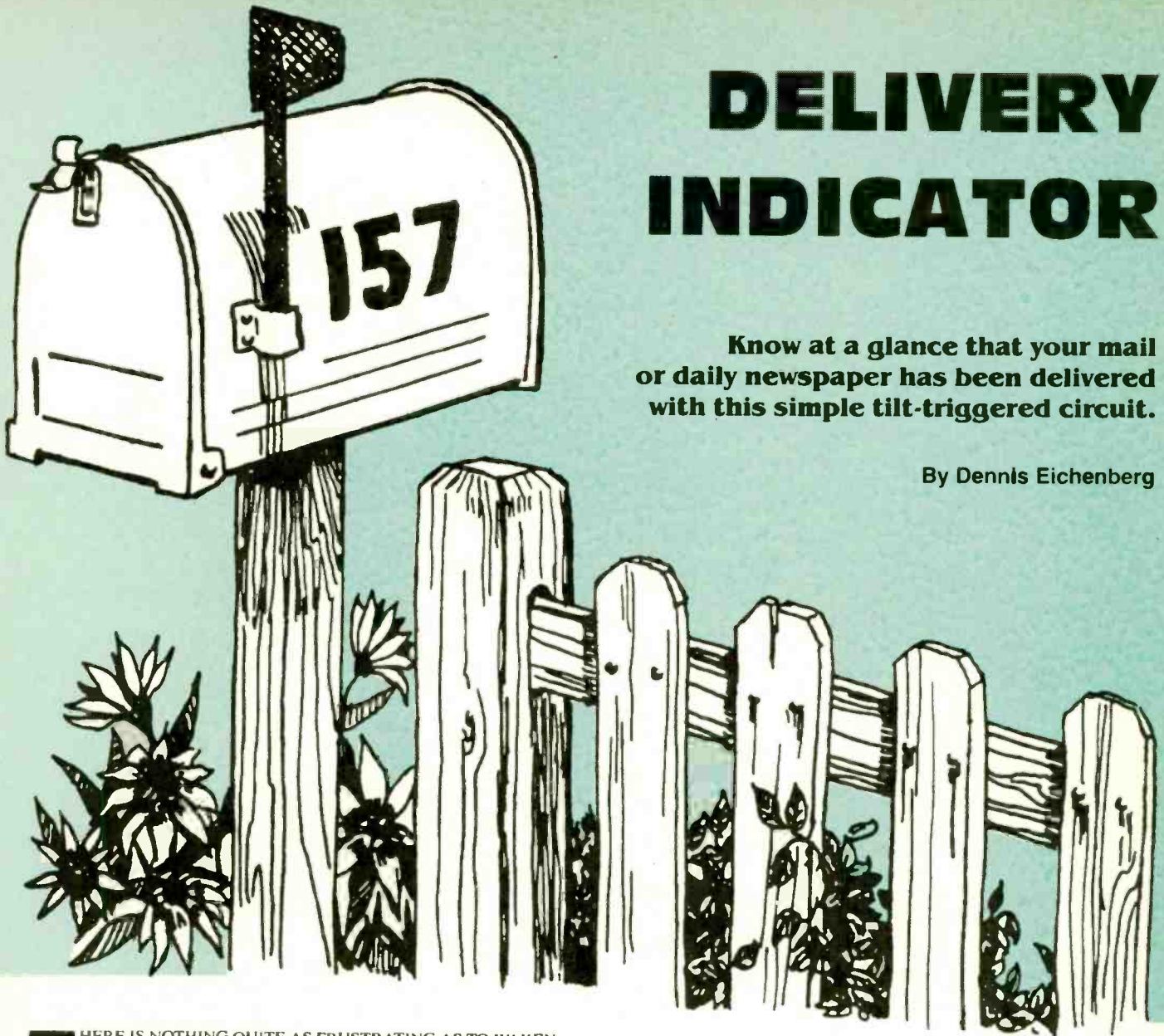

THERE IS NOTHING QUITE AS FRUSTRATING AS TO WAKEN on a cold rainy morning, open the front door, go outside and open the newspaper delivery box, only to find that the newspaper has not yet been delivered. That's a scenario that is repeated several times daily in many households. But, fortunately, there is a solution—*Delivery Indicator*.

The Delivery Indicator is a circuit that can be used to report that your newspaper or mail has been delivered by means of a flashing LED installed within the home. Once the delivery is retrieved, you only have to push a reset button to prepare the circuit for the next event.

The Indicator requires only one integrated circuit, a diode, LED, and a few passive support components, all of which are inexpensive and readily available. So the entire project can be built for less than ten dollars.

Circuit Description

The schematic diagram of the Delivery Indicator is shown in Fig. 1. A single 9-volt battery (B1) provides all of the power required by the circuit. The circuit was designed to be as efficient as possible, thereby maximizing battery life.

The heart of the circuit is U1, a 4001 CMOS quad 2-input NOR gate. A CMOS logic device was selected specifically because of its low-power requirement. Two of the NOR gates,

U1a and U1b, are configured as a positive edge-triggered flip-flop. The edge-triggered configuration is used to avoid disallowed state conditions. The resistor-capacitor networks (R2/C1, and R4/C2) provide a 20-microsecond pulse to accept the input from the switches and prevent a disallowed state from occurring.

Resistors R1 and R3 are pull-down resistors, which provide a low-state input in the absence of a switch closure. Switch S1 is a momentary pushbutton switch that is used to reset the flip-flop. A Mercury tilt switch (S2) is used to indicate that a delivery has occurred, by setting the output of the flip-flop to a low state.

The output of the flip-flop is fed to the input of a gated astable multivibrator that is comprised of U1c and U1d. A high flip-flop output prevents the multivibrator from oscillating, while a low output permits oscillation to occur. The output waveform of the astable multivibrator is dependent upon the following:

$$T_{HI} = (1.1)(R6)(C3)$$

$$T_{LO} = [(1.1)(R5)(R6)(C30)] / (R5 + R6)$$

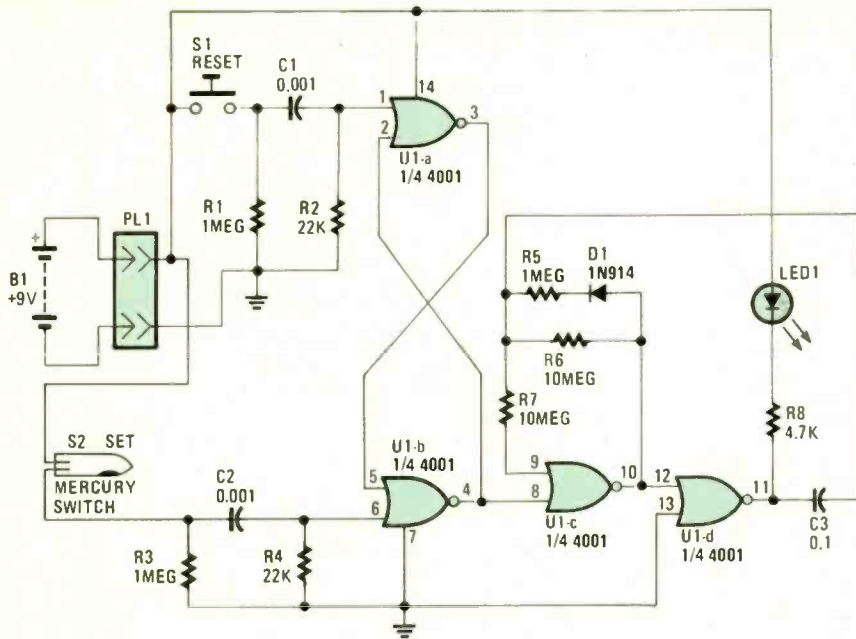

Fig. 1—The heart of the circuit, U1, is used to form a positive edge-triggered flip-flop and a gated astable multivibrator. A couple of resistor-capacitor networks (R2/C1, and R4/C2) provide a 20-microsecond pulse to accept the input from the switches and prevent a disallowed state to occur. A single 9-volt battery (B1) satisfies all of the power requirements for the circuit.

The LED is illuminated when the output of the astable is high and goes dark when the output of the astable is low. The on and off times of the LED were selected to provide a minimum "on" time and a maximum "off" time to conserve battery power. The on/off times based on the component values shown in Fig. 1 are given by substituting the actual component values for the designations in the above equations; for example:

$$T_{\text{OFF}} = (1.1)(10^7)(.1^{-6}) = 1.1 \text{ seconds}$$

$$T_{\text{ON}} = [(1.1)(10^6)(10^7)(.1^{-6})]/(10^7 + 10^6) = .1 \text{ seconds}$$

Resistor R7 is included to provide a cleaner squarewave output than is possible without it. The value of R7 is determined by:

$$R7 = [(10)(R5)(R6)]/(R5 + R6)$$

The value of R7 based on the values of R5 and R6 given in Fig. 1 is:

$$R7 = [(10)(10^6)(10^7)]/(10^7 + 10^6) = 9.1 \text{ megohms}$$

The nearest common value is 10 megohms, which is the value selected for R7 (as revealed in Fig. 1).

The LED selected was specified primarily because of its low-power requirement. The Hewlett Packard HLMP-1700 LED requires approximately 10 mA. The current-limiting resistor, R8, is selected to provide the maximum current required by the LED, and its value can be calculated according to the following expression:

$$R8 = (V_{\text{source}} - V_{\text{LED}})/I_{\text{LED}}$$

or in more practical terms,

$$R8 = (9 - 2)/10^{-3} = 700 \text{ ohms}$$

Although there several standard resistor values between 700 and 1000, R8 is selected as 1000 ohms, which serves to reduce current drain. If the circuit is built using the HLMP-1700 LED, the standby current is 0.005 mA. A standard carbon 9-volt battery can provide close to 80 mA hours.

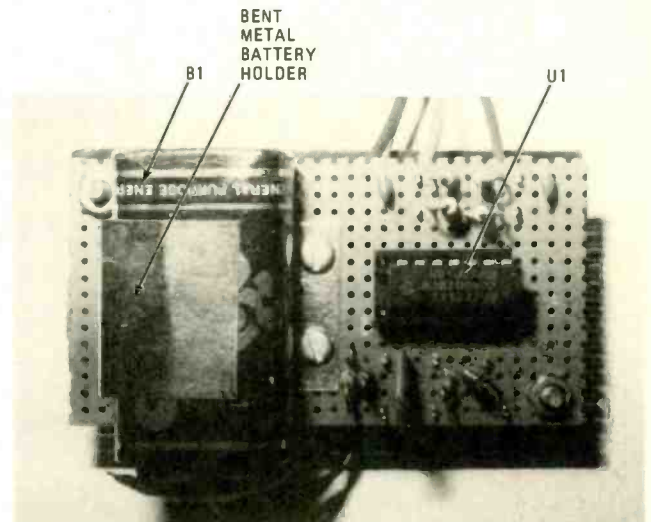

The author's prototype of the Delivery Indicator was built on a piece of perfboard, measuring about 3 × 1.5 inches. A home-made battery holder secures the battery to the board. Short lengths of wire connect the circuit to the LED and S2, which are mounted off-board in some convenient location.

The life of the battery in standby mode is:

$$80 \text{ mAH}/0.0005 \cdot 3 = 1.6 \times 10^4 \text{ hrs, or 1.83 years}$$

Note: You may substitute with a standard red LED, but R8 must be changed to 1000 ohms. Using a standard LED will only reduce the battery life significantly if the LED is flashing for long periods. A long-life battery can be substituted for the standard type specified if battery life is a significant problem.

Construction

Construction of the Indicator is non-critical; therefore, any construction technique may be used. Radio Shack parts (which are also available through other suppliers) were selected wherever possible for convenience. The unit was built on standard perfboard (having a 0.100 × 0.100-inch grid pattern) using point-to-point wiring.

PARTS LIST FOR THE DELIVERY INDICATOR

B1—9-volt, transistor-radio battery
 C1, C2—0.001- μ F, 50-WVDC, ceramic disc capacitor
 C3—0.1- μ F, 50-WVDC, ceramic disc capacitor
 D1—1N914 general-purpose, small signal silicon diode
 LED1—Light-emitting diode, red, high efficiency (Hewlett Packard HLMP-1700)
 PL1—9-volt transistor-radio battery connector
 R1, R3, R5—1-Megohm, $\frac{1}{4}$ -watt, 5% resistor
 R2, R4—22,000-ohm, $\frac{1}{4}$ -watt, 5% resistor
 R6, R7—10-Megohm, $\frac{1}{4}$ -watt, 5% resistor
 R8—4700-ohm, $\frac{1}{4}$ -watt, 5% resistor
 S1—Subminiature, single-pole, single-throw, normally-open, momentary-contact pushbutton switch
 S2—Mercury switch (5A at 125 VAC)
 U1—4001 quad 2-input NOR gate, integrated circuit
 Perfboard, 14-pin (wire-wrap type) IC socket, No. 26 AWG wire, spacers, screws, nuts, washers, solder, duct tape, RTV electrical tape, door knob, double-faced tape.

To minimize the size of the completed project, 6-inch wire leads were provided to splice into the LED and switch wiring, rather than to provide a separate connector. The circuit should be built as small as possible to facilitate installation.

The perfboard was mounted on standoffs from a second board of the same size to provide a flat mounting surface. Care should be taken when handling U1 because it is a CMOS device, which is inherently sensitive to static discharge. Do not handle U1 by its leads and keep it in its container prior to installation. Do not solder directly to U1; instead use the socket recommended in the Parts List.

Installation

The home in which the Delivery Indicator was installed has a mail chute as shown in the photos, which makes an excellent location for installation of the unit. Double-faced tape was used to mount the circuit to the side wall of the chute, with board located near the inside mail-chute door to facilitate battery replacement.

The knob on the inside mail-chute door was replaced with a larger knob which could accommodate the LED and reset switch more easily than the original knob, as shown in the photos. The reset switch was mounted into a hole countersunk on the front and rear of the knob to make the switch less obtrusive. The switch was brought in from the rear of the knob and secured in place. The LED was mounted into a countersunk hole from the rear of the knob. It was retained in the knob by RTV adhesive silicon sealant.

The knob was mounted on the mail-chute door by a screw located at its center. The leads for the reset switch and the LED were brought through two holes drilled through the mail-chute door, one on each side of the center mounting screw.

Lengths of number 26 AWG wire were soldered to the reset switch and LED, and brought back to the circuit board. Only three wires are required because the +9-volt source is common to both the switch and the LED. Duct tape was used to retain the wires in place once they were properly routed. Care was taken to provide enough slack in the wires to permit the mail-chute door to swing freely.

The set switch is installed on either the outdoor newspaper-

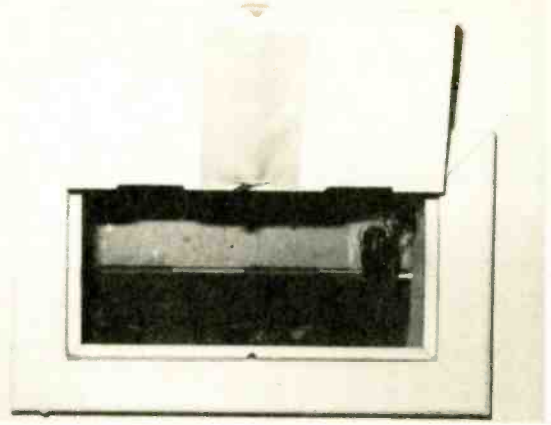

The author's prototype of the Delivery Indicator is shown here installed in a built-in-the-wall type mail chute.

box door, or outdoor mail-chute door, or both as desired. The set switch, a Mercury tilt switch, must be installed properly to permit correct operation. Observe the motion of the door carefully. Follow the same motion with the switch in hand. From that exercise determine the proper mounting angle to ensure that the mercury makes contact with the door open and breaks contact with the door closed. A shim may be required to provide the proper mounting orientation. The switch is held in place by duct tape.

Two number 26 AWG wires are routed from the mercury switch to the mail chute and to the circuit board. If more than one mercury switch is used, each switch is wired in parallel with the others.

Once a delivery has been made, the LED will begin flashing. The flashing will continue regardless if the delivery door is re-closed or left open.

The mail or newspaper is received and the reset switch is depressed to shut off the LED and prepare for the next delivery. ■

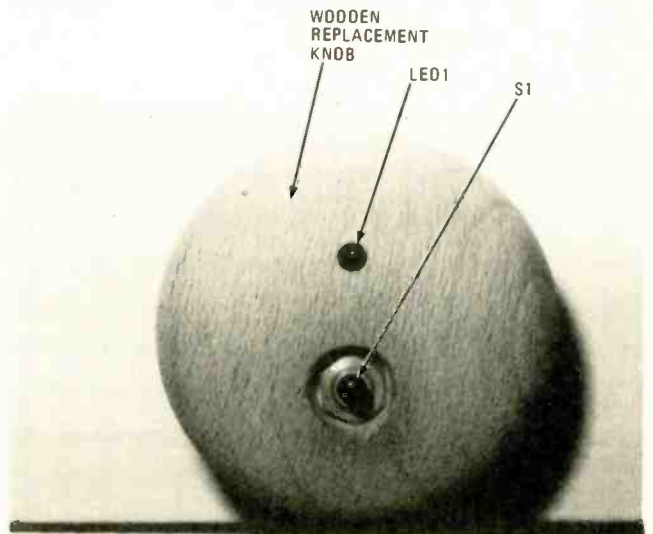

The Delivery Indicator—consisting of a single CMOS integrated circuit, a diode, LED, and a few passive support components—is intended to convey that your newspaper or mail has been delivered. Once the delivery is retrieved, pressing the reset button prepares the circuit for the next event. The author's prototype was mounted in a mail chute, with LED1 and S1 mounted (recessed) in a wood doorknob. The Mercury switch, S2, is mounted to the outside door of the mail chute so that when a delivery is made, the circuit is triggered.

THE UKI OKI PRINTER SWITCH

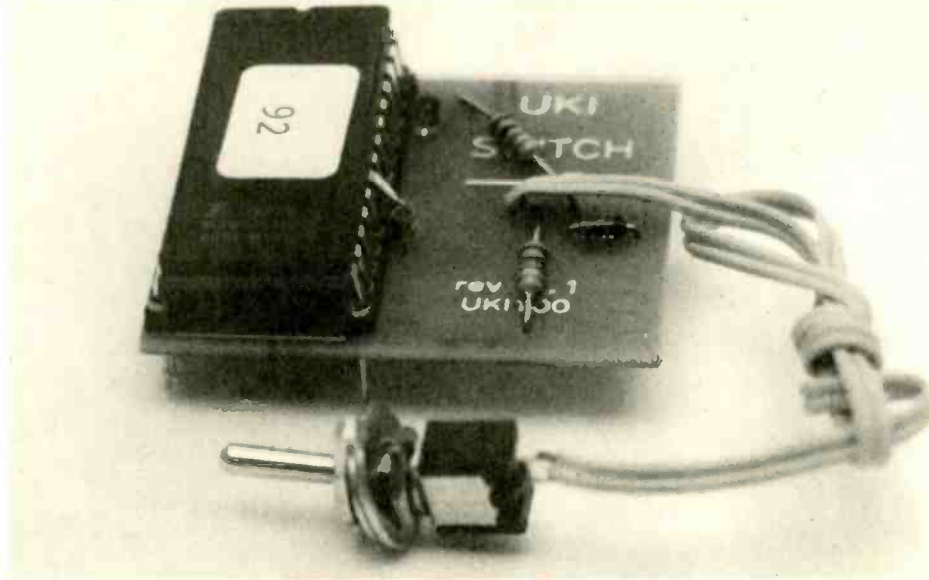

Get use out of both the IBM and Okidata character sets with a switch that adds greater capacity to your printer setup.

By Jeff Holtzman

□ OKIDATA PRINTERS HAVE LONG BEEN OF THE HIGHEST QUALITY, inexpensive, and well-supported by most major applications programs, including both word processors and graphics programs. Advantages include rock-solid construction, user-defined character sets, and high-quality graphics.

In fact, the only real disadvantage of early Oki printers was incompatibility with the IBM graphics printer. Okidata soon realized that fact and introduced an upgrade option that allowed owners of the original Microline 92 and 93 models to attain IBM compatibility.

Later models provided similar options. Installation was a snap: remove an EPROM or two, depending on the model, and install the new EPROM (or two), known as the *Plug 'n' Play* kit.

The only problem was that by gaining IBM compatibility, you lost Okidata compatibility—and many software packages were written for the Okidata printer standard before IBM introduced its own printer. So you had to choose: IBM or Okidata. Otherwise, if you wanted to print something in the non-installed mode, you ended up physically switching EPROM sets. And obviously that's a real hassle.

Articles in computer magazines suggested a solution: burn the contents of both EPROM sets into one large EPROM, and use a switch to select IBM or Okidata mode. The problem was that many people simply didn't have the necessary equipment or expertise to do the job.

So the UKI Switch Corporation (326 Linden Place, West Hempstead, NY 11552) came to the rescue. The company offers a small plug-in circuit board with an EPROM contain-

ing both the Okidata command set and the IBM Plug 'n' Play options. This means that if you have an Okidata printer with just the Oki command set, you don't have to buy the Plug 'n' Play option from Okidata separately. UKI sells different configurations for various models, including the Microline 83, 92/93, and the 192/193.

Installation

Installation is simple, but requires care. The UKI EPROM is mounted on a small circuit board that bridges both EPROM sockets on the Okidata's circuit board. 28 pins on the UKI board plug into the Q4 socket; another pin plugs into pin 20 of the Q5 socket. You must get the alignment right, or your printer won't work. After installation, the circuit board rides about 1/8-in. above the main circuit board, providing plenty of clearance between it and the rear chassis panel.

Trailing from the UKI board is a sub-miniature toggle switch that you can mount in one of the unused holes on the rear panel of the printer. Then, to change modes, you just turn off the power, flip the toggle switch, and turn the power back on.

To make a quick check of your work, turn the power on (in either mode) while pressing the LINEFEED SWITCH. The printer then enters a self-test mode in which it repetitively prints all characters it is capable of printing. Repeat the test in the other mode. If everything is working correctly, you'll get different sign-on messages and different character sets in the two modes.

If you have a problem, make sure the circuit-board pins
(Continued on page 100)

This electronic blood hound sniffs out radiation in and around your home.

RAD HOUND

IF YOU LIVE IN AN AREA IN WHICH A NUCLEAR ACCIDENT IS likely to occur (perhaps in close proximity to Three Mile Island), and are concerned that radiation could contaminate life's essentials (water, food, and air supply), this little circuit can restore some degree of security to your existence by alerting you to the contamination.

Nuclear contamination can stalk the land, leaving little indication of its presence until it is too late—it is a silent, phantom-like killer, in that it's usually not visible and is never audible. But the *Rad Hound* (with its dog-like dedication) will “sniff” out the source of contamination and “bark” its warning to indicate the presence of radiation. Needless to say, such a device (under some circumstances) can mean the difference between life and death for your family.

If the area you live in has been definitely identified as a contaminated area, you may just up and leave—taking your family and all your worldly possessions with you. But in doing so, you must also know whether you're carrying away a contamination “doggy bag” that might possibly harm you and your household over a period of time. It could be in your clothing, in your hair, on your body, even inside your body. You've got to seek it out and then work on the problem of separating it from your body before it's had a chance to do serious damage. That's just the type of problem that the Rad Hound is design to help remedy.

If you live in an area where nuclear contamination is a definite possibility, then you may have considered purchasing one of the store-bought Geiger counters, retailing for at least \$400, which can communicate exact amounts of radiation (in calibrated units) present within a given area either by means of an analog or digital readout. But if, like the average citizen, you are more concerned with knowing *where* the contamination is than you are with knowing *how much*, then the Rad Hound can certainly handle that task.

The sensing device used in radiation detectors is something called a *Geiger-muller* tube. Recently, the manufacturers of the Geiger-muller tube developed a version that is small and economically priced (\$58). Plus, the money you



By A. Peter Campione

spend for that one item alone is well worth the price—after all, who would try to save a “buck” by gambling on the survival of their family?

That's Rad

Figure 1 shows the schematic diagram of the Rad Hound, which consists of (in addition to the Geiger-muller tube) a six volt DC power supply; a solid state oscillator with an output of 2 kilohertz; a high voltage power supply; and an audio amplifier. The power supply can be as simple as four batteries (connected in series), for portable and stationary use. Or you might consider building a power supply, or using a wall-mounted power pack.

The operation of the circuit is lot simpler than one might imagine. Transistor Q1, which is configured as a variation of the Hartley oscillator, generates a low voltage AC signal. That alternating signal is fed across the primary of step-up transformer T1, creating a rising and collapsing field which is, in turn, inductively transferred to its secondary as high-voltage AC. The voltage at the secondary of T1 is fed through D1 and D2. Those diodes form a voltage doubler/full-wave rectifier, to provide an extra boost to the output voltage. The magnified/rectified voltage is then filtered by capacitor C4 into 500-volts DC, which is then fed to a Geiger-muller (G-M) tube.

Inside the G-M tube is a gas that ionizes (conducts) whenever a pulse of radiation enters the tube window. Each pulse causes a brief voltage drop across a 4,700,000-ohm resistor, R5. Capacitor C5 passes that pulse into the audio amplifier (U1) which, in turn, sends its amplified output to the loud-speaker (SPKR1), where it's converted into a pulse of sound.

Be aware that the 500-volts DC on the G-M tube is not regulated. It will drop slightly whenever the tube is busy, but that won't have a noticeable effect on the sound you'll hear. Transistor Q1 is a little “tough guy” that is capable of dissipating up to 115 watts of power. But it just hums along at ten percent of that maximum and doesn't need a heat sink. Trimmer potentiometer R1 in Q1's base circuit, varies the oscillator's frequency just enough so that you can get 500-

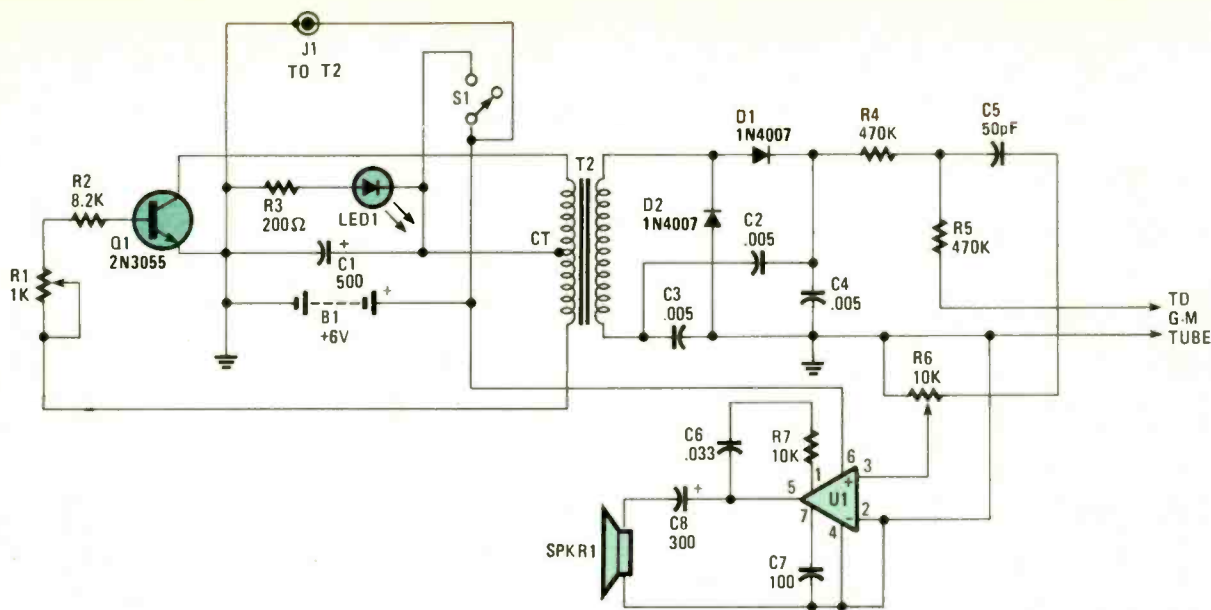

Fig. 1—The Rad Hound, whose operation is almost totally dependant upon a Geiger-muller (G-M) tube, consists (in addition to the tube) of a six volt DC power supply; a solid state oscillator with an output of 2 kilohertz; a high voltage power supply; and an audio amplifier.

volts DC for the G-M tube at the point where R4 and C5 join. (Make absolutely sure your DC voltmeter has a very-high impedance so that you don't load it down.)

It is very important that you use the exact same type transformer for T1 that is specified in the Parts List: a center-tapped 24-volt unit capable of handling at least 450 milliamps of current. A different one may not work at all; or worse, it could put out too much voltage and just burn up your little G-M tube.

Audio Amplifier

For the audio output section, an LM386 audio power amplifier (U1) was pressed into service. That 8-pin chip saves lots of assembly time, and is capable of driving 400 milliwatts of audio power into a 500 milliwatt 8-ohm loudspeaker. Included in the circuit is a bass-boost, which is used to emphasize the low-frequency pulses and to de-emphasize the high-frequency components of the 2-kHz oscillator that might otherwise leak through to the amplifier. The loudspeaker can be any 500-mW unit that you might have on hand. And, when installed in the finished project, it should be protected from damage by covering it with a wire screen or perhaps a grille.

If you want to get fancy, you can use a pair of low-impedance earphones from a portable FM-radio headset as a substitute for the speaker. However, no one else will be able to hear the radiation pulses except the wearer of those headphones. Or you may want to use a normal-through jack (also called a closed-circuit jack by hobbyists). Then when an earphone plug is inserted into the jack, the audio signal is re-routed to the earphones, and when removed, the signal is once again fed to the speaker.

Figure 2 illustrates how to connect such a jack. As shown, the speaker is connected in the circuit. But when a plug is inserted into the jack, the speaker is disconnected and the audio signal is re-routed through the earphones.

Construction

The Rad Hound can be built using the construction method

NORMAL-THRU OR CLOSED-CIRCUIT JACK

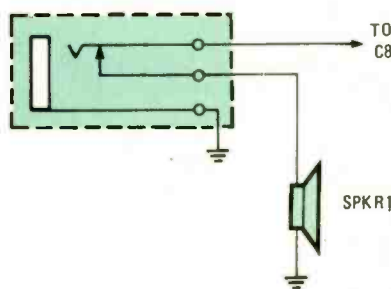

Fig. 2—Illustrated here is the proper way to connect an optional jack that will automatically connect and disconnect the speaker whenever a plug is inserted. As shown, the speaker is connected in the circuit. But when a plug is inserted into the jack, the speaker is disconnected and the signal is re-routed to the earphones.

of preference—printed-circuit, perfboard (with point-to-point wiring), or pre-etched experimenter board—and components laid out in an arrangement most convenient to you. The authors prototype of the circuit was built on perfboard using point-to-point wiring (see photos). If you opt to go the perfboard route, using the authors layout as a guide might make things go a bit smoother.

Start by placing the IC socket and other components on the board and securing them in place by temporarily bending the leads. Use short lengths of insulated wire to make the interconnections between components, beginning with the passive components (connected to the IC socket). Note that LED1, SPKR1, the power switch (S1), and the power jack (J1) are mounted on the front panel of the housing. So put those parts aside until the board components have been installed and your work checked for correctness.

When you are satisfied with your work, put the board to the side and go to work on the panel-mounted components. First drill and cut appropriate size holes in the panel to accommodate the parts. For the speaker hole, depending on what the cabinet is made of (metal plastic, etc.) you may be able to use a hole cutter (like those used by locksmiths).

After cutting the holes mount the components. Be careful when soldering to the LED. While it can withstand quite a bit of heat (for a semiconductor), it is nonetheless, thermal

PARTS LIST FOR THE RAD HOUND

RESISTORS

(All resistors are 1/2-watt, 5% units, unless otherwise noted.)

- R1—1000-ohm, 15-turn, trimmer potentiometer
- R2—8200-ohm
- R3—200-ohm
- R4—470,000-ohm
- R5—47,000,000-ohm
- R6—10,000-ohm PC-mount trimmer potentiometer (RS 271-218)
- R7—10,000-ohm

CAPACITORS

- C1—500- μ F, 12-WVDC electrolytic
- C2—C4—.005- μ F, 1000-WVDC ceramic disc
- C5—50-pF, 1000-WVDC ceramic disc
- C6—.033- μ F, 100-WVDC ceramic disc
- C7—100- μ F, 12-WVDC electrolytic
- C8—300- μ F, 12-WVDC electrolytic

ADDITIONAL PARTS AND MATERIALS

- D1, D2—1N4007, 1-A, 1000-PIV diodes
 - J1—to match plug on T2 (RS 274-1567)
 - LED1—Jumbo red light-emitting diode
 - Q1—2N3055 power transistor (RS 276-2041)
 - U1—LM386 audio amplifier (RS 276-1731), integrated circuit
 - S1—Single-pole, single-throw subminiature toggle switch (RS 275-662)
 - SPKR1—8-ohm, 500-mW loudspeaker (RS 40-245)
 - T1—117-volt AC primary to 24-volt AC, 450-mA, center-tapped secondary, power transformer (RS-273-1366)
 - T2—6-volt DC, 150-mA, wall mount power supply (RS 273-1454)
- Printed circuit or perfboard materials, microphone housing for G-M tube (RS 33-1034), metal cabinet (RS 270-253), wire screen or grill for speaker, carrying handle for project box, alarm clock dial face with luminous paint, 4 C-cell battery holder (RS 270-390), spring clip, wire, solder, hardware, etc.

Note: The Geiger-Muller Tube part # 712 is available, priced at \$58, plus \$2 for postage and handling (postal money order or cashiers check only) from A.P. Campione, 496A Hudson Street, Box H16, NYC, NY 10014. Please allow 6 to 8 weeks for delivery.

sensitive. Once that's complete, the next thing is the housing for the G-M tube.

G-M Tube Housing

The biggest problem in designing the Rad Hound, was in finding a suitable ready-made housing for the G-M tube. Nobody makes them cheaply. But I discovered an old microphone case that had plenty of room inside, once the on/off switch was removed. You can do the same thing if you buy that microphone from Radio Shack for \$7. Just remove the dynamic mike element and the on/off switch, and very carefully place the G-M tube behind the front grill.

The tube itself is small, measuring only .59 inches in diameter and 2.12 inches in length. Pack some plastic foam into the space behind it so that nothing rattles around, after you've soldered the cable's center conductor and shield to the G/M tube. For added protection, you might want to surround the tube in silicon within the microphone housing.

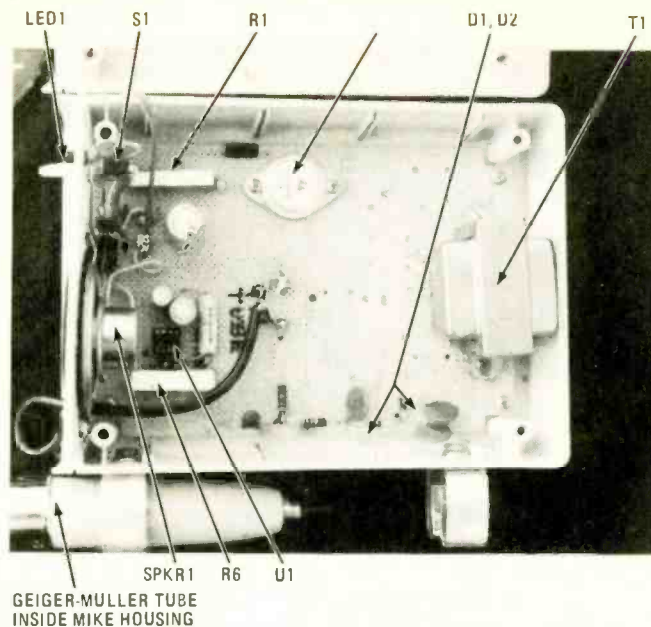

Although the prototype of Rad Hound was built on perfboard, feel free to use the construction method—printed-circuit, or pre-etched experimenter's board—most convenient to you.

Test Source

When you're finished assembling all the parts on your perforated board, made connections from the board to the panel-mounted components, and made absolutely sure that there are no shorts or opens in the 6-volt power-supply circuit, you'll need to obtain a harmless source of radiation for test purposes. (Every good radiation detector carries one for quick tests.)

In your neighborhood, drop in to any alarm-clock repair shop, and ask the proprietor to sell you an alarm-clock face with luminous paint on it—you know, the type that shines in the dark. If you're lucky he'll have one for \$2 made by the Westclox Company. If not, ask him for a wristwatch dial-face with luminous paint on it.

Once obtained, whatever you do don't try to scrape off any of that luminous paint. It's a radioactive compound of radium, and if it gets into your lungs as an airborne powder, you're playing with cancer. Tie a 12-inch length of string or nylon cord to the dial face, and anchor it to the carrying handle on your chassis box. And remember, the Rad Hound is not a toy for children to play with. So label it accordingly.

Final Test

Before you close up the cabinet, hook up the internal 6-volt DC source. Crank it up and adjust trimmer potentiometer R1 until you measure 500 volts DC at the R4/R5/C5 junction. Do not allow the voltage fed to the G-M tube to remain higher than 550 volts for very long; you'll shorten it's life if you do. The voltage fed to the tube must fall within the range of 490 and 550 volts—the tube won't work at any voltage lower than 490 volts and it will over-heat at any voltage higher than the recommended 550 volts.

After you've set the tube feed at 500 volts, remove the batteries and plug in the 6-volt adaptor for external DC power. Make sure that the positive and negative polarity is wired in correctly. The adaptor will put out a slightly higher voltage than the batteries do, so you may find your 500-volt setting now reading 530 volts. Leave it alone, since that value is

(Continued on page 108)

GIZMO

MARCH 1988

INTRIGUING NEW PRODUCTS IN ELECTRONICS

VOLUME 1 NUMBER 1

Minolta Master Series VHS Camcorder	1
Canon Personal Typewriter	2
Phone-Mate Performance Series 7000 Answering Machine	3
Sharp Multi-Play Compact-Disc Changer	4
J.C. Penney Video-Cassette Recorder	5
Teac Stereo Double-Cassette Deck	6

GIZMO/BYTES

Blaupunkt Dallas Car Stereo	7
Panasonic VHS Cam corder	7
Shinton VCRs	7
Plus U.S.A. Halftime-Scissors	7
Healthcheck Blood Pressure Monitor	7
Hewlett-Packard Business Consultant II	8
Onkyo CD Player with Changer	8
Panasonic Bread Bakery	8
Polaroid PhotoMagic System	8
Adjustable Exercise Bike Reading Stand	9
Canon Cat Work Processor	9
Canon VM-E2N 8-mm Camcorder	9
Olympia USA, Inc. Paper Shredders	9
Zenith Home Satellite-Receiving Systems	9
Career Navigator	10
Oster Four-cup Coffemaker	10
Nakamichi CA-5A II Control Amplifier	10
Sonin Ultrasonic Measuring Device	10
UPS Shutdown/Electronic Specialists, Inc	10



CIRCLE 51 ON FREE INFORMATION CARD

Video on the Run

MINOLTA MASTER SERIES VHS CAMCORDER (V-1400). Manufactured by: Minolta Corp., 101 Williams Dr., Ramsey, NJ 07446. Price \$1,810.

Nobody asked us, but it's clear that the consumer-video marketplace faces a major shake-out sooner or later. There's the unresolved question of competing cassette formats, at last count VHS, Beta, 8-mm, and VHS-C. Coming up from behind are newer developments, the now near-standard "high-quality" (HQ) circuitry and, beginning last year Super-VHS. All of that has transpired in the little more than a decade since video became a consumer product.

Technical superiority is no guarantee of eventual market conquest. In the home-video beginning, Beta was clearly the superior format. But the buying public's attention was arrested by a brouhaha regarding recording time (the one category in which VHS excelled) and soon Beta (at least in this country) was on its way to competitive status.

Amid the mounting marketplace uncertainty, the video industry has noticed a somewhat surprising development. Even as VCR sales level off and consumers display uncertainty, its about jumping into newer formats, camcorder sales continued steady and even increase. That despite price tags that put these portable combo recorder/player at the upper end of the video market.

If you have an opportunity to get to

know a state-of-the-art camcorder, there's little mystery to this sales pattern. Camcorders are the kind of electronic toy worth saving up for.

Consumers have become understandably blasé about VCRs. Nowadays, they're just another home-entertainment appliance. But for a first-time user, there's still a trace of magic to the camcorder. We suspect that for a generation of consumers who grew up during the home-movie era, these electronic instant motion-picture machines are nothing short of miraculous. Especially if the camcorder is an elegant unit like the *Minolta Master Series V-1400*. Some experience with the *V-1400's* predecessor model made this rig even more impressive.

Minolta has made this camcorder impressively lightweight (4.4 lbs.), cutting down on body and battery bulk while retaining the previous model's features and capabilities.

This camcorder in its fully automatic mode knows more about capturing good video images than we do. In several weeks of use, we never got around to testing the *V-1400's* manual capabilities (focus, iris control, and shutter speed can all be de-automated), if only because automatically the camcorder recorded such technically splendid pictures.

Even when the images in the electronic viewfinder were seen as little more than gray shadows, the resulting taped image was surprisingly sharp and detailed. *Minolta* partially credits the unit's fine HQ circuitry.

More important is what the firm calls "the electronic equivalent of an adjustable shutter." The camcorder's "MOS image sensor" has a "variable scanning rate." Constructed with 300,000 picture elements (pixels), its ability to select "effective shutter speeds" makes possible rates ranging from 1/60 of a second to 1/2000 of

a second.

Minolta says the *V-1400* can provide "good images even in light levels as low as seven lux." In real life that translated into worthwhile images captured by the light of a single, heavily shaded table lamp and, outside, in near-dusk. There's a vividness and intensity to the colors captured under good lighting far beyond the capacities of home movie systems of the recent past. It's seemingly modest audio pick-up is as detailed and vivid in its recording as the imagery it accompanies.

The *V-1400's* controls and grips have a naturalness which is a tribute to the *Minolta* design department. The right hand fits through a fabric strap and the thumb rests on the record control. Once engaged, it needn't be held down.

The abbreviation REC appears in the viewfinder to remind the operator that tape is running. Actually, the earlier model's red light signal is to be preferred. In that the superimposed letters are in the way of the image, that isn't necessarily a change for the better.

The right-hand forefingers control the camcorder's automatic zoom. While always a stylish capability, in its temptation to overuse, the zoom is particularly reminiscent of pre-electronic home movie making. Operational and secondary controls (like playback features and camera/player selection) are arrayed topside. Further functions are controlled from the left side of the camcorder body.

Information is conveyed to the operator via graphics which appear in the viewfinder. Besides the data (which appears on the recorded tape if engaged) the REC, a battery-power indicator and tape count are superimposed. In the playback mode, rewind and fast-forward, as well as the tape count, appear.

The viewfinder can also function as a quick review monitor. Engaging the func-

tion causes the last few recorded seconds to run backward and forward.

As a playback device, the *V-1400* was entirely satisfactory. Recordings taken from a television broadcast were as clear as dubs from a regular VHS recorder.

Eventually, we predict, somebody is going to market a multi-event timer add-on for camcorders, furnishing the capability which separates portable units from home VCRs. Whether camcorders are built to do the work of a home VCR is another question. One video cameraman we know says it's a bad idea to use the 160 minutes VHS cassettes with camcorders, as in rewind they strain the mechanism.

One aspect we liked about the *V-1400* kit was the variety of adapters supplied. That is in contrast to camcorders of a couple of seasons ago whose makers assumed that the equipment would be used only with the newest generation of televisions. At camcorder prices, we don't blame an owner for not rushing to replace his or her old, pre-home-video tube.

Using the *V-1400* cleared up one video mystery, namely the continuing market popularity of VHS-Compact formats. In comparison with this *Minolta* camcorder, any weight or bulk advantages to the VHS-C units we've examined are virtually nonexistent. What we discovered with this standard VHS camcorder is that the task of filling up a cassette's hour-plus running time in an interesting way can be a definite strain. Particularly since operating the camcorder tends to overwhelm whatever activity is being recorded.

But with the much abbreviated running time of compact VHS, the user is back on familiar, home-movie terrain. Faced with the possibility of convincing friends and relatives to sit through full-length videos of stupefying tedium, the VHS-C format may be the more humane and effective choice.—G.A.

Typographical Era

CANON PERSONAL TYPEWRITER S-58. Manufactured by: Canon U.S.A., Inc., One Canon Plaza, Lake Success, NY 11042. Price \$249.94.

The first primitive version of what we might recognize as a typewriter was patented in England in 1714. The manual typewriter of the recent past was a product of the 19th Century, with the first electric machines appearing in 1935 and electronic units coming along a couple of decades later.

But it was the development of computers which brought about the current stage of typewriter development. Today's electronic machines are a hybrid, using computer technology (like electronic memory), but functioning like any typewriter of the last century—a machine for putting words onto paper.

The *Canon S-58 Personal Typewriter*, on the market for a little over a year, is an inexpensive electronic machine which integrates computer-related capabilities. Plastic components help keep the price low, although as any typewriter repair technician will tell you, these price-cutting parts also shorten the unit's life.

For anyone who's spent their typing life

using manual or pre-electronic machines, the *Canon S-58* takes some getting used to. Its excellent instruction manual, a model of organization and clear language, helps make this process just about as painless as possible.

Each of the *S-58's* features and capabilities are carefully described, logically presented in order of importance and accompanied by clear illustrations and diagrams. The booklet begins with how to insert the paper and continues through a final troubleshooting section which attempts to anticipate problems a novice might run into.

Right at the beginning we discovered a quirk which can be maddening, or at least

Gizmo is published by Gernsback Publications, Inc., 500-B Bi-County Blvd., Farmingdale, New York 11735. Contributors to this issue of Gizmo are Larry Brady, Eric Lacitis, Bruce R. Olson, and John Swenson. Copyright 1988 by Gernsback Publications, Inc. All rights reserved. Printed in the U.S.A.



CIRCLE 53 ON FREE INFORMATION CARD

disconcerting, to an experienced typist. Common to all but a few expensive, electronic typewriters, there's a lag between hitting the keyboard and the letter going onto the page. This brief delay puts the ear out of sync with the fingers.

Comfortable typing, at least before this current generation of electronic machines, depends on rhythm and the *Canon S-58's* key-to-print sequence can be surprisingly distracting.

In the machine's automatic return mode, as the return is being made and the user continues to type, there's a point when the next line begins and the keys start clicking out the word typed while the machine was returning.

The keyboard itself is certainly no IBM

Selectric. It has that fragile, plastic feel that seems to be a feature of computer-style keyboards. It takes some time getting used to the required light touch to the keys. Eventually, even the worst hunt-and-peck keyboardist can adjust.

For a veteran typist, all of this may just be the price of admission to the advantages of contemporary electronic typewriters. In general, we found the *Canon S-58* to be a well-designed and very adaptable personal typewriter.

Tabs, margins, line spacing and automatic bold face and underlining are all easy to master and use. And the *S-58's* correction system demonstrates the unique advantages of memory-equipped electronic typing.

A touch to the keyboard's "correct" button and the previous letter (or up to 30 letters) is wiped out clearly and fully. The user can type the corrected word into the *S-58* even as the correction is being made. Corrections beyond the 30-character memory are a little more complicated. But again the instruction manual is very clear on how to move the carrier back to the proper position in order to make the required correction. The carrier can be moved back in increments of 1/20 of an inch, useful in making a correction when the page has been removed from the machine and reinserted.

An element of electronic typing which struck us as a disadvantage is the relatively short life of cartridge-style ribbons. The one supplied with this machine had to be replaced after about 35 double spaced pages. Convenience, clearly, has its price.

An added feature, as the advertisements might put it, to the *Canon S-58's* capabilities is its use as a simple calculator. "Your electronic typewriter," the manual explains, "can do arithmetic (addition, subtraction, multiplication and division) with numbers of up to 8 digits." Code and the "L" key put the *S-58* into the calculator mode, with the machine automatically typing out the results of computations. This is at least a clever extra for budget-priced electronic typewriter.

As for the disconcerting sonic delay between key and striking action, that crude 18th Century version of a typewriter was designed as a tool for the blind. Perhaps on the verge of the 21st Century, the electronic typewriter is best used by the deaf.—B.R.O.

Just One Touch

PHONE-MATE PERFORMANCE SERIES 7000 ANSWERING MACHINE. Manufactured by: Phone-Mate, 325 Maple Ave., Torrance, CA 90503. Price \$119.95.

A four-foot drop to the floor taken by an expensive combination telephone-answering machine taught us something about these popular home and office personal communication devices. When we took the unit in for repairs, we were told that the cost of fixing it would just about equal the cost of replacing it. With the answering half of the combo out of commission, we were left with a functioning but rather bulky telephone.

The experience made us wary of combination units and also raised doubts about paying top dollar for an answering machine, given that repair charges equal replacement cost. The *Phone-Mate Performance Series 7000* is an answering machine which addresses both of these lessons.



CIRCLE 54 ON FREE INFORMATION CARD

Strictly an answering unit, it's often sold for considerably less than the manufacturer's suggested retail price. We've seen it retailed for as little as \$69.99 by discounters. Despite its budget price, *Phone-Mate* is a long-established brand in the answering machine field, suggesting that its products are both durable and dependable.

Compact and simple to activate and operate, the *Performance Series 7000* has a number of sophisticated features. Its remote capabilities allow the user to hear, replay, erase or save incoming messages from another phone, without carrying a beeper unit to activate the machine. Instead, the 7000 responds to tones generated by a touch-tone telephone. Of course, as the owner's guide explains, "not all push button telephones are touch-tone. In which case, *Phone-Mate* offers a portable "Touchtone Dialer" (model IQ118) so "you can get your messages from a pulse or dial telephone."

One feature which may be appealing to users who spend a lot of time talking to answering machines, is this *Phone-Mate's* instantaneous interface between the pre-recorded greeting message and the beep. The seemingly interminable dead air between message and beep can be one of telephonic major life's irritations. Voice activation cuts out dead time on the incoming message tape as well, especially appreciated when you're listening through a

day's worth of accumulated calls.

The machine's *one-touch operation* is another user-friendly feature. The single "Play Messages" button rewinds the incoming message tape, plays to the end of the final message on the cassette, stops automatically and then rewinds the tape and resets the machine to take messages, all with a single tap of a finger.

The features and capabilities described here are all fairly common to answering machines in a number of price categories. But *Phone-Mate* has come up with some further, useful gimmicks.

If the user is out of town and wants to collect his or her messages, but doesn't want to pay long-distance rates just to hear again incoming messages already received, the *Performance Series 7000* has a nifty *toll-saver* device. Setting the machine to "TS" activates the unit to pick up on the second or third ring only if there are new messages. If the machine allows four or five rings, that tells the user there are no new messages. Which gives him or her a chance to hang up before the toll charge.

Forgetting to turn on the 7000 before leaving home or workplace no longer means a trip back to flip the switch. Instead, as long as the machine is plugged in, the user can call and let the phone ring ten times, which activates the unit to receive incoming messages.

Some more-expensive answering machines feature a user-selected, two-digit

message retrieval code. With this unit, the single-digit retrieval code is permanently set (and printed on a sticker on the underside of the lid covering the cassettes). Unless you've got some reason to be seriously concerned with message security, this is a minor limitation. Similarly, the 7000 indicates the number of received messages with a light. The user has to count the flashes to know how many are stored and waiting. A numerical display would have been a nice refinement, although for many users probably not one worth paying that much more for.

Finally, the machine—in common with most answering machines we've examined—is outfitted with a Lilliputian phone connection cord. Extensions are easily obtained, but why do answering machine manufacturers assume that the user is always going to place the unit next to the phone?

At a reasonable price, the *Phone-Mate Performance Series 7000* offers convenience and a number of genuinely useful features. Including at least one the company may not be aware of.

After our experience with a previous machine taking a disastrous fall, we decided to keep this unit safely on the floor. Thanks to its design and *one touch operation*, all of its controls can be manipulated with your toes, even through a shoe. For our money, that's real user-friendliness.—E.L.

Slipped Discs

SHARP MULTI-PLAY COMPACT DISC CHANGER (DX-C6000). Manufactured by: Sharp Electronics Corp., Sharp Plaza, Mahwah, NJ 07430-2135. Price: \$499.95.

The record industry has had a difficult time keeping up with the music public's demand for compact discs. In 1983, its first year on the market, the compact disc format sold some 800,000 copies. By 1986, some 53 millions CDs were sold, a dramatic 134 percent increase over the previous year. Clearly, this format is a good bet to eclipse the LP in the near future.

The advantages offered by the CD over

the LP format are nearly as great as the LP's unquestioned superiority over the 78. With the compact disc, an hour's worth of programming is stored on a disc smaller than a vinyl single. CDs play back at higher volumes and, depending on the care taken in the remixing and mastering stages, with much higher definition.

Musical reproduction is one area in which the highly-touted *digital revolution* has paid big dividends. Subtle details drowned in the background (and surface) noise of LPs reveal themselves on CD. The audio sales pitch most time honored—"it's as if the musicians were actually in the room"—has taken on some validity in the CD era.

It's no accident that the group which ushered in the LP era in rock, the Beatles, spearheaded last year's CD retail gold rush. Producer George Martin did a spectacular job preparing all the Beatles CD's for release in '87. Every one of the titles reached at least the number four spot in the CD sales charts. Both *Sgt. Pepper* and *A Hard Day's Night* hit number one and last June, five Beatles CDs were in the top 30. Other artists have also garnered good sales with CD releases of their originally LP-recorded music.

Just in time for these multi-CD retrospective re-releases, disc changers became an available option for players, at first only at the high end of the retail mar-

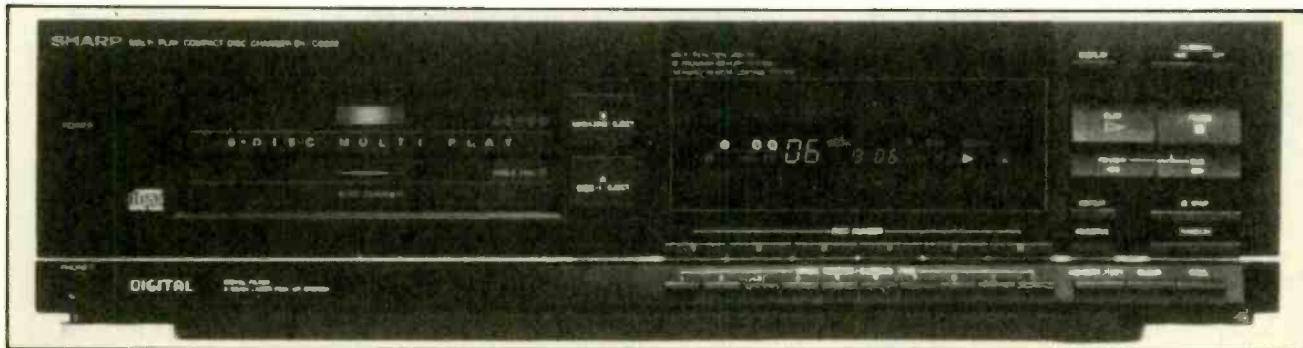

CIRCLE 52 ON FREE INFORMATION CARD



The 6-disc changer mechanism for the Sharp DX-C6000.

ket. But now units in the market middle come equipped with multi-disc capabilities.

Sharp's *DX-C6000* includes many features popularized by more expensive makes. Such as programmable play, random play, remote control, high-speed search, two-speed cue and review, reserve memory and tape dubbing. But its crowning feature is its six-disc CD changer. Looking like a stack of *jewel box* CD cases, the unit slides into the front of the *DX-C6000* and allows the user to program up to seven hours of uninterrupted music. The CDs can be programmed in custom sequence or at random, tracks from one CD playing after tracks from another and so on.

Given the newness of the CD format, it's slightly ironic that changers are

basically mechanical devices, variations on a theme which dates back to the cumbersome record changers of the Pre-LP era. The magazine swings each CD out for play and then swings it back into the stack for storage. The audible clicks and whirring heard during changes sound incongruous coming from a device which represents the very latest in digital audio reproduction.

After living with the unit for some time, we began to wonder just how "random" its random play capability is. Although not a scientific test, everyone in our household agreed that in this mode, the same tracks turned up with disconcerting regularity.

Finally, we had an experience with the *Sharp Multi-Play CD Changer* which made us wonder about the state of this

particular art. After several hours of trouble-free listening, we attempted to change some discs in the magazine and reprogram the player's sequence of play.

For reasons still unknown, the unit went daffy on us—clicking through its six discs, as vividly recorded by the LCD display, but refusing to play any tracks at all. Regardless of the control we engaged, and even after shutting down power and turning it back on, the player and changer continued to misbehave. It was one of those awful moments, known to most electronic consumers, in which we decided we must have done something to break the component, some combination of contradictory commands or an improper sequence of button pushing. But, for whatever reason, the only sounds we could get out of the *DX-C6000* were clicks and whirring. Vigorous manipulation of the remote control offered no relief. So we finally admitted defeat and turned it off. As of this writing, we haven't had the heart to try again.

Pioneering has its price. Our first CD player suffered from serious defects, including shrill, brittle high-end response and an annoying tendency to leap suddenly to deafening volume. So perhaps this first generation of CD changers can't be held to different standards.

Apart from this, we think the *DX-C6000* is an effective compromise between big-ticket CD players with changers and the many bargain basement models with no special features. The multi-disc format is perfect for CD players, because it enhances the format's outstanding characteristic, more music in less space. We just wish we weren't recommending an item which experienced an electronic nervous breakdown while we were testing it.—J.S.

Penny Savior

J.C. PENNEY VIDEO CASSETTE RECORDER (MODEL NO. 686-6184).
Purchased from: J.C. Penney Co., Inc.,
1301 Sixth Ave., New York, NY 10019.
Price: \$450.

Had you asked us six months ago what we thought about buying video gear from J.C. Penney, we'd have said that it was like buying lobsters from F.W. Woolworth. Sure, they look like lobsters, they walk like lobsters, their spiny antennae twitch like lobster-antennae are supposed to twitch—but are they lobsters on the test of taste?

Can a department store known for its underwear compete in the world of retail electronics? Until six months ago, we had never sampled electronic products from Penney's. Now we have. And we're impressed.

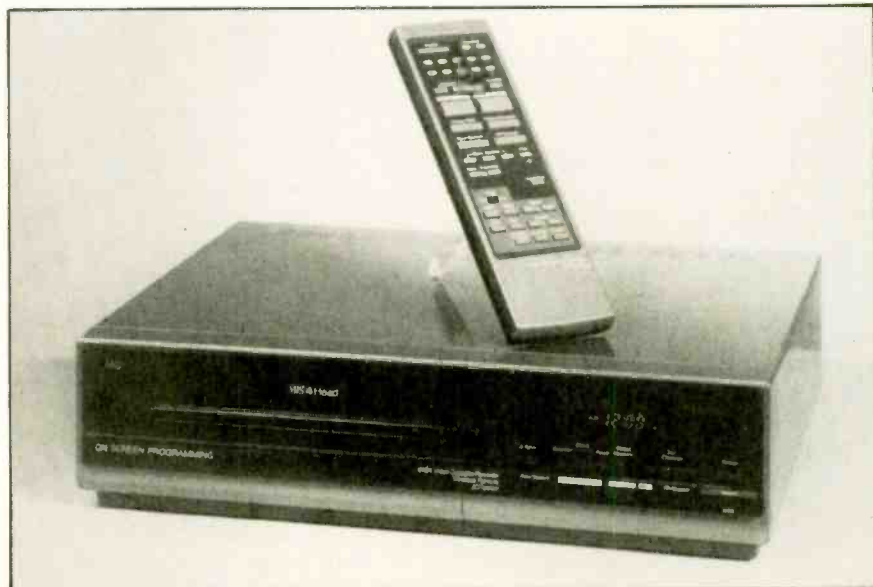

CIRCLE 55 ON FREE INFORMATION CARD

The J.C. Penney tabletop *Video Cassette Recorder* (model 686-6184) is a four-head, HQ, eight-program, three-week marvel of the complicated made simple enough even for pre-electronic grandmother. Here's a VCR so user-friendly that you might consider inviting it into the kitchen after supper for a few hands of pinochle. And of course, it would probably win.

The 6184 comes with everything you'd expect from a current-generation VCR. It offers three-speed playback, on-screen display, fast-forward and fast-reverse plus those standard accessories, cables and adapters, for whatever hook-ups you might require.

And even grandma can follow the easy instructions in the *Penney* operating guide. Beyond basic features, this unit offers a double-speed playback plus variable-speed *slo-mo* and single-frame advance that can be used against the pause/still function.

There's a nifty channel-memory setup

and a one-touch record feature, this in addition to the standard recording mode. We weren't quite sure how or why we'd ever need this one-touch capability until the phone rang during the premier of one of our favorite new shows. Bingo—we pressed the button and didn't miss a minute of "Jake and the Fatman."

An *Help* function guides first-time users or the electronically fearful. But the machine is so easy to program that not even Uncle Jim is going to need to engage this more than once.

If we've got a complaint, it's that the wireless remote's buttons are a little too small for adult fingers trying to piano-up from one channel to another. The 6184 hasn't got the most stylish box on the block, but then the price doesn't come close to what you might pay for swank name-brands available from other retailers. Ours was purchased at a sale price considerably below *Penney's* suggested retail tag.

The only feature lacking is high-fidelity

sound. Given a sound capability beyond one-track, the unit would be darn near perfect, especially as a first VCR in just about anyone's home. And yes, there are still some people without one.

For those who want to use the 6184 in conjunction with a video camera (or with a second VCR) for recording or re-recording, the operations manual gives clear instructions on how-to. And beyond all that, this *Penney's* jewel runs about as quiet as a kitten lost in yarn.

Penney was unwilling to name the manufacturer of this store-brand VCR, but there may be a hint in the manual's section on service which directs the owner to the nearest RCA factory service center. Information *Penney* did share was that after July, the 6184 will no longer be supplied by the company to its stores. Except for consumers who insist on the latest model, the *Penney* change-over most likely means that exceptional prices will be offered on what we found to be an exceptional, home video recorder.—L.B.

Tale of the Tapes

TEAC STEREO DOUBLE CASSETTE DECK (D-525C). Manufactured by: TEAC Corp. of America, 7733 Telegraph Rd., Montebello, CA 90640. Price: \$259.

The long-play record, a staple of the recording industry's advance into the modern era of audio technology, is fast becoming a thing of the past. After decades of dominating music software sales (predating the term *software* itself), the LP began a precipitous decline early in this decade.

Since 1983, more cassette tapes than LPs have been sold. In 1986, 125.2 million albums were purchased, a 25 percent drop from a year before. Meanwhile, 344.5 million tapes were sold, only a slight percentage increase over the previous year's sales.

Clearly, despite the excitement (and hype) surrounding the compact disc and yet-to-be-marketed digital audio tape formats, the cassette is the dominant audio software of the 80s. This has as much to do with the proliferation of affordable playback systems as it does with any inherent advantages of the tape cassette format.

The record industry freaks out around the question of the public's ability to record and copy its own music programming. This is why the cassette format met plenty of music and record industry opposition in the 1970s. The industry put its early money on eight-track tapes, especially because they were inefficient as a copying or duplication medium. Eight track tapes eventually became the recording industry's

Edsel.

Now practically every kid on the street, or in the mall, has a portable cassette player. Tape cassettes are much less durable than LPs. The tapes stretch and break and all but the highest quality tapes eventually fade as particles are scrapped off of the surface each time it passes over the heads of a playback system. Likewise, portable cassette players are seemingly designed to fall apart relatively rapidly. Flimsy cases, break-off buttons and the inevitable fall-to-the-pavement contribute to a neat bit of planned obsolescence that has most street players being replaced as often as sneakers.

That's why the reliable but inexpensive *TEAC Dual Cassette Deck*, the D-525C, is such a superior machine. No portable unit priced at even twice its tag (often under \$150 on sale) can offer the advantages of this sturdy component.

Of course, it won't be used for on-the-spot mixing or dubbing by urban street rappers. But anyone interested in making a high-quality copy of a favorite record before the inevitable vinyl wear-and-tear manifests itself, or making a duplicate of a favorite music tape will find this an invaluable home machine.

Although the D-525C lacks such electronic amenities as auto-reverse (a favorite feature for portable machines) or remote control, its high speed and synchronized dubbing capabilities provide the discriminating do-it-yourself tape engineer with the kind of quality only found in a recording studio a decade ago.

This is the kind of unit the record business would prefer the public didn't have. The music industry opposed the cassette format when it was first marketed, fearing

a loss of revenue from home copying.

Few of those same naysayers would any longer question a format that is now the industry's bread and butter. But it's ironic that their fears regarding the new format, digital audio tape (DAT), has distracted industry watchdogs enough to allow a dual cassette machine like the D-525C to become available to virtually any consumer.

Although it comes arrayed with the sort of visual display with which manufacturers proclaim their audio sophistication, the D-525C is a simple-to-operate unit. It may not be the most sophisticated dual cassette deck on the market, but it's far from the most expensive, either.

Finally, if you're inclined to feel a little guilty about home taping of music, consider these figures: In 1973, 614 million records and tapes shipped and were estimated to be worth a little more than two billion dollars. In 1986, the numbers of records shipped (618.3 million) was roughly the same. But the estimated list price dollar value of those records and tapes had more than doubled to 4.651 billion dollars. For consumers, this might make the music business's fears about home taping difficult to take seriously.—J.S. (Next follows items that would normally go in the Bits & Pieces section of the old Gadget. These now go under the head Gizmo/Bytes.)



CIRCLE 56 ON FREE INFORMATION CARD

Blaupunkt Dallas AM/FM-Stereo Radio SQM 88

Car stereos get installed, they get stolen but one thing which doesn't happen much to them is getting reconfigured. *Blaupunkt* (2800 S. 25th Ave., Broadview, IL 60153), the long-established, prestige audio manufacturer has changed that with its new *Dallas FM/AM Stereo Radio* (SQM 88). Instead of being mounted in the dashboard, the Dallas sits on a flexible stalk, readily maneuvered into any desired position. It's easily removed for theft deterrence and is small enough to carry in a coat pocket or handbag. As *Blaupunkt* points out, "this configuration also frees the normal radio mounting hole for a tape player, CD player or future DAT player." A separate module, which can be installed anywhere in the vehicle, carries the circuitry for the Dallas radio. Among features of the radio itself are *dynamic noise reduction*, scan, preset scan, 15 AM and FM presets, base and treble controls and switching and inputs for two auxiliary audio sources. Price: \$369.95.

CIRCLE 57 ON FREE INFORMATION CARD

Panasonic VHS camcorder

Camcorders, in all their many splendored formats seem out to individualize themselves with non-duplicated special capabilities. A new *VHS Camcorder* (PV-330) from *Panasonic Co.* (1 Panasonic Way, Secaucus, NJ 07094) offers what are described as "digital effects," namely a single-touch freeze frame and, fancier still, "combination effects," with a still image appearing in one of the corners of the viewing screen. The freeze-frame image can then be made to disappear with a "wipe" from right to left replacing "the freeze frame with a live image." In a second mode, "the live picture expands outward from the center of the screen." Finally, an "overlap, undoubtedly better seen than described, in which "the moving image automatically overlaps the still frame." Other advanced features include a CCD image pick up light sensitivity "approaching one lux," a "three-way high speed shutter mode" and a tape indexing system. What's next, 3-D? Price: \$2,000.

CIRCLE 58 ON FREE INFORMATION CARD

Shinton VCRs

Henry Ford, it will be recalled, became world famous for low-price, no-frills transportation. *Shinton West Corp.*, (20435 S. Western Ave., Torrance, CA 90501) is apparently out to do for home video what Henry did with his basic unit. The firm is marketing a *VHS VCR* (4040N), with one-touch recordings, HQ circuitry and 14-day/six-program timer) at surprisingly no-frills suggested retail. The unit utilizes an automatic playback system for the ultimate in passive video viewing. You front-load the cassette and the VCR does the rest, right through rewind. Besides the 4040N, *Shinton* has rolled out the 4030N, virtually identical except for its more subdued box, which brings a slightly higher price. *Shinton* says the silver-finished 4040N is the *mass merchandiser* unit. Price \$289.95.

CIRCLE 59 ON FREE INFORMATION CARD

Plus U.S.A. Halftime-Scissors

If there was such a category as "designer office accessories," *Plus U.S.A. Corp.* (10 Reuten Dr., Closter, NJ 07624) would be recognized as a fashion leader. The firm's newest designer gadget is the *Halftime-Scissors*, three-inch stainless steel blades are contained in a two-piece matte plastic case not much bulkier than a fountain pen. Removing the protective cover opens the blades for business. The item is available in red, white, blue and black. Price: \$9.95.

CIRCLE 76 ON FREE INFORMATION CARD

Healthcheck blood pressure monitor

It used to be nobody was much interested in blood pressure except doctors. Now, everybody seems to be monitoring their own, with the help of coin-operated testing units, street-corner pressure testing stations and home health care devices. Including the compact *Healthcheck Digital Blood Pressure Monitor*. Sold by *Markline Co., Inc.* (14 Jewel Dr., Wilmington, MA 01887), this unit has the advantage of taking a blood pressure and pulse reading via an adjustable band that fits onto the user's finger. Featuring something called "Pulsonic technology," the *Healthcheck* features digital display and is small enough to fit into a briefcase or purse, complete with protective carry case. Price: \$79.

CIRCLE 64 ON FREE INFORMATION CARD



Blaupunkt Dallas AM/FM-Stereo Radio SQM 88

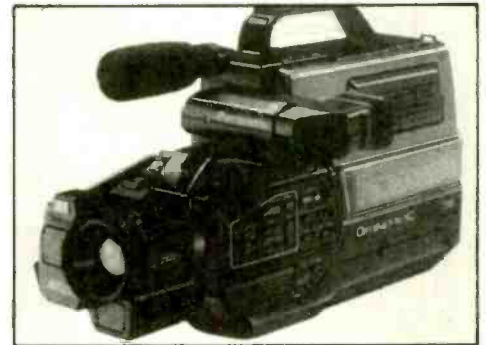

Panasonic VHS Camcorder PV-330

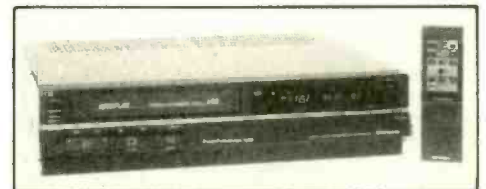

Shinton VHS Video Cassette Recorder

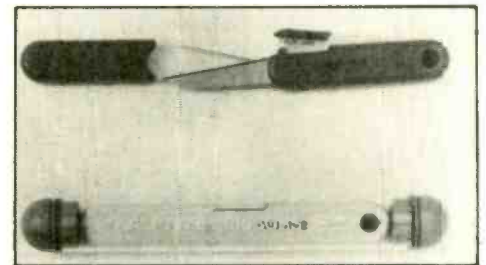

Plus U.S.A. Halftime-Scissors



Healthcheck Digital Blood Pressure Monitor

Gizmo/Bytes



Polaroid PhotoMagic System



Panasonic Bread Bakery SD-BT2P

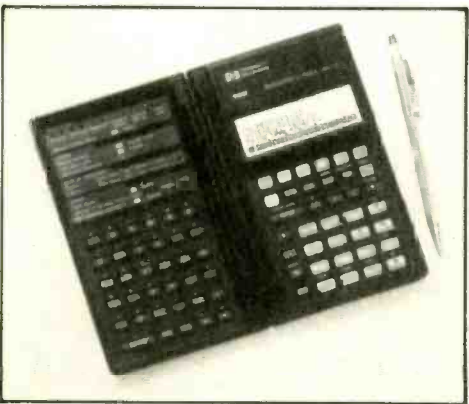

Hewlett Packard Business Consultant II

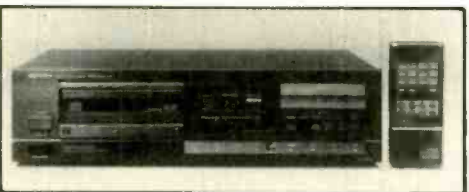

Onkyo CD Player with changer DX-C600

Polaroid PhotoMagic System

Given all the changes in the delivery and reproduction of images that are afoot in the consumer market, it doesn't pay to rest on your previous achievements. Even when the achievement is something epoch-marketing like instant photography. *Polaroid Corp.* (575 Technology Square-9P, Cambridge, MA 02139) has a new product which it's presenting as "an exciting new profit-making opportunity" for enterprising individuals as well as "an ideal fund-raiser for charitable and community groups." Dubbed the *PhotoMagic System*, this instant camera automatically superimposes graphics on the film, framing the subject in the instant picture. The system includes a way to quickly die-cut the finished picture and mount it in specially designed buttons or picture frames. In addition to the camera, the *PhotoMagic* system includes a portable picture button cutter, acetate *art-forms*, plastic buttons and specialized frames. All packaged in a black vinyl case. Price: \$525.

CIRCLE 60 ON FREE INFORMATION CARD

Panasonic Bread Bakery

The staff of life goes space age with a newly introduced kitchen appliance from *Panasonic* (1 Panasonic Way, Secaucus, NJ 07094). Developed for the Japanese consumer market, the *Bread Bakery* (SD-BT2P) is a counter-top unit that manufactures one-pound loaves of bread. First a revolving mechanism mixes and kneads the ingredients. After the loaf rises and assumes the shape of the *Bread Bakery's* bread canister, it's baked by a single heating element. The process takes some four hours, but a built-in timer can set the unit to remain dormant for up to nine hours before bread-making commences, assuring a piping hot loaf when the user wants it. *Panasonic* says its *Bread Bakery* can also knead dough for such foods as croissants, doughnuts and even pita dough (using the *leavening mode*). But the *Bread Bakery* obviously will rise and fall on its merits as a hot bread source, and consumer interest in that baked delicacy. Price: \$329.

CIRCLE 63 ON FREE INFORMATION CARD

Hewlett Packard Business Consultant II

Not only do today's sophisticated calculators do laborious computations for us, but they're beginning to do them in ordinary, non-technical language. For example, the recently introduced *Business Consultant II Handheld Calculator* can use words and symbols as variable names in equations entered by the user and permits entry of equations without programming. From *Hewlett Packard* (3000 Hanover St., Palo Alto, CA 94304), the *Business Consultant II* offers messages and prompts in English, German, Spanish, French, Italian and Portuguese and, according to HP, may be "the first business calculator to offer statistical and cash-flow graphics capabilities." It can produce scatter diagrams, curve fits and histograms, as well as cash-flow graphs. Finally, the unit also has special *TEXT application* for name-and number lists, bonds and depreciation, currency and unit measurement conversions and an appointment menu with an alarm clock. Price: only \$175.

CIRCLE 69 ON FREE INFORMATION CARD

Onkyo CD Player with changer DX-C600

You don't have to be clairvoyant to see what the next stage in the developing CD player wars is likely to be. *Onkyo U.S.A. Corp.* (200 Williams Dr., Ramsey, NJ 07446), like a number of its competitors, is offering a *CD Player/Changer* (DX-C600) with six-disc capacity. *Onkyo* hopes that features like its "acclaimed opto-coupling" technique which electronically separates digital and analog circuit blocks in order to free the unit's playback sound from the harshness sometimes associated with the CD medium will put the DX-C600 over the top with consumers. The unit's programming is so sophisticated that you don't even have to have a disc or disc magazine loaded when you're entering memory play. In other words, you can program discs that aren't even there, kind of spooky when you think about it. Anyway, the next CD player/changer king of the hill, for at least a couple of weeks, will be the brand that markets a seven- or eight-disc changer. In the meantime, the *Onkyo DX-C600* joins the battle of the sextets. Price: \$600.

CIRCLE 81 ON FREE INFORMATION CARD

Canon VM-E2N 8-mm camcorder

Camcorders in the 8-mm format are keeping pace with their more widespread VHS competitors. *Canon U.S.A., Inc.*, (1 Canon Plaza, Lake Success, NY 11042) has introduced a new 8-mm Video Camcorder (VM-E2N) which boasts a 250,000 pixel charge-coupled device image sensor, and recording capability at illuminations as low as five lux. Something Canon dubs a "flying erase head" aims to eliminate blanks and video noise between scenes, ensuring "clean in-camera editing." An intriguing extra is a *Sepia tone button*. The function will record in brown-toned Sepia, giving the image an antique quality. The VM-E2N also boasts, among other features, high fidelity audio, automatic focus, zoom lens, two-hour recording capability and five-second review. Price: \$1,699.

CIRCLE 61 ON FREE INFORMATION CARD

Adjustable Exercise Bike Reading Stand

A healthy mind and a healthy body are supposed to have something to do with each other. Now from a leading manufacturer of fitness equipment, *Bodyguard* (40 Radio Circle, Mt. Cisco, NY 10549), comes a product to allow you to improve one while working on the other. It's an adjustable *Exercise Bike Reading Stand*, to engage the mind while exercising the body. The unit clamps onto the neck or handlebars of any brand exercise bike and features an adjustable page-holder. Made of smoked Plexiglas, we just hope these don't start appearing on non-stationary bicycles. Price: \$21.99.

CIRCLE 71 ON FREE INFORMATION CARD

Olympia USA, Inc. paper shredders

Perhaps inspired by last year's Iran-Contra Congressional hearings, *Olympia USA, Inc.* (Box 22, Somerville, NJ 08876-0022) has entered a new area of business equipment, paper shredders. The firm is offering a full-service line of 13 of these security tools, including the *Olympia Desk-Side Shredder* (2206). "Straight-cut models," the firm says, "turn documents into illegible strips," while "cross-cut" units reduce "a single sheet of letter-size paper to create 2,000 confetti-size particles." In common with other models, the 2206 can take staples and clips, features electronically controlled automatic reverse which eliminates paper jams and messy overflow and dust-free shred collection in fully enclosed plastic bags. All this and styles ranging from pearl gray to walnut wood finish. Price: \$1,349.

CIRCLE 72 ON FREE INFORMATION CARD

Zenith home-satellite receiving systems

Scrambling of signals was supposed to bring big changes to home satellite TV. But if a new product from *Zenith Electronics Corp.* (1000 Milwaukee Ave., Glenview, IL 60025) is any indication, the change may not be so big. Zenith, one of the few electronic giants to dive head-first into home satellite reception, is now offering *Home Satellite Receiving Systems* with built-in decoders. The ZS-6000 features an integrated combination receiver/decoder with something called *Videocipher II*, along with on-screen displays, stereo sound, parental security, automatic antenna positioner, wireless remote control, automatic program recall, front panel displays and a ten-foot antenna. Price: \$2,799.

CIRCLE 74 ON FREE INFORMATION CARD

Canon Cat work processor

We're not sure what the implications of this are, but if the product succeeds, it probably represents a new stage to the computerization of daily life, or something. From *Canon U.S.A., Inc.*, (1 Canon Plaza, Lake Success, NY 11402), the company is calling it the *Cat Work Processor*. While the press release avoids the word computer, the Cat is described as combining "typing, word processing, information storage and retrieval, calculating and communicating with other Cats" or even computers. Its storage capacity is approximately 80 pages or 180 KB. Designed to do away with menus, windows, files, booting, formatting or computer terminology or jargon, it only requires the desk space of a regular typewriter. Its most distinctive feature is a *leap* function, "the first improvement in cursor control since the mouse." Two *leap* keys control text editing, rearrangement, spelling checking, revision, underlining and bold facing. Aimed at office users, the Canon Cat sounds ripe for consumer sales. Price: \$1,495.

CIRCLE 75 ON FREE INFORMATION CARD



Canon VM-E2N 8-mm Camcorder

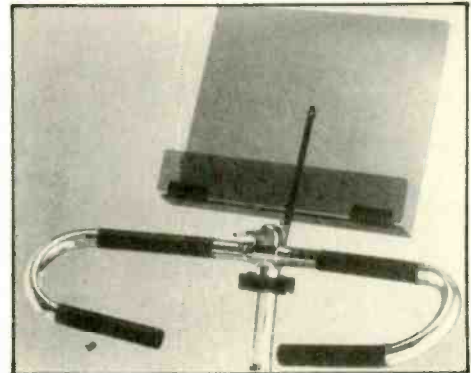

Bodyguard Exercise Bike Reading Stand

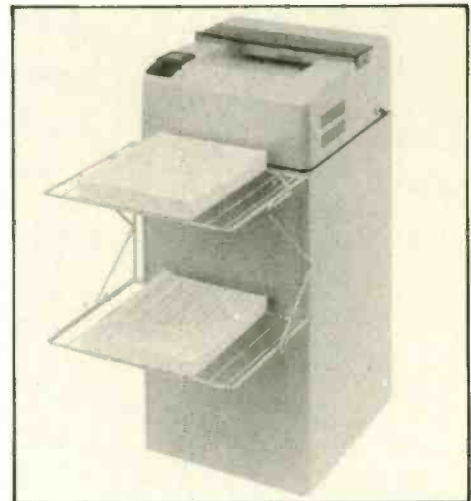

Olympia Desk-Side Shredder 2206



Canon Cat Work Processor

Gizmo/Bytes

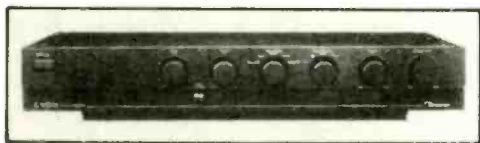

Nakamichi Control Amplifier 90502



Sonin Ultrasonic Measuring Device 60

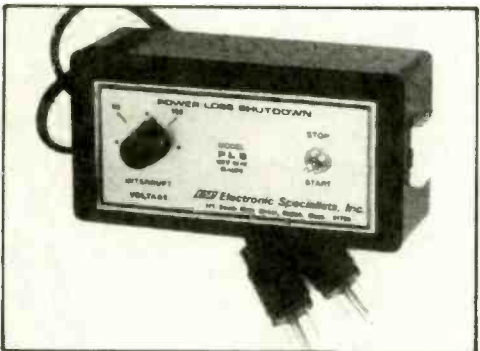

Electronic Specialists Power Loss Shutdown

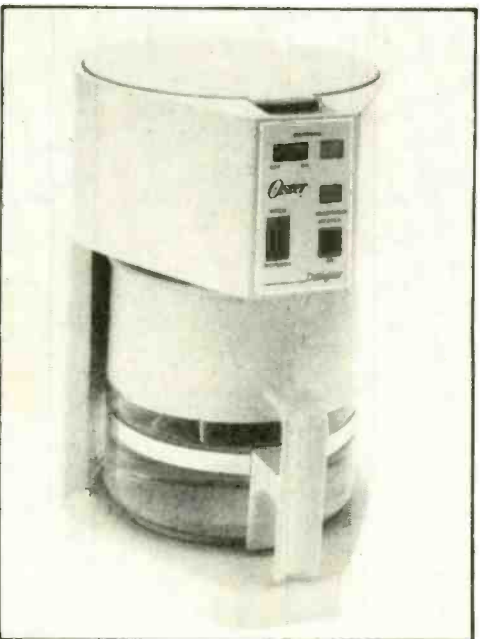

Oster 4-cup Coffee maker 3400

Nakamichi CA-5A II Control Amplifier

Even as capabilities becomes more complex, audio equipment is being simplified. This according to *Nakamichi America Corp.* (19701 S. Vermont Ave., Torrance, CA 90502) in announcing its new *Control Amplifier* (CA-511). This new pre-amp features defeatable tone controls, two-way tape dubbing capability with five high-level inputs plus phono input. Especially noteworthy, Nakamichi proclaims, is the unit's "elegantly simple topology...the simpler the circuit, the better the sound." Price: \$995.

CIRCLE 70 ON FREE INFORMATION CARD

Sonin ultrasonic measuring device

It looks as if the measuring tape and the yardstick might be on their way to the museum of obsolete tools. *Sonin, Inc.*, (672 White Plains Rd., Scarsdale, NY 10583) markets a device which measures the electronic way. Called the *Sonin 60*, the device uses ultrasonic waves, processed via microchips, to measure distances. Pocket-size, the unit is placed against a wall and pointed in the direction to be measured. Readings appear on an LCD and the *Sonin 60* includes dual memories and a calculator to assist in computing areas and volumes of measured space. According to the company, the device incorporates three electronic safeguards. One prevents false readings due to variations in air temperature and humidity, a second eliminates stray signals from objects near the measuring path and the third adjusts the *Sonin's* response to temperature changes. Price: \$99.95.

CIRCLE 65 ON FREE INFORMATION CARD

UPS Shutdown/Electronic Specialists, Inc.

So what happens if a micro-computer's battery back-up system discharges before interrupted regular power resumes? Most PC users probably don't want to find out which is where the *Power Loss Shutdown* from *Electronic Specialists* (171 S. Main St., P.O. Box 389, Natick, MA 01760) comes in. The device will "shut down an entire computer system if commercial AC power has not yet been restored when UPS or SPS batteries have discharged," thereby preventing "undesired computer and power system start up after a power outage." In case you're wondering, *Electronic Specialists* say "models with adjustable AC line drop-out voltage level" are available. Price: \$150.

CIRCLE 66 ON FREE INFORMATION CARD

Career Navigator

Here's an unfortunately timely new software package, the kind PC users may not want, but one which they eventually could need. The *Career Navigator* is dubbed "the computer-powered job search system" and it's been developed by *Drake Beam Morin, Inc.* (100 Park Ave., New York, NY 10017) which calls itself, "the world's largest career counseling and out-placement firm." *Career Navigator* includes a job search handbook and four disks which facilitate self-assessment, creation and storage of up to five different resumes and ten different cover letters, a file of up to a hundred names and addresses, a progress monitor and a permanent personal database for lifetime updates and reference. *Drake Beam Morin* calls the program "highly inactive and individualized." *Career Navigator* is available for the IBM PC, XT, AT and compatibles with 256k, color or monochrome monitor and dot matrix or letter quality printer. Price: \$95.

CIRCLE 73 ON FREE INFORMATION CARD

Oster four-cup coffemaker

Although this product is pitched for households with one or two members, we think it might be just the ticket for people trying to cut down on their coffee intake under any circumstances. It's a new *Four-Cup Coffemaker* (3400) from *Oster* (5055 N. Lydell Ave., Milwaukee, WI 53217) with a 20-ounce capacity which heats water to brewing temperature in just 90 seconds. The model comes equipped with separate on/off signal lights for both the coffemaker and its warming tray and the water reservoir is stainless steel. Price: \$45.95.

CIRCLE 67 ON FREE INFORMATION CARD



**Hands-free conversation
with total privacy
can be yours
with this exciting project!**

HEAD- PHONE INTERFACE

By B. Jones

HAVE YOU EVER NEEDED TO TALK ON THE PHONE FOR long periods of time while having both hands free? I had that problem while working as an operator at a telephone solicitation company and found that I was getting many a neck ache from trying to pinch the phone between my shoulder and ear while writing. To solve the problem I invented a circuit to connect my stereo's headphones to the telephone. I hope that you will find it useful too.

What the Circuit Does

As well as being able to use both hands, we also want to be able to increase the volume of weak incoming calls and decrease the background noise. At the same time the circuit should still allow the use of the phone in the regular way without switching cables.

The Connection of Handset to Phone

This circuit will work only with a handset that has no electronics in it. If you have the right kind of phone it will have a cable between the phone and handset with four wires in it. Two of the wires go to the mike and two go to the speaker, see Fig. 1. The wires to the mike form a current loop with the microphone, which is a carbon granular mike, acting as a variable resistor. Its resistance changes with air pressure and therefore varies the current in the loop. The speaker connection is just like a speaker connection on a stereo. An AC signal comes from the phone and is applied across the speaker terminals.

Connecting the Headphones

In order to connect the headphones to the phone we have to do two things. First we must get the signal that would normally go to the speaker in the handset routed to the headphone speakers. Next we must replace the handset microphone current loop with a circuit which will keep the DC components the way they used to be while injecting the AC

voice component from the electret microphone used on the headphones. Note that this microphone does not work the same way a carbon granular mike does and it is not a direct replacement for the carbon granular mike.

Figure 2 shows the replacement circuit diagram in block form. The signal from the phone that used to go to the handset speaker is broken. One wire is taken as ground and the other is connected to a volume control. Next the signal is AC



While this article was being prepared the staff couldn't keep from tinkering with the headphones (we love our jobs).

Fig. 1—In a telephone, resistance varies with air pressure from the user, thereby changing the current in the loop. That shows up on the phone line as a small AC signal superimposed on the DC voltage.

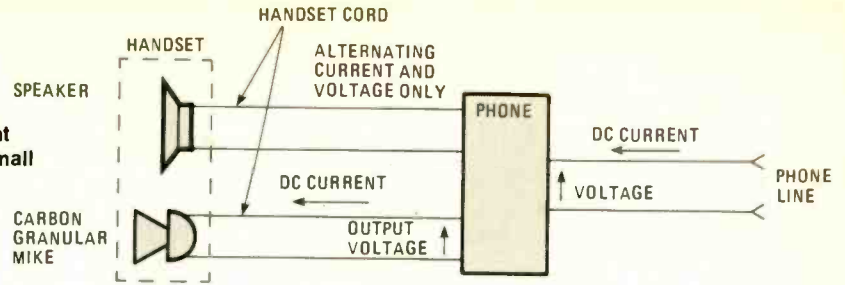

coupled (capacitively coupled) to the incoming amplifier which amplifies the signal and drives both of the headphone speakers.

The replacement circuit for the microphone must have the same DC resistance as a carbon granular mike and allow the injection of AC signals into the loop. The circuit consists of an audio isolation transformer and a resistor in series to get the DC resistance correct. A capacitor bypasses the AC component of the injected signal around this current-setting resistor. The signal from the headphone's electret mike is connected to the outgoing volume control. The signal is then AC coupled to the outgoing amplifier and the output of the amp drives the primary of the isolation transformer. This injects the audio signal into the DC current loop.

The Talk-Back Problem

Talk-back is not something the phone does when it wants

to hassle you, but rather it was designed into the phone to make you feel more comfortable while using it. To control the volume at which a user speaks, the phone purposely feeds a small percentage of the signal it receives from the mike back to the speaker so that the person will hear themselves talk and know that the phone is working properly. Without talk-back users tend to yell into the phone.

In two situations our device suffers from this talk-back system. Fig. 3 shows the difference between a regular and weak call. The phone always feeds the same portion of the mike signal back to the speaker no matter what the incoming signal strength is. When we receive a weak call our device can compensate and bring the call back up to normal level by amplifying the signal between the phone and the speaker. The problem is that the amplifier amplifies both the incoming signal and the talk-back signal that the phone is sending to the speaker. The result being that the talk-back signal ends up

Fig. 2—The headphone interface must pass the mike current while imposing the head set's mike signal on the line. That is done with the isolation transformer shown.

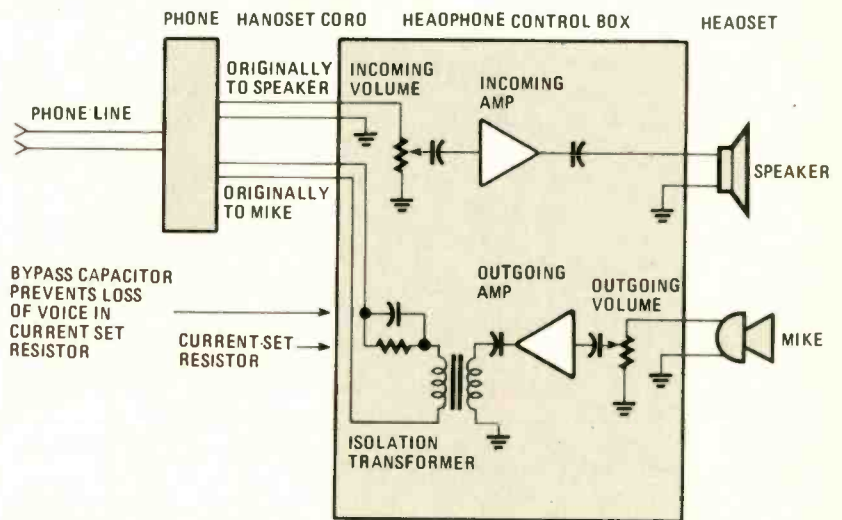
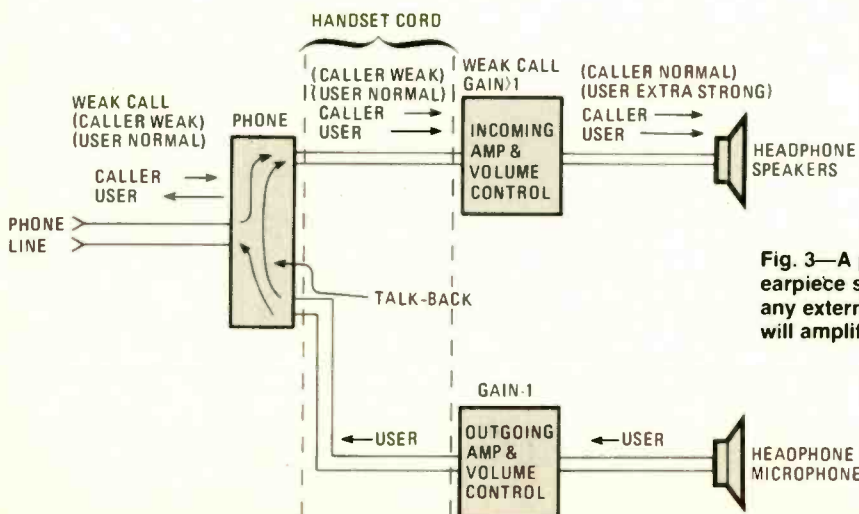

Fig. 3—A phone pipes some of the mike's signal back to the earpiece so you sense the phone working. Because of that, any external amplifier set to amplify a weak incoming call will amplify the signal being fed back as well.



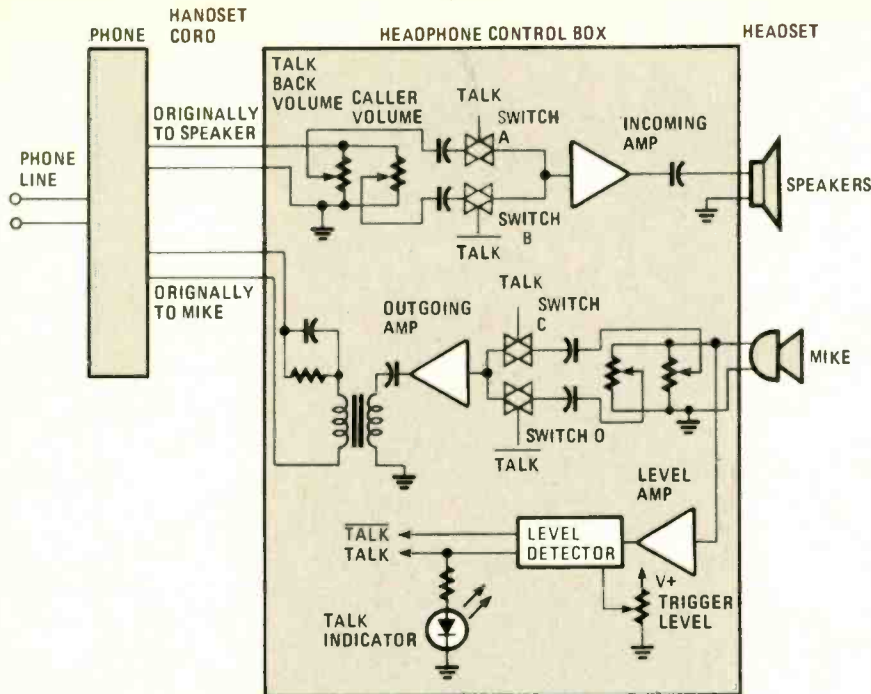

Fig. 4—This block diagram of the unit should give you some idea of how the switching part of the circuit operates.

way too strong and hurts the ears of the user. The user's natural reaction is to talk softer so that it doesn't hurt, but if they do this the other party now has a hard time hearing them because the outgoing signal is now weaker.

Another problem with talk-back is that the phone is feeding back the noise that is being picked up by the microphone when the user is not talking. If the incoming amplifier is set for a high gain to compensate for a weak connection, it will also be amplifying the background noise. The background noise can then become as loud as the other party. Further amplification will not help as it will still amplify both signals.

Beating Talk-Back Problems

One way to fix the trouble would be to reduce the amount of talk-back on weak calls and restore it to normal for strong calls. Unfortunately, the amount of talk-back is determined inside the phone. The only way to change the amount of talk-back is to alter the inside of the phone.

If we instead change the gain of the incoming and outgoing amps as the user speaks and listens we could correct the problem. Here is how it works: Assume the incoming call is weak, therefore it needs to be amplified to be brought up to a normal volume. When the user is not talking, the gain of the outgoing amp is set low. Since the gain of the incoming amp is set high, the call is being amplified to the proper level. Since the gain of the outgoing amp is set low, little background noise is going in the mike input of the phone, therefore the amount being fed back is also low, and there is no background noise heard while listening to the other party.

When the user speaks we change the gain settings so that the outgoing gain is at the normal level and incoming gain is at unity. Since both gains are at the normal levels the talk-back is just right and the user feels comfortable and speaks at the correct level. Our output signal is thus the correct strength.

Note that we could not hear the other party with poor

settings because they would be very weak and we would hear a lot of background noise, but gain is necessary so that the outgoing signal and the talk-back level is right.

Figure 4 shows our solution to the problem. We provide two volume controls for each amplifier. One for when the user is talking and the other for when the user is listening. Those are referred to as the *talk mode* and the *listen mode* respectively. We provide a voice activated circuit that switches between the volume controls automatically when the user speaks.

Circuit Operation

Figure 5 shows the complete schematic. There are actually four sections to this circuit. The first is the incoming amp. The second is the outgoing amp. The third is the voice activation circuit, and last is the power supply, which simply consists of a switch, nickel-cadmium batteries, and a plug for connecting an AC adapter to charge the batteries. The Parts List shows all the

catalog numbers to obtain the parts either from Radio Shack or through the mail from Mouser electronics with their address.

Incoming Amplifier

The signal from the phone enters the box and goes directly to the two 5K incoming volume controls, R1 and R2. They are mounted on the front panel for user access. A shielded cable goes from these controls up to the PC board and connects to the two coupling capacitors, C1 and C2.

Note that all shielded cable used has three conductors in it. There are two center conductors, colored red and white, and the shield surrounds both of those.

Capacitors C1 and C2 connect the two different volume incoming signals to U1, the 4066 switch. The switch selects the signal to be passed on to the incoming amplifier. Another shielded cable is used to take the signal to the base of Q1. Transistors Q1 and Q2 form the incoming amplifier, which is a dual-stage class-A amplifier. The amplified signal is taken from the collector of Q2 and sent to the the headphone speaker jack, J1. Switch S1 allows the handset speaker to be connected either straight to the phone, to the output of the incoming amp, or shut off.

Outgoing Amplifier

The outgoing signal originates at the electret microphone mounted on the headphones. It is brought from here via shielded cable to plug J4. The shield is used for ground, the white is the audio signal from the mike, and red carries V+ to the mike to power it. Plug J4 is plugged into jack J2. Both of these have three connectors to carry the signals mentioned above.

From J2 a shielded cable runs to volume control R3, the background volume mounted on the front panel. The shield is used as ground, the red wire takes the audio signal to one end of the pot, and the white wire brings the audio back from the

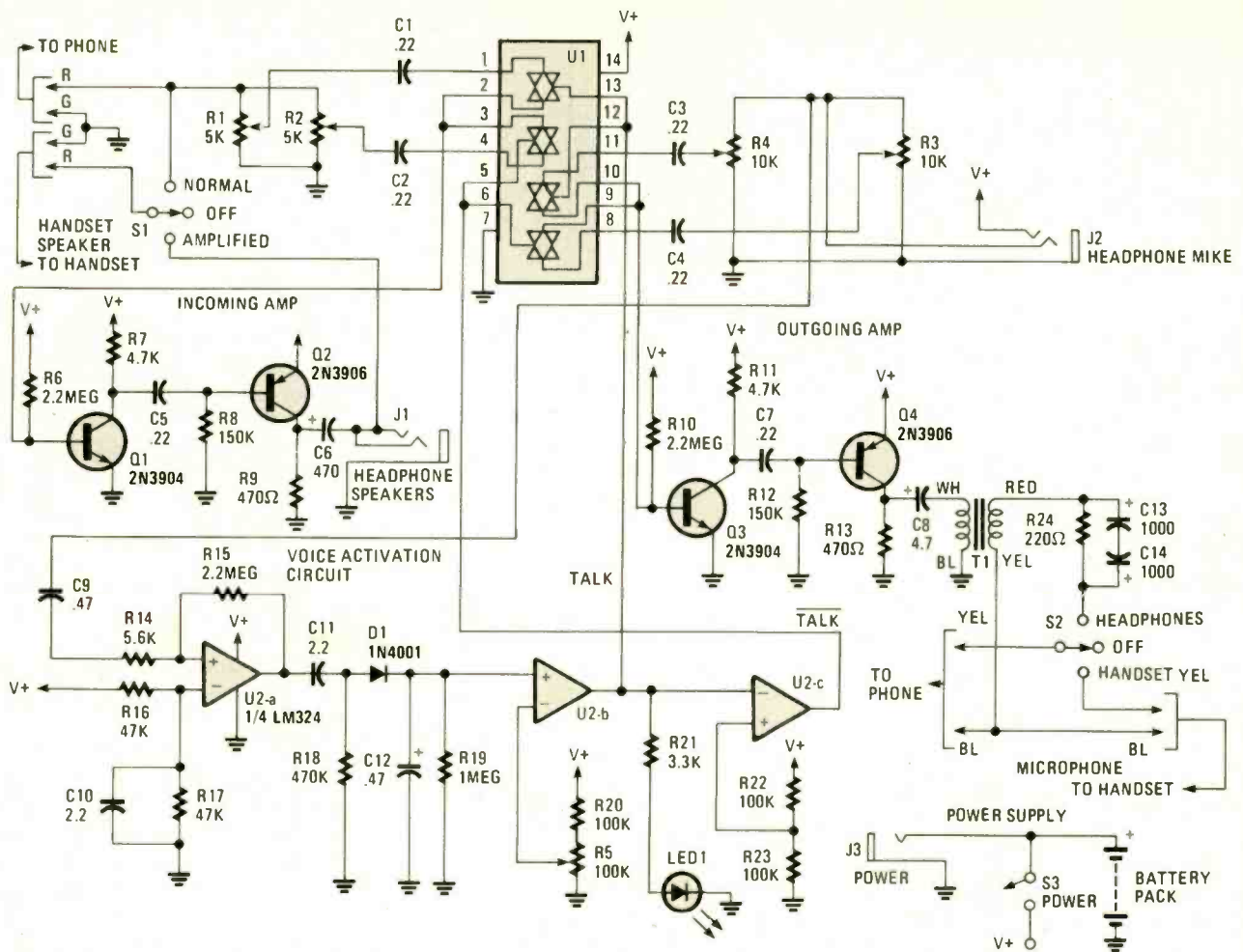

Fig. 5—As you can see, the circuit is composed of four main sections: incoming and outgoing amplifiers, voice activation, and headset circuits. The incoming and outgoing amps are identical except for their output coupling.

center of the pot.

Another shielded cable originates at jack J2 and goes to the PC board. The shield of that cable is ground and the white wire carries the audio from the microphone. The red wire takes the signal coming back from volume control R3 up to the PC board.

At the PC board the red wire is connected to coupling capacitor C4 which leads to U1, the 4066 switch. The white wire goes to R4, which is the outgoing volume control and is mounted on the PC board so that the user cannot change the output level of the circuit.

The signal from R4 is fed to the switch via capacitor C3. The switch selects which signal is to be used and the signal is fed to the base of Q3.

Transistors Q3 and Q4 form the outgoing amplifier. Their arrangement is the same as that used for the incoming amplifier. The outgoing signal is taken from the collector of Q4 and is hooked to the primary of the isolation transformer, T1, by capacitor C8.

The secondary of transformer T1 and resistor R24 form the DC current loop that replaces the carbon granular mike from the original handset. R24 allows for the adjustment of the DC current value. Capacitors C13 and C14 bypass the AC audio around resistor R24. They are connected back to back to form a bipolar capacitor because the polarity of the connection with the phone can not always be counted on. Switch S2

allows either the circuit to be hooked to the phone or the original microphone in the handset. It's center position allows both microphones to be disconnected so the caller cannot hear what is being said.

The Voice Activation Circuit

The signal for the voice activation circuit is taken from the white wire of the cable that goes between jack J2 and the PC board. The signal is the audio as it comes from the mike without going through any volume controls. Capacitor C9 couples the signal to IC2, an LM324 Quad op amp.

The first opamp boosts the signal 393 times. The amplified signal is brought back down to ground by capacitor C11 and resistor R18. Diode D1 gets rid of the bottom halves of the signal and capacitor C12 filters the signal so that a DC voltage of the value of the peak of the AC signal appears at the + terminal of the second opamp.

The DC value depends on whether, and how loudly the user is talking. Resistor R19 discharges capacitor C12 to provide a short delay in the switch of volumes after the user stops talking.

Trigger-level control R5 determines what voltage will be used as the reference for determining what is talking and what is not. The output of the second op amp is the talk signal and the third op amp inverts this to get the talk-bar signal. Those two signals are connected to the control pins on U1, the 4066

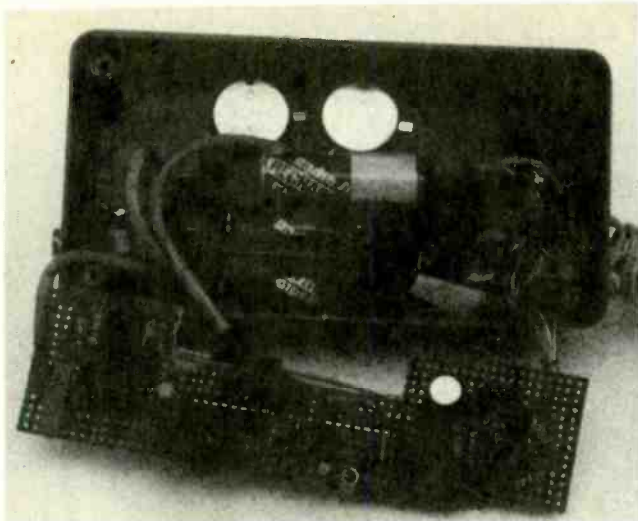

If you have trouble finding a six-battery holder, try a four-battery and a two-battery holder connected in series.

switch to determine which volume controls to use. LED2 displays the status of the talk signal, making it easy to adjust the trigger level.

The Power Supply

Six nickel-cadmium rechargeable batteries supply the power to operate the circuit. Switch S3 allows power to the circuit to be turned on or off. Jack J3 is hooked to the batteries to allow an external charger to be connected. Note that the size of jack J3 is different depending on the source of the charger used, check the parts list carefully. The circuit will run between 10 and 15 hours with the batteries listed. Charging time is about the same.

Constructing the Circuit

Be sure to use shielded cable in the places I have noted. I housed my circuit in a small plastic box from Radio Shack, catalog number #270-223, and hand wired it using a perforated board.

Put four of the potentiometers, the three switches, and the LED on the front panel. Both of the incoming volume controls, R1 and R2, and the listen-mode outgoing volume (background volume) control, R3, should be mounted on the front panel. The trigger level potentiometer, R5, should also be mounted on the front panel.

Jacks J1, J2, and J3 should be mounted on the sides of the cabinet. Remember to leave two holes for the handset cables going to the phone and handset. You make the two cables by

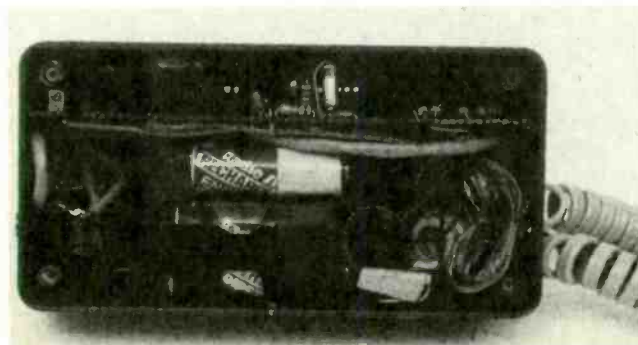

With a little creativity, the circuit can be made to fit in a small enclosure. It is convenient to have the board-mounted trim pot in a position for easy adjustment.

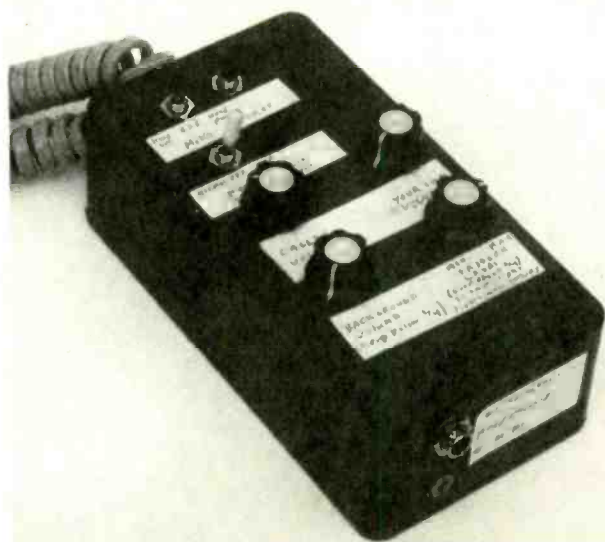

Making the jacks for the mike and headphones two different sizes is a good idea since it helps avoid making an improper hook up. Labeling is also wise and could save your hearing.

cutting the one handset cable specified in the parts list in two. I made the piece to the phone shorter than the one to the handset so I could tell them apart.

I mounted the microphone on the headphones by drilling a hole for a number-six screw in the left side of the headphone's band and bent a piece of heavy aluminum wire to hold the mike. You will need a windscreen over the mike so that air rushing in and out of your mouth doesn't disturb the microphone. I used a scrap one from one of those old Mr. Microphones. Any headphones will work. You will have to find a suitable way of mounting the boom for the mike.

Preliminary Setup

Before adjusting your circuit you will have to set it up in the proper way. First you must charge the batteries. Set switch S3 to the off position. Put the batteries in their holders, connect the AC adapter to jack J3 and plug the adapter into an outlet. If you observe the voltage across the batteries it should go up to between 7.5 and 9 volts when you plug in the adapter. Allow the batteries to charge for about 12 hours. An alternative would be to use regular batteries to test the circuit.

Monitor the current flowing out of the batteries when switch S3 is turned on. It should be no more than about 30ma. If it isn't, check the circuit for shorts or wrong-value resistors.

Adjustments

You will have to adjust a couple of things once you have your basic circuit working. First you should test your phone and find out what the normal value of current is in the microphone current loop. Once you know this value you change the value of R24 to make the value the same when using this circuit. To make this adjustment be sure that the cable to the phone is connected and that switch S2 is set to the headphone position.

The second thing you should do is to check the voltages at the collectors of the four transistors. They should all be within one or two volts of half the power-supply voltage. If they are not, you can adjust the voltages on Q1, Q2, Q3, or else Q4 by changing bias resistors R5, R8, R10, or R12

PARTS LIST FOR THE TELEPHONE-CONTROL BOX

SEMICONDUCTORS

- D1—1N4001 small-signal diode, Mouser #333-1N4001
D2—Red light-emitting diode, Mouser #35BL501
Q1, Q3—NPN small-signal transistor, Mouser #333-KN3904
Q2, Q4—PNP small-signal transistor, Mouser #333-KN3906
U1—CMOS 4066 quad bilateral switch, Mouser #511-4066
U2—LM324 quad opamp, Mouser #511-LM324AN

CAPACITORS

- C1—C5, C7—.22- μ F, Mouser #23AK422
C6—470- μ F electrolytic, Mouser #20WH470
C8—4.7- μ F electrolytic, Mouser #20WK005
C9, C12—.47- μ F tantalum, Mouser #551-0.47M35
C10, C11—2.2- μ F tantalum, Mouser #551-2.2M16
C13, C14—1000- μ F electrolytic, Mouser #20WH901

RESISTORS

(All fixed resistors are 1/4-watt units unless otherwise noted.)

- R1, R2—5000-ohm, linear-taper potentiometer, Mouser #31VA305
R3—10,000-ohm, linear-taper potentiometer, Mouser #31VA401
R4—10,000-ohm, PC-mount potentiometer, Mouser #32NA401
R5—100,000-ohm, linear-taper potentiometer, Mouser #31VA501
R6, R10, R15—2.2-Megohm, Mouser #29SJ250-2.2MEG
R7, R11—4700-ohm, Mouser #29SJ250-4.7K

- R8, R12—150,000-ohm, Mouser #29SJ250-150K
R9, R13—470-ohm, Mouser #29SJ250-470
R14—5600-ohm, Mouser #29SJ250-5.6K
R16, R17—47,000-ohm, Mouser #29SJ250-47K
R18—470,000-ohm, Mouser #29SJ250-470K
R19—1-Megohm, Mouser #29SJ250-1MEG
R20, R22, R23—100,000-ohm, Mouser #29SJ250-100K
R21—3300-ohm, Mouser #29SJ250-3.3K
R24—220-ohm 1/2-watt, Mouser #29SJ500-220

ADDITIONAL PARTS AND MATERIALS

- J1—1/4-in. stereo phone jack, Mouser #16PJ081
J2—1/8-in. phone jack, Mouser #16PJ108
J3—1/8-in. phone jack (for Mouser AC adapt given below), Mouser #16PJ125
J4—1/8-in. stereo phone plug, Mouser #17PP004
M1—electret microphone, Mouser #25LM044
S1, S2—SPDT, center-off toggle
S3—SPST toggle
T1—600-600-ohm audio isolation transformer, Mouser #42TM016

Handset cable, gridboard (6 x 2-in.), Mouser #ME153-1102; case (6 x 3-1/8 x 2-in.), Mouser #546-1591DS-BK; 2-"AA" battery holder, Mouser #12BH321; 4-"AA" battery holder, Mouser #12BH346; 9-Volt battery snaps (for R.S. holders only); 6 "AA" nickel-cadmium batteries, Mouser #547-PS-AA; AC adapter jack J3 depends on adapter, Mouser adapter #41AC109; knobs for volume controls, solder, wire, etc.

respectfully.

The third thing you must adjust is the output volume of the unit. Before you can do that however, you must set it up correctly. Connect the headphones to jack J1 and the microphone to jack J2. Connect the correct cable to the phone and the other one to the handset. Leave the handset on the phone at this time. Set switch S1 to the center (off) position and S3 to the on position. Speak into the microphone and observe LED2. When you speak the LED should light and then go out when you stop speaking. Adjust the TRIGGER LEVEL control R5 if the LED is not lighting at the correct time.

Final Connections

Now connect either an oscilloscope or another phone to the phone line. If you use an oscilloscope be sure to use a three-to-two wire adapter on the power cord because the phone company grounds one of the wires in the phone line.

Set the mike switch S2 to the handset position and lift the handset. Speak at a normal level and observe the strength of the signal on the oscilloscope or the other phone. Next change switch S2 to the headphone position and speak into the headphone's mike. Continue to go back and forth between the two while adjusting volume control R4 to get the levels the same.

Using the Circuit

Before using the circuit connect it to the phone as in the previous section. Also connect the headphones and microphone to the circuit.

Set the three volume controls on the panel to about one quarter turn. Leave the trigger level set to where it was found to work best in the previous section. Set the mike switch, S2 to headphone and the handset speaker switch, S1, to off. Turn the POWER switch, S3, on and adjust the trigger level control, R5, if the LED is not lighting at the correct time when you speak into the headphone microphone.

When you lift the handset you should hear a dial tone in the headphones. Adjust the volume of the dial tone with the CALLER VOLUME control, R2. Set the volume you hear yourself with the TALK-BACK VOLUME control, R1. Adjust the amount of background noise you hear with the BACKGROUND VOLUME control R3.

To have another person listen to your conversation just set the handset speaker switch to either normal or amplified and give them the handset. The mike in the handset is still off so the caller will not hear the person with the handset.

To use the handset normally set the mike switch to the handset position and the handset speaker switch to the normal position. While using the handset normally another person can listen on the headphones without being heard by the caller. If the headphones are not to be used while the handset is being used, the power can be turned off, thus saving the batteries.

Hopefully your circuit will serve you as well as mine has served me. I have used mine for about 500 hours now and it has never failed. With a device like this you can let your fingers do a lot of walking! ■

all about THYRISTORS

For power-control applications of any type—from lamp dimmers to overvoltage/overcurrent protection circuits—the thyristor is the way to go

By Robert A. Young, Jr.

IN THE OLD DAYS, VARIABLE POWER-CONTROL APPLICATIONS WERE accomplished through large variable resistors and thyatron tubes, which made the circuit bulky and extremely expensive. However, the development of the *thyatron-transistor*—more commonly known as a thyristor, and sometimes referred to as a reverse-blocking triode thyristor—changed all of that; making possible a more reliable and efficient replacement for its predecessor, the thyatron tube.

The thyristor is not a device unto itself, but rather a whole family of devices. That family includes the SCR (Silicon-Controlled Rectifier), most widely used as a power-control element; CSCR (Complementary, Silicon-Controlled Rectifier), defined as a negatively-triggered SCR; Triac (quite popular in low-current, under 40-ampere, AC circuits); SCS (Silicon-Controlled Switch); ASR (Asymmetrical Silicon Rectifier); SUS (Silicon Unilateral Switch), and SBS (Silicon Bilateral Switch), which are most commonly used as gate-trigger devices for power-control elements.

And that's not all there is to this family: There are a few other devices that can be used as solid-state switches, in variable power-control circuits, and for low-voltage control of high-power circuits.

To successfully use this family of devices, an understanding of their characteristics, ratings, and limitations is imperative. Therefore, we'll cover some of the more significant thyristor characteristics, the basis of their ratings, and their relationship to circuit design.

SCR's

Figure 1A shows the schematic symbol for the SCR—the first, and probably the most important member of the thyristor family. Its structure is like that of a four-layer diode, with a gate connected to the P-section nearest its cathode,

Fig. 1—Shown here is the schematic symbol for the SCR; B illustrates the PNPN structure the schematic symbol represents. A two-transistor SCR construct (similar in structure to the SCR) is shown in C and the four-quadrant characteristic curve for the SCR is shown in D.

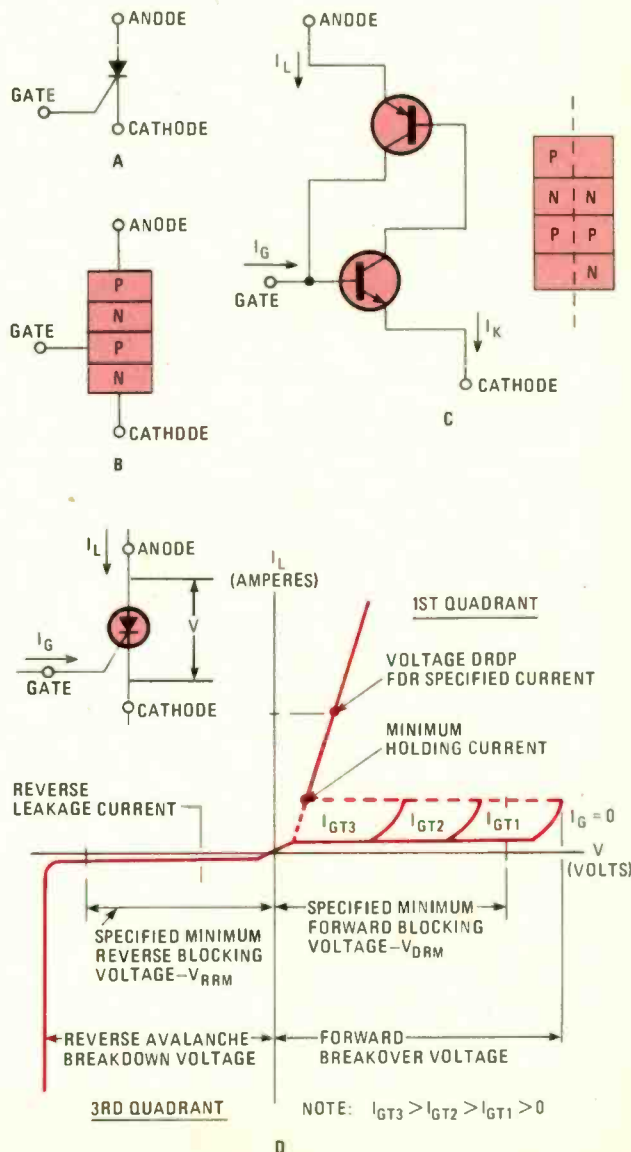

as shown in Fig. 1B. A two-transistor SCR construct (which is similar in structure to the SCR) is shown in Fig. 1C, and Fig. 1D shows the IV-quadrant characteristic curve for the SCR.

The interconnection of the transistors (see Fig. 1C) is such that if current is injected into any leg of the construct, the gain of the transistor (if sufficiently high) causes current to be amplified (regenerated) in the other leg. In order for regeneration to occur, the sum of the common-base current gains (α) of the transistors must exceed unity. Because junction leakage current is relatively small and current gain is designed to be low at the leakage-current level, the PNP device remains off unless externally acted upon.

When sufficient trigger current is applied to the gate of the construct (raising loop gain to unity) regeneration occurs, and the on-state principle current is limited primarily by external circuit impedance. Removing the initiating trigger does not effect turn-off provided that the unity-gain criteria (or latching-current requirement) is met.

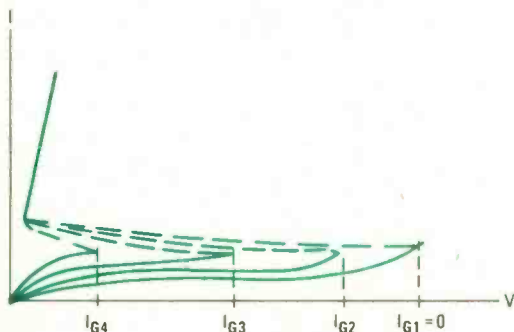

Fig. 2—Here is the interaction of gate current and voltage in an SCR. When gate current (I_G) is zero, the applied voltage must reach breakover before switching occurs. But, as gate current increases, the SCR's ability to block the applied voltage is reduced, and turn-on occurs.

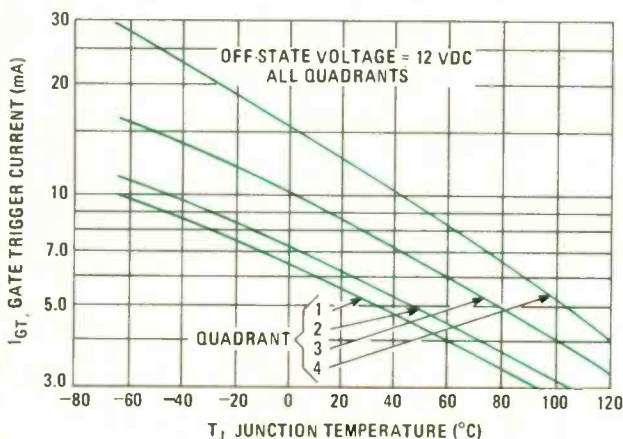

Fig. 3—Gate sensitivity is shown here as a function of temperature. Since junction-leakage currents and current gain increase with temperature, the magnitude of required gate-trigger current decreases. The voltage drop across the gate also decreases as temperature increases.

In order to induce turn-off, the SCR's loop gain must be brought below unity. From Fig. 1C, it appears that shorting the gate to the cathode would bring that about; however, in

SCR operation very-little current is diverted via such a short. Principle current must fall below a certain level before gain falls below unity and turn-off can commence.

In fabricating SCR's, a shorted-emitter design is generally used in which (schematically) a resistor is added between the SCR's gate and cathode. Because current is diverted from the N-base through the resistor, the gate-trigger (I_G), latching (I_L), and holding (I_H) currents all increase. The prime reasons for the shunt resistor—without which leakage current could initiate turn-on—is to improve performance at elevated temperatures.

Sensitive-gate SCR's (and thyristors in general) use a high-resistance shunt or none at all. Consequently, their characteristics can be altered dramatically by way of an external resistance, which has only minor effect on most shorted-emitter designs. Junction temperature is the fundamental variable affecting SCR characteristics.

Increased temperatures make SCR's easier to turn on and keep on. Thus, circuit conditions that determine turn-on must be designed to operate at the lowest anticipated junction temperatures. At the same time, circuit conditions that are to turn off the SCR or prevent false triggering must be designed to operate at the maximum anticipated junction temperature.

Pulling the Trigger

The turn-on of the SCR has been described as requiring the injection of a current—in the form of gate current (I_G), anode-leakage current, or avalanche breakdown of a blocking junction—to raise the loop gain to unity. The breakover voltage of a SCR can be varied or controlled by the injection of gate current. Figure 2 shows the interaction of gate current and voltage in an SCR. Note that when I_G is zero, the applied voltage must reach the breakover point before switching occurs. (There is an I_G level at which the SCR's, and thyristors in general, behave more like rectifiers.)

Because SCR turn-on can induce high instantaneous power dissipation, die failure may result unless the magnitude and rate of rise in principle current (di/dt) is restricted to tolerable levels. Normally, SCR's are operated at voltages lower than their breakover rating, and turn-on is induced by gate signals of sufficient amplitude to assure complete turn-on independent of the applied voltage.

Trigger Sensitivity

Because junction-leakage currents and current gain (see Fig. 1C) increase with temperature, the magnitude of the required gate-trigger current decreases, and the gate—which can be regarded as a diode—displays a lessening voltage drop as temperature increases. (Figure 3 shows gate sensitivity as a function of temperature.) It's important that the gate trigger circuit be designed to deliver sufficient I_G at the lowest temperature anticipated.

Further, it's advisable that maximum gate ratings, and peak- and average-power dissipation ratings be observed. Although turn-on criteria has been discussed in terms of current, it's more basic to consider the SCR as being charge controlled. As the trigger-pulse duration is reduced, its amplitude must be correspondingly increased.

The gate-pulse width required to induce SCR conduction also depends on the time required for the anode current to reach the latching value. It may be necessary to maintain a gate signal throughout the conduction period in applications where the load is inductive, or where the anode current may

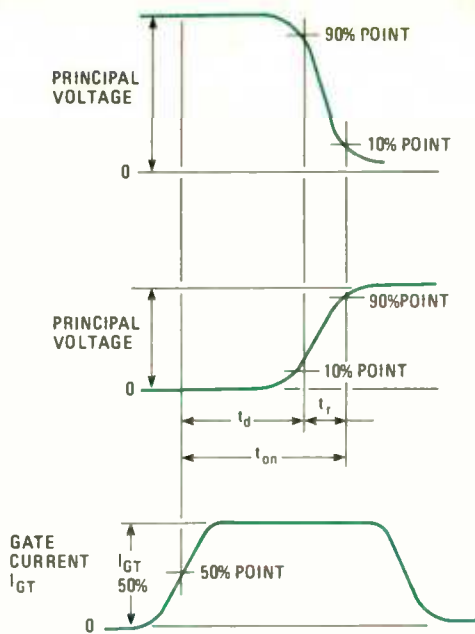

Fig. 4—SCR turn-on time has two stages; a delay time (t_d) and rise time (t_r). The total gate-controlled turn-on time (t_{on}) is measured from the 50% point of the gate-trigger to 90% of the principal current value. The rise time (t_r) is the time required for principle current to achieve 90% of its maximum value.

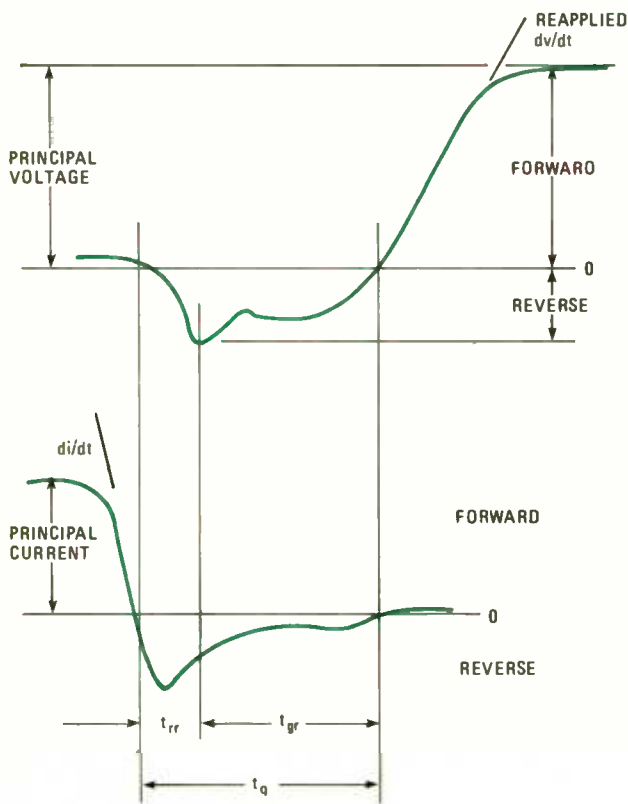

Fig. 5—Turn-off time is a property associated only with unidirectional thyristor devices. The recovery time of the SCR is comprised of two stages: a reverse recovery time and a gate-recovery (forward-blocking) time.

swing below the holding value within the conduction period.

When triggering an SCR with DC, excess reverse leakage normally occurs if the trigger signal is maintained during the reverse-blocking phase of the anode voltage. That happens because the SCR acts like a remote-base transistor. When high gate-drive currents are used, substantial dissipation may occur in the SCR. Therefore, some means must be provided to remove the gate signal during the reverse-blocking phase.

Latching and Holding Characteristics

As mentioned, it's necessary to have sufficient principal current flowing for the SCR to remain on when the trigger is removed. The required principal-current—called latching current, I_L —is primarily affected by temperature in shorted-emitter structures. To induce turn-off, principal current must fall below the latching level. The current at which turn-off occurs, called the holding current (I_H), is similarly affected by temperature, and dependent on gate impedance.

Reverse current on the SCR gate markedly increases the latch current and hold levels, while forward biasing its gate may significantly lower those levels compared to those specified, which are normally given with the gate open. Sometimes failure to account for such instances causes latch or hold problems when SCR's are driven by transistors with saturation points of a few tenths of a volt. SCR's of shorted-emitter design are obviously not as sensitive as those that have no built-in shunt.

Switching Characteristics

When triggered by a gate signal, SCR turn-on time has two stages; a delay time (t_d) and rise time (t_r)—the time required for the principal current to rise from 10 to 90% of its maximum value—as shown in Fig. 4. The total gate-controlled turn-on time (t_{on}) is defined as the time between the 50% point of the leading edge of the gate-trigger voltage and 90% point of the principal current.

The peak off-state voltage (which is related to the magnitude of the gate-trigger current, having a nearly inversely-proportional relationship) increases as the delay-time is decreased. Since high voltage causes increased regenerative gain, t_r is influenced primarily by off-state voltage.

It's important to note the relationship between the principal voltage and current flow through the SCR during the rise-time interval. During that time, the voltage drop is high and current density, due to rapid-charge, can produce localized hot spots on the die, which can permanently degrade the blocking characteristics. It's important that power dissipation at turn-on be restricted to safe levels.

Recovery Time

Turn-off time is a property associated only with SCR's and other unidirectional devices. The recovery time of an SCR is comprised of two stages: a reverse recovery time, t_{rr} , and a gate-recovery time, t_{gr} (see Fig. 5). When the SCR's forward current is reduced to zero (at the end of forward conduction), the application of reverse voltage (V_R) between the anode and cathode of the SCR causes reverse current (I_R) to flow until I_R is decreased to the leakage level. Reverse recovery time (t_{rr}) is measured from the point where the principal current changes polarity, to a specified point on the I_R waveform, as shown in Fig. 5. During that period, the anode and cathode are being swept of their charge so that V_R may be supported.

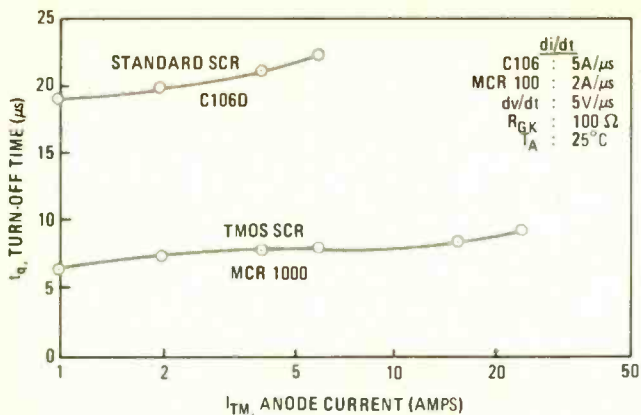

Fig. 6—In general, SCR's exhibit longer t_q with increasing I_{TM} . I_{TM} and di/dt have the strongest effect on t_q . If an SCR must have a short t_q when a low I_{TM} is present, a large gate-trigger pulse (I_{GT}) is required to trigger it.

A second recovery period, called the gate-recovery time (t_{gr}), must elapse for the charge stored in the forward-blocking junction to recombine so that forward voltage can be successfully blocked by the SCR. Gate-recovery time is usually much longer than t_{rr} . The total time from the instant reverse recovery current begins to flow, to the start of the forward blocking voltage, is referred to as circuit-commutated turn-off time or t_q .

Turn-off time depends on a number of circuit conditions, including on-state current prior to turn-off, rate of current change during the forward to reverse-voltage transition, reverse-blocking voltage, rate of change of reapplied forward voltage, gate bias, and junction temperature. Increasing junction temperature and on-state current increases t_q and has a more significant effect than any of the other factors. Negative gate-bias decreases t_q .

For applications where an SCR is used to control AC power, V_R is applied during the entire negative half of the sine wave. Turn-off is easily accomplished for most devices at frequencies up to a few kilohertz. In applications where an SCR is used to control the output of a fullwave rectifier, there's no V_R available for turn-off. Thus turn-off can only be accomplished if the rectifier output dips below the SCR's I_H value for a sufficiently long period. Turn-off problems may occur at 60-Hz, particularly when controlling an inductive load.

Jumping the Gun

Certain circuit conditions can cause SCR's to turn on without a gate-trigger signal having been applied (i.e., false triggering). For example, a rapid rise in anode voltage (symbolized by dv/dt and defined as the rate of change in voltage with respect to time), transient-induced anode breakover, and spurious gate signals can all cause false triggering.

When a voltage is suddenly applied to an SCR that's turned off, turn-on might be initiated even though no trigger signal is present at its gate. If, however, the SCR is controlling AC, false triggering due to a transient-imposed voltage is limited to no more than a half cycle of the applied voltage. Turn-off occurs at the zero-crossing point.

On the other hand, if the principal is DC, the transient may cause the device to switch on—due to a rapid rise in anode voltage, resulting from the internal capacitance of the

SCR—in which case, turn-off can henceforth only be accomplished through circuit interruption.

A voltage applied across the anode/cathode terminals of an SCR causes capacitance-charging current—a function of the applied off-state voltage ($I = C dv/dt$)—to flow through the device. If the rate of the voltage rise exceeds a critical value, capacitance-charging current exceeds gate trigger current, causing the SCR to turn on. Due to increased sensitivity, operating the device at high temperatures reduces the SCR's ability to support a steep rising voltage.

Solutions and Cautions

In sensitive-gate devices and shorted-emitter designs (to some extent), dv/dt ability can be markedly limited by inserting a resistance from cathode to gate. Reverse-bias voltage has even more influence in an SCR. More commonly, a snubber network is used to keep dv/dt within the limits of the SCR when the gate is open. Transient voltages, occurring as a result of disturbances in the AC line caused by various sources, such as energizing transformers, load switching, solenoid closure, and the like may generate voltages that exceed the SCR breakover rating.

Generally speaking, SCR's switch on (transferring energy to the load) whenever breakover is exceeded. Thus, care should be taken to ensure that breakover—which could result in blocking-characteristics degradation—does not occur. For applications where low energy, long-duration transients may occur, it's advisable that an SCR with a higher voltage rating than the highest anticipated transient be used.

It's a good practice to provide some form of transient suppression; an MOV or Zener diode, for example. An RC snubber is effective in reducing the effects of high-energy, short-duration transients frequently encountered. The snubber is usually used to prevent the static dv/dt limit from being exceeded. And may be effective in limiting the amplitude of the transient, as well.

Under no circumstance should the device dv/dt limit exceed the minimum rate of rise off-state voltage applied immediately to its anode/cathode terminals after the principal current of the opposing polarity has decreased to zero.

In noisy electrical environments, enough energy could cause a trigger current to be induced in the gate wiring via stray capacitance or electromagnetic induction. Thus, it is necessary to keep the gate lead short and provide a direct common return to the SCR's cathode. In extreme cases, shielded cable may be required. Another commonly used method is to place a capacitor (on the order of 0.01 to 0.1 μ F) across the gate and the cathode, increasing the SCR's ability to withstand high voltage changes by forming a capacitive divider with the anode-to-gate capacitance. The gate capacitor also reduces the rate of application of gate-trigger current, which may cause di/dt failures if a high inrush load is present.

To ensure long life and proper operation, it's important that the operating parameters be kept within the SCR's ratings—the most important being temperature and voltage, which are loosely related. The voltage rating is valid only up to the maximum operating temperature of that particular device type. The temperature rating may be designed to ensure suitable voltage ratings, switching speeds, and dv/dt . (Various manufacturers may chose different criteria to establish their ratings.) Current ratings are chosen so that at a practical case temperature, the power dissipation won't cause the junction-temperature rating to be exceeded.

SCR Turn-off

SCR's, in addition to traditional power-control applications, are used in areas where turn-off characteristics are vital. For example, reliable high-frequency (greater than 20 kHz) inverters and converters require a precisely controlled t_q . But, it's difficult to tailor the t_q of a particular SCR for a given set of circuit conditions.

We've already established that SCR's turn on and remain on even after the gate trigger is removed, as long as the loop-gain criteria is satisfied—*i.e.*, as long as the sum of the common-base current gains (α) of the equivalent NPN and PNP transistors exceed unity. To turn off the SCR, the loop gain must be brought below unity; *e.g.*, the on-state principal anode current (I_A) must be reduced below I_H . For AC-line applications, that occurrence is automatic during the negative transition of the waveform.

However, in DC applications (inverters, for example), the anode current must be interrupted or diverted. Once anode current in the SCR ceases, a period of time (which is dependent on temperature, forward current, and other parameters) must elapse before the SCR can again block forward voltage. The SCR t_q can be understood by considering the three junctions that make up the SCR. When the SCR is conducting, each of the three junctions is forward biased and the N and P regions (base regions) on either side are heavily saturated with holes and electrons.

Turning off an SCR

To affect turn-off in a minimum amount of time, it's neces-

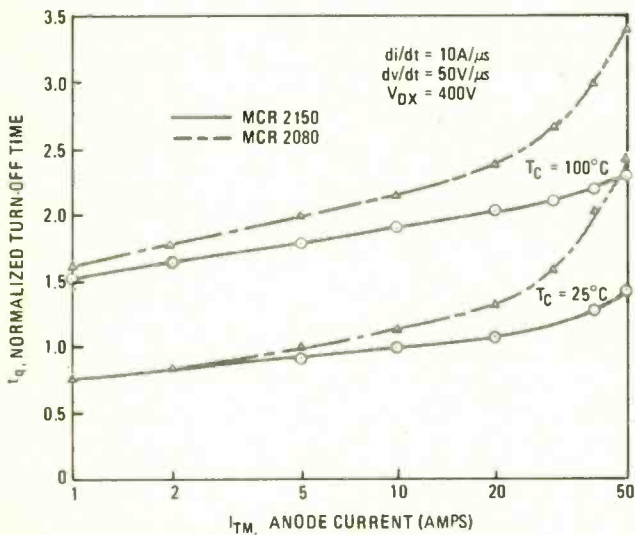

Fig. 7—Increasing temperature increases t_q for SCR's.

sary to apply a negative (reverse) voltage to the anode, causing the holes and electrons near the two end junctions to diffuse, and I_R to flow through the SCR. When the holes and electrons near junctions have been removed, I_R ceases, causing the SCR to assume a blocking state.

However, that doesn't complete recovery, inasmuch as a high concentration of holes and electrons still exist near the center junction. That concentration is decreased by recombination and is largely independent of the external circuit. When the hole and electron concentration near the center junction reaches some low value, the junction assumes its

blocking condition and a forward voltage can, thereafter, be applied without the SCR switching back to the original conduction state.

When measuring SCR t_q , it's necessary to establish a forward current for a period long enough to ensure carrier equilibrium, since I_{TM} has a strong effect on t_q . The current is reversed at a specified di/dt , usually by shunting the SCR anode to some negative voltage through an inductor, causing the SCR to show a reverse-recovery current. Further waiting time must elapse, as the charges recombine before forward voltage can be applied.

The forward voltage is ramped up at a specified dv/dt , with dv/dt delay time being reduced until a point is reached when the SCR can no longer block the forward-voltage ramp, turning it on as the ramp-voltage collapses. The time between that point and the point where forward-current passes through zero and starts to go negative (reverse-recovery phase) is the SCR's t_q .

To see how the various circuit parameters—forward current magnitude (I_{TM}), forward current duration, rate of change of turn-off current (di/dt), reverse-current magnitude (I_{RM}), reverse voltage magnitude (V_{RM}), rate of reapplied forward voltage (dv/dt), magnitude limit of reapplied voltage, gate-cathode resistance, and gate-drive magnitude (I_{GT})—can affect t_q , one condition at a time is varied, while the others are held constant. (Some parameters affect t_q more than others.)

Forward/Reverse-Current Magnitude

Forward-current magnitude and di/dt have the strongest

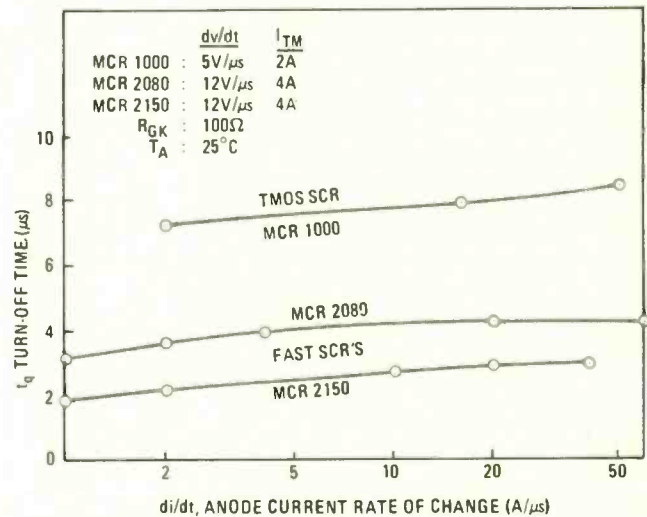

Fig. 8—Varying the turn-off rate of change of anode current also does have some effect on t_q .

effect on t_q . Varying I_{TM} can change t_q by about 30.0%, and the change is attributed to varying-current densities (stored charge) present in the SCR as I_{TM} magnitude is changed. If an SCR must have a short t_q when a low I_{TM} is present, a large gate trigger pulse (I_{GT}) would be advantageous. That turns on a large portion of the SCR to minimize high-current densities that exist only if a small portion of the SCR were turned on (by a weak gate pulse) and the low I_{TM} did not fully extend into the turn-on region. In general, SCR's exhibit longer t_q with increasing I_{TM} , as shown in the curves of Fig. 6.

Increasing temperature also increases t_q (see Fig. 7). Varying the turn-off rate of change of anode current (di/dt) does have some effect on the t_q of SCR's, as shown in Fig. 8. Reverse current (I_R) is actually due to the stored charge exiting the SCR junctions when a negative voltage is applied to its anode. Reverse-current magnitude (I_{RM}) is closely related to di/dt . Increasing di/dt causes an increase of I_{RM} , while a decreasing di/dt causes a lower I_{RM} . By using different series inductors and changing the negative anode turn-off voltage, it's possible to keep di/dt constant, while changing I_{RM} . I_{RM} has little or no effect on t_q when it's the only variable changed.

Reverse anode voltage has a strong effect on the I_{RM} magnitude and di/dt , but when V_{RM} alone is varied, with I_{RM} and di/dt held constant, there is little or no change in t_q time. V_{RM} must always be within the V_R rating of the device.

Reapplied dv/dt

Varying the reapplied dv/dt can vary the t_q of a given SCR by more than 10%. The effect of dv/dt on t_q is due to the anode-gate capacitance. dv/dt applied at the SCR anode injects current into the gate through the anode-gate capacitance ($I_{GT} = C dv/dt$); therefore, as the dv/dt increased, I_{GT} also increases and can induce turn-on.

To complicate matters, injected current adds to the leakage in the junctions just after turn-off. The charge remaining in the center junction is the main reason for long t_q times and, for the most part, is removed by the recombination process. If the reapplied dv/dt is high, more charge is injected into the center junction and prevents its returning to the blocking state, as if it had a slow dv/dt . The higher dv/dt , the longer the t_q time.

Changing the magnitude of the reapplied dv/dt voltage has little or no effect on an SCR's t_q time when the maximum applied voltage is well below the device's breakdown voltage. The t_q time increases if the SCR is being used near its breakdown voltage. Since the leakage current near breakdown is higher than at lower-voltage levels, leakage lengthens the time it takes for the charge to be swept out of the center junction, thus lengthening the usual recovery time of the SCR.

Changing the gate-drive magnitude has little effect on an SCR's t_q time unless it's grossly over or underdriven. When overdriven, there's an unnecessarily large charge in the SCR's junction. When underdriven, it's feasible that only a small portion of the gate region turns on. If anode current is not sufficiently large to spread the small turned-on region, there's a high current and charge density in the region that consequently lengthens t_q time.

Forward Current Duration

Forward-current duration has no measurable effect on t_q time when varied from 100 to 300 microseconds. Longer I_{TM} durations heat up the SCR, causing very short I_{TM} durations, which affects t_q times in view of the lack of time for the SCR to reach equilibrium.

As in transistor operation, reverse biasing the gate of the SCR decreases t_q , due to the rapid depletion of the stored charge. The reduction in t_q for standard SCR's is notable, nearing perhaps 50% in some cases. For fast SCR's only nominal improvement might result. Due to the internal, monolithic resistor of most SCR's, the actual reverse-bias voltage between the gate-cathode is less than the reverse bias supply.

MOS SCR's

Developed from the vertical structured MOS, MOS-SCR operation is like that of its predecessor, while combining the benefits of the high input impedance and fast turn-on of a power MOSFET, and the regenerative, latching action of a thyristor into a single package. Figure 9 shows the proposed symbol for the MOS-SCR, as well as the evolution of MOSFET to MOS-SCR.

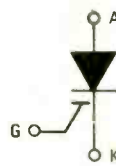

Fig. 9—Shown here is the proposed symbol for the MOS-SCR.

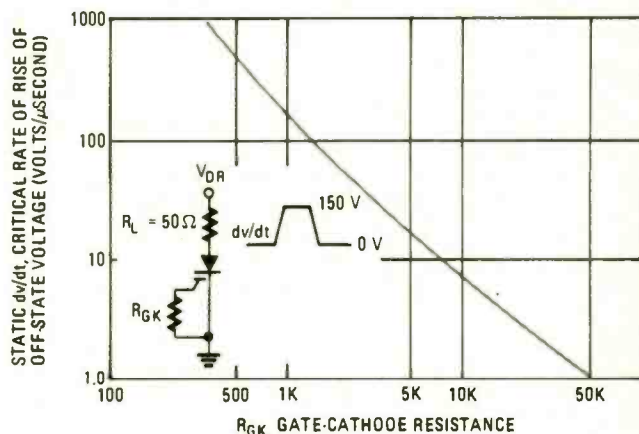

Fig. 10—The resistance bypasses the capacitive current from the input of the device; the lower the resistance, the greater the degree of shunting. With low resistance, the MOS-SCR has greater high dv/dt immunity and higher blocking-voltage capability preventing false triggering.

Referring to Fig. 1D. Turn-on commences when a positive gate-cathode (source) voltage V_{GT} is applied to the FET. The resulting drain current is the base current of Q1. Like the SCR, the collector current of Q1 supplies base current to Q2, and if there is adequate loop gain, regeneration occurs, latching the device into conduction. The gate signal can then be removed, without affect, until the principal current falls below the hold-current level.

Due to its MOSFET input, MOS-SCR's exhibit the high impedance and fast turn-on characteristics of a MOSFET. Its high input impedance allows the MOS-SCR to be readily driven by standard CMOS logic.

Problems with MOS-SCRs

Despite the MOSFET's high static input impedance, providing fast switching (in the tens of nanosecond range) means that the gate input capacitance must be quickly charged (or discharged during turn-off). Thus the gate-source and gate-drain capacitance (and its Miller-capacitance effect) may require that peak charging currents of .5 to several amperes be fed through the gate.

Rather than have a larger charging current capability, a lower one is more desirable, and lower current (larger gate

(Continued on page 102)



TRIANGLES AND VECTORS

By Louis E. Frenzel

E-Z
MATH

Current and voltage in a circuit with reactance do not behave the same way as they do in a purely resistive circuit. Here's a simple method to figure out just what's going on in those mysterious circuits.

□ TRYING TO VISUALIZE WHAT'S GOING ON INSIDE AN ELECTRONIC circuit is usually difficult. We can't see electrons flowing, we can't see voltage, and the concepts of frequency and phase shift are vague at best. To help get a handle on circuit operation, we often resort to the use of graphic techniques which try to visualize circuit action. Triangles and vectors are examples of visual aids that add some dimension to circuit analysis. Anything that helps you picture what's going on inside a circuit will improve your understanding of circuit operation.

Of course, you know what a triangle is. It's a three-sided geometric figure you learned about in high school. Of particular interest in electronics is the right triangle. That's a triangle with one right angle (90°). A vector is just a straight line or arrow that represents some electronic quantity such as voltage, current, resistance, impedance or whatever.

In this installment, you will learn to use triangles and vectors to represent and compute quantities in electronic circuits.

Triangle Basics

A triangle is a geometric figure with three sides and three angles. An angle is formed where two lines meet at a point. Each angle is formed by the intersection of two sides of the triangle. Figure 1 shows a triangle. Note that the angles are designated by capital letters while the sides are indicated by lower case letters.

Angles, as you know, are measured in degrees. One degree is a unit of measure equal to the angle between two lines

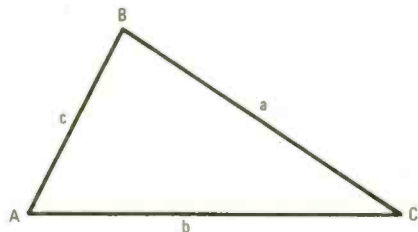

Fig. 1—This simple triangle can help you solve some not-so-simple circuit equations. Note that the sides are given the same letter as their opposing angle.

drawn from the center of a circle that define $1/360$ th of the circumference of the circle. See Fig. 2. If we divide the circle up into 360 "pie slices," the angle between any two lines is one degree.

There are three basic categories of angles: acute, obtuse, and right angles. These are illustrated in Fig. 3. An obtuse angle is one between 90° and 180° . An acute angle is one that is less than 90° . A right angle is exactly 90° . One line is perpendicular to the other.

Several different types of triangles are shown in Fig. 4. A right angle is illustrated in Fig. 4A. The triangle in Fig. 4B is an isosceles triangle which has two equal sides and two equal angles. The equilateral triangle in Fig. 4C has all three sides and all three angles equal.

Knowing the Angles

The sum of all three angles in *any* triangle is 180° . For example, the sum of angles A, B and C in Fig. 5 is:

$$\begin{aligned} A + B + C &= 180^\circ \\ 105 + 30 + 45 &= 180^\circ \end{aligned}$$

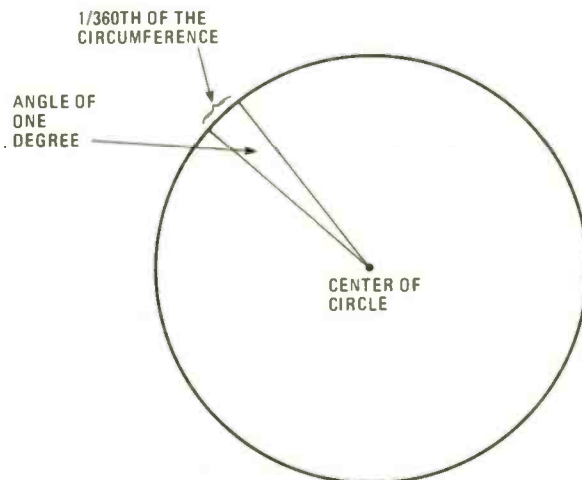

Fig. 2—This is how a degree is defined. It is $1/360$ th of a circle's circumference. The use of the 360° circles actually dates back to before the Summerian astrologers.

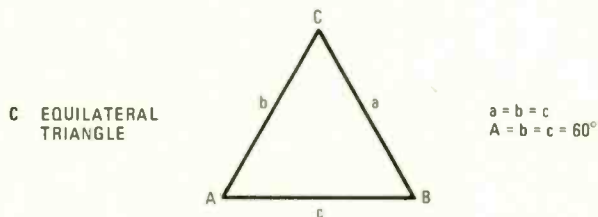
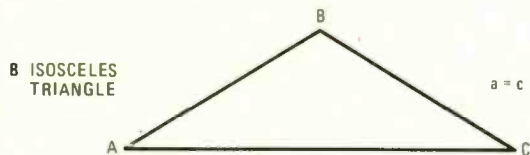
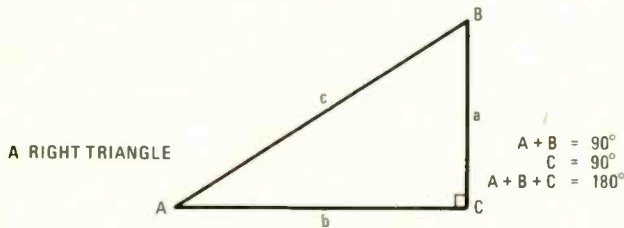
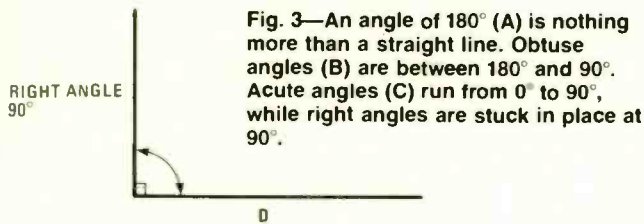
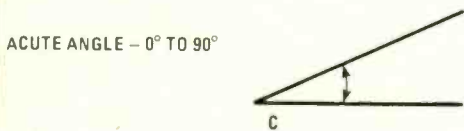
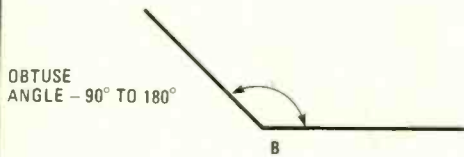
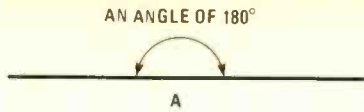

Fig. 4—It's easy to figure out the angles in a right triangle (A) because the sum of the acute angles must be 90°. Isosceles triangles (B) are not too hard since two of the angles in them are equal. Equilateral triangles (C) are the easiest to figure because all the sides are equal and all the angles are equal to 60°.

If you know two angles, you can always find the third. If angles A and B are 76° and 22° respectively, then their sum is $76 + 22 = 98^\circ$. Angle C can be found by subtracting the sum of A and B from 180°.

$$C = 180 - (A + B)$$

$$C = 180 - 98 = 82^\circ$$

The right triangle is a special case. Refer back to Fig. 4A. Since one angle, angle C, is 90°, the sum of the other two must be 90°.

$$A + B = 90^\circ$$

You can find A or B by simply rearranging the formula:

$$A = 90^\circ - B$$

$$B = 90^\circ - A$$

In electronics, it is the right triangle that will be used to help visualize and explain circuits. That will become clear later once we get to working some sample problems.

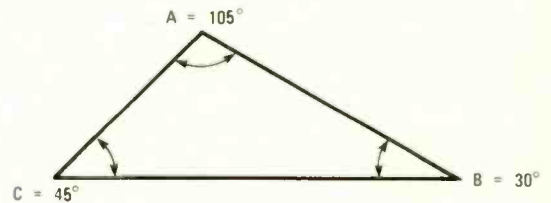

Fig. 5—Adding the angles making up any (obtuse, right, or acute) triangle will always give you a 180° total.

Side Wise

The lengths of the sides of a triangle are interrelated. In a right triangle, if two sides are known, the third side can be computed. Refer to Fig. 6. Assume the sides of a right angle are labelled a, b and c. Side c is opposite to the right angle

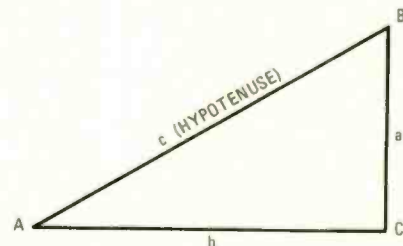

Fig. 6—When using the Pythagorean relation, the hypotenuse (the largest side) is always opposite the 90° angle.

and is called the hypotenuse. The expression below shows the relationship between the sides.

$$c^2 = a^2 + b^2$$

The actual length of the hypotenuse is:

$$c = \sqrt{a^2 + b^2}$$

Of course, you can use algebra to rearrange the formulas to compute either of the other two sides.

$$a^2 = c^2 - b^2$$

$$a = \sqrt{c^2 - b^2}$$

and:

$$b^2 = c^2 - a^2$$

$$b = \sqrt{c^2 - a^2}$$

Information radio is on the air.



Before you hear about it on your old radio, hear it live on your new Informant Information Radio. Whether it's an all-points-bulletin from the State Police, the dispatcher for the city's Fire Department, an ambulance racing to the hospital or a National Weather Service report, the new Informant from Regency makes you a part of all the action... instantly.

*Breakthrough Technology.
Instant Information.*

Informant Information Radio uses a revolutionary new technology that allows you to constantly monitor your police, fire and



emergency frequencies, as well as NOAA weather information channels in all 50 states. All pre-programmed. This new Information Radio utilizes a principle similar to the seek and scan feature found on expensive AM/FM radios. Your information radio scans the public service channels in the area, locates the active signals, locks in and broadcasts all the information right to you. With revolutionary TURBO-SCAN speed!

Hear Your Hometown Like You've Never Heard it Before.

Just turn it on. As easy to use as your AM/FM radio. Instantly, you're tuned into real life adventures. One touch control lets you select and hold police, fire and emergency broadcasts so you don't miss a single minute of the action.

Hear the amazing Information Radio today. Take it home and be a part of the action tonight!!



*Information Radio
for Real Life
Adventure*



CIRCLE 9 ON FREE INFORMATION CARD

That relationship is known as the Pythagorean rule. It is named after the Greek philosopher, Pythagoras, who discovered it in 6 B.C. and used the famous Pythagorean Theorem to prove it.

As you will soon see, That simple formula is extremely powerful and you will use it frequently in electronics.

Let's take a simple example. If side a of a triangle is 40 inches and side b is 30 inches, the hypotenuse or side c is:

$$c = \sqrt{a^2 + b^2}$$

$$c = \sqrt{40^2 + 30^2}$$

$$c = \sqrt{1600 + 900}$$

$$c = \sqrt{2500} = 50$$

Practice Problems

To see how much you remember, try these practice problems.

1. A right triangle has angle B that is 39°. What is angle A?
2. A right triangle has a hypotenuse that is 15 centimeters (cm) long. Side a is 9 cm long. How long is side b?

See answers at the end of this article.

Vector Basics

A vector is just a straight line or arrow that indicates the size or amplitude of some physical or electrical quantity. The length is proportional to the magnitude of the quantity while the direction in which it points indicates movement or its angular relationship to another vector. For example, a vector one inch long might represent a voltage of 2 volts. A vector 3-in. long represent $2 \times 3 = 6$ volts.

Many times you will need to add or subtract vectors. If the vectors are pointing in the same direction, all you do is add their lengths. Suppose a .1-in. vector represents 10 mA. See Fig. 7A. A 3-in. vector, therefore, represents 30 mA as Fig. 7B shows. If these two vectors are pointing in the same direction, you would add them as shown in Fig. 7C. The total is $1 + 3 = 4.0$ -in., representing 40 mA.

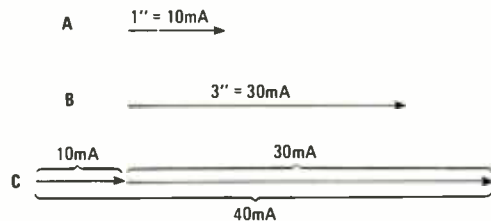

Fig. 7—Any vector (A) in any units can be added to any other vector (B) provided that the point in the same direction and have the same scale.

If the two vectors above are pointing in exactly the opposite directions as shown in Fig. 8, you subtract the two values to get the algebraic sum. The result is $3 - 1 = 2$. The sum vector is pointing in the direction of the largest vector.

If the vectors are not pointing in the same or opposite direction, they cannot be added directly. Special techniques must be used. Take a look at Fig. 9. Vector A represents a pulling force of 30 pounds on the object in the direction shown. Vector B is a pulling force of 40 pounds in another direction. The big question is: what is the total net pulling force, and in what direction will the object move?

The solution to that problem is done graphically. Assume 0.5-in. is equivalent to 10 pounds. Vector A then is 1.5-in. long and vector B is 2-in. long. We first construct a line at the end of vector A equal in length and parallel to vector B. Then, we construct another line at the end of vector B equal in length and parallel to vector A. The result is a four sided figure called a parallelogram. The sum of the two vectors and the direction to the composite pulling force is the length and direction of the diagonal drawn from the object to the far corner. Measuring its length, we see that it is approximately 3.25-in. which is equivalent to 65 pounds of force.

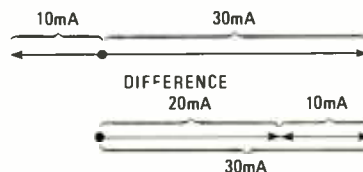

Fig. 8—If vectors point in opposite directions they have to be subtracted to obtain the proper value of their result.

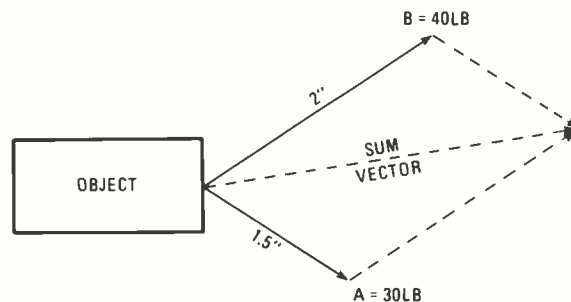

Fig. 9—We can figure out the sum of two vectors not pointing in the same direction by using the parallelogram method. Doing this gives you a new vector at a new angle.

More Vector Addition

Another example of vector addition is shown in Fig. 10. Here the two vectors a and b are perpendicular to one another thus forming a right (90°) angle. We can add these together the same way. Draw in the parallel lines as shown. That creates a parallelogram that, in this case, is a rectangle. The diagonal line is the sum of the two vectors.

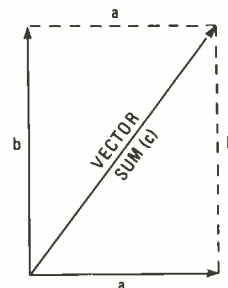

Fig. 10—Vectors at right angles are easy to sum with the Pythagorean relation. that is because they can be laid out to look like a right triangle.

But wait. When you drew in the diagonal, you constructed a right triangle. Now, instead of finding the sum by measuring the length of the diagonal, you can use the Pythagorean Theorem to compute it. Using the values in Fig. 10, the diagonal is:

$$c = \sqrt{a^2 + b^2}$$

If $a = 2$ and $b = 4$, then c is:

$$c = \sqrt{2^2 + 4^2}$$

$$c = \sqrt{4 + 16}$$

$$c = \sqrt{20} = 4.472$$

In electronics, many of the vectors will be at right angles to one another making vector addition very easy. So now, let's get started and apply all of this to some real electronic circuits.

Practice Problems

Verify what you have learned by solving these problems.

3. A 2 centimeter (cm) vector represents 10 volts. A 12 cm vector represents how many volts?

4. Two force vectors a and b are pulling perpendicular to one another. Vector $a = 110$ lb and $b = 80$ lb. What is the total pulling force?

Check your answers at the end of this article.

Analyzing an RL Circuit

There are many electronic circuits made up of passive components like resistors (R), capacitors (C), and inductors (L). Examples are filters, phase shifters, equalizers, impedance matching networks, tuned circuits etc. We can use the triangle and vector math to simplify the analysis and design of those circuits.

For example, take the simple series RL circuit shown in Fig. 11. An AC voltage causes current to flow. In a series circuit, the same current flows in both the resistor and inductor because there is only one path for the current. We know from our general knowledge of electronics that current in an

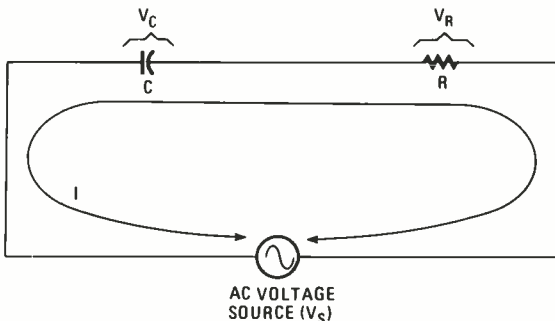

Fig. 11—The relationship between current and voltage in an AC network containing an inductor is not a simple one. Even though this circuit looks simple, the current and voltage across the components cannot be computed with ohms law.

inductor lags the applied voltage by 90° . That is caused by the inductor's inherent characteristic that it opposes changes in current with a self induced voltage. Figure 12A shows the AC current-voltage relationship in an inductor. If there is resistance in series with the inductor, the phase shift will be some value between 0 and 90° .

The current-voltage relationship for a resistor is shown in Fig. 12B. The current and voltage are in phase with one another.

Now, when current flows through a component, it causes a voltage drop to occur across each component. See Fig. 11. We can compute these voltages with Ohm's law if we know the

current value and the values of resistance and inductive reactance. The voltage across the resistor is V_R and the voltage across the inductor is V_L .

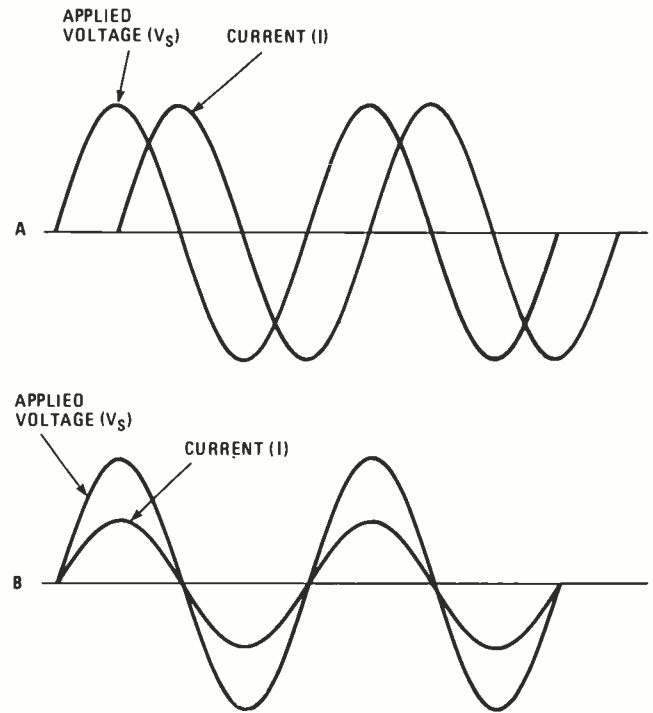

Fig. 12—In an inductor (A) the voltage and current are not in phase with one another. That means that the peaks, troughs and all in between do not occur in unison. In a purely resistive network they current and voltage waves are in perfect sync with one another.

$$V_R = IR$$

$$V_L = IX_L$$

Assume $R = 1.5K$ ohms (1500 ohms), $X_L = 800$ ohms and $I = 2$ mA (.002 A or 2×10^{-3} A). The voltage drops are:

$$V_R = (2 \times 10^{-3})(1500) = 3 \text{ volts}$$

$$V_L = (2 \times 10^{-3})(800) = 1.6 \text{ volts}$$

Reactance

Reactance is the opposition to alternating current flow offered by reactive components such as inductors (coils) or capacitors. Like resistance, reactance is expressed or measured in ohms.

Inductive reactance (X_L) depends on the value of inductance in henries (H) and the frequency (f) of the applied AC in Hertz (cycles per second). It is computed with the simple formula:

$$X_L = 6.28fL$$

Capacitive reactance (X_C) depends upon the frequency (f) and the capacitance in farads (C).

$$X_C = 1/6.28fC$$

For given values of L and C, X_L is directly proportional to frequency while X_C is inversely proportional to frequency. If f increases, X_L increases but X_C decreases.

The total amount of reactance in a circuit determines the current flow.

According to Kirchhoff's voltage law, the sum of the voltage drops across series components is equal to the applied voltage. But there is a problem here. We can't just add the two voltages directly together because they are out of phase with one another. Since the current in the inductor lags the voltage across it by 90° , we can say that the inductor voltage leads the current by 90° . It means the same thing. The voltage across the resistor is in phase with the current. Therefore, the voltage across the inductor leads the voltage across the resistor by 90° . Let's draw a picture of that with vectors to see it better.

Refer to Fig. 13. First we draw a vector pointing to the right representing the current I . Current is the reference in a series circuit since it is common to all components. Of course, the length of the vector is proportional to the actual current value.

Next, we draw a vector representing the resistor voltage (V_R). Since it is in phase with the current, that vector overlaps or coincides with the current vector.

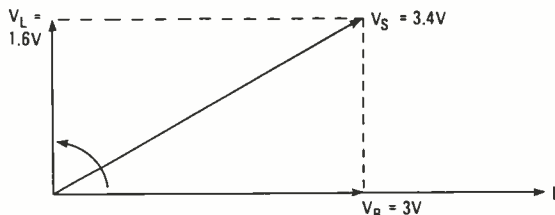

Fig. 13—We can use vectors to show the relationship between the voltages of all components in an AC circuit.

Now we construct the inductor voltage (V_L) vector. The voltage leads the current by 90° . When drawing vector diagrams in electronics, leading is counter-clockwise from the reference (current) vector while lagging is clockwise from the reference. So, the V_L vector leads the current vector by 90° as Fig. 13 illustrates.

At last we can add the voltage vectors. And we do that using the parallelogram method described earlier. The result is a rectangle where the diagonal or hypotenuse represents the applied or source voltage (V_S) (see Fig. 13). And since a right angle is involved, we can use Pythagorean Theorem to compute the exact value of the applied or source voltage (V_S).

$$V_S = \sqrt{(V_R)^2 + (V_L)^2}$$

$$V_S = \sqrt{3^2 + 1.6^2}$$

$$V_S = \sqrt{9 + 2.56}$$

$$V_S = \sqrt{11.56} = 3.4 \text{ volt}$$

The angle formed between the current and source voltage vectors is the actual phase shift in the circuit. As you can see, it is less than 90° . In the next installment, we will show you how to compute it.

Resistance, Reactance, and Impedance

The vector diagram in Fig. 13 shows voltages. But we can convert it to represent resistance, reactance and impedance. Here's how.

We said that the current was common to all components in the series RL circuit. If we divide V_L by the current I , we get X_L as Ohm's law tells us. Dividing V_R by I , we get R . Dividing V_S by I , we get Z , the total circuit impedance. The new vector diagram looks like that in Fig. 14. It looks just like our voltage vector diagram only we are dealing with different quantities.

The current in any circuit is determined by the amount of source voltage (V_S) applied and the total opposition to cur-

rent flow. That's Ohm's law, right? The opposition comes from the resistance (R) and the inductive reactance (X_L). The total opposition is the sum of the resistance and reactance and is called impedance (Z). But as you can see by Fig. 14, the R and X_L vectors are 90° out of phase so we cannot add them directly. Again we use vector addition. The hypotenuse of the right triangle is the total circuit impedance. It can be calculated using Pythagorean Theorem.

$$Z = \sqrt{R^2 + X_L^2}$$

Going back to the values given earlier ($R = 1500$ ohms and $X_L = 800$ ohms), we can use the formula to calculate the total impedance.

$$Z = \sqrt{1500^2 + 800^2}$$

$$Z = \sqrt{2.25 \times 10^6 + .64 \times 10^6}$$

$$Z = \sqrt{2.89 \times 10^6}$$

$$Z = 1.7 \times 10^3 = 1700 \text{ ohms}$$

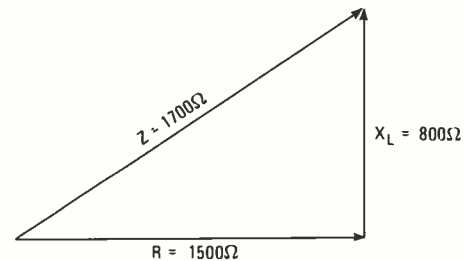

Fig. 14—The total impedance of the circuit can not be computed by adding the impedances of the components together. Since the impedances are 90° out of phase, they must be summed vectorally which is made easier by drawing the vectors.

Knowing the source voltage which we computed earlier (3.4 volts) and the total impedance, we can use Ohm's law to calculate the circuit current.

$$I = V_S / Z$$

$$I = 3.4 / 1700$$

$$I = 2 \times 10^{-3} = 2 \text{ mA}$$

Of course, that jibes with the original value given earlier. As you can see, the vectors and triangles, if accurately constructed, allow you to see the relationship of the various circuit parameters. It makes an otherwise nebulous thing more concrete.

Analyzing an RC Circuit

You can use exactly the same procedures to analyze a resistor-capacitor (RC) circuit of the type shown in Fig. 15. Here you have to remember because of the charging and

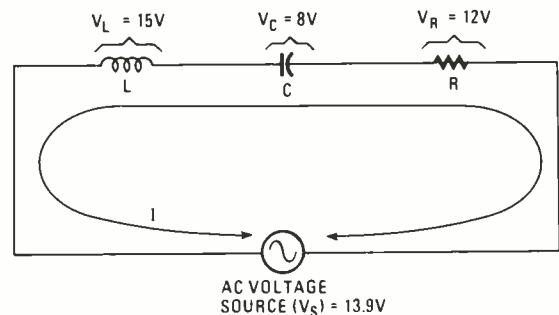

Fig. 15—The relationship between current and voltage in an AC network containing a capacitor is not simple. The voltage across the components must be computed with vectors.

discharging action of the capacitor, the current flowing leads the voltage across it by 90° . That's the same as saying that the voltage across the capacitor lags the current.

Assume that $R = 375$ ohms and $X_C = 500$ ohms. The current is 8mA. Using Ohm's law, you can find the voltage drops.

$$V_R = IR = (8 \times 10^{-3})(375) = 3 \text{ V}$$

$$V_C = IX_C = (8 \times 10^{-3})(500) = 4 \text{ V}$$

Now let's draw the voltage vector diagram. Refer to Fig. 16. The current, being common, is represented by the vector pointing to the right. The voltage across the resistor is in phase with the current so the V_R vector overlaps the current vector.

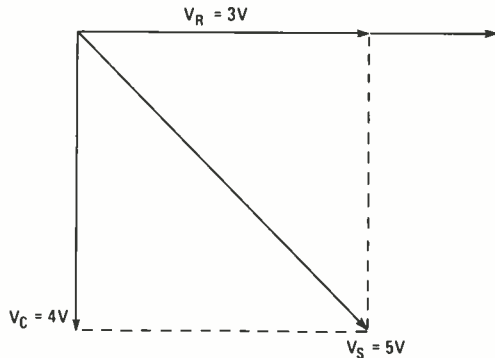

Fig. 16—Since the voltage of the capacitor lags behind the supply (and the resistor), it is drawn pointing downward. Just the opposite of the inductor's vector.

The capacitor voltage V_C lags the current by 90° . So we move in a clockwise direction from the current vector 90° and draw V_C pointing down.

Kirchhoff's voltage law says that the sum of the component voltage drops equals the source voltage (V_S). Ohm's law tells us the component voltage drops are:

$$V_R = IR$$

$$V_C = IX_C$$

where X_C is the capacitive reactance.

These voltages have to be added vectorally. Therefore, we use the parallelogram method. The length of the diagonal or hypotenuse is the source voltage. Of course, since we constructed a triangle with the sides being V_R and V_C , we can use the Pythagorean relation to compute V_S .

$$V_S = \sqrt{V_R^2 + V_C^2}$$

$$V_S = \sqrt{3^2 + 4^2}$$

$$V_S = \sqrt{9 + 16} = \sqrt{25} = 5 \text{ V.}$$

Just keep in mind that you can always rearrange Pythagorean relation to calculate V_R or V_C if you ever need to:

$$V_R = \sqrt{V_S^2 - V_C^2}$$

$$V_C = \sqrt{V_S^2 - V_R^2}$$

Now, we can also construct an impedance triangle as we did with the RL circuit. We already know R and X_C . To get the impedance, we divide the source voltage by the current.

$$Z = V_S/I = 5/8 \times 10^{-3} = 625 \text{ ohms}$$

The resulting triangle is illustrated in Fig. 17. And, of course, you can also use Pythagorean theorem to calculate the impedance.

$$Z = \sqrt{R^2 + X_C^2}$$

$$Z = \sqrt{375^2 + 500^2}$$

$$Z = \sqrt{140625 + 250000}$$

$$Z = \sqrt{390625} = 625 \text{ ohms}$$

Practice Problems

Now, check what you've learned with these exercises.

5. In an RL circuit, the resistor voltage is 12 volts, the applied source voltage is 15 volts. What is the coil voltage?

6. What is the total current in a series RC circuit with a resistance of 20 ohms and a capacitive reactance of 30 ohms? The applied voltage is 7.2 volts.

Look for the answers at the end of the article.

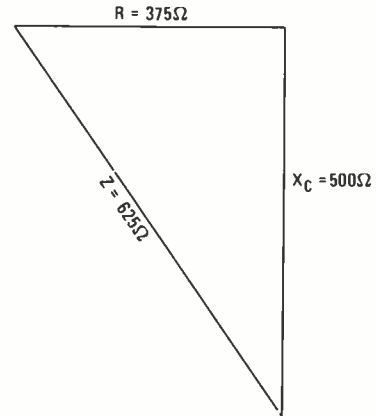

Fig. 17—The impedance of a circuit containing a capacitive load must be computed using a vector diagram (or at least the math for one). Note that the magnitude is still a positive number. That is because the components are squared for computation removing negative signs.

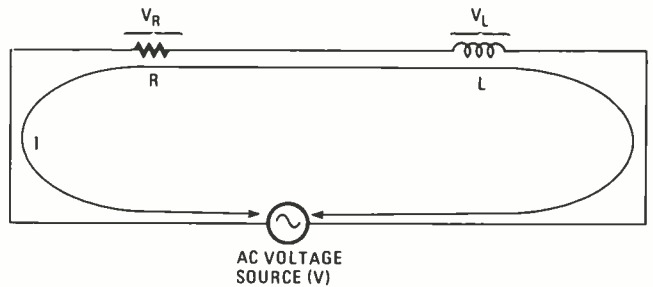

Fig. 18—An LCR circuit does not really make the situation more difficult to analyze. The components for the inductor and capacitor are merely subtracted from one another.

Analyzing LCR Circuits

An LCR circuit contains inductance, capacitance and resistance. An example circuit is shown in Fig. 18. We can draw the vector diagram of the circuit voltages as before. See Fig. 19. The inductor voltage leads the current by 90° and the capacitor voltage lags the current by 90° as shown.

Note one key fact. The inductor and capacitor voltages are 180° out of phase with one another. That is illustrated in the vector diagram of Fig. 19 as vectors pointing in opposite directions. Vectors 180° out of phase with one another are combined by adding them algebraically. That is the same as

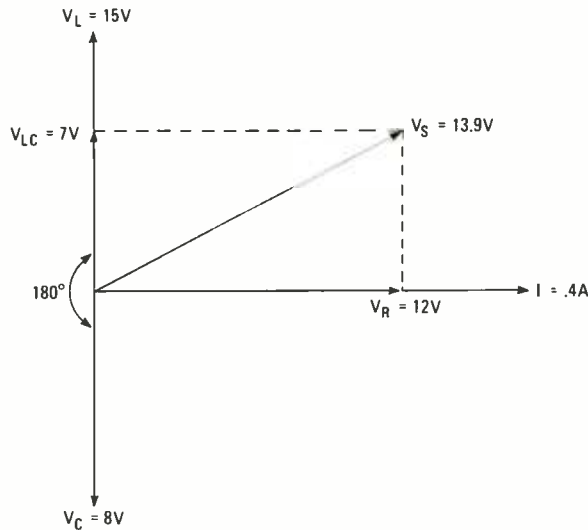

Fig. 19—The component resulting from the difference between the inductor and capacitor vectors is used to find the voltage source magnitude.

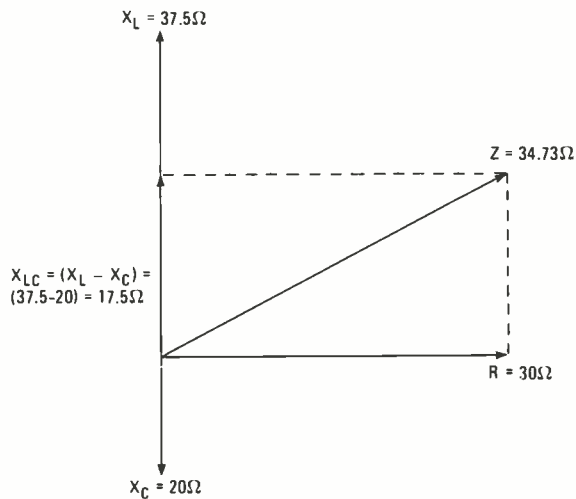

Fig. 20—Calculating the impedance for the LCR circuit is done more easily by subtracting the components of the inductor and capacitor from one another.

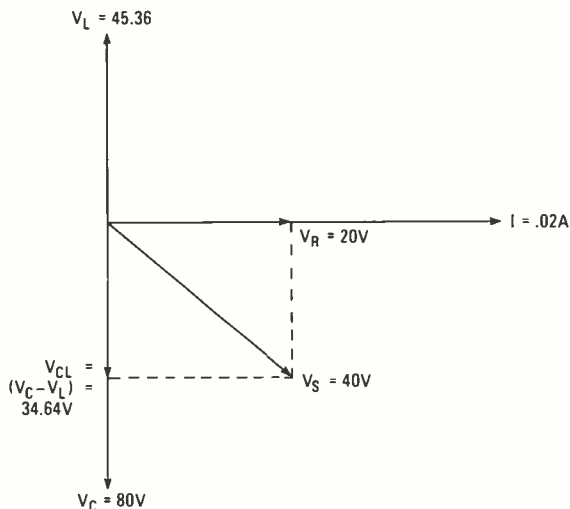

Fig. 21—Even though the resultant vector points downward its magnitude is a positive value.

saying we subtract them. One voltage cancels the other.

Assume $V_L = 15$ volts and $V_C = 8$ volts. The difference $V_{L,C}$ is:

$$V_{L,C} = V_L - V_C$$

$$V_{L,C} = 15 - 8 = 7 \text{ volts}$$

V_C cancelled 8 volts or V_L , leaving a total voltage of 7 volts. Since V_L is larger than V_C , $V_{L,C}$ points in the same direction as V_L . See Fig. 19. Our LCR circuit acts like it is just an inductor and a resistor in series.

Since V_L is greater than V_C , the effect of V_C is totally cancelled. The equivalent circuit is just an RL circuit like that shown back in Fig. 11.

If we convert the voltage vectors to impedances by dividing by the current, we get the result in Fig. 20. Assume the current is .4A.

$$X_L = V_L / I = 15 / .4 = 37.5 \text{ ohms}$$

$$X_C = V_C / I = 8 / .4 = 20 \text{ ohms}$$

$$R = V_R / I = 12 / .4 = 30 \text{ ohms}$$

Note that the inductive reactance (X_L) is greater than the capacitive reactance (X_C). Since they are pointing in opposite directions, they cancel one another. X_L is greater than X_C so X_C is totally cancelled. The total circuit reactance is:

$$X_{L,C} = X_L - X_C$$

$$X_{L,C} = 37.5 - 20 = 17.5 \text{ ohms}$$

Since X_L is greater than X_C , it is as if the circuit only contains an inductive reactance equal to 17.5 ohms. That's why the LCR circuit acts as if it is on an RL circuit. We say the circuit is inductive.

You can now calculate the total circuit impedance as you did before.

$$Z = \sqrt{R^2 + X_{L,C}^2}$$

$$Z = \sqrt{30^2 + 17.5^2}$$

$$Z = \sqrt{900 + 306.25}$$

$$Z = \sqrt{1206.25} = 34.73 \text{ ohms}$$

A more general version of the impedance formula takes into consideration both X_L and X_C .

$$Z = \sqrt{R^2 + (X_L - X_C)^2}$$

You can also write it by reversing X_L and X_C , but the outcome is the same.

$$Z = \sqrt{R^2 + (X_C - X_L)^2}$$

We could also have a condition where V_C is greater than V_L or X_C is greater than X_L . All of X_L is cancelled leaving a smaller net reactance which is capacitive. Therefore, the circuit acts like a resistor and capacitor in series just like the one shown previously in Fig. 15.

You use the same formulas as before to compute values in the circuit. For example, the source voltage is:

$$V_S = \sqrt{V_R^2 + (V_L - V_C)^2}$$

The total impedance is:

$$Z = \sqrt{R^2 + (X_L - X_C)^2}$$

Since the effect of inductance is exactly opposite that of capacitance, the two cancel one another, the large reactance dominating. If X_L is larger, we say the circuit is inductive. If X_C is greater, we say the circuit is capacitive. It's that simple.

(Continued on page 102)



ELLIS ON ANTIQUE RADIO

Learning Morse code in the 1940's

WHENEVER I VISIT A HAMFEST FLEA market, I almost always come away with some ideas for this column. There's usually a fair amount of vintage gear and literature to look at. And sometimes—if the price is right and the piece sufficiently interesting—I've even been known to make a purchase or two.

A few weeks ago, I came home with an Instructograph code-practice machine (mid 1940's model). For those of you who've never met one, an Instructograph generates Morse code characters by means of a perforated paper tape. The spooled tape is pulled along between a pair of contact points by a motor drive. As they're opened and closed by the perforations, the points key an audio oscillator, forming the Morse code characters.

The Instructograph was supplied with a collection of ten different tapes, so that the prospective ham or commercial radio operator could practice receiving a variety of messages at different speeds. For sending practice, a couple of binding posts were provided for a manual code key. And my Instructograph happened to come with a key that was as interesting to me as the machine itself—a World War II surplus J38.

In a B17 Over Berlin

As a teenager in the 1940's, I could never hope to afford an Instructograph—but I certainly had a J38. Like most other military surplus gear dumped on the civilian market at the end of World War II, it was dirt cheap. A couple of bucks would get you one of those beautifully-crafted brass, nickel, and Bakelite specimens.

Connect your J38 to a 69-cent high-frequency buzzer (audio oscillators were also a little expensive for the typical 1940's teen budget) and a dry cell, and you had put together a nifty code-practice set for less than five dollars. If you had a buddy with similar interests, you and he could trade off sending and receiving until you had both mastered the code. At the same time, with that army key in your hand, you could easily imagine that you were a radio operator on a B17 over Berlin or at a front-line command post.

The fact that a J38 was included with the hamfest Instructograph certainly



Echophone Model EC-1, 6 tubes, 3 band, Tuner from 550 to 10 mc. Self-contained speaker. Biological transcription on all bands. AC/DC 117/115 volts. \$24.50

Reader Guertin's 1942 QST ad promised social success to owners of the EC-1!

clinched the deal for me. My own had disappeared years ago, and I didn't think I'd ever own one again. J38's are hard to find today.

In fact, I looked through about a dozen 1950's vintage *CQ Magazines* in the vain hope of finding a nostalgic J38 ad for this column. The ads in the ham radio publications were certainly loaded with surplus material—including such classics as the

T17B mike and the HS33 headset (both were companions of the J38 in the aircraft and command posts of World War II). But apparently, most of the loose J38's had been snapped up by the early 1950's.

The ARRL's 25-Cent Masterpiece

The J38 acquisition really brought back memories about what it was like to prepare for the ham radio-code exams back in the 1940's. One essential piece of literature for the serious prospective ham was the *American Radio Relay League's* excellent pamphlet *Learning the Radiotelegraph Code*.

The 1951 edition now in my library carries a publisher's price of 25 cents, and the one that I had in the mid-1940's may have cost even less. That was certainly no strain on my allowance, and I remember wondering at the time if the League may have been partly subsidizing the price in order to encourage as many prospective hams as possible.

The well-illustrated, slick-paper 1951 edition is loaded with suggestions not only about how to learn the code, but about such things as how to put together an oscillator or buzzer system for code practice; how to adjust and hold the key; how to write when transcribing code; where and when to listen for suitable practice transmission on the shortwave bands, and even how to operate once the license was obtained. There's not a wasted word

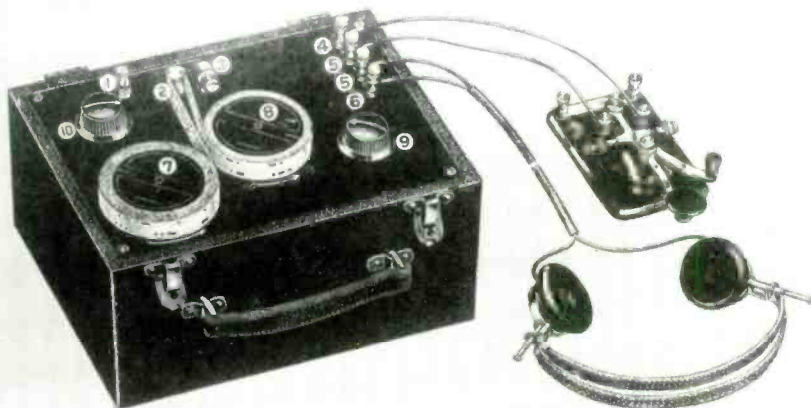

Instructograph code practice machine produced Morse characters by means of perforated paper tape. Drawing is from machine's instruction book.

in this tightly-organized, 32-page pamphlet. I consider it a minor masterpiece of the editor's art.

Dots and Dits

But there was one issue on which I wasn't sure I agreed with the ARRL. The League felt that people should be strongly discouraged from thinking about Morse code as a pattern of dots and dashes. They felt that such a convention was, perhaps, better suited to represent the clicking noises given off by the old-time, land-line telegraph sounders. The long and short tones used in modern radiotelegraph communication were better represented by the words "dah" and "dit," respectively.



Ads for Candler System Morse training always featured a testimonial from code champion Ted McElroy.

Up to a point, I agreed. When speaking the code for the letter "D," for example, it certainly made more sense to say "dahdidit" than "dash dot dot." However, when reading Morse characters off the printed page, I was always able to imagine the sounds better—and quicker—when they were more graphically represented as actual dots and dashes.

Learning the Radiotelegraph Code's chart of the Morse characters was made up of printed "dits" and "dahs." And I remember deciding to make up my own "dot-dash" chart for easier study and memorization. It's interesting to note that the instruction book that came with the Instructograph machine (which dates from about the same period) didn't get cute with the printed Morse. It represented the characters with big, bold, graphic dots and dashes.

Quips for Code Practice

The code practice sending and receiving exercises in Learning the Radiotelegraph Code were set up something like typing lessons. They started out by using just a few basic characters and then, little by little, added new ones until the full set of numbers, letters and punctuation marks was involved. Looking over those exercises today, I can see that the writers used quite a bit of ingenuity and humor to come up with meaningful practice phrases stressing all of the newly-added letters.



The ARRL code-training pamphlet of early 1950's is shown here posed next to author's hamfest J38.

Some were patriotic holdovers from World War II (Uncle Sam Needs Us All; Gasp and Yowl but Buy Defense Bonds; Japan's Junk Quits Quickly) and some were radio related (Pentode Amplifiers Relay Powerful Signals). There was an occasional ethnic comment....Jewish Hats are Apt Attire...Insane Indians Behead Buxom Dames...and an occasional dash of violence...Philip Wallops the Artists Jaw...He Hit His Hostess 50 Times...and, when all else failed, a touch of nonsense...A Puffy Blimp is a Peppery Fishwife...Goofy Pygmy Cogitates Quizzically.

But even though I might take a few affectionate pot shots at it, I have to credit that very effective little pamphlet with teaching me everything that I needed to know to pass the old Class "B" (and later the Class "A") code tests. And when, after a lapse of over 35 years, I took the code tests again to reinstate my license, I found that it wasn't too hard to bring back the old skills.

Since I had never been a code operator in my early ham days, but was merely recalling my original code studies, the book must have been right on target!

Without Tension or Nervousness

No discussion about learning Morse code in the 1940's would be complete without mentioning Walter Candler. His face, looking very sincere behind wire-rimmed glasses, peered out intently from large ads in the major radio publications of the time.

AMAZING NEW VIBROPLEX



PRESENTATION MODEL
Vibroplex presents the first truly speed control key. An adjustable main spring permits operator to send slower or faster as desired. No more wiggly keys... the vibration of serial quality. Built on a base of wood. Free of any resonant parts... only as strong as better. Praised by operators and beginners alike. Try this new Vibroplex key... it'll be delightful. Order your new popular Vibroplex key from \$9.95 up. At your dealer or THE VIBROPLEX CO., INC. 833 Broadway, N. Y. 3, N. Y.

Vibroplex automatic keys (affectionately known as "bugs") were heavily advertised in the 1940's, but they weren't for us beginners!

The Candler system would help you build code speed "without tension or nervousness." Candler offered both beginning and advanced classes, and every ad featured a testimonial by Candler's star pupil, Ted McElroy. Ted was the "official champion radio operator, with a speed of 75.2 wpm."

Like the Instructograph, Candler's system wasn't available to most of us kids. You had to be an adult to come up with the cash or sign up for the time payments. But, with our surplus keys and ARRL's wonderful two-bit booklet, most of us did just fine.

Last Word on the EC-1

Without a doubt, the Echophone EC-1 restoration project has drawn more reader mail than any other subject I've covered in this column. (For those of you who intend to begin an antique-radio restoration project of your own, particularly those for whom this will be the first time you've pulled apart one of yesterday's gems, it's a good idea to go over the material covered in those columns, which began with the July 1987 issue.) Here are a few of the most recent comments.

Roland Ratcliffe of Lockport, NY does service work for the local gas company and found his in a customer's basement. It was free "for the mere price of asking."

John Hall (Newark, DE) purchased his in 1942. He got it on a stopover in Seattle while being shipped to Alaska with the Army Corps of Engineers. Private short-wave sets weren't allowed on the troop ship, but Jim got around the rules by loaning the EC-1 to the ship's radio operator for the rest of the voyage. John and the operator were able to enjoy the radio all the way to Kodiak.

Stephen Shaw (Randfontein, South Africa) inherited an EC-1B from his father. As the 1946 ad he sent along shows, Shaw's set has a slightly different dial face than the EC-1, which we restored in the column. His model has a face that looks more like that of its famous descendant, the Hallicrafters S-38.

But perhaps the last word on the subject comes from reader Jacques Guertin (Quebec, Canada). He sent along an EC-1 ad from the February, 1942 issue of *QST Magazine*. I enjoyed it so much, that I couldn't resist running it in this column even though we finished the EC-1 project several issues ago.

Coming Up

Stay tuned for the next issue, when we'll take a close look at the Instructograph machine that indirectly provided my inspiration for this month's column. I'll be looking forward to hearing from you. Write to Marc Ellis, C/O Hands-on Electronics, 500-B Bi-County Blvd., Farmingdale, NY 11735.



CIRCUIT CIRCUS

A few simple circuits that can make life a bit easier

□ HOW MANY TIMES HAVE YOU GONE TO the junkbox to drag out a speaker for a special project, only to discover that each specimen turned out to be an "orphan" without any written clue as to its impedance or condition? If that sort of problem has been your *long-abiding friend*, then turn to our first circuit. That circuit can help you to cross the electronic bridge to determine the speaker's impedance and condition.

Speaker "Z" Tester

The simple bridge circuit shown in Fig. 1 can make the job of "adopting" a speaker for that next construction project a snap. When a speaker of unknown impedance is connected to the Z Tester (at the test terminals), the impedance of the speaker in question is compared to the impedance of the circuit's internal speaker (SPKR1).

An audio signal, fed through T1 (an audio impedance-matching transformer),

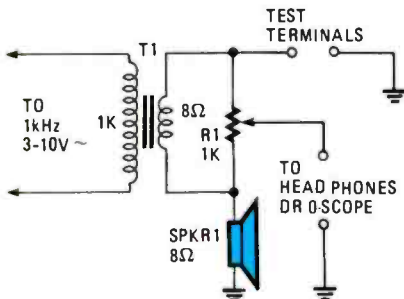

Fig. 1—The Speaker "Z" Tester is a simple bridge circuit that can make the job of determining the impedance of an unmarked speaker a snap. When a speaker of unknown impedance is connected to the Z Tester, the impedance of the speaker in question is compared to that of the circuit's internal speaker.

PARTS LIST FOR THE Z TESTER

R1—1000-ohm potentiometer
T1—Miniature 1000- to 8-ohm, audio output transformer
SPKR1—8-ohm speaker (any size)
Perfboard or breadboard materials, test terminals, cabinet, test oscillator, wire, solder, etc.

is input to the two speakers. Then by adjusting R1, the bridge is brought into balance. When the bridge is brought into balance, the impedance of the unknown speaker can be read on the dial of the balance potentiometer, R1.

Almost any audio sinewave oscillator with an output of 3 to 10 volts will do to drive the bridge circuit. And a pair of headphones or an oscilloscope can be used as the balance indicator. The entire circuit can be built in a small plastic or metal cabinet, or merely breadboarded with clips for all of the necessary external connections.

Making an escutcheon for the circuit is as simple as cutting a three-inch circle from a piece of white cardboard, punching a 3/8-inch hole in the center and mounting it over the shaft of R1. Turn R1 counter-clockwise until it stops, and place a pointer-type knob on the shaft facing the 7:00 position and lock it in place.

Connect an audio generator to T1, and set the frequency to 1 kHz with a sinewave output of 3- to 10-volts peak-to-peak. Connect a scope or headphones to the bridge's output, and a resistance decade box to the test terminals. Set the decade box to 16 ohms and turn R1 for a null in the 1-kHz tone. Mark that point with a dot in front of the knob and write in the number 16. Do the same for resistor values of 3, 4, 8, 40, and 100. Balance each resistor value and mark each value on the white escutcheon.

Connect the speaker in question to the test terminals and balance R1 for a null output. Read out the speaker's impedance on the dial. If you just happen to check out a speaker with a short between turns on the voice coil, the bridge will probably not balance with a null as sharp as with a good speaker.

Auto-Power Adapters

If you are fed up with replacing batteries in electronic gear that you use in your automobile, and would like to tap the power reservoir of the auto's battery and save those hard-earned bucks, then try one of the Auto-Power Adapters circuits shown in Fig. 2 or Fig. 3.

The circuit in Fig. 2 can be adjusted to supply 0- to 10-volts at currents up to 1 ampere, while the circuit in Fig. 3 covers

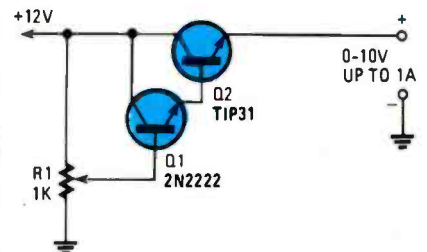

Fig. 2—The Auto-Power Adapter circuit eliminates having to replace batteries in electronic gear that you use in your automobile, by stepping down the battery power to a usable level.

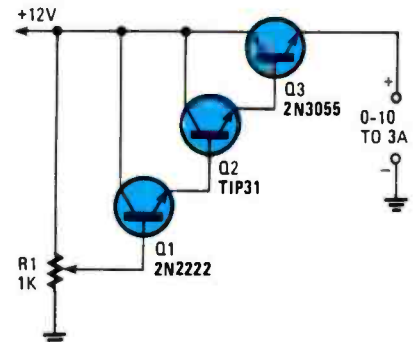

Fig. 3—In this version of the Auto-Power Adapter, the current range of the previous circuit is extended through the addition of a higher-rated power transistor.

the same voltage range with a current output of over 3 amperes. The two Auto-Power Adapter circuits operate alike in the following manner.

Looking at Fig. 2, we see that transistor Q1 is connected in an emitter-follower circuit and its base connected to the wiper of R1. The voltage at the emitter of Q1 follows the voltage at its base from zero to slightly less (minus the junction voltage drop) than the 12-volt source. The output of Q1, at its emitter, is fed to the base of Q2, forcing it to follow the voltage at the emitter of Q1.

Since Q2 is to pass a pretty hefty current, Q2's metal tab should be bolted to a suitable-size heatsink for the load used. The larger the heatsink the better. If the maximum load current requirements are less than 50 milliamperes, leave off Q2 and connect the load to the emitter of Q1.

To really juice up the output current

PARTS LIST FOR THE AUTO-POWER ADAPTERS

R1—1000-ohm potentiometer
 Q1—2N2222 general-purpose NPN silicon transistor
 Q2—TIP31 NPN, tab-mount, silicon power transistor
 Q3—2N3055 NPN silicon, power transistor
 Perfboard or breadboard materials, heatsink material, cabinet, wire, solder, etc.

capacity, go to the circuit in Fig. 3, where another more-powerful transistor is added to the output circuitry. The 2N3055 with a good size heatsink can dish out all the required current.

Neither of the circuits are voltage regulated and the output voltages will vary proportionately with the supplied battery voltage. But for most applications, that will cause no problem. Connect a voltmeter to the output of the circuit and adjust R1 to obtain the desired output-voltage level, and then connect the load across the output terminals. Re-check the voltage and finetune R1 if necessary.

Electronic Circuit Breaker

Anytime you work with a high-current, DC power source, such as an automobile's battery, the chances of sparks flying and metal burning is a real possibility. Fuses make a good, and generally safe, stopgap measure for protecting against disaster caused by overloads and shorts. But if the problem is an intermittent one, and fuses are blowing like leaves falling from autumn trees, then some other plan is going to be called for.

The Electronic Circuit Breaker in Fig. 4 will help keep the bulk fuse boxes intact and allow a broad range of current trip adjustments. With the two power transistors mounted on heatsinks, currents of

over 10 amps can be handled. That makes it an ideal circuit to use when making a test run of a newly built project or any equipment that is to be powered from the auto's electrical system.

After the smoke clears, the debugging is completed, and all is functioning OK, determine the current requirement of the project and select a fuse to replace the Electronic Circuit Breaker. You'll see that the Electronic Circuit Breaker is too valuable to just be used as a full-time, resettable fuse. Just think of the goodies it might save in the future.

Here's how the circuit *percolates*. That's how juice (the electric kind) flows through a circuit when it's all heated up. Two power transistors (Q1 and Q2) are connected in a Darlington configuration, with the base current for Q1 supplied through R5. With nothing else in the circuit, the transistor pair would be like a switch in the on position.

The current that flows through the attached equipment also passes through the sampling resistor, R7, which produces a voltage drop that's proportionate to the load current. U1, a single section of an LM324 quad op-amp, is connected in a voltage-comparator circuit. Resistor R8, a 500-ohm potentiometer, sets the current trip point.

As the load current increases, the voltage being fed to the positive input of the op-amp also increases to a point that causes the output, at pin 1, to switch positive. That positive voltage turns on SCR1, which operates like a switch between the base of Q1 and ground. When that happens, the electronic switch removes the bias from the transistors and the breaker circuit opens.

Any construction scheme should do, but in any case, using an IC socket for the LM324 would be a good idea. Any scrap of aluminum 25 square inches or larger will provide adequate heatsinking for the

transistors. If the Electronic Circuit Breaker is to be used in a high-current application, for a long period of time, then keep an eye on the temperature of the two transistors.

PARTS LIST FOR THE ELECTRONIC CIRCUIT BREAKER

C1—47- μ F, 25-WVDC electrolytic capacitor
 Q1—TIP31 NPN, tab-mount, silicon power transistor
 Q2—2N3055 NPN silicon, power transistor
 R1, R2, R3, R4—6800-ohm, $\frac{1}{4}$ -watt resistor
 R5—270-ohm 1-watt resistor
 R6—1000-ohm, $\frac{1}{4}$ -watt resistor
 R7—0.1-ohm, 20-watt resistor
 R8—500-ohm potentiometer
 S1—Normally-open pushbutton switch
 SCR1—C205A, 1-A, 100-PIV silicon-controlled rectifier
 U1—LM324 quad op-amp, integrated circuit
 Perfboard or breadboard materials, IC socket, heatsink material, cabinet, wire, solder, etc.

Using the Electronic Circuit Breaker is easy. Connect the Breaker circuit to a strong 12-volt DC source, and connect the output of the circuit to a number of low-value resistors, 1, 5, 10, and 20-ohms. Adjust R8 for a trip for each resistor and mark each trip point about the potentiometer's shaft.

The 20-ohm resistor will produce a current flow of 600 mA, and the 1-ohm unit will push the output current to about 12 amps. Several resistors can be series-parallel connected to produce the desired level in between current values. And be sure to mark the value for each current trip point. Set the trip level to the desired current value and connect the Electronic Circuit Breaker in between the power source and load.

You might even consider leaving the potentiometer in the circuit, allowing you to tailor the Electronic Circuit Breaker to the circuit in which it is connected. In that way, whenever an overcurrent condition occurs in the circuit that you are servicing, additional sub-assemblies will be protected from damage. Or consider this: How about designing an adjunct to the Breaker that will reconnect power after the overcurrent condition has been corrected. (Such a circuit would be similar in operation to the overvoltage/overcurrent circuits found in many of today's color TV sets.)

Well that's about all the room allotted to us for this month. So until then, may the flow be with you! ■

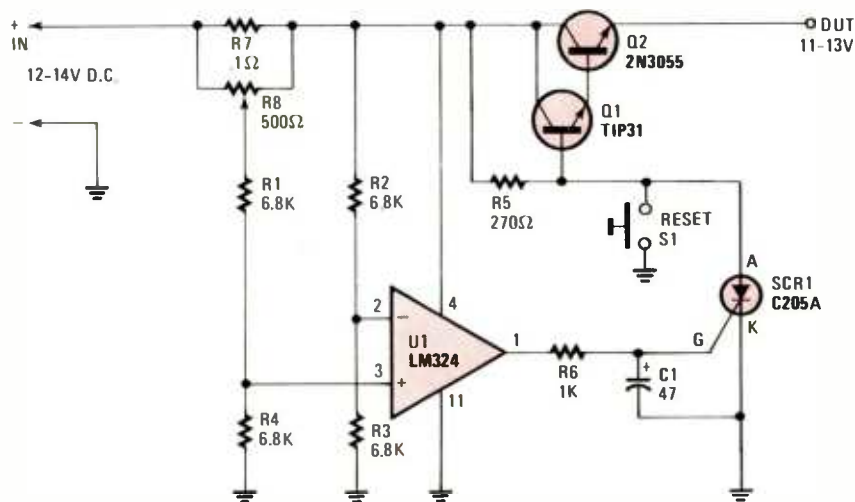

Fig. 4—The Electronic Circuit Breaker provides a broad range of current trip points, making it an ideal when making a test run of a newly built project or any equipment that is to be powered from the auto's electrical system.



By Joseph J. Carr, K4IPV

CARR ON HAM RADIO

An adjustable, active bandpass filter—the CB “crud buster.”

□EVER SINCE I RECEIVED MY FIRST license in 1959, I have loved 40-meter CW, with some flirtation with 20-meters. In those days, almost anyone with a surplus command set receiver (ARC-5 anyone?) capable of homing in on 40-meters could work the CW portions of the band with impunity...and have a heckuva lot of fun doing it.

Besides the skill factor, CW operation is cheap and can be done with relatively low-cost equipment. But today, no one in his or her right mind wants to work 40-meters anytime after sundown...or even within an hour of sundown. If Radio Moscow doesn't nail you with its multi-megawatt signal, then the BBC or the Voice of America will. The 40-meter band is probably the worst example of an overcrowded—nearly useless—band.

So what to do? Of course, with modern HF transceivers, we can buy a 250-Hz or 500-Hz filter to cut through the crud. But that is expensive—at least two filters are needed in practice, and that in itself, pushes the price to over \$180. Another disadvantage of the fixed-filter approach is that it is a *fixed* filter. That is to say, the bandwidth is the same all of the time. We cannot custom tailor the bandpass of the rig to fit the situation.

If we select too wide a bandwidth, then we will hear far too many signals, and weak signals are lost in the roar. Alternately, if we select too narrow a filter, then we must tune too slowly and pay too close attention to what's going on. Most operators that I have talked to claim that a 250-Hz CW filter is actually too narrow for practical use.

The solution is to use an adjustable, active bandpass filter, such as the Heathkit model *HD-1418*, shown with my Kenwood TS-430S in the photo. After using that product on the air, I have dubbed it a “crud buster” because it makes it possible to work CW and SSB on the 40-meter bands—damn the Russians, full speed (well, 15 WPM) ahead!

The *HD-1418* uses operational amplifiers and other chips in an active filter arrangement that permits one to either *notch out* or *peak up* certain frequencies in the audio spectrum. The *HD-1418* is placed in the audio-output line between

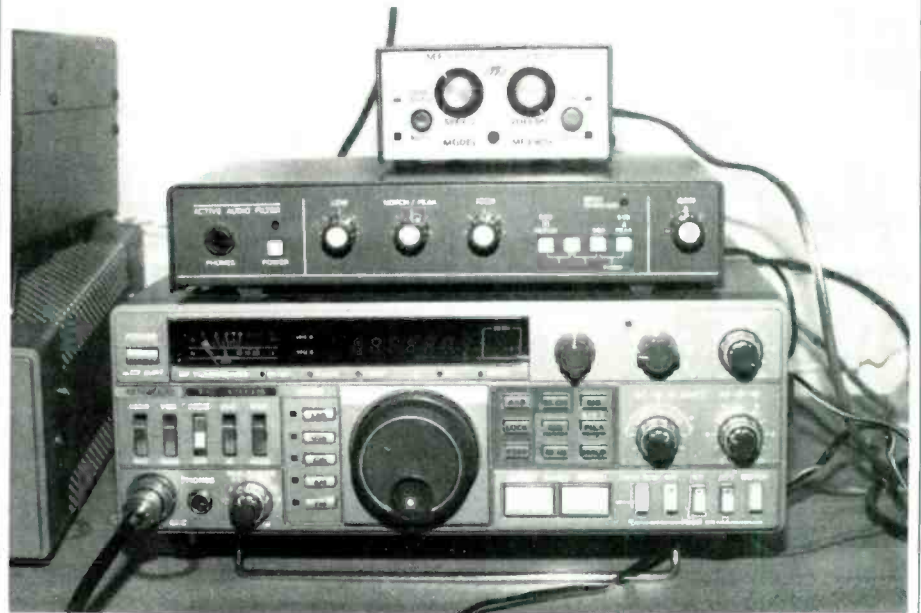

Shown here is the Heathkit model *HD-1418* (adjustable, active bandpass filter), accompanied by the author's Kenwood TS-430S and MFJ Econo Keyer II. The *HD-1418* is placed in the audio-output line between the receiver AF output and either the speaker or the headphones, has an active filter arrangement that permits one to either *notch out* or *peak up* certain frequencies in the audio spectrum.

the receiver AF output and either the loudspeaker or the headphones. There is also a low-level AF output designed to drive tape-recorder inputs and other devices (which allows you to record the received signals).

The front panel controls are as follows: POWER, PHONES, GAIN, INPUT OVERLOAD, LOW/CENTER, HIGH/WIDTH, NOTCH/PEAK and also a series of mode-selection push-buttons.

Phones—This connection is a 1/4-inch phone jack that accepts an earphone plug.

Power—Turns the filter on and off. The power supply is an external transformer pack.

Gain—While the filter power button is on, the GAIN control determines the gain of the amplifier section, hence the drive to the loudspeaker or earphones.

Input overload—A light-emitting diode warns when the input signal is too high for the filter circuitry. The audio output of a receiver can be at quite a high level, so some means of warning is needed.

The controls below are both interactive and dual use. Their function depends upon the settings of the mode pushbuttons on the right side of the front panel.

Low/Center—When used as a LOW control, this knob moves the lower -3 dB end of the audio passband over the range 300 to 2500 Hz. The “low” function is typically used on AM and SSB signals. When selected as a CENTER control, which is used on CW or RTTY signals, the center of the passband is moved up and down over the same 300-2500 Hz range. In this mode, the CENTER control is interactive with the WIDTH control.

High/Width—In AM/SSB modes this control sets the high-frequency end of the passband, and also moves the upper -3 dB end of the passband over the 300 to 2500 Hz range. Care must be taken not to make the high frequency lower than the low frequency. In the CW/RTTY modes, this control sets the width of the passband.

Notch/Peak—This control is activated only by pressing the NOTCH or PEAK buttons, and is disabled if any of the SSB

buttons are pressed. In the notch mode, the center frequency of the passband is severely attenuated; in the peak mode, the center frequency is amplified much more than the other frequencies located in the passband.

Operation

The HD-1418 can be tuned as a bandpass filter with bandwidths of 200 to 2500 Hz, mimicking the behavior of some very expensive filters. Figures 1 to 3 show the various modes of operation in graphic form.

Figure 1 shows a bandpass mode. There are two ways to achieve that mode. In the SSB mode, select high and low frequencies for the -3 dB points. Make the selections by listening to the signal on the air, while adjusting for minimal interference and noise.

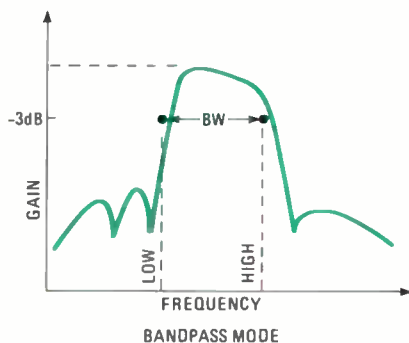

Fig. 1—There are two ways to achieve the bandpass mode. In the SSB mode, select high and low frequencies for the -3 dB points and make the selections by listening to the signal on the air, while adjusting for minimal interference and noise. The other way to achieve the bandpass mode is to use the CW or RTTY modes, and then set the center frequency and bandwidth using the CENTER and WIDTH controls.

The other way to achieve the bandpass mode is to use the CW or RTTY modes, and then set the center frequency and bandwidth using the CENTER and WIDTH controls. The usual way to use this mode is to position the desired signal in the passband with the CENTER control, and then adjust the WIDTH control to attenuate unwanted interfering signals.

Figure 2 shows the "peak" mode. In this case, the CENTER control is used to place the passband on the desired frequency. The desired signal is therefore enhanced, while interfering signals outside of the narrow passband are attenuated.

Figure 3 shows the "notch" mode. Although you might not think of this mode at first glance, it is possibly the most-useful for eliminating interference. The idea is to adjust the WIDTH and CENTER controls such that the notch overlays the unwanted signal, and the desired signal falls into the non-attenuated passband. This mode of

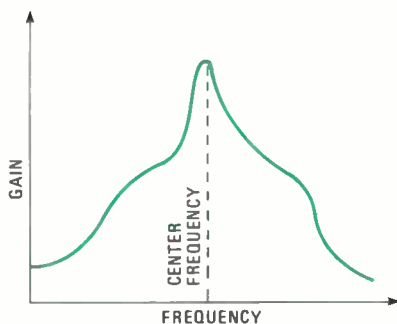

Fig. 2—Shown here is the "peak" mode. In this mode, the CENTER control is used to place the passband on the desired frequency—thereby, enhancing the desired signal, while attenuating (reducing) interfering signals that fall outside the narrow passband.

operation takes a little getting used to, but it is easily mastered and proves exceptionally valuable.

Construction

The construction of the Heathkit HD-1418 is easy. As an experienced constructor, I built mine in one afternoon, while visiting my in-laws ...and their kitchen table with my kids crawling all over the place is not the most ideal workshop. I suspect that even novice builders can successfully put the HD-1418 together in no more than two evenings, or a whole Saturday.

The entire project is built onto a single printed-circuit board. All IC devices are socketed, which makes both construction and servicing extremely easy. Two devices that Heath packages with this kit are imaginative...and fortunately come with most Heathkits.

The first is the little red plastic nut starter. It picks up a 1/4-inch nut on one end and a 3/16-inch on the other...and makes starting tiny nuts on machine screws *duck soup*. The other is the IC remover. Merely a bent piece of sheet metal, it is invaluable

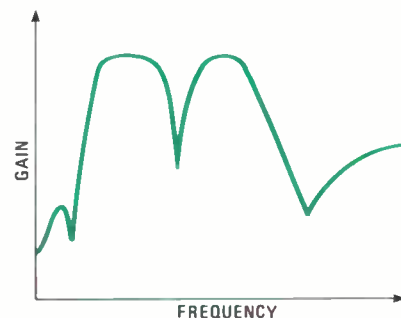

Fig. 3—Shown here is the operation of the filter in the "notch" mode—which is possibly the most-useful for eliminating interference. The idea is to adjust the WIDTH and CENTER controls so that the notch overlays the unwanted signal, and the desired signal falls into the non-attenuated passband.

for removing IC's from their sockets without, in any way, damaging the device.

Conclusion

No one should have to put up with the cacophony of 40-meters after sundown...it's barbaric. But 40-meters is a very useful band that allows communications over both limited groundwave ranges and distant skip ranges. I still find it exciting from my Virginia QTH to simultaneously hear W9/WCW8Ø signals along with W6 and DX.

As to what kind of DX is available, at 0500 EST one morning, I heard what was first taken to be a K2...only to find it was a VK2 in Sydney, Australia. After saying "73" to that one, I worked an EI8 (Irish) for awhile until sun-up shortened the skip. And no, my antenna is not a rotatable 40-meter beam, it's a trap vertical.

Well that's the end of the space set aside for us this month. So until next month, if you have any comments or suggestions, or perhaps just want to chit-chat about the hobby, write to Joe Carr, K4IPV, at PO Box 1099, Falls Church, VA 22041. ■



"This isn't my lunchbox! Don't you know a diskette box when you see one?"



By Herb Friedman

FRIEDMAN ON COMPUTERS

Get a universal monitor driver.

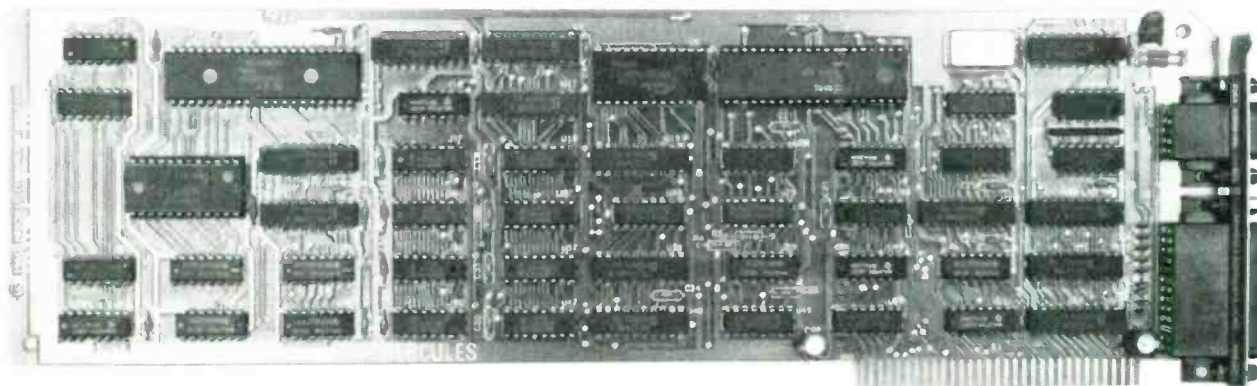

The Hercules Graphics Card is full size. The two connectors on the backplane—on the right—are for a 9-pin TTL monitor and a conventional parallel printer.

□WHEN IBM INTRODUCED THEIR FIRST personal computer, there were actually two separate systems. One was intended primarily for text work, such as word processing and calculations: It featured a special kind of monitor, called a *TTL Monochrome Monitor*, and a matching monitor adapter card that plugged into one of the computer's five "slots." The monitor card also provided an output for a printer. The TTL monitor system provided a very clean and legible character display and, because of its printer output connector, was particularly well-suited for word processing.

The other system was intended to compete with the "home computers" of the day. Its monitor was a special kind of color monitor having separate color and sync inputs, and was known as an *RGB monitor*—the letters R, G, and B representing the red, green, and blue primary-color signals from the computer. Its monitor adapter, known as a *CGA* (for Color Graphics Adapter), was intended primarily for displaying graphics; text characters were a secondary consideration.

They were larger than those of the TTL monochrome adapter, but not necessarily as clear. To compete with the "home computers" of its time, in addition to the RGB monitor output, the CGA card also had a composite output that could drive inexpensive *composite input* color monitors (such as those supplied with Commodore computers), and there was an output for an RF modulator that allowed the computer's

signal to be viewed on a conventional TV. (IBM discontinued the RF modulator very quickly when they realized that the future of personal computing was with the business user and not *home and family*.)

Cheap Monitoring

Discount computer dealers soon real-

ized that since the CGA's composite output could also drive a composite monochrome monitor—which was less than half the cost of a TTL monitor—they could provide an "IBM system capable of both word processing and graphics" at substantially reduced prices.

The average consumer couldn't tell the

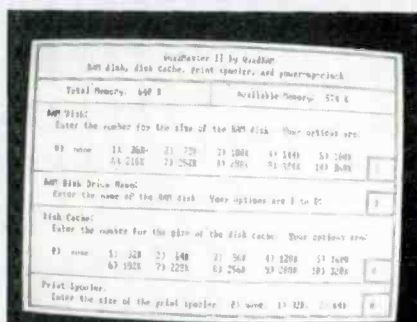
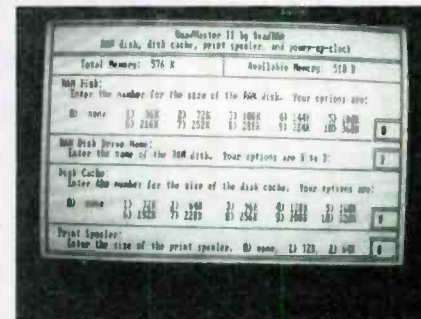
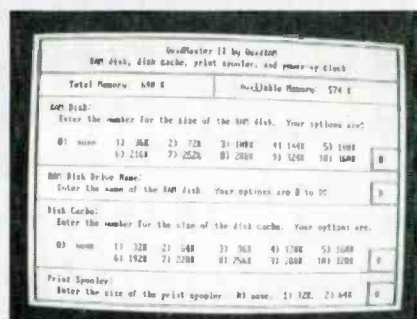

Fig. 1—The only major difference between the Hercules and the CGA adapters is that the Hercules tends to scrunch some graphic displays. Compare the display shown on a true monochrome TTL system (A), the Hercules/TTL system (B), and a EP CGA/composite monitor system (C). If you can see any difference other than screen brightness, you've got a good imagination. (The Hercules/TTL screen has more contrast.)

difference until his eyes got strained from the not-so-clear composite monitor display of the CGA card's character set. Also, the CGA card tended to distort the display of certain popular programs that were specifically intended for a TTL monochrome monitor. In fact, some of the very best "mono" software was not even readable, or legible, when using CGA/composite monitor equipment.

But create a void or a need and someone will rush to fill it. In this case, the solution was something called the *Hercules Graphics Card*, a device which has also been cloned, and what is usually provided in many rock-bottom-priced computer systems.

One Card, Two functions

The Hercules card was a really clever idea. In basic terms, it is a TTL monitor card intended specifically for TTL monitors, but it has the capability to display graphics on the TTL monitor. When running monochrome software, such as a word processor, the text characters are exactly the same as the high-quality characters you find on any of IBM's own monochrome adapter cards.

But, when running in the graphics mode, the entire display resembles that of IBM's CGA. The major difference is in the text characters, as you'll soon see. The Hercules characters are slightly more legible because they resemble the TTL

characters. The only major difference between the Hercules and the CGA adapters is that the Hercules tends to *scrunch* some graphic displays.

For example, Fig. 1A shows the screen display from an IBM TTL monochrome adapter. Figure 1B is the same TTL monitor, but with the monitor driven by the Hercules card. If you can see any difference other than screen brightness, you've got a good imagination. (The Hercules/TTL screen has more contrast because the Hercules card puts out a slightly stronger signal.)

Figure 1C is the same display using a CGA adapter and a composite monitor. Firstly, the vertical height is not as great. But more important, the characters are the CGA characters, which are not as easy to read as the TTL characters because they are separated by only one scanning line.



Fig. 3—Another sight that you wouldn't expect to see is *Printing Press* on a TTL monitor (A). It's usual all-graphics display is shown in B.

Figure 2A and Fig. 2B show the opening screen of the famous software known as *Print Shop*. Now as almost everyone knows, there is no way *Print Shop* will run on a TTL monitor system. Yet, it is running from the Hercules/TTL monitor arrangement shown in Fig. 2A. Figure 2B shows how *Print Shop* appears using a CGA/composite monitor arrangement. Note that the TTL display is somewhat smaller. That appears to be normal: graphics displays running on Hercules/TTL tend to range from slightly to much smaller than when running CGA/composite. However, note the text characters on the screen. Personally, I think they look



Fig. 2—Yes, it's really *Print Shop* on a TTL monochrome monitor (A). The usual all-graphics equipment display is shown in B. Notice the difference in how the text characters appear—the TTL display is somewhat smaller.



FIG. 4—Some graphics displays substantially shrink on the Hercules/TTL system. Greeting card on an all-graphics system is full-size (A). On the Hercules/TTL system (B) the display loses considerable height.

better from the Hercules/TTL setup (Fig. 2A).

Another Tough One

Figure 3A and Fig. 3B show *Printing Press*, another popular "Can't run on TTL" program that actually looks better from the Hercules card (Fig. 3A) than it does from a CGA (Fig. 3B).

Figure 4A and Fig. 4B show a major problem with some graphics software. Figure 4A is *Greeting Card* running on a CGA system. The display is large and easy to read. Figure 4B is the same program running on the Hercules/TTL system. The vertical size is so greatly scrunched that you need really fine eyesight to read some of the screen cues; the text size is smaller than many persons—particularly those wearing bifocals—can read.

But regardless of whether a graphics display is full-size or scrunched, or whether or not the text characters of the Hercules system matches that of the CGA, the important point is that you can display graphics software on a TTL monochrome monitor, which is one heck of an advantage.

Usually Supplied

Because the Hercules card provides both monochrome and graphics capability, discount dealers have discovered that it saves their having to face disgruntled customers wanting to know why their computer can't run the same games that run on their friends' computers.

And so, many of the low-cost computer systems now use a Hercules-compatible graphics card even though the system is supplied with a TTL monitor. The cus-
(Continued on page 107)



JENSEN ON DX'ING

There are many reasons to listen to shortwave programming!

□ TO MANY, SHORTWAVE IS A MEANS OF keeping up on the latest news as it happens around the world. It is a window to the cultures and music of other countries: a chance to learn or brush up on another language. But for many naturalized citizens and second-generation Americans, world-band radio is the way to keep contact with the land of their—or their parents'—birth.

Often I get inquiries from listeners who want to know when and where to tune shortwave programs from the *homeland*—be it Germany, Greece, the Ukraine, or Turkey. So for those of Polish heritage, and other SWL's too, here's the information you've asked about.

Broadcasting began in Poland back in February 1925, with a feeble transmitter of less than 500 watts. Today's *Radio Polonia*—the foreign service of *Polskie Radio Telewizja*—has studios only a mile from the small building in Warsaw's Mokotow district where the original station was located. And the power of the Polish shortwave transmitters is 200 times greater than that first broadcaster.

The best time to hear Radio Polonia is during its daily English transmission to North America, from 0200 to 0400 UTC. Frequencies are 6.095, 6.135, 7.145, 7.270, 9.525, 11.815 and 15.120 kHz. Polish radio also airs 8 half-hour (actually 23 minutes is closer to the mark) English programs for Europe during the day, broadcasting its programming to the winds at 0630, 1200, 1600, 1730, 1830, 2030 and 2230 UTC, on various frequencies from the 6 to the 15 MHz bands.

Some of those transmissions can be heard in North America, too, even though they are not beamed in that direction. Worth trying, for instance, is the 2230 UTC program on 7,270 kHz.

How's the Programming?

Here what some British SWL's, commenting in *Contact*—the monthly publication of the World-DX Club—had to say about the programming:

J. Sheppard, commenting on the News, said that it "seemed reasonable enough for a Marxist country: not too obvious on the propaganda, and a fair mix of internal and international news items. The current



This simple, but attractive bumper sticker is from Argentina's *Radio El Mundo* in Buenos Aires.

affairs review...was notably more aggressive."

K. O'Reilly: "Anyone looking for *magazine* type programs will be disappointed in Polonia."

M. Leigh: "The *Top 20 Show* I found not bad—all the music was Polish and concentrated mostly on easy listening."

E. Southwell: "One of the better stations broadcasting from the Eastern Bloc."

M. Ward: "Manic and anarchic...three presenters compete to see who can talk the loudest, talk the most, and (oddly enough) who can sound spontaneous while reading their prepared script. The appalling state of Radio Polonia's audio quality is, possibly, without a rival on the shortwaves."

The program reviews, clearly, are mixed. But why not hear for yourself? If you want to write to the station for more schedule information, letters go to Radio Polonia, all Niepodleglosci 75/77, Warsaw, Poland.

A Smidgen of Pidgin

It began in the 17th Century, when western traders began dealing with local merchants along the China coast. The ship captains and brokers, arrogantly assuming that the merchants with whom they were dealing could never command a proper understanding of the English language, began talking to them in a sort of "baby talk."

In time, that form of communication between buyer and seller became a language in its own right, *Pidgin* English—pidgin being a Chinese corruption of the word "business."

From Canton and Hong Kong it spread south and east, with the white traders, to New Guinea and the smaller islands. Here, in today's Papua New Guinea, Pidgin is firmly entrenched (a living language), expanding rapidly with increased vitality. Listening to spoken Pidgin on the shortwave stations of the National Broadcasting Commission of Papua New Guinea is a fascinating experience.

In its development, Pidgin took the course of least resistance. As linguist Mario Pei puts it, the language adopted simple English words, strung together with local syntax, and disregarded things like gender and number, having verbs that were timeless and invariable.

The result is strange, to say the least. Missionaries, for example, translated the English word, bishop, into Pidgin thusly: *topside-piecee-Heaven-pidgin-man*. And a butcher is *manbelong-bullamacow*.

There are 19 Papua New Guinea shortwave stations operated by the government NBC. Several, such as the main NBC stations in Port Moresby, are not difficult to hear in North America. Probably the best frequencies to try are 4,890 and 9.520 kHz, during the early morning hours, from about 1000 UTC onward.

But you might want to look for some of

ABBREVIATIONS

CKFX	C is prefix for Canadian SW station call signs (CKWX, CKVP, CFRB, CFCX, etc.)
DJ	Disc Jockey
DX	long distance (over 1000 miles)
DX'ing	listening to shortwave broadcasts
kHz	kiloHertz (1000 Hertz or cycles)
kw	kilowatt (1000 watts)
RCI	Radio Canada International
RTVD	Radio TV Dominicana
SABC	South African Broadcasting Corporation
SIBC)	Solomon Islands Broadcasting Corporation
SW	shortwave
SWL(s)	shortwave listener(s)
TV	television
UTC/GMT	Universal Time Code/ Greenwich Mean Time
WCSN	Christian Science Monitor

the other outlets, such as Radio North Solomon at Kieta in the Solomon Islands, on 3,325 kHz. In Pidgin, it's identification is *Maus Bilong Sunkamap*. (Mouth Belong Sun-come-up, or, Voice of the Sunrise).

Other broadcasters include *Radio Gulf* at Kerema on 3,245 kHz; *Radio East New Britain* at Rabaul on 3,385 kHz; *Radio Milne Bay* at Alotau on 3,365 kHz, and *Radio Western* at Daru, 3,305 kHz.

In mid-winter, you may find some of those broadcasts with decent signals in the "around dawn" time slot, but a number of them can be very tough DX's to log, indeed.

What's Current?

Among the more interesting of the new shortwave voices to hit the airways is *Radio for Peace International*, set up in Costa Rica by the World Peace University, headquartered in Oregon, with United Nations support. Initial broadcasts have been aired on 7,380 kHz, but the station should also be on 15,405 kHz by the time you read this.

Programs on the 15-MHz frequency are to be aired between 2000 and 2300 UTC, and on the 7 MHz channel from 0000 to 0300 UTC. The programming, in both English and Spanish, is aimed at furthering world peace.

Scheduled to be on the air by now is the new international service of an old line Caribbean broadcaster, *Radio TV Dominicana* (RTVD), the government station at Santo Domingo, Dominican Republic. RTVD, some years ago, did broadcast on shortwave. Now it is supposed to return to SW on 15,045 kHz, via the transmitter of *Radio Discovery*.

Jeff White, spokesman for the Florida-based World Radio Network that operates Radio Discovery, announced that RTVD

has leased the air time from the station. RTVD's International Service will mostly feature Spanish programs from the domestic Dominican medium-wave (MW) network, relayed on shortwave. But twice a day, World Radio Network will produce English programs for RTVD's shortwave service. The programs, "This is Santo Domingo," is to air daily from 2000 to 2100 UTC, and again from 0000 to 0100 UTC.

Down the Dial

Here's where you get your say. In this corner of our monthly column, we look at what SWL's are hearing. Your reports could be here next month. Drop me a line—the address is *Jensen on DX'ing, Hands-on Electronics*, 500-B Bi-County Blvd., Farmingdale, NY 11735—and let me know what you are logging on shortwave. Include where you heard it (frequency in kHz) and when in UTC (Universal Coordinated Time). Any questions about SWL'ing also are welcome, as are photos of you and your equipment, to appear in these pages in future columns.

3,905 kHz—one of the Papua New Guinea SW stations, *Radio New Ireland*, has been logged in California at 1045 UTC with Pidgin talk and native vocals.

7,145 kHz—*Radio Algiers* can be heard by North American SWL's during an afternoon transmission, until 2300 signoff with music, political talk and identification—all in Arabic—prior to close-down for the day.

7,240 kHz—Here's another ethnic special for those who might want to hear programming from the land of their heritage. You can hear English news from *Radio Yugoslavia* in Belgrade at 2100 UTC.

9,545 kHz—A nice piece of DX is the *Solomon Islands Broadcasting Corporation* (SIBC) station at Honiara, which can be heard, in English, around 0730 UTC with news and weather, including information on the tides for shippers and fishermen.

13,650 kHz—Some broadcasters can be found in this new shortwave band, including *Radio Baghdad*, Iraq. It has been reported here about 1820 UTC with non-stop Arabic music.

15,150 kHz—*Radio Canada International's* "SWL Digest," a weekly program for shortwave enthusiasts, hosted by Ian McFarland, is one of the more popular SW shows on the air. Look for it Saturdays at 2130 UTC. And, if it's the third weekend of alternate months—March, July, Sept., etc.—you will hear yours truly with a regular shortwave feature, *Don Jensen's Journal*. ■

Credits: Ken Kashiwabara, CA; Richard D'Angelo, PA; Dustin Brann, CA; Peter Dillon, MD; Art Harris, NY; Raymond Slagt, Aruba, Netherlands Antilles

TV, RADIO COMMUNICATIONS



◀ **BP91—INTRO TO RADIO DX'ING** . . . \$5.00. Everything you need to know about radio DX'ing and how you can get into this fascinating hobby area.



◀ **BP155—INTL RADIO STATIONS GUIDE** . . . \$6.95. New edition lists station site, country, frequency. ERP provides for thousands of short wave radio stations. Nine sections cover a variety of broadcast services.



◀ **BP105—ANTENNA PROJECTS** . . . \$5.00. Practical antenna designs including active, loop, and ferrite types that are simple and inexpensive to build, yet perform well. Also included are antenna accessories.

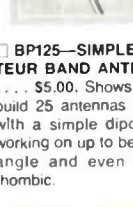

◀ **BP125—SIMPLE AMATEUR BAND ANTENNAS** . . . \$5.00. Shows how to build 25 antennas starting with a simple dipole and working on up to beam, tri-angle and even a mini rhombic.



◀ **BP132—25 SHORT-WAVE BROADCAST ANTENNAS** . . . \$5.00. Good antennas can be inexpensive. Here's 25 different ones ranging from a simple dipole, through helical designs to a multi-band umbrella.



◀ **BP136—25 INDOOR AND WINDOW ANTENNAS** . . . \$5.00. If you can't put up a conventional antenna because of where you live, one of these 25 designs is likely to solve your problem and deliver great reception.



MAIL TO: **Electronic Technology Today Inc.**
P.O. Box 240
Massapequa Park, NY 11762-0240

SHIPPING CHARGES IN USA & CANADA
\$0.01 to \$5.00 . . . \$1.00 \$30.01 to 40.00 . . . \$4.75
\$5.01 to \$10.00 . . . \$1.75 \$40.01 to 50.00 . . . \$5.75
\$10.01 to 20.00 . . . \$2.75 \$50.01 and above \$7.00
\$20.01 to 30.00 . . . \$3.75

OUTSIDE USA & CANADA

Multiply Shipping by 2 for sea mail

Multiply Shipping by 4 for air mail

Total price of merchandise . . . \$ _____
Shipping (see chart) . . . \$ _____
Subtotal . . . \$ _____
Sales Tax (NYS only) . . . \$ _____
Total Enclosed . . . \$ _____

Name _____
Address _____
City _____ State _____ Zip _____



By Marc Saxon

SAXON ON SCANNERS

Digital electronic tuning in a completely miniaturized 100-channel scanner.

□THE SR-15 IS THE FIFTH MODEL IN Cobra's recently introduced family of sophisticated scanners. User-programmable, the unit tunes from 29.0 through 54 MHz, 108 to 174 MHz, 406 through 512 MHz—covering public safety, ham, federal government, business, industrial, maritime, aero and land transportation bands.

The memory feature of the SR-15 (each of the five banks can store up to 20 frequencies) enables added monitoring convenience. Channels can be grouped within the banks in any order for faster and easier access; the memory banks can be monitored separately as well as together in any combination.

A complete array of automatic operating functions are featured, including normal scan, automatic search, channel lockouts, channel priority, selective scan delay, channel hold and manual scan, keyboard lock, and light button.

The Cobra SR-15 has a back-lit, 6-digit LCD display that indicates the frequency, channel position, plus the status of the priority, lockout, delay, and the 5-position memory bank.

The unit offers excellent program memory protection. It will retain your frequencies for up to an hour without batteries, saving you the time and effort of recalling which frequencies you had programmed into the SR-15, and then reprogramming the set.

Ultra compact (6-in. high, 2-3/4-in. wide) and weighing in at only 10 ounces, the SR-15 is housed in a weather-resistant anodized aluminum and high-impact ABS plastic case. Accessories include a rubberized antenna, rechargeable battery pack, AC adapter/charger, earphone, and carrying case. Its suggested retail is \$299.95.

For more information, contact Cobra/Dynascan Corp., 6500 West Cortland St., Chicago, IL 60635 or circle No. 40 on the Free Information Card.

Question Box

Paul J. Stever of Placentia, CA writes to say that not long ago he purchased a Realistic PRO-32 handheld scanner. He'd like to know how he can get it to scan through frequency ranges that weren't designed



The Cobra SR-15 is user-programmable (up to 20 frequencies) and features normal scan, automatic search, channel lockouts, channel priority, selective scan delay, channel hold and manual scan, keyboard lock, and has a back-lit, 6-digit LCD display that indicates the frequency, channel position, status of the priority, lockout, delay, and memory bank. Weighing only 10 ounces, it's housed in a weather-resistant anodized aluminum and high-impact ABS plastic case and carries a suggested retail price of \$299.95. For more information, contact Cobra/Dynascan Corp., 6500 West Cortland St., Chicago, IL 60635, or circle No. 40 on the Free Information Card.

into the unit—for instance above 800 MHz. Also, he wants to increase the range of the unit with a different antenna.

The Realistic PRO-32, with its 200 programmable channels, is a fine scanner, but it's not easy finding add-on accessories that will turn a handheld into much more than you started out with. Several 800-MHz band converters have appeared, but they're intended for base station installation. In other words, if you want 800 MHz in a handheld, you're going to have to check out a handheld like the new Uniden Bearcat BC-205XLT that includes that band in its original design.

Same thing with the antenna; unless you're willing to hook the PRO-32 to a base-station antenna, you're going to have

to accept the fact that a couple of inches of rubber duckie antenna just doesn't equal a roof job. No way, no how.

Walter Kibler of Cedar Rapids, IA would like to monitor some of the activities of the Army Corps of Engineers and asks if we can point him in the right direction.

Well, Walter, that agency operates on a great many VHF and UHF frequencies, although I've found that 163.4125, 163.4375, 163.5625 and 165.1875 MHz seem to be quite active in several areas. An excellent listing of the Corps. of Engineers stations/frequencies is contained in the 6th Edition of the Top Secret Registry of U.S. Government Radio Frequencies, available at \$17.95 (plus \$2 postage/handling) from CRB Research, PO Box 56-GP, Commack, NY 11725.

Reader Barry Hirsh says that in recent months, the huge New York City Transit Authority communications system was modified and modernized. That's just fine, except for the fact that the new system appears to have different frequencies than the old system. Basically, Barry wants to get a handle on the new frequencies used by the NYC Transit Police. We suggest that you try out 160.905 MHz for Manhattan; 160.50 MHz for the Bronx; 160.305 MHz for Brooklyn, and 160.1 MHz for Queens.

Kyle Merriweather, who hails from southern California, points out that the TV news always shows law enforcement officers negotiating with aircraft hijackers via two-way radio. Since that practice is so widespread, he wonders how the aircraft are able to operate on police VHF/UHF FM frequencies when the VHF-aero band uses AM and is on other frequencies. That's a good question.

The police and FBI communicate with the hijackers over frequencies in the VHF-aero band, thus eliminating the need for the plane to have police-band communications capabilities. Mostly, frequencies in the 121.6 to 121.925 MHz portion of the band are used. Those frequencies are all set aside for airport ground-control use and won't cause interference to inflight communications. At airports where there is an assigned ground-control frequency,

(Continued on page 105)

Discover—Explore—Experience
Today's Electronics With ...

McGraw-Hill's Contemporary Electronics Series

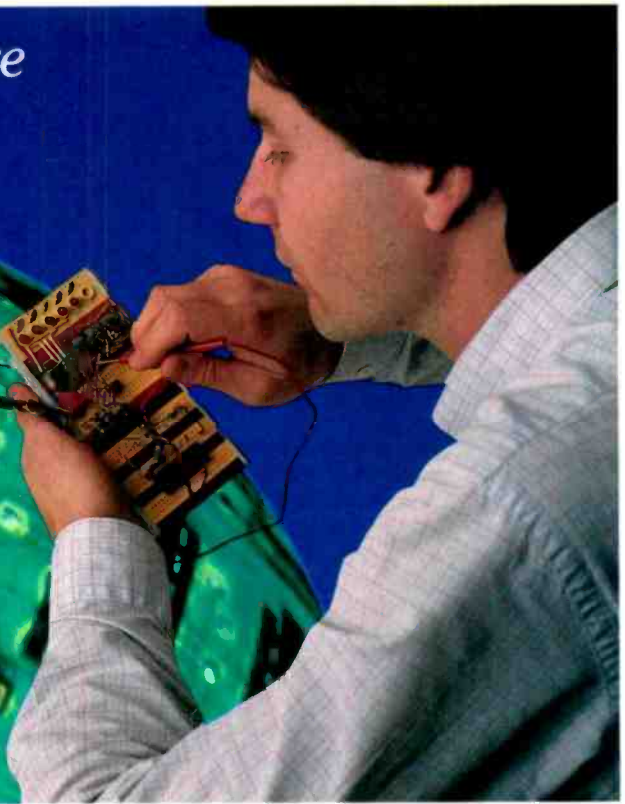

Now you can meet the challenges of today's electronics quickly and easily. This professional level learning series is as innovative as the circuitry it explains and as fascinating as the experiments you build and explore! And it's for anyone who has an interest in electronics... from the hobbyist to the professional.

Thousands Have Already Experienced the Excitement!

Today's high-tech world demands an entirely new and innovative approach to understanding electronics. That's why McGraw-Hill has developed this unique "hands-on" learning method that brings to life the dynamics of the new electronics. It's a unique combination of interactive materials that gets you involved as you build and experiment with today's latest electronic circuitry.

Just how well this innovative learning approach meets the challenge of the new electronics is confirmed by those who have already completed the Series... "You have put me right into the middle of an extraordinary learning experience. With each lab exercise I have gained a new understanding of the intricacies of today's electronics." Or... "For me, the Series was just the answer. I felt confident within my specialty, but my grasp of other areas of electronics was slipping away. Your Series helped me upgrade my knowledge of the latest electronics concepts." Or this from a company director of training... "We manufacture sophisticated electronic products, with a lot of people in sales, assembly and purchasing. McGraw-Hill has answered a real need in helping our employees see the total picture. They now communicate with customers and each other more effectively."

Your Involvement in the New Electronics Begins Immediately.

You master one subject at a time with 15 McGraw-Hill *Concept Modules*, sent to you one

every 4 to 6 weeks. You waste no time on extraneous materials or outdated history. It's an entertaining, lively, nontraditional approach to the most modern of subject matter.

Your very first module takes you right to the heart of basic circuit concepts and gets you ready to use integrated circuits to build a digital oscillator. Then, you'll verify the operation of different electronic circuits using a light emitting diode (LED).

And each successive module brings you up to speed quickly, clarifying the latest advances in today's electronics... from digital logic and micro-processors to data communications, robotics, lasers, fiber optics, and more.

Unique Combination of Interactive Instruction Materials Makes Learning Easy.

Laboratory experiments, vividly illustrated text and interactive cassette tapes all blend together to give you a clear, simplified understanding of contemporary electronics.

With each module you receive a McGraw-Hill *Action-Audio Cassette* that brings to life the facts and makes you feel as if you're participating in a lively dialogue with experts.

Your ability to quickly make this knowledge your own is further aided by strikingly *illustrated* texts that use diagrams, explanations, illustrations, and schematics to drive home and rein-

force the meaning of each important point. Carefully indexed binders conveniently house all this material, as well as the instructions that will guide you through your "hands-on" lab experiments.

Throughout your Series, *laboratory experiments* reinforce every significant concept. With this essential "hands-on" experience using actual electronic components, you master principles that apply all the way up to tomorrow's VLSI (Very Large Scale Integrated) circuitry.

Discover, Explore, Experience for Yourself—15-Day Trial.

In all ways, the Contemporary Electronics Series is an exciting learning experience that offers you the quickest and least expensive method available to master today's electronics... and the only one with "hands-on" experience.

To order your first module for a 15-day

trial examination, simply complete the card and send today! If the card is missing, write to us for ordering information.

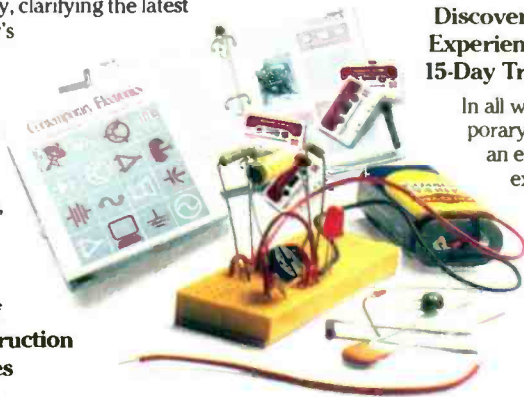

With your first module, you'll build this solderless breadboarding system. As you add additional boards, you create increasingly complex circuits easily and quickly, bringing today's electronics concepts to life.



McGraw-Hill
Continuing
Education Center

3939 Wisconsin Avenue, NW
Washington, DC 20016



By Byron G. Wels

WELS' THINK TANK

Getting used to transistors was hard enough, but IC's...oh well, back to school

□AS MOST OF YOU MAY BE AWARE, I grew up with vacuum tubes and had just gotten a bite on transistors, when I did what most editors do—I went into public relations where the “real” money is! I learned to use (and abuse) adjectives, and sing loudly the praises of equipment I usually hadn’t actually seen, much less tested.

I was hired for that particular job because they had just picked up a new client (a Japanese electronics manufacturer) and needed someone with a *sci-fi* background. My first assignment was to write a new-product release about a portable tape recorder—which I quickly did, and passed along to the boss. He read it, understood none, and told me “It had damned well better be right...Two Japanese engineers would be looking it over.”

We gave them the release, which was quickly tucked into a jacket pocket; it first had to be translated into Japanese. Two days later, my boss got a call to come (with me) to the office, as “corrections had to be made.” The drive to their office was horrible. The boss wouldn’t talk to me, and kept slamming the steering wheel with one hand. When I tried to start up a conversation, he turned the radio to near maximum volume.

When we finally arrived, there were the two engineers, along with a translator. We all smiled, bowed, and exchanged a few good mornings. The interpreter said, “See? Where begin with name of town? Is followed by NJ. Must to have decimal points after N and J.” That was it. The only thing wrong with my release was that they wanted “decimal points” after the N and J in New Jersey. Needless to say, we didn’t play the radio on the way home. Instead, we talked about my raise. But living under *the sword of Damocles* isn’t my way, and I got back into editing.

I remembered that vacuum-tube symbols had grid, cathode, and plate symbols inside the circle representing the tube envelope. Even transistors showed a base, collector, and emitter.

Now, there were rectangular boxes (integrated circuits or IC’s) with nothing but a part number inside, with numbers all about the perimeter. I was lost. And my old familiar Remington Upright finally

gave way to a computer terminal.

I struggled...I sweated...I was even ready to go back to public relations writing, where knowing little could be an advantage! Then I walked into one of my fellow editors’ office and asked “What’s *inside* these boxes?” “Who cares?” He said, “as long as it does the job intended.”

Maxwell, Faraday, and even Volta wouldn’t know what an IC did or was for, anymore than I did! But I could, at least, still *learn* about them. I did, and we’ll probably go further into this later on. Meanwhile, let’s check the mail and see how many copies of the Fips Book it’s going to cost the boss!

Welcome Ladies!

Apparently, not all of our readers are men. We’re happy to welcome this letter from Cathy Primerano, of Bloomfield, NJ, who points out that it seems to surprise everybody, but she’s also an electronics experimenter! Well, why not!—why should the boys have all the fun?

Cathy’s offering, shown in Fig. 1, is a rather unusual adaptation of the many “locator” projects that have appeared in these pages from time to time. Taking a pair of old, portable (under 100-mW) CB transceivers the kids weren’t using any longer, she removed the loudspeaker from one of the units. In place of the loudspeaker, a small Piezo buzzer (BZ1) was wired in with a small relay and battery to operate the buzzer. That unit is then wired to her dog’s collar in such a way that the

antenna will be upright when worn.

Then came a period of training the dog. With a long cord attached to the dog’s collar, she let the dog out to the end of the rope. Then by pressing the transmit switch on the other CB unit, and (at the same time) dragging the dog back in she got him to return home, where he’d be rewarded. By repeating that procedure a few times, the dog learned that when the buzzer went off, he’d get a reward if he rushed home.

Once trained to respond to the buzzer, Cathy says that the rope was eliminated. Now when she wants Fido, she just presses the transmit button, and the next thing you know, he’s scratching at the back door to get in!

Thanks Cathy, it’s nice to know we have some distaff readers out there too. And by the way, your copy of the Fips book should be there by now!

Wake Up Caller

Hey! John Macklin of New Florence, MO...Look what *you* went and did! You’ve gone and earned yourself a copy of the Fips book, which should be in your hands by the time you read this.

John explains that he and a friend of his were discussing problems, when his friend said that his worst problem was oversleeping because his alarm clock didn’t do the job. The design they came up with worked so well, that John decided to share it with us.

Adapt the circuit in Fig. 2 to any radio alarm clock and connect it directly to the

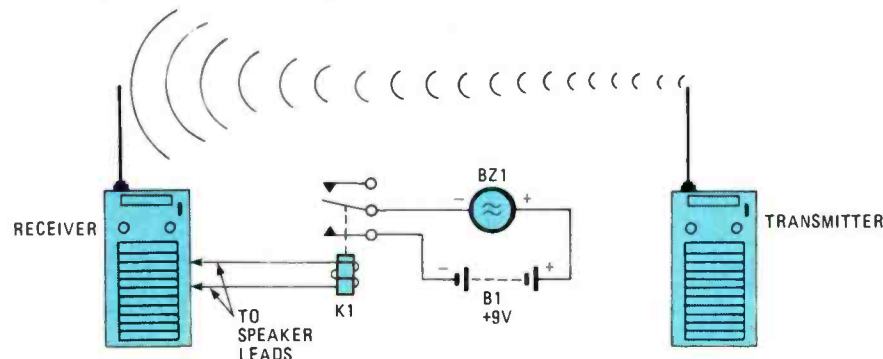

Fig. 1—The locator circuit is built around portable CB transceivers with the speaker from one of the units. Then a relay is wired in its place, and the relay contacts are wired to operate a piezo buzzer (BZ1).

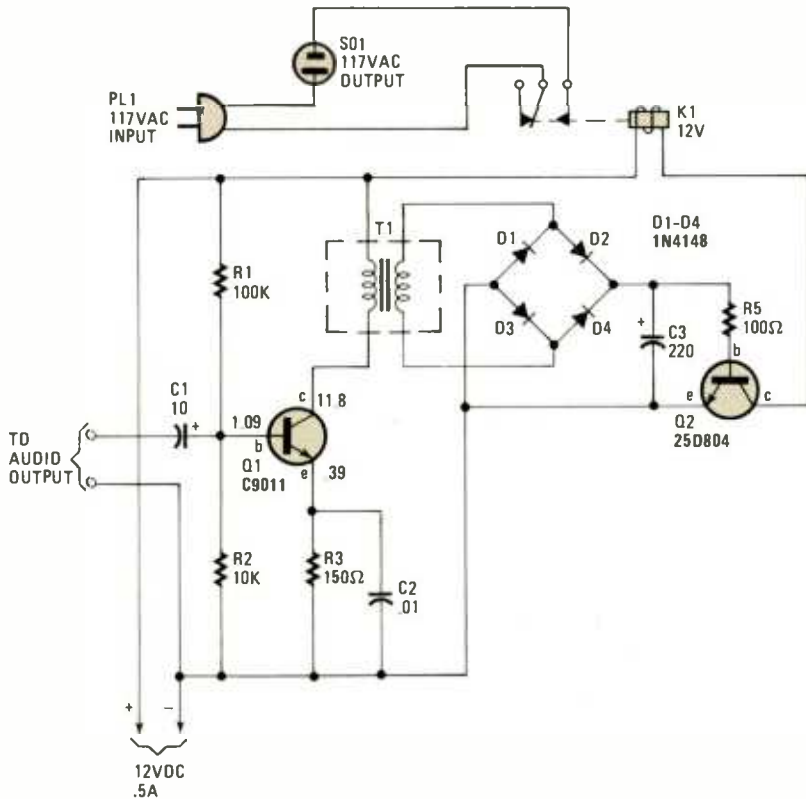

Fig. 2—The Wake-Up Caller is intended as an addition to your radio alarm clock. When connected directly to the earphone jack on the radio, audio signals destined for the speaker excite the relay, turning on the load.

earphone jack on the radio. The audio frequency current fluctuations to which your loudspeaker usually responds, triggers a relay which, along with the correct components, will control an AC outlet which, in turn, will control any sort of alarm device from a loud bell, to a light bulb, or anything else that will do the job of getting you from sleep to wakefulness.

Be careful of the RMS AC output of the radio as it can make or break this circuit. The linear bias region of the Q1 transistor which has been set for a fixed gain is basically a common base-biased transistor configuration which allows the mid-range audio frequencies to be linearly amplified, transformed and then rectified by the combination of transformer T1 and diodes D1-D4. Capacitor C3 filters out current fluctuations over Q2 by charging to the peak value of the rectified current allowing a positive-negative voltage drop across C3. The current flow through R5 is part of a biasing network which chooses the transistor biasing region which, for silicon is 0.7-volts base-to-emitter. When C3 is charged to at least 0.8 volts. That causes Q2 to become forward biased, allowing the transistor to conduct producing a voltage drop across the relay which must reach eight volts to trip.

Just be careful that the relay's contact ratings can handle the applied load!

Simple Alarm Circuit

Tim White of Elmore City, OK (I swear, you guys are making up the names of those towns!) has come up with a winner in the form of a simple burglar-alarm circuit.

Turn your attention to Fig. 3. Tim says, and I quote, "It works like a million bucks." However, checking the schematic, you'll find that it doesn't cost anywhere near that much!

Here's Tim's description: Gate bias for the SCR is provided by the voltage divider formed by resistors R1 and R2. However,

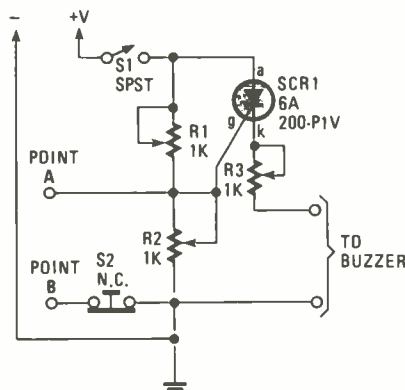

Fig. 3—The Alarm Circuit uses SCR1 (connected in a closed-loop) to detect unauthorized-entry. When the loop opens, the SCR turns on, sounding the buzzer.

R2 is shorted out by whatever is connected to points A and B, which could take the form of switches, phototransistors, foil tape, etc.

When the short is opened (presumably by a would-be intruder), the SCR fires and your alarm—be it a bell, buzzer, siren, relay or light—will indicate an unauthorized entry. The two potentiometers can be replaced by fixed resistors once you are satisfied with the operation of the circuit. And in keeping with our informality of design, Tim adds that "R3 could be removed."

Tim finished his letter by asking if his circuit was worth a Fips book. Watch the mails Tim, watch the mails!

Tone Generator

Here's some happy news for Roger Ingersoll, of Irving, TX. He tells us that a couple of years ago, he was installing a massive sound system in a convention center, and found himself in need of a tone generator to test the cables. Well, there seemed to have been some 20 other men working on the same project, but there were only two tone generators! Roger checked out the price of a commercial unit and when the salesman said "\$30," Roger made a wise decision—he designed and built his own.

Roger's circuit is shown in Fig. 4. The circuit is built around two 555 oscillator/

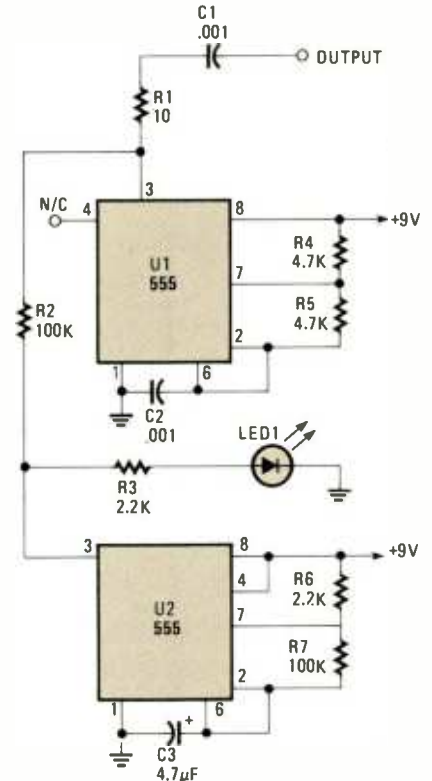

Fig. 4—The Tone Generator is built around two 555 oscillator/timers (although a 556 dual oscillator/timer would have minimized the parts count) each configured as astable multivibrators, and operating at different frequencies.

timers, with both set up for astable operation, each providing different output frequencies in order to produce an alternating tone. The output capacitor, C1, keeps the tone stable as the output drops in resistance. The LED acts as a pilot lamp, while flashing in sync with the operating tone.

The component values are not at all critical—use what you have. The output frequency can be computed for each half by the formula:

$$F = 1.44 / (R1 + 2R2)C1,$$

where R1 is the resistor connected between pin 7 and 8, and R2 is the resistor between pins 6 and 7.

The circuit can be powered from an ordinary nine-volt transistor-radio battery: but for added convenience, do add a single-pole, single-throw switch to power down the circuit when it's not in use. As an afterthought, a 556 timer would have done a better job, but I didn't happen to have one in my junkbox.

By now Rog, you should have received your copy of the Fips book. Hope that you enjoy it.

Battery Substitute

David R. Bell, of Reisterstown, MD sends us a brief letter, with a brief explanation, and a brief diagram. (See Fig. 5.) Well, they say that Sampson was a piker—he slew a thousand men with the jawbone of an ass, and that millions of sales are killed each day with the same weapon!

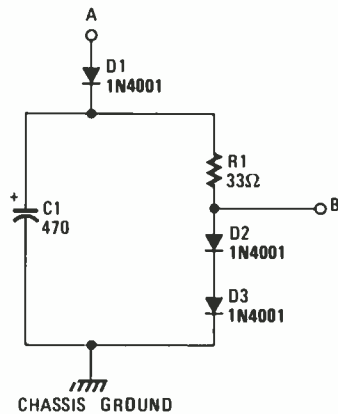

Fig. 5—Originally designed as a battery replacement in a VTVM, the Battery Substitute can be fed from an ordinary 6.3-volt filament transformer.

The problem Dave, is that we have to provide sufficient verbiage to at least wrap some copy around the diagram! One of the *first* things that most authors learn is that magazines pay by the amount of space a story takes. But that always results in the editor having to kill some copy because it's too long.

You needn't concern yourself however, because your schematic looks like a serviceable adjunct to any project that re-

quires battery power. With so few parts, it's certain that any active electronics hobbyist will quickly recoup the cost of putting that circuit together in batteries he no longer has to buy!

Dave explains that he originally designed his circuit as a battery replacement in a VTVM. It provides good voltage regulation, and the AC source can be an ordinary 6.3-volt filament transformer.

Hmmph! That about does it, and it should be sufficient to cover the Fips book we're sending out to you.

Ripple Suppressor

Got an interesting and useful project from Stephen M. Hart, of Omaha, NE. Steve, let's start with basics. You addressed me as "Mr. Wels." Mr. Wels is my *father*. I'm "Byron." The fact of the matter is that we're pretty informal around here, and I'd like to think that we can function best on a first-name basis.

With that said, let's now turn our attention to Steve's schematic diagram, which is shown in Fig. 6. Most AC adaptors are loaded with an unacceptable ripple content. For a ripple of 450 mV, this circuit suppresses that component to less than 5 mV. Resistor R1 provides the necessary bias current to keep the transistor in the active region. Capacitor C1 provides the necessary attenuation for the ripple factor.

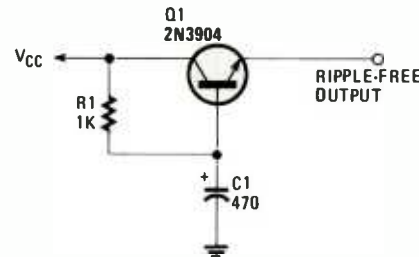

Fig. 6—The Ripple Suppressor is an extremely simple circuit that uses only three components to accomplish its task.

The transistor magnifies the capacitance of C1, as it is seen by the adaptor voltage, V_{cc} , by a factor equal to the transistor's *Beta*. The net effect of the circuit is to provide an equivalent capacitance of $470 \times 100 \mu\text{F}$ or $47,000 \mu\text{F}$. The filtered supply voltage at the transistor's emitter will be in the order of 0.7 volts below the collector voltage.

Steve used a 2N3904 transistor because of its high minimum *Beta* (100) and low cost. The limiting factor for this circuit is the maximum allowable collector current (I_c), which is 200 mA for the 2N3904. If higher supply currents are required, use a transistor with a higher I_c rating.

Steve, thanks a whole lot. By the time you read these words, your copy of the Fips book should already be in your very-capable hands! And if you have any additional circuit designs, that might be beneficial to other readers, send them to us.

Transistor Tester

Lou Supek, of Brunswick, OH, writes to say that he's an old subscriber to *Radio Craft Magazine*, (or did he mean he was a subscriber to the old *Radio Craft*?) and his comment that he wound many plug-in coils on 201A tube bases, brought back a flood of memories. I wonder if you (or any of our other readers can still name the grids in a pentagrid converter? Or maybe tell me what the unique characteristic of the old 6E5 tube was?

I remember reading about a great electronics inventor who was being presented with an award, and responded that "If I have been able to see farther than my fellows, it was only because I stood on the shoulders of giants." In our electronics business, that was never quite as true as it is today—Past is prologue, and the future will be the result of the past. See Fig. 7.

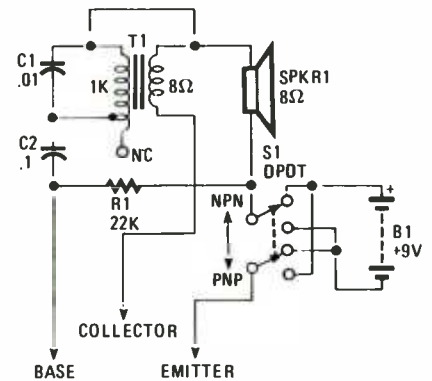

Fig. 7—This Transistor Tester is so uncomplicated that it could be permanently mounted to PC or perfboard, or thrown together whenever necessary.

Today's electronic gadgetry, such as VCR's, stereo components, TV's and the like, are loaded with transistors. Normal testing procedures usually require that the component be unsoldered and resoldered—a task that not only becomes a time-consuming pain in the neck, but can also result in mistakes, making the possibility of leaving the unit being serviced in worse condition than it was when we started on it.

They say a doctor buries his mistakes, a chef eats his mistakes, and we in electronics have shelves full of projects that we haven't finished working on yet! Lou's circuit, although he didn't provide step-by-step, component-by-component description, is almost self-explanatory. The bottom line is that the three clip leads get connected to the transistor terminals, and you *don't* have to unsolder them!

Lou, your copy of the Fips book is on the way. Enjoy.

5-volts On Tap!

Dave Martin, of Knoxville, TN, built this super-simple circuit and says that
(Continued on page 100)

Hands-on Electronics
THE MAGAZINE FOR THE ELECTRONICS ACTIVIST!

33.50 U.S.
 \$5.95 CANADA
 AUGUST 1987
 43784

INCLUDING 12-PAGE GADGET

TROOPER-PROOF HIDE-AWAY RADAR DETECTOR SYSTEM
 Avoid being harassed by troopers with this super-snooper device!

BUILD THE GEE-WHIZ BADGE
 Surround your convention nameplate with solid-state chase lights

TV RECEPTION IN MOUNTAINOUS REGIONS
 How to use refraction, diffraction and scatter to pull in a signal

COMPUTERS AND HAM RADIO
 Old and new technologies merge to add new excitement to an old hobby

Build the... DIGI-LYZER IC TESTER
 Quickly check out questionable IC's in a logic circuit you can control!
 See Page 42.

PLUS—
 The VCR Box makes a comeback!
 How they made the 4-megabit RAM chip!
 Reintroducing the all-band field strength meter
 Unusual chassis for the project builder!
 Plus much, much more!

3 New Fun & Cards This Issue



NOW
Hands-on Electronics[®]
Every Month!

■ IF YOU'RE THE KIND OF READER that doesn't want to wait, you can order your next copy of **Hands-on Electronics** now. **Hands-on Electronics** is crammed full of electronic projects that you won't be able to wait to build for yourself. You can expect top-notch digital projects, fun-to-play electronic games, valuable add-on computer projects, BCB and shortwave receivers, photographic/darkroom gadgets, devices to improve your car's performance, test equipment ideas, and more in every issue of **Hands-on Electronics**.

■ YOU CAN HAVE THE NEXT TWELVE ISSUES of **Hands-on Electronics** delivered to your home for only \$18.95 — saving \$11.05 off the single copy price.

■ EVERY ISSUE OF **Hands-on Electronics** will continue to contain a variety of construction articles to suit every taste. In addition, feature articles on electronics fundamentals, test equipment and tools will round out each issue. Of course, **Hands-on Electronics** will continue to provide new product and literature listings to keep you up to date on the latest developments in electronic technology.

■ GET IN ON THE ACTION! Order your next issue of **Hands-on Electronics** today. Use the convenient order coupon below. Be sure to send check or money order—no cash!

Hands-on Electronics SUBSCRIPTION

I want to be sure I don't miss any issues. Send me ONE FULL YEAR — twelve issues — of **Hands-on Electronics** for \$18.95 (Canada \$23.95 U.S. Funds).

Payment Enclosed

Please charge my

Visa Mastercard Signature _____

Bill Me Later

Acct. # _____ Exp. Date _____

Allow 6-8 weeks for the first issue to arrive. Offer valid in U.S. Funds Only.

Please print

 (Name)

 (Street Address)

 (City)

 (State)

 (Zip)

Detach and mail today to:
 HANDS-ON
 ELECTRONICS
 SUBSCRIPTION DEPT.
 P.O. BOX 338
 MOUNT MORRIS, IL
 61054

AHOC8

COMPU-THROTTLE

(Continued from page 38)

- U1, Pin 12—Momentum switch
- U1, Pin 13—Up switch
- U1, Pin 14—Starting Speed switch
- U1, Pin 15—Down switch

Because of the way modular telephone extension cords are built, it is easy to get them wired up wrong (Refer back to the construction section of this article).

Further Experimentation

Several of the components in the output circuit are on a DIP header that is referred to in Fig. 1B as U4. The DIP header allows for experimentation by providing easy access to the circuit. There are many possible component configurations and many possible output signals that can be generated.

Several signals are available:

- Pins 1 through 6, and 8—Output to regulator
- Pins 11 and 12—Main pulse signal
- Pin 9—Average pulse signal
- Pin 16—Filtered DC supply
- Pins 13, 14, 15—Ground
- Pins 7 and 10—Spare

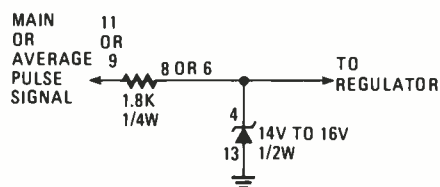

Fig. 6—To obtain the two pure pulse outputs shown in Figs. 2 and 3, connect the following circuit elements into the DIP header (U4) using the terminals indicated.

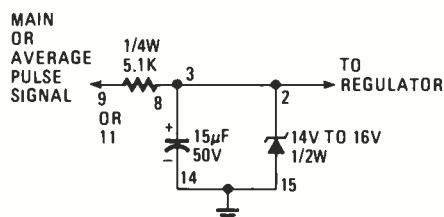

Fig. 7—Either pulse output shown in Figs. 2 and 3 may be filtered with a resistor and capacitor into a pure DC voltage like the one shown in Fig. 4 by using the above hookup.

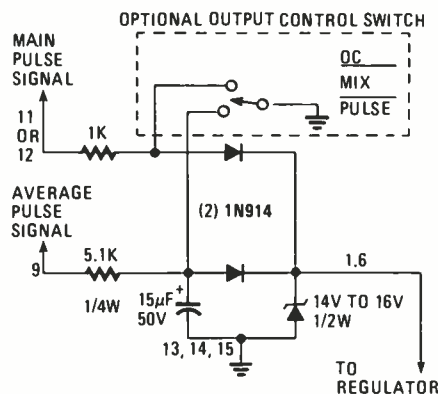

Fig. 8—This circuit provides a combination of pulse and DC power as shown graphically in Fig. 5. The main-pulse output is used to provide a full-voltage pulse while the average-pulse output is used to provide the DC component.

The Main Pulse Signal has a duty cycle which is 80% on and 20% off at full speed. The Average Pulse Signal is the same below half speed. Above half speed, it increases slightly faster so that at full speed it is fully on.

A word or two about motors and power packs is in order here: Many commercially available power packs have a provision for "Pulse Power." The normal output is full-wave rectified DC. When pulse power is selected, the output is changed to half wave. While this gives better low-speed performance, it also causes the motor in the locomotive to heat up at higher speeds. This is due to the "back emf" of the motor, caused by its inductance. Since an inductor resists a change of current, when the power is turned off, it acts like a flywheel. The higher the frequency, the greater the flywheel effect. Low frequencies cause large pulses of current, which cause heating. Since the Compu-Throttle's pulse output starts at a low frequency (30 Hz), but increases at higher speeds (up to 400 Hz), this problem is minimized.

Many waveforms can be generated by reconfiguring the components on the header. Some that the author has experimented with are:

1. A pure pulse output using just the main pulse output (See Figs. 2 and 6).
2. A pure pulse output using just the average pulse output (See Figs. 3 and 6).
3. Either pulse output can be filtered with a resistor and capacitor into a pure DC voltage. (See Figs. 4 and 7). This is similar to many "transistor throttles" on the market.
4. The circuit shown in Fig. 8 provides a combination of pulse and DC power (See Fig. 5). The main-pulse output is used to provide a full-voltage pulse while the average-pulse output is used to provide the DC component. The two signal diodes in this circuit cause the output to be the higher of the two signals, so the main-pulse output always provides the full "on" part of the pulse while the average output provides the low (or "off") part of the signal. This signal may reduce the heating of some motors.

The difference between configurations 1 and 2 is that configuration 2 will cause the train to run slightly faster. Conversely, for a given maximum speed, the first one allows a higher voltage starting pulse. This may be needed for starting some especially sluggish locomotives.

In all configurations, the Zener diode determines the maximum "on" voltage. If it is omitted, it will vary with the unregulated, filtered, power supply. This will probably not be noticed unless the load changes while a train is running (for example, another train enters the same circuit), at which time both will change speed. An advantage of eliminating the Zener diode is that U6 will have a minimum voltage drop and will not generate as much heat.

The author has used all but configuration 3, and all seem to work well.

5- and 10-ampere adjustable voltage regulators are available if the 3-ampere output rating is not enough for your application. Keep in mind that T1, BR1, D1, Q1, and Q4 also carry the entire output current, so they must also be changed.

Although the author has not tried it, with some additional circuitry it should be possible to detect the presence of a train on the track circuit. See discussion of the tri-color LED1 below.

Operation

The Compu-Throttle is easy to operate once you get the

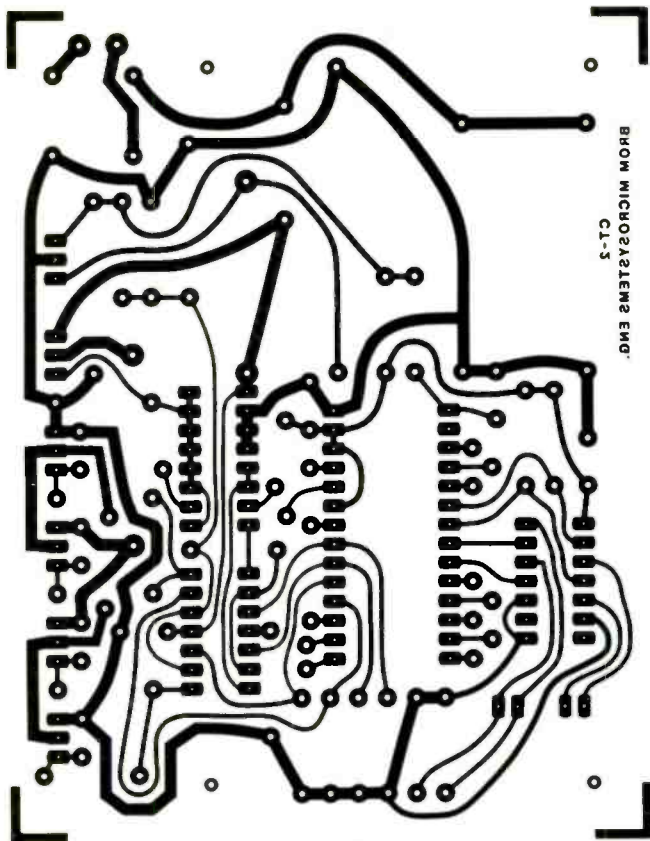

SOLDER SIDE

Fig. 9. Same-size printed-foil pattern for the circuit board made by the author to assemble the Compu-Throttle.

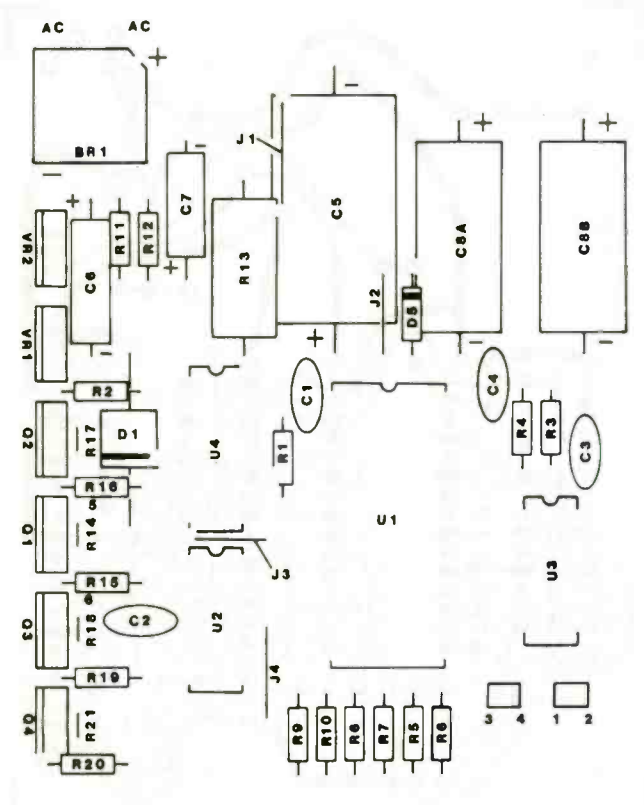

Fig. 10—Parts location for the Compu-Throttle printed-circuit board. Parts are on the flip side of the board.

feel of it. Full instructions are given in the *Operator Instructions*.

The tri-color LED1 in conjunction with the LM350 provides some useful information on the condition of the track circuit. The track circuit can be open, shorted, or have a normal load (the motor in the locomotive). The throttle can either be off, on forward, or on reverse. The color of LED1 indicates the currently selected direction. The LM350 and the output circuitry have an interesting side effect: Even if the throttle is in the stopped position, if there is no load (an open circuit), there will be enough voltage to light LED1 dimly. If you watch LED1 while you put a train on the track, you will notice that it glows while the circuit is open, and goes out when the circuit through the motor is complete. While the train is running, the brightness of LED1 increases as the speed is increased, unless there is a short circuit, at which time LED1 will go out.

These indications are summarized in Table 3.

TABLE 3—LED1 COLOR

Compu-Throttle:	Track Condition		
	Open	Normal	Shorted
Stopped forward	Dim Green	Off	Off
Stopped reverse	Dim Red	Off	Off
On forward	Bright Green	Bright Green	Off
On reverse	Bright Red	Bright Red	Off

Conclusion

Having a microcomputer as the heart of the Compu-Throttle gives much flexibility to the final design and a reduced parts count. It also makes it easier to change the performance of the whole circuit. Self-test software makes it possible for the builder to check out the circuit and the microcomputer itself with just a voltmeter.

Even though this project will improve the performance of your model train locomotives, the better conditions the locomotives are in, the better they will run.

The author has enjoyed designing, building, and using this project. Even more enjoyable is seeing other model railroaders use and enjoy it. The other member of the model railroading club that the author belongs to enjoy using it so much that they have been heard to say that they would rather not run trains if the Compu-Throttle were not available. ■

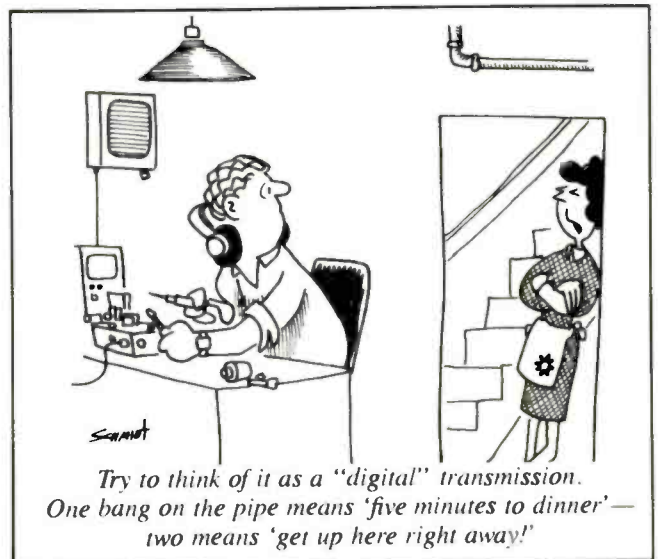

THE UKI OKI PRINTER SWITCH

(Continued from page 45)

are inserted all the way into the Oki's EPROM sockets. Those pins are larger than regular IC pins and require extra force to seat properly.

Documentation and Extras

A single IBM-format disk is included with the UKI switch. It contains short documentation files for installing the circuit board in the supported printers, and a utility that allows you to set up your printer for pitch (10, 12, or 17 characters per inch), double-width characters, print quality (draft or correspondence), enlarged or emphasized print, line spacing (six or eight lines per inch), page length, tab columns, and left margin (in Oki mode) or paper-out alert (in IBM mode). The set-up codes can be sent directly to the printer or saved in a disk file. You can then create several set-up files for different kinds of print jobs.

For example, you might want to run off BASIC program listings in compressed type at 8 lines per inch. You'd select the appropriate items from the menu, and then save them as a file called LISTINGS.OKI. Then, to put your printer in the desired mode, you'd type the following (assuming you're working from a hard disk):

```
C>TYPE LISTINGS.OKI>PRN
```

Other files might contain settings for letters, extra-wide

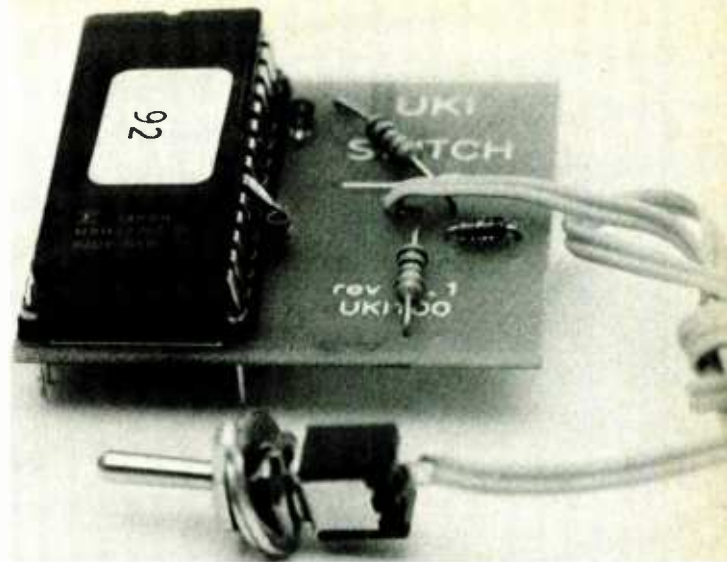

Fig. 1—A custom EPROM on a small circuit board plugs into your Okidata printer to provide switch-selectable IBM and Okidata compatibility at the flip of a switch. For more information circle number XX on the Free Information Card.

spreadsheets, database listing, etc.

The UKI Oki switch is a highly useful accessory, and at \$49.95, a real bargain. If you've got an Okidata printer, you need a UKI Oki printer switch.

WELS' THINK TANK

(Continued from page 96)

what makes this his favorite, is that it is also his first effort at independent circuit design. (See Fig. 8.) He's using a 7805 voltage regulator and Dave admits to one flaw, in that the problem is that 9-volt transistor radio batteries usually don't last very long. However, this unit allows one to transport a TTL circuit away from the workbench and it also can serve as a temporary 5-volt power supply until you get around to building something a little more suitable.

Those of you who are considering a circuit of this sort would do well to go back and look at some of the other circuits in this very issue! We've even got regulators and filters and all sorts of goodies that could work together to do all sorts of outstanding things.

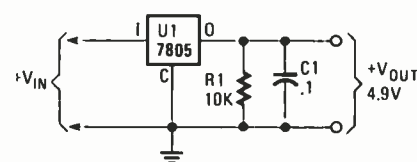

Fig. 8—This circuit, built around the 7805 5-volt regulator, can power low-current (1 amp or less) 5-volt circuits, such as TTL or CMOS based projects.

Headlight Reminder

David Herman, of Laurel, Montana, tells us that when it comes to his car's headlights, he's totally absentminded. Don't sweat it Dave; we've all of us done

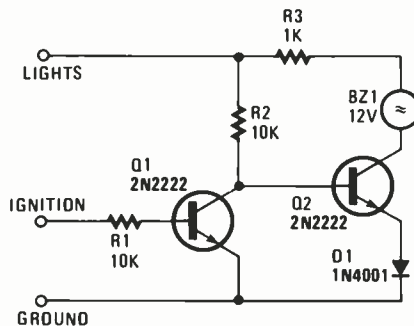

Fig. 9—The operation of the Headlight Reminder circuit is controlled by your auto's ignition switch, which is connected to the base of transistor Q1.

that same thing. And I know what you mean about booster cable jump-starts. But your little reminder circuit (See Fig. 9) is a doozy, and I'm betting that there are a lot of us out there who are going to be putting this one together.

Looking at the schematic diagram, it's easy to see that operation of the circuit is controlled by your auto's ignition switch, which is connected to the base of transistor Q1. Turning on the ignition, biases Q1 on. With Q1 turned on, its collector (which determines the input to Q2) goes low, and Q2 is held off. With Q2 off, the buzzer (which is connected in series with Q2) is silent.

With the ignition and lights *both* on, Q1 goes on and the base voltage of Q2 is lower than its emitter voltage due to voltage drop across D1 so with Q2 off, thus the buzzer is still quiet. When the lights *only* are on, current through R2 forward biases

Q2. Q1 is de-energized, and current flows through R3, the buzzer, Q2 and D1, so guess what? Right! The buzzer sounds.

There really isn't a critical part in the entire circuit, and your junkbox should yield everything that you'll need, maybe even the buzzer. The hardest part of the job is finding the proper wires under the hood or the dashboard.

Power Supply

In the mail, Randy! Randall Mason, of Raleigh, NC, not only sent in a beautiful power supply idea, he provided full and excellent descriptive text, and a schematic diagram (see Fig. 10) that made our art director totally flip out! "I wish they could all come in like that," he said. "But if they did, I'd lose my job."

Randy explains that this power supply circuit is capable of converting a positive 12- or 15-volt source to provide a negative 5.2-volt output, while delivering 0-50 mA of current. In operation, the 555 timer's frequency varies with the load current. The resulting positive output pulses (at pin 3) vary in repetition rate, but have a relatively constant duration. Each pulse turns on Q1 and rapidly charges C4. When pin 3 pulls the positive side of C4 low, the charge on C4 is transferred to C3. Line and load regulation are approximately 1%. C1 charges through R1 while pin 3 is high. Pin 3 goes low when pin 6 reaches $\frac{2}{3}$ of the V_{cc} .

Capacitor C1 then discharges through R3, Q2, and the IC's open collector discharges the transistor at pin 7; transistor

(Continued on page 103)

This will be coming to you when you subscribe to **Radio-Electronics**

- **HELPFUL CONSTRUCTION ARTICLES...**
 - Test Equipment
 - Hi-Fi Accessories
 - Telephone Accessories
 - Music Synthesizers
 - Computer Equipment
 - Automotive Equipment
 - Intruder Alarms-Home & Car
 - Video Accessories
- **NEWS ON NEW TECHNOLOGY**
 - Computers
 - Microprocessors
 - Satellite TV
 - Teletext
 - Automotive Electronics
 - Speech Synthesizers
 - IC Applications
- **FASCINATING "HOW TO DO IT" ARTICLES...**
 - Build Your Own Projects
 - Make Your Own PC Boards
 - Wiring Techniques
 - Soldering and Desoldering
 - Design and Prototyping

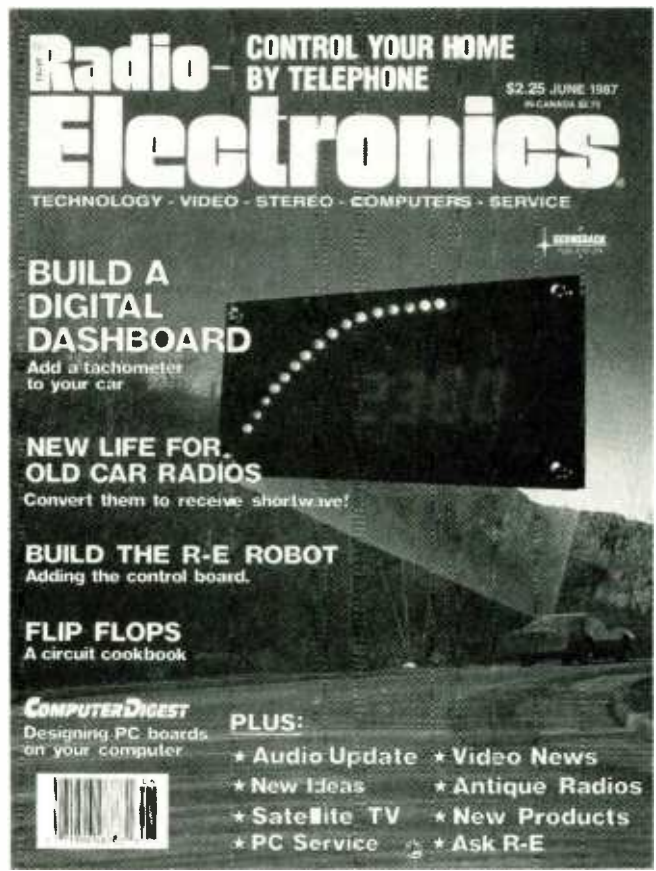

- **HOW YOU AND THE COMPUTER CAN BE FRIENDS...**
 - Getting Started
 - Programs, Circuit Design, Games
 - A/D-D/A Interfacing
 - Peripheral Equipment
- **NEW AUDIO DIMENSIONS FOR YOUR PLEASURE...**
 - Noise-Reduction Devices
 - How to Connect that Extra Add-On
 - Hi-Fi Accessories
 - New Technology
- **TV WONDERS FOR YOUR FUTURE...**
 - Latest Receivers and Circuits
 - The Home Entertainment Center
 - Projection TV
 - Satellite TV Receivers
 - Jack Darr's Monthly Service Clinic
 - Service Problems and Solutions
- **REGULAR MONTHLY FEATURES**
 - DESIGNERS NOTEBOOK by Robert Grossblatt
 - HOBBY CORNER by "Doc" Savage, K4SDS
 - STATE-OF-SOLID-STATE by Bob Scott
 - WHAT'S NEWS, new products, stereo news and NEW IDEAS, STEREO PRODUCTS, NEW COMPUTER PRODUCTS FOR HOME/JOB and MUCH MORE!

Radio-Electronics covers all aspects of the fast moving electronics field...featuring
**COMPUTERS • VIDEO • STEREO
 TECHNOLOGY • SERVICE
 COMMUNICATIONS • PROJECTS**

Get it all!

Subscribe today to **Radio-Electronics**! Don't miss a single issue and...see subscription card in back of this issue for big savings.

When you select one of the subscription offers listed on the handy coupon—you'll be assured of having your copy reserved, even if it sells out on the newsstand. Make sure you get all the excitement in every issue of **Radio-Electronics**, every month, by filling in and mailing your subscription card today.

MARCH 1988

E-Z MATH

(Continued from page 79)

Practice Problem

Here's a problem that will help you review all the key facts you have learned here. 7. A series LCR circuit like that in Fig. 18 has the following specifications:

$$\begin{aligned}
 R &= 1000 \text{ ohms} \\
 X_L &= 2268 \\
 X_C &= 4000 \text{ ohms} \\
 \text{source voltage } (V_S) &= 40 \text{ volts.}
 \end{aligned}$$

Answers to Practice Problems

1. 51°

If $A + B = 90^\circ$ in a right triangle, then:

$$\begin{aligned}
 A &= 90^\circ - B \\
 A &= 90^\circ - 39^\circ = 51^\circ
 \end{aligned}$$

2. 12 cm

$$\begin{aligned}
 b &= \sqrt{c^2 - a^2} \\
 b &= \sqrt{15^2 - 9^2} \\
 b &= \sqrt{225 - 81} \\
 b &= 144 = \sqrt{12}
 \end{aligned}$$

3. 60 volts

If 2 cm is equivalent to 10 volts, then:

$$1 \text{ cm} = 10/2 = 5 \text{ volts}$$

A 12 cm vector then is

$$12 \times 5 = 60 \text{ volts.}$$

4. 136 lb

If the pulling forces are perpendicular, then a right angle is formed so the Pythagorean relation can be used.

$$\begin{aligned}
 c &= \sqrt{a^2 + b^2} \\
 c &= \sqrt{110^2 + 80^2} \\
 c &= \sqrt{12100 + 6400} \\
 c &= \sqrt{18500} = 136 \text{ lb}
 \end{aligned}$$

5. 9 volts

$$\begin{aligned}
 V_L &= \sqrt{V_S^2 - V_R^2} \\
 V_L &= \sqrt{15^2 - 12^2} \\
 V_L &= \sqrt{225 - 144} \\
 V_L &= \sqrt{81} = 9 \text{ volts}
 \end{aligned}$$

- Compute the total circuit impedance.
- Calculate the circuit current.
- Find the component voltages.
- Calculate the supply voltage.
- Draw the voltage vector diagram.

Check your answers at the end of the article.

Next month, we will introduce you to basic trigonometry. Along with what you have learned here, the trig will allow you to compute the angles in the voltage and impedance triangle so that you will know the actual phase shift between current and voltage. ■

6. .2 A

First find the total circuit impedance:

$$\begin{aligned}
 Z &= \sqrt{R^2 + X_C^2} \\
 Z &= \sqrt{20^2 + 30^2} \\
 Z &= \sqrt{400 + 900} = \sqrt{1300} = 36 \text{ ohms}
 \end{aligned}$$

Next, use Ohm's law to find the current.

$$\begin{aligned}
 I &= V_S/Z \\
 I &= 7.2/36 = .2 \text{ A}
 \end{aligned}$$

7. a. 2000 ohms

$$\begin{aligned}
 Z &= \sqrt{R^2 + (X_C - X_L)^2} \\
 Z &= \sqrt{1000^2 + (4000 - 3368)^2} \\
 Z &= \sqrt{1000^2 + 1732^2} \\
 Z &= \sqrt{1000000 + 3000000} \\
 Z &= \sqrt{4000000} = 2000 \text{ ohms}
 \end{aligned}$$

b. 20 mA

$$I = V_S/Z = 40/2000 = .02 \text{ A} = 20 \text{ mA}$$

c. 80 volts

$$\begin{aligned}
 V_R &= IR = (.02)(1000) = 20 \text{ volts} \\
 V_L &= IX_L = (.02)(2268) = 45.36 \text{ volts} \\
 V_C &= IX_C = (.02)(4000) = 80 \text{ volts}
 \end{aligned}$$

d. 40 volts

$$\begin{aligned}
 V_S &= \sqrt{V_R^2 + (V_C - V_L)^2} \\
 V_S &= \sqrt{20^2 + (80 - 45.36)^2} \\
 V_S &= \sqrt{20^2 + 34.64^2} \\
 V_S &= \sqrt{400 + 1200} \\
 V_S &= \sqrt{1600} = 40 \text{ volts}
 \end{aligned}$$

THYRISTORS

(Continued from page 70)

series resistance) is more compatible with the output-sourcing capability of standard CMOS logic gates; the less current that is sourced, the higher the CMOS high-level output voltage. That allows the high logic-level output to be used for driving other CMOS logic, if so required.

However, the high gate impedance can create dv/dt problems. Junction capacitance can couple a capacitive current to the device input when a fast positive-going step voltage is large enough, conduction might be inadvertently induced. To minimize the dv/dt effect, the gate of the MOS-SCR should be terminated in an impedance similar to the gate-cathode resistance of a sensitive gate SCR or gate-source resistance of a power MOSFET.

The resistance by-passes the capacitive current from the input of the device; the lower the resistance, the greater the degree of shunting. With low resistance, the MOS SCR has

greater dv/dt immunity and higher blocking voltage capability, as illustrated by the curve in Fig. 10.

For optimum CMOS to MOS SCR operation, two impedance conditions should be satisfied: The gate circuit should limit the degree of the MOSFET turn-on, and the gate-cathode impedance should be low to increase device blocking-voltage capability.

LASCR's

The Light-Activated Silicon-Controlled Rectifier (LASCR) is another off-shoot of the SCR, which can be triggered into conduction by either a beam of light (a form of electromagnetic radiation) or an electrical pulse applied to its light/current-sensitive gate area.

Its basic four-layer PNP construction is similar to that of ordinary SCR's with one exception: the PN junctions are formed on a silicon pellet in an elongated manner to permit irradiation by a light source. The spectrum of visible light

for activation ranges in color from red to violet, corresponding to wavelengths between 0.7 microns (red) down to 0.4 microns (violet). (One micron is one-millionth of a meter.) Photosensitive devices such as the LASCR respond more

efficiently to the longer wavelengths of the infrared region. The LASCR's uses include power switching and control applications such as optical sensing, phase control, computers, and related digital-electronic control systems. ■

WELS' THINK TANK

(Continued from page 100)

Q2 stays off as long as the negative output voltage is large enough to turn on the 6.0-volt Zener, D5. When load current discharges C3 enough to turn off D5, Q2 turns on and begins another discharge of C1. The resulting output ripple is about 100 mV. Unless the load current is light, ripple frequency is above the audio range. Either way, even if load current varies, ripple is inaudible because no chokes or transformers are present.

The output does increase slightly with temperature, and you can (if you wish) generate a more-negative output by selecting a higher-voltage Zener (D5); but be aware that diode losses limit the output to -8 volts at low-current levels. U1 should never be driven by more than 15 volts, especially at full load.

Sump-Pump Controller

Remember, you saw it here first! I'm telling you, we bring you the latest, the utmost, the *ipssisima verba*, the be all and end all... Al Disciullo, of Ashland, MA, offers a circuit (See Fig. 11) to completely control your sump pump! Al, what are you guys going to come up with next?

Al tells us that this circuit does away with such things as float switches that can get stuck, and he speaks from personal experience. He says the circuit is extremely reliable and easy to build. And he put his together from junk box parts. He put his into service over two years ago, and hasn't had to touch it since then.

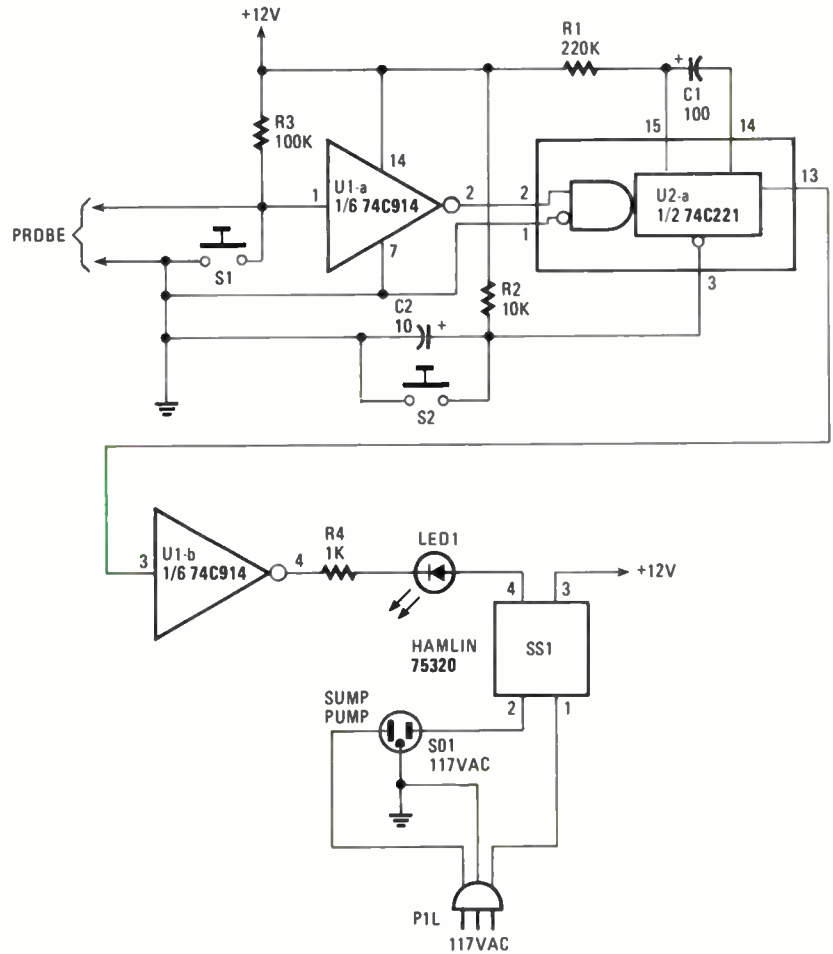

Fig. 11—The Sump-Pump Controller is designed to do away with such things as float switches that can get stuck. Its operation begins when water in the sump places a short across the probe input to the circuit, placing the input to U1-a at ground potential.

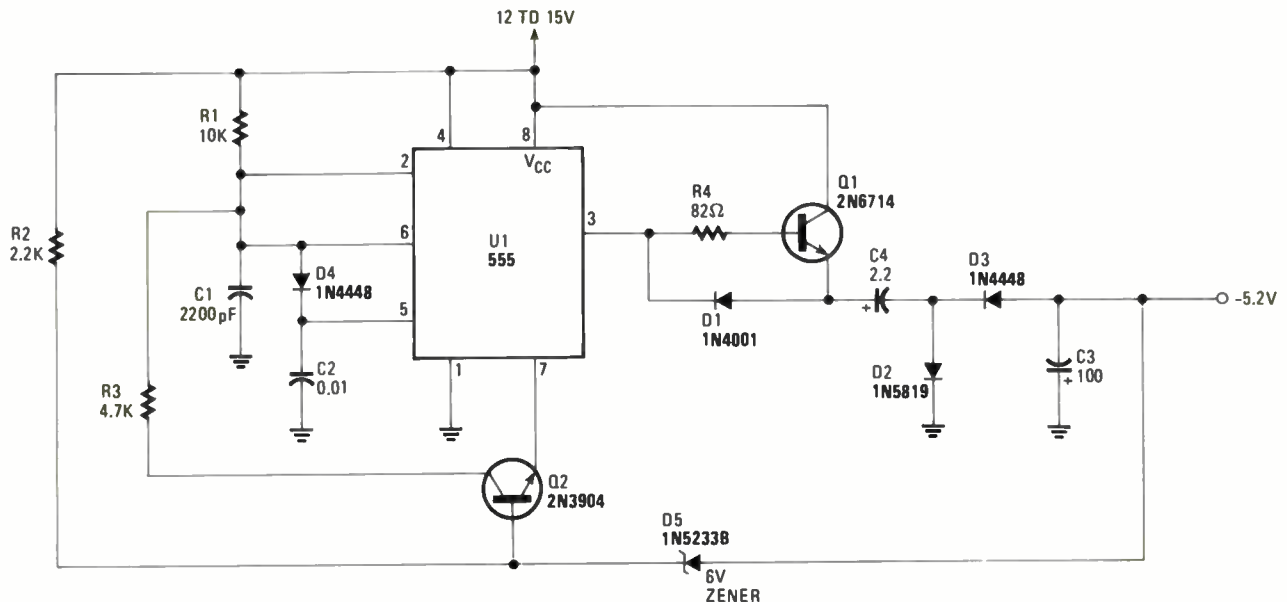

Fig. 10—This circuit, built around a 555 oscillator/timer, digests a positive 12- to 15-volt input, to provide a negative 5.2-volt output.

The circuit's operation begins when water in the sump causes a short across the (probe) input, placing pin 1 of U1a (a hex Schmitt trigger), at ground potential. That causes the output of U1a, at pin 2 to go high. The high output of U1a is fed to pin 2 of U2 (a dual non-retriggerable monostable multivibrator), forcing its output to go high which, in turn, causes the output of U1b to go low.

With the output of U1b now low, LED1 lights and the sump pump is triggered into operation via solid-state switch SSI. With the RC values given in the schematic diagram, the circuit sets the pump's run time at about 22 seconds, reducing the water level within the pump. The cycle repeats whenever the water level rises sufficiently to contact the probe. Also included, but not required, is a power-on reset, formed by R2 and C2, RESET switch S2 and TEST switch S1.

You can make a simple probe out of a piece of coaxial cable by separately tinning both inner conductor and shield. The tinned ends serve as the probe for the circuit. Using coax also improves the circuit's noise immunity; thereby, preventing false triggering due to external sources. And because the probe is used to sense the presence of water, a line-isolated power transformer should be used for the 12-volt supply.

What's it good for? Well, we like it as-is, but imagine its use as a flashing pilot lamp. No matter what application you find for it, it's certain to attract a good-deal more attention!

LED Flasher

Here's a quickie from T.R. Harris.

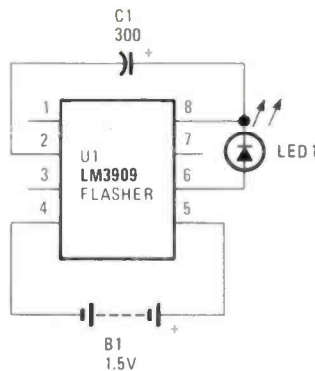

Fig. 12—The LED Flasher is just about the simplest do-nothing circuit that you can build. So if you're into blinking lights, here's your chance to get your hands dirty.

Okay, T.R. Because you sent us so little written material with this one, we're only sending you half of a FIPS book.

Take a look at Fig. 12 and you'll see just about the simplest *do nothing* circuit we've ever done. Using an LM3909 flash-

er chip and a few extra components, you can make the LED flash on and off. If you aren't happy with the flash rate and want to speed it up or slow it down, all you have to do is vary the capacitance of capacitor C1. The circuit can easily be powered by an ordinary "AA" cell, which should be good for about four days of continuous duty.

If you think the LED isn't lighting up brightly enough, you can add additional voltage, but be careful not to exceed four volts. If you do go over four volts, you're either going to fry the chip or blow the LED.



\$350

NEW IDEAS

42 PROJECTS
COMPLETE PARTS LISTS
ONE-EVENING PROJECTS
EASY TO BUILD

■ NEW IDEAS is packed with 42 practical circuits for the Electronics Experimenter and Project Builder. In addition to the headlight alarm, the voltage freezer, and the remote telephone ringer, you get complete plans for a simple Tesla coil project that can generate 25,000-volts AC and draw one-inch sparks. Other interesting projects are: a sound-effects generator, a crystal tester, a stereo remote control, and much, much more! Each project was selected for its low cost of parts!

■ WANT TO EXPAND your knowledge of electronics? Build gadgets that only you can have on your block? Acquire a library of projects? NEW IDEAS is the gold mine of circuits you should own and read. You could start the first night building a project that will have others praising what it can do and admiring you for building it.

■ THERE ARE PROJECTS for everyone—automotive, household, test equipment, audio and hi-fi, and projects just for fun.

NEW IDEAS—Circuits for Experimenters and Project Builders!

- Please send one copy of NEW IDEAS at \$3.50. First Class postage and handling \$1.00 (U.S. and Canada only). All other countries: \$2.00 for sea mail, \$3.00 for air mail.
- Please send _____ copies of New Ideas. Total cost is sum of copy price and First Class postage and handling cost multiplied by number of issues ordered.

Please print

Allow 6-8 weeks for the material to arrive.

Detach and mail today:
HANDS-ON ELECTRONICS
Reprint Department
500-B Bi-County Boulevard
Farmingdale, NY 11735

(Name)

(Street Address)

(City)

(State)

(Zip)

All Payment must be in U.S. Funds!

H-388

BOOKSHELF

(Continued from page 27)

The Complete Computer Career Guide

By Judith Norback, Ph.D.

The rapidly expanding computer job market can be confusing at best to those who would like to get into the field, but don't know where to begin. Now, computer expert and educator, Judith Norback provides a realistic assessment of 25 major computer career options ranging from technician, data entry operator, systems programmer, and systems analyst to software engineer, hardware designer, computer salesman, and computer consultant.

Based on interviews with those currently working in the computer field, *The Complete Computer Career Guide* delves into real-life job requirements, benefits, and drawbacks. In addition to job description, educational and experience



CIRCLE 99 ON FREE INFORMATION CARD

requirements and salary ranges, job environment, working hours, where to get started on a successful job search, and personality requirements.

Also included is a preview of new computer opportunities such as CAM engineer, CAM technician, laser technician, robot technician and more.

The Complete Computer Career Guide, order No. 2654, contains 256 pages, costing \$12.60 in paperback, available from TAB Books Inc., PO Box 40, Blue Ridge Summit, PA 17214; Tel. 717/794-2191.

SAXON ON SCANNERS

(Continued from page 90)

that's the channel used.

As an interesting sidelight, pilots and air controllers have a secret codeword that permits the pilot to clue in the ground

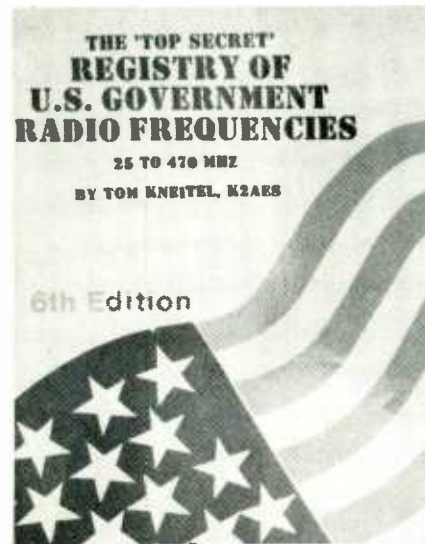

An excellent listing of the Corps. of Engineers stations/frequencies is contained in the 6th Edition of the Top Secret Registry of U.S. Government Radio Frequencies, which is available at \$17.95 (plus \$2 postage/handling) from CRB Research, PO Box 56-GP, Commack, NY 11725.

station that a hijack is in progress. If the pilot reports that he is going to set his transponder to 7500 (Squawking 7500), or says anything at all about a "Code 7500," ground controllers are alerted. The ground-station operator will ask the

Hands-on Electronics

- SP1 Special Projects #1 (Winter 1980) . . . \$6.00
- SP4 Special Projects #4 (Summer 1982) . . . \$6.00
- SP5 Special Projects #5 (Winter 1983) . . . \$6.00
- SP6 Special Projects #6 (Spring 1983) . . . \$6.00
- SP7 Special Projects #7 (Summer 1983) . . . \$6.00
- SP8 Special Projects #8 (Fall 1983) . . . \$6.00
- SP9 Special Projects #9 (Winter 1984) . . . \$6.00
- SP10 Special Projects #10 (Spring 1984) . . . \$6.00
- 111 Hands-On Electronics #1 . . . \$5.00
- 112 Hands-On Electronics #2 . . . \$5.00
- 113 Hands-On Electronics #3 . . . \$5.00
- 114 Hands-On Electronics #4 . . . \$5.00
- 115 Hands-On Electronics #5 . . . \$5.00
- 115A Hands-On Electronics #6 . . . \$4.50
- 116A Hands-On Electronics (Jan-Feb '86) . . . \$4.50
- 116B Hands-On Electronics (Mar/Apr '86) . . . \$4.50
- 116C Hands-On Electronics (May/Jun '86) . . . \$4.50
- 116D Hands-On Electronics (Jul/Aug '86) . . . \$4.50
- 116E Hands-On Electronics (Sep/Oct '86) . . . \$4.50
- 116K Hands-On Electronics (Nov '86) . . . \$4.00
- 116L Hands-On Electronics (Dec '86) . . . \$4.00
- 117 Hands-On Electronics back issues (1987) . . . \$3.75
Write in issues desired _____
- 150 TV Descrambler . . . \$3.00
- EH87 Experimenters Handbook . . . \$3.95
- 152 8-Ball Satellite TV Antenna . . . \$5.00
- 107 Radio-Electronics back issues (1987) \$3.25
- 106 Radio-Electronics back issues (1986) . . . \$3.75
Write in issues desired _____

REPRINT BOOKSTORE

- 105 Radio-Electronics back issues (1985) . . . \$4.25
(Jan. 85 not available)
Write in issues desired _____
- 104 Radio-Electronics back issues (1984) . . . \$5.25
(December 1984 issue is not available)
Write in issues desired _____
- 103 Radio-Electronics back issues (1983) . . . \$5.50
(Jan., Aug., Dec. are not available)
Write in issues desired _____
- 102 Radio-Electronics back issues (1982) . . . \$5.75
(Jan. is not available)
Write in issues desired _____
- 153 Etch your own PC boards . . . \$3.00
- 154 How to Repair VCR's . . . \$3.50
- 155 IBM Typewriter to Computer . . . \$3.00
- 125 Radio-Electronics Annual 1985 . . . \$5.95
- 126 Radio-Electronics Annual 1986 . . . \$4.95
- 156 How to Make PC Boards . . . \$2.00
- 157 All About Kits . . . \$2.00
- 158 Electro Importing Co. Catalog (1918) . . . \$5.95
- 159 Low Frequency Receiving Techniques
Building and using VLF Antennas . . . \$6.00
- 160 New Ideas - 42 Circuits . . . \$3.50
- 161 Descrambling (Feb., 1984) . . . \$3.00
- 162 Build Your Own Satellite TV Receiver \$7.00
- 163 Receiving Satellite TV . . . \$7.00
- 164 Modern Electrics (April, 1908) . . . \$3.00
- 165 How to Repair CD Disc Players . . . \$5.00
- 166 Collected Works of Mohammed Ulyses Fips (62 pages, April Fools Collection) . . . \$7.50
- 167 Designing With IC's . . . \$4.00

To order any of the items indicated above, check off the ones you want. Complete the order form below, include your payment, check or money order (DO NOT SEND CASH), and mail to Hands-on-Electronics, Reprint Department, P.O. Box 4079, Farmingdale, NY 11735. Please allow 4-6 weeks for delivery.

If you need a copy of an article that is in an issue we indicate is unavailable you can order it directly from us. We charge 50¢ per page. Indicate the issue (month & year), pages and article desired. Include payment in full, plus shipping and handling charge. Make checks payable to Gernsback Publications, Inc.

ARTICLE _____

PAGES _____

MONTH _____

YEAR _____

TOTAL PAGES _____

@50¢ each

TOTAL PRICE _____

MAIL TO: Hands-on-Electronics
Reprint Bookstore, P.O. Box 4079, Farmingdale NY 11735

All payments must be in U.S. funds

SHIPPING CHARGES IN USA & CANADA

\$0.01 to \$5.00 \$1.00	\$30.01 to 40.00 \$4.75
\$5.01 to \$10.00 \$1.75	\$40.01 to 50.00 \$5.75
\$10.01 to 20.00 \$2.75	\$50.01 and above \$7.00
\$20.01 to 30.00 \$3.75	

SORRY—WE ONLY
SHIP TO USA & CANADA

Total price of merchandise \$ _____
Sales Tax (New York State Residents only) \$ _____
Shipping Charge (see chart) \$ _____

Name _____ Total Enclosed \$ _____

Address _____

City _____ State _____ Zip _____

H-388

MARCH 1988

HANDS-ON MARKETPLACE

FOR SALE

SURVEILLANCE electronics, debugging, kits. Latest high-tech. Catalog \$2.00. **TECHNOLOGY SERVICES**, 829 Ginette Street, Gretna, LA 70056.

FLASH! Xenon strobes, **Laser equipment!** Ultraviolets. Lab equipment. Plans! Electronic kits. Free catalog. Write/call! (203) 672-0123. **ALLEGRO ELECTRONICS**, 3G Mine Mountain, Cornwall Bridge, CT 06754.

2716/58/32/32A EPROM programmer. Plans and two additional projects plus hardware bonus! \$2.50 plus \$1.00 S/H. **GALLIUM JUNCTION**, 540-C N.E. Northgate Way, Ste. 542, Seattle, WA 98125.

TAKE the beep out and get a clear picture. Any channel, cable converters. **Panasonic, Pioneer, Jerrold, Hamlin, Scientific Atlanta.** Hand remotes. (313) 979-5794.

SEND fifty dollars to **EVOLA-ELECTRONICS**, P.O. Box 1268, Sterling Heights, MI 48311. Phone numbers or addresses of over fifty dealers. Decoding cable and satellite and related items.

COPYGUARD corrector restores rental movies. Connects between VCRs. Satisfaction guaranteed. \$59.95 plus \$4 handling. 1-800 338-8751.

CLASSIFIED AD ORDER FORM

To run your own classified ad, put one word on each of the lines below and send this form along with your check to:

Hands-on-Electronics Classified Ads, 500-B Bi-County Boulevard, Farmingdale, N.Y. 11735

PLEASE INDICATE in which category of classified advertising you wish your ad to appear. For special headings, there is a surcharge of **\$10.00**.

() Plans/Kits () Business Opportunities () For Sale
() Education/Instruction () Wanted () Satellite Television
() _____

Special Category: \$10.00

PLEASE PRINT EACH WORD SEPARATELY, IN BLOCK LETTERS.

(No refunds or credits for typesetting errors can be made unless you clearly print or type your copy.) Rates indicated are for standard style classified ads only. See below for additional charges for special ads. **Minimum: 15 words.**

1	2	3	4	5
6	7	8	9	10
11	12	13	14	15 (\$21.00)
16 (\$22.40)	17 (\$23.80)	18 (\$25.20)	19 (\$26.60)	20 (\$28.00)
21 (\$29.40)	22 (\$20.80)	23 (\$32.20)	24 (\$33.60)	25 (\$35.00)
26 (\$36.40)	27 (\$37.80)	28 (\$39.20)	29 (\$40.60)	30 (\$42.00)
31 (\$43.40)	32 (\$44.80)	33 (\$46.20)	34 (\$47.60)	35 (\$49.00)

We accept MasterCard and Visa for payment of orders. If you wish to use your credit card to pay for your ad fill in the following additional information (Sorry, no telephone orders can be accepted.):

Card Number _____

Expiration Date _____

PRINT NAME _____

SIGNATURE _____

IF YOU USE A BOX NUMBER YOU MUST INCLUDE YOUR PERMANENT ADDRESS AND PHONE NUMBER FOR OUR FILES. ADS SUBMITTED WITHOUT THIS INFORMATION WILL NOT BE ACCEPTED.

CLASSIFIED COMMERCIAL RATE: (for firms or individuals offering commercial products or services) \$1.40 per word prepaid (no charge for ZIP code)...**MINIMUM 15 WORDS.** 5% discount for same ad in 6 issues within one year; 10% discount for 12 issues within one year if prepaid. **NON-COMMERCIAL RATE:** (for individuals who want to buy or sell a personal item) \$1.15 per word, prepaid....no minimum. **ONLY FIRST WORD AND NAME** set in bold caps at no extra charge. Additional bold face (not available as all caps) 25¢ per word additional. Entire ad in boldface, \$1.70 per word. **TINT SCREEN BEHIND ENTIRE AD PLUS ALL BOLD FACE AD:** \$2.05 per word. **EXPANDED TYPE AD:** \$1.85 per word prepaid. Entire ad in boldface, \$2.20 per word. **TINT SCREEN BEHIND ENTIRE EXPANDED TYPE AD:** \$2.30 per word. **TINT SCREEN BEHIND ENTIRE EXPANDED TYPE AD PLUS ALL BOLD FACE AD:** \$2.70 per word. **DISPLAY ADS:** 1" x 2 1/4"—\$160.00; 2" x 2 1/4"—\$320.00; 3" x 2 1/4"—\$480.00. General Information: Frequency rates and prepayment discounts are available. **ALL COPY SUBJECT TO PUBLISHERS APPROVAL. ADVERTISEMENTS USING P.O. BOX ADDRESS WILL NOT BE ACCEPTED UNTIL ADVERTISER SUPPLIES PUBLISHER WITH PERMANENT ADDRESS AND PHONE NUMBER.** Copy to be in our hands on the 18th of the third month preceding the date of issue (i.e.; Aug. issue copy must be received by May 18th). When normal closing date falls on Saturday, Sunday or Holiday, issue closes on preceding work day. Send for the classified brochure. Circle Number 49 on the Free Information Card.

CABLE T.V. "BOXES"

**Converters—Descramblers
Remote Controls—Accessories**

- ★ Guaranteed Best Prices ★
- ★ 1 Year Warranty—C.O.D.'s ★
- ★ Immediate Shipping ★
- ★ FREE CATALOG ★

Call or Write:

TRANS-WORLD CABLE CO.
HC 83, Box 531
Pequot Lakes, MN 56472
(218) 543-6471

TRANSISTORS-TUBES: MRF421 \$24.00, MRF454 \$15.00, MRF455-MRF477 \$12.00, MRF492 \$16.95, SRF2072 \$13.50, 3800 \$18.95, 2SC2879 \$25.00, 6LF6-6LQ6-6JS6 \$10.95, 8950 \$15.95. New Ranger AR3500 all mode 10 meter transceiver \$319. Quantity discounts! Best prices on hard-to-find parts, antennas, mics, power supplies, & equipment! Catalog \$1.00 (refundable), or free with order. **RFPC**, Box 700, San Marcos, CA 92069. For information or same day shipment—call (619) 744-0728. **VISA/MC/C.O.D.**

PLANS/KITS

BUILD this five-digit panel meter and square wave generator including an ohms, capacitance and frequency meter. Detailed instructions \$2.50. **BAG-NALL ELECTRONICS**, 179 May, Fairfield, CT 06430.

PROJECTION-TV... Convert your TV to project 7 foot picture...Results comparable to \$2,500.00 projectors...Total cost less than \$30.00...Plans and 8" lens \$21.95...Illustrated information free. **MAC-ROCOMA-HG**, Washington Crossing, PA 18977. Creditcard orders 24 Hours. (215) 736-3979.

CRYSTAL radio sets, plans, parts, kits. Catalog \$1.00. **MIDCO**, 660 North Dixie Highway, Hollywood, FL 33020.

DJ beatmeter you can build. Organize your L.P.s by beats per minute like the pros do to make "mixing" faster, easier. Plans and instructions \$2.00. **LER-COM**, P.O. Box 2274, Sta.1, Kingsville, TX 78363.

VOICE disguisers! FM bugs! Telephone transmitters! Phone snoops! More! Catalog \$1.00 (refundable): **XANDI ELECTRONICS**, Box 25647, 32K, Tempe, AZ 85282.

ELECTRONIC Dowser—Book of theory and complete plans for sensitive Cryptesthetic/Galvanic instrument, \$10. **NOVA SYSTEMS**, 11208-C Iron Oak Trail, Austin, TX 78750.

DIGITAL oscilloscope. A unique project. Plans \$5.00. **MIKE McGLINCHY**, 214 Verano Dr., Los Altos, CA 94022.

MUSIC-on-hold. Easy to build circuit adds music or your recorded announcements-on-hold to any phone. Complete plans \$10.00. Kits/plans catalog \$2.00. **LESTRONICS**, Box 2321-H, St. Louis, MO 63114.

DETECTIVES, experimenters. Exciting new plans. Hard to find micro and restricted devices. Large catalog \$5.00 refundable on 1st order. **WILSON**, P.O. Box 5264, Augusta, GA 30906.

BUSINESS OPPORTUNITIES

EARN big bucks designing custom cable television distribution systems for homes. This report also tells how to avoid the ten costly mistakes that professionals often make. \$10. postpaid. **B. TANNER**, Box 82582, Fairbanks, AK 99708.



**TUBES - 2000 TYPES
DISCOUNT PRICES!**
Early, hard-to-find, and modern tubes. Also transformers, capacitors and parts for tube equipment. Send \$2.00 for 20 page wholesale catalog.

ANTIQUE ELECTRONIC SUPPLY
688 W. First St. • Tempe, AZ 85281 • 602/894-9503

CABLE EQUIPMENT

CABLE-TV Secrets—the outlaw publication the cable companies tried to ban. **HBO, Movie Channel, Showtime, descramblers, converters, etc.** Suppliers list included, \$8.95. **CABLE FACTS**, Box 711-H, Pataskala, OH 43062.

CABLE TV DESCRAMBLERS

CABLE TV converters. Scientific Atlanta, Jerrold, Oak, Zenith, Hamlin. Many others. **"NEW" VIDEO HOPPER "The Copy Killer"**. Visa, M/C & Amex **1-800-826-7623. B&B INC.**, 10517 Upton Circle, Bloomington, MN 55431.

BATTERIES

HARD to find sizes Lithium/Gelyte/Nicad/custom paks discount prices; call or write **BATTERY TERMINAL**, 2492 Merrick Road, Bellmore, New York 11710. (516) 679-8600.

COMPUTERS

COMMODORE repair. \$39.95 for C-64. Oldest/largest authorized repair center in the U.S. Fast turnaround...."Commodore Diagnostician." A complete diagnostic reference chart for fixing Commodore computers. Over 4,000 sold. \$6.95 plus \$1.00 postage....**HD C-64 power supply \$27.95....VISA/MC...KASARA MICROSYSTEMS, INC.**, 31 Murray Hill Drive, Spring Valley, NY 10977, 1-(800) 248-2983 (Nationwide) or (914) 356-3131.

COMMODORE replacement chips at low prices. Quantity prices of any two or more: 6510-\$8.95, 6526-\$8.95, 6567-\$14.45, 6581-\$10.95, 82S100-\$10.95, 325572-\$9.95, 325302-\$10.95, 8721-\$10.50, 8722-\$12.95, 901 series-\$9.95 and many others....**VISA/MC...KASARA MICROSYSTEMS, INC.**, 31 Murray Hill Drive, Spring Valley, NY 10977, 1-(800) 248-2983, (Nationwide) or (914) 356-3131.

THIS IS AN EXPANDED TYPE AD. Notice how it stands out on this page. To get your ad set in this type style mark your classified ad order, "Expanded-type ad," and calculate your cost at \$1.85 per word.

MASTERCARD AND VISA are now accepted for payment of your advertising. Simply complete the form on this page of the Market Center and we will bill you.

ADVERTISING INDEX

HANDS-ON ELECTRONICS magazine does not assume any responsibility for errors that may appear in the index below.

Free Information No.		Page
6	AMC Sales	23
5	All Electronics	27
—	Amazing Devices	12
—	Antique Electronic Supply	107
10	CIE	11
7	Cook's Institute	23
8	Digi-Key	CV2
—	Elec. Industry Association	13
—	Electronic Tech. Today	5, 89
—	Electronics Book Club	3
—	Grantham Col. of Engineering ..	15
—	HOE Reprint Bookstore	105
13	Heath	7
—	ISCET	107
11	MCM Electronics	17
—	McGraw Hill Book Club	28
—	McGraw Hill (CED)	93
—	NRI	21
—	Pacific Cable	CV3
9	Regency	CV4
—	Star Circuits	12
—	Trans World	106

pilot if the use of Code 7500 was intentional. If the pilot answers in the affirmative, or doesn't reply at all, then public safety agencies will be made aware of the situation. However, communications with the aircraft will remain routine so as not to make the hijacker(s) aware that the alarm has gone out.

Oscar Cooper of Dayton, OH says that he saw a mobile unit used by the *USAF's Office of Special Investigations*. There was a VHF-low band whip antenna on the vehicle, and Oscar asks how he can scan in on these people. Nationally, the USAF's OSI operates in this band on 40.17 and 40.19 MHz. Punch those frequencies into your scanner and see what happens.

Keep those letters coming, gang. We are always on the lookout for your photos, questions, suggestions, frequency information, and just about anything related to scanners and VHF/UHF two-way communications. Write to: Marc Saxon, *Saxon On Scanners, Hands-on Electronics*, 500-B Bi-County Blvd., Farmingdale, NY 11735. ■

FRIEDMAN ON COMPUTERS

(Continued from page 87)

tommer knows nothing from a few scrunched graphics displays, and is perfectly happy because he or she can run "all software."

Well...Not Really All

Unfortunately, there is no truly "universal" monitor card, just as there is no such thing as a perpetual-motion machine. (Although **Hands-on** receives at least four projects a year that claim to be perpetual-motion devices. You should see the latest one: It generates two gallons of gasoline for each gallon used to run the machine.)

Some software, usually games, will run only on a true CGA card; they won't run at all on the Hercules card. Hercules provides a booklet that lists compatibility if you suspect that certain software won't run. But all the biggies, such as Lotus, will run on the Hercules card.

Best Buy

I have virtually all the various monitor adapters, even a TTL piggybacked with a CGA card, so that they both take up only one slot; and I believe that the Hercules type card is the best buy if you're trying to keep computer costs at rock-bottom. Naturally, nothing equals having separate adapters and two monitors—one TTL and the other RGB color—but when you've got the budget stretched tighter than a Soprano's vocal chord's as she hits high-C, a Hercules-type card and a TTL monitor is the best dollar/performance value.

So if you're out buying your first PC-compatible and you're trying to keep overall costs at rock-bottom, go for a Her-



**You Can Be
One Of The
20,000 Technicians
Certified BY ISCET**

The International Society Of Certified Electronics Technicians offers permanent certification by administering the CET exam with the FCC recognized communications option for \$20. A second exam on FCC regulations for a \$10 fee is required for a Radiotelephone License. Upon passing, technicians receive both a permanent Radiotelephone Operator Certificate and a CET Certificate issued by ISCET.

ISCET Offers License Renewal

ISCET has developed a program for registration of those who currently hold a valid Radiotelephone Operator License. By sending a completed application, a photocopy of your FCC License, and \$10 your license will be renewed with the assurance of a recognized national technicians association behind it.

For More Information Contact:
**ISCET 2708 W. Berry, Ft. Worth, TX
76109. (817) 921 - 9101**

cules-compatible card and the TTL monitor. Oh, yes! And forget that nonsense about having to pay extra for a printer card if you don't get a "true"

monochrome adapter. The Hercules Graphics Card and all its real clones provide the conventional parallel-printer output connector. In fact, the back end of

the Hercules card looks just like a mono card: it has one 9-pin D-connector for the TTL monitor and a 25-pin D-connector for a parallel printer. ■

RAD HOUND

(Continued from page 48)

within the safe operating range of the tube. Set R6 (the audio volume control) for 90% of maximum and close up the cabinet for Rad Hound's final checkout.

Operating Rad Hound

Turn on the Hound and give it 10 seconds to charge up. Place the clock's dial face about one inch away from the G-M tube's window. You should get a good volume of sound from the loudspeaker if your cabinet is closed up.

To get a working idea about the effective range of radiation, collect a few insulators—sheet of paper, a piece of lead plate, a piece of aluminum; all three should be just big enough to cover that dial face.—and make a laboratory type test. Keep the dial face always separated from the G-M tube face by one inch space.

You should hear a radiation count of about 5000 counts per minute. Now place the paper insulator between the two and notice the slightly reduced radiation count. Replace the paper insulator with the piece of lead plate. Notice how much more reduction is made by the lead plate than was made by the paper.

Then replace the lead plate with the aluminum plate. Notice that the aluminum is not as good as insulator as the lead, but it's much better than the paper as an insulator. Naturally, the thicker the metal plate the greater its insulating quality.

While you are still testing it, notice that the Inverse Square Law is at work. That means, doubling the distance between the G-M tube and the source of radiation reduces the radiation count by 75% not 50%. So the best insulator that you can

Once completed, Rad Hound's operation can be checked using a source of radiation, such as an luminous clock face.

have between you and the contamination is plenty of distance.

Go to your local library and get whatever information is available on radiation detection. Learn how to differentiate between alpha rays, beta rays, and gamma rays. Each one has its own characteristics and can be separated once you know the proper procedure.

If a nuclear emergency does occur in your area, you can feel secure in knowing that you are prepared to deal with it in your own small way with the Rad Hound radiation detector. Finally, if your set works fine, show it to all the people you live and work with. They should be told what it's for, how to use it, and to treat it with respect. ■

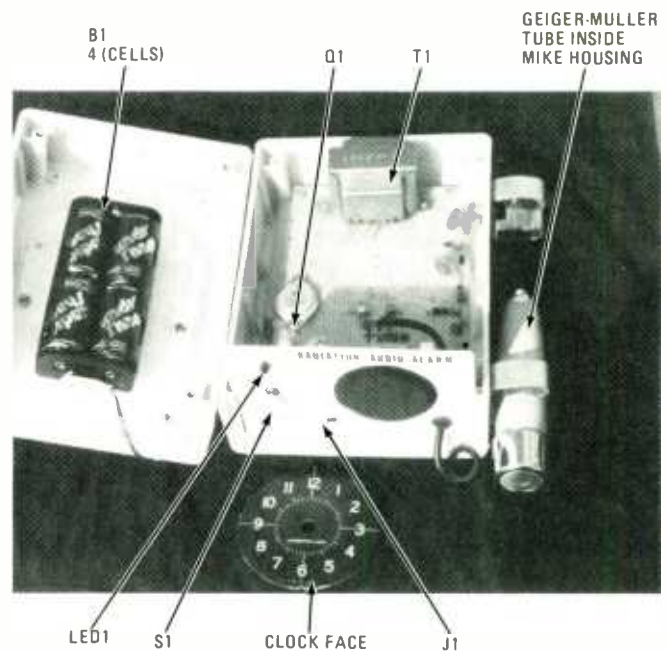

CHEMICAL POLARITY EXPERIMENT

(Continued from page 41)

spoon of ordinary table salt (sodium chloride) in one ounce of water. Wait a moment for the undissolved materials to settle. Pour the two solutions into a small bottle and shake gently. That gives you two ounces of indicator solution.

The Test

Pour some of the indicator solution onto the paper towel. Use just enough to soak the paper thoroughly. This is a good time to make sure the two contact rods are actually touching the paper; otherwise, the meter will not work. Now connect the terminals to any source of low-voltage direct current, a battery, a power supply, whatever. Keep your eyes on the paper towel. As you watch, the area beneath one of the electrodes will turn a beautiful shade of red. This indicates the negative pole of the power source (Photo 3).

It works like this. When the sodium chloride goes into solution the sodium and chloride ions take up an independent existence. The chloride ions, which carry a negative charge,

are attracted to the positive electrode, or anode, where a tiny amount of neutral chloride gas is released. The sodium ions, which carry a positive charge, are attracted to the negative electrode, or cathode. The sodium reacts with the water to form sodium hydroxide. Sodium hydroxide is an alkali and so the phenolphthalein changes color.



The red ring around the contact is proof that the ions have separated and migrated. Notice no change at the other electrode.