

JUNE 10, 1976

A MICROPROCESSOR THAT MATES WITH ANY PERIPHERAL FAMILY/101

Cathode-ray: how they make oscilloscopes better/113

Designing efficient amplifiers with FETS/122

97232

FOUR DOLLARS A MCGRAW-HILL PUBLICATION

Electronics®

1420 NIL251 CANA6 NOV77

MATT NEILL
2516 NE CLACKAMAS
PORTLAND OR



**CHOOSING
SIDES
IN WATCH
TECHNOLOGY**

THIRTEEN SOLUTIONS TO YOUR NEXT EDP SIGNAL TRANSMISSION CABLE PROBLEM

WOVEN RIBBON CABLE. Components PVC insulated twisted pairs

TWISTED PAIR. Components PVC insulated conductors

JACKETED BONDED RIBBON CABLE. Components 95Ω air-spaced miniature coaxial cable

DUAL LAYER, JACKETED WOVEN RIBBON CABLE. Components PVC insulated twisted pairs

BONDED RIBBON CABLE. Components PVC insulated single conductors

TRI-LEAD. 2 conductors polyimide insulated, center conductor silver coated, Teflon FEP insulation overall

MULTI-CONDUCTOR 95Ω AIR-SPACED COAXIAL CABLE. (White Green twisted pair for power)

50Ω COAXIAL CABLE — RG-174/U

95Ω MINIATURE AIR-SPACED COAXIAL CABLE — Braided shield

95Ω MINIATURE AIR-SPACED COAXIAL CABLE — Foil shield

100Ω TAPE CABLE — 28 AWG stranded conductors, PVC insulation

80Ω TAPE CABLE — 32 AWG conductors polyester insulation

85Ω TAPE CABLE — 29 AWG conductors Teflon FEP insulation

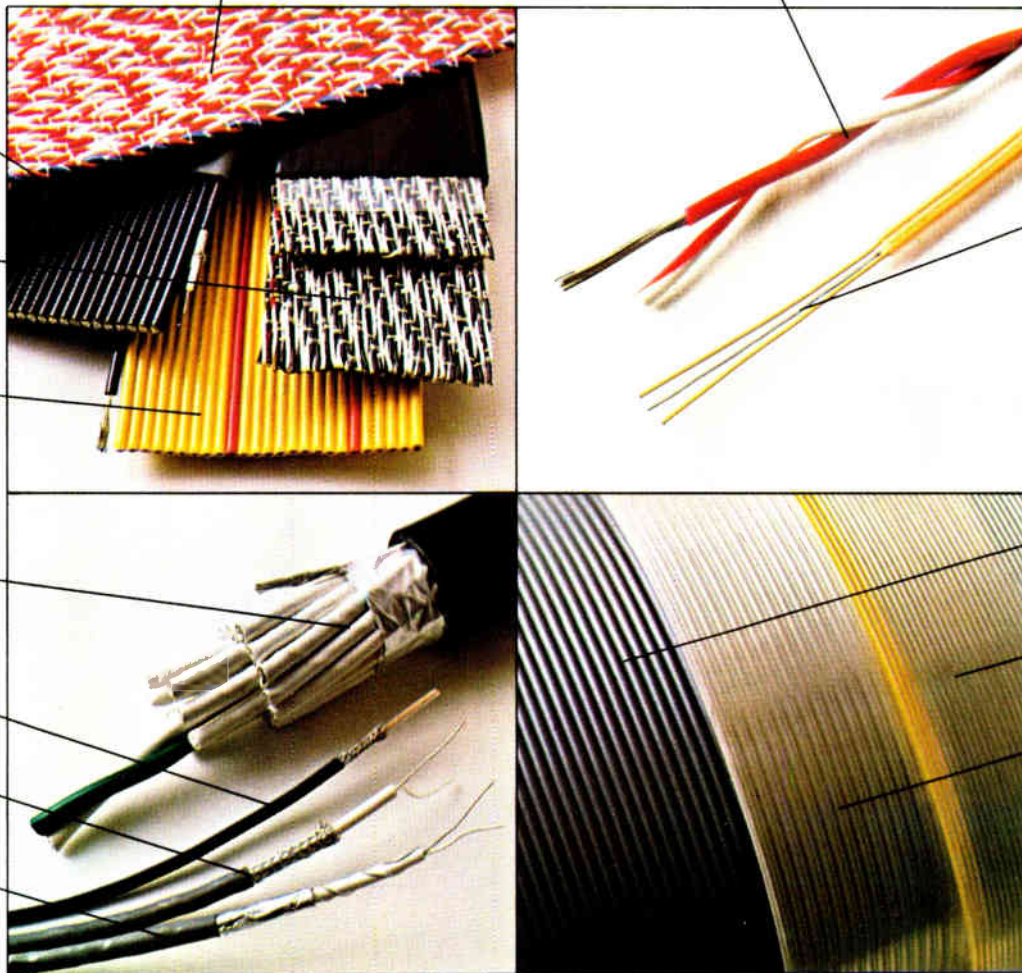

Limited space, cost, mechanical properties and operating environment are just a few of the considerations when specifying signal transmission cable.

Millions of feet sold

That's why Brand-Rex makes over a dozen different kinds of transmission cables . . . for leading CPU and peripheral equipment manufacturers around the world. Options include twisted pairs, standard or miniaturized air-spaced coax in round conventional configurations, or in flat forms such as Brand-Rex TAPE CABLE* or bonded and woven ribbon cable. They're available with a broad range of insulations from PVC, to polyester, to flame-retardant polyethylene, to irradiated types.

Our Engineers can help

Ask Brand-Rex engineers to recommend the best cost/performance cable to meet *your* signal transmission circuit needs. If we don't already make it, we'll design it for you. Call or write your local Brand-Rex sales engineer or Brand-Rex Company, Electronic and Industrial Cable Division, Willimantic, CT 06226. 203/423-7771.

BRAND-REX

ELECTRONIC & INDUSTRIAL CABLE DIVISION

Other Brand-Rex Divisions
 Abbott & Co. wiring harnesses
 Nonotuck Manufacturing Co. copper wire
 Pyle-National Co. electrical connectors
 Telecommunications Cable Division
 Teltronics, Inc. telephone equipment and components
 Brand-Rex Ltd. (Scotland) wire and cable

Let's talk about a way for you to save hours in microprocessor SOFTWARE DEBUGGING

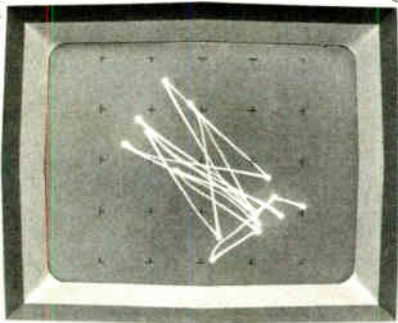

HP's 1600S Logic State Analyzer, in the MAP mode, lets you examine the unique "fingerprint" of every logic system.

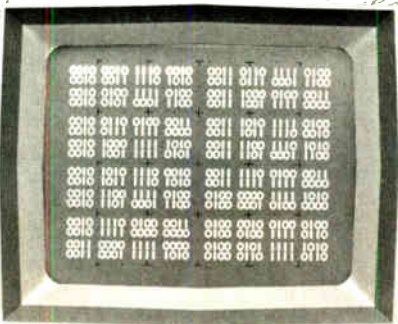

In the TABLE mode, the 1600S displays up to 16 lines of code, with their sequential relationships in familiar logic notation.



I mean many hours of savings if you've ever had this problem: You've just finished

your prototype microprocessor-based system, made the preliminary checks on the hardware, and loaded the program in RAM. You hit the start button. Everything's running smoothly, then wham! You're out of business. Things are out of sequence and the system is doing things you never intended. Now you could be in for hours—or even days—of troubleshooting.

But let me tell you about a much faster way to spot software problems... with HP's 1600S Logic State Analyzer. This instrument lets you look inside your operating circuit—right on the buses and qualifier lines—and see program implementation. That's the fastest way I know to locate software problems in operating circuits. Actually, the 1600S gives you two ways to view program flow:

Mapping. This is a dynamic view of your system's operation... a pattern of dots and lines that are unique for each program. Each dot is a specific data word. It's location indicates binary magnitude, and its brightness indicates relative frequency of occurrence.

You might call the map a personal fingerprint. It's different for every program. With a little practice, you can easily spot a suspicious pattern and locate the word or group of words that could be the trouble

source. Then you simply position a cursor over the word in question and push a front-panel switch to go to the Table display mode.

Table. The CRT now gives you a display of word flow using the word you selected as the trigger point. It displays up to sixteen 32-bit words at one time... in familiar One's and Zero's. You can look at events leading up to, surrounding, or following the trigger word. And even delay up to 99,999 clock cycles beyond the trigger point to view events anywhere in your program.

Suppose your problem is an erroneous data word that causes an unwanted jump. Mapping helps you spot the jump, and the Table mode lets you quickly compare each data word leading up to the jump with your written program.

That's just a simple example. HP's 1600S Logic State Analyzer, priced at \$7100*, can speed more complex software debugging problems, too. We'd like to tell you more. And HP has arranged a number of seminars to make that possible. Find out how to attend one in your area by calling your local HP field engineer. He can also supply you with complete spec sheets and application notes detailing the use of mapping

for troubleshooting minicomputer and microprocessor systems. You'll discover an exciting new concept in digital troubleshooting.

*Domestic U.S.A. price only.

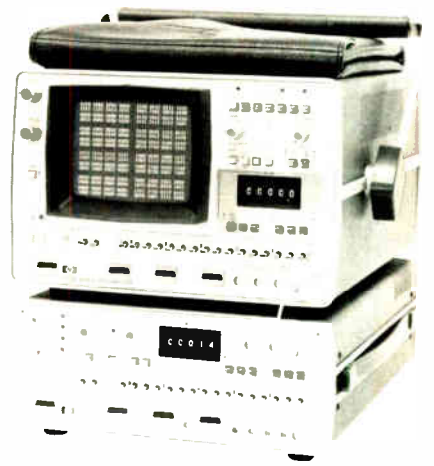

HEWLETT  PACKARD

Sales and service from 172 offices in 65 countries

Electronics/June 10, 1976

Circle 1 on reader service card 1

Long, short-period pulses speed synthesizer setting, 109
INSTRUMENTS: Advances in CRT design improve oscilloscopes, 113
COMMUNICATIONS: FET power amp boosts transmitter efficiency, 122
ENGINEER'S NOTEBOOK: Scanner overcomes slewing rate limits, 128
Large hexadecimal display is legible from afar, 129

143 New Products

IN THE SPOTLIGHT: An IC instrumentation amplifier, 143
3 1/2-digit multimeter packs logic on one chip, 144
PACKAGING & PRODUCTION: Three gases aid passivation, 147
COMMUNICATIONS: Connectors simplify fiber optics, 153
DATA HANDLING: Transport handles tapes at 75 in./s., 175
SEMICONDUCTORS: Dual-setpoint timer is monolithic, 193
SUBASSEMBLIES: Analog Devices invades new market, 207
MATERIALS: 218

Departments

Publisher's letter, 4
Readers' comments, 6
News update, 8
Editorial, 10
People, 14
Meetings, 20
Electronics newsletter, 25
Washington newsletter, 47
Washington commentary, 48
International newsletter, 55
Engineer's newsletter, 132
New books, 222
New literature, 226

CHIs set the pace for oscilloscopes, 113

Finer resolution, brighter traces, storage capability, bigger bandwidth—all these advances in cathode-ray-tube design have also benefited oscilloscopes. The next step may well be the all-solid-state display, built out of charge-coupled devices.

And in the next issue . . .

Special report on electronics games . . .
MOS moves into high power . . . approaches to microprocessor programming.

Electronics/June 10, 1976

3

Announcing Hewlett-Packard's Real-Time HP-IB Minicomputer.

Your powerful connection to easier automated testing.

The Real-Time HP-IB Minicomputer is the best thing to happen to automated testing since the Hewlett-Packard Interface Bus (HP-IB*), which brought order and simplicity to the world of programmable instruments. Now you can apply the power of an HP 21MX minicomputer to your bus for do-it-yourself automated testing.

With an HP-IB/21MX Minicomputer your multi-programming system can run

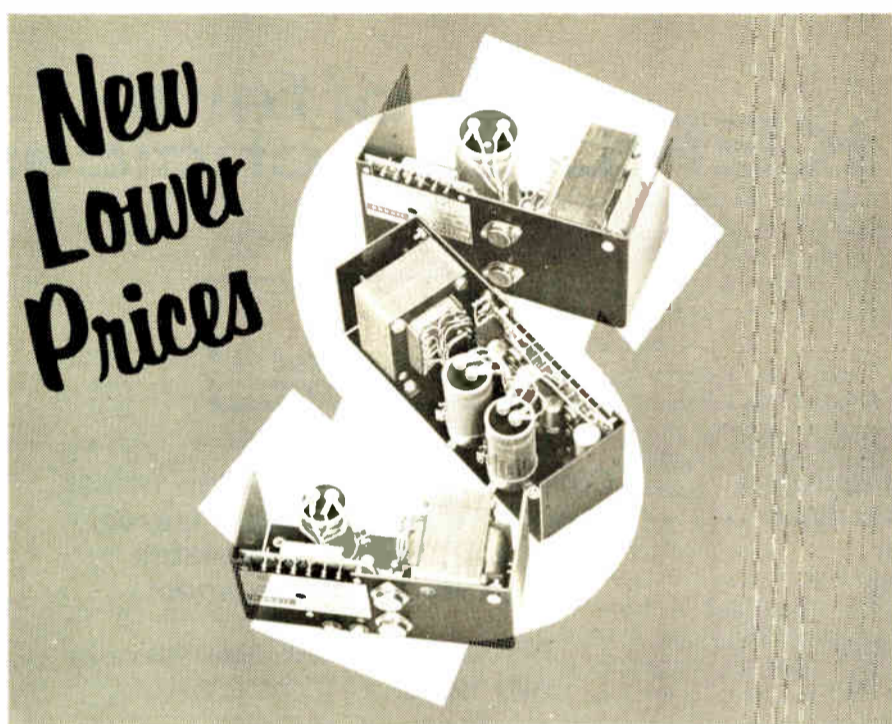
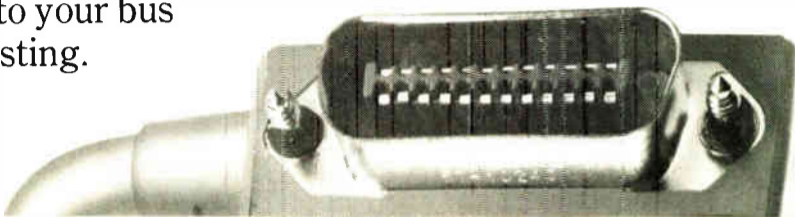

Start Getting Your Money\$worth Out of Power Modules

Now, you can really start getting your moneysworth out of power modules with Abbott's new LOW COST series. Designed to give you 100,000 hours of trouble-free operation (that's 11½ years), these reliable units meet the needs of OEM engineers. Their purchase price is about \$7 per year of service. The model LC series feature:

- 47-420 Hz Input Frequency
- 0.1% Regulation
- +60°C. Ambient Operation
- Single and Dual Outputs
- 1 Day Stock Delivery

These units provide more quality per dollar compared to similar items on the market. See table below for prices on some of our LC models. Many other LC models are listed in our catalog.

If analyzing the many similar power supplies on the market is confusing, if you are concerned about the long-term reliability of those units, then decide on an Abbott power supply for your system. Your best buy in OEM power modules is ABBOTT.

Abbott also manufactures 3,000 other models of power supplies with output voltages from 5 to 740 VDC and with output currents from 2 millamps to 20 amps. They are all listed with prices in the new Abbott Catalog with various inputs:

60 \overline{A} to DC
 400 \overline{A} to DC
 28 VDC to DC
 28 VDC to 400 \overline{A}
 12-38 VDC to 60 \overline{A}

5V @ 6 Amps	5V @ 10 Amps	12V @ 10 Amps	15V @ 4 Amps	28V @ 1 Amp	±12V @ 1.2 Amps	±15V @ 4 Amps
LC5T6	LC5T10	LC12T10	LC15T4	LC28T1	LLC12T1.2	LLC15T4
\$62	\$73	\$99	\$73	\$62	\$87	\$119.00

Please see pages 1054-1056 Volume 1 of your 1975-76 EEM (ELECTRONIC ENGINEERS MASTER Catalog) or pages 612-613 and 620 Volume 2 of your 1975-76 GOLD BOOK for complete information on Abbott Modules.

Send for our new 60 page FREE catalog.

abbott transistor

INDUSTRIAL PRODUCTS DIVISION
 general offices eastern office

5176 W. Jefferson Blvd./Los Angeles 90016
 (213) 930-1040 Telex: 69-1398

1224 Anderson Ave./Fort Lee, N.J. 07024
 (201) 224-6900 Telex: 13-5332

6 Circle 6 on reader service card

World Radio History

Readers' comments

Stay away from 220 MHz

To the Editor: The Electronics Industries Association is still manning its public-relations guns trying to convert the amateur 220-megahertz band to citizens' band radio service. I am greatly disappointed to see a magazine of the stature of *Electronics* publish this PR claptrap in the guise of an editorial [March 18].

Citizens' band communications between unrelated stations are commonplace and possibly constitute the major use of CB—for example, truck-to-truck advisories of road conditions, police-car locations, etc. Five watts may be OK for a start, but linear amplifiers that boost power to the 300-to-1,000-w range have been selling well.

Clearly, if illegal conversations and the illegal transmitter power were eliminated, most of the interference problems of CB would vanish. But the EIA would like to move this can of worms up to 220 MHz so its members can sell more radios. This course can lead only to disaster. It is bad for CB, amateurs, and the communications profession.

Jack Althouse
 Palomar Engineers
 Escondido, Calif.

Share and share alike?

To the Editor: My company just got my first patent, and I got a dollar and a plaque. After development of the idea, the potential customer changed his mind, so my company has taken a loss so far.

If the patent results in sales of millions, I certainly won't mind sharing the profit my idea provided. Should I also share the loss?

Brad Denniston
 AIL division, Cutler Hammer
 Melville, New York

Correction

The resolution of Techmet's Laser-mike, an automatic optical micrometer, is typically ±0.0005 inch, with ±0.00001 in. attainable in one model. An erroneous resolution was given in the caption for Fig. 1 of "The industrial laser—a special tool for special needs." [*Electronics*, April 29, p. 89].

Let's talk about a way for you to save hours in microprocessor SOFTWARE DEBUGGING

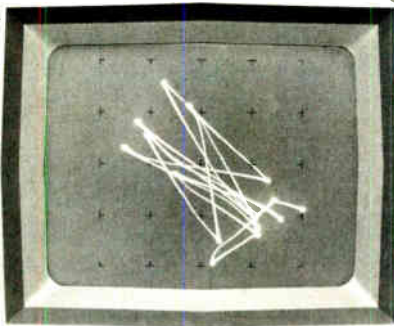
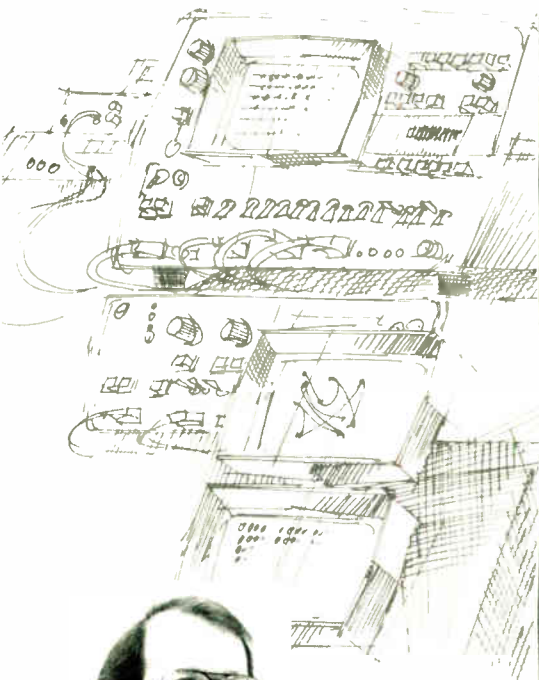

HP's 1600S Logic State Analyzer, in the MAP mode, lets you examine the unique "fingerprint" of every logic system.

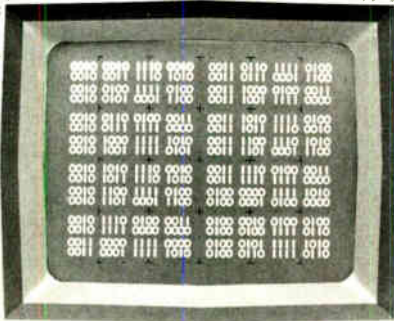

In the TABLE mode, the 1600S displays up to 16 lines of code, with their sequential relationships in familiar logic notation.



I mean many hours of savings if you've ever had this problem: You've just finished

your prototype microprocessor-based system, made the preliminary checks on the hardware, and loaded the program in RAM. You hit the start button. Everything's running smoothly, then wham! You're out of business. Things are out of sequence and the system is doing things you never intended. Now you could be in for hours—or even days—of troubleshooting.

But let me tell you about a much faster way to spot software problems... with HP's 1600S Logic State Analyzer. This instrument lets you look inside your operating circuit—right on the buses and qualifier lines—and see program implementation. That's the fastest way I know to locate software problems in operating circuits. Actually, the 1600S gives you two ways to view program flow:

Mapping. This is a dynamic view of your system's operation... a pattern of dots and lines that are unique for each program. Each dot is a specific data word. It's location indicates binary magnitude, and its brightness indicates relative frequency of occurrence.

You might call the map a personal fingerprint. It's different for every program. With a little practice, you can easily spot a suspicious pattern and locate the word or group of words that could be the trouble

source. Then you simply position a cursor over the word in question and push a front-panel switch to go to the Table display mode.

Table. The CRT now gives you a display of word flow using the word you selected as the trigger point. It displays up to sixteen 32-bit words at one time... in familiar One's and Zero's. You can look at events leading up to, surrounding, or following the trigger word. And even delay up to 99,999 clock cycles beyond the trigger point to view events anywhere in your program.

Suppose your problem is an erroneous data word that causes an unwanted jump. Mapping helps you spot the jump, and the Table mode lets you quickly compare each data word leading up to the jump with your written program.

That's just a simple example. HP's 1600S Logic State Analyzer, priced at \$7100*, can speed more complex software debugging problems too. We'd like to tell you more. And HP has arranged a number of seminars to make that possible. Find out how to attend one in your area by calling your local HP field engineer. He can also supply you with complete spec sheets and application notes detailing the use of mapping

for troubleshooting minicomputer and microprocessor systems. You'll discover an exciting new concept in digital troubleshooting.

*Domestic U.S.A. price only.

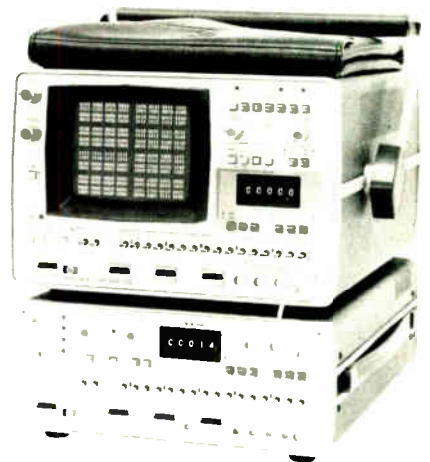

HEWLETT *hp* PACKARD

Sales and service from 172 offices in 65 countries

Announcing Hewlett-Packard's Real-Time HP-IB Minicomputer.

Your powerful connection to easier automated testing.

The Real-Time HP-IB Minicomputer is the best thing to happen to automated testing since the Hewlett-Packard Interface Bus (HP-IB*), which brought order and simplicity to the world of programmable instruments. Now you can apply the power of an HP 21MX minicomputer to your bus for do-it-yourself automated testing.

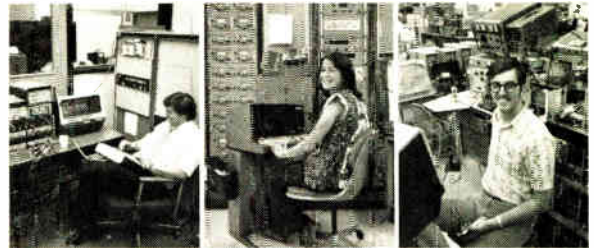

With an HP-IB/21MX Minicomputer your multi-programming system can run multiple instrument clusters concurrently. And your system also can be generating new programs in Real-Time BASIC, FORTRAN IV or HP Assembler; organizing and analyzing data; and producing timely management reports. All at the same time.

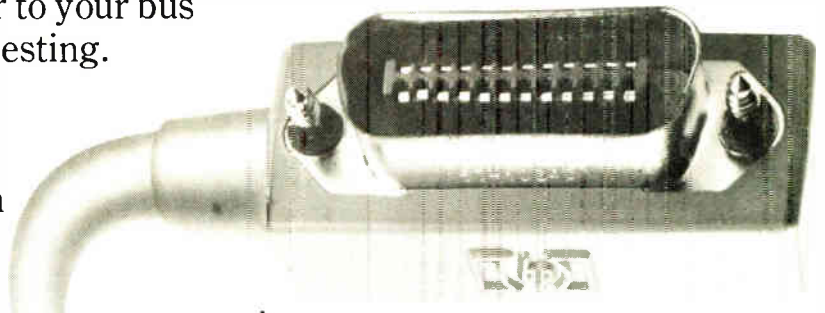

21MX minicomputers can even be easily linked together to form plant-wide networks. And upwards to a central HP 3000 or IBM 360/370.

Real-Time HP-IB Minicomputers. They give you the simplicity of HP-IB interfacing, and the minicomputer power to gain real management control of your automated testing. Prices, with disc and bus interface included, start at about \$33,000 in the U.S.

For more on what Hewlett-Packard's Real-Time HP-IB Minicomputers can do for you, call your nearest HP field sales office. There are 172 of them around the world.

*Hewlett-Packard's implementation of IEEE Standard 488-1975, "Digital Interface for Programmable Instrumentation."



Sales and Service from 172 offices in 65 countries.
© 1976 Hewlett-Packard Company

29 Electronics Review

CALCULATORS: National Semiconductor readies nonvolatile unit 29
SOLID STATE: Six Trapatt diodes yield 35 W at 7.5 GHz 30
OCEANOGRAPHY: Smart hydrophone tracks ocean currents, 31
MILITARY: Dual radar spots mortars, artillery, 31
Speech patterns analyzed by entry-control system, 32
SOLID STATE: HP discloses work on SOS products, 34
MICROPROCESSORS: Signetics' 8080 emulator boasts high speed, 34
PERIPHERALS: Texas Instruments adds to microprocessor family, 36
NEWS BRIEFS: 36
PACKAGING & PRODUCTION: Film carrier uses standard chips, 39
SOLID STATE: CCDs go into digital processing, 41

51 Electronics International

WEST GERMANY: Wedge-shaped antenna broadcasts uniform field, 51
GREAT BRITAIN: System keeps track of vehicles, 51
AROUND THE WORLD: 51
FRANCE: Systems-building modules are themselves modular, 52

66 Probing the News

COMPUTERS: Add-on memories battle IBM, 66
CONSUMER: Is quadraphonic sound poised for a push? 68
COMMUNICATIONS: Canada thinks small, 72
COMPANIES: Tadiran has the formula, 74
PEOPLE: TRW's Webb cheered by POS, 78

91 Technical Articles

CONSUMER: Choosing sides in digital watch technology, 91
SOLID STATE: 8-bit microprocessor aims at control applications, 101
DESIGNER'S CASEBOOK: 555 timer makes linear v-f converter, 108
Long/short-period pulses speed synthesizer setting, 109
INSTRUMENTS: Advances in CRT design improve oscilloscopes, 113
COMMUNICATIONS: FET power amp boosts transmitter efficiency, 122
ENGINEER'S NOTEBOOK: Scanner overcomes slewing rate limits, 128
Large hexadecimal display is legible from afar, 129

143 New Products

IN THE SPOTLIGHT: An IC instrumentation amplifier, 143
3½-digit multimeter packs logic on one chip, 144
PACKAGING & PRODUCTION: Three gases aid passivation, 147
COMMUNICATIONS: Connectors simplify fiber-optic links, 163
DATA HANDLING: Transport handles tapes at 75 in./s, 175
SEMICONDUCTORS: Dual-setpoint timer is monolithic, 193
SUBASSEMBLIES: Analog Devices invades new market, 207
MATERIALS: 218

Departments

Publisher's letter, 4
Readers' comments, 6
News update, 8
Editorial, 10
People, 14
Meetings, 20
Electronics newsletter, 25
Washington newsletter, 47
Washington commentary, 48
International newsletter, 55
Engineer's newsletter, 132
New books, 222
New literature, 226

Highlights

Cover: The toss-up in digital watch technology, 91
Competition between rival logic and display technologies is fierce, and no one can tell whether complementary MOS or injection logic, light-emitting diodes or liquid crystals will come out ahead in this year's digital watches.

Cover design is by Art Director Fred Sklenar.

Quadraphonic sound grows sweeter, 68

A new integrated-circuit matrix system, based on better mathematics, promises sharper four-channel separation and directionality—and greater consumer appeal.

8-bit processor chip focuses on control, 101

The limited processing and memory requirements of electronic scales and other simple controllers are satisfied by a special-purpose microprocessor—a single chip that interfaces with any 8-bit TTL-compatible bus-oriented peripherals.

CRTs set the pace for oscilloscopes, 113

Finer resolution, brighter traces, storage capability, bigger bandwidth—all these advances in cathode-ray-tube design have also benefited oscilloscopes. The next step may well be the all-solid-state display, built out of charge-coupled devices.

And in the next issue . . .

Special report on electronics games . . .
MOS moves into high power . . . approaches to microprocessor programming.

EDITOR-IN-CHIEF: Kemp Anderson

EXECUTIVE EDITOR: Samuel Weber

MANAGING EDITOR: Arthur Erikson,
International

SENIOR EDITORS: Laurence Altman,
Ray Connolly, Lawrence Curran,
John Johnsrud, H. Thomas Maguire,
Stephen E. Scrupski

ART DIRECTOR: Fred Sklenar

ASSOCIATE EDITORS: Howard Wolff,
Gerald M. Walker, Alfred Rosenblatt

DEPARTMENT EDITORS
Aerospace/Military: Ray Connolly
Circuit Design: Don Blattner
Communications & Microwave:
Richard Gundlach
Components: Lucinda Mattera
Computers: Stephen E. Scrupski
Consumer: Gerald M. Walker
Industrial: Margaret A. Maas
Instrumentation: Andy Santoni
New Products: H. Thomas Maguire
Michael J. Riezenman
Packaging & Production: Jerry Lyman
Solid State: Laurence Altman

CHIEF COPY EDITOR: Margaret Eastman

COPY EDITORS: Everett C. Terry, Ben Mason

ART: Charles D. Ciatto, *Associate Director*
Patricia Cybulski, *Assistant Director*

EDITORIAL SECRETARIES: Janet Noto,
Julie Gorgoglione, Penny Roberts

FIELD EDITORS

Boston: Lawrence Curran (Mgr.), Pamela Leven
Los Angeles: Larry Waller (Mgr.)
Midwest: Larry Armstrong (Mgr.)
New York: Ron Schneiderman (Mgr.)
San Francisco: Bernard Cole (Mgr.)
Judith Curtis
Washington: Ray Connolly (Mgr.)
Frankfurt: John Gosch
London: William F. Arnold
Paris: Arthur Erikson
Tokyo: Charles Cohen

McGraw-Hill World News

Director: Ralph R. Schulz

Brussels: James Smith

Madrid: Dom Curcio

Milan: Andrew Heath

Moscow: Peter Gall

Paris: Joel Stratte-McClure

Stockholm: Robert Skole

Tokyo: Colin Gibson

PUBLISHER: Dan McMillan

DIRECTOR OF MARKETING: Pierre J. Braudé

MARKETING ADMINISTRATION MANAGER:
Wallis Clarke

CIRCULATION MANAGER: Nancy L. Merritt

MARKETING SERVICES MANAGER:
Tomlinson Howland

RESEARCH MANAGER: Margery D. Sholes

Microprocessors pack a lot of power into a small package, so that they can take on a number of jobs without having to be customized for each one. The resulting volume production translates into a rather phenomenal price/performance ratio.

It had to happen, of course, but that basic strength—all things to all applications—is already considered by some to be a bit of disadvantage. When Electronic Arrays Inc. designed its EA 9002, the emphasis was on specialization.

Let's hear the design philosophy in the words of Electronics Arrays' Bill Wickes, who wrote the technical article that starts on page 101. "A while back some friends of ours, Ed Lee and Matt Biewer of Pro-log, a newly emerging company in Monterey, Calif., specializing in microprocessor applications, approached us with an idea. The idea was that while the 8080 or 6800 are good microprocessors, they are not configured for small, low-cost real-time controller and logic replacement applications. They are too sophisticated, too complex to easily comprehend, an overkill for the job. Electronic Arrays felt the same way and after many joint sessions the specifications for the EA9002 emerged."

Was the design what they had in mind? Yes, according to Wickes. "It was conceived from the ground up as a stand-alone digital process controller capable of interfacing with the real world through an 8-bit parallel TTL-compatible data bus. The timing and control signals allow the use of the individual bus-oriented TTL-compatible devices best suited to an application. It combines the

on-board 64-byte scratch-RAM of the F-8, the push-pop subroutine stack of the MCS-4, the simplified timing concepts of the PPS-4, the straightforward peripheral addressing techniques of the 6800, and the general-purpose registers of the 8080, with a simple instruction set and a single +5-v supply."

Digital watches are certainly an idea whose time has come. With shipments in 1975 of some 3.5 million units, sales this year should soar to at least 15 million. And in 1980, estimates have it, more than 90 million should pass into the hands and onto the wrists of consumers.

Right now, a number of semiconductor houses are vying for a piece of the digital-watch action and, as our cover says, choosing up sides in the electronic technology that makes the watches possible.

Our consumer editor, Jerry Walker, who wrote the article beginning on page 91: "It isn't clear whether watches with complementary metal-oxide semiconductor chips or those with integrated-injection-logic chips will be the preferred technology. Both approaches offer advantages, and the two technologies are running neck and neck at the watch-chip level. Watch displays—whether liquid-crystal or light-emitting-diode displays—have not been sorted out, either."

But there is a lot of activity in digital watches and much more to come. You'll find out just what in our digital-watch status report.



June 10, 1976 volume 49, number 12
93, 116 copies of this issue printed

Published every other Thursday by McGraw-Hill, Inc. Founder: James H. McGraw 1860-1948. Publication office: 1221 Avenue of the Americas, N.Y. N.Y. 10020. Second class postage paid at New York, N.Y. and additional mailing offices.

Executive, editorial, circulation, and advertising addresses: Electronics, McGraw-Hill Building, 1221 Avenue of the Americas, New York, N.Y. 10020. Telephone: (212) 997-1221. Teletype: 12-7960. TWX: 710-581-4879. Cable address: MCGRAW HILL, NEW YORK.

Subscriptions limited to professional persons with active responsibility in electronics technology. Publisher reserves the right to reject non-qualified requests. No subscriptions accepted without complete identification of subscriber name, title, or job function, company or organization, and product, manufactured or services performed. Subscription rates: in the United States and possessions \$12.00 one year; \$30.00 three years. Canada and Mexico \$14.00 one year; \$32.00 three years. Europe \$35.00 one year; \$87.50 three years. Japan, Israel and Brazil \$60.00 per year. Australia and New Zealand \$80.00 per year, including air freight. All other countries \$40.00 per year. Limited quota of subscriptions available at higher than basic rate for persons outside of field served as follows: U.S. and possessions and Canada \$25.00 per year; Europe \$40.00; Japan, Israel and Brazil \$85.00; all other countries \$50.00. Single copies: \$4.00. Please allow four to eight weeks for shipment.

Officers of McGraw-Hill Publications Company: Gordon L. Jones, President; Paul F. McPherson, Executive Vice President; J. Elton Tuohy, Executive Vice President-Administration; Gene W. Simpson, Group Vice President; Senior Vice Presidents: Ralph Blackburn, Circulation; John B. Hodgund, Controller; Ralph R. Schulz, Editorial; David G. Jensen, Manufacturing; Vice Presidents: James E. Boddart, Planning & Development; Edward E. Schirmer, Marketing Administration.

Officers of the Corporation: Shelton Fisher, Chairman of the Board; Harold V. McGraw, Jr., President and Chief Executive Officer; Robert N. Landes, Senior Vice President and Secretary; Ralph J. Webb, Treasurer.

Registered in U.S. Patent Office. Copyright ©1976 by McGraw-Hill, Inc. All rights reserved. The contents of this publication may not be reproduced in whole or in part without the consent of copyright owner.

Subscribers: The publisher, upon written request to our New York office from any subscriber, agrees to refund that part of the subscription price applying to copies not yet mailed. Please send change of address notices or complaints to Fulfillment Manager, subscription orders to Circulation Manager, Electronics, at address below. Change of address notices should provide old as well as new address, including postal zip code number. If possible, attach address label from recent issue. Allow one month for change to become effective.

Postmaster: Please send form 3575 to Fulfillment Manager, Electronics, P.O. Box 430, Hightstown, N.J. 08520.

for your HIGH VOLTAGE NEEDS KEPCO offers a choice:

OPS

group IXB

High Speed (no output capacitor) operational power amplifier-type instruments for your control requirements

OPS 500B: 0–500V @ 40 mA
 OPS 1000B: 0–1000V @ 20 mA
 OPS 2000B: 0–2000V @ 10 mA

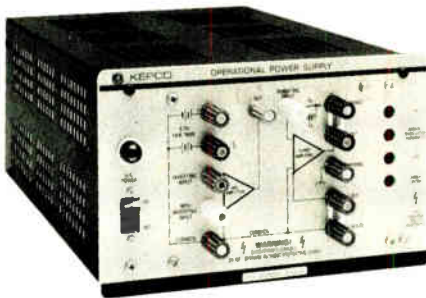

You may exercise control over the high voltage output with a 0–5V control signal, or use the built-in pre-amplifier to scale or sum your inputs operationally. The output follows input signals with a 100 μ sec programming time constant (OPS 500B). Current limit is both adjustable and electrically programmable.

Slew Rate Limit 1 V/ μ sec.
 Gain 10^6 V/V
 Offset Voltage (for Load) <10 μ V
 Noise 0.01% of E_o or 15 mV rms

APH

AUTOMATIC CROSSOVER

Conventionally filtered (low noise) bench style voltage and current stabilizers for your stable high voltage requirements

APH 500B: 0–500V @ 40 mA
 APH 1000B: 0–1000V @ 20 mA
 APH 2000B: 0–2000V @ 10 mA



Control voltage with a 10-turn precision panel control (or program like the OPS). Another 10-turn panel control adjusts the output current. LED annunciators signal operation in either voltage mode or current modes. A built-in "uncommitted pre-amplifier" is available for scaling or summing programming inputs. Output is monitored on a pair of 2½" meters.

Stabilization (for Load) <0.005%
 8-hour Drift <0.01%
 Noise <1 mV rms

Write Dept.
 FG-14.



Kepeco high voltage power supplies are designed with your needs in mind. Our Catalog describes models ranging up to 5000 volts; up to 200 watts and includes both unipolar and bipolar instruments.

with KEPCO you're in control!

KEPCO, INC. • 131-38 SANFORD AVENUE • FLUSHING, N.Y. 11352 U.S.A. • (212) 461-7000 • TWX # 71C-582-2631 • Cable: KEPCOPOWER NEWYORK

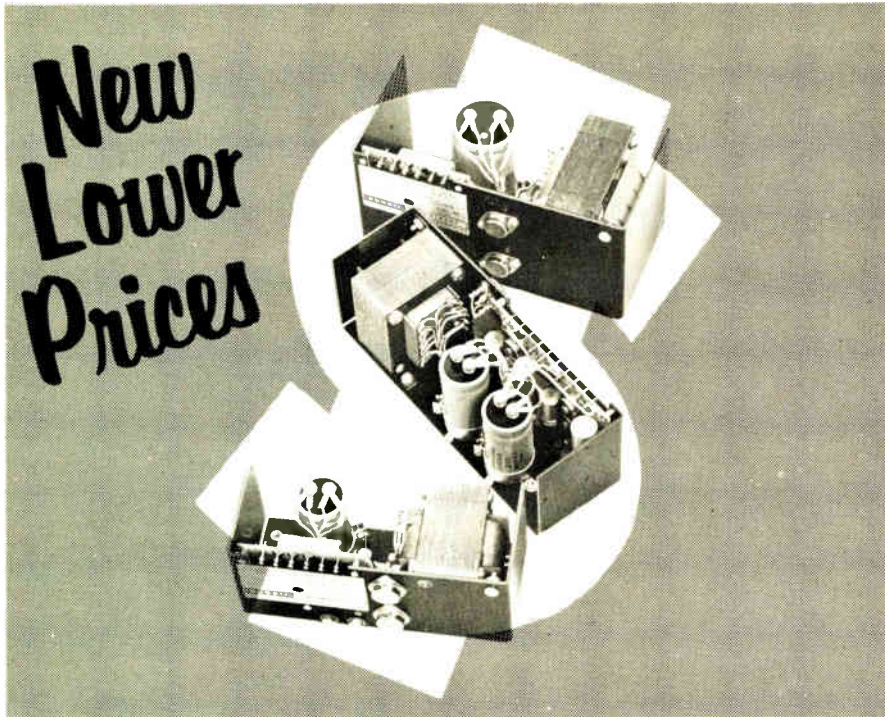

Start Getting Your Money\$worth Out of Power Modules





Now, you can really start getting your moneysworth out of power modules with Abbott's new LOW COST series. Designed to give you 100,000 hours of trouble-free operation (that's 11½ years), these reliable units meet the needs of OEM engineers. Their purchase price is about \$7 per year of service. The model LC series feature:

- 47-420 Hz Input Frequency
- 0.1% Regulation
- +60°C Ambient Operation
- Single and Dual Outputs
- 1 Day Stock Delivery

These units provide more quality per dollar compared to similar items on the market. See table below for prices on some of our LC models. Many other LC models are listed in our catalog.

If analyzing the many similar power supplies on the market is confusing; if you are concerned about the long-term reliability of those units, then decide on an Abbott power supply for your system. Your best buy in OEM power modules is ABBOTT.

Abbott also manufactures 3,000 other models of power supplies with output voltages from 5 to 740 VDC and with output currents from 2 milliamps to 20 amps. They are all listed with prices in the new Abbott Catalog with various inputs:

60  to DC
 400  to DC
 28 VDC to DC
 28 VDC to 400 
 12-38 VDC to 60 

5V @ 6 Amps	5V @ 10 Amps	12V @ 10 Amps	15V @ 4 Amps	28V @ 1 Amp	±12V @ 1.2 Amps	±15V @ 4 Amps
LC5T6	LC5T10	LC12T10	LC15T4	LC28T1	LLC12T1.2	LLC15T4
\$62	\$73	\$99	\$73	\$62	\$87	\$119.00

Please see pages 1054-1056 Volume 1 of your 1975-76 EEM (ELECTRONIC ENGINEERS MASTER Catalog) or pages 612-613 and 620 Volume 2 of your 1975-76 GOLD BOOK for complete information on Abbott Modules.

Send for our new 60 page FREE catalog.

abbott transistor

INDUSTRIAL PRODUCTS DIVISION
 general offices eastern office

5176 W. Jefferson Blvd./Los Angeles 90016
 (213) 930-1040 Telex: 69-1398

1224 Anderson Ave./Fort Lee, N.J. 07024
 (201) 224-6900 Telex: 13-5332

6 Circle 6 on reader service card

World Radio History

Readers' comments

Stay away from 220 MHz

To the Editor: The Electronics Industries Association is still manning its public-relations guns trying to convert the amateur 220-megahertz band to citizens' band radio service. I am greatly disappointed to see a magazine of the stature of *Electronics* publish this PR claptrap in the guise of an editorial [March 18].

Citizens' band communications between unrelated stations are commonplace and possibly constitute the major use of CB—for example, truck-to-truck advisories of road conditions, police-car locations, etc. Five watts may be OK for a start, but linear amplifiers that boost power to the 300-to-1,000-w range have been selling well.

Clearly, if illegal conversations and the illegal transmitter power were eliminated, most of the interference problems of CB would vanish. But the EIA would like to move this can of worms up to 220 MHz so its members can sell more radios. This course can lead only to disaster. It is bad for CB, amateurs, and the communications profession.

Jack Althouse
 Palomar Engineers
 Escondido, Calif.

Share and share alike?

To the Editor: My company just got my first patent, and I got a dollar and a plaque. After development of the idea, the potential customer changed his mind, so my company has taken a loss so far.

If the patent results in sales of millions, I certainly won't mind sharing the profit my idea provided. Should I also share the loss?

Brad Denniston
 AIL division, Cutler Hammer
 Melville, New York

Correction

The resolution of Techmet's Laser-mike, an automatic optical micrometer, is typically ±0.0005 inch, with ±0.00001 in. attainable in one model. An erroneous resolution was given in the caption for Fig. 1 of "The industrial laser—a special tool for special needs." [*Electronics*, April 29, p. 89].

Electronics/June 10, 1976



Faster than a speeding 741...

... more stable than a drifty FET!

Say hello to *Superslew*, generally known as PMI's Mild Mannered OP-01 general purpose bipolar monolithic op amp.

Finally OP-01 has been discovered for what he really is: a speed demon who slews at $18V/\mu\text{sec}$ in inverting configuration. His rise time of 150nsec. (with only 2% overshoot) puts him into competition with the Big Dollars op amps. But OP-01 works cheap—@ \$1.25 (100-999). His V_{OS} , as low as 0.3mV, and I_{OS} , as low as 2nA, make OP-01 the ideal op amp for DAC's. And he settles to 0.1% in 700ns (comparable to dielectric isolated op amps).

Bipolar monolithic, OP-01 fits most standard 741 sockets. Available in chips or package, *Superslew* can pass any MIL level; MIL-883B is instantly available from our distributors.

So if it's not a bird, not a plane, but a faster-than-a-741 op amp you need, call for *Superslew*—our OP-01. An exciting, dynamic data sheet is yours by writing *Shazam* at the address below.



Precision Monolithics, Inc.

1500 Space Park Drive, Santa Clara, CA 95050
(408) 246-9222. TWX: 910-338-0528.
Cable MONO.

Circle 7 on reader service [Radio History](#)

Want 90
DVM's
for 90 days?



At 90 different places? For short-term, peak DVM needs, call the "Instrument Professionals". They can put the models you need, when and where you want them. Rental is the economic answer to training, field retro-fit or other short-term DVM needs.

Write or call for data on our other specialties: Instrument Leasing • Computer Peripherals • Equipment Sales • Instrument Service.

Circle 8 on reader service card

Call  Get our FREE Catalog
Continental Rentals

Div. Continental Leasing Co., Inc.
175 Middlesex Turnpike, Bedford,
MA, 01730 (617) 275-0850

Metuchen, NJ (201) 549-8500;
Gaithersburg, MD (301) 948-4310; TX
(214) 357-1779; Elk Grove, IL (312)
439-4700; Costa Mesa, CA (714)
540-6566; Santa Clara, CA (408)
735-8300; Los Angeles, CA (213) 477-7521

News update

■ In this election year, it should come as no surprise that the progress of Compuvote Corp. in selling its microprocessor-controlled voting machine is "right on target." That's the estimate of Fred L. Carter, the former Los Angeles County election commission chairman who heads the firm. "We've had interest from every major jurisdiction in the country," says Carter. Right now, three cities are close to a decision on whether to buy the machine, says Carter—Denver, San Francisco, and Chicago.

San Francisco is labeled by Carter the best prospect: it will make its decision by July 15. Compuvote, which is based in Beverly Hills, Calif., is still negotiating with the other two cities. Chicago's tentative plan is to change half its voting machines in the first phase, and Los Angeles county plans to field-test the Compuvote system in the November general election.

Only two changes have been made in the hardware since last year [*Electronics*, June 12, 1975, p. 41]. A digital readout has been added to enable the voter in the booth to tell for sure if he has actually punched the correct hole, and C-MOS memory has replaced n-MOS technology because it uses less power and offers more capacity.

■ Cray Research Inc. has sold its first computer system since the Minneapolis company was organized in 1972. The customer is the University Corp. for Atmospheric Research, and the deal is for a Cray-1A system to be installed at the National Center for Atmospheric Research in Denver. The center has not yet decided whether to lease the equipment or purchase it for \$8.9 million.

Earlier this year Cray delivered a Cray-1 system to the Los Alamos Scientific Laboratories for test and evaluation. This activity came as the company announced a first-quarter loss of \$290,929 on revenue of \$14.2 million. Cray Research went public March 13.

Liquid Rivets, Bolts, Nails, Staples, Etc.

One drop goes a long way in fastening almost anything to almost anything.

Metals, for instance. And plastics. And ceramics. And rubber.

Eastman 910[®] adhesive bonds fast, too. Almost instantaneously. With only contact pressure.

Tensile strength? Up to 5,000 psi at room temperature.

For further data and technical literature, write: Eastman Chemical Products, Inc., Kingsport, Tennessee 37662.



Circle 119 on reader service card

Reliability at 300° C is not the only reason Babcock Electronics uses Ekkcel™

Designing for reliability means considering the extremes. Relays designed for ambient temperatures of 125° C (256° F) see much higher internal temperatures when in operation at this extreme. So components like arc cages, bobbins, and shield insulators have to be able to take the higher temperatures.

Babcock Electronics found ceramic too fragile to withstand the vibration and shock. Other high temperature plastics tend to outgas at the operating temperatures which caused contact resistance problems.

Ekkcel injection molding resins were the perfect answer. Our high temperature reliability at a continuous 300° C (572° F) is unmatched. And our radiation resistance is 10¹⁰ rads.

We'd like to work with you on similar high temperature applications. We can help you give your electronic components all the reliability you can get.

Carborundum Plastics, Inc.
Ekkcel Division
5785 Peachtree Industrial Blvd.
Atlanta, Georgia 30341
(404) 455-6127

CARBORUNDUM



Circle 9 on reader service card

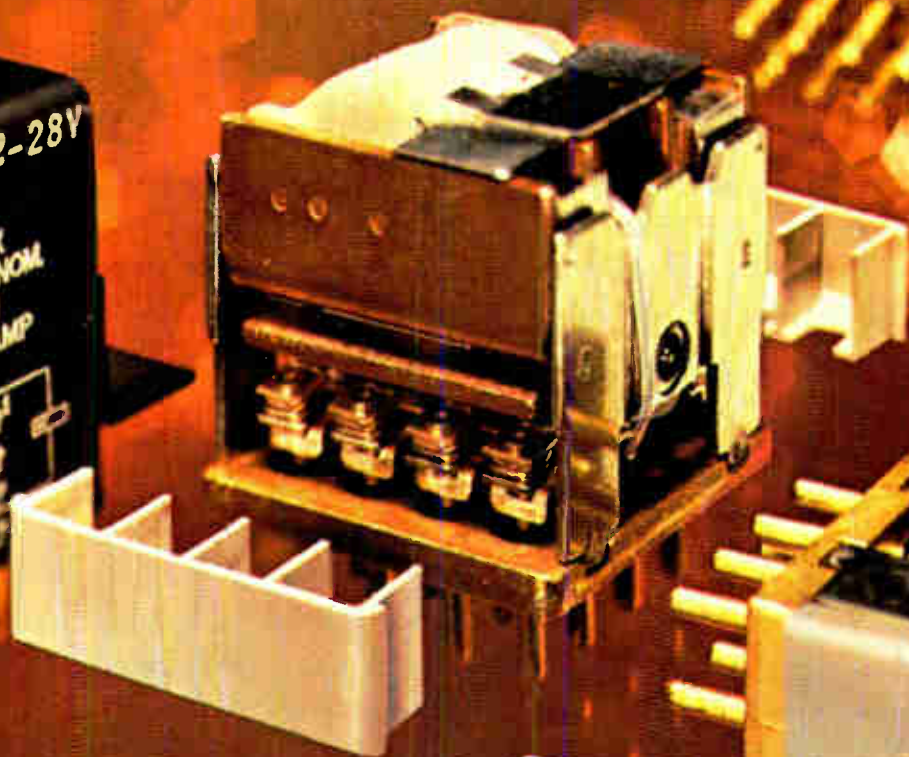

Legislating competition out of telecommunications

A bitterly divided telecommunications industry is girding for battle in Congress later this year over the controversial Consumer Communications Reform Act of 1976. First introduced in the House three months ago with virtually no support, there have been 89 similar bills introduced in the House with 125 sponsors—more than a quarter of the membership. On the Senate side, there are two bills with 12 sponsors, 11 of them backing a bill introduced by Indiana Democrat Vance Hartke, now in line to succeed to the chair of the Commerce subcommittee on telecommunications. The rapid growth of support for the bills, which Federal Communications Commission chairman Richard E. Wiley sees as designed “to submerge or destroy” telecommunications competition, is widely credited to intensive and large-scale lobbying in an election year by AT&T, its affiliates, and the members of the U.S. Independent Telephone Association.

The position of the telephone companies, as expressed by AT&T chairman John deButts, is that “the current trend of Federal regulatory policy is adverse to the interest of the public.” By permitting selective competition in the carriers’ more lucrative markets, deButts believes, the FCC is producing “a Government-imposed allocation of the market, arbitrarily established and artificially maintained.”

The opposition sees it differently, particularly in its interpretation of what has come to be known on Capitol Hill as “the Bell bill.” Jack Biddle, president of the Computer Industry Association, translates the bill’s wording as legislation to prohibit any competition; to let AT&T acquire the companies that have come into being to serve consumer needs that it has so long neglected; and to let it deal only with states on terminal interconnections, since AT&T has been unable to get its way with the FCC, the courts and the White House.

Data Transmission Co. and MCI Telecommunications Corp., two of the largest specialized carriers authorized to compete with the Bell System using microwave networks, have yet to show a profit. And both acknowledge that passage of the legislation would quickly put them out of action altogether. The North American Telephone Association, made up of independent terminal-equipment suppliers, says that accuracy demands the bill be labeled “The Monopoly Protection Act of 1976.” To fight the legislation, some opponents have formed ACCT—Ad-hoc Committee for Competitive Telecommunications.

If the telephone industry’s bill is, as its opponents contend, so blatantly monopolistic and contrary to the public interest, it will never get out of committee. Why, then, the intense concern? Kevin Hannon, NATA executive director, suspects AT&T never believed the bill would pass at all, but may already be on the way to achieving its goal of putting its competitors out of business by indirectly denying them access to capital in the financial community.

“This is a capital-intensive industry,” Hannon explains. “They only want the publicity that will scare off the financial community. Once they have done that, all other questions become moot. No money, no industry, no competition.”

Whether the threat is direct or indirect, however, one thing is clear. Competition in telecommunications can only bring benefits—to the equipment makers, to the carriers, and, most important, to the public. We hope, after hearings are held, that Congress will reject limitations on telecommunications competition. For those engineers and managers whose livelihood depends on telecommunications competition, the issues raised by AT&T’s lobbying efforts cannot be ignored.

"Digital Signal processing is too much."

"Too much time. Too much money. Too much power." Not anymore.

Advanced Micro Devices announces three easy-to-use, economical, low-power Schottky circuits for high-performance digital signal processing.

Am25LS14. It's an 8-bit by 1-bit serial/parallel LSI multiplier that performs digital multiplication in two's complement notation.

Am25LS15. It's a quad, serial adder/subtractor designed for use with the Am25LS14 in recursive and nonrecursive digital filtering or butterfly networks in Fast Fourier Transforms.

Am25LS22. It's an 8-bit serial/parallel register with sign extend for use with the Am25LS14.

These devices can be used together to implement digital filters, FFT processors, spectrum analyzers

and data compression and transmission systems at rates above 30MHz and at cost and speed/power levels lower than ever before achievable. And, like everything we make, it's MIL-STD-883 for free.

Too much time? Too much money? Too much power? Not anymore.

Digital Signal processing has arrived. Ask for it by name: Am25LS14, Am25LS15 and Am25LS22.

Digital Signal Processing Handbook. 

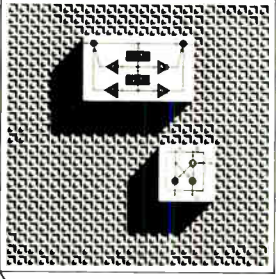

Drop us a note on your company letterhead, and we'll send you the 86-page Digital Signal Processing Handbook. For free.

Advanced LP/Schottky

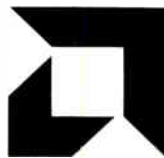

Advanced Micro Devices • 901 Thompson Place, Sunnyvale, California 94086 • Telephone (408) 732-2400
Distributed nationally by Hamilton/Avnet, Cramer and Schweber Electronics.

Your next digital logic analyzer.

Biomation's new 851-D
8-channel, 50 MHz logic analyzer.

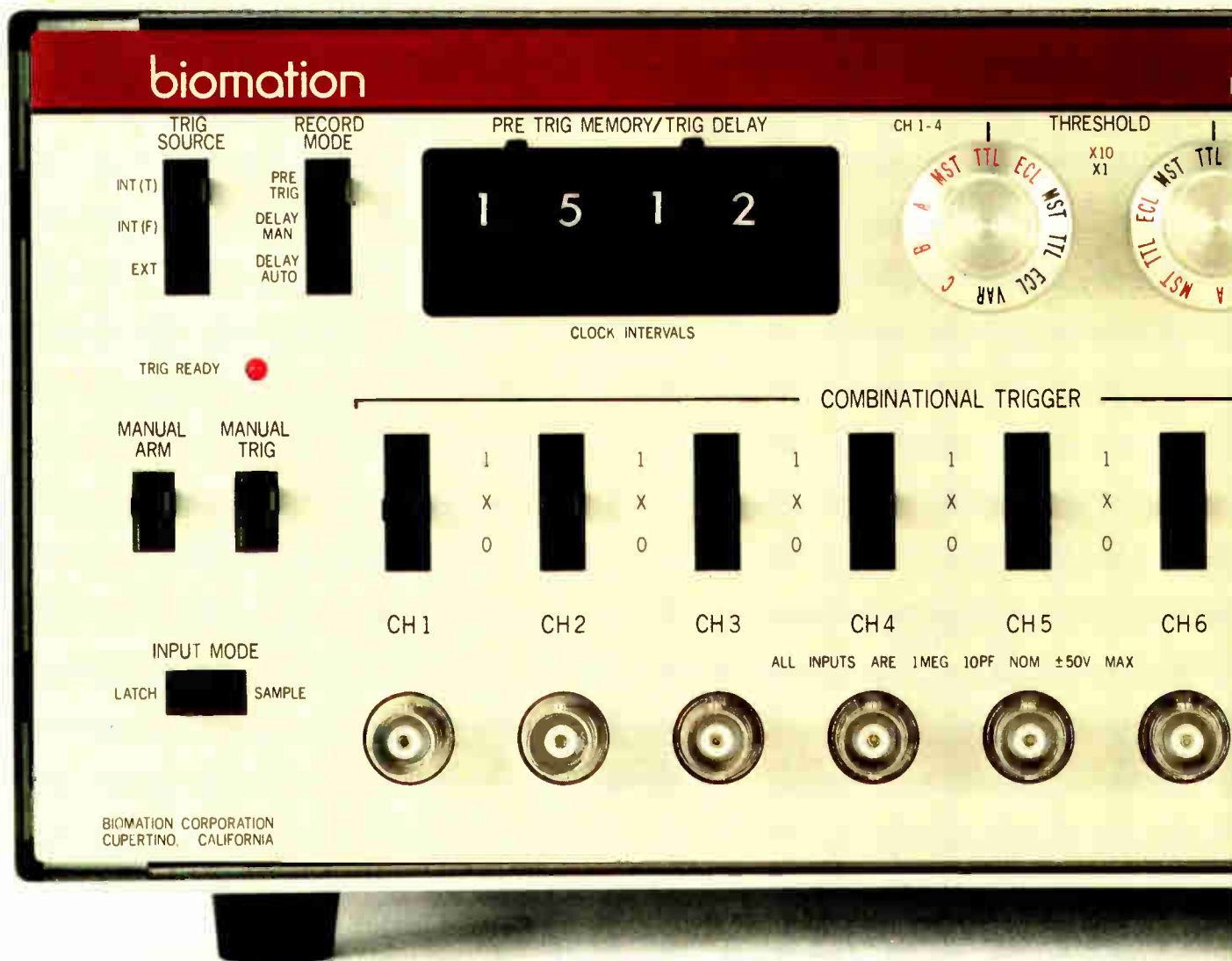

Digital logic analyzers are revolutionizing the solutions of design and trouble-shooting problems. Biomation, building on our early waveform recording technology, has created the tools you need for your fast new digital world. We offer the most complete line of logic analyzers anywhere. And our thousand-plus customers have helped us develop the most useful features for real-world problems of digital system design and test. Our new 851-D catches, records and displays 8 channels of high speed logic. It is the slickest handling, most cost-effective logic analyzer we've seen yet. But don't take our word for it. Check over the features for yourself.

• Ideal companion for your 2-trace portable scope • Portable and self-contained • 8 channel • 50 MHz • Digital delay for precise

trigger control • Accepts synchronous clock input (0° or 180° phase) • Provides internal clocking • Catches glitches as narrow as 5 ns • Pre-trigger recording • 512 bit per channel memory • Captures 512 words before, after, or around the trigger • Expanded and mixed display • Constant brightness expand to X20 • Combinational "true" trigger • Any-change" trigger • Built-in delay (4 digit) • Latch mode (catches single pulses) • Adjustable threshold levels for channels 1-4 and 5-8 • Step-and-wait cursor control • Steps through data one bit at a time • Price: \$3575. • Delivery: 30 days A.R.O.



What next?

If you want to see a demo, right now, of our new 851-D or any of our digital logic analyzers (we have both less expensive and more powerful models), pick up the phone and call (408) 255-9500. Ask for Roy Tottingham at ext. 851-D. Or circle the reader service number and we'll send data. Biomation, 10411 Bubb Road, Cupertino, CA 95014.

851-D shown actual size

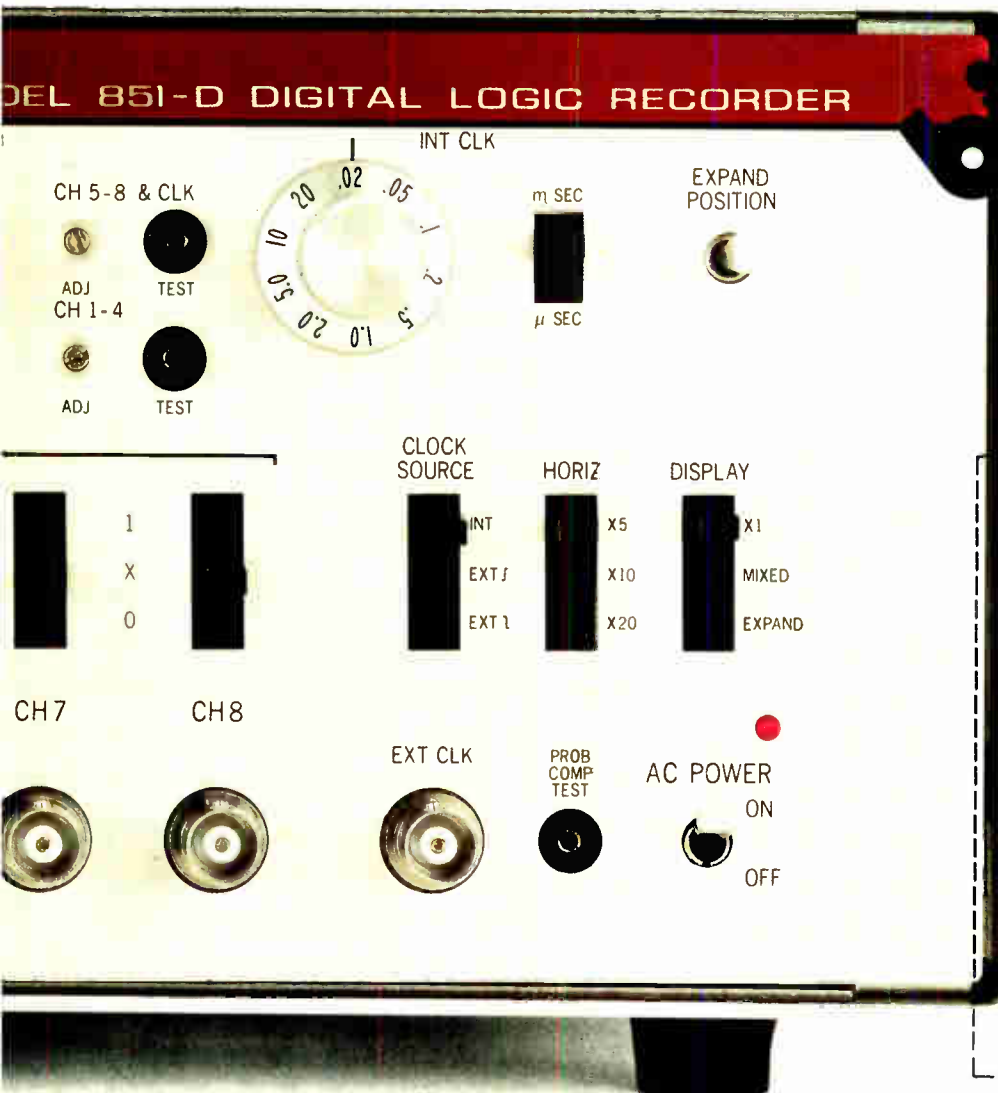

Biomation
Creating tools for technology

- Sounds great, but I don't know what all of the features actually do. Please send more information.
- Send information on your complete digital logic analyzer line.

Name _____

Title _____

Company _____

Street Address _____

City _____ State _____

Zip _____

Biomation
10411 Bubb Road, Cupertino, CA
95014, (408) 255-9500.
TWX 910 338 0226

1 RCL SWITCH DOES THE JOB OF 12!



- SUBMINIATURE Multi-deck Rotary Switches with ADJUSTABLE STOPS... permitting the user to vary the number of positions instantly.
- Select 2 through 10 positions by moving external plate.
- As many as 4 poles possible per deck!

Send For New '76 Catalog Or
Call our Hotline For Name
Of Your Local Representative
Or Stocking Distributor.
(201) 374-3311

AMF

RCL Electronics

General Sales Office:

700 So. 21st Street

Irvington, N. J. 07111

People

Now at National, Ebertin
sees calculator growth

Even though the calculator market, especially the low-priced end, appears to be approaching saturation, don't expect it to go away. What's more, the complex MOS LSI chips that created it are sure to be used in a number of creative ways to generate products markets with growth potentials just as dramatic as calculators.

In addition to those expectations, 39-year-old Michel Ebertin predicts that his new employer, National Semiconductor Corp., will continue to be a large factor in calculators and a leader in the new calculator-spawned markets. Formerly director of calculator product marketing at Rockwell International, Ebertin just a few weeks ago moved to National as operations director for calculator, game, and microcontroller products.

"When transistor radios first came out," says the 6-foot, 2-inch French-born, but Brooklyn-raised engineer, "it was said that once everybody had one and the market was saturated, the market would go away. Well, everyone is not only still buying transistor radios, they're buying bigger and better ones." Just as developing expertise led to new growth markets for transistor radios, he says, so, too, will it benefit calculators.

National's just-introduced calculator-chip-based microcontroller family [*Electronics*, May 27, 1976, p. 146] is a good example, says Ebertin, of the way calculator makers such as the Santa Clara, Calif., company will attack a number of new markets.

"One new market area that is particularly exciting to me is personal electronic games," says the man who was not only prominent in launching Rockwell into the calculator and microprocessor business but was instrumental in defining devices in both areas that have become industry standards. "I don't mean video Pong-type games, I'm talking about calculator-based games an individual can play either



At play. Michel Ebertin predicts big gains for calculator-based games.

all alone or against someone else."

National's first effort in this direction, he says, will be with Quiz Kid II, introduced at the Consumer Electronics Show. On it children can play arithmetic games alone or against each other. "And that's just the beginning. The possibilities are endless and profitable."

Bourns's Entreklin plans
intensified market research

Being named president of \$100 million Bourns Inc., succeeding company-founder Marlan E. Bourns, gives Guy B. Entreklin Jr. obvious pleasure. But it also poses some questions for a man of his reflective nature. Uppermost is how to continue the company's healthy growth. "That's a hard act to follow," he remarks.

Sales of the Riverside, Calif., company doubled from 1966 through 1975, with profits nearly keeping pace until the recession and other problems triggered a sharp decline last year. Entreklin served as executive vice president and chief operating officer since 1974, moving up through the hierarchy after joining the firm in 1963.

One way Entreklin plans to capture continued growth is to put even

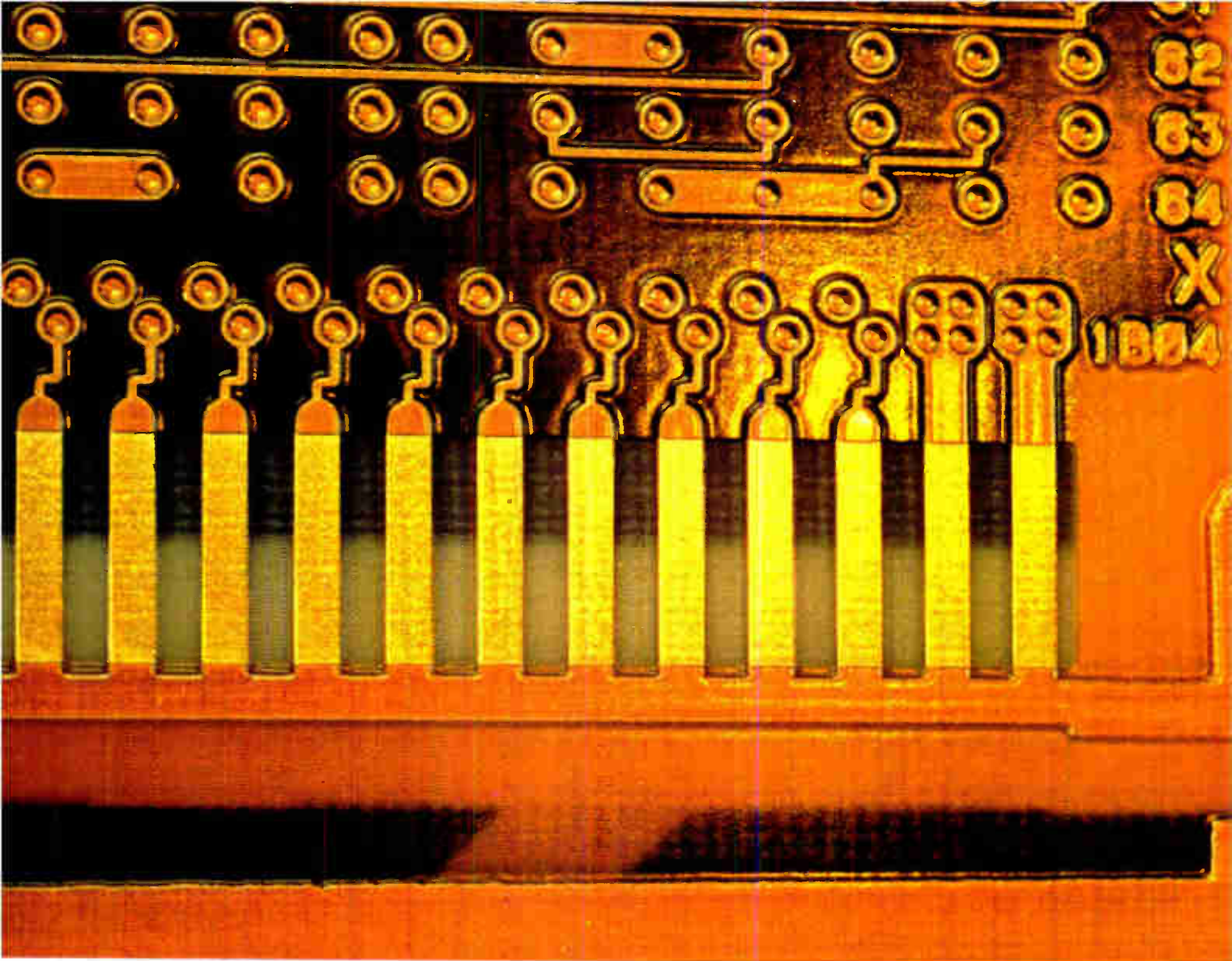

Circuit Board courtesy of General Electric Corporation

How much gold can new RISTON* Phototape save you?

Perhaps, quite a bit. We call RISTON Phototape "the gold-saver" because it eliminates wasteful plating of busbars and robber's edges. And that means less gold for the reclaiming process.

RISTON Phototape also makes more sense, since it uses the same equipment as your RISTON dry-film process. With a minor modification of your RISTON HRL-24 Laminator, you

can increase productivity and reduce the operating cost of your yellow room.

Ask your RISTON Technical Representative to show you just how much gold you can save with RISTON Phototape. And you'll get an obvious bonus in high-quality board work with the sharpest lines of demarcation.

RISTON Phototape—another innovation from Du Pont—brings the accuracy of dry-film photo-imaging to

your plating operation. It's part of Du Pont's commitment to bring increased productivity and higher-reliability to your board-making systems.

Call your Du Pont RISTON Technical Representative today. Or write: Du Pont Company, Room 25007, Wilmington, Delaware 19898.

*Registered U.S. Pat. & Tm. Off. for Du Pont's processable dry-film photoresist system.

RISTON Division



Electronics

Subminiature capacitors with small mounting areas for printed circuit boards

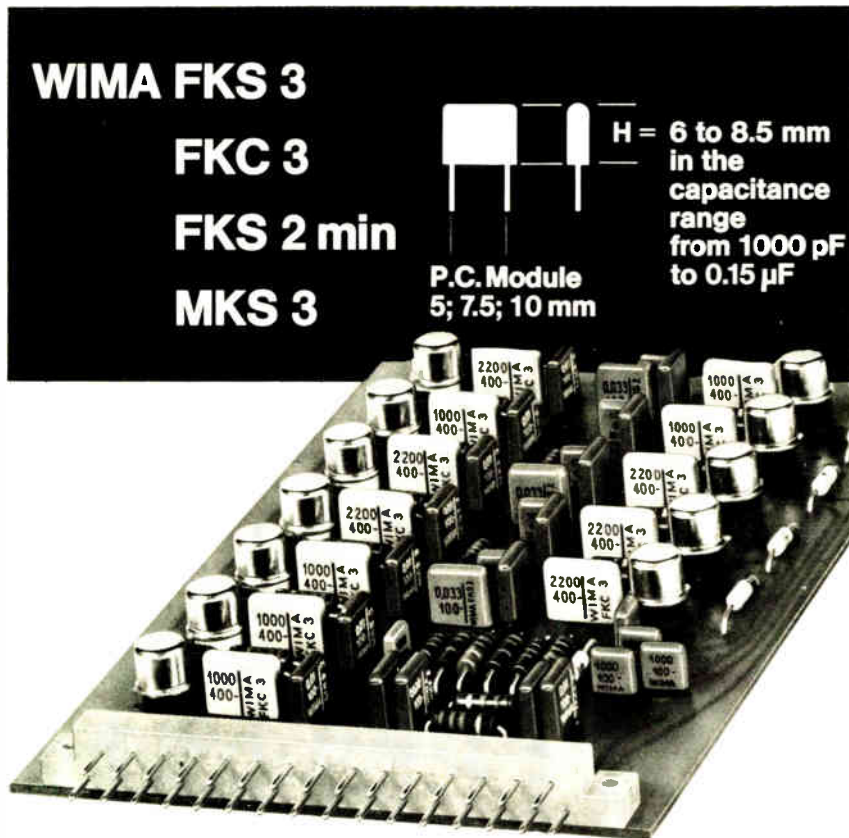

Characteristics:

The design has made better use of the vertical area in order to reduce the mounting area requirement for the capacitor. This facilitates greater packing density and easier mounting on printed boards.

The termination wires are compatible with the standard printed board grid to allow simple insertion. Equally important, the height of the capacitors is compatible with transistors.

These new cast-moulded capacitors are so small that they offer advantages hitherto not obtainable when used on printed circuit boards.



WILHELM WESTERMANN
 Spezialvertrieb elektronischer Bauelemente
 D-68 Mannheim · Fed. Rep. of Germany
 P.O. Box 2345 · Tel.: (0621) 40 80 12

People

more push into the planning, development, and marketing of Bourns' major product lines: trimming potentiometers. Here, the usually cautious Entekin flatly asserts, Bourns is number one in the field. "Our basic concepts and philosophy remain the same—making the best possible potentiometers." However, he confesses to a plan to tinker with the success formula—"to do an intensified job of market research and see how big a need exists before we build a product."

Bourns' biggest headache right now comes from a French manufacturing subsidiary, Ohmic, which is piling up sizable monthly losses because of the depressed European market for components. Bourns wants to sell Ohmic, but hasn't found a buyer, and to reduce the work force, but the French government won't allow it. Bourns is continuing to negotiate, and Entekin is optimistic about bringing the situation under control.

Another matter that has caused Bourns no end of trouble is litigation concerning its efforts to buy out all shareholders and return to being a private company. Entekin, reiterating company policy, says that this plan has been dropped. While the company might buy more shares, there are no plans to do so at present.

Strategy. New president of Bourns, Guy B. Entekin says basic concepts will remain.



Microprocessors take control with Teledyne I/O converters

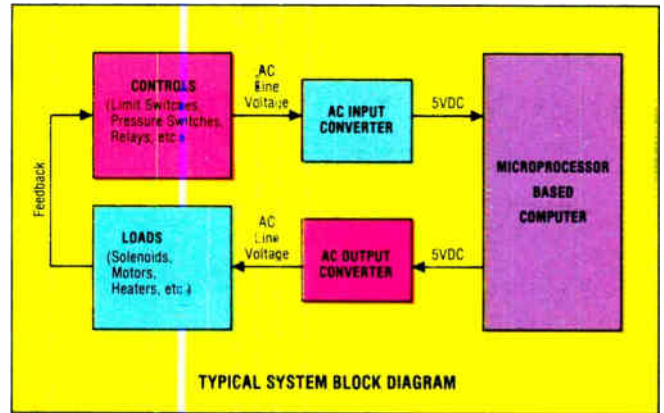

Modular packaging of input/output interface circuitry. That's what Teledyne I/O Converter Modules provide microprocessor based industrial controls for maximum I/O flexibility and expandability. This single circuit modular concept features all-solid-state circuitry, 1500V optical isolation, and high noise immunity. Our 671 Series modules plug directly into a low cost custom-designed mounting panel, which physically isolates

service wiring from logic connections. For pc boards, we offer the same circuitry in our 675 Series low profile package. Both series include ac and dc input/output converters.

So for the best in I/O interface circuitry for microprocessor based industrial controls, contact the people who know the "ins and outs" of this business — Teledyne Relays.

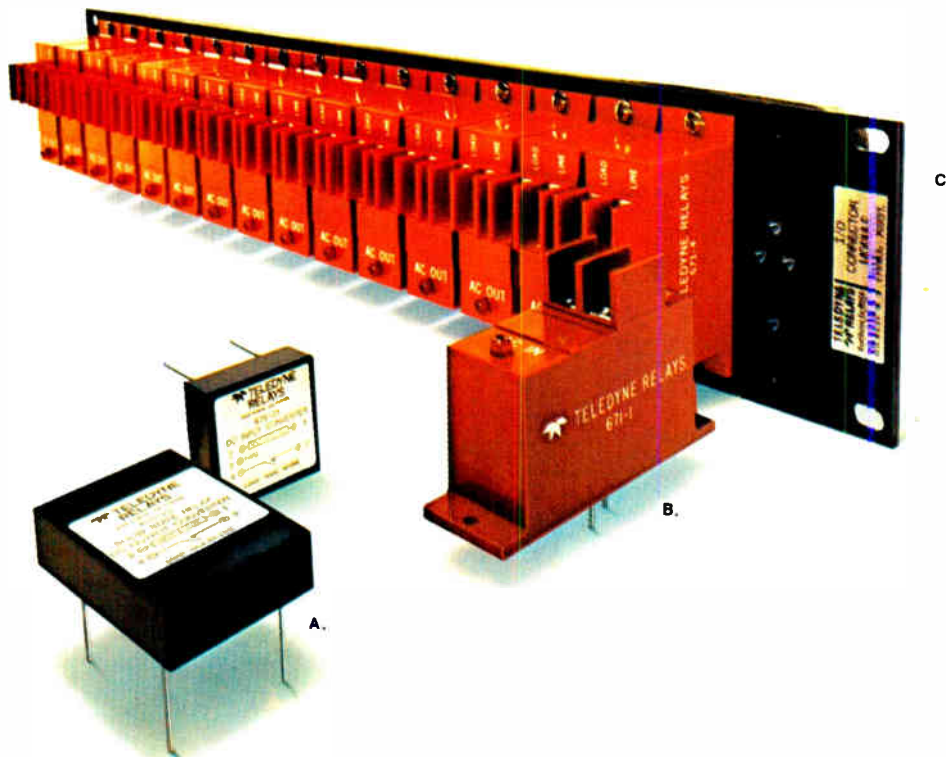

- A. 675 Series** — Low profile I/O converter modules for pc board mounting
- B. 671 Series** — Panel mounted I/O converter modules (with integral LED status indicators)
- C. 671P Series** — Custom-designed mounting panel

TELEDYNE RELAYS

3155 West El Segundo Boulevard, Hawthorne, California 90250
Telephone (213) 973-4545

The Battle of the 80's

Think of your next microcomputer as a weapon against horrendous inefficiencies, outrageous costs and antiquated speeds. We invite you to peruse this chart.

Features:	8080A	Z80-CPU	Features:	8080A	Z80-CPU
Power Supplies	+5, -5, +12	+5	Instructions	78	158*
Clock	2 ϕ , +12 Volt	1 ϕ , 5 Volt	OP Codes	244	696
Standard Clock Speed	500 ns	400 ns	Addressing Modes	7	11
Interface	Requires 8222, 8228 & 8224	Requires no other logic and includes dynamic RAM Refresh	Working Registers	8	17
			Throughput	Up to 5 times greater than the 8080A	
Interrupt	1 mode	3 modes; up to 6X faster	Program Memory Space	Generally 50% less than the 8080A	
Non-maskable Interrupt	No	Yes	*Including all of the 8080A's instructions.		



Announcing Zilog Z-80 microcomputer products.

With the next generation, the battle is joined.

The Z-80: A new generation LSI component set including CPU and I/O Controllers.

The Z-80: Full software support with emphasis on high-level languages.

The Z-80: A floppy disc-based development system with advanced real-time debug and in-circuit emulation capabilities.

The Z-80: Multiple sourcing available now.

Your ammunition: A chip off a new block.

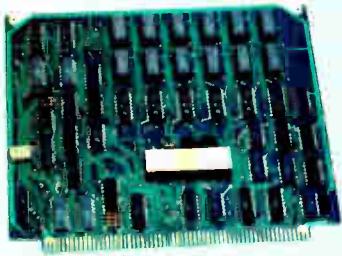

A single chip, N-channel processor arms you with a super-set of 158 instructions that include *all* of the 8080A's 78 instructions with *total* software compatibility. The new instructions include 1, 4, 8 and 16-bit operations. And that means less programming time, less paper and less end costs.

And you'll be in command of powerful instructions: Memory-to-memory or memory-to-I/O block transfers and searches, 16-bit arithmetic, 9 types of rotates and shifts, bit manipulation and a legion of addressing modes. Along with this army you'll also get a standard instruction speed of 1.6 μ s and all Z-80 circuits require only a single 5V power supply and a single phase 5V clock. And you should know that a family of Z-80 programmable circuits allow for direct interface to a wide range of both parallel and serial interface peripherals and even dynamic memories without other external logic.

With these features, the Z80-CPU generally requires approximately 50% less memory space for program storage

yet provides up to 500% more throughput than the 8080A. Powerful ammunition at a surprisingly low cost and ready for immediate shipment.

Mighty weapons against an enemy entrenched: The Z-80 development system.

You'll be equipped with performance and versatility unmatched by any other microcomputer development system in the field. Thanks to a floppy disc operating system in alliance with a sophisticated Real-Time Debug Module.

The Zilog battalion includes:

- Z80-CPU Card.
- 16K Bytes of RAM Memory, expandable to 60K Bytes.
- 4K Bytes of ROM/RAM Monitor software.
- Real-Time Debug Module and In-Circuit Emulation Module.
- Dual Floppy Disc System.
- Optional I/O Ports for other High Speed Peripherals are also available.
- Complete Software Package including Z-80 Assembler, Editor, Disc Operating System, File Maintenance and Debug.



On standby: Software support.

All this is supported by a contingent of software including: resident microcomputer software, time sharing programs, libraries and high-level languages such as PL/Z.

On standby: User support.

Zilog conducts a wide range of strategic meetings and design oriented workshops to provide the know-how required to implement the Z-80 Microcomputer Product line into your design. All hardware, software and the development system are thoroughly explained with "hands-on" experience in the classroom. Your Zilog representative can provide you with further details on our user support program.



Reinforcements: A reserve of technological innovations.

The Zilog Z-80 brings to the battlefield new levels of performance and ease of programming not available in second generation systems. And while all the others busy themselves with overtaking the Z-80, we're busy on the next generation—continuing to demonstrate our pledge to stay a generation ahead.

The Z-80's troops are the specialists who were directly responsible for the development of the most successful first and second generation microprocessors. Nowhere in the field is there a corps of seasoned veterans with such a distinguished record of victory.

Signal us for help. We'll dispatch appropriate assistance.



Zilog MICROCOMPUTERS

170 State Street, Los Altos, California 94022
(415) 941-5055/TWX 910-370-7955

Circle 19 on reader service card

AN AFFILIATE OF **EXON** ENTERPRISES INC.



POWER PROTECTED WITH CONATHANE®.....

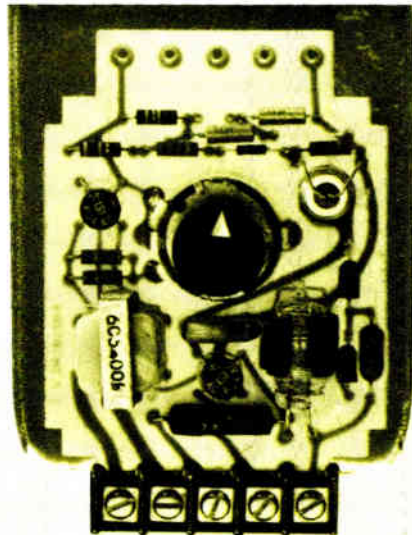

NON-MOCA* BASED POTTING, CASTING AND MOLDING COMPOUNDS

A proven series of systems developed by CONAP assure the performance of electrical/electronic gear exposed to hostile environments. The CONATHANE EN-Series are two-part, 100% solids, unfilled translucent liquid polyurethane systems. Ideally suited to potting, molding and encapsulation of water-tight electrical connectors, harness breakouts, cables, other electrical/electronic devices including flexible coatings for printed circuitry. Five hardness ranges are available in this series of eight systems, varying from a soft 45 Shore A to a semi-hard 90 Shore A.

Elastomers prepared from CONATHANE systems provide these exceptional advantages. • Hydrolytic stability. No changes in hardness after 42 days of continuous exposure at 97° C. and 95% humidity, and less than 10% loss in tensile strength. Even boiling in water has no effect. • Superior thermal shock resistance from -70° C. to 135° C. • Stable electrical properties over a wide temperature range. • Fungus resistance. • Exceptionally high Dielectric Strength properties (all systems > 600 vpm). • Excellent sound transmission (acoustical) characteristics. • Good handling properties. *DuPont Trademark

Get complete specifications. Write for Technical Bulletins covering this unique CONATHANE Series of resin systems, or send details of your requirements.

CONAP

CONAP, INC. / OLEAN, N. Y. 14760 / 716-372-9650

CONAP (CANADA) LTD.

5200 Dixie Rd. North - Unit 41 / Aerowood Industrial Plaza / Mississauga, Ont.

Circle 20 on reader service card

2-75

Meetings

International Microwave Symposium, IEEE, Cherry Hill Inn, Cherry Hill, N.J., June 14-16.

Electrical Insulation International Symposium, IEEE, Queen Elizabeth Hotel, Montreal, Que., June 14-16.

ICC '76 International Conference on Communications, IEEE, Marriott Motor Hotel, Philadelphia, June 14-16.

Joint MMM-Intermag Conference, IEEE and AIP, Hilton Hotel, Pittsburgh, June 15-18.

Fault-Tolerant Computing Conference, IEEE, Chatham Center, Pittsburgh, Pa., June 21-23.

Device Research Conference, IEEE, University of Utah, Salt Lake City, June 21-23.

Electronic Materials Conference, AIME, University of Utah, Salt Lake City, June 23-25.

13th Design Automation Conference, ACM and IEEE, Rickey's Hyatt House, Palo Alto, Calif., June 27-29.

Conference on Precision Electromagnetic Measurements, IEEE, NBS, and URSI, NBS Laboratories, Boulder, Colo., June 28-July 1.

Symposium on Frequency Standards and Metrology, NBS and URSI, Copper Mountain, Colo., July 5-7.

Summer Computer Simulation Conference, IEEE et al., Sheraton Park Hotel, Washington, D.C., July 12-14.

Power Engineering Society Summer Meeting, IEEE, Portland Hilton Hotel, Portland, Ore., July 18-23.

Nuclear and Space Radiation Effects Conference, IEEE, University of California, San Diego, July 27-30.

International Microwave Power Symposium, International Microwave Power Institute, (Edmonton, Alberta, Canada), Louvain, Belgium, July 27-30.

**Some companies
call two IC Converters
a complete line.**

**Now if they only had
the one you wanted.**

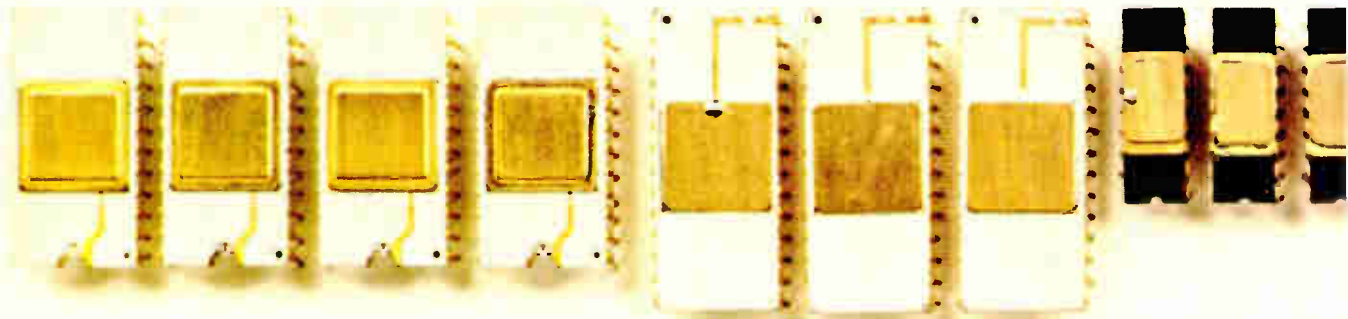
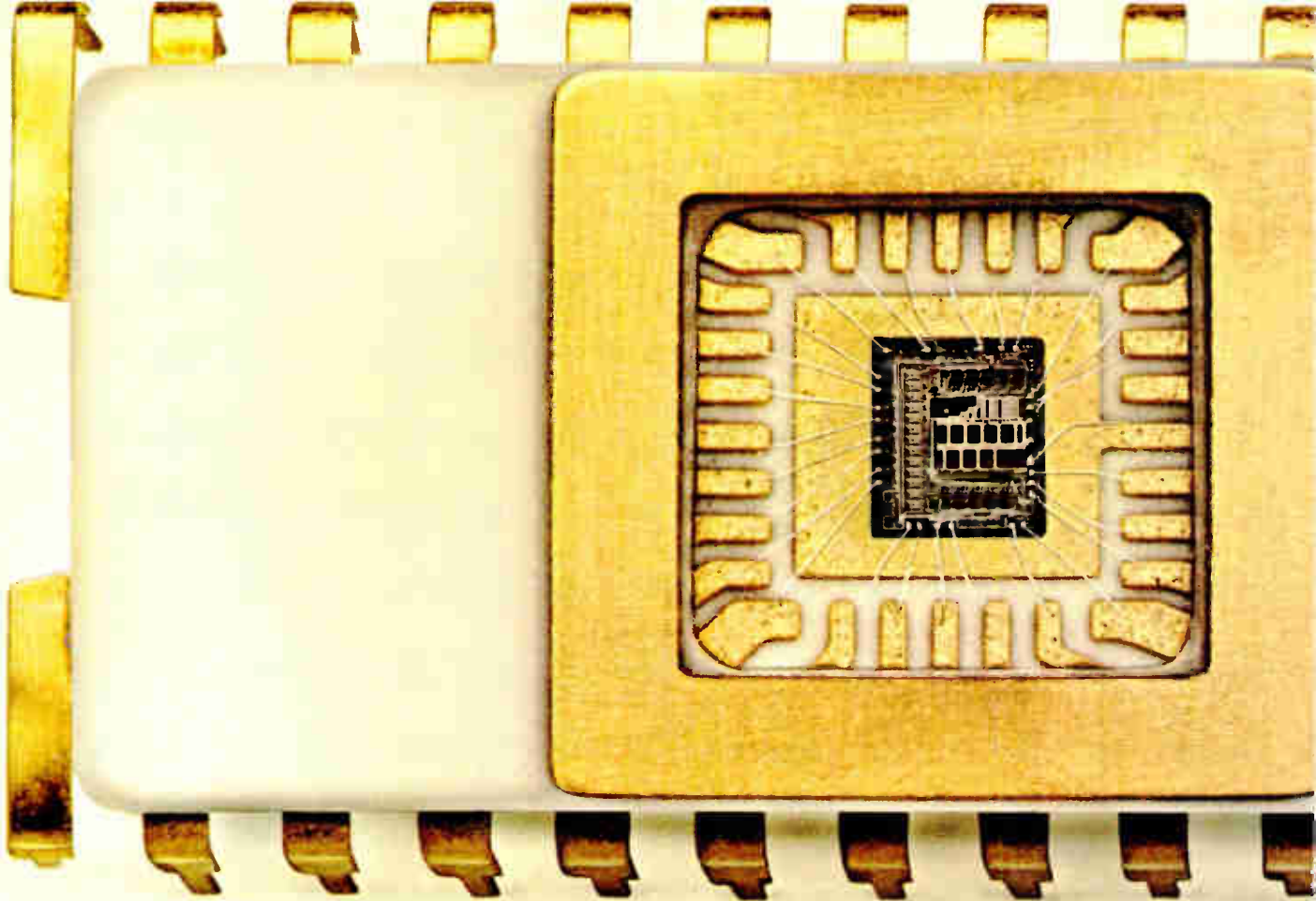

Analog Devices. We're for real.

It's hard to tell what's real and what's make believe nowadays. With all the claims and counterclaims about IC Converter capability.

We want to set the record straight.

The Analog Devices IC Converter expertise is more than talk. More than product. More than potential.

It's our ten years experience in data converter technology. It's the support and characterization of our family of IC Converters. It's the assessment of market needs, the implementation to meet those needs. It's the reality of a worldwide technical sales force that knows the IC Converter business from design through application. It's helping our customers solve their problems more efficiently.

The real world. Real products are the first measure of leadership. We have more than twenty bona fide IC Converters for immediate delivery in quantity.

A dozen or so more are in the wings which boast the advantages of low power CMOS and high stability bi-polar construction. Analog Devices IC Converters

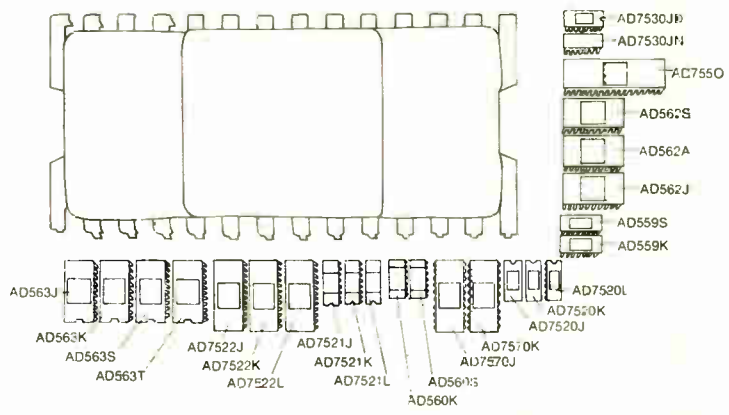

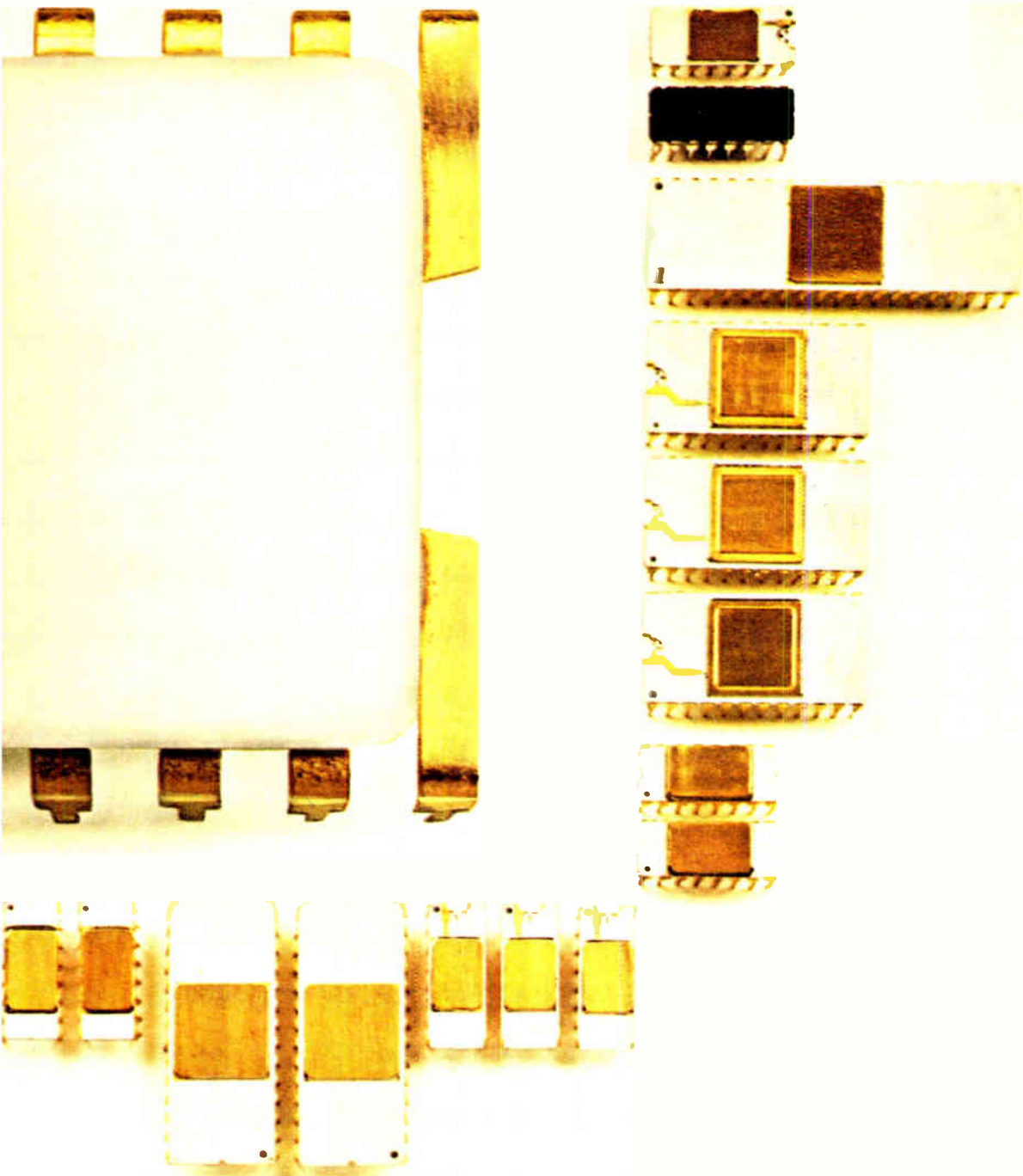

give you the solution to the very real problems of cost, reliability and performance.

From the 10-bit CMOS DAC, AD7520, to the 12-bit laser trimmed DAC's, the AD562 and AD563, and the microprocessor compatible 13-bit CMOS A/D Converter, AD7550, you'll find the right IC Converter to meet your specific needs. They're all available in a variety of performance and package options.

Making it real. IC production technology at Analog Devices is what separates us from our competition. Carefully controlled processes ensure the highest possible yield even on the most difficult chips. Add the fact that our IC Converters are true IC Converters specifically designed to maximize the advantages of bi-polar and CMOS technology with a minimum number of chips. Plus our exclusive laser trimming to guarantee IC Converter performance and our policy of 100% testing for complete stable final

characterization of each device make us your best source of IC Converters. We're the real company in precision measurement and control.



The real IC Converter company.

Analog Devices, Inc., Norwood, Massachusetts 02062
East Coast: (617) 329-4700, Midwest: (312) 894-3300, West Coast: (213) 595-1783, Texas: (214) 231-5094, Belgium: 03 38 27 07, Denmark: 97 95 99, England: 01/94 10 46 6, France: 686-77 60, Germany: 089/53 03 19, Japan: 03/26 36 82 6, Netherlands: 076-122555 and representatives around the world.

Circle 23 on reader service card

A resistor for all reasons

Here's a way to cut the daylights out of your fixed resistor inventory. Standardize on our Type CC cermet. It's sized like a ¼-watt but you get performance that ranges from ⅛-watt at 125°C to ½-watt at 70°C (250 volt max.) Tolerance is 1% over the complete resistance range of 10 ohms to 22.1 megs or 0.5% from 10 ohms to 499K. TCR is as low as ± 50 ppm/°C. The one resistor for all reasons: industrial, RN55C, RN55D and RLR07 needs to 1% and 2% tolerance. We have what you need; our distributors have it when your need is now. Ask for Publication EC33.

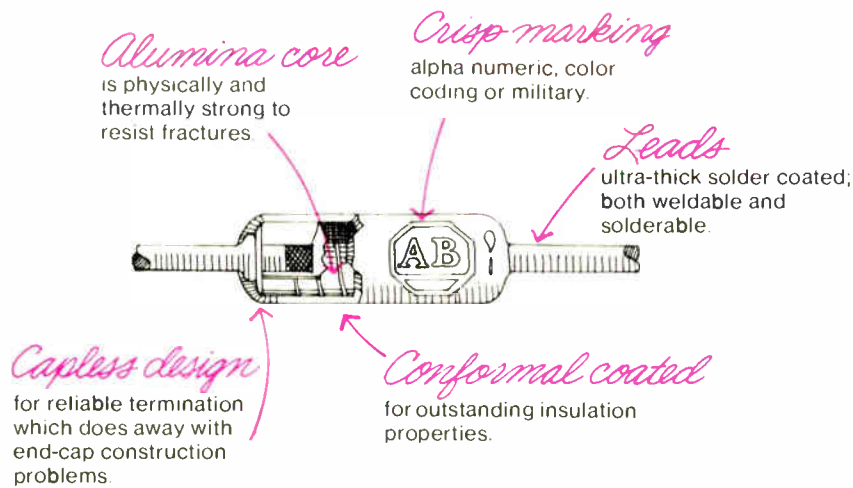

Quality in the best tradition.



ALLEN-BRADLEY
Milwaukee, Wisconsin 53204

EC129

Bumped film carrier handles most ICs

A new bumped film carrier developed by Pactel Corp. of Westlake Village, Calif., may make it possible **to assemble hybrid ICs with the film-carrier or beam-tape automated method.** Up to now, the need to have the bumps—extra metalization—built up over a chip's normal aluminum pads has limited film-carrier packaging mainly to high-volume digital ICs in dual in-line packages. The bumps protect the chips from the heat of thermocompression bonding.

Developed by Pactel for General Dynamics, the new tape chip carrier has copper IC patterns on one side of a polyimide tape, just like the conventional film carrier. However, the inner leads of the new type tape patterns are in electrical contact with specially metalized, 3-mil-high bumps on 8-mil centers on the other side of the tape. **This eliminates the need for special wafer metalization,** with its attendant costs, yield losses, and reduced chip availability. What's more, it is compatible with virtually all IC chips.

Prime first to use commercial 16-k RAMs in system

It appears that the first computer manufacturer to announce a memory based on the new **commercially available 16-kilobit random-access memory chips** is Prime Computer Inc., Framingham, Mass. Four-Phase Systems, Cupertino, Calif., had previously announced a computer using its own 16-k RAM chips [*Electronics*, Nov. 27, 1975, p. 36]. Prime says it is demonstrating a memory using Intel chips and packing 256,000 bytes on a board measuring 16 by 18 inches. The memory plugs into the company's new model 400 computer [*Electronics*, Feb. 5, p. 92] and allows the computer to be expanded up to 8 megabytes of directly addressable memory.

Price of the board will be \$35,000 says Prime, but deliveries will be on a system-by-system basis until the company is satisfied that it can get enough 16-k chips to assure regular deliveries. That announcement probably will be made in September.

Mostek shipping samples of its 16-k RAM

Mostek Corp. has begun to ship sample quantities of its 16-k RAM, the MK 4116. Close to a dozen major customers have seen parts; **access times are all faster than 200 nanoseconds.** Mostek is the third vendor to sample a 16-pin 16-k RAM, following the Intel and Texas Instruments versions released earlier this year [*Electronics*, Jan. 8, p. 27]. Like TI's, and unlike Intel's, Mostek's requires 128 refresh cycles and uses unlatched outputs. The firm expects to build production steadily, reaching as many as 10,000 a week by January.

Displays combine maps, computer data

Control Data Corp. and Litton Display Systems are expected to receive this month several million dollars each to develop what are perhaps the largest displays ever built with their respective and competing technologies. As the second phase of its Interactive Computer Presentation Panel project to combine standard maps and computer-generated information, the Army is paying for two approaches: **Control Data's transparent plasma panel over standard paper maps, and Litton's transparent maps over a light-emitting-diode display.** Two years from now, the firms will compete head-on for the program's engineering development phase.

Under an initial study contract completed early this year, Control Data built a 16-by-16-inch transparent display. It plans to demonstrate that display with a backlighted map in a battlefield scenario at this month's Armed Forces Communications and Electronics Association show in Washington, D.C. Litton will be there, too, to demonstrate its display, which is designed around 392 edge-stackable plug-in LED modules.

IEEE presidential race shifts into earnest campaigning . . .

Both candidates-by-petition for president of the IEEE now claim to have the **signatures of enough members to get on the fall election ballot** and to have their campaign statements plus rebuttals appear in the August issue of the institute's monthly publication, Spectrum. While the submitted signatures were being validated, Irwin Feerst reported a count of more than 3,300 and Robert Rivers, more than 1,600. Both exceed the 1,448 signatures required to make the ballot and run against the candidate nominated by the board of directors, Robert Saunders. And Carlton Bayless has collected enough signatures to challenge Robert Buskman for executive vice president.

. . . and a campaign statement runs into trouble

The main objective of getting the required number of signatures validated early this month, even though it is possible to continue collecting names until the end of July, was to provide time for Spectrum to prepare the candidates' statements and rebuttals for August publication. However, the procedure may be interrupted by a **squabble between candidate Feerst and the IEEE headquarters.**

Feerst submitted his statement in the form of a flow chart, similar to a computer decision-block diagram, which was rejected as not fitting the format stipulated by the magazine. Spectrum is editing the diagram to follow the usual candidate statement style, in order to avoid delaying publication, but Feerst is not satisfied, because, first, notification of rejection came from IEEE general manager Herbert Schulke, rather than the Spectrum editor, and second, the magazine uses flow charts in other articles.

Auto makers looking at 80-cent temperature sensor

Dale Electronics has started sending to the auto firms samples of a wirewound nickel, bobbin-type temperature sensor that it will sell for 80 cents each in large quantities. **The barebones unit, suitable for measurements of air temperature, has a response time of 7 seconds,** compared to the 35 seconds response time of the firm's \$2.75 molded sensor, now used to sense air and water temperatures for the Bendix fuel-injection system in Cadillac Seville.

Canada's air-traffic system ready to be tested

The Canadian government's highly automated air-traffic-control system **will begin performance-evaluation tests later this month or early next.** Called JETS, for joint en-route terminal system, the concept uses CRT terminals linked to Interdata minicomputers in a distributed-processing system, and was designed by Sanders Associates, Nashua, N.H. Sanders has licensed CAE Industries in Ottawa, Ont., to build a large part of the display. When phase one of the contract is completed, seven en-route and two terminal centers will be equipped, requiring 140 systems in all.



A chip off the old block.

As you can see, this chip is housed in ceramic and mounted in a forty pin, dual in-line package.

As you can't see, it's a NOVA[®] computer.

Inside that packaging sits a full 16-bit, silicon gate, NMOS microNOVA CPU. The mN601.

The mN601 is the first microprocessor designed and manufactured by a minicomputer company. And it's the highest performance NMOS microprocessor on the market. With our 160 nanosecond RAM, it has a memory cycle time of 960 nanoseconds and the fastest instruction times going. Like an Add of 2.4 microseconds. And a Load of 2.9 microseconds.

The mN601 has the 16-bit NOVA instruction set including hardware stack for easy programming. And 16-bit data for efficient memory use.

It also has hardware multiply/divide for fast program execution. Integral data channel logic for easy interfacing to high performance peripherals. Control and timing for high density RAM memories. Integral hidden refresh logic that overlaps instruction execution timing. Plus a unique I/O encoding scheme for efficient easy interface design. Even the real-time clock is included. All of which reduces the chip count.

And all that computer is in a single chip.

And because the mN601 is a NOVA, it uses the most mature, field-proven software you can get with any micro. So you can cut back on development time and cost by using compatible software like our diskette-based Disc Operating System and our Real-Time Operating System.

Also, the mN601 comes with the full documentation support you'd expect from a minicomputer company like Data General.

If you want more than a chip, you can get it. There's a whole chip set, a 4K computer-on-a-board and a fully-packaged 9-slot microNOVA MOS mini. And there's more.

Don't stop here.

Sign up for a technical seminar on the microNOVA. They'll be held in major cities around the country from New York to Los Angeles. They'll last a half-day. And they're free.

For more information call our toll free number, 800-225-9497 (Unless you're in Massachusetts. In which case, call 1-617-485-9100 Ext. 2509.)

microNOVA:

A giant reduction in the NOVA line.

DataGeneral

• Data General, Route 9, Southboro, Mass. 01772 (617) 485-9100. Data General (Canada) Ltd., Ontario. Data General Europe, 15 Rue Le Sueur, Paris 75116, France. Data General Australia, Melbourne (03) 82-1361

NOVA is a registered trademark of Data General Corp.

World Radio History

Circle 27 on reader service card

SIEMENS

When your reputation's riding on the quality of your 4K RAM's, Siemens 203 is the one test system to own. Ask Mostek — they own ~~five.~~ ^{eight.}

Mostek demanded high-throughput yet thorough testing for their 4K RAM's. They also wanted fast delivery. Siemens provided the answer—a semiconductor memory tester which delivered the performance they needed. And delivered it on time.

The 203 Semiconductor Memory Device Test System is a new, powerful tool for evaluating the performance of RAM's, ROM's and Shift Registers in production, engineering, and incoming inspection. The system satisfies all aspects of high-speed functional and DC-parametric testing requirements to provide total test flexibility and lowest cost-per-unit throughput.

The microprogrammable processor in the 203 generates address sequences and data patterns at true 20 MHz test rates, enhancing its use for future high-speed devices. Multi-cycle timing is provided by 16 independently programmable channels.

A high-resolution 1 NS clock permits meaningful time-related device tests, ensuring accurate, repeatable test results.

The 203 Test System is totally unique in the semiconductor memory test field. It offered Mostek an unmatched test capability at the least overall cost; it can do the same for you. Today and tomorrow.

Siemens Corporation Computest Products

3 Computer Drive, Cherry Hill, N.J. 08034 (609) 424-2400

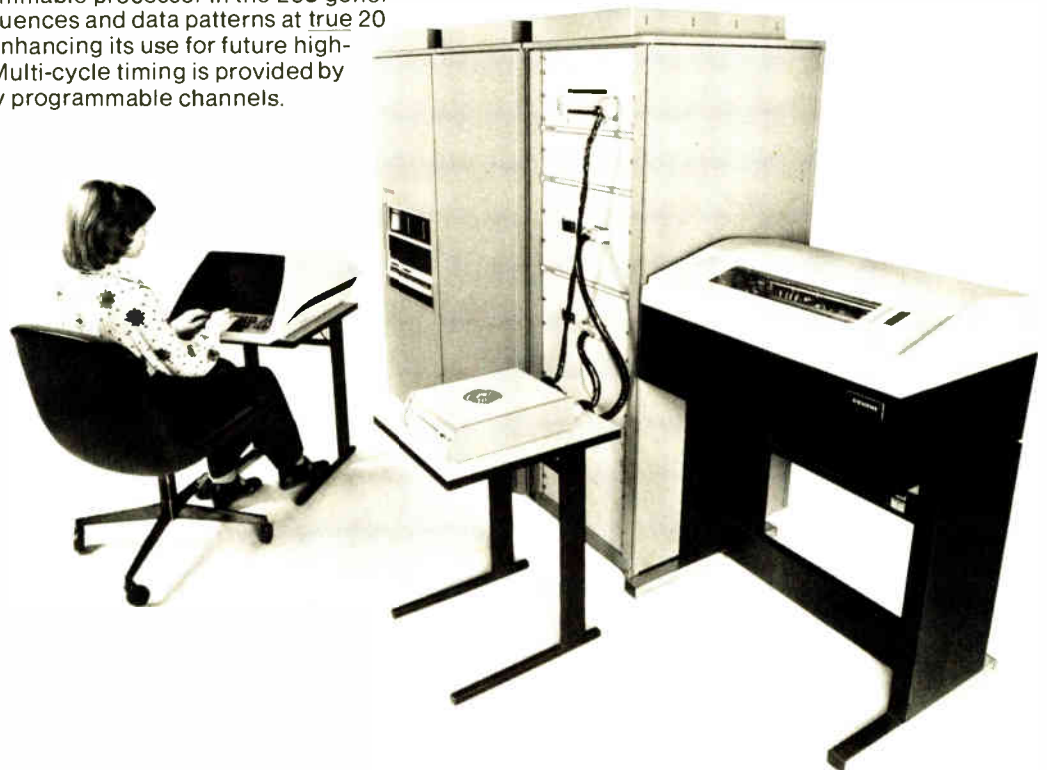

National's scientific calculator has long-term all-semiconductor memory

C-MOS, MNOS, and p-MOS memory elements, plug-in program units help 7100 handle 4,240 program steps

The permanent-program-storage end of the hand-held-calculator market has so far been the exclusive domain of the \$795 HP-65 and the \$395 SR-52. Both Hewlett Packard and Texas Instruments, though, will have to move over and make room for a powerful new member of the club from National Semiconductor Corp.—the all-semiconductor-memory 7100, which will be ready for this Christmas season.

With the all-semiconductor approach taken with the 7100, according to Robert Johnson, director of advanced calculator development at the Santa Clara, Calif., firm, three different types of memory are used to achieve nonvolatility. Present calculators, including the HP-65 and the SR-52, use standard p-channel metal-oxide-semiconductor random-access memories that lose their data when the power is turned off. The 7100 will be the first to feature complementary-MOS RAMs that in the standby mode retain information indefinitely using only a battery's trickle current.

Then, instead of preprogrammed magnetic cards, the 7100 features factory-preprogrammed plug-in "library" cartridges containing a 16,384-bit p-MOS mask-programmable read-only memory. Finally, instead of another set of blank magnetic cards on which a user can permanently store his own specially

developed programs, there is a user-alterable plug-in file cartridge containing two 1,024-bit nonvolatile metal-nitride-oxide-semiconductor RAMs, capable of retaining data for years without power. These cartridges will cost about \$20 apiece.

According to Kris Graham, 7100

"dump" it into working registers and frees the internal memory, giving the 7100 a number of capabilities that simply overpower the competition. Internally, for example, the calculator has 240 merged-program steps and 32 user-available data-storage registers, compared with 224

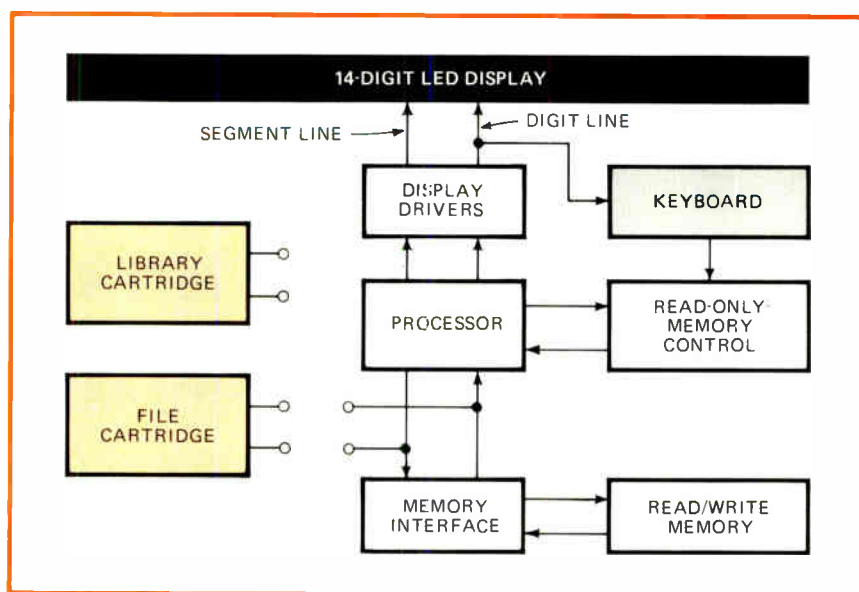

product-marketing manager, the heart of the \$395 calculator is a 1.5-by-2.5-inch printed-circuit board containing 11 chips essential to the system: four 1,024-bit C-MOS RAMs, three p-MOS read-only memory control elements organized as 32 pages of 64 eight-bit instruction words each, the p-MOS memory and processor element, a RAM-interface chip, and two bipolar interface chips to the 14-digit LED display.

Overpowering. The fact that the preprogrammed plug-in ROM acts as an integral part of the system, says Graham, makes it unnecessary to

steps and 20 registers for the SR-52 and 100 steps and 9 registers for the HP-65. "In addition," Graham says, "use of the factory-recorded programs in the library cartridges as subroutines to the program in the mainframe memory brings the total program step capacity to 4,240."

If the user develops a program that is greater than the 240 merged steps in the internal memory, another 240 steps can be stored on the MNOS file cartridge and used as a subroutine. By comparison, to store 4,240 steps in the SR-52 would require 21 cards and in the HP-65, 43

cards. "And in neither case would the steps be available as subroutines to the internal memory," says Johnson. The 7100 has four subroutine levels and eight program flags, versus 2 and 5 for the SR-52 and 1 and 2 for the HP-65 as well as 66 keyboard functions versus 51 for the HP-65 and about 80 for the SR-52. However, the 7100 has 23 key functions for programming.

Other features include backspace, insert, single-step, delete, and pack capabilities for debugging, editing, and reviewing programs; symbolic labeling; conditional and unconditional branching; and decrement and branch of zero. Unlike the HP-65 with its reverse-Polish notation, the 7100 uses straight algebraic logic and has only 3 levels of parentheses versus the 9 for the SR-52.

The comparatively low cost of the 7100, says Johnson, comes not only from the elimination of the motor-driven card reader, but also from the use of standard chips. "Except for the 16-k ROM in the library cartridge, which was designed specifically for this calculator application, and the MNOS RAMs supplied by an outside vendor, everything is available from one of several standard National families of devices."

Johnson expects to be in production with the 7100 in time for the Christmas season. Supplied with the calculator will be two file cartridges, a library cartridge with a 75-program mathematics package, a battery pack, carrying case, charger, and instructions. Financial, statistical, and engineering cartridges are in development. □

Solid state

Six Trapatts yield 35 W at 7.5 GHz

In the search for high-power solid-state sources for long-pulse radar transmissions, researchers have tried to connect Trapatt diodes in series to increase power. The trouble is, in experiments so far, the diodes' thermal paths were also in series, which

made continuous-wave or long-pulse operation impossible.

Now engineers at the Georgia Institute of Technology have applied computer simulation to the circuit characterization of the Trapatt diode, including mounting parasitics. The resulting packaging guidelines, coupled with much experimentation, has led them to a remarkably efficient structure: six Trapatt diode chips on a diamond substrate. While the chips are mounted electrically in series, thermally they are in parallel.

With the diamond substrate specially selected for good thermal conductivity and measuring only 0.03 inch square by 0.02 in. high, the circuit produces 35.5 watts at 7.5 gigahertz. Other combinations of two, three, and four chips provided 12, 14, and 21 w at about 8.7 GHz. All circuits achieved nearly 100% combining efficiencies.

Parallel operation. Walter Cox, head of the solid-state sciences division of Georgia Tech's Engineering Experiment Station, says that parallel operation is a must. Pulse widths of 50 microseconds look like cw operation to the diodes because for those time intervals, the diode approaches thermal equilibrium. Efficiently series-combining the diodes increases the rf impedance of the combination, easing matching.

Initial experiments in the project, which had support from the Naval Electronic Systems Command, were conducted at 2 GHz. The diode chip was mounted on a diamond substrate along with an alumina capacitor on a copper slug, and a gold wire was attached to the capacitor and to the top of the diode chip. Various package capacitance values were made by changing capacitors, and diode lead-inductance variations

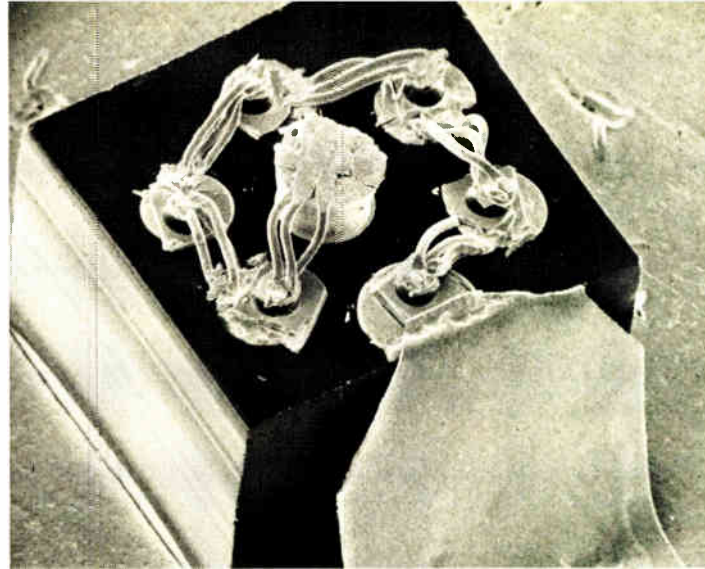

Real jewel. Six mesa Trapatt diodes, surrounding copper post used to contact center conductor of coaxial transmission line, are mounted on 0.03-inch-square, 0.02-inch-high diamond substrate.

were made by adjusting the number and length of contact wires.

There was a drastic change in conversion efficiency for capacitance values greater than 1 picofarad, yet variations in lead inductance had little effect. Above a maximum value of package capacitance, which is related to the diode depletion-layer capacitance, the characteristic Trapatt voltage waveform is lost.

Packaging. Further computer simulation and experiments showed that at 7 GHz, the location of the diode on a metalization pad used to mount it to the diamond substrate and the point where the grounding strap contacts the pad significantly affected performance. When using small metalization pads not much bigger than the diode itself and a small quartz standoff for contacting to minimize package capacitance, the efficiency of two diodes in series just about equals that of a single diode chip at frequencies up to 9 GHz.

Omitting either of these conditions results in a 50% drop in combining efficiency. "Although some sensitivity of diode performance to higher-order harmonics was expected, a 50% reduction was not," says Cox. "The apparent significance of these harmonics was surprising and had been previously overlooked."

"It doesn't appear as if six devices is the limit," says Cox, "but too many devices will have to be spread out for thermal considerations and this will affect package parasitics." □

Oceanography

Smart hydrophone tracks currents

Ocean-research sonic buoys are normally tracked by moored hydrophones and the information sent by cable to a land station, perhaps 20 miles away—an expensive procedure. If the information can be stored for up to a year, though, the hydrophone's location is not limited by cable length.

However, fitting a year's worth of data onto a limited amount of magnetic tape requires a "smart" data-collection package. What's more, besides having to identify valid signals and discard noise, "this data package is limited to a 200-milliwatt power drain, so practical design demands a low-power complementary-MOS microprocessor," says its developer, Albert Bradley, research associate at Woods Hole Oceanographic Institute.

The package, to be moored 2,000 meters deep, will be used in a Navy-sponsored program to track ocean currents. By timing signals from up to 200 free-drifting sonic buoys, the system can track buoy movement. Surprisingly little is known about ocean currents, and the Navy is interested in their effect on sound propagation, while biologists want to follow the transport of nutrients.

Operation. In the Woods Hole system, each buoy transmits the same narrow-band frequency sweep, which is picked up by the hydrophone. Its output voltage is amplified and fed into a double-conversion superheterodyne receiver—a double mixing operation that reduces the signal frequency to approximately 1–2 hertz.

After filtering to remove ambient sea noise, the low-frequency output is hard-limited, removing all amplitude information and leaving only the polarity. The result, essentially, is a series of pulses, which are sampled at 10 Hz by an RCA 1802, 8-bit C-MOS microprocessor. It stores 800

successive samples in random-access memory. Every 1/10 second, the 800-bit stack is compared with an ideal transmission.

To reduce power drain, the microprocessor is operated at slow speed, and the high-speed bit comparison is performed predominantly in a simple module, hung on the processor bus, which contains two 8-bit registers. The microprocessor transfers the ideal transmission and the stored samples from memory into these registers, 8 bits at a time. If a predetermined number of bits agree, the signal is stored in stack.

"This is a crude cross-correlation," explains Bradley, "but it is good enough for our purposes, since there is no information in the signal. We are merely trying to identify the signal in a noisy background."

In operation, only the four largest signals that arrive during each 10-minute interval are saved. The buoys operate on a real-time clock and their launch time is precisely known. They are spaced out so that only two transmit within a 10-minute interval. By storing the four largest signals, the two valid transmissions are sure to be captured.

When the tape is retrieved, the scientists can identify which two of the four signals represent buoy transmissions. Since they float very little in the 8 hours between trans-

mission, by lining up 10-minute windows, the signals closest in transmission times will be buoy signals. □

Military

Dual radar spots mortars, artillery

Convinced that two radar beams are better than one for detecting and tracking hostile mortar and artillery fire, engineers at Raytheon Co.'s equipment division came up with a dual-beam system that's undergoing tests at the Army's Yuma Proving Ground in Arizona. An even tougher test comes next month, though, at Fort Stewart, Ga., where the Hostile-Weapons Location System will face shell fire in a rainy, radar-clutter environment.

The Yuma and Fort Stewart tests, although using Army facilities and including Army observers, are being conducted by the Naval Electronic Systems Command and Marine Corps, for which Raytheon developed the system. Raytheon officials would like the Army to take a close look at it, though, claiming their system can do the same job for which the Army is developing two radars. These are the AN/TPQ-36 counter-mortar system and the AN/TPQ-37

Weapons-location competition heats up

Hughes officials, fresh from winning out over Sperry's Gyroscope division in the artillery-locating TPQ-37 competition, report the Army "elated" with the performance of both the Hughes and Sperry systems. Herbert Cox, marketing manager for weapons-locating radars at the Hughes Ground Systems group, Fullerton, Calif., says further that the counter-mortar TPQ-36 encountered no blind speed problems in its Yuma tests, already completed. He says the difficulty can be avoided by varying the pulse-repetition frequency to cover any blind spots.

When asked to discuss results with both their TPQ-36 and TPQ-37, Army officials deferred to Cox, who terms the Yuma tests of the TPQ-36 very successful. Regarding costs, Cox says Hughes has received a number of incentive awards for meeting cost targets for both systems. The unit production costs were established at the outset of both programs. The TPQ-36 is to cost \$534,000; the TPQ-37 is targeted at \$1.1 million—both in fiscal 1973 dollars.

Cox points out that the TPQ-36 is being readied for its trials in Fort Stewart's rain—ahead of Raytheon's HWLS—and that while a narrow L-band beam has an advantage over X band in rain, the HWLS fan beam illuminates such a large area that its advantage in rain is negated.

artillery-detection radar [*Electronics*, Oct. 30, 1975, p. 71], both of which are being built by Hughes Aircraft Co.

Raytheon has support from the Directorate of Defense Research and Engineering in alerting the Army to the system's capability. In February, during congressional testimony, Malcolm R. Currie, DDRE director, said, "It is not clear that all of these systems are required, and a series of comparative tests will be made to assess the relative performance of these systems."

Two radars. Officials at the Sudbury, Mass., Raytheon division are confident that their system, which combines on one pedestal an L-band search-and-detection radar with an X-band tracking unit, will vindicate their approach because of results already in hand. The system faced more than 2,000 rounds of mortar and artillery fire even before the Yuma tests began. In those ear-

lier tests, "HWLS successfully located multiple weapons with excellent accuracy over a 180° sector," claims Edward F. Hudson, marketing manager for counter-weapon radar systems at the division. What's more, they were "firing simultaneously at high rates."

Hudson and Albert Bachman, Raytheon's HWLS program manager, say the L-band fan beam from the continuously rotating antenna gets around the "blind speed" problem of X-band in detecting high-velocity artillery projectiles. Radar can be blind to a target at certain combinations of target velocity with detection system wavelength and pulse-repetition frequency.

These variables can combine to hide the target in the clutter because the target's doppler velocity cannot be determined. Although L band does eventually encounter blind speeds, "you have to go to many multiples of X-band blind speeds before you reach the first L-band blind speed," Hudson asserts. The TPQ-36 is an X-band system, while the TPQ-37 uses S band.

Scanning. Once the L-band beam detects an incoming projectile, the system's AN/UYK-20 computer determines the projectile's range, azimuth angle, and doppler velocity. This data is used to position the phased-array X-band pencil beam to track the target and to select a pulse-repetition frequency that prevents the lower X-band blind speeds from masking the round.

The X-band system develops a trajectory pattern after several scans, and the processor also computes the weapon's location from the trajectory data, all before the projectile's impact. The idea is to call in a counter-strike quickly—a goal that may be realized by linking through a modem the HWLS to the Army's Tacfire offensive-artillery system or to the Marine Tactical Data System.

The Univac UYK-20 is in volume production for the Air Force and

Navy, Raytheon points out, and both the L- and X-band portions of their system are updated versions of proven hardware. While a production HWLS would cost more than the TPQ-36 countermortar radar's projected cost, Hudson and Bachman claim that it would be only half the cost of the artillery-locating TPQ-37. The HWLS, however, couldn't be operational as soon as the other two systems. □

Speech analyzed by entry-control system

The military is becoming increasingly concerned about protecting secure areas—such as buildings that house computers with classified information in the data base. To control access, the Air Force has been given the task of developing systems for automatic speaker, handwriting, and fingerprint verification that can be used by all the services. The first to get a thorough field test is a speaker-verification system soon to be installed at Pease Air Force Base, near Portsmouth, N.H.

An advanced development model, developed by Texas Instruments and the Mitre Corp. for the Air Force Electronic Systems Division, Hanscom Air Force Base, Mass., works with four-word phrases spoken by a person seeking access to the secure area. It compares them with a digitized representation of that speaker's voice previously stored in computer memory. If the speaker passes the test, a door or gate opens.

Denial. In tests involving more than 200 persons at Mitre in Bedford, Mass., the system bettered established error rates, says Wolf Haberman, group leader in Mitre's Security Systems Group. It denied entry to authorized persons about 1% of the time and allowed entry by unauthorized users in less than 1% of the tests.

A potential user must first enroll in the system. To do this, he uses a keyboard to enter his four-digit identification number, which tells the TI980B computer that a new

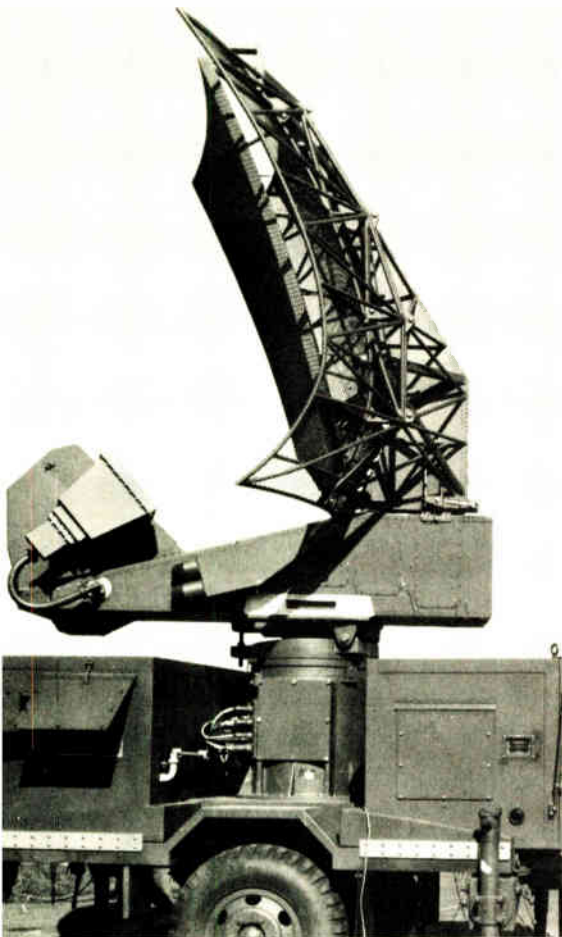

Double up. With smaller L-band feed horn mounted on side of X-band horn, mobile hostile-weapons-location radar sports two reflectors, avoids blind-speed problems.

The

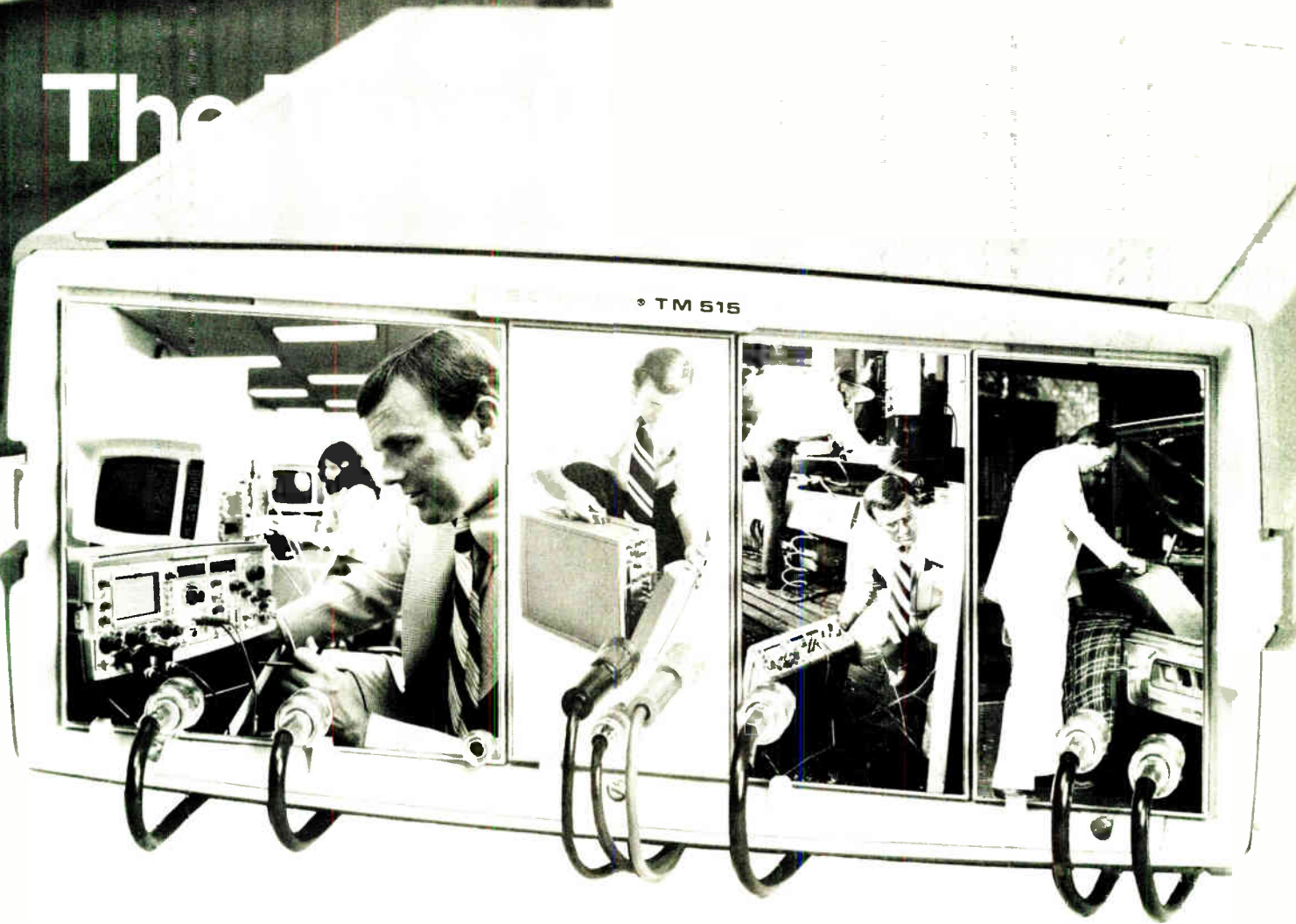

A New Concept In Portable Test Equipment

The **TEKTRONIX TM 515 Traveler Mainframe** looks like luggage, but it's really a five-compartment mainframe that provides power and interface connections for TM 500 plug-in modular test and measurement instruments. Typically weighing less than 32 pounds (with instruments), it's small enough to fit under an aircraft seat, moisture and dust resistant, and rugged.

With the **TM 515**, you can take the same instruments with you that you use in the lab . . . and maintain the same standards in the field. The case holds five plug-in instruments, and the covers serve as a storage area for your accessories. Now you can concentrate on making mea-

surements instead of the logistics of getting your instruments to the test site.

You can optimize your system by selecting from over 35 general-purpose and specialized TM 500 plug-ins. Plug-ins include DMMs, counters, generators, power supplies, signal processors, logic analyzer, oscilloscopes, monitors, and even blank plug-ins for your custom

circuits. Intended application areas range from digital field service to medical, from audio/communications to on-site industrial control maintenance.

For more information, contact your local Tektronix Field Engineer or write or phone: Tektronix, Inc., P.O. Box 500, Beaverton, Oregon 97077, (503) 644-0161 ext. 5542. In Europe: Tektronix Limited, P.O. Box 36, St. Peter Port, Guernsey, Channel Islands.

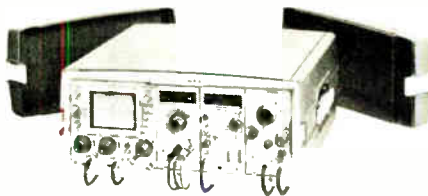

For Technical Data circle 32 on Reader Service Card.

For Demonstration circle 33 on Reader Service Card.

reference file is being created. He is then directed by a recorded voice to speak at least 20 four-word phrases into a microphone, which are digitized and stored. Adolph Fejfar, Mitre's task leader for entry-control subsystems, explains that monosyllabic words with a single energy peak—usually centered on a vowel—are used to simplify the time registration in the computer.

Low-pass filters, an analog-to-digital converter, and a digital filter bank process speaker's stored phrases, using a technique that improves the signal-to-noise ratio and emphasizes variations between speakers. One part of the technique gives the high-frequency components more gain.

When the user wants to enter the secure area, he again keys in his identification number, calling up his reference file for comparison, and is directed by recorded voice to repeat one of the phrases. As he speaks, a

time sample is taken every 10 milliseconds, with the reference pattern for each word totaling 100 milliseconds.

The new speech material is digitally processed to get a single numeric representation for a given time sample, which is compared with the representation for that word that's been previously stored. As the sampling continues, the computer tabulates the speaker's score for all four words, Fejfar says. This score becomes the speaker's standard error for that four-word phrase.

After the initial field tests are complete, the Air Force Electronic Systems Division will develop a system specification to be used for commercial procurement of more systems. The system, as well as the handwriting and fingerprint verification efforts, are administered by the division's base and installation security systems program office. □

Solid state

HP's 4-year gamble on SOS pays off in products, performance

A few years ago, it looked like silicon-on-sapphire would satisfy the quest for a process that would yield devices with the speeds of bipolar technology, the densities of n-channel metal-oxide-semiconductor devices and the low power of complementary-MOS.

After much investigation and a few casualties, such as Inselek, though, most semiconductor makers have pulled out of the search. The one exception is RCA Corp., which has the only commercially available SOS memories and is working on an SOS version of its 1802 microprocessor.

However, one non-semiconductor company—Hewlett-Packard Co.—felt that, for it, SOS was a viable process—one that would give it an almost overpowering competitive edge across its entire product line. As a result, it spent four years and several million dollars on develop-

ing a proprietary C-MOS-on-sapphire process.

Payoff. Now, it looks as if the gamble has paid off. HP computer-circuit developers have obtained two to five times better performance with SOS than with other methods. For instance, 16-bit minicomputer-type C-MOS-on-sapphire CPU chips, with densities in the range of 150 gates per mm², are operating with propagation delays of 1 to 4 nanoseconds at speed-power products of 0.25 picojoules. Noise margins are good and are in the comfortable 4-volt range.

According to Richard Anderson, general manager of HP's Cupertino, Calif., Data Systems Division, it has successfully manufactured thousands of circuits using SOS, and has at least eight large-scale integrated circuits on the way. The division's trump, though, is the 16-bit microprocessor chip that is equivalent to a

minicomputer CPU and will run with cycle times in the 100–300-nanosecond range. HP will use a three-chip set of SOS processor circuits to build a machine with performance that will be equivalent to its present 3000 computer.

Why SOS. In the past, it was not so much developing the process that was the problem, as it was doing it in a cost-effective way. Admittedly, says Anderson, developing SOS has been an expensive proposition. Not only is the sapphire substrate, which acts as an insulator, much more expensive than the usual silicon wafer, it is harder to etch. However, HP executives are convinced that for high-performance circuits the SOS systems will ultimately yield lower-cost circuits than those built with bulk MOS and I²L. So far HP's experience with SOS indicates that, once the SOS starting material is firmly in hand, wafer defect densities are much lower than those of comparable single-channel and bulk C-MOS designs.

"Our economics are not the economics of a semiconductor company," he says. What HP was looking for, says Anderson, was something that would give its computer products a performance edge that was several orders of magnitude ahead of the competition—"Something the customer will be willing to pay handsomely for, and something hard for the competition to copy." □

Microprocessors

Emulation speeds 8080A at Signetics

Using Schottky-bipolar devices, Signetics Corp. is aiming to chip away at the high-performance end of the market for the Intel Corp. n-channel MOS 8080A microcomputer. The subsidiary of Philips in Sunnyvale, Calif., will soon begin volume production of a Schottky-bipolar emulation of the 8080A and several of its peripheral devices. To produce the chips, Signetics will use the ver-

Look what you get when **Tektronix** builds a 50 MHz portable

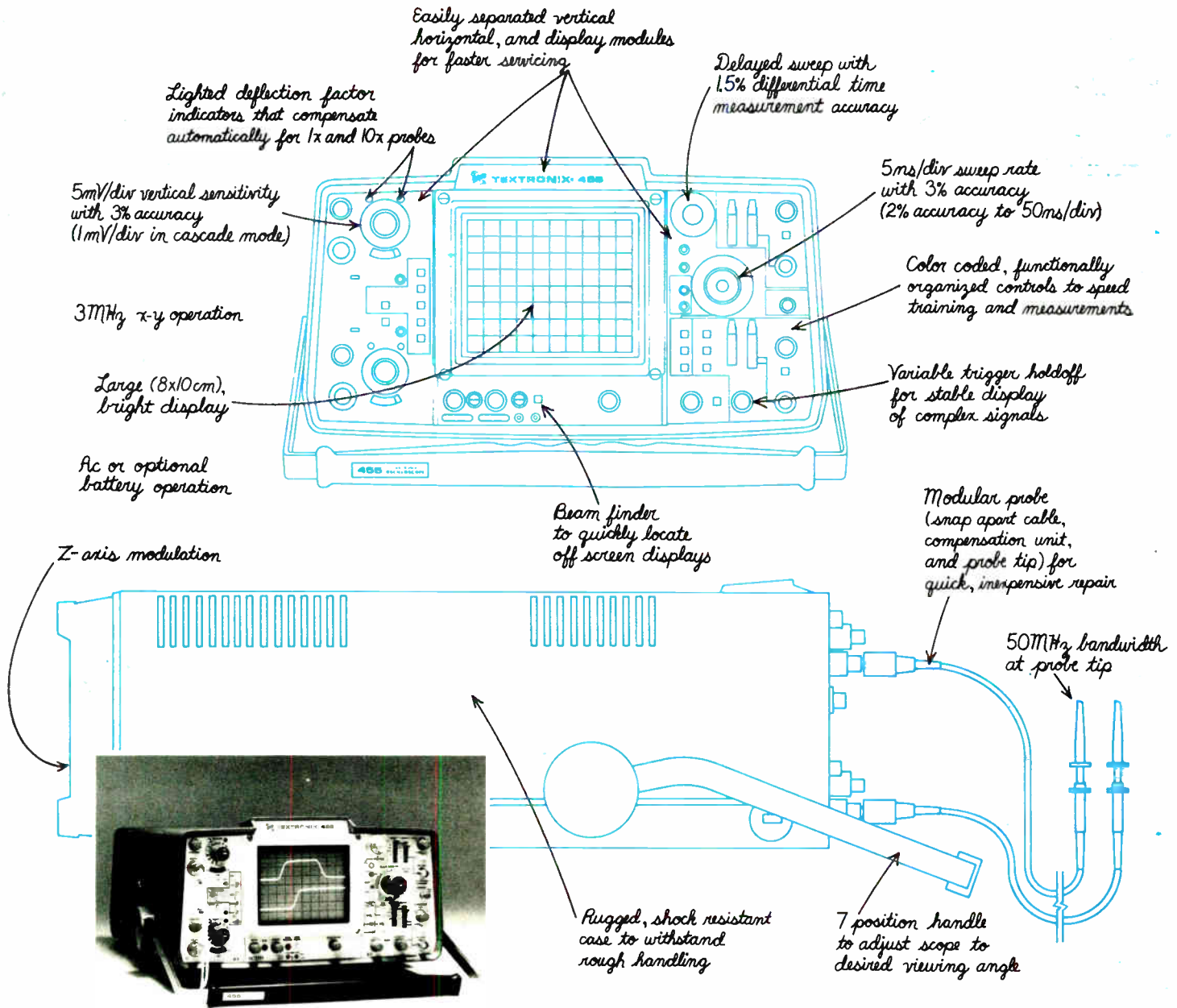

TEKTRONIX 455 — \$1745

And the 455 offers the quality, reliability, and service you expect from Tektronix.

If your application requires higher bandwidth and/or storage, the high performance TEKTRONIX 400 Series offers 6 other outstanding portable oscilloscopes. Bandwidths include 100 MHz, 200 MHz, and 350 MHz. Also offered are a fast transfer storage model capable of displaying single-shot, 100 MHz signals and a split screen, bistable storage model.

For a no obligation demonstration of how the 455 and other TEKTRONIX Portable Oscilloscopes deliver performance, convenience, and cost effectiveness for your

application, contact your Tektronix, Field Engineer. Or for complete information write: Tektronix, Inc., P.O. Box 500, Beaverton, Oregon 97077. In Europe write: Tektronix Limited, P.O. Box 36, St. Peter Port, Guernsey, Channel Islands.



U.S. Sales Prices FOB Beaverton, Oregon

For Technical Data circle 34 on Reader Service Card.

For Demonstration circle 35 on Reader Service Card.

sion of Intel's faster 3000 series that it second-sources.

What's more, Frank Brunot, bipolar-microprocessor marketing manager at Signetics, says the emulation—which the company calls the 80E—will achieve system speeds two to 12 times faster than the 8080A and will replace it in the high-speed end of the application spectrum. Although Signetics says this is only 5% of total 8080A applications, it represents a \$1 million market that's growing at 5% to 10% a year.

Evolution. "When you look at what's happening in the microprocessor marketplace, the setup was a natural one," Brunot says. "What we saw was a large group of systems houses—such as NCR, TRW, and Sperry-Univac, to name a few—who use the 8080 in terminal-cluster controllers, for example. They've come up with new systems, and they want to do more things—do more diagnostics, use more terminals—and they find the MOS processors like the 8080 have run out of gas."

But most of these users have a minimum of 100 man-years of software written for the 8080, he continues. And they're faced with the choice of looking for a faster MOS processor or going to a mini-computer. "In either case it would involve rewriting all their software," he says, "throwing 90% of the development work on their systems into the trash can." A bipolar emulation like the 80E, he says, offers a third alternative that gives users the needed speed improvements and saves their software. Brunot figures enough customers will be willing to pay the 80E's price of \$150 per kit or board in volume.

Emulation. Each 8-bit array has its own carry-look-ahead unit so that the two arrays may operate independently of one another, he says. During 16-bit operations of the sort handled by the 8080A, the two arrays are merged.

Functionally equivalent to a 10–20-chip microcomputer system consisting of the Intel 8080A central processing unit, together with Intel's 8228 system controller, 8224 clock generator and driver, and 8212 8-bit

input/output port, the 80E emulation is configured around two independent arrays, each containing four 3002 CPUs. The two 8-bit buses for the processing units are tied together, and a single control bit from microprogram memory determines which data bus is to be enabled during a particular instruction.

In contrast to the 500-nanosecond clock-cycle time of the 8080A, Signetics' 80E emulation using the faster 3000-series devices has an equivalent microinstruction-cycle time of 110 ns. The performance advantages of the 2-bit-slice approach vary, Brunot says, depending on the kind of operation that is required and the number of microinstructions needed to implement it.

"In some cases, the 80E requires two to three times the number of microcycles to do an equivalent operation," he says. "But, at worst, the degradation is still a two-fold improvement over the 8080A system."

In most applications, however, the same operations can be performed in fewer cycles, resulting in the increase in speed. □

Peripherals

TI adds to its TMS 9900 family

One of the strengths boasted by Texas Instruments for its 16-bit TMS 9900 microprocessor is the device's communications-register unit, an on-chip serial port and register that allows bits, bytes, or words to be addressed in the input/output interface. Now the firm is backing up that capability with a family of serial-structured peripherals.

"These circuits will allow the designer to better use the 9900's inexpensive serial I/O," says Alan Lofthus, TI's TMS 9900 project

News briefs

Hewlett-Packard upgrades its 3000 Series computer

A microprogrammed processor and fast 4-kilobit RAMs are two of the major hardware features of Hewlett-Packard's new 3000 Series II computers. The systems are aimed at what Paul C. Ely Jr., general manager of HP's computer group, calls the "fastest growing segments of the computer market"—super minis, small-business computers, and general-purpose computers. The new models of the 3000 execute 50% more instructions per second than the earlier 3000 systems. The company announced three new models: Model 5, with 128 kilobytes of semiconductor main memory, 15-megabyte disk, 1,600-bit/inch tape, and an HP 2640 cathode-ray-tube system console; model 7, with 192 kilobytes of main memory, two 47-megabyte disks and similar tape and console; and the model 9, which differs primarily in its 320 kilobytes of main memory. Prices of the systems are, respectively, \$110,000, \$150,000, and \$190,000.

Another industry peril: gold theft

Since public trading of gold became legal during 1975 in the U.S., electronic component firms using the precious metal as a plating material have become prime targets for thieves. While losses so far have not received wide attention, industry sources say they are on the climb.

The latest victim is Viking Industries Inc., Chatsworth, Calif. last month, it discovered it had been hit for about \$250,000 in gold-plated contacts used in connectors for printed-circuit boards. The annual fiscal-year-end audit turned up the loss, an official said, which took place sometime since last October. Although Viking's security measures already were termed extra-heavy in the gold-plating area, their entire system is being reevaluated.

Further complicating the investigation by Los Angeles police detectives is the compact nature of the contacts. "They all could be packed in a 10-inch-square box," the company official says. "There's little question that the public gold market makes us more of a target than when it had to be sold through illegal channels."

Our Converters Stay Tough...



... Everywhere

Data conversion is our business. Analog-to-digital converters. Digital-to-analog converters. Resolver-to-digital converters. Complete data acquisition systems.

We make them all. Over 200 standard and mil range devices. 0°C to 70°C. -25°C to 85°C. -55°C to 125°C. The broadest line of data conversion products in the industry.

Converters built to meet the tightest specs. With guaranteed linearity and accuracy. Incomparably stable. Totally adjustment-free. Compactly packaged. Hermetically sealed. And, competitively priced.

Every one of our products is 100 percent tested. Each circuit is functionally laser-trimmed to eliminate the need for zero and gain adjustments. Our resistor networks have been life-tested for more than 5,000,000 unit hours at 125°C

with a typical ratio shift of less than 0.001 percent per 1,000 operating hours. Network tracking characteristics are guaranteed at 1 ppm from -55°C to 125°C. Performance no competitor can best. That's why our converters stay tough... everywhere!

DAC-80. 12-bit binary or 3-digit BCD digital-to-analog converters for \$19.50 in quantities of 100. Compactly packaged. With their own internal reference supplies and voltage output operational amplifiers. And, a nonlinearity of $\pm 1/2$ LSB.

MN7100. A complete eight-channel, 8-bit data acquisition system that sells for \$140 in

quantities of 100. Measuring only 2.14 x 1.16 inches, this tiny hermetic DIP has a throughput of 90 kHz, is one-fortieth the volume of a modular system, and uses one-third the power — 1.2 watts.

MN7200. The first low-cost 8-channel, 14-bit resolver-to-digital converter that combines microprocessor and advanced data conversion technologies. Priced at \$1,750 in unit quantities. Completely adjustment-free, the MN7200 has an accuracy of four minutes or less over the system's 0 to 70°C temperature range.

From basic resistor networks to packaged systems, one of our conversion products is ready to go to work for you.



MICRO NETWORKS CORPORATION

324 Clark Street, Worcester, Massachusetts 01606 Telephone 617 852-5400

World Radio History

Circle 37 on reader service card

SCIENCE/SCOPE

Pictures from NASA's Landsat-1 satellite are helping Alaska's natives -- some 100,000 Indians, Eskimos, and Aleuts -- select the best lands from the 99 million acres set aside for them from the federal public domain. Doyon, Ltd., one of 12 regional native corporations, asked the University of Alaska to recommend the best land in a vast, roadless tract in central Alaska. Using the Landsat pictures and the limited ground and aerial data available, university scientists mapped seven million acres. The maps show potential farm land, marketable timber, and hard-rock mineral deposits. The Landsat pictures were taken by the Hughes-built multispectral scanner.

More than 20 countries have selected the U.S. Army's TOW (tube-launched, optically-tracked, wire-guided) missile as their infantry heavy assault anti-tank weapon. Hughes/Tucson has produced more than 120,000 TOWs to date. Test firings from 150 lots -- governed by the Army's rigid "fly before buy" program -- have resulted in 100 percent acceptance. Missile reliability in all firings, foreign and domestic, is 97.6 percent. TOWs fired from U.S. Army AH1Q Cobra helicopters have been equally reliable. TOW can also be installed in several other helicopters, foreign and domestic.

The Smithsonian Institution's new National Air and Space Museum in Washington, D.C., will have an automatic central control system manufactured and installed by Hughes' microelectronic products division. The high-speed, wide-bandwidth system will control exhibits, fire safety, security, environment, remote inquiry and display terminals, and two-way closed-circuit television. It also will transmit 464 channels of high-fidelity audio to locations throughout the museum for individual exhibit sound tracks and visitor information announcements.

Engineering opportunities at Theta-Com, a Hughes subsidiary which manufactures microwave and VHF-distribution equipment for the CATV industry, include: CCTV Applications Engineer experienced in security surveillance applications, to prepare proposals, design installations, supervise construction. Some travel....Microwave Relay Equipment Design Engineer, intermediate level....Experienced Digital Communications Engineer. All positions require BS or higher degree. Send resume and salary history to: Director of Engineering, Theta-Com, P.O. Box 9728, Phoenix, AZ 85068. An equal opportunity employer.

A new type of high-voltage DC circuit breaker -- the first to be placed in commercial operation -- will be designed and built by Hughes Research Laboratories under contract to the Electric Power Research Institute. The breaker will be installed in the Pacific Intertie system. It will permit automatic transfer of current from an earth-return mode (which is used when station equipment of one pole of the normally bipolar system is rendered inoperative) to a metallic-return mode. The disconnect switch the Hughes breaker will replace requires about an hour to make this transition, during which the Intertie system is completely shut down.

Creating a new world with electronics

HUGHES

HUGHES AIRCRAFT COMPANY

manager in Houston. While the 9900 can handle faster parallel transfers, such as direct memory access and memory-mapped I/Os, "nobody else offers a microprocessor with a serial port," he explains, "so we're concentrating initially on peripherals for serial I/O transfer."

The 9900's communications register unit, adapted from TI's mini-computer family, will take 16 bits in or out of the microprocessor in 17 microseconds—about a third as fast as the simplest parallel-transfer scheme. But the serial transfer can be implemented for about a third the cost of a memory-mapped I/O, and about a tenth that of direct-memory-access transfers. And the register unit is fast enough for interfacing keyboards, displays, data converters, floppy disks, and some hard-wired logic. Lofthus says.

Coming soon. The new parts, all aimed at replacing multiple-package TTL designs, include:

- The 9901 programmable interrupt and I/O chip, with samples available next November. The single 5-volt chip includes seven I/O ports and six individually maskable interrupt-request lines. The 40-pin dual in-line package contains an interval timer and nine programable lines that can be used for either function.

- The 9902 universal asynchronous and 9903 synchronous receiver/transmitters. The 18-pin UART, available late this year, will feature programable data rate (from 75 to 76,800 bits per second), character length (5 to 8 bits), stop bits, and parity. The 20-pin 9903 is similar, with programable sync register, and will support bi-sync and synchronous data-link-control communications protocols. Both contain on-chip interval timers (64 to 15,384 microseconds).

- The 9904 one-chip clock generator, a low-power Schottky part needed for the 9900's four-phase clock. Sampling starts this summer.

"These are all serial devices, not bus-oriented, and as such, their application will be limited to the 9900," Lofthus says. "There are any number of circuits that take advantage of a bus-type structure; they

can be adapted to the 9900 for the faster parallel-transfer schemes." TI does plan, however, to develop its own bus interfaces for the 9900 where they are needed. □

Packaging & production

Mask combines metal, emulsion

Photomasks for integrated-circuit production are normally one of two types: a photo emulsion on a glass plate or a hard-surface chrome mask. Now, scientists at the Central Laboratory of Photoprocesses of the Bulgarian Academy of Sciences have developed a third type of photomask which combines the optical qualities of an emulsion mask with the long life of a chrome mask.

The new photomask starts out as a sandwich structure—photoresist, an isolating layer of Alvanol, and an evaporated silver bromide photosensitive layer built up on a chrome-clad plate. This light-sensitive layer is optically homogeneous, and its Rayleigh scattering is much less than in emulsion-type masks so that it can record micrometer- and sub-micrometer-sized details more sharply. Again because of negligible scattering, the silver bromide layer is less sensitive to overexposure, which with emulsions often coarsens details.

Processing of the mask, which is of the projection type, starts with exposure of the plate by a multichannel repeater with a standard light source. The silver bromide layer is developed, dipped in a stop bath and then rinsed in distilled water. The developed silver serves as a master mask for the photoresist. After drying, the material is exposed to ultraviolet light, and then the intermediate isolating layer along with the remaining silver bromide pattern is removed by dipping the plate in acetone or cyclohexane.

The resist-patterned chrome plate is then ready for conventional photolithographic processing. The final metal image, depending on the

CABLES, CIRCUITS, CONNECTORS — HUGHES PUTS IT ALL TOGETHER.

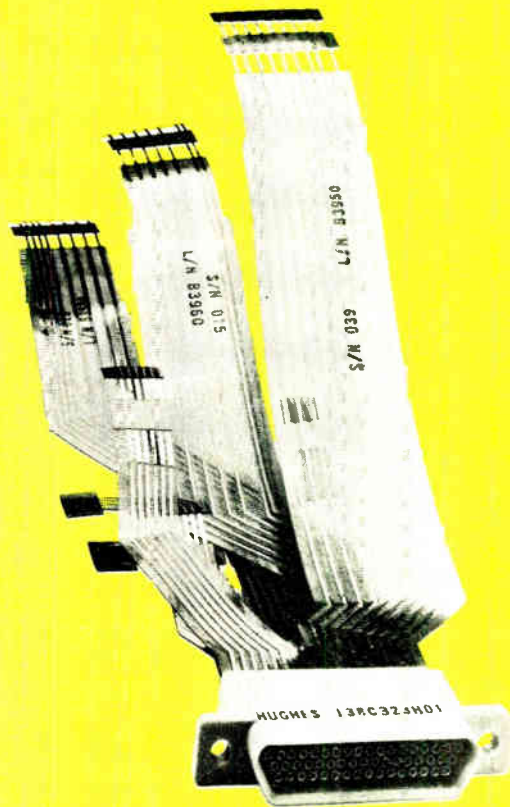

We're the company that has total interconnection capability — in flat cable, flex circuits and connectors. And we've had more experience designing them for high technology applications.

But we do more than design them to work together — we also put them together for you in special assemblies.

So call the people you can count on. Call us, (714) 549-5701. Or write: 17150 Von Karman Avenue, Irvine, CA 92714.

HUGHES
HUGHES AIRCRAFT COMPANY
CONNECTING DEVICES DIV.

We crack the tough ones.

Save yourself a headache, specify versatility with the Airpax "76" digital tach.

The Airpax "76" Series tach satisfies your needs for a wide range of functions.

It can handle anything from simple accumulation, to speed, to sophisticated ratio functions.

The "76" offers you additional features like overspeed and under-speed protection, input switching, adjustable clock rates, even current or voltage outputs.

Rugged enough to withstand just about any industrial environment, the

"76" is designed for easy panel mounting. And the price is competitive, even compared with less versatile digital tachometers.

Look into the "76." A digital that can do it all and do it well.

For more information, circle our number on the reader service card. If you're pressed for time, give us a call. We're standing by, ready to help you.

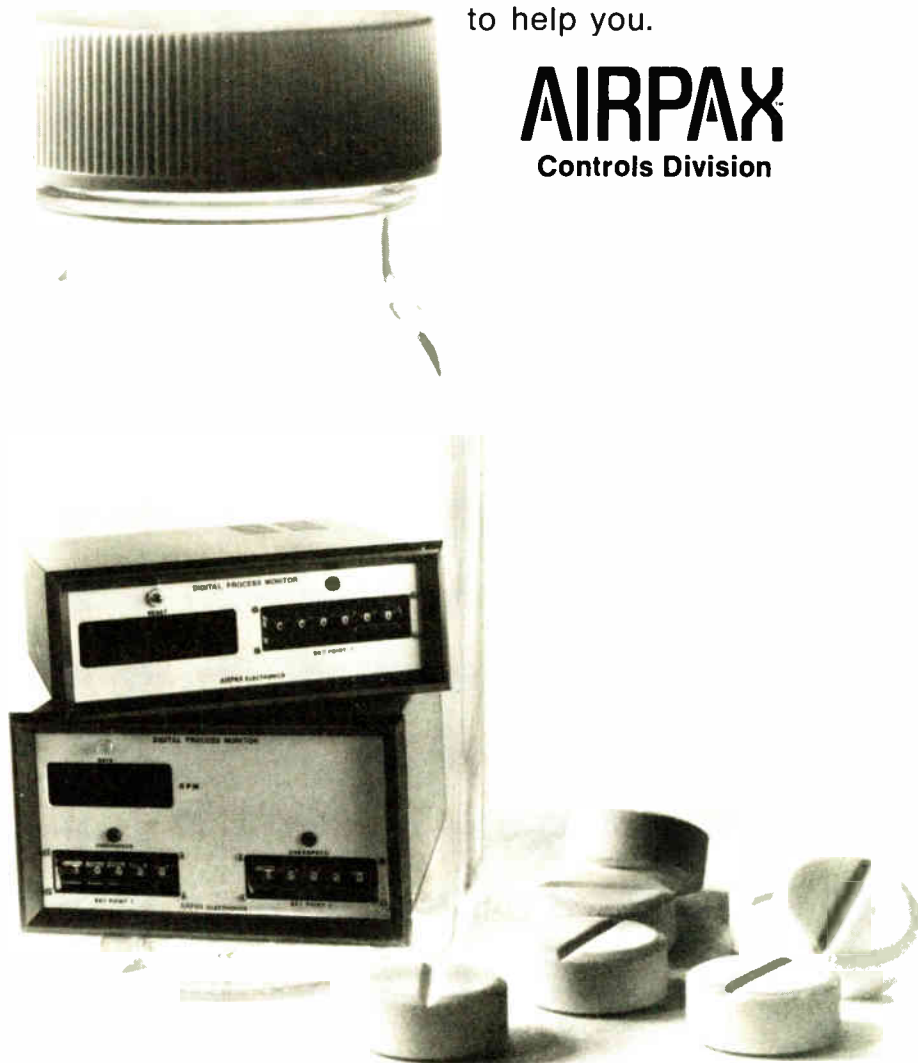

AIRPAX
Controls Division

6801 W. Sunrise Boulevard, Fort Lauderdale, Florida 33313 (305) 587-1100

Other Divisions:

Circuit Breakers and Glass Seals, Cambridge Division, Cambridge, Md.

Broadcast T.V. Equipment, American Data Corp., Huntsville, Ala.

15

Electronics review

combinations of positive or negative silver bromide and positive or negative photoresist used, may be either a positive or a negative copy of the original artwork. □

Solid state

CCDs go into digital processing

Although charge-coupled devices have primarily been used as digital shift registers or analog delay lines, a program at TRW Systems Group is using them to perform digital computations and logic. And when fabrication is completed sometime next year, a single CCD chip slated for military application will perform fast Fourier transforms for recursive filtering and even more complex signal processing.

According to Thomas A. Zimmerman, section head for development and applications at the Redondo Beach, Calif., Microelectronics Arrays department, testing the individual functions that will make up the chip has already been completed. He points out that the FFT configuration would satisfy applications in sonar, radar, communications, and voice processing.

Hardware on the chip includes three 16-bit adders and four 16-by-16 multipliers, and except for output buffers, everything on the chip is a charge-coupled device. The buffers could be built with bipolar or metal-oxide-semiconductor devices in order to achieve a high enough current-drive capability.

Present chip dimensions—350 by 300 mils overall—will be miniaturized as the program proceeds, Zimmerman says. The chip is based on 7.5-micrometer photolithography, two-level metal interconnections, and standard two-phase CCD design.

"We believe the chip's significance lies in the improvements that CCD technology permits in both packing density and speed-power-product ratios over n-channel MOS and bipolar integrated-injection

logic," Zimmerman explains. The chip has five times the packing density of the n-channel MOS that performs an equivalent function and 10 times that of bipolar, he asserts. In speed-power-product terms, the CCD unit, operating in the 1-10-megahertz range, holds a 10:1 edge over n-MOS and as much as that over TTL at the higher speeds.

Serial correlator. A typical signal-processing function, where the chip would be used as a serial correlator, illustrates one of the simplest of its operations, since only two multipliers are needed, Zimmerman says. Here, the FFT provides two simultaneous serial correlations by accumulating the product of two input variables. This function would be useful in communications where in-phase and quadrature signals are to be obtained.

In addition, the chip's computational capability allows a number of other uses once control signals, gating, and timing sequences are provided. Thus, it could be applied as a two-pole, recursive digital filter; a single-pole, time-multiplexed, recursive digital filter, or a lattice, digital filter-analyzer and synthesizer for voice processing.

Despite the abilities of CCD technology in computational digital logic devices, their development lagged until TRW's program began several years ago, Zimmerman says. Soon after, the Navy started its funding. Development of CCDs by semiconductor firms was directed into memories and imaging devices that paid off commercially sooner. And the services themselves were focusing on analog applications.

To achieve acceptable speed with the technology, limited by the basic nature of the charge-transfer principle, TRW resorts to "pipelining." Zimmerman points out that this is a fairly common technique that moves data through the circuit in a serial fashion. New data is entered before previous results appear at the output. Thus, the output data rate is determined by a delay of only 1 bit rather than the 16 bits being processed. This allows operation at up to a 5 megahertz rate. □

For high-density CMOS/LSI circuits

Call Hughes
(714) 548-0671



1,021-channel Digital Frequency Synthesizer. 5V supply, 5 MHz input. (HCTR 0320)



Decade Counter/Latch/Decoder/Driver. Up/down, 2 MHz, 5V operation, 7-segment output (HCTR 0200)
4 Decade Counter. Up/down, 2 MHz, BCD outputs (HCTR 4010)



4-Decade Counter. 1 MHz, BCD outputs. (HCTR 6010)

Custom MOS designs. Use our experience in MOS/LSI circuits to meet unusual requirements like wide supply variations, high speed, ultra low power, differential amplifier input, RC oscillator and crystal oscillator. (Ask for custom MOS brochure).

Call number above or write to 500 Superior Ave., Newport Beach, CA 92663.

Custom MOS Designs



HUGHES

HUGHES AIRCRAFT COMPANY

Solid State Products Division

The Hard Hats

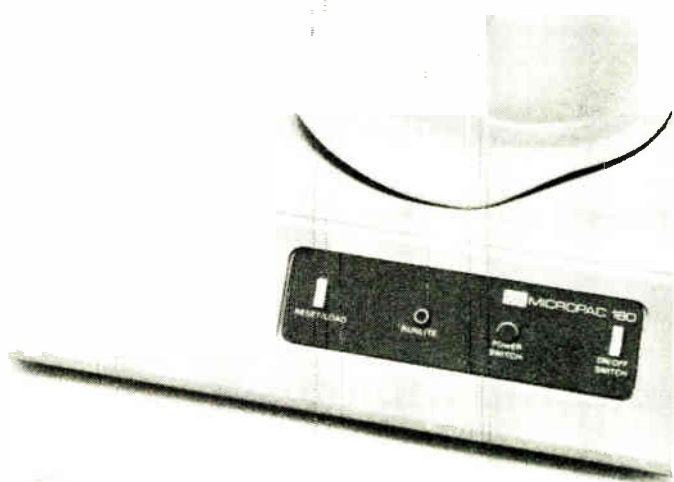
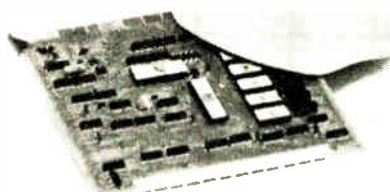
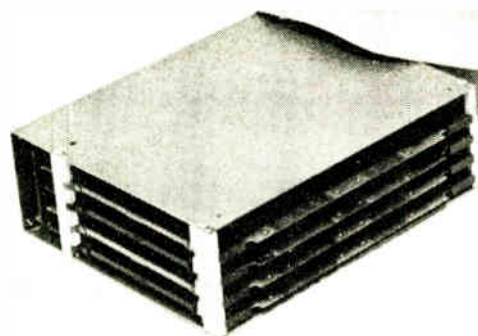

Introducing the first microcomputers tough enough to survive in the real industrial world. And, at a price you can afford.

The PCS 180 Series. From single board micros for under \$300* to packaged systems with integrated CRT and full ASCII keyboard for \$995*. Microcomputers that won't cook in sealed enclosures. With memories that stay up when the power goes off. No one can beat the price. No one can best the performance.

PCS 180s are designed for dirty, corrosive environments. Gathering, analyzing, and sorting data. Monitoring instruments. Starting, stopping, and regulating events. Even communicating with other computers. No matter what the application, there's a PCS 180 ready to put on its hard hat and go to work for you.

SUPERPAC 180. The most advanced general-purpose microcomputer on the market today. Priced at \$995*, the SuperPac 180 gives the system builder both full ASCII keyboard and CRT display capability in a single, low-cost attractive package. Desk-top or rack-mounted, SuperPac 180 includes a PCS 1806 microcomputer, as well as a four-slot chassis, power supply, and self-contained keyboard and CRT control unit. The SuperPac 180 provides 16 lines of 16 or 64 characters, 1024 directly addressable character locations, programmable cursor, blink, and reverse video capabilities.

MICROPAC 180. A low-cost, rack-mountable industrial microcomputer system priced at \$695*. The MicroPac 180 includes a PCS 1806 microcomputer, as well as a four-slot chassis, power supply, and industrial front panel with on-off switch and status indicators.

PCS 1810. A single board micro with 256 bytes of CMOS RAM, plus provisions for up to 1K bytes of RAM and 3K bytes of EROM/ROM. The PCS 1810 features power fail/auto restart and built-in battery backup that can support the CMOS RAM for up to 10 days. The unit also includes a crystal-controlled clock, 16 digital inputs and outputs, a serial I/O port, a tri-state bus port, and DMA capability. All for \$290*.

For applications where built-in battery backup

is not important and where more memory is required, PCS offers the 1806 with 1K bytes of RAM and provisions for 7K bytes of EROM/ROM. All for \$265*.

Both microcomputers are available with standard four, eight, and twenty slot chassis with power supply at prices starting at \$450*.

All PCS microcomputers offer a full range of peripherals designed to enhance program development and support production systems. PCS software permits easy "trouble shooting" and saves programming time by eliminating much of the duplication and repetition that program writing often involves.

Whether you're an OEM or end user, whether you buy in small, medium, or large quantities, PCS offers a cost-effective solution to your automation problem. Equipment in modular construction that makes configuring, changing or expanding a system easy, economical, and trouble free.

PCS systems — a new era in process control.

.....

Please send me more information about PCS single board microcomputers the micropac 180

Please have a salesman call.

Name _____ Title _____

Company _____

Street _____

City _____ State _____

Telephone _____ Zip _____

.....

Process Computer Systems, Inc.
5467 Hill 23 Drive, Flint, MI 48507 313-767-8920
TWX-810-235-8667

*In quantities of 50

Checkmated by
high pushbutton
switch cost?

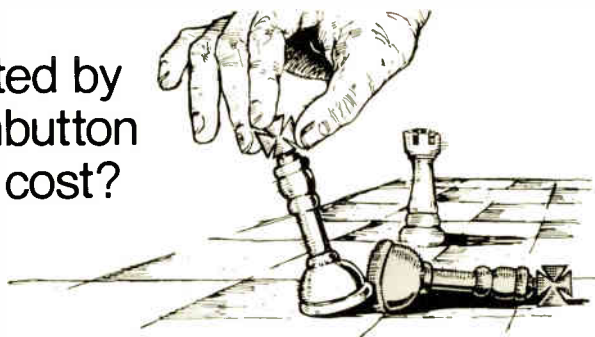

Check These Centralab Distributors For Three New Ways To Cut Switch Costs

The three new Centralab Pushbutton Switch products shown below are now available from Centralab Pushbutton Switch Distributors. They're low-cost money savers, and yet they offer the same high-quality features of all Centralab switches.

You can get these new products,

custom assembled to your specifications, from our factory trained Distributor Switch Specialists.

Contact your Centralab Distributor, listed at the right, for complete details. Ask for a copy of Centralab's New Pushbutton Switch Catalog, Series No. 301.

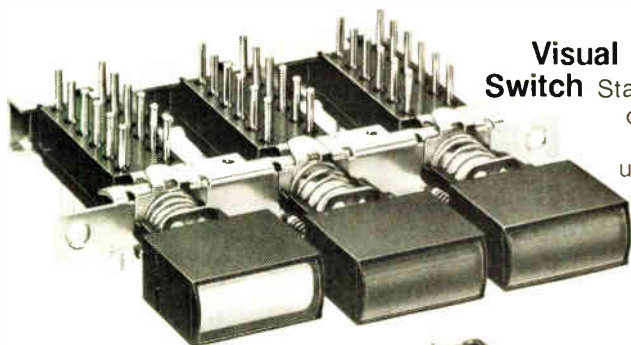

Visual Display in a Non-Lighted Switch

Status indicator button adds visual display to non-lighted Centralab switches. The button, with a unique fluorescent display, uses reflected ambient light to indicate switch status. 6 display colors. Black or chrome plated buttons. 140° peripheral viewing angle.



5-amp Pushbutton Line Switch

UL listed for TV-5 rating: 120V, 5A, 78A

peak inrush current. Accepts all Centralab button options.

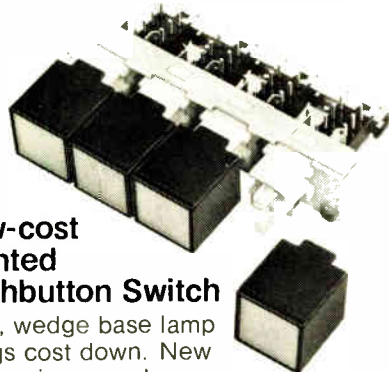

Low-cost Lighted Pushbutton Switch

T-1 $\frac{3}{4}$, wedge base lamp brings cost down. New options increase harmonized panel aesthetics. Flat or recessed lenses. 8 lens colors. 15mm or 20mm spacing. Switch assemblies to 13 stations.

DISTRIBUTOR PRODUCTS



CENTRALAB

Electronics Division
GLOBE-UNION INC

5757 NORTH GREEN BAY AVENUE
MILWAUKEE, WISCONSIN 53201

**FOR LOW-COST
PUSHBUTTON SWITCHES
CHECK YOUR CENTRALAB
DISTRIBUTOR.**

CALIFORNIA
Kierulff Electronics, Inc.
Los Angeles
213/685-5511

Kierulff Electronics, Inc.
Palo Alto
415/968-6292

Kierulff Electronics, Inc.
San Diego
714/278-2112

COLORADO
Kierulff Electronics, Inc.
Denver
303/371-6500

FLORIDA
Hammond Electronics
Orlando
305/849-6060

INDIANA
Radio Distributing
Co., Inc.
South Bend
219 287-2911

MASSACHUSETTS
Sterling Electronics
Watertown
617/926-9720

MINNESOTA
Gopher Electronics Co.
St. Paul
612 645-0241

NEBRASKA
Radio Equipment Co.
Omaha
402/341-7700

NEW YORK
Electronic Equipment
Co., Inc.
Hempstead
516/538-5510

Peerless Radio Corp.
Lynbrook, L.I.
516/593-2121

Summit Distributors, Inc.
Buffalo
716/884-3450

NORTH CAROLINA
Kirkman Electronics, Inc.
Winston-Salem
919/724-0541

OHIO
ESCO Incorporated
Dayton
513 226-1133

Pioneer-Standard
Electronics, Inc.
Cleveland
216/587-3600

PENNSYLVANIA
Cam/RPC Industrial
Electronics
Pittsburgh
412/268-2600

Herbach & Rademan, Inc.
Philadelphia
215/426-1700

Pyltronic Industries, Inc.
Montgomeryville
215/643-2850

TEXAS
Southwest Electronics Inc.
Stafford
713/494-6021

WASHINGTON
Almac/Stroum Electronics
Seattle
206/763-2300

ISOSTAT LICENSED

NATO to start F-16 production before final approval

European production of the F-16 lightweight fighter for the North Atlantic Treaty Organization will begin later this year—**months before the Pentagon's scheduled approval next January of U.S. production tooling** and close to a year before full U.S. production by General Dynamics Corp. is authorized in September 1977. "There is really no risk involved," says program director Lyman Josephs of General Dynamics, "since the F-16 is essentially a tuned-up version of the prototype YF-16, which already has been thoroughly tested with over 750 hours of flying."

The longer lead times required to set up the Belgian and Dutch production lines—as much as a year longer than the U.S., says Josephs—make the early go-ahead necessary to meet the NATO delivery schedule of 348 planes. Current U.S. policies, Josephs says, "do not recognize these facts, and it is causing some anxiety among the more doctrinaire officials in the government." Josephs denied a published report that NATO is having problems lining up qualified European avionics suppliers for the plane and that General Dynamics plans to bring any of the NATO F-16 avionics business back to the U.S. as a result.

Navy's CMS-2 leads DOD competition for a common language . . .

The Defense Department is running economic trade-off studies on three candidate languages from as many services for selection as the single higher-order software of the future known as DOD-1 [*Electronics*, Dec. 25, 1975, p. 52].

Some insiders contend that the Navy's CMS-2, originally developed for use with Sperry Univac division's AN/UYK-7 system, **is leading the competition for selection within 12 to 18 months** as the Pentagon's answer to demands for a single tactical system language to hold down software-hardware cost ratios, which now run to 8:1. Competing with CMS-2 are the Air Force's Jovial and the Army's Tacpol.

. . . as Navy names four packages for tactical use

Until selection of DOD-1, which might very well be a derivation of all three competing systems, the Navy says it will standardize on four high-order languages for tactical use. To enforce its program throughout an estimated 60 combat-computer systems, the Navy plans establishment in the Naval Materiel Command in Washington of "**a single office for compiler-configuration management** to ensure that variations of basic language do not occur." So says the Navy's H. Tyler Marcy, assistant secretary for R&D, who says CMS-2 will be used for tactical ship and airborne applications.

The language for automated test equipment will be Atlas, originally developed for the avionics test system known as VAST, while the third standard language will be SPL/1, the Navy's newest and first adopted for acoustic-signal processing. To cut software support and transport costs, Marcy says, the Navy plans to standardize on Fortran as its single software-support language for all of its operating systems.

Washington commentary

Lyman Josephs' lesson in management

Federal frustration with the costs and performance of some of its major weapons systems and their contractors is well known. Hardly a week goes by that some member of the Congress doesn't charge the Pentagon or one of its contractors with failure to perform as promised. The charges are invariably picked up and disseminated by the press—sometimes incorporating the defendant's response, sometimes not.

The frustrations of contractors with their Federal customers, on the other hand, are less well known. Criticizing the customer is more than bad form. It is bad for business. Thus specific corporate criticisms of Federal failures in system management are rarely voiced publicly, no matter how valid.

Fort Worth's exception

One refreshing exception to the latter rule occurred in Dayton, Ohio, last month when General Dynamics Corp.'s Lyman C. Josephs addressed the closing luncheon of the National Aerospace and Electronics Conference. A corporate vice president of GD, Josephs functions as both deputy general manager for the company's Fort Worth division and as director of the company's F-16 lightweight fighter program for the Air Force and for NATO.

Josephs is a plain-spoken person who might easily be mistaken for a Marine Corps general. "When he says, 'jump'," says one of his Fort Worth subordinates, "the only question anyone asks is 'How high?'" But Josephs is also known and respected within his organization for supporting his managers. "The program manager," he argues, "must be the man whose decisions are upheld by higher authority, even when he is slightly wrong. It should be up to the functional specialist to justify his position against the program manager's decision, rather than the other way around."

Self-protection

The failure of the military to grant its project chiefs freedom to manage and then support their judgments is Josephs' biggest frustration. "There has been a lot of talk since Dave Packard's days" as deputy secretary of defense of the need "to loosen the reins on program managers and give them the authority they need to run their programs." But, he adds, "the subtle program difficulty is that they don't get the support they should."

Why the failure? "The trouble in the military," says Josephs, "is that there are too many

people busy protecting their" careers by writing covering memos when critical choices must be made. "Too often a functional specialist will write a memo for the file in such a way that a program manager has no choice but to cave in or risk missing a promotion." The consequence, Josephs contends, "leads inexorably to cost growth, schedule problems, and unnecessary gold-plating. I spend more of my time fighting off people like this on the F-16 program than I do most anything else."

The performance of General Dynamics on the F-16 program thus far suggests Josephs is winning most of those fights. The two-plane prototype program, he says, was completed on schedule and within the \$37.9 million ceiling price. "General Dynamics closed its books at the end of the program with earnings of approximately \$2.1 million for all that activity," he revealed.

The winning management approach to the F-16 program is one Josephs calls "the matrix system" in which "the program director had all the authority and responsibility for execution of the prototype program which the chief executive of the corporation had." By using experienced personnel in building the matrix, the F-16 managers were permitted to make their own technical and business decisions without the necessity of checking with higher authority—a time-consuming process. "The principle we used was that decisions were audited by higher authority after the fact to avoid delays," Josephs explains. "We found that very few decisions required change." When the program moved to full-scale development, Josephs took "the same team that had done the prototype and expanded it, but the core people were still there."

Return to basics

There are some fundamental lessons worth learning again in the management principles adopted by Lyman Josephs for the F-16 program. They sound simple, of course, no more than common sense coupled with a willingness to delegate authority and responsibility throughout the program's management chain.

But the unfortunate fact of life is that these fundamentals have become the exception rather than the rule within the management structure of many military weapons programs. And until more contractors insist, like Lyman Josephs, on their restoration, congressional critics of military management will continue to find multiple targets of opportunity. —Ray Connolly

Sprague puts more passive component families into dual in-line packages than any other manufacturer.

Call Sprague First!

**HIGHER
PACKAGING
DENSITY**

**LOWER
PRODUCTION
COSTS**

plus improved performance and compatibility with DIP microcircuits

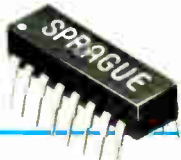

**DIP
MULTIPLE
TANTALUM CAPACITORS**

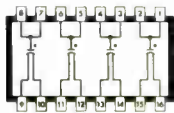

Solid-electrolyte tantalum capacitors with 2 or 4 sections per package. 8- or 16-pin configurations. Standard ratings are $6.8 \mu\text{F} @ 35\text{V}$, $15 \mu\text{F} @ 20\text{V}$, $22 \mu\text{F} @ 15\text{V}$, $33 \mu\text{F} @ 10\text{V}$. Capacitance tolerance, $\pm 20\%$. Operating temperature range, -55°C to $+85^\circ\text{C}$. Write for Bulletin 3542 or circle 91 on reader service card.

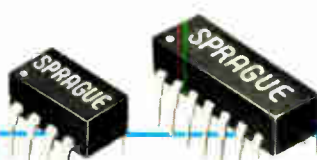

**DIP
MULTIPLE
CERAMIC CAPACITORS**

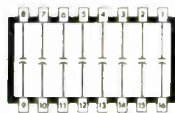

Monolithic[®] construction . . . alternate layers of ceramic dielectric material and metallic electrodes are fired into a solid homogenous block. 2, 4, 7, or 8 capacitor sections per package. Standard ratings, 18 pF to $0.1 \mu\text{F} @ 100\text{V}$. Capacitance tolerance, $\pm 20\%$. Write for Bulletin 6242 or circle 92 on reader service card.



**DIP
TANTALUM/CERAMIC
CAPACITOR ASSEMBLIES**



Solid tantalum and Monolithic[®] ceramic alternating isolated sections. Choice of 4 or 8 sections per package. Standard tantalum ratings, $6.8 \mu\text{F} @ 35\text{V}$, $15 \mu\text{F} @ 20\text{V}$, $22 \mu\text{F} @ 15\text{V}$, $33 \mu\text{F} @ 10\text{V}$. Ceramic ratings .01, .047, $.1 \mu\text{F} @ 100\text{V}$. Cap. tol., $\pm 20\%$. Write for Engineering Bulletin 6642 or circle 93 on reader service card.



**DIP
RESISTOR/CAPACITOR
NETWORKS**

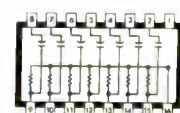

(1 of 3 designs)

Metanet[®] metal-film resistors and Monolithic[®] ceramic capacitors in bypassed pull-up, R-C coupling, speed-up, and active terminator networks. Resistor ratings, 100 to 6800Ω with 125 mW power dissipation. Capacitor ratings, 100 pF to $.01 \mu\text{F} @ 100\text{V}$. Write for Engineering Bulletin 6612 or circle 94 on reader service card.

**DIP
MULTIPLE
METAL-FILM RESISTORS**



Noble metal film resistors encased in protective glass. Choice of 7 or 8 resistors per 14- or 16-pin package. Resistance values, 50Ω to $100,000 \Omega$. Power dissipation, 125 mW. Standard resistance tolerance, $\pm 5\%$. Operating temperature range, -55°C to $+70^\circ\text{C}$. Write for Bulletin 7042 or circle 95 on reader service card.

**DIP
PRECISION RESISTOR
NETWORKS**

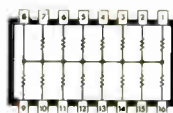

(1 of 5 designs)

Noble metal film resistors in pull-up, pull-down, interfacing, and terminating configurations, for applications requiring repetitive resistance patterns. 14- or 16-pins. Up to 28 resistors per package. Individual resistors from 50 to $100,000 \Omega$. Dissipation, 125 mW. Write for Bulletin 7042 or circle 96 on reader service card.

**DIP
MULTIPLE
PULSE TRANSFORMERS**

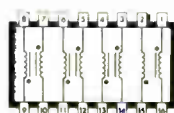

(1 of 2 designs)

Four transformers in 16-pin package. All cores have exclusive protective coating. Inductance values from 10 to $1000 \mu\text{H}$. ET product values of 5 volt- μsec . Choice of four turns ratios . . . 1:1, 2:1, 3:1, 4:1. Operating temperature range, 0°C to $+70^\circ\text{C}$. Write for Engineering Bulletin 40400 or circle 97 on reader service card.

**DIP
TAPPED
DELAY LINES**

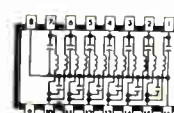

Lumped constant delay lines . . . ideal for timing and pulse synchronization circuits. 14- or 16-pin packages with delays of 50, 100, or 150 nanoseconds at a characteristic impedance of 100Ω . Working voltage, 50 VDC. Operating temperature range, 0°C to $+70^\circ\text{C}$. Write for Bulletin 45004 or circle 98 on reader service card.

Popular Types Now Available OFF-THE-SHELF From Your Sprague Industrial Distributor.

For complete technical data, write for any of the above-mentioned Engineering Bulletins to: Technical Literature Service, Sprague Electric Company, 35 Marshall Street, North Adams, Mass. 01247.

THE BROAD-LINE PRODUCER OF ELECTRONIC PARTS



“Power FETs bipolars in the next

“Field-effect transistors are one of the oldest branches on the semiconductor family tree, and the simplest active devices to use today. But until Siliconix developed a 25-watt VMOS power FET, you could not take advantage of that simplicity in digital drive, power supplies, servos, motor control and most other high current switching and linear circuits.”

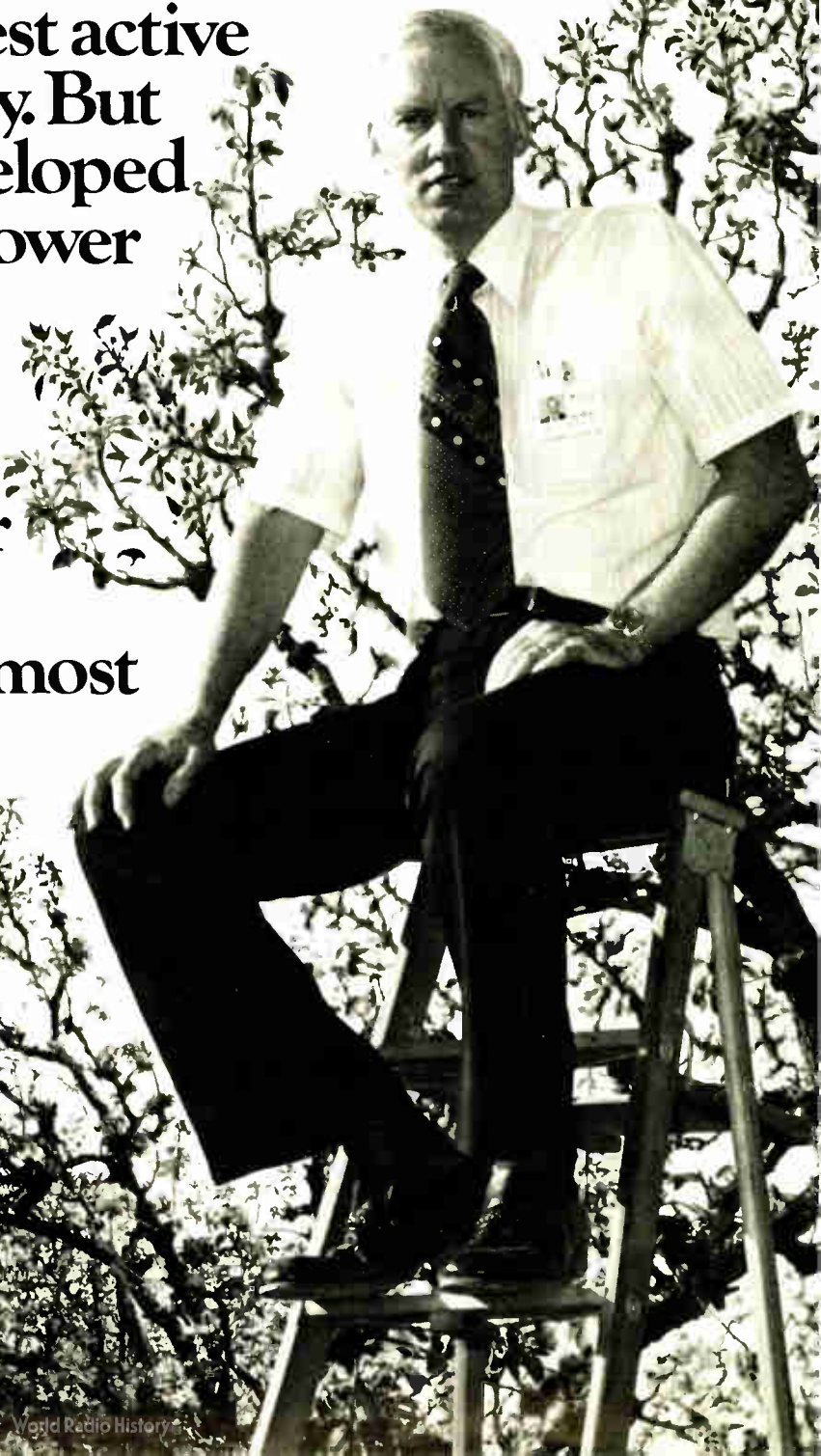

just may eliminate five years."

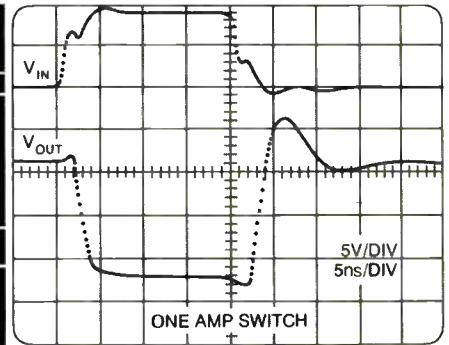
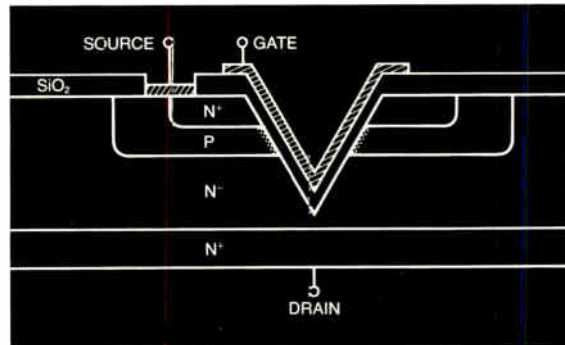

"Historically, designers have had to use Darlington bipolar devices to control high currents. But FETs have the advantage in other respects. They operate with near zero input current, are easier to bias, and are not susceptible to secondary breakdown, thermal runaway, or current hogging, and exhibit no minority carrier storage time.

"With Siliconix' new vertical MOS (VMOS) technology, the current control problem is solved. Our new VMP 1 MOSPOWER™ FET switches 1 ampere in 4 nanoseconds and performs excellently at 2 amps.

"In a VMOS transistor, current flows vertically from a source region at the top of the chip to a substrate drain. This construction multiplies current density through the channel and enhances high speed switching performance.

"Digital designers will find the VMP series as easy to use as a gate. It requires no interface circuit design, can switch faster than TTL and, because FETs are voltage-controlled, it requires negligible input current. For example, CMOS can easily control an ampere of drive current with a single VMP. When multiple devices are used in parallel, they share current instead of hogging it.

"In switching supply regulators, since the VMP series has effectively no minority carrier storage time, switching speeds can be greatly increased offering drastically improved efficiencies.

"Analog control designers can avoid thermal runaway, eliminate preamplifier stages and achieve highly linear control. A high input impedance and low leakage (typically 200 nanoamps or less) gives the current gain equivalent of

nearly infinite bipolar beta. Transfer characteristics are linear from 200 milliamps to over 2 amps.

"In any application that requires drive power, VMOS means economy, simplicity and reliability."

PART NUMBER	BREAKDOWN VOLTAGE	R _{DS} MAX AT 1 AMP
25 Watts TO-3 Package		
VMP 11	35 Volts	1.8 Ohms
VMP 1	60	3.0
VMP 12	90	4.0
4 Watts TO-39 Package		
VMP 21	35 Volts	2.0 Ohms
VMP 2	60	3.0
VMP 22	90	4.5

To order the VMP series, contact our franchised distributors: Components Plus, Cramer, Elmar, Hamilton/Avnet, Pioneer, Quality Components or R.A.E. For more details, call or write Siliconix, 2201 Laurelwood Road, Santa Clara, CA 95054, (408) 246-8000.

Siliconix incorporated

New:tone receiver hybrids from Beckman.

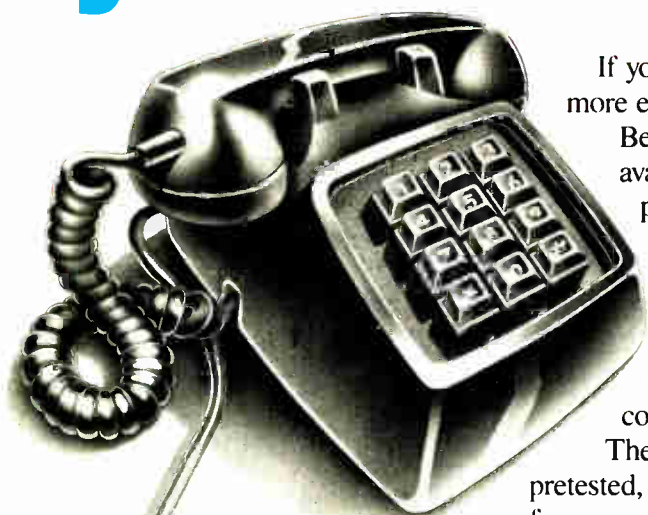

If you're into tone receiver applications, here's a smaller, more economical solution for your designs.

Beckman Series 883 Telephone Tone Receiver Hybrids, available off-the-shelf as individual modules or as preassembled systems.

First, they give you up to 75% space savings over conventional tone-receiver systems. They're so much smaller because we use hybrid technology. And each whole subsystem fits on one standard 4½" x 6" PC board. Picture it: your entire system cut to ¼ of the conventional size.

Then, you save money. That's because Series 883 is pretested, calibrated, and retuned to meet tough Bell System performance requirements. And you also save on design, engineering, production and inventory costs.

Series 883 hybrids are perfect for telephone central office or PBX tone receiver applications. And, with proper interfacing, they can turn standard push-button phones into computer terminals for banking, accounting, security, and other signal communications systems.

Find out more about these excellent, space-saving hybrids now by calling Beckman Helipot Division, (714) 871-4848, Ext. 1776.

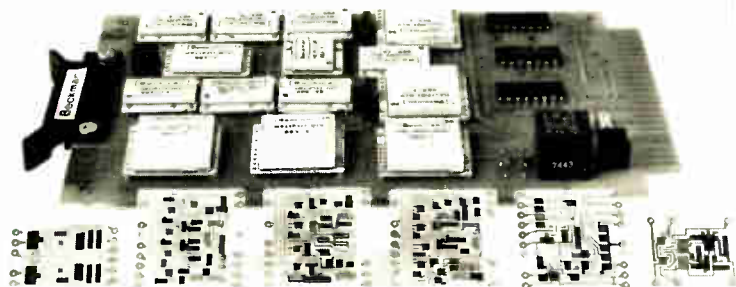
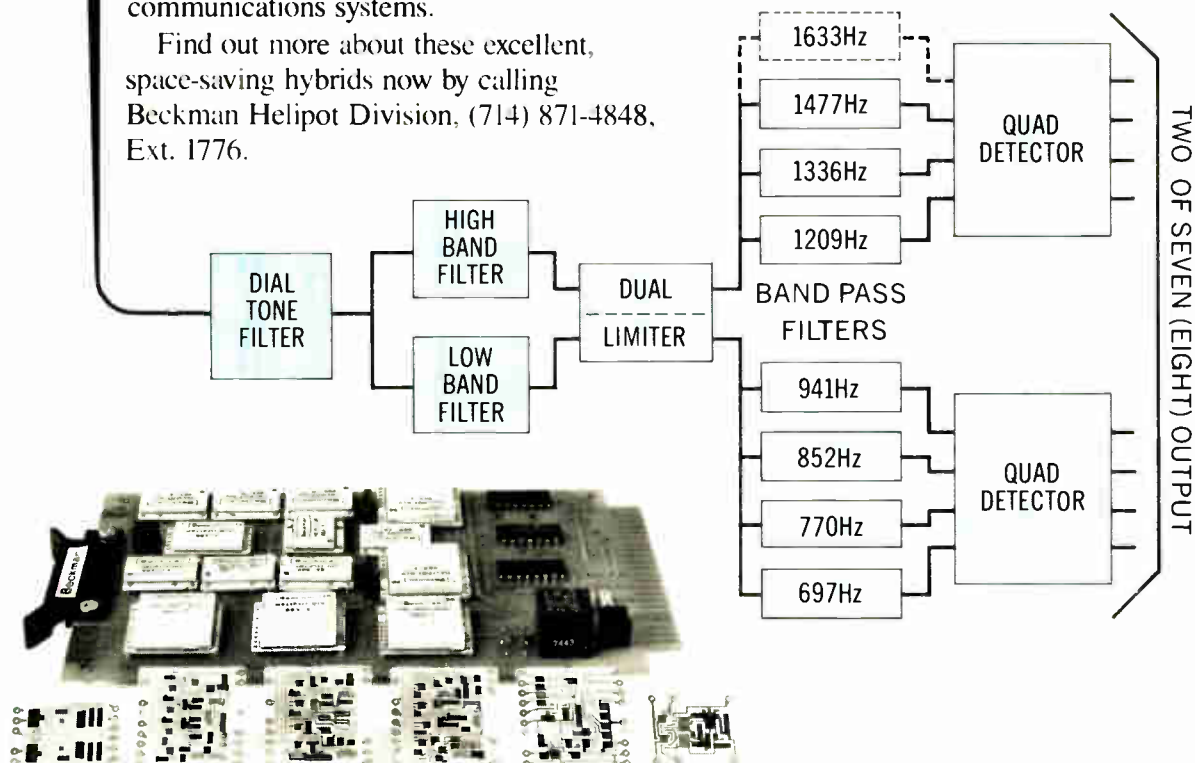

BECKMAN®

HELIPOT DIVISION

If you need hybrids, you should know about Beckman.

German post office broadcasts uniform field with wedge-shaped TV antenna

The West German post office has developed an antenna, somewhat like an inverted snowplow blade, that is said to broadcast television signals at microwave frequencies with much better radiation characteristics and signal coverage than standard antennas. An example is now atop a tower in West Berlin for use in a 12-gigahertz TV-transmission system.

To ensure uniformity of the signal and maximize transmitting power, more power must be radiated toward the far reaches of the antenna's coverage. This compensates for the fact that, with increasing distance from the antenna, the radiation density becomes smaller.

Angles. Assuming the antenna to be at the center of a circular, flat, obstacle-free area, a constant field-strength distribution is possible if the vertical-radiation pattern varies as the cosecant of the angle of depression below the horizontal and if there is a horizontal omnidirectional pattern. This antenna produces these radiation characteristics.

Developed by a team led by Herbert Thielen, the antenna has been successfully tested at the Darmstadt research institute of the post office. For omnidirectional signal radiation, the antenna would consist of six reflectors, arranged in the form of a hexagon. In the West Berlin application it covers only a 100° sector, so there are only two reflectors, each with its own horn feed.

Computer determination. The reflector shape, which approximates the ideal cosecant shape, was determined by a computer calculation and optimization process, Thielen says. Vertically, it has a curved surface, but horizontally, it has a straight surface. The top-to-bottom distance of the reflector is 1.25 meters, with top and bottom widths of 1.6 and 1.05 meters, respectively.

The light-weight antenna was

built by Gruenzweig und Hartmann. The center is a honeycomb-structured aluminum layer, with glass fiber-reinforced plastic layers on either side. The reflecting surface is coated with copper foil less than 200 micrometers thick. The antenna gain is between 17 and 19 decibels—more than 7 dB higher than the gain of conventional TV signal-distribution antennas.

Great Britain

System keeps track of fleet vehicles

An automatic vehicle-location system based on a microprocessor can place a vehicle within 33 feet of its actual location, according to the developer, Marconi Research Labora-

tories. Known as Landfall, for Links and Nodes Data-base For Automatic Land-Vehicle Locations, the system is an extension of Marconi Labs' earlier work in automated vehicle location. Typical applications would be in police patrol cars and similar fleets, where a central dispatcher needs to know locations of individual vehicles.

The system has an Intel 8080 microprocessor that stores information on the road network in a random-access memory. The intersections are termed nodes, the exits are called ports, and the roads joining the nodes and ports are called links. The microprocessor has a dynamic random-access memory, complete with a coded map of the area. Each node and port is given an identifying number, and the lengths of connecting links are stored.

All this information is stored in

Around the world

German system indicates visibility on runway

Control-tower decisions on takeoffs and landings under limited visibility may become a lot easier with a microprocessor-controlled system that indicates precise visibility. Developed by AEG-Telefunken and its affiliate Eltro GmbH, the so-called RVR (for runway visual range) system is modularly constructed and thus can be adapted to the requirements of individual airports. A prototype was exhibited at the German aerospace show in Hanover last month.

The system consists of a number of sensors installed at strategic spots along the runway and a data-evaluation unit usually located in the airport's meteorological station. Three kinds of sensors are used: transmissometers for measuring the visibility of the atmosphere, background-luminance sensors for determining the environmental brightness, and devices to measure the intensity of the runway lights. A basic RVR system consists of up to five transmissometers and one sensor each for background luminance and runway-light intensity.

The parameters picked up and measured by the sensors are sent to the evaluator, where a 16-bit PACE microprocessor from National Semiconductor Corp. in the U.S. calculates the visual range on the runway. It uses the degree of transmission in percent, the background luminance in lux, and the runway-light intensity in candelas. It then references these values to a certain measuring distance and indicates the calculated result, the runway visual range, in meters on a gas-discharge display. Also indicated on similar displays are inputs from the sensors.

the 8080's RAM, which has a 12-kilobyte capacity. The vehicles have sensors. The driver activates the system by indicating his starting node, and the information is continually updated by the processor and displayed numerically.

The system has been tested in an area of 10-12 km in Chelmsford, and Marconi officials say it works even for 180° turns. Information about entire towns apparently will fit into a tiny memory storage—for example, all of Essex's 32,000 nodes fit into one 4-track cartridge.

Marconi's system—which cost about \$5,000 per vehicle—differs from the Boeing Co.'s Flair system [*Electronics*, Feb. 21, 1974, p.30], which relies on a compass to get dead-reckoning information. "We have a heading sensor to give us turn information," says one member of Marconi's systems-application group. "We have an ordinary dis-

tance transducer tied to the steering of the vehicle. We do know that magnetic compasses cause real problems." Also, accuracy of the Boeing system is to within 50 feet.

Later this year, Britain's Home Office will allow several companies, including Marconi, to test their systems on individual vehicles in the West Mercia area. □

France

Systems-building hardware has modules made of modules

When a manufacturer says his equipment is modular, that can mean almost anything. But a French systems-engineering company has made the word mean more than most. For the MAT 80 line of systems-building hardware introduced last week, Sodeteg-T.A.I. has come up with modules that are themselves modular.

For starters, the firm, part of the Thomson-Brandt group, has used

MAT 80 (for Microsystème d'Automatisme Temps Réel) hardware to implement a letter-sorting system that can route up to 18,000 envelopes per hour into 20 different bins. A package sorter will follow, as will use as an interface in an electrical dispatching system.

In fact, the line could find a place in all sorts of industrial-control systems—its modules can be combined to make control equipment as

Our 12 Capacitor plants will keep your production line producing

If capacitor problems have been worrying your production people, we can help. For 75 years we have set industry standards with innovations like polystyrene and polypropylene film, metalized film, stacked film and high dielectric ceramic to keep our customers ahead of their competition. Our success can be your success. Twelve capacitor manufacturing facilities strategically placed throughout the world in Austria, Germany, Spain, France, Brazil, Mexico, and in the U.S. will support and cross support your every capacitor need. Our Mesa, Arizona plant, specializing in tantalum capacitors, has earned a reputation for quality products that will satisfy your most demanding industrial and military needs.

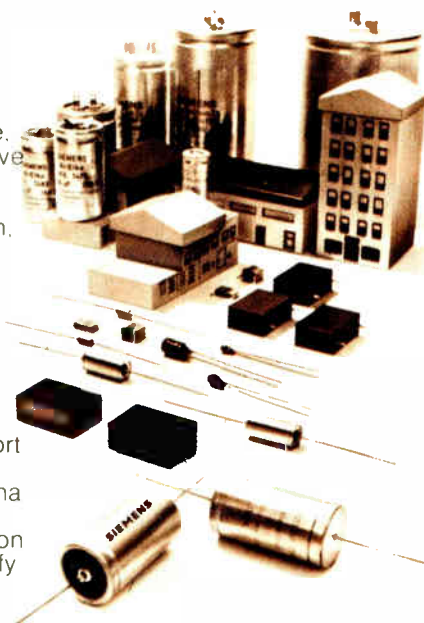

So be it tantalum, standard aluminum electrolytic, computer grade aluminum electrolytic, ceramic, metalized film or stacked metalized film, you can rest assured that our nationwide service organization of representatives and distributors will react with the right capacitor at the right time, and at the right price. You have enough on your mind without worrying about capacitors. So call on us. It will be like owning your own capacitor plant

**Siemens Corporation,
Components Group,
186 Wood Ave. South,
Iselin, N.J. 08830
(201) 494-1000**

SIEMENS

52 Circle 719 on reader service card

simple as a stand-alone fast scanner or as sophisticated as a micro-computer with multiple central processing units. "We think of the MAT 80 as an instrument that fits between the services of a mini-computer and a data-acquisition device," says Philippe Gutmann, deputy managing director.

To tailor the hardware to the application, there are some half a dozen kinds of modules—actually printed-circuit boards that plug into a cabinet designed to fit a standard 19-inch relay rack. The major modules are a microcomputer built around an Intel 8080, a programmable controller of automated operations, memory cards with up to 32 kilobytes of random-access and read-only memory, direct bus address, multiplexers, and input/output interfaces.

A simple configuration—a small memory, a CPU, one or two I/O

cards, the basic rack and cabinet, and a power supply—runs about \$2,200. A top-of-the-line setup goes for about \$17,000.

Combining. These basic modules add up to literally thousands of possible configurations. With the exception of the microprocessor and the programmed controller, the boards are themselves modular. Each is split into five sections. The standard back section carries most of what is back-panel wiring in conventionally packaged hardware.

The other four sections—running at right angles to the fifth—carry submodules. And the firm has developed a library of 30 of them, including a "watchdog" for system surveillance, a block of 16 inputs, a data-transmission interface, and a group of 8 priority interrupts.

Sodeteg-T.A.I. stores the submodule layouts as Mylar masks. To produce a specific module for a sys-

tem, it's mainly a matter of pulling the four masks needed out of the library and making a master for the whole board, which is photoengraved conventionally.

At first glance, it might seem it would be simpler to make each submodule a small, separate board. But Henri Carcassonne, the engineer who worked out the concept, can trot out a lot of solid arguments for putting quartets of modules on a big board.

There's a significant saving in copper, he points out. Then too, the standard back section eliminates extensive back-panel wiring. What's more, the layout separates the logic from the output circuitry, a big plus in industrial environments. The connector at the rear edge of the board handles the bus connections. Four connectors on the front edge take care of the I/O connections to the process under control. □

Our reputation for quality Hi-Rel zeners just means We're Good, Not Expensive

Look at Our Low Cost DO35 Zener Diode

If you need high-quality low-cost zener diodes for your industrial applications, take a look at our low-cost DO35 double-slug zener. It's available from 3.3 to 47 Volts in the IN5225 to IN5261, IN746 to IN759 and IN957 to IN977 JEDEC series.

Significantly, our low cost zeners come from the same place as our Hi-Rel, Jan, Jantx, Jan TXV, S1N and T.C. zeners and are manufactured with the same attention to detail.

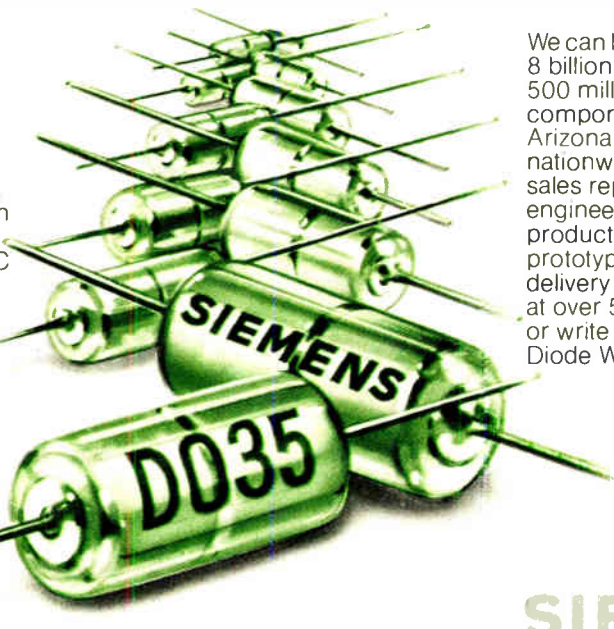

We can back your action. We are an 8 billion dollar company with over 500 million dollars in world wide component sales. Our Scottsdale, Arizona zener diode facility and nationwide service organization of sales representatives and field engineers will keep your production lines supplied. For prototypes you can get instant delivery from one of our distributors at over 50 stocking locations. Call or write today for your free Zener Diode Wall Chart.

**Siemens Corporation,
Components Group,
186 Wood Ave. South,
Iselin, N.J. 08830
(201) 494-1000**

SIEMENS

The Ten Most WANTED INSTRUMENTS



Brush Oscillograph 260



Associated Research
Fault Finder

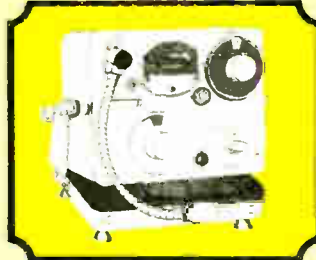

General Radio
Sound Level Analyzer



Honeywell Tape Recorder

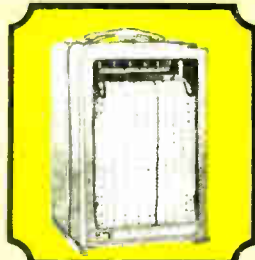

Esterline Angus Chart Recorder



Associated Research
Insulation Tester

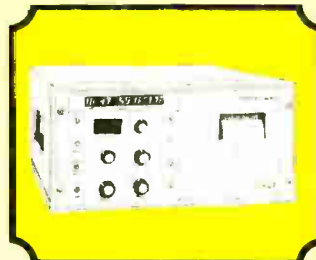

Kaye Data Acquisition System



Tektronix Oscilloscope

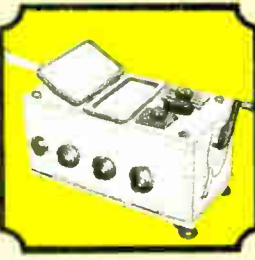

Biddle Megger

RENT'EM FROM GE

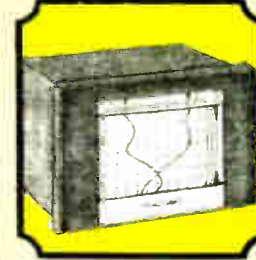

Texas Instruments
Temperature Recorder

What's at the top of your Most Wanted List? Quick • rental instruments has rounded up over 5,000 different instruments from all the manufacturers. Our 100 Sales/Service Centers are major-city located,

coast-to-coast. And we'll ship your instruments on the day you call, calibrated to the manufacturer's specs.

Short or long term rentals, money-savers when you want instruments. For more information call your nearest Rental Center or (518) 372-9900 collect.

Quick•rental^{*} instruments

GENERAL  ELECTRIC

*Trademark General Electric

ALA. BIRMINGHAM (205) 925-3101 • ARIZ. PHOENIX (602) 278-9515 or 8516 TUCSON (602) 294-3139 • CAL. LOS ANGELES (213) 674-7900 SAN FRANCISCO (415) 436-9260 • COL. DENVER (303) 371-1260 • CONN. SOUTHINGTON (203) 621-4055 • FLA. JACKSONVILLE (904) 751-0610 • GA. ATLANTA (404) 458-2231 • ILL. CHICAGO (219) 933-4500 • IND. INDIANAPOLIS (317) 639-1565 • KY. LOUISVILLE (502) 452-3311 • LA. NEW ORLEANS (504) 367-6528 • MD. BALTIMORE (301) 837-4500 • MASS. BOSTON (617) 396-9600 Ext. 160 SPRINGFIELD (413) 781-1111 • MICH. DETROIT (313) 285-6700 Ext. 212 or 209 • MINN. MINNEAPOLIS (612) 522-4396 • MO. KANSAS CITY (816) 842-9745, ST. LOUIS (314) 342-7834 • N.J. CLIFTON (201) 471-6556 • N.Y. BUFFALO (716) 876-1200, CLIFTON, N.J. (201) 471-5556, SCHENECTADY (518) 385-2195 • N.C. CHARLOTTE (704) 525-0311 • OH. CINCINNATI (513) 874-8512, CLEVELAND (216) 523-6382, TOLEDO (419) 691-3501 • OR. PORTLAND (503) 221-5101 • PA. PHILADELPHIA (609) 424-4450, PITTSBURGH (412) 462-7400 • TEX. DALLAS (214) 357-7341, HOUSTON (713) 672-3569 • VA. RICHMOND (804) 232-6733 • WASH. SEATTLE (206) 854-0211 • W.V. CHARLESTON (304) 346-9421 • WISC. MILWAUKEE (414) 744-0110 • PUERTO RICO PONCE (809) 843-4225.

Hitachi delivers 2-million-bit bubble memory

Hitachi Ltd. has completed a prototype 2-million-bit bubble random-access-memory module built of 32 64-kilobit chips that have an average access time of 5 milliseconds. **Aided by a subsidy from the Japanese government, the basic technology was developed during fiscal 1974 as part of the nation's pattern-information-processing project.** The prototype memory, delivered in December 1975, was fabricated to specifications of Musashino Electrical Communication Laboratory of the Nippon Telegraph and Telephone Public Corp. as part of its electronic-telephone-exchange development program. **Since the capacity of the chips has been growing about fourfold a year and the government subsidy is still being received, the company is obviously now making 256-kb chips.**

Despite their four times larger capacity, the 64-kb chips, which measure 6 by 6.4 millimeters, are only about 50% larger than Hitachi's earlier 16-kilobit chips. The new chips store each bit of information in a square measuring 20 μm on a side. The memory is organized as eight chips on a plane. To create a rotating magnetic field, the memory is structured into coils, with two planes per coil and two coils per module. The magnetic components of the memory module measures 23 by 48 by 120 μm , excluding peripheral electronic circuits, which are larger than the magnetic portion. This 2-million-bit memory has a larger capacity than some commercially available drums, which have an average access time of 10 ms.

Japanese develop ultra-low-loss fiber-optic cable

An ultra-low-loss fiber-optic cable has been developed by the Fujikura Cable Works Ltd., one of the three companies developing fiber-optic cables for Nippon Telegraph & Telephone Public Corp. The new cable has a loss of only 0.47 decibel per kilometer at 1.2 micrometers, and a loss below 1 dB per km between 0.95 and 1.37 μm . **This clad cable, which is produced by a chemical-vapor deposition method, has a core 58 μm in diameter and cladding 152 μm in diameter.** The loss was minimized by nearly complete elimination of water, the OH radical, from the glass. The remaining OH radical is said to be only 50 parts per billion.

The new cable will greatly extend the span between repeaters over which signals can be sent down fiber-optic cable. On the other hand, since clad, as opposed to graded, cable has poor group-delay characteristics it is not suitable for transmission of very wideband signals—signals with unusually high pulse-repetition rates.

Siemens seeks top spot in European LED products

Now that it has considerably expanded and mechanized its facilities for manufacturing discrete light-emitting diodes, Siemens AG this year is gunning to quadruple last year's LED production. This output, the German company says, will make it Europe's largest LED producer. **Another three-fold increase in production is planned for 1977.**

With gains like that, the firm's LED output will be growing faster than the market generally, comments a spokesman for the Munich-based company. The world discrete, LED market this year is estimated to be some 250 million units, and the company predicts it will expand to 350 million units next year. About 60% of Siemens' LED production is exported. The best-selling units are still red-emitting types, but sales of green and yellow versions are accelerating, Siemens says.

International newsletter

Data transmitter from Philips is integrated on chip

Researchers at the Philips Central Labs in Eindhoven, the Netherlands, have developed a digital data transmitter that integrates the input filter and modulator on a single chip of 3.6 by 3.7 millimeters. **The data transmitter, which is programable by an external read-only memory, is based on integrated-injection logic.** It is suitable for various modulation techniques, carrier frequencies, and spectral distributions.

With two transmitter/ROM configurations, various types of phase modulation are possible—for example, eight-phase modulation at 4,800 bits per second on an 1,800-hertz carrier frequency. Vestigial-sideband transmitters for 2,400 b/s and 4,800 b/s can also be implemented with a single I²L chip. **The transmitter can be integrated on a chip because a complex digital post-modulation filter is eliminated, and a simply constructed interpolating-type digital input filter is used.**

New French laws to protect people from EDP abuses

The French government is expected by the end of 1976 to establish laws governing the use of computers. A government-appointed commission has just published a two-volume "Rapport de la Commission Informatique et Liberté," which will be presented to the Minister of Justice at the end of June. Ministry sources say that "specific proposals will be made in the next session of parliament" regarding the use of computers and their infringement on personal liberty. **Laws will be proposed "to limit certain projects involving computers which violate individual freedom."**

Philips group leads phone-pact bidders in Saudi Arabia

A consortium headed by Philips Telecommunicatie Industrie apparently is at the head of the line for a massive telecommunications contract in Saudi Arabia. The Dutch-led group has been asked by the Saudi government to put together a proposal for expanding the country's telephone network from the current 190,000 lines to 660,000.

In addition to the hardware—including 10 group-switching centers, 10 stored-program-control subscriber exchanges, and line equipment—the project involves training personnel and running the net.

Two Japanese firms combine car radio and CB transceiver

Japan's leading manufacturer of citizens' band equipment, Cybernet Electronics Corp., will join one of the leading automobile-radio manufacturers to produce a combination car radio and CB transceiver. The a-m/fm multiplex stereo radio is being made by Fujitsu Ten Ltd., a subsidiary of Fujitsu Ltd. The first customer is Midland International's Communications division in Kansas City, Mo. **About 30,000 sets a month will be produced initially. The expected retail price in the U.S. is \$300.**

Germany and India install 60-MHz telephone systems

The use of 60-megahertz telephone-transmission systems with a capacity of 10,800 channels per coaxial line is proliferating. **The West German post office last month put into operation the country's first 60-MHz system, the Siemens-developed V 10800, in three sections that are part of the 300-kilometer route between Frankfurt and Duesseldorf.** Work is continuing to complete the link between the two cities. Meanwhile, Indian postal authorities have ordered a 60-MHz, 10,800-channel system from the Philips Communications division in the Netherlands. The system, India's first, will be installed along a 35-km route from Bombay to a nearby town. A 60-MHz system is already operating in Sweden.

New from Centralab...

CERBON™ TRIMMER RESISTORS

Affordable Stability...
300% More
Stable Than Carbon...
at a Carbon
Trimmer Price!



Why pay more? With Centralab's new CERBON trimmers you get stability approaching cermet and at carbon prices ... As little as 28¢ in distributor 1,000 quantities; as low as 10¢ in high volume orders.

The secret of CERBON superior performance? A totally new thick film resistor element, which combines both potentiometer and conventional thick film technologies, *plus* a heat stable ceramic substrate, *plus* a dual-tine contact spring, *plus* "Fluxgard" protection from dust and wave soldering contaminants. In short, a totally balanced electromechanical system.

Look at these benefits:

- TCR less than -400 ppm/°C.
- CRV less than 2% of maximum resistance.
- Rotational life exceeds 500 cycles.
- Adjustability (typical) -0.05% of total voltage.
- High overload capability—

1 watt at 25°C ambient for 1,000 hours exhibits less than 2% cumulative resistance change. • Maximum stability in humid environment — Resistors exposed to an atmosphere of 40°C at 95% relative humidity for 300 hours return within four hours to +2.5% of their initial readings.

CERBON trimmers are offered in a resistance range of 1 K ohm to 1 megohm with a choice of standard PC terminal configurations. They fit universally accepted circuit board mounting patterns. And they're ready now for fast delivery in any quantity.

Write for complete technical data on Centralab's new CERBON trimmer resistors. Or call (915) 779-3961 for a free evaluation sample. Move up to CERBON and save!

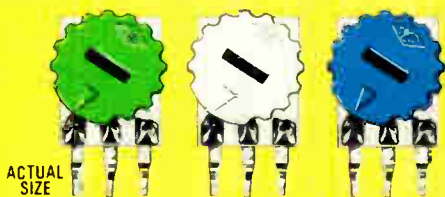

Knob colors available in white, blue, red and green for ease in assembly operations.



CENTRALAB

Electronics Division
GLOBE-UNION INC.

7158 MERCHANT AVENUE
EL PASO, TEXAS 79915

AVAILABLE CIRCUIT OPTIONS

Thanks to their ceramic substrate, Centralab CERBON trimmers permit a variety of screen printed circuit options. Here are three typical circuits:

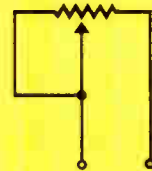

TERMINAL SHORTING

One of five electrical termination options available.

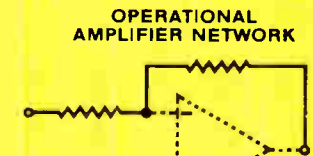

OPERATIONAL AMPLIFIER NETWORK

Typical CERBON trimmer resistor network incorporating one variable and two fixed resistors on dual substrate configuration.

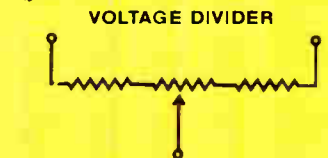

VOLTAGE DIVIDER

Fixed and variable resistors can be ratio matched for precise values and to insure temperature tracking. Eliminates need for costly discrete resistor selection.

Circle 57 on reader service card

Only TRW/IRC offers you complete resistor choice.



You get exactly the resistor you need for your application.

No compromises. No "favorites." Just quality.

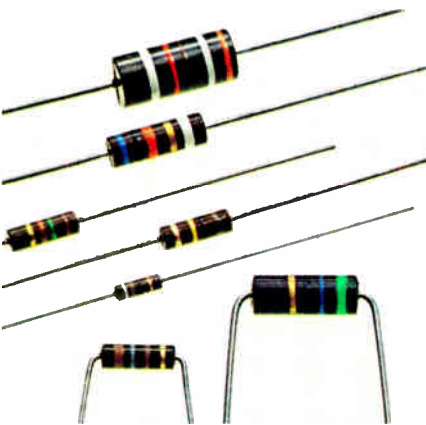

Carbon comp.

Billions used in consumer, industrial, military applications. TRW/IRC carbon comp. capability ranges from standard commercial types through established reliability RCR's, to ultra-high range (10^{11} ohms). Where you're using carbon comp.'s in automated assembly, TRW/IRC packaging options can help cut the cost of interfacing with your machines. Card packs, lead tape reels, cut and formed leads...we'll be glad to explore the potential economies with you.

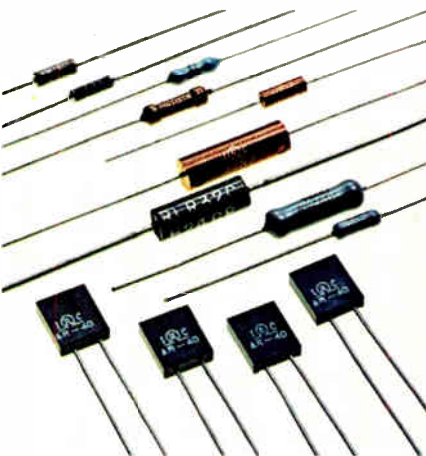

Metal Film

TRW/IRC has brought the state of the art in thin-film to a performance level equaling high-stability wirewounds. Capabilities include resistors with tolerances to $\pm 0.01\%$ and ± 3 PPM T.C. ...high-rel units... precision subminiatures...and, of course

the popular RN's. You can also look at alloy films offering high-temperature and high-voltage capability at low cost.

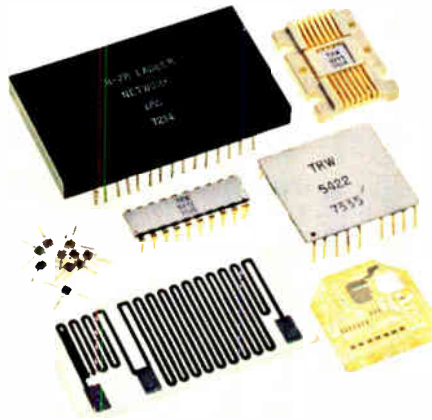

Resistive Networks

Advanced resistor technology here. These IC compatible, precision tantalum-film circuits provide inherent low noise, excellent stability, and hermetic performance without hermetic cost. Tolerances from 5% to 0.05% available in custom designs. TRW/IRC also offers the industry's most complete line of discrete fixed resistors.



Wirewound

The line starts with molded wirewound resistors—"space-savers" that bridge the cost-performance gap between composition resistors and precision wirewounds. It proceeds to standard, non-insulated types

for appliance/automotive use...to precision subminiatures offering high power density... to low cost fusible, flameproof units for consumer and industrial applications... to tubular and flat power wirewounds with ratings to 250 W.



Metal Glaze™

This is TRW/IRC's thick-film technology—for all types of low power resistor applications. Metal Glaze is widely accepted for its built-in power handling reliability, resistance range, and cost effectiveness. Numerous standard and special designs—precision, semi-precision, flameproof, high-rel, high-voltage.

All types...all technologies... one source

To wrap it up, TRW/IRC offers you the most complete line of fixed resistors in the business, with many of the popular types available from one source—your local TRW/IRC distributor. Having a direct pipeline to each of our plants, he can give you fast delivery.

Contact your local TRW sales office for application assistance, custom designs, and special engineering help when you need it. TRW/IRC Resistors, an Electronic Components Division of TRW, Inc. Plants at Boone, N.C., Burlington, Iowa, and Philadelphia, Pa. Write TRW/IRC Resistors, 401 N. Broad St., Philadelphia, Pa. 19108. Or call (215) 923-8230.

Through Omron's 43-year history, each product has been designed and built as we have seen needs and filled them. One by one, year after year, as your needs grew, so did our family. And our family continues to grow—so that today Omron offers some of the broadest lines of control components available.

Omron enjoys a worldwide position of leadership—a position built on excellence in engineering, manufacturing, and marketing. And Omron's

commitment to quality products and service means you'll get *what* you need, *when* you need it.

So welcome Omron as your component supplier. Tell us your needs. Our applications engineering department will respond to your phone inquiries for key performance data within 48 hours.

Omron will prove—you're not alone anymore!



**Welcome
to the family,
little fella**



Omron Corporation of America
Corporate Headquarters
Sears Tower, Chicago, Illinois

Sales and Service
1051 State Parkway
Schaumburg, Illinois 60172
Phone: (312) 885-9500



Circle 61 on reader service card

When you can buy all this for a total of \$701*

Expansion Slot for optional
Distributed I/O System
or Memory

Card Cage with
motherboard

Memory with 256 16-bit
words RAM and sockets
for 8k ROM

CPU with Real-Time Clock,
AutoLoad and Power Fail
Restart capability

10-Amp Power Supply
with cable assembly

Operator's Console and
mounting plate

 COMPUTER AUTOMATION, INC.

The ALPHA™ LSI-3/05 Millicomputer. The lowest priced, 16-bit, full-scale, packaged computer in the world.

...building your own just doesn't add up.

Sum and substance. An unbeatable combination even for our competition, so you needn't feel too badly.

Especially when you consider everything we've got going for us.

Specialization, of course. OEM computers — *low-cost* OEM computers — are our only business. The NAKED MINISM people, remember? And when you do only one thing, you do it better.

Experience, too. Over 10,000 up-and-running, field-proven computers successfully integrated into all kinds of sophisticated OEM products.

Also, some things Henry Ford would have appreciated. Buying in volumes most OEM's can't manage. Building the same way.

Where all that gets you is on the down-hill side of the learning curve... where we get our pay-off and you get the lowest-priced, most reliable computers around.

That explains why we can, but not necessarily why you can't. Here's the rest of the rationale:

The chip shot: a hit or a myth?

The fallacy of the micro-processor is that a chip set isn't a computer. Even if you got your chip sets *free* you still couldn't build a computer equivalent to our ALPHA LSI-3/05 for \$701.

Price out the subassemblies shown in the picture and see what we mean. CPU, memory, card cage, power supply and console. All of that design and development time. Amortized over maybe a few hundred systems?

Heart of the ALPHA LSI-3/05 shown at left is this NAKEDSM MILLI central processor and memory for \$395*

ComputerAutomation will build thousands of ALPHA LSI-3/05 systems.

Then there's the packaging and fabrication. Cable assemblies, too.

Just think about the procurement activity alone. The lead time. Getting our picture?



The ALPHA LSI-3/05 is offered in three series featuring a choice of card cages, consoles, memories and power supplies.

Computers vs computerization

How do you talk to a computer?

Mostly with money, it turns out. Interface money. And mostly a lot of it.

Interfacing a computer to one or two peripheral devices can easily cost as much or more than the computer itself.

Which is why we invented the Distributed I/O System. An optional interfacing system that simultaneously interfaces up to 32 peripherals and special devices, serial or parallel in any combination, for less than \$200* per interface.

What you see is not exactly what you get

Here's what else you get when you buy an ALPHA LSI-3/05 millicomputer:

- 95 powerful instructions
 - Individually vectored interrupts
 - Direct Memory Access
 - Memory expansion to 32K
 - Maxi-Bus interchangeability for easy upward expansion to our full line of compatible minicomputers
- Plus full-fledged mini-computer software.

From the people who brought you the NAKED MINI

The people with the largest line of compatible computers in the world.

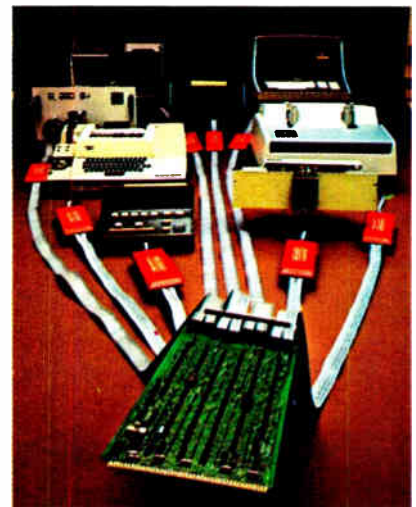

Maxi-Bus compatible ALPHA LSI-3/05 achieves unprecedented cost-effectiveness with ComputerAutomation's new Distributed I/O System.

The people with the lowest-priced computers in the world.

The people with the first and only Distributed I/O System in the world.

The people who've been simplifying OEM build versus buy decisions for years.

ComputerAutomation
NAKED MINI Division

U.S.A. 18651 Von Karman, Irvine, CA 92715
(714) 833-8830
EUROPE Hertford House, Denham Way, Maple Cross, Rickmansworth WD3 2XD, Hertfordshire, England; Telephone: Rickmansworth 71211

All prices shown are for lots of 100 (U.S.A. only)

Patent Pending

For further information circle 62
Please have a salesman call circle 63

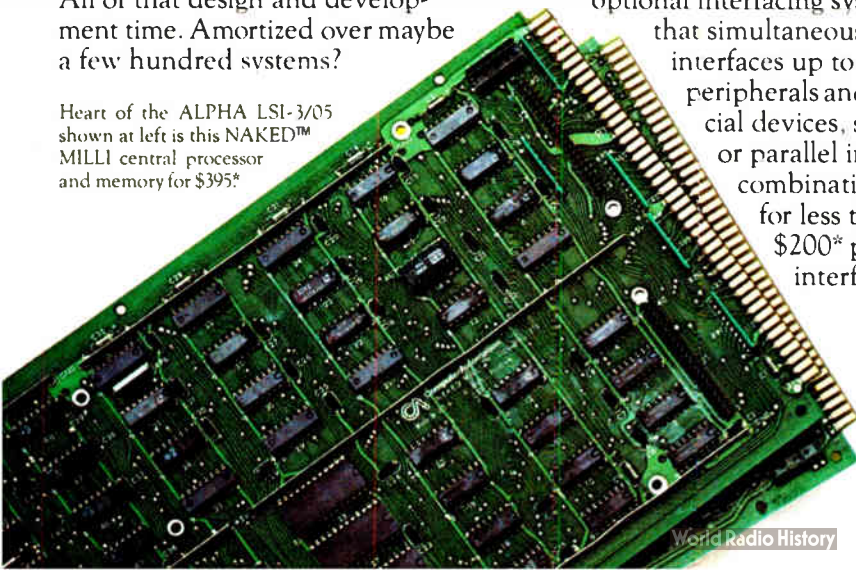



$$X_n = \sum_{k=0}^{N-1} x_k \exp(-i2\pi nk/N), \quad 0 \leq n \leq N-1.$$



Sharpen your competitive edge. Use an HP computing calculator for design, analysis, control, and test.

In the highly competitive, high technology electronics business, everything counts: keeping costs in line, exploring promising design alternatives, shortening lead-times, testing products and prototypes, and increasing productivity. That's where HP computing calculators, software, peripherals, and interfacing capabilities come in. They can help you get and maintain a competitive edge.

Three computing calculators and plenty of peripherals: It's your choice. We offer a range of computing power and I/O options so you can configure a system just right for you.

Choose the low-cost HP 9815 for programmed problem-solving, small interfacing applications, and quick keystroke calculations. It's easy to use and easy to justify.

The HP 9825 with interrupt, direct memory access, live keyboard, and a state-of-the-art NMOS processor has minicomputer

capabilities for systems control jobs and for raw number-crunching capability.

The HP 9830, programmed in BASIC, is an all-purpose system. With an extensive software library and a large choice of peripherals (including 4.8 million bytes of mass memory and data communications capability), it may be all the computing power a small company or a large department requires.

HP peripherals include card readers, paper tape readers/punches, printers, storage devices, a CRT, and a digitizer. And, the X-Y plotter is just the thing for analysis of circuit designs.

Software, specialized and generalized, helps you look at more alternatives.

HP engineers developed software to optimize designs and analyze engineering problems quickly. There's a State Variables package for control system analysis. There's CNAP for circuit design and analysis, BAMP for microwave design and analysis, and Digital Simulation for state and timing analysis.

You can add other programs, too—commonly needed math routines and statistical programs to name but two. Programs are also available for accounting applications, report generation, and financial analysis.

Automate your instruments. We make the connection friendly.

From simple data logging to complex system integration, our programming commands and interface cards make instrument interfacing easy. Whether your instruments require BCD, bit-parallel, RS 232-C, or HP-IB (HP's implementation of IEEE Standard 488-1975), you plug the correct interface into the calculator and connect the cable to your instrument. It's the friendly connection.

HP computing calculators: from initial design to final test. Whether you're in research, design, production, or test—or all four—we can provide the computing power and programs to help you increase productivity and sharpen your competitive edge. We have a new brochure for electronic engineers that will show you how. Get a copy from your HP representative, or circle our reader service number in this magazine.

HP computing calculators put the power where the problems are.



Sales and service from 172 offices in 65 countries

P.O. Box 301, Loveland, Colorado 80537
F. F. Assisi, Inc., 31, Washington, (301) 948-6110, Chicago, (312) 677-0400
Atlanta, (404) 434-4000, Los Angeles, (213) 811-2921, Toronto, (416) 678-9410

IBM giveth and taketh away

Giant's reduction in prices will hit independent add-on-memory makers, but new operating system will give them new sales target

by Stephen E. Scrupski, Computers Editor

By reducing purchase prices by as much as 35%, IBM Corp. has at last reacted to growing incursions by independent manufacturers of semiconductor memories into the System/370 add-on-memory business. However, a parallel IBM move may aid the independents.

Although the independent manufacturers are exhibiting little concern over the cuts, the move was definitely a reaction by IBM, says Ted Withington, staff member of market analyst Arthur D. Little Inc. and veteran IBM watcher. "The market for the independents has been growing only by degrees," he says, "not by large leaps forward. The independents have been prosperous as their penetration into the IBM base has grown. Now IBM has counterattacked, and it's going to be a good deal tougher."

The bright spot in the price-cutting announcement, as far as the inde-

pendents are concerned, was that it was followed a few days later by an announcement of a new operating system that requires more memory than previous ones. Thus, the two announcements seemed to go hand-in-hand: the need for more memory will benefit the independents as much as IBM. "I look for IBM's software over the next two to three years to be 'memory-eating,'" says Richard Andreini, vice president for systems marketing at Advanced

Memory Systems in Sunnyvale, Calif., who thus feels little discomfort from the announcement.

As shallow as their penetration has been—the independents have

tem/370 series in 1976, the independents will take about 5 billion bits. In 1977, Egan says, the additions will rise to a total of 21 billion bits with the independents taking about 6.3 billion.

The independents have been wielding a major selling point—prices have been less than half the IBM level in many instances. Datapro Research Corp., Delran, N.J., says that before the price cut, IBM prices for the model 158, to take one example, had been about \$263,000 for 1 megabyte of additional memory. The independents, however, were quoting prices down around \$120,000 per megabyte, or even lower. However, even at this price differential, Datapro says, the cumulative penetration by the independents hit only about 12% by the end of 1975 in the worldwide total of 1,000 installed 158s.

Now, with the price cuts, independent prices

will be about two-thirds as high as IBM's—"about where they should be," claims AMS' Andreini. He and others point out that, traditionally, marketers of plug-compatible equipment for IBM systems have offered prices that were about 70% as high as IBM's and have been able to build a good business for themselves. Thus, the price cuts, they feel, will have little effect on their business. "It probably will inhibit some users who need a large differ-



Competitor. This is Intel's in-7168, an add-on for IBM's System/370 model 168. The Intel memory stores 1 to 8 megabytes.

been able to nibble off only 10% to 15% of the cumulative memory installations so far—in 1976, they could double that and install nearly 30% of the add-on memories, speculates Richard Egan, assistant general manager of Intel Corp.'s Memory Systems division in Sunnyvale, Calif.

Egan estimates that, of the 18 billion bits of additional memory expected to be installed on models 135, 145, 158, and 168 of the Sys-

ential in prices in order to justify going to the independents, but things will soon get back to normal," says Intel's Egan.

Census. Basically, here's the way Datapro Research Corp. sizes up the worldwide System/370 census:

- For the top of the line, the model 168, there are about 250 installations, and the independents have penetrated this add-on memory market only by about 1% (the percentage primarily reflects the infancy of the business).
- There are about 1,000 model 158s, and penetration is about 12%.
- There are about 2,700 145s, and penetration is about 16%.
- There are about 4,000 135s, and penetration is about 8%.

The independents can be classified in two groups: those that make the memory systems and those that market them. Makers include Advanced Memory Systems; Cambridge Memories Inc. of Bedford, Mass.; Intel Memory Systems division; National Semiconductor Memory Systems division of Santa Clara, Calif., and Electronic Memories and Magnetics of Hawthorne, Calif.

Marketers include: Intel; Cambridge Memories; EM&M (the only three makers that also sell directly to the end users); Control Data Corp. of Minneapolis; Storage Technology Corp. of Louisville, Colo.; Itel Corp. of San Francisco; Memorex Corp. of Santa Clara, and Computer Investors Group of Stamford, Conn. These marketers essentially buy the memory systems from the makers. National, for example, markets through Intel, Memorex, and STC, while AMS markets through Memorex, Control Data, Itel, and Computer Investors.

Shift. The leaders in this field are a brand new batch of semiconductor makers taking advantage of the latest in 4-kilobit random-access-memory chips. There's been a geographical shift to the West, says Intel's Egan, leaving only Cambridge Memories in the East—its semiconductor plant is in Poughkeepsie, N.Y. Egan, who himself emigrated westward from Cambridge, points out there were once about 15 suppliers of add-on core memories for the System/360, but with the 370,

the number has shrunk to just the few that have the semiconductor technology well in hand. "The independents' prices are now generally in line with the costs of the chips, based on current yields," says Joseph Kruey, president of Cambridge Memories, but Cambridge and, presumably, all the other producers are looking at the 16-kb chips to see when they might be used to reduce costs and prices further. However, he says, there does not seem to be great pressure to get the 16-kb chips into production of add-ons.

However, even the independents' prices have been dropping. Datapro points out, for example, that during the first quarter of 1976, add-on memory for the model 145 dropped from about \$140,000 for 384 kilobytes to about \$83,000.

The independently produced memories, although fully plug-compatible with IBM mainframes, offer users some extra features not available from IBM. For example, Intel's new add-on for the model 168 uses an 8080 microprocessor in the maintenance panel to log errors and thereby warn of potential failures.

Extras. The independents' memories also allow users to go beyond limits established by IBM. The model 158, for example, has a limit of 4 megabytes (some observers say that the limits are set by IBM because users who will eventually need more memory will be encouraged to move up to a completely larger system, rather than just expand the memory), while the independents offer compatible memories that expand the 158's capacity up to 8 megabytes.

Finally, there seems to be little concern among the independents that IBM will soon announce its new series.

Instead of a new series, the independents are watching for announcements of the models 138 and 148—enhancements of the 135 and 145, just as the 158 and 168 represented enhancements of earlier models 155 and 165, which had core memories. The models 155 and 165 also represent a market for add-on memories, since the semiconductor memories can be made compatible and speed up the system at the same time. □

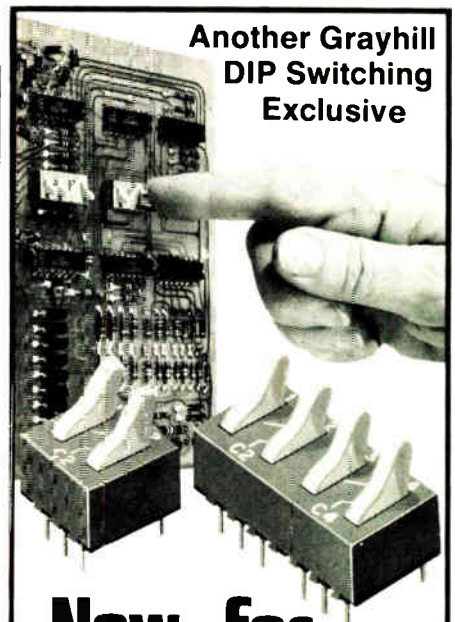

Another Grayhill
DIP Switching
Exclusive

Now—for front panels: Grayhill's TOGGLE-DIP™

Life-rated at 50,000 operations,
toggle actuated
for fingertip operation

- Extraordinary life of 50,000 operations or more at logic levels, 25,000 at 125 mA, 30VDC.
- Positive feel provided by unique spring-loaded sliding ball contact and detent system.
- Available with SPDT circuitry, two, three or four stations; DPDT with one or two stations; switches may be stacked side to side for multi-station arrays.
- Provides Double Throw switching, satisfying logic '1' and logic '0' input requirements.

Now for the first time, you can secure the many benefits of DIP switches along with the performance characteristics necessary for front panel usage. Grayhill's new TOGGLE-DIP™ Switches supplement our extensive and acclaimed line of rocker DIP switches. They bring you the fingertip ease of actuating well-spaced toggles along with the mechanical and electrical life ratings provided by Grayhill's unique construction method.

Delivery is from stock for prototype quantities, and may be arranged through your local Grayhill distributor. Grayhill's new TOGGLE-DIP™ Switches are fully described in Bulletin 259, available free on request from Grayhill, Inc., 561 Hillgrove, La Grange, Illinois 60525 (312) 354-1040.

Grayhill
INC.

Consumer electronics

Quadraphonic sound poised again

Work on getting bugs out of matrix technique is spearheaded by IC decoding system developed by National and British firm

by Bernard Cole, San Francisco bureau manager

After five years of ups and downs in the marketplace with audiophiles being alternately charmed and disillusioned with its performance, quadraphonic sound appears ready for technical advances again.

Indeed, if the development activity in one of the two main techniques of implementing four-channel sound on disks—the matrix system—is any indication, this time it's for real. Among other things, CBS Inc., which pioneered the matrix approach with its SQ system in 1971, has developed a so-called Paramatrix system that goes a long way toward solving the directionality and operation problems that turned off the public to its original system. And Sansui of Japan, developer of the competing QS quadraphonic approach, is reported also to be developing a similar advanced system.

But both are holding their work in abeyance until they see what happens as a result of a new agreement between Tate Ltd., a British audio electronics firm, and National Semiconductor Corp. to develop an integrated-circuit matrix decoding and enhancement system. Its promise is that, retrofitted to existing systems, it could improve the four-channel sound separation and directionality of any matrix decoder by 50% to 100%.

Present systems typically have channel separations that vary from 15 decibels to 40 dB, depending on direction, total harmonic distortion of 0.1% to 0.5%, and signal-to-noise ratios of about 40 to 50 dB. The Tate system in its breadboard version, says company managing director Wesley Ruggles, allows any matrix

system to achieve a constant 30 to 40 dB of separation in any direction, as well as 0.05% distortion and 70 dB s/n. According to Thomas Reine, director of linear marketing at National, the Santa Clara, Calif., semiconductor company is at work

on three bipolar linear ICs that could achieve comparable performance.

"From what we've seen and heard so far, the Tate system is far ahead of anything in the marketplace or in development," says CBS'

Sounding off. The three key elements to be reduced to ICs by National are the detector, a processor, and a matrix multiplier. Chips should be ready for testing by this fall.

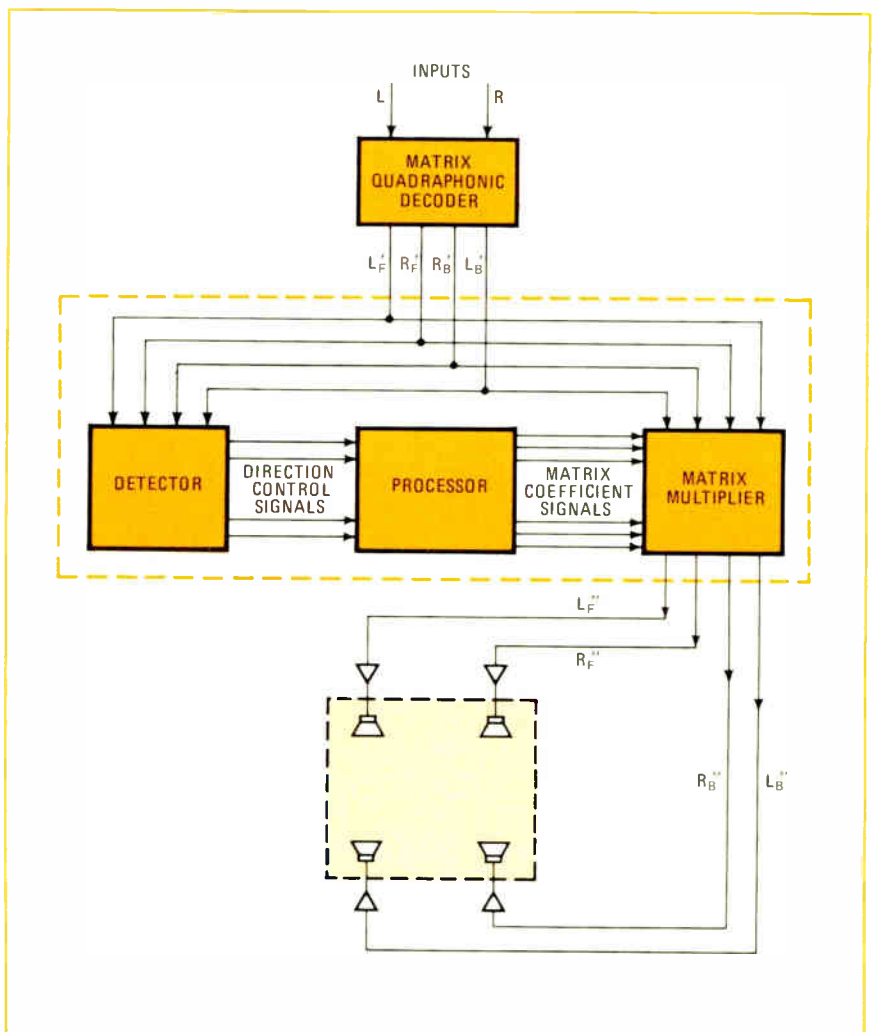

Joseph Dash, director of new product marketing. "If it can be successfully produced in integrated-circuit form, it will bring quadrasonic sound back to life."

What the Tate system appears to do is eliminate many of the internal inconsistencies that have plagued the matrix approach since its introduction in the early 1970s by CBS, Sansui, and several other companies. In this approach, through various mathematical encoding techniques, a matrix algebraically combines four original signals—right and left, front and back—into two for recording in normal stereo fashion. In playback, a decoder converts the two signals back to four, delivering an approximation of the originals to four speakers in the receiver system.

"What excited many of us in the audio equipment and recording industries was that the matrix approach allowed us to dovetail quadrasonic very easily with stereo and quadrasonic receiver systems," says Herbert Lipold, chief engineer at Fisher Radio Corp., the Long Island City, N.Y., producer of audio equipment. "In addition, matrix quadrasonics could be broadcast over the same fm channels as stereo, which meant we had a built-in tool to boost sales of equipment."

"Unfortunately, in these early systems, each of a matrix disk's decoded channels—because of poor separation (about 3 dB)—contains not only the signal intended for it but also spillover, or crosstalk from other channels' signals." This poor performance, Lipold says, is one reason many audio manufacturers switched to the other approach to quadrasonic disk systems—the discrete channel, CD-4, system developed by Victor Corp. of Japan, built by Hitachi and Signetics, and promoted heavily in the United States by RCA Inc. [*Electronics*, March 1, 1971, p. 73].

In the years since 1971, companies such as Motorola Semiconductor—which built the first SQ matrix IC—have developed second, third, and fourth generation systems that add various kinds of front-to-back, left-to-right, corner-to-corner, and wave-matching circuitry to im-

prove the separation. But while separation has improved five-to-tenfold, to about 15 to 40 dB, directionality is still a major problem, Lipold says. "Where separation in any one direction, say left or right, may be as high as 40 dB, the separation in other directions can be as low as 15 to 20 dB."

New matrix. What Tate engineers have come up with, Ruggles says, is a modifying matrix that extends the mathematical solution on which existing matrix decoders are based. "The difference between our solution and everyone else's, is that, where everyone else has tried to fix the matrix by adding compensating logic, we've gone back and fixed the mathematics."

Functionally, this new matrix will be implemented by means of three specially designed circuits in the Tate/National IC set: a detector that continuously recognizes the direction of the predominant sound source from any matrix decoder, such as SQ, and produces corresponding control signals; a processor that imposes the suitable level-limiting and time-constant characteristics on those signals and generates from them a number of voltages representing the coefficients of the modifying matrix, and a matrix multiplier that multiplies the incoming four signals by the modifying matrix to obtain four output signals in which the directionality of the predominant sound source is enhanced.

The system, says National's Recine, is now in mask layout and prototype chips should be available for testing by this fall. He says National is committed to having a system up and running in time for the Consumer Electronics Show next spring and shipping parts in quantity soon thereafter.

And if the Tate/National system doesn't solve the problems, someone else will eventually come up with a system that does, Dash says. "The market potential is just too large to ignore." Recine agrees, and estimates that, if the IC set being developed jointly with the British firm works, it could bring "several tens of millions of dollars in sales to National over the next four to five years." □

a little A-300 goes a long way.



In high frequency transmission. RF power generation for industrial and research processes. RFI/EMI and general laboratory applications, too.

The Model A-300 is a totally solid state power amplifier, covering the frequency range of 0.3 to 35MHz with a gain of 55dB. Capable of delivering 300 watts of linear Class A power and up to 500 watts in the CW and pulse mode, the A-300 is the ultimate in reliability.

Although the unit is perfectly matched to a 50 ohm load, it will deliver its full output power to any load (from an open to a short circuit) without oscillation or damage.

Complete with power supply, RF output meter and rack mount, the A-300 weighs a mere 89 pounds and operates from ordinary single phase power.

High power portability goes a long way for \$5350.

For further information or a demonstration, contact ENI, 3000 Winton Road South, Rochester, New York 14623. Call 716-473-6900 or TELEX 97-8283 E N I ROC

ENI

The World's Leader
in Solid State
Power Amplifiers

Announcing a BiMOS breakthrough...

The RCA 3140: most useful op amp since the 741.

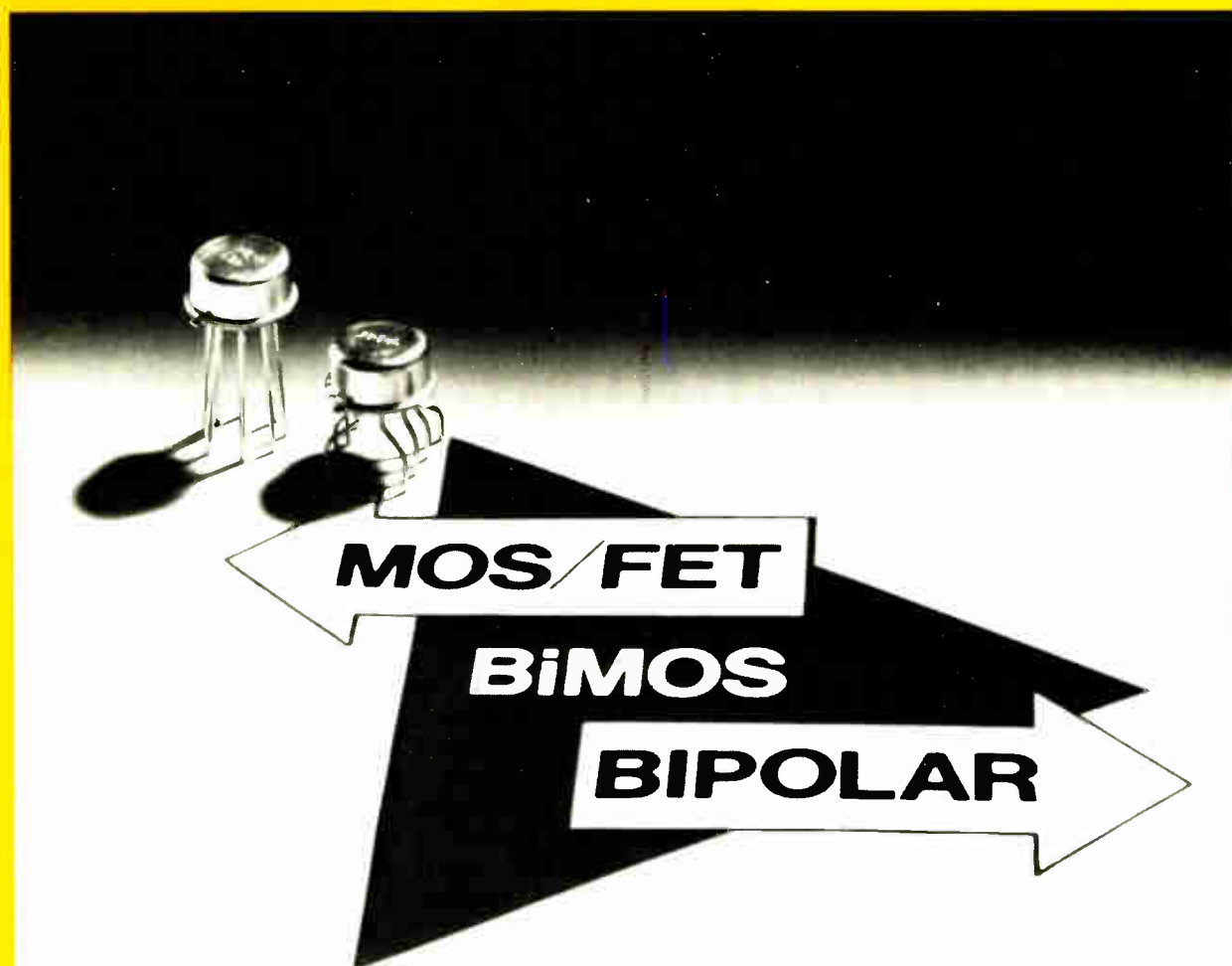

**For the price of a 741 you get
a lot more op amp.
MOS/FET input makes the difference.**

Every so often a new advance greatly expands op amp versatility. In 1965 there was the general-purpose 702. Followed in 1966 by the 709, with higher voltage, gain and input impedance. Along came the 101 with still higher voltage and gain. Then in 1968 the remarkable 741 gave you the added benefits of on-chip compensation and low cost.

Now, RCA announces a new giant step toward the ideal op amp. The CA3140 Series of BiMOS op amps.

It gives you the big advantages of MOS/FET input...plus bipolar speed and high supply voltage operating capability: 4 to 44 V, dual or single supply. That means very high input impedance: 1.5 T Ω typ. Very low input current: 10 pA typ. at ± 15 V. Low input offset voltage: as low as 2 mV max. Wide common-mode input voltage range—can be swung 0.5 V below negative rail. In addition, output swing complements input common-mode range, permitting full utilization of low supply voltages (down to 4 V). And PMOS input devices are protected by rugged bipolar diodes.

BiMOS vs. 741

You get all of those features for the price of a 741. 69 cents at the 100 unit level for the CA3140T, S. Plus big circuit savings. BiMOS minimizes bias circuitry. Allows single supplies in portable, automotive and instrumentation equipment.

BiMOS vs. BI-FET

Compared to recently announced higher-priced BI-FET types, the CA3140 offers lower input currents, higher input resistance, improved offset current and comparable offset voltage—all with high slew rate and bandwidth. So chances are, you don't have to pay the higher prices.

In fact, in most existing circuits using premium op amps, the CA3140 permits cost reductions and/or improved performance with minimum circuit redesign. And if you have an application where you ruled out op amps altogether because of cost...reconsider. The CA3140 is cost effective in many places where other op amps are not.

Low circuit cost

The CA3140 needs no external compensating circuitry. It is characterized for low-cost TTL systems requiring operation at 5 V and maintains operation down to 4 V. Its wide bandwidth—4.5 MHz unity gain—makes possible low-cost video and audio circuits. For low-cost sample and hold and other data acquisition systems, it offers fast settling time: 1.4 μ s typ. to 10 mV. When it's driving power transistors, the output swings to within 0.2 V of the negative supply, eliminating the need for level-shifting circuitry.

CA3140 vs. 741 at a glance

Characteristics	Limits						Units
	CA3140T, S			CA741CT, S			
at Supply Volts: V ₊ = 15 V, V ₋ = -15 25 C	MIN	TYP	MAX	MIN	TYP	MAX	
Input Resistance, R _i	300,000	1,500,000	—	0.3	2	—	M Ω
Input Current, I _i	—	10	50	—	60,000	500,000	pA
Input Offset Current, I _{IO}	—	0.5	30	—	20,000	200,000	pA
Input Offset Voltage, V _{IO}	—	5	15	—	2	6	mV
Slew Rate, SR (Closed Loop)	—	9	—	—	0.5	—	V/ μ s
Gain-Bandwidth Product, f _T	—	4.5	—	—	1.0	—	MHz
Common-Mode Input Range, V _{ICR}	15	15.5 to 12.5	11	12	13	12	V
Output Swing R _L = 2K Ω	14	14.4 to 13.0	12	13	13	10	V
Large Signal Voltage Gain, A _{OL} R _L = 2K Ω	—	20,000	—	—	20,000	—	

Versatile building block

Beyond standard op amp uses, the CA3140 can perform in many other applications. Such as ground-referenced single-supply amplifiers. Sample and hold amplifiers. Long-duration timers/multivibrators. Photocurrent instrumentation. Peak detectors. Active filters. Comparators. Tone control circuits. Function generators. Power supplies. Portable instruments. Intrusion alarm systems.

Six commercial versions are available: in the TO-5, the standard CA3140T and the premium types CA3140AT and CA3140BT; the CA3140S, CA3140AS and CA3140BS are the DIL-CAN versions of the TO-5. Also available is the chip version—CA3140H. The CA3140 series is available processed to all levels of MIL-M-38510/883.

Send for 13 useful circuits.

To show you how useful the CA3140 is, we've designed it into 13 typical circuits. To get these circuits plus other information, contact your RCA Solid State distributor. Or RCA.

Write: RCA Solid State, Box 3200, Somerville, N.J. 08876; Ste Anne de Bellevue H9X 3L3, Canada; Sunbury-on-Thames, U.K.; Fuji Bldg., Tokyo, Japan.

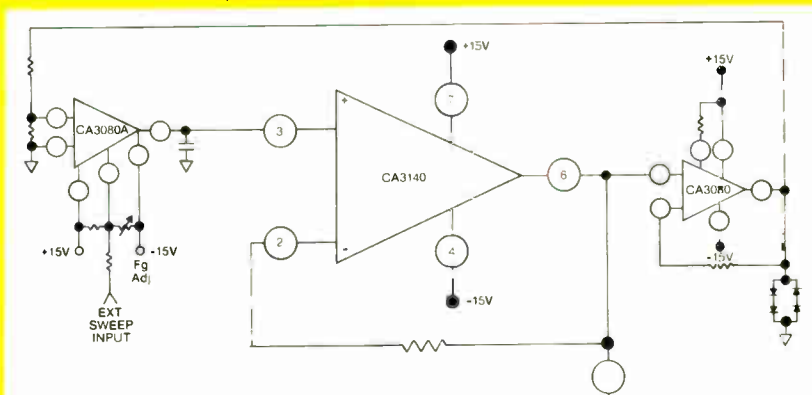

Basic Function Generator

The CA3140 gives 1,000,000:1 range, single control when used as a buffer readout for the integrating capacitor in this basic function generator. The RCA data sheet (File No. 957) tells you how to build this circuit.

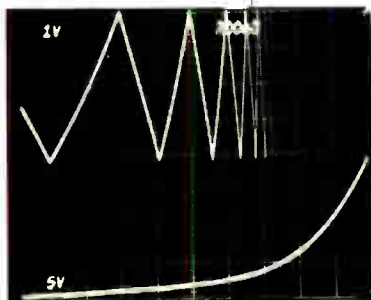

RCA

RCA. Full house in Linear ICs.

Circle 71 on reader service card

Communications

Canadians think digital

Plan to start with smaller switching in less centralized offices, while AT&T concentrates on big cities

by Richard Gundlach, Communications & Microwave Editor

The telecommunications industry is going digital; that's no longer in doubt. The only question remaining is how best to handle the transition. The answer, judging from the way it's being done in the U.S. and Canada, depends on competition and need.

South of the border, AT&T is faced with growing competition from specialized common carriers cutting into its lucrative toll routes, particularly in high-use metropolitan areas. So it has decided to beef up its large toll-switching systems to provide increased service at reduced costs per circuit mile. To this end, AT&T has already cut over its first all-electronic digital toll switch, No. 4 ESS, in Chicago, and plans to continue to add these large capacity switches in high-use areas. By 1978, 20 should be in operation.

But Bell Canada is taking a different tack. With a need to serve smaller, less centralized groups of subscribers, the Canadians see distributed digital switching as the key. The numbers tell the story: 1,300 to 1,400 central offices of all shapes and sizes with over 1.25 million lines serving less than 100 subscribers each.

Money saver. Bell Canada's commitment to speedy digital conversion is a strong one. "Although we have the option of waiting, delay could be costly," points out Robert C. Scrivener, chairman and chief executive officer of Northern Telecom Ltd., the manufacturing arm of the Canadian phone company. Three quarters of Bell Canada's intertoll network will be digital in the early 1990's and will be all-digital by the turn of the century.

The digital route is dictated by the simple need to reduce costs. With digital switching techniques, large switches can be replaced with small solid-state components to reduce costs of equipment and maintenance. And digital technology is particularly suitable for remote peripheral operation: with both control and voice signal in digital format, chunks of the switch can be moved to new locations close to clusters of subscribers and linked to the main switch by digital carrier lines. This means a tremendous savings in copper and outside plant as well as a savings in maintenance costs and space.

"Crowded cable ducts in cities are rapidly filling up, and the costs of replacing new cable is skyrocketing," says W. C. Benger, group vice president for transmission at Northern Telecom. And according to Scrivener, a way must be found to move digital equipment into central offices economically alongside analog gear, so that even the relatively few customers who want the benefits of digital services can be accommodated while those others still satisfied with only step-by-step switching can be served economically until the whole office has to be changed.

As Gordon E. Inns, vice president of Bell Canada's Ontario region, tells it: "We recently finished a study that showed we could save as much as \$40 million per year in new capital if we went digital that otherwise would have to be spent on new trunks, loops, buildings, and wire centers needed to serve Bell Canada territory. And that's just capital. We haven't even begun to estimate the



benefits that will accrue from increased flexibility, shorter provisioning intervals and easier maintenance."

Looking at the numbers, the Canadians figure that digital implementation of all the existing copper and mechanical switches could reduce the work force by a third. And today's large-scale integrated technology, coupled with increasing use of software, will make the switch-over feasible, adds Scrivener.

Lloyd Webster, vice president and product-line manager at Northern Telecom, points out that digitizing and distributing switching equipment is already saving money and claims that Northern's new family of digital multiplexed switching systems, called DMS, will not only reduce maintenance costs, but will also eliminate equipment needed for digital-to-analog interfacing. The distributed-switching aspects of the new digital equipment family, which is LSI-implemented, stored-program controlled, and all-electronic, serves to place parts of



the central office closer to the subscriber loop.

Natural evolution. The DMS family carries the proven technology of Northern's digital private automatic branch exchange, the SL-1, into the local office or community dial office system. These systems need only a fraction of the space now occupied by the older mechanical switches. For example, 3,500 lines of DMS-10, Northern's digital multiplex switching system for local offices, fit into the same space now occupied by 500 lines of step-by-step switching equipment. To replace crossbar switching, the digital switch uses less than 25% of the space. It uses half the space of some of today's stored-program-controlled analog systems. Moreover, a DMS remote-switching system can easily handle the more demanding and growing needs of a new building over the same few pairs of wires that served the old building. And one central maintenance center can provide a teletypewriter printout in straightforward language as the system continuously monitors itself. The printout can pinpoint trouble areas as close as a specific circuit card.

The first in the digital-multiplexed family is the DMS-1 switch. It can handle up to 256 lines and will be introduced in the fall. To be used initially as an analog subscriber subcarrier system, it will later serve as a remote network when connected to a particular digital switch. Other systems will follow.

Included will be a fully digital central office for 1977. Called the DMS-10, it will handle from a few to 6,000 lines. By 1980 there will be a large digital system, similar to AT&T's No. 4 ESS switch, for local central office switching. It will be able to handle toll calls and control up to 100,000 lines.

"We at Bell Canada have decided that DMS is the way to go and we are planning for it right now," Inns says. "By the mid-1980s we expect to have DMS in most of our major cities and in many of our smaller central offices. That should account for about 15% of our exchanges, but will provide service to only about 8% of our customers." □

This is an echo chamber?

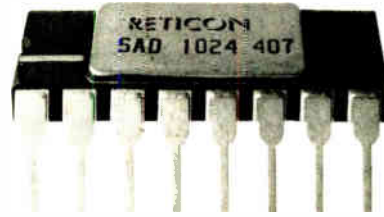

Yes, and much more! It is the first N-channel Bucket Brigade Device designed with the audio engineer in mind. The **SAD-1024 Serial Analog Delay** will provide reverberation, echo, tremolo, vibrato and chorus effects in electronic organs and musical instruments. It will equalize speaker systems in an auditorium, or can be used in speech compression or voice scrambling systems. The SAD-1024, which contains two independent sections of 512 analog storage elements will accomplish all of these with a signal-to-noise ratio in excess of 75 dB. The two sections may be used independently or they may be connected in sequence to provide 1024 clock periods of delay. The delay provided by the device can be continuously varied by the clock rate from less than one millisecond to more than one second.

Other performance characteristics include: Signal bandwidth from 0 to 200 KHz, less than 1% total harmonic distortion, 0 dB insertion loss, and less than 5 mW power requirements from a single 15V power supply.

You get all of these features for less than 1¢ per storage element in OEM quantities.

We also offer a complete circuit card to help you evaluate this exciting new device. Other devices for applications such as time base correction in the video bandwidth are also available.

There are over 70 salesmen and 16 distributors to serve you worldwide.

RETICON®

910 Benicia Avenue
Sunnyvale, California 94086
(408) 738-4266 • TWX: 910-339-9343

Companies

Israel's Tadiran finds the formula

\$200 million company's steadfast faith in electronics has led to worldwide business in military radios

by Hesi Carmel, McGraw-Hill World News

In the short history of Israel's industrial development, one company has enjoyed unprecedented success. And one of the main reasons has been its unswerving belief that the future is electronics.

The company is Tadiran, Israel Electronics Industries Ltd. Turning out two thirds of Israel's total electronics product, Tadiran has also gained an eminent position on the world market in the field of military tactical-communications systems. In fact, with \$100 million of its projected 1976 sales total of \$200 million derived from exports, Tadiran will be the country's largest single exporter. And, at the AFCEA (Armed Forces Communications and Electronics Association) show in Washington June 8 to 10, Tadiran was scheduled to be the second largest single exhibitor and probably the only foreign one.

The company began in 1961 as a small maker (\$750,000 in sales) of batteries and quartz-crystal devices. Its growth from then till now has been shepherded by a dynamic and enthusiastic director-general, Elkana Caspi, one of the new Israeli generation of American-style managers. It was Caspi who gave to Tadiran its esprit de corps and modern management methods, and it was Caspi who convinced government officials during the economic crisis of 1965-66 that electronics was the path to growth.

Long line. In 1969 it became an international corporation, with half its shares owned by the Israeli labor-union controlled Koor Industries Ltd. and the other half in the hands of Americans. Today, the company makes, in addition to mili-

tary products, a line of consumer goods (air-conditioners, refrigerators, washing machines, and television sets), computer terminals, and telephone exchanges, as well as nickel-cadmium batteries and quartz crystals.

But the backbone of Tadiran is its military radios. Many have proved their worth in Israel's wars. And the war-won experience has led to the improvement of American radios made by Tadiran under know-how agreements. For example, the AN/VRC-12, a vhf/fm mobile set with 920 channels between 30 and 76 megahertz, has gone through many changes. The LSA-100T has gained a loudspeaker, and the AN/GRC-106A, an hf single-sideband model with 280,000 channels between 2 and 30 MHz, has an added automatic tuning system.

Besides foreign-licensed products, Tadiran has developed a variety of its own models. One, the PRC-660, has evolved into a family of multi-service radio sets. The most popular radio in the Israeli army, it is one of

Tadiran's best export items and may become the standard radio in several European armies.

Currently the pride of Tadiran is the recently developed TRC-645T, a radio-telephone system housed in a shelter that can be mounted on vehicles or carried by helicopter. It is crowded with a variety of communications gear for use by senior officers during combat and can maintain long-range communications via teleprinter, telegraph, radio, or line. Foreign armies have already ordered \$10 million worth as military



On the move. The TRC-645T is a shelter-contained radio-telephone system that can be truck-mounted or carried on a copter.

Motorola Modestly Publishes Op Amp Specs National Can't

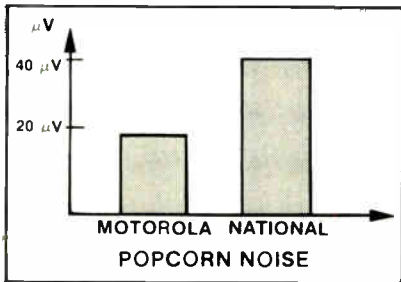

Motorola N series '1741 and '1458 are guaranteed less than 20 µV noise while others are typically above 20 µV.

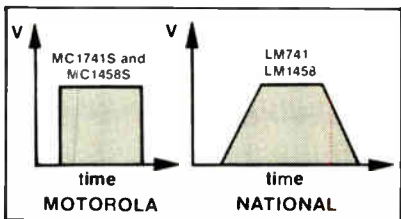

Motorola S series '1741 and '1458 are guaranteed 20 times faster in slew rate and power bandwidth than other typical specs.

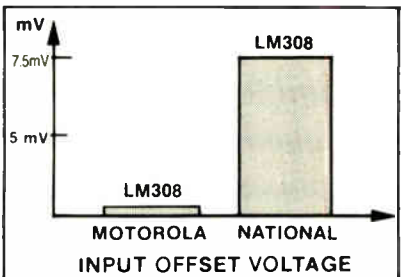

Motorola '308 series is laser trimmed to guarantee less than 0.3 mV input offset, ensuring far less adjustment at your door.

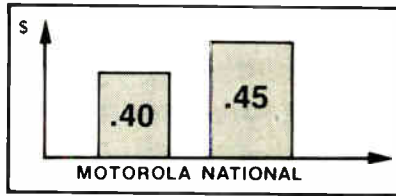

Motorola '1741 and '301 mini-dips are lowest priced in the industry (latest 100—up).

Op Amp Flip Chips

MCCF1709	Uncompensated
MCCF1741	Compensated
MCCF1458	Dual
MCCF3403	Quad
MLMCF324	Quad

Motorola offers the only Flip Chip op amps in the industry for the do-it-yourselfer.

STANDARD PRODUCT RELIABILITY AUDIT PROGRAMS

MOTOROLA	NATIONAL
(1) EPIIC — Environmental Package Indicators for Integrated Circuits	?
(2) LAPP — Linear Accelerated Punishment Program	
(3) CRP — Consumer Reliability Program	

Motorola's first concern is op amp reliability and you can take that to the bank.

1 Opmanship . . .

MC3403 Quad Op Amp—Right Now
 MC3458 Dual Single Supply—Right Now
 MC3471 Quad FET Input Op Amp—July '76
 MC4558, a '1458 with guaranteed 2.5 MHz Bandwidth—Pretty Quick
 MC4741, Four '1741 in Single DIP—Right Now
 LF155/156/157 FET Input Op Amps—July '76
 LM324 Quad Op Amp—Right Now

And you thought we were just a production house

 **MOTOROLA Semiconductors**

P.O. Box 20912, Phoenix, Arizona 85036

The new chip inductor. A miniature specifically designed for reflow soldering and hybrid circuits.

Delevan proudly announces another first in hybrid circuit component design. Only .1" square by .075" high, the newest member of the Delevan Micro-i, inductor series was engineered to withstand the high-temperature exposure of reflow soldering used for thick film processing.

High temperature insulated magnet wire is thermal compression bonded to gold plated metallic solder rails. The solder rails wrap around the sides of an alumina substrate to provide a visual indication of the solder bond.

Thermal exposure during assembly or rework is a severe test of component capability ... and can be a controlling factor in reliability and performance.

When dependability is first priority, check out the new series 103 miniature leadless chip inductor ... built to stand the heat. Ask for bulletin 103.

Delevan
Division



**AMERICAN
PRECISION
INDUSTRIES INC.**

270 QUAKER RD / EAST ALBANY, N.Y. 14052
TELEPHONE 716/652-3600 TELEEX 091-293

OTHER DIVISIONS OF AMERICAN PRECISION INDUSTRIES INC.
BASCO • OUSTEX

Probing the news

planners look for more mobility in communications.

The third factor in Tadiran's success—in addition to devotion to electronics and modern management—is its R&D. That effort occupies 300 engineers and technicians (out of a total of 6,000 employees) and 4% to 5% of the company's gross. "We are already working on the products of the eighties and nineties," says Akiva Meyer, vice president for planning and development. The two-pronged objective is to increase the proportion of home-developed products from 20% today to 60% in 1980 and that of civil and consumer goods. By 1980, Meyer says, 20% of the projected \$200 million in exports will be nonmilitary.

Other jobs. Among major development projects are:

- A rural telephone system that can handle up to 400 subscribers. It has its own power supplies and can be delivered by helicopter.

- SEDA—for solar energy for domestic applications—which has spawned an experimental solar-powered refrigeration unit. "In four years," says project director Heyuda Lando, "we expect to have a fully developed, mass-producible product." This project is expected to lead to a basic solar power supply for the home.

- Lithium batteries for medical and other special use. Tadiran is going into a joint venture with a German company to market the batteries in Europe.

- An advanced high-speed data terminal that prints 120 characters per second with its asynchronous serial impact printer. More than 200 units were sold last year in Europe; exports this year are expected to reach 1,000.

Tadiran says that, despite Arab boycott pressure, it continues to gain new customers and markets. In fact, it is said that Saudi Arabian companies have approached Tadiran, through its London agent, for details about the rural telephone system. It is such happenings that lead Caspi to say: "For a company from a small country like Israel, we have made some impact." □

HOW THE LEADER IN DIGITAL VOLTMETERS PLANS TO STAY THERE.

A while back, we got a head start on everybody else in DVM's. People bought more of our instruments than they did the competition's.

Nothing has changed.

We still have the lead because we discovered a few things about the test and measurement field. We learned some things about developing new DVM's for the changing electronics industry.

Above all, we learned, don't offer a DVM unless it truly has value for the guy on the bench.

That means value across the board.

Five-range AC/DC volts to 1200V	only Fluke
Six-month calibration cycle	only Fluke
10,000-Hour demonstrated MTBF	only Fluke
Environmental capability specified and defined	only Fluke
Full line of accessories offering HI volts to 40 KV, RF to 500 MHz, current to 600A	only Fluke

There's not much competition.

Not just one feature that's unique or one lock-out spec, but an entire package that makes complete sense and offers you total value all the way around. Take specs, for example. We publish very conservative specifications. No one else does, but we think it's important that the instrument gives all the specs we've guaranteed. And then a little more. We feel that you ought to get better performance than you expected when you buy a Fluke instrument.

So what should you expect in a DVM?

First, an initial low cost. But also a low cost of ownership.

The Fluke 8600A sells for \$549.*

But, even more important, the 8600A has a demonstrated 10,000 hours MTBF. We've fully defined and specified environmental capabilities. And the calibration cycle is 6 months.

That's going to save you a bundle in cost of operation.

Without any sacrifice in specs.

Guaranteed six-month accuracy specs at 15°C to 35°C with an extremely low

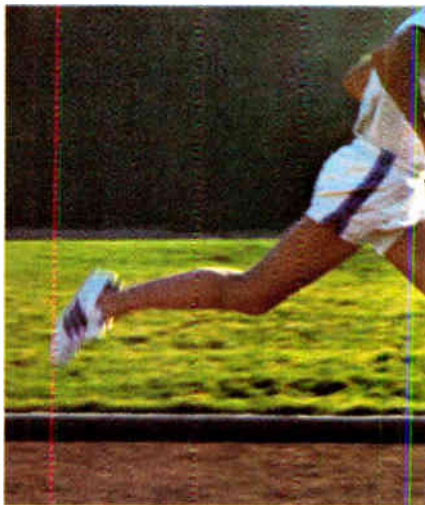

A running start helps.

temperature coefficient. Five ranges each of ac and dc volts to 1200V with 0.02% dc and 0.2% ac accuracy. Five ranges each of ac and dc current to 2A with 0.1% dc and 0.3% ac accuracy. Six ranges of resistance to 20 megohms with 0.1% accuracy. AC bandwidth to 100 kHz.

Autoranging through all ranges plus individual range selection. Continuous

overload specified for all ranges/functions with overload indication.

Features for flexible operation.

Environmental capability specified and defined. Automatic zeroing. Low 7-watt power consumption for reliability. And a full line of accessories including 40 KV high voltage probe, 500 MHz RF probe and 600 A ac current probe. A self-contained rechargeable battery option.

And remember, those are conservative specs for the 8600A. At \$549.

A genuine value from Fluke.

Which suggests we plan on being the leader in DVM's for a long time coming.

No matter how much it upsets our competitors.

For data out today, dial our toll-free hotline, 800-426-0361.

John Fluke Mfg. Co., Inc., P.O. Box 43210, Mountlake Terrace, WA 98043

Fluke (Nederland) B.V., P.O. Box 5053, Zevenheuvelenweg 53, Tilburg, Netherlands.

Phone: (013) 673-973 Telex: 52237

**Domestic price only.*



THE INDUSTRY STANDARD. 8600A DVM. 

POS outlook cheers TRW's Webb

Executive points to customer base acquired from Singer in a market he expects will grow at least 20% a year



Guided by J. Sidney Webb, a corporate executive vice president, TRW Inc.'s Electronics Group moved quietly into the data-communications market in 1971. First concentrating on equipment and services necessary to supply business credit data, then offering point-of-sale hardware, TRW's data-communications operations became profitable in late 1974. This was noteworthy at a time when losses forced many firms with wide experience and big investments out of the field.

Last month, TRW signed an agreement to take over service for all Singer Corp.'s POS equipment, some 65,000 installations with a value of about \$500 million, the industry's largest customer base. Also, the firm introduced its microprocessor-controlled 2001 POS system, which features a video terminal and can be reprogrammed on-site. Clearly, TRW Electronics is gaining momentum in an extremely competitive field. To update the firm's strategy and timetable, *Electronics* questioned Webb. Here are excerpts.

Q. Just how, why, and when did TRW get into data communications?

A. Briefly, six years ago the board asked me to look into whether we could get fallout from our high-technology-components and military-aerospace-satellite businesses. After a long study, we chose this area. One of the first things we ran into was Datapoint Corp. [a troubled terminal maker], where we took a minority interest, helped them, and in 1971 made an agreement to be their international distributor. At the same time we entered the related telephone-equipment business when we

bought Digital Products. From over in the Systems Group, we transferred a company called Credifier, now Data Systems, and began to implement our strategy.

Q. What is your strategy, and how is it different from your competitors'?

A. One way is we decided against getting into the POS business right away with a "me, too" product. We didn't want to take huge losses, and mostly since we believe the coming thing is the microprocessor, we felt we had to have a new generation. So we began to design what became the 2001. At about that time we agreed to build and maintain May Co.'s own POS but not sell it to anyone else, because it was not right for the entire marketplace. And when Credit Data Systems was also transferred to me in 1973, we decided to concentrate on business credit. We are not a hardware company in the sense of selling individual parts, such as terminals, to anybody. We are an electronic systems company that can tell a customer we understand his business well enough to help solve his problems.

Q. How did TRW make money early in the game, while most others didn't?

A. One basic reason is we would rather sacrifice growth than profits. Our feeling is against pie-in-the-sky and huge losses for a long time, weighed versus possible payoff.

Q. How does the Singer deal fit into your plans?

A. Foremost, I believe it's going to be very profitable right from the start. Second, it will help our POS grow nationwide, adding maybe 2,400 people to our 400, and also help both retail and financial.

Q. How does TRW see the growth po-

tential of data communications?

A. At least 20% a year; some parts like transactional data communications, 30% to 35% a year.

Q. Whom do you rank as the main competition?

A. That's a hard one, because it depends on their position in different segments. For example, I guess NCR is the biggest in POS, but small in financial. Burroughs is the opposite, and IBM is in everything, so it's hard to say. If you're talking about POS in supermarkets—and we're not in that—National Semiconductor is doing pretty well.

Q. What do you need to round out your plans?

A. A couple of years to demonstrate that large investments in POS and business credit are sound, especially to handle the huge task of Singer maintenance. And a bigger telephone-equipment business because we feel the communications and computer fields are so crossing and co-mingling, it's hard to tell one from the other. It's obvious the telephone industry has to go digital, with voice as well as data, and the software and equipment are similar. Finally, I don't see any big holes where, to complete our data-communications business, we need this or that. The areas we're in today in the next two years are going to show tremendous growth. □

IT WAS BOUND TO CAUSE DOUBT, CONFUSION, WORRY AND A LITTLE PANIC.

Before the 6011A came along, a lot of people thought they knew who made the best signal generator.

Now, there's doubt and confusion.

We started with the best everyone else had. Then, we began our serious design work on the 6011A—a new, microprocessor-based signal generator. And along the way, we also solved the problems of setting frequencies and amplitudes. There had to be less dialing, and no time standardizing. We decided to get rid of all the unnecessary adjusting. And let the microprocessor do the work for you.

People are finding they can't just buy that comfortable old name, with the same old features. Fluke has a signal generator that does a whole lot of things that no one else can do.

Read on. You'll see why the competition is a little panicky.

The 6011A performs the functions of an oscillator, counter and level meter setup over a range of 10 Hz to 11 MHz, within amplitudes ranging from 0.4 millivolts to 5 volts rms and -55 dBm to $+27$ dBm. And does it fast.

The microprocessor stores up to nine combinations of output settings in memory. That's frequency and amplitude combinations, with modulation and range settings. Particularly important for repetitive tests at several frequencies and amplitudes. Less time. No operator error. A push of the button recalls the setting.

We had a few people test the 6011A. Using the 6011A recall capability, they could call up nine different frequency and amplitude combinations within four seconds.

Once the setting is called up, edit control lets you modify your frequency or amplitude with a simple turn of a dial. Any decade, as indicated by the brighter digit on the readout, can be changed. Increment or decrement with complete carry and borrow capability. And a recalled frequency or level can be modified without changing the original stored entry.



"How much better can a signal generator be?"

The reference mode lets you add or subtract frequencies or levels relative to previously entered references.

Level limit eliminates damage to sensitive devices. The operator can't use an output greater than a pre-programmed safe limit.

The 6011A is designed for free form entry of volts, millivolts, dBm, Hz, kHz, and MHz. For example, output levels entered in volts can be modified in

decibels to a resolution of 0.01 dB. The user can select volts peak-to-peak or rms volts terminated in 50 ohms or open circuit. Maximum open circuit voltage is 28.28 volts peak-to-peak. At 11 MHz!

Accuracy is so good there's no need for output verification. An rms sensor controls the output accuracy to better than ± 0.05 dB. Frequency response is flat to within ± 0.025 dB from 100 Hz to 5 MHz. Output frequency accuracy is within 3 ppm over a one-year period and a wide temperature range.

Finally, we kept the price way down. At \$3995*, the 6011A is 40% less than anything remotely comparable.

About now, are you beginning to feel you're going to expect a lot more from your next signal generator? Well, ask for a 6011A demonstration first.

And find out how much you can expect from a signal generator. For data out today, dial our toll-free hotline, 800-426-0361.

John Fluke Mfg. Co., Inc., P.O. Box 43210, Mountlake Terrace, WA 98043
Fluke (Nederland) B.V., P.O. Box 5053, Tilburg, The Netherlands.
Phone: (013) 673-973 Telex: 52237

*U.S. price only.



INNOVATIVE 6011A SIGNAL GENERATOR **FLUKE**

21 YEARS OF REASONS TO LOOK HERE FOR PRECISION MEASUREMENT.

For over 21 years, we have not altered the integrity of our precision measurement line.

Our general instrument line is built to the same standards of quality.

Before you buy a DMM, counter, signal generator or any other general instrument, always take a look at a company's precision measurement line. There is a connection.

Ask about their experience in precision technology. Inquire into the extent of their precision measurement product line. Find out about their standards and traceability.

Then compare to what you see here.

1955: Fluke introduces the world's first DC differential voltmeter.

Over 21 years ago, we began building differential voltmeters—in many instances, setting the standards for the industry. Here are three.

The 893A is an AC/DC differential voltmeter with DC accuracy of $\pm 0.01\%$ of input and AC accuracy of $\pm 0.05\%$ of input. There is infinite input impedance from 0 to ± 1100 VDC. Resolution is 1 ppm of range.

The 895A DC differential voltmeter achieves an absolute accuracy of $\pm (25$ parts per million of input + 1 ppm of range + 5 uv) from 0 to ± 1100 VDC. Over the entire range from 0 to ± 1100 VDC, the 895A offers infinite input impedance at null. A unique Fluke solid state, photo-chopper-stabilized 1100 VDC reference supply is calibrated against a zener EMF with state-of-the-art stability



"I wouldn't expect anything less than a long and distinguished history."

and temperature coefficient parameters. Due to the excellent stability of the zener supply, the overall stability of the 1100 VDC reference is better than 5 ppm peak-to-peak per hour, and 8 ppm peak-to-peak per day.

The 931B is a true RMS voltmeter designed for rapid measurements of AC waveforms regardless of their shape. Accuracies to $\pm 0.05\%$ of reading are obtained in a simple-to-operate portable instrument with a five-digit readout. As with all Fluke differential voltmeters, the 931B incorporates a "TVM" or conventional direct-reading mode for rapid indication of the RMS value of input. Frequency response in TVM mode is 2 Hz to 2 MHz. Response in the null or differential mode is 2 Hz to 1 MHz.

The 893A is \$1445*, the 895A is \$1745*, and the 931B is \$1545*.

1957: Fluke introduces ultra-stable DC calibrator.

Two years after introducing differential voltmeters, we expanded our precision measurement line to include DC calibrators. Now, Fluke provides a full range of instruments for all DC calibration needs. Here are three.

The 343A is a seven-dial DC calibrator that provides parameters of stability, temperature, and response required by a wide range of applications. Its accuracy is $\pm 0.002\%$ of setting with 0.1 ppm resolution.

The 382A operates as a combination $\pm 0.01\%$ voltage calibrator and $\pm 0.02\%$ current calibrator. It offers voltage outputs to 50 V and current capabilities to 2 A. Maximum power available is 100 W. The stability of the 382A is 25 ppm per 24 hours.

The Model 335D provides $\pm 0.001\%$ accuracy as both a DC voltage standard and a differential voltmeter. Accuracy and stability across the operating range is unmatched by any other commercial instrument available.

The 343A is \$2195*, the 382A is \$2245*, and the 335D is \$3995*.

1963: Fluke introduces thermal transfer standard.

For 13 years now, we've been in the business of building high technology standards. Here are three standards representative of the Fluke line: 510A, an AC reference standard; 540B, a transfer standard; and 731B, a DC reference standard.

The 540B stands by itself in the industry. Nothing else this good is



893A, 931B, and 895A differential voltmeters.

335D, 343A, and 382A DC calibrators.

For information on the 343A circle 340 For demonstration on the 335D circle 343 For information on the 5200A circle 346 For demonstration on the 5205A circle 349 For information on the 515A circle 352
For demonstration on the 343A circle 341 For information on the 382A circle 344 For information on the 200A circle 347 For information on the 7105A circle 350 For demonstration on the 515A circle 353
For information on the 335D circle 342 For demonstration on the 382A circle 345 For information on the 5205A circle 348 For demonstration on the 7105A circle 351 For information on the 760A circle 354

commercially available. The 540B is a thermal transfer unit for NBS traceable measurement and calibration of AC voltage and current. Measurement capability is 0.25 V to 1000 V rms AC over 14 ranges, with a frequency range from 5 Hz to 1 MHz. Basic AC to DC transfer accuracy is $\pm 0.01\%$ without the use of calibration curves or correction tables.

The 510A is a precision-fixed frequency AC voltage source suited to calibration or test applications. Outputs of 10 V rms and 10 mA with available frequencies from 50 Hz to 100 kHz at an accuracy of $\pm 0.01\%$. Total harmonic distortion is less than 0.005% to 50 kHz. Short-term stability is 20 ppm pk-pk.

The 731B DC Transfer Standard is designed to give the calibration facility and standards lab a working standard for production testing. Standard cells are extremely sensitive, especially to shock, vibration and temperature change. Instead, the 731B can be hand-carried and subjected to severe environmental conditions, yet still provide transfer accuracies to a few ppm traceable to the delicate saturated cells. Transfer accuracy is 2 ppm. One year absolute accuracy is 30 ppm.

The 510A is \$645*, the 540B is \$1795*, and the 731B is \$595*.

1964: Fluke introduces total function meter calibrator.

Today, in the field or in the lab, Fluke meter calibrators give you accuracy, flexibility and safety in a total function meter calibrator.

Take the 515A portable calibrator. This lightweight precision calibration source is ideal for on-site calibration of measuring instruments. With four DC voltage ranges, 3 AC ranges, resistance capability from 10Ω to $10\text{ M}\Omega$ and a rechargeable battery pack, you can perform eight hours of field operations on battery power. And that's with 0.003% DC accuracy from 1 V to 100 V.

For lab use, look at Fluke's 760A meter calibrator. With its all-solid-state construction, the 760A offers direct percent-error readout (without computation tables) on a single range for AC and DC volts, amps and ohms functions. DC voltage accuracy for the 760A is a respectable $\pm 0.05\% + 25$ microvolts from 1 mV to 1000 V.

Calibrate with Fluke. In the field (model 515A) for \$2145*, or at the bench (model 760A) for \$3745*.

1966: Fluke introduces DC calibration systems.

Eleven years after we introduced our first precision measurement instrument, we offered the Fluke-designed system.

Accuracy to 5 ppm is standard in this DC voltage and ratio calibration system, with resolution and ratio accuracy to 0.1 ppm.

In a functional, self-contained enclosure, the 7105A offers voltmeter and power supply calibration capability, a differential voltmeter, ratio calibrator and a null detector.

The system is self-calibrating, and is supplied with certificates of traceability to the NBS. The 7105A sells for \$8995*.

1972: Fluke introduces AC calibration system.

We entered the market with a fully programmable AC calibration setup.

Together, the 5200A precision AC calibrator and the 5205A precision power amplifier can calibrate AC devices up to 1200 rms. Frequency range is DC to 1.2

MHz. DC output of 1600 volts is available (using 5205A as a stand-alone amplifier). Maximum output current is 200 mA and will drive a 1500 pF capacitance load. Long-term stability is 200 ppm/6 months, midband accuracy is 0.02% overall, and response is a fast 0.5 sec.

Both instruments are short-circuit proof, fully guarded and interlocked. Phase lock input and quadrature output are standard features.

The calibrators interface easily with almost any system. Field installable serial and parallel isolated programming options are available. The system sells for \$8990*.

*U.S. price only.

For data out today, dial our toll-free hotline, 800-426-0361.

John Fluke Mfg. Co., Inc., P.O. Box 43210, Mountlake Terrace, WA 98043

Fluke (Nederland) B. V., P.O. Box 5053, Tilburg, The Netherlands. Phone: (013) 673-973 Telex: 52237

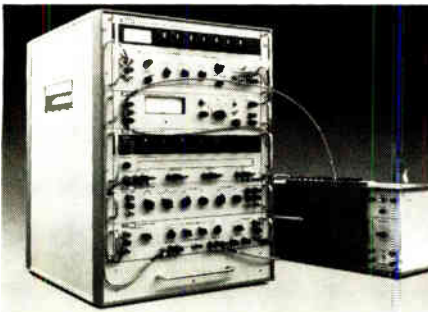

7105A DC calibration system.

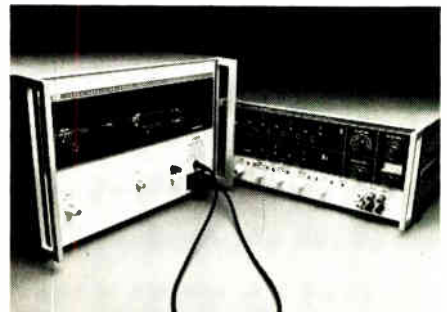

5200A AC calibrator and 5205A power amplifier.



731B, 510A, 540B standards.



515A and 760A meter calibrators.

TEST AND MEASUREMENT INSTRUMENTATION. **FLUKE**®

For demonstration on the 760A circle 355
For information on the 893A circle 356
For demonstration on the 893A circle 357

For information on the 931B circle 358
For demonstration on the 931B circle 359
For information on the 895A circle 360

For demonstration on the 895A circle 371
For information on the 540B circle 372
For demonstration on the 540B circle 373

For information on the 731B circle 374
For demonstration on the 731B circle 375

For information on the 510A circle 376
For demonstration on the 510A circle 377

Breakthrough in mass termination.

Lower-cost coaxial ribbon cable assemblies. In any length.

**New AMP coaxial ribbon cable
is just that—true coax in ribbon
form. With no compromises.**

No degradation in system performance.

Solves the long-existing coaxial cable termination problem.

We can provide complete assemblies for your specific requirements. In any length, with 6 to 26 positions. The assemblies come in 50-, 75- or 93-ohm ratings, on .100-inch grid spacing. And 95-ohm rating on .125-inch spacing. Connectors mate with .025" posts—either 90° board-mount pin headers or I-O posts.

Revolutionary patented concept with drain wire parallel to center conductor, permits low-cost gang stripping and terminating, and still further demonstrates AMP's leadership in quality solutions to termination problems.

For information on AMP coaxial ribbon cable that gives you true coaxial performance, and reasonable price, call (717) 564-0100, circle the Reader Service Number, or write AMP Incorporated, Harrisburg, PA 17105.

AMP is a trademark of AMP Incorporated.

Circle 85 on reader service card

The ribbon is made up of individual coaxial cables, each with a solid center conductor and a foil-wrapped drain wire shield. The drain wire is not spirally wound around the dielectric, but runs parallel with the center conductor. This feature allows the cable to be cut anywhere and yet be consistently and reliably terminated.

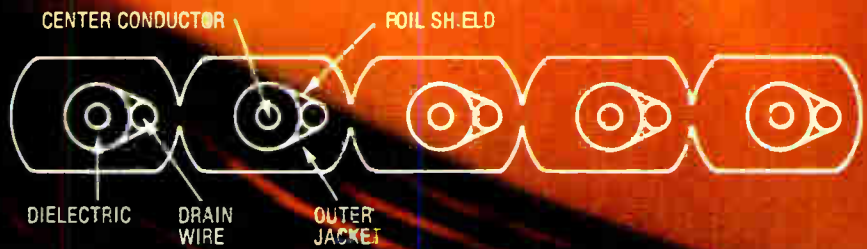

AMP
INCORPORATED

TEKTRONIX logic analyzers



for the digital domain



Timing and binary information together with intensified trigger marker and cursor displayed by the 7D01 Logic Analyzer. The number of sample intervals from the trigger point to the cursor appears at the top of the display; cursor position—displayed in binary—appears across the bottom of the crt.

New Plug-ins with Expanded Capabilities

For digital design and testing applications, you'll find that Tektronix Logic Analyzers and Oscilloscopes are literally made for each other. To expand your digital analysis capabilities, choose either the 7D01 Logic Analyzer (a new plug-in for our 7000-Series laboratory oscilloscope family) or the LA 501 Logic Analyzer and its new companion plug-in, the WR501 Word Recognizer (these two are packaged as modular TM 500-Series instruments to work with almost any oscilloscope).

Features these analyzers have in common include:

- **16 Channel Operation**
- **15-ns Asynchronous Timing Resolution**
- **4k Memory to Store Pretrigger Data**
- **Word Recognition**
- **High Z Probes**

For versatile data acquisition, these logic analyzers let you select the number of channels and the resolution best suited to specific applications:

- 16 Channels, 20 MHz, 256 Memory Bits**
- 8 Channels, 50 MHz, 512 Memory Bits**
- 4 Channels, 100 MHz, 1024 Memory Bits**

You'll like what we've done to **reduce circuit loading problems** associated with testing high-speed and high-impedance logic families. With our new P6451 active probes, which have an input impedance of **1 M Ω paralleled by 5 pF at the probe head**, you'll be able to test virtually any logic family.

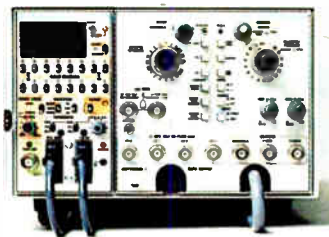

LA501/WR501, Members of the TM 500 Series

Take your logic analyzer right to the problem with the LA 501 Logic Analyzer and its new companion word recognizer, the WR 501. Packaged as modular AM 500 test instruments, this pair works with any oscilloscope or X-Y monitor. Now you've got versatile logic analysis capabilities to complement the oscilloscope you probably already own.

Word recognition with digital delay gives you fast access to almost any location in the data stream.

For **channel-to-channel timing comparisons**, you can select any trace and position it next to any other. And **timing tic marks** on each channel enhance visual analysis.

No matter what your application—design, production testing, or service—we've got a TM 500 logic analysis configuration for you.

On the bench, power the LA 501 and WR 501 with the TM 503 mainframe or the TM 504 mainframe (now you've got room for another TM 500 module like the DM 502 Digital Multimeter).

In a rack, use the RTM 506—there's room enough for the LA 501, the WR 501, the SC 502 Oscilloscope, and one more module. Or you can mount the LA 501 and WR 501 in a TM 503 side by side with a 604 Monitor. The 6½-in. display is easy to read.

For **field portability**, try the TM 515 Traveler Mainframe. It's rugged and durable, yet as attractive as carry-on luggage. You can pack the LA 501, the WR 501, and the SC 502 and have a complete logic analysis system in a suitcase.

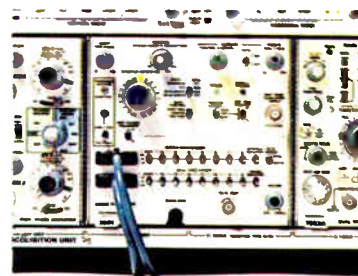

7D01, A Member of the 7000 Series

Turn any 7000-Series laboratory oscilloscope into a versatile 16-channel logic analyzer with the new 7D01 dual-wide plug-in. Now, gaining logic analysis capability is as simple as adding a plug-in.

With a four-compartment 7000-Series mainframe and plug-ins, you get a truly powerful logic design tool: **a logic analyzer and a real-time oscilloscope in one unit**. Use the 7D01 Logic Analyzer to locate a digital domain problem, then zero in for detailed analysis by using the 7D01's word recognizer to trigger the analog portion of your oscilloscope. Now you can do it with one instrument and display your digital and analog information on the same crt.

With the 7D01 you also get **timing and binary information displayed simultaneously** on the crt. You do it with a cursor. And because the cursor can be moved in single clock intervals, **timing comparisons are faster, easier and more error-free than visual estimates**. When the cursor is moved to a given clock position, the binary word at that point is read out across the bottom of the display.

For more information, ask for our Logic Analyzer brochure A 3341. To get your copy, contact our local Tektronix Field Engineer, or write to Tektronix, Inc., P.O. Box 500, Beaverton, OR 97077. Telephone: (503) 644-0161. TWX: 910-467-8708

Tektronix Logic Analyzers are currently available only in the United States.



TEKTRONIX®

committed to
technical excellence

UNRETOUCHED

MICROPHOTOS

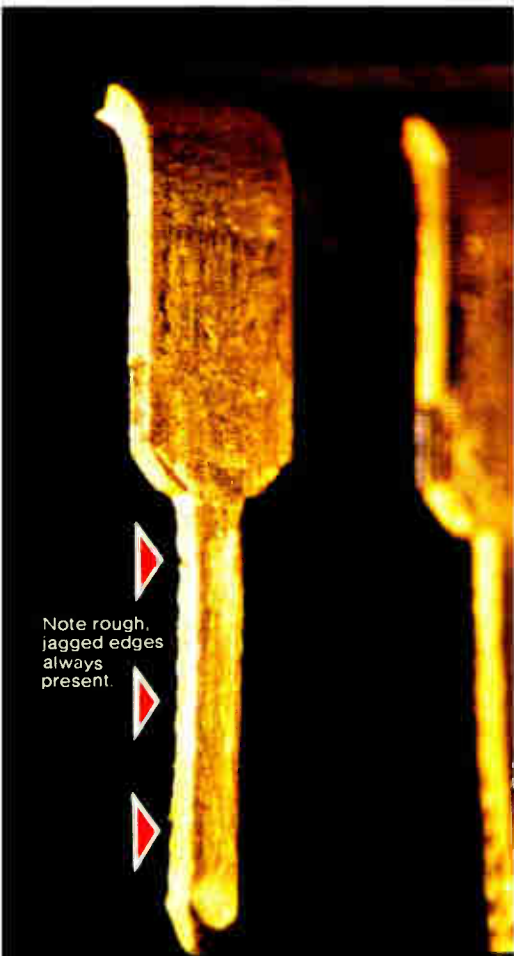

Note rough, jagged edges always present.

Your IC lead frames look like this at 30X enlargement (unretouched). Because they are punched out of metal, the edges are rough, jagged and irregular. In contrast, the flat sides of the lead frame are smooth, even and perfectly plated.

Arrows indicate scars and abrasions made by rough edge of lead frame.



22X magnification, unretouched

THEIRS

An ordinary edge-bearing socket contact after 5 insertions of DIP lead frame. Contact has been spread apart to show inside faces of contact. Notice how the contact has scars and abrasions from rough, irregular edge of IC lead frame. Electrical contact is degraded and resistance is increased. Reliability is obviously reduced.

Lead frame in place in an ordinary edge-bearing contact.



Arrows indicate contact surface still smooth, clean, free from abrasions.



22X magnification, unretouched

OURS

ROBINSON-NUGENT "side-wipe" socket contact after 5 insertions of DIP lead frame. Contact has been spread apart to show inside faces of contact. See how the RN contact—because it mates with the smooth, flat side of the IC lead frame—retains its surface integrity. This 100% greater lead frame contact results in continued high reliability.

Lead frame in place in RN "side-wipe" contact.



High reliability IC sockets... we've got 'em all!

Expose 'junk' socket problems

Secret of RN high reliability

'side-wipe' DIP sockets

revealed by microphotos

Here's microscopic proof that high reliability Robinson-Nugent "side-wipe" DIP sockets make 100% greater contact than any edge-bearing socket on the market. This advance design provides constant low contact resistance, long term dependability—trouble-free IC interconnects. Yet RN high reliability DIP sockets cost no more than ordinary sockets!

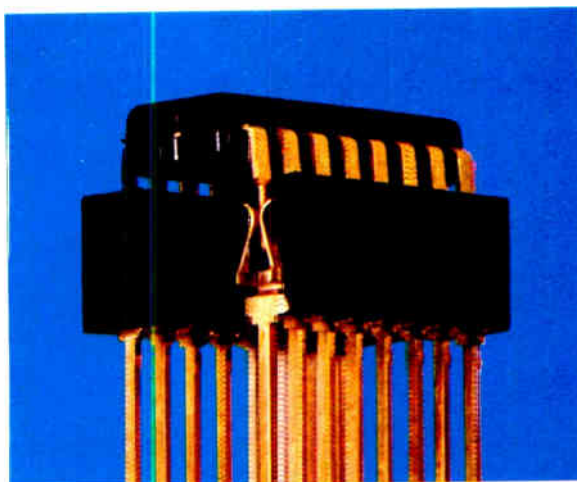

Get the high reliability that eliminates trouble. RN "side-wipe" DIP sockets make contact with the wide, flat sides of your IC leads. You get 100% greater surface contact for positive, trouble-free electrical connection.

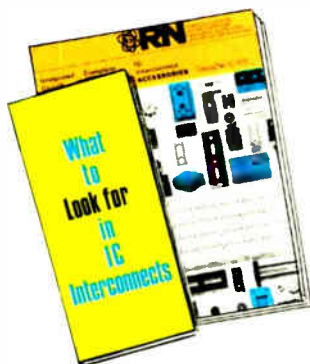

WRITE TODAY

for catalog and informative book "What to Look for in IC Interconnects." Free from Robinson-Nugent—the people who make more kinds of high reliability IC sockets than anyone.

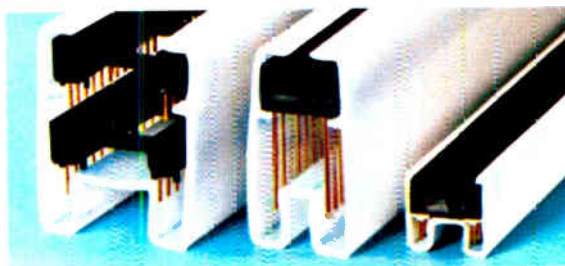

They're even packaged for high reliability. "Protecto-pak"[™] packaging delivers consistently perfect RN sockets to your production line—for automated or manual assembly.

RN ROBINSON NUGENT, INC.

800 East Eighth Street, New Albany, Indiana 47150 • Phone: (812) 945-0211

Circle 89 on reader service card

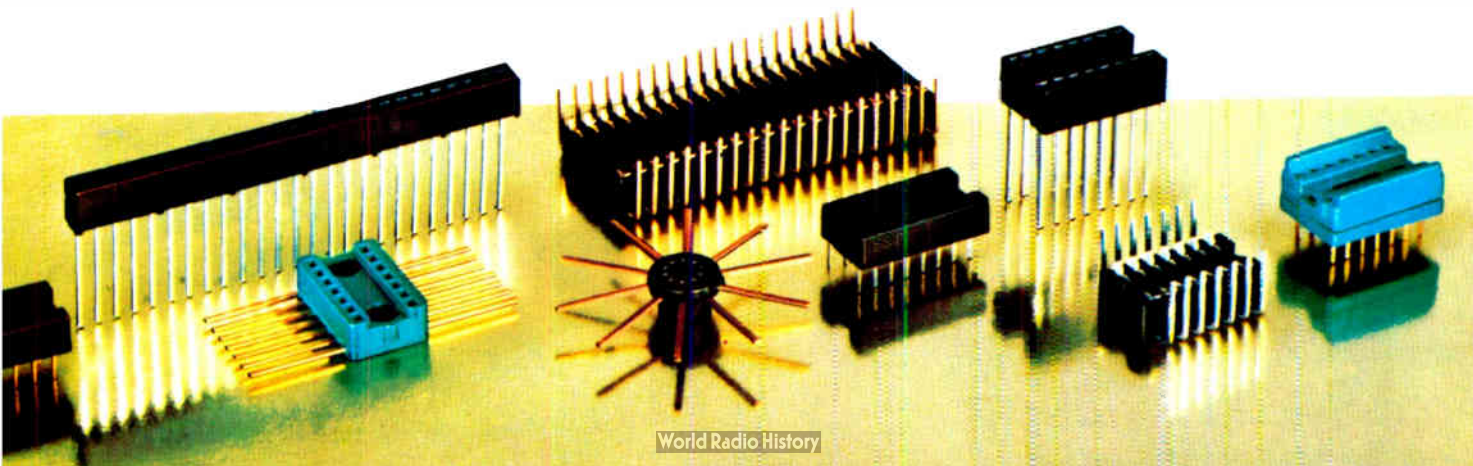

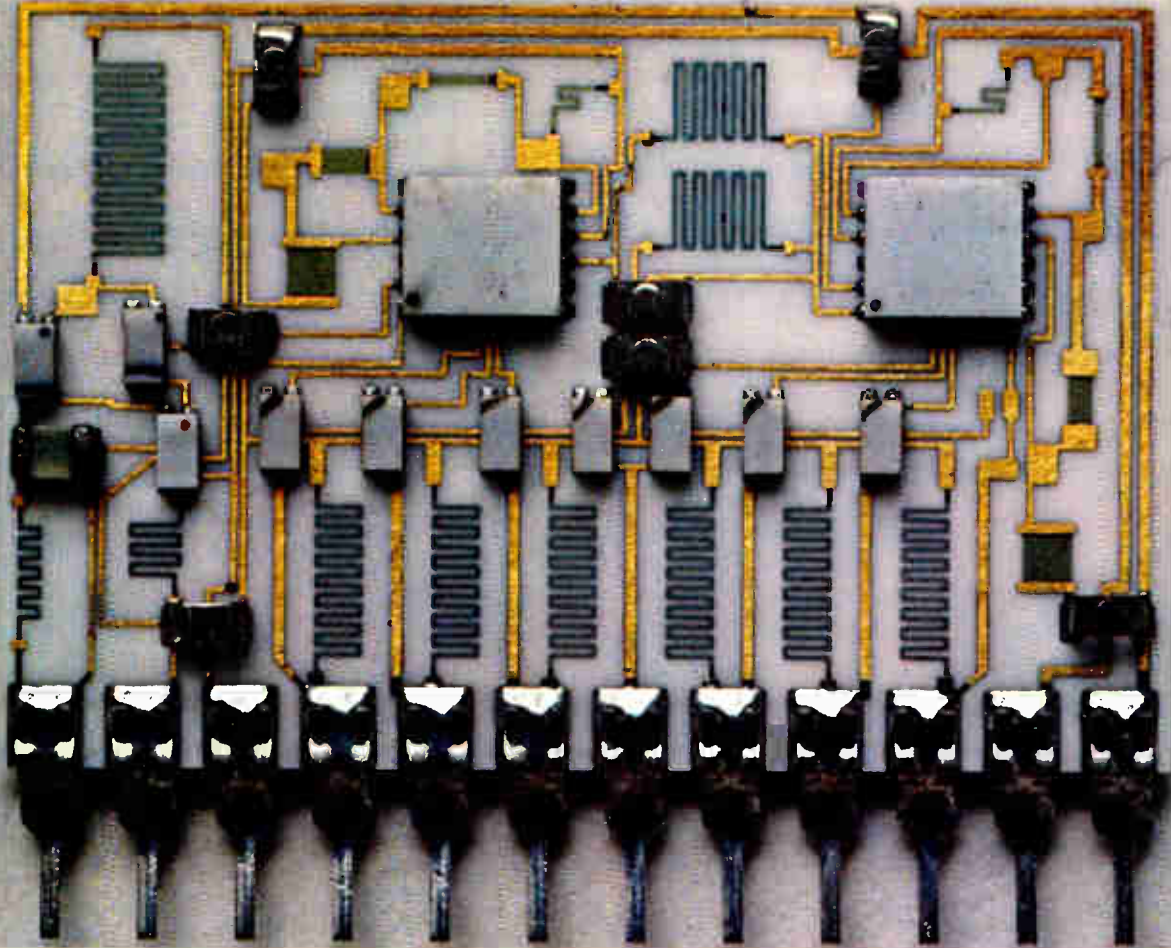

In this complicated world, you can't afford to be without us.

Introducing the GR 2230. The first computer-controlled network and module tester for under \$20,000.

These days, multi-leaded networks and modules have become so complex, you simply can't get away with sample testing.

Yet in-house or calculator-based test systems are just too slow. And the computer-controlled ones cost an arm and a leg.

But now there's the GR 2230.

At the heart of this compact bench-top system is a small but powerful micro-computer. To give you computer-controlled speed, accuracy and flexibility. All starting at just \$15,000.

The 2230 will test networks, modules, and low-frequency passive circuits at speeds up to 80 tests per second, measuring to specified limits the performance of each circuit component.

It can be programmed by just about anyone, thanks to its unique English-language macro-instruction keyboard. Programs are then automatically stored on magnetic cards for easy retrieval.

In addition, the system will continuously print out all test data and can be easily interfaced to virtually any device handler.

The new GR 2230. A computer-controlled tester you can afford. Now that you can't afford to be without a computer-controlled tester.

GenRad, Inc. (formerly General Radio), Test Systems Division, 300 Baker Avenue, Concord, Mass. 01742. 617-369-8770.



GenRad

The difference in software is the difference in testers.

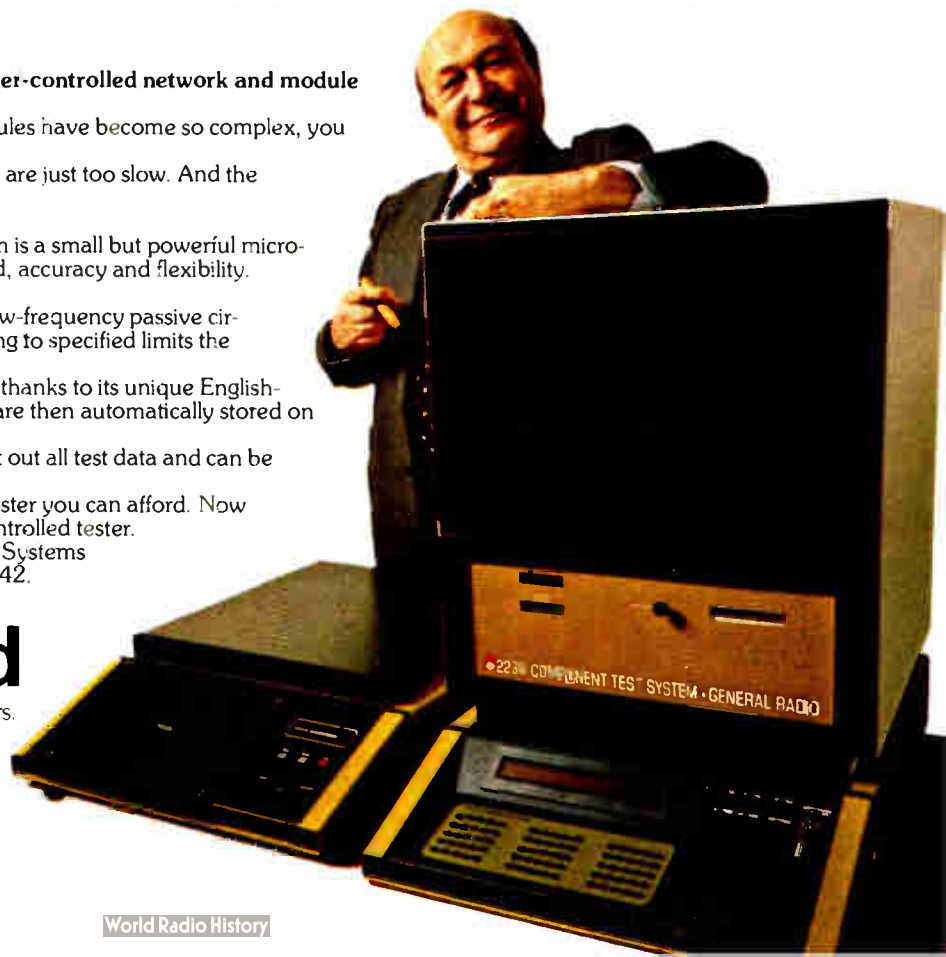

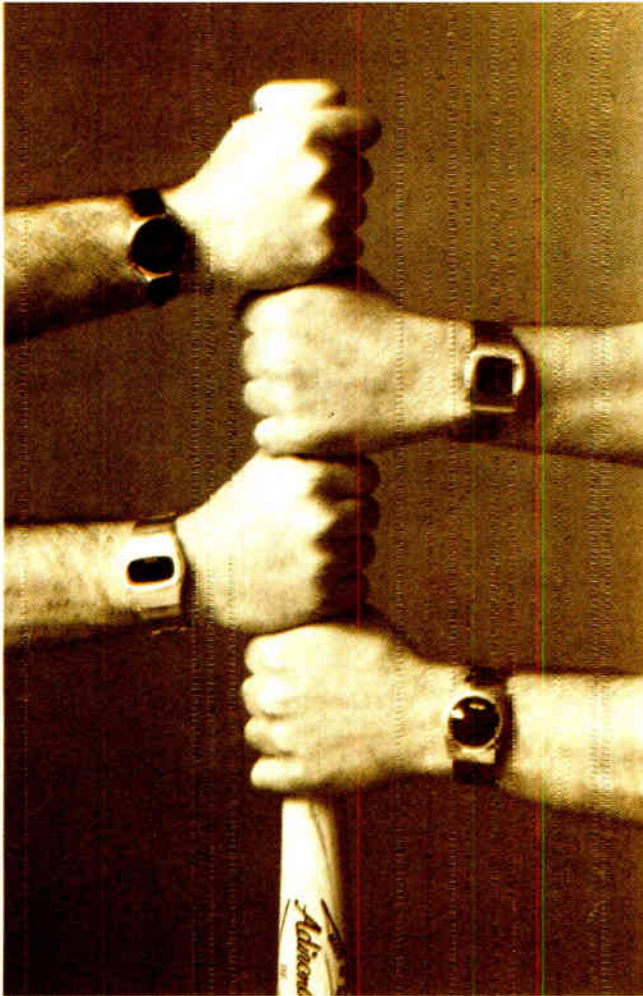

Choosing sides in digital watch technology

It's I²L or C-MOS and LED or LCD as electronics firms perfect the approach to reliability and lower costs

by Gerald M. Walker, *Consumer Editor*

□ As solid-state digital watches have become an accepted part of the consumer market, new developments by the electronics companies fighting for a piece of the action have been tied to perfecting the technology to increase reliability and lower costs. In the 1976 models, exploitation of large-scale integrated semiconductor technology has made possible the new low-priced digitals, just as it already has provided affordable flexibility for the expensive, multifunction models.

While the watch industry has been forced to adjust to the dynamics of the technology, the semiconductor industry has been painfully adjusting to the cycles of the watch market. Although electronics companies around the world have dug in for the sales battle, which peaks at Christmas time, the technology driving product development has not settled down.

It isn't clear whether watches with complementary-metal-oxide semiconductor watch chips or those with integrated-injection-logic chips will be the preferred technology. Basically, semiconductor companies with MOS experience have tended to stay with this technology for their watch chips, although a couple have developed I²L capability as well. And those manufacturers grounded in bipolar, transistor-transistor logic technology have tended to exploit their expertise in developing the closely related I²L watch chips. As a result, there will be both kinds of chips in the watches sold this year.

Both approaches offer advantages for watches. On the one hand, I²L offers small geometries and the one-

chip watch with segment drivers and digit drivers mounted on-board. By virtue of its current output, it is well suited to the light-emitting-diode display.

On the other hand, C-MOS supporters have recently been able to announce single-chip watches, thanks to the packing density possible with silicon-gate processing techniques. Putting the drivers on board also should reduce production steps for the watch module. Thus, the two technologies are running neck and neck at the watch-chip level.

Two display types

Watch displays have not been sorted out, either. Liquid-crystal displays are staging a comeback in the field-effect mode, after a disastrous debut in which the quality, appearance, and reliability of the dynamic-scattered mode turned off consumers. Field-effect LCDs have proved to be superior to dynamic-scattered types for the watch application in three ways—they require lower voltage to operate, they have faster response and erase time, and they eliminate troublesome ghosts.

The continuous display has been the preferred approach in Japan and in Europe. But, in the United States, the LED display continues to dominate for a number of reasons. First of all, cost and reliability were favorable before the digital-watch demand materialized, thanks to the impact of the handheld calculator on LED development. Indeed, some argue that, because of the design demands imposed by its volume production, the calculator explosion set the stage for the rapid

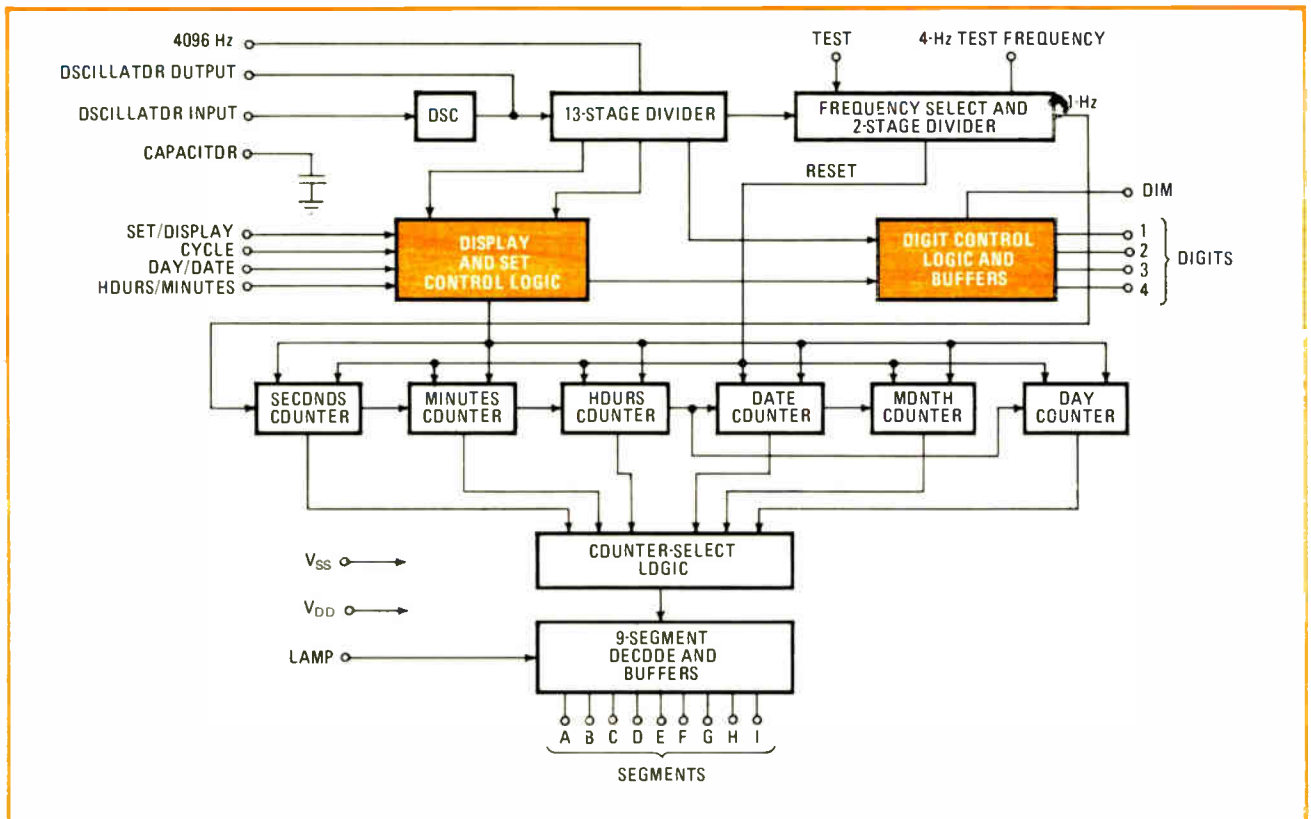

1. **C-MOS consolidation.** National's new light-emitting-diode display watch chip is an ion-implanted, metal-gate device with, typically, 15 microwatts of power dissipation and on-chip direct-drive outputs for alphanumeric display. It measures 157 by 155 mils.

development of the low-cost, high volume digital watch.

Actually, neither display has been ideal for a digital watch. The LED's power drain requires a battery-conserving switch to turn on the display. It's also almost impossible to see in direct sunlight. The LCD cannot be seen in the dark without an auxiliary light, is difficult to read at an angle, and, because of its sandwich construction, it suffers from double images under certain conditions.

Some of these problems have been overcome. There are inertial switches that turn on the LED at the flick of the wrist. Also, some models now have light-sensing capability to increase the intensity of the display in bright ambient light, while reducing it in dim light.

Virtually all LCD watches made this year will have some type of backlight for viewing in the dark. And ever-thinner glass sandwiches are making it possible to bring the display closer to the face of the watch, thus increasing the viewing angle and reducing double images.

Designing for mass production

Despite the publicity on solid-state watches last year, actual shipments in 1975 were probably not more than 3.5 million units, with an average retail price of \$100 each. By contrast, worldwide sales for analog watches were 220 million last year. A report by securities analyst William D. Witter Inc. says the largest supplier of digital-watch modules in the world, Hughes Aircraft Co., shipped only 1.08 million units in 1975, and the largest producer of finished watches, financially troubled Litronix, shipped just 600,000 units. The largest producer of

both modules and finished watches, National Semiconductor, only shipped 875,000 units.

But all of this is going to change rather quickly. This year total electronic watch sales should zoom to 15-17 million units with another 3-5 million in the supply pipeline. Average retail selling price will be around \$50, since the \$20 digital arrived this spring. Total worldwide digital-watch sales by 1980 are expected to pass the 90 million mark, with an average selling price of about \$25.

These figures are having an important impact on watch design. The profits to be reaped from the digital-watch boom will go to the companies that can adapt to efficient mass production and keep prices coming down, yet cater to demands for styling and added features. Just how best to accomplish this tall order is still not clear—for that matter, there may not be a single right answer. While some companies have entered or dropped out, the basic structure of the digital watch industry remains essentially the same as it was last year.

MOS or I²L depends on past know-how

Design of the present generation of watch chips reflects the rapid emergence of digital watches from novelty to mass production. Generally most of the effort has gone toward three goals: first, design to mesh with cost-effective production; second, design to accommodate new functions economically, and third, design to overcome deficiencies in previous models or else make the watch easier to use. The higher-priced models feature at least five functions—hours, minutes and sec-

The Swiss and the Japanese begin to move

American firms have moved so far and so fast into digital watches that industry observers are wondering if Switzerland and Japan, the major world producers of mechanical watches, will manage to close the gap. Switzerland's watch industry is just beginning major commitments to the new technology. The Japanese industry has the digital technology, but has delayed applying it in mass production because of its investment in the manufacture of quartz-crystal analog watches.

At the Basel Watch and Jewelry Fair in late April, Swiss exhibitors were hailing 1976 as the kickoff year for Swiss-made solid-state watches. Output of digital watches made with Swiss modules should jump from something like 70,000 units last year to over a million this year.

Ebauches SA, which produces 85% of the Swiss jeweled movements, is shooting for between 50% and 60% of the solid-state modules as its market share. The other major contenders are Société Suisse pour l'Industrie Horlogère, Modules Electroniques SA, and Mondaine Watch Ltd. SSIH is best known for its high-priced Omega and Tissot brands, MSA is a subsidiary of Nepro Watch, and Mondaine is a small, Zurich-based firm.

Ebauches has by far the most ambitious plans. "Our investment in microelectronics plants from 1975 to 1980 will run about 60 million Swiss francs" (about \$25 million), says company executive Paul Tschudin. The firm decided in September 1974 that it had to get into watch-chip production. To save development time, it bought the necessary know-how on complementary-metal-oxide semiconductors from Hughes Aircraft Co. for \$1.3 million. Late last year, the first circuits came off the line, which is running with adequate yield, Tschudin says.

The Ebauches line consists of two light-emitting-diode watches and two liquid-crystal-display models, all using 32,768-hertz crystals and C-MOS chips. One LCD model has solar cells flanking the readout to keep the batteries charged. The five-function models will probably sell for around \$40.

Running second to Ebauches in module production is MSA, which should turn out close to 350,000 LCD modules this year, according to Nepro president Paolo Spadini. He expects to double or triple output next year.

Unlike Ebauches, MSA buys all of its chips from a U.S. C-MOS supplier and from Eurosil in West Germany. Its mainstay is an extra-flat (4.5 mm thick), six-digit LCD unit that lists for around \$38.50 in large quantities.

At Mondaine the target is 10,000 LCD modules a month, all with 32-kilohertz crystals paired with C-MOS

chips developed jointly with Eurosil. At the top of the line is a 6-digit display that lists for just over \$75.

Another Swiss source for chips is Faselec, held by Philips Gloeilampenfabrieken of the Netherlands in association with watch-industry interests. It has a standard watch chip fabricated in silicon-gate C-MOS technology that's compatible with the 1424 chip of American Microsystems Inc. It makes custom devices as well. According to Faselec, about half the chips for digital watches made in Switzerland will come from Swiss sources.

Liquid crystal appears to be becoming the preferred display mode. Brown Boveri Co., whose main business is electrical equipment, went into mass production of twisted nematic LCD modules last year and is now turning out some 200,000 a month, mostly for export. The firm is pushing hard on prices, with a 3½-digit display selling for under \$4.

Top-of-the-line brands such as Piaget and Omega are still banking on analog quartz-crystal watches. For instance, Piaget came to the Basel Fair with a watch using a new circuit developed at the Centre Electronique Horloger, the industry's research-and-development center. Instead of the usual 32-kHz quartz crystal adjusted with a trimmer capacitor, the scheme uses a "loose" 500-kHz crystal and achieves high accuracy by means of an adjustable frequency divider. It's adjusted to match the precise frequency of the crystal through a correction count stored in an on-chip memory. Faselec produces the chip for Piaget.

The Japanese watch makers, who rank second in worldwide production, have maintained a low digital profile, but more for business than technological reasons. Satisfied with concentrating on their domestic market for digitals, Seiko, Orient, Casio, Ricoh, and other Japanese companies will probably ease into foreign markets cautiously. Their major advantage is innovative use of LCDs for calendar and seconds readouts.

Seiko, the largest watch company in Japan, is set up to manufacture almost all of digital-watch parts—integrated circuit, quartz crystal, LCD display, and probably the power cell. It also buys C-MOS watch chips from outside.

So far the firm has been content to introduce a high-priced six-function chronograph watch that uses two chips. The company is cool toward fancier models such as calculator watches. It has developed an experimental inductive pager that uses mechanical filters. Because the pager draws high current, putting one in a watch would probably require the addition of a battery charger.

onds timing, an a.m. and p.m. indicator, and the date. A sixth function usually is the month. In low-priced watch lines, yield and economy in production looms much larger than adding any functions. To serve both ends of the market, C-MOS companies have concentrated on developing the single-chip watch with maximum density at minimum size for both LED and LCD displays.

The new six-function National Semiconductor C-MOS chip, for instance, is a device of 157 by 155 mils that is capable of directly driving an alphanumeric LED display. With single- or two-button control of the display, this unit draws 15 microwatts in power dissipation. Except for the quartz crystal and a trimmer capacitor, all

the components required for the six functions are on this chip, including the resistor-capacitor oscillator used for the antiresonant type of quartz crystals (Fig. 1). This chip, like other recent C-MOS LED types with direct-drive characteristics, is actually smaller than previous chips that had separate digit drivers.

National's liquid-crystal-display chip, which will serve as Novus' entry into the LCD watch competition, is designed for high-volume production for basic five-function products. Measuring 176 by 177 mils, this C-MOS device has an on-chip voltage multiplier—either a doubler to provide 2.5 volts minimum at 1 microampere current or a tripler to provide 4 v minimum at 1

μA load current, depending on the model (Fig. 2). The chip can provide output pulses of 256 or 1,024 hertz to drive a dc-dc converter off the chip for the higher voltage needed for the display. This design provides enough display-drive capacity on one chip to add another function, a six-digit stopwatch.

With such new devices from various semiconductor houses coming on-stream this year, C-MOS proponents among watch and watch-module makers argue that I^2L does not buy them any significant advantages. For example, current for C-MOS is 1 to 3 μA , compared to 7 to 8 μA for I^2L . In addition, processing steps have become almost as simplified as those in I^2L .

Touting what it calls high-density C-MOS (HD/C-MOS), Micro Power Systems Inc., Santa Clara, Calif., employs an improved silicon-gate interconnect system for creating very-large-scale integrated circuits, which it supplies as custom chips to watch makers. The key to HD/C-MOS is the use of low-resistivity materials that make multi-level interconnects practical.

According to the firm, silicon-gate conductors used for interconnections cannot provide resistivities any lower than 80 ohms per square, even when boron doped. The new process uses a proprietary material that can provide a resistivity of less than $1 \Omega/\text{sq}$.

For the new generation of the watches, the company has developed HD/C-MOS II, a refinement of the original process that features a smaller cell design in order to achieve circuit densities five to six times greater than conventional C-MOS. Compared to metal-gate C-MOS, it's 30% greater in density. When interconnect patterns for HD/C-MOS II and I^2L are taken into account (not just cell size), the new process provides 190 gates per square millimeter compared to 120 to 200 gates/ mm^2 quoted for I^2L . Power dissipation is 3 nanowatts to 150 microwatts for the former; 6 nW to 70 μW for the latter.

Agreeing that the performance and processing technology of MOS can now match the economies of I^2L , Greg Reyes, group vice president and general manager of consumer products for Fairchild Camera and Instrument Corp., Palo Alto, Calif., points out that its new C-MOS watch-chip process benefits from the firm's ability to manufacture from a 4-inch wafer. The chip used in Fairchild's latest LED watches is about 140 square mils.

"No doubt the I^2L process looks to be simpler than C-MOS initially," he says. "But in a watch design, it appears that more processing steps are required than were originally anticipated.

"The votes are not in on the advantage of one or the other, so we'll have to wait and see. However, based on our capability, we chose C-MOS." Fairchild has I^2L capability too, but appears to be aiming it toward computer applications rather than watches.

"If we had never made C-MOS devices," says William Weakland, division manager of the solid-state products division of Hughes Aircraft Co. in Newport Beach, Calif., "we would have tried I^2L as the quickest, least expensive way of getting into the watch module business. But we have more experience in C-MOS now and I^2L does not represent an advantage."

Another reason Hughes is committed to C-MOS is that

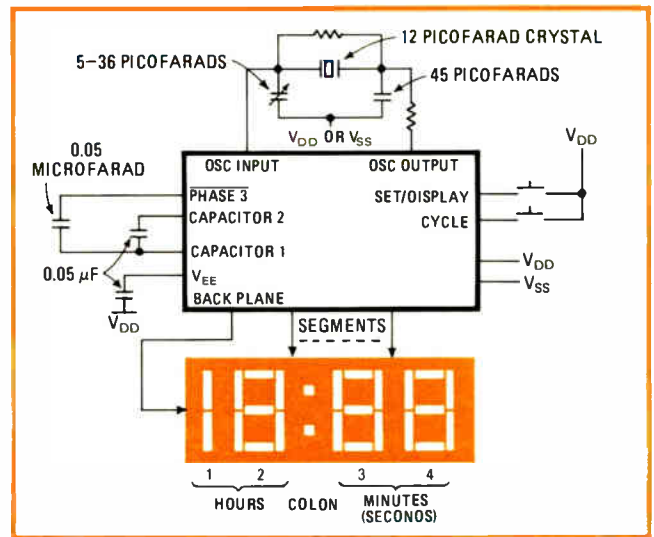

2. Double or triple advantage. National's latest LCD watch chip permits an on-chip tripler, which provides 4 volts of minimum power at 1 microampere of load current. On-chip voltage doublers may be substituted for the tripler if only 2.5 V minimum is required.

it has chosen to use 786-kilohertz crystals rather than the 32-kHz ones generally designed into a watch. (Hughes makes 90% of its own quartz crystals.) While they are said to be more accurate and make possible a simpler module design, they draw more current than the 32-kHz version, so a combination with the I^2L would reduce battery life.

I^2L doesn't waste time

While efforts by the C-MOS supporters have been directed toward maximizing chip density, I^2L devices have this advantage intrinsically. High packing density and small LED driver circuits are particularly beneficial for digital watches. Earlier this year, Texas Instruments rocked the watch industry by announcing a new line of digitals, but the fact that they were to be I^2L was almost incidental to the \$19.95 price and the plastic case.

First significant numbers were shipped in March, well ahead of the promised date—confounding those who said it couldn't be done. National and Fairchild have since announced C-MOS watches in the same price range, also in plastic cases.

TI examined both I^2L and MOS technologies before it entered the watch competition and chose the former route because of its high level of integration—making possible the single-chip watch module—and its promise of high yield. The company had a strong capability in the bipolar TTL process and felt that it could produce the bipolar I^2L in equally large quantities. Moreover, C-MOS yields were not economical, the company decided. Finally, the elimination in the I^2L module of the display driver that would be necessary in the C-MOS module tipped the balance to the former. Subsequent high-quantity yields for the \$20 watches proved this decision to be correct for the TI.

Other semiconductor companies are entering the I^2L sweepstakes. Signetics Corp., Sunnyvale, Calif., has developed a chip for a six-function LED watch. As a trial effort the company came up with a three-function de-

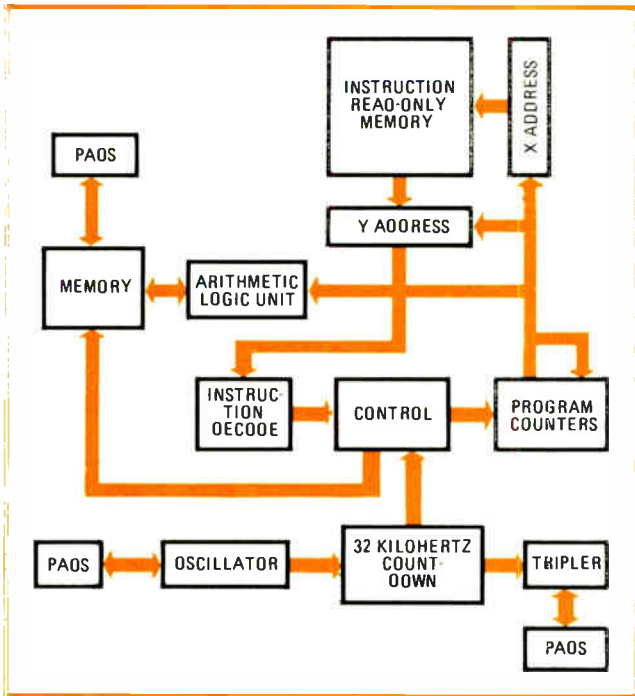

3. Processor-based. The new programmable C-MOS watch chips like this unit from American Microsystems Inc., are more like micro processors in architecture and design implementation than they are like typical large-scale integrated circuits.

vice that measures 86 by 96 mils. The six-function version will be about 25% smaller. The chip size was achieved, not as a result of high packing density alone, but also by the use of divide-by-two circuits requiring only four base regions (Fig. 5). The average gate-packing density on this chip is 120 gates/mm². The highest density of 320 gates/mm² occurs in the 32-kHz-to-8 Hz countdown chain.

The divide-by-two circuit is the building block for the time counters and the divide chain on the three-function unit. The reduction from six to four bases in the divider gave a one-third savings in area, important because more than 35 of the circuits are used in the design, so that the four-base circuit is 12 mil².

ITT's Semiconductor division in West Palm Beach, Fla., has larger I²L chips, 240 mils square, custom designed for watches at both ends of the market. The high-end device is for a five-function watch plus stopwatch, which will be a first for I²L. The stopwatch will time in full seconds rather than hundredths, and the simple start-stop timer will have no lap-time call-up.

The design uses pnp segment drivers, rather than Darlington npn versions found in other digital watches. This feature helps extend battery life. The npn drivers draw 60 to 100 mA compared to 5 to 10 mA for the pnp version.

ITT's espousal of I²L is not surprising considering the company's experience in bipolar transistor-transistor-

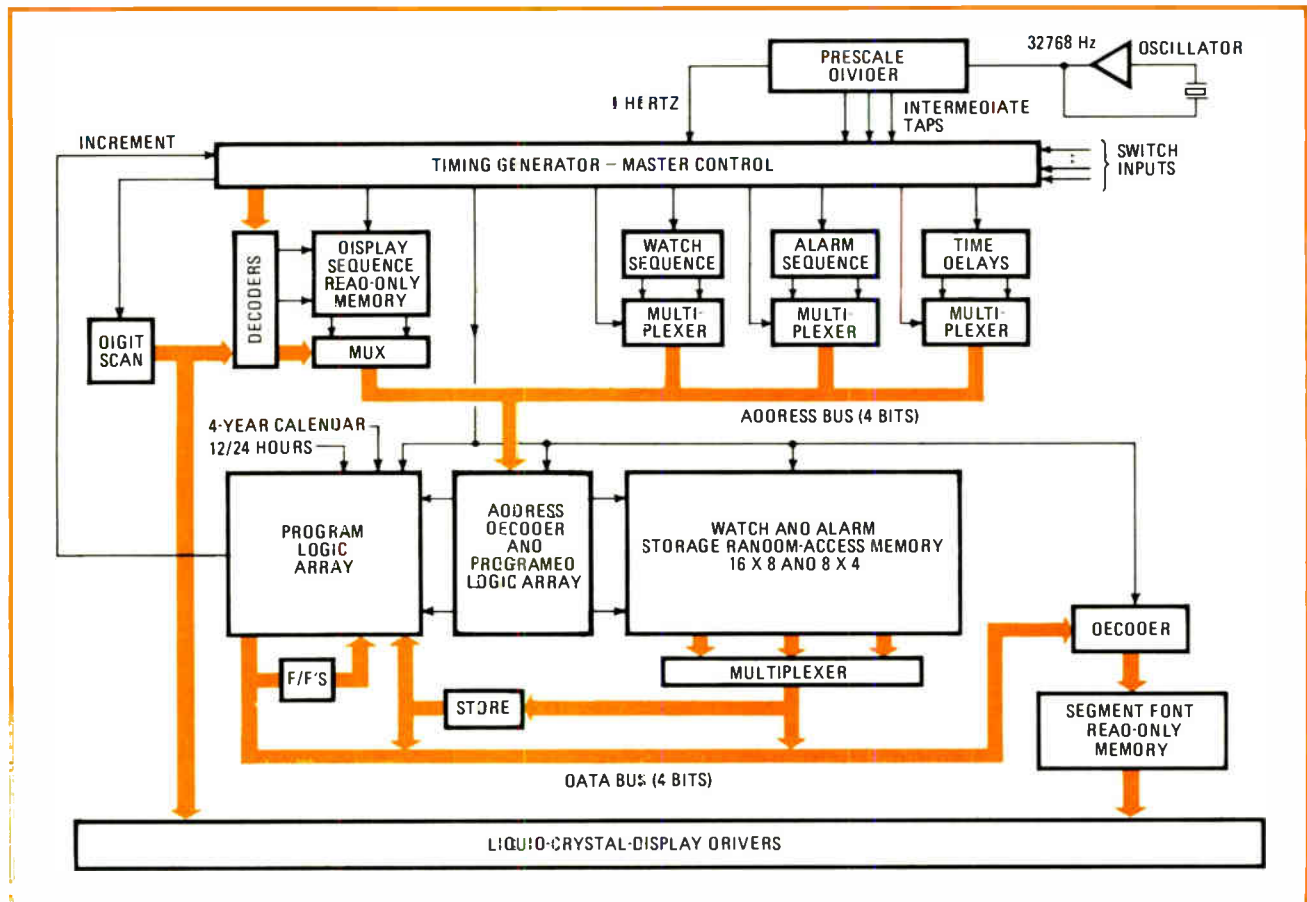

4. More programmable. In order to provide flexibility in adding to watches new features such as stopwatches or two time zones, this Intel chip uses processor architecture, including programmable logic-array portions. It may be programmed for 4-, 6-, and 8-digit displays.

logic technology. Applying the economies of automated production to the injection technology played an important role in the firm's entry into the watch market. Because of the close relation between the bipolar technologies, the company has been able to move rapidly.

It has chosen a special approach to module-production. The watch chip is bonded to a lead frame and encapsulated in plastic, and the other parts—display, trimmer capacitor, crystal oscillator, and batteries—are mounted around the lead frame to form the completed module (Fig. 6). Other than the shape, the process is no different than that which the firm uses for standard plastic-packaged integrated circuits. Leads are bent around the module to make contact with the batteries, and the display switch is a simple single-pole contact to a lead brought through the side of the capsule.

Highly mechanized production

The finished module for TI's \$19.95 watch is mounted in a plastic case also manufactured by the company. This entire manufacturing process is highly mechanized from lead bonding to final testing, at labor-saving costs that obviate the need for off-shore operation.

To lower costs, mechanizing module production while reducing materials costs and parts count represent the next big push in watch manufacture. To accomplish this, modules have been redesigned.

For example, Microma's new LCD module consists of 20 to 30 parts, compared to 90 or more in previous models. Three printed-circuit boards with attendant screws, nuts, wire interconnects, and other hardware have been reduced to one thick-film printed network on a ceramic substrate with the chip bonded in place. The substrate is soldered or connected by epoxy to the module frame. The incandescent backlight for the LCD and the display itself are held in place with one mechanical clamp. Finally the batteries have been positioned so that they cannot be improperly inserted. They are held in place by a new battery port cover.

Even though AMI has abandoned the module and end-product market, it is trying to set up a joint venture with another company to have its new module design put into production. Thus, there's a very good chance that its redesigned LCD module will eventually make it to the marketplace.

The module's configuration is keyed to large-scale, economical production. Basically, the firm's engineers changed the module's concept to include not only the chip, display, crystal, and batteries, but also the switching and waterproofing responsibilities normally assigned to the case. The command, set, and backlight buttons also are part of the module (Fig. 7). The only role for the case is styling and a means of attaching the watchband.

In the final format, the three switching buttons are on the face of the watch under the display. They are ultrasonically welded to the module in milliseconds to insure a watertight fit. The switch has been simplified as well. Y-shaped contacts ride on a rubberized base so neither spring nor button shaft is required to activate the backlight or seconds delay.

AMI estimates that this new arrangement could cost as

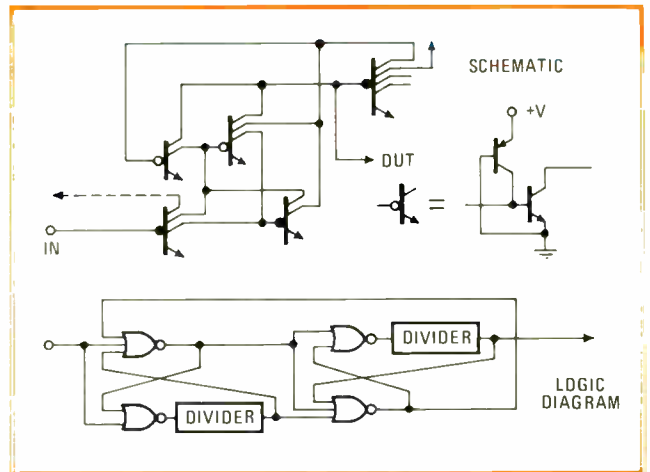

5. Space saver. Use of four-base-region, divide-by-two circuits in Signetics' 1²L watch chip makes possible a reduction of almost a third in the divide-by-two area of the chip. The prototype is 86 by 96 mils. The production model will be smaller.

little as 10¢ for all three switches, compared to 30¢ to 60¢ each for present spring-mounted units. The module material is a special, reactive-process plastic claimed to be stronger than previous materials.

As watch technology settles down to more standardization in chips and displays, the next step in mass-production efficiency could be application of film-carrier technology [*Electronics*, Dec. 25, 1975, p. 61]. With sprocketed 16- or 35-millimeter film, the chip would be bonded to one frame of the film, and the other components to a second frame. These would be folded one on top of the other with the top frame containing the time-keeping die attached directly to the LCD display. This technique, which is in large-volume production of other semiconductor products, could be assembled in a high-speed automated line, eliminating boards, connectors, and wiring almost entirely.

Programming watch functions

The most significant development for the multifunction higher-priced watches has been this year's introduction of microprocessor-like architecture—the so-called programmable chips—using C-MOS technology. While the single chips are meant to be very-high-volume devices produced economically, the programmable chips are designed to accommodate various perform-

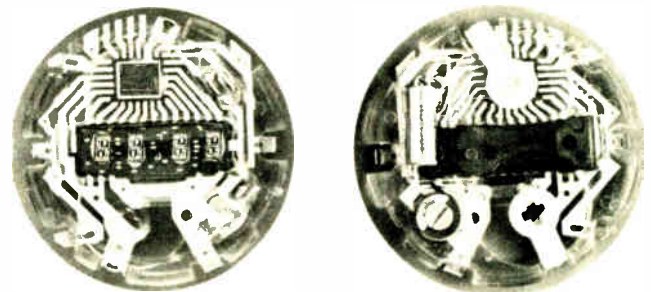

6. Plastic pack. This TI module is a chip and lead frame encapsulated in plastic (clear only in this model) similar to its other IC packages. Two of the leads bend around (right) to make contact with the batteries on the reverse side.

ance levels economically by providing the manufacturer flexibility to alter them at the mask level.

The economy comes not from minimizing the chip size, but from maximizing the number of optional functions available from the same basic architecture. Savings in turn-around time to meet changing market demands is the key here. Basically the difference between the programable chip and the standard watch chip is that the former's functions are established by a ROM that is mask-programed by the manufacturer, and the latter uses hardwired logic. The programable is in effect a small, serial-type computer.

American Micro Systems Inc., Intel Corp., and Harris Semiconductor have announced processor-like chips. The AMI device, which was originally 172 mils on a side, now measures 120 mils square. About half of the silicon-gate chip is a 6,000-bit ROM (Fig. 3). The company can set up a hardware simulator with a programable ROM and manipulate various functions during design, then set the ROM pattern for the production unit.

A 4-bit-by-28-word shift register provides static read/write memory capability needed by stopwatch or alarm functions for tracking time. A 4-bit, binary-coded-decimal adder performs the arithmetic/logic function. Also on the ROM is a program counter with a 12-bit address.

To save on chip space for the memory, the core circuitry is n-channel MOS and the decode is p-channel MOS. One p-type pull-up element controls each row or column of 32 n-type pull-down transistors. The chip would probably be two or three times larger without this arrangement. The first samples are due next month.

Programed logic arrays

Intel's processor-type watch chip, which has been customized for use by the company's watch subsidiary, Microma Inc., measures 164 by 197 mils. It differs from the AMI design by using programed logic arrays (Fig. 4) for timesetting control, along with a ROM and a random-access memory for time counting and related functions. It will be possible to program this chip at the mask level for 4-, 6-, and 8-digit displays, as many as eight timing functions, and choice of several styles of characters in an alphanumeric format.

This watch chip is almost as complex as the Intel 8080 microprocessor. It's actually two watches in one—a stopwatch and a standard time counter—with controls for both stored in a RAM. The area devoted to the stopwatch could be used for an alarm, storage of special dates set by the user, or else for a second time zone, if any of these functions were desired instead. It's a multiprocessor in that it decodes and processes independent information simultaneously—display, stopwatch, different time functions, and time-and-date setting, which is controlled by 424 bits of programed logic array.

Designed for a liquid-crystal display, the chip features internal multiplexing with signals fed out through the ROM decoder into the LCD drivers where information is latched and updated continuously.

Harris Semiconductor plans to have available soon its version of the mask-programable single chip with passive components and digit drivers for LED display. Here,

too, it will be possible to call out such options as dual time, stopwatch, or alarm functions after layout and design of the basic chip. Included is a popular new feature—a register that automatically takes the watch out of the time-and-date setting mode after a number of seconds. This may prolong battery life.

Digital watch displays and overall styling are perhaps the most important features influencing purchase. Electronics companies have directed considerable effort toward improving displays, especially.

Right now LEDs and LCDs are the only viable display choices. It may be five years before any alternative such as electrochromic displays will come along to unseat them. There are about 70 companies around the world with some level of research in ECD, so it's reasonable to expect the technology may make it into watches in the future. A major difference between the two present technologies is the impact of the calculator explosion on the development of the light-emitting diode.

For some time, LED suppliers have been able to use more efficient materials for brighter displays, to apply magnification techniques for smaller, less power-hungry digits, and to select LED chips for better matching digit to digit. They acquired these techniques when upgrading calculator displays. For watches, though, there are new filtering combinations to improve LED visibility in bright light.

There's not much more that can be done with the LEDs, except expanding the number of character fonts available and introducing new colors. Hewlett-Packard's Optoelectronics division has just begun supplying a monolithic LED chip for use in a new Pulsar alphanumeric watch. The format is unusual because the two letters indicating the day of the week are vertical. The chip is strobed by a one-in-seven counter. Its most noticeable feature, the payoff of a monolithic chip, is the lack of segmentation in the characters. They are continuous, clean in appearance, and easy to read (Fig. 8). This will be especially important for watches intended for non-U.S. markets because some foreign names for days, particularly German and French, do not look well when displayed on a segmented LED watch.

Diodes with colors other than red are available, but it will require volume demand to help cross the yield barrier. Yellow will probably be the first to make it since the materials and wavelength are close to those used in red. Green displays are a more difficult problem, however, and may not be feasible for a watch for some time. Combinations of colors are possible, if not probable.

LCDs: comeback of the year

The improvement needed in liquid-crystal displays—visibility in the dark, color, increased angle of visibility, and more attractive character fonts—can all be achieved. And, after something like five years of promises, LCDs are beginning to deliver on these. What's more, new, more chemically stable materials that can operate up to 125°C and better packages have helped bring back the technique as a strong contender in reliability and cost for watch displays. The impetus in watches, of course, is that liquid crystal requires very low power and as a result can be a continuous display,

Waiting for Timex

Next month at the Retail Jewelers Show, the electronics industry expects to find out for certain what the giant of the American watch business, Timex, is going to do about digital watches. Unquestionably, it will jump in far more aggressively than it has so far.

Though highly secretive about specific plans, Timex has publicly cast its vote toward the liquid-crystal display. It has acquired RCA's LCD facilities while purchasing large quantities of the displays from outside vendors. The firm is buying chips and has cranked up its extensive production facilities to prepare for a counterattack on the upstart semiconductor-based watch companies.

After a couple of false starts and the introduction of a relatively high-priced (for Timex) LCD that didn't sell well, the mass-market tornado is almost ready to hit its electronics-company competitors where they are weakest—distribution. Through the sheer weight of its 180,000 to 190,000 retail outlets around the world, Timex will try to overpower the other digital watch makers.

Timex has the cash, the marketing know-how, and the muscle in pricing to be a factor in the low end of the digital watch market, despite the head start others have enjoyed. As one nervous semiconductor executive marvelled, "If Timex sells two watches in each of its outlets, it's got a big market."

which the light-emitting diode cannot match.

At Beckman Instruments' Helipot division, Fullerton, Calif., the largest U.S. supplier of LCDs, efforts are toward perfecting faster-reacting materials. For now, volume is the main concern, so Beckman has concentrated on its screen-printing process to increase production and its glass-fret sealing process to insure reliability. Probably the most common field failure in the early LCDs was in faulty sealing of the frets that complete the glass sandwich forming the display.

Also, the LCD producers have slowly been able to influence the quality of the polarizers used to make the characters visible in the crystal field. The polarizer suppliers are mainly involved in the sunglasses market, which imposes totally different demands than those of the watch display. Minor imperfections, color variations, and other process faults hardly noticeable in mass-produced sunglasses are major flaws on a watch face. Polarizers do have a major unavoidable drawback: they cut down the amount of light striking the liquid crystals, dimming the display.

Virtually all new LCD watches will have some form of backlighting to make the display visible in the dark. While the majority will have incandescent lights turned on by a command button, a more interesting solution is the use of a beta-radiation light with two or three tiny phosphor-coated tubes filled with tritium gas.

Because the gas is a radiation source, a license from the Atomic Energy Commission is required to put watches on the market. Micro Display Systems, the Dallas-based maker of the Sensor watch, is the only firm to reach the market with the tritium backlight, but other watch makers have applied for government approval.



7. **Simplicity.** This AMI module has command and set buttons on the face and simplified switches to mechanize production, save costs.

The firm puts phosphor-coated tubes of tritium gas providing a maximum radiation level of 160 millicuries into a metal pan and seals the unit to the back of the liquid-crystal display. The glow from the phosphor excited by the radiation is noticeable only in the dark. It solves the problem of seeing the LCD in the dark without a lightbulb and switch and without putting any wear on the batteries.

Safety, however, is a big factor in handling of the tubes. Tom M. Hylltin, company president, says, "The government is being super-careful and we have no argument with its motives. In two or three years when we have proved how safe the tritium source is, the restrictions will probably be relaxed. It's an absolutely safe product."

The firm's liquid-crystal process is somewhat different from others. It starts with a very thin glass, $\frac{1}{4}$ to $\frac{1}{2}$ mm thick, which can be handled only in individual display-sized pieces. Therefore the patterns are etched one at a time, and the glass sandwich is made using a proprietary procedure. The result is a very thin display that does not produce multiple images at sharp viewing angles. The digits also appear to be very close to the surface.

Colored polarizers

About a year ago, MDS introduced a line using different polarizers for various colors, but they did not sell very well. The blues were accepted because they looked crisp, but the reds and oranges got nowhere. The firm's standard colors continue: a silver/blue combination for stainless steel cases and two brown shades for gold cases, both in eight different fonts.

There is ample opportunity for electronics companies



8. Easy reader. Hewlett-Packard's monolithic light-emitting-diode chip makes it possible for Pulsar to feature a vertical day display in readable script rather than in segments, useful in non-U. S. markets.

to exploit the flexibility and capacity of the digital watch in order to tap as many different buyers' tastes as possible. At the same time there have been some changes simply to make the standard five- and six-function watches easier to use or cheaper to produce.

One of the more controversial possibilities has been replacement of the quartz-crystal oscillator with a resistor-capacitor oscillator. Just about every company in the business has studied the possibility, especially when the quartz crystals were in short supply last year as digital watches went into mass production.

But there has been no discernible movement in this direction. The RC approach is not likely to attain accuracy equal to the quartz crystal. An oscillator of that type is extremely susceptible to drift from temperature coefficients. And converting to such a watch would introduce a problem of matching resistors and capacitors to perform efficiently together. Cost differences between the quartz crystal and RC oscillator are not as great anymore either. Nevertheless, a oscillator watch of this type will no doubt be designed to test market acceptance.

Eliminating the command buttons of an LED watch in favor of an inertial switch that turns on the display at the flick of the wrist is a potent innovation. Pulsar introduced a mercury-type version last year and Gruen has just brought out a watch with a simpler magnetic type of inertial switch.

The Pulsar switch is monitored by internal logic that provides a set of conditions during which the display will actually be energized. Even with this control, the firm's engineers estimate that 20 to 25% more activations than normal occur from arm movements. The Gruen switch is designed around a permanent magnet and a metal ball. When the wearer flicks his wrist, the ball slides away from the magnet and completes a contact that turns on the display. However, the ball does not leave the magnetic field, so that it immediately returns to its initial position, breaking the contact. Here, too, activating the display inadvertently through movement of the wearer's arm will be unavoidable.

Sharp Corp., Osaka, Japan, which makes digital watches for the Orient Watch Co., has a unique switch for its LED watch. The bezel around the watch face is insulated from the body of the watch (Fig. 9). A mere touch anywhere on the bezel completes a circuit through the body that turns on the display for 1.5 seconds. While the time display is still on, a second touch will show the date. A button is provided for calling out the seconds.

Some digital-watch wearers so dislike resetting them that they will ignore time changes while travelling and dread daylight-savings time. To make resetting easier, Pulsar has introduced a new procedure that eliminates

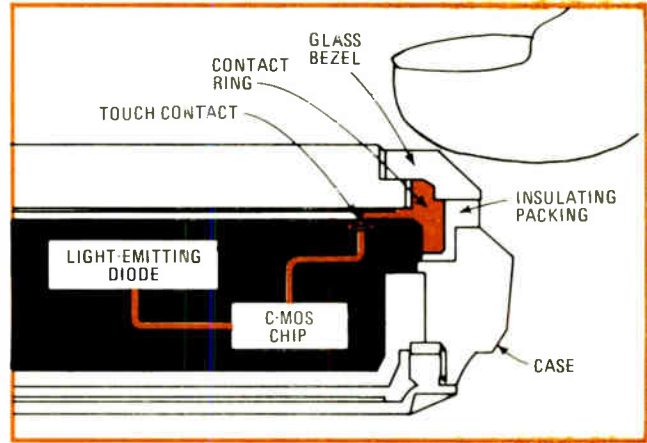

9. Easy-on LED. While some watches have inertial switches to make it easier to turn on the display, Sharp has a contact ring on the face that acts as the button. The user completes the circuit through his body by touching the ring.

the magnet required to set the watch. Now the wearer need only press the command buttons three times rapidly to call up the setting mode. One button turns on the month and hour display, and the other, day and minute. To advance the left-hand digits (month or hour), wearers push the top button, and, to advance the right-hand digits (day or minutes), they push the bottom button. The display goes out of the set mode automatically after five seconds.

More in sight

Until now the watch companies have been mainly interested in duplicating functions of a standard mechanical watch, yet there's much more in sight, made possible by LSI technology. Functions such as stopwatches, dual time zones, alarms, and date reminders are natural offshoots of the basic timekeeping operation. There are a couple of calculator watches on the market which have opened new marketing possibilities.

Two new areas, often discussed but difficult to realize, are biological monitoring and personal paging. The monitors for pulse or temperature will require good sensors to be mounted on the back of the case and a means of converting the readings to digital format. Monitor watches are feasible technically, but may be difficult to market, because they are quasi-medical instruments and might require some sort of medical clearance.

The paging watch, leading to a digital-communications instrument for the wrist, also involves innovations unrelated to digital-watch technology. Power drain would be quite high, although for an internal building-only pager the central transmitter could provide the chief energy source. Compact antennas would also be a problem, but not one impossible to solve.

Says Fairchild's Reyes, "In the 1980-to-1985 time-frame we'll have the Dick Tracy wrist radio. The first ones will be pagers using digital-signal processing, because they'll be easiest to do. But it's reasonable to expect voice communications too." By the end of this year, the possibility is quite strong that more innovative products will be announced, despite the problems of providing a marketable product. □

Designing broad band transformers?

Here
comes
help



DESIGN DIRECTION — Tell us your application for broad band components. We'll send you complete design information on the only ferrites manufactured, tested and guaranteed for bandwidth performance. Your design will be easier and more precise with graphs of R_p and X_p vs. frequency and design examples that work.

COMPONENT SELECTION — Give us your circuit parameters and we will select a Broad Band-Rated[®] component with 16,000 perm to replace expensive metal laminations. Or give us your bandwidth requirements from 100 Hz to beyond 250 MHz and we'll choose from our complete range of toroids and mated parts in recommending a specific solution.

Call **APPLICATIONS ENGINEERING**, (201) 826-5100 or write: Indiana General, Keasbey, New Jersey 08832.

RESCUE VEHICLE — CREATIVE PLAYTHINGS

ENM indiana general
a division of Electronic Memories & Magnetics Corp.
Keasbey, N.J. 08832 • (201) 826-5100

8-bit microprocessor aims at control applications

LSI chip uses single power supply, interfaces with any 8-bit bus-oriented TTL-compatible peripherals

by W. E. Wickes, *Electronic Arrays Inc. Mountain View, Calif*

□ Although the microprocessor is rapidly taking over many tasks formerly performed by minicomputers, standard processors are too sophisticated for many controller applications. Popular 8-bit microprocessors such as the Intel 8080 and Motorola MC6800 are an overkill for controller jobs that don't require extensive processing or large memories.

Mindful of the difficulties and wasted power involved in designing a standard microprocessor into a simple

controller system, Electronic Arrays started to design a large-scale integrated chip specifically for that purpose. Design goals were minimum device count, simple control capability, and operation from a single power supply. Not only were these objectives met in the EA9002, but the device can interface with any 8-bit bus-oriented peripheral that is compatible with transistor-transistor logic. Typical applications might be an electronic scale, a bulk-weighing system for proportioning ingredients

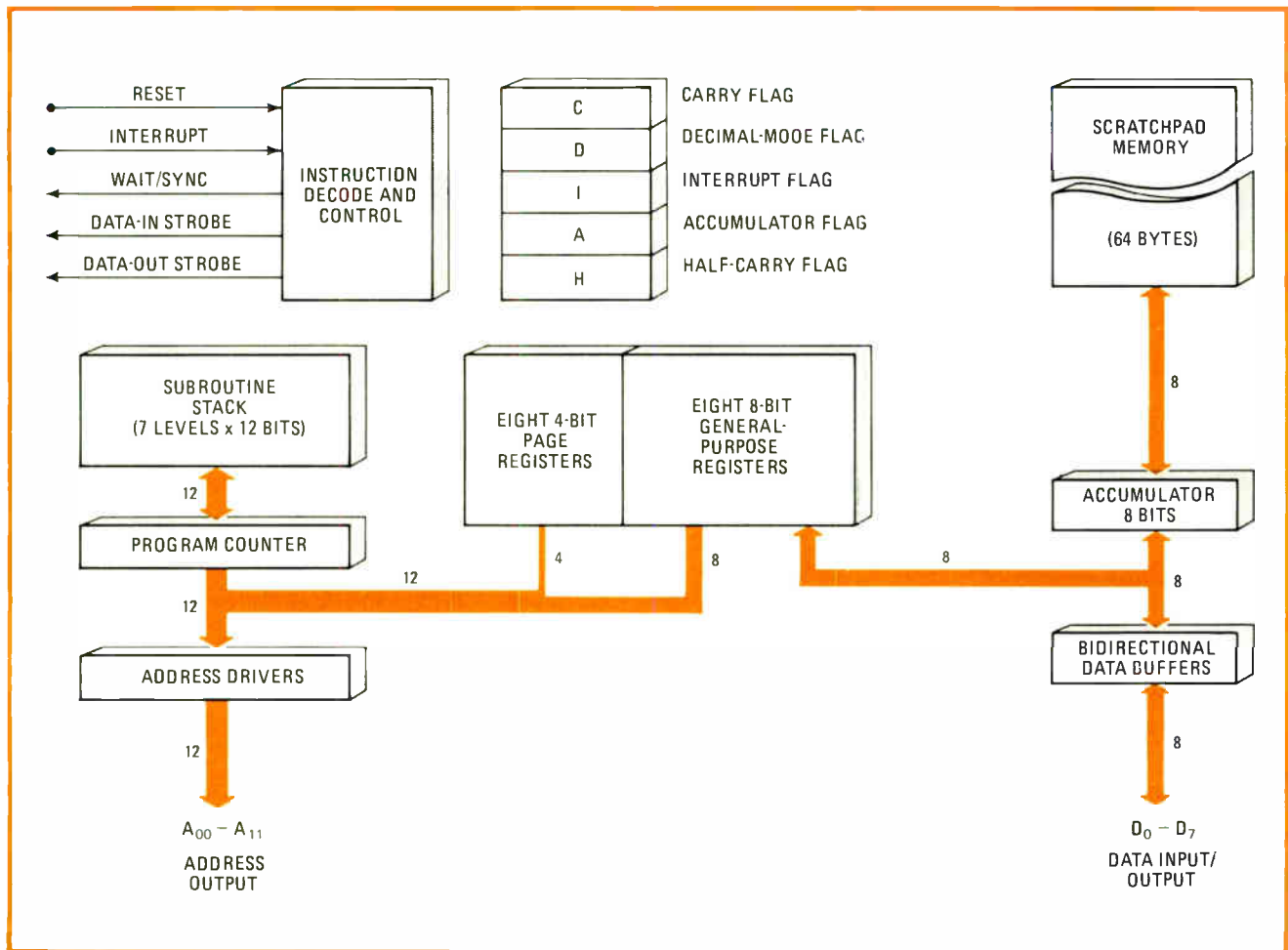

1. Stand-alone controller. Eight-bit LSI microprocessor chip interfaces with any manufacturer's bus-oriented TTL-compatible peripheral, offers a simplified instruction set, and contains 512 bits of on-board RAM, which is sufficient for many small control problems. The 28-pin package operates from a single +5-V power supply and has a single-phase clock input that controls all internal clock phases and data flow.

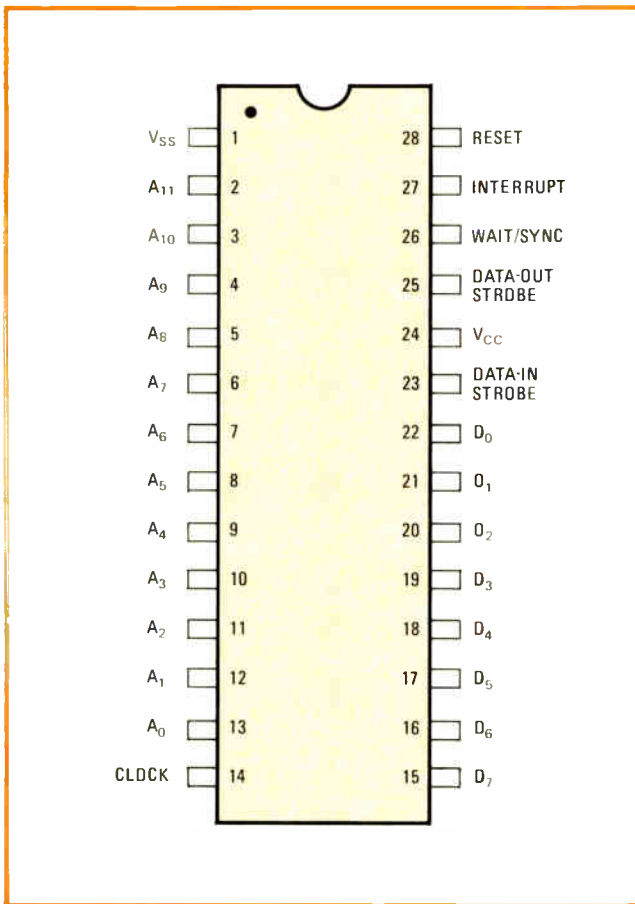

2. EA9002. The one-chip, 8-bit parallel microprocessor is fabricated with n-channel silicon-gate MOS process.

into a concrete mixer, and a point-of-sale terminal activated by either an electronic wand or keyboard inputs.

Because of the 8-bit TTL-compatible data bus, the user may select his favorite random-access and read-only memories, as well as the peripheral input/output devices that best suit his needs. He may mix or match the components to suit his application.

Typically, the EA9002 requires 20% less code than the MC6800 and 25% less than the 8080, but it does not provide the direct-memory access that the other two chips do. Its 12-bit address bus can directly access 4,096 words of memory, while the 8080 and 6800 both have 16-bit address buses that can directly access 65,536 words. This access to large memory capacity makes these chips more suitable for data processing or number-crunching applications. However, the EA9002 can access large memories through memory-bank-select techniques, such as those used for years with Digital Equipment Corp.'s PDP-8 minicomputer. Typically, though, the EA9002 fits the category of controllers requiring 2,048 words of ROM, 1,024 words of RAM, and associated I/O devices.

Internal arrangements

The LSI device (Fig. 1) has the standard microprocessor features: bidirectional bus drivers, control register, flags, accumulator, data registers, program counter and control-signal inputs. In addition, there are

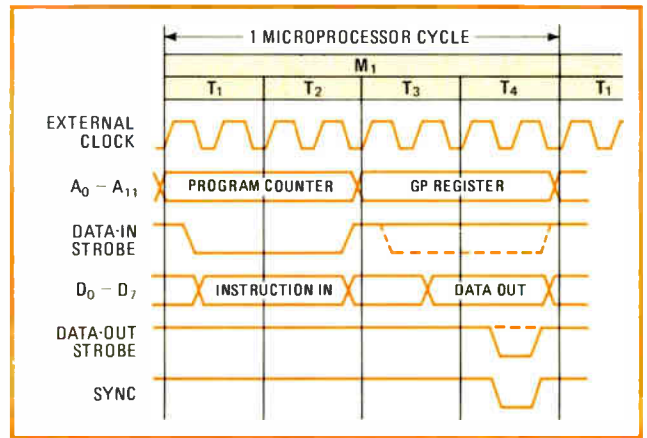

3. Repetitive timing. Each time the MPU reads in instructions or data, a data-input strobe is generated. A data-output strobe is generated each time data is delivered. The end of each internal-instruction operation triggers a sync pulse.

a seven-level subroutine stack, eight 12-bit general-purpose data registers, and an on-board 64-byte scratchpad memory that is independent of external memory. For many small instrumentation-control problems, an external RAM is unnecessary, since the scratchpad provides enough memory by itself.

An internal flag D (for decimal) allows the user to perform 8-bit binary arithmetic or packed binary-coded-decimal (dual 4-bit operands) with automatic decimal correction. This is accomplished by simply setting the flag in one state or the other.

The accumulator (A) flag indicates whether or not the accumulator is zero, a convenient test indicator for many binary or arithmetic operations. When this flag is combined with a COMPARE instruction, the user can implement conditional-jump (GO-TO) routines as a function of the accumulator being equal to, less than, or greater than a designated general-purpose register. Also, an external interrupt input automatically vectors the microprocessor to a user-defined interrupt service routine.

A data-out strobe (DOS) is generated each time the microprocessor transfers data to an external peripheral. A data-in strobe (DIS) is generated each time it receives data or instructions from an external device.

Additionally, a wait/sync (WIS) pin serves a dual purpose. A negative-going pulse is sent from this pin at the end of each instruction-execution cycle. If this WIS pin is pulled low by external control at the beginning of an address cycle, the microprocessor will enter a WAIT mode and remain there until the signal is released. This maneuver allows the chip to wait for slow external devices or to be single-stepped through instructions.

Timing

The EA9002 has a single input pin to receive the single-phase clock that controls all internal-clock phases and data flow. This single-phase clock input was selected because of pin limitations: the EA9002 is a 28-pin package (Fig. 2), and an internal clock oscillator would have needed two pins. It was decided that control was a more effective job for the extra pin.

Timing is simple and straightforward (Fig. 3). One-byte, one-cycle instructions take one microprocessor cycle time, while one-byte, two-cycle instructions take two. Two-byte, two-cycle instructions also take two of these cycles.

The processor always addresses an instruction from the program counter and addresses the data field from a designated general-purpose register. During an instruction-fetch period, a DIS is generated, and another DIS is generated when data is moved into the processor. If the device is transferring data, a DOS is generated.

If the instruction calls for an internal operation such as ADD, no strobe is generated during the second half of a cycle. At the end of each instruction execution, however, a sync pulse will appear on the WAS pin. To operate the processor at a maximum external clock frequency of 4 megahertz, the maximum access time for external devices is 450 ns.

The instruction set provides for data-handling, address-formatting, jump, control, and input/output instructions. The state of the decimal-mode flag automatically designates either binary or binary-coded-decimal (BCD) arithmetic for add and subtract operations. The user may add or subtract from a designated general-purpose register or from any location in scratchpad memory. Logical operations are performed between a designated register and the accumulator. Also, four rotate instructions dictate the direction in which the accumulator will rotate and whether it will rotate with or without carry.

Internally, data may be moved to or from the accumulator and a general-purpose register or a location in scratchpad memory. Externally, data may be entered or

retrieved either from the accumulator or a designated general-purpose register. In that way, a byte of data can be brought in or moved out from the processor without affecting the accumulator contents.

Since the EA9002 generates all instruction addresses from the 12-bit general-purpose register, the user need not worry about complicated addressing modes. There is no ambiguity or confusion in addresses. The internal seven-level, 12-bit subroutine stack automatically stores the next sequential address following a jump to subroutine (JSR); thus, a return from subroutine (RET) automatically enters the correct address pointer into the program counter.

Because no jumps are relative, programs can be easily created and edited. Many routines require a jump on all 0s or all 1s status after decrementing or incrementing a data pointer or index register. Two instructions, DRJ (decrement and jump) and IRJ (increment and jump), combine these actions to further minimize code and simplify program generation.

Special instructions are CSA, DLY and NOP. The CSA (copy to accumulator) examines all internal flags, as well as the 3-bit internal pointer to the subroutine stack. This check can be useful in program debugging, monitoring, or testing. The two nonoperating instructions DLY (delay) and NOP (no operation) provide internal timing delays at the user's option, or can fill a ROM coding with all 1s or 0s.

Comparing microprocessors

Figure 4 compares the EA9002, Intel's 8080, and Motorola's 6800 for an often-used routine—entering a data string from a peripheral to memory. The 9002 op-

	μs	BYTES	CODE	COMMENT
INTEL 8080	5	2	FETCH IN SOURCE	Input to accumulator from I/O
	3.5	1	MOV M, A	Move A to memory
	2.5	1	INX H, L	Memory pointer
	2.5	1	DCR B	String length
	5	3	JNC FETCH	Fetch next data
	18.5	8		
MOTOROLA 6800	4	3	FETCH LDA A	Input to accumulator from I/O
	6	2	STA A, X	Store A to memory indexed
	4	1	DEX	Pointer and string length
	4	2	BGT FETCH	Fetch next data
	18	8		
EA 9002	2	1	FETCH INP 4	Input to accumulator from I/O
	2	1	WRS 5	Store in scratchpad memory
	4	2	DRJ 5, FETCH	String length and pointer
	8	4		

4. Comparing MPUs. When the minimum system in Fig. 5 transfers a 63-byte string of data from a peripheral to internal scratchpad memory or external RAM, it takes half the time and half the code of the same system built around the Intel 8080 or Motorola 6800.

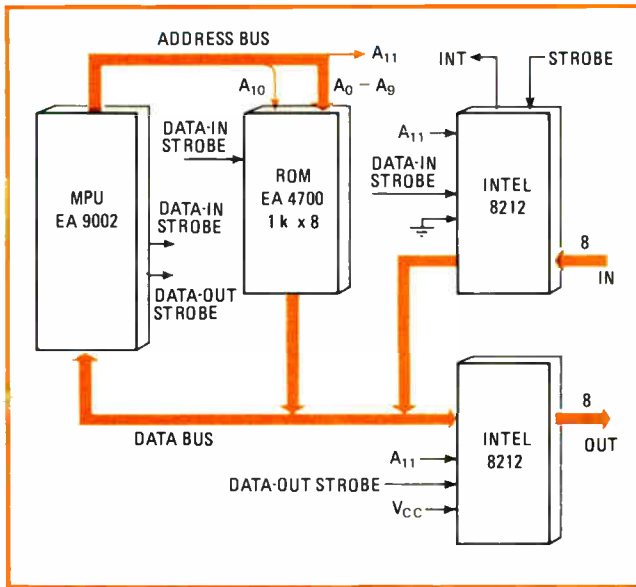

5. Minimum system. A minimum system may consist of a MPU chip and associated ROM, which, in turn, interface with peripherals through devices such as the Intel 8212 input/output ports.

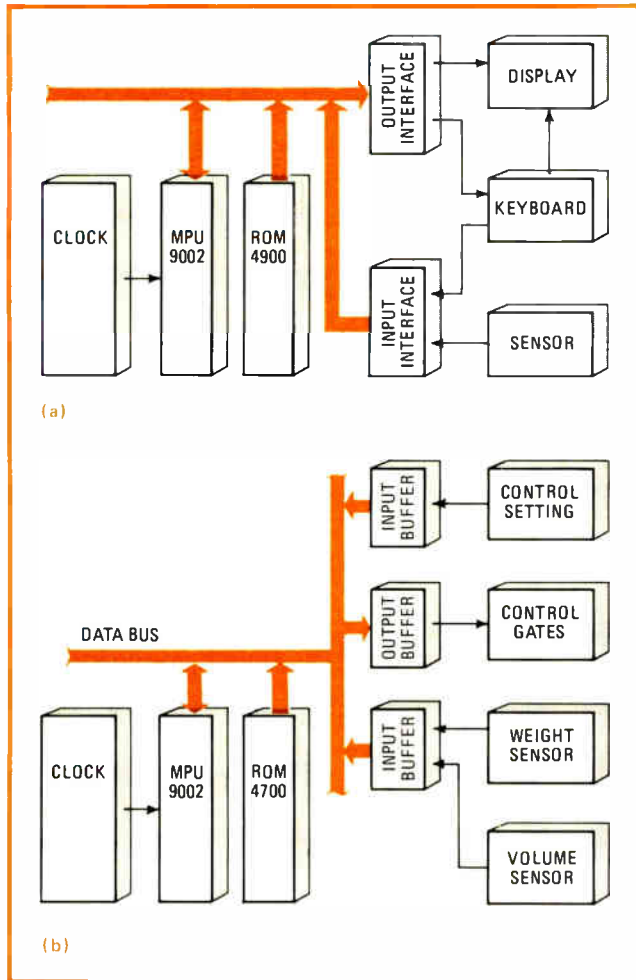

6. Weighing in. Two similar applications for the microprocessor are (a) the electronic scale, which weighs the product and calculates the bill, based on a price per pound, and (b) a batching system for weighing and dispensing a predetermined mix of ingredients.

erates twice as fast while requiring half as many bytes of instruction code. This example assumes a minimum system such as Fig. 5, but the microprocessor could just as easily be transferring the data string to external RAM instead of to the internal scratchpad memory. The data string can be any length (it is 63 bytes in this example).

In either situation, an initialization sequence identifies the source of data, destination of the data, and the length of the data string. It remains to the subroutine to send a byte from an I/O to the accumulator.

The next event is to move the byte from the accumulator to the designated memory location. The destination pointer must now be indexed so that the next byte will go to the next location in memory, and a string-length counter must be decremented. If all the data has not been received, the MPU must jump back to fetch the next byte. A test, therefore, must be performed on the string-length counter to determine whether or not it is zero.

In the 8080, the data-destination pointer must be indexed, the string-length counter must be decremented, and then a test on the string-length counter determines if the loop is completed.

The 6800, with its indexing capability, can utilize the X register for a memory pointer, as well as a string-length counter. However, it must still do an independent test on the X register to determine if the loop is completed.

The EA9002 uses a general-purpose register as a combined memory pointer and string-length counter. In addition, the decrement-and-jump instruction not only decrements this counter, but also performs the "test for 0," which eliminates the need for separate test and jump instructions.

Tackling control

An electronic scale (Fig. 6a) commonly found in supermarkets is a typical application for the EA9002. For such a scale, whenever the weight sensor exceeds the null position, an interrupt is sent to the processor, which, in turn, responds by sending the weight to the display. Next, the operator keys in a price per pound, and the EA9002 computes the total price and displays it. In large-scale systems, a tare value may also be entered, and a record of the transaction may be printed.

The software can easily implement the interrupt routine, keyboard scanning, display formatting, and updating, as well as timing and formatting for the digital printer interfacing. In this application, the 9002 normally operates in a keyboard-scanning and/or display-refresh mode. And because the only mathematical subroutines are fixed-point add, subtract, and multiply in decimal arithmetic, the binary/decimal flag should be initially set to the decimal mode, and all arithmetic is automatically performed in packed binary-coded digits.

In this application, low-cost TTL devices can interface with all inputs and outputs because the EA9002 is fast enough to keep a display refreshed, scan the keyboard, and wait for a new key entry or an interrupt from the sensor. Since the on-board RAM is sufficient, no external RAM is required, and a 1,024-word ROM program is more than ample to contain all firmware.

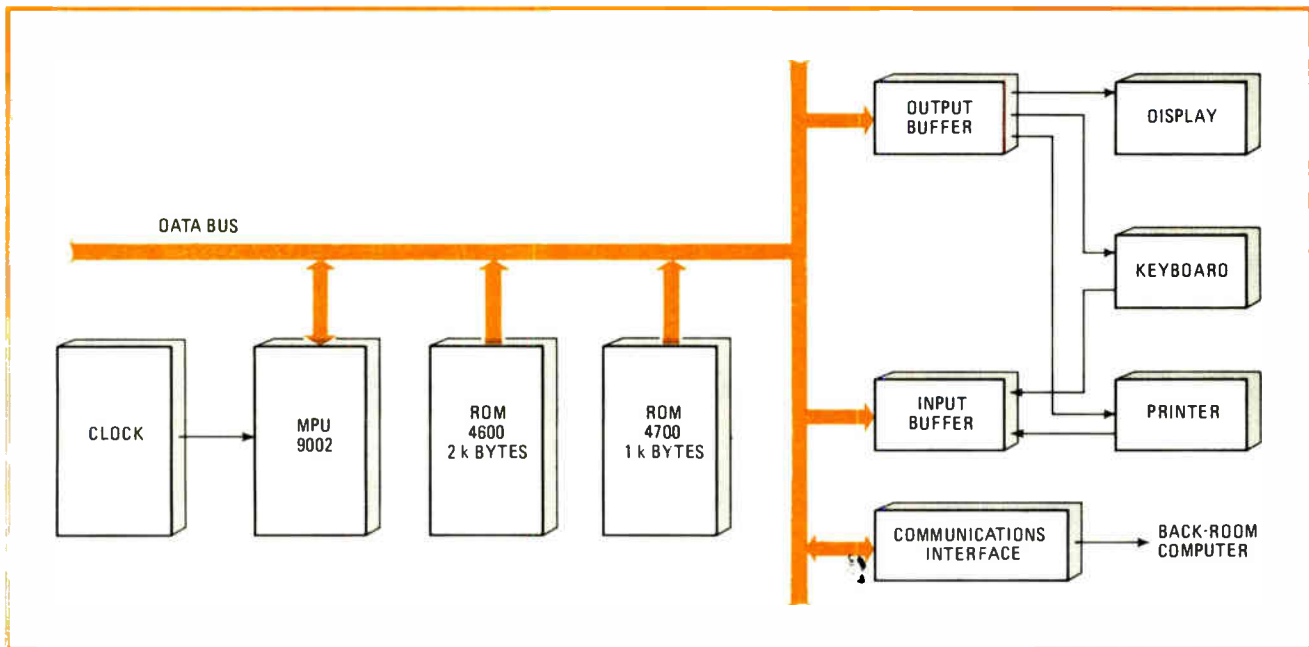

7. Consumer sales. Another EA9002 application is this point-of-sale terminal in which the MPU responds to keyboard inputs, updates the display, and formats and sends data to the receipt printer. In addition, it may communicate with a back-room data-processing computer that transmits prices and a tax, when applicable, in response to product-code inputs at the keyboard.

Another typical application is loading a concrete mixer with the exact amount of sand, gravel, and cement by weight and water by volume (Fig. 6b). This system could rapidly pay for itself by eliminating human error in both the amounts and ratios of materials used.

The software program in ROM contains an algorithm that computes the mix of ingredients according to the amount of concrete desired. The microprocessor, under software control, opens the hopper gate until a sensor signals that enough has been loaded. Then the device turns off the gate and advances to the next ingredient until the sequence had been completed. When the mixer is filled, the processor notifies the operator.

Basically, the system needs the on-board RAM of the EA9002, 1,024 words of ROM, and any number of TTL-buffer interface devices. Although smart peripherals could be used, normally they are not cost-effective in small systems and only complicate the software. Because events occur more slowly than microprocessor speeds, the 9002 would have no trouble sampling the control setting and turning on and off the appropriate gates while sampling inputs from the various sensors.

A point-of-sale terminal (Fig. 7) represents a slightly more complex problem. The microprocessor must scan a keyboard, react to specific key inputs, set up and refresh a display, format data, and transmit sales data to a receipt printer, as well as transmit and receive data to and from a back-room computer.

If the back-room computer is assumed to contain all prices, the operator must key in a product code. This code is transmitted to the computer, which then sends back a price and tax, when applicable. These figures are displayed as well as printed on the cash receipt.

Typically, the terminals are polled constantly by the back-room computer. After a terminal transmits data,

the computer acknowledges its receipt and responds with the price. This sequence is so fast that the operator is unaware of any time lapse and recognizes that the cycle has ended only when the terminal prints the ticket and displays the price.

If an electronic wand reads the product code, the terminal treats the wand as a keyboard input. In this operation, the terminal normally does not require much working memory because the on-board RAM suffices. However, 2,048 or 3,072 words of ROM may be required to handle the more involved operating routines characteristic of this terminal, as well as the character-storage and timing requirements of the printer.

While all I/O interfacing can be handled by the microprocessor, a smart keyboard/display device is desirable. Such a device, now under development, will further minimize component count, enhance peripheral interfacing, and reduce ROM code.

Adding to the system

Electronic Arrays has already developed supporting memory components and a programmable keyboard-encoder chip. Smart interface devices will become available the latter part of 1976. Assembler software programs are available for the NCSS timesharing network (an international network operated by National CSS Inc., Norwalk, Conn.), and a complete user's manual will be available soon.

Also, development boards, a low-cost, stand-alone system emulator, and a software development system will be available in the second quarter of this year. This emulator will contain a resident-assembler option, interface to teletypewriter or cassettes, have hex-pad input and hex displays so that the user can load programs, and execute in real time, as well as monitor and edit actual operations. □

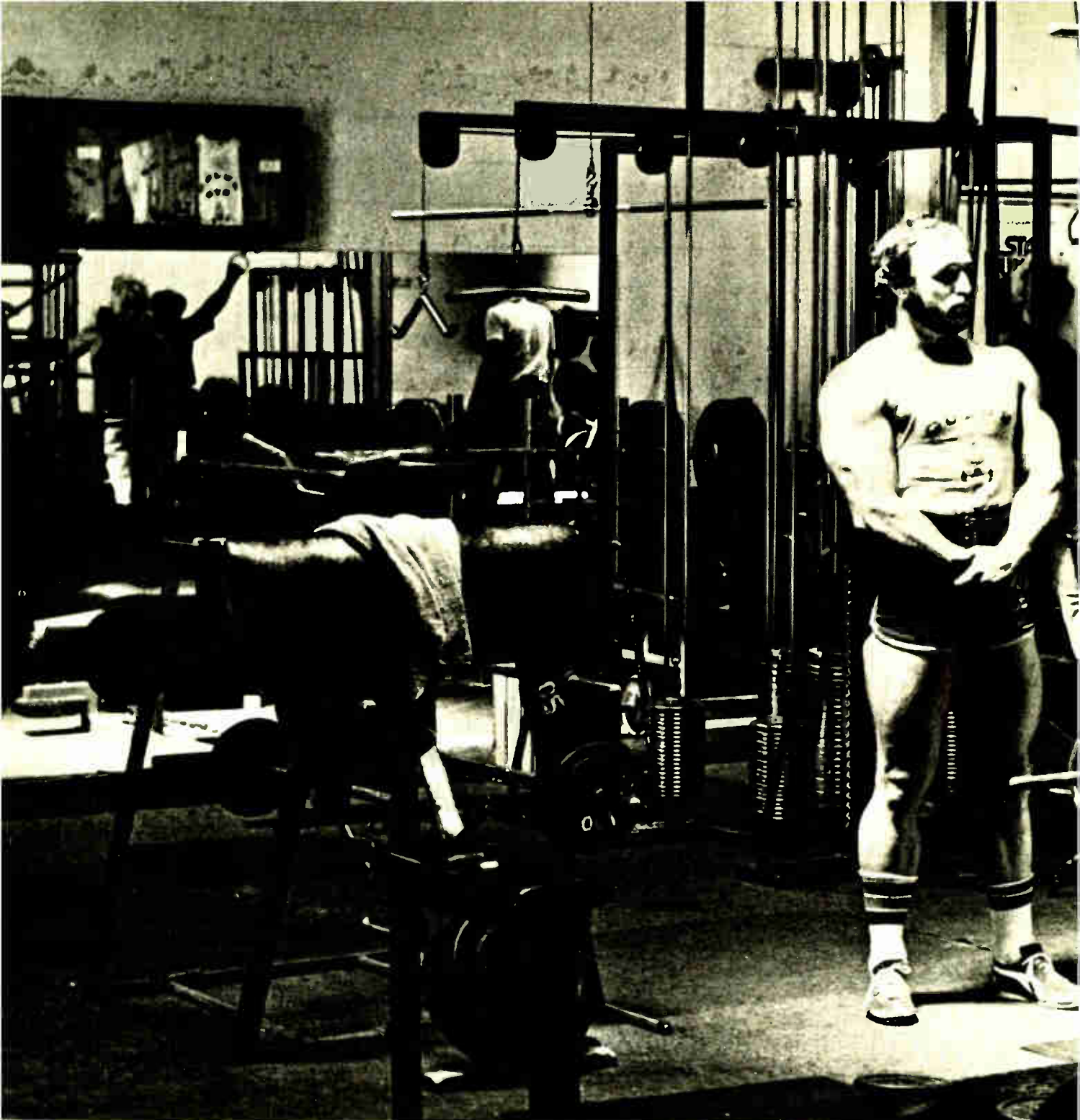

Easy does it. Fairchild's Low Power Schottky becomes the TTL logic to beat.

Standard TTL was terrific in its time

But for most new designs today Fairchild's Low Power Schottky is simply better

How LS changed the TTL rules.

In the first place, Fairchild LS *beats* standard TTL for speed

Low Power Schottky actually operates as fast as standard TTL. Or faster. Typically, LS delivers speeds of just 5ns per gate, or

10ns worst case
Better yet, you get all this speed at a power demand of just 2mW per gate - about *one-fifth*

the power requirement of conventional TTL
Of course, you already know the basic advantages of low

power Less heat Lower noise Simplified system design Easy MOS-to-TTL interface

Which means on a system basis, Fairchild's LS can more than save you work, effort and performance
It can save you *money*

Redesign now. And beat the rush.

The point is if you're still designing with standard TTL.

FAIRCHILD 9LS (54LS, 74LS) DEVICES AVAILABLE

LS00	*LS12	LS32	*LS77	LS112	LS151	*LS163	LS192	LS258	LS298
*LS01	LS13	LS37	*LS83	LS113	LS152	*LS168	LS193	LS259	LS365
LS02	LS14	LS38	*LS85	LS114	LS153	*LS169	LS194	LS260	LS366
LS03	LS15	LS40	*LS86	LS125	LS155	*LS170	*LS195	*LS266	LS367
LS04	LS20	*LS42	*LS89	*LS126	LS156	*LS173	LS196	LS279	LS368
LS05	*S21	LS51	*LS90	*LS132	LS157	*LS174	LS197	*LS280	*LS375
LS08	LS22	LS54	LS92	LS133	LS158	LS175	LS251	*LS283	*LS390
LS09	LS26	LS55	LS93	LS136	*LS160	*LS181	LS253	LS290	LS393
LS10	LS27	LS74	*LS95	LS138	LS161	LS190	*LS256	LS293	*LS395
LS11	LS30	*LS75	LS109	LS139	*LS162	LS191	LS257	*LS295	*LS490
									LS670

*Available 3rd Quarter 1976

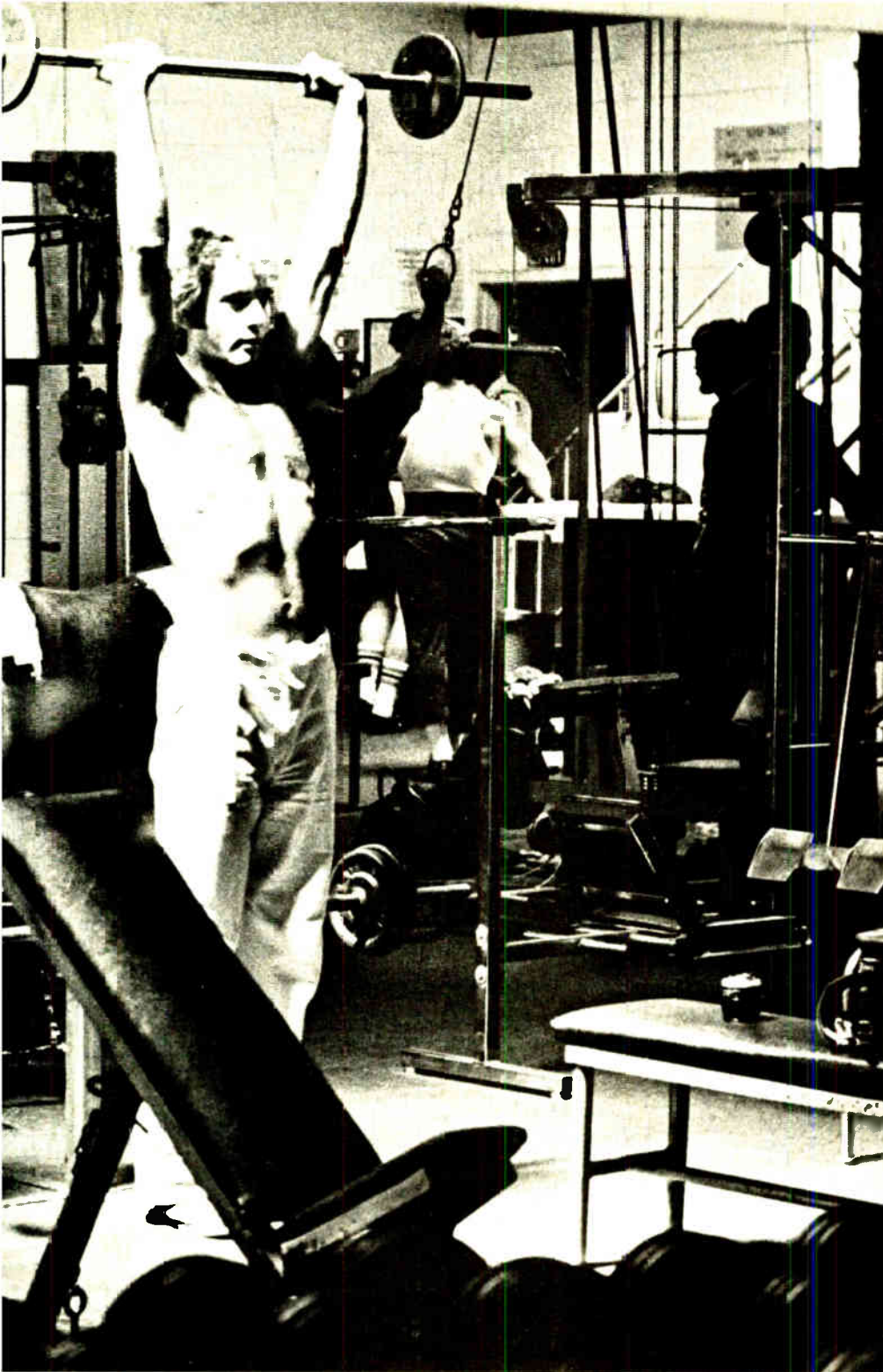

Fairchild's Low Power Schottky can really move you ahead.

And the best time to make your move may be right now.

As TTL logic comes into short supply today, you'll find most additional production comes in Low Power Schottky.

So if you start redesigning your systems to LS now, you can beat the rush for TTL availability later.

If you're already designing

with LS, now's the time to place your order with Fairchild to insure earliest delivery.

Several other things you should know about LS.

First, Fairchild has led in the development of Low Power Schottky, and we have every kind you need — more than 100 devices. All pin-for-pin compatible with standard TTL.

Order today from your local Fairchild Sales Office.

Representative or Distributor

Free LS offer.

We've also put together a whole book on LS. And its free. Just write to Fairchild Camera & Instrument Corp., Digital Division, 464 Ellis Street, Mountain View, CA 94042. Or phone (415) 962-3716 or TWX 910-379-6435.

The new logic Low Power Schottky by Fairchild.

FAIRCHILD

WHO ELSE?

Current source and 555 timer make linear v-to-f converter

by Andrew McClellan

Case Western Reserve University, Cleveland, Ohio

In many situations it is desirable to linearly control the output frequency of a 555 timer circuit by adjusting a potentiometer or an input voltage. In the conventional astable configuration of the 555, the timing capacitor discharges and charges through one or two timing resistors. Thus the frequency is inversely related to changes in the timing components, and is also inversely related to changes in the control voltage.

However, inexpensive and accurate linear voltage-to-frequency conversion can be obtained from the 555 astable multivibrator circuit in Fig. 1. A voltage-dependent current I linearly charges the timing capacitor C so that output frequency increases linearly with the input control voltage V_{in} . During the charging phase of the cycle the capacitor voltage is given by:

$$V_C = V_{CC}/3 + It/C$$

Charging continues until V_C reaches $2V_{CC}/3$, making charging time t_c equal to $V_{CC}C/3I$.

At this point the capacitor rapidly discharges back to

$V_{CC}/3$ through the ON resistance R_{CE} of the discharge transistor in the timer (pin 7). The discharge time, t_d , is approximately equal to $0.69R_{CE}C$.

The circuit is designed to make t_c much greater than t_d , so the period T of the multivibrator is very nearly equal to t_c and the frequency f becomes:

$$f = 3I/V_{CC}C$$

The 741 operational amplifier and transistor Q_3 form a voltage-dependent current source such that:

$$I_1 = (V_E/R_E)[\beta_3/(\beta_3 + 1)] = V_{in}/R_E \text{ (approx.)}$$

where β_3 is the forward current transfer ratio of Q_3 . The op amp greatly reduces any drift due to change of V_{BE} in Q_3 .

To allow the input voltage V_{in} to be referenced to ground, the capacitor is actually charged by current I from the current mirror formed by Q_1 , Q_2 , and Q_4 that makes I equal to I_1 . The transistor Q_4 functions in a modified cascode configuration to increase the output impedance of the current source and increase the tracking of I_1 and I . Substituting V_{in}/R_E for I in the frequency equation gives:

$$f = 3V_{in}/R_EC V_{CC}$$

For a maximum input control voltage of 10 volts and the parameters used, the charging current can be easily varied over a range from 10 microamperes to 1 milliampere, and the output frequency in hertz is given by:

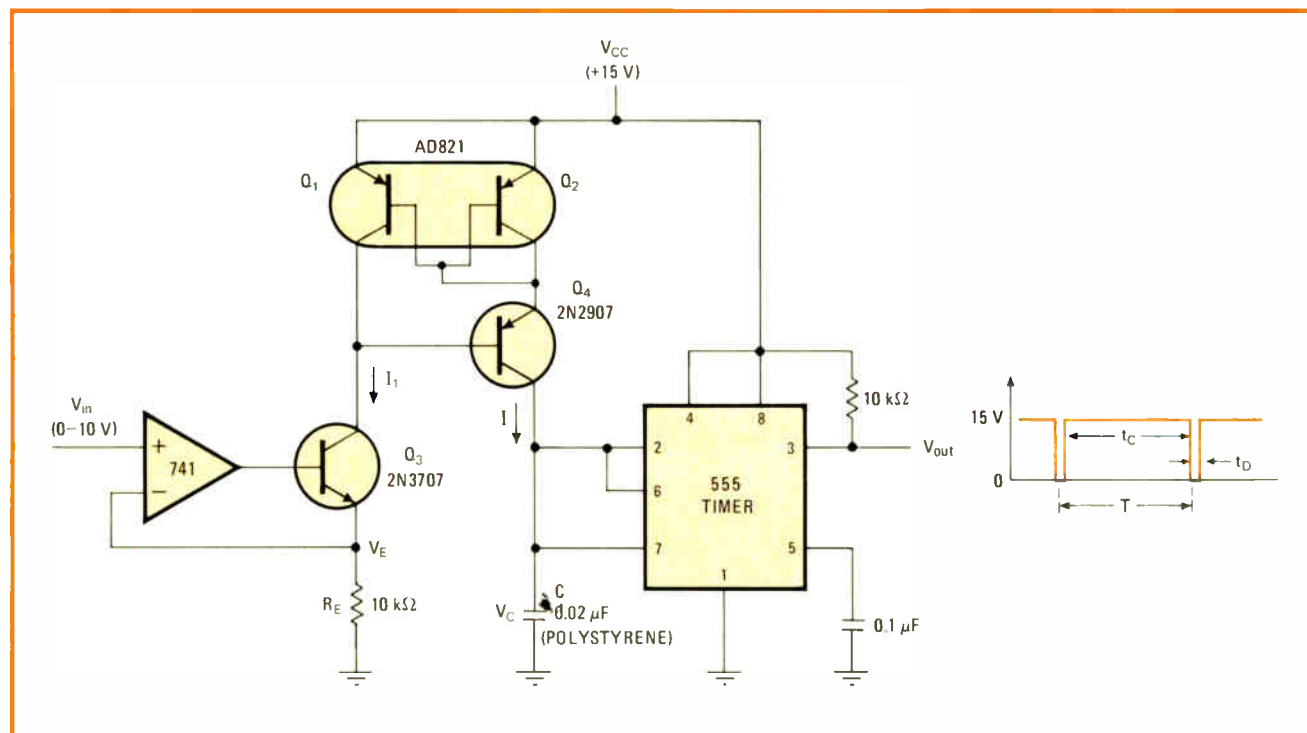

1. Linear voltage tuning. Inexpensive linear voltage-to-frequency converter uses an op-amp-driven transistor current source and a current mirror to charge the timing capacitor in a 555 astable multivibrator circuit from control voltage V_{in} .

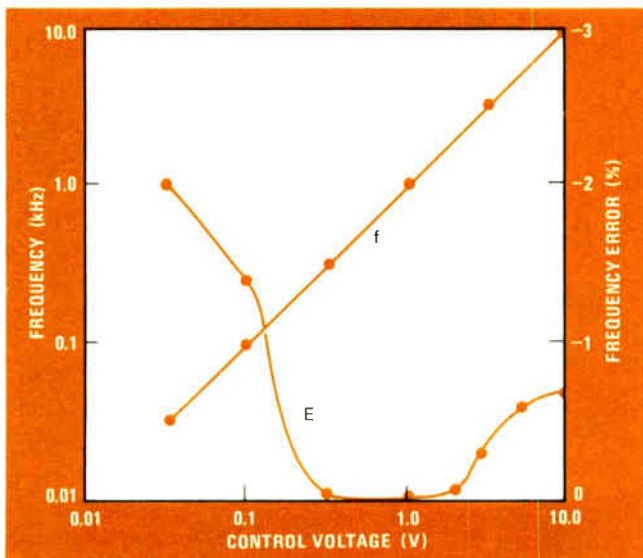

2. Straight and accurate. Graphs show the experimental frequency-versus-voltage relationship, and the percentage departure from linearity, obtained with the circuit in Fig. 1.

$$f = 10^3 V_{in}$$

The experimentally obtained frequency and accuracy are shown in Fig. 2. At high frequencies (10 kilohertz) the non-zero discharge time (t_d) becomes significant and tends to make the frequency less than the predicted value. At low frequencies (100 hertz) the decreased transistor betas and the bias currents of the comparators (pins 2 and 6) decrease the voltage-to-current conversion factor and tend to also make the frequency less than the predicted value. This latter error may be compensated for to some degree by adjusting the offset of the 741 so that $V_E = V_{in} + 1.5$ mV. This has the effect of increasing the conversion factor at low input voltages without seriously affecting the accuracy at larger input voltages. Here this technique reduces the error in the 100-Hz region to less than $\pm 0.4\%$.

For higher-frequency operation (1–100 kHz), it's better to reduce capacitor C to 0.002 microfarad, rather than decrease R_E ; otherwise the ratio of t_d to t_c would become too large, and errors would result at the high end of the frequency range. □

Long/short-period pulses speed synthesizer setting

by Gregory W. M. Yuen

University of Technology, Loughborough, Leicestershire, England

An up/down counter is sometimes used to generate binary digits to tune a phase-locked-loop frequency synthesizer. However, the process is slow—each digital word at the counter's output is set to the desired value by push buttons that increment or decrement the count by one each time the button is pushed.

To speed up the tuning process, the buttons can be held down for a while. In this mode of operation the pulse generator rapidly steps the counter up or down through a succession of states.

The circuit shown below combines both tuning modes. Momentarily pressing a button generates a single pulse that increments or decrements the counter by one, as shown in cycle 1 of the timing diagram.

Keeping the button depressed for more than about half a second steps the counter to change the tuning at a 10-hertz rate; this condition is illustrated in the cycle diagram. Depressing the appropriate button causes the counter to step in the desired direction. As the desired frequency is approached, the button is momentarily pressed to manually step the counter repeatedly until the desired frequency is obtained. Since the method combines the speed of oscillator-derived stepping and the precise tuning of manual stepping, it provides both coarse and fine tuning.

In the circuit diagram, IC₁ is an ITT 74124 universal pulse generator. It consists of two cascaded monostables with feedback to make it operate as an oscillator. When

the inhibit-oscillator input is high, this feedback path is active.

In the quiescent state, no button is pressed. Because IC₁'s inhibit oscillator input is low, there is no oscillation. Because flip-flop FF₁'s \bar{Q} output is low, both transistors are off. When a button is pressed momentarily, it triggers the first monostable in IC₁ to send a pulse to output Q₁. Pulse width T₁ depends on the timing circuit connected to pins 1, 2, and 3. The second monostable is triggered from the trailing edge of Q₁. The Q₂ and \bar{Q}_2 outputs from the second monostable, at pins 10 and 9 respectively, have widths T'₂ that depend on the timing circuit connected to pins 11, 12 and 13 (C₂, R₁ and the internal resistance connected to the second monostable—the transistors stay off because FF₁'s \bar{Q} output does not change). When cycle 1 is completed, the output pulse from Q₂ has incremented or decremented the counter by one.

If either button is pressed for a considerably longer period, the initial sequence of events is essentially the same as before. However, FF₁'s \bar{Q} output goes high when its clock input is taken high by Q₂ which goes high at the end of cycle 1. This turns on the transistors and R₁ is shorted out, resulting in a shorter pulse width, T₂, from the second monostable. T₂ is smaller than T'₂, and the period of oscillation is T₁ + T₂. Cycle 2 repeats for as long as the button is pressed.

For both monostables in IC₁, the output pulse width is given by 0.695CR seconds, where C is the capacitance in farads across pins 1 and 2 or 11 and 12, and R is the resistance in ohms across pins 2 and 14 or 12 and 14. (Pin 14 is the V_{CC} supply pin.) Internal timing resistors with a nominal value of 7.2 kilohms each are connected at pins 3 and 13 for monostables 1 and 2 respectively. To use the internal resistor, the appropriate pin is taken to V_{CC} either directly or via an additional series resistor. In the latter case, the timing resistance R is the sum of

We think a board tester should catch \$3 defects while they still cost \$3 to fix.

Any defect your board tester doesn't catch right away is going to cost you money—lots of it. And if the defect goes all the way to your customer, it could even cost you your reputation for reliability.

Catch defects before your customers do.

Consider the Hewlett-Packard DTS-70 Digital Test System for your board testing needs. It's a system designed to let you catch more \$3 defects while they still cost just \$3 to fix—not three hundred dollars or more. The speed and efficiency of the DTS-70 helps reduce human error while actually increasing fault detection and location. Quick, accurate, fault location that tells you what the problem is and where it is.

Our advanced test generation capability can handle large circuit boards, up to 200 MSI IC's or 10,000 gate equivalents, so you need not be concerned that your boards are too large or complex. The DTS-70 simulates faults without needing a known good board. It provides a

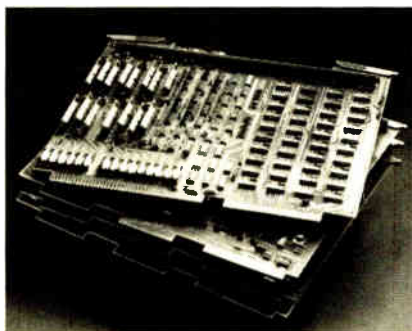

Complex boards mean higher failure rates.

learn the entire testing procedure and start running tests in a few hours. And what's more, our system is the expert. It automatically provides the operator assistance needed. If you make a mistake during test operation the system not only tells you, it gives you instructions on what to do next.

It could pay for itself in less than a year.

The Hewlett-Packard DTS-70 is a system designed to save you money.

In fact, it could literally pay for itself in less than a year of operation.

You can use the system's minicomputer efficiency to generate tests for new boards while normal production testing continues.

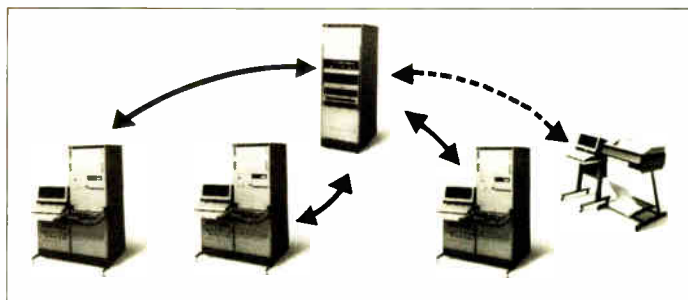

The new Hewlett-Packard DTS-70 Digital Test System.

Or, as production test needs grow, up to three test stations can be operated from the same minicomputer.

The new Hewlett-Packard Digital Test System. It gives you all the features that you need at a surprisingly low cost.

We're on the spot to provide service and support worldwide. So for more complete information, call your nearby Hewlett-Packard office or write. We'll be glad to send you our brochures on the DTS-70 Digital Test System and TESTAID III software.

WARRANTY REPAIR COST	IN PLANT REPAIR COST
<p>\$300.</p>	<p>\$3.00</p>

measure of test effectiveness at each stage of test generation so that you know when you have a truly comprehensive test.

The Board Tester should be an expert. Not you.

Our DTS-70 Digital Test System is so easy to use that your production test operators can



Sales and Service from 172 offices in 65 countries.
1507 Page Mill Road Palo Alto, California 94304

06603A

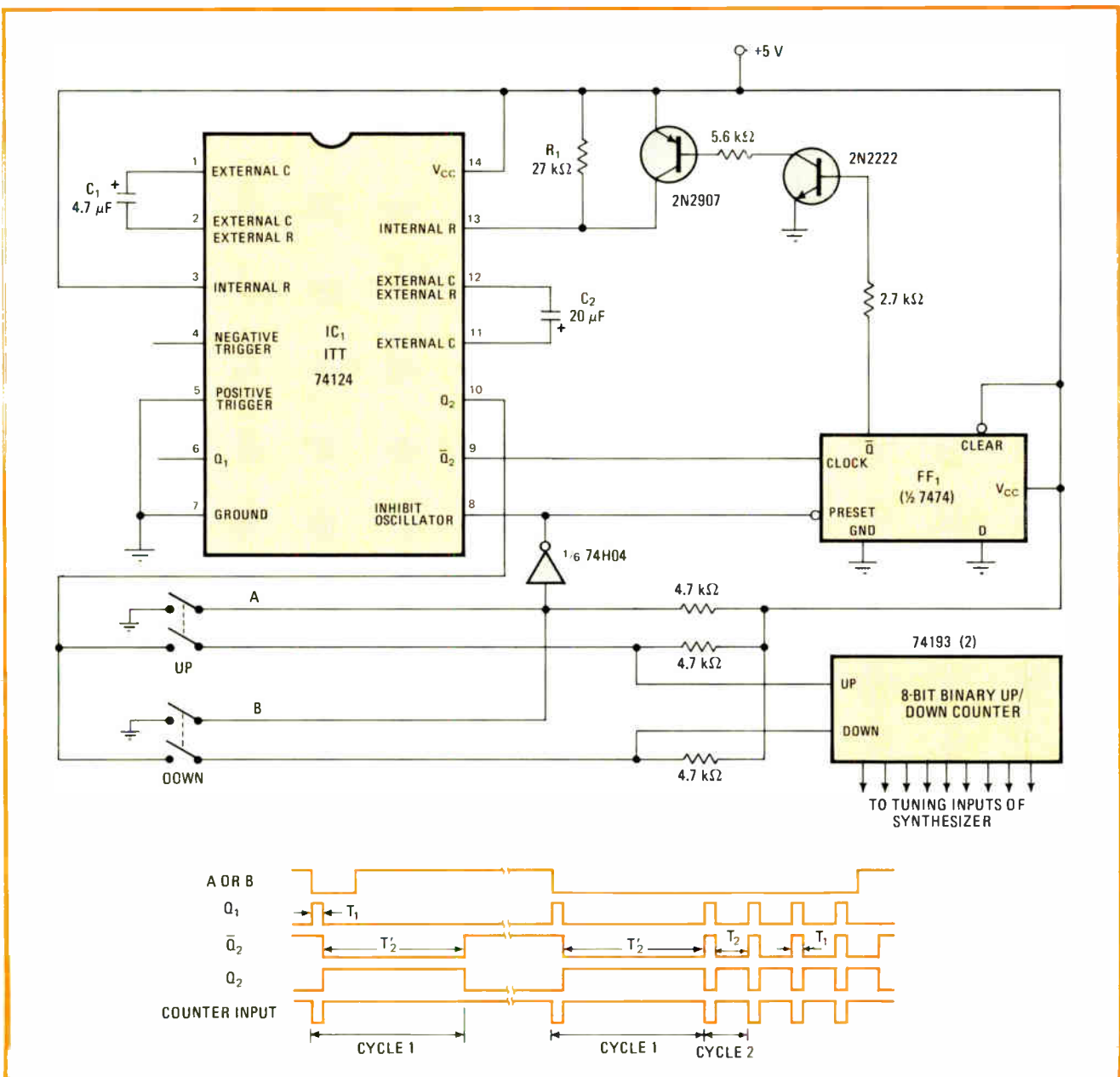

Two buttons set digital tuning word. Digital outputs from up / down counter constitute an 8-bit word that specifies the output frequency of a frequency synthesizer. Speedy access to any of 256 possible words is provided by incrementing or decrementing the counter with pulses. If a button is depressed momentarily, a single pulse is generated; if the button is held down, a fast stream of pulses is generated.

the internal and external resistances. Thus:

$$T_1 = 0.695(4.7 \mu\text{F})(7.2 \text{ k}\Omega) = 24 \text{ ms}$$

$$T_2' = 0.695(20 \mu\text{F})(7.2 \text{ k}\Omega + 27 \text{ k}\Omega) = 480 \text{ ms}$$

$$T_2 = 0.695(20 \mu\text{F})(7.2 \text{ k}\Omega) = 100 \text{ ms}$$

The measured pulse widths agreed well with these calculated values. Tantalum capacitors were used for C_1 and C_2 .

The up/down counter, consisting of two cascaded 74193s, increments or decrements the output word when the up or down button is pressed. Obviously, the indication of channel or frequency can be derived from the counter's output. If, however, continuous tuning is also provided (by opening the loop at the PLL's voltage-controlled-oscillator tuning-voltage input and connect-

ing this input to a variable-dc voltage source), a frequency counter is used to display the frequency.

If the synthesizer's address word for tuning is in binary-coded decimal, 74192s or other up/down decade counters may be used. Larger tuning-address words can be accommodated by cascading more counters.

A memory (random-access or programable-read-only, depending on whether or not volatility is undesirable) allows arbitrary tuning sequences, including skipping or repeating individual frequencies. If this facility is required, the memory is inserted between the counter and the synthesizer's tuning-address input. □

Designer's casebook is a regular feature in Electronics. We invite readers to submit original and unpublished circuit ideas and solutions to design problems. Explain briefly but thoroughly the circuit's operating principle and purpose. We'll pay \$50 for each item published.

The only Double-Balanced Mixers with a 2-YEAR GUARANTEE*

featuring Hi-Rel tested diodes-

still only

\$7.95
(500 pieces)
\$9.95 (1-49)

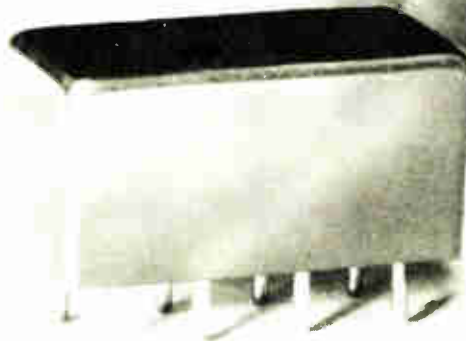

*including diodes!

Yes, a two-year guarantee for DBM's is now a reality . . . made possible by an accelerated-life diode screening program adopted at Mini-Circuits.

Each Schottky diode used in Mini-Circuits' SRA-1 mixers is now preconditioned by the HTRB (High Temperature Reverse Bias) technique, previously reserved almost exclusively for semiconductors assigned to space applications. With HTRB testing, each diode is operated for 168 hours at 150°C with one volt reverse bias applied.

To screen out "infant mortality", the diodes are deliberately stressed to accelerate aging and to force time-related failure modes to take their toll. In conventional testing or "baking", the diode does not experience anywhere near the stress encountered with the HTRB program. Hence, the ability at Mini-Circuits' to locate the potentially-unreliable diodes before they are assembled into SRA-1 units. And, with double-balanced mixers, the overall reliability hinges almost entirely on the diodes used.

Yes, the HTRB procedure costs us more and screens out more devices. But our goal is to improve reliability to a level unmatched for off-the-shelf DBM's at no increase in cost to our customers. You — our customers by your overwhelming confidence in our product line have made us the number one supplier of DBM's in the world.

To earn your continuing support, we are now employing HTRB Hi-Rel testing for every diode used in the SRA-1, at no increase in cost to you. So, for the same low price of \$7.95, you can purchase our SRA-1, with a two-year guarantee, including diodes.

To ensure highest system reliability demand highest quality diodes on your source-control drawings and purchase orders. Specify SRA-1 mixers, with HTRB tested diodes from Mini-Circuits... where low price now goes hand-in-hand with unmatched quality.

MODEL SRA-1

Freq. range (MHz) LO - 0.5-500, RF 0.5-500, IF dc-500

Conversion loss (dB)	Typ.	Max.
One octave from band edge	5.5	7.5
Total range	6.5	8.5
Isolation (dB)	Typ.	Min.
Lower band edge to one decade higher	LO-RF 50	35
Mid range	LO-RF 45	30
Upper band edge to one octave lower	LO-RF 35	25
	LO-IF 30	20

Min. Electronic attenuation (20 mA) 3 dB

Signal, 1 dB compression level + 1 dBm

Impedance all ports 50 ohms



Mini-Circuits Laboratory

A Division Scientific Components Corp.

International Representatives: AUSTRALIA General Electronics Services, 99 Alexander Street, New South Wales, Australia 2065. ENGLAND Dale Electronics, Dale House, Wharf Road, Firmley Green, Camberley Surrey. FRANCE S. C. I. E. D. I. M. E. S., 31 Rue George, Sand, 91120 Palaiseau, France. GERMANY, AUSTRIA, SWITZERLAND Industrial Electronics GMBH, Klüberstrasse 14, 6000 Frankfurt/Main, Germany. ISRAEL Vectronics Ltd., 69 Gordon Street, Tel Aviv, Israel. JAPAN Densoh Kavsha Ltd., (Yuchi Building, 8-1) Chome, Hamamatsucho, Minato-ku, Tokyo. EASTERN CANADA B. D. Hummel, 2224 Maynard Avenue, Utica, NY 13502 (315) 746-7821. NETHERLANDS, BELGIUM, LUXEMBOURG, Cormex, Veldweg 11, Haltem, Holland. NORWAY Dalamatik AS, Distensjøveien 62, Oslo 6, Norway.

US DISTRIBUTORS: NORTHERN CALIFORNIA Cain White & Co., Foothill Office Center, 105 Fremont Avenue, Los Altos, CA 94022 (415) 948-6533. SOUTHERN CALIFORNIA, ARIZONA Crown Electronics, 11440 Collins Street, No. Hollywood, CA 91601 (213) 877-3550.

For complete product specifications and U.S. Rep. listing see MicroWaves "Product Data Directory," Electronic Designs' "Gold Book" or Electronic Engineers Master "EEM"

Advances in CRT design augur improved oscilloscopes

by A.G. Shephard, Thomson-CSF
Electron Tube Division, Paris, France

□ The oscilloscope has become an indispensable measuring tool in all fields of science and technology, at least partly because of improvements in the oscilloscope's basic component—the cathode-ray tube. Although some CRTs being manufactured today are little different from those introduced in the first scopes in the 1930s, during the early days of television, the capabilities of some modern CRTs have outpaced the electronics used in scope design. And recent developments, chiefly charge-coupled devices, will probably bring about an

oscilloscope generation that is more likely to be integrated into data-collection systems than to stand alone as isolated instruments.

In choosing a cathode-ray tube, the scope maker considers deflection factor, bandwidth, storage capability, reliability, and display quality, which includes screen dimensions, trace brightness, spatial resolution, and geometric distortion. With the variety of CRTs now available, the manufacturer can satisfy most requirements on these counts.

The remaining headaches mainly concern bandwidth. The upper limit is being raised constantly. Whereas a 30-megahertz laboratory oscilloscope was considered exceptional in 1955, 350-MHz models are now in common use, and a demand, admittedly limited, exists even for gigahertz capability. Working in close liaison with oscilloscope designers, CRT manufacturers have played, and are still playing, an important role in this evolution.

Simple beginnings

Many of the requirements of educational institutions and repair shops can be satisfied by 10-MHz oscilloscopes that use CRTs of relatively simple design (Fig. 1), differing little in principle from the first tubes ever to be manufactured. Electrons from a hot cathode are collimated into a fine beam and accelerated toward a phosphor screen that is several kilovolts positive with respect to the cathode.

The electron beam is deflected so as to graphically display the incoming signal information (usually as a function of time) along horizontal and vertical axes. Electrostatic deflection is nearly always used. Although

1. On screen. The first commercial oscilloscope, of which an example is in the Smithsonian Institution, was introduced by Allen B. DuMont Labs in the 1930s. Deflection connections were made directly to the CRT, the box shown acting only as a high-voltage power supply.

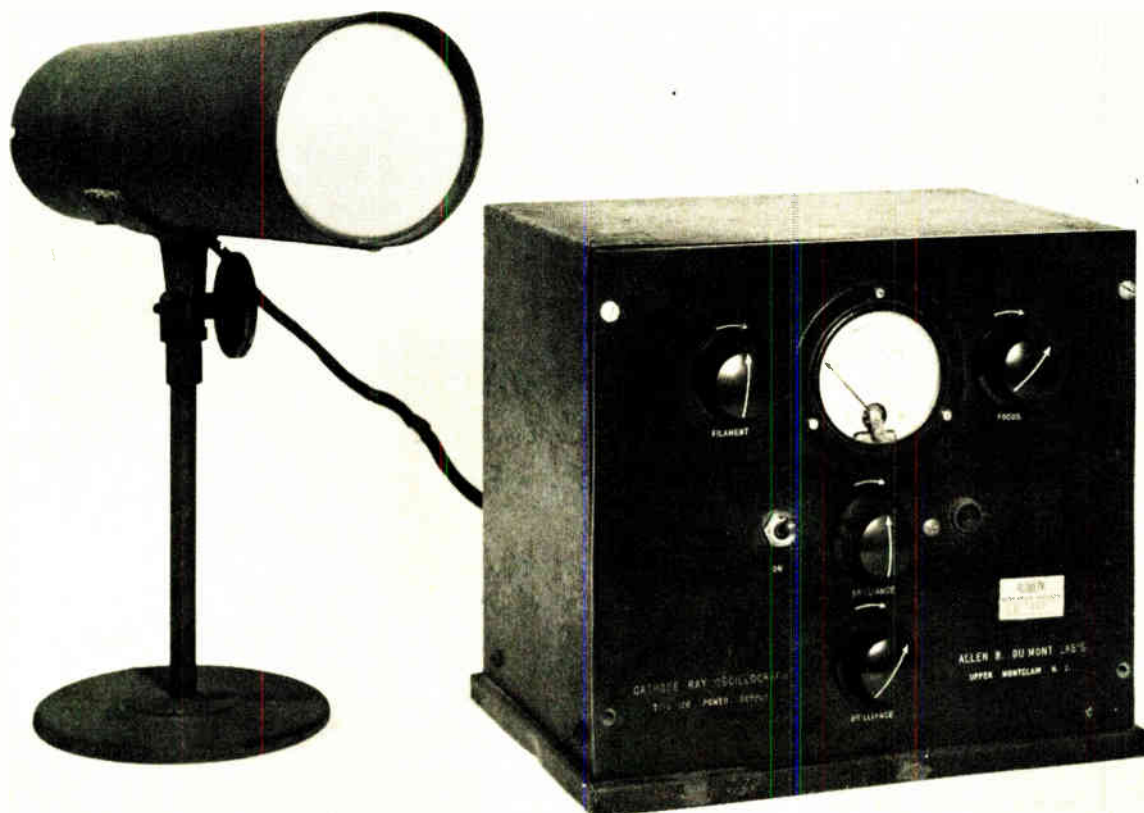

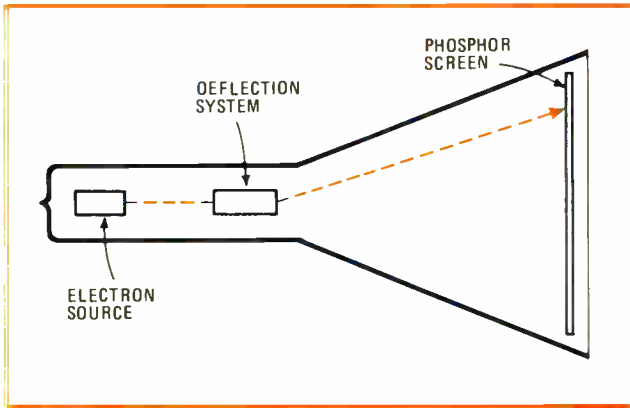

1. Simple CRT. The most common oscilloscope CRT, still widely used in low-frequency instruments, differs little from early units.

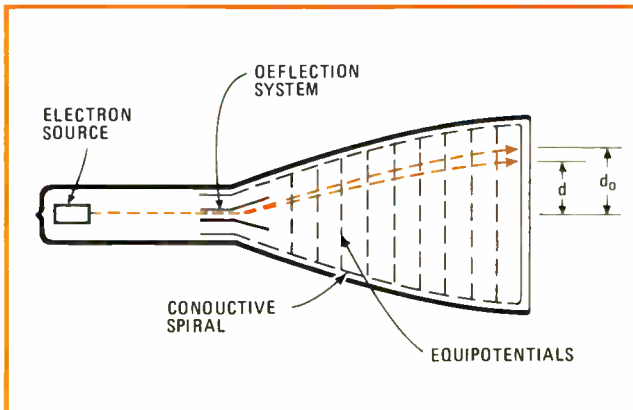

2. Spinning a field. The voltage across a conductive spiral on the inside surface of the CRT creates a field that accelerates the beam.

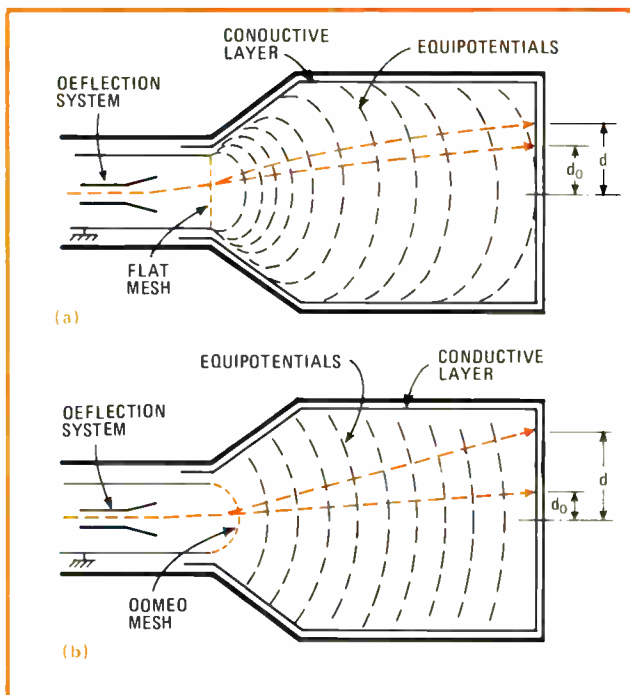

3. Magnifying through a mesh. Either a flat or curved mesh helps improve the deflection factor of a scope CRT. The radially traversed equipotentials of the domed-mesh tube increase this effect.

magnetic deflection gives a slightly smaller spot size, coil-design problems and excessive power consumption impose an upper limit on useful operating frequency of 2 to 3 MHz. Tubes using this principle are normally found only in oscilloscopes that have limited frequency response and large screens.

Because of their unsophisticated design, these simple tubes are relatively cheap to manufacture, but their low trace brightness makes them totally unsuitable for operation above 20 MHz. Since trace brightness depends on the energy imparted to the screen by the electron beam, and hence on accelerating voltage, the only way to improve trace brightness would be to increase the accelerating voltage. But to do so would automatically increase the already high value of the deflection factor (see "Measuring deflection," p. 116). Increasing the length of the deflection plate could reduce the deflection factor, but the increased interplate capacitance would hurt the CRT's high-frequency performance.

Post-deflection acceleration

In an attempt to increase trace brightness without unduly affecting the deflection factor, CRT manufacturers long ago introduced tubes in which the energy of relatively low-voltage electrons was increased after deflection. This technique is known as post-deflection acceleration, or PDA.

The first tubes of this kind had a resistive spiral electrode painted on the inner surface of the glass bulb (Fig. 2), and the potential difference across the two ends was about 10 kilovolts. The spiral creates equipotentials that act as a converging lens, progressively accelerating while bending the beam toward the tube axis. The deflection that would occur if there were no convergence, d_0 , divided into the actual deflection, d , is known as the compression ratio; it is commonly 0.4 to 0.6. Since the beam is divergent, the compression ratio can be improved by lengthening the tube. Unfortunately, a CRT made that way tends to be rather cumbersome.

The next development was the introduction of a flat or domed field mesh into the spiral PDA tube. Placed just after the deflection plates, it modifies the shape of the equipotentials, thus avoiding the compression effect associated with pure spiral PDA tubes. These tubes are much shorter than spiral PDA CRTs that have the same deflection factor.

In modern tubes, the spiral has been eliminated altogether. It has been replaced by a continuous conductive coating (Fig. 3) that has a potential of 15 to 20 kv with respect to the field mesh. A strong field is created between the mesh and the bulb wall, which yields two results: it accelerates the electrons (PDA) and also increases the deflection (deflection magnification).

The earliest tubes had flat field meshes. They provided good trace brightness and deflection factor and were suitable for operation up to 100 MHz. Domed-mesh tubes have an even more pronounced deflection-amplification effect. Typical figures for d/d_0 are 2 to 3.5, compared to 1 to 1.5 for flat-mesh tubes. They are now being used in oscilloscopes designed for operation in the 50-to-300-MHz range.

Both types suffer from disadvantages that directly re-

sult from the use of field meshes. First, the beam is diffracted by the grid-like form of the mesh, increasing spot size and reducing contrast. Second, an appreciable part of the beam is intercepted by the mesh, which then emits secondary electrons that reduce control further and can also cause a halo effect on the screen. This halo, although always present, is not noticeable under most conditions. However, when the time base is unusually slow, the halo is clearly visible. The effect is more pronounced with domed-mesh than with flat-mesh tubes.

Quadripolar Lenses

An improvement in the tubes, the use of quadripolar and slot lenses, was developed in 1967 by Thomson-CSF. These tubes, which are extremely compact, have a very low deflection factor, wide frequency response, excellent trace brightness and geometry, and complete absence of the problems that characterize mesh-type tubes. The secret lies in their PDA/deflection-magnification system, consisting of a set of quadripolar lenses followed by a slot lens (Fig. 4).

This tube design greatly reduces the problems encountered in developing large-bandwidth oscilloscopes. Yielding a bright trace because beam-attenuating meshes are eliminated, it allows signals with very fast rise times to be displayed. Because of the extremely low deflection factor, the deflection sections can be driven by amplifiers that have moderate gain. The low deflection factor also makes possible compact, large-screen tubes, which are ideal for the growing market in large-

display portable oscilloscopes. Spatial resolution is excellent because there is neither beam diffraction nor secondary emissions. And because tubes of this design are lighter and more robust than field-mesh tubes, they are ideal for applications where weight and mechanical reliability are of utmost importance.

Deflecting the beam

So far, little has been said about the primary deflection system, and, for the sake of simplicity, all of the drawings have shown conventional deflection plates. The maximum frequency response of a set of conventional plates depends on the time taken by an electron to pass between them. If it takes more than an appreciable fraction of the signal cycle time, then the net deflection will be either reduced or zero.

Frequency response could be improved by reducing transit time by means of a reduction in plate length or an increase in electron velocity, but either technique would adversely effect the deflection factor. Because of the high degree of deflection amplification obtained in quadripolar lens tubes, the deflection factor may be sacrificed to a certain extent. For that reason, such tubes, even with conventional plates, have a larger bandwidth than their domed-mesh counterparts.

Another problem becomes apparent when the CRT is judged as part of an oscilloscope, instead of alone. Because the impedance of the plates is inversely proportional to the signal frequency, the amplifier that drives them must be capable of functioning correctly with a

4. Sharpening the image. Quadripolar and slot lenses, shown here following conventional deflection plates, help focus the beam while eliminating the halo effect of field meshes. And since the beam doesn't have to pass through a mesh, trace brightness is increased.

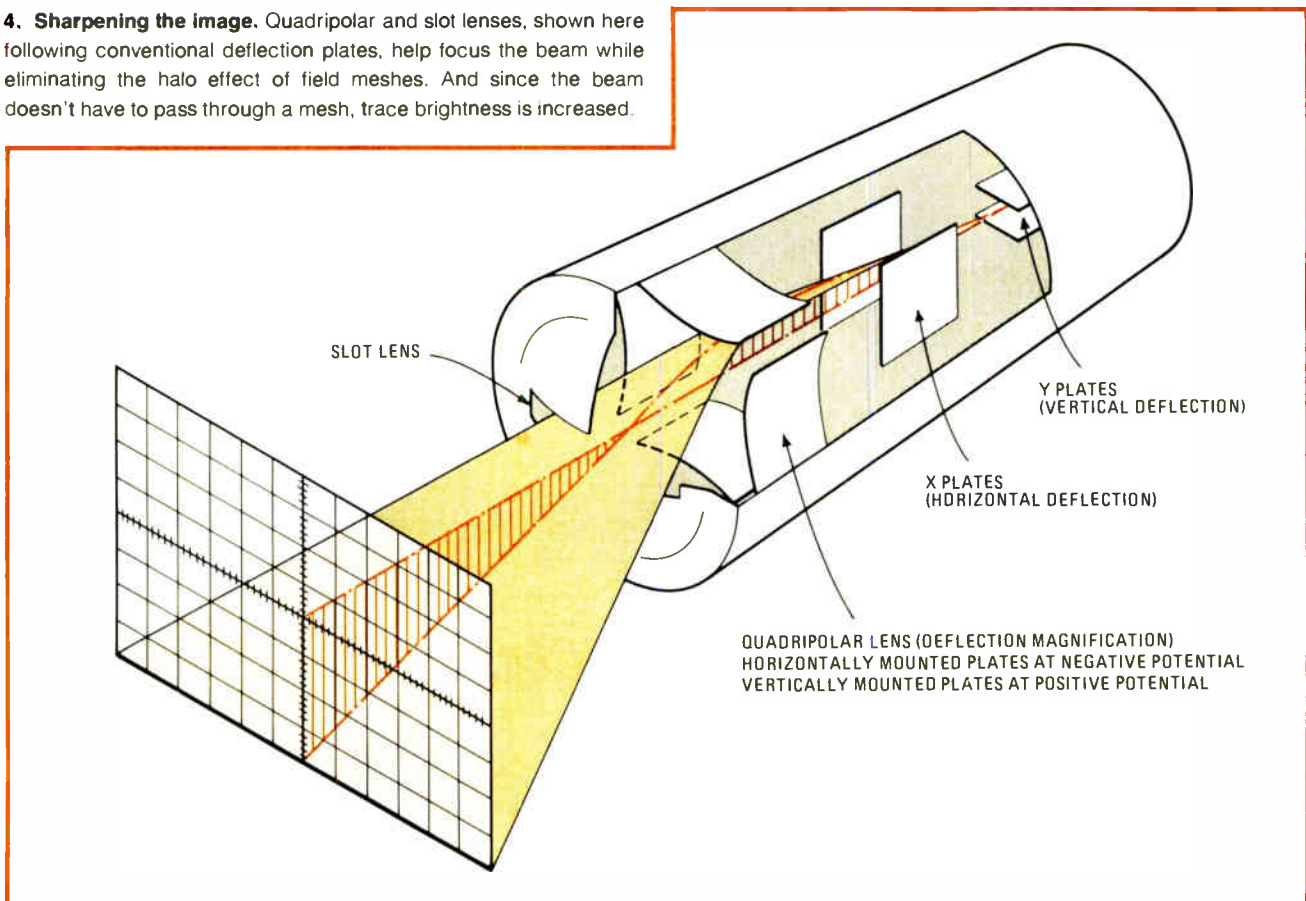

Measuring deflection

Two terms to describe the capability of a deflection system to alter electrons' trajectories are deflection factor and its inverse, deflection sensitivity. The meanings of the two terms are sometimes reversed. An electron of energy eV_0 , passing through an electrostatic field V_s that is perpendicular to its original trajectory (V being the potential difference across the deflection plates), will be deflected. The deflection, d , is $(V/V_0)(Ll/2s)$.

The deflection factor of a CRT, V/d , is the number of volts required for a 1-centimeter (or graticule division) deflection:

$$V/d = (2sV_0)/(Ll)$$

This capability can also be expressed in terms of deflection sensitivity as the number of centimeters or graticule divisions of deflection obtained with a deflection voltage of 1 volt.

wide range of loads. The design of such amplifiers becomes difficult, if not impossible, for large-bandwidth oscilloscopes.

For these reasons, conventional plate systems are not to be recommended beyond 150 MHz for domed-mesh tubes and 250 to 300 MHz for quadripolar-lens tubes, which have shorter deflection plates and less plate-to-plate capacitance. For frequencies higher than these, transmission-line systems are used (Fig. 5).

Instead of one relatively long plate, a series of short plates is used. These are interconnected by inductive/capacitive delay elements to match the signal propagation time to the electron transit time so that the electron is constantly deflected during its passage between the plates. In addition, and of major importance to the oscilloscope designer, correctly adapted transmission-line systems have a frequency-independent impedance, which greatly simplifies design of the deflection amplifier.

In addition to the previously mentioned improvements, which are largely concerned with electron optics, the actual presentation of the visible image has changed over the years. The P1 phosphor, in common use for a long time, has now been replaced to a great extent by P31, which exhibits superior characteristics for most oscilloscope applications. The color is more agreeable to the eye and better matched to the spectral sensitivity of films used in oscilloscope cameras. In addition, P31 has a more rapid rise time and higher luminosity, which makes it superior for display of fast transients.

Trace brightness has been nearly doubled by coating the back surface (electron-gun side) of the phosphor with a thin layer of aluminum. The metal acts as a mirror, reflecting outward the light that is emitted from the phosphor back in the tube.

Adding a grid

Until the late 1960s, most oscilloscope measurements were made by reading along a plastic graticule in front of the CRT. This graticule was easily damaged, and parallax resulting from the separation between the image

TABLE 1: OSCILLOSCOPE CRTs

CRT type	Advantages	Disadvantages	Frequency range
Simple	Low cost Fairly small spot (0.4 mm)	Low deflection factor (30 V/cm) Low trace brightness	Up to 10 MHz
Spiral PDA	Medium price Small spot (0.2 to 0.3 mm) Bright trace	Medium deflection factor (10 V/cm) Bulky	Up to 50 MHz
Flat-mesh lens	Medium price (higher than spiral PDA) Fairly small spot (0.4 mm) Good deflection factor (6 V/cm)	Medium trace brightness Halo caused by mesh	50 to 100 MHz
Domed-mesh lens	Medium-sized spot (0.45 mm) Compact Very good deflection factor (4 V/cm)	High price Medium trace brightness Halo caused by mesh	50 to 300 MHz 500 MHz possible
Quadripolar lens	Fairly small spot (0.4 mm) No halo Compact Excellent deflection factor (1.5 V/cm)	High price Medium trace brightness	50 to 500 MHz 800 MHz possible

on the phosphor and the graticule caused reading errors. In later CRTs, the graticule is being placed inside the tube in the same plane as the phosphor.

Although increasing accuracy, internal graticules caused unexpected problems for the CRT manufacturer. The slightest errors in trace geometry, not noticeable with an external graticule, became immediately obvious and reason for complaint. However, accuracy in mounting and the general precision of the electron optics have been improved, so that the accuracy of the modern oscilloscope CRT is becoming more and more accepted.

Many oscilloscopes can display two or more traces at the same time. The simplest technique with a standard CRT is to chop or alternate the incoming signals at a high frequency and apply them at different times to the vertical-deflection plates. The traces are separated by dc-level controls.

Another technique provides two continuous traces by means of a special CRT in which the electron beam is split in two after leaving the horizontal-deflection plates, but before reaching the vertical-deflection plates, of which two independent sets are used. A third technique permits all parameters to be varied by means of two completely independent sets of electron guns and horizontal- and vertical-deflection plates.

The most recent change has been made possible by the availability of large-screen CRTs. For many years, the standard display format has been 8 by 10 centimeters, but new CRT screens are 10 by 12.5 cm, and even larger sizes are becoming available. Although the absolute resolution remains the same, the readability has been greatly improved by 10-by-12.5-cm screens, so that this format may rapidly replace its predecessor as a standard.

All of the CRTs described so far have one thing in

common: when an electron strikes the phosphor screen, the resulting luminous spot is only visible for an instant. When looking at sufficiently fast, repetitive phenomena, the eye integrates the successive traces to give an impression of continuity. With very slowly evolving signals or fast nonrecurrent phenomena, some form of image-storage system is required. When required for use with a conventional oscilloscope, storage is usually provided by a camera.

Capturing the image . . .

However, another type of instrument is available for these applications. This is the storage oscilloscope in which a direct-view storage tube (DVST) replaces the conventional CRT. And even though a DVST can store incoming signals and display a continuous image, the stored data can be totally erased in a few milliseconds.

The main difference between the two basic classes of DVST is where the signal is stored. In one, the phosphor-target tube, the storage medium is the phosphor of the screen. This system is inexpensive because it is simple to construct and also simple to operate. Because of the way it works, the phosphor-target tube is commonly called a bistable tube. Since the operation of this class of tube has been extensively described elsewhere, it won't be dealt with here.

Capable of much better performance is a class of tube, in commercial production at Thomson-CSF since 1962, in which the storage medium is a special mesh that is placed near to the phosphor (see Table 2). Because of the principle of operation, this tube is known as the variable-persistence (or half-tone) storage tube.

The basic structure of a variable-persistence DVST resembles that of a conventional CRT with several components added (Fig. 6). The storage-and-display section consists of a phosphor viewing screen, a metal-mesh collector electrode, and a metal-mesh backing electrode that has a thin layer of dielectric (the storage surface) deposited on the side facing the writing gun.

Operation of the tube depends on the secondary-emission characteristics of this dielectric so that the storage surface can be charged either positively or negatively, according to the energy of the incident electrons.

The flood guns (normally two) continuously emit a wide-angled beam of low-velocity electrons that is shaped by the collimator so that the meshes and phosphor are evenly and orthogonally irradiated. Electrons approach positively charged areas of the storage mesh, then will pass through the holes in the backing electrode, be accelerated, and strike the phosphor.

Those approaching negatively charged areas will be repelled back toward the collector. The storage mesh acts like the control grid of a triode in that the transmitted beam of electrons will be modulated by varying levels of positive charge present on the storage surface. In this way, half-tone information can be displayed on the phosphor screen.

. . . storing it . . .

To write and store information, the storage surface is locally charged in a positive-going sense by the beam from the writing gun. The electrons are energetic

enough to give a secondary-emission ratio that is greater than one.

The resulting trace of positive charges can be turned into an image by the flooding beam. Because the flooding-beam electrons don't remain on the storage surface (they are either repelled or transmitted through the holes), an infinite-duration display seems to be possible. But in practice, residual gas molecules inside the tube are ionized by the flooding beam, positive ions are deposited on the storage surface, and display contrast is reduced by the appearance of a luminous "stain" of increasing intensity until, eventually, the information is lost. This phenomenon is called "fading positive." Long-term retention can be accomplished by switching off the flood guns so that written information is stored indefinitely before being displayed.

. . . and letting go

To erase stored information, a positive pulse is applied to the backing electrode. Low-energy flooding-beam electrons are then attracted toward the storage dielectric (the surface potential of which has also been raised because of capacitive coupling) and charge it uniformly to the negative flooding-gun cathode potential. On removal of the positive pulse, the backing-electrode potentials falls to its original value and, because of capacitive coupling, the storage-surface potential falls to the unwritten state. New information can then be written and stored.

If variable-persistence operation is required, the single positive erase pulse is replaced by a train of shorter pulses, each of which partially erases. Persistence may be varied by adjusting the pulse duty cycle.

The DVST can be used as a normal CRT by cutting off the flooding beam and dropping the collector potential (normally around +100 v) to 0 v. To prevent trace broadening, the backing electrode must also be biased negative enough to keep secondary electrons, which are generated by writing-beam electrons striking the storage surface, from reaching the phosphor viewing screen.

Stored writing speed and viewing time are inter-

5. Down the line. Large-bandwidth oscilloscopes demand deflection systems more complicated than simple plates. Electrons are accelerated all along the delay-transmission line shown here.

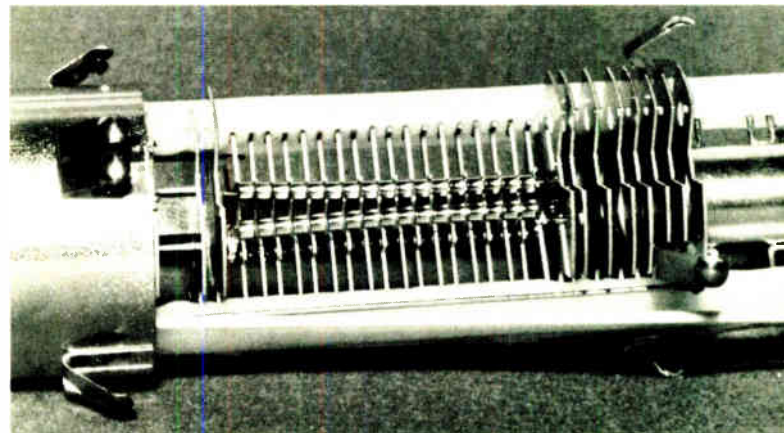

related. If information is written onto the storage surface by a very fast beam, the displayed trace will be faint, and it will soon be drowned in the increasing background glow of the fading-positive effect. Because of this, the effective writing speed in storage operation is limited to around 500 cm/ μ s in most tubes. This is equivalent to storing a single-shot 9-ns rise-time signal with 3.5-cm amplitude.

Although this is sufficient for the majority of applications, higher stored writing speeds are desirable in certain domains. In such cases, a fast-transfer storage CRT can be used.

The fast-transfer-storage CRT is similar in principle to a variable-persistence DVST, but it has two storage meshes instead of one. The first has been designed to capture high-speed signals at the expense of viewing time. The stored signal is then transferred to the second mesh, which is designed for long viewing times.

What's coming in scope CRTs

Future developments in CRTs will be aimed at separating the data-gathering from the display functions. In the past, CRT development has been stimulated by the demands for such improvements as increasing bandwidth, sensitivity, brightness, and resolution. Virtually all of those needs can be met by present-day tubes, except for some problems in the gigahertz region. Even

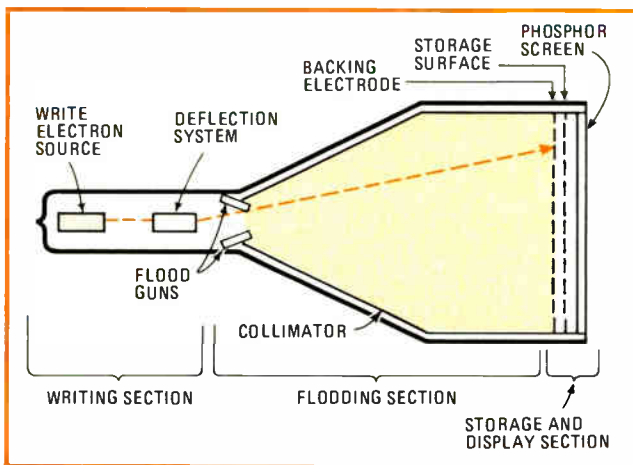

6. Holding on. The flood guns in a typical direct-view storage tube supply electrons that pass through the storage mesh, on which a trace has been written, before they illuminate the screen.

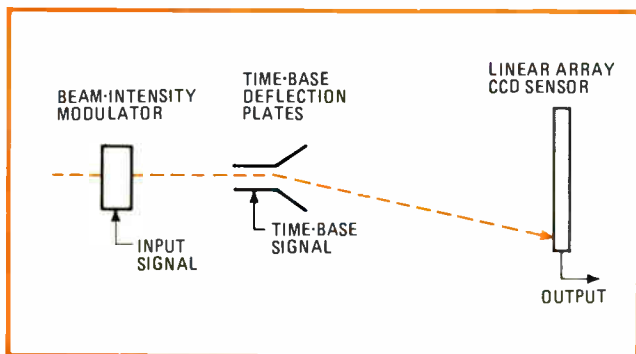

7. Variable intensity. Future oscilloscopes may use a modulated beam writing on a CCD target instead of on a CRT.

there, highly specialized (and also rather expensive) tubes yield reasonable results. However, the total market for oscilloscopes with this level of performance is limited to a handful per country, since their main application is in advanced research into nuclear and laser phenomena. The vast majority of users are more than satisfied by the performance of scopes at 10 to 500 MHz.

For some time, the oscilloscope has been widely considered part of an integrated data-treatment network, rather than an isolated unit. Hence, the demand is increasing for models with digital outputs, compatible with standard data-processing equipment. Various ways have been tried to adapt relatively conventional oscilloscope technology to satisfy this demand. But is this the way to solve the problem, or should the whole function of the CRT and oscilloscope be reconsidered? This question was posed to a group of Thomson-CSF engineers responsible for CRT development, and they tried some crystal-ball gazing.

The opinion was unanimous that, although the conventional oscilloscope will continue to be used for the foreseeable future, it will soon be complemented, and for certain applications replaced, by a high-speed data-storage system with digital readout plus an auxiliary display monitor.

How could high-speed data storage with digital readout be obtained? Among the various ideas proposed, three give food for thought; all are based on CCD technology.

Applying CCDs

The first idea calls for a linear-array CCD to be enclosed in an evacuated glass bulb that also contains an electron gun and horizontal-deflection (time-base) plates (Fig. 7). No vertical-deflection plates would be required because the incoming signal information would modulate the electron-beam current by means of the electron gun's control grid, for example.

The information would be captured by the linear-array CCD, read out, and stored by a second CCD. It could then be displayed at will by means of a simple, low-cost CRT or digitized for further data treatment. This approach would provide a good digital-output oscilloscope at relatively low cost; the combined cost of the CCD unit and simple CRT monitor could be appreciably less than the cost of today's high-performance CRTs that not only have to display information, but also have to be able to

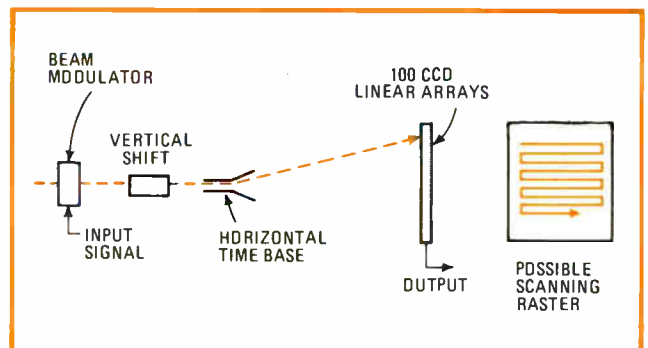

8. More data. Raster scan across a CCD array could extend the recording time of the modulated-beam system.

TABLE 2: MESH VS. PHOSPHOR STORAGE

	TYPICAL MESH STORAGE TUBE	TYPICAL PHOSPHOR STORAGE TUBE
Phosphor	P31: High brightness	P1 or similar: less bright
Variable persistence	Yes	No
Half-tone storage (z-axis modulation)	Yes	No
Writing speed	Unaffected by aging	Decreases with aging
Stored brightness	Unaffected by aging	Decreases with aging
Brightness	Up to 100 times higher	
Split-screen capability	No	Yes
Structure	Relatively complex	Simple

capture it. With present CCD technology, models working at 20 to 100 MHz are envisioned.

The next idea is a variation of the first. The single linear array would be replaced by a set of up to 100 parallel linear arrays (Fig. 8). The principle of operation would be the same, but since the time base describes a raster, the possibilities are numerous. For example, the information could be treated as a continuous train of signals so that the capacity would be increased a hundredfold. Alternatively, the information in each linear array could be extracted separately for such signal processing as eliminating noise.

In these two concepts, a sampled analog output would have to be subsequently digitized. The third idea would give a direct digital output (Fig. 9). And, when suitably read out, the output signal could be treated directly by standard data-processing units.

A series of linear-array CCDs would be scanned in both X and Y directions by the electron beam as in a conventional oscilloscope, but the operation would be fundamentally different. Intensity would be indicated by position along the array, and time would be governed by which array the information is stored in. The

two previous plans would furnish time information by position along the array and intensity information by the quantity of charge in the CCD elements.

Evaluating CCD potential

The advantages of the three proposed systems over standard CRTs would be:

- An output that would be either digital or sampled and therefore easy to digitize.
- High writing speeds, because an inherent gain of several thousand is possible with CCD targets.
- Readout that could be handled by a cheap standard CRT so that high performance would be possible at a relatively low overall cost.
- Compactness, and low manufacturing costs. By exploiting the technique of the single CCD strip with beam-intensity modulation, it should be possible to construct storage-oscilloscope systems that are cheaper than conventional models.

Such a new-generation oscilloscope would require some form of display unit to provide a visual check of the signal being fed into associated data-processing unit. This check could be made by a simple low-cost CRT for many applications, but an alternative immediately springs to mind—the plasma-discharge display panel.

The plasma panel, which has high writing speed and an inherent memory, is ideally suited for this type of oscilloscope because of its compatibility with digital and sampled signals. And since the typical panel is only about 12 millimeters thick, an instrument using it would be considerably less bulky than one using a CRT.

Research-and-development work now being carried out on these projects will doubtless open up new horizons in signal monitoring and measurement. However, the conventional oscilloscope, with its advantage of immediately showing what is happening, is likely to remain the primary research tool for many years, and the new instruments will be used in a backup role for more detailed or convenient analysis. □

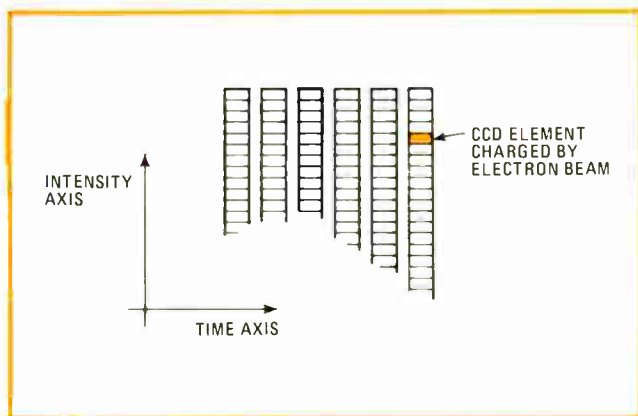

9. CCD CRT. If scanned like a standard CRT, a CCD array can give the same information as the tube but in digital form.

We've doubled our high voltage Power Transistor line.

Read what's in it for you.

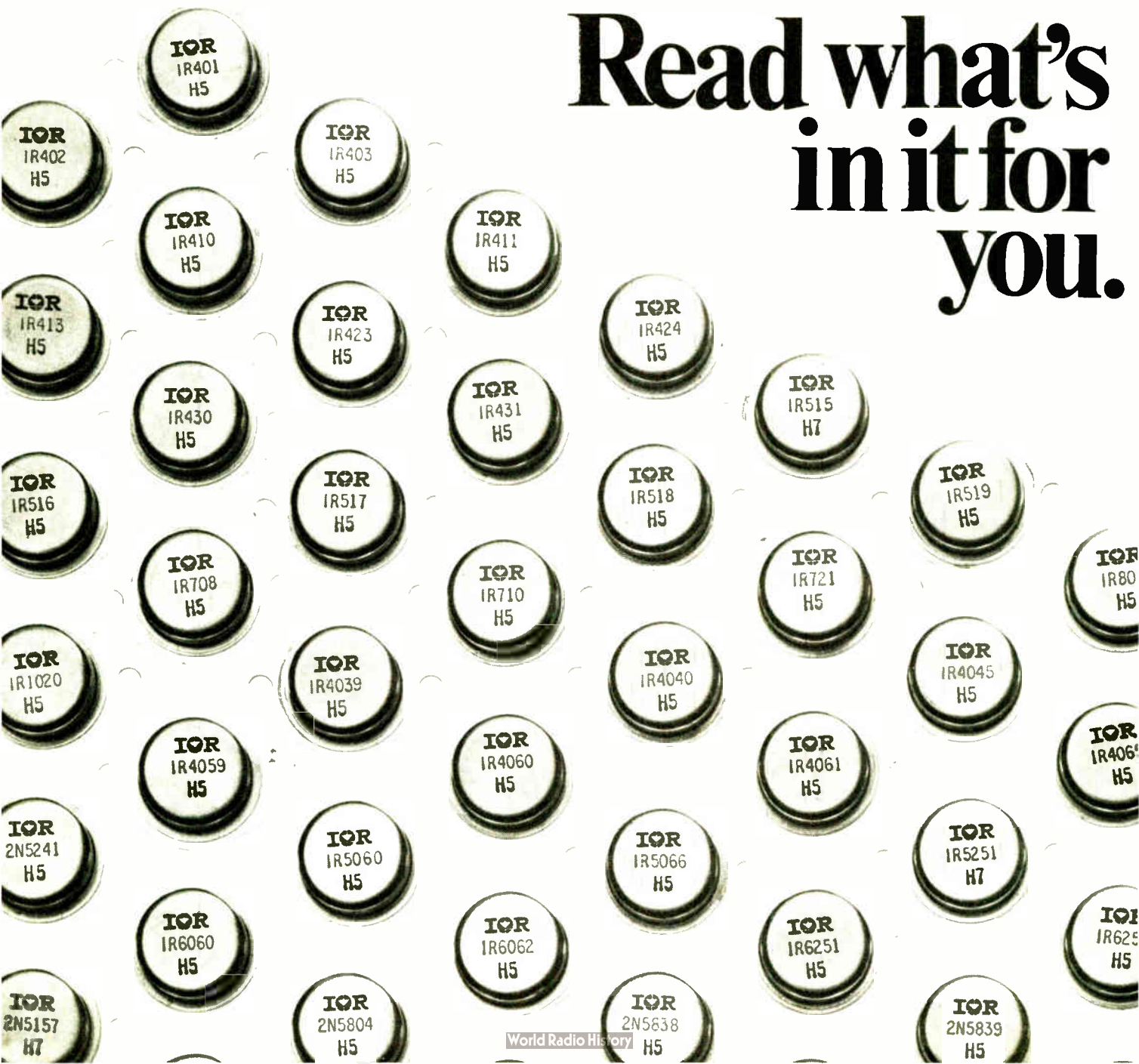

Our new, expanded line offers a lot more types than we could show here. But that isn't important to you. What is important is that now you can probably get a better device than you are now using, for these reasons.

All of the top power transistor companies make pretty good high voltage devices with low sats, broad operating areas, low switching losses. IR gives you that, and more.

For example, we use hard-glass passivation for our chips. That gives our devices longer life than those using organic passivating materials. It also gives a high-temperature stability that you can see in Figure 1, but may never see for other devices. It costs us more to apply. But it is far better for you in the long run.

We build and rate our devices to operate reliably and continuously at maximum rated junction temperatures. Other brands which come up short in high-temperature stability may require temperature derating. Check the performance of the ones you use.

Because we've specialized in "power" semiconductors for more than 28 years, we know the

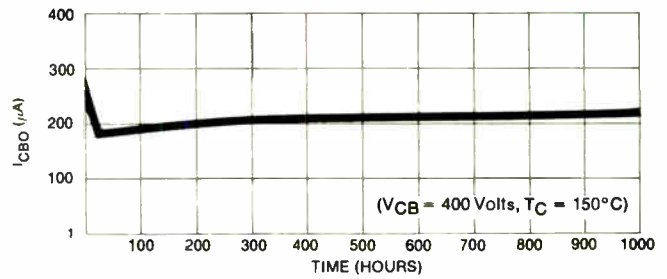

FIGURE 1 Typical High Temperature Reverse Bias Characteristics Vs. Time

importance of reliability testing. In addition to testing the 11 basic parameters of every device, we perform 100% tests on a curve tracer to make sure each part has a sharp high-voltage characteristic.

And there are other demands on power devices we've learned to handle over the years. Like mounting chips to the substrate so they stay there through years of temperature cycling. And making connections between the chip and case that last. Little things? No. They loom large when things go wrong on other devices.

In the case of chips to package yourself, you'll get a completely finished, fully protected and tested transistor for more flexibility in design and higher yields in your end product.

We offer the most popular types for the applications listed, so get our "Power Transistor Application Guide". Check it for our equivalents to the types you're using now. When you find them, you've found the way to add more stability and longer life to your product without adding to your costs.

That's what's in it for you!

Contact your local IR salesman, rep or distributor, or write to: International Rectifier, 233 Kansas Street, El Segundo, CA 90245. Call (213) 322-3331.

Our "Power Transistor Application Guide" gives the part numbers of types available for these applications. Get yours today.

Switching Power Supplies	64 Types
High Voltage Linear Regulators	30 Types
Auto Ignition Systems	22 Types
Ultrasonic Power Generators	13 Types
Vertical Deflection	17 Types
Horizontal Deflection	23 Types
Motor Drives	32 Types
High Frequency Lighting	11 Types



International Rectifier

... the innovative semiconductor people



Circle 121 on reader service card

FET power amplifier boosts transmitter efficiency

by Frederick H. Raab, *Polhemus Navigation Sciences Inc. Burlington, VT*

□ Most of the power needed to drive a radio transmitter is consumed in the power amplifier. For that reason, the efficiency of the power amplifier determines the battery and heat-sink requirements of portable communications equipment and rescue beacons. Increasing this efficiency can improve performance, increase operating life, or decrease the size and weight of a transmitter.

The high-frequency power amplifier described here operates in the class F mode for high output efficiency and exploits the negligible drive-power requirement of a field-effect transistor. The prototype produces a maximum of 330 milliwatts with 73% efficiency at 25 megahertz. This design won an award in the 1974 double-diffused-MOS contest sponsored by Signetics Corp. while the author was with Cincinnati Electronics Corp.

As shown in Fig. 1, the amplifier uses a single FET or a pair of FETs in parallel, driven to act as a switch. The parallel-tuned output circuit acts as a short circuit to all harmonics of the signal frequency, but the impedance transformation produced by the quarter-wavelength transmission line causes the drain to see a short circuit for the even harmonics and an open circuit for the odd harmonics.

This combination of impedances produces a square-wave drain voltage and a half-sine-wave drain current. Since the drain voltage is near zero while drain current

is flowing, the FET dissipates very little power. This mode of operation, designated class F, could ideally be 100% efficient and thus provide 27% more output power and 27% greater efficiency than class B operation (see F. H. Raab, "High efficiency amplification techniques," *IEEE Circuits and Systems Journal*, 1975, vol. 7, no. 10, pp. 3-11).

The Signetics SD-200 is well suited to this application because it can operate as a switch at frequencies that reach into the very-high-frequency region. To operate the FET as a switch, more voltage is applied to the gate than is necessary to sustain the current flowing in the drain. Since the drain current is sinusoidal when it is not zero, a sinusoidal gate voltage of sufficient amplitude causes switching. What's more, because the gate voltage is sinusoidal and gate current is negligible, this amplifier can be driven directly by the radio-frequency oscillator or frequency multiplier. This capability eliminates components and reduces power consumption.

Transmission line boosts efficiency

Figure 2 depicts an equivalent circuit for the amplifier shown in Fig. 1; the FET is replaced by a switch and a series saturation resistance R_{on} . The switch opens and closes at the signal frequency. Load resistor R_L is shunted by a tank circuit that has infinite impedance at

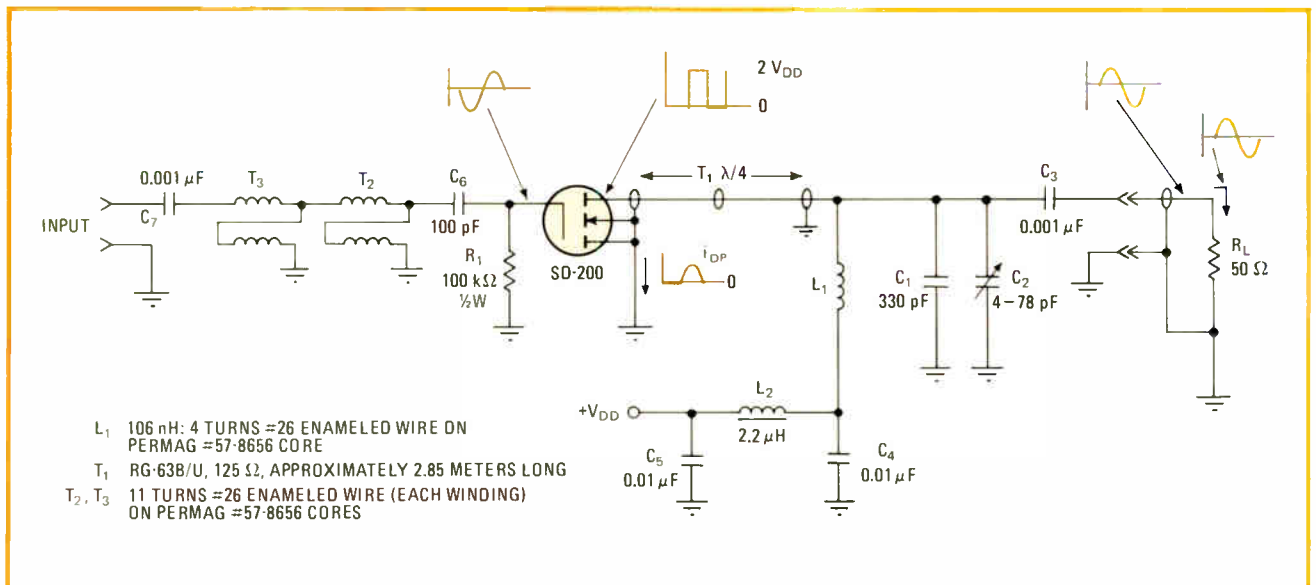

1. High efficiency. A microwave field-effect transistor acts as a high-speed switch in a highly efficient rf power amplifier that operates in the hf region. A quarter-wave transmission line produces the desired impedances for multiresonator class F operation. Without the quarter-wave line, the amplifier would operate in the class B mode. This circuit operates at 25 MHz and delivers 330 mW into a 50-ohm load.

the signal frequency and zero impedance at all harmonics. The impedance presented to the drain by the transmission line therefore depends on the frequency. At the fundamental frequency, the transmission line is a quarter-wave transformer; its input impedance is:

$$R = R_o^2/R_L$$

where R_o is the characteristic impedance of the line. At the even harmonics, the line acts as if it were a half-wavelength long and reproduces the short-circuited output at the drain. At the odd harmonics, it acts as a quarter-wavelength line, converting the shorted output into an open circuit at the drain. This set of impedances is the key to high-efficiency operation.

The FET is driven so that it is turned on to act like a closed switch half of the time and turned off to operate as an open switch half of the time. When the FET is driven on, the drain voltage must be zero. The short circuits for the even harmonics require that only the fundamental and its odd harmonics be present in the drain-voltage waveform. These components combine to produce a square-wave drain voltage.

Since the average voltage on the drain must be V_{DD} so that there is no dc drop in the rf choke, the square wave has levels of 0 and $+2V_{DD}$. To simplify the discussion, the characteristic impedance of the line is assumed to be the same as the load resistance, so that R and R_o are equal to R_L , and R_{on} is assumed to be zero. The fundamental-frequency component of the square-wave drain voltage then appears across the load:

$$v_L(t) = (4V_{DD}/\pi) \sin \omega t$$

Incidentally, this voltage lags the drain voltage by 90° because of the phase shift in the quarter-wave transmission line.

The fundamental-frequency current that flows in the load is just the load voltage divided by R :

$$i_L(t) = (4V_{DD}/\pi R) \sin \omega t$$

The odd harmonics in the drain-voltage waveform convert the sine wave into a square wave, but since they do not cause current to flow, they consume no power. The output power is produced entirely by the fundamental-frequency current and voltage:

$$P_o = \frac{1}{2} v_{LP} i_{LP} = \frac{8V_{DD}^2}{\pi^2 R}$$

When the FET is off, the drain current must be zero. The rf choke passes only dc, so the fundamental-frequency current that flows through the load must also flow through the drain. Since the transmission line is an open circuit to odd harmonics, the drain current must be composed of a fundamental and even harmonics. Furthermore, because the transmission line acts as a short circuit to even harmonics, the drain can draw any amount of even-harmonic current necessary to meet other circuit requirements. This even-harmonic current results in a half-sinusoidal drain current whose peak amplitude is equal to the peak-to-peak amplitude of the output current:

$$i_{DP} = 8V_{DD}/\pi R$$

The even-harmonic currents circulate through the

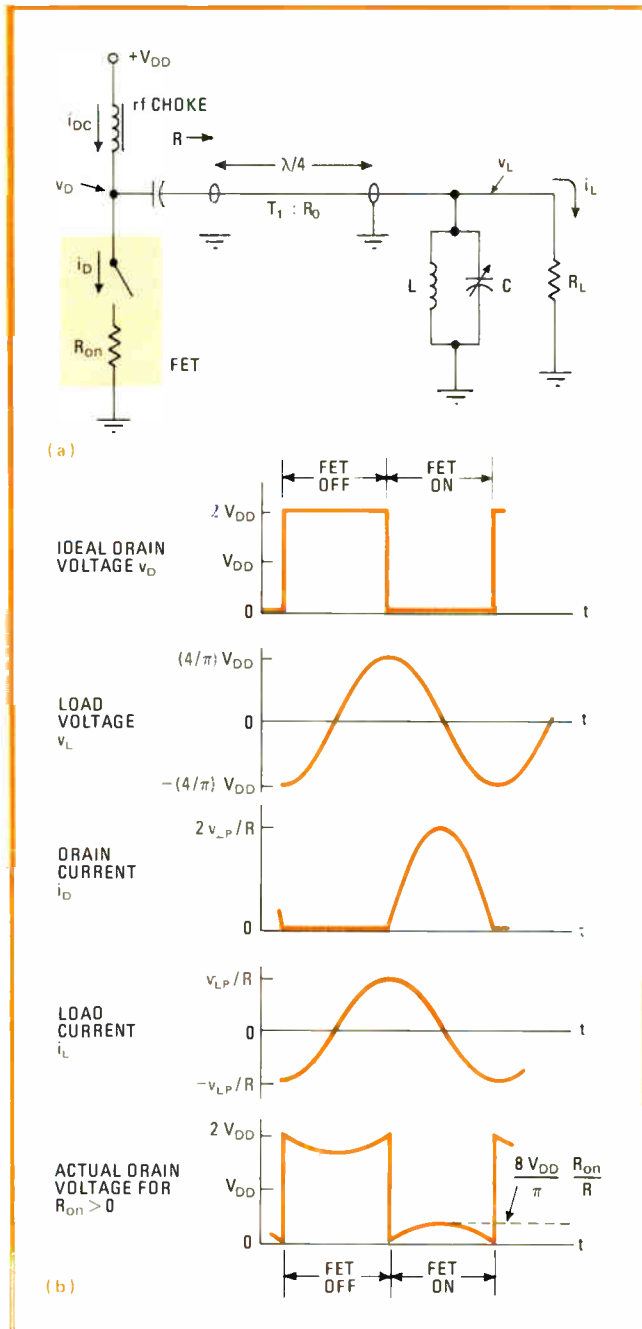

2. Here's how. Equivalent circuit (a) and waveforms for voltages and currents (b) show operation of class F amplifier. Switching action of FET produces square drain-voltage wave, but tuned circuit and transmission line remove harmonics to produce sinusoidal outputs. Values on curves are for case of $R_o = R_L = R$.

drain, transmission line, and output network, but no power is consumed because they produce no voltages.

The dc input required is the average drain current, which is obtained by dividing i_{DP} by π :

$$i_{DC} = 8V_{DD}/\pi^2 R$$

Multiplication of i_{DC} by V_{DD} gives the input power as $8V_{DD}^2/\pi^2 R$; since this is the same as the expression for output power, the efficiency of the ideal class F amplifier is 100%. This result is also apparent from the drain

voltage and current waveforms in Fig. 2b. When drain current is not zero, drain voltage is zero, and when drain voltage is not zero, drain current is zero. Consequently, no power is consumed by the device.

Saturation resistance lowers efficiency

In a real FET, saturation resistance R_{on} is greater than zero and, therefore, the device consumes some power, reducing the efficiency of the amplifier below 100%. The output voltage and current must be sinusoidal, however, and the drain current must be half-sinusoidal. This drain current, flowing through the saturation resistance, causes the bottom of the drain voltage to differ from a square wave by a half-sinusoid with a peak value $i_{DP} R_{on}$, or $2v_{Lp} R_{on}/R$, as shown in Fig. 2b.

Since there can be no even harmonics in the drain-voltage waveform, the half-sinusoidal droop also appears in the top part of the waveform. This droop reduces the output voltage because it acts in opposition to the fundamental component of the ideal square wave. The resulting output voltage across the load can be determined by equating the fundamental component of the drooping drain voltage and the output:

$$v_{Lp} = (4V_{DD}/\pi)[R/(R+2R_{on})]$$

When this equation is used in the expressions for drain current, dc current, output power, and input power, the efficiency of the class F amplifier is found to be:

$$\eta_F = R/(R+2R_{on})$$

Maximizing the power

In a reliable amplifier circuit, the peak voltage and peak current should not exceed the ratings of the FET. For the SD-200, these are 25 v and 50 mA, respectively; therefore, V_{DD} must not exceed 12.5 v, and i_{DC} must not exceed 15.9 mA for a single device or 31.8 mA for two devices in parallel.

Maximum power output is obtained by choosing the load line R so that maximum drain current is reached when the maximum supply voltage is applied. This value of R is:

$$R_{MP} = (8V_{DD\text{ MAX}}/\pi i_{DP\text{ MAX}}) - 2R_{on}$$

If the saturation resistance R_{on} were zero, the optimum resistance would be 637 Ω , yielding an output of 198 milliwatts. Saturation resistance reduces not only efficiency, but also the maximum power. For the typical R_{on} of 40 ohms, R_{MP} becomes 637 - 80 or 557 ohms. The efficiency is therefore:

$$\eta_F = 557/637 = 87.5\%$$

A single device with typical saturation resistance can thus produce about 173 mW.

Assessing actual performance

A working model of the circuit in Fig. 1 is shown in Fig. 3a. Transformer T_1 used a 125-ohm transmission line simply because it was available; however, its load line produces nearly maximum power for a parallel pair of FETs. Although it may seem crude to use such a large coaxial cable with such a small device, the same load

Evaluating class F operation

Class F operation of a power amplifier in a high-frequency transmitter provides 27% higher efficiency and 27% higher output power than class B. A quick comparison with class C is difficult because class C amplifiers are operated with many different conduction angles and varying degrees of saturation.

The efficiency of an amplifier in Class C operation can be increased by decreasing the conduction angle toward zero. But since the power output decreases when the conduction angle is decreased, class C operation provides high efficiency only when output power is low. Class F operation, however, provides the high efficiency at high output power.

The field-effect transistor in the circuit of Fig. 1 would operate as a conventional class B amplifier if the transmission line were removed. In that mode, the FET is driven to act as a current source instead of a switch. The parallel-tuned output causes the drain voltage to be sinusoidal. For maximum efficiency, the drive voltage is adjusted so that the drain voltage swings from 0 to +2 V_{DD} . By analysis similar to that for the class F operation, the efficiency for class B is found to be

$$\eta_B = (\pi/4)[R/(R+2R_{on})] = 0.785\eta_F$$

When R_{on} is zero, the class F circuit has an efficiency of 100%, and this equation yields the 78.5% maximum efficiency of class B operation.

could have been produced with a pi-network matching 50 Ω to 30 Ω and a 95- Ω miniature transmission line, and at higher frequencies, the line could be printed on the circuit board. The carrier frequency of 25 MHz made it possible to build components easily and to measure impedances of the first three harmonics with a vector-impedance meter.

The input circuit is simple and noncritical. Transformers T_2 and T_3 multiply the input voltage by four. R_1 prevents charge buildup on the gate. The parallel-tuned output tank has a Q of 3. The rf choke delivers dc power through L_1 and T_1 so that it operates into a low impedance and it does not have to contend with harmonics.

The 125-ohm transmission line and 50- Ω load should produce a drain load line of $125^2/50$ or 312 Ω , but the measured load line was 280 Ω . The difference may have been caused by variations in the coaxial cable and impedance transformation by stray reactances. With the measured load-line resistance of 280 Ω and R_{on} of 45 Ω , the expected efficiency is $280/(280+90)$, or 75.5%. The power output of a single FET with this load line will be limited by the peak-current rating of 0.05 A. The maximum supply voltage and power output are consequently:

$$V_{DD\text{ MAX}} = (0.05)(280)\pi/8(0.755) = 7.25\text{ V}$$

$$P_o = 8(0.755)^2(7.25)^2/280\pi^2 = 86.5\text{ mW}$$

This load line is much more suitable to a pair of FETs. If the saturation voltages are equal, the equivalent R_{on} is half that of a single FET. For an R_{on} of 22.5 Ω , the pre-

dicted efficiency is 86%, and the power output is 332 mW. The FETs must have the same saturation resistances, or else the current must be divided equally by matching resistors or a current transformer.

If the same FET were operated in class B with the same load line, its efficiency would be only 59.3% and its power output 53.5 mW. A pair of FETs operated in class B would have an efficiency of 67.5% and an output of 205 mW.

The SD-200 performs well as a switch, as shown by the waveforms in Fig. 3b. The FET showed no tendency to oscillate during transition, and no neutralization circuitry was required. Any tendency to oscillate is reduced by operating as a switch because the FET has no gain when saturated or cut off.

The measured performance of the amplifier is shown in the five graphs of Fig. 4. Graph 4a shows output power as a function of supply voltage. Agreement with theoretical calculations is very good. Graph 4b shows

that efficiency is nearly constant for all supply voltages, except for a slight tendency toward higher efficiency at lower outputs. The single FET achieved an efficiency of about 71% at 86 mW output, which is nearly the predicted 75.5%.

By using two FETs, efficiency was improved to 73%. Why the efficiency did not improve as much as predicted is not known. Possibly, the current did not divide equally, which would have made equivalent R_{on} larger than expected. But when both one and two FETs were used, the class F amplifier exceeded the theoretical efficiency and power output for class B operation.

This type of amplifier has excellent amplitude-modulation characteristics, as shown in graph 4c. Output voltage $v_{L,P}$ varies linearly with supply voltage V_{DD} , except when the single FET exceeds its ratings (above V_{DD} of 7 V). The drive voltage was the same for all values of V_{DD} . This useful property of class F amplifiers results from using the drive to operate the device as a switch. In a class B or C amplifier, the FET acts as a current (or voltage) source, and both the drive and supply voltages must be modulated.

Feedthrough from the gate was negligible, even at the lower output levels. Since efficiency at reduced outputs is at least as high as it is at maximum power output, the efficiency of a modulated amplifier is at least as high as that of a continuous-wave amplifier. This is not true of a transistorized amplifier, where the saturation voltage becomes more significant at low outputs.

Graphs 4d and 4e demonstrate that this type of amplifier does not require critical adjustment. Although it is certainly not a broadband amplifier, it can be operated over a 10% bandwidth with negligible loss in efficiency. The peak drive voltage was held constant at 17 V at the gate, and 17/4 V at the input, for all of the previous data, but it could have been decreased by 6 dB without significant loss in efficiency.

Refining the design

Higher efficiencies may be obtained by using a value of R larger than R_{MP} , but then the output is less than maximum. The use of R less than R_{MP} lowers both the efficiency and the output power.

The desired drain-load line can be produced in a variety of ways. If the parallel-tuned output were replaced by a π -network, the input impedance of the π -network and the characteristic impedance of the transmission line would then determine R . As an alternative, broadband transformers might be used. The transmission line must have essentially the same propagation velocity for at least the fundamental through the fourth harmonic. Coaxial cable is satisfactory, but 300- Ω television-antenna lead-in is not.

The carrier frequency must be low enough that switching occurs in a small fraction of a cycle so that, generally, the carrier frequency should not exceed about one tenth of the unity-gain frequency of the device.

The SD-200 has a unity-gain frequency higher than 1 GHz, so operation is possible at frequencies above 100 MHz. The SD-202 could be used at even higher frequencies, but it has a lower output. Capacitance at the

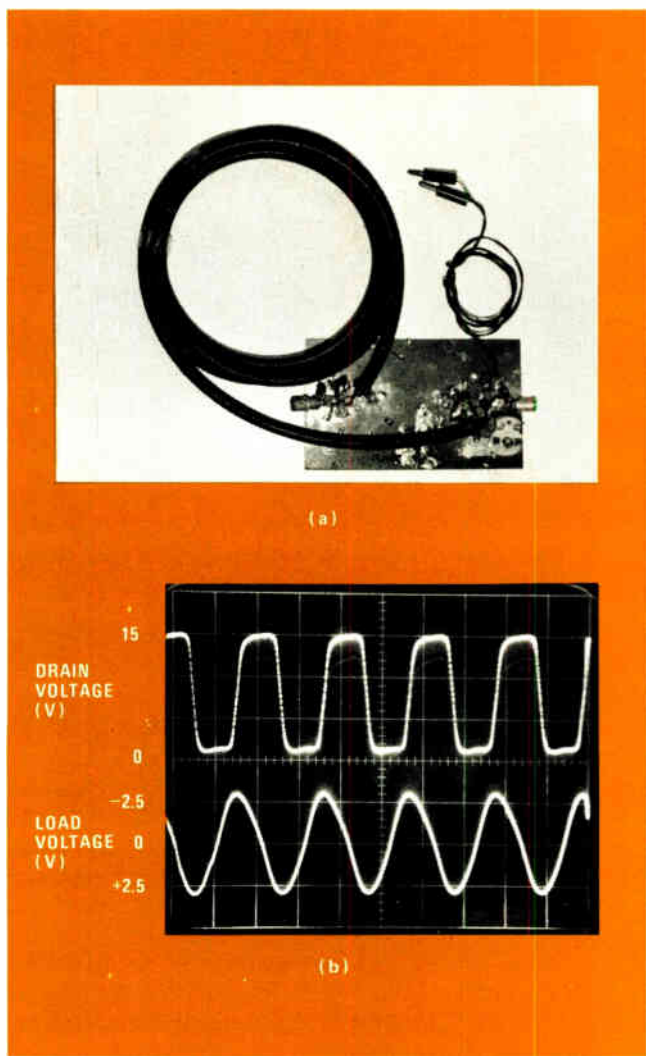

3. Model operation. Actual circuit (a) has input circuits and FETs on the left, output tuning and dc feed on the right. Transmission line T_1 is obvious. Voltage waveforms (b) correspond to those in Fig. 2. To miniaturize, a transmission line could be printed on the circuit board or approximated by discrete elements.

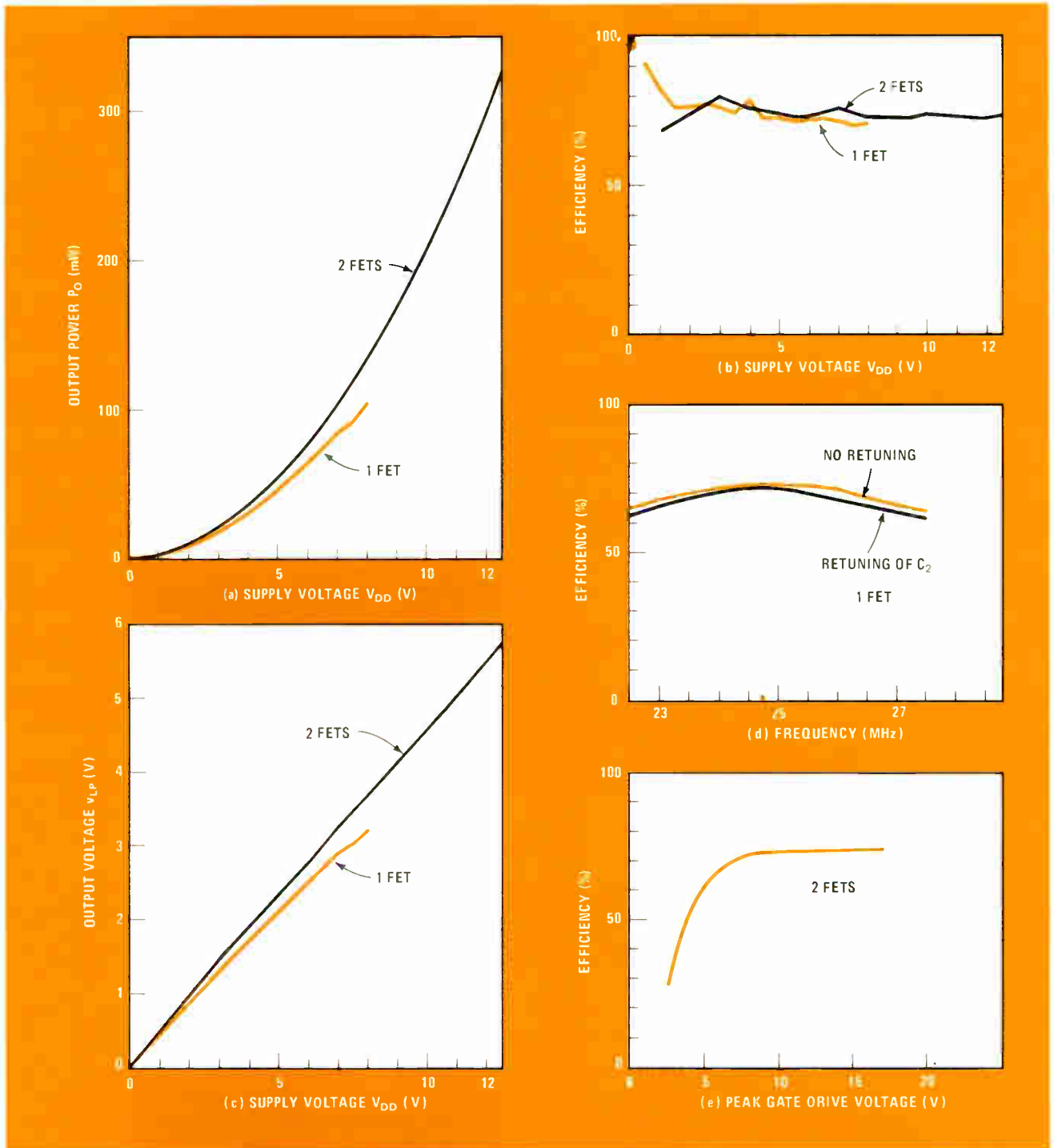

4. Graphic display. Measured performance of 25-MHz class F amplifier is shown in family of curves for a single FET and for two FETs in parallel. The nearly constant efficiency with varying output is demonstrated in (b), while modulation linearity is apparent in (c). Performance over a 10% bandwidth is shown in (d), and insensitivity to drive variations in (e). New V-MOS FETs can provide greater rf output.

drain should be kept to a minimum because it impedes rapid switching.

Since the gate voltage required for saturation depends on the drain current at a particular instant, sinusoidal drive can be used. When the driving voltage is below about 1 V, the device is cut off. The characteristic curves suggest a peak voltage of at least 6 V. The SD-201 should not be used because the diode protection will interfere with the driving signal. The gate capaci-

tance may be included as part of the tank circuit of the previous stage. It should be possible to drive this amplifier from an oscillator or frequency multiplier with sinusoidal output, since negligible power is required.

Advances in FET technology will make it possible to extract higher output power from this type of circuit. For example, the recently-announced Siliconix VMP-1 V-MOS FET with a 50- Ω transmission line and a 30-V supply should produce about 12 W of rf output. □

5½ DIGIT ACCURACY. 4½ DIGIT PRICE.

The 4600 is our brand new 4½ digit multimeter. It gives you the accuracy and resolution of typical 5½ digit multimeters. At half the cost.

And the 4600 stays accurate longer than other DVM's. DC accuracy stays within 0.01% ± one digit for six months at a time. We guarantee it.

80dB normal mode noise rejection produces a 10,000:1 reduction of excess noise. A full decade better than the 1,000:1 reduction of comparable instruments.

Loading errors are virtually eliminated by the 4600's 10,000M Ω input impedance on the two lowest DC voltage ranges.

There's a lot more. Send for a free catalog on our new 4½ digit 4600 multimeter. And find out how to get 5½ digit accuracy without paying for it.

Dana Laboratories, Inc., 2401 Campus Dr., Irvine, CA 92715. 714/833-1234.



DANA[®]

Others measure by us.

Circle 127 for product demonstration
Circle 115 for literature

Back-and-forth scanner overcomes slewing-rate limits

by James A. Blackburn
Wilfrid Laurier University, Waterloo, Ont., Canada

An incremental plotter or line printer that can store entire lines in a buffer memory can be made to print the lines alternately forwards—from left to right—and backwards—from right to left. This refinement will significantly increase its speed because it will no longer need the carriage return function with its all-too-finite slewing rate. In fact, only the minimum character-to-character print rate will then be affected by the mechanical inertia of the print-head assembly (or, in the case of

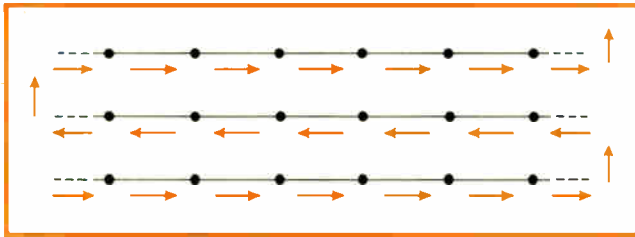

1. **Zig-zag scan.** Two-dimensional scan in minimum time is achieved by reversing scan direction on alternate rows, as indicated here. Initial address (0,0) is at lower left, and scan halts at (15,15).

an all-electronic display system, by the finite settling time of the amplifiers).

The technique is applicable to all two-dimensional scanning that must be performed incrementally. However, it is particularly efficient when each horizontal line contains many points, because in such cases the dead time during carriage return is proportionately large.

The circuit described here generates the required address sequences. It was designed as part of a rapid-film-scanning densitometer. The X and Y addresses can be sent via digital-to-analog converters to a servo system for incrementally moving the film holder past a photodetector. Alternatively, the vertical and horizontal count pulses may be used directly to drive stepping motors. If an appropriate clock frequency is chosen, the film may be scanned in the minimum time compatible with motor torque, sample stage inertia, and step size. A digitized replica of the image on the film may then be obtained by logging the densitometer output at each selected address.

The circuit shown in Fig. 2 performs an alternating-direction scan with TTL integrated circuits exclusively and is thus capable of high-speed performance. The clock frequency would normally be selected so that it is optimum for incremental motion in the X direction. In the example presented here a 16-by-16-address grid is employed. Other choices would be relatively easy to implement by cascading counters and/or changing the max-min address testing.

Briefly, the circuit functions as follows. Switch SW is

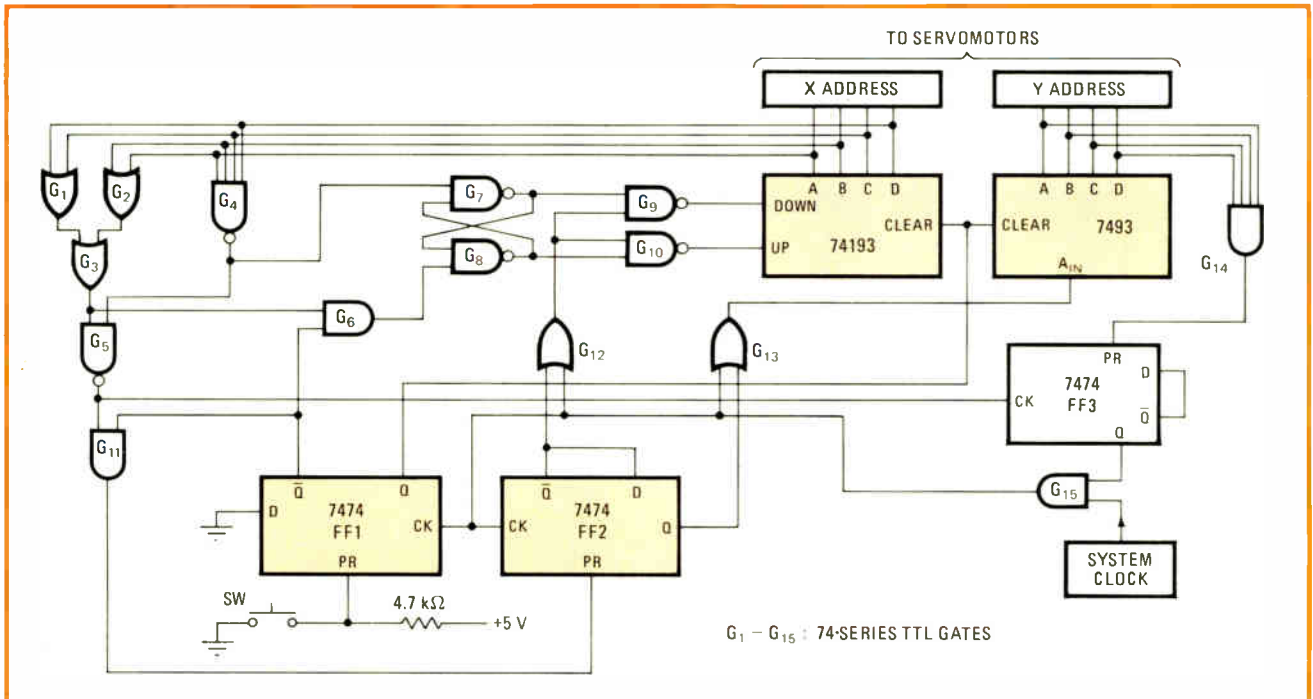

2. **Scan-control logic.** Logic circuit for alternating-direction incremental scanner uses 74-series TTL gates, flip-flops, and counters. Flip-flops are triggered by rising pulse edges, and counters by falling edges. Count pulses could drive stepping-motor controllers directly.

depressed. This sets all counters to zero, presets the three D-type positive-edge-triggered flip-flops (7474), and initializes the R-S flip-flop composed of gates G_7 and G_8 . Note that the output of G_{14} is low; therefore clock pulses are passed freely through G_{15} . The first rising edge on the clock stream to occur after SW is released triggers flip-flop FF₁, thus enabling the X and Y counters and G_6 . Gate G_{11} is now irreversibly enabled so that the end-of-line test performed by gates G_1 – G_4 directly controls the PRESET function of FF₂.

As can be seen in the timing diagram (Fig. 3), the output of G_{11} rises for a half cycle because G_5 is initially high. However, the clock pulse has preceded this event by an interval equal to the propagation delay of FF₁. Therefore FF₂ does not toggle, and its Q output remains at logic 1.

Subsequent negative clock edges are passed through G_{12} and G_{10} , causing the X address to increment steadily. The timing diagram indicates the sequence of events as the end of the first line is reached. A final negative clock edge causes a count of 15 to be achieved. The output of G_4 immediately goes low, toggling G_7/G_8 . As a result G_9 is enabled and G_{10} disabled, while the outputs of G_5 and G_{11} rise, enabling FF₂. A half cycle later, the rising clock-edge toggles FF₂, enabling G_{13} and disabling G_{12} . The next falling edge increments the Y address without affecting the X counter. Following this a positive edge again toggles FF₂, this time closing G_{13} but opening G_{12} . The X address now will decrement steadily until a zero count is reached, when a similar logical sequence will route a clock pulse to Y and prepare G_7/G_8 for upcounting. (Note that FF₂ can be toggled by the clock pulses only when the output of G_5 is high—that is, when either a minimum or maximum X address is obtained.)

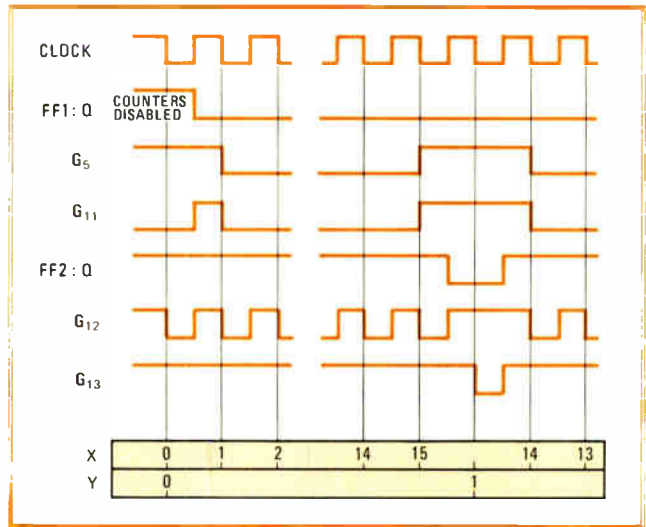

3. Pulse sequences. Timing diagram shows output states of selected gates and flip-flops in circuit that produces back-and-forth scanning, and the X and Y addresses that control servomotors.

When the fifteenth Y increment occurs, G_{14} goes high and enables FF₃. From the timing diagram it can be seen that G_5 will already be high at this moment. FF₃ does not change state until the next rising edge is applied to its clock input, at the completion of the last horizontal scan. A final falling clock edge causes G_5 to go high, toggling FF₃ and disabling G_{15} so that no further clock pulses reach the rest of the circuit. The X and Y addresses are thus frozen at this terminal count.

Once SW is released, the entire scan proceeds automatically and halts at the final address. Logging an entire image therefore requires no attention from the operator. □

Large hexadecimal display is legible from afar

by A. J. Bryant

Manico Electronics Ltd., Winnipeg, Manitoba

Better visibility and a wider range of alphanumeric characters result when the seven segments standard in light-emitting-diode displays are made up of two LEDs each and multiplexed with six other LEDs. The arrangement of 20 discrete LEDs described here provides 1.5-inch numerals and letters that can be read from 30 feet away with clear distinction between such "twins" as 0 and D.

The display can be particularly useful in micro-processor applications in process and machine controllers, where hexadecimal numbers representing steps or parameters must be clearly visible from distances of 10 feet or more. Commercial displays do not meet this need. The numbers 0–9 plus the letters A–F represent

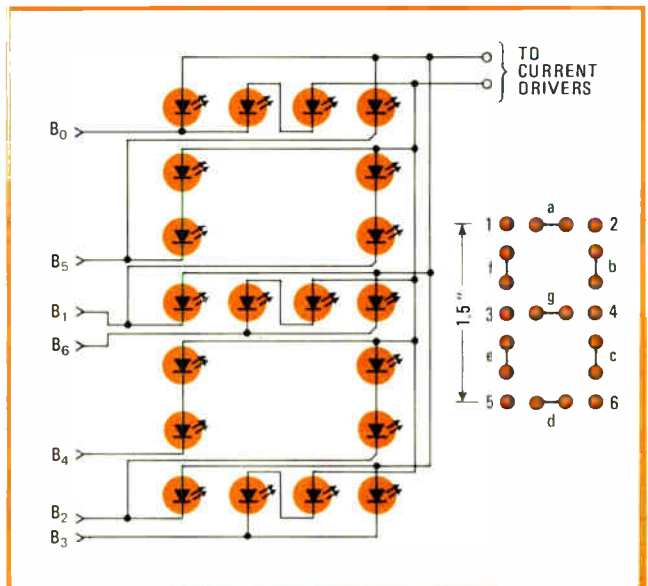

1. Really big show. Twenty light-emitting diodes arranged in a 1/8-inch-by-1 1/2-inch array display any symbol in the hexadecimal number system. This display can be read at distances as great as 30 feet.

the quantities 0–15 in hexadecimal notation.

Figure 1 shows the 20 LEDs in a 4-by-7 array. There are seven segments made up of two diodes in series and six individual diodes; the two-diode segments are labeled a, b, . . . g, as in any seven-segment display, and the six individual diodes are labeled 1, 2, . . . 6. The 13 different current paths that these segments and individual diodes provide are controlled by the outputs of a read-only memory and an on/off multiplexing voltage. So only two current drivers are required.

When a character is displayed, the multiplexing voltage causes the appropriate segments and then the appropriate individual diodes to light, but they go on and off so quickly that they appear to be on continuously.

Figure 2 shows the display-circuit arrangement and the program of the ROM. If the symbol B is to be displayed, then all of the segment LEDs and individual diodes 1, 3, and 5 must light. The program shows that for the letter B, all of the segments are 0s (low voltage). When the on/off multiplexing signal is 0, the inverter puts high voltage on the segments and they all light.

When the multiplexing signal is a 1, high voltage is applied to all of the individual diodes. The cathodes of 1, 3, and 5 have been grounded by the ROM, so those diodes light up; but the cathodes of 2, 4, and 6 are held high, so they do not light.

For representation of the hex B, the binary ROM inputs to A₃, A₂, A₁, and A₀ are 1011, and A₄ is 0 for the segments and 1 for the individual diodes. Thus the memory chip is programmed so that input 01011 produces outputs 0000000 on B₆ . . . B₀, and input 11011 produces 1111000. Note that output B₇ is not used.

To provide a more even distribution of light in the multiplex mode, different current drivers can be used for the segment line and for the line to the individual diodes, or the duty cycle of the on/off signal can be changed. Most available ROMs can sink the current required by the LEDs, but a buffer may be required, depending upon the specific combination. □

Engineer's Notebook is a regular feature in Electronics. We invite readers to submit original design shortcuts, calculation aids, measurement and test techniques, and other ideas for saving engineering time or cost. We'll pay \$50 for each item published.

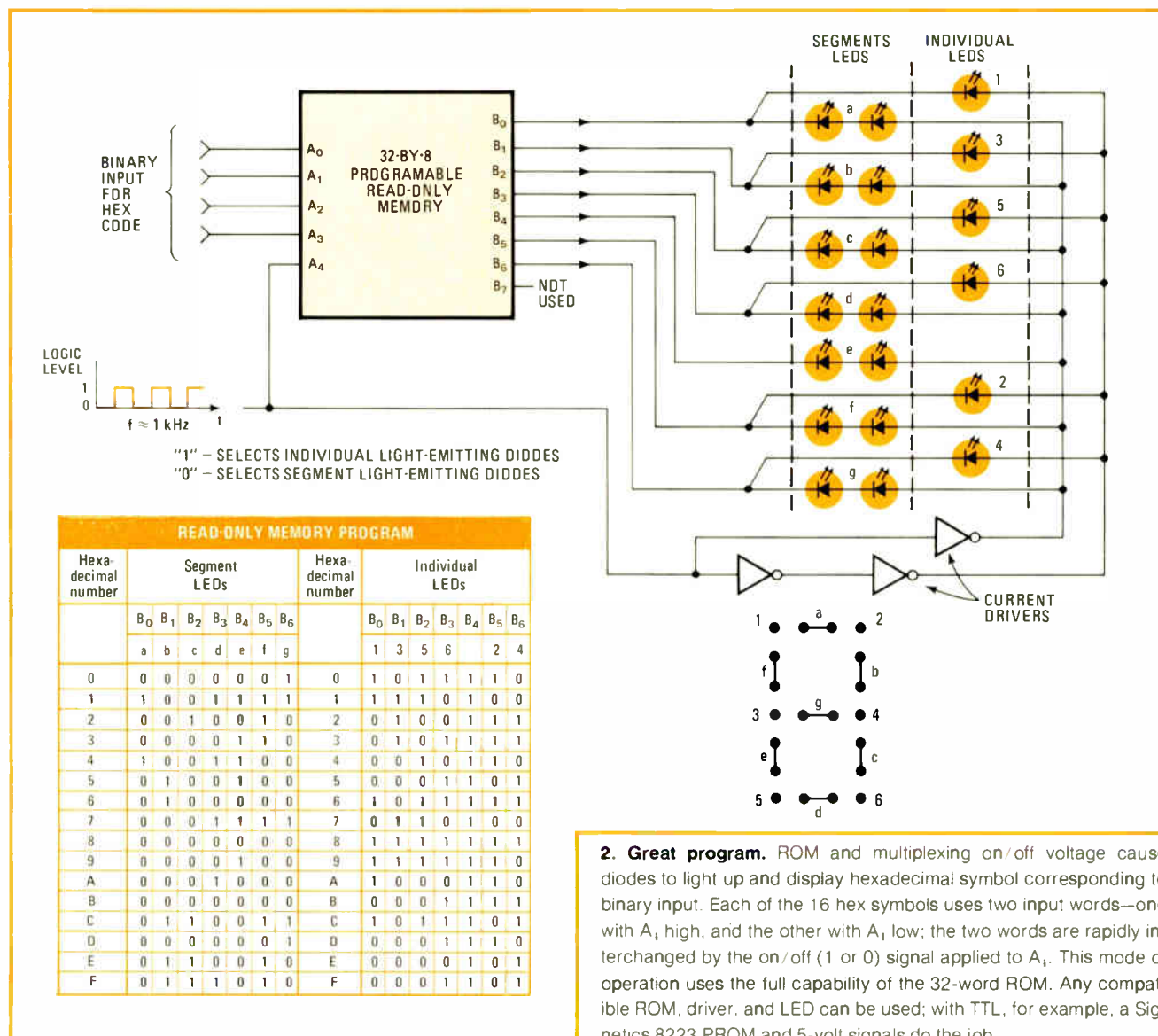

2. Great program. ROM and multiplexing on/off voltage cause diodes to light up and display hexadecimal symbol corresponding to binary input. Each of the 16 hex symbols uses two input words—one with A₁ high, and the other with A₁ low; the two words are rapidly interchanged by the on/off (1 or 0) signal applied to A₁. This mode of operation uses the full capability of the 32-word ROM. Any compatible ROM, driver, and LED can be used; with TTL, for example, a Signetics 8223 PROM and 5-volt signals do the job.



The keyboard switch with a heart of gold

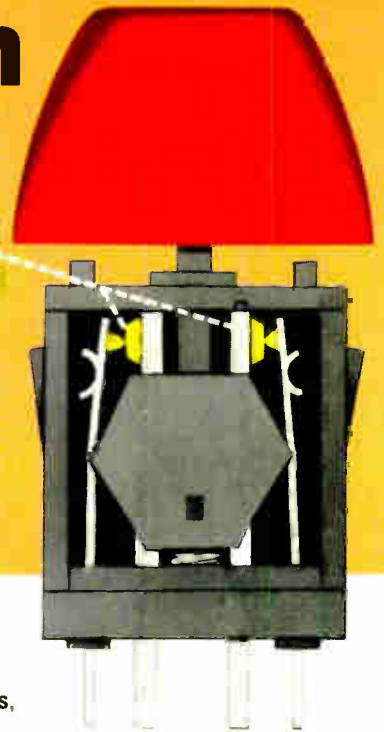

...keeps your product WORKING year after year...after year.

In your keyboard or ours, Cherry key switches just don't fail. The knife-edge contact area is so small (9 millionths of a square inch) ... the contact pressure so great (about 5,000 psi) ... the gold alloy so pure and firm-free ... that you are assured of positive contact every time. For 50 million operations and beyond. (Which is probably beyond the life expectancy of your product!)

Cherry "heart of gold" keyboard switches are available individually or with two-shot molded keycaps. Hopefully, you want keycaps. Because, *we have keycaps* ... in more legends, sizes, type faces than you're likely to find anywhere else. Sculptured keycaps? We've got 'em. Gloss or matte finish? We've got *both*. Colors? Lighted? Specials? Sure! Some "off the shelf" ... all at prices that make it obvious why the *Cherry way* is the *economical way* to put a heart of gold in any keyboard.



For free test sample switch and catalog, just TWX 910-235-1572 or PHONE 312-689-7700

CHERRY



CHERRY ELECTRICAL PRODUCTS CORP., 3608 Sunset Avenue, Waukegan, IL 60085

Cherry switches now available locally from distributors.

Circle 131 on reader service card

Thermal jacket aids some pc-board tests

There's an easy way to test circuit boards functionally at high or low temperatures, says Suzanne Jenniches, project engineer, Westinghouse Defense and Electronics Systems Center, Baltimore, Md. Speaking at the Westinghouse Machine Tool Forum, she suggested building a thermal jacket. You sandwich the board between the halves of a metal jacket that is filled with a nonconductive foam like polyurethane (but do make sure that the board's edge connector extends outside the jacket). Place the assembly inside the thermal chamber, and let it soak for an hour at the desired temperature. Then pull it out and plug it into the interface used for ambient testing. **The jacket will maintain the temperature with less than 1°C drift for 3 to 5 minutes**—more than ample time, she says, since most automatic functional tests are over in 20 seconds or less.

Flux estimates for magnetic shields need tripling

When designing magnetic shields, most engineers estimate the flux exposure to the shield and calculate shielding attenuation using the shield's B-H curve. But even though the calculations are correct, the shield may not produce the anticipated result, cautions Richard D. Vance, president for Ad-Vance Magnetics Inc. Tests in his firm's labs show that **attenuation resulting from the shield varies with the shield's orientation and often deviates from the calculated value by a factor of two or three**. He therefore suggests using triple the flux density in calculations to yield a more acceptable correlation.

More information on this anomaly is in the company's new catalog, more than half of which is devoted to engineering aids, calculation assists, typical solutions, and reference data. Write Ad-Vance Magnetics Inc., Rochester, Ind. 46975.

LEDs can survive in 120-V ac circuits

A light-emitting diode can be made to operate directly in a 120-volt ac circuit, says Alan R. Miller of New Mexico Institute of Mining and Technology. You must **place a 1N1461 rectifier across the LED (but with reverse polarity) to guard against destructive reverse voltage**, and you must also put a capacitor of about half a microfarad in series with the parallel diodes to limit the LED forward current to a safe 20 milliamperes without consuming appreciable power. The capacitor must be nonpolar and be rated for at least 200 volts.

How to keep that idle iron cool but not too cool

"I used the series rectifier arrangement to hold idling soldering irons cooler [*Electronics*, Dec. 11, 1975, p. 120], but I was not quite satisfied—the copper tip cooled too much with the rectified current," writes G. Lohrmann of Zurich, Switzerland. (Remember—the rectifier was connected in series with the soldering iron and a shorting switch was connected across the rectifier to bring the iron up to operating temperature when necessary.) But with a zener diode in place of the rectifier, he says, **current flows fully in one direction and partially in the other, keeping the iron warmer**. For 120-v lines, a zener with about 72 to 82 V breakdown is adequate, he adds.

—Stephen E. Scrupski

Design with the complete flat cable/connector system.

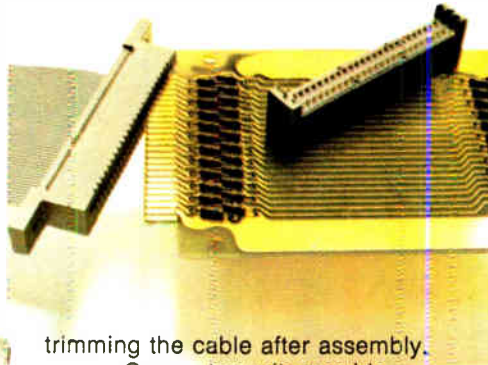

trimming the cable after assembly.

Connector units provide positive alignment with precisely spaced conductors in 3M's flat, flexible PVC cable. The connector contacts strip through the insulation, capture the conductor, and provide a gas-tight pressure connection.

With cable, connectors and assembly tools from one design and manufacturing source, you have added assurance the connection will be made surely, with no shorts or "opens."

And "Scotchflex" now offers you more design freedom than ever. From stock you can choose shielded and non-shielded 24-30 AWG cable with 10 to 50 conductors, and an ever-increasing variety of more than

The 3M DELTA pin and socket connector.

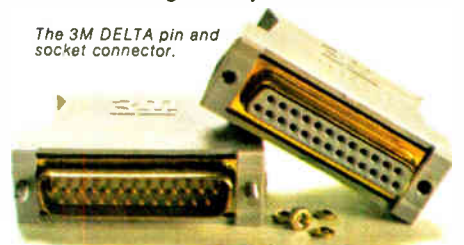

Assembly-cost savings are built in when you design a package with "Scotchflex" flat cable and connectors. But more important, 3M Company offers you the full reliability of a one-source system: cable *plus* connectors *plus* the inexpensive assembly aids that crimp the connections quickly and securely (with no special operator training required).

The fast, simple "Scotchflex" assembly sequence makes as many as 50 simultaneous multiple connections in seconds, without stripping, soldering or

100 connectors to interface with standard DIP sockets, wrap posts on standard grid patterns, printed circuit boards, or headers for de-pluggable applications. 3M's DELTA "D" type pin and socket connectors are now also available. For full information, write Dept. EAH-1, 3M Center, St. Paul, MN 55101.

3M
COMPANY

See our catalog in EEM 2-1034.

3M's "Scotchflex" line.

"Scotchflex" is a registered trademark of 3M Co.

EDWARD
ROBERTS
PRIME SOURCE FOR
FANS AND BLOWERS

only HOWARD

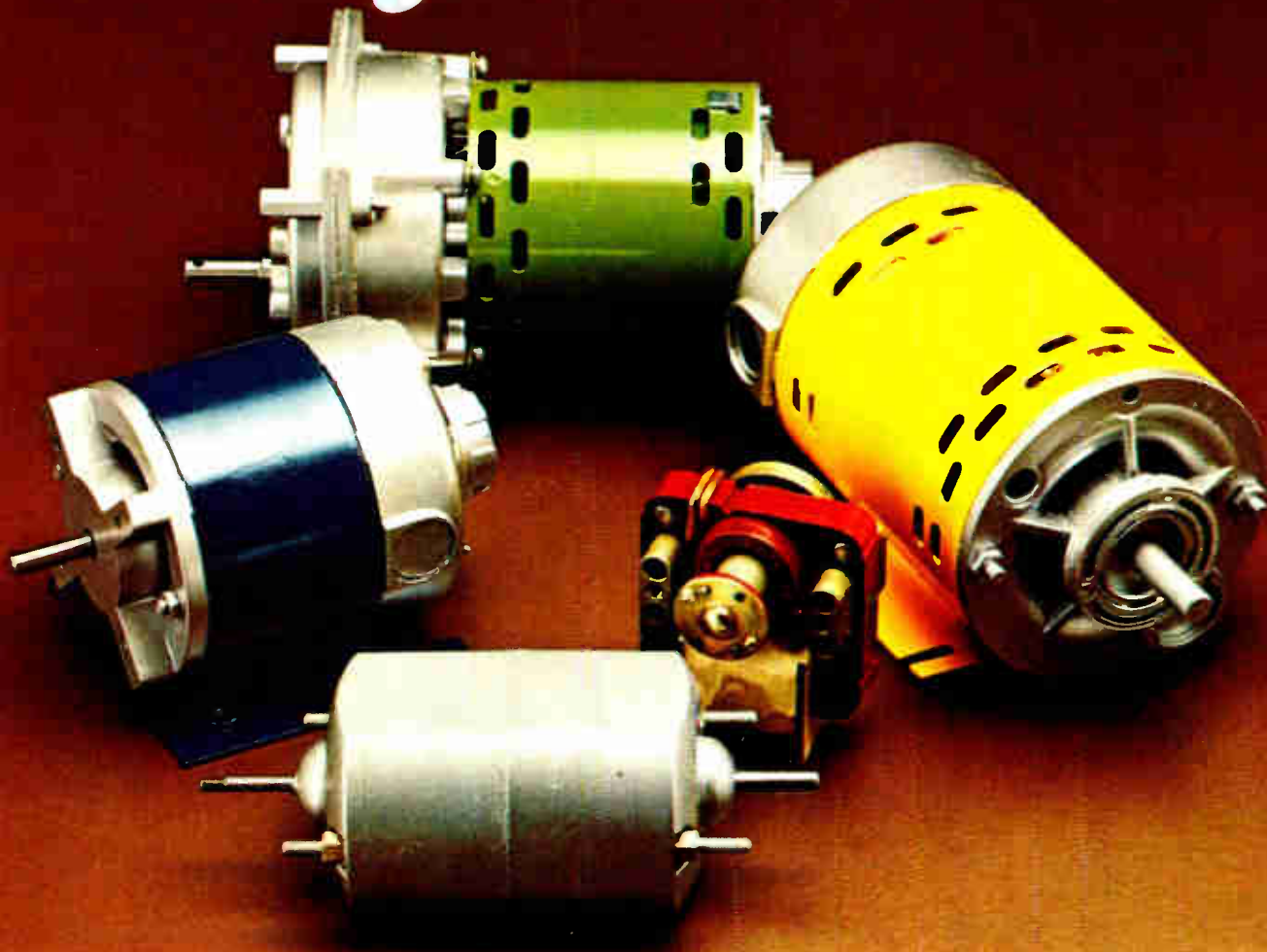

And Howard also tries harder to make your job as easy as possible. No "take-it-the-way-we-make-it" reaction to your product problem. We'll modify our motors, fans and blowers to eliminate your design problems. See why more and more major companies are selecting Howard as another prime source?

Howard offers Universal/DC, Induction or Shaded Pole FHP motors/gearmotors—each one engineered to your specs. Some of the most successful (and demanding) firms in the nation—companies like IBM, XEROX, WESTERN ELECTRIC, 3M and MC GRAW-EDISON have found Howard's personalized service suits them just fine.

WRITE FOR HOWARD'S NEWEST
FHP MOTOR/GEARMOTOR CATALOG NOW.

Circle 134 on reader service card

has 'em all!



Howard's got a full line of fans and blowers. Fans that are interchangeable with those you are now using—yet deliver the same amount of air with from 2 to 3 db less noise! Fans and blowers that will fit your product—at a low price that may surprise you. SEND FOR OUR NEW FAN/BLOWER CATALOG TODAY.

HOWARD

Circle 135 on reader service card

HOWARD INDUSTRIES
One North Dixie Highway, Milford, Illinois 60952
Phone: (815) 889-4105

World Radio History

HOWARD REPRESENTATIVES

ARIZONA Phoenix
The Thorson Company (602) 956-5300
CALIFORNIA Los Angeles
TechRep Associates (213) 641-5830
San Francisco
Richards & Associates (408) 246-5860
CANADA Toronto
Connectral, Inc. (416) 449-8784
COLORADO Denver
The Thorson Company (303) 759-0809
CONNECTICUT Torrington
Motoreps of New England (203) 482-3193
(203) 489-9084
FLORIDA Tampa
Tech-Rep Associates, Inc. (813) 595-2834
ILLINOIS Chicago
K M G Sales Company (312) 437-5815
MINNESOTA Minneapolis
T. H. Ayre Associates, Inc. (612) 474-4125
MISSOURI St. Louis
Lawton Sales Company (314) 725-1330
NEW JERSEY Red Bank
Motoreps of New York (201) 741-3356
NORTH CAROLINA Cary
Electrical Systems Co. (919) 467-0831
OHIO Dayton
Electrical Systems Co. (513) 434-9822
TEXAS Dallas
The Thorson Company (214) 233-5744
Houston
The Thorson Company (713) 771-3504
WASHINGTON Seattle
The Thorson Company (206) 455-9180
WISCONSIN Racine
K M G Sales Company (414) 639-9005

HOWARD DISTRIBUTORS

CALIFORNIA Torrance
Airsupply Company (213) 538-5080
Inglewood
Force Electronics (213) 776-1324
Mountain View
Elmar Electronics (415) 961-3611
Sun Valley
Richey Electronics Inc. (213) 768-3800
(213) 875-2862
San Diego
Richey Electronics Inc. (714) 565-4444
Burlingame
Rose Electronics (415) 697-0224
CANADA Montreal
Cesco Electronics, Ltd. (514) 735-5511
Vallier
Cesco Electronics, Ltd. (418) 524-4641
Ottawa
Cesco Electronics, Ltd. (613) 729-5118
Toronto
Cesco Electronics, Ltd. (416) 661-0020
Vancouver
Intek Electronics, Ltd. (604) 324-6831
COLORADO Denver
Integrated Electronics (303) 534-6121
FLORIDA Largo
Tech-Sales (813) 595-2834
ILLINOIS Westmont
Bodell Co., Inc. (312) 323-9670
GEORGIA Atlanta
Electro-Air (404) 351-3545
KANSAS Wichita
Radio Supply Company (316) 267-5213
MARYLAND Baltimore
Radio Electric Service Co. (301) 823-0070
Beltsville
Resco-Washington (301) 937-5890
MASSACHUSETTS Cambridge
Apollo Electronics, Inc. (617) 868-3120
North Billerica
Pacer Electronics (617) 862-3300
(617) 667-8383
MINNESOTA St. Paul
Gopher Electronics (612) 645-0241
Minneapolis
The Joel Company (612) 545-5669
NEW YORK E. Farmingdale
Harrison Radio Corp. (516) 293-7990
Buffalo
Standard Electronics, Inc. (716) 685-4330
NEW JERSEY Hanover
States Electronics Parts Corp.
(201) 887-2550
NORTH CAROLINA Raleigh
Radio Electric Service Co. (919) 832-2077
OKLAHOMA Tulsa
Component Specialties, Inc. (918) 664-2820
OHIO Cleveland
W. M. Pattison Company (216) 441-3000
Dayton
Esco, Inc. (513) 226-1133
PENNSYLVANIA Philadelphia
Almo Electronics (215) 698-4000
Philadelphia
Herbach & Rademan Inc. (215) 426-1700
TEXAS Houston
City Electronic Supply (713) 621-1060
Dallas
Component Specialties, Inc. (214) 357-4576
Houston
Component Specialties, Inc. (713) 771-7237
Austin
Component Specialties, Inc. (512) 459-3307
Stafford
Southwest Electronics, Inc. (713) 494-6021
Richardson
Southwest Electronics, Inc. (214) 234-3050
UTAH Salt Lake City
Diplomat/Alta-Land, Inc. (801) 486-7227
WASHINGTON Seattle
Radar Electric Co., Inc. (206) 282-2511
WISCONSIN Racine, Triplex (414) 633-8226

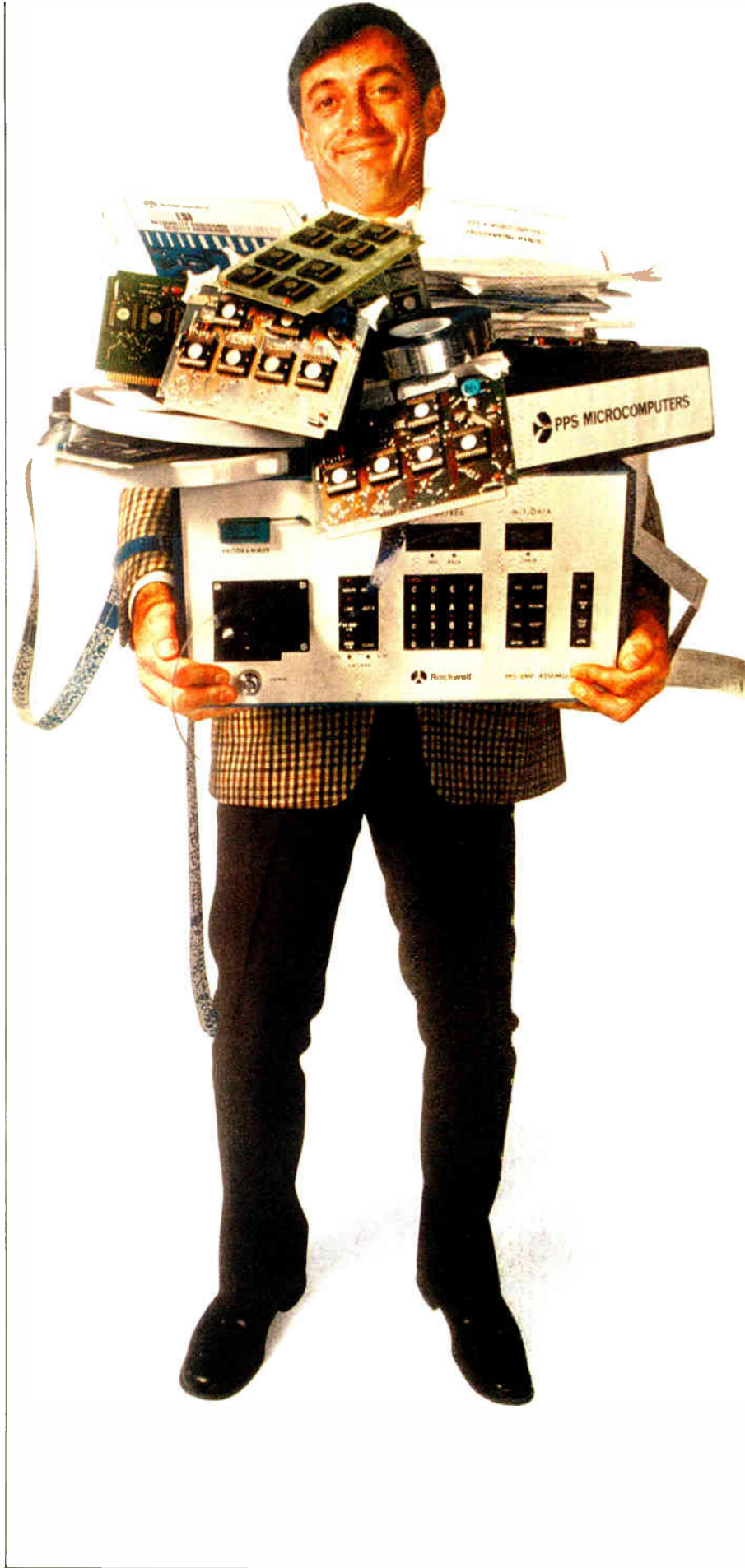

Rockwell is support for

SOFTWARE

At Rockwell, we've been designing software for equipment based on programmable MOS-LSI CPU's since 1967. (During 1975, we shipped our 1,000,000th microcomputer!)

Because of this experience, the assembly/simulation programs we offer for our modern parallel processing system (PPS) microprocessors are powerful, seasoned, debugged and practical.

HARDWARE



For your own computer, you can purchase our assembly/simulation programs in Fortran IV, or you can use them via time-sharing networks.

But computer or not, the design aids we think you'll use most are our Assemblators—microcomputers equipped with our assembly/simulation programs.

They're designed to rapidly translate your equipment specs into powerful, multi-function PPS instruction codes.

there with system your microcomputer development.

Assemblators also serve you in debugging software by examining CPU, I/O or memory address registers by the bit; in real-time software check-out of systems with peripherals; and in generating your PROM and, finally, ROM masked codes. You can emulate any chip in your system board. And you can even use our Assemblators to test our devices or boards during your incoming inspection.

And best of all, our Assemblators cost far less than a good oscilloscope.

Finally, of course, Rockwell offers you all the evaluation boards you need for prototype development, plus comprehensive, easily understood technical literature and manuals.



BRAINWARE

Our applications engineers all have backgrounds in software and system design. They're ready to help you

with specific answers to your microcomputer development questions. They're as near as your telephone.



Real Seminars

Better yet, you can meet them in person at one of our designers' seminars where you'll receive intensive training, in small classes, from instructors dedicated to teaching you software design skills.

PARALLEL PROCESSING ENDS DESIGNERS' NIGHTMARES.

In our parallel processing system micro-computers, the CPU synchronously executes overall processing and control while independently intelligent LSI I/Os control peripherals. This means that, when you change or add a peripheral in your

design, you need redo only a portion of your software—not the whole program—and your overall program is smaller to begin with.

**Support
is
wherever
you are.**



Rockwell support is as close as your phone. It starts with your first call to our distributors — Hamilton /Avnet or Schweber — or to our home office. Rockwell representatives are also available locally. For addresses, write or phone: Microelectronic Device Div. Rockwell International P.O. Box 3669 Anaheim, California 92803 (714) 632-3729



Rockwell International

...where science gets down to business

IT'S NOT
JUST
ANOTHER
PRETTY
INTER-
FACE.

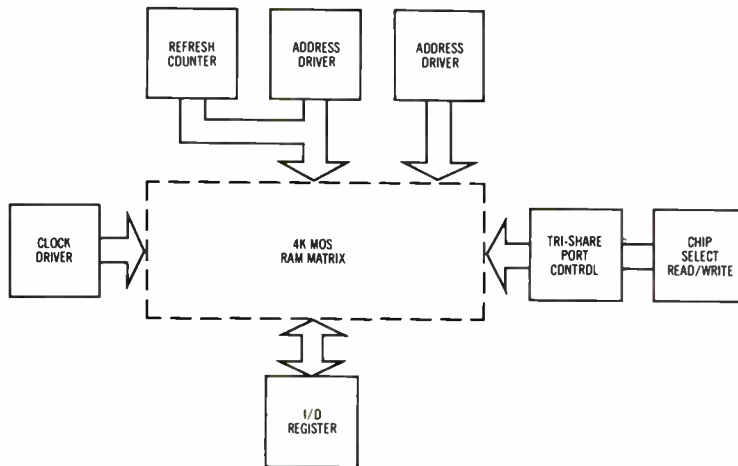

Look no further. Our RAM Interface Circuits solve memory design problems. And when we say solve, we mean solve.

Our Interface Circuits offer Schottky technology, PNP inputs, TTL/DTL compatibility, fall-through latch design, and more.

You can use them with 16, 18 or 22 pin RAMS and they're designed specifically to satisfy memory circuit drive requirements.

This diagram says it better than any words can. And if the diagram turns you on then you'll love our 12-page booklet. Yours merely for the asking or the writing.

National Semiconductor Corporation EE10
 2900 Semiconductor Dr., Santa Clara, CA 95051

Gentlemen:
 Send me your book on RAM Interface Circuits.

NAME _____ TITLE _____
 COMPANY _____
 ADDRESS _____
 CITY _____ STATE _____ ZIP _____

National Semiconductor 

What price Zeiss?

The small Epi-Microscope is the best buy anywhere...

... and, for the other five microscopes shown here, too, the price depends entirely on your needs. Whether production line, industrial research, or quality control, Zeiss quality and features always add up to true economy. Zeiss microscopes do more now, can be expanded to do more later, never become obsolete. The Zeiss range of optics and accessories is unequaled.

1. Epi-Microscope. A small and versatile upright incident-light microscope for production, QC and R/D. Rugged and sturdy. Can be mounted on various stands, or attached to machinery in the shop. Switches instantly from brightfield (for regular surface examination) to darkfield (to detect scratches, dirt, small de-

fects). Nomarski interference contrast makes minutest elevation differences stand out. Accepts cameras and TV attachments. Best buy on the market. **Reader service number 156.**

2. Standard KK-08—the Semi-Conductor Microscope. Features Epi-Nomarski optics at production-line cost. Makes it easy to spot pinholes, stacking faults, alignment errors, etching problems, bonding defects, mechanical damages, and many minute irregularities not detectable with any other light microscope technique. 3 x 3" stage with stainless steel plate makes loading and unloading rapid and easy. Can be expanded for research with wide range of accessories, also for photomicrography. **Reader service number 157.**

3. Invertoscope M. The smallest, most compact metallographic microscope. Ideal for fast, routine examinations. Yet has great optical features found in our larger microscopes. Excellent for brightfield and microscopy in polarized light and Nomarski interference contrast, even with Glarex projection screen. Great stability, low price. **Reader service number 158.**

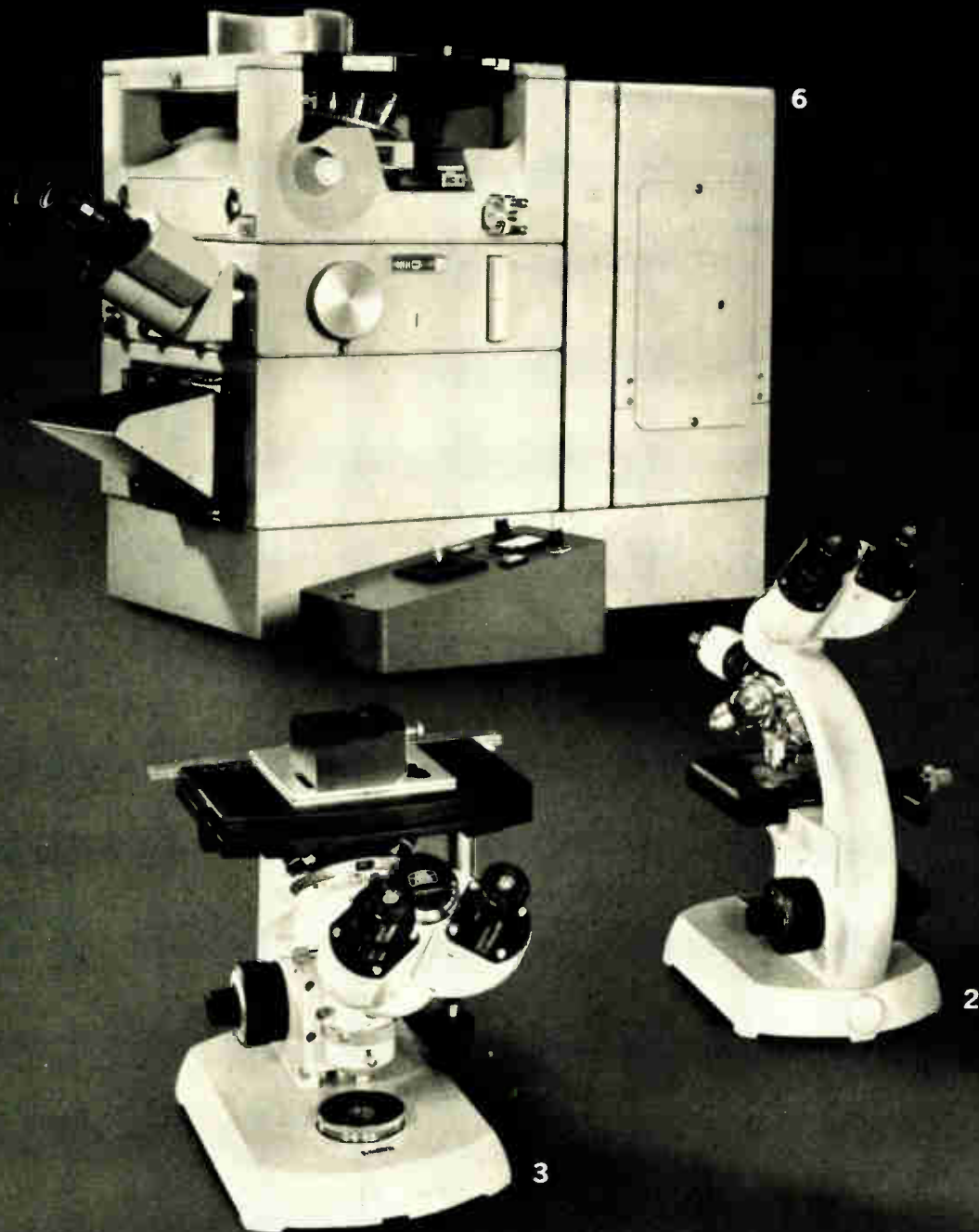

4. Universal Microscope. Recognized as the most universal microscope. With fully interchangeable optics and components for all microscope techniques in reflected and transmitted light, including UV. Accepts all accessories and camera formats, including TV and projection screen. With automatic scanning stage, ideal for photometry and quantitative stereometric image analysis. **Reader service number 159.**

5. Ultraphot IIIB with fully integrated, fully automatic camera systems for 4 x 5" and 35mm, and correct exposure reading from the center of the image field. For all microscope techniques in transmitted and reflected light. Continuous magnification from 2.5x to the limits of light microscopy. Holds 3 lamp housings simultaneously; the flip of a lever selects the illumination source and mode. Ideal for grain-size determinations by either micrometer eyepieces or projector. **Reader service number 160.**

6. Axiomat—a revolutionary modular microscope system. The finest, most stable metallograph ever made. Newly com-

puted optics, topped by a new Epiplanapochromat 125/1.6 with highest resolution ever achieved. Extreme widefield, and built-in zoom system for easy magnification change to the limits of light microscopy. All standard ASTM magnifications. Exceptionally large stage (8 x 17"). Stages remain stationary for utmost stability while focusing is done by moving the objectives — also remote-controlled. Two fully integrated, fully automatic camera systems. Quantitative image analysis by photometer or TV. Modular concept permits different assembly of modules, also for upright microscopy. **Reader service number 161.**

For details write Carl Zeiss Inc., 444 5th Avenue, New York, N. Y. 10018. Or phone (212) 736-6070.

In Canada: 45 Valleybrook Drive, Don Mills, Ont., M3B 2S6. Or phone (416) 449-4660.

Nationwide service

BRANCH OFFICES: BOSTON, CHICAGO, COLUMBUS, HOUSTON, LOS ANGELES, SAN FRANCISCO, WASHINGTON, D. C.

ZEISS

THE GREAT NAME IN OPTICS



WEST GERMANY

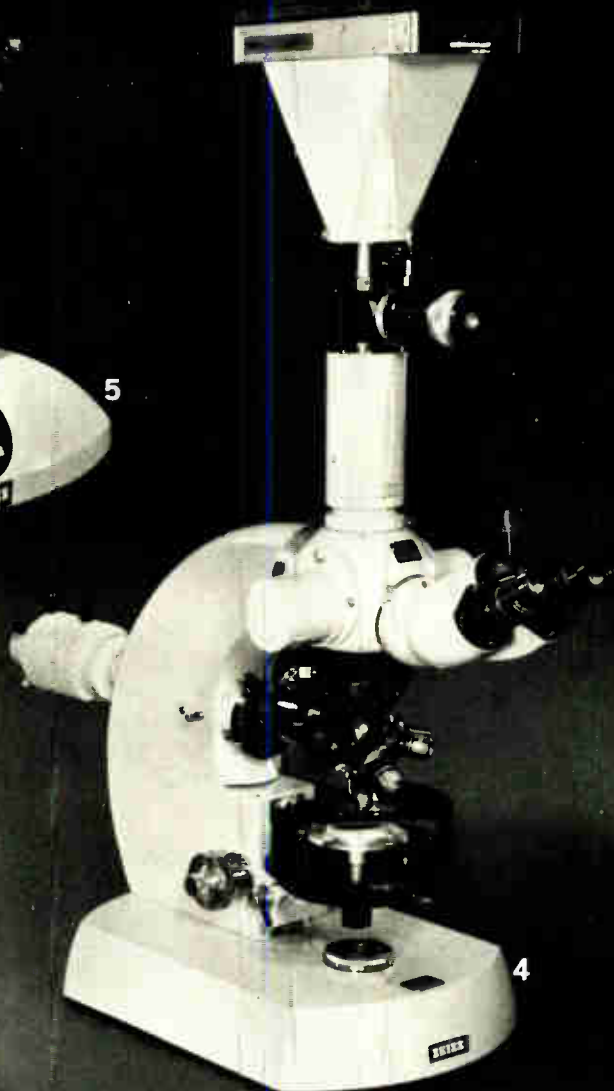
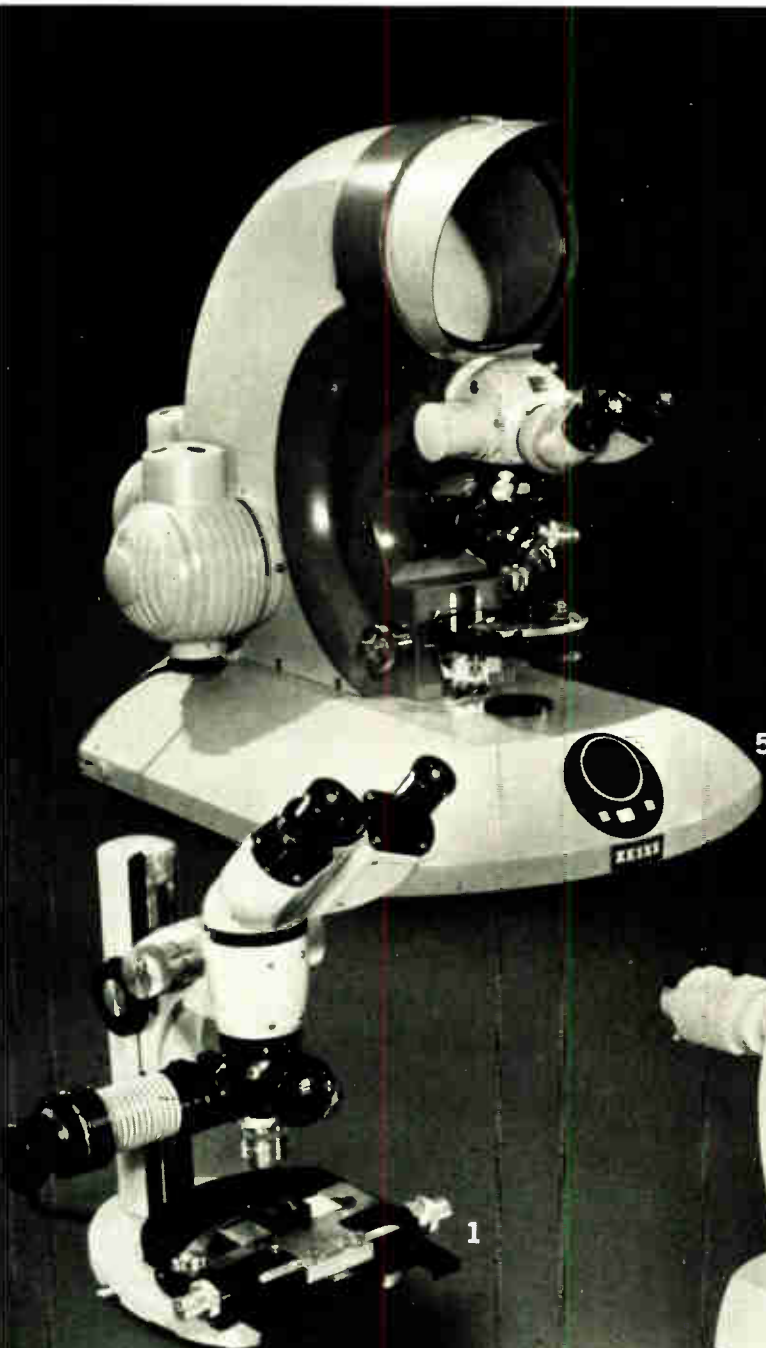

64 crosspoint Self-latching reed matrix

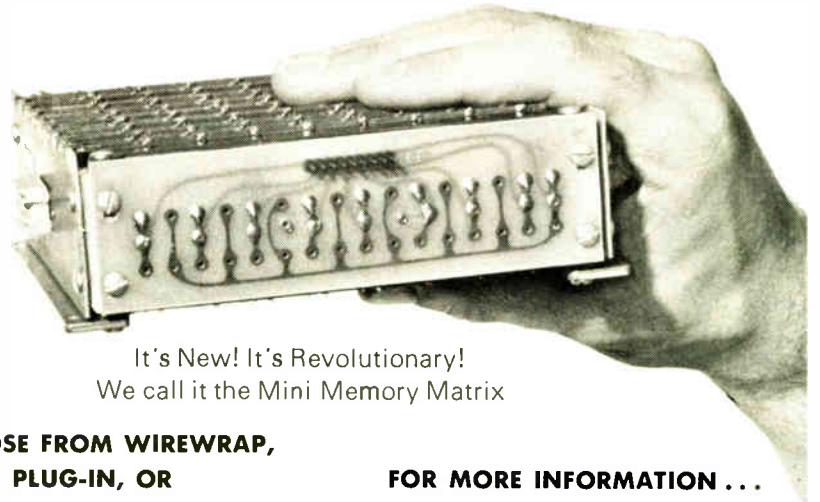

It's New! It's Revolutionary!
We call it the Mini Memory Matrix

CLARE'S NEW MINI MEMORY MATRIX OFFERS A PACKAGING SELECTION THAT STRETCHES THE IMAGINATION.

Four compact packaging formats offer engineers real flexibility in creating multi-pole switching arrays for telecommunications, process controls and automatic test equipment systems. The basic 64-crosspoint switching module is built around Clare's durable magnetic self-latching dry reed switch capsule. With Rhodium-plated contacts insuring several million operations.

IT REMEMBERS. IT ERASES.

The multiple crosspoint coils are uniquely interconnected to provide coincident selection paths. Simultaneous current pulses on the X and Y axes address the crosspoints. A new selection automatically erases the previous selection. Dielectric spacing inhibits crosstalk while providing a stand-off rating at 600 Vdc on standard models, 800 Vdc as an option.

CHOOSE FROM WIREWRAP, CABLE PLUG-IN, OR PCB TERMINALS.

Both the wirewrap and cable plug-in units are available in 2 or 4-pole 8X8 arrays. The PCB unit comes in 2-pole 8X8 and 8X16 arrays.

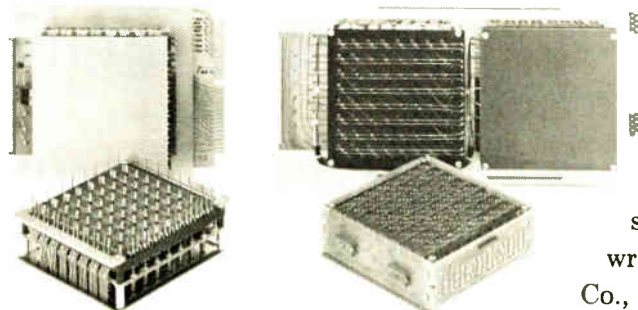

The PCB unit is compatible with conventional pre-wired card cage assembly techniques. The cable plug-in units mate with standard 9-pin in-line socket and 16-pin DIP jack terminations.

FOR MORE INFORMATION . . .

The new 969 Series is certainly worth finding out about. A New Mini Memory Matrix catalog is now available. Also available are two "TAR" (Technical Application Reference) publications: TAR-Clare Mini Memory Matrix and TAR-Clare Self-Latching Dry Reed Relays. For more specific design information, write G. Neeno, C. P. Clare & Co., 3101 W. Pratt Ave., Chicago, Ill. 60645. Phone: (312) 262-7700.

**QUALITY, SERVICE,
RELIABILITY**

C. P. CLARE & COMPANY a subsidiary of
GENERAL INSTRUMENT CORPORATION



new from CLARE

Ion implantation opens another door

National's bipolar FET process used for op amps yields monolithic instrumentation amplifier with J-FET inputs

by Bernard Cole, San Francisco bureau manager

Using the ion-implanted bipolar process it has applied so successfully to operational amplifiers, National Semiconductor Corp. has gone into production on the industry's first monolithic instrumentation amplifier that incorporates junction-FET inputs.

The closest approaches until now to a one-chip op amp combining FETs and bipolar devices have been hybrid devices costing about \$9 each in quantity, says David Whetstone, Bifet product marketing manager at National. What National has achieved with the LF152/252/352, he says, is a single monolithic device measuring 55 by 91 mils that will be priced at about \$5.50 each in similar 100-piece quantities. Compared to existing monolithic instrumentation amplifiers, he says, the LF152 combines the high speed of all bipolar devices with the low power of all complementary-metal-oxide-semiconductor chips. "And of all the existing monolithic instrumentation amplifiers," says Whetstone, "the LF152 is among the lowest in gain nonlinearity error—typically 0.02% to 0.05%."

If standard diffusion techniques had been used to put the high-voltage p-channel junction FETs on the same chip as bipolar transistors, the device would have drifted more than bipolar amplifiers with temperature and voltage. "But because the J-FETs are made by means of ion implantation, there is uniform doping across the wafer," he says, "with the result that matching is very close, with offset voltages typically less than 3 millivolts and offset temperature drift about 5 microvolts per degree centigrade."

High impedance. As a result, the high-accuracy matching gives the J-FET input devices on the LF152 very high input impedances—about 2×10^{12} ohms—and extremely low bias currents—about 3 picoamperes. An internal differential feedback technique gives it a high common-mode rejection—about 100 decibels minimum when gain is set at 100—without going to the expense of color resistor matching, the company points out.

The amplifier gain can be easily adjusted from 1 to 1,000, says Whetstone, by changing the value of a single resistor. The bandwidth and slew rate are also controlled externally, and the sense input and device output are pinned out separately for added versatility and to allow a change of gain without rezeroing. The devices are aimed at microprocessor-based systems in industrial process control and instrumentation.

Bifet switches. Another Bifet family scheduled for release this month is a broad selection of quad analog switches, in which a unique circuit technique maintains a constant resistance over the analog voltage range of +10 volts. The inputs are designed to operate from minimum transistor-transistor-logic levels, says Whetstone, and switch operation also ensures a break-before-make action. Configurations of these single-pole single-throw devices include both two and four normally open and normally closed switches, with and without disable. Advantages over their chief competition—C-MOS units—are no latchup problems for the user and no worry about electrostatic charge.

Other features of the family include small-signal analog signals to 50 megahertz, -50-decibel open switch isolation at 1.0 MHz and about 1-nanoampere leakage current in the off state. Available now, the devices are priced at \$2.85 each in quantities of 100.

National Semiconductor Corp., 2900 Semiconductor Dr., Santa Clara, Calif., 95051 [338]

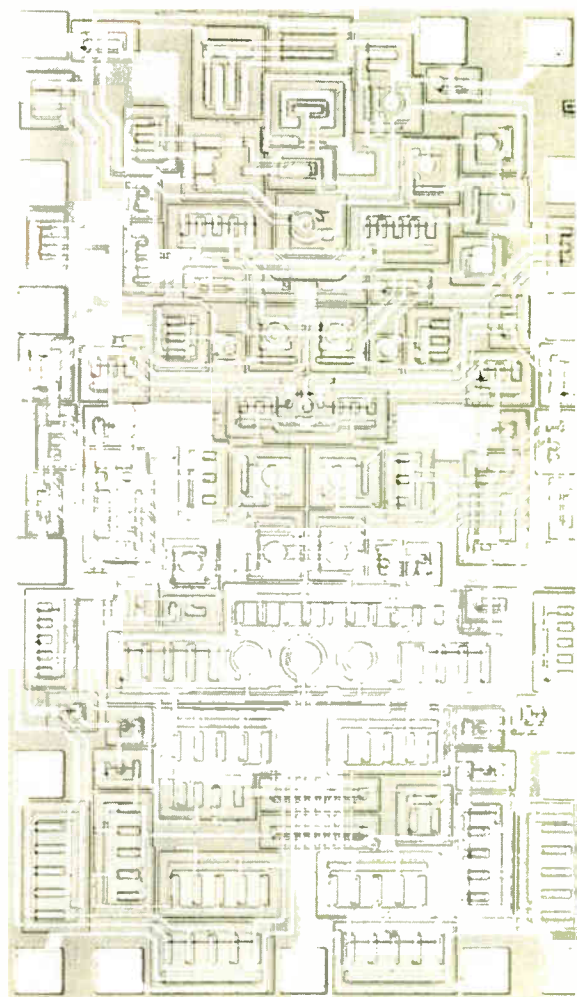

Multimeter packs logic on one chip

Data Precision's 3½-digit model 175 is priced at \$189, features lower range and same 100-microvolt resolution as costlier model 245

by Lawrence Curran, Boston bureau manager

Pack a single CMOS chip with all the logic required for a 3½-digit (2,000-count) multimeter—something that takes six integrated circuits in a 4½-digit instrument with the same resolution—and you can cut costs substantially. That's what Data Precision Corp. has done with its \$189 model 175. For that price, the buyer also gets batteries, a recharger, test leads, and a carrying case [*Electronics*, May 27, p. 35].

Nor has the Wakefield, Mass., firm skimped on the unit's specifications. It handles five ranges of ac and dc voltage and current, plus six ranges of resistance measurements, with a basic accuracy within 0.1% ±1 least significant digit and a full year between calibrations. The 175 brings Data Precision a step down in price from its own 4½-digit model 245 but adds a lower range—100 millivolts full scale—that the 245 lacks, giving the 175 the same 100-microvolt resolution as the 245.

The ac and dc voltage ranges are 100 mv, 1, 10, 100, and 1,000 volts; resistance may be measured from 100 milliohms to 20 megohms in six

full-scale ranges from 100 ohms to 10 megohms, and the ac and dc current ranges are from 100 microamperes to 1,000 milliamperes. The unit is 1¼ inches high, 5½ in. wide, and 3½ in. deep, and comes with an instruction manual and a one-year warranty on parts and labor.

"We're hoping to open a new market for people who don't want to spend more than \$200 for an instrument," says Harold Goldberg, president. He says that among potential customers are manufacturing and field-service personnel who are not trained in sophisticated test techniques. Besides cutting the IC parts count by five from the company's model 245, Goldberg says costs have been cut also because a 0.443-in.-high light-emitting-diode display is used instead of a gas-discharge display, which eliminates the need for a dc-dc converter. Further, use of a ceramic resonator for a clock, instead of an RC feedback oscillator as in the 245, allows greater precision at no increase in cost, he points out.

The unit offers frequency re-

sponse to 50 kilohertz, with accuracy to within 3% at that limit. In current measurements, both dc and ac sensitivity is 100 nanoamperes; in both cases a maximum current of 2 amperes may be read without using external shunts.

The 175 also provides common-mode voltage tolerance of 500 v dc (or peak ac) maximum when connected to an ac power line, or 1,000 V dc (or peak ac) maximum for battery operation. On the resistance ranges, the instrument will withstand 25 v dc or rms ac continuously without losing calibration.

The rechargeable nickel-cadmium batteries will operate for up to six hours without recharging. A low-battery condition is indicated by the decimal point on the display, which blinks continuously some 10 minutes before the battery level will invalidate the reading.

The model 175 will be available within 30 days from the stocks of representatives.

Data Precision Corp., Audubon Rd., Wakefield, Mass. 01880. Phone (617) 246-1600 [339]



The REMEX RFD 1000 — Because It's Versatile. Double or single density with capacity up to 6.4 Mbits... IBM standard or 32 hole hard sectored media without drive modification... IBM compatible or expanded hard and soft sectored formats for application flexibility... Unit select daisy chain capability for maximum controller efficiency... Selectable DC negative voltage for system compatibility... Individual drive housing or two drives horizontally side by side in a 19 inch rack configuration.

The REMEX RFD 1000 — Because It's Reliable. Ceramic head for extended life... Precision machined, die-cast construction... Operator interlock and expandable clutch for media protection... Front panel "head in contact" indicator and optional "head in contact" door lock... Optical write protect to assure data security... Stylus ball lead screw positioning system for long-lived accuracy... Optical track 00 sensing for drive carriage protection.

The Remex RFD 1000 is the RIGHT peripheral from Remex.

This Is The Only Flexible Disk Drive You Will Ever Need

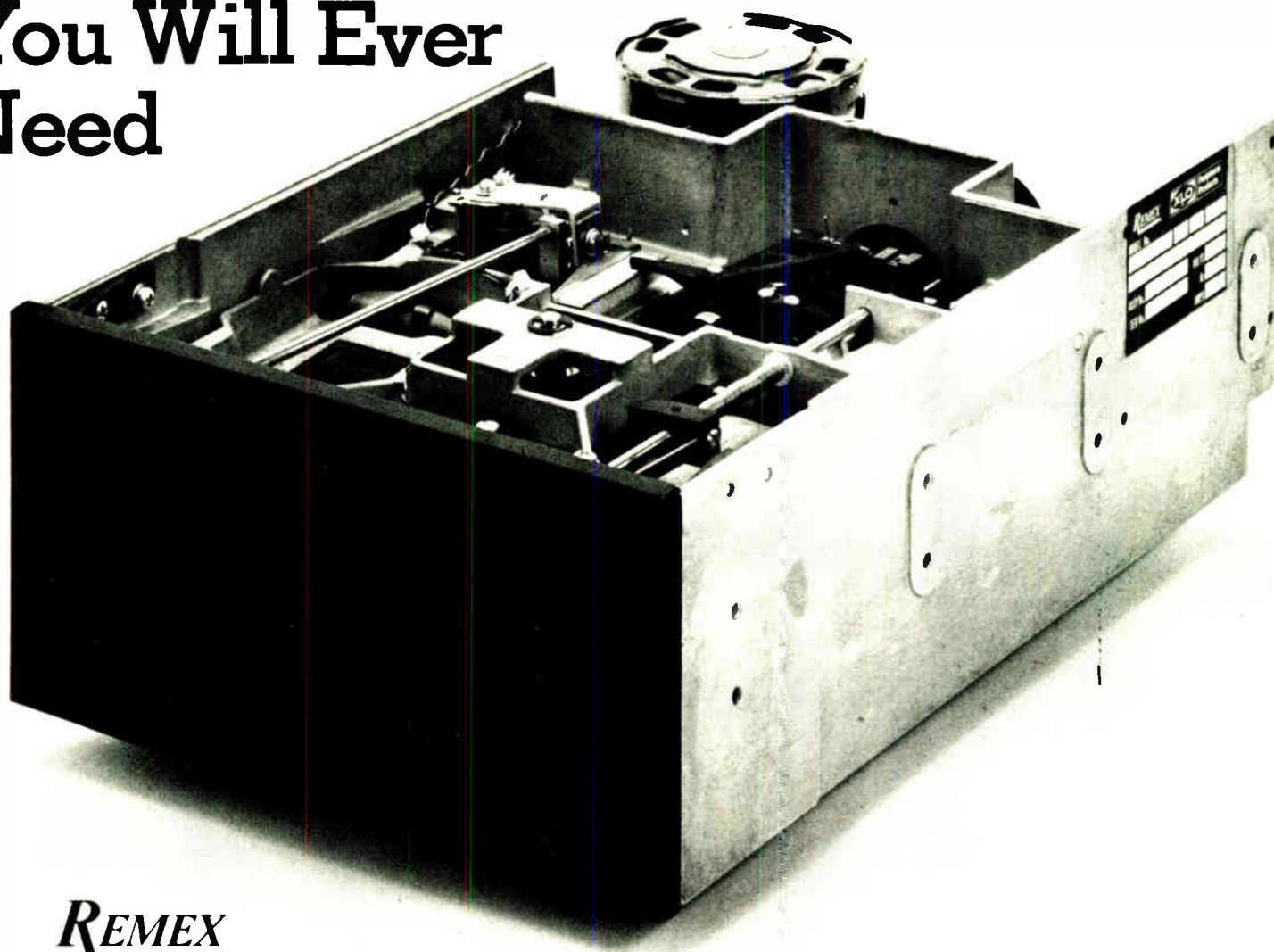

REMEX



**Peripheral
Products**

1733 E. Alton Street, P.O. Box C19533, Irvine, California 92713
(714) 557-6860, TWX (910) 595-1715. In Europe and the U.K.: SpA, Microtecnica
Via Madama Christina 147, Torino, Italy 10126. Circle 145 on reader service card

Ex-Cell-O Corporation

World Radio History

THE NO TRADEOFF 1k x 4 PROM

**If greater bit density,
P. C. board savings and high
reliability are essential
in your PROM design,
and you can't afford
to sacrifice speed, and
you need it now, at the
lowest possible price,
this is your part.**

MMI PROMS

DEVICE	OUTPUT	ORGANI- ZATION	PINS	OPERATING RANGE	MAX ACCESS TIME*	100-999 PRICE
6352/53-1	OC/TS	1024 x 4	18	comm	60 ns	\$15.95
5352/53-1	OC/TS	1024 x 4	18	mil	75 ns	33.50
6340/41-1	OC/TS	512 x 8	24	comm	90 ns	15.95
5340/41-1	OC/TS	512 x 8	24	mil	90 ns	33.50
6305/06-1	OC/TS	512 x 4	16	comm	60 ns	7.00
5305/06-1	OC/TS	512 x 4	16	mil	75 ns	15.95
6300/01-1	OC/TS	256 x 4	16	comm	55 ns	3.25
5300/01-1	OC/TS	256 x 4	16	mil	75 ns	7.90
6330/31-1	OC/TS	32 x 8	16	comm	50 ns	2.55
5330/31-1	OC/TS	32 x 8	16	mil	60 ns	5.00
10149	ECL OE	256 x 4	16	comm	30 ns	17.50

*Access times guaranteed over the full temp range.

For more information call, TWX or write:

United States

Monolithic Memories, Inc.
1165 East Arques Avenue
Sunnyvale, CA 94086
Tel: (408) 739-3535
TWX: 910-339-9229

Europe

Monolithic Memories, GmbH
8000 Munich 80
Mauerkircherstr. 4
West Germany
Tel: (089) 982601, 02, 03, 04
Telex: (841) 524385

Far East

Monolithic Memories, Ltd.
Parkside-Flat Bldg
4-2-2, Sendagaya Shibuya-Ku
Tokyo 151, Japan
Tel: (3) 403-9061
Telex: (781) 26364



Selection.

MMI 1k x 4 PROMs are available in both commercial and military temperature ranges and with open collector or three state output options.

Compatibility.

MMI 1k x 4 PROMs are available in standard 18 pin cerdip and ceramic packages. The MMI 5352-1 series 1k x 4 PROMs are pin and function identical to the Harris HM-7642-5 series, yet the MMI parts are substantially faster.

Second Sourcing.

If only half the companies who have announced this part are able to deliver it, there will still be adequate second sources.

Availability.

MMI 1k x 4 PROMs were the industry first and have been in high volume production for over 9 months.

Speed.

At 60 nsec max over the full commercial temp and voltage variation the MMI 1k x 4 PROMs are the fastest available.

Support.

MMI applications engineers are available for consultation on your particular application. Programming is available at MMI facilities in Sunnyvale, California, Munich, Germany and Tokyo, Japan as well as at MMI distributors worldwide.

Price.

Our PROM prices are always the lowest, not only for 1k x 4 PROMs, but across the board. Check the table against what you're paying elsewhere and prove it to yourself.

Confidence.

MMI started the PROM revolution with the first 1k, 2k and 4k PROMs and is now the world's largest bipolar memory supplier. The Schottky TTL process and nichrome fuse technology have been proven in a host of high volume production programs. Our reputation for high quality parts and on-time delivery is unmatched.

Family.

The MMI 1k x 4 PROM is not an only child. We offer the most complete and competitive line of PROMs available anywhere.

Monolithic Memories, Inc.

New products

Packaging & production

Three gases aid passivation

Low-temperature silicon nitride technique permits higher wafer throughput

Using a three-gas approach, a low-temperature silicon nitride passivation system is ready for production by Applied Materials Inc. Its Plasma I reactor system is capable of depositing silicon nitride films on wafers at anywhere from room temperature to about 400°C. Inputs for two more gases allow etching, too. What's more, wafer throughput is higher than other machines known to be in development [*Electronics*, p. 40, Mar. 4, 1976].

In conventional, high-temperature silicon nitride passivation, temperatures higher than 750°C are used. However, high-temperature passivation of an entire wafer can destroy its electrical characteristics. So semiconductor manufacturers coat them with a final oxide layer of glass, which does not seal the wafer completely.

In applications where a hermetic seal is important, says Ted Rafalovich, marketing manager for chemical-vapor-deposition equipment at Applied Materials, it is necessary to use a ceramic package. Plasma I, he

says, being a low-temperature nitride process that gives complete passivation, allows the use of considerably less expensive plastic packaging.

The basic system is packaged in an enclosure that measures 72 inches wide by 32 in. deep. The top of the enclosure functions as a counter-high work station that provides space for wafer loading and unloading. The reactor itself is a resistance-heated, parallel-plate system equipped with electrodes to generate a glow discharge.

Reactant gases, injected at the center of the reactor, are dissociated into a plasma and flow outward in a radial pattern over the substrates. Unlike some other low-temperature nitride-passivation machines using silane and nitrogen, the Applied Materials process uses a mix of silane, ammonia, and nitrogen. The company went that route, Rafalovich says, because the nitrogen-silane approach, while it permits a relatively low temperature, lacks flexibility. Plasma I, on the other hand, he says, can mix the three basic gases to obtain a number of different processing profiles, depending on the temperature constraints, wafer throughput, deposition thickness, and other user considerations. Temperature is automatically regulated by a closed-loop control system incorporating a fixed-thermocouple temperature sensor, with a stability of $\pm 5^\circ\text{C}$.

At an operating temperature of 300°C, capacity of the system for a

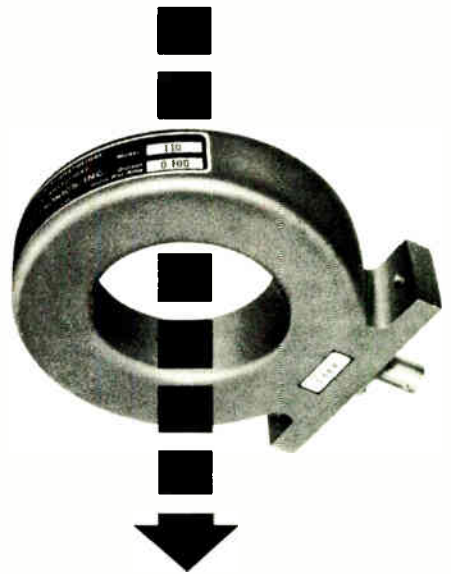

Wide Band, Precision CURRENT MONITOR

With a Pearson current monitor and an oscilloscope, you can measure pulse or ac currents from milliamperes to kiloamperes, in any conductor or beam of charged particles, at any voltage level up to a million volts, at frequencies up to 35 MHz or down to 1 Hz.

The monitor is physically isolated from the circuit. It is a current transformer capable of highly precise measurement of pulse amplitude and waveshape. The one shown above, for example, offers pulse-amplitude accuracy of +1%, -0% (typical of all Pearson current monitors), 20 nanosecond rise time, and droop of only 0.5% per millisecond. Three db bandwidth is 1 Hz to 35 MHz.

Whether you wish to measure current in a conductor, a klystron, or a particle accelerator, it's likely that one of our off-the-shelf models (ranging from 1/2" to 10 3/4" ID) will do the job. Contact us and we will send you engineering data.

PEARSON ELECTRONICS, INC.

4007 Transport St., Palo Alto, CA 94303, U.S.A.
Telephone (415) 494-6444



Circle 147 on reader service card



Positively uniform.

Batch-after-batch consistency. That's the reason new Kodak micro positive resist 809 can offer you less waste, higher yields, and better process reliability.

In addition, you get wide processing latitude, fast exposure, and high-quality results with contact, projection, and proximity printing.

And because the solids remain in solution, it needs no refiltering for at least twelve months.

For details, write Eastman Kodak Company, Department 412L (48-G), Rochester, N.Y. 14650.

RESULTS COUNT

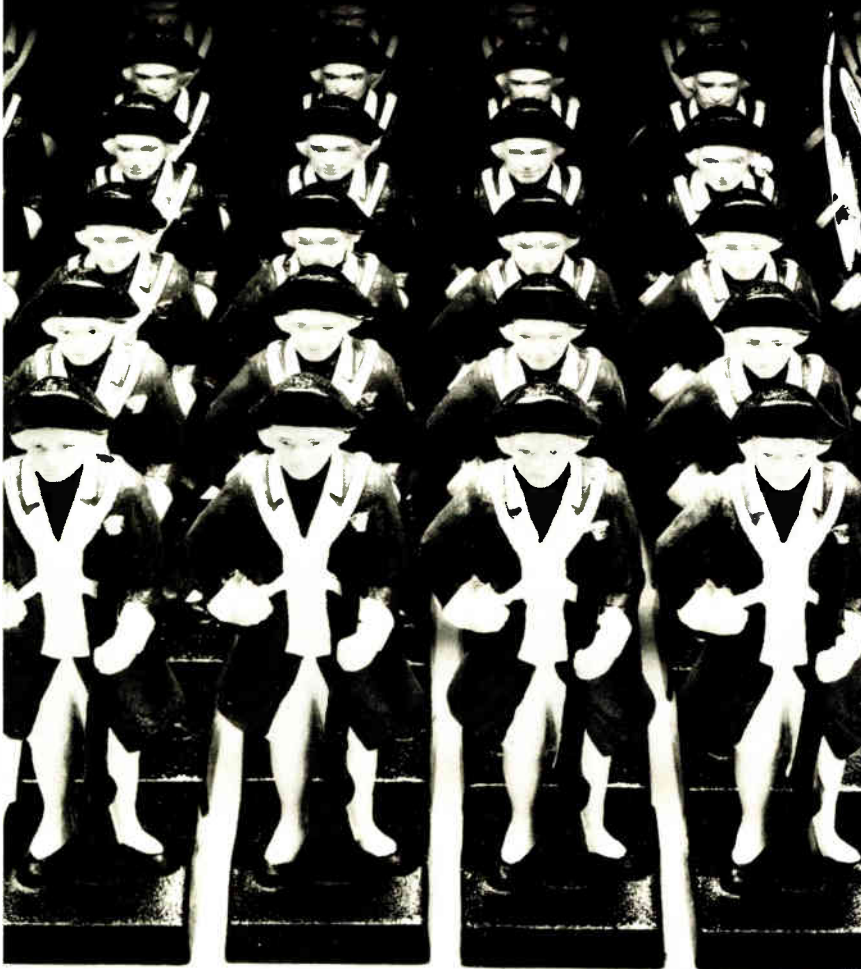

Kodak micro positive resist 809

New products

5,000-angstrom passivation layer is 60 2-inch-diameter wafers, or 14 4-inch wafers per half-hour run. Deposition thicknesses range from 1 to 10,000 angstroms, while deposition rates are typically 200 to 400 angstroms per minute. Thickness is guaranteed at $\pm 10\%$, and the refractive index at 2.0 ± 0.1 .

Basic system cost is \$44,000 to \$55,000, and delivery is 30 days.

Applied Materials Inc., 2999 San Ysidro Way, Santa Clara, Calif. 95051 [391]

Small solder-bump package competes with the DIP

Where board space is at a premium and assembly and manufacturing cost-cutting is vital, the dual in-line package may not be the best way to package integrated circuits. After about a year of development, General Instrument Corporation's Microelectronic division has developed a square chip-package called the Mini-Pak. It is about $\frac{1}{2}$ inch on a side and $\frac{1}{8}$ in. thick (about a third the size of a DIP). The Mini-Pak's connections are brought out on solder bumps 0.015 in. high on 0.050-in. centers on the bottom of the chip carrier, eliminating the rows of printed-circuit holes needed for assembly of DIPs.

In the manufacturing stage of the new package, the chip is mounted on top of a small square piece of G-10 glass epoxy and wire-bonded to plated conductors that link up to

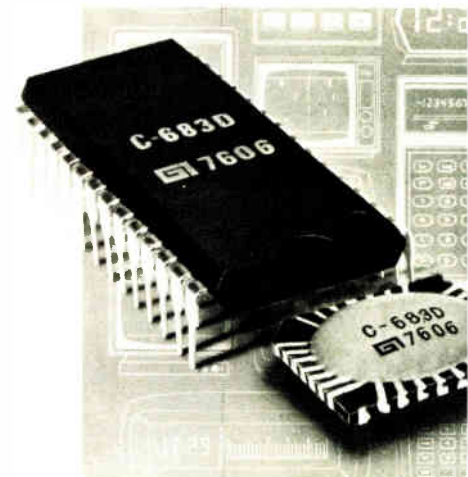

BAUSCH & LOMB 

StereoZoom[®] 5

microscope

Meet the new MORE
and LESS microscope

MORE in optics . . .

MORE in mechanics . . .

LESS in price.

This new StereoZoom 5 completes the royal family of world-leading Bausch & Lomb Stereomicroscopes. Fills a need in electronics for a middle zoom range of 0.8X-4.0X (5:1 ratio) for bonders, welders, assembly, and quality control.

More in optics. Higher resolution . . . 200 lines/mm at 4X. Better color correction. Less distortion. Flatter fields . . . no refocusing to see detail at edge of wide field. Zooming is fast with image continuously in focus through full range, while maintaining full working distance of 4". Workers see more, faster, easier, more accurately.

More in mechanics. Tighter precision tolerances for better alignment, smoother operation. Eyepieces can be locked in to prevent theft or tampering, but are still rotatable. StereoZoom 5 is directly interchangeable with other Bausch & Lomb pods, and can be used with many of the existing StereoZoom modules and accessories. Attractive new modern styling and professional black and white finish.

Less in price. Priced lower than other stereomicroscopes with equivalent features.

More . . . There's more to the new StereoZoom 5 story.

Discover this exciting new instrument by arranging for a free, no-obligation demonstration. Catalog 31-2436 is also just for the asking.

Circle 149 on reader service card

You know our reputation in DC to DC

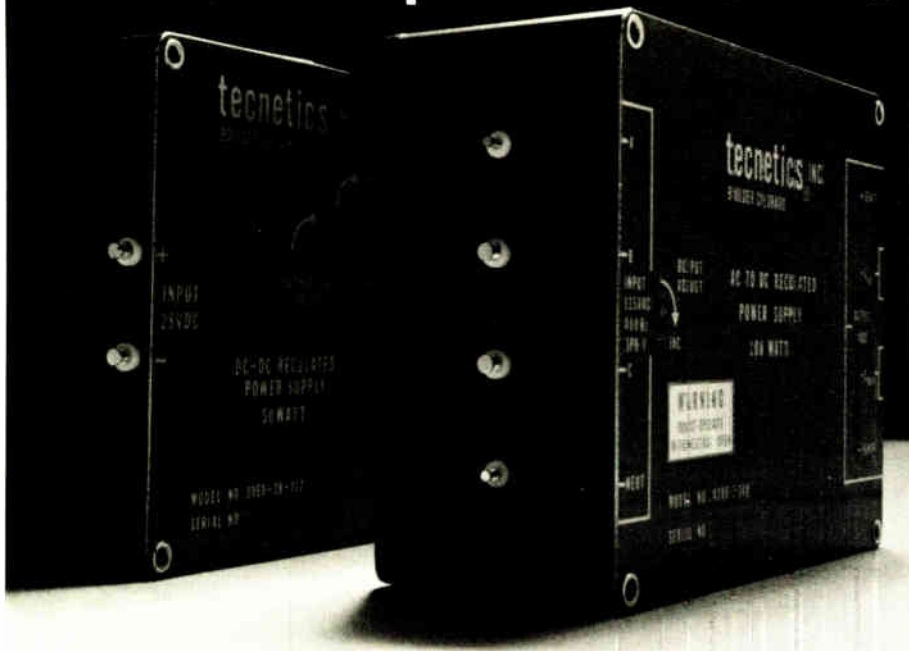

Wait till you see Tecnetics' new 400 Hz AC power supply

We earned a reputation with our line of DC to DC power supplies. Now, we add to it with a new 400 Hz AC power supply. Like our 28VDC power supplies, the AC model features extremely high packaging density, high efficiency and reliability. Most important, it's small, measuring in at only 4x4x2 inches and weighing 36 ounces fully encapsulated.

These power supplies are designed to meet

the rugged vibration, shock, humidity and altitude specs of the aerospace industry (Mil-E-5400). They also have separate, remote error-sensing terminals to compensate for voltage loss, assuring that the voltage level remains constant at the load.

Write for our 26-page catalog that gives full specs and prices on these and over three hundred other power supplies.

SPECIFICATIONS	3000 SERIES - DC TO DC	4000 SERIES - 400 Hz AC TO DC
Output Power	150, 100, 50, & 25 watt models	100, 50, & 25 watt models
Output Voltages	13 standard outputs from 5 to 48V	13 standard outputs from 5 to 48V
Input Voltages	28VDC or 48VDC (48VDC only on 150 w units)	115VAC $\pm 10\%$, 400 Hz (Single or 3 phase)
REGULATION		
Line	(LL to HL) 0.3%	(115V $\pm 10\%$) 0.2%
Load	($\frac{1}{2}$ to FL) 0.1%	($\frac{1}{2}$ to FL) 0.1%
Load	(NL to FL) 0.4%	(NL to FL) 0.5%
Temp	0.01%/°C	0.01%/°C

tecnetics® The Power Conversion Specialists P.O. Box 910,
1625 Range Street, Boulder, Colorado 80302 (303) 442-3837 TWX 910-940-3246

Circle 150 on reader service card

HOPE

in a word is what we are.

Project HOPE exists because there are people with hope—people who have given 3.5 million men, women, and children on four continents the chance for happier, more productive lives through improved health care.

Give to



Department A
Washington, D. C. 20007

New products

the array of solder bumps on the under side of the package. The chip is then protected by a gray plastic coating.

To attach this Mini-Pak to a circuit board, it's only necessary to heat its perimeter and allow the solder bumps to reflow onto the pc board's connections—a process that is self-aligning. GI has developed a simple soldering head (with a square adapter) that permits easy attachment and removal of Mini-Paks.

At present, 20 GI calculator chips, all with compatible pinouts allowing for a standardized calculator-board layout, are available in 28-pin packs. Chips housed in the new 28-pin package will be about 7 cents cheaper than the same units in DIPs.

The next chip to go into the new package has been designed for a TV game. Eventually an entire line of standard chips will follow. To accommodate larger chips, a 40-pin version will be ready later this year.

The Mini-Pak is compact enough to compete in those applications where bare chips are wire-bonded directly to pc boards and hybrid substrates. Moreover, it is easier to handle and test than a chip, and it lends itself to batch assembly.

General Instrument Corp., Microelectronics,
600 West John St., Hicksville, N.Y. 11802.
Phone (516) 733-3000 [392]

Magnetic-card programs digital-IC tester

Instead of changing a hard-wired performance board or rewiring the jumpers on a patch panel every time he wants to test a different type of circuit, the user of a model 5045A digital IC tester merely slips a single magnetic card into the tester's front-panel slot. The unit is then ready to test the device fully. For any given IC two cards are available: one for go/no-go testing, the other for diagnostic. The 5045A can handle a wide variety of logic types, such as RTL, DTL, HTL, TTL (including low-power and other sub families), ECL, and C-MOS. Universal pin electron-

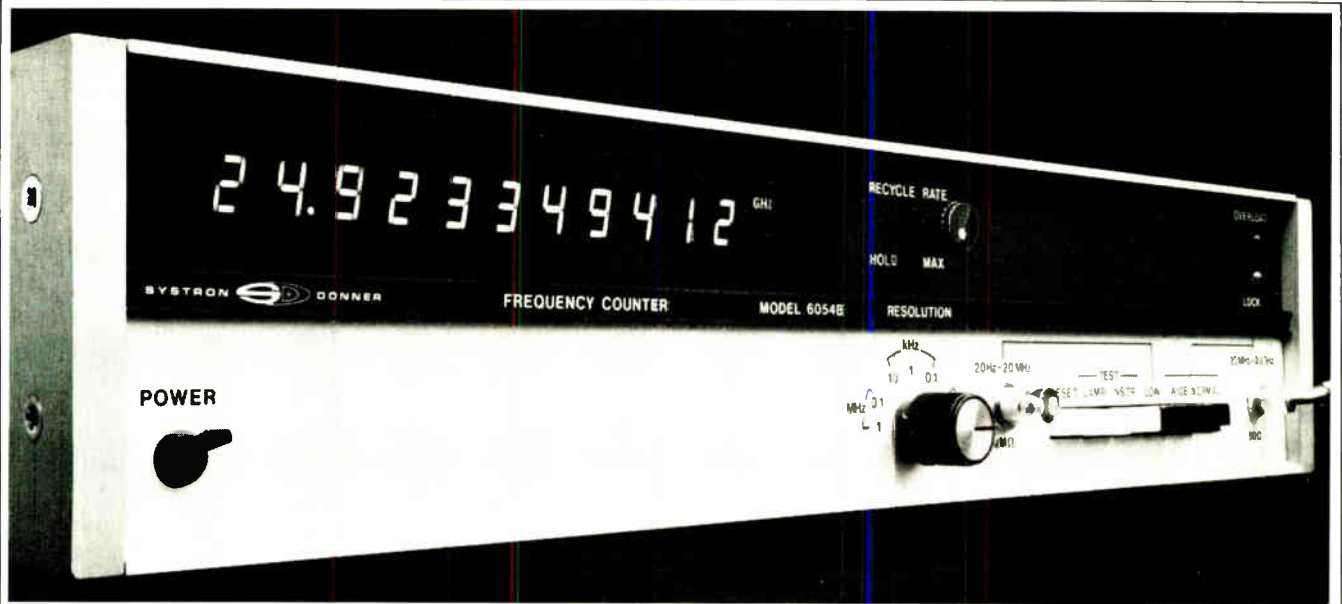

24 GHz

-30 dBm sensitivity, FM tolerance standard

Just those three features alone put Systron-Donner's new Model 6054B Microwave Counter in a class by itself! But there's lots more:

Complete Coverage: From 0.02 to 24 GHz in one band with one connector input. **Eleven** digits give you fully displayed readings.

Sensitivity: -30 dBm to 10 GHz; -25 dBm to 18 GHz; -20 dBm to 24 GHz.

Dynamic range: No dead zone! Operative over the complete range up to +30 dBm (1 watt).

Protection: Unlike other counters offered to date, the Model 6054B provides early warning of pending overload conditions via flashing LED's.

FM tolerance: Full channel loading and heavily modulated signals with rates up to 10 MHz are measured easily with S-D's FLACTO™ technique.

Speed: Fast acquisition and 1 Hz resolution in one second are provided over the entire frequency range.

Discriminator output: Gives the operator a visual picture of any modulation characteristics on the carrier.

Other Models: If you don't need 24 GHz coverage, S-D also offers 18 GHz and 3 GHz automatic counters.

To find out more about the new performance leaders in microwave counters, call Scientific Devices or contact S-D at 10 Systron Drive, Concord, CA 94518. Phone (415) 676-5000. Overseas, contact Systron-Donner in Munich; Leamington Spa, U.K.; Paris (Le Port Marly); Melbourne.

SYSTRON  DONNER

Our carry-in recorder/reproducer will carry on for 32.8 hours!

The 70-lb. Sabre VI: It's a giant leap beyond any other small, high performance IRIG analog tape recorder/reproducer. Records at 8 electrically selectable speeds: 120 ips through 15/16 ips; reproduces at any 3 electrically selectable speeds; records from 15.3 minutes at the highest speed to 32.8 hours at the slowest on 14" reels. Remote speed selection and LED footage counter. LED bar data monitor. Let us give you full details.



SANGAMO RECORDERS

THE INNOVATORS IN TAPE INSTRUMENTATION

Sangamo Electric Company

Data Systems

P.O. Box 3347 • Springfield, Illinois 62714

(217) 544-6411

New products

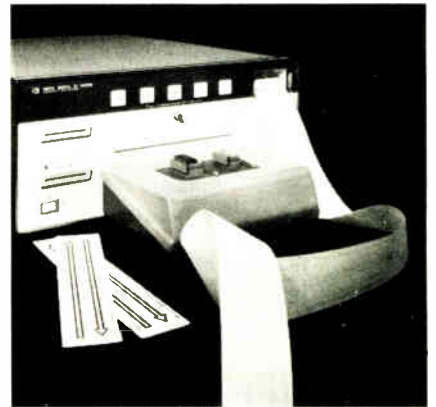

ics let each pin act as a driver, receiver, clock, power supply, input, or output. Power-supply voltages to 15 v or both positive and negative voltages to 7.5 v are available.

A built-in thermal printer provides a permanent record of failure information. Included in the print-out is the total number of devices that have passed or failed since the card was entered.

An important feature of the instrument is its ability to produce a program card for a read-only memory regardless of the ROM's program. All that is needed is a single card for the generic ROM type and a known good ROM. The 5045A sells for \$9,000; magnetic cards sell for \$30 each in small quantities, \$25 each for 10 and up.

Inquiries Manager, Hewlett-Packard Co.,
1501 Page Mill Rd., Palo Alto, Calif. 94304
[393]

Unit tests solderability of plated-through holes

An instrument for testing the solderability of plated-through holes has the advantage of doing its testing in a nondestructive manner. The unit operates by measuring the time it takes for capillary action to draw a bead of molten solder up through the hole. After testing, if the board proves satisfactory, it may be put back into production by simply blowing the molten solder from the hole. This nondestructive feature is expected to save the price of the instrument—\$4,800—in a very short

Lost any data lately?

Loss of power doesn't bother data stored in Nitron's MNOS non-volatile memories. The data is safe even if the power stays off for several years. Without backup batteries.

Nitron's NVMs can be erased and reprogrammed in or out of your circuit. Electrically. And because they're fully decoded and bus compatible, using them is just like using more conventional memories. No programming hardware or UV light sources to mess with. They're single word alterable and interface with either TTL or CMOS. What more can you ask for?

Nitron's new generation of NVMs: First the 64x4 NCM7040, and now the 256x4 NCM7050. Available off the shelf. So don't lose any more data. Or time.

Write or call

NITRON

10420 Bubb Rd., Cupertino, Calif. 95014
(408) 255-7550

NITRON
A division of **MCDONNELL DOUGLAS**

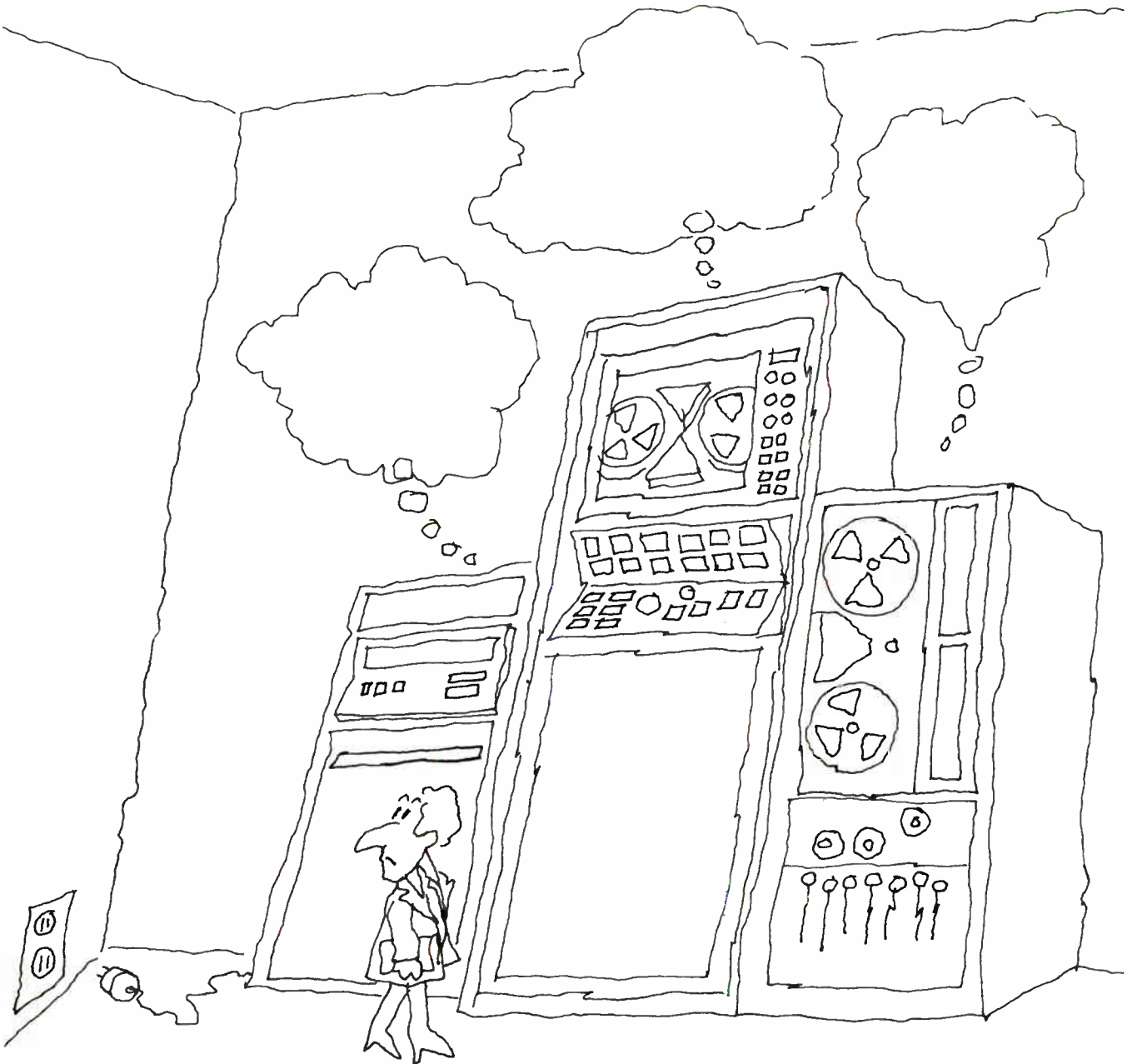

OFF-THE-SHELF KEYBOARDS?



This telephone keyboard *is*, and the others might as well be.

The key legend that makes one



keyboard different from another costs next to nothing. Prototyping?

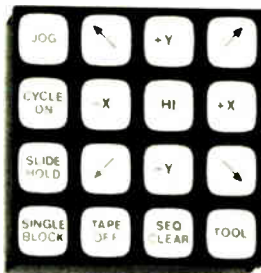

The Chomerics approach makes small quantities of custom keyboards practical.



Special encoding?
No problem.
Tight schedule?
You've come to the right place. Application: Communications? Lab instruments? Computers? whatever

— Key in to the leader. **CHOMERICS**



77 Dragon Court
Woburn, Ma. 01801
(617) 935-4850

New products

time. The tester, which can handle multilayer boards up to 24 inches by 24 in., has a delivery time of two weeks.

Multicore Solders, Westbury, N. Y. 11590 [394]

Garry offers stitch-weld versions of its IC panels

Garry Manufacturing Co., a major producer of wrapped-wire boards of many types, is offering stitch-weld versions of its entire line of IC pluggable packaging panels. The new boards will use individual socket contacts made with a 303 stainless-steel shell, gold-plated over nickel, with a gold-plated beryllium-copper contact spring member. The socket contacts are designed to accept standard ICs with 14, 16, 18, and 22 pins. Larger patterns for LSI devices and universal patterns are also available, as are boards with ground- and voltage-committed terminations. The new panels sell for from \$1 to \$2 per IC position in small quantities. Delivery time is four to six weeks.

Garry Manufacturing Co., 1010 Jersey Ave., New Brunswick, N. J. 08902. Phone Harry A. Koppel at (201) 545-2424 [396]

TOPICS

Production

B&G Enterprises, Santa Clara, Calif., has introduced a can opener for semiconductor metal-can packages from size TO-3 to TO-46. The device, which is claimed to open the cans with a clean, burr-free cut, sells for \$250. . . . **Rogers Corp., Chandler, Ariz.**, is marketing a flexible-circuit prototyping kit. Priced at \$25, the kit includes three 8-by-10-inch sheets of copper circuit elements on 1-mil polyimide film. Instructions and a designer's guide are also included. . . . **The Du Pont Co., Wilmington, Del.**, has announced increases in the price of its Mylar polyester film. The increases typically range from 7% to 11%.

we did it.

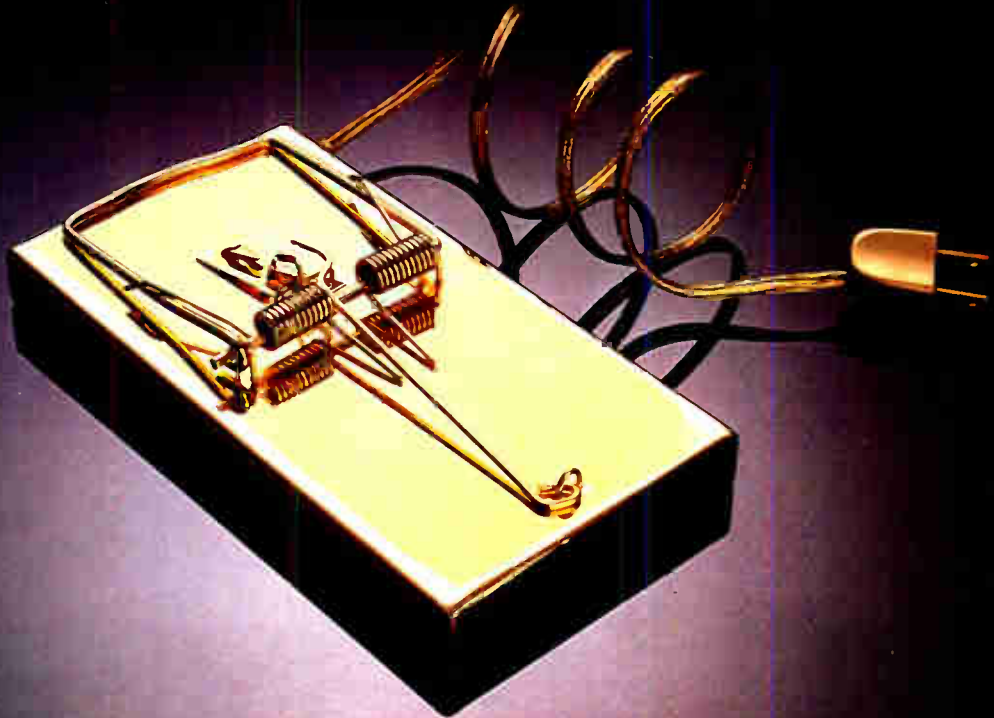

We built a better The AMI 6800.

The verdict is in from engineers, scientists, universities and magazine editors. The 6800 has become the most sought-after microprocessor family in the world.

With our new price breaks, it now makes sense to use the AMI 6800 for all applications—from simple, low-cost controllers to high-end microcomputers.

And with our system, you only need one 5-volt power supply. That brings the cost down even more. So for about the same price you'd pay for a 2-chip system, you can get the fast, flexible AMI 6800. The 8080 needs three power supplies. Not to mention at least four TTL devices. That puts it right out of the low-end ballpark.

Even when you move up to a more sophisticated microcomputer, you'll find the same kind of cost advantage in our favor. With the bus-oriented AMI 6800, you can hook up a total of ten memories and peripherals without adding any TTL.

This point underlines the basic reason for the AMI 6800's superiority. It was designed after a thorough study of the early microprocessors, and was patterned after the most successful minicomputers. Whereas the 8080 was designed to be compatible with the 8008. So it's stuck with many of the 8008's weaknesses.

You can learn a lot from other people's mistakes.

A comparison of the 6800 and the 8080 is a classic example of this truism. In virtually every important feature, the 6800 comes out ahead. Often way ahead.

We've already mentioned power supplies (our single +5V versus their three $\pm 5V$,

+12V) and interface (no buffering needed for up to 10 devices our way versus 4 to 6 packages for the 8080). But now take a good look at some other key hardware differences.

We have a simple 5-volt non-overlapping clock which is easily generated from a dual one shot such as a 9602. Theirs is a 0 to 8.5 volt or 0-11 volt non-overlapping asymmetrical waveform with specified delays between phases.

Ours has two levels of external interrupt, one of which is non-maskable. Theirs has only one maskable interrupt.

We save program space with two accumulators instead of one. But even more important in terms of space and cost saving is our interrupt stacking. This automatically stores all registers when the program is interrupted. With the 8080, you need an external subroutine of 4 or 5 instructions every time you hit this condition.

Now look at addressing. They don't have an indexed mode. We do. That can be really important, especially in peripheral applications. We give you a very powerful tool in relative addressing, allowing self-relative code. The 8080 doesn't. And we also have direct addressing, which lets the 6800 use two bytes of code to three for the 8080—a saving of 33 percent.

Our instruction set tells you a lot.

Ours is very flexible and much easier to learn, tailored more like a minicomputer. Take the 6800's branching ability. Besides positive, negative and zero, ours can branch

on equality and all inequality conditions. The 8080 can't test directly for inequalities. So it has to go through two or three additional steps to test for these conditions.

The 6800 can also isolate and test bits in a word much more easily than the 8080.

All this adds up to a 15 to 30 percent more efficient use of memory space. So the 6800 requires less hardware, less interface, less software. And being so much easier to use, the AMI 6800 microprocessor helps you beat the competition to market with a more reliable product.

The family plan makes growing easy.

The AMI 6800 is now a thriving family of nine, with more on the way.

Besides the S6800 MPU, there are the S6810 128 x 8 static RAM; the S6820 Peripheral Interface Adapter; the S6830 8K static ROM; the S6831 16K static ROM; the S6834 512 x 8 EPROM; the S6850 Asynchronous Communications Interface Adapter; the S6860 MODEM; and the S2350 Universal Synchronous Receiver/Transmitter.

For low power or battery backed-up products, our new S5101 256 x 4 CMOS RAM fits right in.

Our S6800 is not only versatile. It can be very tough. It now comes in an industrial temperature range of -40°C to $+85^{\circ}\text{C}$.

The AMI 6800 microprocessor family: you can't do better than that.



microprocessor

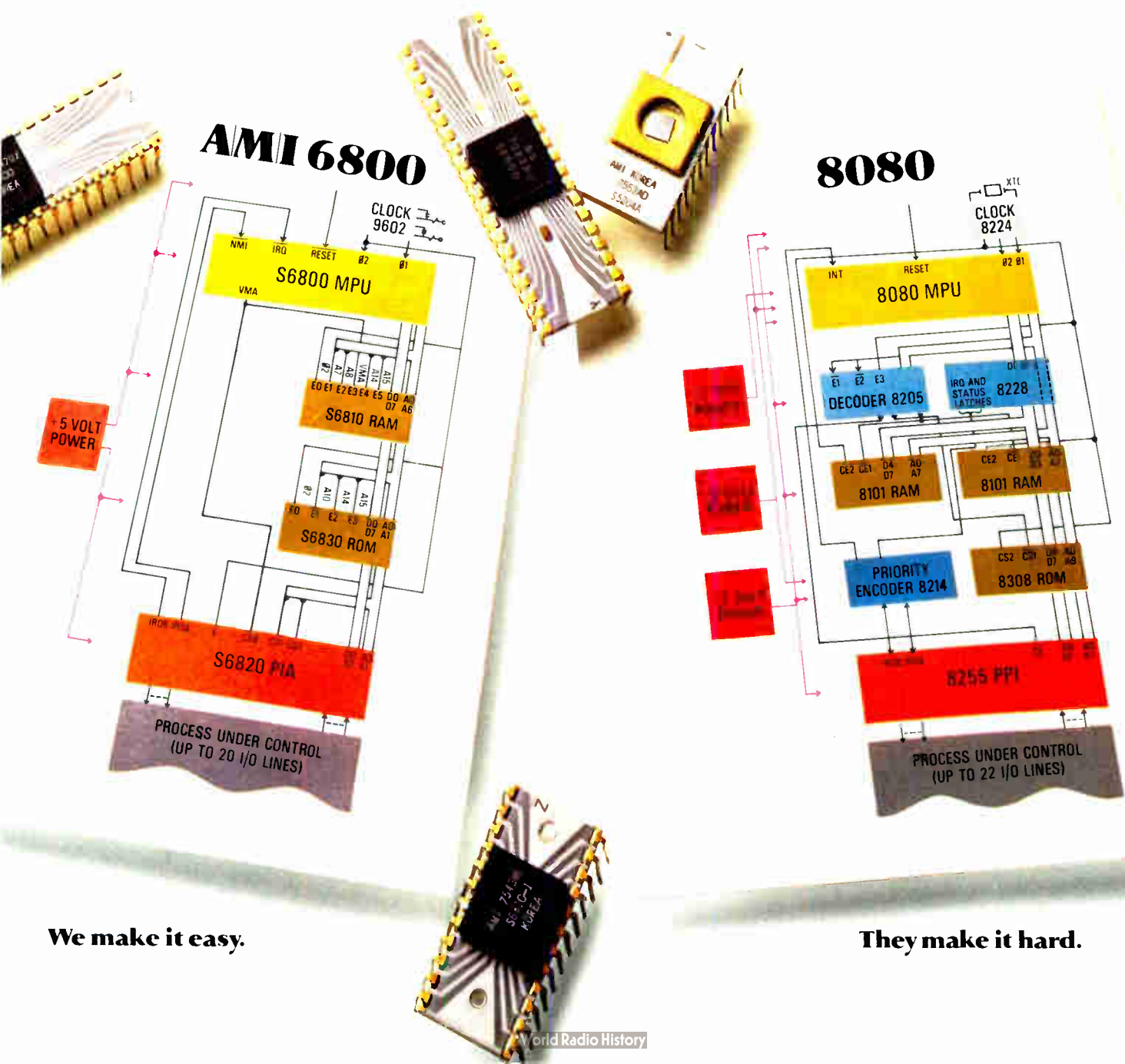

We make it easy.

They make it hard.

We built a better The AMI 6800 Development

It's so much better than the competition, they'll have to change their whole development philosophy to catch up.

The standard AMI 6800 Micro-computer Development Center consists of the 80 character x 25 line CRT, the dual floppy disk with disk operating system, an S6834 EPROM programmer, an RS232 interface, 16K words of RAM memory, a software debug package, editor and assembler.

You will also have options coming out of your ears. The most significant for most people probably are a character printer; EPROM and RAM memory modules; and soon an in-circuit emulator so you can use the CRT like a front panel.

Like everything else about the AMI 6800, our development system is a programmer's dream. We avoided the multiple box approach, with lights and switches, in favor of a very smart CRT with full debug software.

This bypasses all those hassles with paper tape, front panels, teletype or cassettes. In many cases, it cuts programming time from hours to minutes.

With your hands on the keyboard, and your eyes on the

screen, you can modify programs instantaneously. You can interrupt after every instruction, and get a complete snapshot of the state of the machine. Or look at all the registers and change their values, simply by pressing a key. And you never have to translate addresses into binary to get information. In short, our smart CRT helps you make the right decision right away.

Why learn two processors when one will do?

Strange as it may seem, some development systems have different micro-processors inside than the one you're program-



support system.

Microcomputer Center.

ming outside. So you have to learn two instruction sets instead of one.

Naturally, there's an AMI 6800 inside our terminal. And its performance there proves once again how powerful and versatile this micro-computer is.

Among many functions, it edits the screen, controls the communication's interface, and interacts with the disk and keyboard.

Besides high-speed program development (you can complete a typical edit/assembly sequence in a couple of minutes), you can configure our MDC as a test station for incoming 6800 parts. The results are right there on the screen for you to see.

There's no such thing as obsolescence.

With up to one megabyte of storage on-line in the dual floppy disk and a CRT controlled by our versatile 6800, you don't have to worry about this system ever gathering dust.

It converts very easily to a powerful, stand-alone microcomputer for a variety of uses, such as inventory control. Try that with any other development system, and you wind up with a pain in the peripheral. (Ask the competition for even a dumb CRT and they'll send you away to an independent supplier.)

We have another handy development tool, too, called the AMI 6800 Prototyping Board. This helps you debug programs, build 6800 hardware, evaluate parts, and even program our S6834 EPROM in about 40 seconds.

The Board has two 86-pin edge connectors, one for microprocessor bus extension and the other for input/output. Also on-board are 2K bytes ROM; 2K bytes EPROM; EPROM programming; 1K bytes RAM; totally buffered MPU; restart address selection; TTY operating system software; ROM subroutine program library; serial and parallel I/O ports.

In short, there's no better micro-computer than the AMI 6800. And there's no better way of developing it than with the AMI 6800 Micro-computer Development Center.



It can cut programming time from hours to minutes. That's right - minutes!

Don't take our Take theirs.



The facts about the AMI 6800 family speak pretty clearly for themselves. But the actions of some pretty big companies say even more.

Companies like Conrac, Hewlett-Packard, Memorex, Tektronix and TRW have selected the AMI 6800 for new products. And the varied uses they're

word for it.

making of our microcomputer speak volumes for its flexibility, power and organization.

The AMI 6800 turns the Conrac CRT into a highly intelligent terminal that adapts easily to perform a variety of stand-alone and peripheral computer functions. Hewlett-Packard's model 9815

programmable calculator achieves more speed and interface capability with the help of the AMI 6800.

Memorex selected the AMI 6800 for use in their new 1377 high-speed CRT.

In Tektronix' case, it allowed the 4662 Interactive Digital Plotter to include multiple interfaces, resident alphanumeric character generation and digitizing capability in a low-cost package.

TRW's new point-of-sale terminal, through the use of a 6800, offers multiple terminal personalities.

Although everyone recognizes the basic strengths of the AMI 6800, it seems everyone has a different reason for specifying it. Another tribute to its tremendous versatility.

The AMI 6800 has a great past, present and future.

We've been making MOS longer than any other company in the world. In our ten year history, we've never made a bigger commitment to any program, in terms of money and manpower, than we have to this one.

It marks a turning point for us. Although we're still the leading custom MOS manufacturer (and intend to remain so), the AMI 6800 is spear-heading our rapid advance in standard products.

Much of this effort is dedicated to keeping the AMI 6800 as the Number One microcomputer family. Soon 16K RAMs will be joining our 4K EPROM and other compatible memories. And new communications circuits will extend the 6800's capabilities in that field.

With plants in Santa Clara, California, Pocatello, Idaho and Korea, we're geared to handle any size orders. Very small to very big.

That's another important reason the big companies are coming to us. So why don't you get in touch with your nearest AMI sales office, distributor or representative listed on the next page. Or contact us at AMI, 3800 Homestead Road, Santa Clara, California 95051. Phone: (408) 246-0330. You couldn't make a better decision. Take their word for it.

AMI
AMERICAN MICROSYSTEMS, INC.



*The Conrac 480 25
CRT Terminal*



*The TRW 2001 Point-of-Sale
Terminal*



*The HP 9815 Programmable
Calculator*



*The Memorex 1377
High-Speed CRT*



*The Tektronix 4662 Interactive
Digital Plotter*

How do you get the AMI 6800? It's a snap.

Now it's as easy to get hold of the AMI 6800 as it is to use it.

We've built up our sales and distribution network to give you the products you need as soon as you need them. So snap up some AMI 6800s for your new products. And watch people beat a path to your door.

HEAD OFFICE:

AMI
3800 Homestead Road
Santa Clara CA 95051

SALES OFFICES UNITED STATES

Long Beach CA 213 595-4768
San Jose CA 408 249 4550
305 830-8889
Elk Grove Village IL 312 437-6496
Norwood MA 617 762-0726
Livonia MI 313 478-9339
Minneapolis MN 612 559-9004
Monsey NY 914 352-5333
Cleveland OH 216 292-6850
Ambler PA 215 643-0217
Richardson TX 214 231-5721

SALES OFFICES: INTERNATIONAL

England - Swindon Wiltshire
Swindon 0793 31345
France - Vincennes 01 374-0090
Italy - Milan 02 29 37 45
Japan - Tokyo 501 2241
West Germany - Munich
089 48 30 81

REPRESENTATIVES: UNITED STATES

AMMON & RIZOS
Oklahoma - Oklahoma City
405 373 2748
Texas - Dallas 214 233 5591
Texas - Houston 713 781-6240

BARNHILL FIVE

Colorado - Denver 303 426-0222
Utah - West Bountiful
801 292-8991

BENEKE & MCCAUL

Missouri - Grandview
816 765-2998
Missouri - St Louis 314 434-6242
CAN TEC REPRESENTATIVES INC
Ontario - Ottawa 613 225-0363
COULBOURN DEGREIF INC
Maryland - Baltimore
301 247-4646

HADDON ASSOCIATES

California - San Diego
714 569-9445

HECHT HENSCHEN & ASSOCIATES INC

Arizona - Phoenix 602 275-4411
LOWREY & ASSOCIATES
Michigan - Brighton 313 227-7067

NORTHWEST MARKETING ASSOCIATES

Washington - Bellevue
206 455-5846

OASIS SALES INC

Illinois - Elk Grove Village
312 640-1850

PRECISION SALES COMPANY

New York - Syracuse 315 458-2223

REP INC

Alabama - Huntsville
205 881-9270
Georgia - Tucker 404 938-4358
North Carolina - Raleigh
919 851-3007

TECHNICAL REPRESENTATIVES INC

Indiana - Indianapolis
317 849-6454

DISTRIBUTORS AND REPRESENTATIVES: INTERNATIONAL

ARGENTINA

Arturo E. Vercesi
Rivadavia 2057 Dept 11-A
Buenos Aires
46-2950

AUSTRALIA

CEMA Distributors Pty Ltd
G PO Box 578
Crows Nest N S W 2065
439-4655

Warburton Frank - Pty Ltd
199 Parramatta Road
Auburn N S W 2144
648-1771

BRAZIL

DATATRONIX Electronica Ltda
Av Pacaembu 746 CONJ 11
Sao Paulo Brazil
209-0134

DENMARK

GDS - Henckel ApS
Fyrrevangen 4
DK-4622 Havdrup
38 57 16

ENGLAND

Adrian Electronics Ltd
28 High Street
Winslow Buckinghamshire
MK18 3HF
Winslow 3535

APEX Components Ltd
396 Bath Road Slough
Berkshire England
63741

Quarndon Microelectronics Ltd
Slack Lane
Derby DE3 3ED
32-651

FINLAND

Atomica AB
PO Box 125
SF-00121 Helsinki ?2
66 17 99

FRANCE

Electronique MS
89-93 Rue des Alpes
Cidex L 190
F-94533 Rungis
686-7425

PEP-Produits Electroniques
Professionnels S A R L
2 rue Barthelemy
F-92120 Montrouge
735 33 20

HONG KONG

Shankin Co Ltd
Rm 503-5 KAM Chung Bldg
54 Jaffe Road
05 281 521-3

INDIA

Radiosound
42 Canady Bridge
Bombay 400 004
353997

ISRAEL

Tadiran - Semiconductors Division
PO Box 646
Tel Aviv
267272

ITALY

Celdis Italiana S p A
via Luigi Barzini 20
I-20125 Milano
68 06 81

MEXICO

Semiconductores Calif S A
Pasaje Reforma 90-Altos
Mexico Baja California
2 5701-03

NETHERLANDS

RITRO Electronics B V
Geffeweg 22 PO 123
Barneveld
50 41

NEW ZEALAND

David J Reid NZ Ltd
PO Box 2630
Auckland 1 New Zealand
492-189

SYRACY

GDS-Henckel A p S
Heerlokka 14
N-1440 Drobak
93 15 97

REPUBLIC OF SOUTH AFRICA

Radiokom 1969(Pty) Ltd
PO Box 56310
Pinetown 2123
48-5712

SPAIN

Ataio Ingenieros S A
Enrique Larreta 10 y 12
Madrid 16
215-35 43

SWEDEN

AB Rifa
Fack
S-161 11 Bromma 11
826-2600

SWITZERLAND

GDS Sales S A
8 rue de l'Aubepine
CH-1211 Geneve 9
21 59 77

GDS Sales S A

Muehlebachstr 54
CH-8008 Zurich
59-434

TAIWAN

General Industries Taiwan Inc
11th Floor Room D
Fortune Building
52 Chang An E Road Sec 2
Taipei 104
5221204

WEST GERMANY

Omi-Ray GmbH
D-4054 Nettetal 1
Ritzbruch 41 Postfach 31751
02153 7961

MIKROTEC GmbH

D-7000 Stuttgart 1
Johannesstr 91
695-530



AMI
AMERICAN MICROSYSTEMS, INC.

Snap up the AMI 6800 here:

DISTRIBUTORS: UNITED STATES

ARROW ELECTRONICS:
Minnesota—Bloomington
(612) 888-5522

CENTURY ELECTRONICS:
New Mexico—Albuquerque
(505) 292-2700
Utah—Salt Lake City (801) 487-8551

CESCO ELECTRONICS, LTD.:
Canada—Montreal (514) 735-5511

INTERMARK ELECTRONICS:
Washington—Seattle (206) 767-3160

SCHWEBER ELECTRONICS:
California—Costa Mesa (213) 924-5594
and (714) 556-3880

Connecticut—Danbury (203) 792-3500
Florida—Hollywood (305) 927-0511
Georgia—Atlanta (404) 449-9170
Illinois—Elk Grove Village
(312) 593-2740

Iowa—Cedar Rapids "Lorenz Sales"
(319) 393-6912

Maryland—Rockville (301) 881-3300
Massachusetts—Waltham
(617) 890-8484

Michigan—Troy (313) 583-9242
Minnesota—Edina (612) 941-5280
New Jersey—Somerset (201) 469-6008
New York—Rochester (716) 461-4000
Westbury (516) 334-7474

Ohio—Beachwood (216) 464-2970
Texas—Austin (512) 837-2890
Dallas (214) 661-5010
Houston (713) 784-3600

Canada—Mississauga, Ont.
(416) 678-9050

SEMICOMP CORP.:
California—Newport Beach
(213) 971-5253 and
(714) 833-3070

STERLING ELECTRONICS:
Arizona—Phoenix (602) 258-4531
Louisiana—Metairie (504) 887-7610
Massachusetts—Watertown
(617) 926-9720

New Jersey—Perth Amboy
(201) 442-8000

New Mexico—Albuquerque
(505) 345-6601

Texas—Dallas (214) 357-9131
Houston (713) 627-9800

Virginia—Richmond "Meridian
Electronics" (804) 359-0221

R. V. WEATHERFORD CO.:
Arizona—Phoenix (602) 272-7144
California—Anaheim (714) 547-0891
Glendale (213) 849-3451
Palo Alto (415) 493-5373
Pomona (714) 623-1261
San Diego (714) 278-7400

Colorado—Englewood (303) 761-5432
New Mexico—Albuquerque
(505) 842-0868

Texas—Dallas (214) 243-1571
Houston (713) 688-7406

Washington—Seattle (206) 243-6340

Circle 163 on reader service card

New products

Communications

Optical links made simpler

Single-fiber cable has tough plastic sheath, takes inexpensive connectors

Because relatively inexpensive connectors latch with relative ease onto its tough plastic sheath, a new fiber-optic cable from Du Pont should make it simpler and economically feasible to set up optical communications links. Joining other improved cables that have recently been announced by Fiber Communications Inc., Galileo, ITT Electro-Optics and Valtec, Du Pont's new entry is a pure-silica single-fiber cable.

Labeled PFX-S108R02, it has an attenuation of less than 80 decibels per kilometer at wavelengths from 550 to 800 nanometers. That attenuation level gives a cable-run capability of 300 meters, a sizeable increase over Du Pont's earlier PFX-0715 seven-fiber cable. What's more, the cable's large, 8-mil-diameter core and numerical aper-

ture of 0.4 allow efficient coupling without concern about fiber misalignment.

The cladding material is made with a special proprietary polymer to which a connector can fairly easily be directly attached without throwing the fiber off center. Misalignment losses are thus minimized even without the use of elaborate tooling. Moreover, the Lucite-like cladding is tough and thick so that crimping problems are lessened. A soft jacket of Hytrel is easily stripped off, leaving high-strength Kevlar strands to grab in the connector, which provides good strain relief. Furthermore, Du Pont engineers feel that even inexpensive injection-molded plastic connectors will provide good performance—a plus in fiber-optic links requiring many connectors.

Another feature of the cable is its extremely small bend radius—put at 0.125 in. on the data sheet—which helps when installation must be made in very tight quarters. (Indeed, Du Pont engineers say fibers didn't break even with the cable knotted tightly and pulled from either end.)

The pure silica core used in the new cable has much higher radiation resistance than glass or doped silica. This resistance, according to

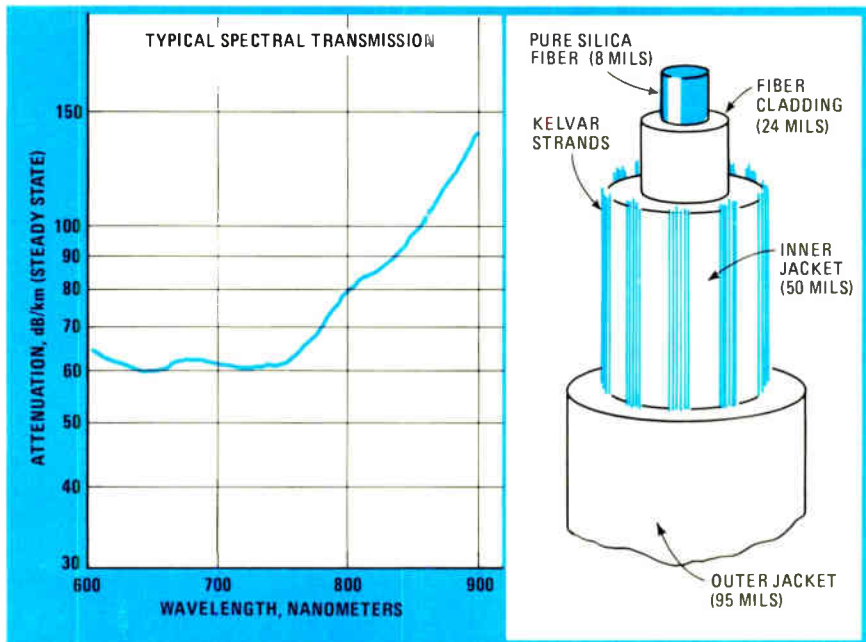

TO-92

**FROM THE COMPANY
WHERE PRICING IS
AS IMPORTANT AS
TECHNOLOGY**

NPC is expanding its Silicon Epoxy Transistor line and product-families listed below are available from stock. More to come!

NPN
3904
EBC

PART NO.	DESCRIPTION	UNIT COST AT 1,000	PART NO.	DESCRIPTION	UNIT COST AT 1,000
2N3903	4 NPN General Purpose Amp/Switch, Cu Lead Frame	\$.11 .12	2N4400	III PNP Medium Speed, Medium Current Switch, Cu Lead Frame	\$.13 .14
2N3905	6 PNP General Purpose Amp/Switch, Cu Lead Frame	.11 .12	2N4402	IV PNP Medium Speed, Medium Current Switch, Cu Lead Frame	.13 .14
2N4123	24 NPN General Purpose Amp, Cu Lead Frame	.11	NPC2369	NPN High Frequency Amp, Cu Lead Frame	.15
2N4125	26 PNP General Purpose Amp, Cu Lead Frame	.10 .11	NPCA18	NPN Very Low Noise Amp, Cu Lead Frame	.23
2N5088	89 NPN Low Noise Amp, Cu Lead Frame	.14 .15	NPC918	NPN VHF Oscillator, Cu Lead Frame	.23
2N5086	87 PNP Low Noise Amp, Cu Lead Frame	.14 .15	2N4248/49/50	PNP Low Noise Amp, Cu Lead Frame	.14
2N5208	10 NPN Low Noise Amp, Cu Lead Frame	.14 .15	NPC3638	A PNP Medium Speed Switch, Cu Lead Frame	.16
NPCA20	21, 22 NPN General Purpose Amp, Cu Lead Frame	.11	NPC3390	NPN Tight Beta General Purpose Amp, Cu Lead Frame	.14
NPCA70	PNP General Purpose Amp, Cu Lead Frame	.12	NPCD05	D55 Complementary General Purpose Amp, Cu Lead Frame	.11
			NPCD06	D56 Complementary Low Voltage Drivers, Cu Lead Frame	.11
			NPCH10	NPN High Frequency Amp, Cu Lead Frame	.21
			NPCH17	NPN VHF Oscillator, Cu Lead Frame	.28
			2N5208	PNP VHF Oscillator, Cu Lead Frame	.17
			NPCA42	43 NPN High Voltage Amp, Cu Lead Frame	.23 .20
			NPC92	93 PNP High Voltage Amp, Cu Lead Frame	22 .19
			2N5225	NPN General Purpose Amp, Cu Lead Frame	.11
			2N5226	PNP General Purpose Amp, Cu Lead Frame	.11
			NP5.9V.5	5.9V TO-92 Reference, Cu Lead Frame	.10



6660 VARIEL AVENUE • CANOGA PARK, CALIFORNIA 91303
(213) 887-1010 • TELEX 69-8481 • TWX 910-494-1954

New products

Du Pont engineers. is important in military and nuclear environments.

The cable is available for immediate delivery in 50-300-meter lengths at a cost of \$5 per meter. Du Pont sees the price dropping to about \$1 per meter for large-quantity orders.

E.I. Du Pont de Nemours & Co., Plastics Dept., Wilmington, Del. 19898 [401]

Audio analyzer makes multiple measurements

Unusually flexible and complete, an audio analyzer system for the telecommunications and broadcast fields offers a combination of measurement modes, including stereo phase and level differences. The model ROR300 saves time both in broadcast studios, in testing and

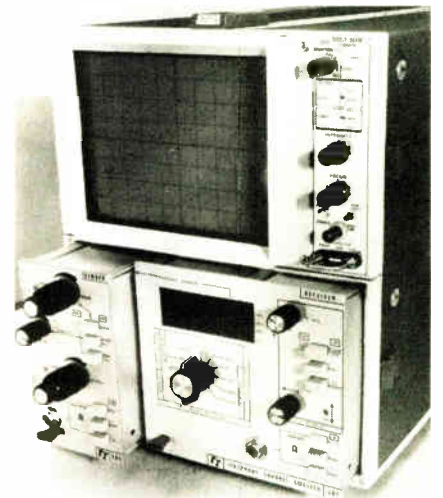

aligning radio channels, and in recording companies, in testing and equalizing consoles and tape-recording equipment. It may also serve as a standard for audio measurements on telephone program channels and for production tests for audio-equipment makers. Because there is a digital readout for each type of measurement in addition to the scope display, point-by-point as well as swept measurements are possible. The basic system (shown above) includes the scope mainframe plus the model 301 generator plug-in and the model 302 analyzer plug-in. Price of the basic

Here's a simple way to put a microprocessor in your product.

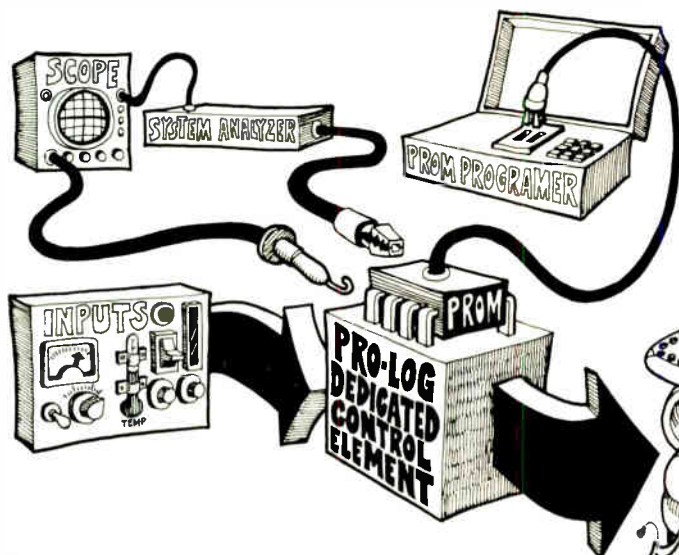

This is what you'll work with if you buy one of Pro-Log's dedicated control elements with the microprocessor already built in.

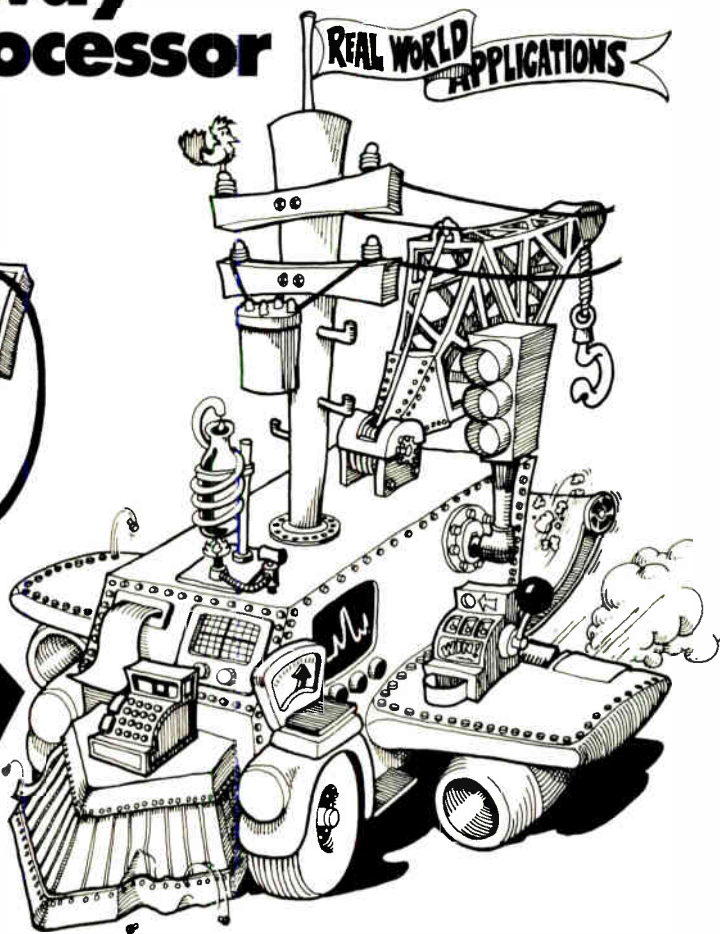

Buy a dedicated control element, for all practical purposes a black box, with a microprocessor already built in.

We've developed subsystems using microprocessors. They come in modular configurations readily expandable to meet your product requirements. You hardwire them directly to relay contacts, switches, push buttons, displays or other real-world devices. They give you all the capabilities of a microprocessor with none of the headaches. And we deliver them in a matter of weeks.

When you use our subsystems, we give you the kind of production and documentation assistance that results in a product your present manufacturing people can build and your present service force can support.

And system design stays with the design engineer.

Plus, we give you something more, a free set of plans and a second source.

Order 250 subsystems and we'll throw in free non-exclusive manufacturing rights and a complete set of manufacturing and assembly plans allowing you to build your own hardware, relying on us as an established and dependable second source.

We make everything you need to design with microprocessors.

Our starter sets include a microprocessor subsystem, a Series 90 PROM programmer, a microprocessor system analyzer, plus all associated hardware. 4-bit sets cost around \$3,000, 8-bit sets around \$3,500, a substantial savings over what you'd pay if you purchased all these items separately.

We have education too.

Our half-day introductory seminar takes a hard look at the function of microprocessors in real-world applications.

Our three-day hands-on design course teaches engineers how to formulate, program and use microprocessor modules.

Our free booklet, "The Microprocessor User's Guide" answers all your questions.

It explains what a microprocessor is, what it's capable of doing, what criteria you need to evaluate the ones on the market and how Pro-Log can help you put them to best use. Write for your copy.

To show how much Pro-Log can save you both in time and money, consider this. We've got a one-card 4004-based system called the PLS-401A. It includes a microprocessor; crystal controlled clock; 16 lines of TTL input; 16 lines of TTL output; sockets for 1024 words of program memory; 80-character RAM and built-in power-on reset. It costs only \$99 in quantities above 500 (\$175 in quantities of 10.) How long would it take, and what would it cost you to design and build something in-house that could do the same job?

And this is just one example of the many microprocessor subsystems we offer using 4004, 4040, 8008, 8080, and 6800 microprocessors.

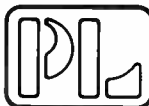
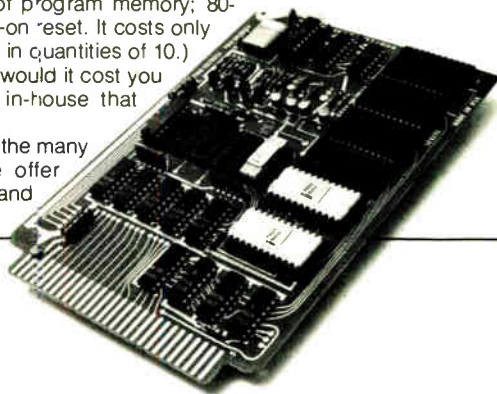

PRO-LOG CORPORATION
2411 Garden Road
Monterey, CA 93940
Telephone (408) 372-4593
TWX 910-360-7082

FF202

It programs itself to test your printed-circuit boards.

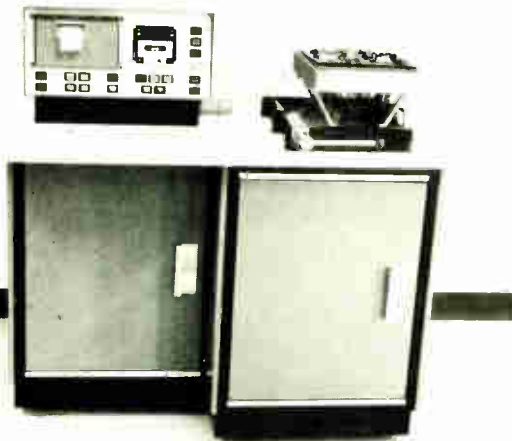

Forget about software costs when you install a **SHORTFINDER™ FF202** to test bare boards or to find shorts and opens on printed-circuit assemblies. The microprocessor-controlled FF202 uses data derived from a known good board to generate the test program. Self-programming a typical board requiring 600 test points takes only 24 seconds. Then, FF202 finds and identifies shorts and opens and automatically prints repair data at 400 ms per fault.

SHORTFINDER® FF202 can help you increase product yield and reduce manufacturing cost. Let us show you how.

WRITE FOR COMPLETE DATA.

Circle 166 on reader service card

FF FAULTFINDERS Inc.
10 AYS DRIVE, LATHAM, NY 12110 (518) 783-7786

Irvine, CA
Sunnyvale, CA
Park Ridge, IL
Faultfinders GmbH, Eschborn, Germany
Cicero, IN
Waltham, MA

New products

system is \$4,720. Delivery time is less than 90 days.

W&G Instruments Inc., 119 Naylor Ave., Livingston, N.J. 07039 [403]

Digital phase shifters cover bands through uhf

Driven directly from transistor-transistor-logic circuits, a line of digitally controlled phase shifters is particularly useful for phasing antenna systems, scrambling data communications, and other signal-processing applications. The PSD series shifters which are designed for applications through the high- to ultra-high-frequency ranges, vary the phases of rf signals in binary increments up to 360°. Overall phase-shifting error is less than the least significant bit. Incremental accuracies within ±0.2° are described as typical.

A key unit of the new line, the PSD-84-53-1, covers the full 0-to-360° phase-shift range. It is an 8-bit device and uses p-i-n diodes to switch precise lengths of cable in and out. Frequency range is 30-76 megahertz; maximum input, +10 dBm; impedance, 50 ohms; VSWR, 1.25; insertion loss, 3 decibels, and switching time, 4 microseconds.

Although standard units operate from TTL, devices driven by other logic types, including ECL and MOS, can be supplied.

Merrimac Industries Inc., 41 Fairfield Place, West Caldwell, N.J. 07006 [404]

Phone-line equalizer has wide dynamic range

For use with subscriber lines and automatic secure switches, as well as applications where equalization is required for voice and data signals being transmitted on the same line, a wideband line equalizer covers 10 hertz to 70 kilohertz. The model 133 incorporates a 25-dB gain-regulating amplifier to compensate for flat line loss. Also included is an adjustable RC equalizer to compensate for

Autoranging Frequency Counting to 60 MHz with 1 Hz Resolution



B&K-PRECISION MODEL 1801 \$240

- For laboratory, production line or maintenance applications
- Automatic ranging, 20 Hz to 40 MHz is guaranteed...readout to 60 MHz is typical
- TTL circuitry updates the six-digit display five times per second
- Resolution to 1 Hz obtained by suppressing digits above 1 MHz when switching to 1 SEC mode



MHz display of 3.579548 MHz input (AUTO mode)



KHz display of overflow of 3.579548 MHz input (1SEC mode)

- Available for immediate delivery, from local B&K-PRECISION distributors
- 10-day free trial offer

B&K PRECISION

PRODUCTS OF DYNASCAN
6460 W. Cortland Avenue
Chicago, IL 60635 312/889-8870
In Canada: Atlas Electronics, Toronto

Circle 241 on reader service card

SURPRISE!



HP's New Stackable Subminiature Lamps

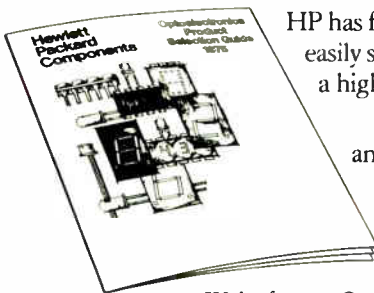

HP has four new LED lamps in radial lead subminiature epoxy packages. And they can be easily stacked on 2.21mm (0.087") centers for high density applications. These lamps offer a high on/off contrast ratio combined with a wide viewing angle.

Choose the HP 5082-4100 for the red, -4150 for the yellow, -4190 for the green and -4160 for our new high-efficiency red.

Contact Hall-Mark, Schweber, Wilshire or the Wyle Distribution Group (Liberty/Elmar) for immediate delivery.

Write for our Optoelectronics product selection guide and get all the details on HP's broad line of LED lamps.

01603

HEWLETT  **PACKARD**

Sales and service from 172 offices in 65 countries.

*501 Page Mill Road, Palo Alto, California 94304

The Low Priced AM-FM Signal Generator 1.5 MHz to 80 MHz.

Model 950A presents a direct 5 digit frequency display. Provides precise FM with calibrated deviation to ± 30 kHz and full AM capability with a direct reading calibrated meter. RF output is adjustable from $0.1 \mu\text{V}$ to 3 volts, automatically leveled to within $\pm 1/2$ dB. Frequency accuracy is 0.005%.

Write or call today for pricing, delivery and complete specifications.

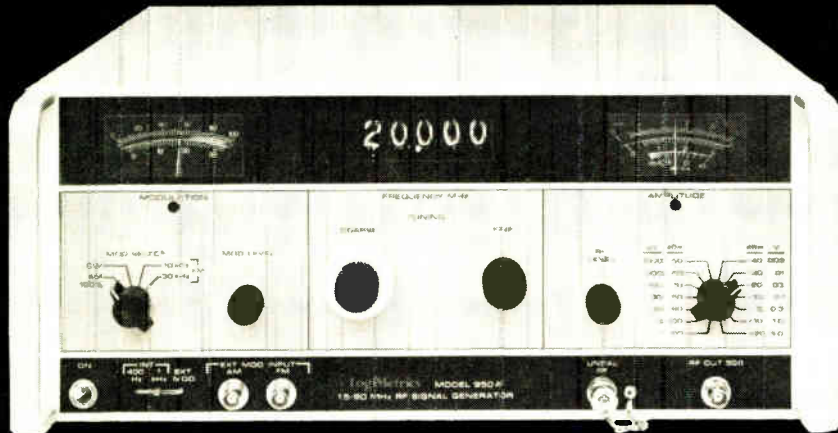

LogiMetrics

121-03 Dupont Street, Plainview, New York, 11803, (516) 681-4700/TWX: 510-221-1833
RF Signal Generators, Frequency Synthesizers, Traveling Wave Tube Amplifiers

Circle 168 on reader service card

check what \$10 can buy.

Unbiased product analyses for designers, planners, buyers

Characteristics / Prices / Users' Ratings / Comparisons / more

- | | |
|--|---|
| <input type="checkbox"/> Minicomputers (189 models) \$10 | <input type="checkbox"/> Alphanumeric Display Terminals (182 models) \$10 |
| <input type="checkbox"/> Microcomputers (33 models) \$10 | <input type="checkbox"/> Word Processing Systems (105 models) \$10 |
| <input type="checkbox"/> Microprocessors (31 models) \$10 | <input type="checkbox"/> Small Business Computers (158 models) \$10 |
| <input type="checkbox"/> Data Communications Facilities \$10 | <input type="checkbox"/> Remote Batch Terminals (78 models) \$10 |
| <input type="checkbox"/> Modems (280 models) \$10 | <input type="checkbox"/> Remote Computing Services (98 companies) \$10 |
| <input type="checkbox"/> IBM System 370 \$10 | <input type="checkbox"/> Proprietary Software Ratings (210 products) \$10 |
| <input type="checkbox"/> Teleprinter Terminals (149 models) \$10 | <input type="checkbox"/> User Ratings of General Purpose Computers \$10 |

160-page 1976 Directory of 780 EDP Suppliers. Special Price: \$15.

FREE with purchase. Our latest catalog of reports on EDP and automated systems. Selected from Datapro's monthly updated information systems.

Please enter my order for the reports checked above.

Enclosed is check for \$ _____ Bill me, adding \$2 handling

Name _____ Title _____

Company _____ Phone _____

Address _____

City _____ State _____ Zip _____

For those who value information.
datapro

Datapro Research Corporation
1805 Underwood Boulevard
Delran, NJ 08075 (609) 764-0100

New products



high-frequency rolloff of cable transmission systems. Basic frequency response is flat over the specified range, with equalization gain adjustable up to 25 dB at 70 kHz. Impedance is 135 ohms, balanced, and impulse noise is specified at 20 bits in a 10-minute period. The model 133 consists of one or two plug-in equalizer modules and one plug-in power supply module containing a power switch, fuse, and pilot lamp.

TM Systems Inc., 25 Allen St., Bridgeport, Conn. 06604. Phone S. Feldman at (203) 366-4571 [405]

Mobile duplexers cover range from 144 to 174 MHz

Two additions to a line of duplexers include the model 636A mobile duplexer (shown below), which has four capacitively tuned temperature-compensated helical resonators, two in the receive channel and two in the transmit. The model 636-S6A, also a mobile unit, uses six resonators, the two extra cavities providing the added isolation required in some systems. Both devices have a frequency range of 144 MHz to 174 MHz with a minimum separation of 4.5 MHz. Maximum power input is 50 watts.

Phelps Dodge Communications Company, Route 79, Marlboro, N.J. 07746 [406]

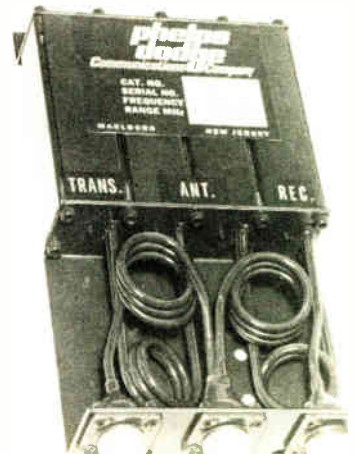

168 Circle 242 on reader service card

Why Parylene works where other microelectronic protection fails:

Controlled conformality

There's a uniform coating of parylene all the way around the half-mil tip of this phonograph needle. That's true conformality, and only parylene gives it, in precisely controlled thicknesses from .002 to 3 mils, in one step. Unlike spray or dip coatings, parylene won't bridge or puddle, or thin out at sharp edges, creating potential failure points. The parylene coating is completely uniform, no matter how dense or intricate the module. And because it's applied at room temperature, there's no component discomfort.



△200 @ thermal shock protection

This hybrid microelectronics relay has undergone 200 45-minute cycles from -120 to 80°C, simulating earth-orbiting conditions. This X-ray shows all leads remain intact. Parylene protection was at work, on the transformer core and then the whole assembly before packaging (TO-116). There was no appearance of corona up to 5000 V_{dc}; leakage was reduced from 10μA to <0.001μA at 1000V. RTV encapsulation suffered dimensional mismatch, straining and snapping leads, with 500 V/mil bulk breakdown.

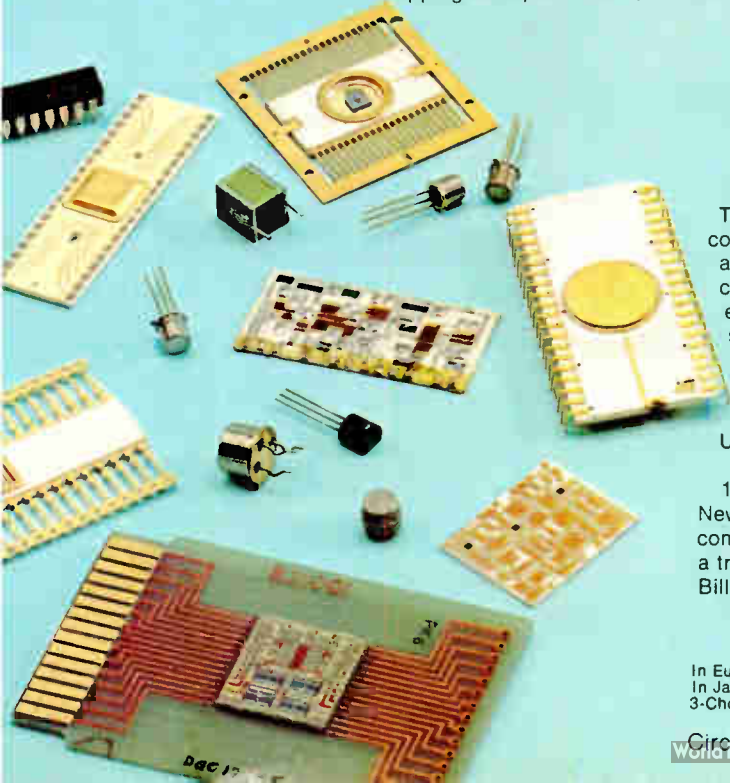

Crevice penetration in hybrids

This beam lead has a 0.3 mil parylene coating all the way to the weld. Parylene penetrates deep within small crevices, maintaining clearance while putting a coherent coating under beam leaded chips and air bridges. No area is left unprotected, preventing shorts and allowing the designer great latitude in component spacing and sizing. And parylene secures loose debris while preventing breakoff of pigtailed during shock and vibration loadings.

Lead Strengthening

It took up to 75 grams pull to break these 1 mil wires. Bare 1 mil aluminum wires, for instance, exhibit bond strengths of 3-5.5 grams; coated with 1 mil of parylene, pull strength increases by 60-70 grams.

So wire and bond are stronger, and sideward shorts and loop collapse during extreme g-loads are prevented. Parylene coatings will penetrate the less than 1 mil clearance between beam lead bonded chips and the substrate, giving such strong coating coverage that the chip cannot be lifted without destroying it.

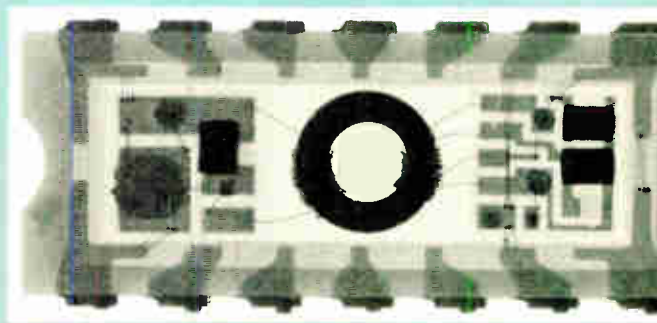

X-ray courtesy NASA Lewis Research Center and Sterer Eng. & Mfg. Co.

Broad cost effectiveness

These are some of the circuit modules now being protected with a conformal coating of parylene. Because nothing else offers parylene's combined protection against thermal cycling, shock, vibration, humidity, solvents, radiation, ionic contamination. Better barrier protection than liquid coatings like silicones, epoxies, and urethanes. On hybrids you can combine parylene with a hermetic seal for optimum environmental protection . . . and parylene alone will often do the job, and at less cost than hermetic seals. Parylene is compatible with active devices, and meets the tough requirements of MIL-I-46058C.

For long term reliability, parylene provides a cost-effective solution.

Union Carbide invented the parylene system. Various patents apply; commercial use of the patented technology is licensed. Write for our 16-page brochure: Union Carbide Corp., 270 Park Avenue, Dept. RFB-65, New York, N.Y. 10017. For instant communication, and information about a trial run at reasonable cost, call Bill Loeb at (212) 551-6071.



In Europe: Mr. Peter Crook, Bakelite Xylonite Limited, Redfern Road, Tysley, Birmingham, England.
In Japan: Mr. N. Fusada, Tomoe Engineering Co. Ltd., Shin Shin Kai Bldg., 14-1 Nihonbashi 3-Chome, Chuo-Ku, Tokyo.

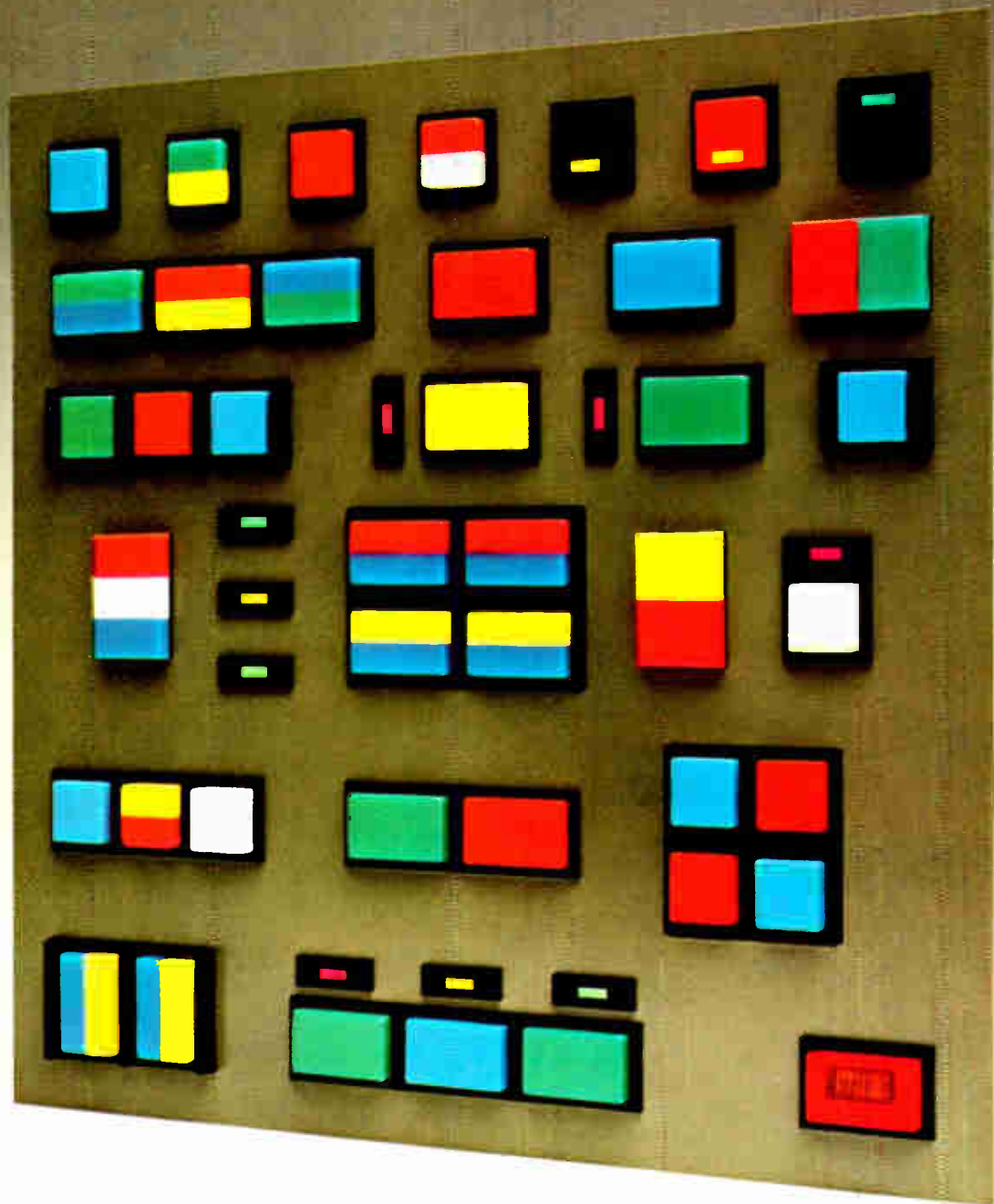

The first good-looking pushbutton that looks

Until recently, if a pushbutton looked good, its electrical flexibility usually didn't. And if it offered electrical flexibility, it usually didn't offer much in the way of looks.

Then MICRO SWITCH introduced the AML (Advanced Manual Line) pushbuttons and indicators. The most comprehensive line ever designed.

AML devices have been designed for appearance by industrial designers. Button height, bezel size, and the compatibility of the square and rectangular shapes combine to "harmonize" your panel. Because the AML line is so broad, you won't have to end up with different looking units to perform different functions.

Displays range from split-screen and hidden-color to a unique, three-segment lens cap indica-

tor, all with transmitted or projected illumination, and a choice of lamps including a T-1 $\frac{3}{4}$ wedge base lamp, neon and LED.

The AML units have been designed to look good to electrical engineers, too.

Particularly in flexibility.

Three different electrically rated switches in the same size housing. You can choose solid state pushbuttons that operate at 5V or 6-16V with a built-in regulator, sink (TTL) and source (CMOS). Electronic control from logic switching to 3 amps, 120 VAC. And power control up to 10 amps at 120 VAC.

All AML units have been designed to offer the same shallow depth, to provide a unique



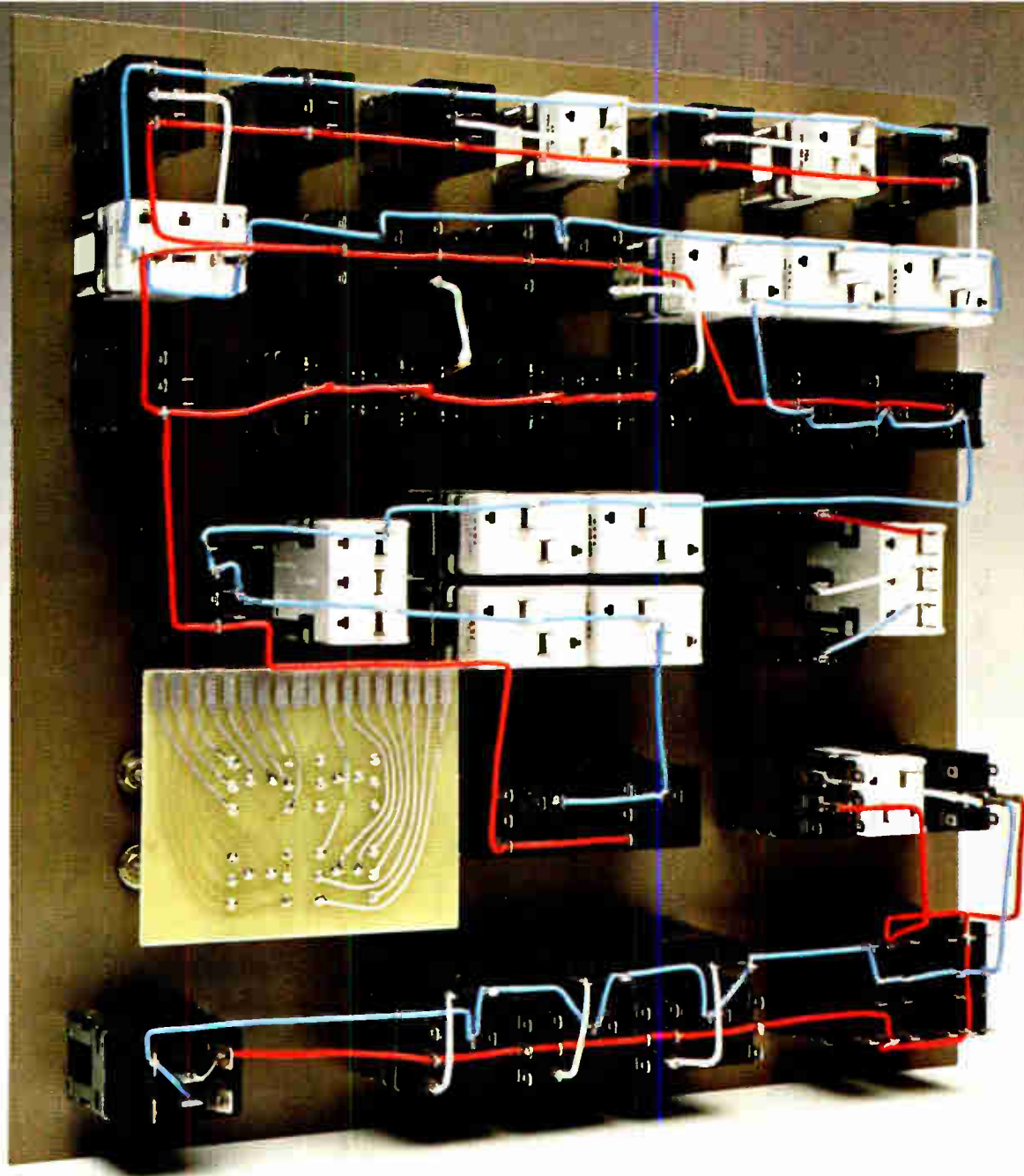

just as good when it's time to wire it.

single level termination. Which means easier wiring and a neat, "clean" appearance. You can either snap them in place from the front, or sub-panel mount them, using individual, strip or matrix mounting hardware.

There's no problem with international acceptance, either. Every AML device is designed to meet the requirements of IEC, CEE24, UL and CSA standards.

But we believe there's more to building better panels than just offering better pushbuttons

and indicators. That's why we have MICRO SWITCH personnel available to help you solve your specific panel design problems on a personal basis. For more information, write for our "Control Panel Layout Design Guide." Or call your nearest MICRO SWITCH Branch Office or Authorized Distributor.

Either way, you'll end up with one thing. A pushbutton that works as well as it looks.

MICRO SWITCH

FREEPORT ILLINOIS 61032

A DIVISION OF HONEYWELL

Circle 170 for Data, 171 for Salesman call.



Alabama still has room for profitable growth.

For the third straight year, capital investments announced for new and expanding industries in Alabama were over one billion dollars. (Only one other southeastern state has ever announced new capital investments exceeding the billion-dollar mark in a single year.)

The fact is, industries and businesses still find Alabama a profitable environment in which to locate, expand and grow.

Alabama has a labor training program that can supply you with qualified workers—at no cost to you for the state-supported training service. In 1975 alone, some 5,000 people were trained to meet industrial needs.

Chances are good that whatever else your needs might be—energy sources, available land, or navigable waterways—Alabama has that, too.

And Alabama Power will help you find it.

Just write G.T. Nelson, Vice President, Alabama Power Company, Industrial Development Department, Box 2641, Birmingham, Alabama 35291. Tell us what you need. We'll help you find it. Because Alabama wants you.

Alabama's Open for Business. ap

HERMES LOOP ANTENNA

THREE SAMPLE SITES
ON THE NORTH AMERICAN
CONTINENT —

DIFFERENT LATITUDES
DIFFERENT CLIMATE



64°N



42.5°N

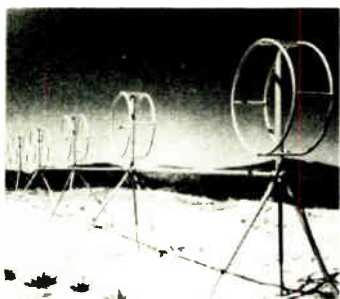

32.5°N



Good Listeners maintain a low profile

Even in the solitude of the forest depths, from rooftops, arctic tundra, swamps to sweltering tropics, 'neath snow, sand or ice, the Hermes Loop antenna keeps an ear to the sky. The amazing aperiodic antenna does away with vast log periodic and rhombic arrays - those towering antenna farms.

In rosette configuration, the Hermes loop antenna provides an omnidirectional broadband receiving array in space merely 1/100th that of the traditional antenna farm.

More than 53 government agencies around the world have pressed the loop antenna into service.

A new, even more compact version is available. Only Hermes Electronics makes it.

**2-32MHz
BROADBAND**



ASK US Send for our Brochure

Hermes Electronics Limited

Suite 315

2020 F Street NW

Washington, DC 20006 USA

202-296-2978

TWX 710 822 1106

4051 personal computing:

Ask a BASIC question, get a Graphics answer.

Compare Tektronix' 4051 to any other compact computing system. There's a Graphic contrast.

Wide-ranging performance right at your desk. BASIC power. Graphics power. Terminal capability. You've got instant access to answers, all from one neat package.

Easy-to-learn, enhanced BASIC. We took elementary, English-like BASIC, and beefed it up for more programming muscle. We've designed it with MATRIX DRAW, features like VIEWPORT,

WINDOW, and ROTATE, to help you get your teeth into Graphics almost instantly.

There's a Graphic contrast. The 4051 will handle most application problems. But for your most complex problems, the 4051's Data Communications Interface option can put you on-line to powerful Graphic applications that no stand alone system can tackle.

Just \$6995.* Less than most comparable alphanumeric only systems. Including 8K workspace, expandable to 32K, with 300K byte cartridge tape drive, full Graphics CRT, upper/lower case, and all the BASIC firmware.

Talk to Tektronix today! Your local Sales Engineer will fill you in on our 4051 software. Our range of peripherals. Our flexible purchase and lease agreements. And he'll set up a demonstration right on your desk. Call him right now, or write:

Tektronix, Inc.
Information Display Group
P. O. Box 500
Beaverton, Oregon 97077



TEKTRONIX®

Circle 174 on readerservice card

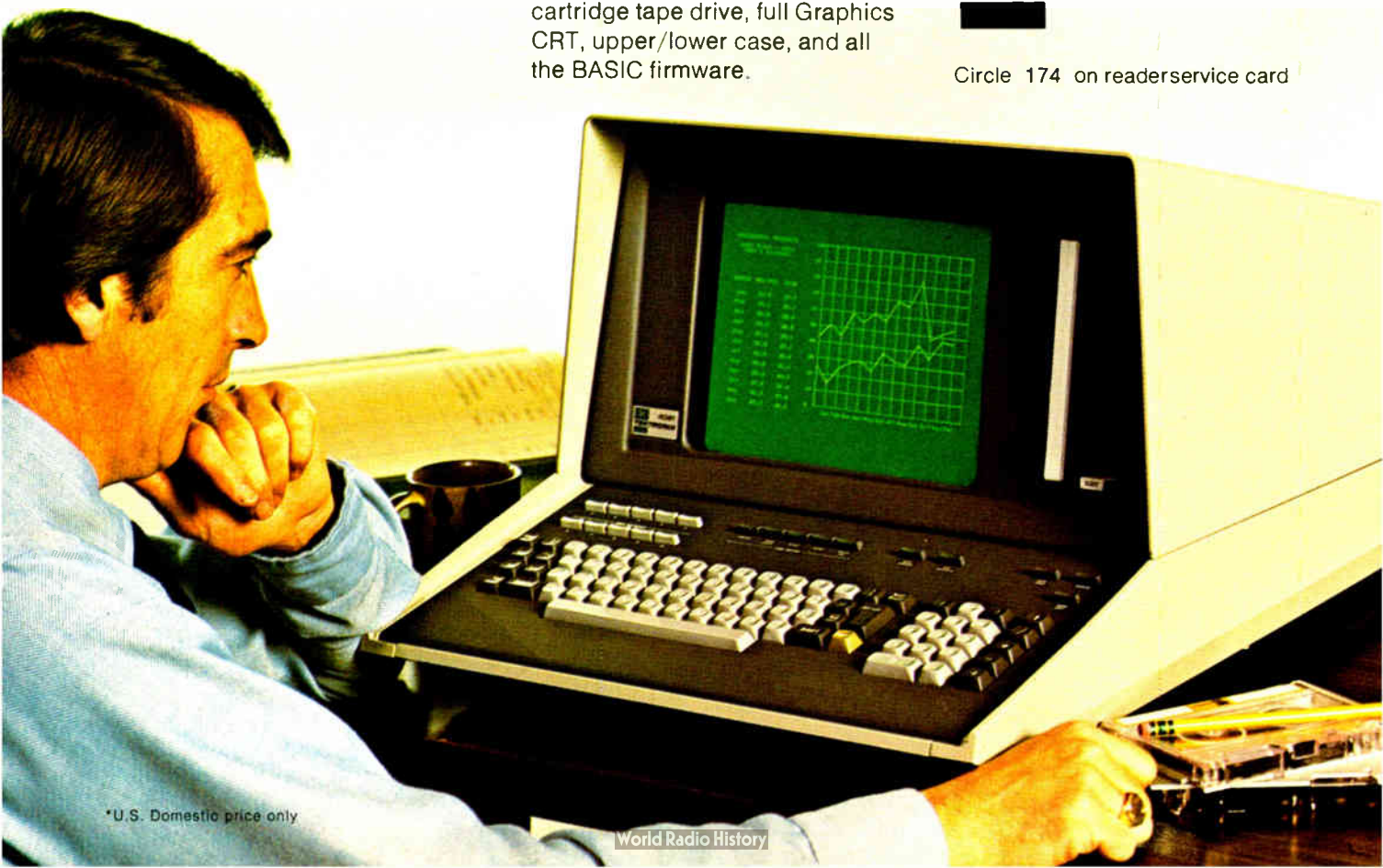

*U.S. Domestic price only

World Radio History

New products

Data handling

Handling tape at 75 in./s

Floating-shuttle transport eliminates vacuum-column types, has constant tension

A high-speed floating-shuttle tape transport from Qantex can handle tape speeds up to 75 inches per second without the complexities of vacuum-column transports which were previously required for speeds above 45 in./s.

High-speed digital tape transports must stop and start the tape within milliseconds of the host computer's command. Although the capstan system can accelerate and decelerate the tape itself in the short time intervals required, it's difficult for the reel motors to do the same for the two heavy reels. Conventional transports use either mechanical or vacuum-column tape buffering to allow the capstan to get the tape off to a fast start, while permitting the takeup and supply reels to accelerate or decelerate more gradually.

For tape velocities from 12.5 through 45 in./s, tension-arm buffers of progressively increasing complexity have become standard. Beyond 45 in./s, because buffer inertia problems increase with the square of tape velocity, tension arm methods no longer solve the problem. Consequently, tape transport designers have been obliged to resort to elaborate vacuum-column buffering for 75 in./s and higher speeds.

Qantex's shuttle-buffering principle is actually an evolutionary step from the conventional tension-arm method. Since both tension arms swing in the

same direction during acceleration and deceleration, the two arms could be replaced by a single arm carrying two tape-idling rollers. If this hypothetical single-tension arm were made infinite in length, then the two idler rollers would move up and down in a straight-line path, instead of an arc. Thus, Qantex dispensed with the single-tension arm altogether, thereby eliminating the mass of the arms, and arranged for the two tape idlers to be mounted on a lightweight framework that is constrained to travel up and down, in response to capstan acceleration and deceleration.

Displacement of the shuttle from its central, neutral position develops a signal that sets the nominal speed of the two reel motors. A further sensing device monitors tape tension, providing a control signal that increases one motor's torque and decreases the other's to provide constant tape tension under all modes of operation. The new tape transport is built with about 30% fewer parts than vacuum-column transports, for reduced weight, simpler design, lower power consumption, and improved reliability. The noise created by the vacuum column's rushing air also is eliminated, and so is the suction system, which has a tendency to pull dust and other particles into the vacuum chamber. In addition—because vacuum methods

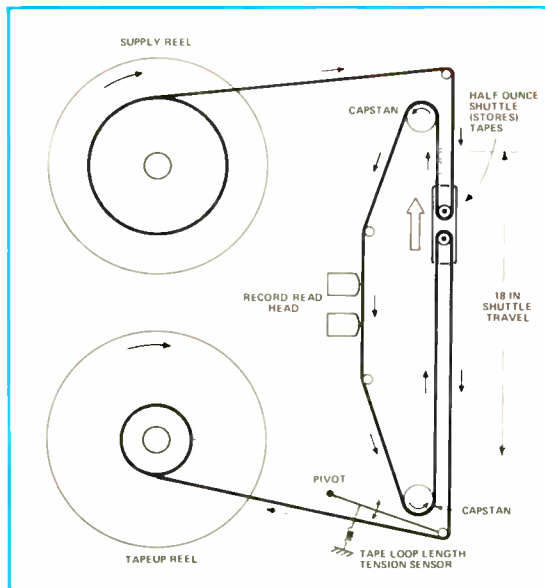

Some open talk about open frame Q SERIES power supplies

We're so open about our Q Series Open Frame Power Supplies because we want you to know everything about them. Like our one year warranty. And stock delivery. About our thermal design, the best around, making our heat sensitive parts run cooler and operate longer. And we're the **only** maker of Open Frame Power Supplies where all components operate well within mfrs. specs.

That's why Deltron "Open Frames" save you money three ways: When you buy them. By avoiding costly downtime. And by lasting longer.



Forward and reverse voltage protection
Barrier block interface
Infinite resolution adjustments
Full interchangeability
115/230 vac, 47-440 hz



Socketed IC regulation system
Filters meet mfrs. ripple ratings
Glass epoxy PC boards
Loss of sense protection
Designed for U.L. Recognized Component Index



Socketed power semiconductors
Iridized aluminum chassis
Computer grade electrolytics
Special circuits to protect IC

Choose from these models:

Size A	Size B	Size C	Size D	Size F
Model No.	Model No.	Model No.	Model No.	Model No.
volts — amps	volts — amps	volts — amps	volts — amps	volts — amps
0.5 — 3.0	0.5 — 6.0	0.5 — 9.0	0.5 — 12.0	0.5 — 18.0
0.6 — 3.0	0.6 — 6.0	0.6 — 9.0	0.6 — 12.0	0.6 — 18.0
0.12 — 1.7	0.12 — 3.4	0.12 — 5.7	0.12 — 7.0	0.12 — 10.8
0.15 — 1.5	0.15 — 3.0	0.15 — 4.8	0.15 — 6.3	0.15 — 9.4
0.18 — 1.3	0.18 — 2.6	0.18 — 4.0	0.18 — 5.2	0.18 — 7.8
0.20 — 1.3	0.20 — 2.6	0.20 — 4.0	0.20 — 5.2	0.20 — 7.8
0.24 — 1.2	0.24 — 2.4	0.24 — 3.3	0.24 — 4.8	0.24 — 7.2
0.28 — 1.0	0.28 — 2.0	0.28 — 3.1	0.28 — 4.2	0.28 — 6.0
Dimensions	Dimensions	Dimensions	Dimensions	Dimensions
4" x 4 1/2"	5 5/8" x 4" x 2 1/2"	7 1/4" x 2 1/2"	9 1/2" x 2 1/2"	13 1/4" x 2 1/2"
Price	Price	Price	Price	Price
1 — \$37.00	1 — \$54.00	1 — \$67.00	1 — \$87.00	1 — \$113.00
100 — \$26.00	100 — \$44.00	100 — \$54.00	100 — \$70.00	100 — \$91.00
250 — \$24.00	250 — \$41.00	250 — \$51.00	250 — \$66.00	250 — \$85.00

For some more open talk about Deltron Q Series and a copy of our Comparative Engineering Reports, write or call collect to Deltron, Inc., Wissahickon Avenue, North Wales, Pa. 19454, Telephone: 215-699-9261, TWX 510-661-8061.

Deltron inc.

SLIMSWITCH

**DIGITRAN QUALITY
AT LESS THAN 25¢ PER POSITION**

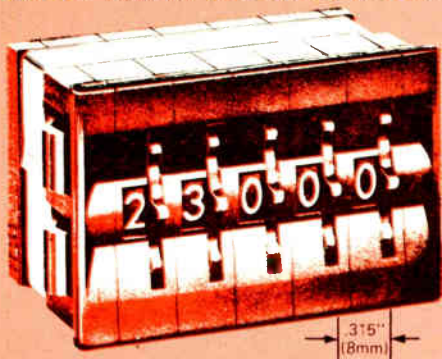

Series 23000 "SNAP-IN" SLIMSWITCH

They're low cost switches, but their life expectancy is still over 1,000,000 detent operations.

- Only .315" (8mm) wide.
- Assemble without the use of tools.
- Install without the use of tools or hardware.
- Available from local distributor stock.
- Specials available from the factory.

Send for a Series 23000 "SNAP-IN" SLIMSWITCH Data Sheet.

DIGITRAN®

Pasadena, California 91105 • Phone (213) 449-3110

For more information use the Inquiry Form provided on this page.

INQUIRY FORM

1. DO YOU WANT MORE INFORMATION? Yes, send data about:
 KL MINIKEY Keyboard Series 8000 MINISWITCH Series 23000 SNAP-IN SLIMSWITCH Series 29000 ECONOMY MINISWITCH Series 12000 MINIBUTTON Series 24000 DIGILEVER Series 28000 MINILEVER QPL Approved DIGITAL SWITCHES DIGITAL VOLTAGE DIVIDER and RESISTANCE DECADE Catalog Send me your complete "DIGITAL SWITCH" Catalog. Send a

Sales Engineer to see me. My phone is: (_____) _____

2. Is the purchase of this type product anticipated? Yes No. If "Yes", what is your application? _____
3. Is your requirement: Current 1-3 months 3-6 months longer?
4. How many assemblies per year? under 100 100-500 500-1000 or more.
5. Are you responsible for: Design Specification Purchasing?
6. Have you specified or purchased products of the type made by Digitran in the past? Yes No. If yes, whose? Digitran
 Other _____
7. Have you ever been contacted by a Digitran Sales Representative? Yes No. If "Yes", When? Recently 3-6 months ago 6-12 months ago 12 months or more.

Name _____ Title _____

Company _____

Address _____

City _____ State _____ Zip _____

For detailed information about Digitran's products, please complete this INQUIRY FORM, clip and send it to:

THE DIGITRAN® COMPANY

A Division of Becton Dickinson Company

BD

E/10/76

855 South Arroyo Parkway • Pasadena, California 91105

New products

don't work at low ambient air pressure—for unpressured aircraft applications, vacuum-column transports must be hermetically sealed in vacuum-tight enclosures, Qantex engineers point out.

The new transport handles tape reels up to 10½ inches in diameter, accommodating up to 2,400 feet of ½-inch magnetic tape. The unit records and reads bidirectionally at 75 in./s, equivalent to a data rate of 120,000 bytes per second at 1,600 bits per inch. Standard recording modes are 800 bits/in. NRZI, or 1600 bits/in. phase-encoded, providing either seven-track or nine-track operation.

In single quantity, the floating-shuttle tape transport is priced at \$4,400, with prices decreasing rapidly for OEM-quantity orders. A militarized version of the transport also is available.

North Atlantic Industries, Qantex division, 200 Terminal Drive, Plainview, N.Y. 11803. Phone (516) 681-8600 [361]

Cassette transport operates at 10 inches per second

A digital cassette tape transport system from Braemar uses the company's developed CD-200 transport for a compact data recording system at a reasonable cost. The new system, called the CS-400, is ideal for microprocessor use, requires only one supply voltage (between 14 and 30 volts) and is totally TTL compatible. Operation is also feasible at voltages below 14 volts, the company says.

The CS-400's electronic package accepts and delivers serial digital data at TTL levels at an 8,000-baud rate. The unit operates at a nominal density of 800 bits per inch at 10 inches per second, with other speeds and densities optional. Its C-MOS circuitry assures low power consumption.

The system has two-channel capability, and both tape tracks are available for data. The active channel is determined via TTL command, and the user can write on one track.

WE'RE WARNING YOU...

... it's easy to design instrument panel warning systems around these NEW panel mounted solid state audio indicators. Choice of six models . . . supplied with .250" (6.4mm) quick-disconnect tabs. Pleasing continuous or pulsing tone gets attention. Rated 85 dbA at 800 Hz . . . 5 to 15 vdc, 15 to 30 vcc and 30 to 50 vdc. Special frequencies available on large orders. Fits 1.125" (28.5mm) opening, with optional adapter ring (Model AI-301) for larger openings. Rugged reliability . . . tested for minimum 1000 hours operation at maximum rated voltage. Solid state circuitry means no arcing, RF noises or electrical interference. Compact . . . weighs just 50 grams. Ask for new free catalog.

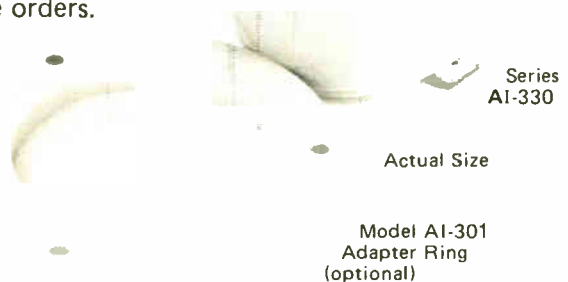

Where to buy an audio indicator for every need



3680 Wyse Road, Dayton, Ohio 45414
Tel. (513) 890-1918, TWX 810-450-2523

Selected distributorships available.

CALIFORNIA, COSTA MESA
MarVac Electronics

MASSACHUSETTS, SHARON
Adcour

MICHIGAN, FARMINGTON
CMP Distributor Co.

NEW YORK, ROCHESTER
Ossmann Components

OHIO, CLEVELAND
CMP Distributor Co.

OHIO, CINCINNATI
COLUMBUS
Hughes Peters, Inc.

TEXAS, DALLAS
K. A. Electronics

UTAH, SALT LAKE
Newark Electronics

WASHINGTON, SEATTLE
Frank Jackson & Associates

WISCONSIN, MILWAUKEE
Taylor Electric

ONTARIO, WILLOWDALE
Electro Sonic, Inc.

B. C., VANCOUVER
Deskin Sales Corp.

For information circle 244 on reader service card

For salesman circle 179 on reader service card

Stay current with small lamp data from General Electric. It's free.

**Check these 6 halogen cycle lamps
GE has added to its low-voltage line.**

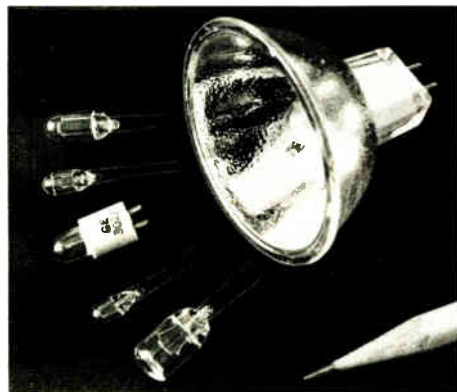

General Electric now offers over 27 halogen cycle lamps that pack high light output in small packages. (In addition, GE offers 8 sealed beam halogen lamps primarily for aircraft applications.) Bulb diameters range from $\frac{3}{8}$ " to $\frac{1}{2}$ ". Lengths from .520" to 2.25". Voltages from 3.5 to 28. O.V. And candlepower from 2.15 cd up to 250 cd.

They're ideal for you if you're designing applications such as optical systems, instrumentation, illuminators, fiber optics, card readers, displays and aircraft navigation. A variety of terminals are offered.

For updated technical information circle the number below or write GE for Bulletin #3-5357.

**These GE wedge base miniature lamps offer
you savings in time, money and space.**

These lamps are ideal for applications such as indicators, markers and general illumination where space is at a premium. Their wedge-based construction makes them easy to insert and remove. They don't require bulky, complicated sockets. And because the filament is always positioned the same in relation to the base, you get consistent illumination from lamp to lamp.

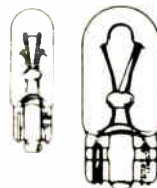

You can choose from over 25 types of GE wedge base lamps. Voltages range from 6.3 V to 28 V. Candlepower from 0.03 to 12 cd. Bulb sizes range from subminiature at 6mm to a heavy-duty bulb at 15mm.

To send for updated wedge base lamp technical information, circle number below or write GE for Bulletin #3-5259.

**These three free GE catalogs include
important data changes that could affect
your present design. Send for yours today.**



#3-5169

June '75 Miniature lamp catalog features 40 pages and 500 data changes for complete 500-lamp line.



#3-6252R1

Feb. '75 Sub-miniature lamp catalog features 24 pages and 91 changes for more than 210 lamps.



#3-6254R

Dec. '74 Glow Lamp catalog features 8 pages and 50 changes for 83 Glow Lamp Indicator and Circuit Component lamps.

For up-to-date technical information on any of these items write: General Electric Company, Miniature Lamp Products Department #3382-M, Nela Park, Cleveland, Ohio 44112.

GENERAL  ELECTRIC

New products

switch channel, change direction, and continue writing on the other track, without having to rewind the tape.

The system uses the Manchester phase-encoding technique and provides ANSI-compatible data. For improved accuracy, the system uses Auto Sync, a decoding scheme with internal compensation for bit-to-bit variations. Auto Sync also allows the customer to record close to startup and obtain short inter-record gaps. Since Auto Sync is self-clocking and is operated from the data channel, the second channel is retained for data applications.

The price is \$350 each in 1,000 quantities.

Braemar Computer Devices Inc., 11950 Twelfth Ave. South, Burnsville, Minn. 55337.

Phone (612) 890-5135 [362]

Computer Automation adds
direct memory access

Computer Automation Inc. has added a direct-memory-access capability to its distributed I/O systems, which now interface peripherals to the company's Alpha/LSI family of minicomputers. The new DMA I/O distributor is a single printed-circuit card (approximately 7 by 16 inches) that handles up to four different low- and medium-speed peripherals simultaneously, in any mix, serial or parallel. It is designed to enable existing peripherals to run in a DMA mode without having to rewrite application software or to discard existing I/O interface hardware.

Each peripheral is controlled by a microcoded processor (called a PicoProcessor) embedded in the peripheral connecting cable. The microcoding performs all device interfacing, protocol, formatting, and error-checking. The distributor thus converts each "intelligent cable" in the I/O Distributor system to DMA. DMA I/O also supports programed I/O or interrupt I/O to enable the user to run DMA or non-DMA without the need to purchase added distributors.

Because the PicoProcessors are

Ask Control Data

**CYBERNET® Services for
turnaround that'll give
you answers now.**

We have it.

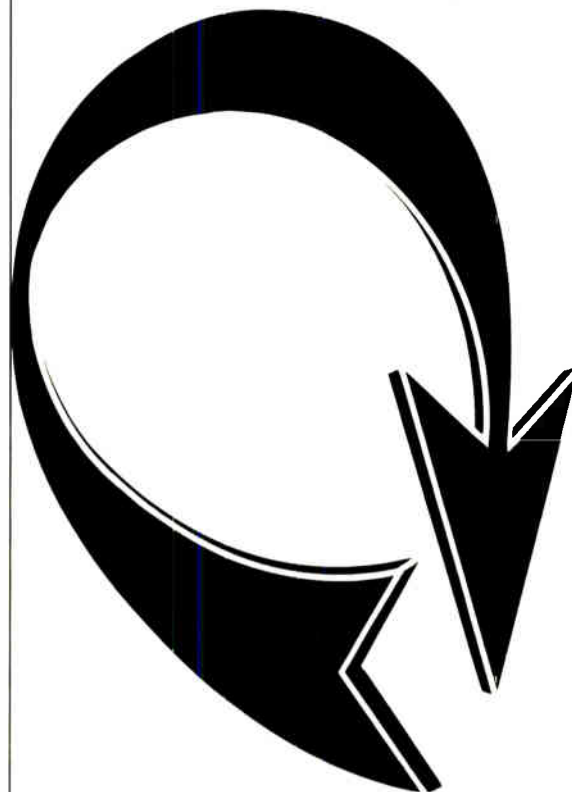

CDC® CYBER 76 Service has some surprises for you, if you've only thought of it in terms of big, unique, long-run problems. It handles those, of course, just as expected. Faster and more accurately than any other system.

But more and more **CYBERNET** Computer service users are finding that the huge capacity, speed and precision of the **CDC CYBER 76** pays off for a wide variety of applications. Pays off by getting you answers in seconds, instead of hours. Less waiting for you and all the people waiting for your answers.

And, here's a real payoff. Benchmark runs by a number of companies show significantly lower processing costs compared to their conventional method of processing.



Let us show you the spectrum of **CDC CYBER 76 Service** applications programs available. For information, contact your nearby **CYBERNET Center**; write to **CDC, Box 1980, Twin Cities Airport, MN 55111**; or call our hotline, collect **612/853-7600**.

CYBERNET Service Centers are in more than 50 cities in the U.S. and Canada.

**GD CONTROL DATA
CORPORATION**

33% more power to the people.

**Power/Mate presents
Econo/Mate II.**

The open frame power supply.

Now Power/Mate brings you 33% more power in the same package size with the second generation of our Econo/Mate series.

The size is the same, the basic components are the same for easy interchangeability. But that's where the similarity ends.

Econo/Mate II adds features like dual AC primary and a plug-in IC regulator for improved regulation.

And Econo/Mate II is tough. Computer design, quality control and Power/Mate's experience helps insure 100,000 hr. MTBF even at this higher power output.

But for all its features, Econo/Mate II is still, most of all, economical.

We wouldn't call it Econo/Mate if it wasn't.

Econo/Mate II is in stock, ready for delivery. Send for our free brochure.

Prices start at \$19.95.

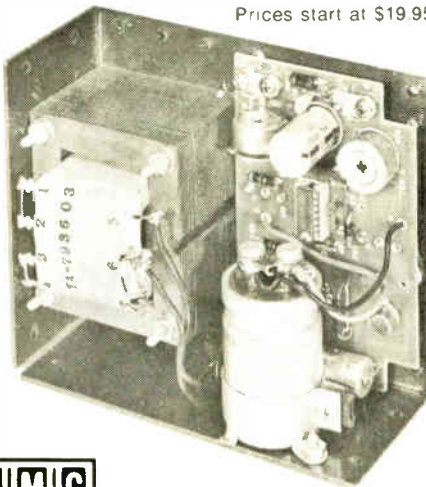

POWER/MATE CORP.

World's largest manufacturer of quality power supplies

514 South River Street/Hackensack, N.J. 07601 / Phone (201) 343-6294 TWX 710-990-5023

Circle 180 on reader service card

New products

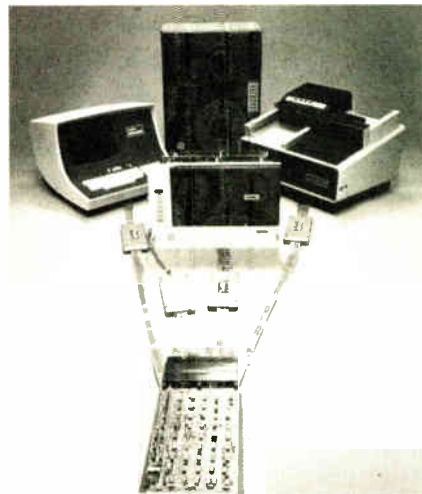

microprogramed, only a few different versions are required to interface to a wide range of standard and special-purpose peripherals. Intelligent cables containing the PicoProcessors are available for serial or parallel interfaces. The serial version communicates with such devices as Teletypes, terminals, modems, and special devices that might include keyboards, badge readers, and control panels. The parallel version interfaces with such standard peripherals as paper-tape readers and punchers, line printers, card readers, and various general-purpose devices.

Computer Automation, Inc., 18651 Von Karman, Irvine, Calif. 92664. Phone (714) 833-8830 [363]

Programmable RAM aids microprocessor design

Memory contents can be altered in-circuit with a KPRAM (Keyboard-Programmable Random-Access Memory) that is used in the development of microprocessors, minicomputers and other digital systems. Taking the place of a ROM or PROM, the unit contains a RAM, 16-key keyboard, address switches, and a display button for benchtop use. Hexadecimal byte data is entered into the KPRAM by keyboard and is in-circuit, byte-alterable. Memory address is selected by toggle switches. The data bus is three-state and de-

VECTOR-PAK SYSTEM SOLVES PACKAGING PROBLEMS

- CAGES NOW AVAILABLE FULLY OR PARTIALLY ASSEMBLED.
- NEW EASY-TO-ORDER NUMBERING SYSTEM.
- BUILT IN ADJUSTABILITY AND FLEXIBILITY TO SOLVE YOUR PACKAGING PROBLEMS.

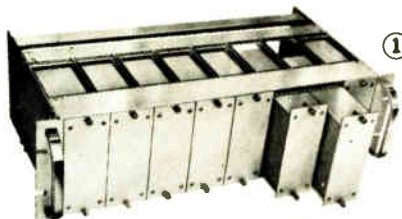

①

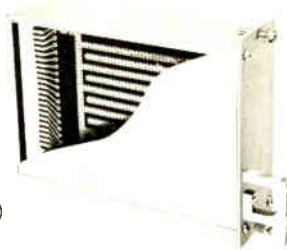

③

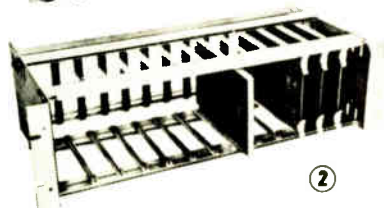

②



④

- ① Rack mountable cage and module systems available in 3 1/2", 5 1/4", 8 3/4" heights and 9", 12", 15" depths. Immediate availability — assembled or kit versions.
- ② Card Cages with plastic or aluminum guides located on .15", .25", or .3" multiples.
- ③ EFP cases with card slots, slide out sides — many sizes.
- ④ Multi-Mod Cases with card slots enclose circuitry for elegant instruments.

Also Available — Plug-In cards for microprocessors, ICs, etc. — many sizes and patterns.

Send for new specification sheets.
NIM bins and modules also available.

Vector ELECTRONIC COMPANY, INC.
12460 Gladstone Ave., Sylmar, California 91342
Phone: (213) 365-9661 ■ TWX (910) 496-1539



32476

180 Circle 245 on reader service card

Electronics/June 10, 1976

SELECTIVE MIXTURE.

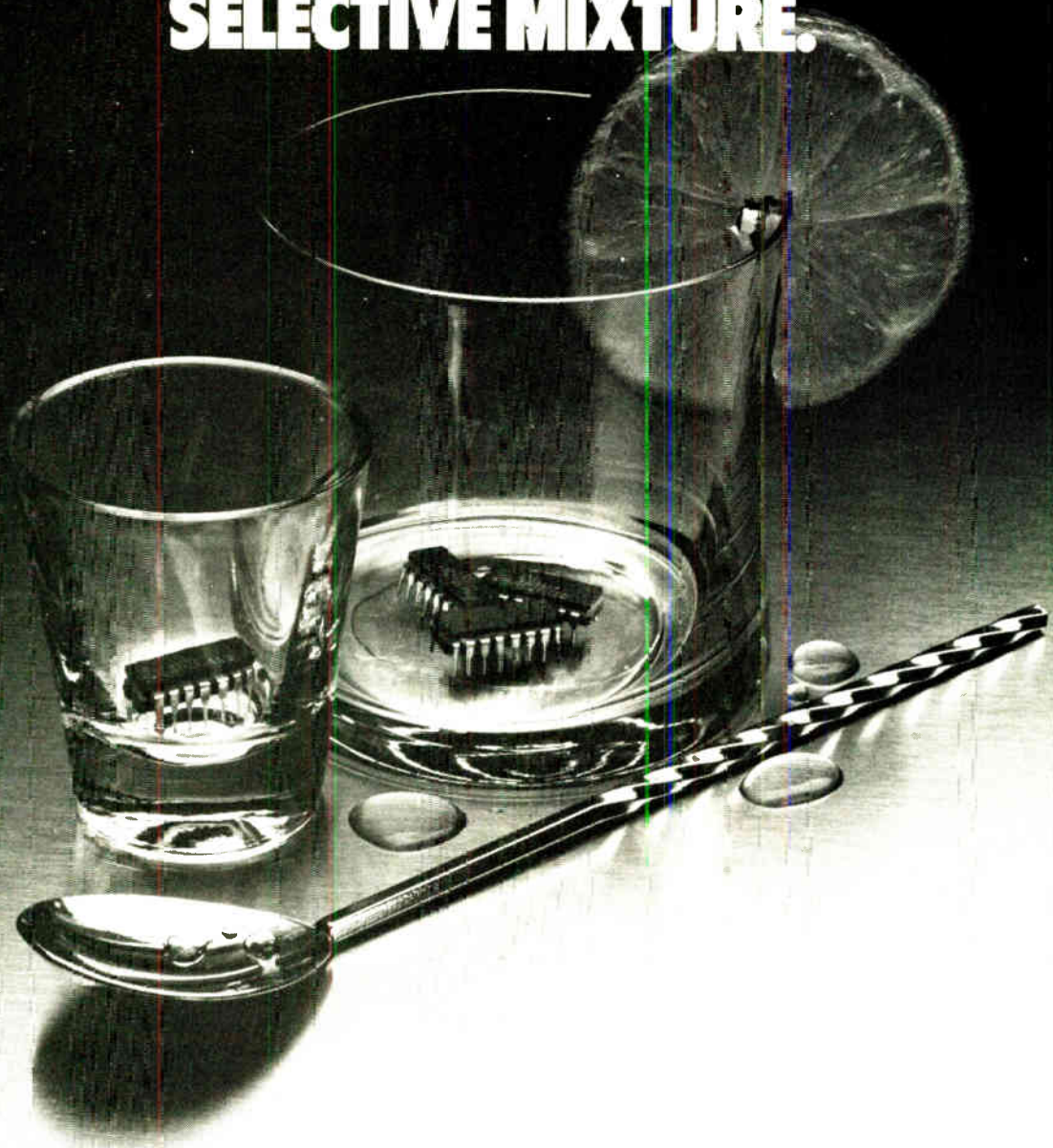

It's time to toast the 54C/74C and 4000 series logic families.

Because while they've always been electrically compatible, now many of the functions are pin-for-pin compatible.

So here's to a selective mixing of them in your system.

You'll find that mixing these two CMOS families gives you more available functions from which to choose.

So your chances of finding the right ones are better.

And it minimizes the amount of CMOS devices you need to implement the logic.

In addition, you can take advantage of each family's vintage features for better overall performance.

Features such as higher guaranteed noise margin, greater output drive, and the higher speed of the 54C/74C series.

When you're ready to set up these CMOS families in your system, your Harris distributor can mix in the right ingredients.

We're not only a qualified supplier of both CMOS series devices, but also your number one source.

Which means better delivery, as well as guaranteed availability of any new series devices that are introduced on the market.

For more information on how we can help you have a more efficient CMOS system, just call our CMOS Application Information Hot Line at 800-327-8934.



HARRIS
SEMICONDUCTOR
A DIVISION OF HARRIS CORPORATION

P.O. Box 88C, Melbourne, Florida 32901 (305) 724-7412

WHERE TO BUY THEM: OEM SALES OFFICES: CALIFORNIA: Long Beach (213) 426-7587, Palmdale (415) 964-6443 **FLORIDA:** Fort Lauderdale (305) 971-3200, Melbourne (305) 724-7430 **ILLINOIS:** Hinsdale (312) 325-4141 **MASSACHUSETTS:** Wellesley Hills (617) 237-5433 **MINNESOTA:** Minneapolis (612) 335-2505 **NEW YORK:** Endwell (607) 754-5464, Melville LI (516) 249-4530 **OHIO:** Dayton (513) 222-7636 **PENNSYLVANIA:** Wayne (215) 687-6680 **TEXAS:** Richardson (214) 231-9031

SALES REPRESENTATIVES: ARIZONA: Scottsdale (602) 941-5590 **CALIFORNIA:** Los Angeles (213) 870-9191, Mountain View (415) 961-2121, San Diego (714) 565-9444 **COLORADO:** Denver (303) 773-0666 **CONNECTICUT:** East Norwalk (203) 838-1493 **FLORIDA:** Boca Raton (305) 395-6108, Oviedo (405) 355-3222, Tampa (813) 933-3183 **ILLINOIS:** Elk Grove Village (312) 640-1250 **INDIANA:** Indianapolis (317) 849-6454 **IOWA:** Cedar Rapids (319) 393-6562 **KANSAS:** Wichita (316) 943-6211 **MARYLAND:** Randallstown (301) 922-1248 **MASSACHUSETTS:** Burlington (617) 273-1313 **MICHIGAN:** Farmington (313) 476-2446 **MISSOURI:** Hazelwood (314) 731-5793, Kansas City (816) 761-6443 **NEW JERSEY:** Keasbey (516) 567-9900, West Caldwell (516) 567-5300 **NEW MEXICO:** Albuquerque (505) 265-5655 **NEW YORK:** Albany (518) 489-7408, 4777 Huntington Station (516) 517-5900 **OHIO:** Cleveland (216) 831-8292, Dayton (513) 890-2130 **OREGON:** Beaverton (503) 643-6444 **PENNSYLVANIA:** Allison Park (412) 487-4300, King of Prussia (215) 265-0634 **TEXAS:** Dallas (214) 691-4592, Houston (713) 661-3007 **VIRGINIA:** Falls Church (703) 534-7200, Lynchburg (804) 237-4741 **WASHINGTON:** Bellevue (206) 454-0300 **CANADA:** Montreal (514) 636-6723, Ottawa (613) 749-0742, Toronto (416) 676-1042

NATIONAL DISTRIBUTORS: Hamilton/Avnet, The Harvey Group, Inc., Schreiber Electronics, R.V. Westerman Company

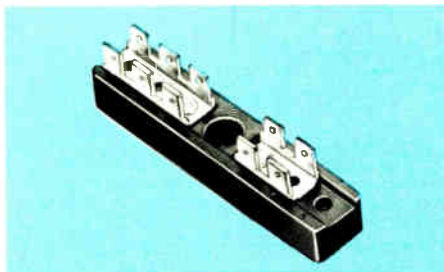

Sometimes it's important to have the right disconnections.

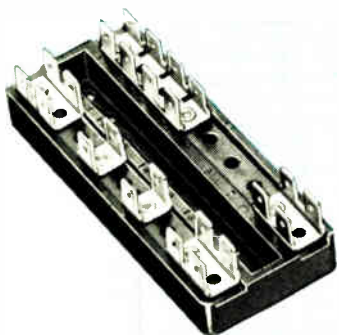
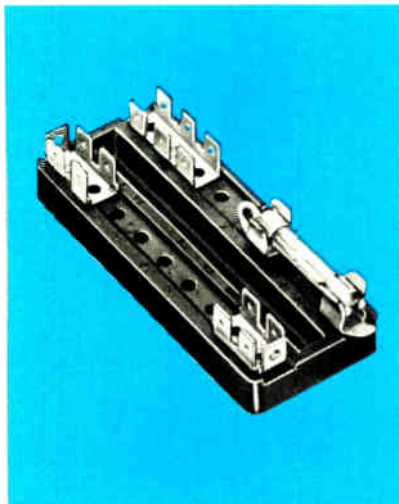

Consider the molding compound. Elmec did and chose Plenco.

Many quick-disconnect terminal arrangements can be made on the standard terminal blocks produced by Elmec Products Co., Chicago.

The blocks are molded of our Plenco 544 Black General-Purpose Phenolic Compound. Elmec writes why:

"A phenolic recognized by U.L. for terminal blocks, your material was chosen for its ease in molding combined with a faster cure to enhance production. Plenco 544 also fulfills our other production requirements," continues this manufacturer, "enabling us to

purchase larger quantities of raw materials."

End of quote. But chances are only the beginning of your satisfaction when you, too, turn to Plenco for answers in thermosetting compounds.

PLENCO
THERMOSET PLASTICS

PLASTICS ENGINEERING COMPANY
Sheboygan, WI 53081

Through Plenco research . . . a wide range of ready-made or custom-formulated phenolic, melamine-phenolic and alkyd thermoset molding compounds, and industrial resins.

New products



pressed. Eight LEDs above the keyboard display information on the data bus continuously or display the contents of the memory on command. An optional power supply/battery pack, the BP-1, provides power backup and permits out-of-circuit programming. The KPRAM is available in four standard sizes: 256 words by 4 bits, 256 by 8, 512 by 4, and 512 by 8, with standard pinouts or user-wired adapter kit. Prices range from \$225 to \$325 for the KPRAM and \$150 for the BP-1.

Sunrise Electronics, 228 N. El Molino Ave. Pasadena, Calif. 91101. Phone Michael Byrne at (213) 793-7552 [366]

Compiler for Basic runs on 8080 microprocessor

The Micro Basic I software package includes a compiler, text editor, loader, debugger, and runtime support for use on the 8080 microprocessor. Using the well-known Basic language, the designer can program directly on the 8080 processor system. The software requires 32 kilobytes and can run on the Intellect Microcomputer Development System (MDS).

Ryan-McFarland Corp., 608 Silver Spur Rd., Rolling Hills Estates, Calif., 90274. Phone (213) 377-2353 [365]

High-level language for bit-slice microprocessors

A high-level programming language and compiler has been developed

A New Capacitor Line . . . from the Capacitor People

COMPLETE LINE OF FILM CAPACITORS

POLYESTER FILM FOIL AND POLYESTER METALLIZED FILM

- EXCELLENT QUALITY
- COMPETITIVELY PRICED
- VOLTAGES FROM 100 THRU 1000 VDC
- CAPACITANCE VALUES TO 10.0 μ F
- 5 TYPES IN 3 CONFIGURATIONS
- GREATER CAPACITANCE WITH SMALLER CASE SIZE

IMMEDIATELY AVAILABLE!

ERIE . . . the Capacitor People . . . now introduces a complete line of economically priced Film Capacitors, featuring a broad range of case sizes, mounting styles and capacitance values. Designed for coupling, by-pass and filtering applications, these capacitors are recommended for industrial, consumer and communications equipment. Available in 100, 200, 400, 600 and 1000 VDC in capacitance values from 680 pF thru 10.0 μ F. Featuring ERIE-quality in both aluminum metallized and aluminum foil, non-inductive construction.

You can't find a better source for capacitors than ERIE . . . the Capacitor People who give you a little more for your money.

Write today on your corporate letterhead for our five new Film Capacitor catalogs . . . or call Customer Engineering at 814/453-5611.



ERIE STYLE WMM
METALLIZED POLYESTER FILM



ERIE STYLE BMM
METALLIZED POLYESTER FILM

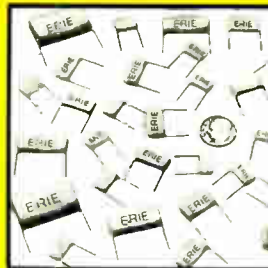

ERIE STYLE DMM
METALLIZED POLYESTER FILM



ERIE STYLE WMF
POLYESTER FILM
ERIE STYLE DMF
POLYESTER FILM



ERIE

ERIE TECHNOLOGICAL PRODUCTS, INC.
ERIE, PENNSYLVANIA 16501
814/453-5611

They've been around...



These Top 500 companies got there by using only products and services of the highest quality. That's one of the reasons they use Fibra-Sonics. They recognize the distinct advantages of using our ultrasonic fluxless soldering system for soldering metals, exotics, glass and ceramics.

The G-35 generator shown here delivers 35 watts of ultrasonic heated power into the soldering iron, and features push button controlled power levels of heat and sound energy.

Solid state circuitry assures you of worry-free durable performance. And auto-feedback and power tracking leads to perfect production every time.

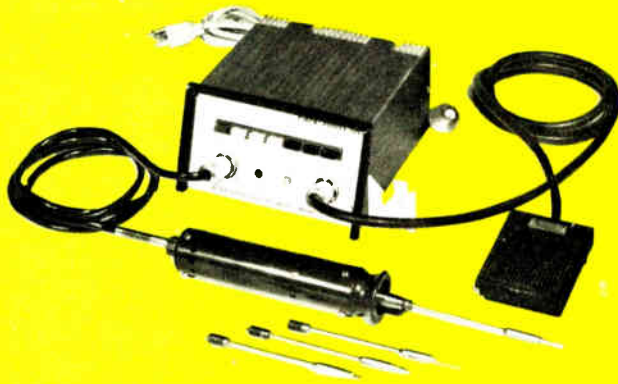

To find out how we can help you, send samples of your materials and a description of your requirements to Fibra-Sonics. We'll return them to you without cost or obligation.

FIBRA-SONICS, INC.

4626 N. Lamon Avenue • Chicago, Illinois 60630 / (312) 286-7377

Circle 184 on reader service card

Own your own holder to hold your own!

Hold your own copies of Electronics in specially designed slipcase holders. They'll keep your Electronics library neat and handy—a permanent information file, issue by issue.

Just complete the coupon and mail to Jesse Jones. He'll process your order upon receipt, postpaid.



ELECTRONICS BOXER
Jesse Jones Box Corporation
2250 E. Butler St., Philadelphia, Pa. 19137

Please send me: boxes @ \$4.25 each; 3 boxes @ \$12.00; 6 boxes @ \$22.00.
My check or money order is enclosed.

Name: _____

Address: _____

City: _____ State: _____ Zip: _____

New products

for use on Advanced Micro Devices' 2900 bipolar bit-slice micro-processors. Called DAPL, the language covers simple bit patterns as well as register transfer and also provides error-checking facilities. Microprograms can be as large as 8,192 words by 256 bits, syntax is free-form, and commands can help locate program segments at specific word or ROM boundaries, according to the manufacturer.

Zeno Systems, Inc., 2210 3rd St., Suite 110, Santa Monica, Calif., 90405. Phone (213) 396-6020 [364]

Head-per-track memory aimed at industrial uses

With a recording density of 3,320 bits per inch, the model 530C head-per-track disk memory is designed for random-access data storage in such applications as process control, power distribution, numerical control and key-entry devices. Also, it can be installed in mobile systems. Available with capacities up to 40 million bits on 512 data tracks, the unit consists of three primary assemblies. Each has an electronics module, power supply, and 512-track disk module. All three are in one compact cabinet, and the entire assembly can be mounted in a standard EIA rack.

General Instrument Corp., Rotating Memory Products, 13040 South Cerise Ave., Hawthorne, Calif. 90250 [368]

Dc-to-dc converter provides power backup for phone data

Switching and transmission equipment in telephone central offices operates from 48-volt dc batteries that are immune to power outages. But, most data-processing systems that record billing information run from commercial ac power and, despite backup ac sources, can lose data when power fails.

To prevent this, Pertec Corp. has designed a 48-volt dc-to-dc converter for the magnetic-tape transports it makes for these systems. The

HR-40

3 and 4 Channel

Strip Chart Recorder

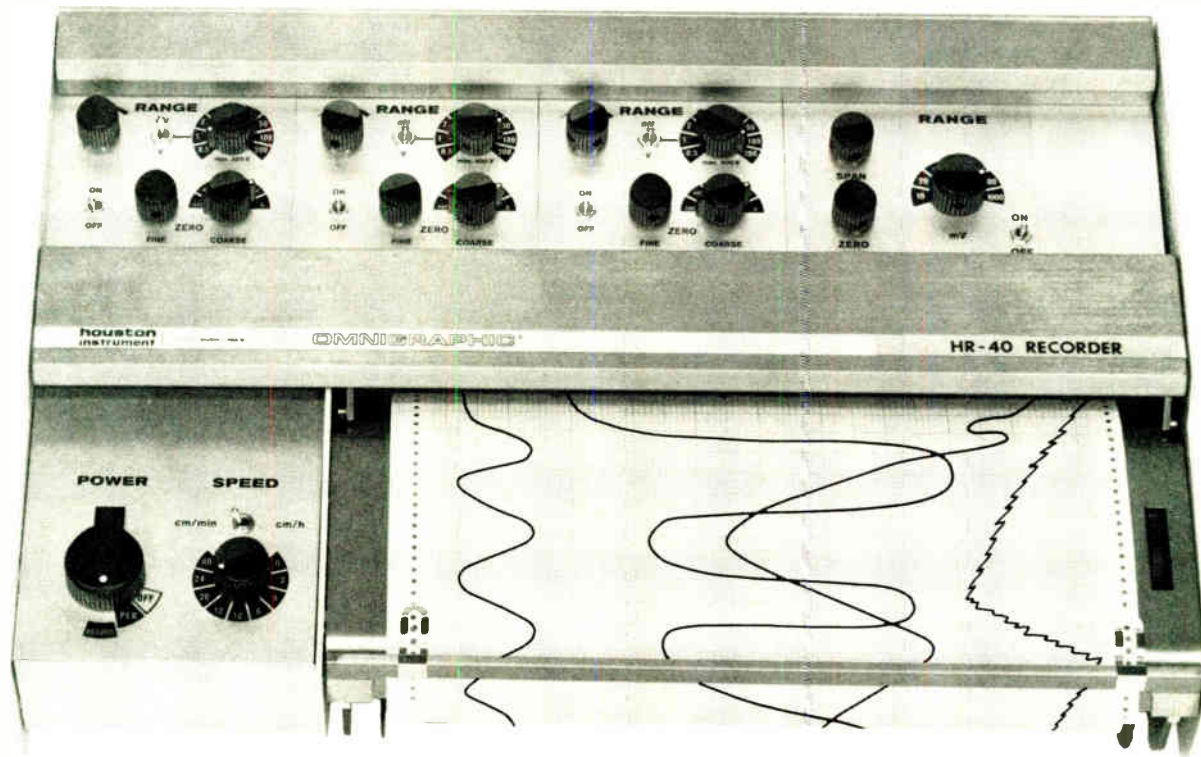

OMNIGRAPHIC®

New from Houston Instrument

- Standard options available
- 10" or 250 mm recording width
- Disposable fiber tip cartridges in four colors
- All pens cover full chart width (Writing distance between channels only 2 mm)
- Price from \$3200.
- Full scale response ¼ sec.
- Choice of 2 interchangeable, plug in, input modules. 0.5mv to 200v full scale
- Either English or Metric chart speeds
- 16 Switch selectable chart speeds 1 inch/min. to 24 inches/hr.

**houston
instrument**

® A registered trademark of Houston Instrument

DIVISION OF BAUSCH & LOMB

ONE HOUSTON SQUARE (at 8500 Cameron Road) AUSTIN, TEXAS 78753
 (512) 837-2820 TWX 910-874-2022 cable HOINCO
 EUROPEAN HEADQUARTERS Rochesterlaan 6 8240 Gistel Belgium
 Phone 059/277445 Telex Bausch 81399

"the recorder company"



RELIABILITY walks in with

ELORG

PHOTOMULTIPLIER TUBES

THE WIDE SPECTRUM. From near-infrared to X-rays.

THE BROAD FIELD OF USES. B & W and color TV — broadcasting, applied, closed-circuit, small-frame; phototelegraph; infrared TV; photometry; spectrometry (infrared included); scintillation equipment for monitoring lasers

THE TWENTY-PLUS TYPES, INCLUDING: FEU-82 — particularly suited for scintillation equipment. The light response linear (by anode current) in pulsing mode, up to 800 mA.

FEU-57 — ideal for ultraviolet region. The photocathode offers 5×10^{-3} A/W response, anode — 2000 A/W (at 230 nm wavelength).

FEU-96 — the one for measuring threshold light fluxes. The cathode dia. mere 3 mm. Dark current 3×10^{-10} A. Response threshold 5×10^{-13} lumen/Hz².

FEU-113 — specifically developed for infrared research. Oper. range from 300 to 1060 nm. Cathode response at 1060 nm wavelength — 6.5×10^{-4} A/W. Response by anode current 300 A/W.

FEU-114 — THE RUGGEDNESS IS UNMATCHED. Withstands vibration to 20 g, 1 Hz to 3000 Hz, linear acceleration up to 500 g and single impacts as strong as 1000 g. Operative within 250 nm to 850 nm range.

The louvres dynode system in the FEU Photomultiplier Tubes ensures a broad linear range of light response, stable anode (plate) current, independence of external magnetic fields.



Exporter:

ELORG

32/34 Smolenskaya-Sennaya
121200 Moscow · USSR
Telex 7586

Circle 186 on reader service card
186

New products

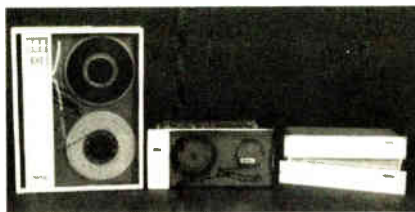

converters, packaged either inside or remote from the transports, operate from the same batteries that power the phone equipment, and the converters may accommodate optional formatters and buffers.

The Pertec units accept raw battery power and, through a high-frequency switching regulator, convert the 48 volts dc ($\pm 15\%$) to unregulated outputs of 5 v and 16-24 v. Regulators inside Pertec's transports use the 5-v input to run logic circuits and the 16-24 v for tape-deck motors. Additional cost of the converters is \$300 each.

Peripheral Equipment Division, Pertec Corp.,
9600 Irondale Ave., Chatsworth, Calif.

Loading mechanism protects flexible disk drive

Available in a single and a dual version, a flexible disk drive, the Facit 4231, is compatible with the IBM 3740. Track-to-track access time is 4 milliseconds maximum. A novel loading mechanism provides exact positioning of the disk, at the same time offering full protection against damage to the disk. The mechanism consists of a driving spindle and a moving, self-adjusting, lightweight cone. The cone moves toward the spindle upon which the flexible disk lies, adjusting it gently and accurately before securing it at the right position. In the dual model the loading, rotation, and access mechanisms and the drive electronics are common.

Facit-Addo Inc., 66 Field Point Rd., Greenwich, Conn. 06830 [369]

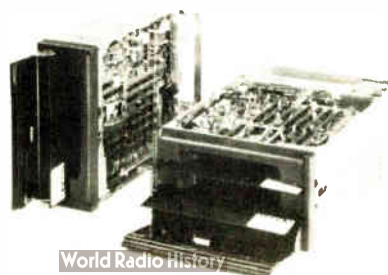

World Radio History

Why pay \$3,000⁰⁰ for a source listing of a higher level microcomputer language?

SCELBAL is here. Now. Only \$49.



SCELBAL. SCIENTIFIC ELEMENTARY BASIC LANGUAGE FOR 8008/8080 SYSTEMS. A complete, illustrated gold mine of source listings, techniques, flow charts, routines and more. Took several years to develop. Now it's yours for years to come. The first time that intimate details of a higher level language program have been offered to the public at such a low price.

Look at all you get! **5 Commands:** SCR, LIST, RUN, SAVE, LOAD. **14 Statements:** REM, LET, IF... THEN, GOTO, FOR with STEP, END, INPUT, PRINT, NEXT, GOSUB, RETURN, optional DIM. **7 Functions:** INT, SGN, ABS, SQR, RND, CHR, TAB. Runs in 8K or more. Here's all the data needed to customize a high level language for your system — at a fraction of expected cost. Entire book only \$49 ppd!

Order your copy today! "SCELBAL — A Higher Level Language for 8008/8080 Systems." Only \$49 ppd. Master Charge, Postal/Bank Money Orders preferred. Personal checks delay shipping up to 4 weeks. Pricing, specifications, availability subject to change without notice. Prices for U.S. and Canadian delivery at book mailing rate. Add \$2.50 if Priority Air Service (U.S.) desired. Foreign orders add \$6.00. Do it now!



SCELBI COMPUTER CONSULTING INC.

1322 Boston Post Rd. Rear
Milford, CT 06460/(203) 874-1573

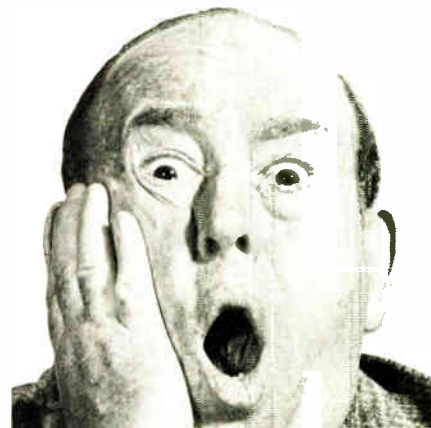

Circle 247 on reader service card
Electronics/June 10, 1976

Need DEC Memory?

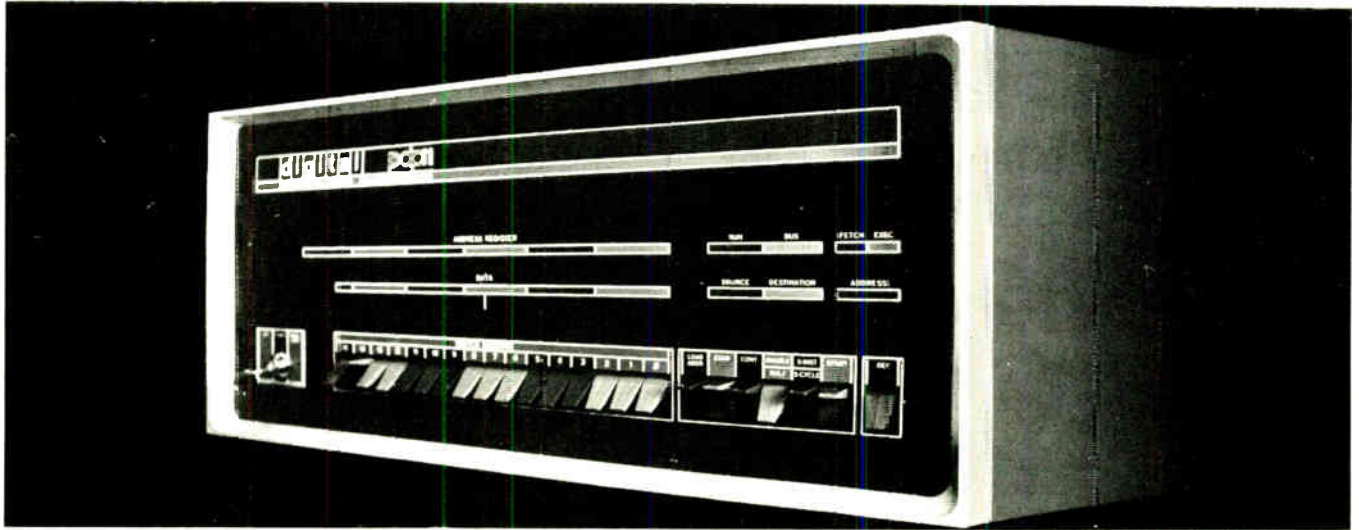

You'll get more for your money from EMM

More bits for your buck. Up to twice as much memory for your dollar from EMM. And you have a choice of core or semiconductor technology.

Improved reliability. EMM's totally engineered memory and interface mean high MTBF, low MTTR.

Proven quality and performance. EMM has been building memory since 1961. We bring all those years of experience and proven performance to the design of memory for your DEC minicomputer.

A year's warranty. When you buy Add-in/Add-on memory from EMM, you get a one year unconditional warranty against defects in workmanship and performance.

So when you need more DEC memory, take a long look at what EMM has to offer . . . buy direct from "the memory company" and save.

Want to know more about our Add-on and Add-in memories for DEC and most other major minicomputers? Call your nearest EMM office or contact us at:

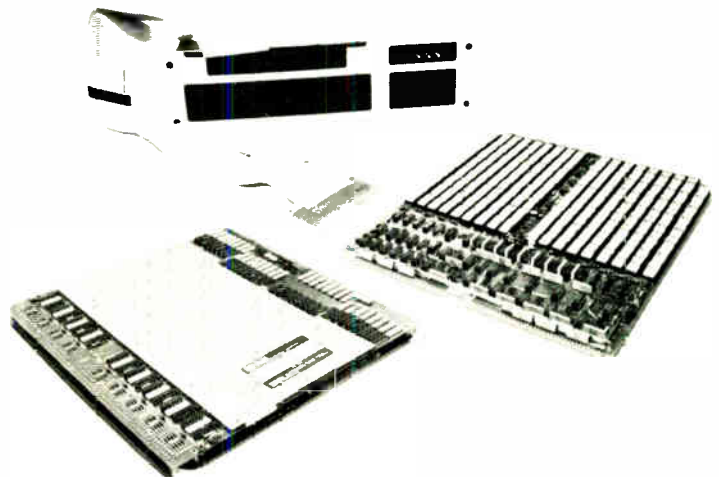

EMM ELECTRONIC MEMORIES
COMMERCIAL MEMORY PRODUCTS

A Division of Electronic Memories & Magnetics Corp.
12621 Chadron Ave., Hawthorne, Calif. 90250

EMM Model	Increment and Type	Used With	Advantages	Price Qty One
7405	16K/32K Core in Add-on Chassis	PDP-11 UNIBUS	Up to 128K in 5 1/4" Chassis. Interleave and Parity Options	\$8500 (64K words)
7805	16K NMOS in Add-on Chassis	PDP-11 FASTBUS	Up to 128K on the FASTBUS (64K in 5 1/4" Chassis) Includes Parity	\$19,000 (64k words)
7711	8K/12K/16K NMOS Add-In	LSI-11	High density, High Performance	\$1590 (16K x 16)

EMM OFFICES: WESTERN REGION, Regional Office, San Francisco (408) 247-9711, Los Angeles Area (213) 644-9881, Orange County Area (714) 639-5811, EASTERN REGION, Regional Office, Boston (617) 861-9650, Chicago Area (312) 297-7090, New York Area (516) 423-5800, INTERNATIONAL OFFICES, European Headquarters, United Kingdom (01) 751-1213, West Germany (069) 714.30.40.

REPRESENTATIVES: BFA Corporation: Scottsdale, Ariz. (602) 946-4215, Las Cruces, N.M. (505) 523-0501, Denver, Colo. (303) 344-3800, Albuquerque, N.M. (505) 292-1212, Salt Lake City (801) 466-6522, Electronic Marketing Specialists: Sherman Oaks, Calif. (213) 990-4244, San Diego, Calif. (714) 566-1000, Sunnyvale, Calif. (408) 245-9291. In Canada: Cantec, Toronto (416) 457-4455, Montreal (514) 620-3121, Ottawa (613) 225-0363. In Japan: Nishio Electronics (03) 544-8396.

New ideas from a new source for flat cable and connectors

There are a lot of reasons why you should consider the newest source of flat cable connectors. To begin with, the newest source is one of the most experienced full line wire and cable manufacturers. So we know a lot about cable and how to connect it. Let's start with our cable. It's compatible. Matches all flat-cable con-

nectors designed for 0.050 in. (1.27mm) conductor spacing. Excellent teardown characteristics make it easy to cleanly separate the conductors—essential when cable has to be routed to more than one location. It can be folded back on itself without damage to conductors or insulation—ideal for intricate cable routing. Another

bright idea: an exclusive footage indicator on the reel shows how much cable is left. And it's UL listed (style 2651). Complies with requirements of FR-1 flame test. The connectors, (57 of them) are an integral part of our flat cable connection system. They also offer some bright new ideas as you can see:

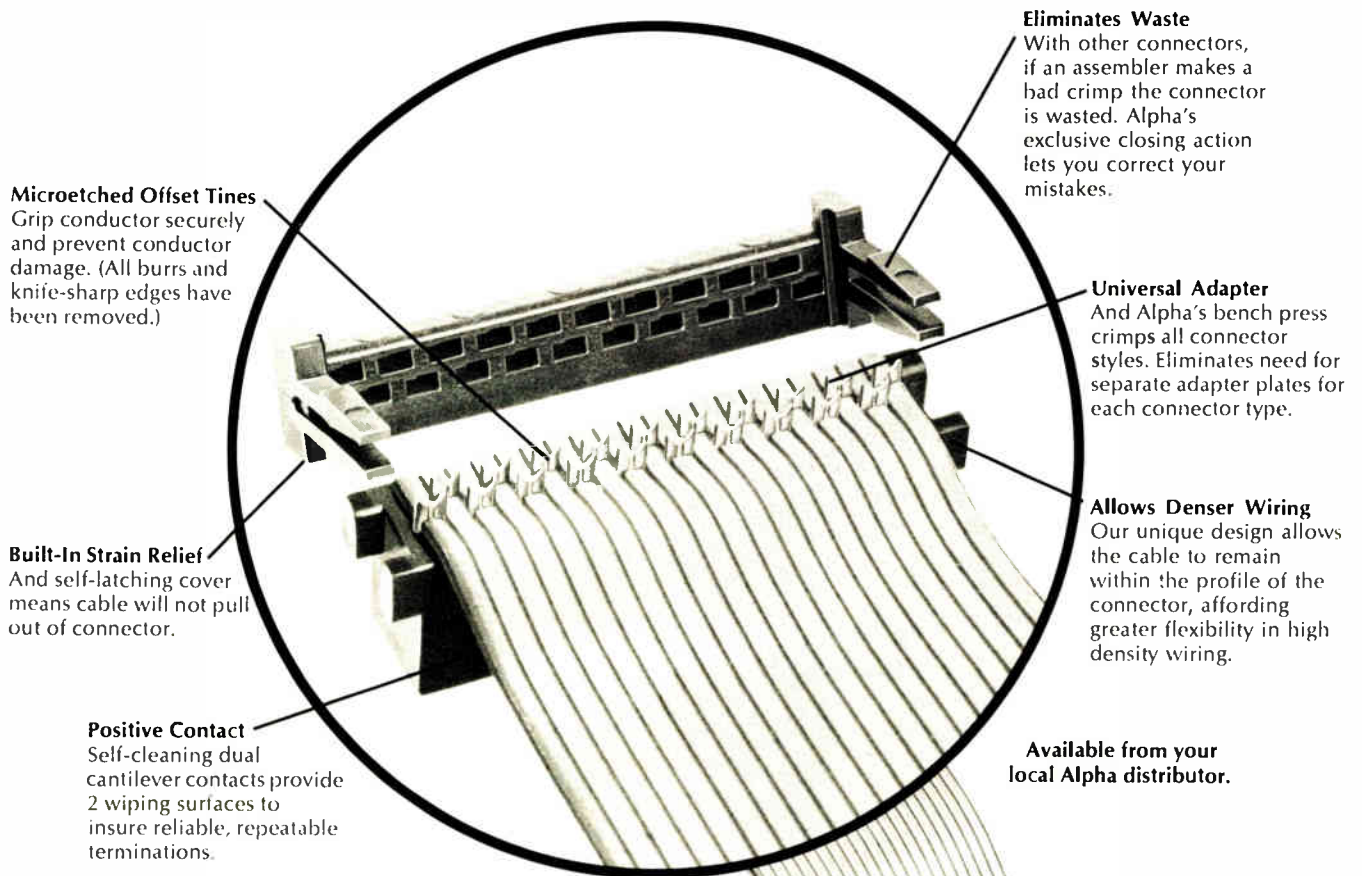

Microetched Offset Tines
Grip conductor securely and prevent conductor damage. (All burrs and knife-sharp edges have been removed.)

Built-In Strain Relief
And self-latching cover means cable will not pull out of connector.

Positive Contact
Self-cleaning dual cantilever contacts provide 2 wiping surfaces to insure reliable, repeatable terminations.

Eliminates Waste
With other connectors, if an assembler makes a bad crimp the connector is wasted. Alpha's exclusive closing action lets you correct your mistakes.

Universal Adapter
And Alpha's bench press crimps all connector styles. Eliminates need for separate adapter plates for each connector type.

Allows Denser Wiring
Our unique design allows the cable to remain within the profile of the connector, affording greater flexibility in high density wiring.

Available from your local Alpha distributor.

Complete Line
Female socket connectors
Headers
DIP connectors
PCB connectors.



Alpha Wire Corp., 711 Lidgerwood Ave., Elizabeth, N.J. 07207 (201) 925-8000

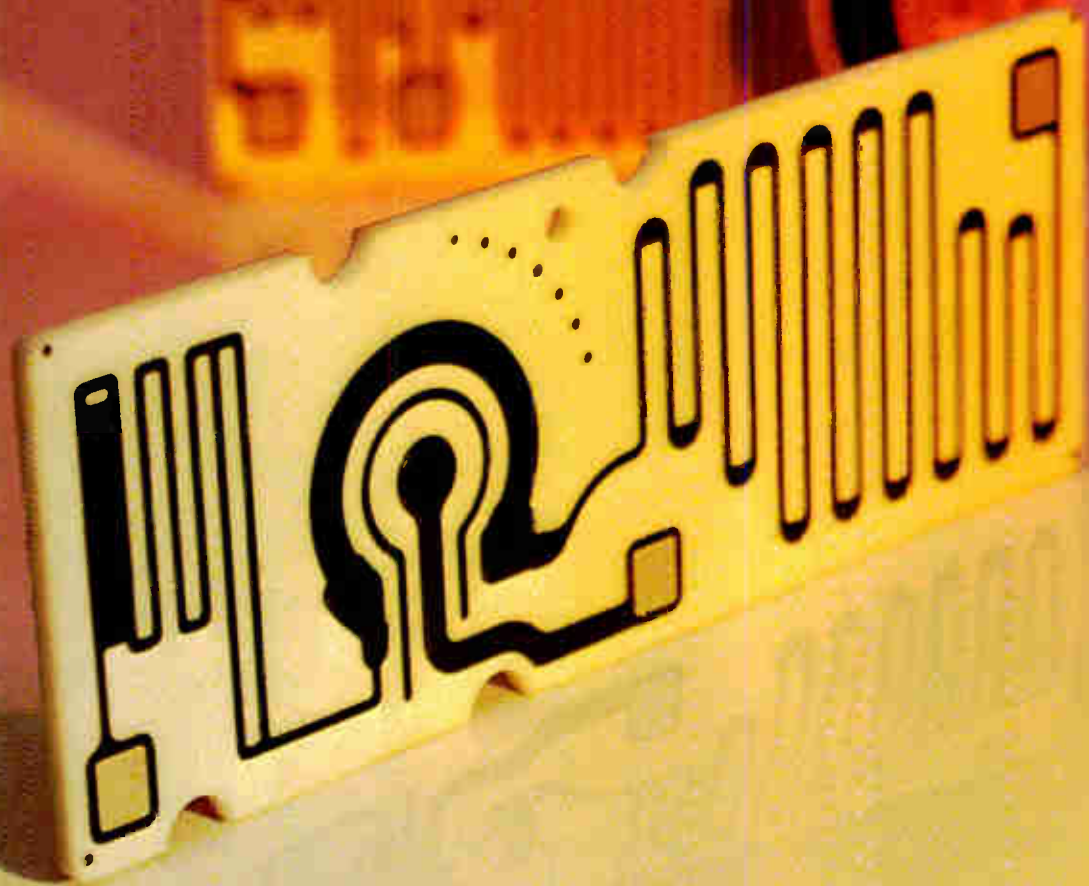

For high-voltage applications, thick film manufacturers have 3 reasons for choosing Du Pont materials systems.

Excellent performance. Ease of processing. Technical service. Du Pont's compatible systems of thick film conductor and resistor compositions give you all these, and more.

Excellent performance

Du Pont's 9400-Series Resistors offer superior surface characteristics for variable resistors—a distinct advantage if you manufacture TV focus control potentiometers. Contact resistance variation is typically less than 2%.

And the 9400-Series provides resistivities of 100K to 10 Megohms per square, with excellent stability under continuous high-voltage stresses in

excess of 10K volts per inch and pulses in excess of 50K volts per inch.

High yields

Excellent reproducibility of the 9400-Series Resistors helps keep your production running smoothly and yields high. Add a compatible, low-cost conductor—like Palladium/Silver 9308 or Platinum/Silver 9770—and you have a cost-effective system of materials for high-voltage applications.

...and service too!

Du Pont's experienced Technical Representatives guide you in choosing the right products to meet your high-

voltage requirements. Then they help you optimize processing conditions to achieve the best performance from the Du Pont product system.

And they're backed up by skilled product specialists and a fully-equipped customer service laboratory, where products are tested under end-use conditions.

Whether you manufacture high-voltage components, resistor networks or hybrid circuits, Du Pont has a cost-effective system of thick film materials for your application. Call—toll-free—800-441-9475. Or write: Du Pont Company, Room 25159, Wilmington, DE 19898.

Electronic Materials Division



Electronics

Circle 189 on reader service card

IN WIRE-WRAPPING  HAS THE LINE.....



OK MACHINE & TOOL CORPORATION

3455 Conner St., Bronx, N.Y. 10475 (212) 994-6600 / Telex 125091

Circle 190 on reader service card

Price & Performance that can't be matched!

DigiTec's full-function Universal Counter/Timers and Frequency Counters supply extended frequency ranges at a ratio of price to performance that can't be matched.

Outstanding features include dual input channels with independent controls, high input sensitivity, oven controlled crystal, and full 9 digit LED display with autoranging.



50 MHz ... Universal Counter ...	8510A ...	\$725
150 MHz ... Frequency Counter ...	8720A ...	625
150 MHz ... Universal Counter ...	8520A ...	850
500 MHz ... Universal Counter ...	8530A ...	995
600 MHz ... Frequency Counter ...	8730A ...	795
1 GHz ... Frequency Counter ...	8740A ...	995
1 GHz ... Universal Counter ...	8540A ...	1295

DigiTec. **UNITED SYSTEMS CORPORATION**

918 Woodley Road, Dayton, Ohio 45403
(513) 254-6251, TWX (810) 459-1728

DigiTec: precision measurements to count on.

*These instruments available under
GSA contract GS-00S-27741.*

Buss Fuses Specialize Too!

with a complete line in protecting
telephone · communications and
similar equipment

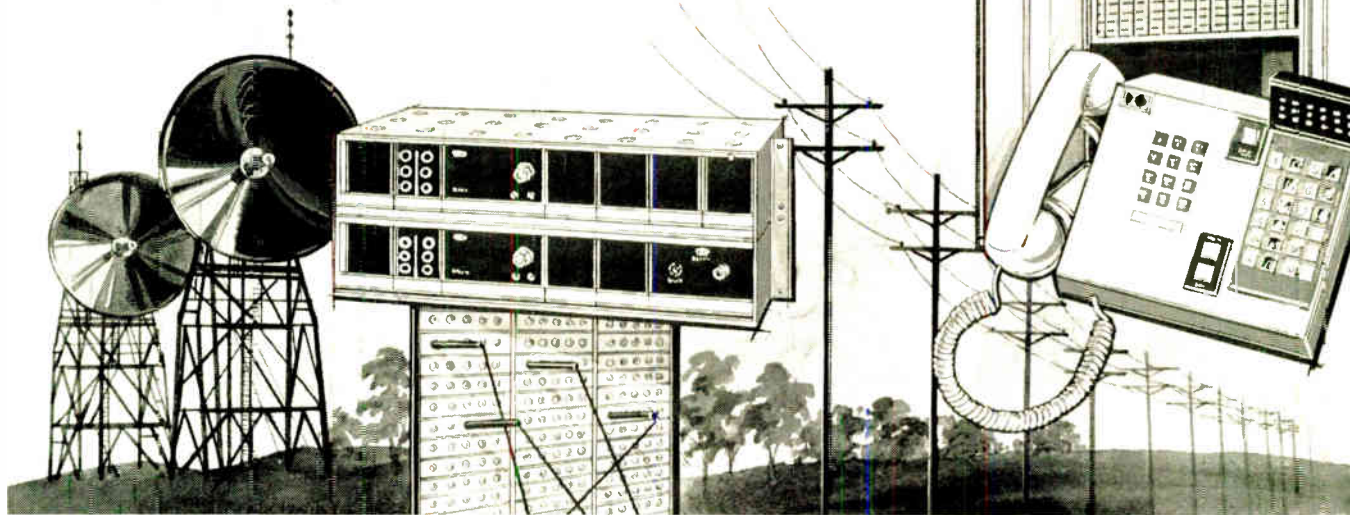

BUSS Series 70 FUSES

... signal indicating, alarm activating — designed to give positive contact on the alarm circuit. Indicating pin is color coded for quick identification of ampere rating. Available from 18/100 to 10 amp., rated 300 V or less.

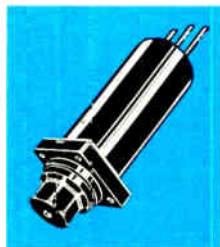

BUSS HWG FUSEHOLDER

... especially designed to take Series 70 fuses. Bayonet type knob has hole for fuse indicating pin. Holder can be mounted from front or back of panel or cantilever from rear. Metal shoulder plate and strap on holder provides strength for mounting screws. Terminals can be wire wrapped or soldered. Rated 10 amp., 300 V or less.



BUSS GMT FUSES and HLT FUSEHOLDER

... for multiple circuit apparatus where space is at a premium. Holder takes mounting space of only 1/4"x1-15/32". Fuses are color coded and are signal indicating, alarm activating. Available from 18/100 to 10 amp., rated 300 V or less.

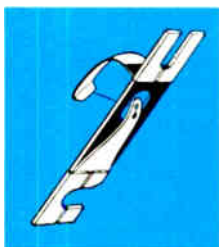

BUSS GRASSHOPPER FUSES

... visual indicating, alarm activating — designed to give positive contact on the alarm circuit. Fuses are color coded for type and ampere. Available from 18/100 to 5 amp., rated 90 & 100 volts or less.



BUSS WER FUSES

... insulated base has copper clad, tinned terminals slotted for #10 screws. Fuse link clearly visible for quick identification of open fuse. Ampere rating stamped on fuse for positive identification. Available from 1/4 to 10 amp., rated 32 volts or less.

Write today for your copy of *BUSS Bulletin COM-X*



BUSSMANN MANUFACTURING
a McGraw-Edison Company Division
St. Louis, Missouri 63107



The first GTO SCRs you can actually use.

An 8A series with gate turn-off gains up to 1000—even at 125°C.

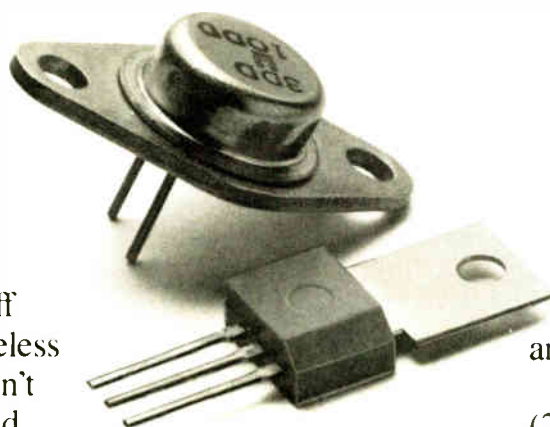

Up till now, gate turn-off SCRs have been pretty useless products. They simply didn't have high enough gains and low enough turn-off voltages to be practical for real-world applications.

But now there's Unitrode's new 8A GTO SCR.

Unlike other GTO SCRs, which need 1A or more to turn off 4 or 5A, ours can turn off 4A with just a few milliamps — for a gain of nearly a thousand.

Unlike other GTO SCRs,

our turn-off gains are virtually flat right up to 125°C.

Unlike other GTO SCRs, which need -30 to -70V for turn-off at the gate, ours need less than -5V.

Of course, our GTO SCRs will also give you the basic GTO benefit of simplified circuit design. Making them perfect for applications like ignition systems, DC circuit

breakers, multivibrators, and inverters.

Unitrode fast switching (200ns) GTO SCRs are available from 50 to 400V in either TO-66 hermetic or TO-202 plastic packages and start at the lowest price in the business.

And that's the most practical part of all.

For fast action, call 617-926-0404, or drop us a line on your corporate letterhead. Unitrode Corporation, 580 Pleasant Street, Watertown, MA 02172.

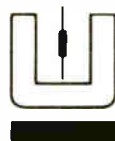

UNITRODE

New products

Semiconductors

Dual-setpoint timer is IC

Monolithic device aims at \$75-\$100 portion of market in control applications

Aiming at the high-volume, \$75-\$100 portion of the industrial timer/counter market now dominated by electromechanical devices, Siliconix Inc. has gone into production with what is described as the industry's first monolithic dual-setpoint timer.

Designated the DF215 and containing the equivalent of 2,000 transistors on a 104-by-112-mil chip, the device, says its designer, Christopher L. McAfee, uses p-channel, depletion-mode MOS to implement all the necessary logic for a single- or dual-setpoint timer or counter.

According to Siliconix' vice president of engineering, John Hulme, electromechanical systems now dominate the market for automatic interval-timing in industrial processing, commercial food preparation, automatic feed, fluid- or material-dispensing applications as well as test timing. They range in price from \$50 to \$350. To date, semiconductor equivalents of this function, usually in the form of standard TTL, p-MOS or C-MOS monolithic single-setpoint timers, have penetrated only the upper \$200 to \$350 portion of the market. "Although component costs on previous integrated-circuit approaches to this market," says Hulme, "have been relatively low—typically \$2 to \$3 for each decade counter implemented in standard logic and \$8 or so for a monolithic device with several decades and a single setpoint—this is not adequate for most automatic control and timing functions that are to be found in industry."

What is also needed are at least two control outputs, two setpoints, and range selectivity over several

ranges. Consequently, explains Hulme, the total systems cost generally keeps such IC-implemented counter/timers out of the low \$50-\$200 end of the industrial timer/counter market.

What Siliconix has done is to combine an elapsed-time/event counter, setpoint-compare logic, time-base logic, multiplexed outputs, four decades of logic, and the capability of selecting any of four time ranges from 000.1 second to 99 hours and 59 minutes, onto a 28-pin device that will cost only \$10.85 in 100-quantities and \$9.90 in quantities of 1,000. The timer continually compares the elapsed time with one of two setpoints to produce one or two precise intervals on two control outputs. The DF215 counts either events or time intervals using a 50- or 60-hertz power line as a time base and, unlike timers with setpoint registers on the device, it will not lose the setpoint values if power fails. Other features include 16-millisecond accuracy, a single 8-to-20-volt power supply, low power (typically 50 milliwatts), and an internal oscillator for logic timing. The devices are available from stock.

Siliconix Inc., 2201 Laurelwood Rd., Santa Clara, Calif. 95054 [411]

Rugged op amp has p-MOS input and bipolar output

Many uses are expected for an operational amplifier that RCA Solid State division has given a p-channel MOSFET input stage and a bipolar

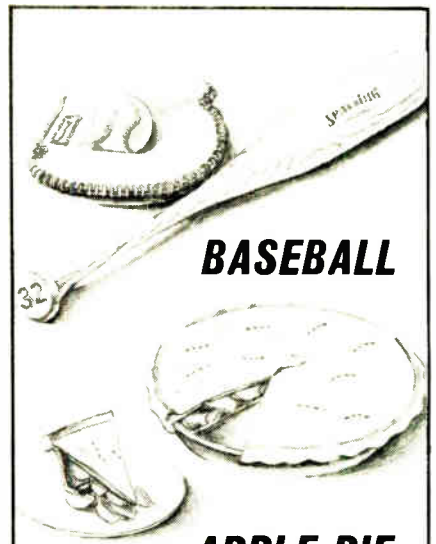
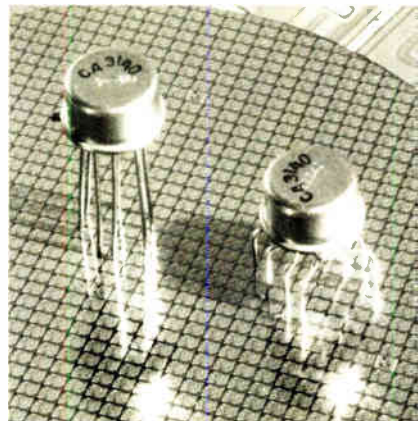

BASEBALL



APPLE PIE

**... and T.F.S.
RESISTOR
PASTES**

**GOOD THINGS
DON'T CHANGE.**

Take T.F.S., Inc. 850 Series Resistor Pastes:

1. The only system offering TCR's less than 100 ppm from 1 to 1,000,000 Ω /sq.
2. Super stability after laser trimming — fastest trim rates by abrasive trimming.
3. 20-25% thinner print means greater paste coverage.
4. 850°C firing, 25 minutes total firing cycle (60 minute cycle will also work).
5. PARTILOK® Vehicle assures no settling and print repeatability.

THE SAME ADVANTAGES EXIST WITH POWEROHM® FORMULAS:

600 Series—600°C firing on glass or ceramic
780 Series—Consumer Products
850-D Series—For firing on top of dielectrics.



For full information contact
THE PASTEMAKER

THICK FILM SYSTEMS, INC.
324 PALM AVENUE SANTA BARBARA CALIFORNIA 93101
TEL: (805) 963-7757

New products

output stage with a wide output-voltage range. Called a BiMOS op amp, the model CA3140 is considered by RCA to be "the most useful op amp since the introduction of the 741 in 1968." Its versatility permits it to fill virtually all 741 sockets, as well as others.

The p-MOS input stage is similar to the one used in RCA's CA3130 but with the added features of internal compensation and high supply-voltage operation. The latter permits operation from 4 to 44 volts, dual or single supply.

According to RCA, the addition of bipolar diodes protects the input so effectively that, under simulated electrostatic conditions up to 1,000 volts, the CA3140 proved to be more rugged than any other device, including bipolar and J-FET-input op amps. Performance features for the CA3140 include: very high input impedance of 1.5 teraohms, typically; very low input current of 10 picoamperes at ± 15 v, typically; low input-offset voltage of 5 millivolts, typically; wide common-mode input voltage range, -0.5 v below negative rail; and output swing to within 0.2 v of negative supply.

Applications include comparators, active filters, peak detectors, sample-and-hold amplifiers, tone controls, function generators, power supplies, portable instruments, long-duration timers and multivibrators, photocurrent instrumentation, ground-referenced single-supply amplifiers in automobiles and portable instrumentation, and operation in TTL systems. Prices range from 52 cents to \$9.95 each, depending on whether they are standard, premium, or 100%-tested premium types.

RCA Solid State Division, Box 3200, Somerville, N.J. 08876 [412]

Voltage reference acts also as monolithic thermometer

Monolithic voltage references that are adjustable are invading the marketplace in increasing numbers [*Electronics*, Dec. 25, 1975, p. 94].

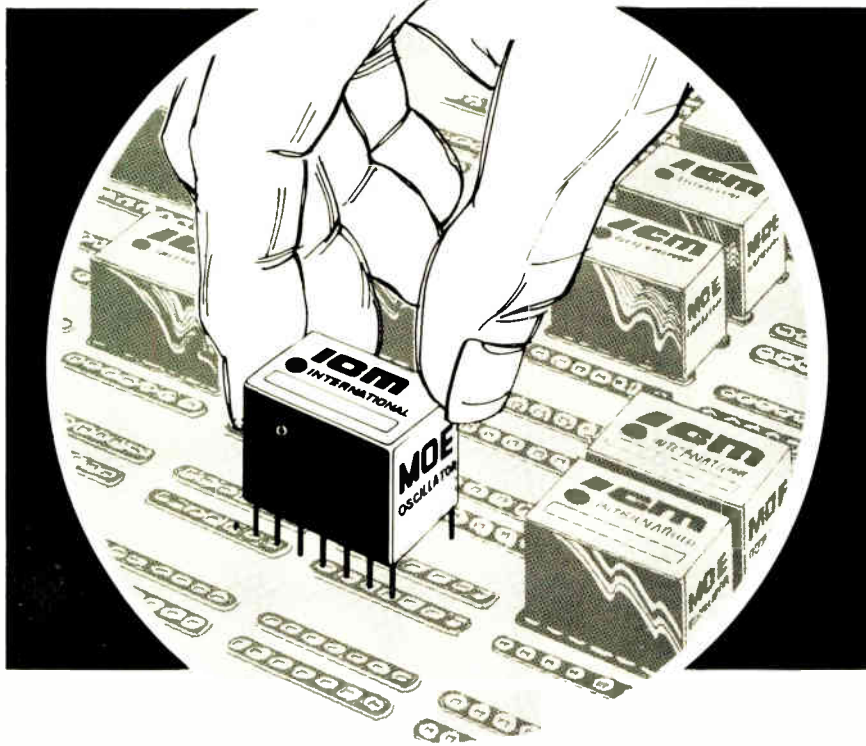

INTERNATIONAL'S **moe** CRYSTAL OSCILLATOR ELEMENTS

A Complete Controlled Signal Source from 6000 KHz to 60 MHz

The MOE series is designed for direct plug-in to a standard dip socket. The miniature oscillator element is a complete source, crystal controlled, in an integrated circuit 14 pin dual-in-line package with a height of $\frac{1}{2}$ inch.

Oscillators are grouped by frequency and temperature stability thus giving the user a selection of the overall accuracy desired. Operating voltage 6 vdc. Output wave shape — non sine.

TYPE	CRYSTAL RANGE	OVERALL ACCURACY	25°C TOLERANCE	PRICE
MOE-5	6000KHz to 60MHz	+ .002% -10° to +60°C	Zero Trimmer	\$35.00
MOE-10	6000KHz to 60MHz	+ .0005% -10° to +60°C	Zero Trimmer	\$50.00

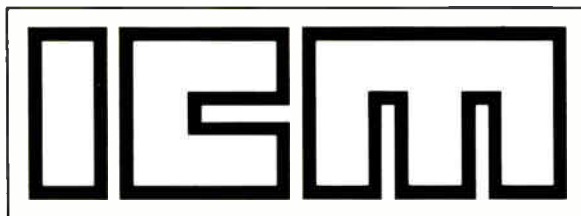

International Crystal Manufacturing Company, Inc.

10 North Lee, Oklahoma City, Oklahoma 73102

THE MATCHMAKER

Telefile introduces the only disk system flexible enough to match any minicomputer with any of the hot, new 3330-type drives. Big disk storage at a mini price.

Telefile now has available the most flexible large capacity disk system for minicomputers on the market today. The Matchmaker. It comes two ways:

As a disk system for users (DS-16-C) where we match your minicomputer with any of the latest 3330-type technology drives you want. Telefile supplies the complete package.

As an OEM disk controller. You can order just controllers alone (DC-16-C) and mix and match minicomputers and drives to satisfy your customer's whims and storage requirements.

Either way, disk system or controllers alone, you are assured of flexibility, performance features, and price no one else can match.

Each system stores up to 1.2 billion bytes.

You can match just the right drives to meet your storage capacity needs all the way from 13.3 million to 1.2 billion bytes per controller. Each DC-16-C Matchmaker controller handles up to four drives. Minicomputers never had it so good.

Choose any of the latest drives.

You've seen them announced one-by-one and they're coming on strong. CalComp's Trident. Control Data's Storage Module. Diablo's 400 Series. The Ampex 9000's and Memorex 677's. Each builds upon IBM 3330 technology, which means higher storage densities and new circuitry for superior reliability.

To switch drives, simply change one controller circuit board. We've timed it at 63 seconds flat!



Compatible interfaces to eleven minicomputers.

We're designing a complete line of compatible interface boards to match up to many minis: Data General, DEC, Interdata, Keronix, D.C.C., Microdata, Honeywell, Lockheed, H-P, Varian, and Cincinnati Milacron. Simply fit our tailor-made computer interface module inside your computer chassis and you're in business. If you have another type mini, we'd be glad to design one for you.

Or you can design your own interface.

Your designers may want a piece of the action. Our general interface board makes it easy. Your board will tie in directly, bringing big disk storage to any 16-bit minicomputer.

A controller so small you can even hide it.

The Matchmaker is our smallest controller yet. It is totally self-contained right down to its power supply and cooling system. It's small enough to tuck away in a drive housing or in a rack above, below, or even behind the computer. Out of sight.

We'll even make you a faceplate.

If you want to show the Matchmaker off, we'll make a bezel to match your computer panel. Private label it and call it yours. There's no end to the flexibility.

Easy "front door" maintenance.

Five circuit boards slip right in from the front of the DC-16-C Matchmaker. A disk interface board, a general interface board, a command/timing board, a memory/address board, and an optional maintenance board for offline disk pack formatting and test exercising.

Unmatched features

- Contains 512-byte buffer for data rate matching
- Variable data search and read
- Block transfer of data up to mini-addressing capacity
- Offset positioning and data strobe controls
- Write protection to the sector level
- Sequential or staggered sector addressing
- Defective track relocation and alternate track addressing
- Overlapping seek capability
- Multi-sector operations across head and cylinder boundaries

We wrote the book on disk controllers, and you can get it free.

For years, we've helped mini-computer users grow their disk capacities. Now our Matchmaker system is a quantum leap forward. A new in-depth, hot-off-the-presses Matchmaker technical manual gives you all the facts. Write for it. Prove to yourself that this is one disk controller no one else can match.

Telefile

Turning minis into maxis with moxie



Please send me your Matchmaker book. I'm interested now later (more than six months from now).

NAME _____

TITLE _____

PHONE _____

ORGANIZATION _____

ADDRESS _____

CITY _____

STATE _____ ZIP _____

Telefile Computer Products, Inc.
17131 Daimler Street, Irvine, CA 92714
Free ph. (800) 854-3128, In Ca. (714) 557-6660
Telex 68-5660 TELEFILE IRIN

SLIM-MOX

**NOW VICTOREEN
QUALITY COSTS LESS
THAN A DOLLAR.**

Victoreen announces SLIM-MOX, our new, thick-film, flat substrate resistor.

Compact in design, it carries with it all the quality and dependable performance you have come to expect from Victoreen.

SLIM-MOX, right now, is available from stock in a wide range of standard resistance values. More important, SLIM-MOX will deliver the same proven performance in high-voltage applications that you find in more expensive resistors with more bulk.

Specify SLIM-MOX in any standard resistance value and your unit cost will be less than one dollar in OEM quantities. Truly a major cost breakthrough for resistors designed for miniaturized

electronic networks and equipment, or other critical applications that demand stability and reliability.

Standard tolerance is $\pm 15\%$ for all standard resistance values which include 1, 2,

5, 10, 20, 50, 100, 200, 500, 1000, 2000, and 5000 megohm. All in stock. With a voltage coefficient of better than 5 ppm/volt, full-load drift typically less than 0.5% in 1000 hr at 70° C, and 250 ppm TCR or less to 5000 megohm, SLIM-MOX is a little, big performer. For less than a buck. From a name you know you can count on. Victoreen.

**Victoreen Instrument Division,
Sheller-Globe Corporation,**



**10101
Woodland
Avenue,
Cleveland,
Ohio 44104**

SG
SHELLER-GLOBE CORPORATION

SLIM-MOX SPECIFICATIONS

Resistance Range	1M-5,000M
Power Rating @ 70°C	2W
Maximum Operating Volts (Applicable above critical resistance)	10,000V
Available Tolerance	15%
Critical Resistance	50M
Max. Service Temperature	150°C

New products

and among the latest is a type that can operate also as regulator and thermometer. The REF-02 series provides a stable +5-volt output that can be adjusted over a $\pm 6\%$ range with minimal effect on temperature stability, which is 3 ppm/°C. The REF-02 can be used as a 5-v, 4-ampere regulator. In addition, the device has a temperature-transducer output pin, and the output voltage here is linearly proportional to the package temperature within a few 10ths of a percent, effectively permitting the unit to operate as a monolithic thermometer. A special bandgap design permits single-supply operation of the REF-02 over an input voltage range of 7 v to 40 v and a low current drain of 1 milliampere. Low cost, low noise (10 microvolts peak to peak), and low power (15 milliwatts) make the device suitable as a stable reference in portable instruments, digital voltmeters, and analog-to-digital and digital-to-analog converters. Prices range from \$1.90 to \$22 each, depending on specifications, for 100-999 pieces.

Precision Monolithics Inc., 1500 Space Park Dr., Santa Clara, Calif. 95050 [413]

Ultrasonic sonar system fits on a single chip

Just about all the components needed for an ultrasonic sonar system, not counting the transducer and the display, are included in the LM1812 transceiver. The novel monolithic circuit includes a 12-watt transmitter and a selective receiver that contains a 10-watt display driver. Operating from a 12-volt battery, the IC delivers pulses of about 200 kilohertz for a duration of about 800 microseconds to an external transducer and then listens for an echo. A particular feature of the device is that it does not need alignment with the transducer. Furthermore, the ultrasonic section prevents mode-hopping of the transducer so that, in a complete system, transducers can be interchanged without problem. Housed

Seeing Double?

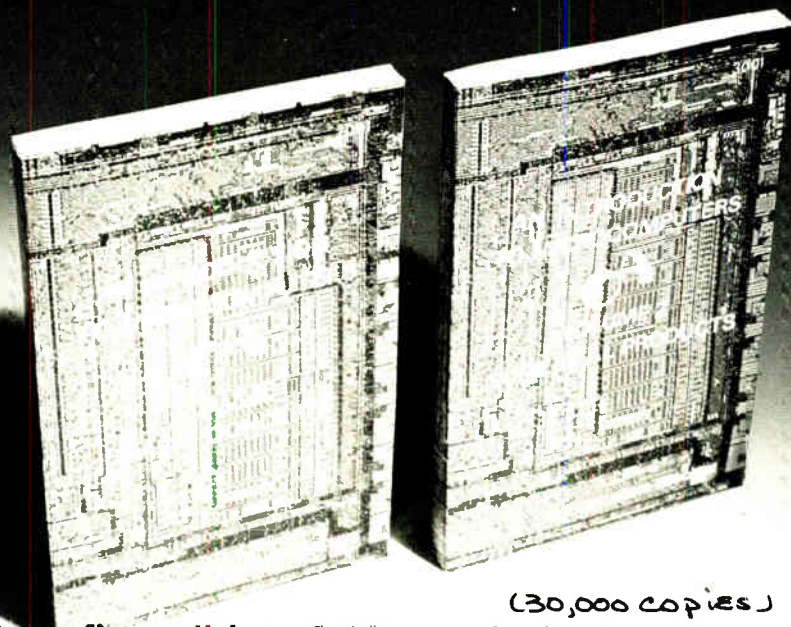

(30,000 COPIES)

No it's just that the first edition of this popular book sold out in 5 months flat.

The second edition of **AN INTRODUCTION TO MICROCOMPUTERS** has been revised and expanded to two volumes, to keep up with the fast-moving microcomputer industry's pace of change.

Have things changed that much in just 5 months? You probably know the answer to that already: a flood of new and second-source CPU chips and a whole host of new LSI support packages. Nowhere else can you get all this vital information. **VOLUME I — BASIC CONCEPTS** surveys the subject, from elementary concepts to system configuration and design. In **VOLUME II — SOME REAL PRODUCTS** we take a long, hard look at the products available today and about to be announced tomorrow. If you're actually putting together your first system, you may find some help in the latest addition to the microcomputer library: **8080 PROGRAMMING FOR LOGIC DESIGN**.

Whether you are planning new products, updating existing ones, or simply need to keep abreast of the latest developments in this revolutionary new technology, **AN INTRODUCTION TO MICROCOMPUTERS** has become the industry's standard reference on the subject.

VOLUME I — BASIC CONCEPTS, takes you by the hand, from elementary logic and simple binary arithmetic through the concepts which are shared by all microcomputers. It tells you how to take an idea that may need a microcomputer and create a product that uses one. This book is complete — every aspect of microcomputers is covered: the logic devices that constitute a microcomputer system; communicating with external logic via interrupts, direct memory access, and serial or parallel I/O; microprogramming and macroprogramming; assemblers and assembler directives; linking and relocation — everything you need to know if you are going to select or use a microcomputer. Volume I is equivalent to Chapters 1 through 6 of **AN INTRODUCTION TO MICROCOMPUTERS**, first edition, but with extensive new sections on chip slice products and serial I/O. Order publication number 2001. Date available: May 31, 1976.

VOLUME II — SOME REAL PRODUCTS, covers real microcomputers, in considerable detail. Every major microcomputer: 4-bit, 8-bit or 16-bit, is described, including some soon to be announced products. Major chip slice products are also covered. More than 20 microcomputers in all. Order publication number 3001. Date available: July 15, 1976.

8080 PROGRAMMING FOR LOGIC DESIGN, is a completely new book on a totally new subject: implementing digital and combinatorial logic using assembly language within an 8080 microcomputer system. What happens to fan-in and fan-out? How do you implement a one-shot? This book simulates well known digital logic devices using assembly language; next it shows you how to simulate an entire schematic, device by device, keeping the assembly language simulation as close to the digital logic as possible. But that is the wrong way to use a microcomputer; the book explains why, then shows you the correct way. This book describes the meeting ground of programmer and logic designer; it is written for both readers. Order publication number 4001. Date available: June 15, 1976.

For ordering and pricing information in Europe contact:

SYBEX

Publications Department
313 Rue Lecourbe
75015 — Paris, France
Telex: 200858 Sybex

Everywhere else:



OSBORNE & ASSOCIATES INC.

P.O. Box 2036 • Berkeley, California 94702 • (415) 548-2805

Copies of each book are available for \$7.50 per book plus sales tax for California residents. Discounts are available on orders of 100 books or more. Please be sure to include publication numbers with order. Add 30 cents for surface mail, \$2.50 for airmail shipping charge when ordering from outside the U.S.A. Dealer, distribution and translation inquiries welcome.

BankAmericard and Master Charge orders accepted • Please include in mail order: card number, expiration date, full name and address

THIS digital data printer does the most **\$495** FOR

Newport built the Model 810 Printer with you in mind...with maximum interface potential, reliability and performance characteristics. We invite you to take a look inside and compare these outstanding features before you buy another printer.

- 9 columns, Std: expandable to 18
- Small size 4½" H x 8½" W
- Programmable two-color printing
- Fixed or floating decimal point
- Standard adding machine paper fan-fold or roll
- Spare IC gates available to user for interfacing
- Remote paper advance
- Convenient paper and ribbon loading
- Internal formatting patchboard
- 3 million operations MTBF
- Last record viewed without paper advance
- Print mechanism available separately

OPTIONS INCLUDE:

- Internal data storage
- Sequence counter to 99999 counts
- Digital clock (days,hr.,min.,sec.)
- Universal breadboard card

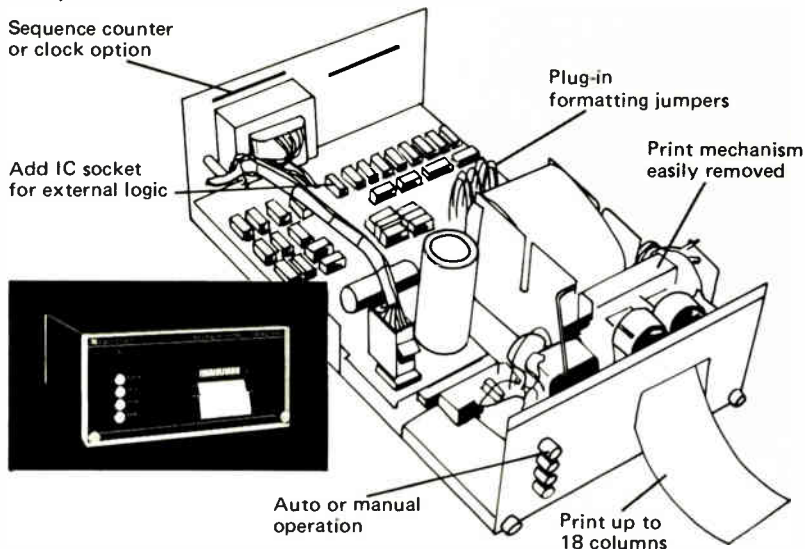

Newport Laboratories, Inc.
630 E. Young St.
Santa Ana, CA 92705
Call Collect: (714) 540-4686
In Netherlands, Call:
Amsterdam (20) 45-20-52

NEWPORT

Circle 198 on reader service card

HOPE

in a word is what we are.

Project HOPE exists because there are people with hope—people who have given 3.5 million men, women, and children on four continents the chance for happier, more productive lives through improved health care.



Department A
Washington, D. C. 20007

New products

in an 18-pin plastic DIP, the LM1812 sells for \$12 in hundreds.

National Semiconductor Corp., 2900 Semiconductor Dr., Santa Clara, Calif. 95051. Phone Rick Joy at (408) 732-5000 Ext. 6381 [414]

IC multiplier can generate 32-bit word every 300 ns

Built for military and commercial high-speed processing applications, a monolithic 16-bit large-scale integrated circuit from TRW Inc. can perform a complete double-precision 16-by-16-bit parallel multiplication in 300 nanoseconds or less. The circuit contains more than 18,000 components on a silicon chip about ¼ inch square. The circuit can multiply two 16-bit words to generate a 32-bit word (double-precision). Inputs and outputs are fully TTL-compatible. The outputs have three-state control. A single 5-volt power supply is used. Emitter-follower logic is adopted internally because of its high speed and very low power consumption—1.4 milliwatts per gate. The 16-by-16-bit multiplier is expected to sell for about \$250 in small quantities when production models are ready for the market near the end of 1976.

Defense and Space Systems Group, TRW Inc., One Space Park, Redondo Beach, Calif. 90278.

Zinc oxide varistor disks protect against transients

Eliminating the need to overspecify semiconductors or to install protection circuits in many applications, a line of zinc oxide varistor disks, series V94, protects vital circuitry or semiconductors from voltage/current spikes or turn-on transients on the supply line. The disks are easy to install across main power sources carrying rms voltages from 55 to 415 volts, with no circuitry change in most applications. They are available in a selection of 11 sizes. The disks are used extensively in contact

The Family.



For the straightforward operator who wants a top-quality, economy-priced instrument... the F71.

- Wide frequency response—0.0002 Hz to 20 MHz
 - Sine, square, triangle and DC-level waveforms
 - 5/95% variable symmetry control to 1 MHz.
 - Fixed and variable offset
 - Calibrated coarse/fine frequency tuning
- \$695.**

For the digital-and-analog professional who wants a multipurpose pulse/function generator... the F72.

- All basic capabilities of F71 plus:
 - Trigger and gate mode
 - True pulse generator pulse
 - Separately adjustable rise and fall times of 15 ns to 1 sec.
 - Variable start-stop phase
 - Slope and level controls
 - External sync
- \$895.**

For the all-around engineer who wants a highly versatile unit for a wide variety of applications... the F74.

- All capabilities of F72, (except F74 has a fixed rise/fall times of 15 ns) plus:
 - Continuous and triggered sweep: sweep-and-hold, and burst
 - Interstate's exclusive direct-reading sweep limit control
 - 1000:1 sweep width
 - Sweep up/sweep down selection
 - Selectable sweep ramp or frequency analog out
- \$945.**

For the sophisticated user who wants the very best function generator money can buy... the F77.

- All features and advantages of F74 plus:
 - Selectable logarithmic/linear sweep
 - Sweep sync
 - Analog power amplifier
- \$1095.**

Get to know our first family better — send for our SERIES 70 catalog today.

**SERIES 70 Function/Pulse Generators
are our First Family.**

**INTERSTATE
ELECTRONICS CORPORATION**
Subsidiary of A-T-O Inc.

CRYDOM'S NEW LOW COST TRIAC SSR



New from Crydom. The TL Series of 10 amp triac solid state relays. Superior breakdown voltage ratings — 300V for 140VAC units & 500V for the 280VAC series. Input filter on control side prevents false triggering. Built-in snubber protects against false turn-on. Crydom quality throughout. Designed for resistive lamp loads or light inductive loads. Save 20% with our new triac output SSR.

Call or write today for details.

Features:

- Filtered control input
- Built-in snubber
- Optically coupled
- 20% lower in cost
- Standard Crydom package
- Zero voltage switching

INTERNATIONAL RECTIFIER **IR** CRYDOM
RECTIFIER DIVISION

1521 Grand Avenue, El Segundo, California 90245 • (213) 322-4987

Circle 200 on reader service card

New products

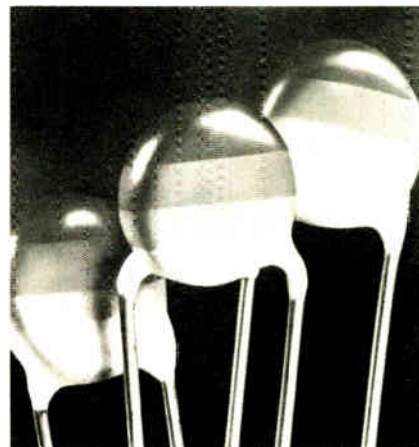

are protection and transient suppression, in protecting solid-state relays, reducing lightning effects, and in inductive and transformer switching circuits.

Mepeco Electra Inc., A North American Philips Co., Columbia Rd., Morristown, N.J. 07960 [416]

SCRs come in miniature
low-profile four-pin DIPs

Designed to simplify the layout of printed-circuit boards and to be compatible with automatic handling, testing, and insertion equipment, a line of SCRs developed by Varo Semiconductor comes in low-profile four-pin DIPs. The VCRC series has 200-, 300-, 400- and 600-volt ratings at 1.5 amperes. The gate-trigger current is 15 milliamperes. Principal applications are in power switching, power control, and ignition. Two of the devices will fit into a standard 14-pin socket.

Varo Semiconductor Inc., P.O. Box 676, 1000 N. Shiloh, Garland, Texas 75040
Phone (214) 272-4551 [417]

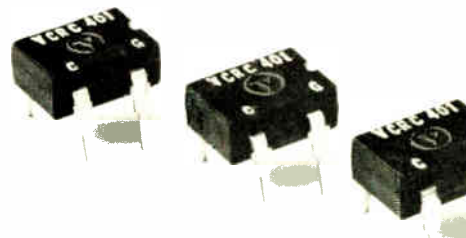

If you don't need it for forever, don't build it for forever.

Here's an application for our ACE solderless breadboards you may not have thought of.

Next time you only need a circuit for a little while, build it up on an ACE. There's an ACE the right size for almost any circuit you have to build. And ACE is a more reliable solderless breadboard, so your circuit can stay functional for as long as you need it together. Then, when your need for the circuit disappears, just disassemble it and use everything over again. It's all good as new.

And what's true for ACE is also true for our versatile A P Super-Strips™, Terminal and Distribution Strips.

So if you have a special application circuit that you won't need around forever—a test jig, a set-up-and-calibrate hookup, you name it—put ACE to work for you. The time you save may be your own. ACE. The All Circuit Evaluator from A P Products.

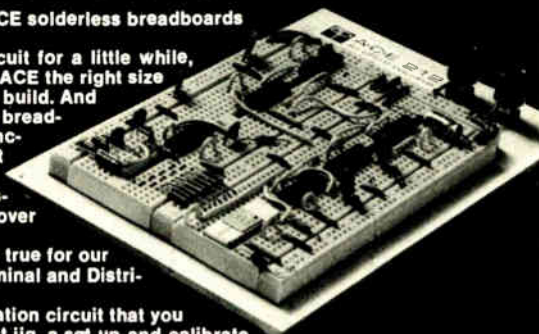

Order No.	ACE Model No.	Tie Points	DIP Capacity	No. Buses.	No. Posts	Board Size (inches)	Price Each
923333	200-K (kit)	728	8 (16's)	2	2	4-9/16x5-9/16	\$18.95
923332	208 (assem.)	872	8 (16's)	8	2	4-9/16x5-9/16	28.95
923334	201-K (kit)	1032	12 (14's)	2	2	4-9/16x7	24.95
923331	212 (assem.)	1224	12 (14's)	8	2	4-9/16x7	34.95
923326	218 (assem.)	1760	18 (14's)	10	2	6-1/2x7-1/8	46.95
923325	227 (assem.)	2712	27 (14's)	28	4	8x9-1/4	59.95
923324	236 (assem.)	3648	36 (14's)	36	4	10-1/4x9-1/4	79.95

Ohio and California Residents Add Sales Tax
All orders subject to acceptance at factory.

Write us for the full line A P Products catalog.



A P PRODUCTS INCORPORATED
Box 110-E Painesville, OH 44077 (216) 354-2101
TWX: 810-425-2250

For quick phone service, call
the A P distributor nearest you:

(201) 224-8032	(412) 782-2300	(612) 488-0201
(206) 682-5025	(415) 326-5432	(617) 237-6340
(213) 768-3800	(415) 969-9240	(617) 273-1860
(215) 698-4000	(513) 236-9900	(617) 879-0860
(216) 587-3600	(516) 483-9200	(713) 350-6771
(312) 298-8580	(516) 883-0999	(713) 777-1666
(313) 525-1800	(If no distributors in your area, call factory)	(803) 253-5333
(314) 863-7800		(914) 664-0088

200 Circle 264 on reader service card

Electronics/June 10, 1976

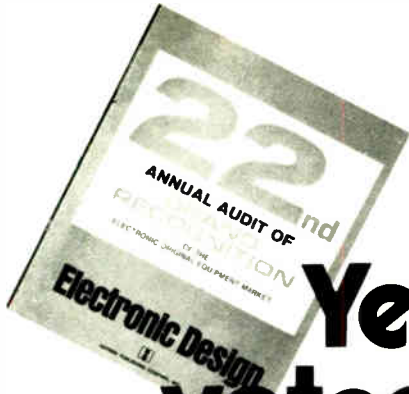

Year after year GR is voted #1 in RLC Bridges

Whenever a product-preference study is conducted, GR is always voted #1 for RLC bridges. And by a wide margin. Perhaps it is because we've been in the business for so long (over 50 years at making bridges). Or maybe our reputation for building in high quality is a factor. Or our engineering savvy. Or whatever. We think it is all these things plus a lot more that keep us in the top spot as a supplier of bridges and RLC standards.

Today, you'll find GR bridges and/or standards in laboratories, at QC and incoming-inspection stations, and in production environments throughout the world wherever R, L, or C measurements are made.

For complete information on GR's broad line of manual, automatic, and precision bridges, as well as RLC standards, request copies of our 40-page *Impedance Measuring Instruments* brochure plus the 36-page brochure on *Impedance Standards and Precision Bridges*.

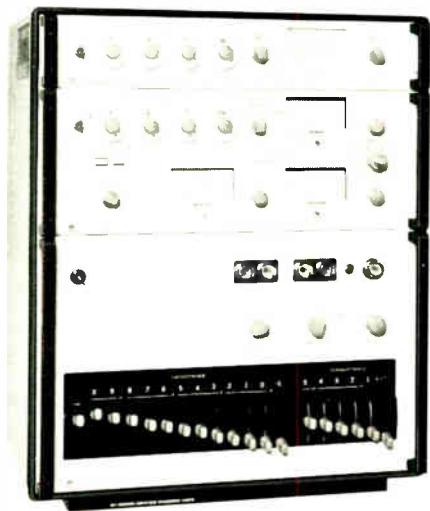

Precision Bridges

This line of products typically find their greatest use in standards labs, where scientists and engineers push the state-of-the-art in measuring electrical parameters. The 1621 Precision Capacitance-Measurement System shown here is capable of measuring capacitance in increments as small as 0.1 attofarads (10^{-18} pF).



Manual Bridges

Shown here is the 1650-B Impedance Bridge, probably the most popular bridge in use today.

RLC Standards

No bridge is complete without a standard and the GR 1408 Reference Standard Capacitor shown here is just one of dozens available from GR.



Automatic Bridges

GR introduced its first automatic bridge at the WESCON show in 1964. Several other models have followed since, with the 1686 Digital Capacitance Meter shown here being the latest addition to the product line.



GenRad

300 BAKER AVENUE, CONCORD, MASSACHUSETTS 01742

ATLANTA 404 394-5380 • BOSTON 617 646-0550 • CHICAGO 312 992-0800 • DALLAS 214 234-3357
 DAYTON 513 294-1500 • LOS ANGELES 714 540-9630 • NEW YORK (N.Y.) 212 964-2722, (N.J.) 201 791-8990
 SAN FRANCISCO 408 985-0662 • WASHINGTON, DC 301 948-7071
 TORONTO 416 252-3395 • ZURICH (01) 55 24 20

Phase lock your sources with this ultra-stable, low-cost oscillator

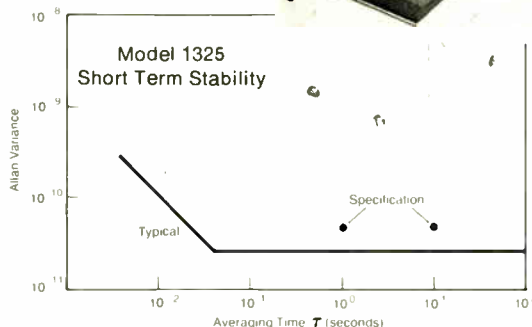
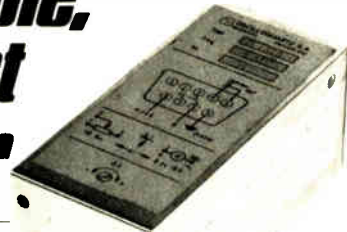

from OSCILLOQUARTZ... world leader in quartz crystal technology, comes the compact, rugged and remarkably low cost (\$390) Model 1325 oscillator. For narrow-band radars, satellite and other communication systems, it provides the advantages of critical frequency accuracy plus outstanding frequency stability and spectral purity shown above. It achieves its low-noise, super-stable performance over a wide range of environmental conditions. Frequency adjustment is with input of a 0 to +10 VDC signal or with screwdriver adjustment.

MODEL B-1325	
Frequency	5 MHz nominal
Frequency Stability Long Term (aging)	5×10^{-10} per day after 30 days continuous operation
Short Term	5×10^{-11} for $T = 1$ to 100 sec.
Temperature Stability	$< 6 \times 10^{-9}$ from -40 to +55°C
Power Requirement	1.5 watts (operating @ 25°C)
Size	2 x 2 x 4.6 inches

Complete engineering, price and performance data. Write: 182 Conant St., Danvers, MA 01923 or Call: (617) 777-1255 TELEX 94-0518

"A STEP AHEAD . . . IN TIME"



202 Circle 202 on reader service card



ACTUAL SIZE

A miniature MIL-S-3786 Type SR-19 switch at amazingly low cost. 12-position, up to 5 sections, with PC plug-in contacts available for back section. 10,000 cycle minimum, -65° to +85°C. Gold-plated, silver alloy contacts. Tri-ball detent, 16 in/oz torque.

Contact your Oak distributor or call toll-free: 800/435-6106 for additional information

OAK Industries Inc.

SWITCH DIVISION/CRYSTAL LAKE, ILLINOIS 60014

Circle 265 on reader service card

What every IC system designer needs is easy to get.

Cambion's Integrated Packaging catalog 119A has 70 pages full of products for the designer. Breadboards, Wire-Wrap* cards, card files and hardware, logic assemblies, power supplies, sockets. These are only a few of the quality Cambion products featured. Write today for your FREE copy. Cambridge Thermionic Corporation, EA 6, 445 Concord Avenue, Cambridge, MA 02138.



Standardize on

CAMBION®

The Guaranteed Electronic Components

*Reg. TM Gardner Denver Co

Circle 266 on reader service card

For low level. For narrow band. For sure.

The center frequency phase locks to external reference signal, 10Hz to 10KHz.



Select bandwidth from .03Hz to 300Hz.

For precision measurement or comparison of signals in the presence of noise or interference.

New Dynatrac narrowband voltmeter.

Now you can be sure you are measuring what you think you are measuring. This important new engineering tool will measure the signal at the exact frequency you tell it to look at, and that's all it will look at. There's no drift in either amplitude or frequency, even at bandwidths as low as .03 Hz.

The diagrams below show Dynatrac narrowband voltmeters in some typical design engineering and quality control applications.

For further information or to arrange a demonstration, contact John Hanson at Ithaco, Box 818E, Ithaca, New York 14850. (607) 272-7640. TWX 510-255-9307.

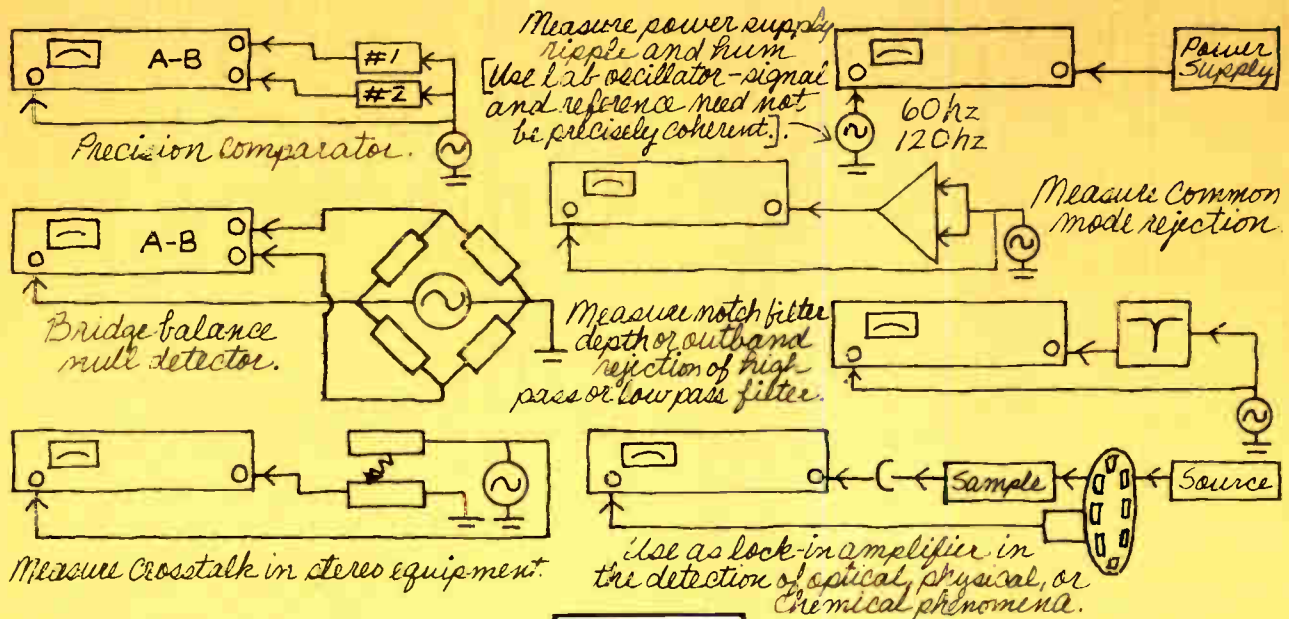

FEATURE ARTICLES FROM *ELECTRONICS* AVAILABLE IN REPRINT FORM

No of
copies
wanted

New reprints

- ___ R-600 World market report 1976
24 pp \$5.00
- ___ R-526 How reliable are today's com-
ponents 16 pp \$3.00
- ___ R-524 Special report on bipolar
large-scale integration 12 pp
\$3.00
- ___ R-522 Special report on power semi-
conductors 12 pp \$3.00
- ___ R-514 Eight ways to better radio re-
ceiver design 6 pp \$3.00
- ___ R-512 Design of circuits for dan-
gerous environments 4 pp
\$3.00
- ___ R-510 Bipolar integration advances
with I²L microprocessor 8 pp
\$2.00
- ___ R-508 Designing microprocessors
with standard-logic devices
12 pp \$3.00
- ___ R-506 The case for component
burn-in 7 pp \$2.00

Charts

- ___ R-516 Electronic symbols (chart)
\$2.00
- ___ R-211 Electromagnetic spectrum
(16-page report and chart)
\$4.00
- ___ R-213 Electromagnetic spectrum
(chart) \$2.00
- ___ R-326 Optical spectrum (6-page re-
port and chart) \$3.00
- ___ R-327 Optical spectrum (chart)
\$2.00

Books

- ___ R-520 Microprocessors—Electronics
Book Series \$8.95
- ___ R-11 Computer-aided Design 135
pp \$4.00
- ___ R-032 Active Filters 88 pp \$4.00
- ___ R-031 Circuit Designer's Casebook
182 pp (U.S. only) \$5.50
(foreign) \$12.00

Other Reprints

- ___ R-518 Special issue—productivity
\$4.00
- ___ R-434 Designing automated systems
with the new standard inter-
face 12 pp \$3.00
- ___ R-432 An update on communi-
cations satellites 8 pp \$2.00
- ___ R-430 Choosing the right bipolar
transistor model for com-
puter-aided design 20 pp
\$3.00
- ___ R-428 Designing with low-cost la-
sers 6 pp \$2.00
- ___ R-504 U.S. forecast 1975 20 pp
\$3.00
- ___ R-502 European forecast 1975
20 pp \$3.00
- ___ R-500 Japanese forecast 1975
16 pp \$3.00
- ___ All three forecasts \$7.50
- ___ R-426 Special issue—technology up-
date 1974 \$4.00
- ___ R-424 Microprocessor applications
28 pp \$3.00
- ___ R-422 A microprogramable mini-
computer 8 pp \$2.00
- ___ R-420 Computerized text-editing
and typesetting 8 pp \$2.00
- ___ R-418 Computer analyses of rf cir-
cuits 8 pp \$2.00
- ___ R-416 Optical waveguides look
brighter 8 pp \$2.00
- ___ R-414 The ion-implanted n-channel
process 6 pp \$2.00
- ___ R-412 Liquid cooling of power semi-
conductors 6 pp \$2.00
- ___ R-410 Special report on passive
components 16 pp \$3.00
- ___ R-408 Bringing sight to the blind
8 pp \$2.00
- ___ R-406 Designing with the new logic,
C-MOS and bipolar 16 pp
\$3.00
- ___ R-328 Special issue—pervasiveness
of electronics \$2.00
- ___ R-324 Semiconductor memories are
taking over data-storage ap-
plications 16 pp \$3.00
- ___ R-322 Special report: new displays
complement old 10 pp \$2.00
- ___ R-320 Special report on designing
with flat cable 14 pp \$3.00
- ___ R-318 Special report on auto elec-
tronics 16 pp \$3.00
- ___ R-316 Hybrid circuits solve tough
design problems 16 pp \$3.00
- ___ R-312 Leadless, pluggable IC pack-
ages reduce costs 7 pp \$2.00
- ___ R-310 Penetration color tubes are
enhancing information dis-
plays 6 pp \$2.00
- ___ R-308 Program for transition from
nonlinear to linear transistor
model 6 pp \$2.00
- ___ R-306 Charge-coupling improves its
image, challenging video
camera tubes 8 pp \$2.00
- ___ R-209 Semiconductor RAMs land
computer mainframe jobs
15 pp \$2.00
- ___ R-207 Technology gap starts to
close for computer peripher-
als 16 pp \$3.00
- ___ R-205 Bridging the analog and dig-
ital worlds with linear ICs
16 pp \$3.00
- ___ R-203 East Europe market report
16 pp \$2.00
- ___ R-113 Optoelectronics makes it at
last 34 pp \$4.00
- ___ R-107 Wanted for the '70s: easier-
to-program computers 24 pp
\$4.00
- ___ R-104 The new concept for memory
and imaging: charge-coupling
12 pp \$2.00
- ___ R-023 Special report on tomorrow's
communications 32 pp \$3.50
- ___ R-15 Special report on LSI pack-
aging 18 pp \$3.00

Payment must accompany your order

Make check or money order pay-
able to Electronics Reprints. All
orders are shipped prepaid by
parcel post. Allow two to three
weeks for delivery.

Back issues now available:
1960 to 1969, \$5.00 each
1970 to 1973, \$3.00 each
1974 to 1975, \$4.00 each

USE THIS PAGE AS YOUR ORDER FORM

Cost of orders \$ _____
Plus 10% handling charge \$ _____
TOTAL AMOUNT ENCLOSED \$ _____

Mail your order to:
Janice Austin
ELECTRONICS REPRINTS
P.O. Box 669
Hightstown, N.J. 08520

SEND REPRINTS TO

Name _____
Company _____ Dept. _____
Street _____
City _____ State _____ Zip _____

Get top performance and soldering safety...



Fujitsu quality printed circuit board relays

FUJITSU

Fujitsu is now marketing two classes of space-saving relays for pc board applications, and designed for maximum safety and convenience when using flow-soldering assembly techniques. So, if you're a maker of industrial, control, communications, or entertainment equipment, get smart and choose the relays that answer your pc board construction problems—top quality Fujitsu relays.

Miniature GP-type BR-series in SPDT

Featuring the Fujitsu high-strength packaging that resists flux contamination caused by flow soldering, the BR-series is the perfect choice for general-purpose applications demanding the smallest size. Available in versions with 3A contact rating (BR311 type) and in ultra-miniature models (BR211) for smaller loads, Fujitsu BR-series relays offer the wide range of model choice, high product dependability, and long life expectancy that makes for



greater equipment reliability, more satisfied customers.

Low-profile FRL410-series in DPDT, 4PDT

The outstanding Fujitsu FRL410-series of low-profile relays offers a compact package size for high-density component mounting and tighter circuit board clearances that can mean dollars of savings all around. Available in both DPDT and 4PDT contact arrangements with a range of coil voltage ratings of from 5V to 48VDC, the FRL410-series is perfect for communications or other applications demanding small size, low power consumption and long-life operation. Features the same flux-proof package as BR-series relays.

Fujitsu printed circuit board relays. They're a proven and high performance alternative, in full compliance with applicable safety/performance standards, and at prices that will make you wonder why you didn't think Fujitsu before.

FUJITSU LIMITED

Communications and Electronics

Tokyo, Japan

For further information, please contact

■ **Components Division (Head Office)** Syuwa-Onarimon Bldg. 1-1 Shinbashi 6-chome, Minato-ku, Tokyo-105, Japan. Phone: Tokyo (03) 437-2111. Cable: FUJITSULIMITED TOKYO. Telex: 2422808 FT.SIN.J. ■ **New York Office** 680 Fifth Avenue, New York, N.Y. 10014, U.S.A. Phone: (212) 265-5360. Telefax: 23-234969. ■ **Fujitsu California, Inc.** 1135 East Janis Street, Carson, California 90746, U.S.A. Phone: (213) 631-0858. 537-8930. Telex: 230-673387. ■ **London Office** Norman House, 105/109 Strand, London, W.C.2, England. Phone: 240-0461/0462. Telex: 5122305



HP 9830* users... your floppy disk is here! \$3895.

- The FD-30 runs on cassette commands... that means *no software changes!* Because it runs on your existing programs.
- The FD-30 finds files *50 times faster* than either the 9830 or the 9865 cassette drive.
- The FD-30 stores 5 cassettes of data at the cost of one cassette.
- The FD-30 stores a 6,000 word array in *4 seconds* via a simple STORE DATA—the HP 9880 mass memory takes 11 seconds to do the same job.
- The FD-30 sells for *less than a third* of the 9880B.

Infotek's FD-30 provides 305K bytes of user area. Or 5 to 7 cassettes of data on-line, retrievable *50 times faster* than your present system.

No installation!

You can fit the FD-30 neatly between the calculator and printer. Just plug-in the I/O connector and power cord. And its color design perfectly matches the 9830.

Latest Technology

We're using the latest technology microprocessor for the controller/formatter and the finest floppy disk system.

All for \$3895.

Plus you get quality comparable to the 9830.

Call us collect at (213) 966-7431. Or write Infotek Systems, 733 E. Edna Place, Covina, Ca. 91723. Ask about other 9830 compatible products.

*a product of the Hewlett-Packard Company



Infotek Systems

The M-600 amp works harder at 2.5 ohms

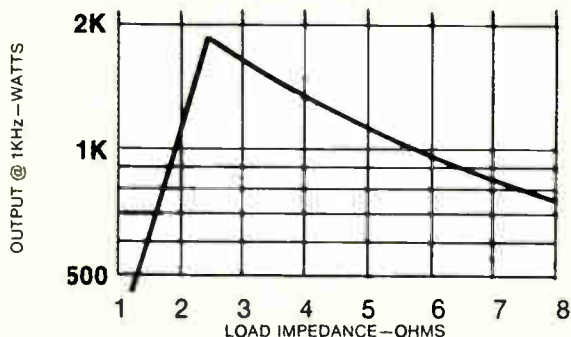

So each watt costs less

You get more watts per dollar from the Crown M-600 power amp if your circuit design lets it look at a 2.5Ω load.

The M-600 provides power from DC to 20KHz with complete protection against shorts, open circuits, mismatch, RF burnout and thermal overload. The M-600 will even drive a purely reactive load without overheating. Designed for continuous operation at full rated power, at any rated frequency.

One M-600 will cost you \$1,795. A copy of the spec sheet is free. Write today.

We'd also like to hear from you if you have any special amplification problems in the DC-20KHz range. We've already solved some tough, unique problems. We'd like to consider yours.



**CROWN
INDUSTRIAL**

1718 W. Mishawaka Road, Elkhart, Indiana 46514
219/294-5571

Subassemblies

Analog Devices in new market

Company's data-acquisition entry is low in speed, cost; firm sees price dips coming

Introduction of a 12-bit data acquisition system by the modular instrumentation division of Analog Devices Inc. marks the company's first foray into that market. The DAS 1128 is a second-source product, essentially matching Analogic's MP 6912 unit in form, fit and function—but not in speed.

James O. Fishbeck, the division's marketing manager for modular converters, says the firm chose not to compete with the 6912's 100-kilohertz throughput rate because the market for modular systems with that speed is smaller than the market for the DAS1128's 50-kHz throughput. "The industrial and microprocessor-based markets that we're interested in don't appear to need that throughput rate," Fishbeck maintains.

The DAS1128 measures 3 by 4 by

0.375 inches. In size and pinouts, it's an alternate both to the 6912 and to products introduced earlier by Burr-Brown Research Corp. and Data Translation Inc., among others. "This market is just emerging," Fishbeck points out, "and prices are starting to come down. For those reasons, and because of our established name in data converters, we feel we can jump in a bit late but at a lower price than some of the other products." The DAS1128 is priced at \$295 in 1-9 quantities.

The new entry provides everything required for multichannel high-speed data acquisition, including scanning, analog-to-digital conversion, programming, control and timing. It incorporates a 15-microsecond analog-to-digital converter, sample-and-hold amplifier, precision reference, high-stability buffer amplifier, and a 16-channel multiplexer. It employs an integrated-circuit successive-approximation register for the a-d conversion, and Analog Devices' own AD562 12-bit d-a converter chip.

Key specifications include a non-linearity temperature coefficient of 2.5 parts per million per degree C, an 8 ppm/°C gain tempo for stability, and relative accuracy within ±0.012% of full-scale range at a 33-Hz throughput. The unit is available

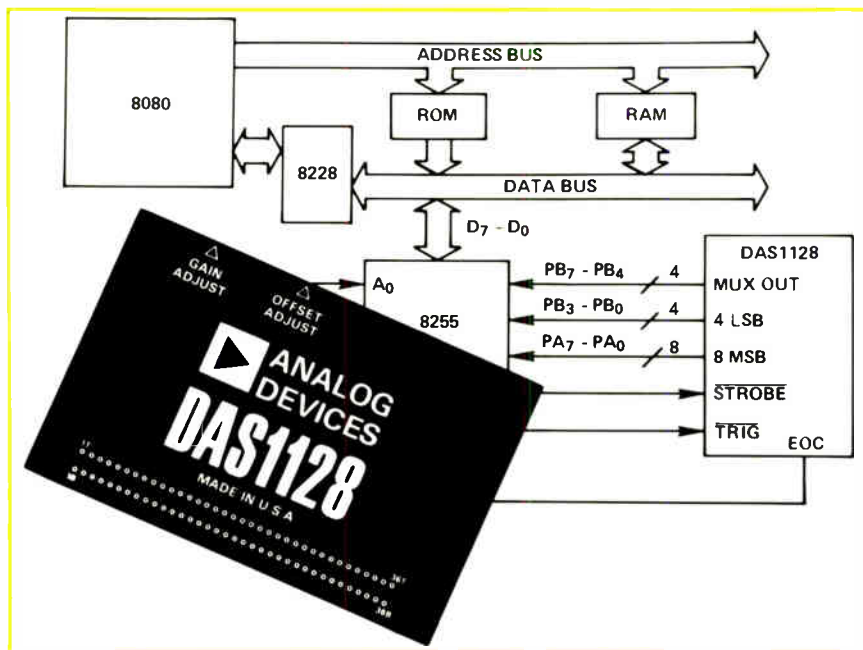

PC plug-in transformers

New flat-head design

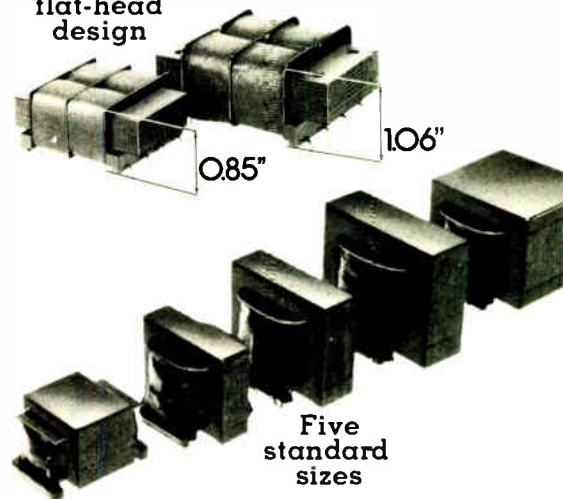

not just more, but more kinds—all available off-the-shelf

- 200 ratings
- 5-120 volts
- 8 ma to 4.8 amps
- single or dual primaries
- 1 to 24 VA

We've made it our business to keep availability and price more than competitive, with no performance compromise. Add to that a uniquely comprehensive selection, complete with exclusive low-profile flat-head transformers as low as 0.85" inches high...

you get it all, with Signal.

AND, SHIPPED PRONTO

We guarantee 48-hour shipment of your prototype (1-4 pc.) order, or you get the Polaroid "PRONTO™" camera free.

FREE CATALOG

Lists over 1000 standard transformer and choke designs, from 1 to 10,000 VA. Write or call: Signal Transformer Co., Inc., 1 Junius St., Brooklyn, N.Y. 11212; phone: (212) 498-5111.

signal
TRANSFORMER

New products

from stock, the company says. Analog Devices Inc., P.O. Box 280, Route One Industrial Park, Norwood, Mass. 02062. Phone Lowell Wickersham at (617) 329-4700 [381]

Economy supplies offer automatic protection

A Black Knight line has been added to the economy series of power supplies from Adtech Power Inc. Operating from 115/230 volts, 47-120 hertz ac line, these units are available in ratings of 5 volts at 10 amperes, 12 v at 7 A, 15 v at 6 A, 24 v

at 5 A, and 28 v at 4 A. Voltage adjustment is $\pm 5\%$, and the units are regulated $\pm 0.1\%$ for line and load. Ripple of the units is 1 mV rms. Protection features include automatic foldback current-limiting overload and short-circuit protection, IC regulator protection, reverse polarity protection, and inductive load protection. An overvoltage protection crowbar is available as an option. Prices are \$67 each for one and \$54.05 each for hundreds.

Adtech Power Inc., 1621 S. Sinclair St. Anaheim, Calif. 92806. Phone George W. Mousel at (714) 634-9211 [383]

Amplifiers drive dc servo motors up to 1½ horsepower

Servo amplifiers, called the A6421 Saturn series, are designed for full four-quadrant operation in driving all types of dc servo motors with ratings up to 1½ horsepower. The servo amplifier has no dead band and

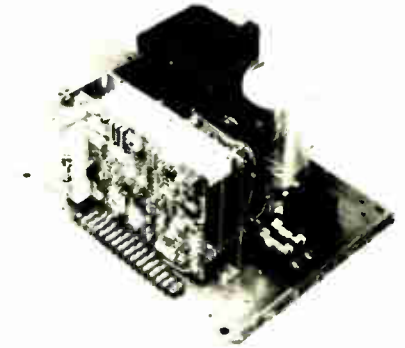

provides a true linear output. The high energy-storing reservoir of capacitors is capable of providing a proportional current output up to ± 28 amperes and a voltage up to ± 85 v dc. Two of the latest in the A6421 series are the A6421-9A, which operates from 120 or 240 v ac single-phase power; and the 9B, which operates from 240 or 480 v ac three-phase power. Both include power supplies, a preamplifier, and a compensation circuit. The A6421 series is designed for both speed control and position control in



Problem:

You want to save time and money with a single source that covers all your packaging needs.

Solution:

Bud will help you do it with a product directory that covers anything and everything you need. Call and get it now.

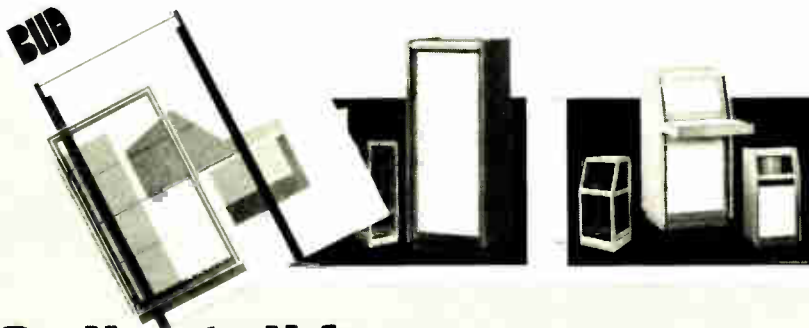

The Bud catalog is the industry's definitive enclosure reference. With it you can choose, order and receive — on time — whatever rack, cabinet or enclosure you need to package your product; whatever accessory you need to make your product even more functional. **YOUR PROBLEM IS SOLVED!**

Call toll free:

(800) 321-1764; in Ohio, (800) 362-2265.

BUD

BUD RADIO, INC.
Willoughby, Ohio 44094

We made them first. To last.

Available now from Singer: Size 8 and 11 Bu/weps synchros designed to meet the latest requirements of MIL-S-20708C specifications.



Kearfott, the first to design Bu/weps size 5, 8 and 11 synchros, has over the years constantly made them better. These units are used in fire control systems, radar, navigation, missile functions and other applications requiring a high level of precision, endurance and reliability.

These Kearfott synchros operate over the entire temperature range of -55°C to $+125^{\circ}\text{C}$. They are DOD qualified and listed in the QPL.

(They can also meet reasonable cost requirements in computers, electronics and other types of business equipment.)

You can get these synchros in the following Bu/weps types:

Size 8	Size 11
26V 08CX4c	26V 11CX4c
26V 08CDX4c	11CX4e
26V 08CT4c	26V 11TX4c
	26V 11CDX4c
	11CDX4b
	26V 11CT4d
	11CT4E

We'll be happy to send you drawings and technical details on request. Also for Kearfott Size 5 Bu/weps CX, CDX and CT units, and Size 11 and 15 resolvers. Units with the same characteristics but different Bu/weps shaft variations are also available. Write for information to the Singer Company, Kearfott Division, 1150 McBride Avenue, Little Falls, N.J. 07424.

SINGER
AEROSPACE & MARINE SYSTEMS

New from Standard Grigsby

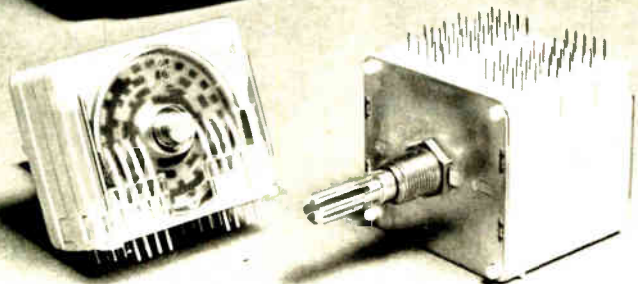

P/relTM

the programmable rotary encoded logic switch everyone will be talking about...

... because no other rotary switch has as much versatility with as low a cost as Standard Grigsby's P/rel switch!

The economy is twofold. This switch not only lends itself to full automation, but installed costs are lower by the use of our printed circuit terminals (solder terminals are also available).

A specially processed printed circuit disc is fully

programmable to the truth table of any code. We provide 100% program disc inspection to customer specifications. Up to 60 detent positions are available with our new double ball Dual FlexTM detent. And, the use of concentric shafts allows up to 120 detent positions from a single switch!

Everyone will be talking about P/rel . . . so will you!

Send for your free "Yes" button and literature.



standard grigsby, inc.

920 Rathbone Avenue, Aurora, Illinois 60507. Phone (312) 897-8417

Circle 210 on reader service card

Own your own holder to hold your own!

Hold your own copies of Electronics in specially designed slipcase holders. They'll keep your Electronics library neat and handy—a permanent information file, issue by issue.

Just complete the coupon and mail to Jesse Jones. He'll process your order upon receipt, postpaid.

ELECTRONICS BOXER
Jesse Jones Box Corporation
2250 E. Butler St., Philadelphia, Pa. 19137

Please send me: boxes @ \$4.25 each; 3 boxes @ \$12.00; 6 boxes @ \$22.00.
My check or money order is enclosed.

Name: _____

Address: _____

City: _____

State: _____



Zip: _____

New products

many industrial system applications. Westamp Inc., 1542 15th St., Santa Monica Calif. 90404. Phone Jim Manda at (213) 393-0401 [384].

Switching regulated supply operates over military range

A high-efficiency series of power modules converts 115 volts ac, 400-hertz power to 50 watts of regulated dc power at voltages ranging from 5 to 50 v dc. According to the maker, Abbott Transistor Laboratories, the UN series is one of the few switching regulated supplies capable of operating over the full military range of -55 to +100 C. The modules regulate dc input voltages to 0.3% over their full input range of 115 v rms $\pm 10\%$. Load regulation is 0.5% for no load to full load at constant input voltage. Ripple and

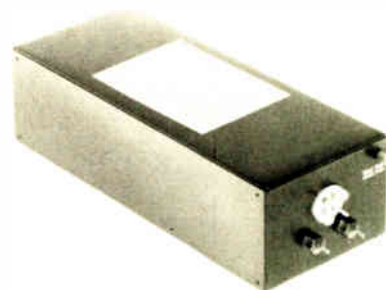

noise has been kept to 25 v rms, 100 mV peak to peak, over the range from 25 to 100 C, and other features include full rated output current from -55 to 85 C, derated to 80% of full-load rating at 100 C (baseplate temperature). Temperature coefficient is specified at 0.03%/C maximum. The UN series is fully encapsulated and hermetically sealed. Price is \$425.

Abbott Transistor Laboratories Inc., 5200 W Jefferson Blvd., Los Angeles, Calif. 90016. Phone (213) 936-8185 [385].

Frequency error held under $\pm 0.05\%$ in v-f converter

With a guaranteed nonlinearity of less than $\pm 0.015\%$ of full scale, $\pm 0.015\%$ of signal, the model 4725

Ask CONTROL DATA about the improved Model 9427H "Hawk" OEM Cartridge Disk Drive with double-the-uptime performance.

We have it.

Hawk—updated, simplified, field-tested and proven for twice-the-reliability of previous models. 12 MByte standard, 6 and 3 MByte optional. Average access 35 ms. Data rate: 2.50 MHz.

Test "Hawk." Evaluate it for new high-uptime standards of performance and reliability. Compare it with competition. Once you do, you'll use "Hawk" with confidence. And get such key advantages as these:

Versatility

For interface versatility, you can choose CDC or one of several competitive interfaces. Star or daisy chain configuration. The unit in daisy chain configuration is removable without affecting other units.

For control versatility, the control panel module is removable for placement in a remote location.

Ease of Maintenance

Hawk's modular design offers individually replaceable sub-assemblies that simplify maintenance, keep downtime down.

An independent blower motor assures continuous standby capability and clean disk area—and improved reliability.

The power supply is self-contained; the input is universal 100-250 VAC, 50/60 Hz.

Hawk even offers a Fault Isolation and Retention Module! This optional device provides diagnosis to board level and stores fault information. Even when power is removed!

Whether large OEM, or small, check into "Hawk." For reliability, performance, options. For Cartridge Disk Drives you can sell with confidence in your system.

Call (405) 946-5421 or return coupon to: Terry J. Hardie, Product Sales Manager,
Control Data Corporation, 4000 NW 39th Street, Oklahoma City, OK 73112
Please send more information on your Cartridge Disk Drives.

Ask the CDC OEM people

NAME _____ TITLE _____
COMPANY _____ ADDRESS _____
CITY _____ STATE _____ ZIP _____ PHONE _____

CDC CONTROL DATA
CORPORATION

Resist it!



Protect components from elevated temperatures with Raychem UL recognized, heat-shrinkable tubing (125°C). Ideal for applications where insulation must be FR-1 rated.

Semi-rigid, polyolefin tubing is easily applied by automated tubing applicators such as the VIP* for high production rates. Write for free samples.

*VIP Industries

Raychem Corporation
Electronics Industries Group
 300 Constitution Drive
 Menlo Park, California 94025
 415 329-3860

Raychem

Circle 212 on reader service card

New products



voltage-to-frequency converter offers pin-for-pin compatibility with many widely used v-f converters. The company also guarantees a full-scale frequency error of less than $\pm 0.05\%$, plus a zero error of only 10 millivolts that may be trimmed to zero. The 4725 is expected to have applications in highly cost-sensitive applications such as analog-to-digital conversion, and in motor speed control. Unit price is \$29.50.

Teledyne Philbrick, Allied Drive at Rte. 128, Dedham, Mass. 02026. Phone Frank Goodenough at (617) 329-1600 [386]

If you want a microcomputer with all of these standard features...

- 8080 MPU (The one with growing software support)
- 1024 Byte ROM (With maximum capacity of 4K Bytes)
- 1024 Byte RAM (With maximum capacity of 2K Bytes)
- TTY Serial I/O
- EIA Serial I/O
- 3 parallel I/O's
- ASCII/Baudot terminal compatibility with TTY machines or video units
- Monitor having load, dump, display, insert and go functions

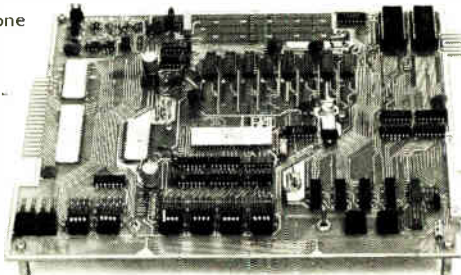

- Complete with card connectors
- Comprehensive User's Manual, plus Intel 8080 User's Manual
- Completely factory assembled and tested—not a kit
- Optional accessories: Keyboard/video display, audio cassette modem

interface, power supply, ROM programmer and attractive cabinetry... plus more options to follow. **The HAL MCEM-8080. \$375**

...then let us send you our card.

HAL Communications Corp. has been a leader in digital communications for over half a decade. The MCEM-8080 microcomputer shows just how far this leadership has taken us... and how far it can take you in your applications. That's why we'd like to send you our card—one PC board that we feel is the best-valued, most complete



microcomputer you can buy. For details on the MCEM-8080, write today. We'll also include comprehensive information on the HAL DS-3000 KSR microprocessor-based terminal, the terminal that gives you multi-code compatibility, flexibility for future changes, editing, and a convenient, large video display format.

HAL Communications Corp.
Box 365, 807 E. Green Street, Urbana, Illinois 61801
Telephone (217) 367-7373

Digital clock module includes power supply

A complete digital clock system from Fairchild, called the FCS8100, contains an MOS circuit, a display with alarm-set indicators, and a colon in a solid-state module that measures only 3.5 by 1.75 inches and is 1-in. thick. The module incorporates power supply and output drive circuitry for alarm and clock-radio operation. Only switches required by the application and a transformer with a 1.6-volt center-tapped secondary are needed to turn the unit into a functioning clock. Price of the clock module is



Circle 268 on reader service card

**Announcing
a NEW FREE SERVICE!**

Need more bids? Better competition?

**With one phone call you
can shop the entire
marketplace for
any Electronic
or Electrical
Product!**



CALL TOLL FREE 800-336-0226

In Virginia 800-572-3007

You'll hear a recorded message on how this
NEW buying concept can go to work for you
at no cost or obligation whatsoever!

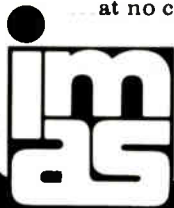

**industrial marketing
advisory services, inc.**

2425 Wilson Boulevard Arlington Virginia 22201

A NEW PERSPECTIVE IN MARKETPLACE EFFICIENCY!

Circle 270 on reader service card

**The GOULD/Brush 2600.
Versatility unlimited in a
direct writing recorder.**



Announcing the
new, high performance
Gould 2600—undoubtedly the
most versatile recorder available

today. The 2600 features an unequalled frequency response
of 30 Hz at 100 mm and 50 Hz at 50 mm with 99.65%
linearity. A servo-controlled penmotor assures precise
response, while the famous Gould pressurized inking
system produces the highest quality rectilinear traces.

You can order the 2600 with three 100 mm channels. Or
with one 100 mm channel and four 50 mm channels. Or
with six 50 mm channels.

Call your nearest Gould Sales Engineer or write Gould
Inc., Instrument Systems Division, 3631 Perkins Avenue,
Cleveland, Ohio 44114. Or Gould Allco SA, 57 rue St.
Sauveur, 91160 Ballainvilliers, France.

**TOLL FREE NUMBER
(800) 325-6400
(In Missouri (800) 342-6600)**



Circle 269 on reader service card

SCRUB

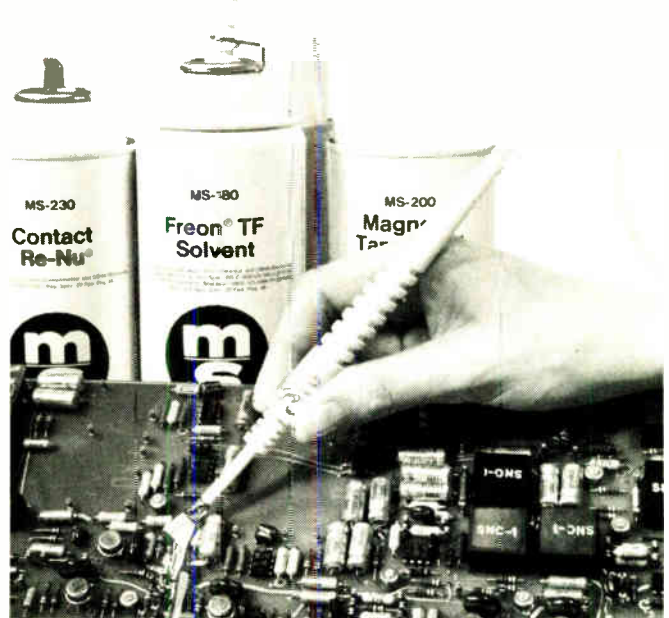

INCREASE YOUR SOLVENT CLEANING ACTION... NO WASTE

- Brush has finger-tip control for on-the-spot cleaning — eliminates solvent waste.
- Scrubbing action of brush permits use of milder solvents.
- Attaches to all M/S aerosols.
- Sensibly priced.

**TRIAL
OFFER**

**miller-stephenson
First In Purity**

E6U

MILLER-STEPHENSON CHEMICAL CO., INC.
Danbury, Connecticut 06810 / (203) 743-4447

- Enclosed is \$2.00, please send my MS-180 Solvent.
- Enclosed is \$5.00, please send my MS-180 Solvent
PLUS MS-226 Extension Hose and Brush.
- Please send FREE literature and Military Specs.

Intended Use

Name Dept./Title.....

Company

Address

Circle 213 on reader service card 213



Scanbe-gram



RE: THE SOCKET THAT ENGINEERS SWEAR BY

ENGINEERS ALL OVER THE WORLD SWEAR BY - NOT AT - SCANBE'S FAMOUS ME-2 SOCKET.

ME-2'S ARE SPEC'D INTO PRODUCT AFTER PRODUCT... BECAUSE ENGINEERS KNOW THIS SOCKET WON'T LET THEM DOWN.

MILLIONS HAVE BEEN SHIPPED...NOT ONE HAS EVER BEEN RETURNED DUE TO FAILURE.

CHECK THESE FEATURES...TAPERED ENTRY CHANNELS... EDGE-GRIPPING CONTACTS...REMOVABLE PINS...CLOSED ENTRY DESIGN...REMOVABLE CAP...PLUS MANY MORE.

SEND FOR COMPLETE SPECS AND PRICES.

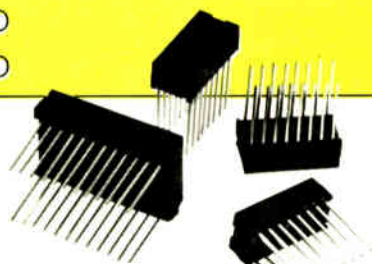

"Imitated... never duplicated."

SCANBE
CANOGA INDUSTRIES

Scanbe Manufacturing Corp.
3445 Fletcher Ave., El Monte, CA 91731
Tel: (213) 579-2300 • TWX: 910-587-3437

Circle 214 on reader service card

**SPRAGUE
GOODMAN**

TRIMMER CAPACITORS

Our only business!



PISTONCAP® Multi-Turn Tubular

- Low-Loss, Glass or Quartz
- High Stability/High Reliability
- Simple, Long-Life Adjust Mechanism
- Professional / Military Applications, MIL Approved

CERAMIC Single-Turn

- Compact, Conserves Board Space
- Variety of Mounting Configurations
- Low Cost for Commercial/Industrial Applications

FILMTRIM* Single-Turn Film

- PTFE, Polypropylene, Polycarbonate
- Most Stable Trimmer for Size
- Very Wide Capacitance Ranges
- Low Cost for Commercial/Industrial Applications

*Trade Mark

Tired of broken delivery promises and poor quality? Deal with the trimmer capacitor specialist, for quality products delivered on schedule! Call on us for custom designs too, we deliver!

TRIMMER CAPACITORS - OUR ONLY BUSINESS!

Sprague-Goodman Electronics, Inc.

(An Affiliate of the Sprague Electric Company)

134 FULTON AVE., GARDEN CITY PARK, N.Y. 11040 • 516-746-1385 • TLX: 14-4533

214 Circle 271 on reader service card

New products

\$12 for quantities of 1,000.

Similar 0.8-inch-high clock displays also are available in either 3½- or 4-digit formats. They are priced at \$5.60 to \$6.25 each in 1,000-lots.

Optoelectronics Division, Fairchild Camera and Instrument Corp., 4001 Miranda Ave., Palo Alto, Calif. 94304 [387]

Two dc-to-dc converters run from 48-volt dc source

Designed for use in the telephone industry and in systems powered by a 48-volt common bus, two 110-watt switching-regulated dc-to-dc converters operate from a 48-v dc source. Both are off-the-shelf models; one has a triple output and the other, a single output.

Model 61315D offers three outputs of 4.75 to 5.25 v, 11.4 to 15.75 v, and -11.4 to -15.75 v. The 5-v output is controlled by the main switching regulator and the ±12- to ±15-volt outputs are series-regulated independently. The 110-watt maximum output power may be shared among the three outputs within current ratings of each individual supply, making current available where it is needed. The single-output converter, model 61005C, has an output of 4.75 to 5.25 v.

Both compact, convection-cooled models use an advanced 20-kilo-hertz transistor-switching design that minimizes radiated and conducted interference. Input voltage may range from 42 to 56 v dc for continuous operation.

Price of the model 61315D is \$525; of the 61005C, \$400. OEM and quantity discounts are available. Estimated delivery time is two weeks. Inquiries Manager, Hewlett-Packard Company, 1501 Page Mill Road, Palo Alto, Calif. 94304 [388]



Market-Directed® Surveys Provide Inputs Tailored To Your Decision Making

Do you know the size of markets for your products? Do you know if your products are preferred? By whom? And why they're preferred? Do you know if your salesmen reach the buying influences for your products? What proportion are contacted? Which is your best advertising message? What are your industry's marketing trends?

These are a small number of the questions that can be answered for you through actionable research by the unique facilities of McGraw-Hill.

Today's dynamic marketplace requires more market information than ever before.

Studies conducted by McGraw-Hill Research to fill the needs of corporate management, marketing executives, product managers, sales managers and advertising managers are identified as "Marketing Directed Surveys" by McGraw-Hill Research.

These surveys bring you new information about your company, its products, their markets, marketing tools used in the markets, and your advertising program.

For more information about "Market-Directed Surveys," write for our booklet *Answers for Decision Makers in Marketing*, or phone Allen Cobb, Jr., Director of Research (212) 997-6823.

McGraw-Hill Research
McGraw-Hill
Publications Company
1221 Avenue of the Americas
New York, N.Y. 10020



PRESENTING Bowmar's new "Standard" Keyboards

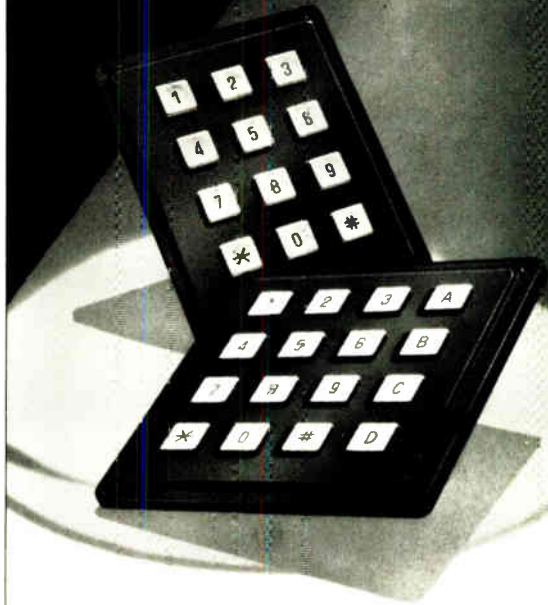

In keeping with Bowmar's role as the innovating leader in the keyboard industry these new 12 and 16 station "Standard" keyboards are the perfect companions for many of today's keyboard applications. Available off-the-shelf, each is loaded with a broad array of Bowmar quality features.

- Gold or silver epoxy contact pads
- Plastic bezel and 2-shot molded keys
- Single or double closure contacts
- Tactile/audible feedback
- Row and column or single column matrixes
- Short stroke/low profile

Please send me full information on Bowmar "Standard" keyboards.

Name

Company

Street

City

State Zip

 **Bowmar**

Mail to: Bowmar Instrument Corp., Dept. EN
3000 Bluffton Road, Fort Wayne, IN 46809

For Information circle 114 on Reader Service Card
For Salesman call circle 272 on Reader Service Card

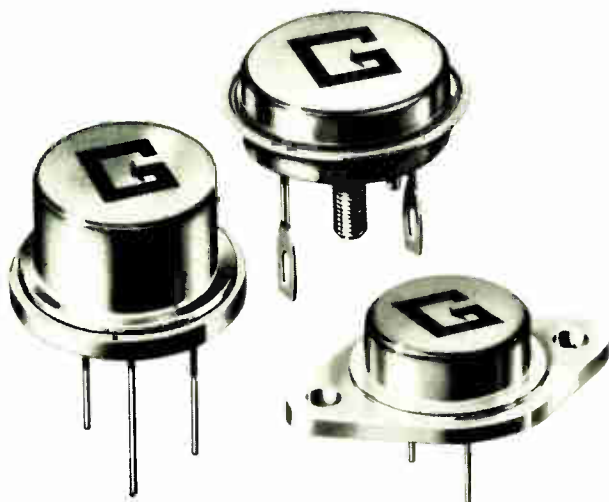

Q:

**WHERE CAN YOU GET
RELIABLE GERMANIUM
POWER TRANSISTORS?**

A:

GPD

Q:

**IS THERE A DEPENDABLE
GERMANIUM POWER
TRANSISTOR FACTORY?**

A:

GPD

When you need germanium power transistors for military, industrial or commercial applications, the overwhelming answers are always found at Germanium Power Devices. They come in 20 package pellet combinations with power dissipations from 75 amps to 1 amp. We manufacture every type including JAN, EIA and PRO ELECTRON. In these series: AD, ADY, ADZ, ASZ, AUY. We'll always come up with a solution for you because we make custom devices to meet your requirements. So, put your germanium power transistor questions to us.



**GERMANIUM
POWER
DEVICES CORP**

P.O. BOX 65, SHAWSHEEN VILLAGE STATION
SHETLAND INDUSTRIAL CENTER, YORK STREET, ANDOVER, MA 01810
(617) 475-5982 TELEX 94-7150

216 Circle 216 on reader service card

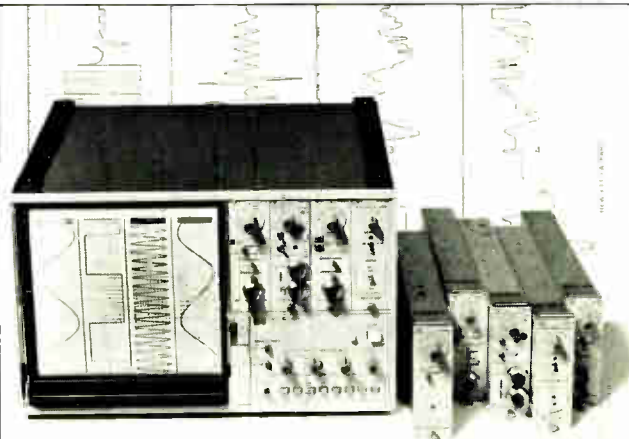

HP gives you up to 4 channels and more in an oscilloscopic recorder.

HP gives you more in a two channel or a four channel oscilloscopic recorder. With things like handy front panel controls, crisp-dry trace, stainless steel pens, plug-in signal conditioners and an assortment of many other options, including paper tape take-up. And with HP reliability. Compare the value against any recorder. At any price. You'll see how much more they give you. For details write: Hewlett-Packard, 1501 Page Mill Road, Palo Alto, CA 94304.

11604

HEWLETT  PACKARD

Sales and service from 172 offices in 65 countries.
1501 Page Mill Road, Palo Alto, California 94304

Circle 273 on reader service card

KEYLOCK SWITCHES



SWK-12
SERIES

Avoid unauthorized use of your equipment with our SWK-12 SPST switches. Double bitted keys for high security. 5 amp @ 125 VAC

rating. SWK-13 SPST types have single bitted keys for normal security; 4 amps @ 125 VAC. Also available with momentary action. Choice of key codes, also.

Call (617) 685-4371 for detailed information and prices.

RIGHT ANGLE TOGGLE



MTM-RA
SERIES

Our miniature RIGHT ANGLE PC TOGGLE switches may cost a little more, only because they are the best in the industry! Available as 1 or 2 pole. Most important are our technical features, of which there are too many to list in this small ad.

Call (617) 685-4371 to discover why our competitors charge extra for our standard features.

ALCO ELECTRONIC PRODUCTS, INC.
1551 OSGOOD STREET, NORTH ANDOVER, MA 01845 U.S.A.

TEL: (617) 685-4371 TWX: 710 382 0552

A SUBSIDIARY OF

AUGAT
INC.

Circle 274 on reader service card

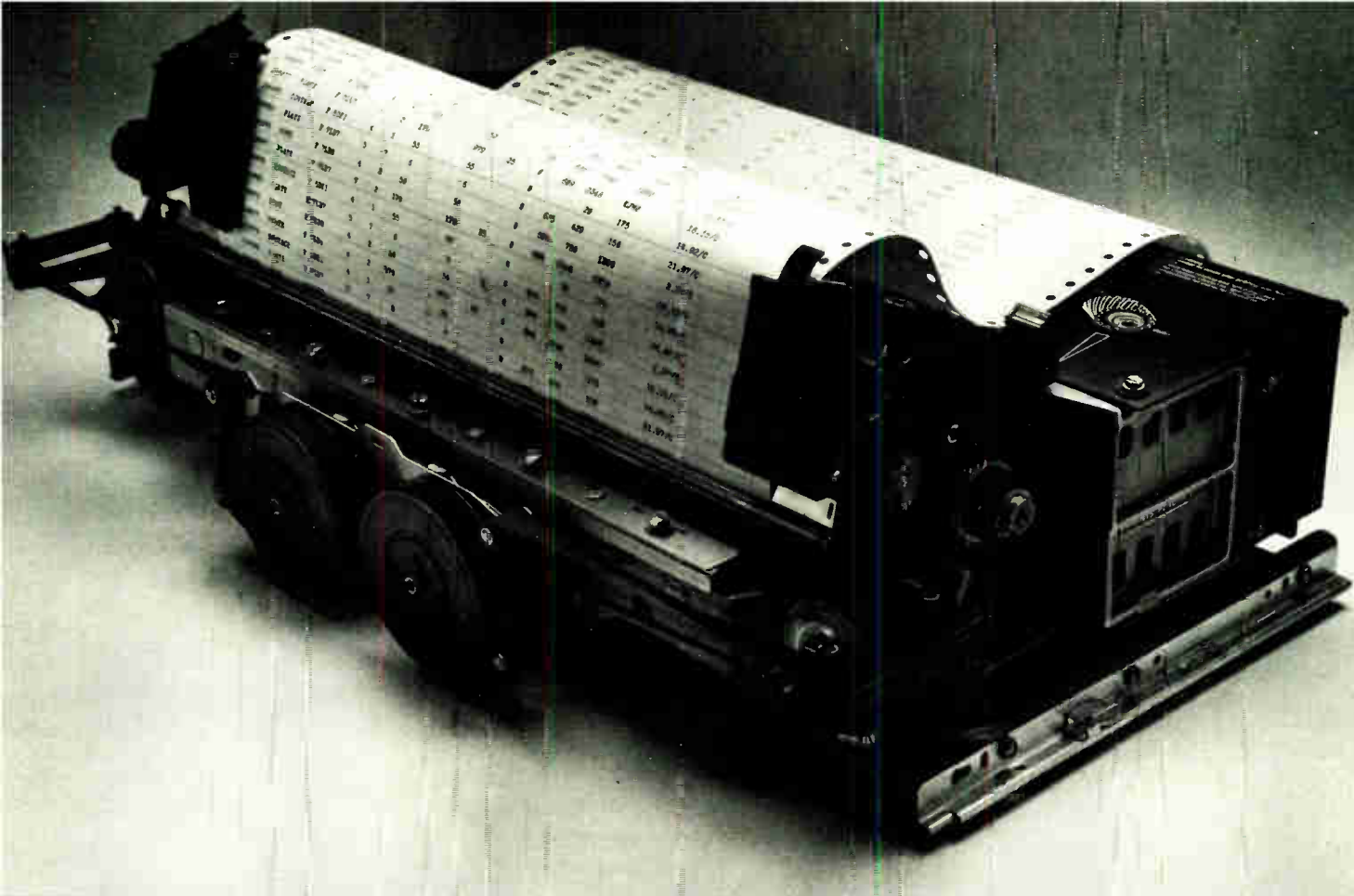

**132 columns. Over 300 lines per minute.
Under \$2000*.**

In printers, it's not just a question of how much they cost, but one of how much you get for your money. And on a price/performance basis, nothing even comes close to the Teletype® model 40 OEM printer.

Besides getting a 132-column, heavy-duty impact printer that delivers over 300 lpm for less than \$2000, you also get a printer with outstanding flexibility and reliability.

The big reason behind the model 40's price/performance advantage over the competition is our unique design. Even though it operates at speeds over 300 lpm, wear and tear is less than you'd find in a conventional printer operating at a much slower speed. Fewer moving parts and solid-state components add up to increased reliability and reduced maintenance.

We'd be ahead if we just stopped there, but the model 40 also offers you a number of other features. Like a choice of character sets, operator-adjustable form width and form length, parity error indication, and a built-in self-test feature, just to name a few.

For complete information, please contact our Sales Headquarters at: 5555 Touhy Ave., Skokie, Ill. 60076. Or call Terminal Central at: (312) 982-2000.



**The Teletype model 40 OEM printer.
Nothing even comes close.**

Teletype is a trademark and service mark registered in the United States Patent and Trademark Office.
*80-column-version available for under \$1400.

Circle 217 on reader service card

Now get a firm grip on your lead-mounted semi's and heat problems, too

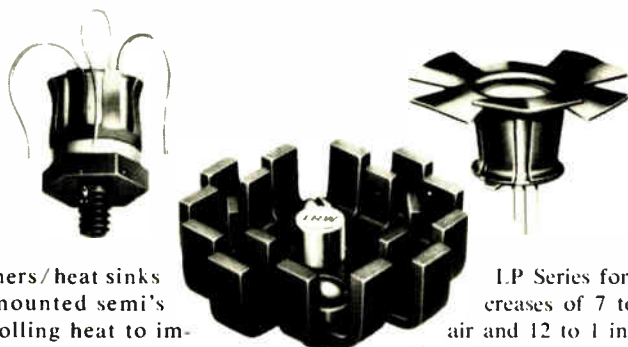

IERC retainers/heat sinks hold lead-mounted semi's while controlling heat to improve reliability or let you operate at higher power levels. Our TXB's for Mil-spec environments are excellent retainers on p-c boards or serve as efficient thermal links between case and heat sink. BeO washers are available for electrically-hot-case applications. Use our staggered-finger

LP Series for power increases of 7 to 1 in still air and 12 to 1 in forced air with no increase in junction temperature. And, if your semi's are already mounted, slip on a Fan Top and get higher wattages for just pennies. Send for catalog. IERC, 135 W. Magnolia Blvd., Burbank, Calif. 91502, a subsidiary of Dynamics Corporation of America.



Check 76

Circle 218 on reader service card

REAL TIME Analog I/O for Intel SBC 80/10 or MDS-800

A single board Analog I/O system for Intel's new single board computer. For laboratory or industrial measurements our DT1751 system can process 16 analog input channels and has 2 analog output channels with power amplifier for driving industrial loads. Drive CRT's directly as well...using the built-in point plot controller.

Real Time measurements are easily done with standard features such as external A/D trigger plus convenient interrupt operation. Optional switch gain amplifier extends dynamic range to 14-bits. CALL US at (617) 879-3595 for a complete set of applications data.

DATA TRANSLATION

INC

109 CONCORD ST., FRAMINGHAM, MA 01701 (617) 879-3595
TELE X 94 8474

...the analog I/O company

218 Circle 219 on reader service card

New products/materials

Thermosets, plastic materials that undergo a chemical reaction when heated and take on a permanent shape, are used throughout the electronics industry for molding dual and single in-line components with epoxy, silicone and polyester coatings. Usually these materials are available in a two-part blended solid or powdered form. A novel one-component thermoset liquid resin molding process has been developed by Hi-Tech Industries for low-viscosity, low-pressure and fast-cycle electronic encapsulation. With the new process, polyester and epoxy DIP packages have been molded on metal lead frames in 18 seconds as against the three minutes needed to mold the same devices with conventional epoxy.

A patented nozzle design, together with specially formulated resins, are used in the new process. The new nozzle insulates the pre-catalyzed one-component resin system from the heat of the mold. Five one-part liquid polyester resins are available from Hi-Tech with physical properties for a variety of electronic applications. Tensile strengths of the liquid resin materials range from 1,160 to 5,870 psi. One of the new resins, Hi-Tech 4000, is already being successfully used by Unitrode Corp. of Methuen, Mass. as an encapsulant for 50- to 1,000-volt, 1-ampere silicon rectifiers which meet MIL-STD-750 and MIL-STD-202.

The new Hi-Tech materials are readily adaptable to most transfer- and compression-molding presses. The process eliminates resin pre-treatment and reduces pre-curing. Hi-Tech and an outside firm are developing an adapter to modify existing molding machines to the new process for about \$7500.

Hi-Tech Industries, Inc., 180-08 Liberty Ave., Jamaica, NY 11433 [476]

A new family of high-strength liquid composites combines the low viscosity and ease of handling of silicones with the high tensile and tear strengths associated with organic polymers. The materials from SWS Silicones Corp. are known as Silgan

What you must know about Microprocessors.

The microprocessor has permanently changed the methods of designing and building electronic equipment—from process and industrial control to computer-based designs in instruments, communication and consumer/commercial equipment.

But, getting into microprocessors is no snap. As a fundamental departure from the old familiar hard-wired logic techniques, the microprocessor technology has already produced a host of devices competing for the designer's attention, each with its own software and hardware.

This book cuts through the confusion, presenting the design and application potential of this exciting technology in a manner that will appeal to the design engineer who needs to know how to use microprocessors as well as the system analyst who must assess the tradeoffs between micro-

processors and other techniques to accomplish his system goals.

Using articles from the pages of Electronics, this book contains practical and up-to-date information on available microprocessor devices, technology and applications—ranging from the simplest 4-bit p-channel MOS system to the second-generation n-MOS 8-bit processor chips, and the new injection logic and Schottky TTL bipolar processor families needed for the toughest computer-based control applications.

UPCOMING VOLUMES

Others already planned for the Book series: *Thermal Design*, *Mini-computers in Action*, *Large Scale Integration*.

Use form below to order your copy. Prices on 10 copies or more, available upon request.

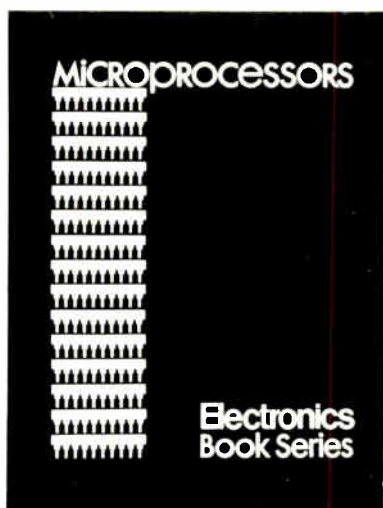

Electronics Book Series

P.O. Box 669 Hightstown, N.J. 08520

Send me _____ copies of "Microprocessors" at \$8.95 per copy.



I must be fully satisfied or you will refund full payment if the book is returned after 10 days free trial examination.

Payment enclosed Bill firm Bill me

Credit Cards Charge My Book To

American Express Master Charge Acct. No. _____
 Diners Club BankAmericard No. _____

Date Card Expires _____ Interbank No. _____

1st No's. above name on Mastercharge only.

Name _____ Title _____

Company _____

Street _____

City _____ State _____ Zip _____

Signature _____

Schottky Barrier Rectifiers

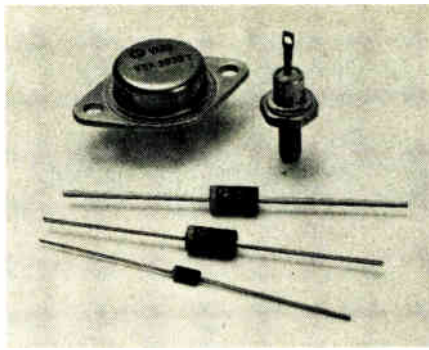

- **Five series: 1A, 3A, 5A, 15A & 30A (I_o) with 20V, 30V and 40V (V_{RM}).**
- **Extremely fast recovery (t_r), very low forward voltages (V_F), high reliability and low cost.**
- **VSK 120, 130 & 140-1A series in DO-41 packages.** 550 mV (V_F). 40A peak 1/2 cycle surge (I_{FSM}). 10 mA (I_R) at T_J=100°C.
- **VSK 320, 330 & 340-3A series.** Epoxy package, axial leads. 475 mV (V_F). 150A surge. 30 mA (I_R) at T_J=100°C.
- **VSK 520, 530 & 540-5A series.** Epoxy package, axial leads. 450 mV (V_F). 250A surge. 75 mA (I_R) at T_J=100°C.

- **VSK 1520, 1530 & 1540-15A series in DO-4 metal stud cases.** 600 mV (V_F). 300A surge. 75 mA (I_R) at T_C=100°C.
 - **VSK 3020T, 3030T & 3040T-30A series.** Center-tapped, common cathode, 15A per leg in TO-3 package. 630 mV (V_F). 300A surge. 75 mA (I_R) at T_C=100°C.
- All series have junction operating temperature range of -65°C to +150°C.

**Call Mike Hawkins
214/272-4551
for more information**



Design us in . . . we'll stay there
VARO SEMICONDUCTOR, INC.

O. BOX 676, 1000 N. SHILOH, GARLAND, TEX. 75040 (214) 272-4551 TWX 910-860-5178

EUROPEAN OFFICE: UK: **VARO SEMICONDUCTOR INTERNATIONAL, INC.**
Deppdene House, Bellegrave Road, Welling, Kent, England DA163PY, 01-304-6519/0
Circle 220 on reader service card

New products/materials

TM elastomers and cure at room temperatures without exotherm and with low shrinkage. The elastomers also have low-temperature flexibility (to 90°C) and resistance to corrosion, moisture and harsh environments.

Presently, Silgan materials are based on a styrene-acrylic ester copolymer and are commercially available as one- and two-component systems. One-component systems (J series) cure without exotherm at room temperature upon exposure to atmospheric moisture. Under normal conditions, skinover time is 30 minutes and complete curing takes 24 hours. Two-compo-

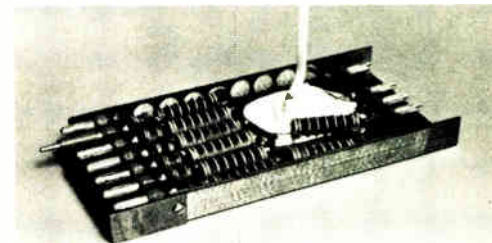

nent systems (H series) cure at room temperature when mixed with a catalyst. Tack-free curing time is four hours.

The Silgan liquids can be used as potting agents, conformal coatings, encapsulants and sealants. In one potting application using conventional epoxy material 2% shrinkage resulted in two separate pouring operations and a total potting time of 24 hours. The same component potted with Silgan H622 has a shrinkage of 0.5% resulting in only one pouring cycle and a setup time of 3-4 hours.

SWS Silicones Corp., Adrian, Michigan 49221 [477]



**General Electric offers you
a full line of High-quality
low-cost CCTV Camera
Systems for a Wide
Variety of
Applications!**

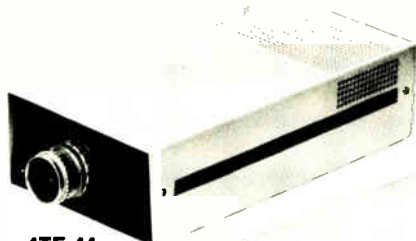

4TE-44
INDOOR MODEL



4TE-45
OUTDOOR MODEL

For complete information, circle the Read Service Card number (below) or contact:

General Electric Company, Imaging Systems Operation, (360-21S), Room 104, Bldg. 7, Electronics Park, Syracuse, N. Y. 13201 (phone 315-456-3293).

GENERAL ELECTRIC

NOW DDU

A COMPLETELY INTERFACED



LOGIC DELAY LINE

Data Delay Devices has developed a digital delay unit, series DDU, which eliminates the interfacing in T²L circuits.

With the following advantages:

- T²L input and outputs
- 1500NS total delay
- Fast rise — Time on all taps
- Up to 10 taps
- Each tap isolated and with 10T²L Fan-out capabilities
- Exact delay at each tap



Request spec. sheet DDU

DATA DELAY DEVICES

253 CROOKS AVE., CLIFTON, N.J. 07011

Tel. (201) 772 1106

Circle 30 on reader service card

This Publication is Available in MICROFORM

from...



Xerox University Microfilms

300 North Zeeb Road,
Ann Arbor, Michigan 48106
(313) 761-4700

PLEASE WRITE FOR COMPLETE INFORMATION

Dialight sees a need:

(Need: The widest choice for your every application.)

559 0101-001 MOUNTS IN 0.250" HOLE

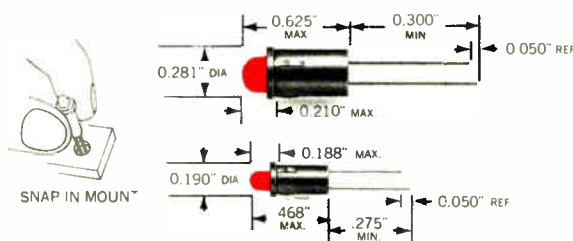

558 0101-001 MOUNTS IN 0.156" HOLE

558 and 559 SERIES Available in red, green or yellow LEDs, with and without integral current limiting resistors. Snap-in mounting requires no additional hardware. Straight terminals suited for wire-wrapping and/or soldering. Low power requirements—15 to 20mA. In 1000-lot quantities each
558-0101-001 . . \$.33. 559-0101-001 . . \$.33.

559 0101-003 MOUNTS IN 0.250" HOLE

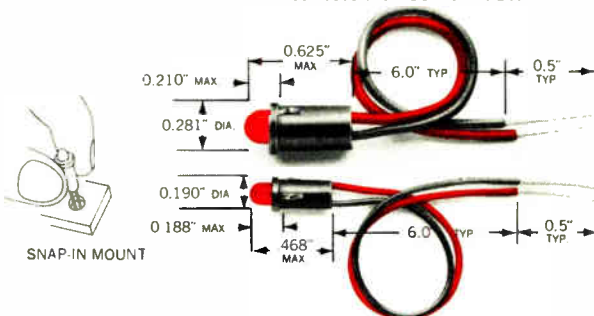

558 0101-003 MOUNTS IN 0.156" HOLE

558 and 559 SERIES Available with 6" wire leads, these red, green or yellow LEDs are designed for quick positive insertion in 0.031" to 0.062" panels. Compact design allows high density packaging. In 1000-lot quantities each
558-0101-003 . . \$.75. 559-0101-003 . . \$.71.



Dialight, the company with the widest choice in switches, LEDs, indicator lights and readouts, looks for needs . . . your needs . . . and then they develop solutions for your every application. No other company offers you one-stop shopping in all these product areas. And no other company has more experience in the visual display field. Dialight helps you do more

with these products than any other company in the business, because we are specialists that have done more with them. Talk to the specialists at Dialight first. You won't have to talk to anyone else. Send for your free new copy of Dialight's current catalog.

DIALIGHT

Dialight, A North American Philips Company
203 Harrison Place, Brooklyn, N. Y. 11237
(212) 497-7600

See Dialight.

New books

Introduction to Microcomputers and Microprocessors, Arpad Barna and Dan I. Porat, Wiley-Interscience, 108 pp., \$10.50.

If you're starting from zero so far as a knowledge of microprocessors is concerned, you could do worse than invest \$10.50 in this book. It won't take you very far into the details of design, but it will provide a foundation from which to attack the manufacturer's detailed literature or the many articles now appearing in technical magazines.

From one point of view, the book is just a glossary of terms, arranged according to subject and stitched together to form a running text. After all, it's only 108 pages long, so you can't get much more than a quick runthrough on any one aspect of microprocessors. Nevertheless, what's there is clearly written and should be easily understood by anyone with a technical background.

For example, Chapter 3 covers basic programing techniques in nine pages. In that nine pages, the au-

thors deal with the following topics: machine-language instructions, basic instruction sets, assembly-language instructions, macroinstructions, higher-level languages, subroutines, and flow charts. The individual treatment of each of these topics is therefore little more than an extended definition. But the authors do get to the kernel of each topic and explain it clearly.

Other chapters outline the basic structure of microprocessors, input and output, arithmetic operations, arithmetic and logic circuits, main memory, control units, and miscellaneous software topics. Each chapter concludes with a set of problems for use in a self-study program.

The book is rather light on references to other material, citing only six other titles. But anyone involved in electronics today can hardly miss the mass of material now appearing on microprocessors and could easily assemble his own file of articles.

Handbook of Circuit Analysis Languages and Techniques, Randall W.

Jackson and Lawrence P. McNamee, eds., Prentice-Hall, 809 pp., \$34.50

This book is actually a series of boiled-down user's manuals for the following circuit-analysis programs: Astap, Belac, Circ, Circus 2, Ecap II, Lisa, Martha, Sceptre, and Syscap. But although its scope is limited—it covers only the nine programs—it is still an excellent work. The editors have done an admirable job with the material, even to supplying informative historical background where appropriate.

Most of the major circuit-analysis programs are included, and the editors devote an entire chapter to each program, giving a bird's eye view of what each one is all about and how each one works. This sort of treatment has a number of advantages. The reader can compare the capabilities of the programs, as well as how difficult or easy they are to use. There are also extensive reference lists for further reading.

For the novice, the book provides

We tailor TWTs

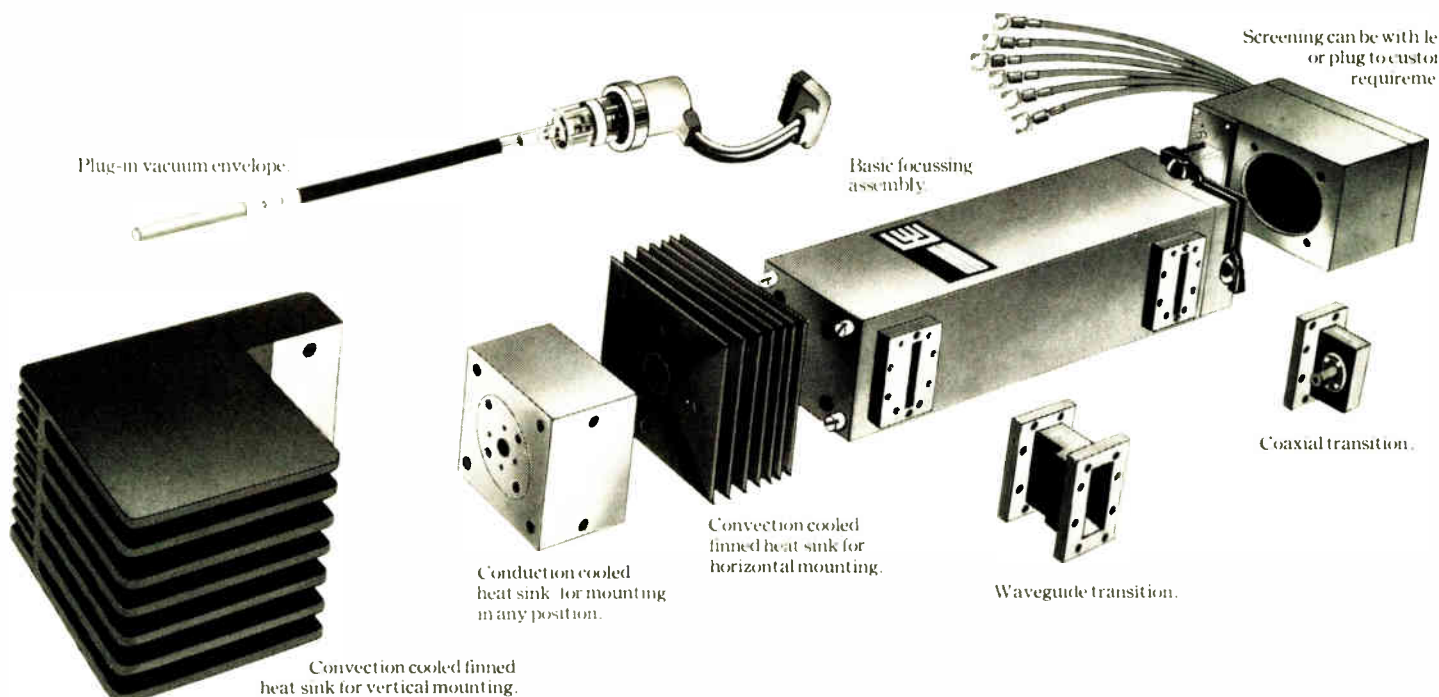

a painless way of familiarizing himself with CAD. For the fellow who's already into CAD, the book enables him to quickly compare other programs with the one he's using.

Recently published

Physical Principles of Semiconductor Devices, Harry E. Talley and Don G. Daugherty, Iowa State University Press, 367 pp., \$16.50.

Systems Engineering Methodology for Interdisciplinary Teams, A. Wayne Moore, Wiley-Interscience, 431 pp., \$27.50.

Frequency Synthesizers: Theory and Design, V. Manassewitsch, Wiley-Interscience, 524 pp., \$27.50.

Introduction to Logic and Switching Theory, Nripendra N. Biswas, Gordon and Breach Science Publishers, 354 pp., \$29.50.

Communications Channels: Characterization and Behavior, Bernard

Goldberg, ed., IEEE Press, 762 pp., \$22.95.

Microwave Circuits and Amplifiers, P. Grivet, Academic Press, 749 pp., \$79.50.

Modern Guide to Digital Logic: Processors, Memories, and Interfaces, Editors of United Technical Publications, Tab Books, 294 pp., \$9.95, \$6.95 (paper).

Modern Electronics Math, Jerrold R. Clifford and Martin Clifford, Tab Books, \$12.95, \$9.95 (paper).

Troubleshooting with the Dual-Trace Scope, Robert L. Goodman, Tab Books, 224 pp., \$8.95, \$5.95 (paper).

CBer's Handy Manual, Tab Books, 48 pp., \$1.50 (paper).

CBer's Handy Atlas/Dictionary, Tab Books, 64 pp., \$1.95 (paper).

CB Radio Schematic/Serviceing

Manuals, Vols. 1, 2, and 3, Tab Books, 200 pp. each, \$8.95, \$5.95 (paper) each.

Build Your Own Working Robot, David Heiserman, Tab Books, 238 pp., \$8.95, \$5.95 (paper).

TV Schematics: How to Read Between the Lines, Art Margolis, Tab Books, 252 pp., \$8.95, \$5.95 (paper).

Microelectronics, Clayton L. Hallmark, Tab Books, 266 pp., \$8.95, \$5.95 (paper).

The Electronic Battlefield, Paul Dickson, Indiana University Press, 244 pp., \$10.00.

French-English Science and Technology Dictionary (fourth edition), Louis DeVries and Stanley Hochman, McGraw-Hill Book Co., 683 pp., \$13.50.

Computer Circuit Analysis: Theory and Applications, Frank A. Ilardi, Prentice-Hall, 406 pp., \$17.50.

Fast at EEV.

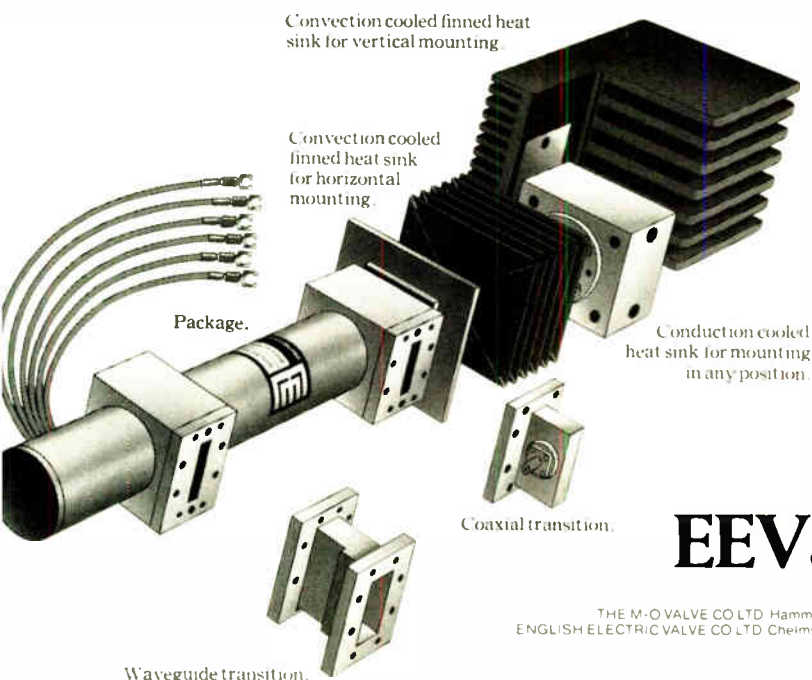

EEV make travelling wave tubes on a modular 'building block' system. So you get exactly the tubes you want from EEV, and you get them quickly. Our production capability has now expanded into new and much larger premises. You can depend on EEV for fast service for TWTs covering all civil and military communications bands. Send us your spec or write for data sheets.

EEV and M-OV know how.

THE M-O VALVE CO LTD Hammersmith London, England W6 7PE Tel. 01-603 3431 Telex 23435 Grams Thermionic London ENGLISH ELECTRIC VALVE CO LTD Chelmsford Essex, England CM1 2QU Tel. 0245 61777 Telex 99103 Grams Enelectico Chelmsford

Genalex

Keeping up with LSI

The Electronics Book Series offers you a handbook on the current and revolutionary impact of LSI on digital design. This 220-page book presents a unique opportunity for circuit designers, systems designers, and engineering managers and supervisors to bring their expertise into line with today's LSI design requirements.

The content: six general areas

1. LSI technology: the latest MOS and bipolar techniques.
2. LSI devices and performance: memory, logic and interface.
3. LSI design techniques: devices in actual design examples.
4. LSI circuit modeling: hand-on design techniques using computer-aided design.
5. LSI circuit testing: devices and techniques for automatically testing LSI components.
6. Applications: selected to show range of LSI capability—electronic switching, data acquisition, and industrial control.

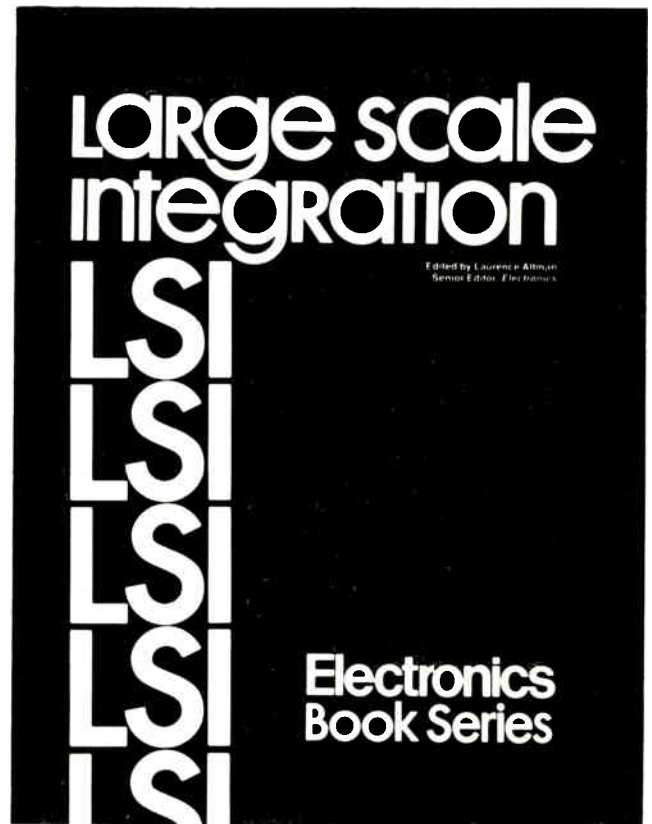

Electronics Book Series

PO Box 669
Hightstown, N.J. 08520

Send me _____ copies of "Large Scale Integration" at \$9.95 per copy.

I must be fully satisfied or you will refund full payment if the books are returned after ten day trial examination.

Payment enclosed Bill firm Bill me

Credit Cards Charge My Book To

American Express Master Charge Acct. No.
 Diners Club BankAmericard

Date Card Expires _____ Interbank No. _____

1st No's. above name
on Mastercharge only.

Name _____

Title _____

Company _____

Street _____

City _____

State _____ Zip _____

Signature _____

McGraw-Hill Electronics
IS THE SOURCE
FOR BOOKS, TOO

Did you know there's a way to STOP advertising mail you don't want?



You can now get your name off—or on— advertising mailing lists by writing DMMA's Mail Preference Service

By CELIA WALLACE
DMMA Consumer Affairs Director

If you don't want to receive advertising mail, there's a simple, effective way to stop most of it. Just contact the Direct Mail/Marketing Association (DMMA), a group representing businesses that use mail to advertise their products and services, and they'll send you a *name-removal* form. Your name will then be removed from the lists of many DMMA member companies who conduct most large-scale mail advertising campaigns.

Think you want to be taken off mailing lists?

According to Robert DeLay, President of the DMMA, people who take steps to get their names removed from mailing lists, later decide maybe it isn't so bad after all when they think of what they would be missing. Such as catalogs, new product samples, chances at sweepstakes and cents-off coupons.

MPS also enables you to be added to lists.

However, if you feel you don't get your fair share of mail offers, the DMMA offers another service to get your name *on lists* so you'll receive more offers in special interest areas such as crafts, books, sports, investments, clothing, travel and gardening.

If you want to take advantage of either of these services offered by the DMMA, simply send the coupon below.



MAIL TO:
DIRECT MAIL/MARKETING ASSOCIATION
c/o McGraw-Hill, P.O. Box 500
Hightstown, New Jersey 08520

- STOP IT!** I don't want to be on anyone's "list." Please send me a *Name-Removal Form*.
- SEND ME MORE!** I'd like more mail on my favorite interests and hobbies. Send me an *"Add On" Form*.

PRINT NAME _____
ADDRESS _____
CITY _____
STATE _____ ZIP _____

NEW!



A mighty big catalog about some mighty small switches.

This 44 page catalog consolidates the complete line of C&K small switches into a single, fact-filled, easy-to-read volume. It includes everything you need to know about joggles, rocker and lever handles, printed circuit mountings, snap-acting pushbuttons, 6 AMP alternate action and momentary pushbuttons, subminiature and micro-miniature pushbuttons, illuminated rockers, miniature power, slide, and thumbwheel switches—plus how-to-order information and a complete list of worldwide C&K distributors. Ask for your free copy and we'll show you a million and one ways to turn on the juice.

C&K Components, Inc. 103 Morse Street, Watertown, MA 02172
TEL: (617) 926-0800 TWX: 710 327-0460 TELEX: 92 2546
Free Engineering Sample on Request

Circle 31 on reader service card

HEATH

Schlumberger

SCOPE SENSE



Where else but Heath can you buy a dual-trace,

DC-15 MHz scope for only \$775?

- 1 mV/cm input sensitivity
- 45 MHz typ. triggering bandwidth
- Time base sweep to 100 nsec/cm; X5 magnifier
- Fully regulated power supplies • X-Y capability
- Operates on common line voltages from 100 to 280 VAC

Read about the **SO-4510**, other proven values in our new **Assembled Instruments Catalog**.



FREE! SEND FOR IT TODAY!

Heath Company, Dept. 510-180
Benton Harbor, Michigan 49022

INPUT/ OUTPUT Connection Systems

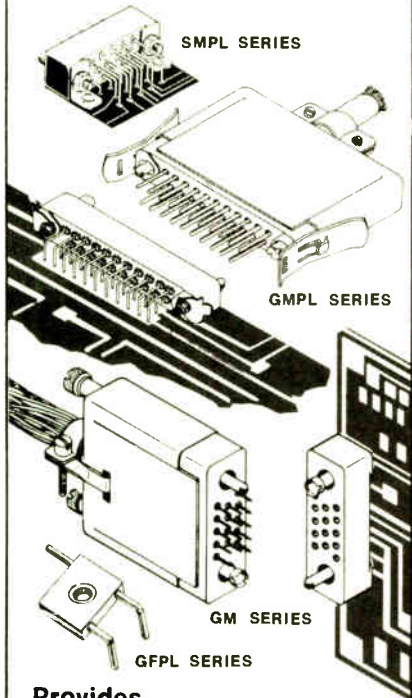

Provides

1. Reduction of Assembly Time
2. Reliability
3. High Density
4. Stock Availability

Specifications

- **Sizes** — Miniature and subminiature
- **Contacts** — .150 and .094 spacing, #20-#30 wire size
- **Contact Arrangements** — 2 through 50
- **P.C. Board Mountable Connector** — Pin or socket contacts, straight or 90° angled
- **Cable Connector** — Pin or socket contacts — crimp removable, solder, or wrap post
- **Accessories** — Polarized guides or threadlocks, metal shells, hoods, and strain reliefs



**POSITRONIC
INDUSTRIES INC.**

208 West Center
Rogersville, Missouri 65742
417-753-2851 Telex 436445

**CONNECTOR
DIVISION**

Representatives and distributors located throughout United States, Canada, and Europe.

Send for catalogs. Samples available for specific applications.

New literature

Dana 3½ & 4½ Digit Multimeters

Presenting the most complete line in the world

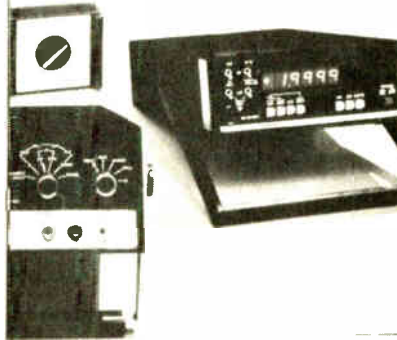

Multimeters. Dana's 4600 digital multimeter is highlighted in the company's 16-page color brochure on its line of 3½- and 4½-digit multimeters. A color-coded specification chart covering the line provides finger-tip access to equipment characteristics and comparative information. For copies of the brochure, write or call Mr. Chris Everett, Product Manager, Dana Laboratories Inc., 2401 Campus Dr., Irvine, Calif. 92713, phone (714) 833-1234. Or circle 421 on reader service card.

Error control. Introducing communications engineers to the principal features and benefits of error-control coding, a 12-page booklet contains both tutorial and product information. Forward error correction and error detection with automatic repeat request are compared according to application and channel and user requirements. Both block and convolutional encoders-decoders are described, with emphasis on the latter. Applications of error-control products to packet-switching networks are described. Linkabit Corp., 10453 Roselle St., University Industrial Park, San Diego, Calif. 92121 [422]

Resistors. Low-cost molded resistors, open wirewound types, sensors, cement boats, and vitreous enamel resistors are among the new developments listed in an expanded engi-

PINPOINT HEAT

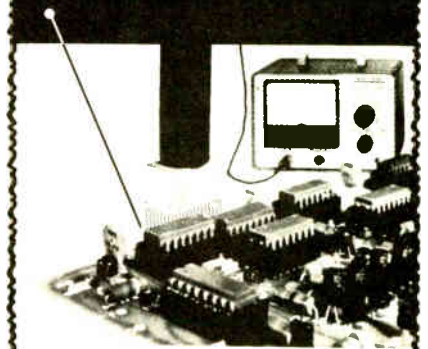

Heat any I. C. or semiconductor component to its rated temperature with a heat probe. Accuracy $\pm 1/2^\circ\text{C}$. Or check the component's temperature with a thermocouple probe. Accuracy $\pm 1^\circ\text{C}$. Model 810 Thermo-Probe does both. Reads out directly in $^\circ\text{C}$ and $^\circ\text{F}$ on a large 4½-inch meter.

PRICE \$299.50 F.O.B. South Laguna

Models with other temperature ranges available. For details write to:

**MTI MICRO-TECHNICAL
INDUSTRIES**

P.O. Box 287 South Laguna, CA 92677

(714) 545-3734 • TWX 910-587-3425 MICRO OHM ELM

Circle 99 on reader service card



SINEWAVE OSCILLATORS

Low Distortion
0.05Hz to 20kHz

**FIXED FREQUENCY
RESISTIVE TUNEABLE
SINGLE PHASE
QUADRATURE**

F.D.I. also manufactures
Active Filters, Tone Encoders,
Tone Detectors and other
Communications products

Frequency Devices Inc.
25 Locust Street
Haverhill, Mass. 01830

(617) 374-0761/TWX 710-347-0314

Circle 101 on reader service card

neering catalog on precision and power wirewound resistors. It is offered by RCL Electronics Division, AMF Inc., 195 McGregor St., Manchester, N.H. 03102. A new section of the catalog is devoted to RCL's Special Products division and includes engineering information on such diverse products as molded temperature connectors, bridge reference junctions, automotive temperature sensors, computer resistors, and chromel alumel reference networks. All dimensions are shown in both inches and millimeters. [423]

Busing devices. A 12-page design guide for multi-layer laminated busing devices assists the designer in preparing drawings for his busing system. Many design standards, suggestions, and specifications are included. Copies of the brochure are available from Busco Engineering Inc., 119 Standard St., El Segundo, Calif. 90245 [424]

Flexible circuits. Fast-moving developments in the flexible-circuit industry are described in a 12-page color brochure from Buckbee-Mears. The brochure is designed to aid the engineer in creating the most efficient flexible circuitry for his specific applications. The design guide includes advice on circuit layout, conductor considerations complete with information on copper characteristics, various dielectric materials, and a description of the various manufacturing processes. Write to: Design Guide, Circuits Division, Buckbee-Mears Company, 245 E. Sixth St., St. Paul, Minn. [426]

"You can design your own ICs"

-H.R. Camenzind
Creator of the 555 Timer

Monochip is the way to do it. It's a low cost, fast way to make custom IC's. \$1800 gets you 50 prototypes in three weeks. Very simple. We taught the old IC technology some new tricks and built a multi-million dollar business around it. With volume delivery and second sourcing.

Get started with our \$39 Monochip Design Kit. It contains easy-to-follow instructions, parts and design aids, everything you need to Monochip your circuit.

interdesign

The Real Custom IC House.



designing your flexible circuit
bmc

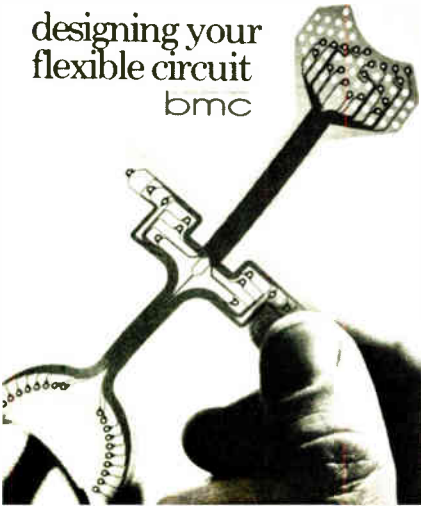

Interdesign 1255 Reamwood Avenue Sunnyvale, CA 94086 (408) 734-8666

Name _____ Company _____ Address _____ City _____ State _____ Zip _____

Phone _____

My check is enclosed for the Monochip Design Kit (\$39)

Send only technical details on Monochip.

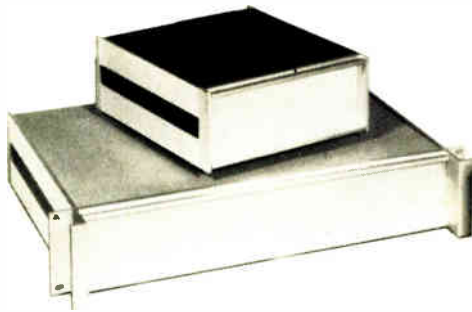

BUCKEYE CASES

Buckeye bord-pak cases are made of aluminum extrusions and available in 1/3, 1/2, 2/3 and full rack widths. Full fabricating capabilities and complete electronic packaging needs from Buckeye include: colorful cabinets, 4 sizes of adjustable P.C.B. Racks, patented card guide modules; retractable tilt-stands with feet, and a complete line of matching instrument knobs.

Write today for free colorful literature!
the BUCKEYE stamping co.

555 Marion Rd., Columbus, Ohio 43207

"QUALITY PRODUCTS SINCE 1902"



GUIDES • CABINETS • KNOBS • RACKS

Circle 228 on reader service card

New products

Remote multiplexing. Written for designers of data-acquisition systems, Burr-Brown's six-page application note AN-80, entitled "Remote Multiplexing," points out the advantages that multiplexing and digital transmission have over direct wiring and analog transmission. In comparing direct-wired analog transmission with digital multiplexing, the note discusses data quality and data integrity and gives a typical example as a basis for comparison of installation costs. Also detailed are the factors that must be weighed in installing remote multiplexing systems. These cover data integrity, touching on the effects of various network configurations and taking into account bandwidth considerations, error-detection techniques, and electrical isolation requirements. [425]

Soldering. A basic primer on the selection and use of solder has been prepared by the Solder Manufacturers Committee of the Lead Industries Association. The 16-page booklet recounts important solder applications in industry and suggests advantages of the process over alternative joining methods. The text also covers joint design, pre-cleaning, surface preparation, and fluxing. Copies of the booklet may be obtained by writing to: LI Association Inc., Dept. A, 292 Madison Ave., New York N.Y. 10017 [427].

Photoelectric controls. Dozens of photoelectric applications for production and material-handling control are described in a 48-page handbook offered by Micro Switch, A Division of Honeywell, 11 W. Spring St., Freeport, Ill. 61032. The extensively illustrated booklet treats a variety of scanning, signal-conditioning, and electrical-output considerations. Nearly a third of the handbook is devoted to solutions of such problems as counting, height-monitoring, label-detection, translucent-object detection, penetration scanning, fill-level control, inspection, and prevention of conveyor jam-ups. [428]

RF PACKAGES — MICROWAVE SYSTEMS

AUTOTRACK ANTENNA SCR-584 RADAR SYSTEM

360 deg AZ 210 deg EL 1 mil. accuracy. Missile vel. accel. and slew rates. Amplidyne control. Handle up to 20 ft. dish. Compl. control chassis. ALSO in stock 10 cm. van mounted rad. system. Conical scan. PPI. 6 ft. dish. 300 pg. instr. bk. on radar \$25



RF SOURCES

CW: 300-535KHz 500W; 2-30MHz 3KW; 4-21MHz 40KW; 24-350MHz 100W; 385-585MHz 1KW; 750-985MHz 10KW; 95-8.8GHz 150W; 1-1.5GHz 110W; 1.7-2.4GHz 10KW; 4.4-5GHz 1KW; 8.8-11GHz 200W. Many more.

UHF: 1 Megawatt 210-225MHz 5µsec 180 PPS; 14KW 400-420MHz .0002DC; 1KW 400-700MHz .002DC

L BAND: 1KW 1-1.5GHz .1DC; 500KW 1.2-1.35GHz 2µsec 400PPS. Many more. Phone or write.

S BAND: 1KW 2.4-2.6GHz .75µsec 1200PPS; 250KW 2.7-3.1GHz .8µsec 1600PPS; 500KW 2.7-3.1GHz .8µsec 1600PPS; 1 Megawatt 2.7-2.9GHz 1µsec 1200PPS; 5 Megawatts 2.75-2.85GHz 2.5µsec 400PPS.

C BAND: 225KW 6.275-6.575MHz .4µsec 680PPS; 250KW 5.4-5.8GHz .5µsec 680PPS; 1 Megawatt 6GHz .4µsec 1000PPS. Many more. Phone or write.

X BAND: 100W 9.2-9.5GHz .5µsec 1000PPS; 1 KW 8.9-9.4GHz .001DC; 65KW 8.5-9.6GHz .001DC; 250KW 8.5-9.6GHz .0013DC; 400KW 9.1 GHz 1.8µsec 450PPS. Many more. Phone or write.

Ku-K BAND: 50KW 16.4-16.6GHz .001DC; 135KW 15.5-17.5GHz .006DC; 40KW 24GHz .0007DC; 40KW 35GHz .0004DC. Many more. Phone or write.

PULSE MODULATORS + H.V.P.S.

245 KW LINE Output 16 KV 16 A. .25 µs 4000 PPS.
 405 KW FLOATING DECK Output 20 KV 20 A 1 µs to 10 milisecond pulse.

500 KW LINE Output 22 KV 28 A. .4/1.75/2.25 µs 2500/550/300 PPS.

1 MW HARDTUBE MIT MODEL 9 Output 25 KV at 40 A. .25 µs .002 D.C.

2.0 MW LINE 30 KV 70 A. 1/2 µs 600/300 PPS.

3 MW LINE Output 39 KV 75 A. .25/1 µs 500 PPS.

10 MW LINE 76 KV 135 A. 2.5 µs 350 PPS.

17 MW LINE 17 KV 1000 A. 2-5 µs 150-2000 PPS.

SEND FOR FREE 20 PG. CATALOG

AN/MP5-19 S Band Tracker

Pwr: 500 KW. Range: 100 miles. Display: PPI and "A" scopes. 8' dish. Heilhut mounted.

RADAR SYSTEMS

K BAND MONOPULSE 40KW E-34

KU BAND SEARCH 135KW B-58

X BAND MISSILE CONTROL NIKE AJAX/HERC

X BAND HI-RES. MONOPULSE TRACKER

X BAND FIRE CONTROL 250KW M-33

X BAND WEATHER/SEARCH 250KW AN/CP5-9

X BAND AIRBORNE TRACKER 50KW B-47

X BAND MOBILE TRACKER 40KW AN/MPQ-29

X BAND WEATHER/SEARCH 40KW AN/SPH-5

X BAND ANTI-INTRUSION 7 KW AN/TPS-21

X BAND ANTI-INTRUSION CW DOPPLER AN/PPS-9/12

X BAND TRANSPONDER 100W AN/DPN-62

C BAND HGT. FDR. 5MW FPS-26. 1MW TPS-37

C BAND SEARCH 285KW AN/SPS-5B/D

S BAND HEIGHT FINDER 5MW AN/FPS-6

S BAND SEARCH COHERENT 1MW AN/FPS-18

S BAND ACQUISITION 1MW NIKE AJAX/HERC

S BAND TRACKER 10' DISH 500KW AN/MPQ-18

S BAND MORTAR LOCATOR 250KW AN/MPQ-10A

S BAND TRACKER 250KW AN/MP5-9

L BAND SEARCH 40' ANTENNA 500KW AN/FPS-75

L BAND SEARCH 500KW AN/TPS-1D/GSS-1

UHF SEARCH 1MW TPS-28

DRONE CONTROL SYSTEMS

UHF COMMAND SYSTEM AN/URW-14

X BAND DATA LINK AN/UPW-1

X BAND TRACKER AN/MPQ-29

X BAND TRACKER AN/MSQ-51

60 FT. DISH

Complete with Az-El pedestal, ready for installation. Immed. delivery. Write or call.

SPARE PARTS IN STOCK

Nike Ajax, Nike Hercules, M 33, MP5-19, TPS-1D, TPS-10D, FPS-6, SPSK, SCR-584, HIPAR. Many more. write



**Radio
Research
Instrument
Co., Inc.**

3 QUINCY ST. NORWALK CONN 06850
 (203) 853-2600

Electronics advertisers

June 10, 1976

■ Abbott Transistor Labs Inc.	6	Data General Corporation	27	■‡ Howard Industries	134 135
Advanced Micro Devices	11	Datapro Research Corp.	168	■ Hughes Aircraft Company	38 39 41
■ Airpax Electronics	40	Data Translation Inc.	218	Indiana General	100
Alabama Power Co.	172	■ Delevan Division American Precision Industries, Inc.	76	Industrial Mktg. Advisory Svcs. Inc.	213
Alco Electronics Products Inc.	216	Deltron	175	Infotek Systems	206
Allen Bradley Company	24	■ Dialight Corporation	221	‡ Interdesign	227
Alpha Wire Corp.	188	■ The Digitran Co.	176	International Crystal Manufacturing Company	194
American Microsystems Inc.	155-163	■ Eastman Chemical Corp.	8	International Electronics Research Corporation	218
■ AMP Incorporated	34 85	■ Eastman Kodak Company Graphics Division	148	■ International Rectifier Corp., Semi Div.	120 121
■ Analog Devices Inc.	21 23	° Edelektron	7E 9E	Interstate Electronics Corp.	199
■ AP Products Incorporated	200	E.I. DuPont De Nemours & Co., Inc.	15 189	■ Ithaco, Inc.	203
■ Bausch & Lomb Inc.	149	° Electrol	10E	■ Kay Elemetrics Corp.	215
■‡ Beckman Instruments Inc. Helipot Division	50	■ EMM-Electronic Memories & Magnetics	187	■ Kepco Inc.	5
° Beckman Instruments Ltd.	58	Electronic Navigation Industries	69	L.E.A.	24E
Biomation	12-13	Elorg Electronorgtechnica	186	■ Logimetrics	168
B & K Precision Division Dynascan Corporation	166	English Electric Valve Company Ltd.	222 223	■ Marconi Instruments Ltd.	54
■ Bourns Inc.	3rd C	■ Erie Technological Products Co. Inc.	183	McDonnell Douglas Co.	153
■ Bowmar Instruments Corp.	215	Fairchild Semiconductor Inc.	106 107	° Membrain Limited	20E
Brand Rex Corporation	2nd C	Faultfinders Inc.	166	Micro Networks Corporation	37
■ Buckeye Stamping Company, The	228	■ Fibra Sonics Inc. Division of C.E. Niehoff	184	Micro Switch Division of Honeywell	170 171
■ Bud Radio, Inc.	208	Figaro Engineering Inc.	233	■ Micro Technical Industries	226
° Burr Brown Research Inc.	14E	■ John Fluke Mfg. Co., Ltd.	77 79 80 81 82 83	■ Miller Stephenson Chemical Inc.	213
■ Bussman Mfg. Division of McGraw Edison Co.	191	■ Frequency Devices Inc.	226	■ Mini Circuit Labs.	112
■ Cambridge Thermionic Corporation	202	Frequency & Time Systems	202	3 M Electronics Division	133
Capital Calculator Co.	233	Fujitsu Ltd.	205	Monolithic Memories Inc.	146
Carborundum Company	9	‡ General Electric Instrument Rental Division	54	■ Motorola Semiconductor Products Inc.	75
‡ Centralab, Distributor Prod.	44	General Electric Co. Miniature Lamp Division	178	‡ National Semiconductor Corporation	138 139
■ Centralab Electronics Division of Globe Union Inc.	57	Gen'l Electric, Tube Prod.	220	° National Semiconductor GmbH	51
■ Cherry Electrical Products Inc.	131	General Magnetics	234	■ Newport Labs.	198
Chomerics Inc.	154	■ GenRad	90 201	Nucleonic Products Co. Inc.	164
■ C&K Components	225	■ Germanium Power Devices Corp.	216	OAK Industries Inc. Switch Division	202
■ Clairex Corporation	4th C	■ Gould Advance	12E 13E	OK Machine & Tool Company	190
Computer Automation	62 63	■ Gould Inc., Instrument Systems Division	213	■‡ Omron Corporation of America	60 61
Conap Inc.	20	■ Grayhill Inc.	67	Osborne & Assoc. of Berkeley	165
Continental Rentals	8	Hal Communications Corp.	212	■ Pearson Electronics	147
‡ Control Data Corp. (CDC Cybernet)	179	Harris Semiconductor	181	° Philips Test & Measuring Instruments Inc.	2E-3E
‡ C.P. Clare & Co.	142	Heath/Schlumberger Scientific Instruments	225	° Piher International Ltd.	59
Crown Industrial	206	Hermes Electronics, Ltd.	173	Plastics Engineering Company	182
Crydom, Div. of Int'l Rectifier	200	■ Hewlett-Packard	1 2 64 65 110 167 216	Positronics Industries	226
■ Dana Laboratories	127	Houston Instruments	185	■ Powermate	180
Data Delay Devices	221			■ Precision Monolithic Inc.	7

THE DETECTORS

Tough infrared measurement problems are no match for The Detectors . . . Sensors' rugged, reliable, low cost thermopile detectors.

Whatever your application . . . from temperature monitoring, spectrophotometry or pollution monitoring to intrusion and fire detection, horizon sensing instrumentation or laser power measurement, The Detectors are ready to help you solve it.

One of The Detectors has the precise combination of high D*, convenient resistance range, excellent responsivity, fast time constant and broad spectral response for your specific application.

Learn about the entire Sensors' line of thin film thermopile detectors. Ask for the free brochure now.

 **sensors, inc.**
3908 VARSITY DRIVE
ANN ARBOR, MI 48104
TEL: (313) 973 - 1400

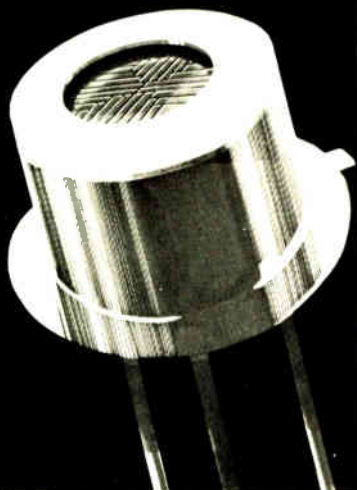

Circle 230 on reader service card

230

Process Computer Systems Inc.	42 43	Teletype	217
Projects Unlimited Inc.	177	■ Theta Instruments	231
Pro-Log Corporation	165	Thick Film Systems Inc.	193
Raychem Corp.	212	‡ TRW/IRC Resistors	58 59
° RCA Electro-optics and Devices	141	Union Carbide Corporation	169
RCA Solid State Division	70 71	United Systems Corp. a Sub of Monsanto Co.	190
■ RCL Electronics Inc.	14	Unitrode Corporation	192
Reticon Corporation	73	Varo Semiconductor Inc.	220
° Rhone Poulenc	4E	Vector Electronics Company Inc.	180
Robinson Nugent Inc.	88 89	Victoreen Instrument Division	196
Rockwell International Electronics Group	136 137	■‡ Wavetek Indiana Inc.	117
° Rhode & Schwarz	1E	Wima Westermann	16
Sangamo Electric	152	XLO-REMEK	145
Scanbe Mfg. Corp.	214	‡ Carl Zeiss, Inc.—Micro	140 141
■ Scelbi Computer Consulting, Inc.	186	Zilog	18 19
° Schlumberger	19E 57		
° S.E.C.I. Divisione Cristalli Liquidi	21E		
° SECI Divisione Componenti	18E		
° SECME	24E		
° Sedeme	8E		
° Sefram	17E		
° Seimarf	87		
■ Sensors Inc.	230		
° Sescosem	47 51		
° Sternice	44		
° SGS Ates	139		
° Siemens A.G. Munich	11E		
‡ Siemens Computest	28		
‡ Siemens Corporation	52 53		
° Siemens Karlsruhe	52		
Siliconix	48 49		
Singer Company Kearfott Division	209		
° Sonimag	23E		
■ Sprague Goodman Electronics, Inc.	214		
‡ Sprague Electric Company	47		
Standard Grigsby	210		
Syston Donner Concord Instrument	151		
° TEAC Corp.	135		
Tecnetics	150		
Tektronix IDD	174		
■‡ Tektronix Inc.	33 35 86 87		
■ Teledyne Relays	17		
Telefile Computer Prod. Inc.	195		

Classified & Employment Advertising

F. J. Eberle, Manager 212-497-2557

■ For more information of complete product line see advertisement in the latest Electronics Buyers Guide
° Advertiser in Electronics International
‡ Advertiser in Electronics domestic edition

What you must know about Microprocessors

Using articles from the pages of Electronics, this book contains practical and up-to-date information on available microprocessor devices, technology and applications—ranging from the simplest 4-bit p-channel MOS system to the second-generation n-MOS 8-bit processor chips, and the new injection logic and Schottky TTL bipolar processor families needed for the toughest computer-based control applications.

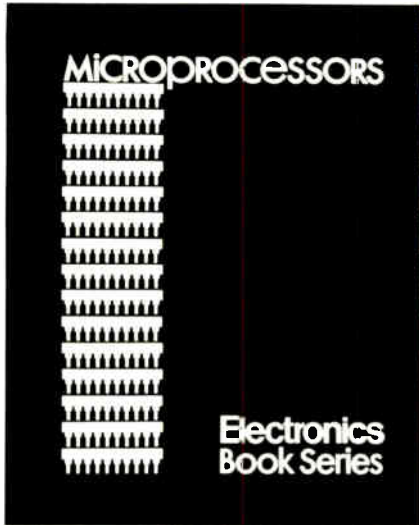

Electronics Book Series

P.O. Box 669
Hightstown, N.J. 08520



Send me _____ copies of "Microprocessors" at \$8.95 per copy.

I must be fully satisfied or you will refund full payment if the book is returned after 10 days: free trial examination.

Payment enclosed Bill firm
 Bill me

Credit Cards Charge My Book To:

American Express Master Charge
 Diners Club BankAmericard

Acct. No. _____

Date Card Expires _____

Interbank No. _____

(1st No's above name on Master Charge only)

Name _____

Title _____

Company _____

Street _____

City _____

State _____ Zip _____

Signature _____

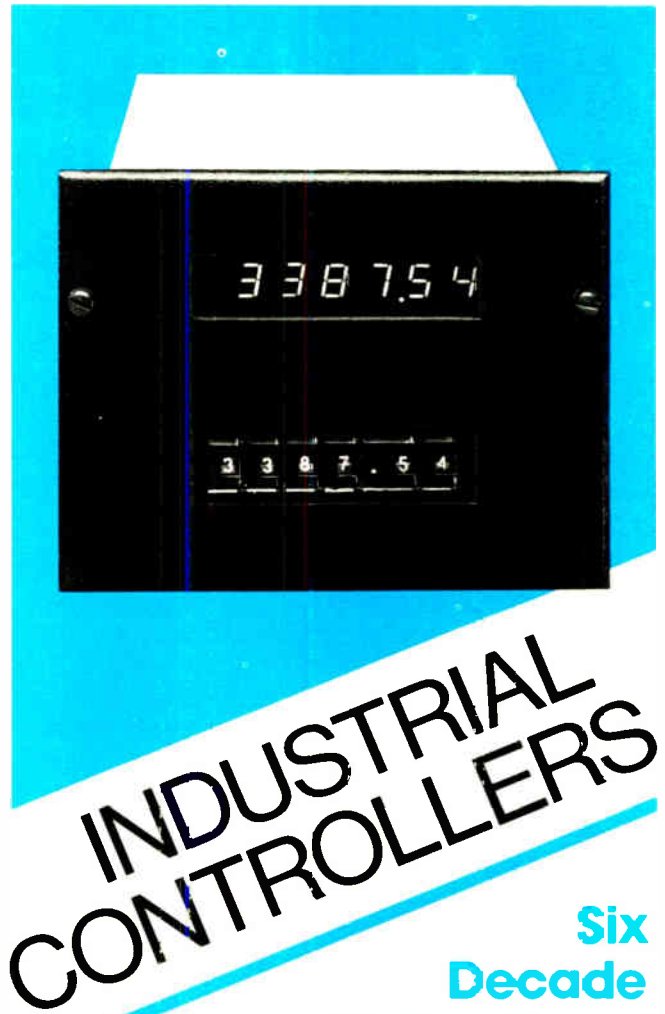

INDUSTRIAL CONTROLLERS

Six Decade Bidirectional Operation... High Noise Immunity... BCD Output

Here's a six decade bidirectional counter-controller especially designed to give long, uninterrupted service in industrial environments. CMOS circuits and special internal filters allow it to be used in high electrical noise environments. LED displays, 10 amp relay output, six decade presets are standard. A six decade set point control is available. Let a Theta Application Engineer help you team an industrial controller with a decitak[®] shaft encoder or other transducer.

LITERATURE:

Write for descriptive literature and your free copy of Digital Solutions to Automatic Control

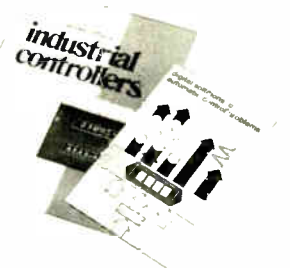

Theta

3002

INSTRUMENT CORPORATION

Fairfield, New Jersey 07006 • Phone: 201-227-4700

If you're not now in the fast-growing data communications equipment market, chances are you will be.

Data communications is one of the fastest-growing electronic equipment markets in the U.S.—during the decade of the '70's, better than 15-20% per year, compounded!

Manufacturers of data processing equipment have recognized the unique nature of *data communications* and have established profit centers to pursue the market for *data communications equipment*. IBM, Burroughs, Sperry-Univac, Honeywell and Digital Equipment Corp. are just a few of the major data processing companies who have separate marketing arms for *data communications*, complete with new products, sales forces, etc. The Bell System, too, through its Teletype Corp., Bell Labs, and Western Electric, has introduced new *data communications equipment*.

Chances are you are going to be a part of the data communications market. There's no better place to start than getting the flavor of the marketplace, equipment, and services than from a copy of "*Basics of Data Communications*".

"*Basics of Data Communications*" is a 316-page compilation of essential articles which have appeared in *Data Communications* magazine. From the basic, tutorial, still state-of-the-art

information published in the 1972 and 1973 Deskbook issues (now out of print), on through information on the practice of present-day data communications, this book includes forty-seven articles covering more than eleven key areas.

"*Basics of Data Communications*" was edited by Harry R. Karp—Chief Editor of *Data Communications* magazine. It is the only book of its kind available anywhere that deals with practical aspects of data communications.

Available this month.

Price: \$12.50

Discounts of 40% orders of ten copies or more.



Electronics Book Series

PO Box 669, Hightstown, N.J. 08520

Send me _____ copies of "*Basics of Data Communications*" at \$12.50 per copy.

I must be fully satisfied or you will refund full payment if the books are returned after ten day trial examination.

Payment enclosed Bill firm Bill me

Credit Cards Charge My Book To

American Express Master Charge
 Diners Club BankAmericard

Acct. No. _____

Date Card Expires _____

Interbank No. _____

(1st No's. above name on Mastercharge only.)

Name _____

Title _____

Company _____

Street _____

City _____

State _____

Zip _____

Signature _____

**Electronics
Book Series**



Classified section

FOR EMPLOYMENT AND SALES OPPORTUNITIES

RATES \$46 per advertising inch (1/4") Commissionable

SIZES 1/4" to 10" deep in widths of one column (1 1/4") two (3 1/4") three (5 1/4"), and four (7")

CLOSING Two weeks prior to mailing

MAILING One week prior to issue date

ISSUE DATE Every other Thursday

AD ORDERS/BOX NUMBER ANSWERS

Send to Electronics, Post Office Box 900, New York N.Y. 10020

POSITION VACANT

Position Available—Need BS Eng. + U.S. exper. in engineering or technical sales. Fee paid by employer. Over 1,000 U.S. client co's. Est. 1959. Send resume & present salary. Atomic Personnel, Inc., Box L. 1518 Walnut, Phila. PA 19102.

Graduate Assistantships in Physics can begin during any quarter. Write: Dr. R. Madey, Kent State University, Kent, OH 44242

Engineers—System, Hardware, Software, Sigit Processing, Analysis, Simulation; Sensors, Command & Control. Many openings in N.E. U.S.A. All fee paid. Submit resume w/sal. info. MBH Assoc. Inc., Personnel Consultants, 1616 Walnut St., Phila., Pa. 19103—Att. H.A. Brelsford, P.E.

FOR INVENTORS

Avoid Piracy of Your Idea or know-how. Before any disclosure assure worldwide Priority Rights. For information write Eurosearch 663 Fifth New York 10022.

EMPLOYMENT SERVICE

Electronics' Industry Newsletter tells you which firms have current employment opportunities, in the field of Electronics, for all types of Engineers, Sales Representatives, Technicians, Executives, Computer Personnel and others. Latest product information is also reported. For information write: Electronics' Industry Newsletter, Dept. 304A, 23573 Prospect Avenue, Farmington, MI 48024.

DON'T forget the Box Number when answering the replies.

CHECK for Accuracy.

INCORRECT

Box Numbers may result in a delay in re-forwarding your reply.

Advertising Sales Staff

Pierre J. Braudé New York [212] 997-3468
Paris Tel: 720-73-01
Director of Marketing

Atlanta, Ga. 30309
100 Colony Square, 1175 Peachtree St. N.E.
[404] 892-2868

Boston, Mass. 02116: James R. Pierce
607 Boylston St. [617] 262-1160

Chicago, Ill. 60611:
645 North Michigan Avenue
Robert W. Bartlett (312) 751-3739
Robert M. Denmead (312) 751-3738

Cleveland, Ohio 44113: William J. Boyle
[716] 586-5040

Dallas, Texas 75201:
2001 Bryant Tower, Suite 1070
[214] 742-1747

Denver, Colo. 80203: Harry B. Doyle, Jr.
123 Speer Blvd. = 400
[303] 837-1010

Detroit, Michigan 48202: Robert W. Bartlett
1400 Fisher Bldg
[313] 873-7410

Houston, Texas 77002: Paul Reiss
601 Jefferson Street, Dresser Tower [713] 659-8381

Los Angeles, Calif. 90010: Robert J. Rielly
Bradley K. Jones, 3200 Wilshire Blvd. South Tower
[213] 487-1160

New York, N.Y. 10020
1221 Avenue of the Americas
Warren H. Gardner [212] 997-3617
Michael J. Stoller [212] 997-3616

Philadelphia, Pa. 19102: Warren H. Gardner
Three Parkway,
[212] 997-3617

Pittsburgh, Pa. 15222: Warren H. Gardner
4 Gateway Center, [212] 997-3617

Rochester, N.Y. 14534: William J. Boyle
9 Greylock Ridge, Pittsford, N.Y.
[716] 586-5040

San Francisco, Calif. 94111: Don Farris
Robert J. Rielly, 425 Battery Street
[415] 362-4600

Paris: Alain Offergeld
17 Rue-Georges Bizet, 75 Paris 16, France
Tel 720-73-01

Geneva: Alain Offergeld
1 rue du Temple, Geneva, Switzerland
Tel 32-35-63

United Kingdom & Scandinavia: Robert Ghey
Tel 01-493-1451, 34 Dover Street, London W1

Scandinavia: Andrew Karnig and Assoc
Kungsholmsgatan 10
112 27 Stockholm, Sweden
Tel: 08 51 68 70 Telex 179 51

Milan: Luigi Rancati
1 via Baracchini, Italy Phone 86-90-656

Brussels: Alain Offergeld
23 Chaussee de Wavre
Brussels 1040, Belgium
Tel: 13-73-95

Frankfurt/Main: Fritz Krusebecker
Liebigstrasse 27c, Germany
Phone 72 01 81

Tokyo: Tatsumi Katagiri, McGraw-Hill
Publications Overseas Corporation,
Kasumigaseki Building 2-5, 3-chome,
Kasumigaseki, Chiyoda-Ku, Tokyo, Japan
[581] 9811

Australasia: Warren E. Ball, IPO Box 5106,
Tokyo, Japan

Business Department

Thomas M. Egan,
Production Manager [212] 997-3140

Carol Gallagher
Production Manager International [212]
997-2045

Dorothy Carter, Production Manager Domestic
[212] 997-2908

Frances Vallone, Reader Service Manager
[212] 997-6057

Electronics Buyers' Guide

George F. Werner, Associate Publisher
[212] 997-3139

Regina Hera, Directory Manager
[212] 997-2544

Gas Sensing Semiconductor

FIGARO GAS SENSOR

TGS quickly senses
even small
amount
of gas.

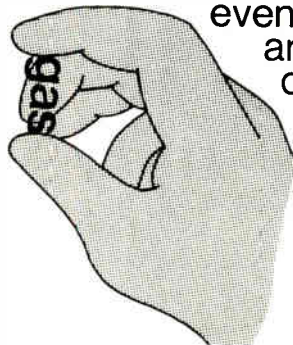

New Models,
some with highly sensitive
CO sensor, now on the market.

Please contact the address below directly for
catalogs and price/delivery information.

FIGARO ENGINEERING INC.

3-7-3, Higashitoyonaka, Toyonaka City, Osaka 560,
Japan/Tel: (06) 849-2156

Cable FIGARO TOYONAKA/Telex 05286155 FIGARO J
Circle 203 on reader service card

PROFESSIONAL DISCOUNT PRICES AVAILABLE ON

HEWLETT  PACKARD

Engineering Calculators

PHONE TOLL FREE
800-638-8906

FOR THE CURRENT LOW DISCOUNT
PRICE OF THE LATEST MODEL
CALCULATOR OF YOUR CHOICE

THE GUARANTEE

10 day money back trial. If you are not completely satisfied you may return the Hewlett-Packard calculator you order within 10 days for a cash refund or charge cancellation. In addition Hewlett-Packard and Capital Calculator Co., Inc. warrant each calculator for a period of one year against defective parts and workmanship.

Capital Calculator Company

 Maryland residents phone:
(301) 340-7200

**701 East Gude Drive
Rockville, Maryland 20850**

SOLID STATE 3 WIRE SYNCHRO TO LINEAR D.C. CONVERTER



RESPONSE CURVE

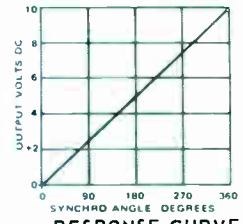
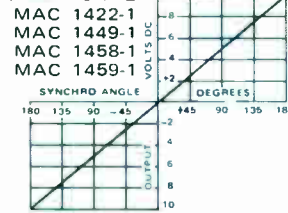

RESPONSE CURVE

MAC 1460-1
MAC 1461-1

FEATURES:

- Develops a DC output voltage linearly proportional to a synchro angle over a $\pm 180^\circ$ range.
- Completely solid state with all of the inherent advantages over a mechanical system such as:
 - High reliability (since there are no moving parts)
 - Light weight—6 ozs.
 - Small size
 - All units hermetically sealed

- Wide temperature range operation
- Output short circuit protected
- Three wire inputs isolated from ground
- Package size may be altered at no extra cost
- Units can be altered to accept different line to line voltages or different operating frequencies at no extra cost
- Not affected by reference voltage or power supply variations.

UNIT	MAC 1422-1	MAC 1449-1	MAC 1458-1	MAC 1459-1	MAC 1460-1	MAC 1461-1
TRANSFER EQUATION	$\pm IV/18^\circ$	$\pm IV/18^\circ$	$\pm IV/18^\circ$	$\pm IV/18^\circ$	$+IV/36^\circ$	$+IV/36^\circ$
ACCURACY (+25°C)	½%	½%	½%	½%	½%	½%
ACCURACY (-25°C+85°C)	1%	1%	1%	1%	1%	1%
L - L SYNCHRO INPUT (VRMS)	11.8	90	11.8	90	11.8	90
FREQUENCY (Hz)	400	400	60	60	400	400
FULL SCALE OUTPUT	$\pm 10V$	$\pm 10V$	$\pm 10V$	$\pm 10V$	$+10V$	$+10V$
OUTPUT IMPEDANCE	$<1\Omega$	$<1\Omega$	$<1\Omega$	$<1\Omega$	$<1\Omega$	$<1\Omega$
L - L INPUT IMPEDANCE	$>10K$	$>30K$	$>2K$	$>10K$	$>10K$	$>30K$
REFERENCE VOLTAGE (VRMS)	26	115	26	115	26	115
OPERATING TEMP. °C	-25 - +85	-25 - +85	-25 - +85	-25 - +85	-25 - +85	-25 - +85
D.C. SUPPLY	$\pm 15V$	$\pm 15V$	$\pm 15V$	$\pm 15V$	$\pm 15V$	$\pm 15V$
D.C. SUPPLY CURRENT	$\pm 75MA$	$\pm 75MA$	$\pm 75MA$	$\pm 75MA$	$\pm 75MA$	$\pm 75MA$
BANDWIDTH	10Hz	10Hz	OPT.	OPT.	10Hz	10Hz
WEIGHT	6 oz.	6 oz.	6 oz.	8 oz.	6 oz.	6 oz.
SIZE	3.6x2.5x0.6	3.6x2.5x0.6	3.6x3.0x0.6	3.6x3.0x1.0	3.6x2.5x0.6	3.6x2.5x0.6

A.C. LINE REGULATION

A new method has been developed which allows us to provide a low distortion highly regulated AC waveform without using tuned circuits or solid state active filters of any kind.

The result is a frequency independent AC output regulated to 0.1% for line and load with greater than 20% line variations over a wide temperature range.

FEATURES:

- 0.1% total line and load regulation
- Independent of $\pm 20\%$ frequency fluctuation
- 1 watt output
- Extremely small size
- Isolation between input and output can be provided

Specifications: Model MLR 1476-1

AC Line Voltage: 26V $\pm 20\%$ @
400Hz $\pm 20\%$

Output: 26V $\pm 1\%$ for set point

Load: 0 to 40ma

Total Regulation: +0.1%

Distortion: 0.5% maximum rms

Temperature Range: -55° C to
+125°C

Size: 2.0" x 1.8" x 0.5"

Other units are available at different power and voltage levels as well as wider temperature ranges. Information will be furnished upon request.

SOLID-STATE SINE-COSINE SYNCHRO CONVERTER - NON VARIANT

This new encapsulated circuit converts a 3 wire synchro input to a pair of dc outputs proportional to the sine and cosine of the synchro angle independent of a-c line fluctuations.

- Complete solid state construction
- Operates over a wide temperature range
- Independent of reference line fluctuations
- Conversion accuracy—6 minutes
- Reference and synchro inputs isolated from ground

Specifications Model DMD 1508-2

Accuracy: Overall conversion accuracy 6 minutes. Absolute value of sine and cosine outputs accurate to $\pm 30MV$

Temperature Range: Operating -40°C to +85°C, Storage -55°C to +125°C

Synchro Input: 90V RMS $\pm 5\%$ LL 400Hz $\pm 5\%$

DC Power: $\pm 15V$ DC $\pm 10\%$ @ 50MA

Reference: 115VRMS $\pm 5\%$ 400Hz $\pm 5\%$

Output: 10V DC full scale output on either channel @ 5ma load

Temperature coefficient of accuracy: ± 15 seconds/°C avg. on conversion accuracy ± 1 MV/°C on absolute output voltages

Size: 2.0" x 1.5" x 2.5"

Units are available with wider temperature ranges and 11.8V LL, 26V reference synchro inputs. Information will be supplied upon request.

There is No Substitute for Reliability



GENERAL MAGNETICS • INC

135 Bloomfield Ave., Bloomfield, New Jersey 07003 - Tel. (201) 743-2700

Circle 234 on reader service card

THE

FIRST INTEGRAL PUSHBUTTON POTENTIOMETER



If you're designing panels with precision data entry or set-point controls, consider the BOURNS Model 3680 KNOBPOT® Digital Potentiometer . . . another innovative idea from Bourns. The 3680 integrates a precision incremental decade potentiometer with an easy-to-read digital display, AND a speedy pushbutton control action. It is handsome, extremely accurate, and a "snap" to install. Everything is INSIDE the Model 3680 . . . no resistors or mini-PC boards are required . . . nothing clutters the back of the unit to steal precious space.

PUSHBUTTON ACTION

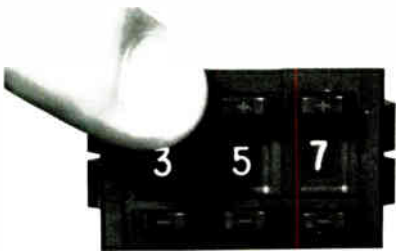

Simple, fast, precise. Push the PLUS button to increase; the MINUS to decrease. Rated life is 100,000 operations per decade.

IN-LINE DIGITAL READOUT

Large, easy-to-read numbers enable fast, "squint-free" data entry and information readout.

ACCURATE

You get what you set with the 3680 . . . every time. The unique Bourns design integrates precision laser-trimmed cermet resistor technology with a positive pushbutton detent action. The result is resolution of output of 1 part in 1000 discrete steps, and dependable repeatability of $\pm 0.1\%$.

COSTS LESS TO INSTALL

Snap-in mounting cuts installation time, eliminates mounting hardware. Integral bezel covers irregular panel cut outs and minor edge blemishes. Terminals match the AMP Series 110 receptacle . . . or can be soldered in the standard fashion.

FEATURES AND SPECIFICATIONS

- stable built-in cermet resistance elements
- 100 PPM/°C tempo • 2 watts power rating
- standard resistance range (3 decade unit) 5K ohms to 1 megohm • $\pm 1.0\%$ resistance tolerance • resolution 0.1%.

COMPACT SIZE

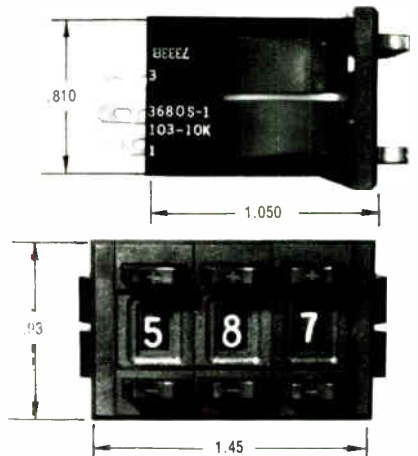

For more information, write or phone the "Panel Power People," TRIMPOT PRODUCTS DIVISION, BOURNS, INC., 1200 Columbia Avenue, Riverside, CA 92507. TWX 910 332-1252. Telephone: 714 781-5610.



Opto-isolators of every type available from Clairex



microsecond range for applications in organs and electric guitars.

2. *Photoconductor-neon lamp.* Neon lamps can operate directly from line voltage and are frequently used in digital applications.

Opto-isolators, photocouplers, and DIP—isolators are all common names for a device which couples circuits via a light beam . . . and Clairex makes them all.

1. *Photoconductor-tungsten lamp.* This module provides slow-speed switching in the low mil-



3. *Photoconductor-LED.* Combines rugged, long life of LED with high-voltage capability of a

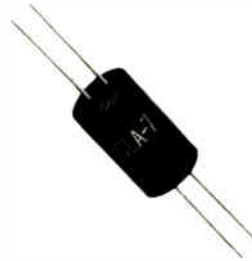

photoconductor. Useful in driving line voltage devices such as triacs to operate solenoids and relays.

4. *Phototransistor-LED.* Designed to operate in the 2-3 microsecond range for high-speed data transmission.



5. *Photodarlington-LED.* Similar to the phototransistor types except that the photodarlington can provide added gain or "transfer ratio" up to . . . 600% minimum over the input signal.

Tell us your "light" problem. We'll develop the solution. Call (914) 664-6602 or write Clairex® 560 South Third Avenue, Mount Vernon, New York 10550.

...in dip-pack and larger sizes.

CLAIREX ELECTRONICS

A Division of Clairex Corporation