

Take your choice of an output from this versatile unit. It's an amplifier with all-pass delay, flat, notch and resonant modes. Also it can function as an oscillator;

a band-pass or rejection filter; a tunable voltmeter having variable bandwidth; a noise, distortion and harmonic analyzer. Check on this new 'lab in a box' on page 110.

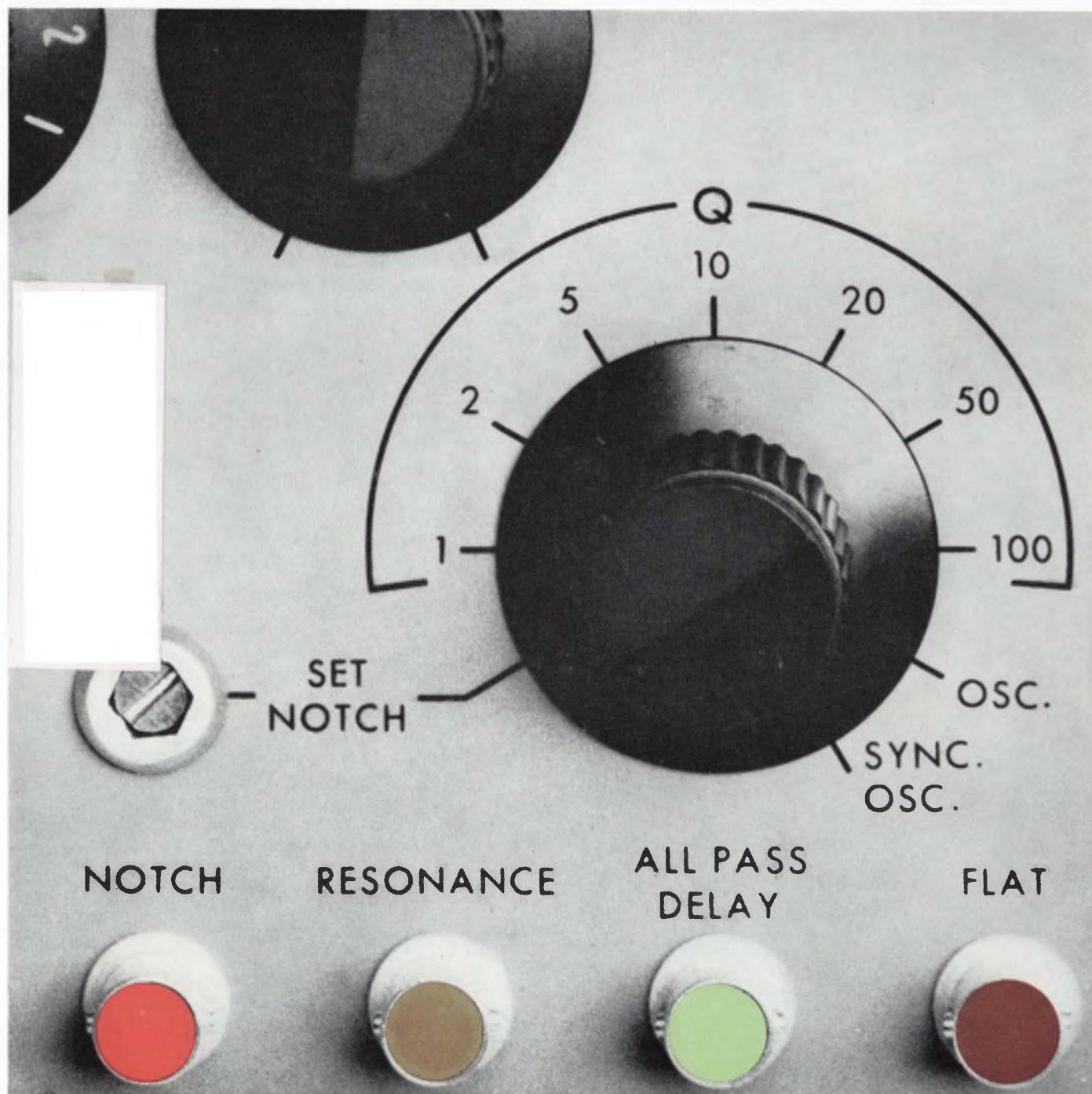



"SPECIAL"

CUSTOM BUILT FILTERS

TO YOUR SPECIFICATIONS

ILLUSTRATED ARE
TYPICAL SPECIAL FILTERS

RANGE OF FREQUENCIES ON SPECIAL UNITS
IS FROM 0.1 CYCLE TO 400 MC.

Over thirty years of experience in the design and production of special filters have resulted in UTC being a first source for difficult units. Present designs both military and commercial incorporate a wide variety of core structures, winding methods, and capacitors to provide maximum performance, stability, and reliability. Fully experienced, top engineering talent backed by complete environmental testing and life testing facilities assure the highest standard in the industry. Full analysis and evaluation of materials are conducted in UTC's Material and Chemical Laboratories. Rigid quality control measures coordinated with exhaustive statistical findings and latest production procedures results in the industry's highest degree of reliability.

MILITARY AND COMMERCIAL TYPES FOR
EVERY PHASE OF THE ELECTRONICS ART

POWER TRANSFORMERS • AUDIO TRANSFORMERS • INDUCTORS • PULSE TRANSFORMERS • ELECTRIC WAVE FILTERS • LUMPED CONSTANT DELAY LINES • HIGH Q COILS • MAGNETIC AMPLIFIERS • SATURABLE REACTORS • REFERENCE UNITS

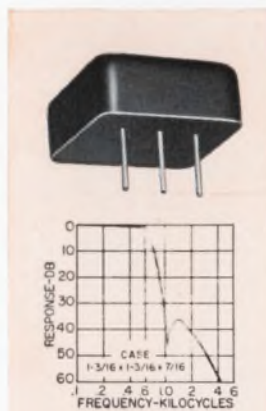

560 — Telemetry low pass filter. Available from 400 ω to 70 KC. \pm 7.5% bandwidth flat to 1 db. Attenuation greater than 35 db beyond the 2nd harmonic of \pm 7.5% frequency. Impedance 47K ohms. MIL-F-18327B. Wt. 0.8 oz.

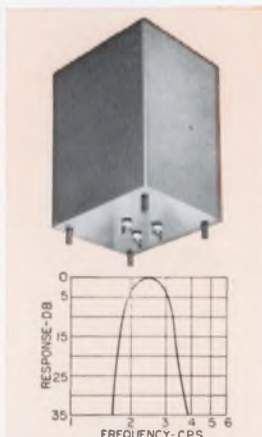

Low frequency band pass filter. Designed for 2.5 cps center frequency. At 2 to 3 cps within 3 db. At 1.5 cps and lower, and 4 cps and higher, greater than 30 db. Source and Load 10K ohms. Size: 4 x 4-11/16 x 6". MA MIL case, MIL-F-18327B.

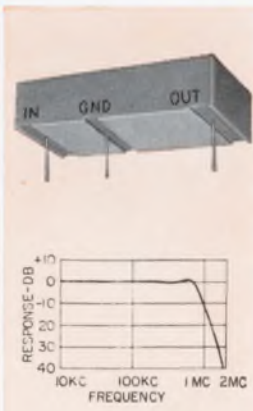

High frequency low pass filter. Zero to 700 KC within 1 db. 1.95 mc to 10 mc 40 db minimum. Source and Load 1000 ohms. Molded flat construction for printed circuit applications. Size: 1 x 2 x 1/2"; Wt: 1 oz. MIL-F-18327B.

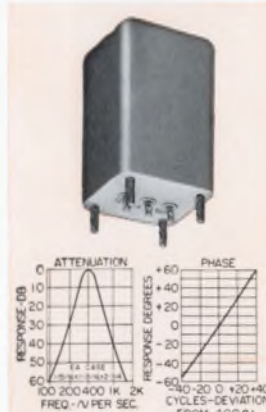

Band pass 400 cycle Gaussian filter. Linear phase response in pass band. Attenuation 380 cps to 420 cps within 0.5 db. 2nd harmonic down 25 db, 3rd harmonic down 45 db. Source and load 5K ohms. MIL-F-18327B Wt., 0.9 lbs.

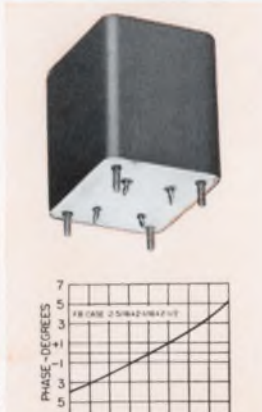

Minimum phase shift 400 cycle band pass filter. Within \pm 1.5 db 370 to 430 cycles, greater than 45 db beyond 1100 cycles. 1K ohms to 100K ohms. MIL-F-18327B; 1 lb.

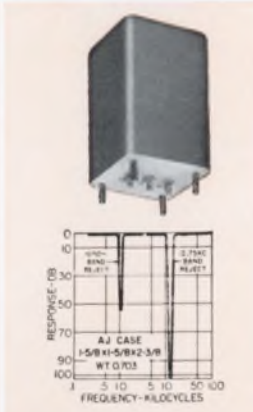

Band reject filters (two shown). The 1050 ω filter has 50 db attenuation and is only 3 db at 950 and 1150 cycles. The 12.75 KC filter has more than 100 db attenuation and is only 3 db at 10.8 and 15 KC. Source and load 600 ohms, both are MIL-F-18327B.

Write for catalog of over
1,300 UTC TOP QUALITY
STOCK ITEMS
IMMEDIATELY AVAILABLE
from your local distributor.



UNITED TRANSFORMER CO.

DIVISION OF TRW INC. • 150 VARICK STREET, NEW YORK, N. Y. 10013

Precision Frequency Comparison with the hp 8405A Vector Voltmeter

The Hewlett-Packard 8405A Vector Voltmeter can make many measurements that were formerly difficult or even impossible, and frequency comparison is just one of the many applications filled by this versatile tool.

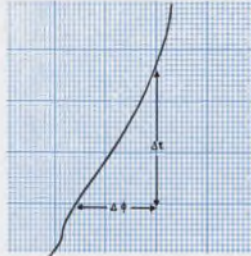

Using the 8405A, you can make frequency comparisons to $1/10^3$ of typical standard frequencies of 1 MHz and above... and it takes only minutes. Older methods took up to a day's time to make similar comparisons with the same resolution. With the 8405A the Channels A and B inputs of the instrument are simply connected to the outputs of the frequency sources to be compared. The phase is compared and indicated on the phasemeter of the instrument. Phase change, and its direction can be recorded by the use of a strip-chart recorder; the frequency difference in proportional parts then can be easily calculated.

Free Application Data

An application note on frequency comparison techniques is now available—write today for your copy of Application Note #77-2, "Precision Frequency Comparison": Hewlett-Packard, 1501 Page Mill Road, Palo Alto, California 94304, Tel. (415) 326-7000; Europe: 54 Route des Acacias, Geneva.

Check the specifications of this new, wideband, 2-channel rf millivoltmeter-phasemeter and match them against your application.

Major Specifications, hp 8405A Vector Voltmeter

Frequency Range is 1 to 1000 MHz in 21 overlapping octave bands; automatic tuning within each band.

Voltage Range for Channel A (synchronizing channel), 300 μ v to 1 v rms (5-500 MHz), 500 μ v to 1 v rms (500-1000 MHz), 1.5 mv to 1 v rms (1-5 MHz).

Voltage Range for Channel B (input to Channel A required), 100 μ v to 1 v rms, full scale. Full-scale meter ranges from 100 μ v to 1 v in 10 db steps. Both channels can be extended to 10 v rms with 10214A 10:1 Divider.

Phase Range of 360° indicated on zero-center meter with end-scale ranges of $\pm 180^\circ$, $\pm 60^\circ$, $\pm 18^\circ$, $\pm 6^\circ$. Phase meter OFFSET of $\pm 180^\circ$ in 10° steps permits use of $\pm 6^\circ$ range for 0.1° phase resolution at any phase angle.

Price: \$2500.

A NEW TIME-SAVING TECHNIQUE



HEWLETT **hp** PACKARD
An extra measure of quality

ON READER-SERVICE CARD CIRCLE 2

Open a savings account here!



Just like a piggybank, our Digi-Twin 800-Series solid state counter really is a great place to save money. The reason is that big space where the plug-ins go. The two **other** big names in counters (Hewlett-Packard and Beckman) offer function plug-ins only. So you're stuck. That didn't seem fair to us, so our Digi-Twin is the only counter offering **three frequency range plug-ins**: 25 Mc, 50 Mc, and 110 Mc. So if you now need only 25 Mc, why pay for 50 Mc? Then if your next project requires a different frequency range you can buy a whole new counter from them... or just an inexpensive 50 Mc or 110 Mc plug-in for ours. ■ Maybe it's our attitude in giving you the best instrument, without charging you all the traffic will bear, that has earned us our solid third place in counter sales. If so, maybe you'll be interested in our ripening plans to offer you more and better instruments. And not just counters, either! ■ Say, have you earned your Crusading Engineers medal yet? It's the newest status symbol given to honor engineers like you who have the guts to compare the performance specs of **all three** major brands of counters. After that it's up to you to decide which counter actually fits your needs best. Earn your medal by writing now for our technical catalog. **It's free.** Incidentally, this counter is delivered without the cash inside.



12973 Bradley • San Fernando, California • Phone (213) 367-2161 • TWX 213-764-5993

FUNCTION MODULES: Counter-Timer Function Module • Frequency-Period (2 modules available) • 600 Mc Heterodyne Converter • Integrating Digital Voltmeter • 100 Mc Direct Counting Adapter • Digital Phase Meter • More Functions Due Soon

COMPUTER MEASUREMENTS COMPANY IS A LEADING DESIGNER AND MANUFACTURER OF ELECTRONIC INSTRUMENTATION TO COUNT, MEASURE, AND CONTROL.
ON READER-SERVICE CARD CIRCLE 3

NEWS

- 13 News Scope
- 17 **Automated centers readied for global net**
Twelve digital message-switching centers to speed military communications in Autodin system.
- 21 **Monochromatic sources yield six-color display**
Solid-state device, switched digitally, produces 'minimum attention' readout for busy observers.
- 24 Hospital computer system to speed therapy.
- 26 Army gets thin-film-logic fuse for projectiles.
- 29 Washington Report
- 42 Letters
- 45 **Editorial: Is fluidics a fine friend or a fearsome foe?**

TECHNOLOGY

- 48 **Looking for a 'universal' circuit?** Here is one approach that uses readily available ICs to perform a number of useful circuit functions.
- 54 **Ten steps to multilayer board design:** Here's how to proceed from the logic diagram of a system to the final artwork stage of the interconnection layout.
- 62 **Try this integrated-circuit digitizer** for accurate frequency measurements in digital form. The simple, reliable circuit needs no calibration.
- 70 **Don't guess the spurious level** of an amplifier. The intercept-point method gives exact values with the aid of a simple nomograph.
- 76 **Ease the design of magnet coils** by using a one-page nomogram that correlates some twenty variables involved.
- 81 Semiannual Index of Articles, July to December, 1966.
- 92 Ideas for Design
- 106 NASA Tech Briefs

PRODUCTS

- 110 **Cover Feature:** Laboratory test unit performs functions of six standard units.
- 114 Test Equipment
- 130 Components
- 159 Microelectronics
- 164 Microwaves
- 172 Materials
- 176 Semiconductors
- 178 Production Equipment
- 184 Power Equipment
- 188 Systems

Departments

- 104 Book Reviews
- 192 Design Aids
- 194 Application Notes
- 196 New Literature
- 206 Advertisers' Index
- 208 Designer's Datebook

Reader Service card inside back cover

ELECTRONIC DESIGN is published biweekly by Hayden Publishing Company, Inc., 850 Third Avenue, New York, N. Y. 10022. James S. Mulholland, Jr., President. Printed at Poole Bros., Inc., Chicago, Ill. Controlled-circulation postage paid at Chicago, Ill., Cleveland, Ohio, and New York, N. Y. Application to mail at controlled postage rates pending at St. Louis, Mo. Copyright © 1967, Hayden Publishing Company, Inc. 61,409 copies this issue.

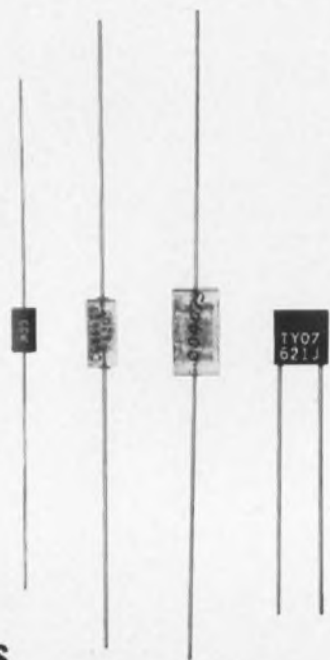

from .5 to 100,000 pf, nothing's as stable as glass

Boil, freeze, bury, drown or irradiate glass, and you won't measure any dielectric change.

Freeze a capacitive element inside that glass, and it's as immune as any capacitor can get to environment, temperature, time, voltage, moisture, frequency, vibration, shock.

That's why nothing comes closer to being the perfect circuit symbol than a CORNING® glass capacitor. And only Corning makes the glass capacitors to meet all these critical circuit needs:

High capacitance in small space. The CORNING® GLASS-K capacitor crams from 1,000 to 100,000 *pf* in a quarter-inch case size.

Dense circuitry, without doubts. The CORNING® TYO capacitor, from 1 to 2700 *pf*, has radial leads, precision case for snug upright mounting.

Documented stability and reliability. Every CORNING® CYFR capacitor, from .5 to 10,000 *pf*, meets our punishing J-950 specification, and is backed by a heritage that includes use in Surveyor, Minuteman, Gemini, among others.

Low cost, high reliability. The CORNING® CYFM capacitor, from .5 to 10,000 *pf*, gives you CYFR-type environment-proof performance at substantial savings.

Why risk an entire system on capacitors that cannot give you the assurance of



Corning dielectric stability? Send for the new CORNING® GLASS CAPACITOR GUIDE to Corning Glass Works, 3909 Electronics Dr., Raleigh, N.C.

CORNING
E L E C T R O N I C S

announcing...

Allen-Bradley Active Filters, which offer a 60 db attenuation over the range of 10Hz (3Hz*) to 100KHz



Allen-Bradley active filters can provide as much as a 50 to 1 reduction in size and a corresponding reduction in weight over conventional passive elements.

The diagram below and performance curve at right illustrate how Allen-Bradley active filters prevent current fluctuations in the power distribution system above 10Hz (3Hz*), developed by pulse modulated communications equipment, such as teletypewriters and other randomly varying loads.

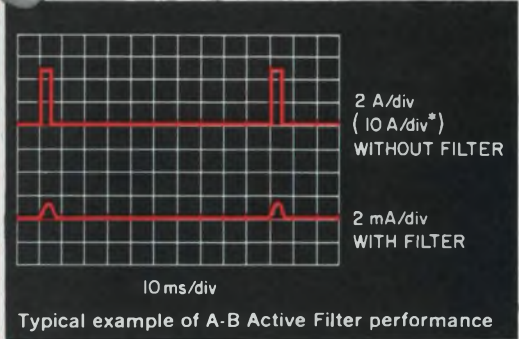
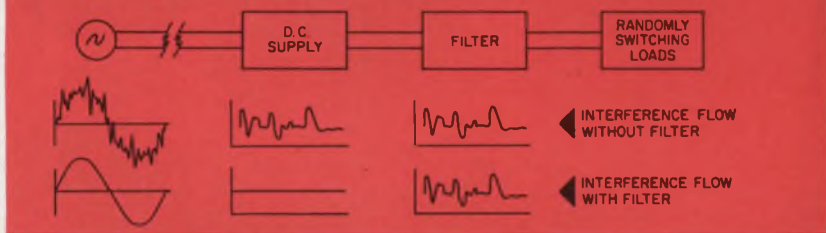

Directly as the result of some new ideas applied to the field of ElectroMagnetic Compatibility, Allen-Bradley has been able to produce a new *active* low pass filter that provides an attenuation of greater than 60 db over the range of 10Hz (3Hz*) to 100KHz. The maximum dc component of the load current is 5 amperes.

The primary purpose of this filter in the above application is to prevent impulses generated by rapid load fluctuations, which may be carrying information of a confidential nature, from being reflected back through the power supply and into the power distribution system.

These new filters are designed to satisfy specific requirements. For instance, power line filters are under development for 60Hz and 400Hz power frequencies. Here, a sharp pass band is afforded the power frequency while greatly attenuating all other frequencies.

Allen-Bradley active filters produce a far greater attenuation of unwanted signals than is possible with a filter composed of conventional passive elements, occupying the same volume. By using the A-B *active* filter, a size reduction of 50 to 1 is attained, together with corresponding savings in weight. These filters employ solid-state circuitry. No external power source is required other than that supplying the power to the load. In addition, complete inrush and short circuit protection is provided.

Allen-Bradley specialists in filter engineering are available to discuss with you such problems for which these new active filters might offer the best solution. Please write: Allen-Bradley Co., 1344 South Second Street, Milwaukee, Wis. 53204. In Canada: Allen-Bradley Canada Limited. Export Office: 630 Third Ave., New York, N. Y., U. S. A. 10017.

*WITH EXTERNAL CAPACITOR

766-1AB



ALLEN-BRADLEY

QUALITY ELECTRONIC COMPONENTS

ON READER-SERVICE CARD CIRCLE 5

ELECTRONIC DESIGN 3, February 1, 1967

Philbrick's NEW BREED Micro-Hybrid Operational Amplifiers Obsolete Monolithics

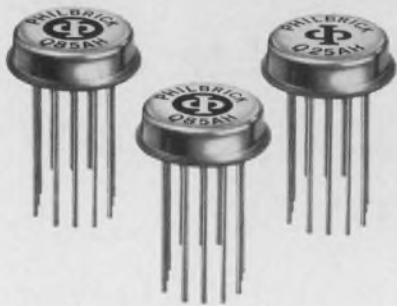

If you are still using monolithic-chip operational amplifiers, your system may be on its way to obsolescence — perhaps even before it gets off the board. A full year of industry-wide evaluation has proved it.

Philbrick's NEW BREED of "micro-hybrid" operational amplifiers combines the best of the linear-monolithic and discrete-component technologies. The result: a line of "micro-hybrid" operational amplifiers unequalled in reliability and performance. You'd expect premium amplifiers like these to cost more. They do — but your total system cost, including design, development, materials, and production, is usually substantially lower when you use NEW BREED Operational Amplifiers.

You can bid, win, and build highly superior "third-generation" systems with the NEW BREED — systems with an order of magnitude better performance, and absolute immunity to overloads, shorts, and supply-voltage stresses. Without the NEW BREED, your analog Aerospace/Weaponry designs are no longer competitive — technologically or economically.

More than 200 systems organizations have evaluated (and many have already approved) the NEW BREED. The facts are all assembled in our report entitled "THE NEW

BREED MICRO-HYBRID — A STATUS REPORT." Write, wire, or phone for your copy. Philbrick Researches, Inc., 46-0 Allied Drive at Route 128, Dedham, Massachusetts 02026. TWX (617) 326-5754. Telephone (617) 329-1600.



GENETIC EVOLUTION OF THE NEW BREED HYBRID

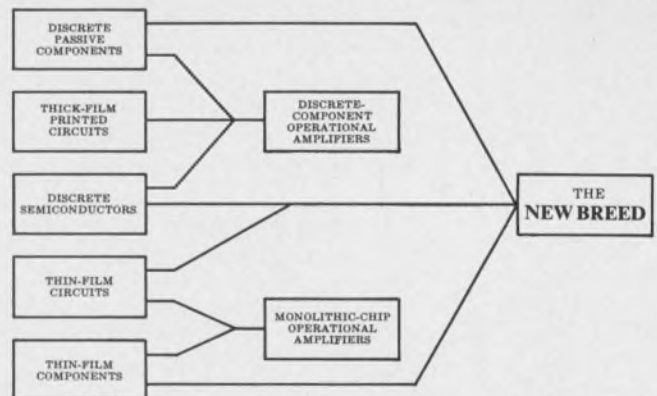

ELECTRONIC ANALOG COMPUTING EQUIPMENT for MODELLING, MEASURING, MANIPULATING and MUCH ELSE



PHILBRICK

ON READER-SERVICE CARD CIRCLE 6

Exclusive!

THERMAL-PAIRING™

for the best behaved hybrids in the business

General Instrument announces:
 Thermal-pairing, a new thermal servo-control technique that establishes new standards of reliability, stability and circuit performance unachievable until now in integrated circuits.

Thermal-paired hybrid microcircuits work like this: If a critical component starts to heat up, the temperature rise is transferred through the common substrate to a control component which reacts to limit the heating. For example, the PC-260 is a high-efficiency hybrid linear amplifier using Thermal-pairing (see circuit diagram). Transistors A & B are selectively positioned on the substrate. If thermal imbalance occurs, the resultant temperature rise in the A transistors is transmitted through the substrate to the B transistors. These transistors, in turn, heat up and readjust the voltage levels to correct the imbalance. The Thermal-paired feedback loop thus eliminates the danger of thermal runaway. Balanced operation resulting in better power efficiency, excellent linearity, and low distortion is maintained with a minimum of circuit complexity.

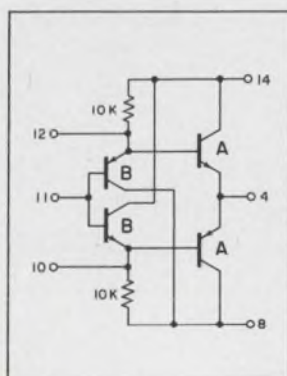

FEATURES: PC-260

Typical Circuit Performance:
 $V_{CC}=V_{EE}=12V$, $R_L=1K\Omega$, $T_A=25^\circ C$

- Power Efficiency
 ($R_L=240\Omega$, 18V_{pp} Swing).....53%
- Bandwidth (3dB),
 $R_S=100\Omega$, $V_{IN}=1V_{pp}$ DC to 40 MHz
- Input Resistance 1M Ω
- Output Impedance 12 Ω
- Output Swing $\pm 10V$
- Total Harmonic Distortion
 $V_{IN}(1.5 V_{rms})$ 0.2%

The PC-260 is immediately available from your authorized General Instrument Distributor. Write for full information.



GENERAL INSTRUMENT CORPORATION • 600 WEST JOHN STREET, HICKSVILLE, L. I., NEW YORK
 ON READER-SERVICE CARD CIRCLE 7



**DON'T GAMBLE
with your MICROCIRCUITS!**

Specify Rugged, Reliable

ERIE BLUE CHIP[®] CAPACITORS

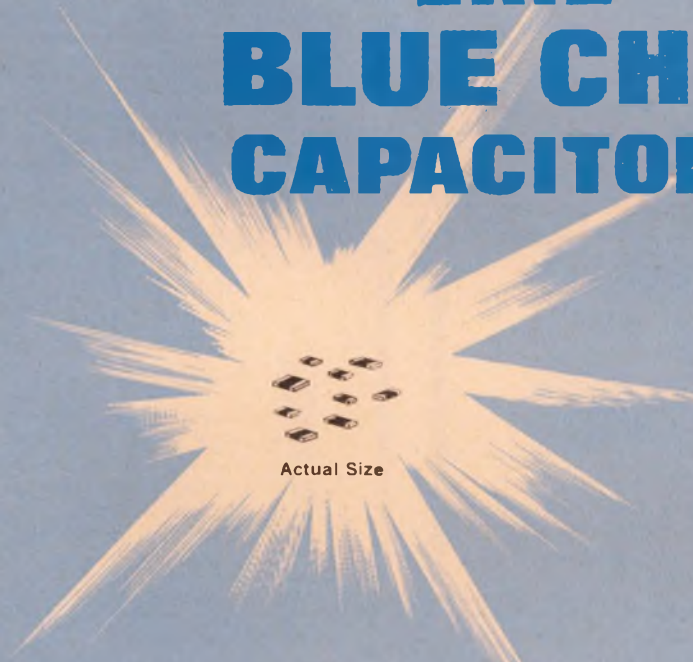

Actual Size

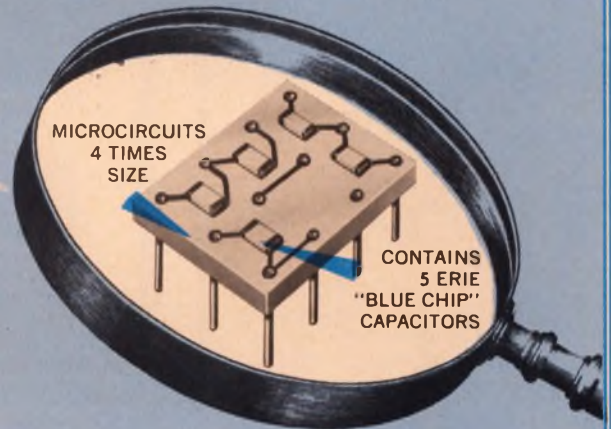

MICROCIRCUITS
4 TIMES
SIZE

CONTAINS
5 ERIE
"BLUE CHIP"
CAPACITORS

**10 to 1,000,000 pF CAPACITANCE RANGE... 50 or 100 WVdc
AVAILABLE NOW FOR MICROCIRCUIT APPLICATIONS**

When one manufacturer . . . ERIE . . . produces the most nearly perfect Ceramic Chip Capacitor in the industry . . . gambling with other chip brands becomes a real game of chance. Erie Chips are considered by knowledgeable engineers as more rugged in construction, they have higher temperature stability, maximum capacitance-to-volume ratio (10 pF to 1.0 mF), greater performance reliability, better solderability . . . and Erie offers an almost infinite variety of Chip Capacitors to suit any microcircuit requirement.

So when you visit Las Vegas . . . gamble. That's why you're there. But when you demand better performance from components in Microcircuits, place the only safe bet . . . ERIE Monobloc Ceramic Chip Capacitors.

Write for technical data on Ceramic Chip Capacitors, Request Monobloc Catalog 8000.

®Trademark for Erie Monobloc Ceramic Chip Capacitors

Another series of components in Erie's Project "ACTIVE" . . .
Advanced Components Through Increased Volumetric Efficiency.



Erie, Pennsylvania

ON READER-SERVICE CARD CIRCLE 8

You Can Get All These Microcircuits from Sprague Electric:

SERIES SU300, LU300 UTILOGIC



K Package

For use in commercial, industrial, ground support applications. Available in two operating temperature ranges, -20°C to $+85^{\circ}\text{C}$, and $+10^{\circ}\text{C}$ to $+55^{\circ}\text{C}$. Propagation delay of 15 to 40 nanoseconds.

*Trademark of Signetics Corp.

ON READER-SERVICE CIRCLE 883

*SERIES SE400, NE400 LOW POWER LOGIC



J Package

Operating temperature ranges: -55°C to $+125^{\circ}\text{C}$, and 0°C to $+70^{\circ}\text{C}$. For use in Aerospace and other applications where low power drain is required. Optimized speed, noise margin.

ON READER-SERVICE CIRCLE 884

*SERIES SE500 LINEAR AMPLIFIERS



K Package

Operating temperature range: -55°C to $+125^{\circ}\text{C}$. Two linear circuits available in 10-lead low silhouette TO-5 case. SE501K is a video amplifier, SE505K is a general purpose differential amplifier.

ON READER-SERVICE CIRCLE 885

*SERIES SE800, NE800 TTL LOGIC



J Package

Designed for high-speed avionics systems. Eight high level circuits including four NAND Gates, Power Gate, Exclusive-OR Gate Input Expander, J-K Flip-Flop.

ON READER-SERVICE CIRCLE 886

UNICIRCUIT® RCTL LOGIC

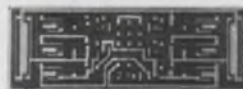

(8x actual size)

Sprague Series US-0100 . . . a complete line of silicon monolithic digital building blocks featuring low power consumption (2 mW typ.)

ON READER-SERVICE CIRCLE 887

UNICIRCUIT® mW RTL LOGIC



TO-5 Case

Types US-0908 through US-0921 . . . Fully interchangeable mW digital building blocks featuring power consumption of 2 mW/node and propagation delay of 40 nsec.

ON READER-SERVICE CIRCLE 888

UNICIRCUIT® CUSTOM HYBRID CIRCUITS

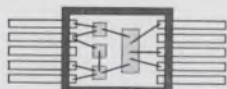

Combine monolithic silicon circuits with tantalum or Ni-Cr alloy resistors. Close resistance tolerances, low temperature coefficient. Resistor matching, $\pm 1/2\%$.

ON READER-SERVICE CIRCLE 889

DIGITAL-TO-ANALOG CONVERSION CIRCUITS



UT-1000—Four-bit ladder network
UD-4001—Ladder switch for driving resistor ladder networks
UD-4024—Buffer amplifier

ON READER-SERVICE CIRCLE 888

*Series SE100, NE100, CS700, SU300, LU300, SE400, NE400, SE500, SE800, NE800 are all available from Sprague Electric under technology interchange with Signetics Corp.

For data sheets on the microcircuits in which you are interested, write to: Technical Literature Service, Sprague Electric Company, 347 Marshall St., North Adams, Massachusetts 01247

SPRAGUE COMPONENTS

INTEGRATED CIRCUITS
THIN-FILM MICROCIRCUITS
TRANSISTORS
CAPACITORS
RESISTORS

PULSE TRANSFORMERS
INTERFERENCE FILTERS
PULSE-FORMING NETWORKS
TOROIDAL INDUCTORS
ELECTRIC WAVE FILTERS

CERAMIC-BASE PRINTED NETWORKS
PACKAGED COMPONENT ASSEMBLIES
BOBBIN and TAPE WOUND MAGNETIC CORES
SILICON RECTIFIER GATE CONTROLS
FUNCTIONAL DIGITAL CIRCUITS

SPRAGUE®
THE MARK OF RELIABILITY

Sprague and ® are registered trademarks of the Sprague Electric Co.

News

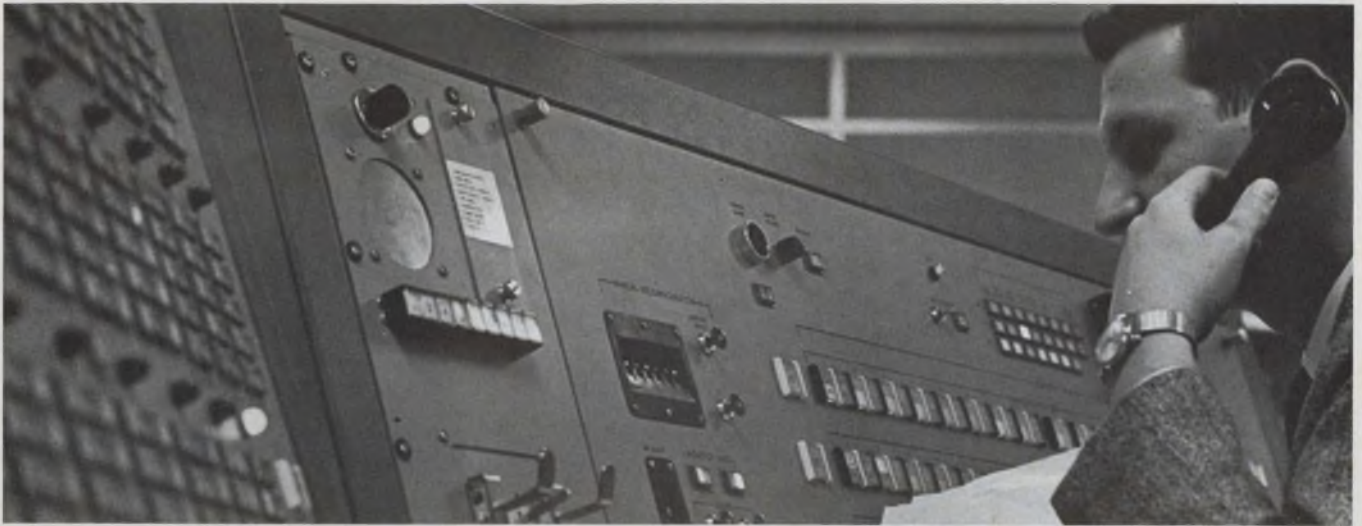

One of 12 digital message-switching centers—each one can automatically handle 32,000

messages an hour—is part of global system to speed military communications. Page 17

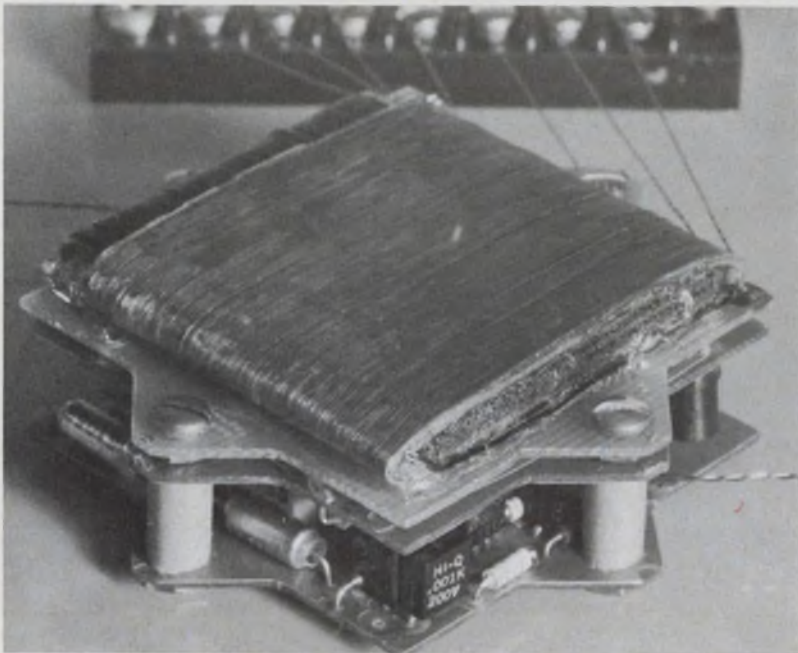

Thin-film magnetic domain-tip propagation logic is tested for use in the fuse timers of Army projectiles. Page 26



Hospital computer net lets doctors treat patients from afar. Page 24

Also in this section:

Monochromatic sources yield 'minimum attention' six-color display. Page 21

GaAs diffusion process triples diode laser power. Page 33

News Scope, Page 13 . . . **Washington Report**, Page 29 . . . **Editorial**, Page 45

RESISTORS FOR PERSPICACIOUS DESIGN ENGINEERS

FILMISTOR® PRECISION METAL-FILM RESISTORS

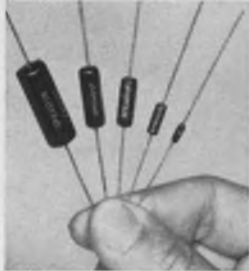

Extended-range Filmistor Resistors now give you dramatic space savings in all wattage ratings — 1/20, 1/10, 1/8, 1/4, 1/2, and 1 watt — with absolutely no sacrifice in stability!

Filmistors offer extended resistance values in size reductions previously unobtainable. For example, you can get a 4.5M Ω resistor in the standard 1/4 watt size, which had conventionally been limited to 1 M Ω . Filmistor Metal-Film Resistors are now the ideal selection for "tight-spot" applications in high-impedance circuits, field-effect transistor circuits, etc.

Other key features are $\pm 1\%$ resistance tolerance, low and controlled temperature coefficients, low inherent noise level, negligible coefficient of resistance, and rugged molded case.

Filmistors surpass the performance requirements of MIL-R-10509E.

Write for Engineering Bulletin 7025C

ACRASIL® PRECISION/POWER WIREWOUND RESISTORS

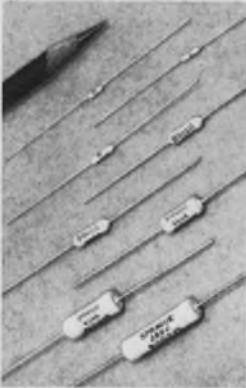

These silicone-encapsulated resistors combine the best features of both precision and power wirewound types, giving them unusual stability and reliability.

Acrasil Resistors are available with tolerances as close as .05%, in power ratings from 1 to 10 watts. Resistance values range from 0.5 ohm to 66,000 ohms.

Their tough silicone coating, with closely matched expansion coefficient, protects against shock, vibration, moisture, and fungus.

Acrasil Resistors meet or exceed the requirements of MIL-R-26C.

Write for Engineering Bulletin 7450

BLUE JACKET® VITREOUS ENAMEL PRECISION/POWER WIREWOUND RESISTORS

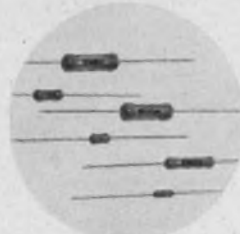

Axial-lead resistors available in ratings from 1 to 11 watts, with resistance tolerances to $\pm 1\%$. Non-inductive windings available to $\pm 2\%$ tolerance.

All welded end-cap construction securely anchors leads to resistor body. Vitreous coating and ceramic base have closely matched expansion coefficients.

Write for Engineering Bulletins 7410D, 7411A



Tab-terminal Blue Jacket Resistors can be had in a wide selection of ratings from 5 to 218 watts, with several terminal styles to meet specific needs.

Tab-terminal as well as axial-lead Blue Jacket resistors can be furnished to meet the requirements of MIL-R-26C.

Write for Engineering Bulletins 7400B, 7401

KOOLOHM® CERAMIC-SHELL POWER WIREWOUND RESISTORS



Koolohm Resistors are furnished in axial-lead, axial-tab, and radial-tab styles, in a broad range of ratings from 2 to 120 watts. Both standard and non-inductive windings are available.

Exclusive ceramic-insulated resistance wire permits "short-proof" multilayer windings on a special ceramic center core for higher resistance values. The tough non-porous ceramic shell provides complete moisture protection and electrical insulation. Koolohms can be mounted in direct contact with chassis or "live" components.

Axial-lead Koolohm Resistors to MIL-R-26C are available in MIL styles RW55 and RW56.

Write for Bulletins 7300, 7305, 7310

STACKOHM® POWER WIREWOUND RESISTORS



Sprague Stackohm Resistors are especially designed for equipment which requires power wirewound resistors of minimum height. Their flat silhouette permits stacking of resistor banks in close quarters.

Aluminum thru-bars with integral spacers act as mounting means and also conduct heat from within the resistance element. Resistance windings are welded to end terminations for maximum reliability. An outstanding vitreous coating protects the assembly against mechanical damage and moisture. Ceramic core, end terminations, and vitreous enamel are closely matched for coefficient of expansion.

Stackohm Resistors are available in both 10-watt and 20-watt ratings, and can be furnished with resistance tolerances as close as $\pm 1\%$. Resistance values range from 1 ohm to 6000 ohms.

Both 10- and 20-watt types meet the stringent requirements of MIL-R-26C.

Write for Engineering Bulletin 7430

Send your request to Technical Literature Service, Sprague Electric Co., 347 Marshall St., North Adams, Mass. 01247, indicating the engineering bulletins in which you are interested.

ON READER-SERVICE
CIRCLE 821

ON READER-SERVICE
CIRCLE 822

ON READER-SERVICE
CIRCLE 823

ON READER-SERVICE
CIRCLE 824

ON READER-SERVICE
CIRCLE 825

SPRAGUE COMPONENTS

RESISTORS
CAPACITORS
TRANSISTORS
THIN-FILM MICROCIRCUITS
INTEGRATED MICROCIRCUITS

PULSE TRANSFORMERS
INTERFERENCE FILTERS
PULSE-FORMING NETWORKS
TOROIDAL INDUCTORS
ELECTRIC WAVE FILTERS

CERAMIC-BASE PRINTED NETWORKS
PACKAGED COMPONENT ASSEMBLIES
BOBBIN and TAPE WOUND MAGNETIC CORES
SILICON RECTIFIER GATE CONTROLS
FUNCTIONAL DIGITAL CIRCUITS

SPRAGUE®
THE MARK OF RELIABILITY

'Sprague' and '®' are registered trademarks of the Sprague Electric Co.

News Scope

8-in-1 satellite launching bolsters communications

The Defense Dept. has reinforced its worldwide satellite communications network with a successful one-shot launching of eight additional relay satellites.

The launching has raised to 15 the number of communications satellites in near-synchronous equatorial orbit at an altitude of about 21,000 miles. With the additional coverage, less time is needed before satellites come into favorable position for relaying priority messages between the Pentagon, Vietnam and other overseas locations.

A single Air Force Titan III-C booster strung the eight satellites into orbit like beads on a necklace. The booster's third stage went through a series of five intricate maneuvers to make the temperature stability of the satellites certain and to eject them at slightly different velocities. The satellites were flung from a dispenser by springs, one at a time.

The Air Force was especially pleased, because the successful launching made up for the loss of eight similar satellites last August,

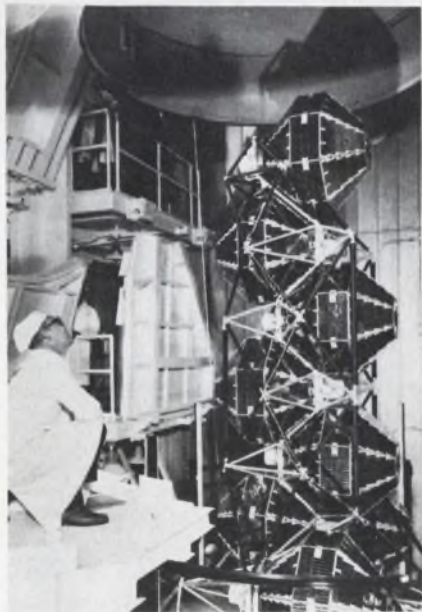

Satellite octuplets before "birth."

when a fully loaded Titan was destroyed following a malfunction during the early stages of flight.

All of the satellites in the network have been built by Philco-Ford's Space and Re-Entry Systems Div. at Palo Alto, Calif. Each has a symmetrical polyhedral shape, is 36 inches in diameter, and weighs about 100 pounds. The radio frequency transmitter produces about 3 W at uhf and X-band from solar cells covering the outer surfaces. The cells are the only source of power. The satellites, built at a cost of \$1 million, have a minimum life expectancy of 18 months.

Eight ground terminals for the network are now in operation. They include two in Vietnam, one at Camp Roberts, Calif., one at Fort Dix, N. J., and others in Great Britain and West Germany.

Four more Philco relay satellites are to be added in order to fill additional gaps.

One of the eight newly launched satellites has been specially calibrated and will function as an orbiting reference standard. It will be used to investigate system problems, such as losses in signal strength, at the ground stations.

New Westinghouse group aims at better teaching

Westinghouse Electric Corp. has established a new company both to train government and industry personnel and to investigate education technology.

Corporation president Donald H. McGannon says: "Underlying the entire project will be a meaningful research program to determine how people can learn faster and better."

The new Westinghouse Learning Corp. will look into methods to help teachers to be more effective in the face of society's growing need for technically skilled workers.

The new corporation will be headquartered in New York and maintain centers in Pittsburgh, Albuquerque, N. M., Washington, D. C., and San Francisco. The parent corporation, already known for its educational radio and TV programs, is also involved in Peace and Job Corps training, and in computer-based teaching experiments in conjunction with the University of Pittsburgh.

Auto makers soft-pedal electric car's rebirth

It will be 10 to 15 years before the electric car becomes commonplace on U.S. highways, according to the "big three" automobile manufacturers (see "Electric car makers preparing to rally," ED 13, May 24, 1966, pp. 17-22). Spokesmen in Detroit say that, despite announced research projects, practical development may take through 1980.

Edward N. Cole, executive vice president of General Motors Corp., cites the lack of lightweight, inexpensive batteries or fuel cells as a major obstacle. "Present fuel cells are at about the same stage of development as the piston engine was during the Wright brothers' first flight," notes Dr. C. R. Lewis of Chrysler Corp.

Dr. Michael Ference, Jr., a Ford Motor Co. vice president, reports that a 500-pound sodium sulfur battery should soon be ready for a small city car to be designed by a British affiliate of Ford. The danger of handling noxious sulfur and flammable sodium at high temperatures has still to be overcome.

An electric car could be road-worthy in six months "if the Government took the interest in transportation on earth that it takes in space," according to Dr. Leslie K. Gulton, of Gulton Industries, Metuchen, N. J. Dr. Gulton, whose company is engaged in auto battery research, says that the Government is presently sponsoring only one electric car project—for travel on the moon.

Chicago fire alters plans for two electronic shows

Plans for two big electronic conferences will be altered but not wiped out by the Chicago fire that razed McCormick Place on January

16. Both meetings were to have been held there this fall.

The conferences are the annual Instrument Society of America Conference and Exhibit, September 11 to 14, and the meeting of the National Electronics Conference, October 23 to 25.

The Instrument Society says it is transferring its show to the International Amphitheatre in Chicago, where society meetings have been held before.

The National Electronics Conference is seeking alternative space at either the International Amphitheatre, the Conrad Hilton Hotel or the Sherman Hotel in Chicago.

"We will positively have a conference," said R. J. Napolitan, general manager of the electronic group. "It's just a question of working out the best arrangement. We're confident that there won't be any serious disruption."

Lani Bird 2 poised to link U.S. with the Far East

Barring last-minute failure, a Lani Bird commercial relay satellite is all set to provide the first constant transpacific television and telephone link.

The first space shot of 1967, Lani Bird 2 zoomed into a near-perfect preliminary orbit from Cape Kennedy Fla., on January 11. This transfer orbit ranges from 193 to 23,087 miles above the earth; it has an 11-hour period.

The drum-shaped satellite has now to be thrust into a circular, synchronous equatorial orbit near the International Date Line. It will then provide 24-hour relay service between the continental United States and Hawaii, Japan and Australia.

The first Lani Bird, launched last October 26, was stranded in an elliptical orbit four days later by the failure of the rocket motor that was to maneuver it into a synchronous orbit. It is now in use eight hours a day relaying 35 voice circuits between the U.S. mainland and the 50th state.

Like its Atlantic counterpart,

Early Bird, Lani Bird is owned by the International Telecommunications Satellite Consortium and operated by the Communications Satellite Corp. (Comsat). Comsat will refund \$3.5 million to the national Aeronautics and Space Administration (NASA) for lofting Lani Bird into space atop a Delta rocket.

The Lani Bird satellite, built by Hughes Aircraft Co., is a larger and improved version of Early Bird. The 192-pound satellite derives 85 watts of power from 12,756 solar cells mounted in its aluminum honeycomb outer shell. Stand-by power comes from two nickel-cadmium batteries. It contains four traveling-wave tubes, any three of which can be operated at once to produce a transmit power of 18 watts. Transmitting six-watt signals with a concentrated antenna beam, it can handle 240 two-way voice channels.

Another communications satellite is due to be put into a synchronous orbit this month near the coast of West Africa to supplement the operations of Early Bird, which has been in service since June 28, 1965. The new satellites will provide communications support for NASA's Project Apollo bid to put three men into orbit together.

Improved data service offered to scientists

Wider service is being offered by the computerized weekly information system run by the Institute for Scientific Information.

A subscriber can now tell the institute what words, word stems and phrases describe his areas of interest. The institute's information system, called Automatic Subject Citation Alert, then automatically sends him computer printouts listing new, pertinent research. This approach augments the system's capability of answering specific questions, such as: "What current papers are being published by X?"

If no findings are made in a given week, the scientist still receives a report confirming the fact that a search was conducted for him.

More than 1600 research journals are examined by the system. The institute, at 325 Chestnut Street, Philadelphia, Pa. 19106, offers the information service at a basic rate of \$100 a year.

Beckman now selling Hughes laser products

Laser products manufactured by the Hughes Aircraft Co. are being marketed by Beckman Instruments, Inc., under a new trade agreement.

The pact gives Beckman the right to distribute and service Hughes Microwave Div. lasers in the United States, its territories and Canada. The basic line of packaged commercial and industrial lasers is being sold under the Beckman name.

Announcement of the agreement was made jointly by Dr. W. H. Christoffers, manager of the Hughes division, and Edward B. Bell, manager of Beckman's Scientific Instruments Operation. Dr. Christoffers said the new arrangement combines the technical and production experience of Hughes, which demonstrated the first laser in 1960, with Beckman's broad marketing coverage in the laboratory, educational and medical field.

The trade agreement does not affect Hughes laser welders, which continue to be marketed by Aircro Welding Products Div.

New bulk-effect device offers 400 kW in X-band

New kilowatt-power bulk-effect devices, researchers at Bell Laboratories and Cornell University predict, may spell the end of power problems at microwave frequencies.

The devices are n-type bulk GaAs diodes, operated in the so-called limited space-charge accumulation (LSA) mode. Cornell reports that it measured 33-W, 0.5- μ s pulses at 10 GHz and computer analysis foreshadows 4-kW pulsed power at X-band. Bell Laboratories observed 20 mW cw at 84 to 88 GHz and 44 to 51 GHz, with 2.0% and 0.7% efficiencies, respectively.

The LSA mode differs from Gunn-effect oscillation in two respects: power in the LSA mode does not depend on frequency; consequently, neither does it depend on the thickness of the sample. For this reason, higher powers can be attained.

The frequency is determined by a tuned circuit, usually a cavity that houses the device, the size of which may pose problems at the predicted 400-kw power level.



For hot and cold insulation...Mystik 7000!

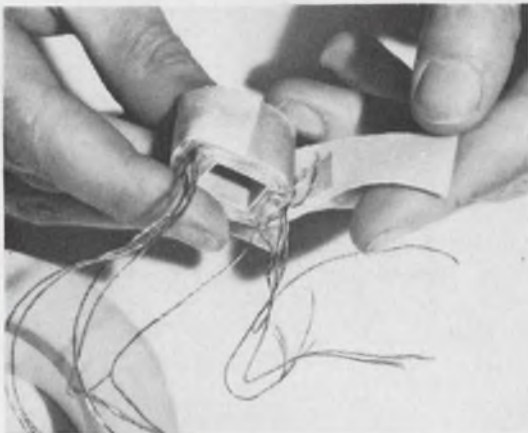

Superior thermal and electrical properties make Mystik 7000 suitable for an unusual range of cryogenic and elevated temperature applications. Uniquely inorganic, it has a tightly woven high tensile glass cloth backing with a pressure-sensitive silicone adhesive. Mystik 7000 has exceptionally high dielectric strength and offers high conformability and excellent shear resistance.

Here is a remarkable tape, perfect for insulating motors, generators or other components which must perform in critical operating environments.

This is only one of the Mystik family of tapes for the electrical industry. If you have an insulating problem or extreme temperature requirement, call your Mystik distributor. He's in the Yellow Pages under "Tape". Or write: The Borden Chemical Company, Mystik Tape Div., 1700 Winnetka Ave., Northfield, Illinois.



**BORDEN
CHEMICAL**

ON READER-SERVICE CARD CIRCLE 9

Now: A Fast Signal Averager

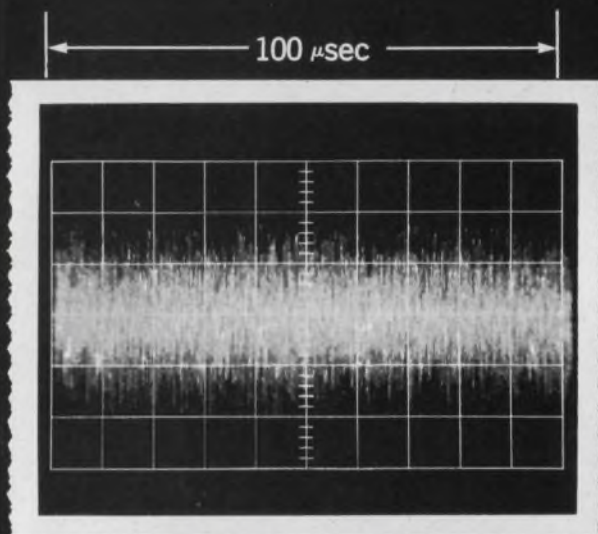

Photo #1—Input to Model TDH-9
SENSITIVITY: 5 V/cm
TIME: 10 μ sec/cm
NOISE-TO-SIGNAL RATIO: 10:1

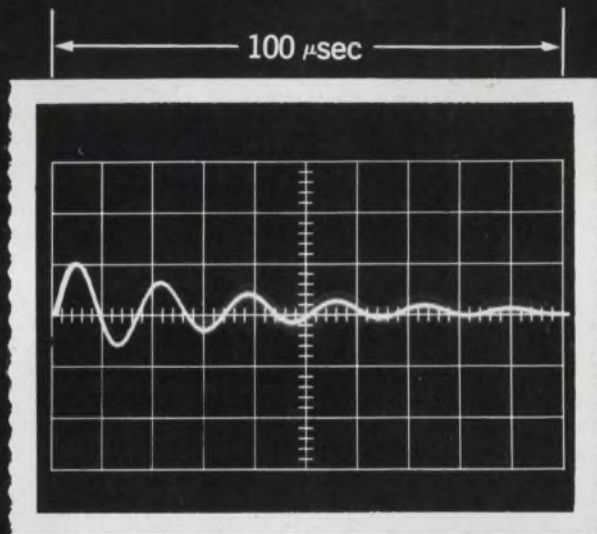

Photo #2—Output of Model TDH-9
SENSITIVITY: 5 V/cm
TIME: 10 μ sec/cm
TDH-9 VOLTAGE GAIN: 10



PAR Model TDH-9 Waveform Educator

Photo #1 is an actual oscillogram of a signal obscured by noise — a situation unfortunately prevalent in many research areas such as studies of biomedical evoked potentials, seismology, spectroscopy, fluorescent lifetime studies, and vibration analysis. Photo #2 shows the dramatic improvement in signal-to-noise ratio when the noisy signal was processed

by the PAR Model TDH-9 Waveform Educator.

This new instrument employs a highly efficient waveform-averaging technique, and at the same time offers the fastest sweep rates obtainable in signal processing equipment of the signal-averaging type. Sweep durations as short as 100 microseconds, with dwell times per channel of 1 microsecond, are obtainable. The high resolution capability of the Model TDH-9 allows observation of waveforms or transients which have heretofore been unresolvable by averaging instruments employing a greater number of channels.

Although the Model TDH-9 Waveform Educator sells for only \$4,200,

we invite functional comparison with the higher-priced digital averagers. We believe you will be pleasantly surprised. For more information about the PAR Model TDH-9, ask for Bulletin No. T-126.

Have a noise problem?

PAR's technical staff, unusually knowledgeable in signal processing problems and techniques as a result of its experience in the development and application of Lock-In Amplifiers, welcomes your specific inquiries. Please call or write.

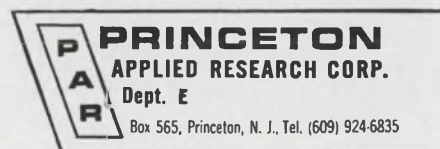

ON READER-SERVICE CARD CIRCLE 10

PREVIEW OF A FASTER AUTODIN SYSTEM

Centers to handle 32,000 messages an hour

U.S. military's worldwide network, due for full automation in 1968, to assign instant priorities

Maria Dekany
Technical Editor

The Defense Dept. has demonstrated the first fully automated communications switching center for its Automatic Digital Network (Autodin).

Capable of handling 32,000 messages an hour, the center is one of 12—all similar—being built to speed communications for the U.S. armed forces around the world.

The \$50 million network, expected to be operational by the spring of 1968, is designed to cut delays in high-priority messages from as much as a couple of hours to less than 10 minutes. Delays in routine messages, which are now reported to run as high as a day or more occasionally, are to be reduced to less than two hours.

The Philco-Ford Corp., builder of the new switching network, unveiled the first center at its plant in Willow Grove, Pa. It will be installed in Alaska later this year. The 11 other Autodin centers are scheduled for installation as follows: three in Southeast Asia, and one each in

the Philippines, Japan, Guam, Great Britain, Germany, Panama, Okinawa and France. Philco-Ford is doing the installing for the Defense Communication Agency and will be responsible for maintenance.

The message centers will operate completely automatically on the store-and-forward principle. If output lines are tied up, the information will be stored until there is an available line to forward it.

No message can get lost

Present military message centers use electromechanical switching relays and manual handling of the messages. Mark Gelman, manager of systems design at Ford-Philco, cites these advantages of the new network, in addition to the gain in speed and efficiency:

- It will keep track of all incoming and outgoing messages, ensuring that no message is lost.
- It will ensure immediate transmission of high-priority traffic. Mistakes due to oversight or misfiling will be eliminated.
- It will make it easier to pre-

serve tight security at message centers, because fewer persons will handle the information.

Autodin, one of many networks that make up the Defense Communications System, has both tributary and switching stations. Some 4000 tributaries accept and deliver messages at each military post around the world. The automated switching stations will serve these tributaries.

The new centers will be connected to each other and to terminals by either 200 or 100 communication lines. Each line will be a full duplex circuit with access to the store-and-forward portion of the center. The terminals may be teletype machines, punch-card or magnetic-tape equipment, or computers.

The positioning of hardware at the centers must be precise, Gelman reports, otherwise signal losses and cross talk in the connecting cables will be too great. Each installation will have to follow a calculated layout, and errors beyond one-third of an inch will not be tolerated.

As an indication of the data-handling ability of the centers, Gelman quotes these figures: a 200-line center must accept on a steady-state basis 60 thousand bits a second, or about four messages a second. The

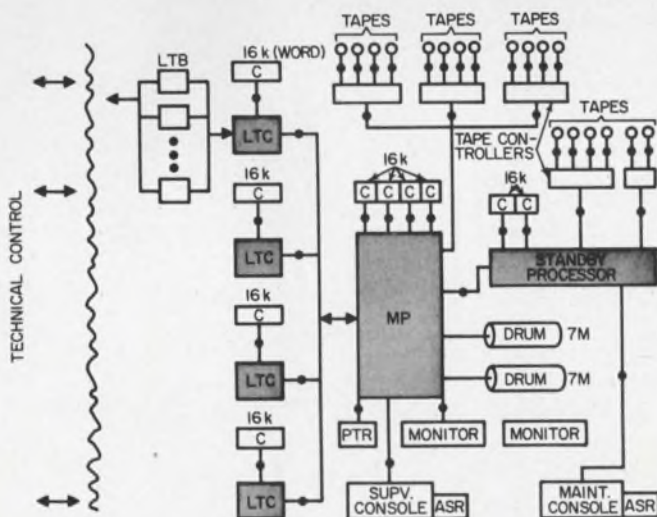

Typical 200-line center uses six identical computers or processors (shaded boxes). In case of failure, electromechanical switches (dots) switch in stand-by units. The five line coordinators take incoming traffic continuously, store it and send it to the message processor.



Layout of center must conform to predetermined pattern with one-third of an inch to avoid losses and cross talk in connecting cables. The method of redundancy through switching rather than by means of more equipment results in more wiring and cables than usual.

(Autodin, continued)

output is to be about 90 thousand bits a second, since one message may have several destination points.

In operation, each 200-line center will have six computers, or processors (see block diagram). The computers, Philco 102s, will differ only in the functions that they perform. Five will operate constantly, the sixth will be a stand-by unit. Of the five operating processors, four are designated line traffic coordinators (LTC). They accept incoming traffic continuously, store it and ultimately forward it to the fifth computer, called the message processor (MP). For outgoing traffic, the coordinators act as buffers for the processor.

High-priority traffic goes first

Each coordinator collects characters from the input lines through line traffic buffers (LTB), assembles the characters into line blocks of 48 characters each, checks parity and performs code conversion when the input is not in the proper code. The buffers check incoming messages for priority and transmit them in order of importance.



Processor is tested manually when switched into stand-by mode. Automatic checkout is performed through maintenance console, teletype (ASR in the block diagram) and card equipment.

The main processor scans all four coordinators once every second. It checks routing indications, assigns storage allocation on two drums, and records the message on two tapes. A journal tape keeps track of entering and departing messages, and a reference tape records the text of all messages.

As another safety precaution against loss of information, the memory processor empties the tables, programs and control information in its core to one of the drums once every second. The drum, in turn, transfers the data to the other drum after a lapse of one second. Hence, if the processor should break down, the drums preserve the information automatically.

Capacity/cost ratio high

Magnetic drums offer the fastest access times and largest capacities within reasonable cost, according to Gelman. Magnetic cores perform just as well, but they need more floor space and cost more, he says.

Referring to the improved speed in message-handling, Gelman says that once a message enters the switching center it takes only 4 microseconds for the actual processing. The remainder of the time is taken up by tie-ups of the communication lines and by the process of feeding in and reading out the information at the terminals.

The storage capacity of each center may be said to be infinite, according to Gelman. The random-access magnetic drums are the primary storage elements, accepting 7 million bits. Magnetic tapes handle the overflow of messages and any number of such tapes may be placed in the center.

System affords switch-in reliability

The obviously vital requirement that the center operate continuously and reliably has been approached in an ingenious manner. Instead of providing redundancy by duplicating equipment, a switching array is used that allows the interchange of identical devices in the system. These configuration switches (black dots in the block diagram) are cross-bar switches (by Erikson Mfg.) of excellent reliability. According to Gelman, their mean time between failures is greater than 10 years.

The configuration switching is

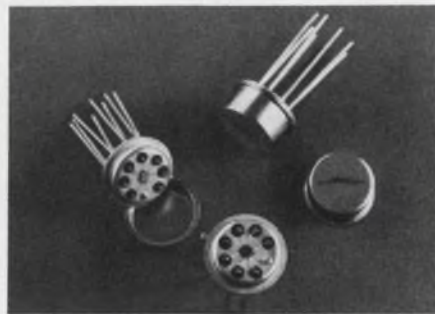

Available from your
NSC
distributor

WESTERN DISTRIBUTORS:

Moltronics of Arizona
2746 West Palm Lane
Phoenix, Arizona 85009
(602) 272-7951

Fortune Electronics
695 Veterans Blvd.
Redwood City, California 94063
(415) 365-4000

Kierulff Electronics
3969 East Bayshore Road
Palo Alto, California 94303
(415) 968-6292

Arco Pacific
Bohamon Drive
Menlo Park, Calif. 94025
(415) 324-1356

Liberty Electronics Corp.
339 South Isis Avenue
Inglewood, California
(213) 678-8111

Spectronics
131 Garnet
Ridgecrest, California 93555
(714) 378-2831

Western Electronic Components
4301 Birch St.
Newport Beach, California
(714) 540-1322
(213) 631-6119

Newark-Denver Electronics Supply
P. O. Box 22045
Denver, Colorado
(303) 757-3351

Pacific Electronics
1336-4 Dillingham Blvd.
Honolulu, Hawaii 96817
817-118

Sterling Electronics, Inc.
1712 Lomas Blvd., N.E.
Albuquerque, New Mexico
(505) 247-2486

Kierulff Electronics
2585 Commerce Way
Los Angeles, California 90022.
(213) 685-5511

Ballard Supply Company
3109 Washington Blvd.
Ogden, Utah 84400
(801) 394-5541

Ballard Supply Company
44 East 6th Street, South
Salt Lake City, Utah 84100
(801) 364-6541

Kierulff Electronics
6133 Maynard Ave., S.
Seattle, Wash. 98108
(206) PA 5-1550

Kierulff Electronics
8137 Engineer Road
San Diego, California
(714) 278-2112

ON READER-SERVICE CARD CIRCLE 162

MONOLITHIC VOLTAGE REGULATOR



- Output adjustable from 2V to 30V.
- Output currents in excess of 5A using external power transistors.
- Can be used as either a linear or a high-efficiency switching regulator.

The first of a new line of monolithic linear integrated circuits

This versatile regulator features regulation better than 1 percent for widely varying load and line conditions. Temperature stability is better than 1 percent over the full military temperature range. As a linear regulator, the LM100 provides current limiting, excellent transient response

and unconditional stability with any combination of resistive or reactive loads. As a switching regulator the circuit will operate at frequencies up to 100KHZ with efficiencies better than 85 percent.

The LM100 is immediately available from distributor stock.

NSC
MICROCIRCUITS DIVISION
NATIONAL SEMICONDUCTOR CORPORATION
2950 SAN YSIDRO WAY, SANTA CLARA
CALIFORNIA 95051 (408) 245-4320

ON READER-SERVICE CARD CIRCLE 164

Did You Know Sprague Makes 32 Types of Foil Tantalum Capacitors?

125 C TUBULAR TANTALEX® CAPACITORS



Type 120D polarized plain-foil
Type 121D non-polarized plain-foil
Type 122D polarized etched-foil
Type 123D non-polarized etched-foil

ASK FOR BULLETIN 3602C

ON READER-SERVICE CIRCLE 851

85 C TUBULAR TANTALEX® CAPACITORS



Type 110D polarized plain-foil
Type 111D non-polarized plain-foil
Type 112D polarized etched-foil
Type 113D non-polarized etched-foil

ASK FOR BULLETIN 3601C

ON READER-SERVICE CIRCLE 852

RECTANGULAR TANTALEX® CAPACITORS



Type 300D polarized plain-foil
Type 301D non-polarized plain-foil
Type 302D polarized etched-foil
Type 303D non-polarized etched-foil

ASK FOR BULLETIN 3650

ON READER-SERVICE CIRCLE 853

TUBULAR TANTALUM CAPACITORS TO MIL-C-3965C



CL20, CL21 125 C polarized etched-foil
CL22, CL23 125 C non-polarized etched-foil
CL24, CL25 85 C polarized etched-foil
CL26, CL27 85 C non-polarized etched-foil
CL30, CL31 125 C polarized plain-foil
CL32, CL33 125 C non-polarized plain-foil
CL34, CL35 85 C polarized plain-foil
CL36, CL37 85 C non-polarized plain-foil

ON READER-SERVICE CIRCLE 854

RECTANGULAR TANTALUM CAPACITORS TO MIL-C-3965C



CL51 polarized plain-foil
CL52 non-polarized plain-foil
CL53 polarized etched-foil
CL54 non-polarized etched-foil

ON READER-SERVICE CIRCLE 855

For comprehensive engineering bulletins on the capacitor types in which you are interested, write to:
Technical Literature Service
Sprague Electric Company
347 Marshall Street
North Adams, Mass. 01247

SPRAGUE®
THE MARK OF RELIABILITY

Sprague and ® are registered trademarks of the Sprague Electric Co.

(Autodin, continued)

controlled by the message processor through a switch controller that decodes instructions and activates the proper function. Identical equipment like memories, tapes, controllers and line traffic coordinators are interchangeable in case of failure.

For example, the stand-by processor can replace any line coordinator in 5 seconds. Within this time the message processor loads the cores of the stand-by unit with the necessary coded information, disconnects the malfunctioning unit and switches in the replacement.

The condition of the message processor is checked by the monitor. The message processor sends coded signals to the monitor at specified intervals. If it does not, the monitor automatically switches in a successor processor to take over. This takes less than 20 seconds. The successor computer is selected by the supervisor at each Autodin switching center when he begins the automated service.

Equipment checks made

Every 250 milliseconds the message processor sends a signal to the monitor, to verify that it is still working. Every 10 seconds the message processor sends another signal, to verify that it has completed its program cycle. The 10-second period allows for the possible switch-in of some peripheral equipment, since the program time of the processor is only 1 second. The presence of this signal is an indication that the processor has scanned all traffic coordinators and is not trapped in a small loop of operation.

About 30 seconds after start-up, whether of the initial unit or a replacement unit, the message processor sends out a single signal to indicate that it is operative.

If any of these signals is lacking, the monitor will replace the message processor.

The system is protected against monitor failure by a stand-by unit. If the monitor malfunctions, a light appears on the supervisor's console. The stand-by monitor may be switched in manually or automatically. ■ ■

One-color sources yield six-color displays

Solid-state device, switched digitally, produces 'minimum attention' readout for busy observers

Neil Sclater
East Coast Editor

Modern display panels are often so packed with information that the observer is unable to pick out what is significant in a hurry. A solid-state device that produces six colors from single-color sources has been designed to ease the observer's problem.

Minute spots on the panel can make complete color changes and form moving images. Eye-catching letters, numbers and patterns can be formed in microseconds by three-bit digital logic. The lights can be switched by a computer.

The high-density, luminescent-fluorescent display scheme is said by

its developer, Hartman-Huyck Systems Co., Inc., Huntington Station, N. Y., to be the first use of a single primary-colored light to produce a multicolor image on one translucent surface.

By bundling hundreds of the small devices into separate modules and arranging the modules on a frame, the designer can form large, gapless display panels.

"Six colors and white are formed in a translucent light pipe, by selectively switching electroluminescent light emitters," explains Kenneth Lally, Hartman-Huyck research engineer.

He says that the light pipe has three regions, each made to fluoresce

in a different primary color. Associated with each region is a thin-film, electroluminescent device capable, on digital command, of stimulating fluorescence in the adjacent region of the light pipe.

Lally says that the light pipes, with attached light emitters, are bundled to form the modules; one end of each light pipe forms a discrete light source without interference from its neighbors in the bundle. The bundled modules form large-scale display arrays.

In explaining how colors are formed by digital logic, Lally notes:

"Each of the three primary color regions of the light pipe can be stimulated individually, and the observer will see a primary color emitting from the end [red, green or blue]. The unstimulated regions of the light pipe will transmit the primary color to the viewing end, but will not themselves be stimulated, because of the difference in energy levels.

Eight optical states

"However, if any combination of two is switched on simultaneously, the observer will see a secondary color, as in classical optical color mixing. By simultaneously switching on all three primary colors, white light will be visible. This, combined with OFF-state black, gives eight possible optical states from each light pipe."

Lally says that the system is designed for "minimum attention" command and control display panels, instruments and other visual systems, where the use of color can improve readability and decrease the operator's reaction time for responses. Each color can represent a quantity, dimension or range.

The Display Techniques Branch of the Rome Air Development Command, Rome, N. Y., has sponsored a program to develop a tactical display based on Hartman-Huyck's patentable technique. The technique resulted from in-house work.

The module recently delivered to

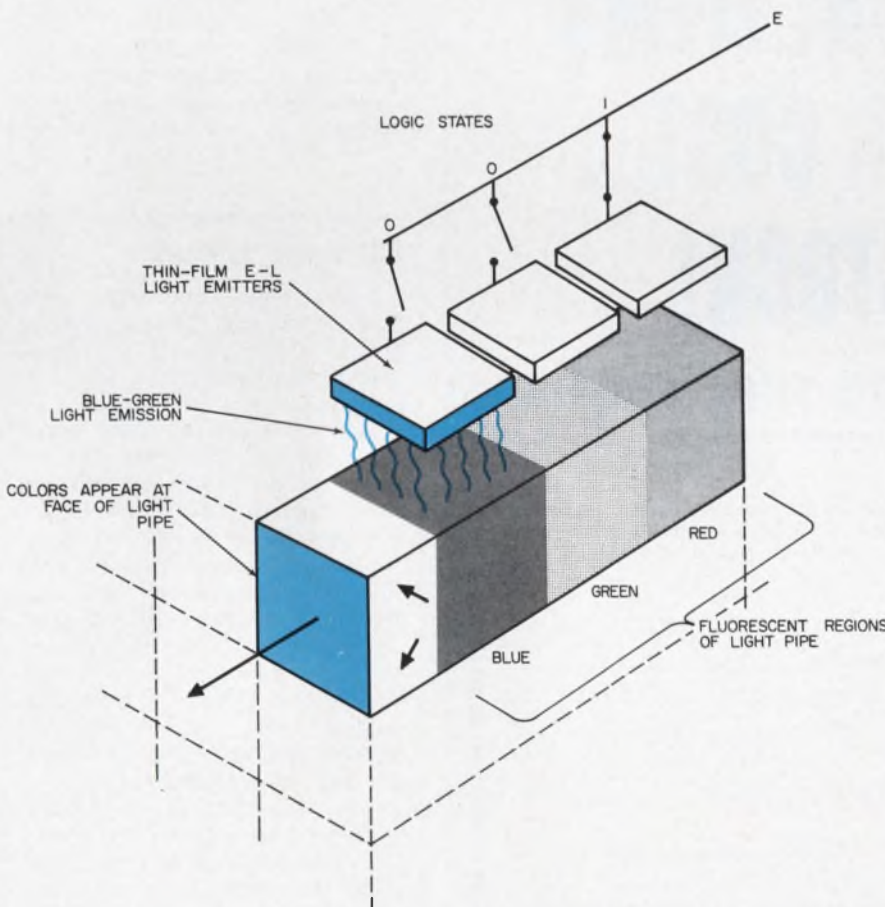

Concept of element of display system that produces six colors plus black and white by switching light emitters. Elements are bundled together to form modules; these in turn form command and control panels.

NO MATTER WHERE YOU'RE GETTING THESE MIL & INDUSTRIAL TRIMMERS AND POTS



WE CAN SUPPLY THE IDENTICAL ITEMS AT LOWER COST... FROM STOCK!

WE'LL PROVE IT! MAIL THIS COUPON.

FAIRCHILD CONTROLS A DIVISION OF FAIRCHILD CAMERA AND INSTRUMENT CORPORATION
 225 PARK AVENUE, HICKSVILLE, L. I., NEW YORK
 TELEPHONE: (516) 938-5600 • TWX: (510) 231 1854
 CABLE: FAIRCON-HICKSVILLE, NEW YORK, U. S. A.

Please quote me on the following items:

Type Number _____ Quantity _____
 Type Number _____ Quantity _____
 Type Number _____ Quantity _____

Name _____ Title _____
 Company _____
 Address _____
 City _____ State/Zip _____

EL14

ON READER-SERVICE CARD CIRCLE 11

NEWS

(color displays, *continued*)

the Air Force was a small bundle of 100 square light pipes, each with three flat miniature electroluminescent light sources attached. The complete module was packaged in a rectangular block about four inches long. Terminals for connection to either digital switches or a computer were brought out at the rear. Arrays of this module will form the display panels.

In operation, three thin-film, electroluminescent light sources, operating at 110 to 400 volts, emit blue-green light in the 4800-to-5500-A range to excite each light pipe element. No frequency shifting of the drive signal is necessary to obtain a desired color change, but voltage variations cause light intensity changes.

In addition to the primary colors, yellow, aqua, and magenta can be produced in the Air Force unit.

Hartman-Huyck engineers report that light amplification occurs within the device. This, they say, is attributable to internal reflections and reradiation within the light pipe. They also say that power consumption is low—approximately 20 watts per square foot of panel. ■ ■

Clearing the air

When New York City's new Madison Square Garden complex opens in the fall, it will have, among other attractions, electronically pure air.

Systems made by CRS Industries, Inc., of Jenkintown, Pa., are being set up in the 20,000-seat sports arena, the 5000-seat forum, 500-seat theater and 48-lane bowling center. Outside air will first be filtered to remove soot and other solids. The air will then move through electrical fields, which will neutralize it by removing the ions. Screen-like electrodes in ducts, with a 28-kV potential on some and 120-Hz RF on others, will create the electrical fields.

The deionized outside air will dilute the air inside, so that smoke and other particles will lose their ability to cling. The suspended pollutants will then be removed from the building by the air-conditioning system.

ON READER-SERVICE CARD CIRCLE 12 ➤

Bendix Pancake connectors can cut weight 60%, length 50%.



Call them JT for short.

That's their name: Bendix® JT Pancake™ connector. And you might say they're just short of phenomenal. They're the smallest, lightest miniature cylindricals available. They're versatile, too. You can choose from crimp, solder, hermetic, potted, or grommetted versions. You can select from eight shell styles including wall mount, box mount, jam nut, straight

or 90° plug. You can choose from nine different shell sizes. From 40 different insert patterns, with 16-, 20-, 22- or 22M-contact sizes, that will accept a wire range of 16 through 28 gage.

Bendix JT Pancake connectors make short work of other problem areas, too. With provisions for up to 128 contact pins in our Double-

Density models, increased resistance to pin bending, greater contact retention, temperature capabilities up to 392°F and improved electrical characteristics through rigid, glass-filled epoxy inserts. For a short description of the Bendix JT connector best suited to your application, write Electrical Components Division in Sidney, New York 13838.

Bendix  **Electronics**

Hospital computer system to speed therapy

Lockheed network designed to let doctors review cases remotely and dispatch orders for treatment

If a new computer-controlled information and communication system proves successful, doctors will be able to order prescriptions, laboratory tests, a diet or review a hospital patient's condition merely by inserting a coded card into a remote computer terminal unit.

Besides speeding the execution of doctors' orders, the system is designed to expedite communications among nurses and other hospital personnel, store information on hospital operations for use by administrators, and join the many departments of a hospital into a central system.

The system was designed and developed by the Hospital Systems Group of the Lockheed Missiles and Space Co. in Sunnyvale, Calif. It consists of a central computer controlled by a number of remote terminals placed throughout a hospital

complex. A spokesman for Lockheed foresees several hundred terminals operating into one regional computer that will store information for many hospitals in the area.

The terminal consists of a video screen, keyboard, printer and light pen. In a typical setup, a number of terminals in a hospital would be linked to a central computer that stores information about patients and optional ways of treating them.

A doctor wishing to issue a medical order would insert a magnetically coded card—his personal property—into a slot on the console. The card would identify him by name as an authorized user. A list of the doctor's patients in the hospital area controlled by that terminal would appear on a screen.

The doctor would then point the light pen at one of the names on the screen, and the computer would look

up the information about this patient. A list of optional treatments that the doctor could prescribe would appear on the screen. He would then point the pen at one type, and a subdivision of that type would be displayed. For example, if he selected antibiotics, the screen would display a list of such subdivisions as penicillin, streptomycin and similar drugs.

By using the pen, the doctor would select the specific medication and the amount and frequency of dosage. After checking the entire order, he would enter it into the computer.

The computer would now take over and break the order into its individual parts and communicate them to the proper departments. An order for a drug would be printed out automatically at the remote terminal in the hospital pharmacy. If laboratory tests were ordered, this request would be printed out at the laboratory. Once the doctor had issued his order, the entire operation would be automatic and require no intermediate paperwork by nurses or other personnel.

A test system consisting of three terminals and an SDS-92 computer is being prepared for shipment to the Mayo Clinic in Rochester, Minn., for evaluation. The SDS-92, a low-cost, general-purpose computer manufactured by Scientific Data Systems, of Santa Monica, Calif., will be used only in the Mayo evaluation phase. It will use a core memory of 4098 words. Lockheed officials said the final version of the system would use a considerably larger computer, which has yet to be selected. One problem that program officials have encountered is finding a high-speed printer that operates quietly enough for use in a hospital environment.

Lockheed officials said that another system would be in operation by June at El Camino Hospital in Mountain View, Calif., for a test in an actual working mode. This system will link a nursing station to the pharmacy and laboratory. ■ ■



Hospital computer terminal unit is used to issue doctor's orders or check a patient's condition. Light pen summons lists of medical orders to screen. New data are entered on the keyboard, and a printer puts the orders on paper.

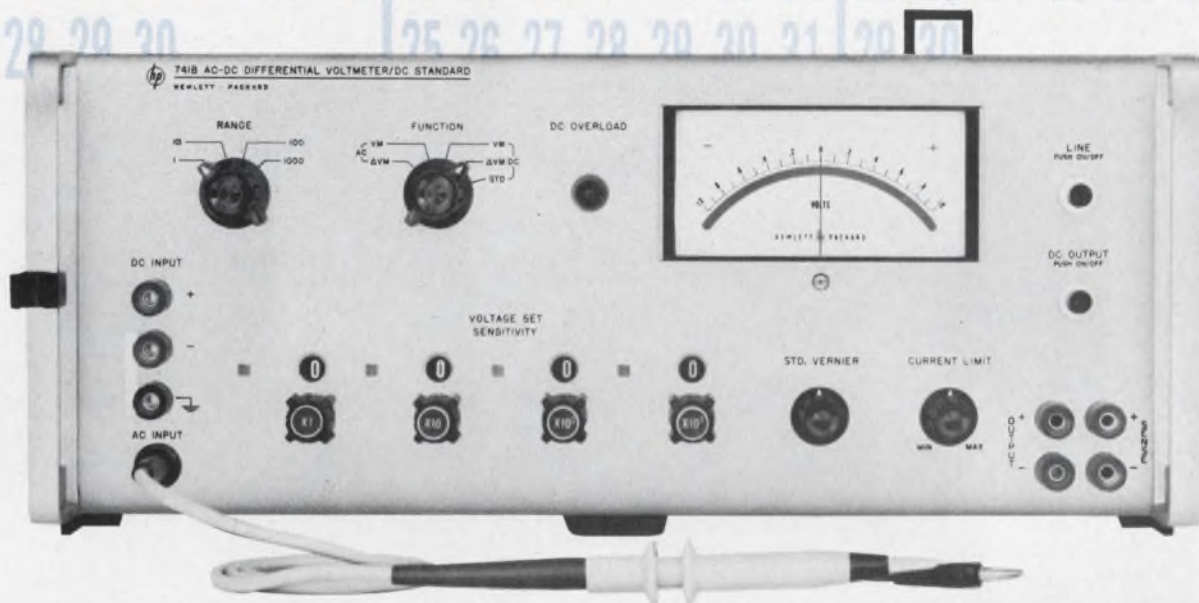

New Low-cost Δ VM / DC Standard Gives **0.01% FOR 90 DAYS**

... and five multi-purpose functions as well, for less than you normally pay for a single-function instrument! Reason for the superior stability of this all-solid-state calibrating tool: use of precision hp wire-wound resistors in the decade and range dividers, plus a temperature-compensated Zener diode reference supply. Other advantages include an input impedance greater than 10^9 ohms in DC Δ VM, and VM independent of null, 5-digit resolution, automatic decimal point, floating input, recorder output, plus overload and short-circuit protection. Calibration labs save high-cost time with 90-day calibration cycle, and **simple two-step calibration from DC to 20 kHz**. Compare price (\$1675) and specs:

DC STANDARD, 90-DAY CYCLE, $\pm 0.01\%$ or 0.001% FS (whichever is greater) from 0-1000 volts. Output resolution is 1 ppm on any range. Short-term stability typically better than 20 ppm/mo. Remote sensing permits output regulation at point of measurement. Temperature coefficient is less than 3 ppm/ $^{\circ}$ C from 0-50 $^{\circ}$ C.

AC DIFFERENTIAL VOLTMETER, 90-DAY CYCLE $\pm 0.02\% + 0.01\%$ of range from 400 Hz to 5 kHz (with reduced accuracy to 100 kHz). TC is less than 20 ppm/ $^{\circ}$ C, 20 Hz to 10 kHz, 5-40 $^{\circ}$ C. Input capacitance of less than 5 pf reduces loading errors and

circuit instabilities during measurement. Input impedance is 1 megohm.

DC DIFFERENTIAL VOLTMETER, 90-DAY CYCLE $\pm 0.02\%$ or $\pm 0.002\%$ FS (whichever is greater) from 0-1000 volts. Input impedance is greater than 10^9 ohms on all ranges independent of null — an ideal characteristic for drift measurements when null cannot be maintained. TC is less than 3 ppm/ $^{\circ}$ C from 0-50 $^{\circ}$ C.

AC-DC VOLTMETER/POWER AMPLIFIER provides greater than 10^9 ohms input on all DC ranges plus high AC input impedance (10^6 ohms shunted by less than 5 pf). In addition to the five functions shown, this calibration lab instrument provides a $\pm 0.02\%$ unity-gain amplifier from 0-1000 volts.

DC DIFFERENTIAL VOLTMETER OPTION 741B 01 provides $\pm 0.01\%$ DC Δ VM, and $\pm 0.02\%$ DC standard. Other specs identical. Ask for a demonstration or contact Hewlett-Packard, Palo Alto, California, 94304. Tel. (415) 326-7000. In Europe: 54 Route des Acacias, Geneva.

HEWLETT  **PACKARD**
An extra measure of quality

ON READER-SERVICE CARD CIRCLE 13

Army gets thin-film-logic fuse for projectiles

Magnetic counter offers three advantages over competitive semiconductor and ferrite devices

Ever watchful for more reliable ways of detonating explosive projectiles, the Army is evaluating the use of thin-film magnetic logic counters.

Fuse timers based on the magnetic phenomenon known as Domain-Tip Propagation Logic (DTPL) have been developed by the Electronics Div. of Laboratory for Electronics, Inc., in Boston. The devices count the lapse of time by stepping small regions, or tips, of reversed magnetization through narrow channels of low-coercive-force magnetic film. This process takes place under the command of external timing pulses.

The tips change the binary state of regions they enter (see "Challenge to transistors in logic circuitry," ED 19, Aug. 16, 1966, pp. 17-18).

Zigzag channels are formed by photoetching on thin films of generally high coercive force. The minute tips surge forward in microseconds into successive legs of the channel

when coils wrapped around the logic substrate are pulsed. The propulsive fields are initiated by oscillator timing pulses.

The Army's Harry Diamond Laboratories in Washington, D.C., has been drawn to DTPL logic for use in fuses because of three properties not found in competing semiconductor and ferrite logic devices:

- Logic memory is nonvolatile; power need be applied only when switching. The device retains indefinitely the last state inserted.

- Bidirectional, long-life operation is inherent. The device can be run indefinitely without failure at rates from dc to 350 kHz in either direction.

- Readout stations can be positioned at many places along the zigzag channel to initiate functions at specified times.

The Army's prototype DTPL counter will count 2000 resettable states at a 10-Hz rate. Thus time sequences up to 200 seconds can be set. Resolution is said to be 0.1 sec-

ond, and accuracy is determined by the oscillator.

The counter consists of a thin-film structure on a glass substrate, with input and output conductors attached. Flat driving coils are wrapped around the substrate, and small plates with two miniature semiconductor coil drivers and one sense amplifier are attached.

The prototype counter has a volume of less than two cubic inches. Less than 3 mA from a 15-volt supply is required to operate the drivers and sense amplifier.

Engineers at Laboratory for Electronics expect the counter to work in the temperature range of -40°C to $+60^{\circ}\text{C}$ while spinning at 35,000 rpm following a 30,000-G shock for a duration of 10 ms.

A magnetic domain is introduced, or "nucleated," into the zigzag channel of thin-film permalloy by means of a 500-mA pulse applied through a short lead placed next to the film surface. The resulting tip is then propagated down each leg of the channel by the fields that are induced in adjacent coils by the driving 100-mA, 20- μs pulses. One or more coils are associated with the direction of each channel leg.

The number of legs or segments is equal to the maximum count. A special multichannel readout pattern terminates the zigzag pattern and produces a detectable "end of count" signal. This signal is amplified and can be used to trigger the detonation.

A separate presetting circuit resets the thin-film counter to zero, by reversing the polarity to the associated drive coils. This action erases the counter channel. The circuit then introduces the domain in the first counter leg and steps the domain to the desired starting position.

If less than 2000 counts are desired, the domain is preset to the position equal to the difference between 2000 and the desired count. The preset count is stored until the external oscillator is energized and the timing sequence begins. ■ ■

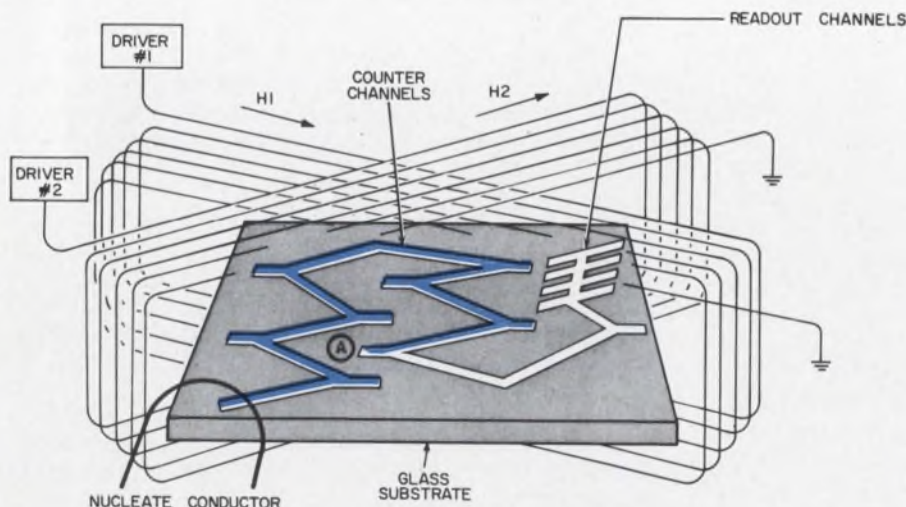

(A) LOCATION OF DOMAIN TIP

Regions of reversed magnetism are moved along a zigzag channel in magnetic thin film by electromagnetic fields induced in adjacent coils. An external timing oscillator pulses the coils. The tip will remain indefinitely in the same position and state until pulsed. A loop at the input introduces the region and the dense channel group at the end furnishes a readout pulse. Coils are associated with each channel leg.

think faster think Burroughs memory systems

**MEMORY SYSTEMS THE FASTEST BIT
MAKES THE DIFFERENCE . . . AND
BURROUGHS MAKES ITS OWN BITS
(BOTH CORE AND THIN FILM).**

The new Burroughs line of core Memory systems is fast . . . as fast as 0.6 μ sec. full cycle time. You can also have a "not-so-fast" model at lower cost if you don't need the speed.

Now, Burroughs 14 years of experience is available to provide you with the Memory system you need for your data handling equipment.

System cycle times of 0.6 and 1.0 μ sec.

Modular building block construction—basic module is 8192 words by 20 bits and contains the core-memory, sense amplifiers, driver circuits and information registers.

Associated memory control module includes timing circuits, address register and decode logic.

FEATURES:

20 mil, 2-1/2D ferrite core memory—manufactured by Burroughs.

Driver Circuits and sense amplifiers use Burroughs hybrid microcircuits.

Monolithic integrated circuits used for all logic and registers.

If you would like your system to think faster write or call for further information on Burroughs memory systems.

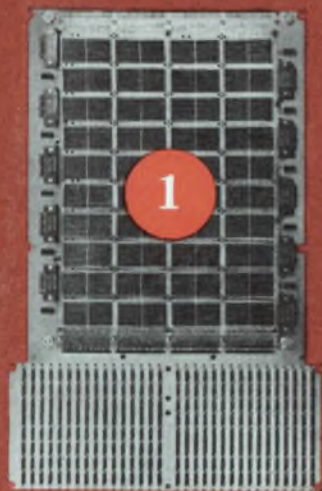
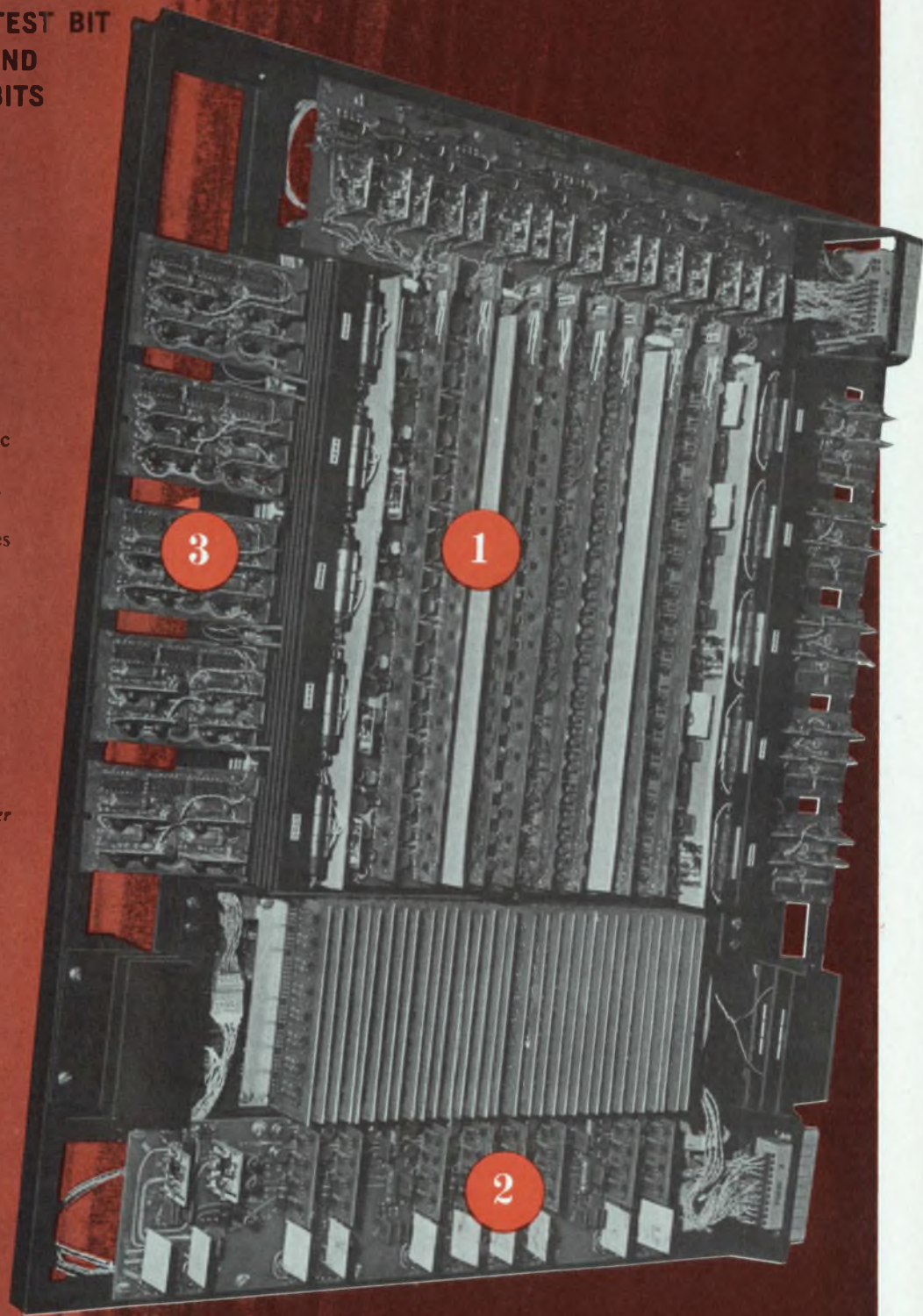

Burroughs Corporation

ELECTRONIC COMPONENTS DIVISION
PLAINFIELD, NEW JERSEY 07061



■ WHY NOT USE G-E PNP SILICON PLANAR TRANSISTORS TO COMPLEMENT YOUR G-E NPN'S?

Specify 2N2904,A—2907,A; 2N3485,A—3486,A; and 2N3502—3505 for collector saturation voltage as low as -0.4 volts (at $I_C = -150$ mA, $I_B = -15$ mA) and outstanding frequency characteristics. These low cost devices are ideal complements to G.E.'s 2N2217—2N2222 NPN devices.

General Electric epitaxial passivated PNP's give you excellent Beta control from 100 microamps to 500 milliamps, frequency capability to 200 MHz, and switching in nanoseconds.

They're available in the TO-18 and TO-46 packages, and the TO-5 configuration with a solid header for better heatsinking. You can choose between epoxy or hermetically sealed packages. Both withstand moisture as well as high ambient or junction temperatures.

For logic circuits, drivers, or peripheral equipment in computers, or in general purpose amplifiers and power supplies, General Electric PNP transistors belong in your circuits. Circle number 811 for more details.

■ HAVE YOU BEEN WAITING FOR A MORE ECONOMICAL HIGH CURRENT SCR?

With the new General Electric C178 type SCR, high performance now costs less than ever.

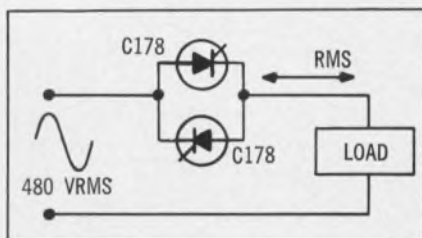

Sample circuit using two GE C178 high current SCR's.

Two inverse-parallel C178's can now control up to 280 amperes (RMS) economically. The C178 is available with blocking voltage capability to 1200 volts. Therefore, operation from 480 volts (RMS) allows power control to the tune of 135 kilowatts. Using

Now lower cost G-E A28 rectifier diodes pull a fast one on reverse voltage

Here's reverse recovery as fast as 100 nanoseconds for up to 20% less than you might expect to pay.

You'll get better overall performance from your circuits with A28 rectifiers. The A28's fast recovery reduces recovery transients to a minimum, giving you better total performance from all circuit components in either high or low frequency applications.

In addition to faster switching and less reverse power dissipation at high frequencies, this diode produces less RFI and transient voltage generation.

In choppers, inverters, sonar

power supplies, ultrasonic systems, and other applications, the A28 offers performance to match the high frequency capability of G.E.'s new high speed SCR's.

Besides the 100 nanosecond A28, four other G-E fast recovery rectifier diodes with 200 nanosecond recovery time are available in these current ratings: 6 amps average (1N3879,R—3883,R), 12 amps average (1N3889,R—3893,R), 20 amps average (1N3899,R—3903,R), and 30 amps average (1N3909,R—3913,R). All offer blocking capability up to 400 volts. For further details circle number 813 on the Reader's Service Card.

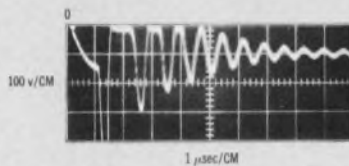

Commutation transient of conventional rectifier diode.

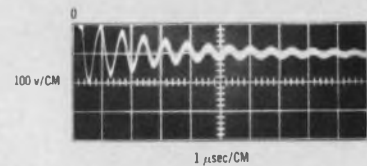

Commutation transient of fast-recovery (A28) rectifier diode.

Commutation conditions: Forward current just prior to commutation, $I_F = 5$ amps; reverse di/dt , $-I_F = 10$ amps/ μ sec; steady state reverse voltage, $E_C = 100$ volts.

1000 volt C178 SCR's the price per kilowatt of switching capability is less than \$2.00.*

As a bonus you can get the same high degree of dynamic performance that's characteristic of General Electric's unmatched C100 series all-diffused, high-power SCR's.

- Minimum dv/dt withstand capability—200 volts/ μ sec.
- Maximum rate of rise of anode current at turn-on (di/dt)—75 amps/ μ sec (from 1000 volts).

Furthermore, the C178 SCR has no peak forward voltage limitation. It offers unusual immunity to forward *In quantities of 100 and up

voltage destruction at breakover provided that switching and follow-through currents are kept within limits.

For more information on the C178 economy, high current SCR circle number 812.

These are just a few examples of General Electric's total electronic capability. For more information on all G-E semiconductor products, call your G-E engineer salesman or distributor. Or write to Section 220-52, General Electric Company, Schenectady, N.Y. In Canada: Canadian General Electric, 189 Dufferin St., Toronto, Ont. Export: Electronic Components Sales, IGE Export Division, 159 Madison Ave., New York, N.Y., U.S.A.



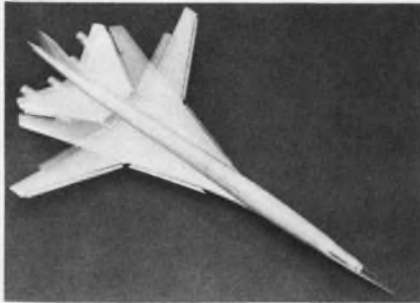

Washington Report

S. DAVID PURSGLOVE,
WASHINGTON EDITOR

Lockheed bounces back

There is no question that gloom was the prevailing mood at Lockheed Aircraft's Washington office at the beginning of the year after the decision that Boeing would build the supersonic transport aircraft. Little by little the gloom has lifted and, as more and more questions are asked about what Boeing really won, Lockheed's future course has become firm and clear.

Lockheed officials now look at the SST decision not as a loss of a market but as a decision that has relieved them of the need to shelve several other short-term plans and to reserve funds for the SST. These future plans involve electronics, and from the way some company members talk, involve them more heavily than the SST program would have.

Company president Daniel J. Haughton has mentioned new civilian cargo jets, advanced medium-range passenger jets, vertical-rise transports and various utility vehicles as endeavors that Lockheed is now free to pursue. He also spoke of "industrial programs in other fields." It is about these and the vertical-rise transports that company officials wax most enthusiastic.

Hospital and information systems important

Lockheed Missiles and Space Co. undertook studies of a possible statewide information system as part of the now famous California experiment that put aerospace firms to work on urban problems. The company's study concluded that there was a need for 50 statewide systems as well as numerous equally large regional and metropolitan-area systems. Lockheed is already a major supplier of complete memory systems for computers and hopes to boost this market.

Another promising area is the education technology field, which Lockheed recently entered. It was only an \$85,000 contract that

Lockheed received from the U.S. Office of Education to develop a computerized system to feed educational research results to schools in Nevada and northern California, but it was an industry landmark. It was the first time that the Office of Education had funneled R&D funds for a major program straight to industry. And the system that Lockheed came up with is expected to set the pattern for at least 20 more similar networks.

A similar sort of system is now being developed under an \$80,000 grant from the Dept. of Health, Education and Welfare to Lockheed to blueprint a hospital disaster planning program in Texas. Small though the contract is, it may be the forerunner of scores of others for other states and large cities.

Major interest is mass air transit

Lockheed's heart, however, is still in aviation. Company officials indicate that most of the newly freed funds and talent will go on aircraft development. Lockheed long remained aloof from the companies that scrambled onto the bandwagon of the Government's high-speed ground transportation program.

It became clear why in December when the Lockheed-California Co. publicly proposed a 60-to-70-passenger compound (winged) helicopter as an air commuter craft for the Northeast Corridor between Washington and Boston. Lockheed is betting on high-speed *air* transportation to link the Northeast Corridor cities rather than a ground system. Lockheed-California's deputy director of engineering, W. H. Statler, contends that city-center-to-city-center service that would satisfy Northeast Corridor requirements will need vertical-rise aircraft that can fly horizontally at high speed. This means winged helicopters.

Robert Nelson, director of the Office of High-Speed Ground Transportation, may well agree. His office is evaluating proposals and studies that may show that a ground network is needed

Washington Report

CONTINUED

if air traffic continues to grow rapidly. Meanwhile Nelson says that "an alternative finding may be that population will continue to decentralize within metropolitan areas, making high-speed short-haul air links essential. In that case, we recommend a strengthened program to develop a satisfactory vertical take-off aircraft." Nelson adds that if he "were to venture a guess as to what the analysis will show, I would be disposed to think that it will emphasize short-run solutions which require relatively little investment . . . , but this is a generalization which will hold only so long as 10 per cent or more of the gross national product goes into defense." Which is the Government's way of saying that any multimillion-dollar purchase of rights of way and construction of transport systems is out of the question until the Vietnam conflict is settled.

An air system, on the other hand, needs no right-of-way purchase, no grading, no major construction. It does need erection of small downtown landing pads and installation of electronic equipment. HSGT Office consultants have pointed out that the requirement for electronic equipment may be considerable. They point out that 50-to-200-passenger aircraft will mean a practically non-stop traffic flow in both directions if they are to substitute for high-speed trains. They must also be able to take off and land in all weathers—and this means even in thick fog or snowstorms in city centers.

Lockheed officials believe that it is only a matter of time before a suitable airframe is mated to an economical vertical take-off engine. The time factor, however, will depend on the electronics. Company officials feel that they have the edge on design of an aircraft and should get whatever Federal support may be going. The big electronics market is up for grabs.

Computers increase transit role

Cities and transit companies that want Federal aid grants may first be told to hire a programmer and rent computer time. Such a requirement in some form or other is apparently being hammered out at the Dept. of Housing and Urban Development. A HUD-funded study at West Virginia University has shown that computer techniques can improve a transit system's over-all scheduling effectiveness.

Transit companies in Kansas City, Cincinnati, Omaha, St. Louis and New York fed data into the project that was designed to improve methods of matching operator and vehicle assignments to transit schedules.

Almost immediately after the results were in, HUD contracted a traffic consulting firm to develop a system for using computers to forecast passengers' transit use. HUD also persuaded the Washington, D. C., Metropolitan Area Transit Commission to investigate how the West Virginia study could be applied to the Washington area. This is an area that cuts across five counties, a number of cities in two states, and a Federal District. It is served by several different transport companies.

HUD is one of the Federal agencies where the use of computers is growing fastest. But that is not the main reason why computer and data-processing companies' Washington representatives remain in constant and close touch with the dept. More than any other government or nongovernment organization, they say, HUD is encouraging—in some cases almost demanding—the use of computer techniques by cities and counties and regional planning commissions all over the country.

U.S. accused of skimping on travel

One of the nation's top authorities on radar and the scientific applications of rocketry electronics has retired from Federal service. But he did not do so in the quiet, gracious manner expected of a senior scientist who has had a distinguished career.

Dr. Robert M. Page, chief scientist and director of research at the Naval Research Laboratory, parted with a blast at the Government's tight restrictions on travel funds. He pointed out that travel to scientific meetings is an important part of a scientist's work; yet the Government is making it all but impossible for its scientists to attend meetings. He contends that scientists who cannot keep abreast of developments in fast changing fields soon lose their usefulness, and he fears that this is the direction in which Government scientists are headed.

Not only is Uncle Sam stingy with the money that is allowed for actual travel, Dr. Page contends, but the Government also cuts down travel by scientists in another, equally damaging way. The overtime pay necessary to permit travel and attendance at meetings is severely restricted. Dr. Page says that the Government scientists are being treated as though they were untrustworthy and that morale is suffering in consequence.

NOW...a full-sized **VOM** in a palm sized "package"



160 Volt-Ohm-Milliammeter
Complete with alligator clip
leads and operator's manual.

..... \$50.00



Carrying Case—
Cat. No. 2225..... \$ 9.50

Accessory Leads—
Probe Tip Lead—
Cat. No. 2055..... \$ 2.75

Simpson 160 Handi-VOM[®]

Simpson Handi-VOM gives you the ranges, the time-saving conveniences and the sensitivity of a full-sized volt-ohm-milliammeter—yet it's only 3-5/16" wide, weighs a mere 12 ounces. Recessed range-selector switch never gets in the way . . . polarity-reversing switch saves fuss and fumble. Self-shielded taut band movement assures high repeatability and freedom from external magnetic fields. Diode overload protection prevents burn-out—permits safe operation by inexperienced employees and students. The demand is BIG, so get your order in to your electronic distributor, TODAY!

RANGES

ACCURACY: $\pm 3\%$ FS DC, $\pm 4\%$ FS AC
DC VOLTS: 0-0.25, 1.0, 2.5, 10, 50, 250, 500, 1000 @ 20,000 Ω/v
AC VOLTS: 0-2.5, 10, 50, 250, 500, 1000 @ 5000 Ω/v
DC MICROAMPERES: 0-50
DC MILLIAMPERES: 0-1, 10, 100, 500
DB: -20 to +10, -8 to +22, +6 to +36, +20 to +50
"0" REFERENCE: 1 MW into 600 Ω
RESISTANCE: Rx1, Rx10, Rx100, Rx100, Rx10K (30 Ω center)



DIVISION



SIMPSON ELECTRIC COMPANY

5200 W. Kinzie Street, Chicago, Illinois 60644

Phone: (312) 379-1121

Export Dept: 400 W. Madison Street, Chicago, Illinois 60606, Cable, Simelco

IN CANADA: Bach-Simpson Ltd., London, Ontario

IN INDIA: Ruttonsha-Simpson Private Ltd., International House, Bombay-Agra Road, Vikhroli, Bombay

Representatives in Principal Cities
... See Telephone Yellow Pages

WORLD'S LARGEST MANUFACTURER OF ELECTRONIC TEST EQUIPMENT

ON READER-SERVICE CARD CIRCLE 14



FREQUENCY STABILITY

TC/VCXO

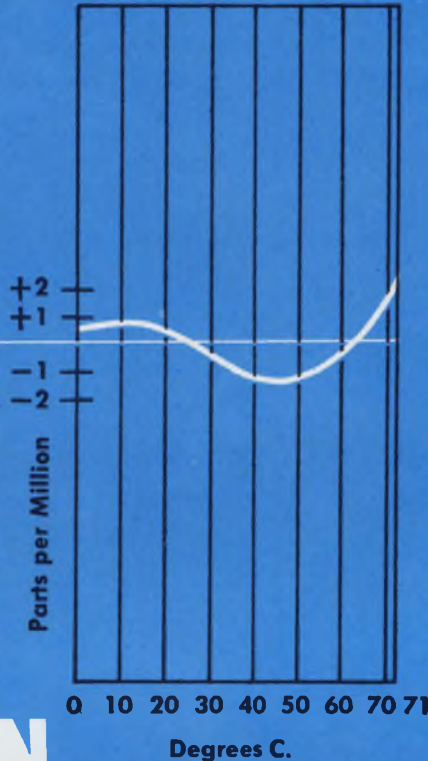

NO OVEN

TC/VCXO

Frequency Stability within $\pm 2 \times 10^{-6}$ over 0 to 71°C range



Typical TC/VCXO Model 5968WA
Center Frequency: 6.8 MHz
Size: approx. 2 1/2" L x 1 1/4" W x 3/4" H

If space and power are limited in your telecommunication system, consider the advantages of the Damon Temperature Compensated Voltage Controlled Crystal Oscillator (TC/VCXO). This rugged, miniaturized unit provides a frequency deviation of ± 100 Hz about center frequency and maintains a stability comparable to that of an "ovenized" unit without the need for added circuitry and power.

The illustration, above, shows a frequency stability curve for a simple Damon TC/VCXO. To achieve comparable frequency stability an "ovenized" unit would require more space and more power.

Tight temperature compensation is only one example of Damon VCXO capability. Low noise, small size and increased reliability are other Damon VCXO accomplishments. Perhaps your telecommunication system suggests new VCXO problems? Consultations between circuit designers and Damon engineers are the best route to proper VCXO selection. As a starter, may we invite you to write for the Damon VCXO Brochure. Damon Engineering, Inc., 240 Highland Avenue, Needham Heights, Mass. 02194 (617) 449-0800.

DAMON

ON READER-SERVICE CARD CIRCLE 16

Sonar helping MDs study the human eye

Precise measurement of the internal structure of the human eye is being done by sonar.

An eye measurement instrument, called an Ocular Reflectoscope by its developers, Automation Industries, of Boulder, Colo., detects and displays both the front and rear surfaces of the cornea and lens and their relative distances from the retina, choroid and sclera at the rear of the eye.

The sonic reflectoscope is said to be of particular benefit to physicians working in optometric and ophthalmological research. One study will use the reflectoscope to determine how the eye develops between infancy and adulthood.

The patient wears goggles, with a rubber-bag eyepiece over the eye to be measured. The bag is filled with liquid to transfer ultrasonic energy from a transducer both into and out of the eye.

The patient, his chin set firmly on a rest, directs his eye toward an illuminated dot in the center of the transducer, to ensure the alignment of the visual axis of his eye with the pulsed ultrasonic beam.

The pulses travel a direct path through the eye and back in approximately 35 μ s, without sensation to the patient.

The different structures of the eye reflect some of the energy, while the remainder propagates farther into the eye. Each reflection is detected by the transducer and converted into an electrical signal.

An expanded scale oscilloscope, which is part of the receiver, permits the eye researcher to interpret internal eye dimensions to an accuracy of 0.03 mm, or 0.0012 in. ■ ■



Medical sonar system uses ultrasonic pulses to measure the eye internally.

ON READER-SERVICE CARD CIRCLE 98 ➤

11 New μ -PAC Modules

I/C Line Expanded — 3C's 5 mc μ -PAC series now offers the systems designer the widest selection of I/C digital logic modules available...and the most experience in I/C module design,

production, and reliability. Write today for complete brochure.

Honeywell

 **COMPUTER CONTROL**
DIVISION

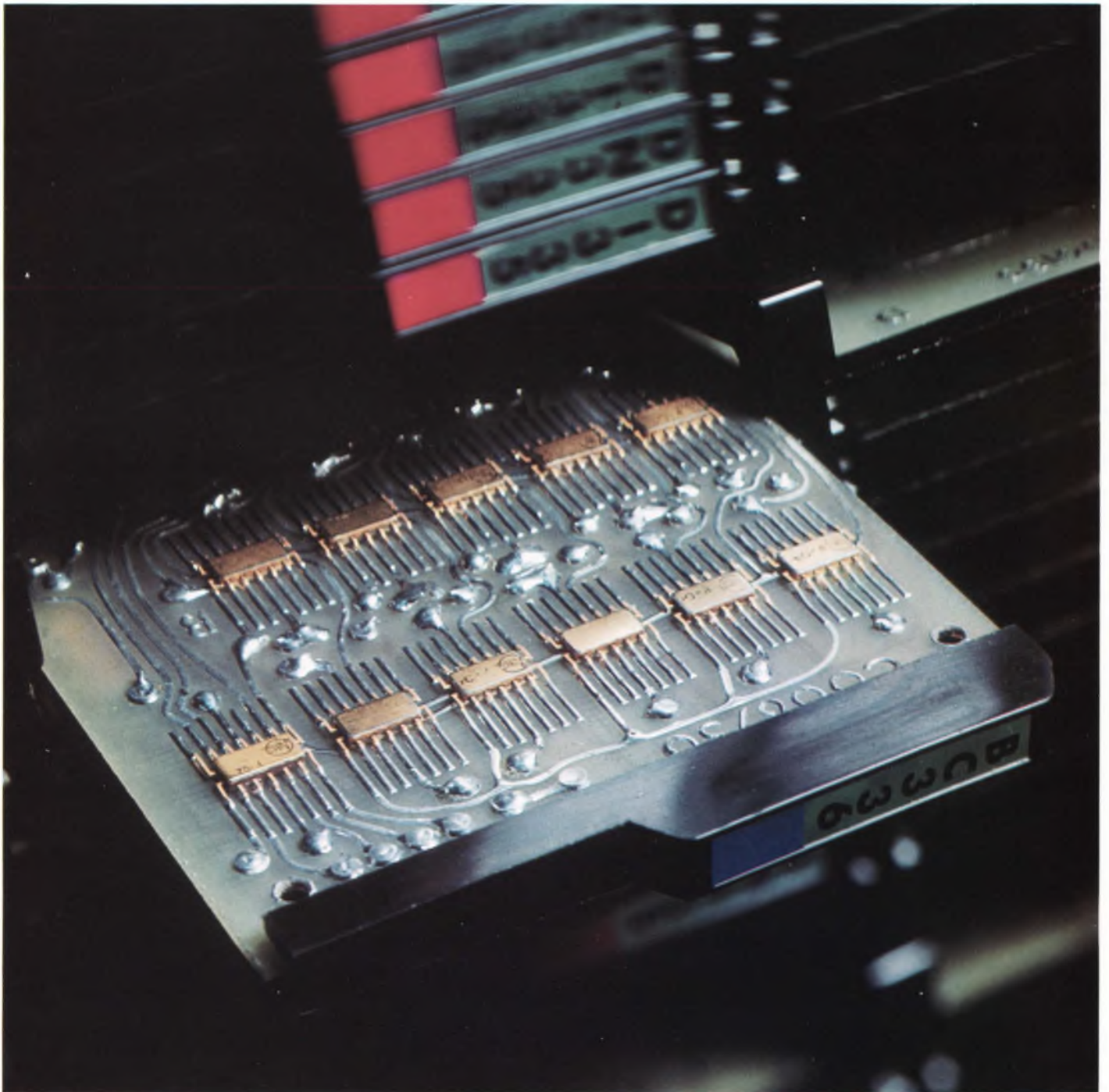

Only Honeywell Offers

The Most Complete I/C in the Industry....Plus Experience in I/C Logic



SM-330 SERIAL MEMORY PAC SERIES — MOS storage techniques offer:

- Maximum packing density — up to 256 bits storage per μ -PAC.
- Low cost — serial storage as low as \$2.50 per bit.

This new series consists of six μ -PACs of different serial storage capacity. Maximum storage ranges from 48 to 256 bits per card. MOS shift register arrays operate between 10 kilocycles and 1 megacycle and both inputs and outputs are μ -PAC compatible. An additional design feature, input and output circuitry at mid-storage points, permits two usable bit storage stages for each card.

μ -PAC Type	Total Storage	Unit Price
SM-330/48	48	\$192.00
SM-330/64	64	\$240.00
SM-330/96	96	\$312.00
SM-330/128	128	\$384.00
SM-330/192	192	\$528.00
SM-330/256	256	\$640.00

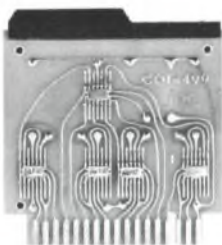

AP-335 ADDER PAC — The AP-335 contains eight half-adder (Exclusive OR) stages. These stages can be combined to perform the full adder, parity generators, or comparator functions.

Unit Price
\$185.00

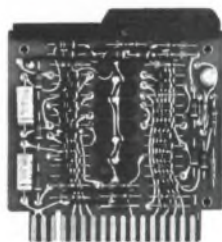

DD-330 DISPLAY DRIVER — The DD-330 is used to decode a BCD input, store the result, and drive a projection type digital display device. The BCD information is applied to the PAC, decoded, and then strobed. The result is stored and retained until a clear signal is applied.

Unit Price
\$99.75

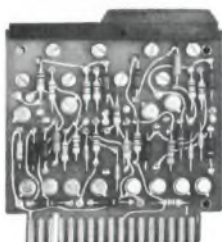

ST-336 ADJUSTABLE SCHMITT TRIGGER PAC — The ST-336 contains two independent trigger circuits, each capable of converting arbitrarily shaped inputs to μ -PAC compatible outputs. There are two potentiometers included in each circuit, one allowing for variation in switching level from +0.5 volts to -2.5 volts and the other allowing for variation in sensitivity from 100 millivolts to 1 volt.

Unit Price
\$105.00

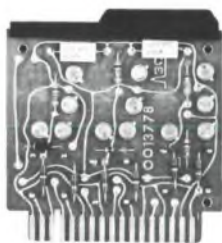

XD-336 TRANSMISSION LINE DRIVER PAC — The XD-336 contains six identical circuits which can drive 50 feet of standard 50 ohm, 75 ohm, and 93 ohm coaxial cables or twisted pair cables at up to 5 megacycle repetition rates.

Unit Price
\$95.00

Logic Line the Most Intensive Modules.

PA-336 POWER AMPLIFIER PAC — The PA-336 contains six 3-input NAND gates, each capable of driving 25 unit loads and 250 picofarads stray capacitance. Each circuit has a separate ground return for optimum noise immunity.

Unit Price
\$75.00



RC-330 RELAY PAC — The RC-330 contains eight microminiature reed relays each of which can switch up to 0.5 ampere with a 10 watt maximum load. Each relay circuit contains two contacts, one coil, and one damping diode shunt.

Unit Price
\$59.75

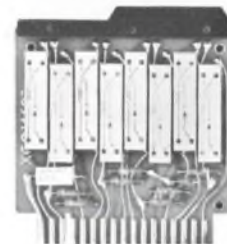

DM-336 ADJUSTABLE DELAY MULTIVIBRATOR PAC — The DM-336 contains two independent adjustable delay monostable multivibrator circuits. The pulse width is potentiometer adjustable from 50 to 300 nanoseconds. By use of external jumpers, pulse widths between 300 nanoseconds and 300 microseconds are available.

Unit Price
\$75.00

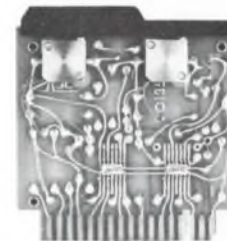

LN-330 SIX BIT DIGITAL TO ANALOG CONVERTER PAC — The LN-330 is a low cost digital to analog converter with better than 2% conversion accuracy. It offers unipolar (0 to +5 volts) and bipolar (+5 volts to -5 volts) operation. The amplifier output provides 1 milliamperere drive capability and offers negligible output impedance.

Unit Price
\$39.75

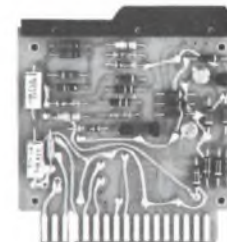

SN-330 SYSTEM NORMALIZER PAC — The SN-330 contains a time delay circuit which pre-conditions system control flip-flops to the proper state at the instant of power turn-on. At a predetermined time after the system power supply is turned on and its voltages have stabilized, the relay contact opens and frees the control flip-flops at the desired state.

Unit Price
\$49.00

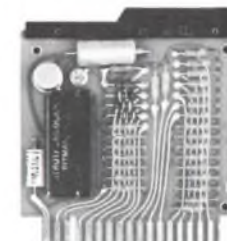

UD-335 UP/DOWN COUNTER PAC — The UD-335 contains four counter stages prewired to provide the counting operation in both the Up mode and Down mode, depending upon the command provided at the control input. Each stage has a DC set input for presetting a starting count. By use of external jumpers, the UD-335 can operate as a BCD counter or a divide-by-6 counter. A common reset is also available.

Unit Price
\$155.00



Logic Line the Most Intensive Modules.

PA-336 POWER AMPLIFIER PAC — The PA-336 contains six 3-input NAND gates, each capable of driving 25 unit loads and 250 picofarads stray capacitance. Each circuit has a separate ground return for optimum noise immunity.

Unit Price
\$75.00



RC-330 RELAY PAC — The RC-330 contains eight microminiature reed relays each of which can switch up to 0.5 ampere with a 10 watt maximum load. Each relay circuit contains two contacts, one coil, and one damping diode shunt.

Unit Price
\$59.75

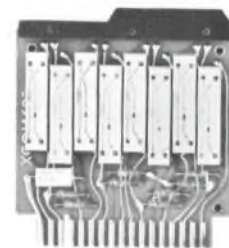

DM-336 ADJUSTABLE DELAY MULTIVIBRATOR PAC — The DM-336 contains two independent adjustable delay monostable multivibrator circuits. The pulse width is potentiometer adjustable from 50 to 300 nanoseconds. By use of external jumpers, pulse widths between 300 nanoseconds and 300 microseconds are available.

Unit Price
\$75.00

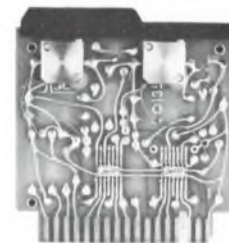

LN-330 SIX BIT DIGITAL TO ANALOG CONVERTER PAC — The LN-330 is a low cost digital to analog converter with better than 2% conversion accuracy. It offers unipolar (0 to +5 volts) and bipolar (+5 volts to -5 volts) operation. The amplifier output provides 1 milliampere drive capability and offers negligible output impedance.

Unit Price
\$39.75



SN-330 SYSTEM NORMALIZER PAC — The SN-330 contains a time delay circuit which pre-conditions system control flip-flops to the proper state at the instant of power turn-on. At a predetermined time after the system power supply is turned on and its voltages have stabilized, the relay contact opens and frees the control flip-flops at the desired state.

Unit Price
\$49.00

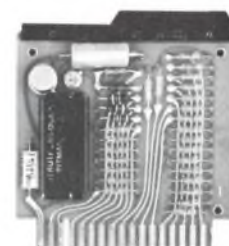

UD-335 UP/DOWN COUNTER PAC — The UD-335 contains four counter stages prewired to provide the counting operation in both the Up mode and Down mode, depending upon the command provided at the control input. Each stage has a DC set input for presetting a starting count. By use of external jumpers, the UD-335 can operate as a BCD counter or a divide-by-6 counter. A common reset is also available.

Unit Price
\$155.00

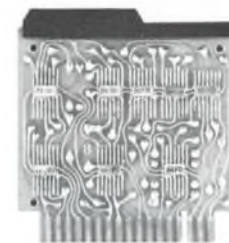

11 New μ -PAC Modules

3C's I/C capability has been developed over more than 3 years of intensive R&D... is backed by more than a dozen years' experience in the module business, from vacuum tubes to

transistors to monolithics. Write today for complete brochure.

Honeywell



**COMPUTER CONTROL
DIVISION**

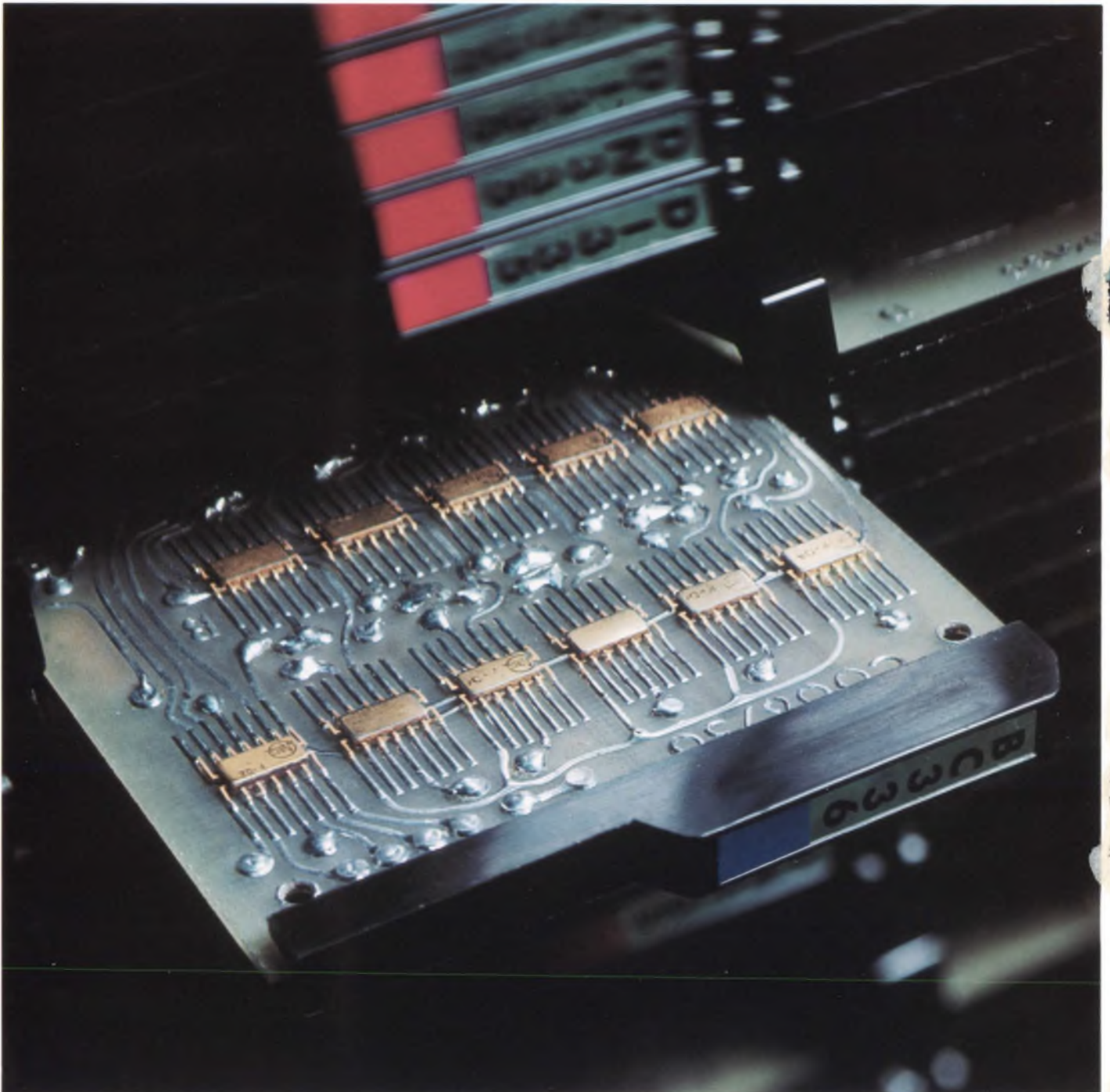

GaAs diffusion process triples diode laser power

A new gallium-arsenide diffusion process is reported to form injection laser diodes that have three times the output power and twice the efficiency of previous devices. The improved process may lead to semiconductor, continuous-wave lasers that will operate at room temperature.

The GaAs laser performance was reported by scientists of a joint project sponsored by the U.S. Air Force Cambridge Research Laboratories, Bedford, Mass., and Northeastern University, Boston. Their lasers have power outputs approaching 3 W (cw) and external quantum efficiencies of about 15 per cent at this power, with the devices cooled to liquid-nitrogen temperatures.

According to the scientists, the best results previously reported with the same measurement techniques were about 1 W (cw) at liquid-nitrogen temperatures (-186°C) and external quantum efficiencies of about six to ten per cent at maximum power.

Junction is shallow

One project scientist, Jacques Ludman of the Air Force, says that the diode lasers are made by diffusing zinc into n-type (4×10^{18} atoms/cm) GaAs to form a junction five to eight microns deep. This process is followed by a two-hour diffusion at 1000°C , with no zinc present in the furnace. This, Ludman says, results in redistribution of the zinc, but the junction migrates less than one micron further into the n-region of the GaAs during this process.

"Ordinarily a GaAs diode with a junction five to eight microns down from the the diffusion side would not lase cw," the scientist said, "but we found that after this treatment we were getting better results than were obtained at the usual single-diffusion, 20-micron junction."

Ludman and Karl Hergenrother,

a researcher at Northeastern, believe that the improved performance is related in part to the fact that the junction is closer to the material surface.

"Laser diodes are capable of more power and efficiency," Ludman says. "Our experiments are directed toward eliminating the heat and resistance losses that rob power."

Ludman explains that for cw room-temperature lasers to be practical, the efficiency at liquid-nitrogen temperatures must be high, because efficiency falls with increasing ambient temperature.

Results compared

The method that Air Force and Northeastern scientists are using to determine power and efficiency is the same one used by other researchers in the field, so the results can be compared meaningfully. The values are measured from the front face of unsilvered lasers. The output from the back face is radiated to the heat sink and lost. A copper cone calorimeter is used to determine power output.

The basic substrate of the diodes is GaAs doped with tellurium. This n-type material is changed to p-type as zinc diffuses into the substrate. The substrate with the shallow junction is then sawed and cleaved into 10-by-30-mil chips.

When cooled by a liquid nitrogen bath and placed across a dc source, the devices lase, producing light out of both ends at 8400 Å.

The researchers say that the power and efficiency would be higher if the lasers were pulsed. The Air Force is especially interested in the devices because of their possible application in lightweight, low-power, portable communication equipment.

Ludman says that a third diffusion may be used, with the zinc source available again if a deeper junction is desired. ■ ■

Coaxial Cables do double duty with POMONA BNC Adaptors

You can increase the flexibility and utility of your laboratory test equipment—and reduce the quantity and variety of coaxial cables—by using BNC Adaptors from Pomona Electronics.



MODEL 1269
BNC Receptacle to
Double Banana Plug



MODEL 1296
Binding Posts
to BNC Plug

Select from these popular adaptors to cover most of your needs... or choose from ten different combinations listed in our General Catalog, sent free upon request.



MODEL 1645
BNC Receptacle to
Shielded Banana Plugs



MODEL 2631 "BREAKOUT"
BNC Receptacle to Minigator Clips

Select from these popular adaptors to cover most of your needs... or choose from ten different combinations listed in our General Catalog, sent free upon request.

POMONA
ELECTRONICS CO., INC.
1500 East Ninth Street, Pomona, California 91766
Telephone (714) 623-3463

ON READER-SERVICE CARD CIRCLE 18

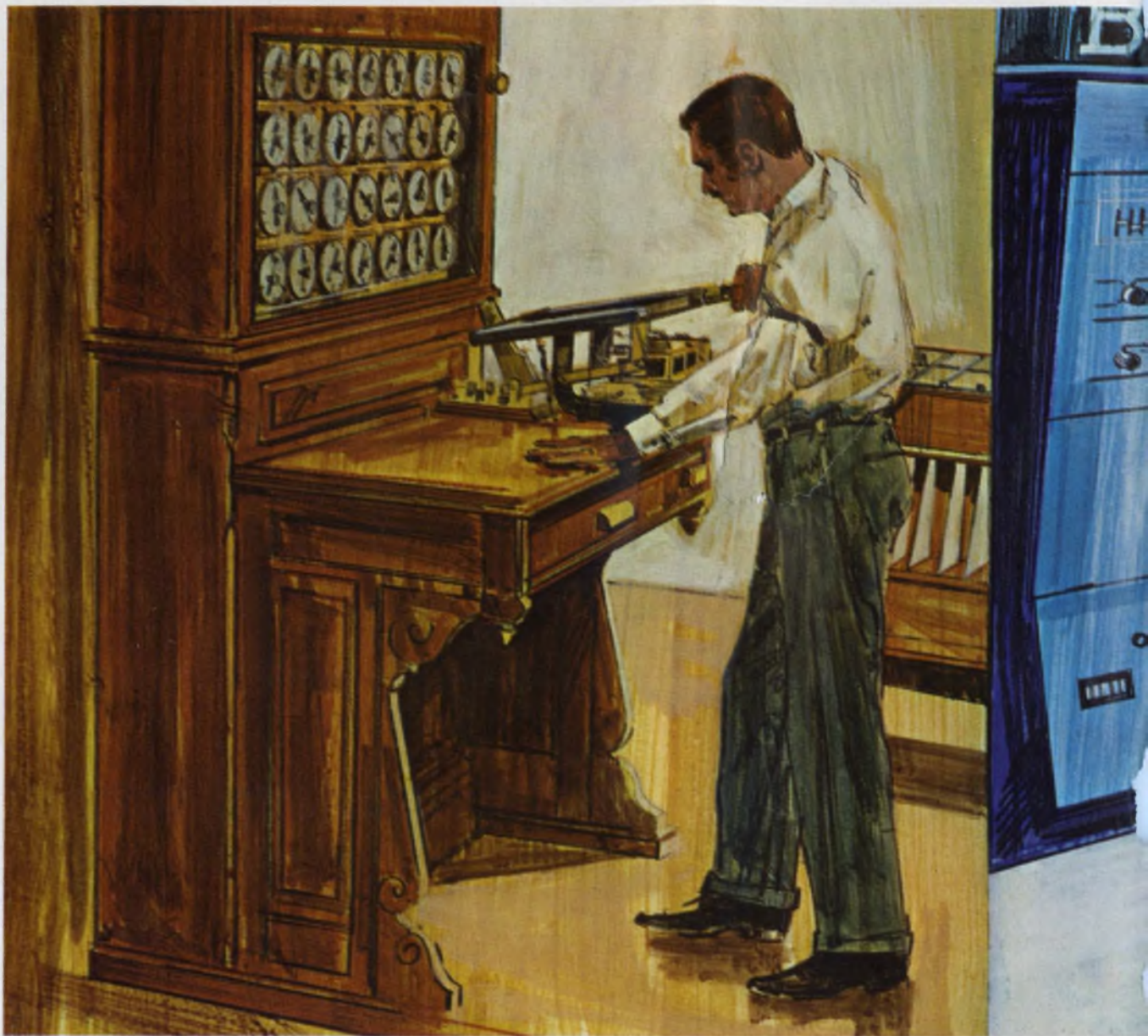

The Kind of Knowledge that makes progress possible...

The year, 1890. The enterprising Dr. Herman Hollerith perfects his contribution to man's progress. It's the Hollerith Tabulating Machine, the first electrified computer introduced to the world.

A simple sorter of coded cards, used mainly in census taking, Hollerith's machine was the foundation upon which thousands of men have applied dozens of sciences. One man's knowledge stimulates others, and they, in their turn, add to the total accumulation of knowledge in the field. As a result tabulating instruments have become more and more complex and sophisticated.



IS THE KIND OF KNOWLEDGE YOU GET FROM KESTER

And so today, machines capable of a million computations a minute serve man in thousands of scientific and industrial applications, freeing him for the pursuit of further knowledge.

This knowledge of experience is the kind of knowledge you get from Kester. For, even in Hollerith's time, Kester Solder products and soldering knowledge were contributing to industry's changing needs.

Today, after 68 years of working with solders, fluxes and their applications, Kester's knowledge of experience stands ready to serve you. Write, phone or wire for specific information.



KESTER SOLDER COMPANY

4201 Wrightwood Avenue, Chicago, Illinois 60639 • Newark, New Jersey 07105 • Anaheim, California 92805 • Brantford, Ontario, Canada

1899-1967—68 years devoted to production of products of the highest reliability—solders and fluxes

ON READER-SERVICE CARD CIRCLE 19

Traffic light uses numerical display

Nine, eight, seven, six, five, four, three, two, one, amber.

No, not a missile launching. It's the readout on a traffic signal that has been tested in Abilene, Tex., since 1963. Instead of flicking suddenly, the light goes into a nine-second numerical cycle before the green turns to amber. The motorist is forewarned.

Invented by James L. R. Hines, a safety engineer and president of the Count-Down Signal Manufacturing Co. of Abilene, the numerical installation can be attached to existing traffic lights. The company says collisions were cut 48% when its attachment was installed at a collision-prone intersection in Abilene.

Solid-state digital circuitry is used to count down the time, based upon a 60-hertz commercial frequency. A control box containing the electronic circuitry is placed at the electromechanical control box in the street. The amber light lens is removed, and an assembly of 28 130-volt, 6-watt lamps is inserted behind the lens. ■ ■

THE FIRST

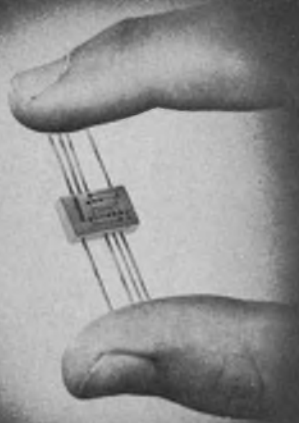

FLAT PACK RELAY

NEW from BRANSON - TO-87 RELAY

This TO-87 size relay creates new design flexibility and capability in low profile applications including circuit boards, packaging with semiconductors, part of integrated circuits and hybrid devices, etc. The TO-87 DPDT relay, rated at 1/4 amp. at 28 volts, measures 3/8" x 1/4" x 1/10" and weighs 1 gram. It is hermetically sealed and exceeds all applicable MIL specifications.

Send For Complete Detailed Specifications

OTHER BRANSON PRODUCTS...

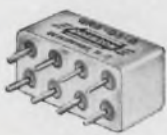

Solid State
Time Delay Relay



4 Pole
1/6 Size Relay



6 Pole DT
Crystal Can Relay



1/2 Crystal Can
4 PDT Relay

Relays... Our Only Business

BRANSON CORP.

VANDERHOOF AVENUE • DENVILLE, NEW JERSEY • 201-625-0600

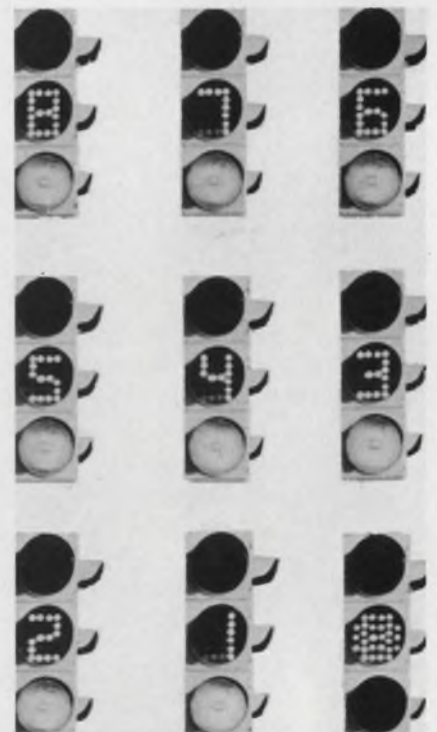

The Count-Down traffic light, as it appears at different stages to motorists.



For those who think big—about availability, that is. Babcock's 1/6-size Model BR10 with unique universal contacts gives you "nonstop" load performance dry circuit to 1 amp. in the same unit. Now, you can order *one* relay to meet all your high-density circuit-board requirements—at no cost premium. And you'll find that this subminiature unit has everything... MIL-R-5757 conformance, unitized construction, solder-sealed or welded versions, standard circuit-board grid pattern, and a wide choice of terminal and mounting styles. Get more information about

the BR10, and the complete Babcock line of relays, all with universal contacts. Write Babcock Relays, Division of Babcock Electronics Corp., 3501 Harbor Blvd., Costa Mesa, Calif.; (714) 540-1234.



SPECIFICATIONS

SIZE: .405" h. x .500" l. x .230" w.	PULL-IN POWER: Low as 80 mw.
WEIGHT: Approx. 0.15 oz.	LIFE: To 150,000 operations
CONTACT ARRANGEMENT: DPDT	TEMP. RANGE: -65° C + 125° C

**Babcock
model BR10
1/6-size relays**

**dry circuit
to 1 amp
universal
contacts**



ON READER-SERVICE CARD CIRCLE 21

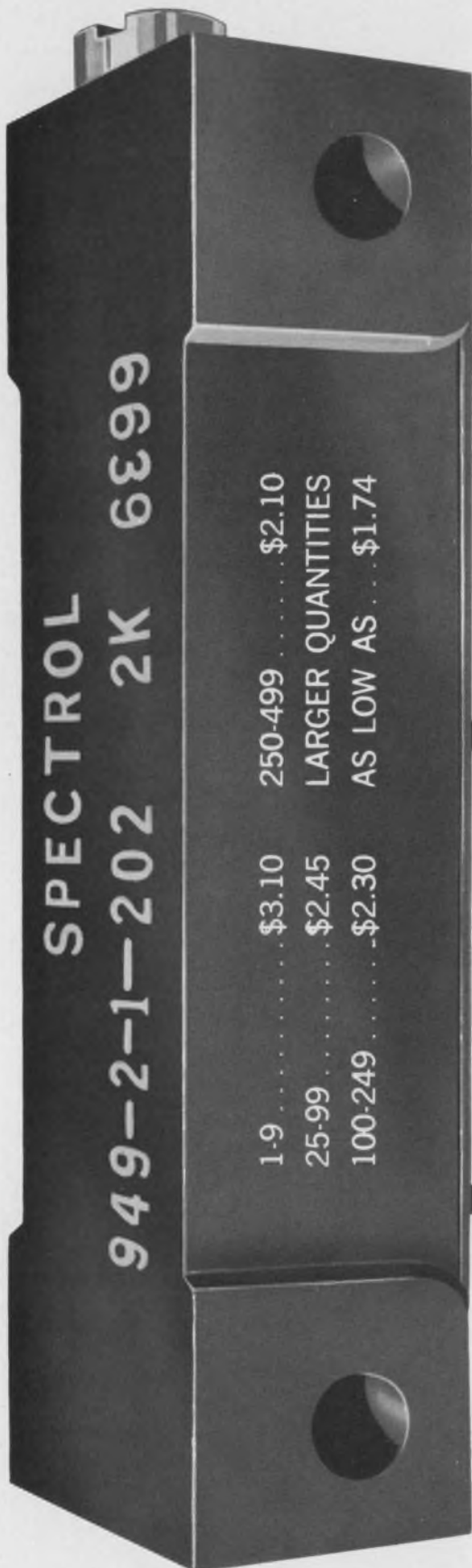

SPECTROL

949-2-1-202 2K 6899

1-9 \$3.10
 25-99 \$2.45
 100-249 \$2.30

250-499 \$2.10
LARGER QUANTITIES
AS LOW AS \$1.74

Biggest cermet value at lowest prices!

Here is the lowest priced cermet trimmer you can buy in an RJ11 package! Even if the Spectrol design was not better (and we think it is) could you afford to ignore the prices?

- And at these prices, what other non-wirewound can beat these specs?
- Resistance Range: 100Ω to 1 megohm.
 - Power Rating: 0.75W @ 70°C.
 - Temperature Range: -25°C. to +125°C.
 - Resistance Tolerance: ±20%
 - Tempco: ±300 ppm/°C. max.
 - Element: Cermet
 - Packages: RJ11 size with 5 mounting options

But the proof is in the product. You'll find it on the shelves of your local Spectrol distributor. Its performance will prove to you that our published specs are conservative. (We like it that way.)



Better Components for Better Systems

SPECTROL ELECTRONICS CORPORATION / 17070 E. GALE AVENUE, CITY OF INDUSTRY, CALIFORNIA 91745 / PHONE: (213) 964-6565 • TWX: (910) 584-1314

NEWS

Tuning fork chops infrared radiation

A compact tuning-fork optical chopper has replaced a cumbersome motor-driven sector wheel, to obtain the required chopping frequencies for infrared spectrometers.

The adaptation of the tuning fork to the spectrometer system has been designed by Herbert Lipson and James Littler, physicists at the U.S. Air Force Cambridge Research Laboratories, Bedford, Mass. They are using the system to investigate the lasing properties of materials.

Choppers, a basic element in most infrared spectrometers, are used to interrupt the beam between the infrared source and the detector, to produce a modulated signal that can be amplified for display on a strip-chart recorder.

Unlike the usual motor-driven, rotating slotted wheel, the new device can be positioned inside the spectrometer, close to the optical exit slits.

The chopper consists of thin, metal blades mounted on the vibrating members of a tuning fork. A battery powers the miniature transistorized oscillator that drives the fork at a set frequency. The oscillator also produces a reference voltage that locks in the synchronous amplifier.

The chopper was developed by American Time Products, Electronics Div., Bulova Watch Co., Inc., Woodside, N. Y. It was made to resonate at 380 Hz, a value close to the optimum chopping frequency of a number of photoconductive detectors. The devices can, however, be made to oscillate at frequencies from 30 to 1000 Hz. ■ ■

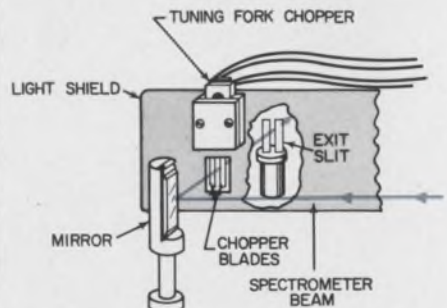

Tuning fork chopper interrupts light so that detector produces a modulated signal for display.



3 times out of 4 our distributor has your switch order in the bag.

Your Cutler-Hammer Distributor sells more than 10,000 different commercial switches and military switches. One of these will do your job, or we're ready to design the special that will.

More often than not, he can fill your switch order from right off his shelf. Because of unit pack.

What's unit pack all about?

First, it covers the 350 basic commercial and military switch models that account for 75% of our Distributors' orders. Next, it is convenient packaging: one switch with mounting hardware per sealed plastic bag; 25 bags per carton.

Most important, unit pack provides immediate local availability of all these popular, conveniently packaged switches. Your Distributor's stocks are substantial. Our factory back-up stocks truly enormous.

Now you have immediate switch selection without tying up dollars in inventory. For prototype production. To cover unexpected rush orders. The switches you need today, you order today. Or yesterday at the earliest.

Chances are excellent our unit pack switch program can pay-off in better service for you. Plan to discuss it soon with your nearby Cutler-Hammer Distributor.

CUTLER-HAMMER

Milwaukee, Wisconsin 53201



low-cost plastic silicon power transistors

NOW



- in complementary pairs!
- for HV applications!
- that are easy to mount!

***THERMOPAD** construction means low thermal resistance and minimum derating! Exclusive, integral heat sink design provides ultra-short (less than 0.030") chip-to-heat sink thermal path!



NOW... EASY MOUNTING!

You can fully utilize the cost and size advantages of Thermopad plastic silicon power with no compromises in chassis or CB mounting convenience. Motorola units are *easy* to work with, *simple* to mount. They require only single-screw, keyhole mounting. The malleable, $\frac{5}{8}$ " leads can be finger-bent in any direction to quickly fit virtually all your particular mounting requirements.

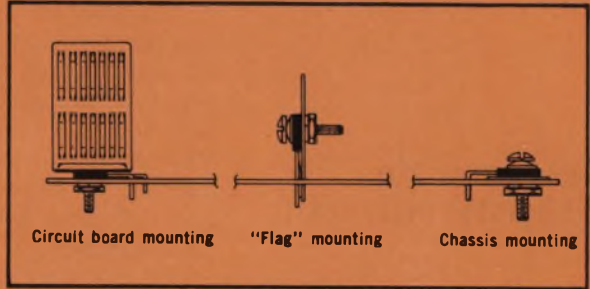

NOW... COMPLEMENTARY SYMMETRY!

Use plastic silicon power the way it was *meant* to be used! Achieve enormous economies with Motorola PNP/NPN Thermopad plastic complementary symmetry capability... an industry first! Eliminate impedance-matching driver transformers and voltage-dependent resistors with the new, 3-ampere, MJE370-71, MJE520-21 series of complementary pairs... get up to 10 watts output in your Class B amplifiers. Your franchised Motorola distributor has evaluation units now!

TYPE	POLARITY	APPLICATION	V _{CEO}	V _{EMO}	I _C	h _{FE} @ 1 A/1 V	P _D @ T _C = 25°C	θ _{JC}
MJE370	PNP	5 Watt Audio Output	30 V	4 V	3 A	25 min	25	5°C/W
MJE520	NPN	Output	40 V					
MJE371	PNP	10 Watt Audio Output	40 V			40 min		
MJE521	NPN	Output						

10-WATT AUDIO AMPLIFIER WITH COMPLEMENTARY SYMMETRY

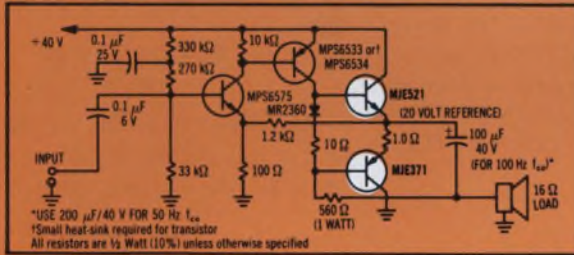

PERFORMANCE DATA:
RATED OUTPUT: 10 Watts (IHFM) music power to 16 ohms
INPUT IMPEDANCE: 30 k ohms (approx.)
SENSITIVITY: 1.0 Volt RMS (nom.) for 10 Watts output
TOTAL HARMONIC DISTORTION: typically less than 1.0% at up to 10 Watts output
BANDWIDTH (as shown): -3 dB at 100 Hz and > 100 kHz

NOW... HIGH VOLTAGE!

It's Motorola silicon... it's Thermopad plastic power... and it's high voltage! The new MJE340 NPN unit is ideal for cost-critical, HV, off-the-line applications. You can get up to 2 watts output in TV, radio, phonograph, tape recorder and intercom amplifier applications or use it as a Nixie† tube driver or in industrial high voltage power supplies.

Put high voltage plastic to work for you — evaluate the Motorola MJE340 today!

TYPE	POLARITY	APPLICATION	V _{CEO}	V _{EMO}	I _C	h _{FE} @ 1 A/1 V	P _D @ T _C = 25°C	θ _{JC}
MJE340	NPN	HV	300 V	3 V	500 mA	30-240	20.8	6°C/W

LINE-OPERATED 1.5 WATT AUDIO AMPLIFIER

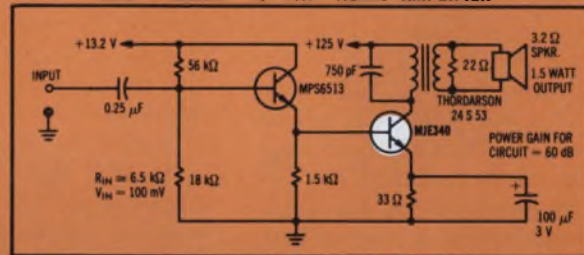

PERFORMANCE DATA: Less than 5% total harmonic at 1.5 Watts output.

Send for technical data on Motorola plastic silicon power today including illustrated "Mounting Procedure & Thermal Aspects of Motorola Plastic Power Transistors!" Box 955, Phoenix, Arizona 85001.



*Trademark of Motorola Inc. †Trademark Burroughs Corp.

MOTOROLA Semiconductors
- where the priceless ingredient is care!

ON READER-SERVICE CARD CIRCLE 165

LETTERS

Hobbies stimulate nonhobbyists' interest

Sir:

Your report ["Model-makers race, fly and sail with electronics," ED 28, Dec. 6, 1966, pp. 24-25] brings into focus for nonhobbyists some of the aspects of avocational applications [of electronics]. There were few omissions and the authors were generally factual. But there were two exceptions:

- They made no mention of commercial multi-proportional-triple and quad-simultaneous radio control equipment available at prices up to \$600 for the amateur airplane, car or boat driver.

- The little pennant in the upper photo on p. 25 serves an even more utilitarian purpose than ophthalmic protection. The hobby is popular. FCC regulations limit the number of frequencies that may be used for "remote control of objects" in the citizens' radio frequency. In a move for self-regulation at crowded flying sites or boat ponds, modelers assigned a color to each frequency. Every transmitter is identified by a colored pennant. Thus, those ready and waiting can determine at a glance whether "their" frequency is clear before tuning up for mutual disaster.

May I suggest that you follow up this introductory essay with a quick review of such things as transistorized servo amplifiers, pulse width/rate detectors, inexpensive superheterodyne receivers, railroad "throttle" controls and other hobby items aimed for sale to a market having limited budget. It is a change from industrial or Government markets.

Yours is one of the few controlled-circulation magazines I read through. Keep up the good work.

W. L. Kincheloe
Head, Preliminary Design
Defense Technology Laboratories
FMC Corp.
Santa Clara, Calif.

One-shot circuit uses familiar technique

Sir:

The Idea for Design titled "Microcircuit plus capacitor make simple one-shot" [ED 28, Dec. 6, 1966, pp. 106-108] describes a delaying technique for generating a pulse. This technique has been used frequently by applications engineers here at Fairchild Semiconductor and elsewhere, I am sure.

One of the most frequent applications of this delaying circuit is to generate a pulse of a known constant duration in order reliably to preset or clear a counter to a new state as a result of the present state of the counter; in other words, if the counter is in state *A*, the requirement is to set it to state *B*. However, if state *A* is decoded and used directly to set the counter to state *B*, as soon as this is accomplished, it will cause the gate used to decode state *A* to go to its inactive state. The output of the gate that decodes state *A*, under these conditions, is a glitch, the duration of which is equal to the gate propagation delay plus the delay time required to reset a flip-flop of the counter. In this case, the decoding of state *A* should be used as an input to the delaying circuit mentioned and the resultant pulse used to preset the counter.

Another application of the delay circuit is the two-phase clock generator or digital-frequency doubler (see below) which appears in Fairchild's *Dual RT_μL Industrial Data Sheet* on p. 3.

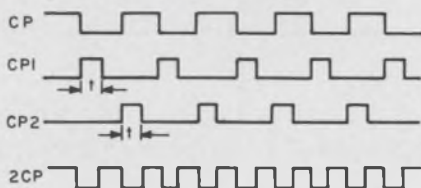
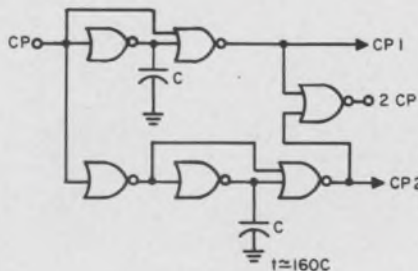

It would be helpful to the design-

er to have a formula relating output pulse width *T* to capacitance *C*. During the time the voltage on the capacitor, $V_{C(t)}$, is changing from $V_O(V_{CE SAT})$ to the turn-on threshold of the transistor, V_{TH} , this is given by the familiar:

$$V_{C(t)} = V_{CC} + (V_O - V_{CC})e^{-t/RC} \quad (1)$$

During the turn-on time of the transistor ($0.9 \text{ V} \geq V_C \geq 0.7 \text{ V}$), the capacitor is in parallel with the transistor base resistor and the forward-biased emitter base diode of the transistor. The Thévenin equivalent resistance of this turns out to be 593Ω . The difference between it and 640Ω can be neglected as a source of error when compared with the variations of the collector resistor, the $V_{CE SAT}$ and the V_{ON} level.

For these reasons Eq. 1 can be used to calculate output pulse width *T* in terms of the other quantities. The pulse width is the time from $t = 0$ until the time the input reaches the minimum value of the high level, V_{ON} , at $t = T$.

Solving for *T* yields:

$$T = RC \ln \frac{V_{CC} - V_O}{V_{CC} - V_{ON}} ;$$

when:

$$\begin{aligned} V_{CC} &= 3.6 \text{ V,} \\ V_O &= 0.140 \text{ V,} \\ V_{ON} &= 0.9 \text{ V, and} \\ R &= 640 \Omega, \end{aligned}$$

then:

$$\begin{aligned} T &= RC \ln 1.28 \\ &= 160 \text{ C.} \end{aligned}$$

Although approximate, Eq. 2 is useful in giving a ball-park estimate of the output pulse width.

Bruce Wenniger

Industrial Applications Engr.
Fairchild Semiconductor
Mountain View, Calif.

Accuracy is our policy

In "Simplify feedback system design," ED 23, Oct. 11, 1966, pp. 62-67, author Frederick Shirley draws attention to two errors in Fig. 2, p. 63: In section 3 phase response, the phase label should be $+90^\circ$, not -90° as printed; in section 8 pole-zero locations, the arc sine of a variable should be ζ , the "damping factor," rather than γ as printed.

among other things...

This P&B relay can save you up to \$2.40* per relay installed

*Compared with ordinary 3-pole dust-covered relays using an octal socket.

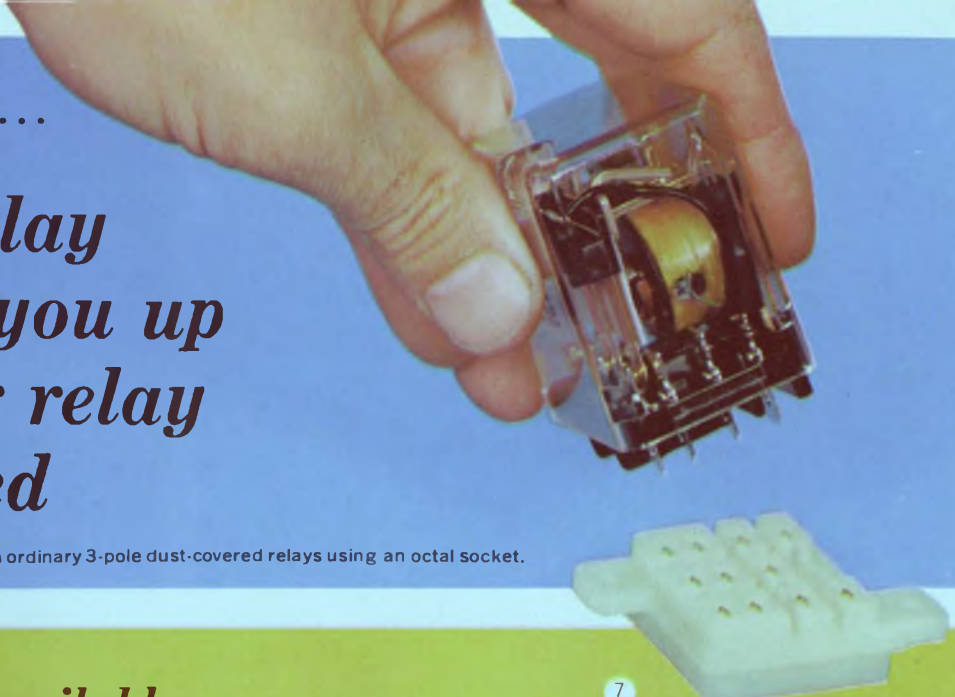

The KU series is available
in many variations
to fit your
requirements

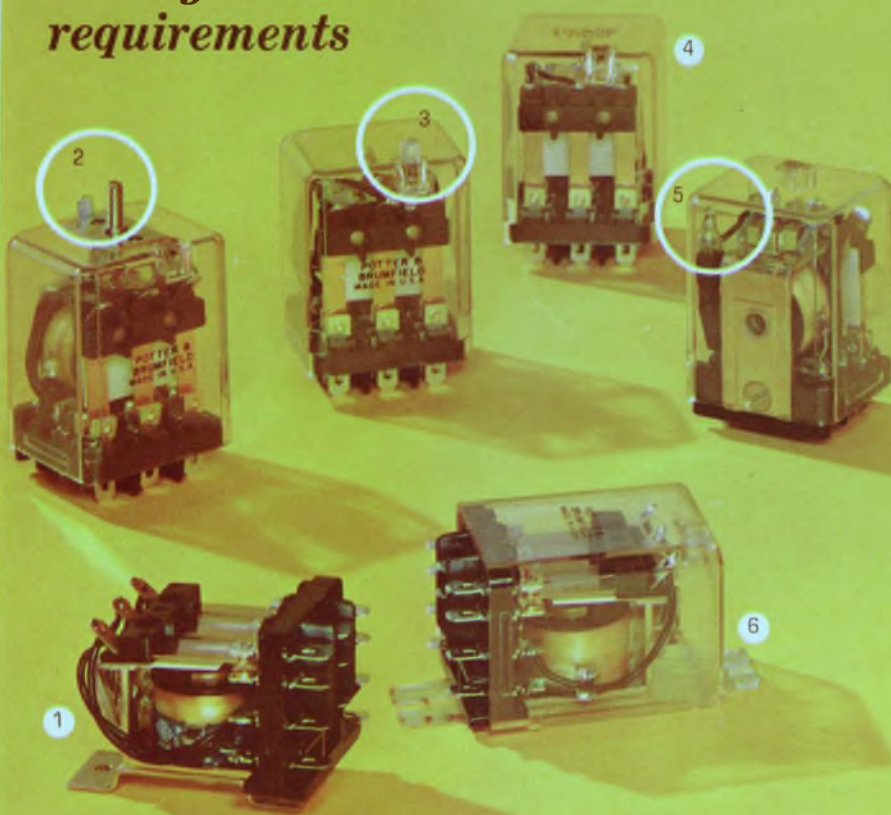

1 Open relays can be mounted with stud and locating tab, tapped core or bracket as shown.

Five or ten ampere contact ratings. AC or DC.

.187" quick connect/solder terminals standard (.205" available).

2 Stud and locating tab on top of cover may be ordered.

3 Built-in push-to-test button is available.

4 High impact polycarbonate dust cover.

5 Optional neon lamp shows if power is reaching coil.

6 Flanged dust covers for direct chassis mounting are available.

7 True 10 ampere nylon socket.

The KUP can save you up to \$2.40 (including socket costs) over similar relays with factory wired octal plugs. A true 10 ampere nylon socket can be supplied to receive the quick-connect terminals. Standard KU/KUP relays are covered by Underwriters' Laboratories Component Recognition Program.

Quick-connect terminals mean faster installation on your production line . . . easier replacement in the field. Standard models have .187" terminals, but .205" may be ordered. All terminals are punched for those who prefer solder connections.

Long life, improved reliability, exceptional versatility and, in the case of covered relays, substantially lower costs are all part of the KU Series. Call your P&B sales representative today, or get in touch with us direct.

KU SERIES SPECIFICATIONS

GENERAL:

Description: 5 or 10 amp. General Purpose Relay.

Expected Life: 10,000,000 cycles, Mech.

Breakdown Voltage: 1,500V rms 60 Hz
between all elements;
500V rms 60 Hz between open contacts.

CONTACTS:

Arrangements: Up to 3 Form C.

Rating: 5 or 10 amps @ 28V DC or 120V AC.

COILS:

Voltage: DC to 110V; AC to 240V 60 Hz.

Power: DC 1.2 W; AC 1 and 2 poles 2.0 VA;
AC 3 poles 2.7 VA.

Resistance: 16,500 ohms max.

MOUNTING:

(open relay) 6-32 mtg. stud, $\frac{7}{32}$ " locating tab
on $\frac{7}{16}$ " centers. Socket available.

STANDARD P&B RELAYS ARE AVAILABLE AT
LEADING ELECTRONIC PARTS DISTRIBUTORS



POTTER & BRUMFIELD

Division of American Machine & Foundry Company, Princeton, Indiana
Export: AMF International, 261 Madison Avenue, New York, New York

TRW IGFET

24 DB gain / 120 DB dynamic range at 100 Mc

The TRW 2N4038/PT200 Insulated Gate Field Effect Transistor has many unique characteristics that will intrigue and inspire the resourceful designer.

- **N CHANNEL:** Enhancement or Depletion Types.
- **HIGH G_m** ($\approx 2000 \mu$ mho): RF/IF Amplifiers, AC/DC Amplifiers.
- **LOW NOISE** (3 DB): RF/IF Amplifiers, Mixers, AC/DC Amplifiers.
- **LOW FEEDBACK** ($C_{gd} = 0.2$ pf): Choppers, Multiplexers, RF Amplifiers.

- **TRUE SQUARE LAW DEVICE:** Product Detectors, AGC Amplifiers.
- **HIGH INPUT R** ($10^{15} \Omega$): Logic Circuits, Instrumentation.

If you have an unusual circuit design problem, TRW IGFET technology may solve your problem. Get your IGFET at local distributors or write TRW Transistor Plant, 14520 Aviation Boulevard, Lawndale, California 90260.

TRW designs and manufactures high performance transistors for the communications industry and specialized types for military and industrial applications.

TRW SEMICONDUCTORS

ON READER-SERVICE CARD CIRCLE 166

Co-Publishers

James S. Mulholland, Jr.,
Robert E. Ahrensford

Editorial Director

Edward E. Grazda

Editor

Howard Bierman

Managing Editor

Robert C. Haavind

Technical Editors

Peter N. Budzilovich
Joseph J. Casazza
Maria Dekany
Frank Egan
Roger K. Field

News Editors

Ralph Dobriner, News Chief
Neil Sclater

West Coast Editor

Ron Gechman

Copy Editor

Peter Beales

New Products Editors

David H. Surgan
Daniel R. Butterly

Washington Editor

S. David Pursglove

Editorial Production

Dollie S. Viebig
Karen L. Sherman

Art Director

Clifford M. Gardiner

Art Assistant

William Kelly

Technical Illustrators

Cheh Nam Low
Douglas Luna

Production Manager

Thomas V. Sedita

Asst. Production Manager

Helen De Polo

Production Assistants

Bernard Wolinsky
Robert M. Henry

Circulation Manager

Nancy L. Merritt

Reader Service

Diane Mandell

EDITORIAL



Is fluidics a fine friend or a fearsome foe?

The headline of a recent newspaper article warns, "Fluid Controls Take Aim at the Electronic Market." The staff-written article that follows starts, "Fluidics, a relatively new technology, is trying to move into electronics' territory."

It is regrettable that the press, particularly the popular press, thrives on sensationalism. The fluidics people don't view their fledgling industry as a David about to attack the electronics Goliath. Why should the press?

On the contrary, the very nature of fluidic components ensures that they will be fine complements to their electronic counterparts (See "Fluidics: a simple pipeline to rugged control," *ELECTRONIC DESIGN*, XIV, No. 20 (Aug. 30, 1966), 17-21). Fluids flow about six orders of magnitude slower than electricity and fluidic logic is comparably slower than electronic logic. On the other hand, fluidics goes where electronics fears to tread. The units, made of metal, glass or plastic, are well suited to hot, sweaty applications where vibrations shake components unmercifully and speed is irrelevant. Their manufacturers claim nothing more.

Not only do the fluidics makers not think that they are going to destroy the electronics makers—they are the electronics makers. The big manufacturers of fluidic devices are General Electric, Honeywell, Sperry, Bendix, Westinghouse, Corning Glass, Aviation Electric, Martin, and Giannini. Sound vaguely familiar?

There is no question that fluidics has a rosy future, but so, too, does electronics. Right now more than a thousand dollars are put into electronics for every dollar invested in fluidics. And about half that fluidics dollar is for government-subsidized research. The skyrocketing cost of labor, however, will put continuous pressure on the business community to seek new, automatic industrial controls; and it will find fluidics. For one thing, fluidic controls can be maintained by the same personnel that presently maintains hydraulic and pneumatic controls. The introduction of fluidics in a plant is thus not accompanied by a new union.

For fluidics, industry will doubtless be the biggest market, but not the only one. It is easy to foresee a number of hybrid applications that will use electronics for speed and signal transmission, and fluidics for endurance in an adverse environment. A solar probe, for example, may well use fluidic guidance and electronic telemetry equipment.

The editors of *ELECTRONIC DESIGN* urge you to learn fluidics and keep abreast of developments. Fluidics is most certainly not a deadly enemy. With a bit of effort, you can make it a useful tool.

ROGER KENNETH FIELD

Look what you can get OFF-THE-SHELF from Union Carbide Distributors

THE FIRST LOW COST FET TYPE OP AMPS

No Plastic — All Metal
and Hermetically Sealed
Mil Grade Components
Throughout

FET Transistor in
Front End For
Low Input Current
& Impedance



Low-Profile Package:
0.4 inches for
P.C. Board
Mounting



H7010A OPERATIONAL AMPLIFIER: \$45

- Very Low Input Current (40 pA typ.) Avoids Drift Problems
- Front-end with FET devices provides Input Impedance of $10^{11} \Omega$
- Immediately Available Off-the-Shelf from Union Carbide Electronics Distributors

APPLICATIONS

Infrared Sensors
PH Sensors
Piezo-Electric Transducers
Ionization Gauges
EEG and EKG Pre-Amplifiers
Analog Integrators
Electrometric Type Voltage Followers
Sample and Hold
(e.g. charge amplifier)

EIGHT FET TYPES AVAILABLE

Op Amp Type	Temp Range °C	Open Loop Gain dB	Band Width MHz	Z_{IN} M Ω	Max Voltage Drift μ V/°C	Input Current pA	Rated Output V/mA	Price (1-4)
H7010A H7010B	-25 to 85	95	3.0	10^5	± 50	40	$\pm 10/\pm 2$	\$45. 50.
H7020A H7020B	-40 to 100	95	3.0	10^6	± 25	40	$\pm 10/\pm 2$	60. 65.
H7030A H7030B	-40 to 100	97	3.0	10^6	± 25	40	$\pm 20/\pm 6$	77.50 82.50
H7000 H7000A	-55 to 125	90	2.5	10^6	± 25	40	$\pm 10/\pm 2$	110. 95.

"A" Pkg. — 1.5 x 1.5 x 0.4 inches, "B" Pkg. — 1.8 x 1.2 x 0.6 inches, No Letter Suffix — $1\frac{1}{8}$ x $1\frac{1}{8}$ x $\frac{5}{8}$ inches. For complete specifications write for catalog listing the entire line of operational amplifiers available from UCE.



Union Carbide Electronics /365 Middlefield Road/Mountain View, California 94040/(415) 961-3300

ON READER-SERVICE CARD CIRCLE 157

Technology

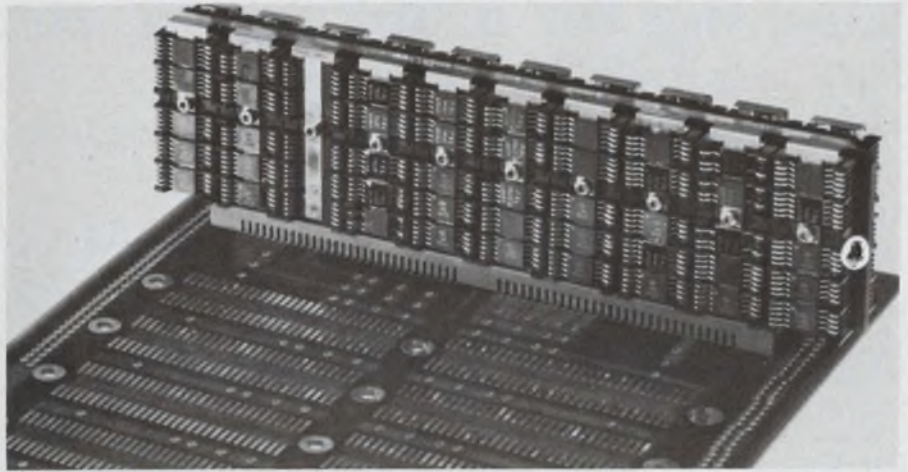

'Grandmother' board interconnects smaller boards in multilayer systems; its use eases incorporation of logic changes. Page 54



Versatile microcircuit forms the nucleus of a number of commonly used circuits. Page 48

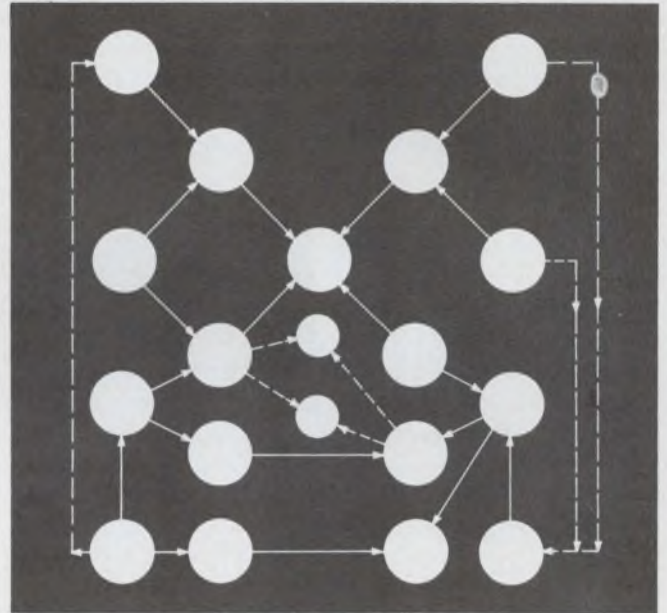

Magnet coil design involves some 20 inter-dependent variables and parameters. Page 76

Also in this section:

Semiannual index of articles, July-December, 1966. Pages 81 to 89

IC digitizer gives accurate frequency measurements in digital form, Page 62

Intercept-point method and nomograph give exact spurious level of amplifiers. Page 70

Looking for a 'universal' circuit?

Here is one approach that uses readily available ICs to perform a number of useful circuit functions.

The truly universal circuit may be no more than a designer's pipe dream. But it is possible, with the addition of just a handful of discrete components, to put a single, versatile microcircuit to use in a variety of applications—oscillators, mixers and gates, to name a few.

Such a flexible microcircuit offers a number of advantages:

- Design duplication is reduced, with a consequent saving in costly design engineering time.
- Reliability is increased, as a result of the greater development effort put into developing one single, highly versatile microcircuit.
- Manufacturing costs are cut, because simpler tooling is required to stamp out only one circuit in quantity.
- Spare-parts inventories can be trimmed to a minimum.

To settle on a circuit that offers these advantages in as many applications as possible, a basic question is what operations must the device perform in order to take care of most of the circuit problems that confront a design engineer. The ten circuit functions described in Table 1 will answer most of the designer's circuit requirements. Not all these functions can be provided by one circuit because they are too diverse, but it is possible to design a circuit that can perform many of them. The ten circuits described cover a frequency range from dc to 20 MHz. Above 20 MHz, circuits must be tuned and their versatility starts to diminish because of the many filters that are likely to be inserted into amplifiers. Practically all integrated circuits in use today are built for frequencies of dc to 20 MHz; low impedances yield the circuit responses up to this high frequency range.

Difference amplifier is most useful

It was concluded that only one configuration could possibly fulfill all the requirements of a

really versatile circuit. The device would have in essence to be a difference amplifier for the following reasons:

- A difference amplifier can produce 360° of phase shift, making various types of oscillators possible.
- A difference amplifier can make push-pull signals (sometimes called complementary output) available, and this is a requirement in many applications.
- A difference amplifier can stay balanced over wide temperature and voltage variations.
- A difference amplifier has the advantage of similar output waveforms or rise times: a current decrease in one side equals the current gained in the other.
- A difference amplifier is not noise sensitive; that is, it will not amplify noise from ground loops or power supplies as easily as other circuits, because both sides of the difference amplifier receive the same noise voltage and these effects cancel out.



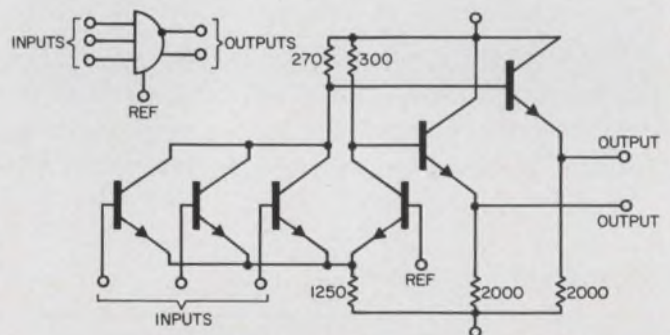



As used here, the term difference amplifier means a basic central control device; the addition of other active devices is required to provide multiple inputs or low-impedance outputs. The

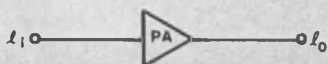

1. This microcircuit amplifier can be used as the basis of a number of commonly used circuits. Crystal oscillators, mixers and limiters are examples of the functions that can be performed by addition of a small number of external components. The dot shown on the upper output lead of the circuit block indicates a complementary output.

Benjamin A. Cola, Systems Engineer, RCA, Missile and Surface Radar Div., Moorestown, N. J.

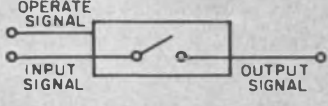
Table 1. Versatile circuit performs these functions.

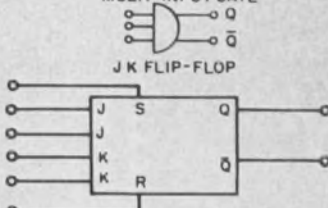
	<p>The mixer circuit is found in almost all analog equipment.</p>
<p>OPERATIONAL AMPLIFIER</p> 	<p>A high-gain feedback device, such as the operational amplifier, is needed to provide for the transfer function required in various circuits. The circuit must have good dc balance to prevent drift in the various configurations that are used. This amplifier cannot easily be tuned for high frequencies.</p>
<p>POWER AMPLIFIER</p> 	<p>Power amplifiers are needed to drive the various output lines used for signal transmission. This is an obstacle to development of a universal circuit because all the components are within the integrated circuit package, and because the dissipation heats up the transistors and increases the circuit's failure rate.</p>
<p>DIFFERENCE AMPLIFIER</p> 	<p>A difference amplifier is useful to add and subtract signals in analog form. It is possible to have a differential type of input to the operational amplifier.</p>
<p>ANALOG SWITCH</p> 	<p>Frequently it is necessary to switch analog data at some convenient time. In such a case, the circuit output is zero, except when a digital level closes the switch; then the output equals the input. The design of the analog switch is very difficult because of dc balance and ac feedthrough problems, but the usefulness of this device cannot be overestimated. It can code RF signals, act as a phase detector, and switch signals off and on for numerous reasons.</p>
<p>OSCILLATOR</p> 	<p>In almost every type of electronic equipment there are oscillators of various kinds. A universal circuit must be able to perform this function as a multivibrator and crystal oscillator, with few or no additional components.</p>
<p>LIMITER</p> 	<p>A circuit that limits input information heavily is very frequently encountered. The universal circuit must have precision limit extremes to square up an input function wherever required.</p>
<p>MULTI-INPUT GATE</p> 	<p>There are two digital circuits that can perform almost all the digital circuitry tasks that a designer requires: the gate and the JK flip-flop. A multi-input gate is a required circuit function for the versatile circuit device. The JK flip-flop is useful in the construction of counters and shift registers, and is a necessary building block for other digital circuits. This circuit is dc-coupled through the S and R inputs and ac-coupled through the J and K inputs. Since the truth table for this device is quite well known, it is not discussed here; it should be mentioned, however, that this device, which also is a set-reset flip-flop, can perform most of the digital flip-flop functions encountered in design work.</p>

versatile circuit would therefore have to contain a number of transistors to achieve its various objectives.

The circuit should be capable of driving output lines, so its output impedance must be low; this could possibly be achieved with a common emitter-follower circuit. The impedances in the device would have to be kept low to achieve a 20-MHz flat frequency response, which is equivalent to approximately 15 ns of rise time. The device should use RC coupling, since it is impossible to standardize on filters within the package; provision should be made to enable a filter to be connected as an external appendage, however.

A simple switching device should be incorporated in the input circuit to turn the input signal on and off for analog gating, mixing, etc. This can be

accomplished by placing transistor collectors and emitters in parallel, so that when a gating signal lifts the emitter of a signal transistor, it can be turned off (see Fig. 1).

Since the circuit will be used frequently, it should have low power consumption; this can be achieved by careful design. The gains through the multiple inputs to the push-pull outputs should be equal, as should the phase shift from the multiple inputs to the outputs. These gain and phase-tracking specifications enable the circuit to be used in mixers and balanced transformers, where accurate requirements are usually the case.

One serious problem is immediately apparent: it is physically almost impossible to build a high-gain, feedback operational amplifier with 20- to 30-MHz bandwidth and yet maintain accurate

Table 2. Actual circuits built with a single type of IC.

	<p>This is the circuit connection for a balanced transformer equivalent, made from the versatile circuit device.</p>
	<p>It is often necessary to take a rounded waveform and sharpen its edges or base-line crossings. A protective circuit should be placed at the input to prevent the circuit from damage by very large inputs. Various input networks can be used: dc coupling, ac coupling, or a diode biased to clip a particular level of the signal. When ac coupling with a diode input limiter is used, back-to-back diodes should be employed to prevent a dc buildup on the capacitor that could change the limited output waveform as a function of input level. The universal circuit connected as a shaper is shown on the left.</p>
	<p>Since integrated circuits are very small and the power dissipation is very low, it is possible to place two or more of the circuits in the same package. The RCA 2D2100 has two circuits per package, and the 2D2101 has four circuits per package. This is a very convenient choice for a heavy limiter circuit where a number of these devices may be needed to limit a signal that varies over a wide dynamic range. The dual gate connected as a two-stage limiter circuit is shown on the left.</p>
	<p>If the multiple inputs of the versatile circuit device are properly connected, it is possible to switch a signal on and off with another input of standard digital levels. The signal input should be dc-biased to the same level applied to the reference input of the difference amplifier, which is midway between the digital levels. The voltage pedestal created when the signal is switched on can be canceled out by operating another gate (preferably on the same silicon chip) in push-pull and adding its output to the switched signal output. When this switch was constructed in the laboratory, the outputs of the gates could be connected together with a jumper wire for signal addition, because the outputs are emitter-followers and one is biased on when other is cut off. The configuration of the versatile circuit device to form an analog switch is shown on the left.</p>
	<p>Since a difference amplifier has one output signal that is in phase with a given input signal, an oscillation will result when a series-tuned crystal is placed across the integrated-circuit connections. The signal will build up until limiting occurs, and push-pull square waves will be available as outputs at useful digital levels. At the input side of the crystal, which acts like a narrow filter, a sine wave of the oscillation frequency appears. Three output waveforms are available.</p>

gain and phase tracking. Thus it might be more efficient to amplify in a separate device that could provide all the operational and video amplifier functions; the "universal" device, with low gain, would serve most of the other circuit functions.

Off-the-shelf ICs do the job

A lot of integrated-circuit work is going on today. In the desire to capture a wide sector of the market for each newly designed IC, designers take into account many of the requirements that have been listed for the versatile circuit. A cursory check of ICs now on the market revealed that in almost all cases their central control was a difference amplifier.

The circuit shown in Fig. 1 is a difference amplifier (RCA development type TA5061) with multiple inputs on one side and push-pull, emitter-follower outputs fed from the collectors. There are a number of readily available microcircuits similar to this that could be used in the applications

listed in Table 2. Some of these microcircuits are:

Fairchild	μ C 1116, μ C 1117 and μ C 1126.
Motorola	MECL family (MC 306, 307, 351, 356, 357, 359, 360, 361 and 362). Also the newer and faster MECL II family (MS 1000 and MC 1200 series).
RCA	Types CD2150, CD2151 and CD-2152.
Texas Instruments	SN 523A, SN 524A, SN 525, SN 526 and SN 5510.

The illustrated circuit meets several of the requirements of the versatile circuit. A balanced difference amplifier, it is constructed on one integrated silicon chip; it has multiple inputs, switched inputs, limit stops, complementary output, low-impedance outputs, and a limited linear range. Standard chips may contain several of these circuits.

If the emitter-coupled gates of the circuit are wired in different configurations, a number of

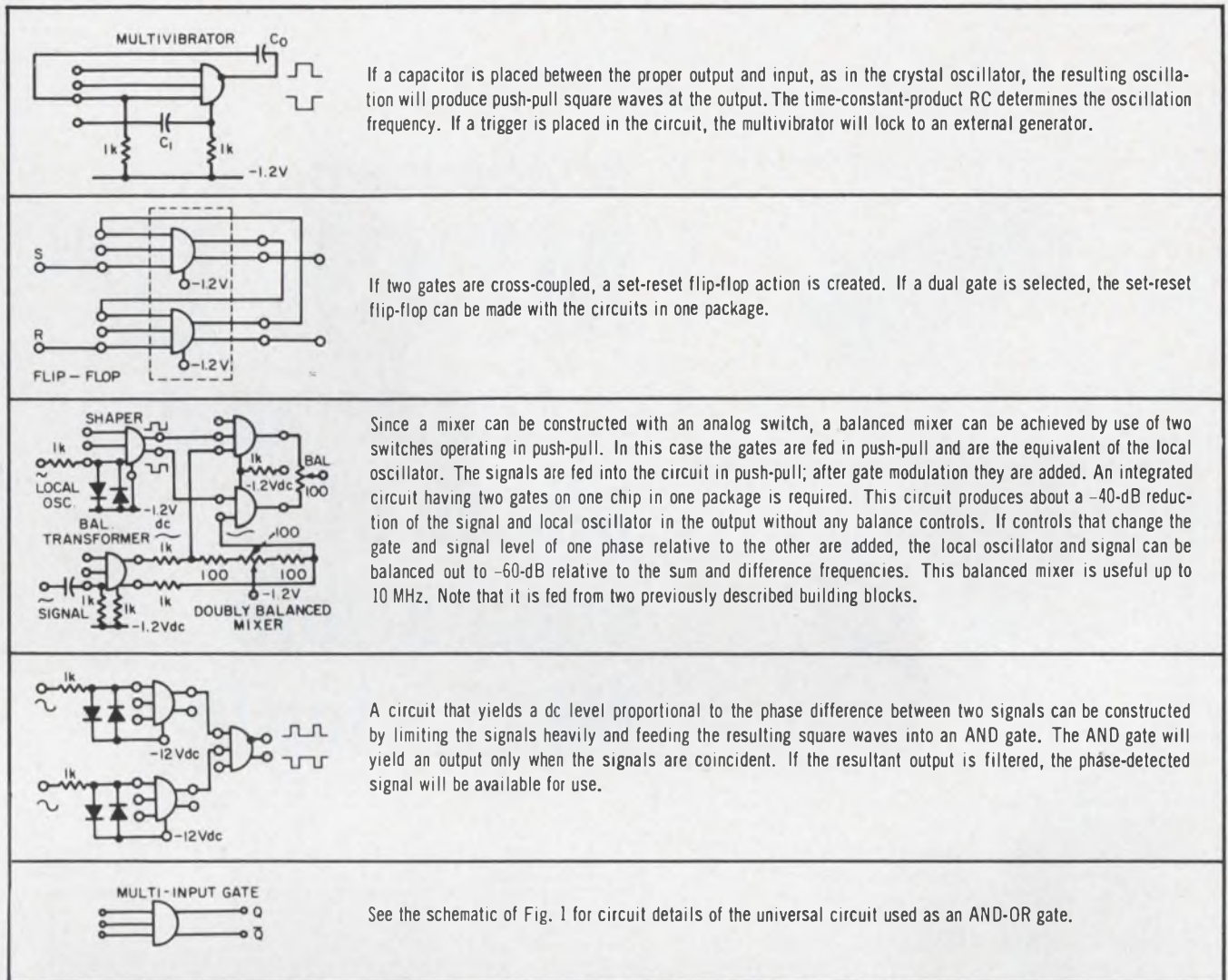

circuit functions can be obtained, including balanced transformer, shaper, limiter, analog switch, oscillator, multivibrator, flip-flop, mixer, phase detector and digital gate. These applications are illustrated and discussed in Table 2.

Since the emitter-coupled gate is linear over part of its range and has a push-pull output for a single-ended input, application of an input signal makes it produce sine-wave outputs identical to those of a balanced transformer. The sine-wave outputs are 180° out of phase plus or minus a small fraction of a degree for any signal frequency input; the output amplitudes are within a fraction of a percentage point of each other.

Circuit can be improved

The circuits in Table 2 were built and performed well. As a result of the differential construction, they were insensitive to temperature and power-supply variations. Very many circuits can be built with the emitter-coupled logic gate as

a nucleus, but if they were redesigned to accommodate the versatile circuit, it is likely that better performance and many more circuits could be obtained. In some cases, the versatile circuit is more cumbersome than one specifically constructed for a given application; for example, a J-K flip-flop can be made from these gates and a few other components, but this circuit can be purchased complete in integrated form.

Experimentally, it was often found more useful to realize gain requirements with an integrated operational amplifier. A complete chassis of precision measuring equipment was designed and constructed with universal emitter-coupled logic circuits and integrated operational amplifiers. The measuring equipment was a hybrid device, partly digital and partly analog in nature. Addition to the emitter-coupled differential amplifier of a few other integrated circuits, such as an operational amplifier and a J-K flip-flop, made it possible to construct the most complicated analog and digital functions. ■ ■

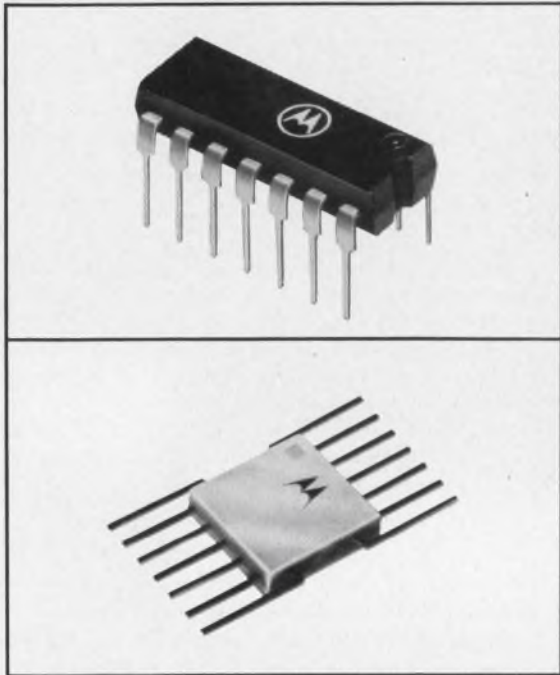

INTRODUCING...

MECL II*

...the second phase of compatible MECL* logic

Featuring:

- The fastest flip-flop in the world — 70 MHz (min) — will shift information in register applications at 70 MHz.
- Compatible with MECL I Series (use in the same system).
- Fastest *useful* speed of any full-complement IC line (from low to high fan-out).
- 40% faster than the MECL I Series (5 ns typical prop. delay).
- Multifunction units for minimum can count — low system cost.
- Complementary outputs — eliminates need for inverters.
- Proven circuit design — three years of successful MECL use.
- Proven high-volume producibility — delivered in millions.
- Compatible with soon-to-be-announced 1.5 nsec MECL with 50-ohm terminated transmission line drive capability — minimum compromise in power and speed . . . and low induced noise.

Send today for technical details on new MECL II integrated circuits. Write Box 955, Phoenix, Arizona 85001.

-where the priceless ingredient is care!

Select from these circuit functions:

Plastic Package (0 to +75°C)	Flat Package (-55°C to +125°C)	Function
MC1001P†	MC1201F†	Single 6-Input Gate
MC1002P†	MC1202F†	Single 6-Input Gate
MC1003P†	MC1203F†	Single 6-Input Gate
MC1004P**	MC1204F**	Dual 4-Input Gate
MC1005P**	MC1205F**	Dual 4-Input Gate
MC1006P**	MC1206F**	Dual 4-Input Gate
MC1007P†	MC1207F†	Triple 3-Input Gate
MC1008P†	MC1208F†	Triple 3-Input Gate
MC1009P†	MC1209F†	Triple 3-Input Gate
MC1010P**	MC1210F**	Quad 2-Input Gate
MC1011P**	MC1211F**	Quad 2-Input Gate
MC1012P**	MC1212F**	Quad 2-Input Gate
MC1013P**	MC1213F**	AC Coupled J-K Flip-Flop
MC1017P†	MC1217F†	Translator
MC1018P†	MC1218F†	Translator
MC1019P†	MC1219F†	Full Adder (10 ns Add Time)
MC1020P†	MC1220F†	Quad Line Receiver
MC1021P†	MC1221F†	Full Subtractor
Coming Soon		
MC1014P	MC1214F	Dual R-S Flip-Flop
MC1015P	MC1215F	Dual R-S Flip-Flop
MC1016P	MC1216F	Dual R-S Single Rail Flip-Flop
MC1022P	MC1222F	Type "D" Flip-Flop
MC1023P		Clock Driver
MC1024P	MC1224F	Dual 2-Input Expandable Gate
MC1025P	MC1225F	4 and 5-Input Expander

† See your Motorola field representative for evaluation units.

** In stock at your nearest Motorola distributor.

* Trademark of Motorola Inc.



MOTOROLA
Semiconductors

POWER SUPPLIES FOR IC SYSTEMS.

Now available in any current to 40 amps.

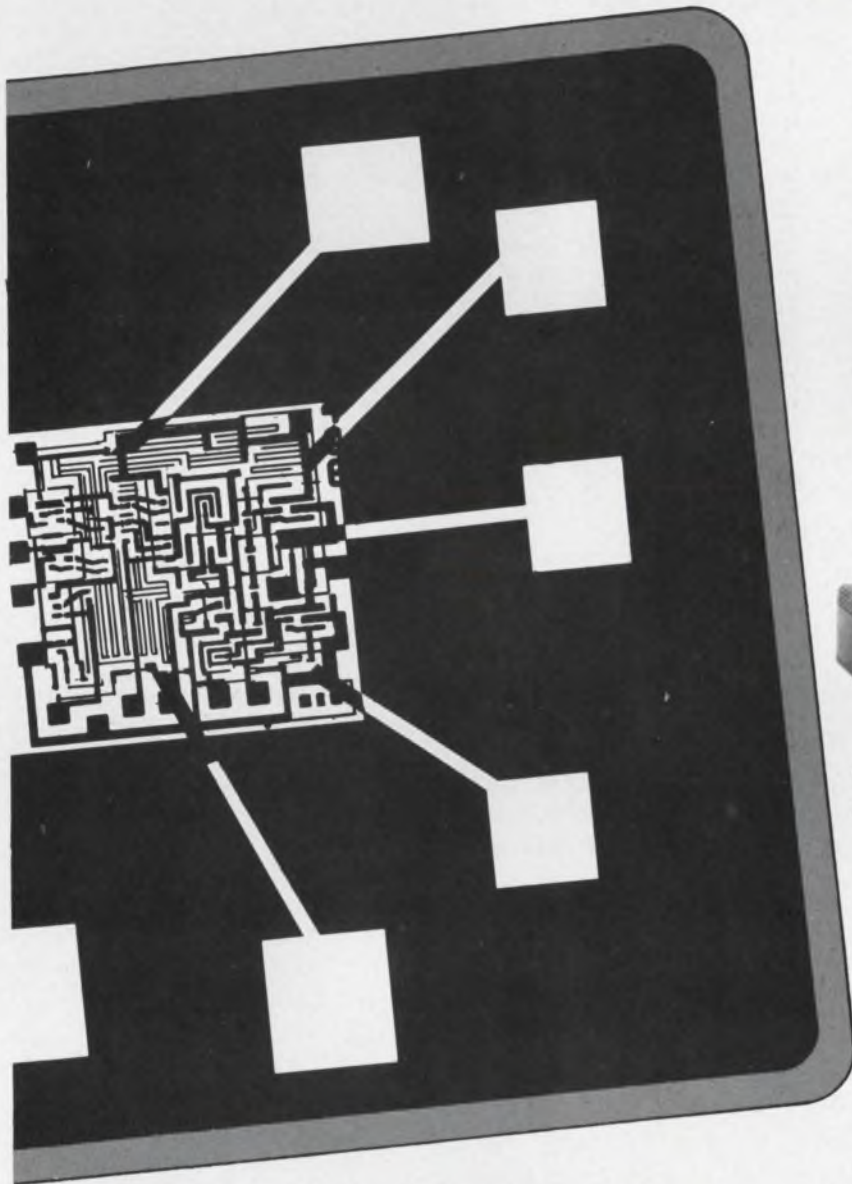

0.75 amps
0 to 5.5 volts
Model HT5-0.7A
\$97



2.0 amps
0 to 5.5 volts
Model HT5-2.0A
\$121



4.0 amps
0 to 5.5 volts
Model HT5-4.0A
\$159



8.0 amps
0 to 5.5 volts
Model HT5-8.0A
\$219



14.0 amps 0 to 5.5 volts
Model HS5-14.0 \$299



20.5 amps 0 to 5.5 volts
Model HS5-20.5 \$380



40.0 amps 0 to 5.5 volts
Model FS5-40.0 \$555

CONSOLIDATED AVIONICS



800 Shames Drive Westbury, L. I., New York 516 ED 4-8400
TWX: 510-222-6151

The modules on this page, designed specifically for IC systems, are just part of Con Avionics' line of power supplies. Those shown all operate at 0 to 5.5 volts with a combined line and load regulation of $\pm 0.05\%$.

Like all Con Avionics power supplies, these are unconditionally guaranteed for five years. They have a typical M.T.B.F. of 100,000 hours.

You'll find Con Avionics supplies for relay applications, logic card systems, or any systems requirement, all listed and priced in our Catalog 66A. For your copy, circle the card, or write, call or TWX Mr. Gerry Albers.

Ten steps to multilayer board design:

Here's how to proceed from the logic diagram of a system to the final artwork stage of the interconnection layout.

*Part 1 of a three-part series**

Multilayer printed-circuit boards appear ideally suited for high-density packaging of integrated circuits. They offer increased density of interconnections compared with single- or double-sided boards, they cut weight and cost by eliminating interconnecting hardware, and their reliability is improved because of the reduction of external solder joints and bulky harness assemblies. But proper multilayer board design requires an early detailed study of trade-offs, sufficient lead time for a full evaluation of alternative routing schemes, and a basic understanding of the materials and manufacturing processes involved in laminates and board assemblies.

Multilayer boards usually interconnect:

- Integrated circuits in any type of package.
- Prepackaged modules terminated in a fixed-pin pattern or connector banks that accept plug-in circuit cards.
- Other multilayer boards.

In any case, most elements that multilayers interconnect have a constant, repetitive pin, tab or lead configuration; this makes it possible to design all or most boards in a system with identical configurations to have identical terminal-point locations that vary only in interconnection circuitry on the layers. The complexity of these internal interconnections and the number of layers can vary from board to board depending on the functions they interconnect, but over-all board thickness can usually be made uniform, since it is possible to vary the thickness of individual layers.

*Part 1 of this series on plated-through multilayer boards details the design sequence for packaging an electronic system. Succeeding articles will discuss laminate materials and their pertinent characteristics and manufacturing steps involved in board fabrication.

George Messner, Product Manager, Photocircuits Corp., Glen Cove, N. Y.

Such a unitized design of individual boards results in cost savings in tooling and hardware, and reduces handling during system manufacture and assembly.

The general sequence for packaging an electronic system with plated-through multilayer boards is shown in the Table.

Steps 1-3: Making the early decisions

At the earliest stage of the design, an important decision must be made about the division of the entire system into individual boards in order to make the best use of space, achieve the least costly throw-away or replacement level, insure the greatest design flexibility, and reduce weight, over-all cost and number of interconnections.

When the physical dimensions of a system are given, the only problem for the design engineer is to make certain that all required components, modules and boards will fit in the specified volume. When the configuration of a system has not been defined, the problem of selecting the optimum board size becomes acute.

An increase in board size, with a corresponding increase in the interconnection complexity, in-

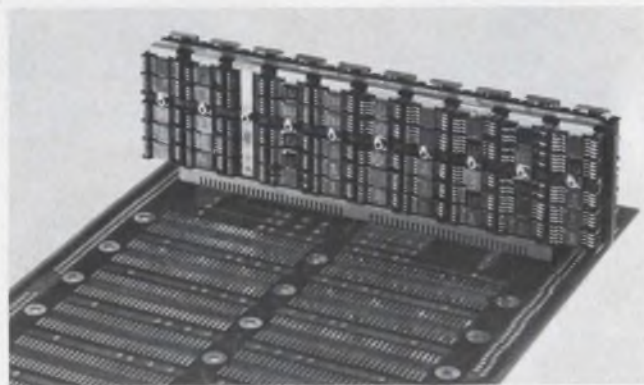

1. Multilayer "grandmother" board interconnects groups of smaller boards. Changes in logic design can often be incorporated by alteration of the external wiring of the "grandmother" board.

creases the cost of a board, not in direct proportion, but at a much slower rate. For instance, to interconnect 25 IC packages, three to four layers are usually sufficient; to interconnect 50 to 60 IC packages, between five and six layers will be required; to interconnect 450 IC packages, 12 layers may be necessary. But doubling the number of layers from 5 to 10 will increase the cost of multilayer boards, made by the plated-through hole method, only by 30 to 40 per cent.

A different approach is to limit the board size by interconnecting only a small but repetitive subfunction, such as an adder, shift register or logic unit. With such a design, a system will consist of a large number of smaller boards, say 50 to 100, but the number of the discrete board types may be only a dozen, some of which will be used again and again in different places in the system. This makes for savings in artwork preparation and in board production since large quantities of identical boards can be manufactured simultaneously, with a corresponding benefit in price. In this case, full advantage cannot be taken of the cost savings that are possible through the elimination of outside interconnections and hardware, because these smaller boards must be interconnected either by external wiring or with another multilayer "grandmother" board to complete a system (Fig. 1). The flexibility, adaptability and maintainability of this type of system, however, is excellent since, in many cases, changes in logic design can be made merely by changing the external wiring of the "grandmother" boards, and replacement of obsolete functions can be limited to smaller boards.

Step 4: Establishing input-output points

Input-output terminations have a strong influence on multilayer board design. If the number of points on a board that require connection to the outside world is equivalent to the number of internal interconnections, then the use of multi-

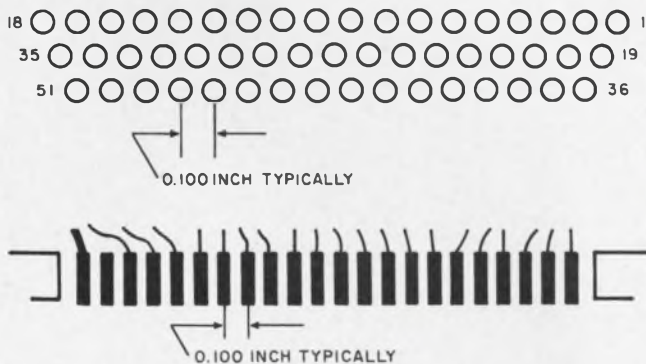

2. Typical pin-type and finger-type connectors used for input-output terminals in multilayer designs. Pin-types offer greater flexibility if additional contacts are needed in the final stages of design.

layer boards will be quite inefficient, and some other packaging method should be used. A good rule of thumb is that in a multilayer board no more than 20 per cent of the total number of terminal points should be devoted to input-outputs; the smaller the percentage the better the design. The present trend to increase the number of integrated circuits on a board decreases the number of input-output points per package. For example, in one system a board with 50 packages required 100 input-output points, exactly the same number as a more recent design that contained 100 flat packs.

Since in all good designs the output-input terminals are located close to one side of the board or on one edge (in the case of finger terminations), sufficient room must be allocated to accommodate an adequate number of these terminations. There is a practical limit to the density of terminal

Table. Ten steps for multilayers

Step	Procedures involved
1-3	Make the early decisions: <ul style="list-style-type: none"> ■ Develop logic diagram ■ Select component types ■ Determine ackaging, interconnection and component attachment methods
4	Partition the system: <ul style="list-style-type: none"> ■ Establish number of input/output points per board ■ Decide on pin or finger terminations ■ Determine maximum number of modules per board
5	Start physical design of board: <ul style="list-style-type: none"> ■ Determine hole sizes ■ Evaluate conductor routing ■ Decide on discrete component location, when applicable
6	Prepare formal drawing of board: <ul style="list-style-type: none"> ■ Include previous information plus new details such as mounting holes ■ Indicate forbidden areas ■ Investigate need for heat sinks
7	Code each module and termination: <ul style="list-style-type: none"> ■ Assign numbers to each element of drawing with corresponding numbers on logic diagram ■ Identify modules with heaviest interconnection traffic and relocate holes where necessary
8-10	Prepare artwork: <ul style="list-style-type: none"> ■ Produce enlarged masters of each board ■ Determine, manually or with computer, optimum conductor routing for each layer ■ Check out final interconnection design ■ Draw or tape enlarged masters of each layer ■ Reduce masters and prepare glass negatives

points in multilayer boards. In the case of pin-type connectors, which usually have two or more rows of pins, the pin separation should be no less than 0.1 inch and pin diameter no greater than 0.03 inch otherwise there will be no room to bring conductors between the first row of pins and the next. In the case of finger-type terminations, it is just possible to accommodate a row of single-sided fingers on 0.05-inch centers. If the fingers are located on both sides of the board, the minimum center-to-center locations must be 0.1 inch; otherwise the plated-through holes will connect the fingers from both sides and it will be impossible to bring separate signals to the fingers on each side of the board (Fig. 2).

There are some advantages in using pin-type connectors to bring input-outputs into multilayer boards. The finger-types limit the over-all thickness of the board which may present occasional problems in locating all the desired interconnections within the predetermined number of layers. There may also be problems if electrical requirements call for greater vertical separation between layers and the over-all thickness of the board is limited by the mating connector. In an emergency it would be easier to use a pin-type connector with more pins—this change will usually require a minimum of additional space on the board; but it is impossible to add extra fingers when all positions available on the board edge have already been used.

The maximum number of termination points which can be placed on a given board determines, in many cases, the maximum number of modules a board can handle. To determine the number of input-outputs, encircle a portion of the logic diagram to be placed on a single board and then count the number of connections crossed by such a hypothetical line. Of course, avoid encircling more modules than there is room to accommodate physically on the board. This method of isolating the subsystem with a minimum of input-output connections automatically groups the functionally most highly interrelated modules on the same board. Conversely, it will determine the maximum number of modules that fit on a single board. Certainly, at this stage many compromises and variations in dividing the system are possible; however, the range in the number of modules per board becomes very evident. Owing to the output terminal limitation, it is not unusual in large systems for some boards not to use all the available module positions. It is more economical to leave such positions unused than to change the uniform design of the boards.

Step 5: Determining hole size and terminal area

After the optimum number of modules per board has been determined, and it has been made

certain that no output signal is dangling without a corresponding terminal point, the physical design of the board can be started. A few ground rules must be observed to produce an efficient board design with minimum problems in circuit layout and subsequent manufacture.

The first step is to determine hole sizes. Holes must have diameters 5 to 10 mils larger than the pins or leads inserted into them to allow for good solder wetting. Room must be left for plating in the holes; the drilled hole is usually 6 to 10 mils larger than the minimum diameter of the finished hole. To ensure that, after drilling, each terminal point on internal layers has a rim of copper exposed around the entire circumference of the hole, a sufficiently large pad must be provided to allow for all possible processing tolerances. Usually such a pad is about 20 mils larger than the drilled-hole diameter. (For a detailed description of the required dimensions and tolerances refer to *Multilayer Board Technical Manual*, prepared by the Institute of Printed Circuits, 3525 W. Peterson Road, Chicago, Ill. 60645; price \$5.00.) Very frequently integrated-circuit packages in flat configurations have their leads connected to the tabs on the surface of the board. In these cases, the plated-through holes serve only to bring signals from internal layers to these tabs. These holes, as well as the "via" or "stitching" holes discussed later, should be made as small as possible in order to allow more room for conductor routing; observe the processing-limitation rule relating hole diameter to the over-all board thickness (customarily a 1:3 ratio).

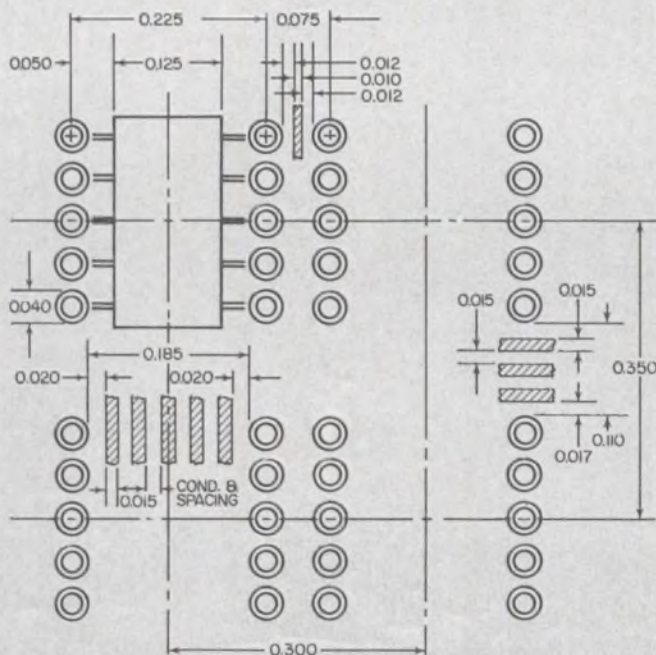

3. Typical in-line hole pattern for interconnecting groups of flat packs on a single layer. Alleys between rows are set aside on the layer to permit conductor routing.

At this stage, it is frequently discovered that there is no room for conductor routing between the holes. There are a number of ways out of this predicament. In some cases, the solution is to decrease pin or lead diameter and reduce correspondingly the hole size and the pad around it. In other cases, the solution requires the module terminations to be grouped to leave alleys between rows or columns of holes so that each point is accessible by at least one conductor (Fig. 4). Such regrouping can be accomplished either by spreading the modules farther apart or sometimes by prebending the leads of the modules and plugging them wider apart, usually in a staggered pattern.

Even in cases where there is sufficient room for conductor routing between terminal points, it is generally good design practice to provide wider alleyways periodically, so that more than one conductor can be routed through them. This practice efficiently eliminates heavily congested conductor areas, saves time in the layout, and often reduces the number of layers. It is especially important to have such wider spaces available near the output terminal side and around input-output areas where conductor density is usually greatest.

If there is sufficient room on the board, a highly recommended practice is to provide a number of holes on the board that are not used for component mounting. These holes, variously called crossover, stitching, or via holes, are used just to bring conductors from one layer to another. The existence of such holes increases conductor density and layer utilization because it allows conductors to

bypass congested areas on one layer by shunting to other layers where the desired area is free. In many designs the number of layers and circuit layout time has been drastically reduced because of the existence of such holes.

It is a common practice to include discrete components in various stages of computer logic. In order to accommodate them, it is advisable to keep an area free of modules, and place in this area a grid of holes regardless of whether or not they will be used. During board manufacture such unused holes may not be drilled. In some cases a row or a column of modules may be entirely removed from a board and this area used for component mounting. In any case, standardizing such component area and hole locations for all boards will save on artwork preparation, tooling—and design headaches.

Step 6: Preparing a drawing of the board

After the board size has been determined, all module positions distributed, pad or hole location fixed and input-output methods selected, the formal drawing of the board can be started. The drawing should contain all the above information, as well as information about other holes such as mounting holes to secure the boards to the frames or to secure connectors or other hardware to the board. It is important to indicate the existence of any forbidden areas where no conductors should be placed during layout and artwork preparation, lest conductors on inner layers be cut through by mounting holes drilled in the final operation prior to assembly.

Before full design information can be included in the drawing, some consideration must be given to the appearance of the surface of the board. This will depend greatly on the type of component connection selected for the system. If flat packs are used and connected by parallel gap welding or some form of solder reflow techniques, adequate tabs must be provided on the surface. Since these operations are apt to weaken the bond of the tab to the plastic substrate, these tabs should never be shorter than 0.1 inch to achieve sufficient anchoring. When surface tabs are used for connection of flat packs, the plated-through holes which bring the signals from internal layers can be staggered to provide more room for conductor routing; this is superior to the customary in-line arrangement used when the IC leads are soldered into holes (Figs. 3 and 4). Dual in-line packages (DIP) have leads placed on 0.1-inch centers allowing easier conductor routing between holes.

In any event, the holes in multilayer boards are very closely spaced and there is not much room between holes on the surface for sizable pads. Therefore it is highly recommended to use "landless holes," where the soldering is done to the

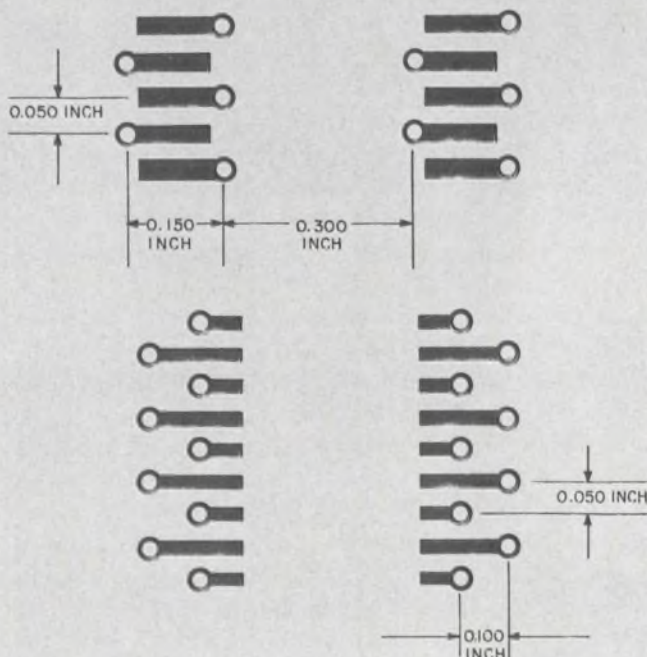

4. Staggered patterns for flat-pack interconnection afford additional spacing for conductor routing in tightly packed areas.

barrel of the hole. Landless holes have the plating contained entirely on the hole walls. The plating overhang around the hole orifice forms a small metallic ring. Landless holes have minimized the occurrence of solder bridging between closely spaced terminal areas and neighboring conductors—a frequent problem in boards with very small spacings. It is also highly recommended that no conductors be placed on the surface of boards connecting integrated circuits. The tolerances of plated-up conductors on the surface are much wider than those on internal layers and in any cases that might present electrical problems and difficulties in handling or assembling such boards. The only exceptions are situations where high-frequency requirements demand a "microstrip" configuration for impedance matching. In such cases, the conductors must be located on the surface of the board.

By having all interconnections on internal layers, the multilayers provide ample room for placing heat sinks on the surface. For flatpack or dual in-line mounting, continuous strips can be placed directly under the body of the package and extended either to selected output points or to any edge of the board for heat extraction. This feature becomes very important in applications where heat cannot be removed by convection and is entirely dependent upon conduction, such as in space. Usually such heat sinks are produced during fabrication of the board, i.e., they will consist of copper foil over-plated with whatever materials are used in plating through the holes. The over-all thickness of heat sinks manufactured by this process will be no more than 6 mils. If this cross section is insufficient, then the heat sinks can be fabricated separately from thicker foils and bonded to the board surface.

The geometry of flat and dual in-line packages lends itself to a much more efficient heat sink design than TO-5 cans. With TO-5 cans it is very difficult to place heat sinks underneath the body. The only solution is to place the ground plane on the surface and then the grounded pin of the module acts as the heat transfer link to the plane and through it to the outside. With such construction there is the possibility that the board will warp more because it has a heavy metal layer on one surface.

Step 7: Coding each module and termination

After the drawings are complete, the position of each module and each termination must be coded. Corresponding numbers are then assigned to the modules in the logic diagram in accordance with the position selected for a particular module on the board. From the logic diagram, it is fairly clear which modules have the most interconnection traffic between them and these should be

grouped in close proximity. Modules which have critical electrical connections between them should be closely placed. Obviously, the modules with the most input-output signals should be located close to the input-output area.

At this point, it is hardly possible to forecast the complete conductor routing plan and thus arrive at an optimum module distribution on the board. Simply adhering to the above rules is usually sufficient to make a reasonable distribution of modules on a given board. Occasionally, more efficient interconnections can be achieved by relocating some modules from their preassigned position during the layout phases of the design.

A somewhat different situation exists with input-output points. The exact pin location of all signal outputs should not be defined at this stage. If both module locations and output positions have been defined before the layout is made, the result may be a highly inefficient conductor routing scheme requiring many more layers than one where at least some degree of freedom is available for the layout.

Before actual layout of the circuitry can start, a few rules about conductor routing must be developed. In multilayer boards it is advisable to use conductors as wide as the design permits. If conductors are made very narrow, the etching tolerance can be a substantial percentage of the conductor cross section and might create some electrical disturbances. Preparation of the artwork can be accelerated if a uniform conductor width is used throughout the entire board, but some narrowing down in critical areas is permitted occasionally. Also, if power distribution buses are used instead of planes, they should be made wide to minimize the voltage drop.

Spacing considerations are of utmost importance. During layer lamination processing, two parallel conductors on the same layer will not move relative to each other but the entire layer might shift a little. If provisions are not made for adequate spacing between conductors and drilled holes, the possibility of shorts or low resistances between various signals is greatly increased. If any trade-offs in spacing are necessary, they should be made at the expense of spacing between adjacent conductors on the same layer, so long as electrical parameters permit, and never between the conductor and terminal areas. It is advisable to calculate from the beginning how many conductors of a given width, properly spaced, can be brought between two terminal points in various areas of the board, then stick to these ground rules during the layout of the conductors and never exceed the specified conductor number. To determine proper conductor widths and spacings consult IPC Multilayer Design Standards.

So far, there had been no discussion of the number of layers or layer-to-layer separation;

such information must also be included on the final drawing but this information can only be available when the entire layout is completed. Preassigning the number of layers before the layout has been started is optimistic and puts unnecessary constraints on that phase of the work.

Step 8: Preparing enlarged masters of the board

After all mechanical considerations have been taken care of and the final drawing is complete, the drafting department can produce enlarged masters containing all terminal points in their exact location with forbidden areas outlined. These masters should then be used for laying out the interconnections on various layers. The scale of this master template must be such that it will be easy to work with yet provide sufficient accuracy of pad and conductor location to achieve a tolerance no greater than ± 0.002 inch on a reduced 1:1 master.

Step 9: Producing interconnection layout sketch

The preparation of the layout is a very interesting topological problem. Several papers on the mathematical background for an optimum conductor routing and the use of computers for this purpose have been presented. Some electronic companies have already successfully computerized such multilayer layout. Recently a number of general papers have been published on the subject.* It appears that the number of variables and restrictions necessary for computerized layout preparation is quite large and requires the services of a very complex installation. Besides, the software preparation for such programs is quite time-consuming and difficult. Therefore, the average engineer who wants to design a multilayer board will for some time to come have to make this layout by manual operation. A general procedure for such manual layout operation is as follows:

To prepare the circuitry layout for individual layers, a number of thin Mylar sheets are placed over the terminal point master. The number of these sheets is equivalent to the expected number of layers and they are taped together so that each one is easily accessible. This overlay package is then placed over a light table and layout work can start. The routing of approximately 80 per cent of the interconnections in a fairly complicated board goes rather fast, but it is the last 20 per cent that cause problems because a path must be cleared for them among the interconnections already laid out. This occasionally requires the transfer of existing

connections from one layer to another to clear a path for the new ones. By the manual method, a circuit layout for a board with eight layers and 2000 holes can be completed in 80 to 120 hours. This includes checking out the interconnections which is done after initial designs have been finished. It should be noted here that one man has to work on one board from the start to the finish of the layout; the work cannot be subdivided among a number of draftsmen. The checking should be done by another man and not the designer.

Step 10: At last, the final artwork

After the layout is completed and checked out, actual artwork preparation is started. It can be done by the conventional method of reproducing the master pad layout for each layer on Mylar, placing it over the pencil sketch which shows the interconnections and then taping the conductors in the same fashion as is done for regular boards. This part of the job can be distributed among many draftsmen, reducing lead time. After the artwork is complete and the conductor widths and spacing are checked out, the masters are reduced by camera to 1:1 size and glass negatives made. These negatives serve as tools for the production of the layers. The artwork operation usually goes faster than the circuit layout. For instance, the artwork for the board described above would take approximately 50 hours plus a few hours of camera and touch-up time.

There are now in existence new artwork-generating machines which can transfer the information from these layer layout sheets by digitizing on a tape and then supplying this tape to numerically controlled artwork generators that produce the final 1:1 masters very accurately. One type of computerized drafting machine is manufactured by Gerber Scientific Instrument Company in Hartford, Conn.

The exactitude required on completed multilayer parts is so great that the tolerances necessary for the manufacturing processes use almost all available space and leave practically no room for mistakes in the artwork. Ideally, the 1:1 glass masters should have the location of terminal areas, line widths and spacings held within 0.001 inch of true. Therefore the work on the enlarged artwork masters must be performed with the utmost care, using the most accurate drafting equipment available.

It should be evident that very serious attention must be paid to all steps in the design and preparation of artwork and that the multilayer board design is a rather long process. Sufficient time must be allowed for these steps in order to ensure that satisfactory boards will in the end be manufactured. ■ ■

*E.g., "Automated Interconnection Schemes at Texas Instruments" by John R. Hanne, TI, and "Automated Circuit Card Etching Layout" by C. J. Fish, Sandia Corp.

Five new complex-function ICs . . .

Cut costs, simplify designs and improve reliability . . . use these new Texas Instruments Series 74 TTL integrated circuits in your digital electronic systems.

Cut costs two ways. First, you pay less per circuit function than when buying conventional ICs. Second, you save on connectors, circuit boards, inventory, and assembly costs . . . since fewer packages and less area is required. Net result . . . you can often realize over-all savings in excess of 50 percent!

You simplify designs because TI has already done a lot of the work for you. These devices, which are fully compatible with

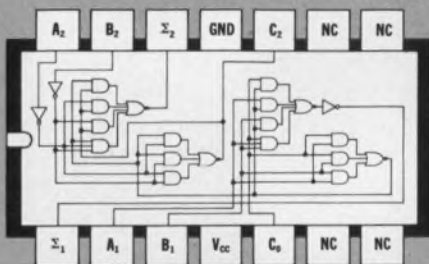

SN7482N DUAL ADDER

- Cost savings of 26% over two single IC adders.
 - 15 nsec serial carry through both additions.
 - Provides the Σ_1 of A_1 and B_1 , and the Σ_2 of A_2 and B_2 , including appropriate carry manipulations.
- Circle 40 on Reader Service card for data sheet.

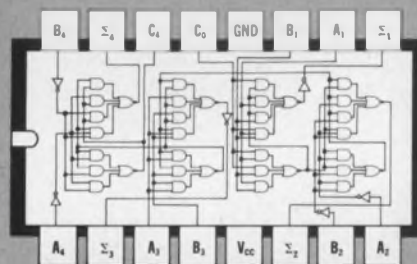

SN7483N QUAD ADDER

- Saves 41% over four single IC adders.
 - 30 nsec serial carry through four additions
 - Provides the Σ_1 of A_1 and B_1 , the Σ_2 of A_2 and B_2 , the Σ_3 of A_3 and B_3 , and the Σ_4 of A_4 and B_4 , including appropriate carry manipulations
- Circle 41 on Reader Service card for data sheet.

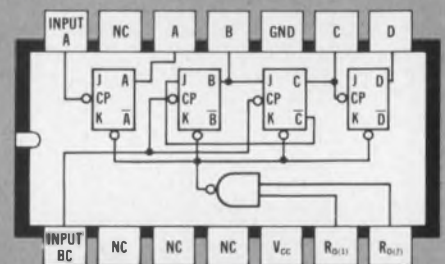

SN7492N DIVIDE-BY-12 COUNTER

- Saves 19% over four separate IC flip-flops and gating.
 - Operates at 15 MHz.
 - Frequency divides by twelve, six, three, or two.
 - Simultaneous independent operation of divide-by-six and divide-by-two sections.
- Circle 42 on Reader Service card for data sheet.

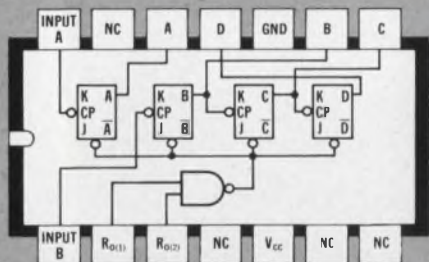

SN7493N FOUR BIT BINARY COUNTER

- Saves 16% over four separate IC flip-flops.
 - Operates at 15 MHz.
 - Ripple through operation provides frequency division by sixteen, eight, four, or two.
 - Simultaneous independent operation of divide-by-eight and divide-by-two sections.
- Circle 43 on Reader Service card for data sheet.

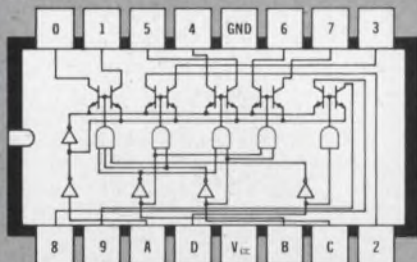

SN7441N BCD-TO-DECIMAL DECODER/DRIVER

- Saves 23% over separate IC decoding circuits and driver transistors.
 - High-voltage output (65 volt guarantee) transistors directly drive gas-filled readout tubes.
 - BCD inputs provided for use with SN7490N decade counter.
- Circle 44 on Reader Service card for data sheet.

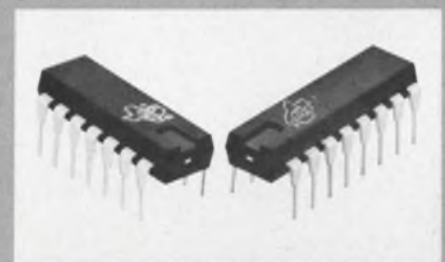

MOLDED PLUG-IN PACKAGES

All Series 74 TTL integrated circuits—including these five new complex functions—are available in TI's popular molded plug-in package. A new 16-pin configuration (right) is provided for circuits requiring more than 14 pins. Both packages have pins located on standard 100-mil centers. These packages provide highest reliability and greatest ease of handling at lowest possible cost.



Find out how TTL complex-function integrated circuits from Texas Instruments can fit into your programs. Ask your local TI Sales Engineer, or write us at P.O. Box 5012, Dallas, Texas 75222

here's how they can work for you!

all other Series 74 integrated circuits, will enable you to develop new systems faster, at reduced expense.

You also improve system reliability — because the increased circuit complexity per package means fewer soldered joints and plug-in connectors.

How can these new TI complex-function ICs work for you? For illustration, we have designed the frequency-measuring subsystem shown below, and compared it with a similar subsystem using conventional ICs. The savings realized here will give some idea of what you may expect.

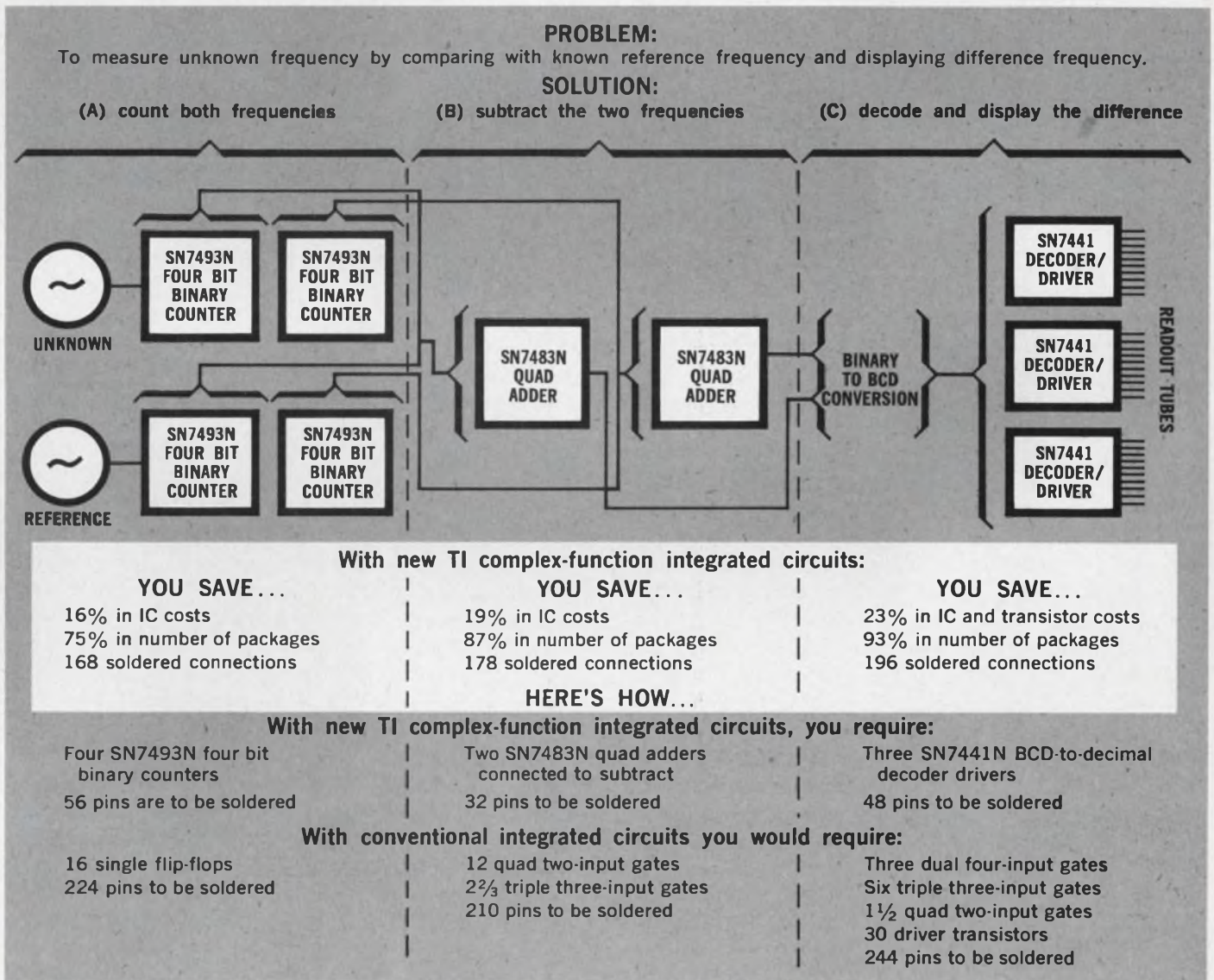

TEXAS INSTRUMENTS
INCORPORATED

Try this integrated-circuit digitizer

for accurate frequency measurements in digital form.

The simple, reliable circuit needs no calibration.

A synchronous bidirectional digitizer makes it an easy matter to obtain frequency and phase measurement in digital form. Using readily available IC modules, the digitizer is a simple, compact, highly reliable semiconductor circuit that requires no calibration and little maintenance. It can be used wherever there is need for a digital count of the phase (or frequency) change between two signals, and is capable of handling signals with an extremely wide dynamic frequency range (from zero to more than 20 MHz).

Applications include airborne frequency monitoring or control systems, telemetry decoding, Doppler navigation systems, and similar areas.

Functionally the digitizer is a high-speed, wide-band frequency comparator that measures the frequency difference between two input signals, *A* and *B*, and converts the difference frequency into digital form, generating an incremental number of output pulses for each cycle of phase change between the input signals. Pulses are generated on one output line if input *A* is the higher frequency, and on the other if *B* is higher, thereby establishing the frequency sense of one signal relative to the other.

In general, one input will be a precisely controlled reference frequency, and the other a data signal, the frequency of which is to be compared with the reference. The two output lines are connected to a bidirectional counter, and the pulses are added as a positive or negative count or recorded on tape for subsequent playback. The circuit will work equally well, however, if both inputs are of unknown or varying frequency, as, for example, in measuring the frequency drift between two oscillators.

Digitizer uses off-the-shelf ICs

The digitizer may generate one or more output pulses for each cycle of phase change between the

Albert Roth, Senior Electronics Engineer, General Dynamics, Electronics Div., San Diego, Calif.

input signals, depending on the desired resolution. The basic concept is that the digitizer accepts signals on each of two input lines, and converts each cycle into a corresponding pulse. Then by mutual cancellation, all pulses on the lower-frequency channel and a corresponding number in the higher-frequency channel are blocked. This leaves a pulse train out of the higher-frequency channel that is the frequency difference between the two inputs.

To see how a unipulse digitizer operates, consider the block diagram in Fig. 1. Input signals, labeled Reference and Data, are fed to synchronous generators *SG-A* and *SG-B*, respectively.

Each synchronous generator converts the incoming signal into a pulse (one pulse per cycle) which is synchronous with an applied high-frequency clock pulse. The pulse rate of the clock is at least twice as great as the maximum input frequency. Thus, the pulses appearing at *A* and *B* occur only simultaneously with the clock pulses, and at no other times. Some of the pulses on *A* will occur simultaneously with some at *B*, but in general the pulses will be synchronous only with the clock, not with each other. A pulse appearing at *A* immediately after one at *B* will be blocked at the output; conversely, a pulse at *B* that immediately follows one at *A* will also be canceled. If two or more pulses appear on either line without an intervening pulse on the other line, all except the first pulse will pass freely on that line. On the other hand, when pulses occur simultaneously at *A* and *B*, both will be blocked. This is the means by which every pulse on the lower-frequency line is canceled and a corresponding number on the high-frequency line likewise. The pulses that are not blocked represent the difference frequency.

All logic elements (flip-flops, AND gates, synchronous generators) are designed so that the propagation delay through each element is equal to one clock period. For example, with a clock frequency of 16 MHz, the output pulse from a given logic element occurs 62.5 ns after the leading edge of an applied input pulse.

The clock pulses, which may be generated internally or obtained from the system, are typically in the order of 10 to 20 ns wide, depending on the clock rate. These pulses are applied to all the logic elements. The clock pulses themselves carry no information but are used solely to synchronize the signals throughout the system in order to guarantee proper operation regardless of input signal configurations or phase relationships. The input data and reference signals are both applied to a synchronous generator (SG) as shown in Fig. 1. The first clock pulse that arrives after the zero-axis crossing of the input signal is gated to turn on (set) a flip-flop within the SG and the next to turn it off (reset), thereby generating a pulse of a width equal to the time between adjacent clock pulses.

The fact that the SG requires two clock pulses, one to set a flip-flop, and another to reset it, is why the clock frequency must be at least twice as great as the maximum input frequency.

Each SG has two outputs, an "assertion" and a "negation," one being the complement of the

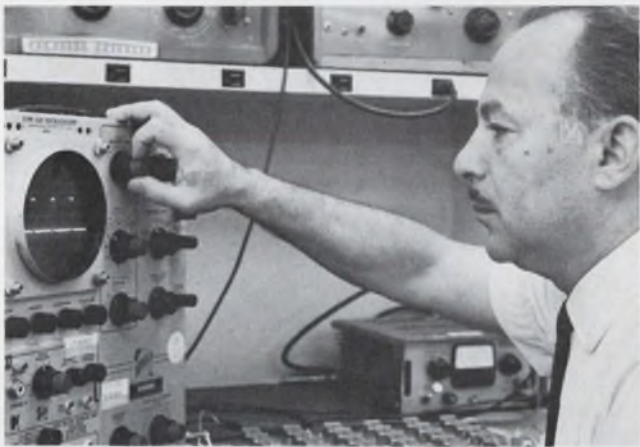

An oscilloscope pattern of digitizer waveforms is examined by author Roth. The integrated-circuit digitizer itself is shown on the bench next to the oscilloscope.

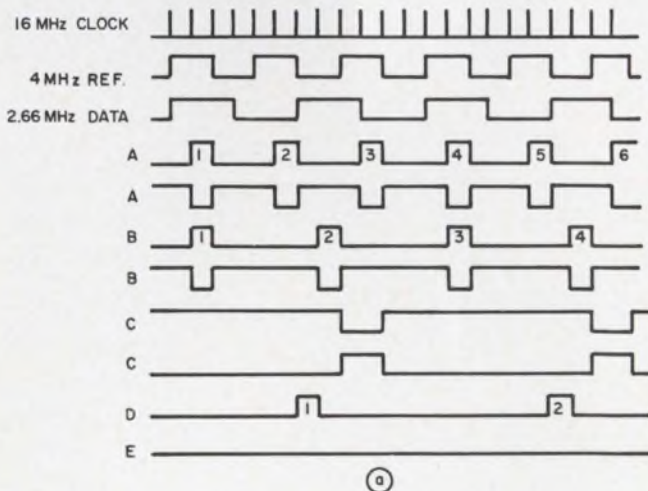

2. Waveforms illustrate digitizer operation. The waveforms shown are those obtained for 4-MHz data input (a) and

other. For example, when an input signal triggers the generator, the "assertion" output goes to the 1 state, and the "negation" output goes to the 0 state. In the quiescent state, the assertion output of the reference synchronous generator (SG-A) is denoted by A , and the negation output is denoted by \bar{A} . Similarly, the assertion output of the data synchronous generator (SG-B) is denoted by B , and the negation output by \bar{B} .

The assertion outputs A and B are fed to respective set and reset inputs of a flip-flop, and also to one input of each of two 3-input AND gates, $AND-1$ and $AND-2$. The negation outputs \bar{A} and \bar{B} of $SG-A$ and $SG-B$ are, respectively, fed to the second input of each AND gate and also to the reset and set inputs of the flip-flop.

The assertion and negation outputs (C and \bar{C}) of the flip-flop are connected to the third input of each AND gate and also to the reset and set inputs of the flip-flop.

To help understand the operation of the circuit, assume a 4-MHz reference frequency input to $SG-A$ (actually, any arbitrary reference less than half

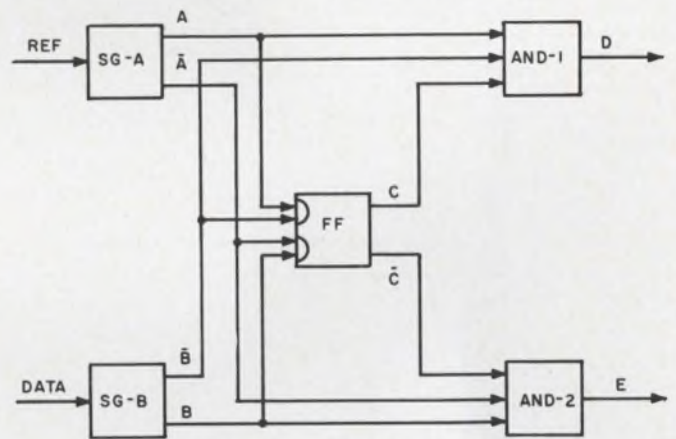

1. Readily available IC modules are used to build this synchronous bidirectional digitizer. The circuit is simple, compact, and requires no calibration.

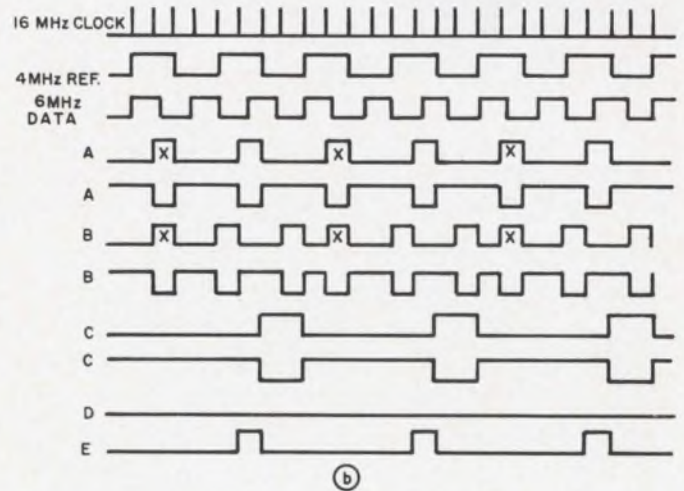

for 6-MHz data rate (b). Any reference less than half the clock frequency could be used.

the clock frequency can be used with this circuit) and a 2.666-MHz data signal (representing a 1.333-MHz negative Doppler frequency) are applied to the data generator, *SG-B*. Assume further that at time t_0 the flip-flop is in the set state, i.e., C is a 1 and \bar{C} is a 0.

The resulting waveforms are shown in Fig. 2a. Bear in mind that the propagation delay time through each element is one unit pulse length (e.g., 62.5 ns), so that the output from each element is delayed by one unit pulse period. This can be seen in the waveform diagrams where pulse *A-1* appearing at the output of *SG-A* is delayed by 62.5 ns after the first triggering clock pulse.

In the waveforms, the leading edges of the input reference and data signals occur simultaneously at t_0 , so that pulses *A-1* and *B-1* occur simultaneously. These pulses appear at *AND-1* and *AND-2* and at both inputs of the flip-flop. Pulses appearing simultaneously at both *A* and *B* will be canceled and will not change the state of the flip-flop, which will remain in its initial set state where $C = 1$ and $\bar{C} = 0$.

A and \bar{B} are connected to *AND-1* and \bar{A} and B

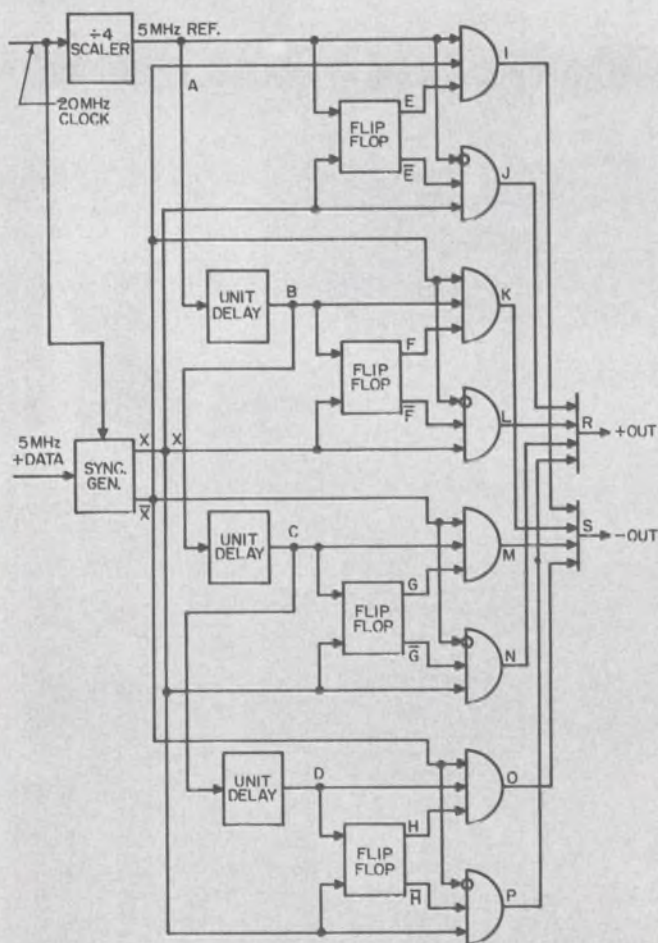

3. The digitizer's resolution can be increased by the addition of logic circuitry that will generate more than one pulse per cycle of phase difference. The number of output pulses obtained is equal to the number of channels added to the basic digitizer.

are connected to *AND-2*. Neither A nor B will be gated through these AND gates ($A \cdot \bar{B} \cdot C = D$ and $\bar{A} \cdot B \cdot \bar{C} = E$).

Since the reference frequency is higher than the data frequency, pulse *A-2* appears next. Both C and \bar{B} are in the 1 state at this time; therefore *A-2* is gated through *AND-1* and appears at D as *D-1* on the "plus" output line.

Pulse *B-2* is generated 125 ns later, but is not gated through *AND-2*, since \bar{C} is in the 0 state at this time. Pulse *B-2* resets the flip-flop to the 0 state, setting C to 0 and \bar{C} to 1; this transition does not occur until 62.5 ns after the generation of *B-2*.

Pulse *A-3* now arrives, and, since C is at a 0 state at this time, is not gated through *AND-1*. However, it sets the flip-flop to the 1 state, making $C = 1$ and $\bar{C} = 0$, again delayed by one unit pulse period. Pulses *A-4* and *B-3* are generated simultaneously, blocked in the AND gates, and leave the flip-flop unchanged. Subsequently, *A-5* is gated through *AND-1*, since C is in the 1 state at that time, and appears at D as *D-2*.

Pulses do not appear at E , since all the pulses on line B are blocked by \bar{C} 's being in the 0 state at the time of their generation.

In essence, then, all pulses on the lower-frequency line have been blocked, and a corresponding number on the upper-frequency line have been blocked; the remaining pulses, being the difference frequency, are gated out on the line having the higher-frequency "surplus."

In the above example, the period between the two pulses arriving at D is 12×62.5 ns or 750 ns. This represents a frequency of 1.333 MHz, which is the difference between the 4-MHz reference and the 2.666-MHz data input signals.

Figure 2b shows the condition where the data signal is higher than the reference. In this case, it is 6 MHz, representing a 2-MHz positive Doppler. By following the same line of reasoning as in the negative Doppler case, pulses will be generated on line E at a 2-MHz rate, which is the difference between the 4-MHz reference and the 6-MHz data signals.

With a 4-MHz reference frequency, the circuit will accept a data signal that may vary between zero and nearly 8.0 MHz and will operate properly within this range. For a system with a 20-MHz clock, the upper range may be increased to approximately 10 MHz.

The building blocks of the bidirectional digitizer were constructed from the H-Pac series of digital-logic modules produced by Honeywell's Computer Control Div. *SG-A* and *SG-B* are standard SG-48 synchronous generators, slightly modified to accept a data frequency of 7 MHz, and renumbered SG-347 to reflect the changed circuitry. The flip-flop is a standard RS-40 and the two

AND gates are modified DA-40 dual active delay pacs. Their modification consists of the addition of a third input to each of the two existing two-input AND gates. Not shown in the sketch, but used in the operational model, were a 16-MHz master oscillator, MO-46, and an SC-49 slave clock to convert the oscillator's sinusoidal output to narrow (16-ns) clock pulses. The clock, of course, is applied to each card in the circuit.

The entire digitizer could be constructed from off-the-shelf components and occupy a volume no greater than that of a standard micropac printed-circuit board.

Simple modification gives higher resolution

With the addition of several more circuit blocks, the digitizer can be converted into a synchronous fractional-cycle detector (SFCD), which can generate a given number of output pulses per cycle of phase change, and thus increase system resolution. The basic circuitry and theory of operation of the SFCD are the same as those of the digitizer; the difference is in the addition of any number of channels, each representing an additional output pulse per cycle of phase difference. For instance, five pulses per cycle would require five channels, each consisting of a delay line, a flip-flop, and two AND gates.

Any desired number of channels may be added within the restrictions imposed by the relationship between the clock frequency and the operating (data) frequency. This relationship states that the nominal data frequency multiplied by the number of channels must not exceed the clock frequency. For example, if four pulses per cycle were required, the nominal data frequency should not exceed 5 MHz for a clock frequency of 20 MHz. Such a circuit would handle a dynamic input frequency range from zero to approximately 10 MHz, with an output pulse rate of nearly 20 MHz, each pulse representing a 90° phase shift.

If 10 pulses per cycle are required, the input frequency must be reduced to 2 MHz, with a dynamic frequency range of ± 2 MHz, each pulse representing a 36° phase shift.

Figure 3 shows a block diagram of a synchronous fractional-cycle detector designed to generate four pulses per cycle of phase change between the data and reference signals. In any system utilizing this circuit, the reference frequency is assumed to be phase-locked to, or derived from, a system clock or frequency standard. If such is not the case, the clock frequency may be derived from an input reference signal by appropriate multiplication of the reference frequency. On the assumption that a 20-MHz clock is used, this signal is fed to a synchronous generator, and to a divide-by-four scaler, which reduces the frequency of the clock to 5 MHz, the reference frequency. The

The synchronous generator

The synchronous generator is a circuit designed to synchronize an externally generated signal with a train of clock pulses. The generator produces precisely one output pulse for each cycle of the input signal. The leading edge of the output pulse occurs simultaneously with the first clock pulse that appears after the input signal crosses the zero axis; the trailing edge of the output pulse is synchronous with the following clock pulse. The output pulse thus has a width equal to that of the period of the clock pulse train.

The circuit ensures that pulses fed to the set and reset inputs of the flip-flop are either synchronous (simultaneous), or arrive with a separation of at least one clock period. This guarantees the proper functioning of the flip-flop without the uncertainty that might be the result if two data signals, applied directly, occurred too close together—e.g., overlapping pulses. In addition, the circuit makes the proper action of the AND gates certain by controlling the arrival at them of the pulses.

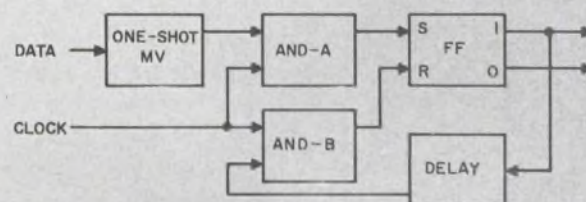

The data signal is applied to a one-shot multivibrator (see block diagram) the ON time of which is slightly greater than the period of the clock pulse train that is applied to AND gates A and B. Triggering the one-shot brings into operation *AND-A*, which gates through the next occurring clock pulse and sets the J-K flip-flop. The output of the flip-flop is transmitted through a delay line, with a delay of approximately half the clock period. This makes *AND-B* operative, so that the next clock pulse is gated through *AND-B* to reset the flip-flop. The flip-flop is so constructed that pulses arriving simultaneously at both inputs will toggle (reset) the flip-flops. Such a condition could occur if the output of the one-shot overlapped two adjacent clock pulses, the first setting the flip-flop and the second passing through both AND gates and arriving simultaneously at the set and reset inputs.

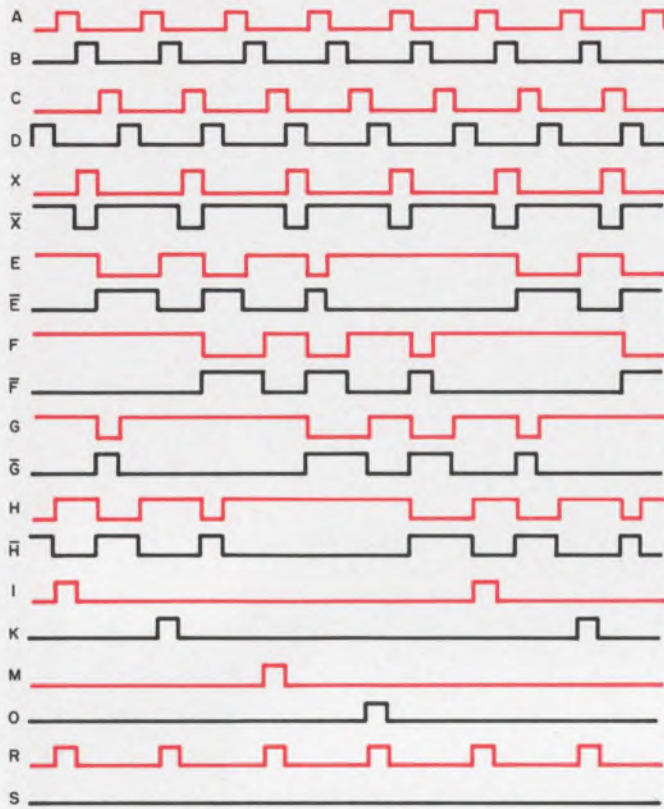

a

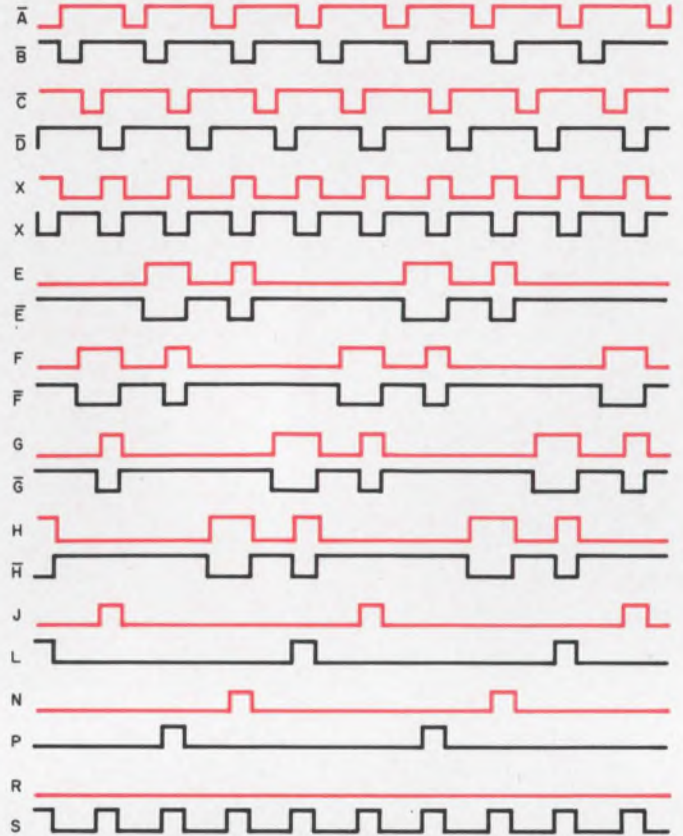

b

4. High resolution digitizer operation is shown by waveforms for data inputs of 4 MHz (a) and 6.66 MHz (b).

output of the scaler is fed to channel A of the SFCD and also to a unit delay line, which delays each pulse by one clock period or 50 ns for the 20-MHz clock. The output of this delay line is fed to channel B, and also to a second unit delay line, from which the output is fed to channel C and a third delay line. The output of the third delay line is fed to channel D. Thus, a train of 5-MHz pulses is generated on each of four lines, with each pulse delayed by 50 ns from those on the line above it.

A nominal 5-MHz data signal is fed to the synchronous generator, the two outputs from which are fed to all four channels.

If the data frequency is higher than 5 MHz, pulses will be generated by the lower AND gate in each channel, one pulse being generated in each adjacent channel for every 90° of phase shift of the data signal relative to the 5-MHz reference. The logic equation for the lower AND gate in channel A is $J = \bar{A} \cdot \bar{E} \cdot X$; similarly for the other channels.

If the data frequency is lower than the reference, one pulse will be generated by each succeeding upper AND gate every 90°. The logic equation for the upper AND gate of channel A is $I = A \cdot E \cdot \bar{X}$; similarly for the other channels.

The outputs of all the upper AND gates are brought together to one OR gate, and the outputs

of the lower AND gates are fed to a second OR gate. The output of one OR gate therefore represents "add" counts; the output of the other OR gate represents "subtract" counts. Thus, $R = J + L + N + P$, and $S = I + K + M + O$.

The waveforms of Fig. 4a represent a data input frequency of 4 MHz, which is lower than the reference by 1 MHz. Pulses are generated only by the upper AND gates I, K, M and O at a 1-MHz rate, but phase-displaced by 90°. The combination of these outputs in the upper OR gate results in a 4-MHz pulse train, as indicated at R.

The waveforms of Fig. 4b represent a data frequency of 6.66 MHz, which is 1.66 MHz higher than the 5-MHz reference. For this condition, pulses are generated by the lower AND gates at a 1.66-MHz rate, with a resulting output at S equal to 6.66 MHz.

The synchronous fractional-cycle detector has the same wide dynamic frequency range and other advantages of the synchronous bidirectional digitizer, but has the added capability of high resolution. This reduces the quantizing noise and so increases system accuracy. The additional cost of obtaining this higher resolution is extremely low, for it requires the addition of only one delay line (or one-shot), one flip-flop, and two AND gates for each channel. ■ ■

Here's A Typical Value: RCA 40458

NEW family
of medium-
power
silicon NPN
transistors
packs BIG
performance
at mass
production
prices

h_{FE} 50 min. at 300 mA
 V_{CEO} (SUS)..... 40 V min. at 100 mA
 V_{CE} (sat)..... 0.3 V max. at 300 mA
 f_T 150 MHz min.
 I_C 1A
 Dissipation: 2 W at 75°C Case Temp.

only 47¢*

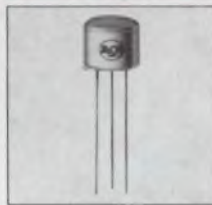

Hermetically sealed
in a metal case

now examine the entire family of value-packed industrial types

RCA 2N3241A Silicon Epitaxial Planar Transistor Family Characteristics									
	2N3241A	2N3242A	2N4074	40397	40398	40399	40400	40458	
BV_{CEO}	25	40	40	25	25	18	18	40	max. volts
h_{FE} 10V, 10mA	100-200	125-300	75-300	165-600	75-300	165-600	75-300	100-300 (50 min. @ 300mA)	
f_T typ.	175	175	80	80	80	80	80	150 min.	MHz
V_{CE} (SAT)	0.25 at 200mA I_C	0.3 at 300mA I_C	0.3 at 300mA I_C	0.25 at 200mA I_C	0.25 at 200mA I_C	0.2 at 100mA I_C	0.2 at 100mA I_C	0.3 at 300mA I_C	max. volts
Turn-on $I_C = 150mA$	75	75	—	—	—	—	—	75	max. nanoseconds
Dissipation** at 25°C Ambient	0.5	0.5	0.5	0.5	0.5	0.5	0.5	0.5	max. watts
I_C	Limited by P_T	Limited by P_T	0.3	0.2	0.2	0.2	0.2	1.0	max. amperes
Price*	\$0.44	\$0.50	\$0.44	\$0.40	\$0.36	\$0.33	\$0.30	\$0.47	

*In quantities of 1,000 and up. **All types available with integral heat radiator for 1 watt dissipation at $T_A = 25^\circ C$. Add 4¢ per unit for these versions.

The new RCA 2N3241A family of NPN epitaxial planar transistors, designed for amplifier and switching service in audio and video frequency ranges, is as versatile as it is reliable. Applications include • relay drivers • video amplifiers • high current audio drivers • saturated switches • TV deflection drivers • medium power audio output amplifiers. All devices offer exceptionally low leakage, low saturation voltages, and high minimum beta. Check the chart for specifications...and note the low prices!

See your RCA Distributor for his price and delivery

Double the 25°C free air dissipation capability from ½ watt to 1 watt by specifying integral heat radiator versions of the devices listed above.

You won't find another family of medium-power silicon transistors with so much performance, at so little cost, available immediately in production quantities. Call your local RCA Field Office for complete information. For technical data sheets write: RCA Commercial Engineering, Section EG2-1, Harrison, N.J. 07029.

*Price in quantities of 1,000 and up.



RCA Electronic Components and Devices

The Most Trusted Name in Electronics

ON READER-SERVICE CARD CIRCLE 28

SERVO PACKAGE

When it comes to servo packages, we've got the technical considerations licked. That goes for both components and packaging design.

We can give you the "tightest" job at the lowest price and meet your delivery requirements, too.

We have literally thousands of different servo components to meet exact requirements. Motors: stepper, synchronous, braked, viscous-damped and inertial-damped. Motor generators: rate, damping, integrating and high-signal-to-noise. Synchros and resolvers of all descriptions. Related devices such as clutches, brakes and gearheads.

We design and build all the associated electronics: servo and buffer amplifiers, stepper-motor logic packages, phase-shifting capacitors, quadrature rejection circuits, electronic choppers and summing, isolation and switching networks.

Shown here are some of the servo assemblies we've designed and produced to customer requirements using standard Kearfott elements plus not-so-standard Kearfott experience.

All you have to do to solve similar problems is call one single source—Kearfott. Write for our new brochure "Kearfott Servos."



Inertial Navigation System Coupler for side-looking radar used in RF4B and RA4C aircraft. Vibration snubbers overcome 500 cps, 30 g vibration.

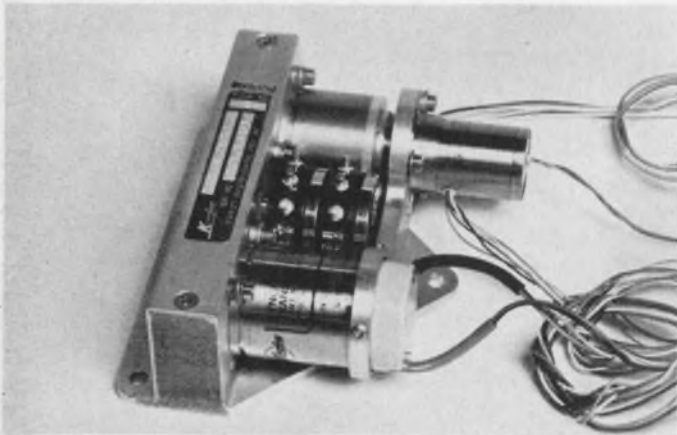

Lead Sight Computer Tracking Servo for helicopter armament system. This servo reflects a special requirement for the command to come from the CT rather than the CX.



PROBLEMS?

ANSWER: KEARFOTT'S

"ALL-UNDER-ONE-ROOF" SERVICES.

KEARFOTT PRODUCTS DIVISION

**GP GENERAL
PRECISION INC.**

AEROSPACE GROUP

Little Falls, New Jersey

Three-Axis Coordinate Transformation Servo for airborne instrument landing system. Electrical inputs to CT's represent position in roll, pitch, and yaw. Electrical outputs are a coordinate transformation of the aircraft's coordinates with respect to ILS coordinates.

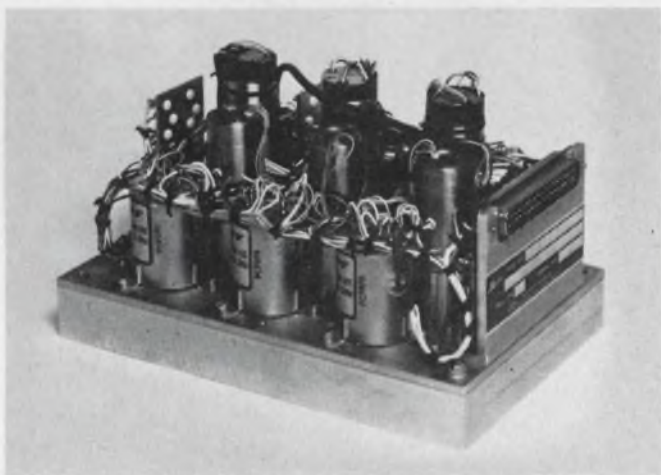

Synchronizing Drive used in flight control system of F4 series acts as a "reference" control for the autopilot. One of the many variations is a "Synchronizing Drive Azimuth Reference."



General Precision, Inc. is a subsidiary of General Precision Equipment Corporation.

ON READER-SERVICE CARD CIRCLE 29

Don't guess the spurious level

of an amplifier. The intercept-point method gives exact values with the aid of a simple nomograph.

Here is a simple way to predict accurately the spurious responses of an amplifier through bands of frequencies. The designer has to know the order and the magnitude of a response only at one frequency to be able to find all responses for any fundamental signal.

Exact knowledge of all spurious signals is essential in designs where an optimum trade-off between dynamic range and low noise is sought; for example, in receivers. This approach is increasingly preferred because of overcrowding of the frequency spectrum and the demand for versatility. When these considerations are important, the designer cannot use the conventional method—that is, shoot for lowest noise and settle for the resulting dynamic range.

The new technique makes use of the intersection of the fundamental and third-order responses on a log-log scale; therefore, it is called the intercept-point method. Besides yielding exact spurious levels, the intercept point can also be used to specify the amplifier in a more general and succinct way. For example, instead of "intermodulation products must be down 60 dB with respect to two signals at 0-dBm output," the engineer can say, "intercept point at +30 dBm."

In the past, when low noise was the primary design goal, a rule of thumb was used to predict the spurious response level, and hence the dynamic range, of amplifiers. This rule states that if two signals are present in an amplifier with an amplitude which is s dB below the 1-dB gain compression point, the third-order intermodulation products will be $2s$ dB below the signal level. However, this rule does not give accurate values for multi-stage transistor amplifiers.

Intercept point predicts 2nd and 3rd responses

A brief mathematical analysis is necessary to establish the relationship between the collector current and spurious signals. The instantaneous transistor collector current, as a function of the

base current, can be expressed as:

$$i_c = i_{b0} + k_1 i_b + k_2 i_b^2 + k_3 i_b^3. \quad (1)$$

If two signals are present at the base of the transistor, such that the base current is:

$$i_b = i_{b0} + a_1 \cos \omega_1 t + a_2 \cos \omega_2 t, \quad (2)$$

then the power-series expansion of the collector current, with Eq. 2 substituted for the base current, will contain components that are functions of:

- The dc bias current.
- The two input signals.
- Harmonics of the two input signals.
- Intermodulation products of the two signals and/or their harmonics.

The following are the pertinent terms of this expansion:

Fundamental:

$$k_1 a_1 \cos 2\pi f_1 t$$
$$k_1 a_2 \cos 2\pi f_2 t$$

Second order:

$$k_2 a_1 a_2 \cos 2\pi(f_1 \pm f_2)t$$
$$(1/2)k_2 a_1^2 \cos 2\pi(2f_1)t$$
$$(1/2)k_2 a_2^2 \cos 2\pi(2f_2)t$$

Third order:

$$(3/4)k_3 a_1^2 a_2 \cos 2\pi(2f_1 \pm f_2)t$$
$$(3/4)k_3 a_1 a_2^2 \cos 2\pi(2f_2 \pm f_1)t$$

This partial list of terms reveals that:

- The fundamental responses are directly proportional to the level of the input signals.
- The second order responses are proportional to the square of the input amplitude.
- The third order responses are proportional to the cube of the input amplitude.

Note that no assumptions have been made so far.

Hence, it can be concluded that a plot of each response on a log-log scale (or dB/dB scale) will be a straight line with a slope corresponding to the order of the response; i.e., the fundamental responses will have a slope of 1, the second order responses will have a slope of 2, etc. It is therefore sufficient to know the order of the response and its magnitude at one point alone in order to be able to plot the level of each response.

That point at which the fundamental response and the third order spurious responses intercept

Franz C. McVay, Vice President of Operations, Avantek, Inc., Santa Barbara, Calif.

will be used here as the reference. It is labeled the "Intercept Point" (P_i). There are several reasons for its choice.

The first reason is, of course, that it is a point established through mathematical analysis and yields more information. Contrast it, for instance, with the 1-dB gain compression point, which reveals only the deviation from the linear at one point of a curve. The shape of this curve at any other point can only be guesswork.

Another reason for selecting the intersection of the fundamental and third-order signals is that the third-order intermodulation product is generally the one that poses the most serious problems in a case where the bandwidth of the device under consideration is less than an octave. In addition, it transpires that the second-order plot intercepts the fundamental at the same point as the third-order. Incidentally, the measurements leading to the conclusion also confirmed that the second harmonic response is 6 dB below the second-order intermodulation response, as predicted by the expanded terms— $(1/2)k_2 a_1^2 \cos 2\pi(2f_2)t$ versus $k_2 a_1 a_2 \cos 2\pi(f_1 \pm f_2)t$. The intercept point may be also used, therefore, to predict the second-order response with good accuracy.

There are some exceptions, due to the system make-up, when the second- and third-order plots do not intercept at the same point. If some technique is used that suppresses even-order spurious responses (such as a push-pull operation), the second-order intercept point may be expected to be higher than that of the third-order. This would not affect the slope, which would still be two and three, respectively.

The concept of the intercept point is therefore valid for those cases, too, where the intercept for the second order does not coincide with that of the third order. However, then the intercept points for second and third order should be specified separately.

A typical set of measurements is shown in Fig. 1. The amplifier—an Avantek Model AP-20—was operated at 300 MHz. The linear portions of the responses have been extrapolated to the point where they intersect. The slope of the lines, drawn through the measured points, is in excellent agreement with the theory. The difference between predictions with the intercept-point and the 1-dB compression-point concepts is illustrated in Fig. 2, through a frequency band from 200 to 400 MHz.

Measured values, indicated by the circled points in Fig. 2 near line C, confirm predictions based on the intercept-point method.

How to use the intercept point

With the intercept point known, it is very simple to calculate the level of spurious responses. The nomograph in Fig. 3 comes handy in the process.

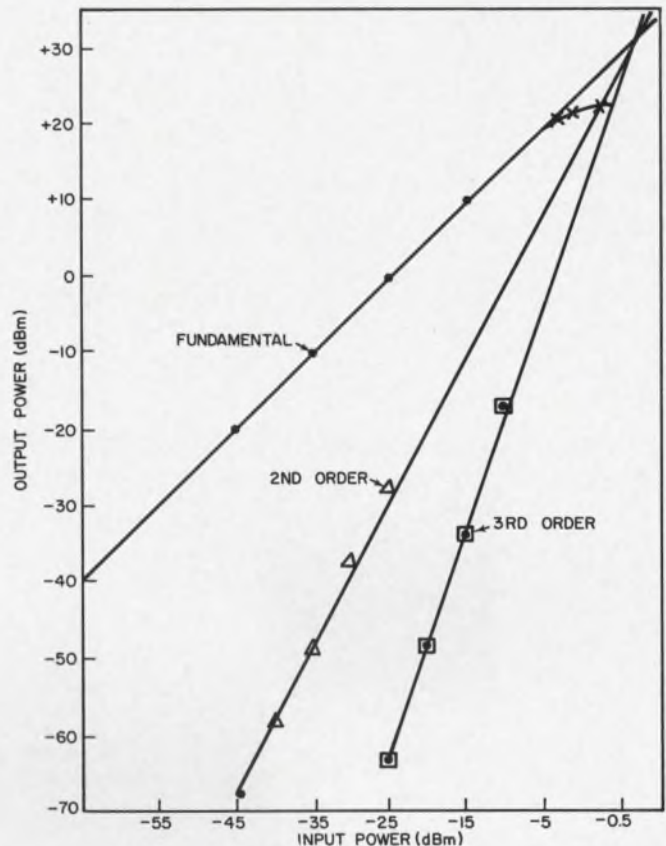

1. The plot of amplifier responses is a set of straight lines on the log-log scale. The slope of the line depends on the order; the fundamental has a slope of 1, the second order has a slope of 2 and the third order has a slope of 3. The intersection of the fundamental and third order yields the intercept point.

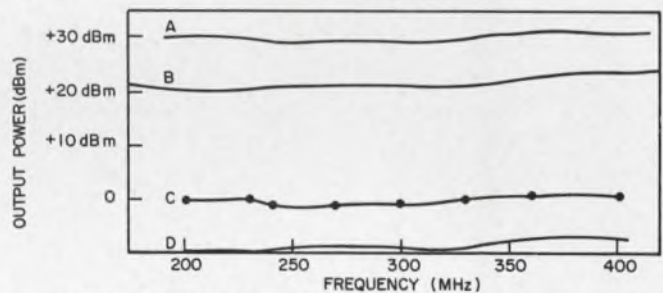

2. A comparison of signal levels, predicted by the intercept method (A) and with the 1-dB compression point (B) shows difference. To achieve a 3rd-order IM level 60 dB down, the signal level predicted with the intercept point (C) is about 10 dBm above that predicted with the 1-dB compression point (D). Dots on (C) are test results.

(Copies of the nomograph are available on a heavy stock paper. For your copy, circle Reader Service No. 349 on the card at the back of the magazine.)

Assume, for example, that the P_i is +30 dBm. The output contains two equal signals of -10-dBm amplitude. What is the level of third-order intermodulation (IM) spurious responses?

As the signal level is 40 dB below the intercept point, the third-order response, having a slope of 3, must be 80 dB below these signals, or at -90

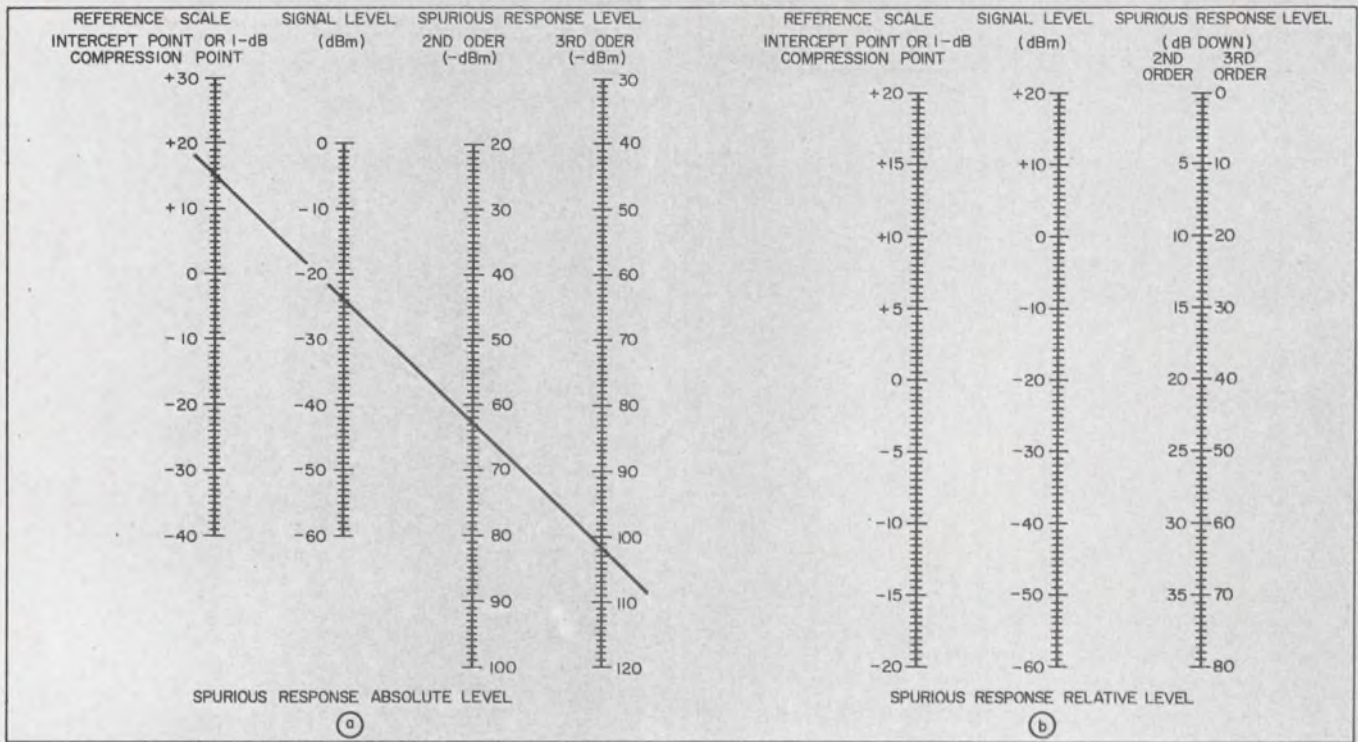

3. Nomographs allow rapid calculations of the absolute (a) and relative (b) spurious levels of the second- and

third-order intermodulation signals. The example worked out in the text is illustrated on (a).

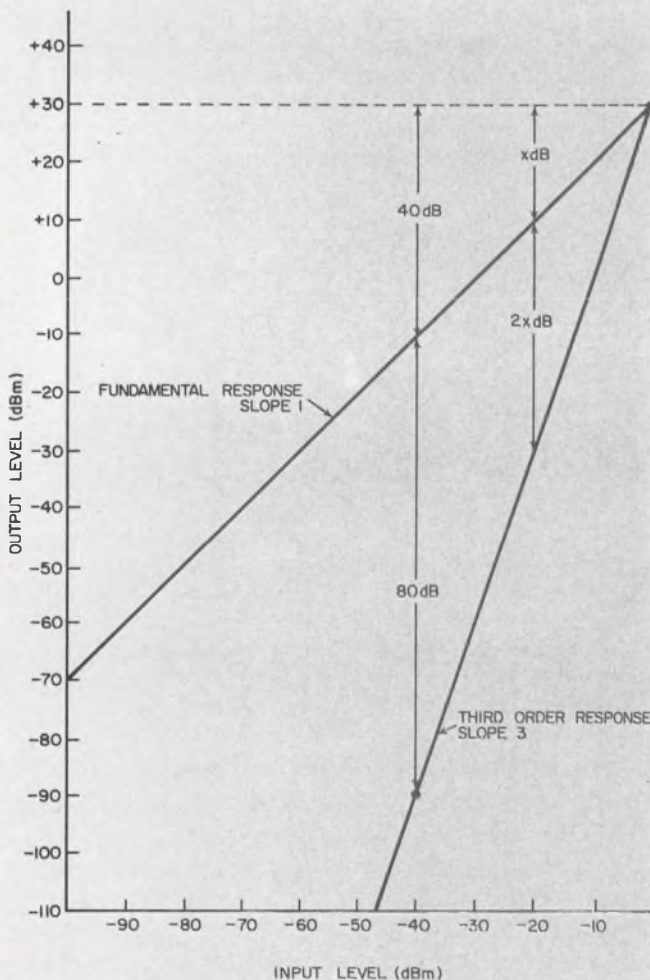

4. The level of the third-order response can be found immediately, once the intercept point and the fundamental signal are known.

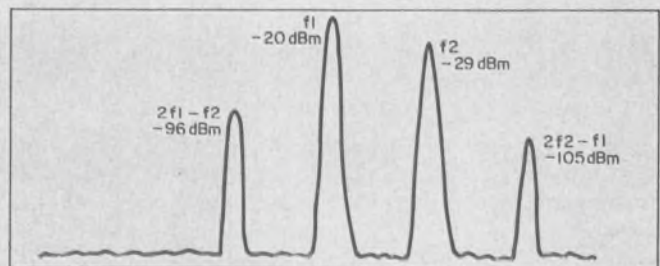

5. The third-order spurious signals, generated by two unequal inputs, will appear on a spectrum analyser as this sketch. Their amplitude can be found by establishing an equivalent amplitude for the two input signals and considering two identical signals at the new level.

dBm, as shown in Fig. 4.

Or, to tackle the same problem from another direction, assume that another set of parameters is specified: The noise figure is 3 dB and the final IF bandwidth is 5 MHz. How do you find the dynamic range of the preamplifier?

With a 3-dB noise figure and 5-MHz bandwidth, the signal-to-noise ratio becomes unity; that is, $S = N$ when:

$$-114 + 3 \text{ dB(NF)} + 7 \text{ dB(BW)} = -104 \text{ dBm.}$$

In other words, the noise power, referred to the input of the amplifier, is -104 dBm for every 5-MHz bandwidth increment. A minimum detectable signal level may then be -101 dBm. Assuming an intercept point of $+15$ dBm, the total range between minimum detectable signals and the intercept point is 116 dB. Two signals, each having an amplitude of one-third the total range, will have

spurious responses at the minimum detectable signal level; therefore, divide 3 into 116. Thus each of the two signals is at about 39 dB below the intercept point. From the nomogram, two signals 39 dB below the intercept point, or at -24 dBm, have third-order spurious responses at -102 dBm. The spurious-free dynamic range in this case is -102 dBm $- (-24$ dBm) = 78 dB.

The next obvious case to consider is that of two unequal signals. The two signals and their third-order IM products appear on a spectrum analyzer as shown in Fig. 5.

The two signals, f_1 and f_2 , generate two spurious responses at $2f_1 - f_2$ and at $2f_2 - f_1$. A quick check of the arithmetic will show that these signals will be equally spaced on a linear frequency scale. The amplitude of the spurious signal on the left, $2f_1 - f_2$, is a function of the product of the amplitudes of f_1 squared and f_2 ; the amplitude of the spurious signal on the right is a function of the product of the amplitudes of f_2 squared and f_1 .

This means that if the amplitude of f_1 is increased by 1 dB, the amplitude of $(2f_1 - f_2)$ —the spurious signal on the left—increases by 2 dB and the amplitude of $(2f_2 - f_1)$ increases by 1 dB.

A rule can now be formulated that covers the case of two unequal signals. Assume two signals, f_1 and f_2 , are at a level of -20 and -29 dBm, respectively, with spurious responses at -96 and -105 dBm, as shown in Fig. 2.

If the amplitude of f_1 is decreased by 3 dB, spurious signal C will be shifted downward by 6 dB. If then f_2 is increased by 6 dB, C will shift upward by 6 dB and be at the same level it was originally; and the amplitude of f_1 and f_2 will be equal (-23 dBm).

The level of two equal signals that yield the same spurious response as the two given unequal signals is determined as follows: Take the stronger of the two signals and subtract from it one-third of the difference between the two signals. This essentially equalizes the two signals, and yields an equivalent amplitude. Two signals at this new level generate the same worst-case third-order spurious level as the two original unequal signals. In the previous example the difference between the two signals is 9 dB [-20 dBm $- (-29$ dBm)]. The worst spurious is the same as one generated by two equal signals at -20 dBm $- 9/3$ dB = -23 dBm.

Simply subtract one-third of the difference between the two signals from the stronger of the two, find this value on the nomograph, and proceed to find the intercept point and dynamic range in the same manner as for two equal signals. ■ ■

Acknowledgment:

The author wishes to express his gratitude to Leonard Seader and Jim Sterrett, for their contributions to the concept and verification of the intercept method.

ANOTHER FABRICATING SERVICE FROM



PROTECT YOUR INSTRUMENTS WITH AMALCO ALUMINUM CARRYING CASES



Amalco aluminum carrying cases are perfect for carrying instruments safely. Tightly sealed to prevent dust, sprays and dirt to enter, these cases are ruggedly constructed to sustain unusual abuse. The Amalco carrying cases come in eight economical sizes and can be modified to suit your specific needs.

Write for descriptive literature and specifications on the Amalco Aluminum Carrying Cases.

OTHER PRODUCTS & SERVICES OF AMERICAN ALUMINUM

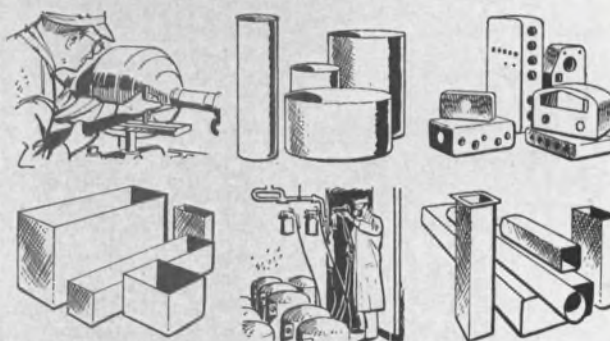

SPECIALISTS IN CONTRACT MANUFACTURING OF ALUMINUM

COMPLETE FABRICATING FACILITIES FOR DEEP DRAWING, HEAT TREATING, SPINNING, ASSEMBLY, SHEET METAL, STAMPINGS, ANODIZING, WELDING, FINISHING.

Send for brochure "Aluminum Fabricating For Industry"



AMERICAN ALUMINUM COMPANY

Manufacturers of Aluminum Products for Industry since 1910

230 Sheffield St. • Mountainside, N. J. • 201-233-3500

ON READER-SERVICE CARD CIRCLE 30

NEW

Lambda high current LK Series power supplies 0-20, 0-36, 0-60 VDC • up to 35 amps • 5¼" height • starting at \$330.

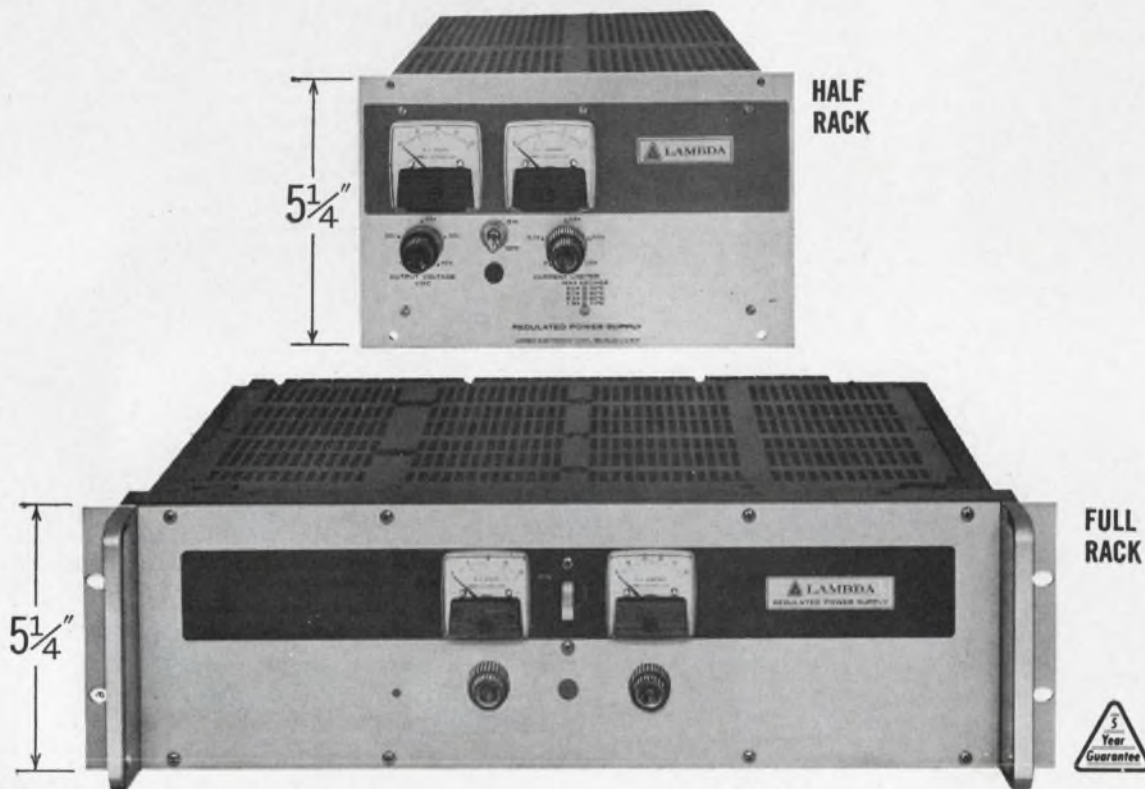

Features

- All Silicon
- Convection cooled
- Remotely programmable
- Meet Mil-Environment specs
- Vibration: MIL-T-4807A
- Shock: MIL-E-4970A
- Proc. 1 & 2
- Humidity: MIL-STD-810
- Meth. 507
- Temp. Shock: MIL-E-5272C
- (ASG) Proc. 1
- Altitude: MIL-E-4970A
- (ASG) Proc. 1
- Marking: MIL-STD-130
- Quality: MIL-Q-9858
- Remote Sensing

- Series/Parallel Operation
- Regulation—.015% or 1 MV (Line or Load)
- Ripple—500 μ V RMS.
- Temp. Coef. .015%/°C
- Transformer—designed to MIL-T-27 Grade 6
- Completely Protected—Short Circuit Proof—Continuously Adjustable Automatic Current Limiting
- Constant I./Constant V. by automatic crossover
- No Voltage Spikes or Overshoot on "turn on, turn off" or power failure
- Wide Input Voltage and Frequency Range—105-132 VAC, 47-63 cps

RACK OR BENCH USE—rubber feet included for bench use.



LAMBDA ELECTRONICS CORP.

515 BROAD HOLLOW ROAD • MELVILLE, L. I., NEW YORK • 516 MYRTLE 4-4200

A Veeco SUBSIDIARY

LA-173

3 full-rack models—Size 5¼" x 19" x 16½"

Model ¹	Voltage Range	CURRENT RANGE AT AMBIENT OF: ¹				Price ²
		40°C	50°C	60°C	71°C	
LK 350	0-20VDC	0-35A	0-31A	0-26A	0-20A	\$675
LK 351	0-36VDC	0-25A	0-23A	0-20A	0-15A	640
LK 352	0-60VDC	0-15A	0-14A	0-12.5A	0-10A	650

6 half-rack models—Size 5¾" x 8¾" x 16½"

Model ¹	Voltage Range	CURRENT RANGE AT AMBIENT OF: ¹				Price ²
		40°C	50°C	60°C	71°C	
LK 340	0-20VDC	0- 8.0A	0- 7.0A	0- 6.1A	0-4.9A	\$330
LK 341	0-20VDC	0-13.5A	0-11.0A	0-10.0A	0-7.7A	385
LK 342	0-36VDC	0- 5.2A	0- 5.0A	0- 4.5A	0-3.7A	335
LK 343	0-36VDC	0- 9.0A	0- 8.5A	0- 7.6A	0-6.1A	395
LK 344	0-60VDC	0- 4.0A	0- 3.5A	0- 3.0A	0-2.5A	340
LK 345	0-60VDC	0- 6.0A	0- 5.2A	0- 4.5A	0-4.0A	395

¹ Current rating applies over entire voltage range.

² Prices are for non-metered models. For metered models add suffix (FM) to model number and add \$30.00 to price.

³ Overvoltage Protection: Add suffix (OV) to model number and add \$70.00 to the price for half-rack models; \$90.00 for full-rack models.

Adlake Mercury Wetted Relay — Application Data

Measurement of "Dynamic Contact Noise" for Low Level Signal Applications



**Adlake AWCS
26000 Series Relay —
2 Switch Form C**

In small signal applications, such as computers, telemetric systems, strain gauges, etc. generated emf. within the system's relays must be taken into account.

Dynamic Contact Noise is a "coined" phrase used to indicate an undesired generated emf. upon contact closure. It is the result of mechanical oscillation of the armature—caused by the impact of the armature on the stationary contacts — sweeping the coil flux.

Typical illustrations of this noise are shown in the oscillograms, with the relay being driven at nominal voltage in the test circuit shown below. The frequency and amplitude are integral functions of system bandwidth and coil drive conditions.

The slight ripple seen at the end of each trace is not noise, but due to resolution of test equipment and test circuit*.

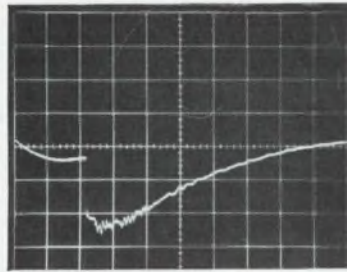

FIGURE 1
Horizontal Deflection 1.0 ms/cm
Vertical Deflection 20 μ V/cm
Systems Bandwidth .06–60 Hz.

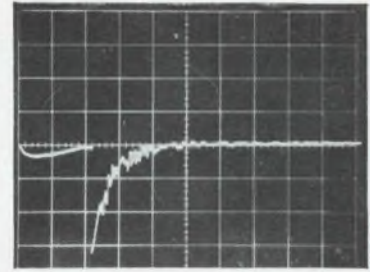

FIGURE 2
Horizontal Deflection 1.0 ms/cm
Vertical Deflection 100 μ V/cm
Systems Bandwidth .06–600 Hz.

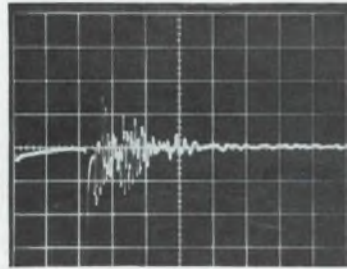

FIGURE 3
Horizontal Deflection 1.0 ms/cm
Vertical Deflection 200 μ V/cm
Systems Bandwidth .06–6K Hz.

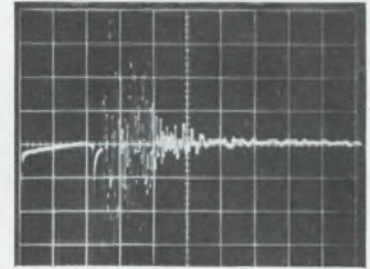

FIGURE 4
Horizontal Deflection 1.0 ms/cm
Vertical Deflection 200 μ V/cm
Systems Bandwidth .06–60K Hz.

TEST CIRCUIT

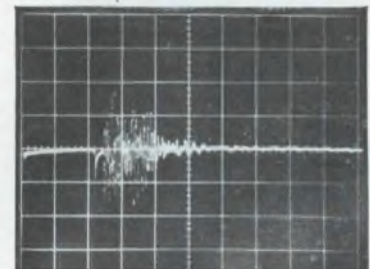
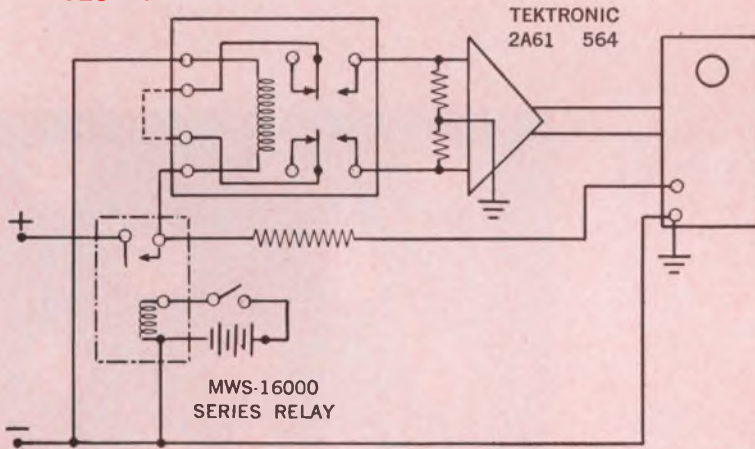

FIGURE 5
Horizontal Deflection 1.0 ms/cm
Vertical Deflection 500 μ V/cm
Systems Bandwidth .06–100K Hz.

* If you have a problem regarding relay applications to a particular system our engineering staff is ready to help you. Contact Mr. Le Roy Carlson, Chief Project Engineer.

Backed by sound research and disciplined engineering, Adlake applies the industry's broadest line of mercury displacement and mercury wetted relays to the creative solution of design circuit problems. However unique or special your application, Adlake can assist you in

developing it. For prompt, personal and knowledgeable attention to your relay needs, contact the one source that is the complete source in the mercury relay field. Contact Adlake today for catalog and further information.



THE ADAMS & WESTLAKE COMPANY

Dept. 1027 Elkhart, Indiana, U.S.A. 46514 • (AC 219) 264-1141

TRANSPORTATION EQUIPMENT • ARCHITECTURAL PRODUCTS • MERCURY RELAYS • DOORS AND ENTRANCES • CONTRACT MANUFACTURING
ON READER-SERVICE CARD CIRCLE 32

Ease the design of magnet coils

by using a one-page nomogram that correlates some twenty variables involved.

The large number of variables and parameters correlated partly by algebraic, partly by empirical equations is the toughest problem in designing magnet coils.

Here is where the nomogram really comes into its own. The single nomogram shown here encompasses practically all coil dimensions from the very small miniature solenoid requiring a winding space of 1/4 square inch of very fine wire (42-gauge) to large magnet coils that occupy 100 square inches of winding area and more.

Furthermore, it makes it possible to visualize the functional interdependence of the variables, and can be so arranged that all expected changes are immediately recognizable. It is useful for a quick, preliminary check whether a certain number of ampere-turns can be fitted into a proposed space and what compromises and limitations have to be accepted.

Why use a nomogram?

To demonstrate the number of variables involved in a coil design and their interrelationships, a PERT-type diagram is given in Fig. 1. Underlining the importance of the ampere-turns produced by the coil, the circle marked *At* (ampere-turns) is placed in the center of the diagram. The figure enables the designer to visualize the number of variables and the degree of complexity associated with calculations of a coil parameter.

It may be argued that most of the steps indicated in Fig. 1 can be carried out on a slide rule. This is true, but a nomogram gives, at a glance, the degree of freedom that the designer has in choosing and adjusting any variable. This is particularly important in coil design where a change in one variable affects several parameters. This advantage of the nomogram can easily be appreciated if calculations are first attempted on a slide rule and then repeated for purposes of comparison using the nomogram.

John H. Fasal, Assistant Chief Engineer, Walter Kidde & Co., Belleville, N. J.

The starting point in evaluating coil parameters is generally the number of ampere-turns required to achieve a specific magnetolectric performance. All other design information can be obtained by simple alignments between the various scales of the nomogram.

In the nomogram of Fig. 2, a number of equations are placed on lines underneath the scales. This part of the nomogram is the "alignment guide" since it indicates the mathematical relationships between the variables and between the corresponding scales. For example, the expression $At = In$ appears on the line joining the *n*, *I*, and *At* scales. The explanation of the symbols in the nomogram and the various relationships correlating them appear in the box.

In preparing the nomogram it was found that some scales coincided with each other, differing only in the location of the decimal point. To avoid confusion, one scale in all such cases was put

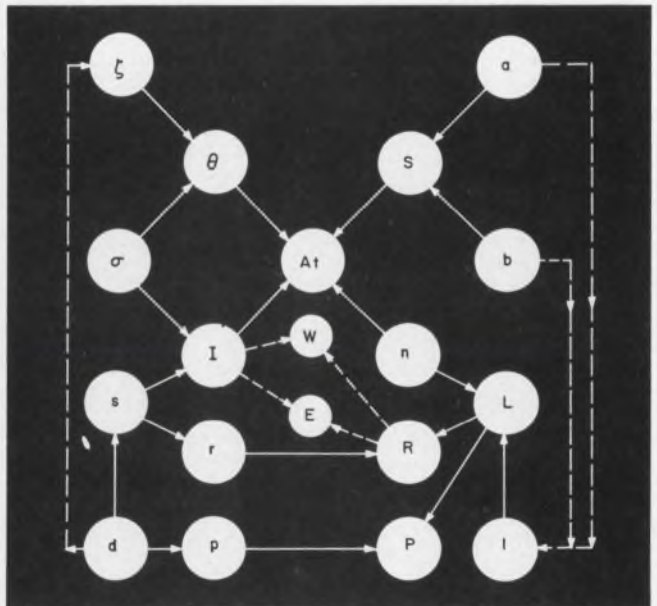

1. The difficulty of manipulating the minimum number of variables associated with the magnet coil design can be visualized by examining this diagram. Arrows joining the circles indicate functional dependence.

Symbols and notation

At	Ampere-turns.
ζ	Theoretical space factor.
σ	Winding current density in A/mil ² .
Θ	At/in ² of window section.
n	Number of turns.
I	Coil current in amperes.
d	Wire diameter in mils.
s	Wire section in mil ² .
S	Available winding area (window minus areas for insulation between layers, bobbin, end leads, etc.) in in ² .
a	Length of the available windings area in inches.
b	Height of the available windings area in inches.
l	Length of one turn (average value) in inches.
L	Total wire length in feet.

Coil-parameter relationships

$At = \Theta \times S.$	(i)	$S = a \times b.$	(vii)
$At = n \times I.$	(ii)	$L = n \times l.$	(viii)
$\Theta = \zeta \times \sigma.$	(iii)	$r = f(s).$	(ix)
$\zeta = \eta_1(d).$	(iv)	$p = \eta_2(d).$	(x)
$I = \sigma \times s.$	(v)	$R = r \times I.$	(xi)
$s = d^2 \pi / 4.$	(vi)	$P = L \times p.$	(xii)

Table. Current density in in A/mil²

Cooling by environmental air		Forced-air cooling		Mode of operation	Temperature rise
Open Coil	Sealed Coil	Open Coil	Sealed Coil		
1.5-2.5	1 -1.5	2 -3	1.5-2.5	Continuous	Moderate
2.5-4	1.5-2.5	3 -5	2.5-4	Intermittent	
2 -3	1.5-2.5	2.5-4	2 -3	Continuous	High
3 -5	2 -3	4 -5.5	3 -5	Intermittent	

alongside its "twin," with each scale properly numbered. The scales in question are for a_{in} , R_n , and p_s ; in the nomogram, the values for these variables are beside the Θ , P_s , and r_n scales, respectively. This is illustrated, for instance, where a horizontal line is drawn on the appropriate scale between Θ and a_{in} to register that $a = 1.8$ inches.

The coil and wire resistances, R and r , respectively, denote the resistance at 20°C. At other temperatures, resistance can be computed using the following expression:

$$R_t = R_{20}[1 + \alpha_{20}(T - 20)], \quad (1)$$

where

$$\begin{aligned} R_t &= \text{resistance at temperature } t, \\ R_{20} &= \text{resistance at } 20^\circ\text{C}, \\ \alpha_{20} &= \text{temperature coefficient of the wire} \\ &= 0.00393 \text{ for copper),} \\ T &= \text{temperature in } ^\circ\text{C}. \end{aligned}$$

One of the most important variables that determine the coil layout is the current density in the windings. At the same time, since it is a function of the windings' location, insulation, encapsulation, cooling, permissible temperature rise and so on, it does not lend itself to a theoretical analysis. Consequently, a table based on empirical data has been prepared for use with the nomogram. The values in the table specify permitted current densities (in A/mil²) for various environmental conditions.

The area, S , occupied by the wire excludes space for end leading, bobbin and interlayer insulation. Up to gauge 35, the wire should be wound in regular layers. Wire finer than gauge 35 may be brought up in random windings, but should be evenly distributed over the available

space in close resemblance to regular layers.

If interlayer insulations are applied, subtract from the available area 1.5 to 2 times the theoretical area occupied by the insulating layers. For instance, if two layers of 0.002-inch-thick Mylar insulation are applied three times and one layer of 0.005-inch-thick oil paper is used between the primary and secondary winding, and if the coil length is two inches, the total theoretical loss of winding area will be $(3 \times 2 \times 0.002 + 0.005) \times 2 = 0.017 \times 2 = 0.034$ in². For all practical purposes S has to be reduced by an area of 0.05 to 0.07 square inch. Furthermore, for each end-lead or tap, subtract the area of an insulating layer of a thickness corresponding to the diameter of the insulated wire. This reduction may be kept somewhat smaller if the coil is long in comparison with its diameter and if several end leads are located on the same layer. On the assumption that the coil mentioned above has four end leads with an exterior diameter of 0.03 inch, the available winding area has to be reduced by a supplementary amount of $4 \times 0.03 \times 2 = 0.24$ square inch.

Exploit the nomogram

Assume that a magnet coil, producing a minimum of 1000 At, has to be designed. The intention is to use a wire with double nylon insulation ($2 \times$ nylon) and to enclose the coil in a hermetically sealed housing exposed to still air and operating continuously with a moderate temperature rise, as defined in the table.

As a start, a total area is allowed for the windings (including insulation, end leads, etc.) of 2 square inches for a coil length of 1.8 inch. Four end leads, made of vinyl-insulated, stranded 20-

MAGNET COILS

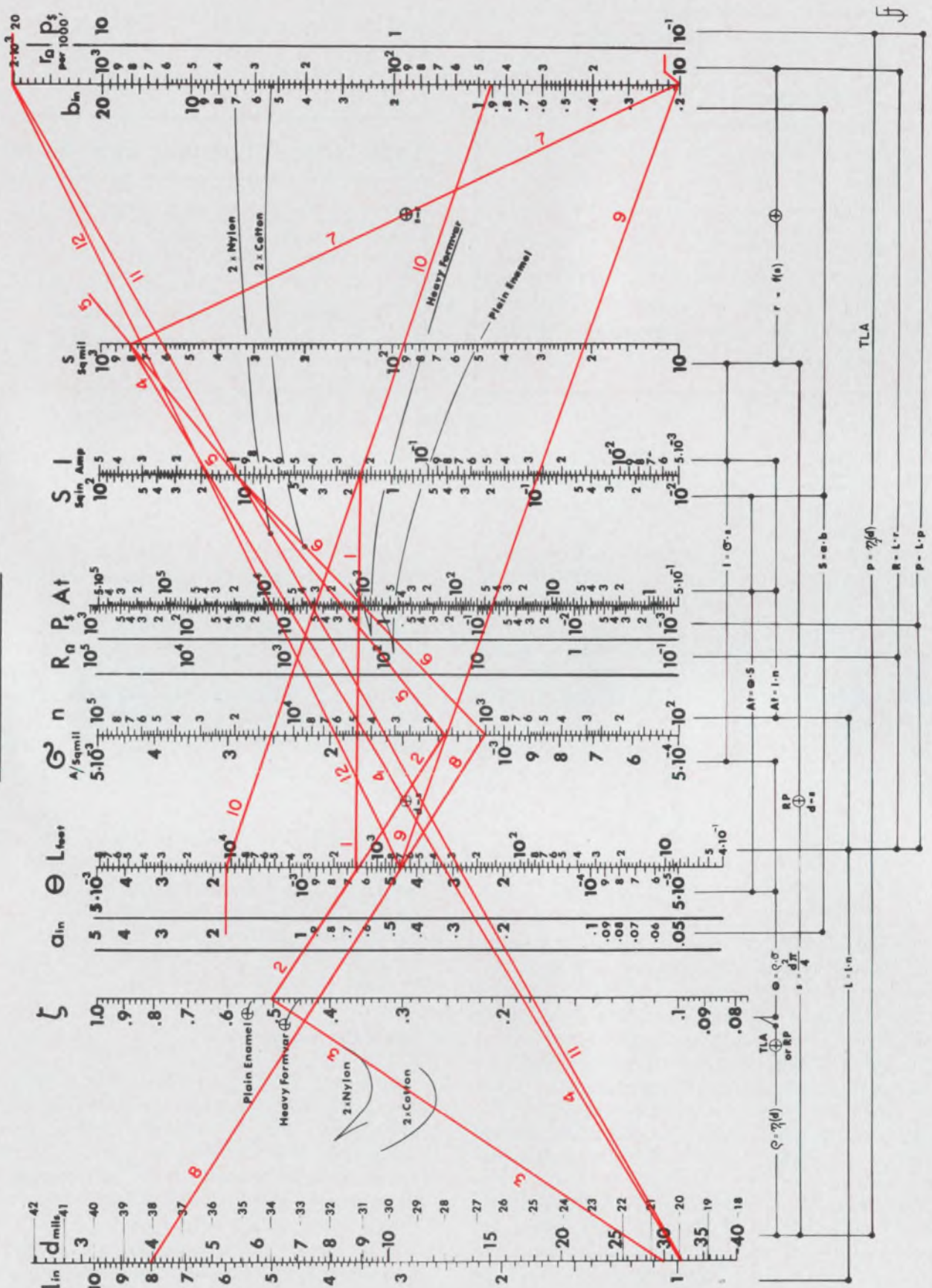

2. The variables and parameters of Fig. 1 can be managed easily with the above nomogram. The straight lines num-

bered 1 through 12 denote the twelve graphical steps required to carry out coil design (see text).

gauge wire, are needed. The wire has an exterior diameter of 0.05 inch. It is assumed that three double layers of oil paper insulation, each 0.002 inch thick, and four layers of kraft paper insulation, 0.01 inch thick, will be applied. The average length of one winding will be about eight inches.

First the actual available windings area, S , is calculated. The oil paper layers will reduce the total space by $3 \times 2 \times 0.002 \times 1.8 = 0.0216 \text{ in}^2$. The wrapping requires a space of $4 \times 0.01 \times 1.8 = 0.072 \text{ in}^2$. The end leading needs $4 \times 0.05 \times 1.8 = 0.36 \text{ in}^2$. The total area is $0.4536 \approx 0.4 \text{ in}^2$. The winding area that is available in practice is therefore:

$$S = 2 - 0.4 = 1.6 \text{ in}^2.$$

From the table the permissible current density, σ , is found to be from 1 to 1.5 A/mil². Choose $\sigma = 1.25$.

All other parameters may now be obtained from the nomogram. All the steps explained below are shown in the nomogram of Fig. 2, where each step is numbered as in the text.

Step 1: Calculate $\Theta = \zeta \cdot \sigma$ where $At = 1000$ and $S = 1.6$ From Eq. i (see box):

$$\Theta = 625 \times 10^{-6} = 6.25 \times 10^{-4},$$

where S in square inches was converted into square mils.

Step 2: From $\Theta = 6.25 \times 10^{-4}$ and $\sigma = 1.25 \times 10^{-3}$, we get $\zeta = 0.5$.

Step 3: The tangent line alignment (TLA) for $\eta_1(d)$ shows that, if 2 × nylon insulated wire is used, the wire diameter has to be:

$$d = 30 \text{ mils.}$$

The nearest standard wire (20-gauge) has a diameter of 31.96 mils. Therefore, 32 mils will be used for calculations in all subsequent steps.

Step 4: Aligning $d = 32$ mils and the reference point (RP) d - s determines on the s scale the corresponding wire section:

$$s = 8 \times 10^2 \text{ mil}^2.$$

Step 5: Wire section $s = 8 \times 10^2$, aligned with the established current density, $\sigma = 1.25 \times 10^{-3}$, defines the current through the windings:

$$I = 1 \text{ A.}$$

Step 6: Aligning the found current, $I = 1$ A, and the desired ampere-turns, $At = 1000$, gives the necessary number of turns:

$$n = 1000.$$

Step 7: The wire resistance, r , per 1000 feet of wire is obtained by aligning $s = 8 \times 10^2$ (corresponding to 20-gauge wire) and RP s - r :

$$r = 10 \Omega/1000 \text{ ft.}$$

Step 8: For an assumed length, l , of 8 in. per turn, the total wire length is obtained by alignment of $l = 8$ and $n = 1000$:

$$L = 665 \text{ ft.}$$

Step 9: Aligning $L = 665$ ft and $r = 10 \Omega/1000$ ft yields the total resistance of the coil:

$$R = 6.75 \Omega.$$

The voltage to be applied to the coil terminals is therefore:

$$E = I \cdot R = 1 \text{ A} \times 6.75 \Omega = 6.75 \text{ V.}$$

Step 10: The height, b , of the wires superimposed in layers is found by aligning the actual winding area, $S = 1.6 \text{ in}^2$, and the length of the coil, $A = 1.8 \text{ in.}$:

$$b = 0.89 \text{ in.}$$

Step 11: A TLA to the 2 × nylon curve or through the RP at its left end gives the price for 1000 feet of 20-gauge, 2 × nylon wire:

$$p = \$20.1/1000 \text{ ft.}$$

Step 12: Finally alignment of $p = 20.1$ and $L = 665$ gives the total price of the wire:

$$P = \$13.5.$$

A change in the quality of the wire from 2 × nylon to heavy Formvar changes all alignments from Step 3 onwards.

The two alternatives would be:

	2 × nylon	Heavy Formvar
At	1000 turns	1000 turns
S	1.6 in ²	1.6 in ²
Θ	6.25×10^{-4}	6.25×10^{-4}
σ	1.25×10^{-3} A/mil ²	1.25 A/mil ²
ζ	0.5	0.5
d	32 mils	10 mils
s	802 mil ²	78.9 mil ²
I	1 A	0.098 A
n	1000 turns	10,200 turns
r	10 $\Omega/1000$ ft	103 $\Omega/1000$ ft
L	665 ft	6780 ft
l	8 in./turn	8 in./turn
p	$\$20.1/1000$ ft	$\$1.4/1000$ ft
R	6.75	700
P	$\$13.5$	$\$9.5$
a	1.8 in.	1.8 in.
E	6.75 V	68.5 V

The use of heavy Formvar wire instead of 2 × nylon wire permits an increase in the number of windings and the total wire resistance so that the same number of ampere-turns may be obtained with less current and higher coil voltage.

This sequence of steps can be changed just like the primary assumptions. In all cases, however, any changes in the parameters can be clearly visualized and the necessary corrections made simply by the relocation of a few lines. ■ ■

When you measure operational amplifier value



use the whole ruler!

The Right Amplifier — You get the amplifier that's just right for your application from Burr-Brown's broad line. General purpose, FET, chopper stabilized, high voltage, low voltage, military, miniature and custom units are available in a wide range of configurations.

The Right Circuit — Burr-Brown wrote the book on operational amplifier applications. In addition to two popular handbooks, a large Applications Engineering staff is always at your service.

The Right Accessories — Burr-Brown has a complete line of support accessories including: power supplies, connectors, circuit simulators, adapters, and regulators.

Immediate Delivery — After all, "Dash" is our middle name. Exclusive Jet-Stock service puts most units in your hands within 24-hours. We have even designed, built and shipped custom demonstrator units in less than one day.

Guaranteed Performance — Every Burr-Brown unit is tested under a Quality Assurance program designed to meet the requirements of MIL-Q-9858A, MIL-I-45208A, MIL-C-45662A, and NASA NPC-200-3.

Reliability — Conservative component stress design, conservative ratings, and stringent process control procedures result in predicted MTTF ratings in excess of 700,000 hours for most units.

Satisfaction — In ten years, we've built a reputation for customer satisfaction we don't intend to jeopardize.

Guaranteed Source — Burr-Brown is still supplying units introduced in 1956 despite averaging 200 new models a year.

No-Cost Evaluation — We currently have over 1,600 demonstrator units available at Field Offices. Which one would you like to evaluate?

Local Service — Over 80 domestic Burr-Brown Engineering Representatives are ready, willing and able to assist you.

FOR CURRENT CATALOG

on Burr-Brown "maximum value" Operational Amplifiers and Accessories, contact your nearest Engineering Representative, write Burr-Brown, or use this publication's reader-service card.

BURR-BROWN

RESEARCH CORPORATION

International Airport Industrial Park • Tucson, Arizona 85706
TELEPHONE: 602-294-1431 • TWX: 910-952-1111 • CABLE: BBRCORP



*Operational Amplifiers
Instrumentation Amplifiers
Function Modules
Analog Simulators
Geophysical Instruments*

ENGINEERING REPRESENTATIVES: ALABAMA, HUNTSVILLE (205) 534-1648 / ALASKA, ANCHORAGE (907) 272-5231 / ARIZONA, PHOENIX (602) 254-6085 / CALIF., LOS ANGELES (213) 665-5181, SAN FRANCISCO (408) 245-3321 / COLO., DENVER (303) 388-4391 / CONN., MILFORD (203) 874-9222 / FLORIDA, ORLANDO (305) 425-2764 / ILLINOIS, CHICAGO (312) 286-6824 MD., SILVER SPRING (301) 588-8134 / MASS., BOSTON (617) 245-4870 / MICH., DETROIT (313) 353-3822 / MINN., MINNEAPOLIS (612) 781-1611 / MO., ST. LOUIS (314) 524-4800 / N.C., GREENSBORO (919) 273-1918 / N.J., CAMDEN (609) 365-2450 / N.M., ALBUQUERQUE (505)

255-1638 / N.Y., ALBANY (518) 436-9649, BINGHAMTON (607) 723-9661, BUFFALO (716) 632-2727, MT. VERNON (914) 968-2200, NEW HARTFORD (315) 732-3775 / OHIO, CINCINNATI (513) 761-5432, CLEVELAND (216) 884-2001, DAYTON (513) 277-8911 / OKLA., TULSA (918) 835-2481 / OREGON, PORTLAND (503) 292-8762 / PENN., PITTSBURGH (412) 243-6655 / TEXAS, DALLAS (214) 363-1671, HOUSTON (713) 928-5251 / UTAH, SALT LAKE CITY (801) 466-8709 WASH., SEATTLE (206) 622-0177 / CANADA, TORONTO (416) 293-7011, VANCOUVER (604) 736-6377

Compatible Current Sinking NAND Logic Summary

Number and function	Typical Specifications at 25°C Free Air Temperature			
	Noise Immunity	Propagation Delay	Power Dissipation	Fan-out
TT_μL				
9000 Clock-gated J-K flip-flop	1 volt	25nsec.	45mW	10
9001 Clock-gated J-K flip-flop	1 volt	25nsec.	45mW	10
9002 Quad 2-input gate	1 volt	10nsec.	12mW	12
9003 Triple 3-input gate	1 volt	10nsec.	12mW	12
9004 Dual 4-input gate	1 volt	10nsec.	12mW	12
9005 Dual AND/OR/NOT gate	1 volt	12nsec.	12mW	12
9006 Dual 4-input extender		4nsec.		
9007 8-input gate	1 volt	10nsec.	12mW	12
9008 Quad 2-input AND/NOR gate	1 volt	12nsec.	12mW	12
9009 Dual 4-input buffer	1 volt	15nsec.	22mW	30
DT_μL				
9111 Parallel-gated clocked flip-flop	1 volt	40nsec.	48mW	8
9930 Dual 4-input gate	1 volt	25nsec.	8mW	8
9931 Clock-gated flip-flop	1 volt	50nsec.	20mW	7
9932 Dual 4-input buffer	1 volt	35nsec.	35mW	25
9933 Dual 4-input extender				
9936 Hex inverter	1 volt	25nsec.	48mW	8
9937 Hex inverter	1 volt	20nsec.	72mW	6
9941 Monostable multivibrator	1 volt	25nsec.	35mW	10
9944 Dual 4-input power gate	1 volt	40nsec.	20mW	27
9945 Clock-gated flip-flop	1 volt	50nsec.	42mW	9
9946 Quad 2-input gate	1 volt	25nsec.	32mW	9
9948 Clock-gated flip-flop	1 volt	40nsec.	48mW	8
9949 Quad 2-input gate	1 volt	20nsec.	48mW	5
9950 High speed gated flip-flop	1 volt	20nsec.	50mW	10
9951 2-input monostable multivibrator	1 volt	25nsec.	35mW	10
9961 Dual 4-input gate w/extender	1 volt	20nsec.	24mW	6
9962 Triple 3-input gate	1 volt	25nsec.	24mW	8
9963 Triple 3-input gate	1 volt	20nsec.	36mW	6
LPDT_μL				
9040 Clocked flip-flop	1 volt	180nsec. (Output going positive) 90nsec. (Output going negative)	4mW	10
9041 Dual 3-input gate	1 volt	65nsec.	2mW	10
9042 Dual 3-input gate	1 volt	65nsec.	2mW	10
9043 Three and 4-input gate w/extender	1 volt	65nsec.	2mW	10
9044 Dual 4-input gate w/extender	1 volt	65nsec.	2mW	10
9046 Quad 2-input gate	1 volt	65nsec.	2mW	10
9047 Triple 3-input gate	1 volt	65nsec.	2mW	10

Contents of Sampler Kit

Qty.	PART		PRICE 1-99 each
	No.	Description	
4	9000	J-K flip-flop	\$ 5.10
2	9002	Quad 2-input gate	\$ 3.65
2	9946	Quad 2-input gate	\$ 3.65
2	9046	Quad 2-input gate	\$20.00

These products are in the industrial temperature range.

FIRST CLASS
Permit No. 111
Mountain View,
California

BUSINESS REPLY MAIL
No postage stamp necessary if mailed in the United States

Postage will be paid by

FAIRCHILD
SEMICONDUCTOR

A Division of Fairchild Camera
and Instrument Corporation
313 Fairchild Drive
Mountain View, California 94040
(415) 962-5011 TWX: 910-379-6435

FAIRCHILD SEMICONDUCTOR
P. O. Box 1058
Mountain View, California 94040



**Compatible Logic can optimize your system.
Send for proof.**

Please send me the Compatible Current Sinking Logic Product Sampler.

Name _____

Title _____

Company _____

Address _____

City _____

State _____ Zip _____

Check enclosed Bill me Bill my company. P.O. No. _____

Check here for data pack only

EDN

Integrated circuits are conventionally classified by family, and within each family by function. This method of classification restricts you to a single family within a system. Now Fairchild allows you to cross family boundaries and to design by function, selecting circuits from compatible logic families. This permits you to choose the best circuit for each function, and to optimize the system as a whole.

What is compatible logic? Fairchild classifies all digital integrated circuits into compatible logic groups: current sinking logic, current sourcing logic, and current mode logic. A current sinking logic gate (for example, a DTL gate) draws current into its output ("sinks" current) when in the low state, and draws virtually no current when in the high state. A current sourcing gate (for example, an RTL gate) drives current out of its output in the high state and, except for minor leakage, drives no current in the low state. Current mode logic can draw or drive current.

Compatible current sinking logic: There are three families within the Fairchild current sinking group: TT_μL (Transistor-transistor Micrologic), DT_μL (Diode-transistor Micrologic®)

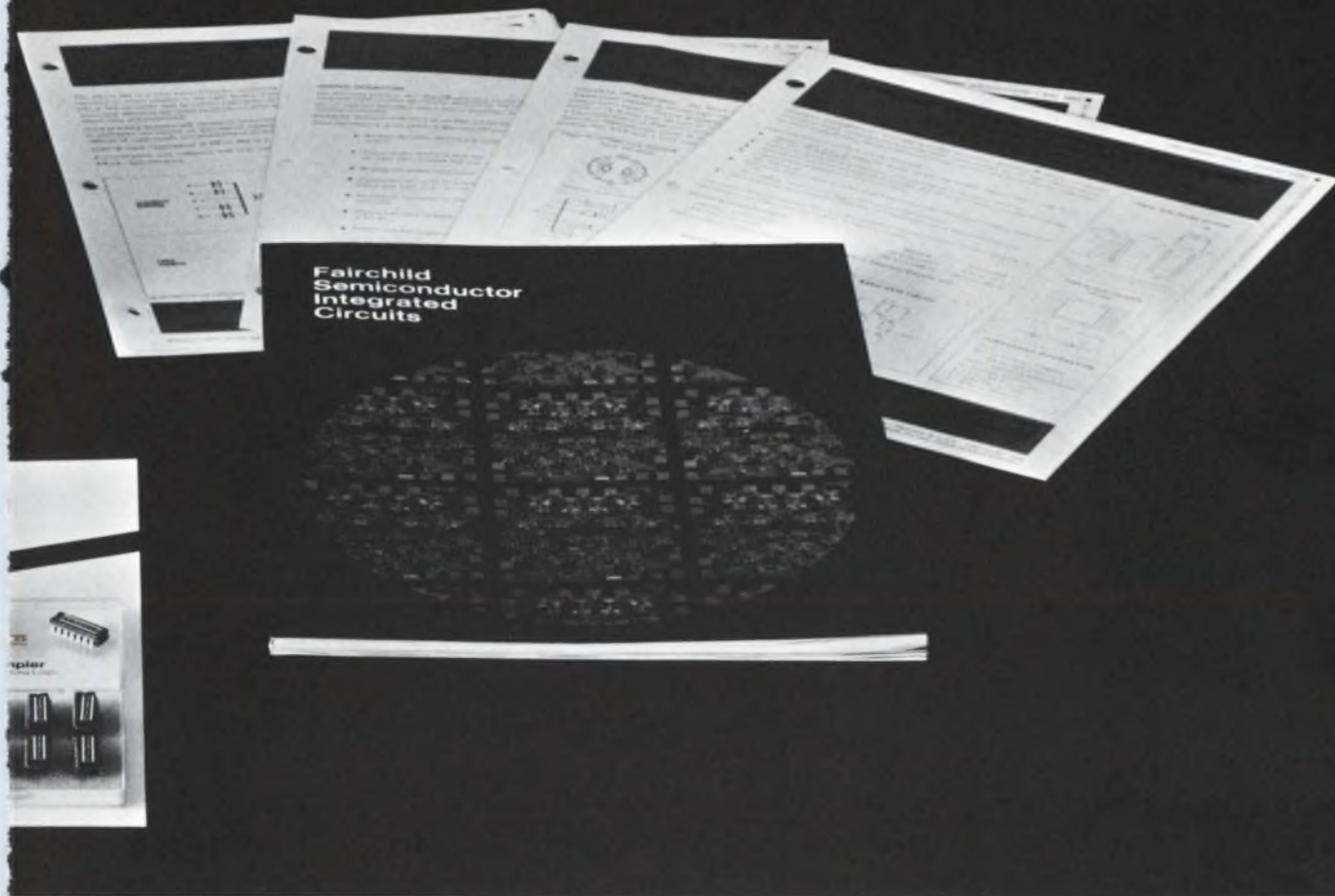

and LPDT μ L (Low-power diode-transistor Micrologic) integrated circuits. By crossing family boundaries within the compatible logic group, you can optimize your system design. Here's how:

How compatible logic helps you: TT μ L is the fastest of the three families and also the one that dissipates the most power. LPDT μ L dissipates the least power, but is slower than the others. DT μ L is right in between, both in speed and in power dissipation. There are clearly some functions in your system that require all the speed you can get. There are other functions where the speed of TT μ L, for example, is wasted, because it is waiting for slower system elements. So you can use a slower logic family and optimize your power dissipation without sacrificing overall system speed. When you design with Fairchild's current sinking logic group, you are assured that all the families within the group are fully compatible.

What we mean by compatibility: All three families use NAND logic, and all basic NAND logic functions are available in any of the three forms. All three families use a single 5V

power supply, and all three are guaranteed to perform compatibly when the specified fan-out and fan-in rules for inter-connecting between logic forms are observed. Pin configurations for the same functions are the same, and all three families come in the same two package configurations (maximum-density $\frac{1}{4}$ " x $\frac{1}{4}$ " Flatpak, and easy-to-handle Dual in-line). Finally, all three families are manufactured using the same technology, so that within the same working environment they will maintain a uniform stability over a period of time.

Get our product sampler: We want you to get acquainted with Fairchild's compatible current-sinking logic group at first hand, so we have prepared a special product sampler you can get. The sampler contains a 90-page book describing Fairchild integrated circuits; a guide to current sinking logic; data sheets on individual products and families; and actual product samples (see listing on back). Our complete product sampler kit sells for \$51.00, which is the over 100 price of the samples alone. But quantities are limited, so act now.

How to get it: Simply return the attached postcard, or call.

Compatible Current Sinking Logic.

We have prepared a special product sampler to help you discover the advantages of designing with Fairchild's compatible logic. You can get it for less than you'd normally pay for the samples alone.



ELECTRONIC DESIGN

semiannual index of articles

July-December, 1966

The articles in each section of this index are grouped under key words, which are intended to indicate the general topic to which the articles refer. The same article may be listed more than once, if its main concern is more than one of these generalized topics.

Careers and Management

- BACCALAUREATE:** An ill wind blows for the baccalaureate EDIT, p. 35, ED 16
- CONTRACTS:** Learn the basics of contracts ... C&M, p. 100, ED 22
- INVENTOR:** So you want to be an inventor EDIT, p. 64, ED 16
- MANAGEMENT:** A Manager can't do it all himself—Learn to delegate authority C&M, p. 88, ED 24
Who's complaining now . . . and who's listening? EDIT, p. 51, ED 28
- STANDARDS:** Let's pay more than lip service to matters of life and death EDIT, p. 49, ED 21

- More standards urged by new organization ... NEWS, p. 14, ED 22
- Reduce paperwork on MIL designs with a cross-referenced index C&M, p. 92, ED 28
- 'Zero Defects': More than patriotic back-slapping EDIT, p. 59, ED 29

Circuits and Mathematical Analysis

- AMPLIFIERS:** Design amplifiers for low noise ART, p. 54, ED 25
- Diode feedback protection for complementary amplifiers IFD, p. 113, ED 22
- For higher gain, diode network reduces negative feedback IFD, p. 110, ED 28

- Hearing aid electronics cured by an M.D. IFD, p. 86, ED 29
- Log IF strips use cascaded ICs ART, p. 56, ED 17
- Low-impedance bias circuit improves amplifier linearity IFD, p. 90, ED 26
- Operational amplifier attenuates faster with three added devices IFD, p. 104, ED 25
- Push-pull output does not change with reference . NASA, p. 92, ED 29
- Raise amplifier input impedance by combining FETs and bipolars ART, p. 62, ED 29
- Stabilize gain in a dc amplifier ART, p. 180, ED 19

Subject listing

Careers and Management	Microelectronics
Circuits and Mathematical Analysis	Microwaves
Communications	Military Electronics
Components	Missiles and Space
Computers and Data Processing	Navigation and Guidance
Consumer Electronics	Packaging
Controls, Automatic	Power Sources
Editorials	Production Processes and Cooling
Human Factors	Radio Frequency Interference
Materials	Reliability
Measurement and Test Equipment	Research and Development
Medical Electronics	Semiconductors and Solid-State Devices
	Telemetry

Department keys

ART	Technical Article
C&M	Careers and Management
DD	Design Decision
DES DIR	Design Directions
EDIT	Editorial
ENG DATA	Engineering Data
IFD	Ideas for Design
NASA	NASA Tech Briefs
NEWS	News
PF	Product Feature
SR	Special Report

index of articles, continued

AMPLIFIERS, cont.:

Tunnel-diode amplifier improves emitter-follower logic IFD, p. 238, ED 19
 Want stable audio amplifiers? ART, p. 46, ED 20

COMPARATOR: Universal waveform comparator uses UJT relaxation oscillators IFD, p. 233, ED 19

COMPUTER-AIDED DESIGN: Check design program availability with this listing of computer programs SR, p. 76, ED 23

Computer-Aided Design: Analysis or synthesis? NEWS, p. 13, ED 22
 Here's a powerful design program using Laplace transform techniques SR, p. 56, ED 23
 Light pen to mask via computer NEWS, p. 33, ED 28

Mighty SCEPTRE analyzes any circuit NEWS, p. 21, ED 26

NASA spurs unity in computer-aided design NEWS, p. 17, ED 23

Need a circuit design program? Why not custom-tailor one to fit your needs? SR, p. 70, ED 23

Simplify feedback system design by using a digital computer SR, p. 62, ED 23

CONTROLS: Thyristor triggering is sure-fire ART, p. 38, ED 20
 Tunnel diodes trigger thyristors ART, p. 46, ED 17

COUNTERS: Capacitor increases speed of transistorized core counter IFD, p. 110, ED 25
 Optical diodes trigger stepping counter IFD, p. 108, ED 25

CURRENT SENSOR: A loss-less current sensor and monitor for less than \$1 IFD, p. 86, ED 29

DELAY CIRCUIT: Transformer in delay circuit compensates for attenuation IFD, p. 92, ED 17

DIMMER: Tandem dimmer uses Triac power controllers IFD, p. 70, ED 16

FILTERS: Predict filter response exactly ART, p. 70, ED 29

FLASHERS: Improve flasher designs DD, p. 82, ED 21

Small flasher circuit uses few inexpensive components IFD, p. 104, ED 25

FREQUENCY: Frequency doubler yields rectangular pulse outputs IFD, p. 90, ED 17

Inexpensive active devices yield frequency conversion IFD, p. 84, ED 29

Simple circuit multiplies frequency up to 40 times IFD, p. 108, ED 28

GENERATORS: Dc-bootstrapped UJT circuit has linear, variable output IFD, p. 68, ED 20

Look beyond the listed specs ART, p. 22, ED 27

Op amp drives capacitor to measure 3-ns-pulse heights IFD, p. 86, ED 21

Square-wave generator uses gate turn-off SCR IFD, p. 92, ED 26

Sweep away drift problems ART, p. 34, ED 27

Variable square-wave generator combines IC with 4-layer diode IFD, p. 108, ED 25

What's missing in generator specs? ART, p. 20, ED 27

HEAT CONTROL: Evaluate thermal runaway point of transistor audio output stages ART, p. 54, ED 28

Infinite heat control uses Triac and contacts IFD, p. 88, ED 17

Thermoelectric module senses its own temperature IFD, p. 90, ED 17

IMPEDANCE: Convert complex numbers to absolute values and angles graphically ENG DATA, p. 96, ED 23

Impedance diagram simplifies complex load characterization IFD, p. 104, ED 24

INVERTERS: Team saturating chokes with SCRs ART, p. 66, ED 25

LEVEL DETECTOR: Buffered binary affords accuracy and stability IFD, p. 94, ED 17

LOGIC CIRCUIT: Challenge to transistors in logic circuitry NEWS, p. 17, ED 19

Two-transistor exclusive-OR gate needs no external power supply IFD, p. 88, ED 26

LOGIC DESIGN: Take the easy road—use the Karnaugh map ART, p. 64, ED 26

MEASUREMENTS: Passive adapter circuit drives decade scaler IFD, p. 92, ED 21

MODULATORS: FETs in balanced modulators improve linearity and bandwidth IFD, p. 112, ED 28
 Self-contained modulator is free of coils, bias supplies IFD, p. 92, ED 21

MOTOR CONTROL: Diode bridge saves wires in motor-reversing systems IFD, p. 106, ED 23

MULTIPLIERS: Analog multiplication and division circuits use log diodes IFD, p. 100, ED 24

MULTIVIBRATORS: Determine a one-shot's period ART, p. 68, ED 18

Differentiating network ensures a-stable starting IFD, p. 74, ED 18

Diodes and capacitor make a-stable self-starting IFD, p. 72, ED 16

Double flip-flop has constant output impedance IFD, p. 102, ED 25

Extra transistor gives Schmitt monostable multi capabilities IFD, p. 65, ED 20

Microcircuit plus capacitor make simple one-shot IFD, p. 106, ED 28

One-shot offers high power and no stand-by current drain IFD, p. 98, ED 24

One-sided flip-flop uses only one SCR IFD, p. 106, ED 23

SCR and UJT form noise-immune mono IFD, p. 92, ED 26

Synchronized one-shot built with three SCRs IFD, p. 110, ED 28

OSCILLATORS: Current-controlled VCO circuit offers linear frequency transfer IFD, p. 110, ED 22

Don't pay too much for stability in oscillators ART, p. 88, ED 25

Four components stabilize common-base oscillator IFD, p. 94, ED 26

'Kick on' the tank circuit ART, p. 60, ED 18

Phase-shift oscillator cuts cost of VCO IFD, p. 106, ED 28

Pulsed oscillator reduces switching transients IFD, p. 100, ED 24

Square-wave generator uses IC NAND gate IFD, p. 102, ED 23

Wide-band oscillator needs only one pair of transistors IFD, p. 88, ED 29

POWER AMPLIFIERS: Avoid variable-load problems

Department keys

ART	Technical Article	ENG DATA	Engineering Data
C&M	Careers and Management	IFD	Ideas for Design
DD	Design Decision	NASA	NASA Tech Briefs
DES DIR	Design Directions	NEWS	News
EDIT	Editorial	PF	Product Feature
		SR	Special Report

.....ART, p. 84, ED 23

POWER SUPPLIES: Try solid-state regulators for your high-voltage dc power supplies ART, p. 76, ED 26

PULSE GENERATORS: Buying a pulse generator? ...ART, p. 12, ED 27
IC and bipolar form compact pulse generator ...IFD, p. 88, ED 21
Linear width-amplifier doesn't attenuate pulses
.....IFD, p. 236, ED 19
Produce fast and clean RF pulses
.....DD, p. 78, ED 21
Transistor-diode combination improves pulser operation
.....IFD, p. 102, ED 23
UJT, bipolars in compact, versatile generator ...IFD, p. 71, ED 18

RAMP GENERATORS: Get ultralinear-ity from ramps ART, p. 68, ED 28

REGULATORS: Balanced load, tight regulation with SCR-Zener circuit
.....IFD, p. 104, ED 23
Shunt circuit smooths power-supply output
.....IFD, p. 114, ED 22

RESONATORS: Short-cut to spliced resonators ...ART, p. 62, ED 20

RADAR: Tackle delay-line circuits graphically ...ART, p. 58, ED 26

SWITCHING: Cam-shaft adds contacts to push-button switches
.....IFD, p. 74, ED 16
Cure switching system noise
.....ART, p. 186, ED 19
Eliminate switch contact bounce with this simple logic design
.....IFD, p. 100, ED 23
FETs make digital switching a snap
.....ART, p. 72, ED 25
ICs end the 'driver gap' in FET analog signal switching
.....ART, p. 50, ED 26
Resistor cuts saturation voltage of switching transistors
.....IFD, p. 106, ED 25
Switch over to field-effects for digital needs ...ART, p. 54, ED 24

TRANSDUCER: Magnetostriction boosts output of strain transducer
.....IFD, p. 98, ED 24

TRANSISTORS: Avoid power transistor failure ...ART, p. 52, ED 18
Complementary Darlington: a leading emitter-follower
.....IFD, p. 102, ED 24
Cut transistor-replacement costs
.....ART, p. 192, ED 19
Try the hybrid-pi ART, p. 66, ED 21

VECTOR ANALYSIS: Simplify vector analysis with a set of nomographs
.....ART, p. 82, ED 26

WARNING DEVICE: Transient alarm indicator draws little stand-by current
.....IFD, p. 72, ED 18

Communications

ACOUSTICS: Versatile underwater

'voice'SR, p. 39, ED 29

AMPLIFIERS: Design amplifiers for low noise ...ART, p. 54, ED 25
Integrated circuit used in FM receiver IF stage .NEWS, p. 14, ED 28
Nomograph gives amplifier noise data ..ENG DATA, p. 60, ED 16
Push-pull output does not change with reference
.....NASA, p. 92, ED 29
Simplify IF amplifier design
.....ART, p. 38, ED 16

ANTENNA: Doppler VOR antenna reduces RF reflection errors
.....NEWS, p. 30, ED 29

FILTERS: Predict filter response exactlyART, p. 70, ED 29

HARMONICS: Suppress harmonics at sourceDD, p. 94, ED 22

HEAT: Evaluate the thermal runaway point of audio output stages
.....ART, p. 54, ED 28

IONOSPHERE: Deeper probe of ionosphere due .NEWS, p. 33, ED 25

LASERS: Are lasers practical for communication systems?
.....SR, p. 56, ED 22
'On target' laser sought for war communications
.....NEWS, p. 14, ED 24
Optics studied for faster space communicating .NEWS, p. 21, Ed 18

MIXERS: Rid mixers of spurious signalsART, p. 210, ED 19

MODULATORS: Demodulate the error signal in FM modulators with a differential network
.....ART, p. 90, ED 23
FETs in balanced modulators improve linearity and bandwidth
.....IFD, p. 112, ED 28
Self-contained modulator is free of coils, bias supplies
.....IFD, p. 92, ED 21

OSCILLATORS: Don't pay too much for stability in oscillators
.....ART, p. 88, ED 25
Four components stabilize common-base oscillator IFD, p. 94, ED 26
'Kick on' the tank circuit
.....ART, p. 60, ED 18
Phase-controlled oscillator has electronic frequency-tuning
.....IFD, p. 74, ED 16
Wide-band oscillator needs only one pair of transistors
.....IFD, p. 88, ED 29

RADIOS: Airline installs portable radiosNEWS, p. 14, ED 23

RELIABILITY: Don't gamble on system performance! ..ART, p. 62, ED 28

SATELLITES: Comsat and NASA sign satellite launch accord
.....NEWS, p. 13, ED 19
Comsat down, Centaur up—a busy week in space
.....NEWS, p. 13, ED 25

Comsat outlines its own R&D programNEWS, p. 4, ED 18
Comsat will purchase satellite earth stationNEWS, p. 14, ED 21
Ford Foundation satellite plan stirs controversy .NEWS, p. 13, ED 21
Pencil-beam communications studiedNEWS, p. 21, Ed 29

TELETYPE: Navy to communicate on a "moonbeam"
.....NEWS, p. 28, ED 21

TELEVISION: Ford and Comsat vie for spaceNEWS, p. 13, ED 19
Small transmitter sends lunar picturesNEWS, p. 28, ED 19
Tubeless TV cameras oust vidicon? Not yet. ...NEWS, p. 13, ED 28
Zenith demonstrates laser TV systemNEWS, p. 14, ED 23

TIME STANDARD: A clearer time beep to be heard in the land
.....NEWS, p. 14, ED 18

Components

DIODES: Diode tester offers no risk to components ..IFD, p. 94, ED 17

FILTERS: Improved mechanical filters compete with crystal and LC
.....NEWS, p. 33, ED 26

GYROSCOPES: Gimbal-less gyros win NASA backing
.....NEWS, p. 22, ED 25

Laser gyroscope measures Navy's roll, pitch and yaw
.....NEWS, p. 26, ED 23

Spinning ball—heart of inertial systemNEWS, p. 20, ED 28

POTENTIOMETERS: Measure potentiometer noise accurately
.....ART, p. 78, ED 17

Try low-resistance trimmers
.....ART, p. 82, ED 28

RELAYS: Avoid relay misapplication
.....ART, p. 76, ED 28

FET amplifier and relay in TO-5 can operate directly off low-level microcircuitryPF, p. 188, ED 28

RESISTORS: 'Field plate' nichrome resistors push planar performance
.....PF, p. 108, ED 24

TWTs: Accuracy increased in TWT inspection ...NEWS, p. 36, ED 24

Computers and Data Processing

A/D CONVERSION: Shrink costs and size by using off-the-shelf microcircuitsART, p. 96, ED 25

A/D SYSTEM has 100-kHz sampling rateNEWS, p. 27, ED 17

BINARY DIVISION: Perform binary division fast ..ART, p. 61, ED 17

CLOCK: Precision digital clock uses ICs and a crystal oscillator
.....ART, p. 70, ED 26

CONSOLES: Computer consoles roll into office ..NEWS, p. 28, ED 19

index of articles, continued

CONTROL: Small-scale control computer has all-IC logic, 960-ns cycle time PF, p. 126, ED 25

COUNTER: BCD counter uses ICs to minimize component count IFD, p. 89, ED 17

DESIGN: Check design program availability SR, p. 76, ED 23
 Computer-aided design: analysis or synthesis? NEWS, p. 13, ED 22
 Computer-aided design: promise and problems DES DIR, p. 34, ED 20
 Here's a powerful design program using Laplace transform techniques SR, p. 56, ED 23
 Light pen to mask via computer NEWS, p. 33, ED 28
 NASA spurs unity in computer-aided design NEWS, p. 17, ED 23
 Need a circuit design program? SR, p. 70, ED 23
 Simplify feedback design by using a digital computer SR, p. 62, ED 23
 Start your computer design with this comprehensive checklist ART, p. 72, ED 24

DIGITAL: Digital computers are no mystery ART, p. 86, ED 22
 FETs make digital switching a snap ART, p. 72, ED 25
 Microelectronics opens the gate to faster digital computers ART, p. 52, ED 16
 Switch over to field effects for digital needs ART, p. 54, ED 24

GATE: Two-transistor exclusive-OR gate needs no external power supply IFD, p. 88, ED 26

HEWLETT-PACKARD breaks into computer market NEWS, p. 13, ED 26

LSI CHIPS away at computer hardware costs NEWS, p. 17, ED 28

LOGIC CIRCUITRY: Challenge to transistors in logic circuitry NEWS, p. 17, ED 19

LOGIC DESIGN: Take the easy road to logic design—use the Karnaugh map ART, p. 64, ED 26

MEDICAL: Western Union to study emergency hospital beds NEWS, p. 13, ED 22

MEMORIES: Memory process puts 645 million bits on a square inch NEWS, p. 21, ED 28
 Microprobe checks tiny magnetic domains NEWS, p. 38, ED 28

MILITARY: AF memory unit 'programs' attacks NEWS, p. 44, ED 25
 IBM announces military/space version of the system/360 NEWS, p. 21, ED 25

MOS ARRAYS: High-speed computers to employ MOS arrays NEWS, p. 14, ED 21

MULTIVIBRATORS: Determine a one-shot's period ART, p. 68, ED 18
 Differentiating network ensures a-stable starting IFD, p. 74, ED 18
 Diodes and capacitor make a-stable self-starting IFD, p. 72, ED 16
 IC double-gate stabilizes monostable multivibrator IFD, p. 70, ED 16

NOISE: Cure switching system noise ART, p. 186, ED 19

PASSIVE ADAPTER CIRCUIT drives decade scaler IFD, p. 92, ED 21

PATTERN RECOGNITION: Computers to read handwritten numbers NEWS, p. 33, ED 24

POLLS: Computer to store public opinion polls NEWS, p. 14, ED 22

RAILROAD: Computers help locate railroad freight cars NEWS, p. 13, ED 24

SOFTWARE: New time-sharing software announced NEWS, p. 14, ED 20

STORAGE: System stores 3200 pages on tiny slide NEWS, p. 30, ED 29

TEACHING AIDS: Computer trainer solves problems, teaches uses NEWS, p. 14, ED 26
 Pilot steers computer; computer steers jet NEWS, p. 23, ED 18

TIMING CIRCUIT: DTL logic NAND gates bring versatility to timing-circuit design ART, p. 74, ED 22

TYPEWRITER: Computer typewriter makes secretary's life easier NEWS, p. 27, ED 22

Consumer Electronics

AUTOMOBILES: Electronic 'co-pilot' for drivers tested NEWS, p. 26, ED 18
 Is there an electric Ford in your future? NEWS, p. 13, ED 22
 Raysistor-bipolar network protects auto starter IFD, p. 66, ED 20
 Sodium-sulfur battery to power electric car NEWS, p. 13, ED 23

CAMERA stores image on plastic film NEWS, p. 28, ED 25

CITIES: Electronic giants plan to build modern cities NEWS, p. 13, ED 24

CLOCK: Precision digital clock uses ICs and a crystal oscillator ART, p. 70, ED 26

COMPUTERS: Computer to store public opinion polls NEWS, p. 14, ED 22
 Computer trainer solves problems, teaches uses NEWS, p. 14, ED 26
 Computer-typewriter makes secretary's life easier NEWS, p. 27, ED 22
 Hewlett-Packard breaks into computer market NEWS, p. 13, ED 26
 New theme: music on a cathode-ray tube NEWS, p. 34, ED 19

FLASHERS: Improve flasher designs DD, p. 82, ED 21
 Small flasher circuit uses few and inexpensive components IFD, p. 104, ED 25

LAW ENFORCEMENT papers sought NEWS, p. 26, ED 22

MERCHANT MARINE is in need of help EDIT, p. 47, ED 22

MEDICAL: Audio/video system checks into hospitals NEWS, p. 24, ED 23
 Hearing aid electronics cured by M.D. IFD, p. 86, ED 29
 New X-ray unit shows 3-D internal views NEWS, p. 13, ED 23
 Robot chemist performs laboratory tests NEWS, p. 33, ED 23
 Western Union to study emergency hospital beds NEWS, p. 13, ED 22

MODEL-MAKERS race, fly and sail with electronics NEWS, p. 24, ED 28

OIL: Dual magnetometers help search for oil NEWS, p. 22, ED 28

Department keys

ART	Technical Article	ENG DATA	Engineering Data
C&M	Careers and Management	IFD	Ideas for Design
DD	Design Decision	NASA	NASA Tech Briefs
DES DIR	Design Directions	NEWS	News
EDIT	Editorial	PF	Product Feature
		SR	Special Report

PHILCO consumer articles may bear Ford's name . . . NEWS, p. 14, ED 21

RADIO RECEIVERS: Integrated-circuit flip-chips in small desk-top AM radio . . . NEWS, p. 13, ED 20
Integrated circuit used in FM receiver . . . NEWS, p. 14, ED 28

RAILROAD: Laser system counts railroad freight cars . . . NEWS, p. 36, ED 28

RECORDINGS: Smuggled recordings fetch up to \$75 . . . NEWS, p. 20, ED 19

TELEVISION: Comsat outlines its own R&D program NEWS, p. 14, ED 18
Ford and Comsat vie for space . . . NEWS, p. 13, ED 19
Ford Foundation satellite: plan stirs controversy . . . NEWS, p. 13, ED 21
Politics blamed for TV discord . . . NEWS, p. 13, ED 20
Tubeless TV cameras oust vidicon? Not yet . . . NEWS, p. 13, ED 28
Vest-pocket TV demonstrated . . . NEWS, p. 26, ED 16

Wasteland revisited: Must CATV be an electronic 'rubber stamp'? . . . EDIT, p. 51, ED 25
Zenith demonstrates laser TV system . . . NEWS, p. 14, ED 23

TRAFFIC CONTROL: More computer cops due . . . NEWS, p. 24, ED 25
Satellites may control nationwide road traffic. . . NEWS, p. 13, ED 18

TRANSCIVERS: Neons control VOX circuits . . . DD, p. 68, ED 17
RCA gets big voice in New York transit . . . NEWS, p. 14, ED 19

TYPESETTING: Latest in typesetting—magnetic-tape "print shop" . . . NEWS, p. 18, ED 23

V/STOL PLANES called best hope for short hops . . . NEWS, p. 14, ED 25

WEATHER: Airport visibility measured by laser . . . NEWS, p. 33, ED 28
Automated smog monitors on horizon . . . NEWS, p. 17, ED 18
Fog! Diode laser signals warning . . . NEWS, p. 44, ED 19
16-lb weather station operated on batteries . . . NEWS, p. 14, ED 23

WESCON engineers tap Nixon for President . . . NEWS, p. 14, ED 21

Controls, Automatic

ALARM: Transient alarm indicator draws little stand-by current . . . IFD, p. 72, ED 18

AMPLITUDE MONITOR: Clamp and complementary pair form amplitude monitor . . . IFD, p. 108, ED 22

AUTOMATA: Electronic 'co-pilot' for drivers tested . . . NEWS, p. 26, ED 18
Electronic frog eyes may search for life on Mars NEWS, p. 17, ED 24

Pilot steers computer; computer steers jet . . . NEWS, p. 23, ED 18

Robot chemist performs laboratory tests . . . NEWS, p. 33, ED 23

DIMMER: Tandem dimmer uses Triac power controllers . . . IFD, p. 70, ED 16

FLUIDICS: Fluidic integrated DDA the size of a cube of sugar . . . NEWS, p. 28, ED 23

Fluidic navigator guides Army on march . . . NEWS, p. 36, ED 25

Fluidics: simple pipeline to rugged control . . . NEWS, p. 17, ED 20

GAIN CONTROL: Try diodes for remote gain control ART, p. 70, ED 22

HEAT CONTROL: Infinite heat control uses Triac and contacts . . . IFD, p. 88, ED 17

Thermoelectric module senses its own temperature . . . IFD, p. 90, ED 17

Two Si diodes and one Zener track temperature changes . . . IFD, p. 88, ED 26

LASER may switch high RF power . . . NEWS, p. 33, ED 23

LEVEL DETECTOR: Buffered binary affords accuracy and stability . . . IFD, p. 94, ED 17

MOTOR SPEED CONTROL: Circuit gives 100:1 range for pm motor speed control IFD, p. 234, ED 19

SHAFT ENCODERS: Read out magnetic shaft encoders . . . ART, p. 72, ED 21

Editorials

BACCALAUREATE: An ill wind blows for the baccalaureate . . . EDIT, p. 35, ED 16

CATV: Wasteland revisited: Must CATV be an electronic 'rubber stamp'? . . . EDIT, p. 51, ED 25

COMPLAINTS: Who's complaining now . . . and who's listening? . . . EDIT, p. 51, ED 28

LEADERSHIP: The electronic designer plays a role in world leadership . . . EDIT, p. 49, ED 18

MARINE: The Merchant Marine is in need of help . . . EDIT, p. 47, ED 22

MEDICAL: Engineer's black box complements MD's black bag . . . EDIT, p. 51, ED 23

MICRONYM: The quest is on for the perfect micronym . . . EDIT, p. 43, ED 17

OCEANOLOGY: It's time we took the plunge in oceanology . . . EDIT, p. 51, ED 24

SAFETY: Let's pay more than lip service to matters of life and death . . . EDIT, p. 49, ED 21

SCIENCE: Man looks to science for

his future happiness . . . EDIT, p. 31, ED 20

SYSTEMS: Saga of a systems man—or, meetings, shmeetings . . . EDIT, p. 47, ED 26

UFO: The UFO puzzle: time for a technical evaluation . . . EDIT, p. 63, ED 19

'ZERO DEFECTS': More than patriotic back-slapping EDIT, p. 59, ED 29

Human Factors

DESIGN: Check off the human factors of your electronic design . . . C&M, p. 218, ED 19

Materials

CABLE: New undersea cable uses transistors . . . NEWS, p. 23, ED 17

METALS: For metal rips in space, an electron welder NEWS, p. 36, ED 23

WIRING: Press-on circuitry wires auto dashboards . . . NEWS, p. 24, ED 22
Strip fine Teflon wire with smooth-jawed pliers . . . IFD, p. 86, ED 29

Measurement and Test Equipment

AMPLITUDE MONITOR: Clamp and complementary pair form amplitude monitor . . . IFD, p. 108, ED 22

ANTENNAS: Circuit tests flex-life of shielded cables . . . IFD, p. 110, ED 22

CALIBRATION: Bureau of Standards calibrating peak-pulse instruments . . . NEWS, p. 21, ED 28

More standards urged by new organization . . . NEWS, p. 14, ED 22

CONVERTER samples CRT signals, acts as scope/recorder interface . . . PF, p. 102, ED 21

CURRENT: A lossless current sensor and monitor for less than \$1 . . . IFD, p. 86, ED 29

CURVE TRACER adapter unit shows FET 'zero- t_c point' . . . IFD, p. 89, ED 17

DIGITAL METER: Integrating digital meter is 75% ICs . . . PF, p. 110, ED 26

DIODE TESTER offers no risk to components . . . IFD, p. 94, ED 17

FUNCTION GENERATORS: Mix-and-match modules create function generators . . . PF, p. 104, ED 17

GENERATORS: Look beyond the listed specs . . . ART, p. 22, ED 27
Op amp drives capacitor to measure 3-ns pulse heights . . . IFD, p. 86, ED 21

Sweep away drift problems . . . ART, p. 34, ED 27

What's missing in generator specs? . . . ART, p. 20, ED 27

index of articles, continued

IC TEST-SET: Economical IC test-set provides gate input/output characteristics IFD, p. 90, ED 26

LASER PULSES: Disk offers simple means of measuring laser pulses IFD, p. 90, ED 21

MICROCIRCUITS: Versatile tester leapfrogs technology NEWS, p. 28, ED 22

OSCILLOGRAPH records in a blur of light PF, p. 112, ED 29

OSCILLOSCOPE: Digital memory scope plucks obscured signals out of noise PF, p. 78, ED 16

PROBES: Flexible circuit probe fits in small places IFD, p. 102, ED 25
Microprobe checks tiny magnetic domains NEWS, p. 38, ED 28

SMOG MONITORS: Automated smog monitors on horizon NEWS, p. 17, ED 18

STORAGE: Integrated dual storage system solves synchronization need IFD, p. 88, ED 21

TRANSISTORS: Measure transistor y-parameters ART, p. 54, ED 20
Second-breakdown testing need not be destructive IFD, p. 66, ED 20

TWTs: Accuracy increased in TWT inspection NEWS, p. 36, ED 24

ULTRASONICS check on pressure leaks NEWS, p. 42, ED 28

Medical Electronics

AUDIOLOGY: Hearing aid electronics cured by MD IFD, p. 86, ED 29

CARDIOLOGY: Cantilevered transducer to power pacemaker NEWS, p. 14, ED 26

HOSPITALS: Audio/visual system checks into hospitals NEWS, p. 24, ED 23
Western Union to study emergency hospital beds NEWS, p. 13, ED 22

RADIOLOGY: New Gatling gun shoots laser beams, not bullets NEWS, p. 13, ED 26

New X-ray unit shows 3-D internal views NEWS, p. 13, ED 23

RESEARCH: Engineer's black box complements MD's black bag EDIT, p. 51, ED 23

Microelectronics

AMPLIFIERS: Log IF strips use cascaded ICs ART, p. 56, ED 17

BCD COUNTER uses ICs to minimize component count IFD, p. 89, ED 17

CLOCK: Precision digital clock uses ICs and a crystal oscillator ART, p. 70, ED 26

COMPUTERS: DTL logic NAND gates bring versatility to timing circuit design ART, p. 74, ED 22
Microelectronics opens the gate to faster digital computers ART, p. 52, ED 16
Shrink A/D conversion costs and size by using off-the-shelf microcircuits ART, p. 96, ED 25
Small-scale control computer has all-IC logic, 960-ns time PF, p. 126, ED 25

DRIVERS: ICs end the 'driver gap' in FET analog signal switching ART, p. 50, ED 26
Integrated low-input, high-output drivers for FET analog switches PF, p. 106, ED 26

FLAT PACKS: Adaptor provides plug-in convenience for IC flat packs IFD, p. 72, ED 16

GENERATORS: Function generator diffused on a single chip NEWS, p. 30, ED 26
Variable square-wave generator combines IC with four-layer diode IFD, p. 108, ED 25

INTEGRATED CIRCUITS: Better isolation boosts IC performance NEWS, p. 17, ED 21
IC activities filling gap between IF and microwave NEWS, p. 21, ED 19
IC yield and adaptive antenna investigated NEWS, p. 33, ED 22
Reduce circuit size and cost with complex function ICs PF, p. 142, ED 25
Researchers push IC performance higher NEWS, p. 17, ED 26

LARGE-SCALE INTEGRATION chips away at computer hardware costs NEWS, p. 17, ED 28

MARKET: 400 million ICs a year are foreseen by 1971 NEWS, p. 14, ED 25

MICRONYM: The quest is on for the perfect micronym EDIT, p. 43, ED 17

MODULES: DTL logic modules shrink systems costs PF, p. 74, ED 20

MULTIVIBRATOR: IC double-gate stabilizes monostable IFD, p. 70, ED 16

PULSE GENERATOR: IC and bipolar form compact pulse generator IFD, p. 88, ED 21

RECEIVERS: Integrated-circuit flip-chips in small desk-top AM radio NEWS, p. 13, ED 20
Integrated circuit used in FM receiver NEWS, p. 14, ED 28

RESISTIVITY: Ruby laser process controls resistivity NEWS, p. 40, ED 25

TESTING: Economical IC test-set provides gate input/output characteristics IFD, p. 90, ED 26

THERMAL PATHS: Don't ignore thermal paths in your integrated-circuit designs ART, p. 76, ED 29

THICK FILMS: Make you own thick-film ICs ART, p. 52, ED 21

THIN FILMS: Reduce thin-film circuit size with this set of design curves ART, p. 64, ED 24

TUNING: 'Resonistor' may tune ICs NEWS, p. 33, ED 17

Microwaves

ANTENNAS: Circuit tests flex-life of shielded cables IFD, p. 110, ED 22
Get rid of cross-polarization in edge-shunt slotted array antennas ART, p. 86, ED 28
IC yield and adaptive antenna investigated NEWS, p. 33, ED 22
Microwave tower shows "new look" NEWS, p. 27, ED 22
Rubber sheets protect Yagi antenna elements IFD, p. 72, ED 18

DELAY LINE: Tackle delay-line circuits graphically ART, p. 58, ED 26

Department keys

ART	Technical Article	ENG DATA	Engineering Data
C&M	Careers and Management	IFD	Ideas for Design
DD	Design Decision	NASA	NASA Tech Briefs
DES DIR	Design Directions	NEWS	News
EDIT	Editorial	PF	Product Feature
		SR	Special Report

GUNN-EFFECT 'sandwiches' give higher cw . . . NEWS, p. 26, ED 18

LASER system helps delay RF and microwave signals . . . NEWS, p. 44, ED 28

MICROWAVE POWER: New uses for microwave power explored . . . NEWS, p. 17, ED 25

PHASED ARRAYS: Gunn oscillators power modular phased arrays . . . NEWS, p. 28, ED 26

Pencil-beam communications studied . . . NEWS, p. 21, ED 29

Phased arrays break the inertia barrier . . . NEWS, p. 20, ED 16

RADARS: Estimate the boresight error before getting a radome for your radar . . . ART, p. 84, ED 24

Evading radar detection is a cinch for aircraft equipped with EASY . . . ART, p. 86, ED 26

Laser radars take a giant step . . . NEWS, p. 22, ED 22

Supersensitive radars spot clear air turbulence . . . NEWS, p. 24, ED 17

35-lb radar set destined for Vietnam . . . NEWS, p. 40, ED 24

RESISTANCE NETWORK: Check the parameters of pads graphically . . . ART, p. 200, ED 19

SILICON DIODES generate more than a watt at 12 GHz . . . NEWS, p. 30, ED 26

SMITH CHART: Make impedance matching easier . . . ART, p. 46, ED 16

TWTs: Accuracy increased in TWT inspection . . . NEWS, p. 36, ED 24

Military Electronics

AIRCRAFT: F-111 delights Air Force; Navy calls it overweight . . . NEWS, p. 13, ED 19

Hearing aids protect aircraft . . . NEWS, p. 28, ED 16

Senate grounds F-111B; bars procurement funds . . . NEWS, p. 14, ED 20

AIR SAMPLER to help Army spot enemy . . . NEWS, p. 13, ED 24

COMPUTERS: AF memory unit 'programs' attacks . . . NEWS, p. 44, ED 25

IBM announces military/space version of the system/360 . . . NEWS, p. 21, ED 25

GUERRILLA: Electronics needed for guerrilla warfare . . . NEWS, p. 36, ED 18

GUIDANCE: Fluidic navigator guides Army on march . . . NEWS, p. 36, ED 25

Inertial guidance in a suitcase . . . NEWS, p. 21, ED 23

GUN: Electronically controlled pellet gun shoots back at Army marksmen . . . NEWS, p. 26, ED 23

LASERS: Laser gyroscope measures Navy's roll, pitch and yaw . . . NEWS, p. 26, ED 23

Laser system used as detonator device . . . NEWS, p. 33, ED 29

'On target' laser sought for war communications . . . NEWS, p. 14, ED 24

MIL SPECS: Reduce paperwork on MIL designs with cross-referenced index . . . C&M, p. 92, ED 28

RADAR: 35-lb radar set destined for Vietnam . . . NEWS, p. 40, ED 24

Missiles and Space

APOLLO: NASA outlines costs of post-Apollo plans . . . NEWS, p. 13, ED 21

NASA should state post-Apollo aims . . . NEWS, p. 13, ED 19

CATALOGS: DOD will issue catalog for space experimenters . . . NEWS, p. 14, ED 28

USAF to catalog spacecraft radar images . . . NEWS, p. 13, ED 21

COMSAT: Comsat and NASA sign satellite launch accord . . . NEWS, p. 13, ED 19

Comsat down, Centaur up—a busy week in space . . . NEWS, p. 13, ED 25

Comsat outlines its own R&D program . . . NEWS, p. 14, ED 18

Comsat will purchase satellite earth station . . . NEWS, p. 14, ED 21

Ford and Comsat vie for space . . . NEWS, p. 13, ED 19

GEMINI: Clues to Gemini's wake lost during undocking . . . NEWS, p. 13, ED 18

Gemini-12 shows man can work in space . . . NEWS, p. 13, ED 26

IBM announces military/space version of the system/360 . . . NEWS, p. 21, ED 25

IONOSPHERE: Deeper probe of ionosphere due . . . NEWS, p. 33, ED 25

LASERS: Laser replaces umbilical cord in spacecraft . . . NEWS, p. 32, ED 26

Optics studies for faster space communicating . . . NEWS, p. 21, ED 18

Pencil-beam communications studied . . . NEWS, p. 21, ED 29

Space-guidance laser will undergo testing . . . NEWS, p. 13, ED 28

LIFE-SUPPORT: Oxygen obtained from aircraft cabin moisture . . . NEWS, p. 14, ED 25

MARS: Electronic frog eyes may search for life on Mars . . . NEWS, p. 17, ED 24

MOON: Close approach to moon improves Orbiter photos . . . NEWS, p. 14, ED 20

'Dead' lunar probe shows spark of life . . . NEWS, p. 13, ED 24

Flying spot sends moon photos . . . NEWS, p. 28, ED 22

NASA looks to Orbiter 2 for real close-ups . . . NEWS, p. 24, ED 21

Small transmitter sends lunar pictures . . . NEWS, p. 28, ED 19

Surveyor prepares for posthumous portrait . . . NEWS, p. 14, ED 19

NASA funds may be cut by one billion dollars . . . NEWS, p. 13, ED 23

NAVIGATION: Ions help determine spacecraft's attitude . . . NEWS, p. 28, ED 21

Night-light satellite to be investigated . . . NEWS, p. 14, ED 19

Satellites suggested for sea navigation . . . NEWS, p. 14, ED 24

NUCLEAR MISSILE CONTRACT goes to Boeing Co. . . . NEWS, p. 14, ED 25

POSEIDON okay means millions for electronics . . . NEWS, p. 13, ED 26

RELATIVITY: Are Russians checking the Theory of Relativity? . . . NEWS, p. 14, ED 28

SATELLITES (See also COMSAT and NAVIGATION): Atomic power asked for missions in space . . . NEWS, p. 14, ED 20

No malfunction clouds Nimbus II's performance . . . NEWS, p. 14, ED 18

Passive satellite loses its skin . . . NEWS, p. 14, ED 18

Pulsed plasma engine runs for 2 years on an ounce of fuel . . . NEWS, p. 21, ED 25

Satellites may control nationwide road traffic . . . NEWS, p. 13, ED 18

SEA-MISSILE DETECTOR takes to its test bed . . . NEWS, p. 13, ED 20

WELDER: For metal rips in space, an electron welder . . . NEWS, p. 36, ED 23

Navigation and Guidance

AIR TRAFFIC: Airline installs portable radios . . . NEWS, p. 14, ED 23

And now, inertial guidance in a suitcase . . . NEWS, p. 21, ED 23

Better airport landing facilities sought . . . NEWS, p. 14, ED 22

New Doppler VOR antenna reduces RF reflection errors . . . NEWS, p. 30, ED 29

Pilot steers computer; computer steers jet . . . NEWS, p. 23, ED 18

Supersensitive radars spot clear air turbulence . . . NEWS, p. 24, ED 17

FLUIDIC NAVIGATOR guides Army on march . . . NEWS, p. 36, ED 25

GYROSCOPES: Gimbal-less gyros win NASA backing . . . NEWS, p. 22, ED 25

Laser gyroscope measures Navy's roll, pitch and yaw . . . NEWS, p. 26, ED 23

Spinning ball—heart of inertial system . . . NEWS, p. 20, ED 28

index of articles, continued

MARINE: Advances sought for deep submersibles NEWS, p. 18, ED 17
 And now . . . inertial guidance in a suitcase . . . NEWS, p. 21, ED 23
 Satellites suggested for sea navigation . . . NEWS, p. 14, ED 24

SPACECRAFT: Ions help determine spacecraft's attitude . . . NEWS, p. 28, ED 21
 Space-guidance laser will undergo testing . . . NEWS, p. 13, ED 28

VISIBILITY: Airport visibility measured by laser NEWS, p. 33, ED 28
 Fog! Diode laser signals warning . . . NEWS, p. 44, ED 19

TIME STANDARD: A clearer time beep to be heard in the land . . . NEWS, p. 14, ED 18

Packaging

BACK-PANEL WIRING harness supersedes connector blocks . . . PF, p. 114, ED 17

CRATING: Psychology pays off in packaging technique . . . NEWS, p. 14, ED 22

SEMICONDUCTORS: New technique seals thousands of semiconductors at once . . . NEWS, p. 44, ED 28
 Transistors mounted in topsy-turvy holders . . . NEWS, p. 17, ED 17

Power Sources

ATOM POWER urged for ocean living . . . NEWS, p. 14, ED 23

BATTERIES: Sodium-sulfur battery to power electric car . . . NEWS, p. 13, ED 23
 Zinc-air battery cuts weight sharply . . . NEWS, p. 40, ED 25

FUEL CELLS: High costs still bar commercial fuel cells . . . NEWS, p. 26, ED 24

PLASMAS: Pulsed plasma engine runs 2 years on an ounce of fuel . . . NEWS, p. 21, ED 25

REGULATORS: Complementary regulator design . . . ART, p. 64, ED 18
 Consider double-loop regulation . . . ART, p. 72, ED 17
 Predict line regulation accurately . . . ART, p. 82, ED 25
 Try solid-state regulators for your high-voltage dc power requirements . . . ART, p. 76, ED 26

SOLAR CELLS: New solar cells heal themselves . . . NEWS, p. 13, ED 19

THERMIONIC CONVERTERS: Interest renewed in thermionic converters . . . NEWS, p. 17, ED 16

TRANSDUCER: Cantilevered transducer to power cardiac pacemakers . . . NEWS, p. 14, ED 26

Production Processes and Cooling

RESISTIVITY: Ruby laser process controls resistivity . . . NEWS, p. 40, ED 25

SPECTROGRAPH: New spectrograph cuts process time . . . NEWS, p. 20, ED 23

THERMAL DESIGN: Beat the heat in electronic systems . . . ART, p. 58, ED 21

Don't ignore thermal paths in your integrated-circuit designs . . . ART, p. 76, ED 29

Infinite heat control uses Triac and contacts . . . IFD, p. 88, ED 17
 Measure thermal resistances . . . ART, p. 206, ED 19

THICK FILMS: Make your own thick-film ICs . . . ART, p. 52, ED 21

THIN FILMS: Reduce thin-film circuit size . . . ART, p. 64, ED 24

Radio Frequency Interference

ANTENNA: New Doppler VOR antenna reduces RF reflection errors . . . NEWS, p. 30, ED 29

NOISE: Design amplifiers for low noise . . . ART, p. 54, ED 25

SWITCHING: Automatic switching may solve RF noise . . . NEWS, p. 46, ED 24

Pulsed oscillator reduces switching transients . . . IFD, p. 100, ED 24

Reliability

AMPLIFIERS: Want stable audio amplifiers? . . . ART, p. 46, ED 20

PILOT LIGHTS: Read off the life of pilot lights from simple nomograph . . . ENG DATA, p. 90, ED 28

POWER TRANSISTORS: Avoid power transistor failure! . . . ART, p. 52, ED 18

RELIABILITY integrates with design . . . NEWS, p. 24, ED 19

TWTs: Accuracy increased in TWT inspection . . . NEWS, p. 36, ED 24

Research and Development

ACCELERATORS: 80-kW accelerator being used by NBS . . . NEWS, p. 14, ED 28

Most powerful atom smasher to make debut . . . NEWS, p. 26, ED 17

BATTERIES: Sodium-sulfur battery to power electric car . . . NEWS, p. 13, ED 23
 Zinc-air battery cuts weight sharply . . . NEWS, p. 40, ED 25

CAMERA stores image on plastic film . . . NEWS, p. 28, ED 25

GUNN OSCILLATORS power modular phased arrays NEWS, p. 28, ED 26

INTEGRATED CIRCUITS: Function generator diffused on a single chip . . . NEWS, p. 30, ED 26

Researchers push IC performance higher . . . NEWS, p. 17, ED 26

JOSEPHSON EFFECT measures physical constant NEWS, p. 22, ED 26

LASERS: Are lasers practical for communication systems? . . . SR, p. 56, ED 22

Better laser modulation sought . . . SR, p. 51, ED 22

Convert units of radiation . . . ENG DATA, p. 98, ED 22

CRT electron beam controls scanning laser . . . NEWS, p. 33, ED 18

Disk offers simple means of measuring laser pulses IFD, p. 90, ED 21

Dyes in solution lase very brightly . . . NEWS, p. 14, ED 24

Fog! Diode laser signals warning . . . NEWS, p. 44, ED 19
 Laser may switch high RF power

Department keys

ART	Technical Article	ENG DATA	Engineering Data
C&M	Careers and Management	IFD	Ideas for Design
DD	Design Decision	NASA	NASA Tech Briefs
DES DIR	Design Directions	NEWS	News
EDIT	Editorial	PF	Product Feature
		SR	Special Report

NEWS, p. 33, ED 23
 Laser radars take a giant step
 NEWS, p. 22, ED 22
 Laser system helps delay RF and
 microwave signals
 NEWS, p. 44, ED 28
 Liquid laser uses inorganic fluid
 NEWS, p. 24, ED 20
 New CO₂ laser delivers 500 watts
 NEWS, p. 33, ED 21
 New Gatling gun shoots laser
 beams, not bullets
 NEWS, p. 13, ED 26
 Silicon attenuators used with lasers
 NEWS, p. 22, ED 17
 Solid state competes with lasers as
 a light source SR, p. 62, ED 22
 Space-guidance laser will undergo
 testing NEWS, p. 13, ED 28
 Zenith demonstrates laser TV sys-
 tem NEWS, p. 14, ED 23
 MEMORY process puts 645 million
 bits on a square inch
 NEWS, p. 21, ED 28
 MAGNETISM: Sensitive SQUID meas-
 ures minute magnetism
 NEWS, p. 35, ED 17
 OCEANOLOGY: Acoustics: Versatile
 underwater 'voice'
 SR, p. 39, ED 29
 Advances sought for deep submersi-
 bles NEWS, p. 18, ED 17
 Deep submersibles travel, 'see' and
 work SR, p. 47, ED 29
 Instruments probing oceans' un-
 knowns SR, p. 36, ED 29
 It's time we took the plunge in
 oceanology EDIT, p. 51, ED 24
 Sonar looks askance at sea bottom
 NEWS, p. 17, ED 22
 RELATIVITY: Are Russians checking
 Theory of Relativity?
 NEWS, p. 14, ED 28
 SUPERCONDUCTION: New alloy is
 superconductive
 NEWS, p. 34, ED 22
 UFOs: Are UFOs really only ball
 lightning? NEWS, p. 14, ED 21
 Dr. Condon to head 15-month UFO
 study NEWS, p. 14, ED 24
 The UFO puzzle: time for a technical
 evaluation EDIT, p. 63, ED 19
 University to analyze flying-saucer
 puzzle NEWS, p. 13, ED 20
 WESCON: Evolution not revolution is
 Wescon theme
 NEWS, p. 22, ED 20
 Listen to what the speakers will say
 SR, p. U68, ED 19

Semiconductors

DIODES: Tunnel diode pellets offer IC
 compatibility for 50¢
 PF, p. 96, ED 29
 Tunnel diodes trigger thyristors
 ART, p. 46, ED 17
 Silicon diodes generate more than a
 watt at 12 GHz
 NEWS, p. 30, ED 26

Silicon increases diode light output
 NEWS, p. 28, ED 23
 DIRECTORY: Semiconductor Directo-
 ry Reference Issue (ED 12, May 17,
 1966) Errata p. 35, ED 17
 FIELD-EFFECT TRANSISTORS: Curve
 tracer adapter unit shows FET
 'zero-tc point' IFD, p. 89, ED 17
 FETS in balanced modulators im-
 prove linearity and bandwidth
 IFD, p. 112, ED 28
 Germanium FETs: needful or need-
 less? DES DIR, p. 81, ED 22
 ICs end the 'driver gap' in FET anal-
 og signal switching
 ART, p. 50, ED 26
 Odd power FETs sprint toward 1
 GHz NEWS, p. 17, ED 29
 Power FET "on" resistance reaches
 a new low PF, p. 132, ED 23
 Switch over to field-effects for digit-
 al needs ART, p. 54, ED 24
 GUNN-EFFECT 'sandwiches' give
 higher cw NEWS, p. 26, ED 18
 LASERS: Silicon attenuators used
 with lasers NEWS, p. 22, ED 17
 MAGNET: Superconductive magnet
 on sale off the shelf
 NEWS, p. 14, ED 26
 MOS ARRAYS: High-speed computers
 to employ MOS arrays
 NEWS, p. 14, ED 21
 THERMAL RESISTANCES: Measure
 thermal resistance
 ART, p. 206, ED 19
 THYRISTORS: Thyristor triggering is
 sure-fire ART, p. 38, ED 20
 Tunnel diodes trigger thyristors
 ART, p. 46, ED 17
 TRANSDUCERS: Cantilevered trans-
 ducer to power cardiac pacemakers
 NEWS, p. 14, ED 26
 TRANSISTORS: Avoid power transis-
 tor failure! ART, p. 52, ED 18
 Cut transistor-replacement costs
 ART, p. 192, ED 19
 Measure transistor y-parameters
 ART, p. 54, ED 20
 New undersea cable uses transis-
 tors NEWS, p. 23, ED 17
 Npn goes to 6 GHz, vies with par-
 amp, tunnel diode and TWT
 PF, p. 84, ED 18
 Pnp has 500-V breakdown, com-
 pletes complementary pair
 PF, p. 126, ED 22

Telemetry

ANIMAL MIGRATION: It may be hard
 to pass the buck
 NEWS, p. 14, ED 23
 LASER replaces umbilical cord in
 spacecraft NEWS, p. 32, ED 26
 PHASED ARRAY: Pencil-beam com-
 munications studied
 NEWS, p. 21, ED 29

THE END

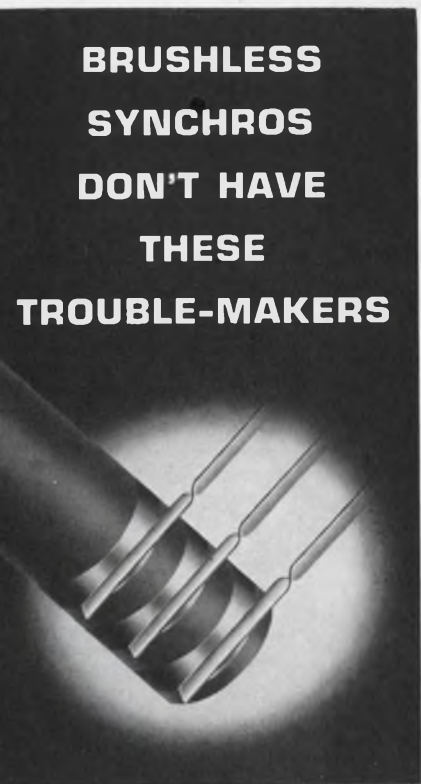

BRUSHLESS SYNCHROS DON'T HAVE THESE TROUBLE-MAKERS

OR THESE TROUBLES:

Brush wear • Arcing • RFI emission
 • Contact bounce • Bearing con-
 tamination from brush-wear parti-
 cles • Brush friction error

We left out all these synchro prob-
 lems by leaving out the brushes.
 Rotary transformers couple signals
 into rotors without contact. Re-
 sult is far longer synchro life —
 which can exceed 10,000 hours —
 with performance equal to the best
 of brush types.

Patented Harowe brushless syn-
 chros are available for all common
 functions, in sizes 5, 8, 10, and
 11 as standard; larger sizes as
 special. All types meet applicable
 requirements of MIL specs. Re-
 quest complete data from —



Servo, Stepper &
 Synchronous Motors
 Motor Generators • Synchros
 Resolvers • Pancakes • Gearheads

HAROWE SERVO CONTROLS, INC.

26 Westtown Road
 West Chester, Pa. 19380
 (215) 692-2700

ON READER-SERVICE CARD CIRCLE 35



**Connectors at 31¢ a
contact pair in a #14 shell—
from Amphenol**



Meet MIL-C-26482 specs on a budget using Amphenol Ultra-Mite* connectors. This new high-density subminiature 224 Series costs only 31¢ a contact pair in a 14-31 configuration (20¢ a pair for the 18-61 size).

Inserts withstand temperatures to

325°F. Five-key polarization prevents mismatching. Hooded female contacts resist test prod damage. Three-pin bayonet coupling ring assures solid connections.

Ultra-Mite is available in two classes—non-environmental and potted—with a choice of four shell

sizes, styles and insert arrangements.

For the full story call your Amphenol Sales Engineer. Or write **Amphenol Connector Division**, 1830 S. 54th Ave., Chicago, Illinois 60605.



AMPHENOL

*Trademark

Specify Amphenol . . . the leading name in cable, connectors, assemblies, RF switches, potentiometers, motors, microelectronics

Simple thermometer converts temperature into voltage

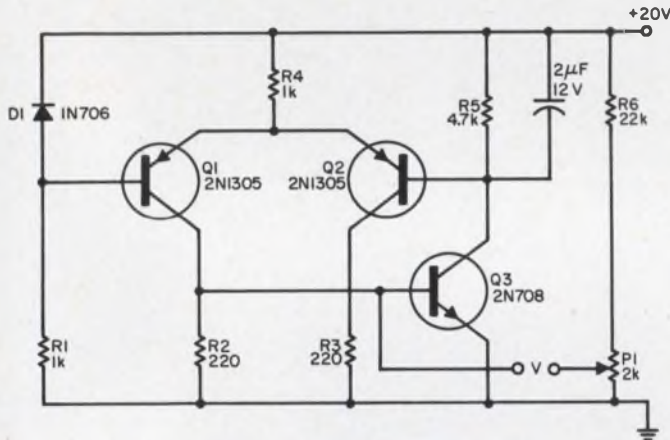

1. Simple thermometer circuit is based on the linear dependence with temperature of the base-to-emitter voltage of a transistor at constant collector current. Output voltage V is taken between the base of $Q3$ and the tap of $P1$.

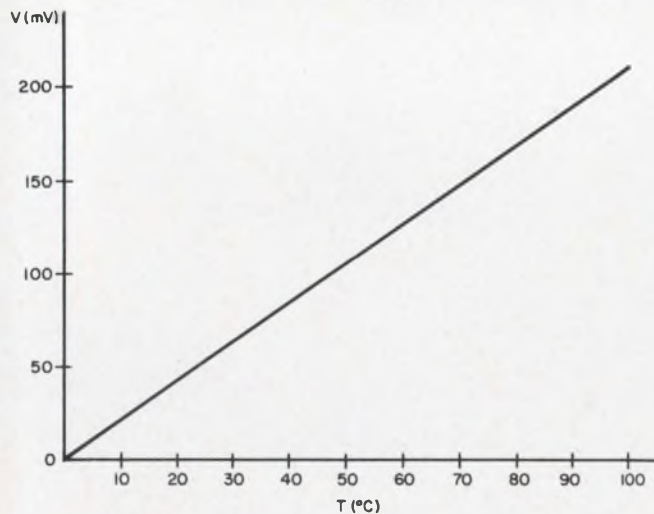

2. 0° to 100°C temperatures can be measured with the circuit of Fig. 1. The temperature coefficient of the circuit is 2.1 mV/°C and the linearity is 1°C.

SEND US YOUR IDEAS FOR DESIGN. Submit your IFD describing a new or important circuit or design technique, the clever use of a new component, or a cost-saving design tip to our Ideas-for-Design editor. If your idea is published, you will receive \$20 and become eligible for an additional \$30 (awarded for the best-of-issue Idea) and the grand prize of \$1000 for the Idea of the Year.

Analog measurement of temperature is a frequently recurrent task of the engineer. Expensive thermometers can often be replaced by the circuit shown in Fig. 1, used in conjunction with a dc millivoltmeter. It is more sensitive than a thermocouple, and the use of a reference temperature is not necessary.

The circuit is based on the fact that, neglecting variations in the collector-to-emitter leakage current I_{CEO} , the base-to-emitter voltage, V_{BE} , of a transistor varies linearly with junction temperature at constant collector current. For most silicon planar transistors, $\Delta V_{BE}/\Delta T$ is on the order of 2 mV/°C. This holds true as long as I_{CEO} can be neglected in comparison with the collector current. The exact value of $\Delta V_{BE}/\Delta T$ depends on the particular transistor used.

The thermal inertia of the sensing transistor, $Q3$ must be low; for usual requirements a silicon planar transistor in a TO-18 case is a good choice. In the circuit shown, I_{CEO} should not exceed 10 μA at the maximum working temperature; this is the case with a good 2N708 at 100°C.

In the circuit of Fig. 1 transistors $Q1$ and $Q2$ comprise a differential amplifier which tends, by modifying the base current of $Q3$, to hold the voltage across $R5$ equal to the Zener voltage of $D1$. This ensures that the collector current of $Q3$ remains constant. The temperature-dependent output voltage V is measured directly between the base of $Q3$ and the center tap of potentiometer $P1$. The purpose of $P1$ is to adjust the temperature at which the output voltage is zero.

Typical variation of the output voltage is given in Fig. 2; linearity is within 1°C over the 0°C-to-100°C range. The thermometer should be calibrated at two reference temperatures such as 0°C and 100°C.

Jean F. Delpech, Institut d'Electronique, Orsay, France.

VOTE FOR 111

(continued on page 94)

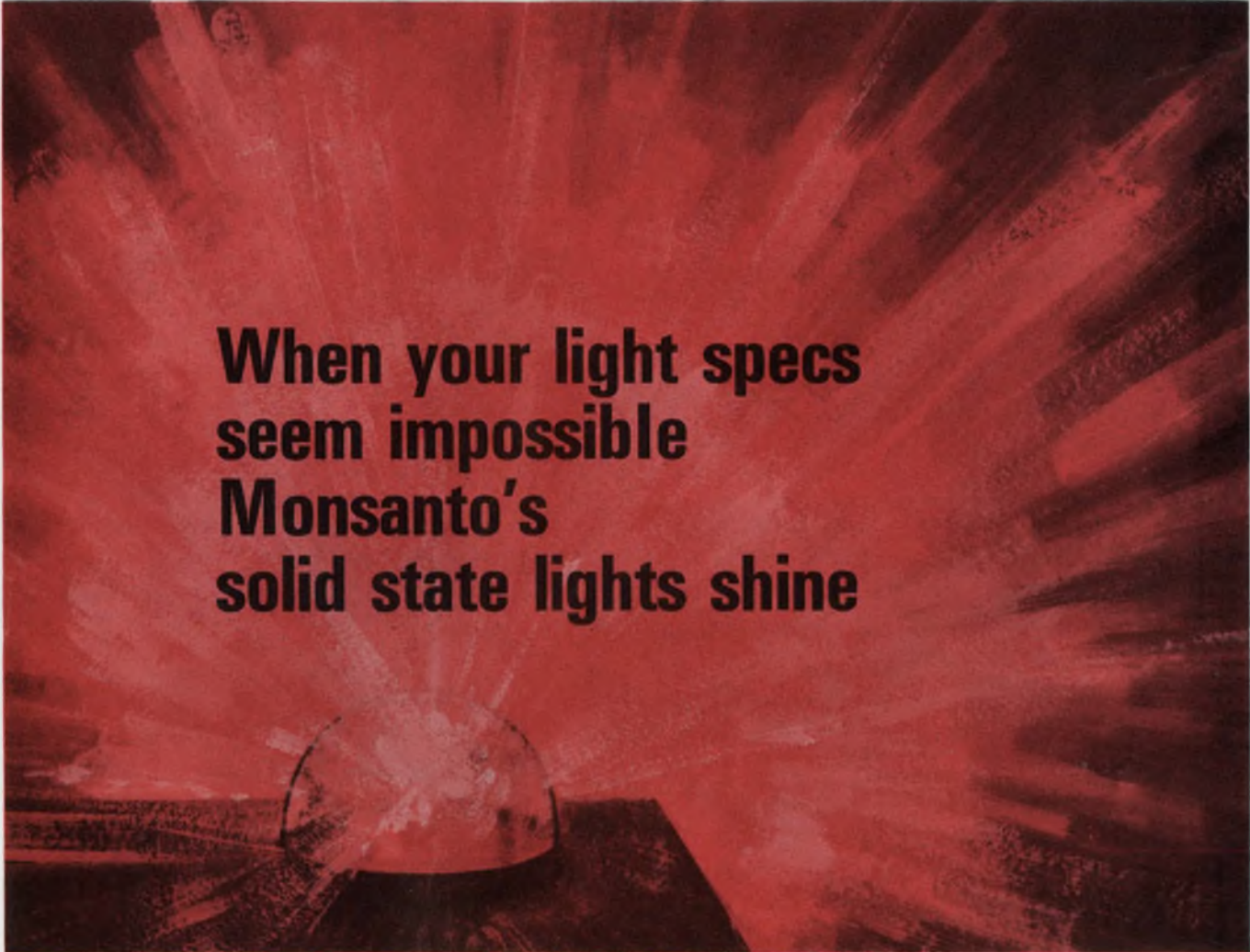

When your light specs seem impossible Monsanto's solid state lights shine

Now you can get a new line of visible and infrared emitting diodes that feature long life, maximum reliability and fast switching speed... at low cost.

These rugged light sources from Monsanto offer you design opportunities never before available in their price range. Just look at the following specifications and unit costs and see why they fit into your design for profit.

MVE-100 Visible Light Emitter. The MVE-100 gallium arsenide phosphide diode is suitable for use as an instrument signal light, panel indicator and for many computer uses. Price ranges from \$14.50 each in lots of one to nine, to \$8.00 each in lots of 1,000.

MVE-101A Visible Light Emitter. The MVE-101A gallium arsenide phosphide diode is packaged in a smaller coaxial package allowing high packing density for those applications where space is critical. Use the MVE-101A for film annotating, reticle illuminations and as indicators. Price ranges from \$16.50 each in lots of one to nine, to \$8.00 each in lots of 1,000.

MVL-150 Visible Laser. The MVL-150 is a gallium arsenide phosphide semiconductor laser which is available

with emission at any desirable wave length between 6,500 A and 8,300 A. This laser is designed for operation at 77 K. Price ranges from \$19.50 each in lots of one to nine, to \$13.00 each in lots of 1,000.

MIE-200 Infrared Emitter. An infrared radiation source consisting of a gallium arsenide mesa diode. It matches efficiency with silicon detectors, providing enough radiated power to work in common mode isolation, card reading, and chopping applications. Price ranges from \$9.85 each

in lots of one to nine, to \$6.00 each in lots of 1,000.

MVA-300A Visible Light Emitter Array. The MVA-300A 5x7 Array is a solid state read-out made with 35 MVE-101A diodes mounted on a metal heat sink. The display is used for visual read-out and film annotation applications. Price \$495.00 each.

For more information on low-cost Monsanto light sources, call (314) OXford 4-2136 or write: Monsanto Company, 800 N. Lindbergh Boulevard, St. Louis, Missouri 63166



ELECTRONICS

ON READER-SERVICE CARD CIRCLE 37

Generate pulses by varying length of the termination line

A fast pulser can be built with approximately ten dollars' worth of components. It has variable pulse width (from 4 to 100 ns) with rise time less than 1.5 ns and amplitude from 5 to 10 volts (depending on the transistor type used). It works in conjunction with any oscilloscope that has 100-volt calibration output. The 100-volt, 1-kHz calibration square wave is used to provide the high voltage and trigger pulses necessary to operate this avalanche transistor pulser.

In Fig. 1a, $R1$ and $R2$ form a voltage divider network. $R1$ is adjusted until $Q1$ avalanches only once per trigger pulse. The combination of $R5$ and

$C1$ integrates the square wave into 30 volts dc, plus 30 volts of sawtooth components (see middle of Fig. 2). This voltage is applied to the collector of $Q1$ and the charge line $L1$ (external RG-58/U). $C2$ and the primary of $T1$ is a differentiation network, which supplies a positive, 10-volt trigger pulse to the collector of $Q1$ at the decaying edge of the sawtooth waves. This trigger pulse causes $Q1$ to avalanche.

The avalanching of $Q1$ dumps the charge stored in charge line $L1$ into the primary of $T2$. The duration of the output pulses is predetermined by the length of charging line $L1$ (0.325 ft/ns pulse width). The $C3-R4$ and $C4-R3$ combinations are the compensating networks. While the output

(continued on page 96)

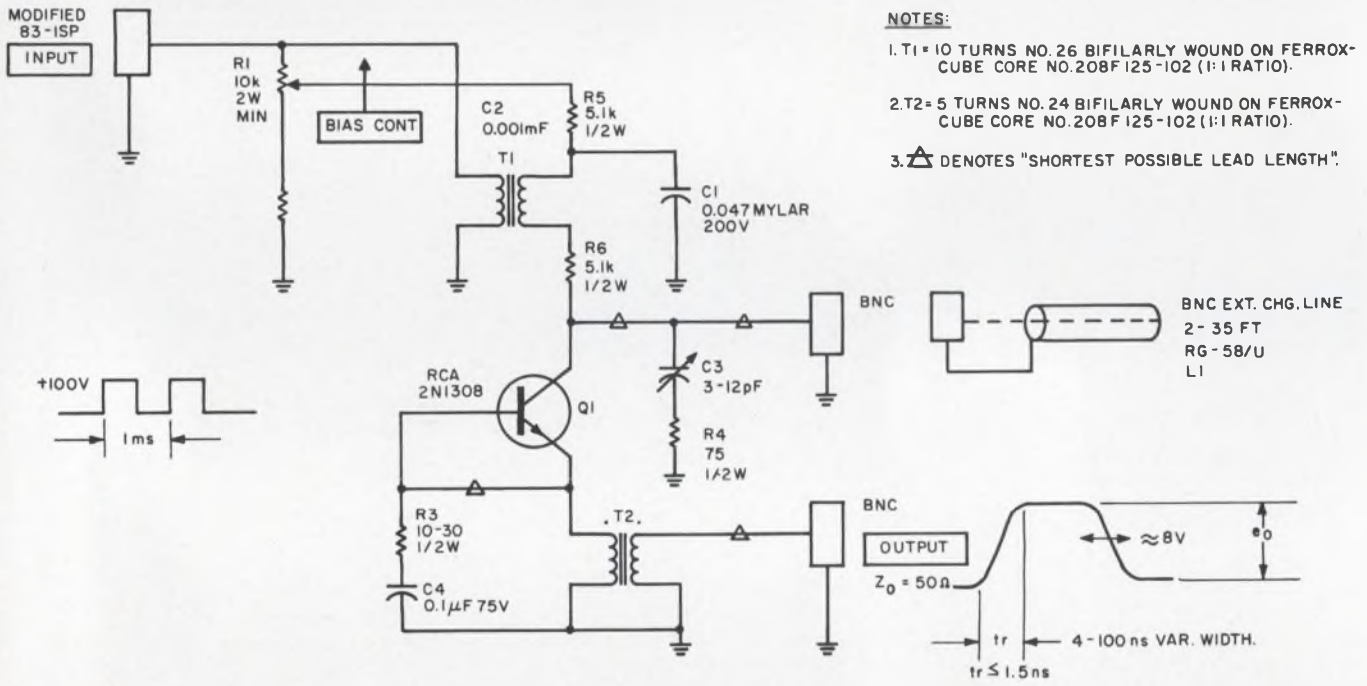

- NOTES:**
1. $T1 = 10$ TURNS NO. 26 BIFILARLY WOUND ON FERROX-CUBE CORE NO. 208F 125-102 (1:1 RATIO).
 2. $T2 = 5$ TURNS NO. 24 BIFILARLY WOUND ON FERROX-CUBE CORE NO. 208F 125-102 (1:1 RATIO).
 3. \triangle DENOTES "SHORTEST POSSIBLE LEAD LENGTH".

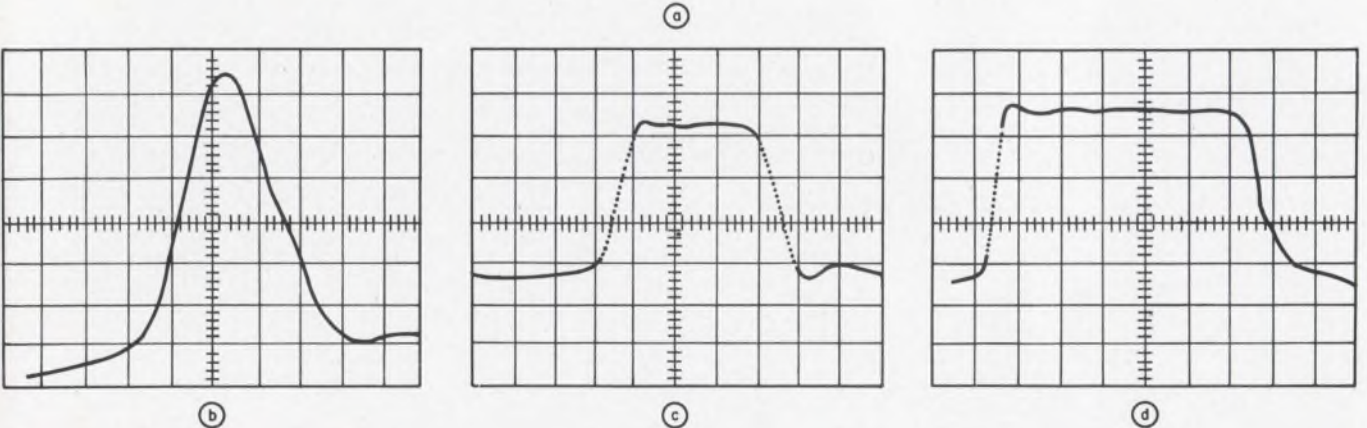

1. Fast pulses can be obtained with this simple circuit (a). Pulse width can be varied from 4 to 100 ns by varying the length of charging line $L1$: (b) with no charge line attached to pulser output terminal, $H = 1$ ns/cm

and $V = 0.5$ V/cm; (c) with a 28-in. charge line attached, $H = 2$ ns/cm and $V = 2$ V/cm; and (d) with 118-in. line, $H = 5$ ns/cm and $V = 2$ V/cm. Care should be taken to keep all leads short when building the circuit.

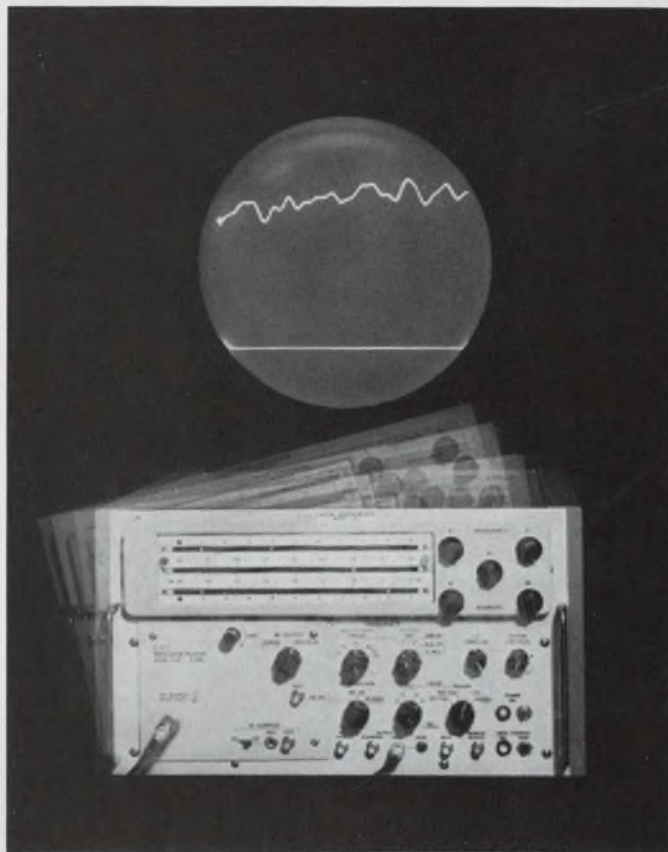
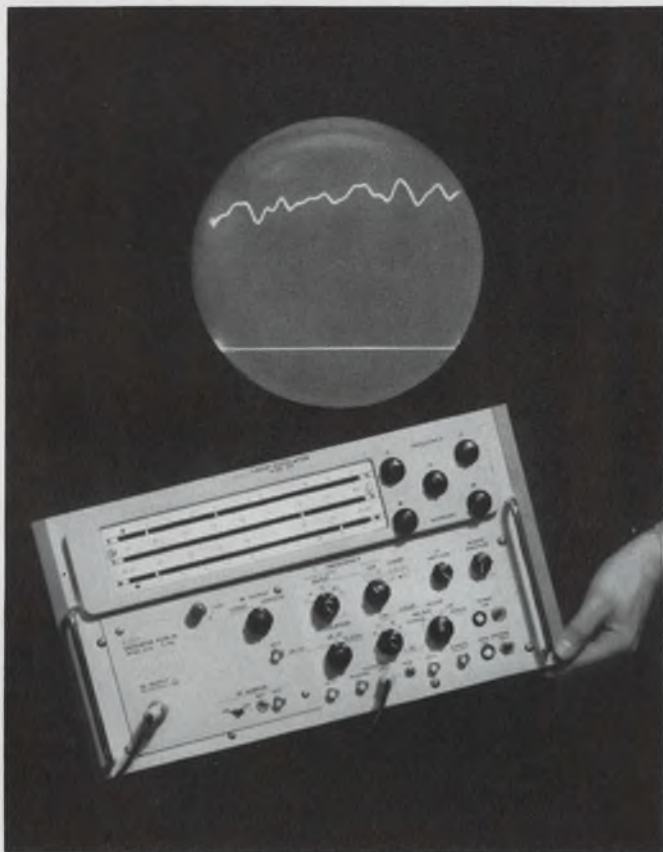

WILL THE SWEEPER YOU BUY STAND THE 4" DROP TEST?

The Alfred 650 Will!

These two photos graphically demonstrate the rugged reliability of the Alfred 650 Sweep Oscillator. Notice, there's no jitter on the scope trace even at the moment of impact.

But unequalled sturdiness is only one of the virtues of the Alfred 650. We use the plug-in approach to save you money and at the same time give you top performance specifications. Typically, you can save over \$4,000 in the 1 to 12.4 GHz range over comparable equipment.

For ease of operation, the controls are laid out in a completely non-ambiguous way. Anyone even slightly familiar with sweepers can run an Alfred 650.

The unique ALFRED three-story slide rule dial with five frequency controls provides unmatched flexibility. Two completely independent

sweeps may be pre-set and selected: broadband sweep $F \rightarrow F_2$ and the symmetrical sweep $F_0 \pm \Delta F$. The independent sweeps permit you to evaluate components first during the broadband sweep, $F_1 \rightarrow F_2$, over one frequency range, and subsequently, during the symmetrical sweep $F_0 \pm \Delta F$ over another frequency range. No readjustment of the frequency controls is required to change from one sweep mode to another. Five single frequencies are available: F_1 , F_2 , F_0 , M_1 and M_2 , which may be pre-set and selected with a convenient front panel control. The single frequencies may be pre-set during swept operation and then selected sequentially for five precise single frequency measurements. Three independent frequency markers may be introduced: F_0 , M_1 , and M_2 . Only ALFRED Sweep Oscillators provide three frequency markers which may be set anywhere in the band and which are independent of the sweep.

Ease of service makes the trouble free Alfred 650 an operator's dream. All components and modules are clearly marked and accessible. Because of low power consumption, (150 watts), there's no need to install a troublesome fan and blow dust all over etched circuits.

The Alfred 650 is available with plug-ins to cover a range of 500 MHz to 40 GHz. PIN diode leveling is offered to 12.4 GHz and grid leveling to 40 GHz. Price of the main frame is \$1,600. Plug-in oscillators start at \$1,550.

For full information, please call your nearest Alfred engineering sales and service center (See EEM or MEH) or address us at 3176 Porter Drive, Palo Alto, California 94304. Phone (415) 326-6496. TWX: (415) 492-9421.

ALFRED ELECTRONICS

"See us at IEEE, Booths 2C12 & 2C14"

ON READER-SERVICE CARD CIRCLE 38

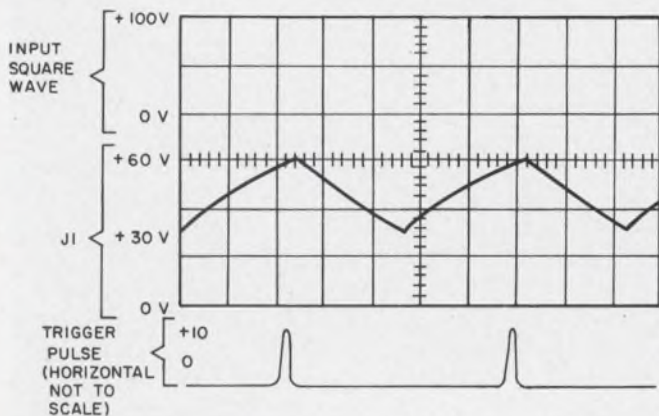

2. Single square-wave input provides all signals required to operate the circuit of Fig. 1.

(loaded by a 51-ohm resistor) is observed on a sampling scope, R_3 is selected for the best pulse shape and C_3 is adjusted for the best compromise between the rise time and the output pulse shape. The secondary of T_2 can be reversed if negative output is desired.

Q_1 for this application is a RCA 2N1308 germanium npn transistor priced at 65¢. Forty-four out of 48 units tested were suitable for use in this pulser.

Various waveshapes obtained with this circuit for different lengths of the charging line are shown in Figs. 1b, c, d.

Robert C. Der, Design Engineer, Lawrence Radiation Laboratory, University of California, Livermore, Calif.

VOTE FOR 112

Multi's duty cycle varies without affecting pulse shape

Addition of a resistor to a standard multivibrator yields a circuit (Fig. 1a) capable of producing a square wave with a widely variable (up to 1:10),

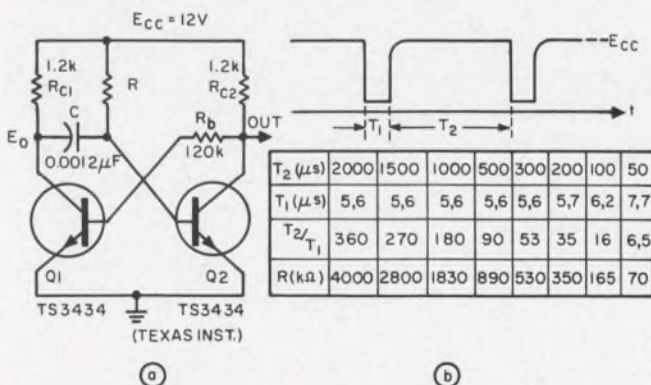

Duty cycle of a multivibrator can be varied without affecting the quality of the pulse by the addition of a single resistor (a) to a standard circuit.

duty cycle. These duty cycle variations are obtained without affecting the wave shape. Rise and fall times are relatively short—100 and 50 ns, respectively—and are independent of either the period or the duty cycle.

Modification of a standard multivibrator analysis gives the following expression for the duty cycle:

$$T_2/T_1 = R/R_{c1} [\ln(2 - E_o/E_c) / \ln(R_{c2} \beta_2/R_{c1})],$$

where all symbols are those defined in Fig. 1a; E_o is the voltage at the collector of Q_1 when Q_2 is OFF, E_c is the voltage drop across capacitor C , and β_2 is the beta of Q_2 .

The resultant waveshapes appear in Fig. 1b. Variations of the duty cycle as a function of R are tabulated below.

Nikola Vidovic, Designer, Hildesheim, Germany.

VOTE FOR 113

Simple circuit delivers clean pulses with good noise rejection

A single, sharp pulse may be obtained with a delay line, spdt push-button switch and a few resistors. The circuit is immune to switch bounce and will provide a single repeatable pulse—so necessary with logic circuitry—with every switch closure.

The circuit has several advantages over normal differentiating circuits used to tame contact bounce. It is low-impedance and, therefore, less susceptible to noise and output loading; the output pulse is flat-topped with sharp rise and fall times; sneak or double pulses can not be generated, and pulse width is independent of voltage.

The circuit (see Figure) operates as follows: The delay line is charged to voltage V through resistor R_1 . R_1 is not critical, for it is used only to prevent current surges and isolate the power supply. When switch S_1 is activated, the delay line will discharge through R_2 , providing a pulse of amplitude $V/2$ and width of $2T_o$, where T_o is the delay time of the delay line. The delay line discharge will occur before the switch has a chance to bounce open, so that pulse width is determined solely by the delay line. Subsequent bounce closures will not produce additional pulses because the line is discharged. Releasing S_1 will recharge the delay line for the next cycle.

The switch is an spdt break-before-make type. Printed-circuit strip line or a long coaxial or twisted-pair cable may be substituted for the delay line. Resistor R_2 should be matched to the delay line and mounted close to the input of the

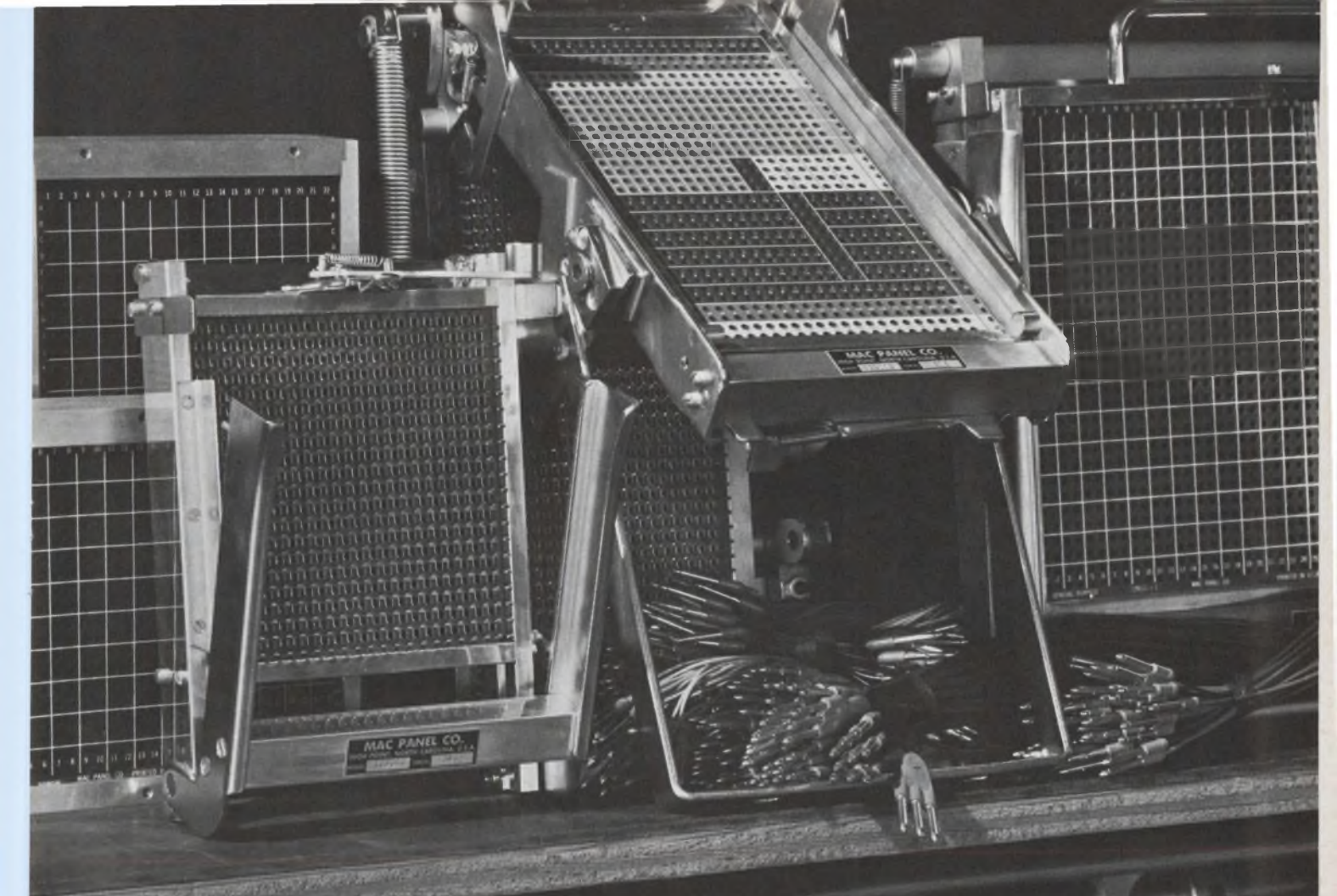

99 out of 100 orders MAC ships off-the-shelf!

(that 100th may take a little longer)

Every day we ship, from stock, plugboards in incredible variety — 200 to 5120 positions, fixed or removable. Receivers — standard, high shock and special design. We also ship — from stock — plugwires in diverse and varied configurations. MAC has a habit of having what you need on hand; we also

have the habit of shipping within 24 hours of receipt of orders. We work very hard to maintain both habits. So if you're tired of waiting four weeks, six weeks — or who-knows-how-long? — check with MAC. You'll find that nobody meets your requirements better. And nobody, but nobody, ships as fast. Even on those special orders.

If you're thinking this is just brag-and-boast, consider. An order will prove it, one way or the other. So order. We're ready.

MAC

O.E.M. DIVISION

MAC Panel Co., Box 5027, High Point, N.C. 27261

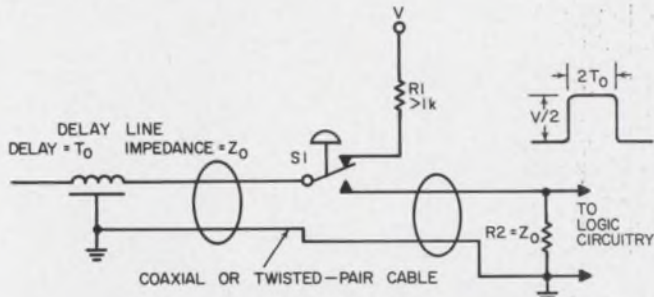

A delay line plus a few simple components can be used to produce sharp, clean pulses. The circuit's low impedance reduces its noise sensitivity.

succeeding circuitry to minimize reflection or "ringing." Impedance matching of the transmission line connecting the delay line and R_2 is not too critical, but an approximate match should be made.

Robert Ziller, Production Engineer, Amery Div. of Fabri-Tek Inc., Minneapolis.

VOTE FOR 114

Schmitt trigger hysteresis memorizes its last state

The Schmitt trigger variation of the basic bistable multivibrator is often used as a wave-shaping or threshold circuit. An attempt is usually made to minimize the circuit's unwanted hysteresis effect. In the following design the hysteresis was put to use.

The requirements were to convert the dc level of a low-frequency teletype square wave and, should the input signal become open-circuited, to latch up the circuit in the state immediately preceding the input opening.

The dc level conversion was provided by a Schmitt trigger and reed relay-driver combination as shown in Fig. 1a. The ability to latch up, or remember, the last input was furnished by the circuit hysteresis and the input bias. With reference to figure 1b, if the input bias voltage, V_B (see Fig. 1b), is adjusted to a point between the UTH (upper threshold) and LTH (lower threshold) points, the trigger circuit will latch up in its last state before the input opening. This circuit operation is due to the fact that the input voltage will always return to V_B when the input becomes open. If the last input signal drove the base of Q_1 above the UTH and then opened, the input would return to V_B and not reach the LTH . Hence, Q_1 would remain ON, which would be its last transition. The circuit will act in a similar manner if the last input signal drove the base of Q_1 below the LTH and then open-circuited.

The circuit shown in Fig. 1 was designed to

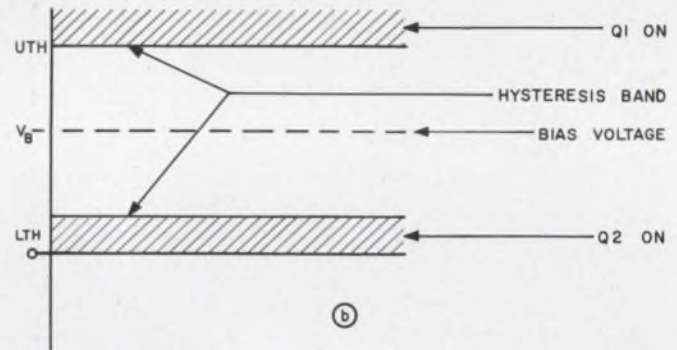
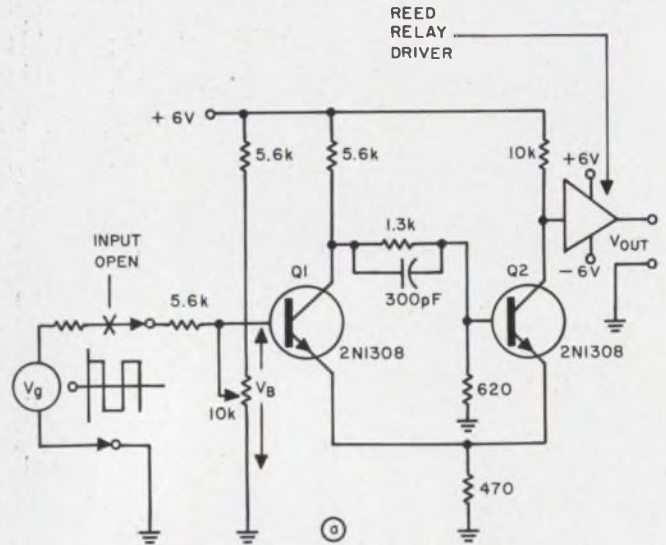

1. Memorizing of the last input is accomplished by adding the bias resistors, R_{b1} and R_{b2} , to the otherwise standard Schmitt trigger circuit (a). Their action is shown in (b).

convert a high-level (± 60 V, 30 mA), polar teletype signal to a low-level signal at frequencies of 22.5 to 75 Hz.

A. R. Campbell, Senior Engineer, Philco Corporation, Philadelphia.

VOTE FOR 115

Voltage-tuned oscillator may be adjusted simply

It is frequently necessary to adjust voltage-tuned oscillators and associated control circuits to obtain frequency vs voltage response. Point-by-point measurement is both tedious and expensive, especially when circuits are being checked over a range of environmental conditions. One method which can simplify the measurement procedure is described below. The test set-up is shown in the schematic.

The sweep output voltage of a sweep generator, covering the frequency range of the oscillator under test, and a low-frequency audio generator output are applied to the horizontal and vertical

First come first served.

You can have all the SDS T Series integrated circuit modules you want now. We're in full production.

All T Series active elements are integrated circuits and guarantee reliable operation at clock rates to 10 mc. Each circuit output drives 14 unit loads, even after generous allowances for wiring capacitance.

Outputs switch 60 ma (4 times more than standard IC's). Noise rejection is at least 1.5 volts at the 0 and 4-volt logic levels.

SDS Natural Logic gives you AND and OR as well as NAND and NOR —

Each card uniquely keyed for proper installation.

Test points.

Ground plane laminated through middle of entire glass-epoxy board.

Load resistors separate from IC's for heat isolation.

Discrete diode-resistor inputs for gating flexibility, high noise rejection.

Four pins reserved for ground lines.

Four integrated-circuit buffer amplifiers in each hermetically sealed TO-5 can.

52 ribbon connectors (26 each side) for easy access to all circuits.

All components clearly identified.

Individual power line filters.

Actual size $4\frac{1}{4} \times 4\frac{3}{4}$.

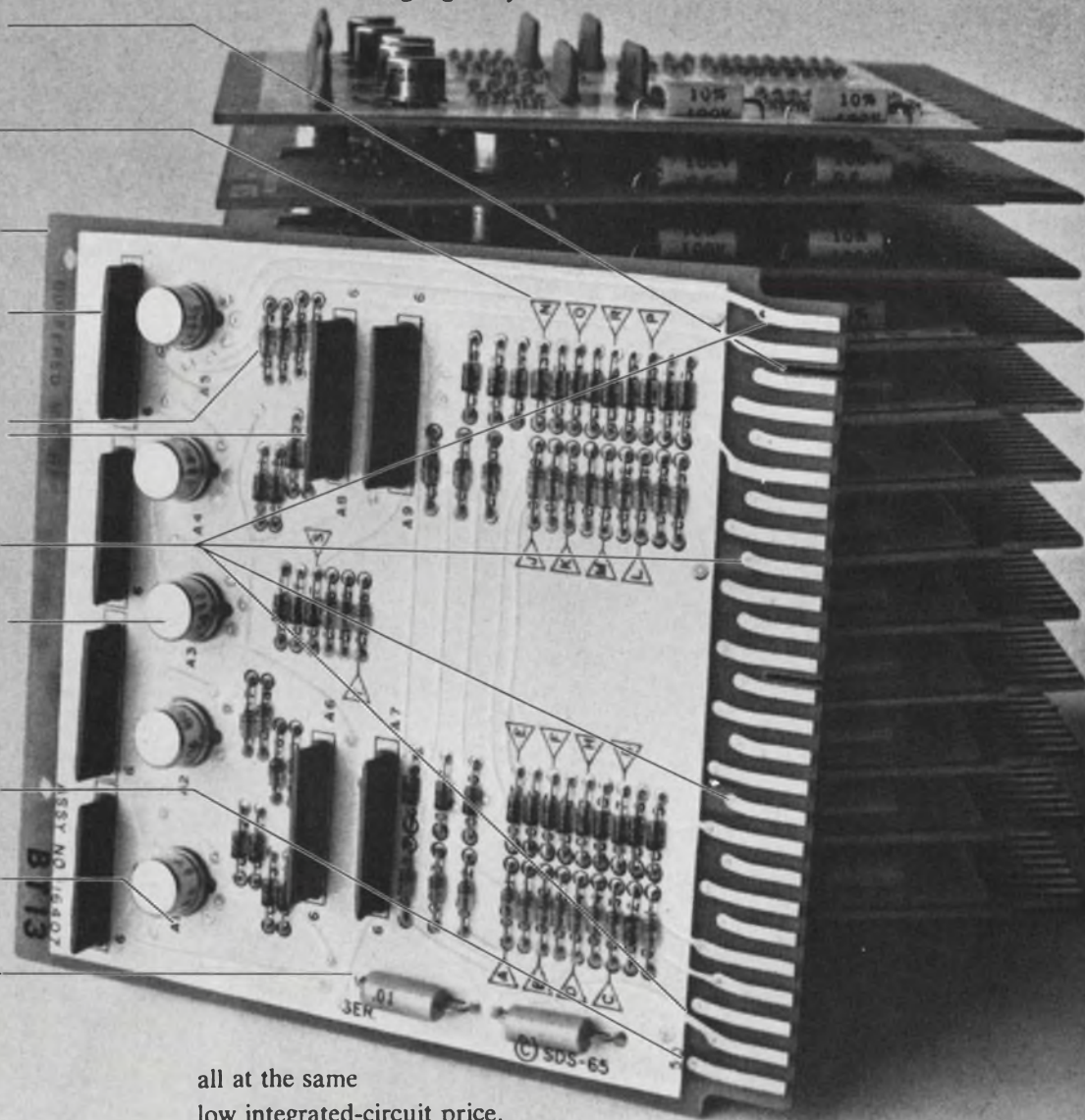

all at the same low integrated-circuit price.

We designed these modules for our new Sigma computers, but we also intend to become the largest manufacturer of logic modules for system designers.

We don't want to give away any of our Sigma secrets. But we'll sell them pretty cheap.

SDS
Scientific Data Systems,
Santa Monica, California

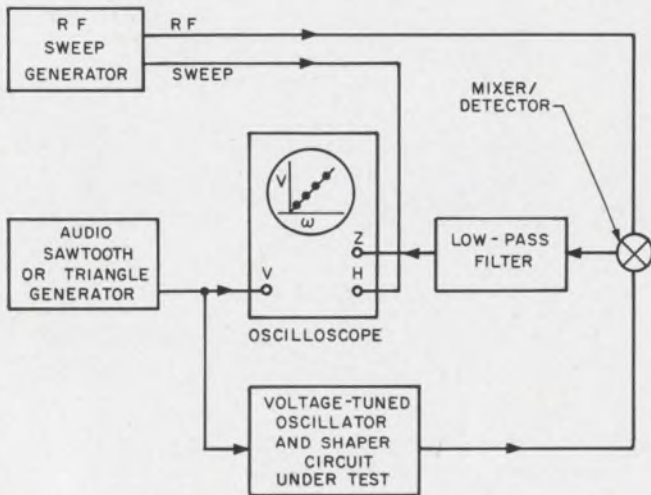

Visual adjustment of voltage-tuned oscillators is simple with the hook-up shown above.

amplifiers of an oscilloscope to create an unsynchronized raster of input voltage vs frequency. The RF outputs of the oscillator are mixed, filtered and applied to the intensity modulation input of the oscilloscope. When there is coincidence of tuning voltage, oscillator frequency, sweep generator frequency and sweep generator sweep voltage, a dot will appear on the scope. In this manner, a stationary dot pattern locus of voltage vs frequency (the dots appear to move up and down the curve) is traced out, and the oscillator and shaping networks may be easily adjusted for linear operation and tested over environmental limits.

Standard test equipment is used for this measurement. Although it helps to have a linear sweep from the RF sweep generator, the display may be calibrated for a sine-wave sweep.

Harrington Ricker, Surveillance Products Section Manager, and Harold Wasson, Sr. Engineer, Vitro Electronics, Silver Spring, Md.

VOTE FOR 116

Two-transistor oscillator generates two frequencies

An oscillator with only two transistors can be used to generate two frequencies. The circuit shown in Fig. 1 is a UJT oscillator followed by its second harmonic tuned circuit. Using the UJT's negative resistance region, the oscillator operates at 278 kHz (see Fig. 2a). The transistor stage is tuned to the second harmonic of the previous stage, i.e., 556 kHz (see Fig. 2b). The sawtooth-like oscillation of the first stage and the smooth sinewave at the output are due to capacitor C2.

The output signal can be applied to a triggering

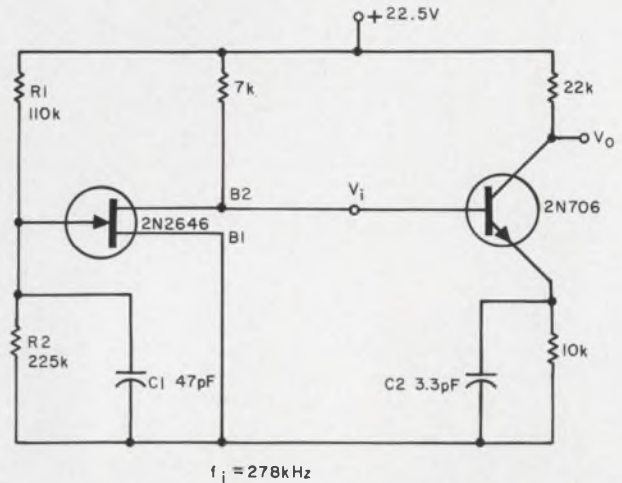

1. Tuning transistor stage to the second harmonic of the unijunction transistor oscillator circuit results in two output frequencies (points V_i and V_o).

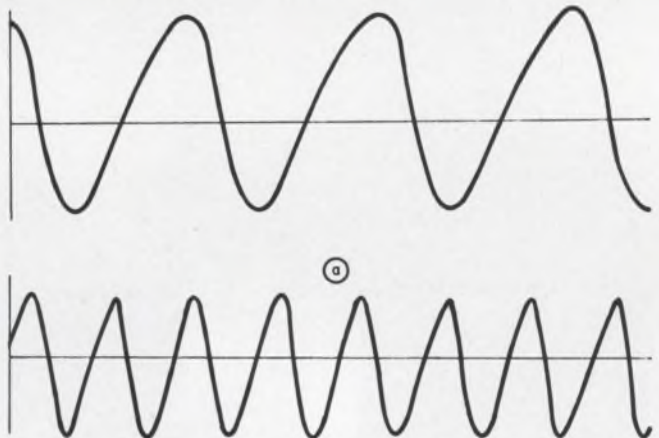

(b)

2. Reasonably good sinewave is obtained (b) from the sawtooth (a) produced by the unijunction oscillator circuit. The output impedance is about 1 kΩ.

circuit, a synchronized circuit, or a sweeping circuit. The circuit can produce other frequencies by varying R1, or R2, or C1 in the first stage and C2 in the second stage; it has an input impedance on the order of 50 kΩ and an output impedance of 1 kΩ. The oscillating frequency can be calculated from $f = 1/R_{eq} C1$, where $R_{eq} = R1 R2 / (R1 + R2)$.

Thac Mac, R & D Engineer, Allen Bradley Co., Milwaukee.

VOTE FOR 117

IFD Winner for Oct. 25, 1966

Robert W. Pargée, Senior Engineer, Electronic Engineering Co., Santa Ana, California.

His Idea, "Complementary darlington: a leading emitter-follower", has been voted the \$50 Most Valuable of Issue Award.

Cast Your Vote for the Best Idea in this Issue.



153,472 radio-dispatched taxicabs and only one tetrode rated for PTTS*

The cab driver is rarely on the air with his dispatcher for as long as 60 seconds and he drives at least 5 minutes between calls. The same goes for most radio-dispatched vehicles.

PTTS* (Push-To-Talk-Service), with its duty cycle of ONE MINUTE ON and FOUR MINUTES OFF has been shown to be the most realistic, economical and practical rating system for vehicular communications systems.

For this reason, Amperex developed the 8637, the only twin tetrode ever designed and rated for PTTS. Featuring high thermal inertia anodes and

incorporating a wealth of twin-tetrode manufacturing experience, the 8637 offers the designer a new approach in creating a better vehicular radio. Fewer, and less costly components may be used. Some typical operating conditions which bear this out are shown on the chart at right . . . lower plate voltage, lower drive and higher efficiency at the VHF frequencies.

The 8637 is a 'small tube', (only 3 1/8" seated height), perfectly suited for today's low-profile designs. Its cost is lower than ICAS and CCS rated tube types of the same power.

For data, applications reports and engineering assistance, write: Amperex Electronic Corporation, Tube Division, Hicksville, L. I., N. Y. 11802.

ALL THIS—and AMPEREX QUALITY, TOO!
ONE 8637—PUSH-PULL

Internally Neutralized Throughout Entire Freq. Range

50 MHz	PLATE	OUTPUT	DRIVE
CCS	375v.	25w.	0.67w.
ICAS	450v.	34w.	0.82w.
PTTS	600v.	84w.	0.86w.

175 MHz	PLATE	OUTPUT	DRIVE
CCS	300v.	18w.	1.4w.
ICAS	350v.	26w.	1.6w.
PTTS	560v.	63w.	2.2w.



Amperex
TOMORROW'S THINKING IN TODAY'S PRODUCTS

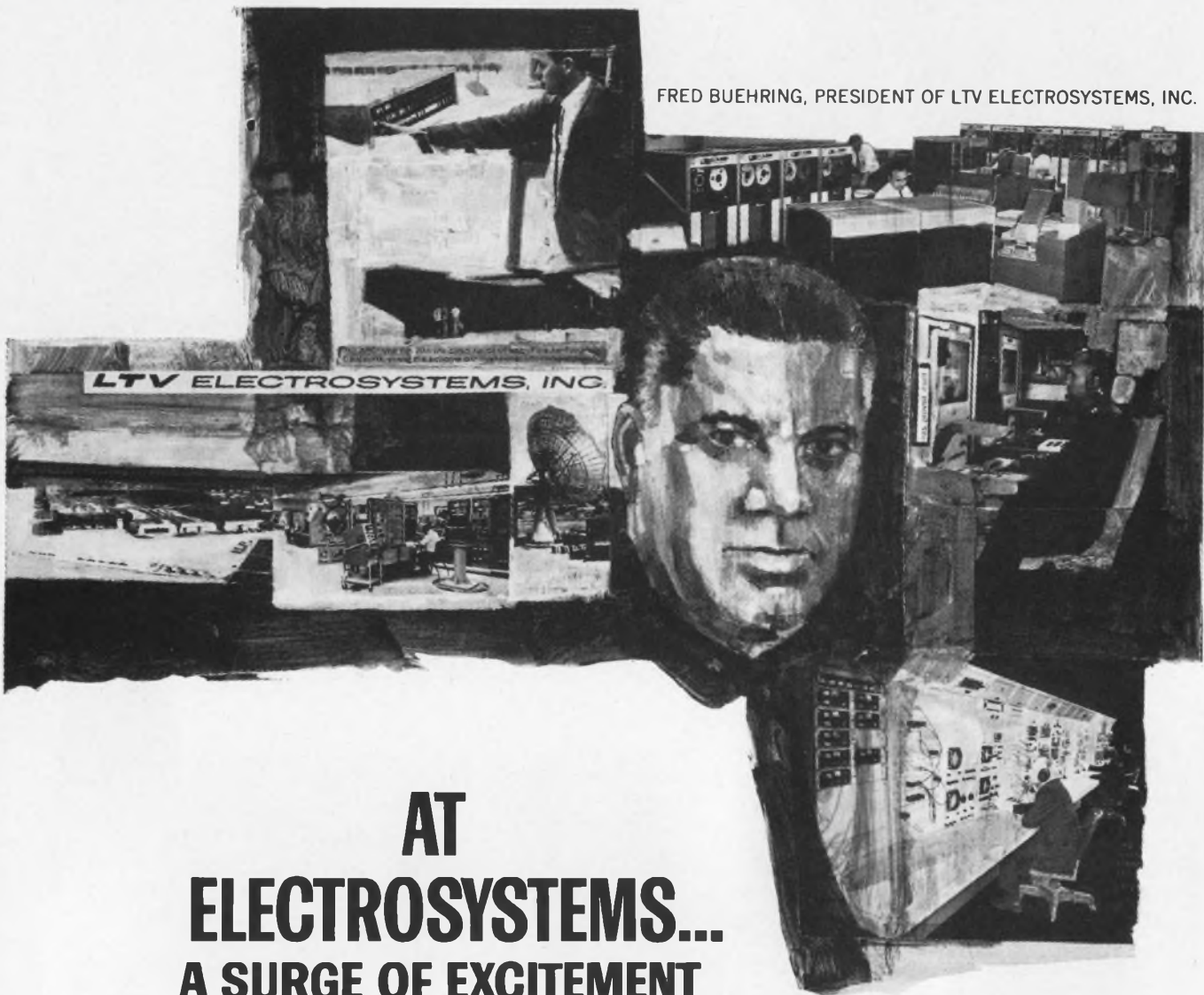

FRED BUEHRING, PRESIDENT OF LTV ELECTROSYSTEMS, INC.

AT ELECTROSYSTEMS... A SURGE OF EXCITEMENT

Every Electronics engineer who is serious about his career and individual professional achievement should know LTV Electro-systems. We are a special kind of electronics company — an entity of accomplishments, both statistical and legendary:

FACTS, FIGURES

LTV ElectroSystems is a systems-oriented electronics company, producing complete mission-ready, special-purpose weapons systems from new and original concepts. Our capabilities range the full spectrum from complete satellite tracking stations; strategic and tactical intelligence, reconnaissance and surveillance systems; new-generation digital communication systems; terrain contour sensing guidance systems; to super power transmitters . . . and more.

Primary customers include the Air Force, Army, Navy, NASA, U. S. prime contractors, foreign governments. Personnel includes more than 1,800 scientists and engineers among 7,000 employees. Facilities are spread among five Texas cities and one site in South Carolina. Annual sales exceed \$100 million and are rising.

THE X QUALITY

While ElectroSystems has outstanding laboratories and facilities, its greatest asset and most vital quality is an intangible

spirit of success and progress which pervades its technical team. There is an attitude of excitement — a personal identification with projects and purposes — seldom found among scientific and engineering staffs.

At LTV ElectroSystems there's room at the top. There's a concept-to-delivery approach and a challenge to intellectual achievement. There's a place for the man with imagination and capability — with the blend of vision and practicality that advances the state of the art . . . usefully.

OPPORTUNITY: THE CONSTANT FACTOR

Top management with technical background, a substantial R & D fund and an impressive backlog of challenging electronic projects give the LTV ElectroSystems engineer the opportunity to grow as we grow — where individual contributions are recognized and rewarded.

If you are serious about your specialty and are motivated to move up, we invite you to examine the opportunities at LTV ElectroSystems. Ask about our environmental test laboratories, the computer systems, the radiation laboratories. Meet the people who set the pace in the exciting surge of ElectroSystems. Write or call collect: Mr. Bill Hickey / P. O. Box 6118 / Dallas, Texas 75222 / Telephone: (214) 276-7111. (A subsidiary of Ling-Temco-Vought, Inc.) An equal opportunity employer m/f.

LTV ELECTROSYSTEMS, INC.

ON CAREER-INQUIRY FORM CIRCLE 900

CAREER INQUIRY – confidential

Respond to the career opportunities advertised in this issue. Fill out and send us this handy resume. **Electronic Design** will do the rest – neatly typed copies of this form will be mailed to the companies of your choice, indicated by the circled Career Inquiry Numbers at the bottom of this page.

3

Name	Home Phone
-------------	-------------------

Home Address (Street)	City	State	ZIP Code
------------------------------	-------------	--------------	-----------------

Age	U.S. Citizen <input type="checkbox"/> Yes <input type="checkbox"/> No	Security Clearance
------------	---	---------------------------

Prime Experience	Secondary Experience

Desired Salary	Availability Date
-----------------------	--------------------------

Employment History – present and previous employers

Company	City, State	Dates	Title
		to	
		to	
		to	

Education – indicate major if degree is not self-explanatory

Degree	College	City, State	Dates
			to
			to
			to

Additional Training – non-degree, industry, military, etc.

Professional Societies

--

Published Articles

--

- Career Inquiry Numbers:**
- 900 901 902 903 904 905 906 907 908 909
 - 910 911 912 913 914 915 916 917 918 919

ELECTRONIC DESIGN
850 Third Avenue
New York, New York 10022

Our best employment ads go home at night

Our own engineers and support personnel are our single best source of new hires. It's a statistic we take justifiable pride in, and work hard to maintain.

LFE is an engineers' organization, which is one way of saying that we're uncommonly aware of our engineering staff's importance to our present success and future growth.

This awareness shows itself in many ways. It forms our organization's structure and its technological interests; and it also permits **LFE** to attract and hold the career-long interest of exceptionally creative and able individuals.

Today more than ever, the span of interests at our Boston headquarters covers a wide range of advanced electronics development, with emphasis in these areas:

Circuit Designers

BSEE, 3 to 5 years of circuit design experience in analog, digital and feed-back amplifier design. Experience in taking circuit and breadboard design into chassis, unit or box hardware.

Mechanical Design/Packaging

BSME, 3 to 5 years' experience in creative mechanical design of electronic systems with emphasis on reliability and manufacturability. Able to do design layout and direct designers. Skill areas should include materials, structures and heat transfer analysis. High density packaging experience on special purpose computers highly desirable.

Reliability Engineers

BSEE, 3 to 5 years' experience in reliability engineering. Will establish mathematical models, conduct reliability apportionments and reliability analysis, participate in design reviews and perform maintainability analyses.

Components Engineers

BSEE, 3 to 5 years' experience in component engineering. Requires an all-around competent background. Experience in the application of component parts, component MIL SPECS, failure analysis and component evaluation.

Product Engineers/

Digital Display Hardware

BSEE, 5 years of product engineering experience. Familiar with electronic components and digital display hardware. Well versed in MIL SPEC requirements for airborne and ground electronics. Will assist in the development of advanced hyperbolic navigation receiving equipment.

Interested candidates should forward their resume to Mr. Robert Berndt, Personnel Manager.



ELECTRONICS DIVISION
LABORATORY FOR ELECTRONICS, INC.

1075 Commonwealth Avenue
Boston, Massachusetts
(617) AL 4-4233
An Equal Opportunity Employer

ON CAREER-INQUIRY FORM CIRCLE 901

Book Reviews



Make way on your bookshelf —this may be a FET 'classic'

Field-Effect Transistors: Physics, Technology, and Applications, J. Torkel Wallmark and Harwick Johnson (Prentice-Hall, Inc., Englewood Cliffs, N. J.). 376 pp. \$17.30

Here is a fundamental book on all aspects of the industry's latest toy—the field-effect transistor (FET). Its treatment of FET physics and technology helps the reader to understand subsequent application sections. Its insight into FET construction and manufacturing techniques should prove helpful to both circuit and device designers. Discrete-component-circuit engineers should find many useful hints on FET limitations and advantages that facilitate their application. IC designers will be better able to plan the manufacture of integrated circuits through a thorough understanding of the operation and physics of the device.

A purely application-minded engineer may feel slighted since only about one-fourth of the book is devoted to bona fide practical applications. However, one must view the "theoretical" portion of the book as a prerequisite to a full understanding of the application material.

—Peter N. Budzilovich

Build a better future for your family and yourself at **MCDONNELL**



1. McDonnell is a "name" in aerospace . . . a name earned by solid engineering achievement in the current decade. The engineering leadership exemplified by successes in Gemini Spacecraft and the Phantom Fighters lifts your career. In anticipation of defense and space needs still a decade away, aerospace engineering teams at McDonnell work ahead of the industry mainstream. Projects as yet unnumbered and unnamed in planetary entry, hypersonic flight, long duration space-flight, time reference systems, aerospace system integration, and missile maneuverability absorb the minds and energies of large R & D groups.

2. McDonnell has never had a major decline in engineering and professional employment. The Company has grown rapidly in every one of its product areas. It presently has a backlog of more than a billion dollars in production contracts, and yet research of is one of the fastest growing activities in the Company.

3. Facilities at McDonnell are second to none in space, advanced aircraft and automation. You'll find organizational and physical working conditions that complement your skills and education. McDonnell testing and development facilities range from man-rated space chambers to Mach 28 wind tunnels, laboratories from microbiology to optics, computers from analog through hybrid to digital. You will find McDonnell is a team organization and nowhere is teamwork as essential as in the aerospace industry. Team organizations keep you from becoming a desk-bound engineer and stimulate the exchange of experience and knowledge so necessary to the development of wisdom.

4. Naturally you want to earn your way and you want all you can earn. McDonnell wages are competitive with that of other industries. But being competitive isn't enough after you show your mettle. Then, it is corporate policy to recognize the unique and individual efforts of those who strive for and achieve engineering excellence. Success will stem from a combination of inspiration and perspiration . . . probably 10% of the former and 90% of the latter. But if you're willing to work, you'll never need to worry about your economic and organizational progress at McDonnell.

5. The McDonnell College Study Plan encourages self development and offers economic assistance plus adjusted work week benefits for advanced degree studies directly related to your job responsibilities. Many private and public colleges and universities in the area offer applicable programs.

6. The Gateway to Space is in St. Louis. You'll be working with the experienced men at McDonnell who designed the aircraft and spacecraft that have, for a decade, dominated aerospace technology. McDonnell is strongly oriented toward government contracting. It has demonstrated the talent that provides exceptional national service while returning worthwhile earnings to investors. As the fastest growing segment of our national economy, the Government provides a stable and continuing marketplace for those companies whose organization is oriented toward effectively serving the Nation's needs.

7. St. Louis is America's "City on the Go". In civic progress, in entertainment, in stores and homes, in industry, in sports and recreation, in education, in construction, in human involvement, St. Louis is the city with a "future" in the center of America.

8. You can best "change the world" by living in a world of change. The climate of St. Louis offers the mental and physical stimulation of four distinct seasons. How can you enjoy a warm fire without a new snowfall for comparison? What other natural phenomena than spring brings such a lift to your spirits? Who has failed to enjoy the comfort of a summer morning or the crisp smell of an autumn afternoon?

9. McDonnell's suburban location allows you to choose from the total spectrum of living locations. You may like the pace of apartment life at the heart of this 2½ million person metropolis. Or you might like the nearby suburbs with small city atmosphere and tree-lined streets. Just as convenient are rural areas, where you can live apart from the hustle yet be close enough to enjoy city-living advantages.

For more information about McDonnell as your future and St. Louis as your home, complete this coupon.

Mail This Form To: **W. R. Wardle, McDonnell Employment Dept. R-1, Box 516, St. Louis, Mo. 63166**

Name _____ Phone _____ Age _____

Home Address _____ City & State _____ Zip _____

Education: BS _____ MS _____ PhD _____ Major Field: _____
Date Date Date

Primary Experience Area: _____

Present Position: _____ Number of Years _____

MCDONNELL

An Equal Opportunity Employer

ON READER-SERVICE CARD CIRCLE 902

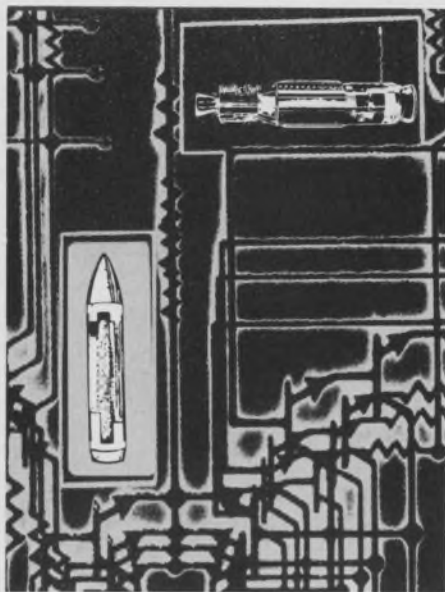

Up.

Down.

On the ground.

The place for new electronics advances is Lockheed.

Whatever environment you now work in—land, sea, or space—look into opportunities at Lockheed. Take Agena and Poseidon for example. Major technical expansion is under way. And both Agena and Poseidon share the need for new concepts and major technical advances. □ Typical Agena assignments include: digital communication systems for data transmission and command, digital and analog flight control systems, optical and infrared sensors, solar power panels, and power conditioning. □ Poseidon's requirements range from weapon effects on electronics to the design and use of state-of-the-art test checkout equipment. □ Undersea, Lockheed is active in deep submersibles and ocean mining. Now under way—the Navy's DSRV and Lockheed's Deep Quest research vehicle. □ On land: unique land vehicle systems, information systems for states and hospitals, and many others. □ Write Mr. R. C. Birdsall, Professional Employment Manager, P.O. Box 504, Sunnyvale, California, or call collect (408) 743-2200, until midnight Pacific Coast Time. An equal opportunity employer.

LOCKHEED

MISSILES & SPACE COMPANY
A GROUP DIVISION OF LOCKHEED AIRCRAFT CORPORATION

ON CAREER-INQUIRY FORM CIRCLE 903

Parallel transistors cut chopper losses

Problem: Develop a transistor chopper circuit that does not require close matching of transistors. Matched characteristics needed in conventional series choppers degrade during the operating life of the transistors causing degraded chopper performance.

Also, in the series circuit, the saturation resistances of the transistor pair add and become one of the major causes of chopper losses.

Solution: A parallel transistor chopper circuit in which one transistor operates in the forward mode and the other operates in the inverse mode, thus acting as a single, symmetrical, bidirectional transistor.

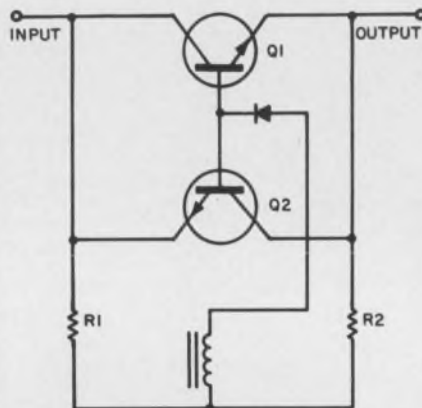

The active chopping element is Q1 and Q2. The transformer (only the secondary is shown) couples the drive signal into the chopping element. The peak amplitude of the drive signal is adjusted to be greater than the maximum input voltage being chopped, to prevent the input signal from overriding the drive signal. Therefore the transistor pair will not turn ON when the drive signal is in the negative half of its cycle.

Rather, when the drive signal is in the negative half of its cycle, the diode will be reverse-biased, blocking the flow of base

Radar Equipment Design Engineers

The Hughes Radar & Space Electronics Laboratories have important opportunities available for experienced Engineers.

System oriented

Engineers, Physicists and Analysts are required for the conceptual design of advanced radar, laser and telecommunication systems. Desirable background would include a broad knowledge of the state of the electronic art and specific experience in sensors, signal processing and communication theory.

Openings are available on nearly all levels—from those with a minimum of two years of applicable, professional experience through those who are interested in and qualified for senior supervisory positions.

Accredited degree and U.S. citizenship required.

For immediate consideration, please airmail your resume to:

MR. ROBERT A. MARTIN
Head of Employment
Hughes Aerospace Divisions
11940 W. Jefferson Blvd.
Culver City 19, California



An equal opportunity employer — M & F



Radar Equipment Design Engineers

The Hughes Radar & Space Electronics Laboratories have important opportunities available for experienced Engineers.

Circuit development

Engineers are desired for assignments involving high-power transmitters for advanced design pulse/pulse doppler radars. Desirable background would include detailed familiarity with transmitter tubes, high-voltage design, solid state techniques, microminiaturization, logic/control, pulse circuits or power supply design.

Openings are available on nearly all levels—from those with a minimum of two years of applicable, professional experience through those who are interested in and qualified for senior supervisory positions.

Accredited degree and U.S. citizenship required.

For immediate consideration, please airmail your resume to:

MR. ROBERT A. MARTIN
Head of Employment
Hughes Aerospace Divisions
11940 W. Jefferson Blvd.
Culver City 20, California

HUGHES

HUGHES AIRCRAFT COMPANY
AEROSPACE DIVISIONS

An equal opportunity employer — M & F



current and turning OFF the transistor pair. The chopping-element leakage during this portion of the cycle is determined by the sum of $R1$ and $R2$.

When the drive signal is in the positive half of its cycle, the diode will be forward-biased and current from the transformer will flow to the bases of $Q1$ and $Q2$. It will flow through the collector-base junction of $Q1$ and the emitter-base junction of $Q2$ to the transformer, through $R1$. At the same time, current will also flow through the emitter-base junction of $Q1$ and the collector-base junction of $Q2$ to the transformer, through $R2$. All four transistor junctions are thus biased ON, enabling the transistor pair to conduct current from the input voltage source to the output in either direction.

The parallel circuit has a combined saturation resistance two to four times less than that of the series circuit. The voltage, developed at one junction, is partially canceled by the voltage developed at the other junction. Only the difference of these voltages appears between the collector and the emitter.

The sum of the emitter-base breakdown voltages for the two transistors determines the maximum input voltage that can be chopped.

Resistors $R1$ and $R2$ should be equal in value to within a few per cent to ensure good symmetry and low offset voltages. The value of the resistors should be selected so that the average base current from either resistor will be slightly greater than the maximum current being chopped. Increasing the base current beyond this point will give slightly lower saturation resistance at the expense of increased chopper noise.

For further information, contact: Technology Utilization Officer, Marshall Space Flight Center, Huntsville, Ala. 35812 (B66-10113).

Radar Equipment Design Engineers

The Hughes Radar & Space Electronics Laboratories have important opportunities available for experienced Engineers.

Product design

Engineering assignments exist which involve the design and conceptual development of transmitters, modulators and power supplies employing BWO, CFA, Magnetron, Klystron and Traveling Wave Tubes. Desirable background would include a working knowledge of fabrication techniques, stress and thermal analysis, cooling, encapsulation, microminiaturization or high-voltage design.

Openings are available on nearly all levels—from those with a minimum of two years of applicable, professional experience through those who are interested in and qualified for senior supervisory positions.

Accredited degree and U.S. citizenship required.

For immediate consideration, please airmail your resume to:

MR. ROBERT A. MARTIN
Head of Employment
Hughes Aerospace Divisions
11940 W. Jefferson Blvd.
Culver City 21, California

HUGHES

HUGHES AIRCRAFT COMPANY
AEROSPACE DIVISIONS

An equal opportunity employer — M & F



Polaroid Land film makes you wait 10 seconds for an oscilloscope picture. The suspense can be unbearable.

We're sorry we can't do anything about that 10-second wait.

But if you can bear up under the strain, you'll get a sharply detailed, high-contrast, trace record.

You can study it, attach it to a report, send it as a test record along with a product shipment, or file it for future reference.

You also get a choice of four films for oscilloscope recording in pack, roll, and 4 x 5 formats.

The standard film has an ASA equivalent rating of 3000. And if you think that's fast, you haven't heard of our special film called Polaroid PolaScope Land film.

With an ASA equivalent rating of 10,000, it's the fastest thing in films. It can actually record a trace too fleeting for the human eye [for instance, a scintillation pulse with a rise time of less than 3 nanoseconds].

Of course, Polaroid Land films are as quick to point out a mistake as they are to point out a success.

If your trace shows an error, you know it right away. And you never go through the tedium of darkroom procedure only to find out that your blip was a blooper.

To use these films on your scope, you need a camera with a Polaroid Land Camera Back. Most manufacturers have them. Including these: Analab, BNK Associates, Coleman Engineering, EG&G, Fairchild, General Atronics, Hewlett-Packard, Tektronix.

You can get complete details by writing to one of these manufacturers or to Polaroid Corporation, Sales Department, Cambridge, Massachusetts 02139.

By the way, if 10 seconds fray your nerves, just imagine what it was like when Polaroid Land film made you wait 60 seconds to see your trace.

"Polaroid" and "PolaScope"®



Polaroid Land Film for Oscilloscope Trace Recording.

Products



Versatile lab unit generates accurately controlled parameters. As band-pass or rejection

filter, Q varies continuously from 1 to 100 in this do-all and be-all unit. Page 110

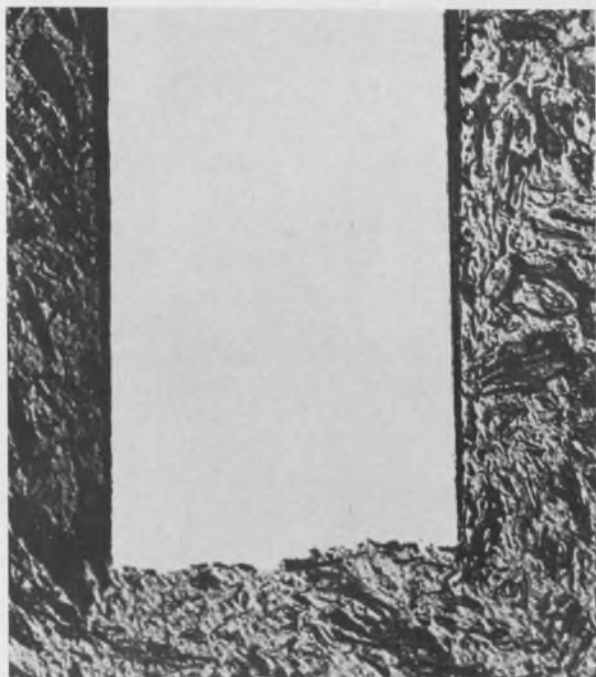

Perfect square edges for flat-pack preforms with this photo-etch alloy. Page 172

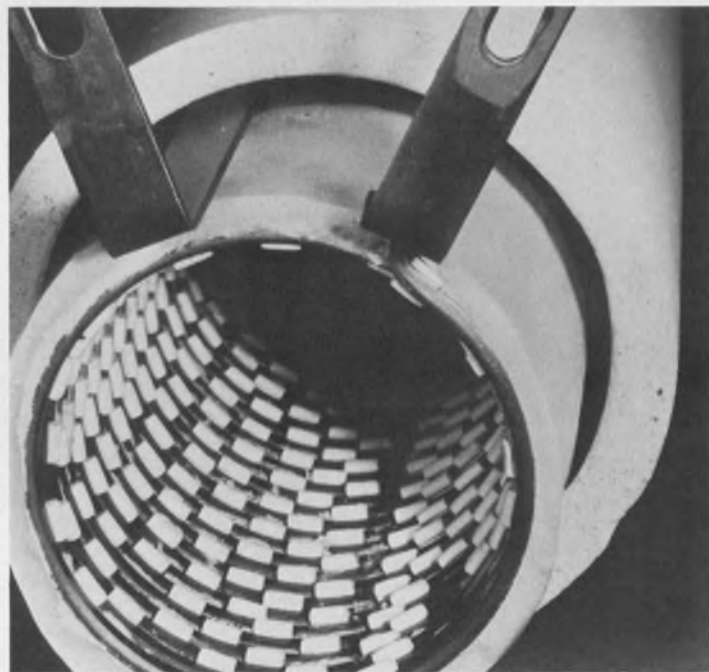

Tubular metallic furnace elements go to 2460°F for volume semiconductor diffusion. Page 178

Also in this section:

Speedy logarithmic converter keeps pace with oscilloscopes. Page 114

Chopper-stabilized drift performance from a chopperless diff-amp. Page 130

Chip capacitors mate with laminates or thin-film substrates. Page 162

Controlled active RC filter circuitry gives lab unit wide applications

Princeton Applied Research Corp., P. O. Box 565, Princeton, N. J. Price: \$1195.

A single laboratory unit, incorporating advanced active RC filter design techniques, performs the functions of six standard units at a cost comparable to that of less versatile multifunction instruments. It can function as:

- Oscillator.
- Tuned amplifier.
- Band-pass filter.
- Rejection filter.
- All-pass delay.
- Tunable μ V meter with variable bandwidth.

Accurately controlled parameters make the Princeton Applied Research model 110 useful for distortion, noise and harmonic analysis, as well as for providing stable oscillator output and wide-band amplification. It can also be used as a synchronous oscillator with sync from an external stable clock or oscillator.

As oscillator or tuned amplifier, the frequency range is 1 Hz to 110 kHz. Amplifier gain is continuously variable from 1 to 10,000.

Figure 1 shows a block diagram of the unit. The flat output gives a flat frequency response over the entire range. The resonance output provides

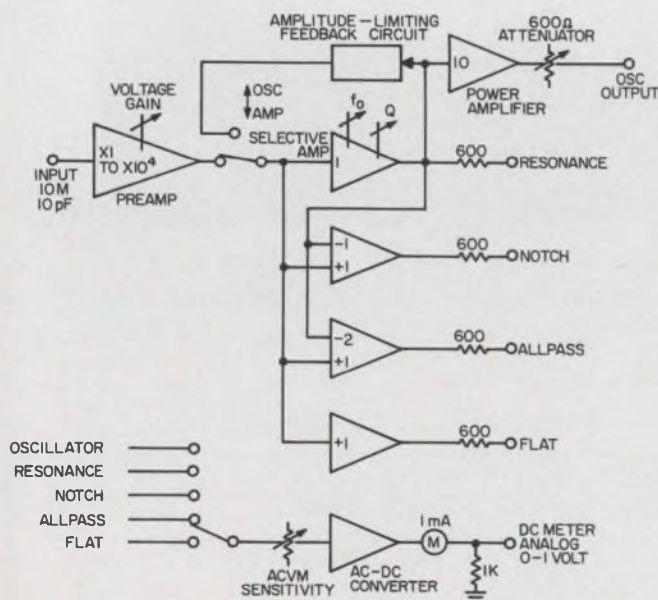

1. Block diagram of the PAR model 110 laboratory unit, showing how the various output modes are developed.

band-pass operation with amplitude at the center frequency determined by the gain control, and frequencies off resonance following the universal resonance curve for a selected Q value. The notch output provides band rejection with amplitudes of all frequencies except the center frequency subject to the gain control. The all-pass delay output gives an amplitude characteristic that is flat with frequency, and a phase lag that increases from 0° to 360° continuously with frequency, with a delay of 180° at the set, or center, frequency. This is accomplished by subtracting twice the output of the selective amplifier from its input. Phase-vs-frequency curves are given in Fig. 2.

The preamplifier consists of four gain-of-ten stages preceded by a unity-gain J-FET buffer stage. The over-all gain is controlled by the addition or removal of gain-of-ten stages, and by resistive attenuators. Gain is increased in steps of 1, 2 and 5, repeated in multiples of 10, to 10,000. A continuous control is provided for vernier adjustment within the steps.

Figure 3 shows a block diagram of the selective amplifier. It can be seen that the notch and all-pass delay functions are produced by linear combinations of the resonance output and the input to the selective amplifier. In this circuit, transmis-

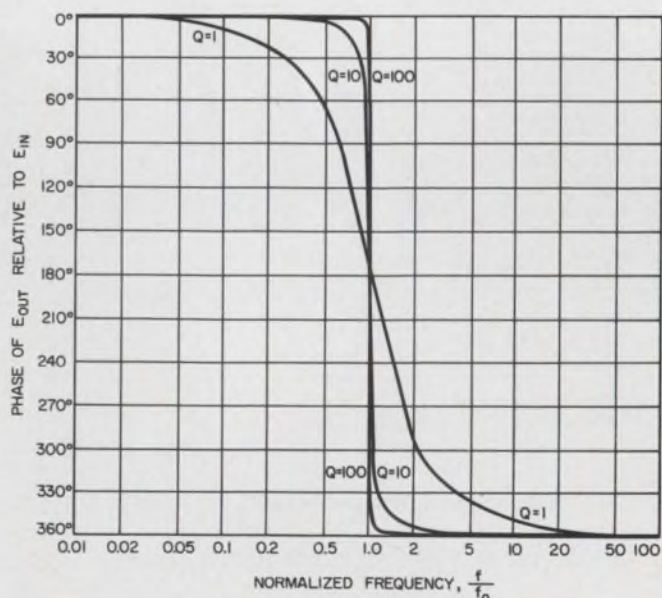

2. All-pass delay output, showing the relation of output phase shift to normalized frequency.

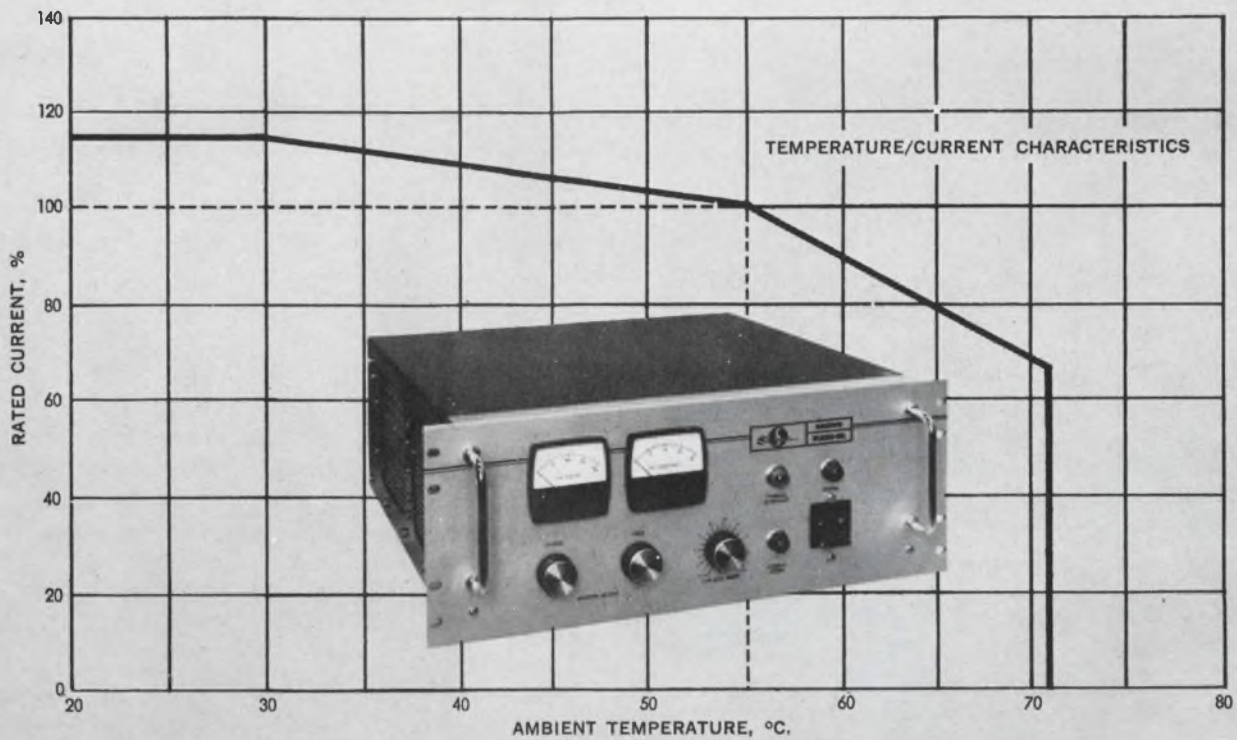

Sorensen DCR Series now with temperature capability to 71°C.

Sorensen Wide Range Power Supplies to 20 kW.

Sorensen's wide range DCR Series has been up-dated and improved. What's new about the DCR's? They are now 100% silicon; ambient temperature capability is now to 71°C. • Four 3-phase models have been added extending power capability to 20 kW; 24 models are now available with ranges up to 300 volts. • Multiple mode programming—voltage/current/resistance. • Voltage regulation, line and load combined, is $\pm 0.075\%$ for most models • Constant current range 0 to rated current. • DCR's meet MIL-I-26600 and MIL-I-6181

specifications and conform to proposed NEMA standards. Front panel indicator for voltage/current crossover. These features of the improved DCR (model numbers will have an "A" suffix) are offered at no increase in price. For DCR details, or for data on other standard/custom power supplies, AC line regulators or frequency changers, call your local Sorensen rep, or write: Raytheon Co., Sorensen Operation, Richards Avenue, Norwalk, Connecticut 06856. Tel: 203-838-6571.

MODEL SELECTION CHART

Voltage	Amps.	Model	Price	Amps.	Model	Price	Amps.	Model	Price	Amps.	Model	Price
0-20	125	DCR 20-125A	\$1180	250	DCR 20-250A	\$1550	—	—	—	—	—	—
0-40	10	DCR 40-10A	360	20	DCR 40-20A	525	35	DCR 40-35A	\$ 750	60	DCR 40-60A	\$925
0-40	125	DCR 40-125A	1390	250	DCR 40-250A	2100	500	DCR 40-500A	3050	—	—	—
0-60	13	DCR 60-13A	525	25	DCR 60-25A	780	40	DCR 60-40A	925	—	—	—
0-80	5	DCR 80-5A	360	10	DCR 80-10A	580	18	DCR 80-18A	780	30	DCR 80-30A	925
0-150	2.5	DCR 150-2.5A	360	5	DCR 150-5A	580	10	DCR 150-10A	780	15	DCR 150-15A	910
0-300	1.25	DCR 300-1.25A	375	2.5	DCR 300-2.5A	580	5	DCR 300-5A	780	8	DCR 300-8A	910



Up in Orbit over Ground Amplifier Problems

?

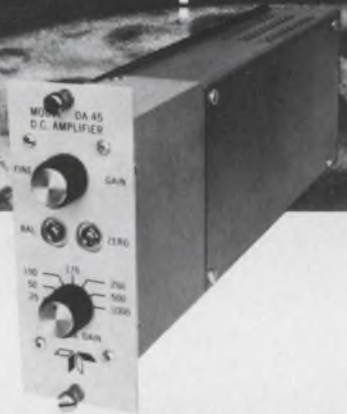

TTC has a down-to-earth solution!

SERIES DA-45 DIRECT COUPLED D-C AMPLIFIERS with *AUTOMATIC DECADE GAIN RANGING

Automatic Decade Gain Ranging and/or Remote Gain Ranging is now being offered as a standard option on TTC's Series DA-45 Amplifiers. Also available are IRIG proportional or constant bandwidth FM outputs. Options such as these, combined with outstanding standard features, make the DA-45 an excellent choice for low level data acquisition and multiplexing systems requiring broadband amplifier characteristics. Features include:

- | | |
|--|---|
| <input type="checkbox"/> DRIFT — 3 μ volts/°C | <input type="checkbox"/> D-C GAIN STABILITY — 0.1% of full scale |
| <input type="checkbox"/> LINEARITY — less than 0.05% BSL | <input type="checkbox"/> OVERLOAD RECOVERY — 60 μ seconds |
| <input type="checkbox"/> OUTPUT — 10V at 100MA | <input type="checkbox"/> CMR — 120db at 60 cps, 100db at 1kc/s |
| <input type="checkbox"/> BANDWIDTH — DC to 200kc/s | <input type="checkbox"/> AUTOMATIC GAIN SWITCHING — less than 3 μ seconds |
| <input type="checkbox"/> INPUT — 10 MV to 1V | |

For complete information on how TTC can provide new solutions to your amplifier problems, write for bulletin DA 45-0766.

*Automatic Decade Gain Ranging, Teledyne Telemetry Company's recently developed automatic gain switching amplifier option.

TELEDYNE TELEMETRY COMPANY

A Division of Teledyne, Inc.



AEROSPACE DIVISION

12964 Panama Street
Los Angeles, California 90066
Telephone (213) 870-9831
TWX: 910 343 6855

DYNAPLEX DIVISION

P.O. Box 341 Alexander Road
Princeton, New Jersey 08540
Telephone (609) 452-2550
TWX: 510 685 2379

COVER FEATURE

sion at resonance is exactly unity, even if the RC tuning does not track perfectly. The transmission approaches zero at frequencies very far from resonance. The Q of the resonance is determined by the gain of a single amplifier stage, and can be set to any value between 1 and 100. On resonance, gain is independent of Q adjustment, and Q is only slightly dependent on tracking. For inputs below 1 V rms, total harmonic distortion of the selective amplifier is less than 0.01%; for input signals up to 5 V rms, it is less than 0.1%.

The ac voltmeter circuit is of conventional design, employing negative feedback around a diode bridge, and a dc voltmeter calibrated in rms values.

Over-all sensitivity of the unit ranges from 100 μ V to 5 V full-scale in steps of 1, 2 and 5 and their decimals.

As harmonic distortion analyzer, the unit can measure harmonic distortion levels as low as 0.001%. Figure 4 is an oscilloscope photograph of the notch output with a square wave applied to the input to the tuned amplifier. This gives a square wave minus a sine wave of the same frequency, leaving all the Fourier components except the fundamental.

In another application of the notch function it is possible to measure one or more small components of a large interfering sinusoid. In harmonic distortion analysis, a very pure single-frequency signal is applied to the system under test, and the response of the system is processed by a sharpened notch adjusted to reject the fundamental. The output of the notch filter then consists of the harmonics generated by the system.

CIRCLE NO. 122

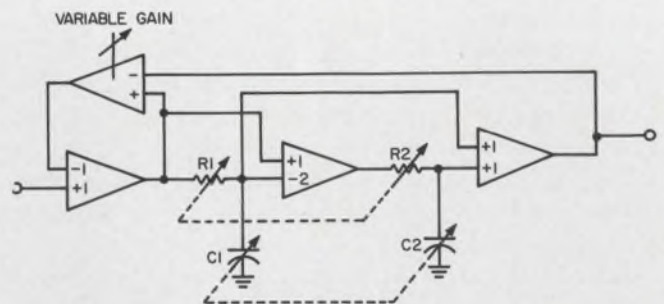

3. Block diagram of the selective amplifier section: a variable-gain amplifier controls Q from 1 to 100.

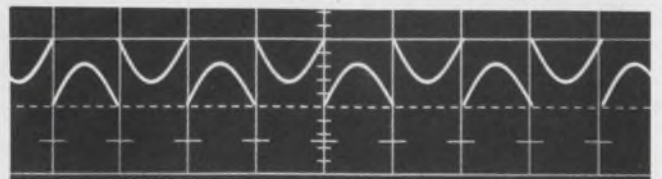

4. Oscillograph of notch output showing square wave with a sine wave of the same frequency subtracted.

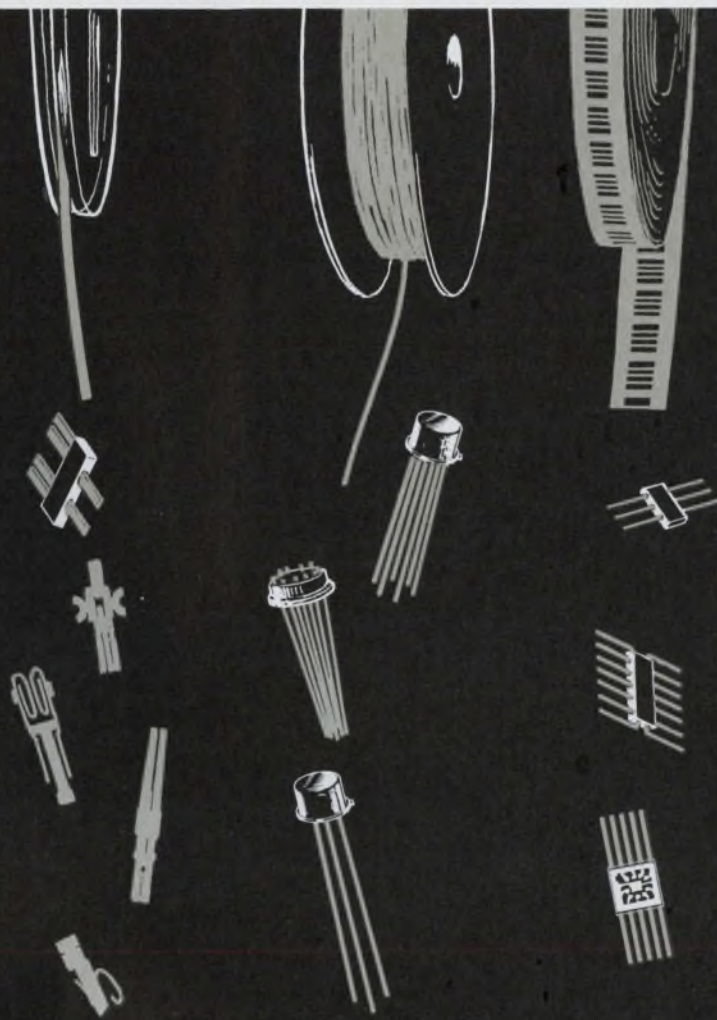

Many parts can be plated better, faster,
and more economically with
**BURTON'S NEW CONTINUOUS
PRECIOUS METAL PLATING PROCESS**

Burton's new CONTINUOUS precious metal plating process normally reduces cost of precious metal substantially by putting the plating only where you want it. In addition, some parts can be plated and manufactured ready for your use (see inset)!

If you use precious metal plated parts of any kind this outstanding advancement in plating techniques may save you time

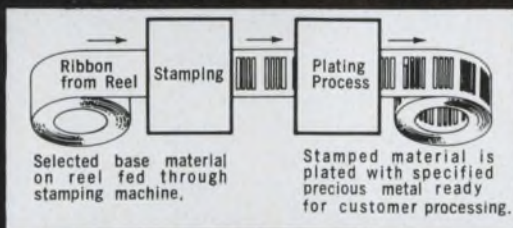

and money while greatly improving quality. Why not find out about it? We'd be glad to send you complete information.



BURTON RESEARCH LABORATORIES, INC.
11240 PLAYA / CULVER CITY, CALIFORNIA / (213) 391-6325

A Division of Burton Silver Plating Company

ON READER-SERVICE CARD CIRCLE 50

Why the most readable readouts have a new lens system.



SERIES 120
3/4 ACTUAL SIZE

We've just designed a totally new lens system for our miniature rear-projection readouts, the Series 120 and the Series 220 (front plug-in model). Since we already had the most readable readouts made—even with the old lens system—why all the effort?

Frankly, the most important thing we (or any other readout manufacturer) have to sell is readability. That's why we keep on working to make the best just a little bit better. This time it really paid off. Our new lens system delivers a significant increase in character sharpness and a 50% increase in brightness! Here's what we did:

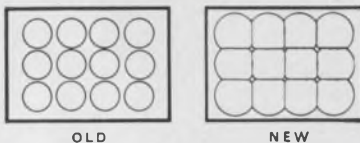

OLD

NEW

First we squared our circular lenses. That gives us greater usable lens area for a two-fold effect: the new larger lenses collect more light; magnification required is reduced. Both factors increase brightness and sharpness.



OLD

NEW

Second, we split the old single condenser lens and made a lens-film-lens sandwich. The old lens refracted light rays toward the projection lens before the rays passed through the film. Of necessity, the lens had steep curvature which limited the usable size of film. The new split-lens condenser refracts light in two stages: before it passes through film and after. By comparison, the new lenses are practically flat, permitting use of larger film and reducing aberration associated with thick lenses. The effect builds up: larger film means less magnification which in turn means greater brightness and sharpness.

So that's why the most readable readouts have their new lens system. Frankly, this new lens system may not seem earthshaking to you, unless you happen to be using readouts. In any case, send us your inquiry. We'll give you the reading on readability!

IEE INDUSTRIAL ELECTRONIC ENGINEERS, INC.

7720 LEMONA AVENUE, VAN NUYS, CALIFORNIA
PHONE: (213) 787-0311 • TWX: (910) 495-1707
© 1966 IEE Representatives in Principal Cities

ON READER-SERVICE CARD CIRCLE 51

TEST EQUIPMENT



Log converter mates with oscilloscope

Pacific Measurements, Inc., 940 Industrial Ave., Palo Alto, Calif. Phone: (415) 328-0300.

The logarithmic converter model 1002 is said to be fast enough to be used with an oscilloscope. The instrument's response time is under 2 μ s at input levels above 100 mV. Its one-million-to-one dynamic range eliminates need for range switching or amplifier adjustment in coverage of a phenomenon. A change of 1 dB in input is converted to a 50-mV change in output signal. Switching for either polarity is automatic and the log of the absolute magnitude of the signal is taken.

CIRCLE NO. 123



Sweep oscillator has crystal plug-ins

Hewlett-Packard, 1501 Page Mill Rd., Palo Alto, Calif. Phone: (415) 326-7000. P&A: unit, \$665; plug-ins, \$40; 7 to 10 weeks.

This 100-kHz to 110-MHz sweep oscillator has two plug-in positions. One determines the range of sweep frequencies and the other accepts as many as eight plug-in marker cards, each with its own frequency-determining crystal. The output is over 0.7 V. Using off-the-shelf plug-ins, the unit will accommodate a variety of test programs. Six frequency-determining plug-ins are available.

CIRCLE NO. 124

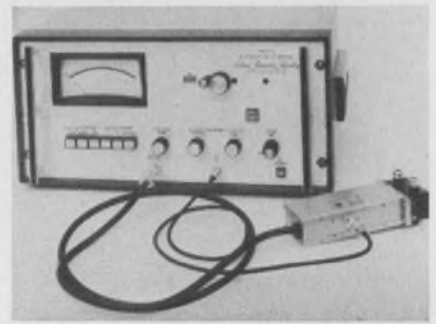

Read RF attenuation at 100 dB in one step

Airborne Instruments Lab., Comac Rd., Deer Park, N. Y. Phone: (516) 595-5000. P&A: \$3500; 60 days.

This attenuation calibrator has a measurement range greater than 100 dB in a single step, with less than 0.4 dB error. Measurement is made by the basic IF series substitution method. It has an accuracy of 0.05 dB per 10-dB increment with a max error of 0.3 dB. Frequency correction for an external local oscillator is contained within the unit, reducing drift by a factor of 500. Normal meter resolution is 0.05 dB per division.

CIRCLE NO. 125



Compact RFI meter covers 10 to 168 kHz

Stoddart Electro Systems, Div. of Tamar Electronics, Inc., 2045 W. Rosecrans Ave., Gardena, Calif. Phone: (213) 770-0270. P&A: \$3250; stock.

A compact portable RFI unit that covers the range from 10 to 168 kHz can be carried by handle or shoulder-strap. A battery pack within the unit permits forty continuous hours of operation. It is useful for detecting both radiated and conducted interference, field intensity measurements, measuring random and broad-band noise and antenna radiation patterns.

CIRCLE NO. 126



Power meter elements field-replaceable

PRD Electronics, Inc., 1200 Prospect Ave., Westbury, N. Y. Phone: (516) 334-7810.

This solid-state power meter uses dry thermoelectric calorimeters, whose thin-film elements are field-replaceable. The unit, type 6685, measures average power of cw, pulse, AM or FM signals from 0.3 μ W to 300 mW over thirteen ranges. Accuracy is $\pm 1\%$ of full scale. The unit claims a temperature stability greater than 0.1%, negligible zero drift, operating range of 60 dB. A battery pack is optional.

CIRCLE NO. 127



Coax cable tester goes to the problem

Automation Dynamics Corp., Industrial Pkwy., Northvale, N. J. Phone: (201) 768-9200. P&A: \$1440; stock to 2 wks.

The "Coax-I-Test" is a fully portable instrument for the testing of coaxial cable. The instrument is said to completely eliminate the need for complicated test setups using bridges, oscillators and slotted lines. The "Coax-I-Test" is provided with push-button controls and can be operated by non-technical personnel with little training required. As an option, go no-go lights can be provided.

CIRCLE NO. 128

New! -- Ballantine Solid State True RMS Voltmeter

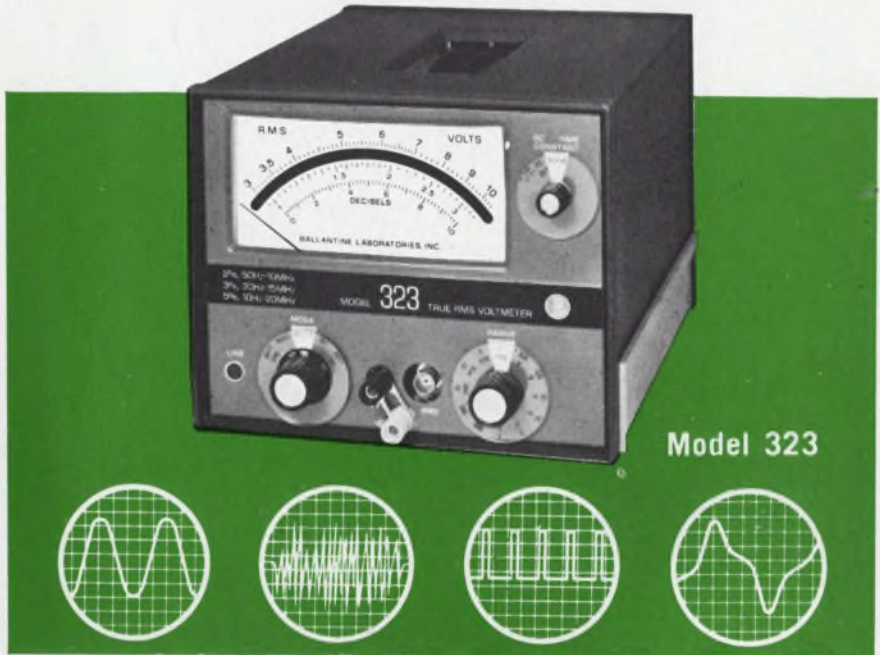

Measures from 10 Hz to 20 MHz regardless of Waveform

Ballantine's new Model 323 is a rugged, all-solid-state voltmeter for True RMS measurements for 10 Hz to 20 MHz . . . and for a wide variety of waveforms. Use it as a completely portable instrument isolated from line effects (due to built-in rechargeable batteries), or plug it into the power line. (Model 323-01 is for use on power line, only.)

FEATURES:

- ★ Measures True RMS of sine waves, square waves, noise voltages and a range of pulses
- ★ Frequency range of 10 Hz to 20 MHz
- ★ Voltage range of 300 μ V to 330 V. (As null detector to 70 μ V)
- ★ Unmatched accuracy: 2% of indication, 50 Hz to 10 MHz; 3% of indication, 20 Hz to 15 MHz; 5% of indication, 10 Hz to 20 MHz. Ballantine's accuracy of 2% means 2% of the actual indication, whether at the top or bottom of a scale
- ★ Operates from built-in rechargeable batteries or line power
- ★ Ideal for recorder applications — DC output of 0.1 to 1.0 V for each range simultaneous with meter reading
- ★ Crest factor: 5 at full scale to 15 at down scale
- ★ Separate isolated signal and case grounds
- ★ Optional 80 dB Attenuator Probe, Model 1301, for operation up to 10,000 V

Prices: Model 323, \$520 (Battery & Line)
Model 323-01, \$485 (Line only)

Write for complete technical data today



BALLANTINE LABORATORIES INC.
Boonton, New Jersey

CHECK WITH BALLANTINE FIRST FOR DC AND AC ELECTRONIC VOLTMETERS/AMMETERS/OHMMEASUREMENTS, REGARDLESS OF YOUR REQUIREMENTS. WE HAVE A LARGE LINE, WITH ADDITIONS EACH YEAR. ALSO AC/DC LINEAR CONVERTERS, AC/DC CALIBRATORS, WIDE BAND AMPLIFIERS, DIRECT-READING CAPACITANCE METERS, AND A LINE OF LABORATORY VOLTAGE STANDARDS FOR 0 TO 1,000 MHZ.

ON READER-SERVICE CARD CIRCLE 52

GET DOUBLE-DEPENDABILITY AND ON-THE-DOUBLE DELIVERY

SWITCHCRAFT'S NEW



double-wipe

PRECISION SLIDE SWITCHES

TOPS IN "COST-TO-QUALITY RATIO" —

Even though per unit cost is low, Switchcraft's new line of completely hand-crafted precision slide switches (formerly known as Muter switches) feature exclusive DOUBLE-WIPE action for true bifurcated contact reliability. Special silver-plated "U" shaped sliders assure positive contact, are self-cleaning and retard oxidation or increased contact resistance.

An exceptionally wide variety of single and multiple-pole switches are available from stock. Eight basic series including general purpose, tandem, quadrum, rocker and miniature. Contacts rated at 0.5 amp, 125 VAC/VDC; 3 amps AC only. Wide choice of knob colors. It is the broadest line of high quality, low cost precision slide switches available.

PRICED RIGHT!

Switchcraft hand crafting and double-wipe reliability costs little more than other switches without these exclusive features.

ANY QUANTITY . . . QUICKLY!

Even super-size orders are ready for delivery in a matter of two or three weeks. Small orders delivered in a week . . . often in only days.

SEND YOUR DRAWING FOR A QUOTATION AND SAMPLE:

Samples of *specific* types can be shipped the day your request is received.



FOR ADDITIONAL INFORMATION,
SEND FOR CATALOG S-330

SWITCHCRAFT

5529 ELSTON AVE., CHICAGO, ILL. 60630

ON READER-SERVICE CARD CIRCLE 53

TEST EQUIPMENT



Ac/dc multimeter retails for \$34.95

EICO Electronic Instrument Co., Inc., 131-01 39th Ave., Flushing, N. Y. Phone: (212) 772-6000. Price: \$34.95.

A recent addition to the imported Truohm multimeter line is the model 100A4 with a dc sensitivity of 100 k Ω /V and an ac sensitivity of 12.5 k Ω /V. Features of the instrument include: double-jeweled $\pm 2\%$ d'Arsonval meter movement, a 4-in. mirror-backed scale and matched-pair diode overload protection.

CIRCLE NO. 129

Low-noise amplifier gives 100-dB gain

Brookdeal of America, Inc., P. O. Box 386, North Falmouth, Mass. Phone: (617) 563-3225. Price: \$576.

With a noise figure below 2 dB, the LA 350 amplifier provides up to 100-dB gain in laboratory applications. The instrument can be used to measure signals from sources such as bridges, microwave crystals, photomultipliers and a variety of other transducers. It has two input modes with input impedances higher than the source impedance from which they are noise matched, thus minimizing circuit loading.

CIRCLE NO. 130

- A** 1395-A Produce Any Pulse You Want
 - countless variety of pulses
 - select from five modules
 - \$575 (plus modules, \$160-\$400)
- B** 1217-C High Performance at Minimum Cost
 - 2.5 Hz to 1.2 MHz
 - <10 ns rise time
 - \$340 with power supply (unreg.)
- C** 1398-A Fast Rise and Fall Times
 - 2.5 Hz to 1.2 MHz
 - < 5-ns rise/fall times
 - \$595
- D** 1396-A Adjustable Bursts of Pulses
 - dc to 500 kHz
 - phase-coherent gate
 - \$490
- E** 1397-A Linear Amplifier with 1.2-Ampere Output
 - < 50-ns rise/fall times
 - 60-V into 50 Ω
 - \$495
- F** 1394-A High-Rep-Rate Pulses
 - 1 to 100 MHz
 - 2-ns rise/fall times
 - \$995

Prices apply in USA only

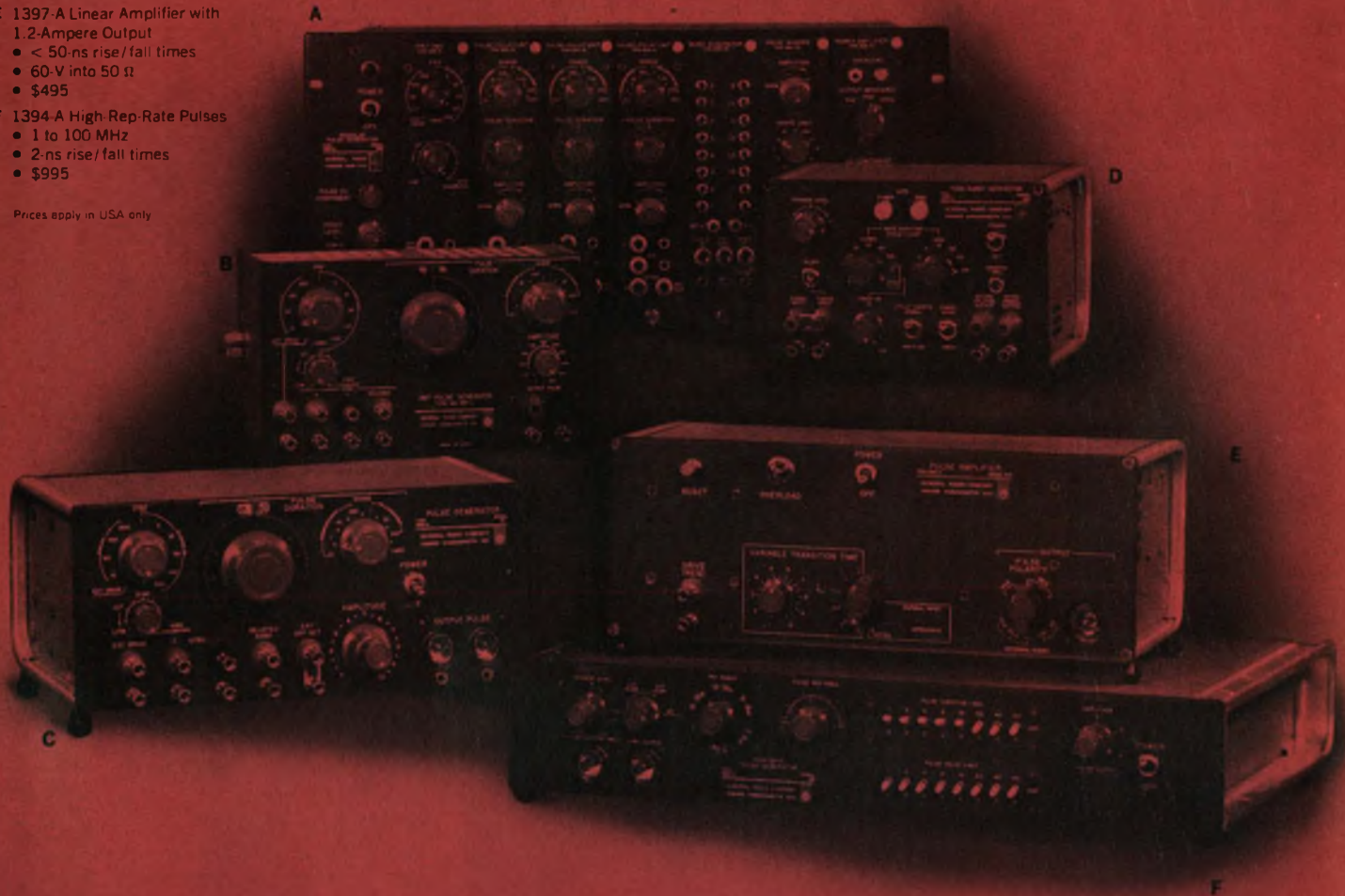

Pulses Galore!

In the market for a good pulse generator? Look into these instruments, with repetition rates as low as 2.5 Hz or as high as 100 MHz, rise and fall times from 2 ns to 10 ms, amplitudes as high as 1.2 A (p-to-p), and the best performance-to-price ratio you can find. If you want the special features of a custom-built pulse generator, our 1395 is the instrument for you. With its five different modules and capacity to handle up to seven modules in thousands of combinations, this instrument can generate just about any pulse or pulse train you can conceive.

For assistance in your hunt for a pulse, write General Radio Company, 22 Baker Avenue, W. Concord, Massachusetts 01781; telephone (617) 369-4400; TWX 710 347-1051.

GENERAL RADIO



12.5-MHz counter has 10-mV sensitivity

Hewlett-Packard, 1501 Page Mill Rd., Palo Alto, Calif. Phone: (415) 326-7000. P&A: \$1650 to \$1685; 5 to 10 days.

Both size and sensitivity are featured in the model 3735A electronic counter. The instrument measures less than 6-3/4 x 7-7/8-in. and has a

10-mV sensitivity. Particularly useful in low-level work, it can count 10-mV sine waves or pulses having peak amplitudes as low as 100 mV and pulse durations as low as 50 ns. Also featured is an input selector that allows one to change the trigger bias level around zero for optimum response to either sine or pulses, positive or negative.

CIRCLE NO. 131

Here's a tiny gang capacitor . . .

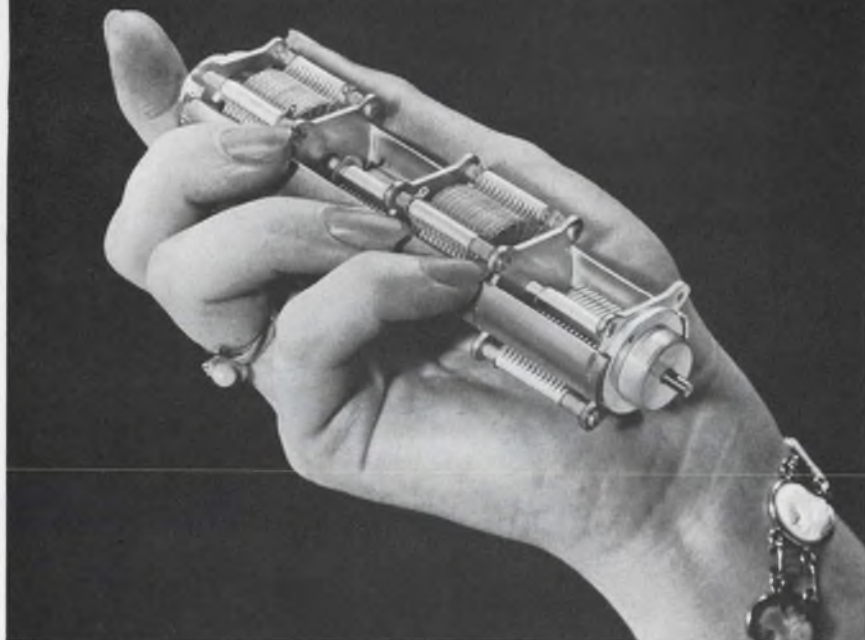

that's rugged, precise, modular

True modular versatility permits a wider-than-ever range of applications for the new, ultra-compact Johanson Type 6100 gang capacitor. Specify from one to five sections . . . each section can be supplied in different capacitance ranges and in the following capacity variations: straight line capacity, straight line frequency, butterfly or split stator. Mounting versatility is another big feature — a special bearing mount permits easy direct panel mounting.

Functional simplicity is the keynote of the 6100. Exceptionally high shock and vibration resistance are the result of a new design utilizing an exclusive spring-type bearing and special alumina support of the rotor and stator. In addition the new 6100 series features low temperature coefficient, low torque and smooth tuning.

Save space . . . save cost. Get all the facts on the Johanson 6100 before you design your next project.

Write for full details, specifications



MANUFACTURING CORPORATION

400 Rockaway Valley Road, Boonton, N.J., Phone (201) 334-2676

ON READER-SERVICE CARD CIRCLE 55

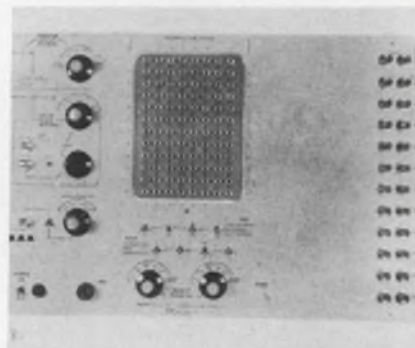

Programable pulser for sequencing systems

Adar Assoc., Inc., 73 Union Square, Somerville, Mass. Phone: (617) 623-3131. P&A: \$4000; stock.

A programable pulse generator, with solid-state IC logic, has a 16 by 12 program matrix board. Programming is done by inserting diode pins. The sixteen time steps make a single pass through the program, operating at stepping rates from 1 kHz to 10 MHz. Any step may be repeated, singly or in pairs, with the number of repeats controlled by an analog timer. The unit has 12 output channels.

CIRCLE NO. 132

Multioctave amplifier covers 0.01 to 400 MHz

Avantek, Inc., 3001 Copper Rd., Santa Clara, Calif. Phone: (408) 739-6170.

Covering multiple octaves without requiring tuning adjustments, this unit can be used in a variety of pre- or post-amplifier situations. The AV-1 amplifier, using all-silicon devices, has a min gain of 29 dB over its frequency range. It is designed to withstand airborne and ground military environments, and operates satisfactorily at 95°C.

CIRCLE NO. 133

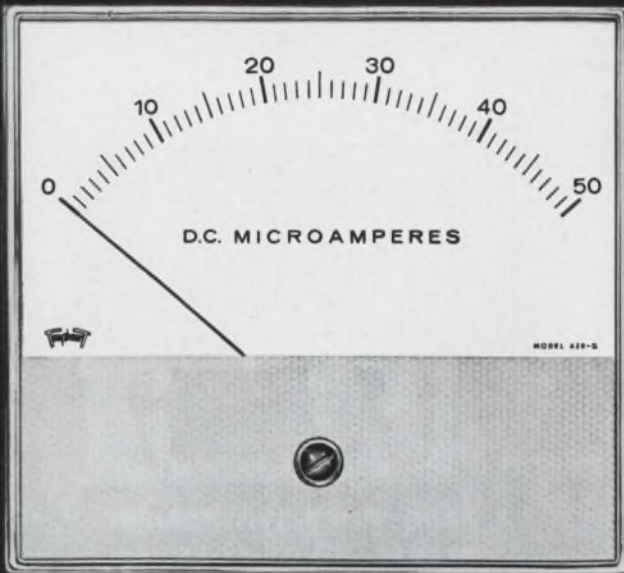

now you see it

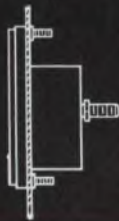

now you don't



THE PANEL INSTRUMENT WITH BUILT-IN FLEXIBILITY

TWO NEW SIZES!
5½" and 1½" (Miniature)

TRIPLET

New Triplet G-Series Panel Instruments offer a modern design that features a greater degree of flexibility and interchangeability.

- 1** Two types of mounting are available—conventional flush type or behind-the-panel with a bezel for modern picture window appearance.
- 2** The insert shield on the front of the meter can be custom painted or printed to meet customer's requirements.
- 3** Triplet's famous self-shielded Bar-Ring magnet, with one-piece die-cast frame, in all DC and DC suspension type instruments.

In five popular sizes: 5½" DC and AC; 4½" DC and AC; 3½" DC and AC; 2½" DC and AC; 1½" (conventional flush mounting only) DC and AC rectifier type.

NOW IN FIVE POPULAR SIZES:

1½" (Miniature); 2½"; 3½";
4½"; & 5½".

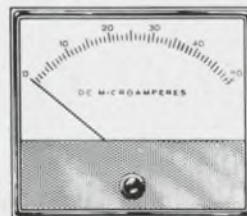
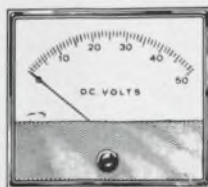

TRIPLET ELECTRICAL INSTRUMENT COMPANY, BLUFFTON, OHIO

Only Vector supplies this full line of 16 RF power amplifier transistors and 6 silicon small signal transistors in quantity for immediate delivery:

RF POWER AMPLIFIER TRANSISTORS:

2N1506	2N3553	V-408
2N1506A	2N3632	V-409
2N2631	2N3733	VX-3375
2N2876	2N3866	VX-3866
2N3374	2N4012	
2N3375	2N4440	

SILICON SMALL SIGNAL TRANSISTORS:

2N709	2N918	2N3633
2N709A	2N2784	V120RH

Get details and technical data from our nearest representative:

Automatic General Electronic Sales, Inc.
6550-B Troost Avenue
Kansas City, Mo. 64131
(816) DE 3-8206

Buchanan & Abrams Associates, Inc.
1512 E. Concord Ave.
Orlando, Fla. 32803
(305) 423-8995

Circuit Sales Company
Lakeside Office Park
591 North Avenue
Wakefield, Mass. 02172
(617) 245-5320

Cooper-Simon & Co., Inc.
7 West Broad Street
Mt. Vernon, N.Y. 10552
(914) OW 9-5400

Fiat Engineering Associates
5133 St. Charles Road
Bellwood, Ill. 60140
(312) 547-6200
TWX 910-234-0964

GM Industries
c/o P.O. Box 3066
Palos Verdes Penin., Calif. 90274
(213) FR 5-4317

J-H Electronic Sales Co.
Box 6844
Towson, Md. 21204
(301) VA 5-4440

J. McDonald Sales Co.
227 S. Cornnell Circle
Fort Wayne, Ind. 46807
(219) 745-9214

Precision Electronics, Inc.
520 Pennsylvania Ave.
Fort Wash. Ind. Park
Fort Washington, Penna. 19034
(215) MI 6-8383

Jack Pyle Company
1611 Borel Place,
Suite #4
San Mateo, Calif. 94402
(415) 349-1266
TWX 910-374-2354

Reed Electronics
2815 Monroe Avenue
Rochester, N.Y. 14618
(716) GR 3-2767

Or call us direct, at Vector Solid State Laboratories,
(215) 355-2700. TWX 510-667-1717.

Vector DIVISION OF UNITED AIRCRAFT CORPORATION
Southampton, Pennsylvania 18966



See us at Booths 4F26-4F34, IEEE Show

TEST EQUIPMENT



Frequency synthesizer makes 20-ns changes

Hewlett-Packard, 1501 Page Mill Rd., Palo Alto, Calif. Phone: (415) 326-7000. P&A: About \$13,500 (both units); May, 1967.

A frequency synthesizer is available that supplies any frequency from 0.1 to 500 MHz and can change frequency typically within 20 μ s. The frequencies are crystal-controlled and are selectable in steps as fine as 0.1 Hz from either remote electrical signals or the 10-column front panel switchboard. The instrument also has an input that permits phase modulation of the output. The synthesizer comes with its companion unit, the synthesizer driver.

CIRCLE NO. 134

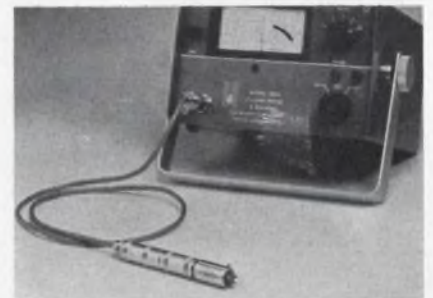

Probe unit converts capacitance to voltage

Lion Research Corp., 60 Bridge St., Newton, Mass. Phone: (617) 969-4710. P&A: \$98; stock.

The model GP 311 capacitance-to-voltage transducer converts an electrical capacitance or capacitance variation directly into a 0 to 10-V signal. The transducer can be used wherever a capacitive transducer is required to drive a meter, recorder, oscillograph, relay or computer.

CIRCLE NO. 135

Designed AS An Industrial...

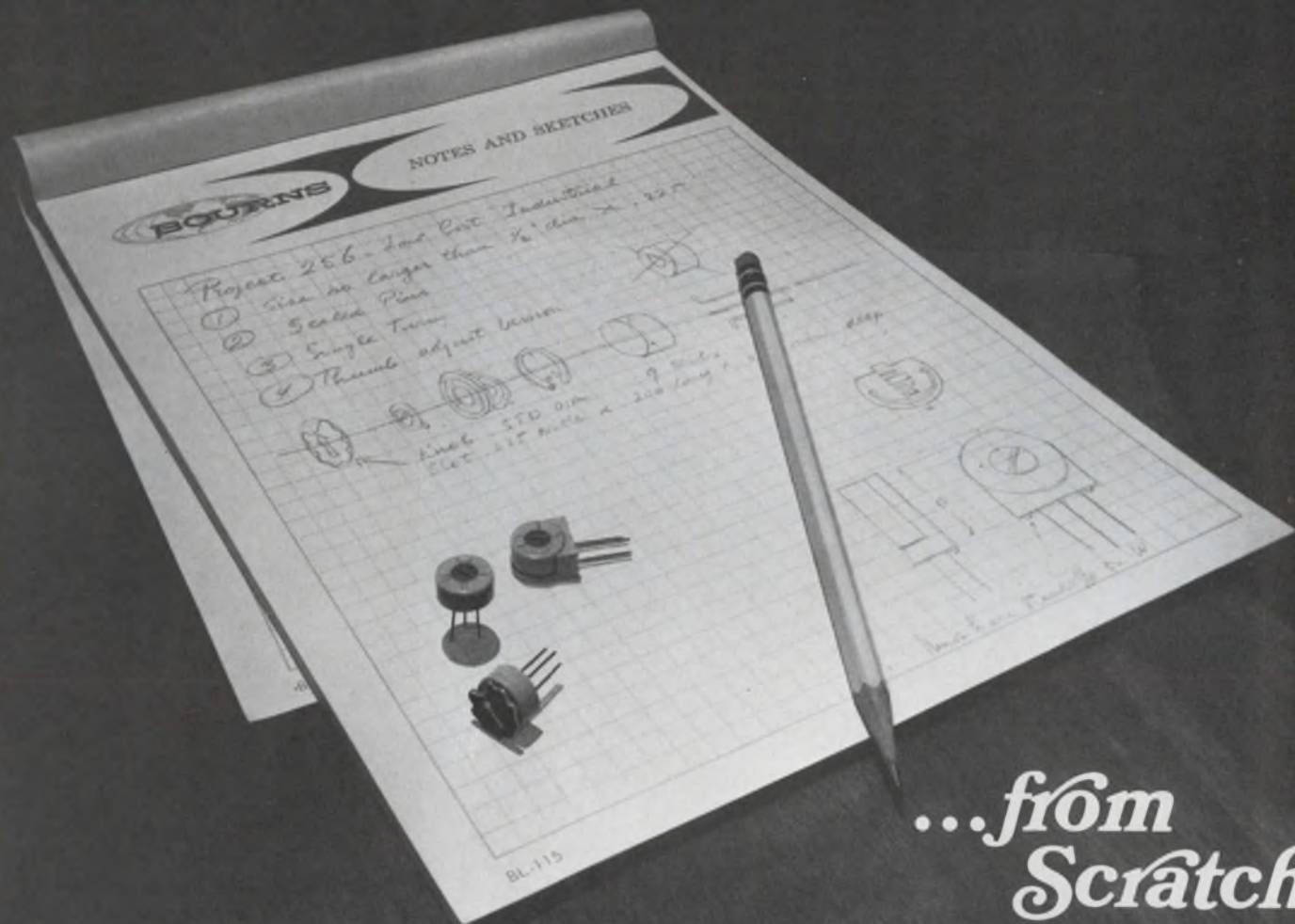

...from
Scratch

The Model 3365 TRIMIT® adjustment potentiometer is an industrial unit . . . designed from the ground up for industrial applications. It is brand new! This low cost single-turn wirewound unit is available in two printed circuit styles . . . each style is also available with thumb adjustment knob. Standard and special resistances are from 10 ohms to 50K. Resistance tolerance is $\pm 5\%$. It is small . . . $\frac{1}{2}$ " diameter by less than $\frac{1}{4}$ ". It is light weight . . . approximately 0.05 oz., in an all-plastic case.

There are several other points we would like to mention about the Model 3365. Its pins are sealed, its terminals gold plated, making it suitable for production fluxing and soldering processes employed on printed circuit boards. The exclusive SILVERWELD® process is used, thus eliminating vulnerable single wire terminations.

We think you will be even more impressed when you have read the complete, detailed specifications and technical data . . . they are available to you by contacting your nearest Bourns office or representative, or writing the factory direct.



3365P



3365W



3365SP-1-(RC)T

SPECIFICATIONS:

Standard Resistance Range	10 to 50K ohms
Resistance Tolerance	$\pm 5\%$ standard
Resolution	0.08 to 0.88%
Power Ratings:	
40°C Ambient	0.5 watt
105°C Ambient	0 watt
Operating Temperature Range	-55 to +105°C
Temperature Coefficient	70 PPM/°C
Humidity, MIL-STD-202, Method 103	100 megohms min. insulation resistance
Shaft Torque	8 oz-in max.
Mechanical Adjustment	280° nominal

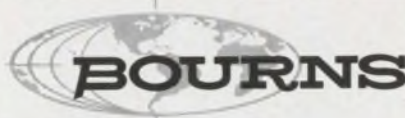

BOURNS, INC., TRIMPOT DIVISION • 1200 COLUMBIA AVE., RIVERSIDE, CALIF.
TELEPHONE 714 684-1700 • TWX: 910-332 1252 • CABLE: BOURNSINC.



Wave analyzer teamed with tracking oscillator

Hewlett-Packard, 1501 Page Mill Rd., Palo Alto, Calif. Phone: (415) 326-7000. P&A: 312A, \$3900; 8 to 12 wks.; 313A, \$1250; 16 wks.

A closed-loop measuring system is formed by teaming a 10-kHz to 18-MHz wave analyzer (312A) with an automatic tracking oscillator

(313A). The 312A has a 7-digit readout, with ± 10 -Hz resolution, drift tracking, no-hunt AFC, and universal input accommodation. The 313A tunes in one continuous band from 10 kHz to 22 MHz, with digital reading and a 100-dB attenuator. It will automatically track the center of any setting on the 312A. Alone, it functions as a wide-band signal generator, flat to ± 0.1 dB.

CIRCLE NO. 136



We've Never Made it Better (neither has anyone else!)

We've been producing the finest quality 80 ohms/cm gold potentiometer alloy since 1958. It is available as round premium grade potentiometer wire as small as .0004". Uniformly heat-treated for maximum linearity and consistency of both specific resistance and TC.

Enamelling is done in our own

plant — to your most exacting specifications.

If your requirements are for high quality, fine potentiometer wire, you should write for a copy of our comprehensive brochure on wire for the potentiometer industry.

Please write on your letterhead; no obligation of course.



7 INTERVALE STREET, WHITE PLAINS NEW YORK 10606 • (914) 949-4757

ON READER-SERVICE CARD CIRCLE 59



X-Y display control gives time-linear plot

Technical Measurement Corp., 441 Washington Ave., North Haven, Conn. Phone: (203) 239-2501.

Data stored in two memory subgroups of the company's "CAT" signal-averaging computer can be controlled for display on coordinate axes by means of this X-Y display control unit. In spectroscopy, the model 650 provides a direct relation between a given energy spectrum and its excitation, independently of the latter's time variation. The unit is applicable to voltage-current relationships and the study of magnetic hysteresis.

CIRCLE NO. 137

Log module has wide input range

Electronic Associates, Inc., 185 Monmouth St., West Long Branch, N. J. Phone: (201) 229-1100. P&A: \$425; 30 days.

This module will deliver to the manufacturer's X-Y recorder accurate data for log plots of rms ac or dc voltage functions in either the arm or pen axis. The unit features the selection of five input ranges in 10-dB steps, continuous plotting of 1000 to 1 input voltage variations, and an output scale factor of 5, 10 and 20 dB per inch plots. The model 12.1384 has a dynamic accuracy of ± 0.5 dB with input varying signal of 2 dB per second.

CIRCLE NO. 138

The Predictables.

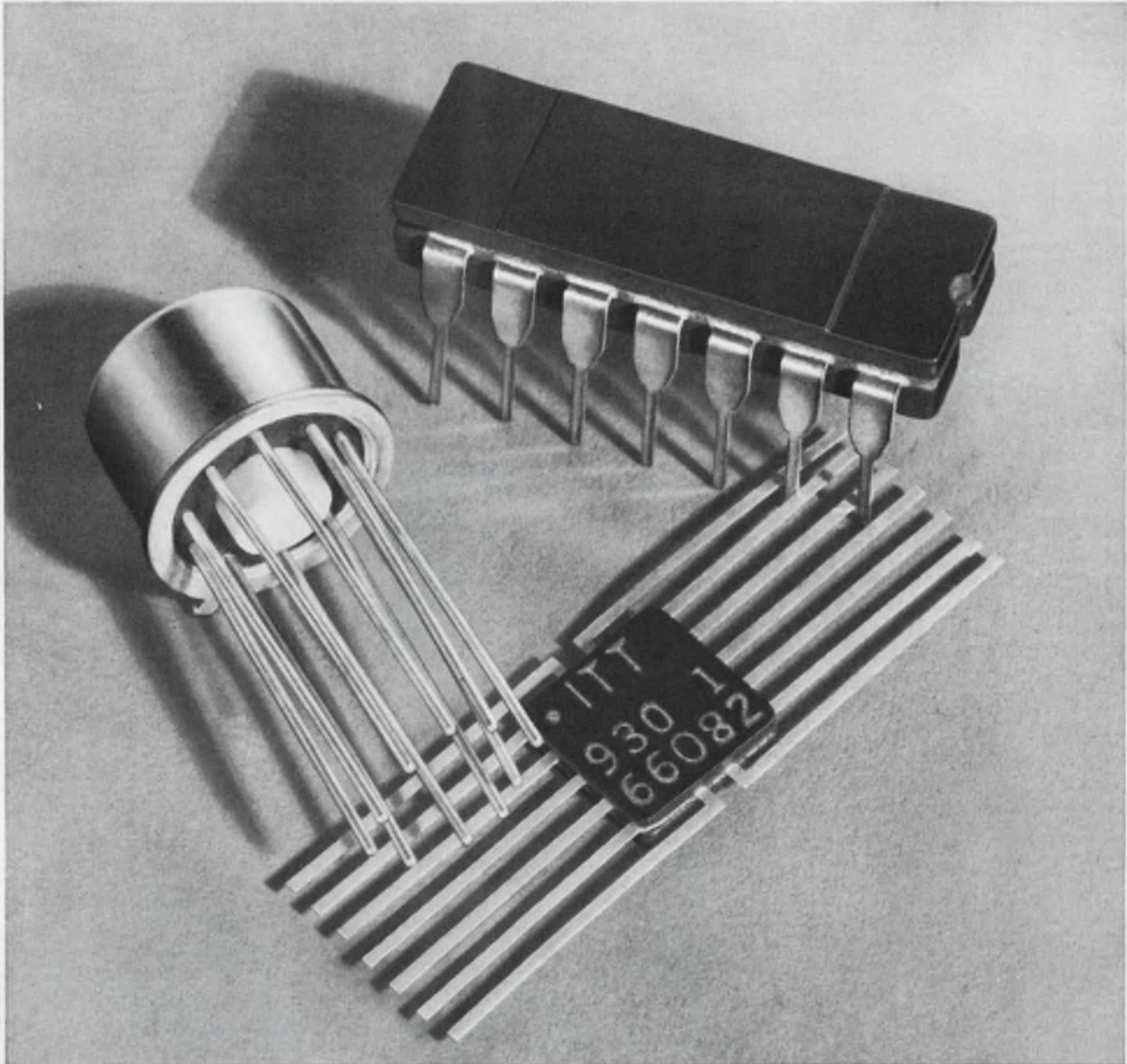

100% DC and dynamic testing verifies the performance of every circuit in ITT's full line of Series 930 DTL

When your order of ITT Series 930 DTL arrives, you can have absolute confidence in its performance. First of all, every circuit gets full DC and dynamic testing at 25°C, plus temperature cycling, centrifuge, and fine leak tests. Then there's 1% AQL testing at -55°C, +25°C and +125°C for 20 dynamic and 15 DC parameters. If circuits flunk, we just don't ship them.

ITT's Series 930 "predictables" come in 15 circuit functions and three package styles. If you're tired of rejecting and returning DTL, try ordering it from ITT. It's available off-the-shelf from your distributor or direct from the factory through your ITT representative. ITT Semiconductors is a Division of International Telephone and Telegraph Corporation.

integrated circuits **ITT**

FACTORIES IN WEST PALM BEACH, FLORIDA; PALO ALTO, CALIFORNIA; LAWRENCE, MASSACHUSETTS; HARLOW AND FOOTSCRAY, ENGLAND; FREIBURG AND NURENBERG, GERMANY

ON READER-SERVICE CARD CIRCLE 60

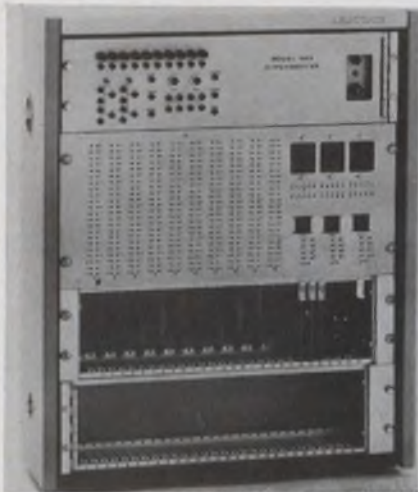

Logic designs checked by "Experimenter"

Wyle Laboratories, 133 Center St., El Segundo, Calif. Phone: (213) 322-1763. P&A: \$2350; 5 to 7 wks.

Called the model 1585 "Experimenter," an instrument provides rapid checkout or demonstration of logic design configurations. The instrument is especially designed for use with the manufacturer's M Series IC logic cards. The "Experimenter" provides ten 44-pin connectors with all pins brought out to a patch panel where desired interconnections can be made. It includes power supply, regulator and four cards for driving the indicators and displays.

CIRCLE NO. 139



Digital voltmeters have polarity readout

California Instruments Corp., 3511 Midway Drive, San Diego, Calif. Phone: (714) 224-3241. P&A: \$845, \$975; stock.

A group of four new solid-state digital voltmeters offers five voltage

ranges in both ac and dc, a large, illuminated four-digit readout with 10% overrange and automatic polarity indication, and 10- μ V resolution on both ac and dc, with 0.05% dc accuracy. Voltage ranges are 0 to 0.1, 0 to 1, 0 to 10, 0 to 100 and 1 to 1000 in both ac and dc. Input impedance is 10 M Ω in the upper three ranges and 1 M Ω in the lower two. All models provide digital readout with display time variable from 0.8 to 10 seconds.

CIRCLE NO. 140

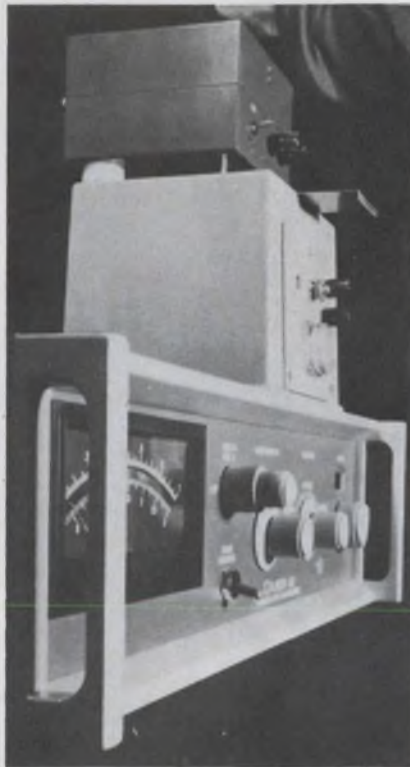

Reed electrometer sensitive to 10⁻¹⁷ A

Cary Instruments, 2724 S. Peck Rd., Monrovia, Calif. Phone: (213) 446-7181. P&A: \$1950; stock.

A sensitivity of 10⁻¹⁷ A is the leading specification of Cary's model 401 vibrating reed electrometer. Standard features include remote resistor switching with three input resistors, remote input shorting, critical damping and master-or-slave capability. Charges as small as 5 x 10⁻¹⁶ coulomb can be measured as can potentials to 2 x 10⁻⁵ volt and resistances of more than 10¹⁶ Ω . Inherent accuracy is $\pm 0.1\%$ ± 10 μ V.

CIRCLE NO. 141



Dc millivoltmeter sensitive to 0.001 V

IB Instruments, Inc., 7016 Euclid Ave., Cleveland. Phone: (216) 431-4790. P&A: \$185; 2 to 4 weeks.

Leading specification of the model 300 dc millivoltmeter is a basic range sensitivity of 0.001 volts. The instrument offers 10 ranges of up to 30 V with floating input and an input resistance of 10 M Ω . Accuracy of this instrument is rated at $\pm 2\%$. Line-operated models are offered for either 115- or 230-V lines.

CIRCLE NO. 142

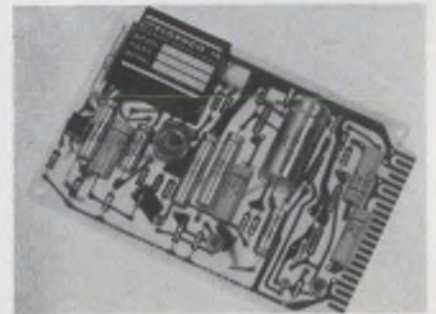

Printed circuit card houses noise generator

Elgenco, Inc., 1550 Euclid St., Santa Monica, Calif. Phone: (213) 451-1635. Availability: 21 days or less.

The 3607A noise generators are mounted on 6-1/2 x 4-1/2-in. PC cards. The new units extend for the frequency spectrum of the manufacturer's 3600 series to 5 MHz. Eleven basic units are available in the 3607A configuration. Each supplies a gaussian noise voltage with a "white" power frequency spectrum adjustable from 0 to 3 V rms and a peak rms capability of at least 3.5 to 1.

CIRCLE NO. 143

V for... Butterfly®

The unique Licon® Butterfly® double-break switch design is as simple as that—two blades that flex simultaneously, then actuate with a positive snap. That simple engineering concept has led to a full line of 2, 4 and 6-circuit miniature, sub-miniature and heavy-duty Butterfly® switches that fight hard to keep your products reliable and durable. It takes a book to tell the story. **This is what it looks like.**

We'd like to send you a copy. Ask.



**Be Victorious with LICON ...
fastest growing
full-line switch supplier**

i t LICON
DIVISION ILLINOIS TOOL WORKS INC.
6615 WEST IRVING PARK ROAD — CHICAGO, ILLINOIS 60634

"Remember, you're never more than a few feet away from a product of ITW"

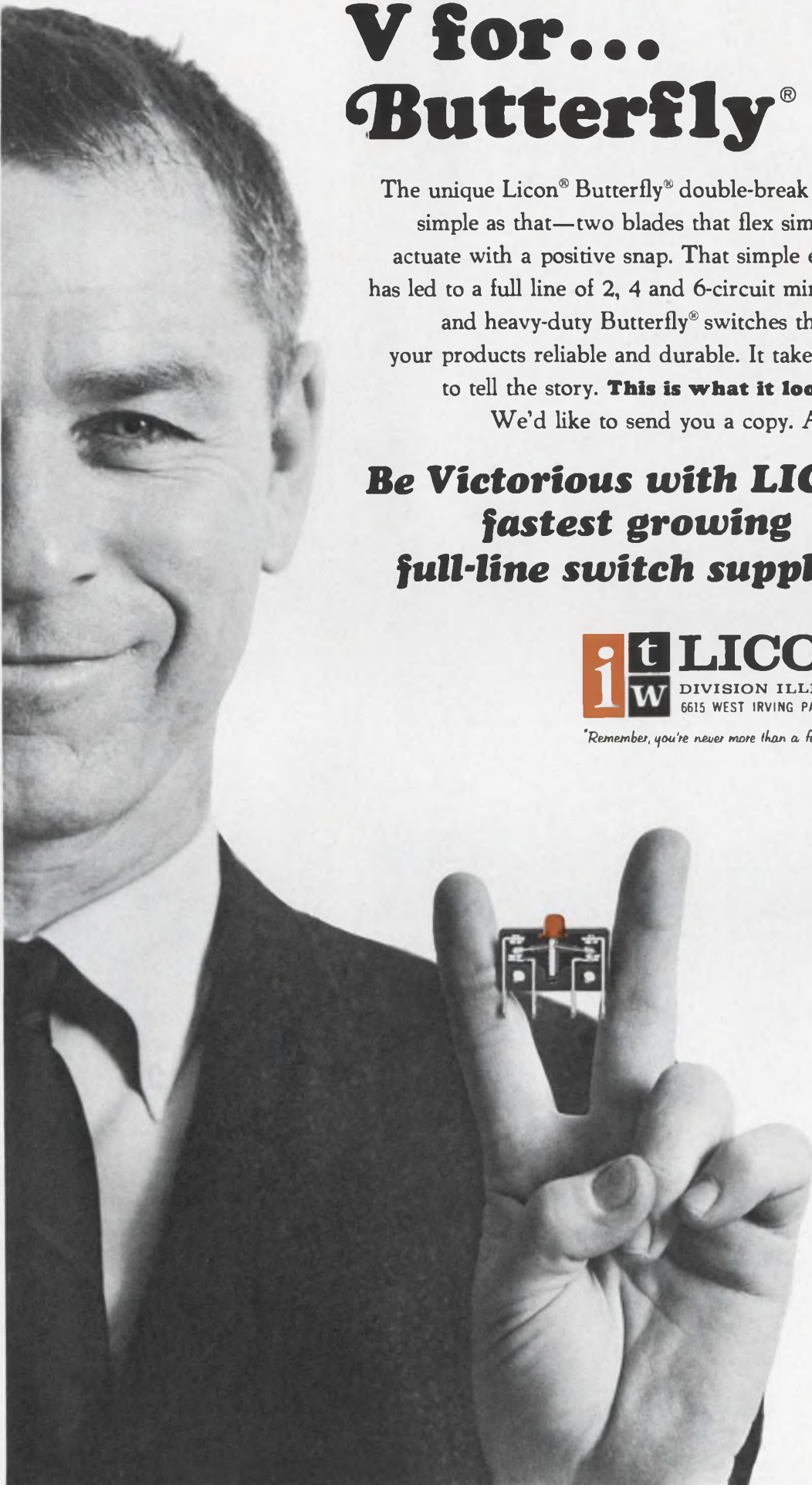

ON READER-SERVICE CARD CIRCLE 151

SPECTRUM ANALYZER OR SWEEP GENERATOR?



YES!

Here's performance versatility where it counts. Just take a look at the frequency patterns below and see how a Telonic Sweep Generator can double as a spectrum analyzer* in hundreds of applications. If you're about to purchase either type of instrument, examine the possibilities of the SM-2000 that covers DC to 3000 MHz, provides CW as well as swept signals, at less than half the cost of a spectrum analyzer alone.



Response of a faulty CW oscillator, causing it to squibulate, or produce side bands around the fundamental signal.

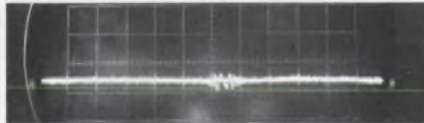

Insertion loss of a modulated buffer amplifier with B+ reduced to 0. Using each 2 cm division of scope as 60 db, amplifier's attenuation is approximately 70 db.

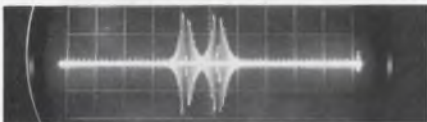

Direct comparison of known with unknown signal, the former attenuated to equal the unknown to determine its strength.

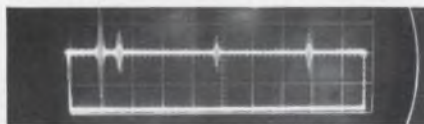

Frequency markers at 80, 90, and 100 MHz identify unknown frequency as approximately 77.5 MHz.



Response of an unstable test signal shown as blurred wave form when compared to a crystal controlled reference.



Display shows DC mark, fundamnt test signal, 1st harmonic, and 1/3, 1/2, and 2/3 of fundamental.



Representatives in all major cities in the U.S. and foreign countries. Factory offices located at Maidenhead, England and Frankfurt, Germany

*CATALOG 70 COVERS THIS APPLICATION IN DETAIL PLUS A DOZEN MORE, AND CONTAINS COMPLETE SPECIFICATIONS ON OVER 30 INSTRUMENTS.



ON READER-SERVICE CARD CIRCLE 152

TEST EQUIPMENT

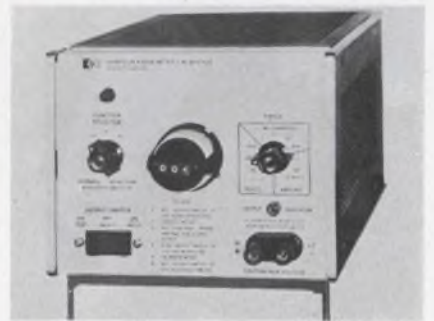

Four meter calibrators in one package

Hewlett-Packard Harrison Division, 100 Locust Ave., Berkeley Heights, N. J. Phone (201) 464-1234. P&A: \$695; 3 weeks.

This instrument can calibrate ac and dc voltmeters up to 1000 V and ac and dc ammeters up to 5 A. It is capable of both constant voltage and constant current output. Its accuracy of 0.2% + 1 digit for dc, and 0.4% + 1 digit for ac, makes it suitable for laboratory or production testing of multimeters and other meters having an accuracy of the order of 1% or higher. The calibrator is packaged for bench or rack use.

CIRCLE NO. 144



Pulse generator ppr is gated or continuous

Advanced Automation Corp., 13709-10 Cordary St., Hawthorne, Calif. Phone: (213) 675-2296. P&A: \$350 (stock); 2 wks.

This pulse generator is a compact, solid-state, general purpose instrument featuring gated or continuous repetition rates to 20 MHz, pulse delay and width to 10 ms and an output pulse of 0 to ± 15 volts amplitude (into a 50-ohm load) with less than 5 ns rise and fall time. The portable unit measures 3-1/2 by 8-1/2 by 9-1/2 in. and may be rack-mounted, singly or in pairs, in only 3-1/2 in. of panel space.

CIRCLE NO. 145

ON READER-SERVICE CARD CIRCLE 153 ➤

This is the solid state 0.003% voltage calibrator with variable current limiting and overvoltage trip. □ Line and load regulation, 0.0005% of setting. □ Panel meter monitors either output voltage or current. □ No cooling fan is needed, so you can forget about damage from dirt and dust. □ All circuits are shielded and guarded. □ Resolution is 0.1 ppm. □ Only 7 inches high. □ Weighs 40 lbs. □ Price is \$2490. □ For more information on the Fluke 332A Voltage Calibrator, call your full service Fluke sales engineer (listed in EEM) or write directly to the factory.



In a crowd or all alone, the Fluke 332A DC Voltage Calibrator stands out. There isn't another calibrator on the market at any price that offers all the advanced technical and user features. By any measure, it's the leader!



Fluke • Box 7428, Seattle, Washington 98133 • Phone: (206) 774-2211 • TWX: (910) 449-2850
In Europe, address Fluke International Corporation • Suite D, Ambassador Hotel, Sophialaan 2, The Hague, The Netherlands

"See us at the IEEE, Booths 2c02, 2c04."



NEW/FROM NORTRONICS



8-CHANNEL CAPABILITY ON 1/4" TAPE WITH LOW-COST MODEL BQL TAPE HEADS

For maximum information storage at minimum cost, Nortronics recommends the new Model BQL. Providing instrumentation head quality at audio head prices, the Model BQL is designed for high speed 8-track stereo duplicating and 4- or 8-channel instrumentation applications.

The Model BQL head is designed with four in-line tracks, spaced so that a pair of staggered heads will produce an interlaced pattern of eight channels on 1/4-inch tape. Track width is .021 ± .001, and head track spacing is .127 ± .001 between centers. Complete technical data is available on request.

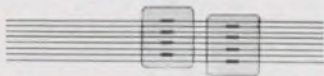

The new Model BQL displays the quality, engineering, ingenuity, and responsiveness to every recording need that have made Nortronics the world's largest manufacturer of laminated core tape heads and the standard-setter for the industry. A wide variety of heads for replacement and prototype applications is available locally from your Nortronics distributor.

If you're using heads, use your head . . . and check Nortronics first!

Nortronics
COMPANY, INC

8101 Tenth Avenue North
Minneapolis, Minnesota 55427

ON READER-SERVICE CARD CIRCLE 154

TEST EQUIPMENT

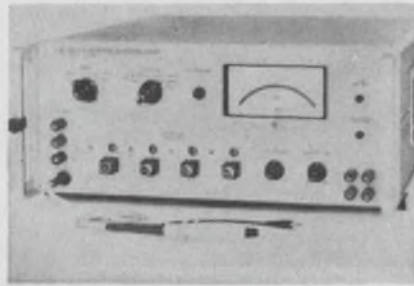

Differential voltmeter tightens its specs

Hewlett-Packard, 1501 Page Mill Rd., Palo Alto, Calif. Phone: (415) 326-7000. P&A: \$1675; 3 wks.

With twice the precision of its predecessor, the ac-dc differential voltmeter/dc standard is accurate to 0.01% of indicated setting, or 0.001% of full scale as a dc voltage standard. This accuracy holds for 90 days from calibration. The model 741B supplies output voltages from 1 μ V to 1 kV in four decade ranges. As a differential voltmeter it measures sine-wave voltages at 0.02% of reading plus 0.01% of full scale. The dc input impedance is constant, and greater than $10^9 \Omega$ on all ranges.

CIRCLE NO. 146



Digital voltmeter features versatility

Dana Laboratories, Inc., Campus Drive at Von Karman Ave., Irvine, Calif. Phone: (714) 833-1234.

This digital voltmeter uses integration as a method of rejecting superimposed or normal mode noise. Since the unit uses integration only to reject superimposed noise, combining this with standard null-balance technique for making the actual measurements, it is possible to select fast measurements without noise rejection, noise rejection by integrating the input signal, noise rejection by filtering the input signal, or combined integration and filtering. The instrument requires no accessories or optional circuit elements. The desired noise-rejection mode is selected by front-panel switches.

CIRCLE NO. 147

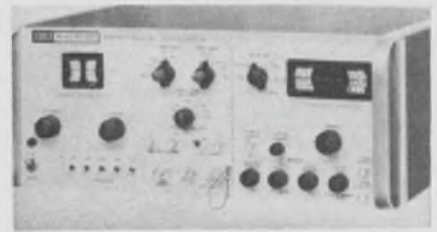

Sweep generator long on features

Jerrold Electronics Corp., 401 Walnut St., Philadelphia. Phone: (215) 925-9870. P&A: \$1095; March.

The model SS-300 300-MHz sweep generator offers as standard equipment a wide variety of usually optional features. Basically, the unit is a solid-state generator that covers the 500-kHz to 300-MHz range with a flatness of ± 0.25 dB. Sweep measurements can be made as wide as 300 MHz or as narrow as 200 kHz. Features include a "birdy-by-pass" marker system, a variable marker system, 1- and 10-MHz harmonic generators and variable sweep from 60/s to 0.2/s, among others. The one option cited for the instrument is a battery-operated capability.

CIRCLE NO. 148



Time code reader in modular form

Dynalectron Corp., Data Sciences Div., 2604 Pittman Drive, Silver Spring, Md. Phone: (301) 588-8488. P&A: \$2000 to \$3600; 30 to 45 days.

Designed for reading serial NASA and IRIG time codes, this time code reader accepts either NASA 36-bit or IRIG B serial, amplitude-modulated, carrier time code formats. It converts the time code for decimal display of time; and provides parallel outputs, both decimal and BCD, for driving remote display units or for parallel entry into a digital data system, recorder or computer. The unit can be used to read serial time codes from magnetic tape, data transmission terminals or time code generators.

CIRCLE NO. 149

program your Tektronix Type 561A or 564 oscilloscope for DC-to-15 MHz applications



Here's new convenience for many Type 561A or 564 applications.

You can program the Tektronix oscilloscope for 6 measurement setups—using the new Type 263 Programmer and the Types 3A5 and 3B5 Automatic/Programmable Plug-In Units.

PUSHBUTTON PROGRAMMING

In this mode, both plug-ins can be programmed using the Type 263 Programmer, which accepts up to 6 plug-in type program cards. Each program card, after initial set-up, establishes the plug-in control functions required for a particular test or measurement . . . with actual measurements made conveniently from the CRT display, as usual. Any number of programmers can be cascaded for applications requiring pushbutton control of more than six measurement set-ups. In REMOTE PROGRAMMING mode, the deflection factor is 10 mV/div to 50 V/div and sweep range is 5 s/div to 10 ns/div.

Programmable Functions: from Type 3A5—V/div, 10X probe indication, and AC, AC Trace Stabilized, or DC coupling, by program card jumper connection . . . vertical positioning by program card potentiometer setting; from Type 3B5—Time/div, X10 or X100 magnifier, trigger mode with coupling, and trigger slope, by program card jumper connection . . . horizontal positioning, trigger level, and magnifier delay, by program card potentiometer setting.

AUTOMATIC SEEKING

In this mode upon SEEK command from the probe or the plug-ins, the oscilloscope automatically presents an optimum display. The SEEK command to the plug-in units automatically adjusts the time and amplitude settings and automatically checks the trigger logic—switching to auto trigger mode, if not correctly triggered, to present a stable display whenever possible. Indicators on the plug-ins light automatically to show the time and amplitude settings. Measurements can then be made quickly and accurately from the CRT display. In AUTOMATIC SEEKING mode, the deflection factor is 10 mV/div to 50 V/div and sweep range is 5 s/div to 0.1 μ s/div.

MANUAL OPERATION

In this mode, both plug-ins are controlled conventionally. Indicators on the plug-ins show the time and amplitude settings. In MANUAL OPERATION mode, deflection factor is 1 mV/div to 50 V/div (5 MHz bandwidth at 1, 2 or 5 mV/div and 15 MHz at 10 mV/div to 50V/div) and sweep range is 5 s/div to 10 ns/div.

Type 263 Programmer (complete with 6 program cards)	\$325
Type 3A5 Automatic/Programmable Amplifier Unit	\$760
Type 3B5 Automatic/Programmable Time-Base Unit	\$890

Oscilloscopes which accept both Automatic/Programmable Plug-Ins:	
Type 561A Oscilloscope	\$500
Type RM561A Oscilloscope	\$550
Type 564 Storage Oscilloscope	\$875
Type RM564 Storage Oscilloscope	\$960

U.S. Sales Prices f.o.b. Beaverton, Oregon

Tektronix, Inc.



For complete information, contact your nearby Tektronix field engineer or write:
Tektronix, Inc., P.O. Box 500, Beaverton, Oregon 97005

ON READER-SERVICE CARD CIRCLE 61

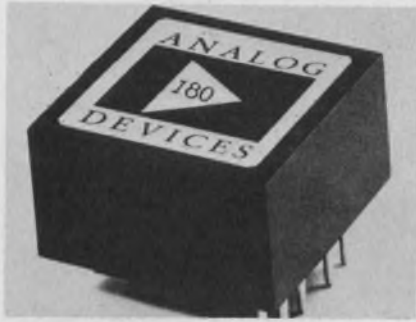

Chopperless diff-amp virtually driftless

Analog Devices, 221 5th St., Cambridge, Mass. Phone: (617) 491-1650. P&A: \$80; stock.

Without using chopper-stabilizing techniques, Analog Devices guarantees that its low-cost differential amplifier module will not drift more than $1.5 \mu\text{V}/^\circ\text{C}$. The model 180 is roughly one-third the price, one-quarter the size and three times as stable as competitive chopper-stabilized diff-amps, according to the company. (Zeltex has units priced at \$200 to \$395, mounted on a 7-by-4-in. PC board with a drift performance of $5 \mu\text{V}/^\circ\text{C}$).

In addition, the Analog Devices model has two-terminal (differential) input rather than the single-ended input of chopper-stabilized units. Thus, the high stability and impedance of the diff-amp can be put to work in the non-inverting and differential configurations.

The low thermal inertia of the monolithic silicon chip input stage, coupled with a proprietary drift-matching technique, makes the amplifier virtually immune to large offsets caused by temperature differences between the two input transistors. Temperature differences don't exist because the chip rapidly reaches uniform temperature. By contrast, a conventional op-amp using discrete input transistors can easily develop $240\text{-}\mu\text{V}$ offset for a 0.1°C temperature difference.

Actual performance figures include 1-mV initial offset at 25°C , 1-nA initial offset current at 25°C , $100 \text{ pA}/^\circ\text{C}$ maximum bias current drift, 50,000:1 common-mode rejection ratio, 4-M Ω differential and 500-M Ω common-mode input impedance, $5\text{-}\mu\text{V}/\text{day}$ long term drift, and $\pm 10\text{-V}$, 2.5-mA output.

CIRCLE NO. 150

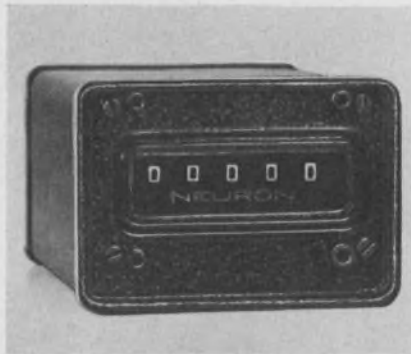

Remote counters rated 2400 counts/minute

Whittaker Corp., 12838 Saticoy St., N. Hollywood, Calif. Phone: (213) 781-8950.

Designed for remote readout, actuation and control, the Series 137 counters feature a count-rate of 2400 counts/minute. Three-, four- and five-digit models are offered in both unidirectional and bidirectional designs. The switch readout is ten-point non-shorting with an epoxy glass switch deck mounted adjacent to each counter wheel.

CIRCLE NO. 211

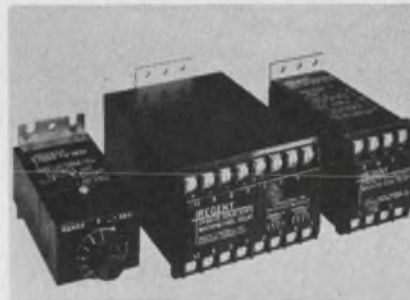

Solid-state timers are interchangeable

Regent Controls, Inc., Harvard Avenue, Stamford, Conn. Phone: (203) 348-7734. P&A: \$45 to \$90; stock.

A family of all-solid-state relays and timers, directly interchangeable with their electromechanical counterparts, is available for assembly of complete solid-state control systems. Interchangeability is in terms of inputs and outputs, physical configuration and schematic diagram symbols. They operate on 115 V, 50/60 cycles and may be used with any standard transducer or load. All units are guaranteed for 500 million operations or 5 years.

CIRCLE NO. 212

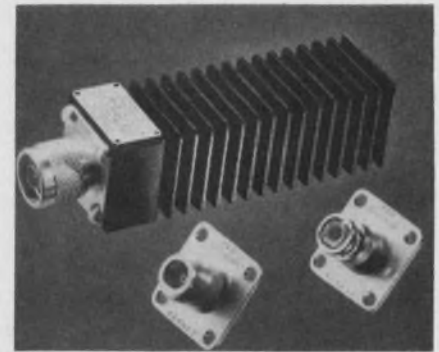

Quick-change load insensitive to attitude

Bird Electronic Corp., 30303 Aurora Rd., Cleveland. Phone: (216) 248-1200.

The Model B8080 Termaline is designed to meet a need for a medium-power RF load that will operate in any position. The use of QC quick change connectors is said to allow great flexibility in this 25-W termination. Changes can be made quickly in the lab or in the field.

CIRCLE NO. 213

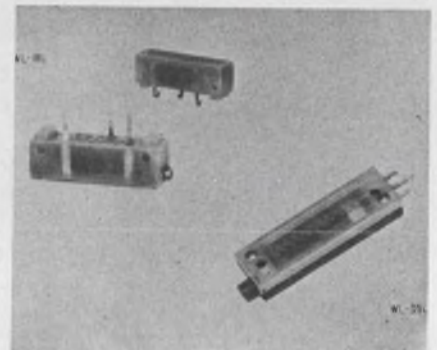

Trimmer pots have "see-through" covers

Bowmar Instrument Corp., 8000 Bluffton Rd., Fort Wayne, Ind. Phone: (219) 241-2743.

Two new series of trimmer potentiometers have translucent plastic covers, allowing inspection without disassembly in many cases. The 18-turn WL-18 series units have 13 resistance values from 10 k Ω to 40 k Ω with half-watt power capabilities from -40 to $+20^\circ\text{C}$, derating to 0 at $+85^\circ\text{C}$. The 35-turn WL-35 units have resistance values from 10 Ω to 10 k Ω and power rating similar to that of WL-18. Both types have wiper idling features to prevent damage from overturning.

CIRCLE NO. 214

**To: The wizards at Hoffman,
the quiet, reliable semiconductor house.**

We just might spend about a nickel more for your splendid commercial 1 watt microglass zeners than we do for those comparatively clumsy cans we've been using. Send us one to abuse cruelly.

Hoffman SEMICONDUCTOR
HOFFMAN ELECTRONIC PARK
EL MONTE, CALIFORNIA 91734

NAME _____

COMPANY _____

ADDRESS _____

_____ ZIP _____

(If you will be so kind as to attach the coupon to your letterhead, it will aid us in discouraging impostors, rascals, free-loaders and hobbyists who make artistic earrings.)

No amplifier needed with Vernistat[®] a.c. pots

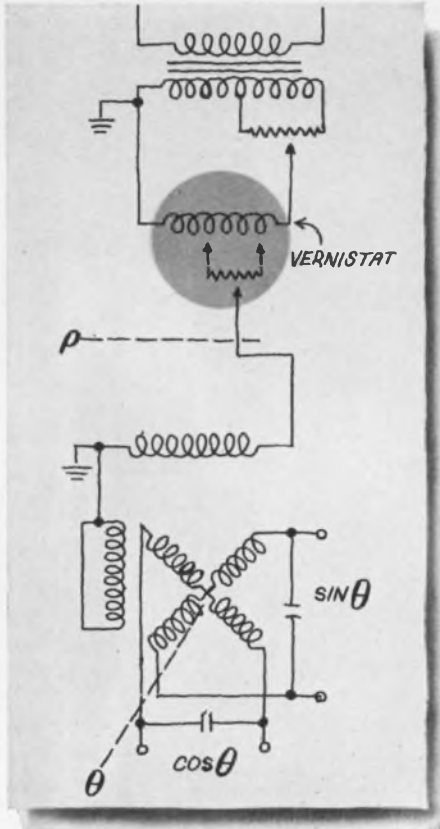

You don't need a buffer amplifier to drive a servomechanism—if you use a Vernistat a-c potentiometer. It has an output impedance low enough to drive a resolver or other low input impedance device directly. Use an a-c potentiometer to simplify circuits, improve reliability, gain greater accuracy and reduce circuit costs. For full information and data sheets, write to Electronic Products Division, Perkin-Elmer Corporation, 131 Danbury Road, Wilton, Connecticut 06897



PERKIN-ELMER

ON READER-SERVICE CARD CIRCLE 63

132

COMPONENTS

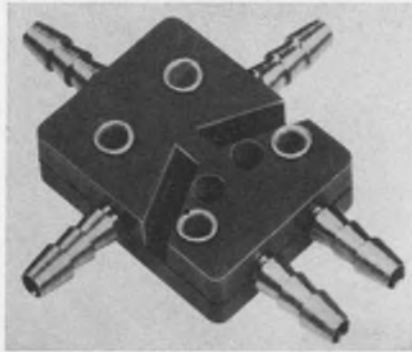

Fluid amplifier avoids impedance match

Aviation Electric, 200 Laurentien Blvd., Montreal, Quebec, Canada. Phone: (514) 744-2811.

The type 1000P01 proportional fluid amplifier is a two-input analog control element that operates with air or most other available gases. A special venting method allows either or both inputs to be operated up to completely blocked conditions. Thus, a single element can be used for pressure, flow or power amplification without impedance matching problems.

CIRCLE NO. 215

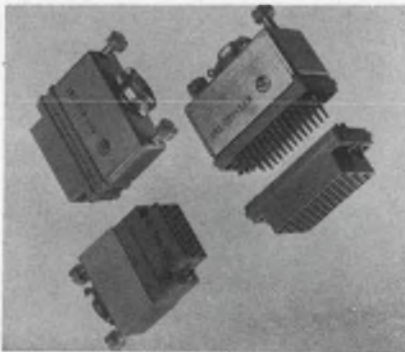

Multi-pin connectors offered in 12 types

Concoa Corp., 5137 N. Elton St., Baldwin Park, Calif. Phone: (213) 962-4461.

Twelve standard configurations are offered in the CRI series connectors. Units in the line provide 9 to 104 contacts. These rack and panel connectors use MIL-approved crimp removable contacts. Built to the specifications of MIL-C-22857, the units have a contact-to-contact voltage breakdown of 4.1 kVdc at sea level and 900 V at 60,000 ft.

CIRCLE NO. 216

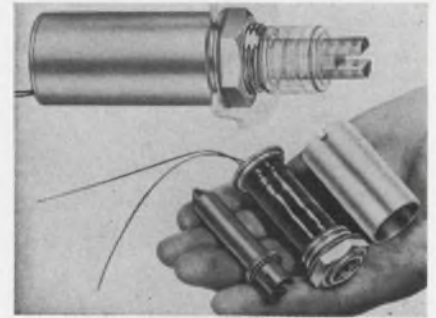

Tubular solenoids long on reliability

Dormeyer Industries, 3418 N. Milwaukee Ave., Chicago. Phone: (312) 283-4000.

A series of tubular-type solenoids are said to provide life-expectancies well beyond that for conventional units. Test runs of over 100,000,000 cycles are reported for the tubular components. Three styles are available with 12 or 24 Vdc coils, in pull-type only.

CIRCLE NO. 217



Dc/dc converter rated at 2 watts

Crestronics, 744 Rocky Loop, Crestline, Calif. Phone: (213) 714-2312. P&A: \$114; 4 to 6 wks.

The 2-W PS 101 dc to dc converter is designed to operate a CRT with a minimum of interference in the audio and RF ranges. The 30-kHz conversion frequency used is well above the audio range and an input filter reduces the RFI conductance noise to a level below 30 mV p-p across a 1-Ω resistor in series with the output. With a 28-Vdc input, the PS 101 provides an output of 5 kV at 0.4 mA.

CIRCLE NO. 218

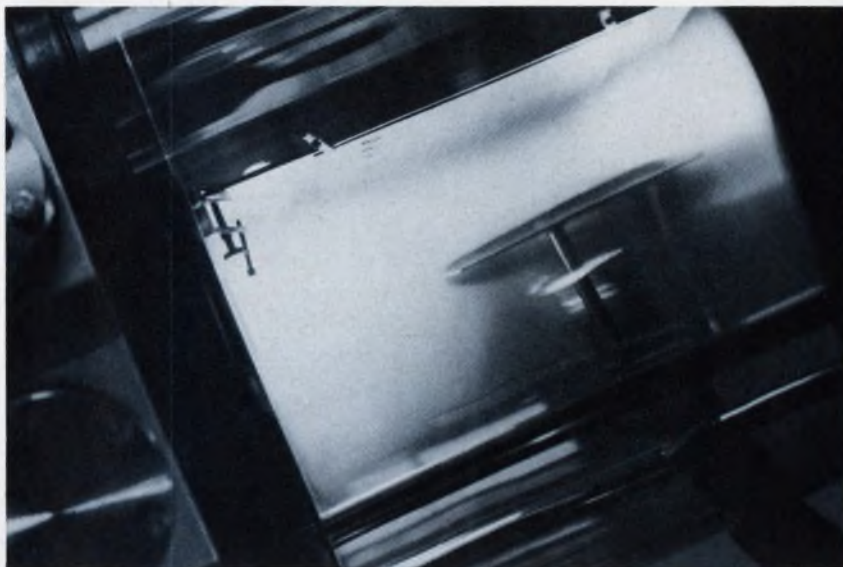

new

RF Sputtering of Insulators with PlasmaVac®... First Production System for the deposition of Insulators

Now, the microelectronics manufacturer can deposit the dielectric in thin-film capacitors, encapsulate thin film and integrated circuits, or carry on surface passivation of semi-conductors.

CVC's new RF Sputtering Unit is a versatile addition to the PlasmaVac low-energy sputtering system, so successful in the controlled deposition of metals,

alloys, and semi-conductors. This first commercially available system utilizing RF Sputtering expands PlasmaVac's capability to include materials like quartz, barium titanate, magnesium oxide, aluminum oxide, synthetic mica, pyrex and other commercial glasses. Sequential deposition of metals and insulators using both dc and RF sputtering to fabricate capacitors can be

done without breaking vacuum.

PlasmaVac with RF Sputtering can deposit more materials with better control than any other deposition equipment available today. And, PlasmaVac adapts easily to your production line or laboratory.

Write us today for full details. Consolidated Vacuum Corporation, 1775 Mt. Read Boulevard, Rochester, N. Y. 14603.



Consolidated Vacuum Corporation

ROCHESTER, N. Y. 14603 • A SUBSIDIARY OF BELL & HOWELL
International Subsidiaries: Woking, Surrey, England
& Friedberg, West Germany

ON READER-SERVICE CARD CIRCLE 64

NOW 2 REED RELAY SERIES

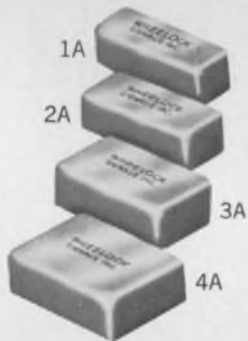

ACTUAL SIZE

ULTRA MINIATURE REED RELAYS SERIES 442

- Smallest multi-pole relays in industry (1-4 poles Form A)
- P.C. Board Mount
- Contacts rated at a full 4 watts
- Occupies 0.055 cu. in. per pole

**SMALL
ENOUGH
TO
CHANGE
YOUR
DESIGN
IDEAS!**



ACTUAL SIZE

ULTRA MINIATURE NEEDLE REED RELAYS SERIES 379

- Occupies only 0.02 cu. in.
- Operates on only 50 mw of power
- Operate time 190 micro-seconds (typical)
- Insulation resistance as high as 1×10^{14}
- Contacts rated at a full 4 watts

BY *Wheelock* OF COURSE

Contact Wheelock first for any of your relay design problems.

Write for new literature on Wheelock's big family of small relays!

WHEELOCK SIGNALS, INC.
273 Branchport Avenue • Long Branch, N. J.
(201) 222-6880



ON READER-SERVICE CARD CIRCLE 65



Reed switch module for pushbutton use

Micro Switch Div. of Honeywell Inc., 11 W. Spring St., Freeport, Ill.
Phone: (815) 232-1122.

With contacts sealed inside glass envelopes for environment protection, the new modules are suitable for low-energy circuits in data-processing systems, intercoms and sensitive audio and visual circuitry. The heart of the module is a fiber-reinforced thermoplastic case holding two normally open dry reed switches and a spring-loaded plunger that moves a cylindrical magnet. Pushing the plunger moves the magnet down near the reed contacts, pulling them together.

CIRCLE NO. 219

Diff-amp swings 200 mA through 10 V at 1 MHz

Analog Devices, 221 Fifth St., Cambridge, Mass. Phone: (617) 491-1650. P&A: \$148; stock.

This 1-1/2-in.³ diff-amp has a shortproof 2-W output that can work into torque-motors, loudspeakers, high-speed recording pens, coax cables, and other low-impedance loads, directly. It is also useful as a low-noise, low-distortion, medium-power ac amplifier. The new amplifier provides ± 200 mA output current at ± 10 V (a 20-V output swing) from dc to 0.5 MHz, and sustains full output current to 1 MHz with voltage reduced to ± 5 V.

CIRCLE NO. 220

THIS NEW COMPUTER QUALITY TRANSISTORIZED DIGITAL READOUT COSTS YOU

~~30%~~
LESS!

NOW

40%
LESS!



40%

**FOR INTEGRATED OR DISCRETE
COMPONENT CIRCUITS**

Identical electrical characteristics, identical driver-decoder functions, identical 1-inch mounting centers—yet these new digital readouts using NIXIE® tubes cost you ~~30%~~ less than fully enclosed (with metal case transistors) TEC-LITE TNR-10 and TNR-30 Series models. New simplified single board design and use of plastic encased silicon transistors substantially reduce assembly time, allowing this far lower price.

**IMPROVED MANUFACTURING TECHNIQUES
MAKE PRICE REDUCTION POSSIBLE.**

\$16.95

TNR-40 Series—Provides decimal readout from decimal input signals of low level. Internal circuits of four standard models are controlled by input signals as small as 3.5 volts. Special versions can be controlled with signals as small as 2 volts or less. High voltage to fire the neon tube's numeral elements is confined to the unit and to the panel area.

Price (0.9 display) in 100-299 quantities: \$18.85 less tube.

For fully enclosed readout, request data on TEC-LITE TNR-10 Series.

\$22.40

TNR-50 Series—Decimal readout is available in 8 standard models to handle 8-wire and 4-wire binary coded decimal input as small as 3.5 volts. A variety of other input codes and signal levels can be accommodated on special order. All-transistor circuitry eliminates diode decoders to reduce the number of components and increase reliability.

Price (0.9 display) in 100-299 quantities: \$24.90 less tube.

For fully enclosed readout, request data on TEC-LITE TNR-30 Series.



INDICATING DEVICES

Transistor Electronics Corporation

Box 6191 • Minneapolis, Minnesota 55424

ON READER-SERVICE CARD CIRCLE 66



**INDICATORS
& SWITCHES**

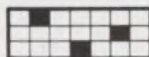

**DATA-PANEL
DISPLAY SYSTEMS**

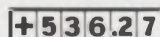

**DIGITAL
READOUTS**

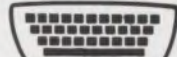

**ELECTRONIC
KEYBOARD
SYSTEMS**

COMPONENTS

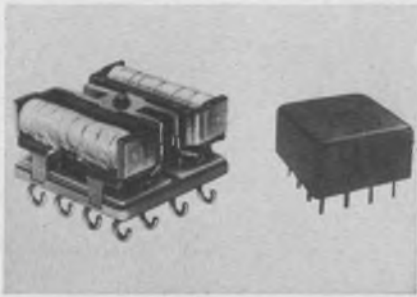

4pdt latching relay has rugged construction

Filtors, Inc., 65 Daly Road, East Northport, N. Y. Phone: (516) 266-1600.

This all-welded 4pdt magnetic latching relay is capable of switching loads rated from low level to 2 A for 100,000 operations, withstanding a 100-G shock and 20-G vibration at frequencies to 2000 Hz. Packaged in a compact, low profile can and weighing only 0.7 ounces, it provides simultaneous switching of 4 circuits in less than 4 ms.

The single-piece H-shaped armature combines rugged construction

with uniform pull-in. It is designed to withstand the forces generated in closing four contacts simultaneously yet retains the dimensional integrity to pull in all the contacts at the same time.

CIRCLE NO. 221



On-line connector formed of nylon

Molex Products Co., 5224 Katrine Ave., Downers Grove, Ill. Phone: (312) 969-4550.

Protected single-lead connections are provided by the Molex plug and receptacle. The terminations are automatically crimped to wires and snap-lock into single wire housings. Detents in the housing secure the mating units for fool-proof connection. Other nylon units are offered for as many as 15 connections.

CIRCLE NO. 222

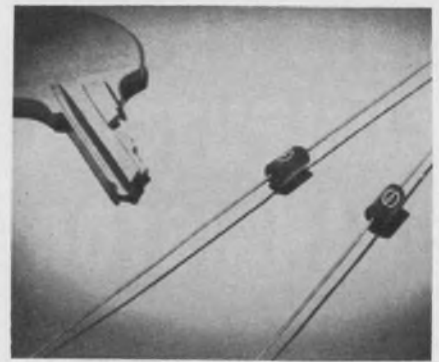

Ceramic capacitor line at home in aerospace

Scionics Corp., 8900 Winnetka Ave., Northridge, Calif. Phone: (213) 341-5500. Availability: stock.

A line of monolithic ceramic capacitors are offered for the requirements of the aerospace industry. The components are said to consistently meet and exceed the environmental requirements of MIL-C-11015C and MIL-C-39014. Size is 0.26 x 0.1-in. diameter and capacitance value is 10 to 22,000 pF. Tolerances are ± 10 and $\pm 20\%$. Temperature range is -55 to 125°C .

CIRCLE NO. 223

DON'T COMPROMISE!!! SPECIFY A PICKOFF UNIT

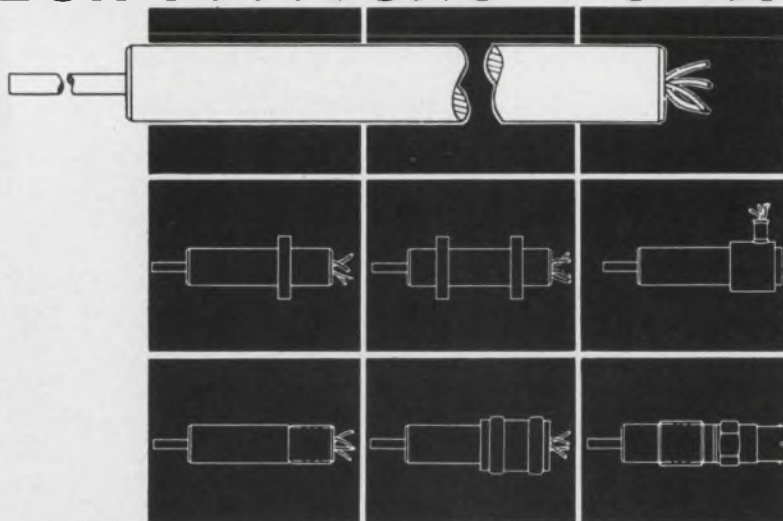

TO MATCH YOUR INSTALLATION

A controlled manufacturing system produces more than a million configurations at standard unit prices. TRANSDUCER SELECTION IS MADE EASY BY A NEW, SPECIALLY-DESIGNED CATALOG SYSTEM. The G. L. Collins A. C. Linear Motion Transducer translates straight-line (linear) motion into an A. C. analog which is useable as a feedback signal for control or display. This instrumentation component has infinite resolution, .0001-inch accuracy, billion-cycle reliability, and linearity to 2% of full stroke. Listed in VSMF and ASCAM Microfilm Catalogs

For more information write or call
G. L. COLLINS CORP
 5875 OBISPO AVE. LONG BEACH, CALIFORNIA 90805
 (213) 636-8141 or 630-3121 - TWX (213) 634-4095

ON READER-SERVICE CARD CIRCLE 67

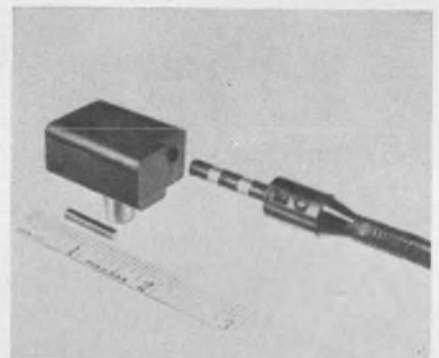

Waterproof switch magnetically operated

Electro Oceanics, Div. of Winsco Instruments, 2000 Colorado Blvd., Santa Monica, Calif. Phone: (213) 451-5646.

A line of waterproof switches, series 62, are magnetically operated. The switches are designed for high resistance to water, oil, or noncorrosive gaseous environments. They connect through the manufacturer's underwater-pluggable connectors and operate by a remote magnet.

CIRCLE NO. 224

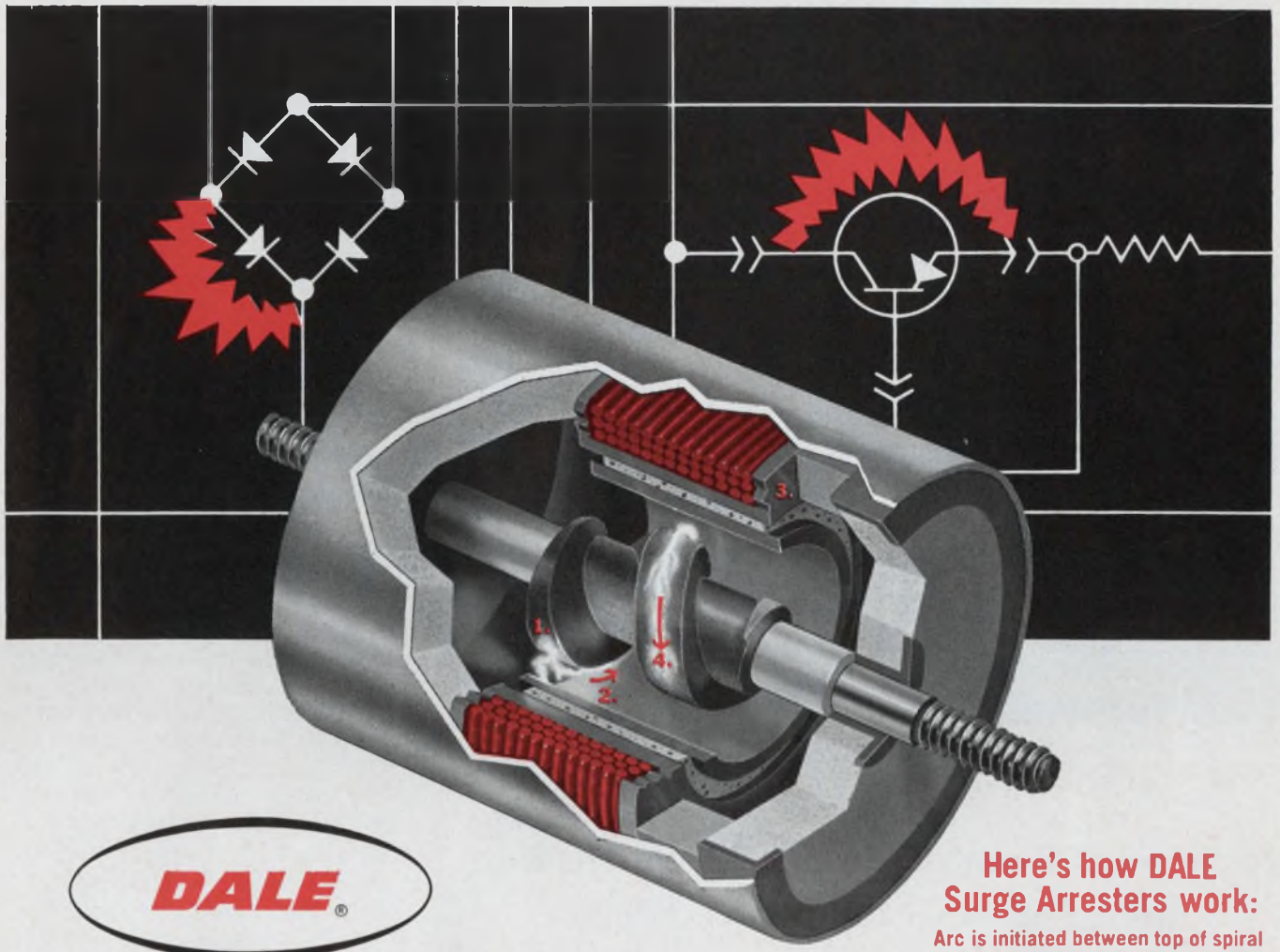

SURGE ARRESTERS stop damaging transients!

Here's how **DALE**
Surge Arresters work:

Arc is initiated between top of spiral electrode (1) and cylindrical electrode (2); Coil (3) is energized. Magnetic field produced by the coil causes spark to rotate down tapered spiral electrode, lengthening it to breaking point (4) before excess current is drawn.

Dale Surge Arresters deliver complete 2-way protection against transient over-voltages from any source.

1. Patented* design bypasses repeated surge voltages without damage to arrester or equipment attached. Pre-ionized atmosphere can be used to establish constant breakdown voltage level.

2. Surge-created arc is extinguished rapidly once normal voltages have been reached. This helps eliminate costly circuit interruptions caused when ordinary spark gaps draw excessive current which blows fuses and opens circuit breakers.

Check the areas where your circuits can utilize this complete transient voltage protection. Dale maintains complete transient voltage laboratory facilities to assist you with application engineering.

*Covered by U.S. Patent No. 2,916,667

For complete information write for new catalog on Surge and Aircraft Lightning Arresters or call DALE: 605-665-7887



TWO TYPES AVAILABLE

LA8 Dustproof case. Will bypass 10 current surges rising to 15,000 amps peak in 5 microseconds and containing total charge of 21 coulombs with no damage to arrester or equipment attached and less than 20% change in original DC breakdown voltage. Spark gap arc-over voltage factory adjustable from 1500 to 4000 VDC \pm 20%.

LA9 Hermetically sealed with soft solder. Will bypass approximately 100 current surges of 300 amps peak with 2 x 4 millisecond wave shape with no damage to arrester and equipment attached and less than 20% change in original DC breakdown voltage. Factory adjustable from 500 to 5000 VDC \pm 20%. (10% tolerance available). Bypass capability derates below 1500 volts.

Both LA8 and LA9 have insulation resistance in excess of 1000 megohms and will not drop below 10 megohms during or after rated number of current surges.

DALE ELECTRONICS, INC.
SIOUX DIVISION
100 Douglas Avenue, Yankton, South Dakota



ON READER-SERVICE CARD CIRCLE 68

NEW! Push-Button Bridge

Measures Impedance to 0.1% Accuracy

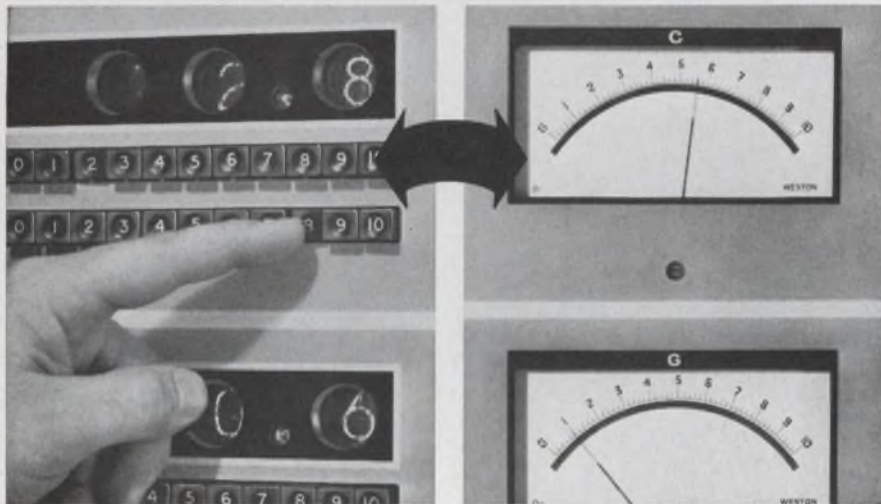

Once the Bridge is trimmed, a series of front-panel range push-buttons are suppressed in sequence until a reading is obtained on the meter. Setting up the first one or two digits of this reading on push-button decade controls gives the final reading.

No Manual Balancing with New Wayne Kerr B641 Universal Impedance Bridge

Now, batch testing of components or the observation of changing values under laboratory conditions are made simpler and faster by the new Wayne Kerr B641 Universal Impedance Bridge.

Designed for the continuous measurement of any type of impedance or admittance, at audio frequencies, as low as 1 picofarad — to an accuracy of 0.1% — the B641 eliminates manual balancing, makes readout virtually automatic.

Operation is simple: once the Bridge is trimmed, it is necessary only to depress a series of front-panel range push-buttons in sequence until a reading is obtained on the electronically-balanced meters. Setting up the first one or two digits of this reading on push-button decade controls makes the balancing automatic; the meters can read the first, second, third or fourth digits.



The Bridge produces analog voltage proportional to the meter readings and BCD (in a 1248 code), for the nixie readout.

The B641 is based on the transformer-ratio-arm principle, giving stable performance even when components under test form part of a sub-assembly (such as a printed board or an encapsulated unit) or when long measurement leads must be used.

SPECIFICATIONS

Overall Ranges: 0.002pF — 50,000 μ F	Accuracy: 0.1% from 1pF to 10 μ F
20p $\bar{\sigma}$ — 500 $\bar{\sigma}$	10n $\bar{\sigma}$ to 100m $\bar{\sigma}$
200nH — 5MH	1mH to 10kH
2n Ω — 50,000M Ω	10 Ω to 100M Ω
Discrimination: 0.01% of max. on all ranges	Price: \$1,700 FOB Montclair, New Jersey

For literature and detailed specifications, write:



Wayne Kerr CORPORATION

18-B Frink St., Montclair, N.J. 07042 • Phone (201) 746-2438

INNOVATIONS IN INSTRUMENTATION

ON READER-SERVICE CARD CIRCLE 69

COMPONENTS

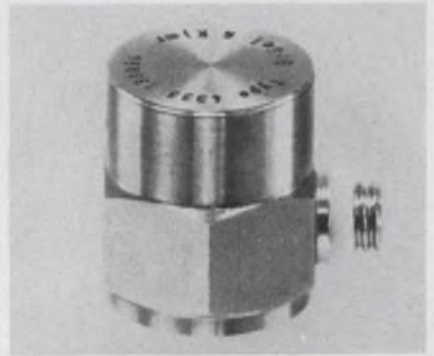

Low-cost accelerometer for lab standards

B & K Instruments, Inc., 5111 W. 164th St., Cleveland. Phone: (216) 267-4800. P&A: \$105; stock.

An accelerometer for standard vibration measurements has more than 15 individual calibrations. Those involving absolute sensitivity are made to 2-minute accuracy of $\pm 2\%$. The unit can be used with all conventional mounting methods, connecting cables, and signal conditioners such as charge amplifiers, cathode followers and voltage amplifiers. Its weight of only 12.7 grams is due to a special titanium housing. Maximum operating temperature is 260°C.

CIRCLE NO. 225

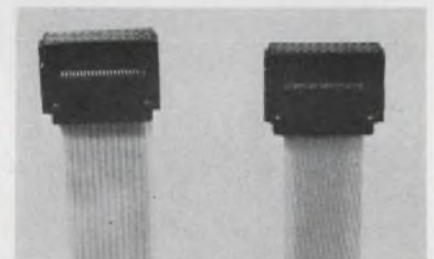

Custom connectors with low-crosstalk lines

aci Div. of Kent Corp., 206 Industrial Center, Princeton, N. J. Phone: (609) 924-3800.

Controlled impedance values, crosstalk, velocity of propagation and capacitance are featured in these connector-cable assemblies. The system shown has min space required for 18 100- Ω transmission lines with min crosstalk. These wiring systems are available unshielded or shielded with metal foil, deposited metal, wire mesh, or other conductive materials.

CIRCLE NO. 226

Can you draw this symbol
in 10 seconds?



or this?

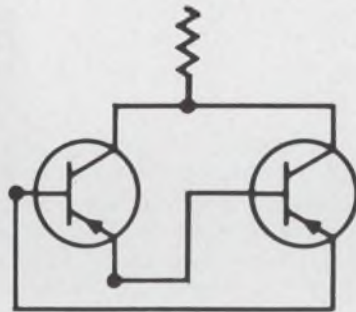

or this?

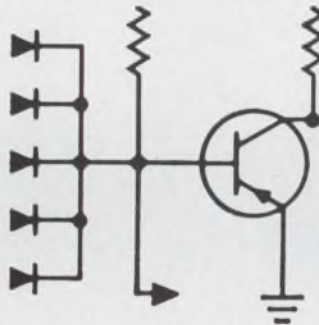

THE DIAGRAMMER CAN!

With The Diagrammer you simply touch one of the 256 push buttons . . . the symbol leaps to the viewing screen . . . you move it to its location . . . and press the Expose button. Ten seconds, if you're slow.

Anything at all, from a line drawing of your company president to a miniaturized circuit. It's fair game for a Diagrammer slide as long as it can fit into a 3" diameter circle.



Mergenthaler

It's fast, it's economical and the quality of the film output is better than your Technical Publications that were printed to MIL Spec.

In case you haven't heard, push-button drafting is "in". Let us tell you the whole story. Just drop a note on your company letterhead to Mergenthaler Advanced Systems, 29 Ryerson Street, Brooklyn, New York 11205. Or call us at (212) 855-0300.

ON READER-SERVICE CARD CIRCLE 70

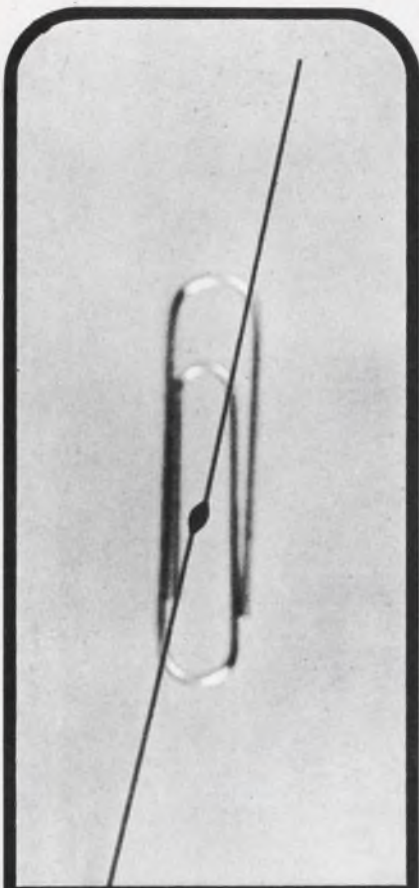

**USCC introduces
the smallest
complete
ceramic capacitor**

If you have size problems with the ceramic capacitors in your microelectronic circuitry, take a look at our C11 Series. It includes the smallest complete ceramic capacitor with the highest capacity-to-volume, yet!

It is available in capacitance values from 1 pF to 1 Mfd with working voltages of 50, 100 and 200. Round or ribbon leads are of Nickel A per MIL-STD-1276 N-1. Excellent for soldering or welding.

Epoxy resin encapsulation offers outstanding insulation resistance, adhesion qualities and high temperature characteristics. You can be sure of continuous, rugged performance. Test it to MIL-C-11015. It'll pass.

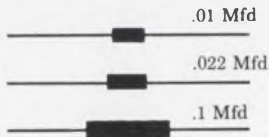

For complete information on the C11 Series, contact:



U. S. CAPACITOR CORPORATION
2151 LINCOLN STREET ■ BURBANK, CALIFORNIA 91504
(213) 843-4222 ■ TWX: 213-846-0904

ON READER-SERVICE CARD CIRCLE 71
140

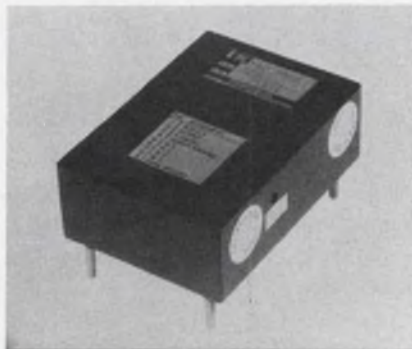

**Dc/ac inverters
stable to 0.25%**

Natel Engineering Co., Inc., 7129 Gerald Ave., Van Nuys, Calif. Phone: (213) 782-4161. P&A: \$460; 30 days.

Frequency stability is rated at 0.25% from 5 to 50 watts in the V series ac power sources. The units are available 50 Hz to 20 kHz for hysteresis synchronous motors or other ac components. Amplitude stability is 1% and regulation is 1% no load to full load. Additional features include polarity reversal protection and MIL-E-5272C construction.

CIRCLE NO. 227

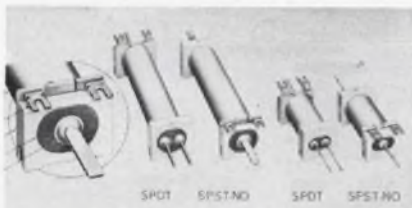

**Axial package design
protects reed contacts**

Magnecraft Electric Co., 5575 N. Lynch Ave., Chicago. Phone: (312) 282-5500. Availability: stock.

The effect of stresses on reed contact leads is said to be minimized through improved packaging in an axial-lead relay line. The coil bobbin is integrally molded with square mounting supports and copper coil terminal inserts. When the reed capsule is in place, ends of the bobbin are closed with plugs. Metallic closure of spaces between end plugs and the leads supports the leads so that mechanical stress cannot effect relay adjustment.

CIRCLE NO. 228

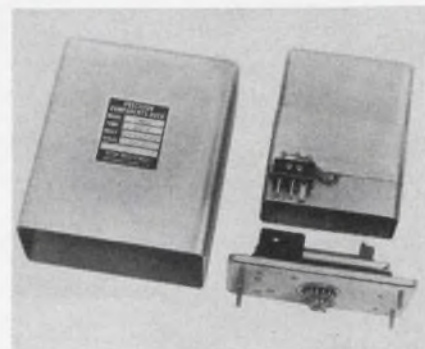

**Control oven
mounts PC card**

Oven Industries, Div. of Greenray Industries, Inc. 5235 E. Simpson Rd., Mechanicsburg, Pa. Phone: (717) 766-0721.

The model 1600 oven accepts a PC card. The oven features a two-part construction that allows the cavity to be disconnected at the base of the fixture, exposing the PC card for wiring operations. The oven is available with snap-action thermostatic control and dc proportional control. Cavity temperature is $65 \pm 2^\circ\text{C}$.

CIRCLE NO. 229

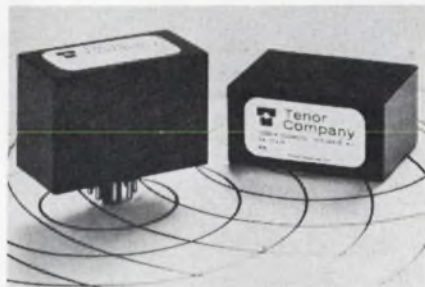

**Fast brake-reverse for
small ac motors**

Tenor Co., 13460 W. Silver Spring, Butler, Wis. Phone: (414) 781-4800. P&A: \$22.75 (500); stock.

Two solid-state devices to brake and reverse small ac induction motors offer fast operation, and claim 10 to 15 times the life expectancy currently available, at lower cost. Designated SM for the brake module and RM for the reversing module, these compact, plug-in components are designed to control the inherent dynamic braking action of small shaded-pole, permanent-capacitor phase-displaced, and other induction motors.

CIRCLE NO. 230

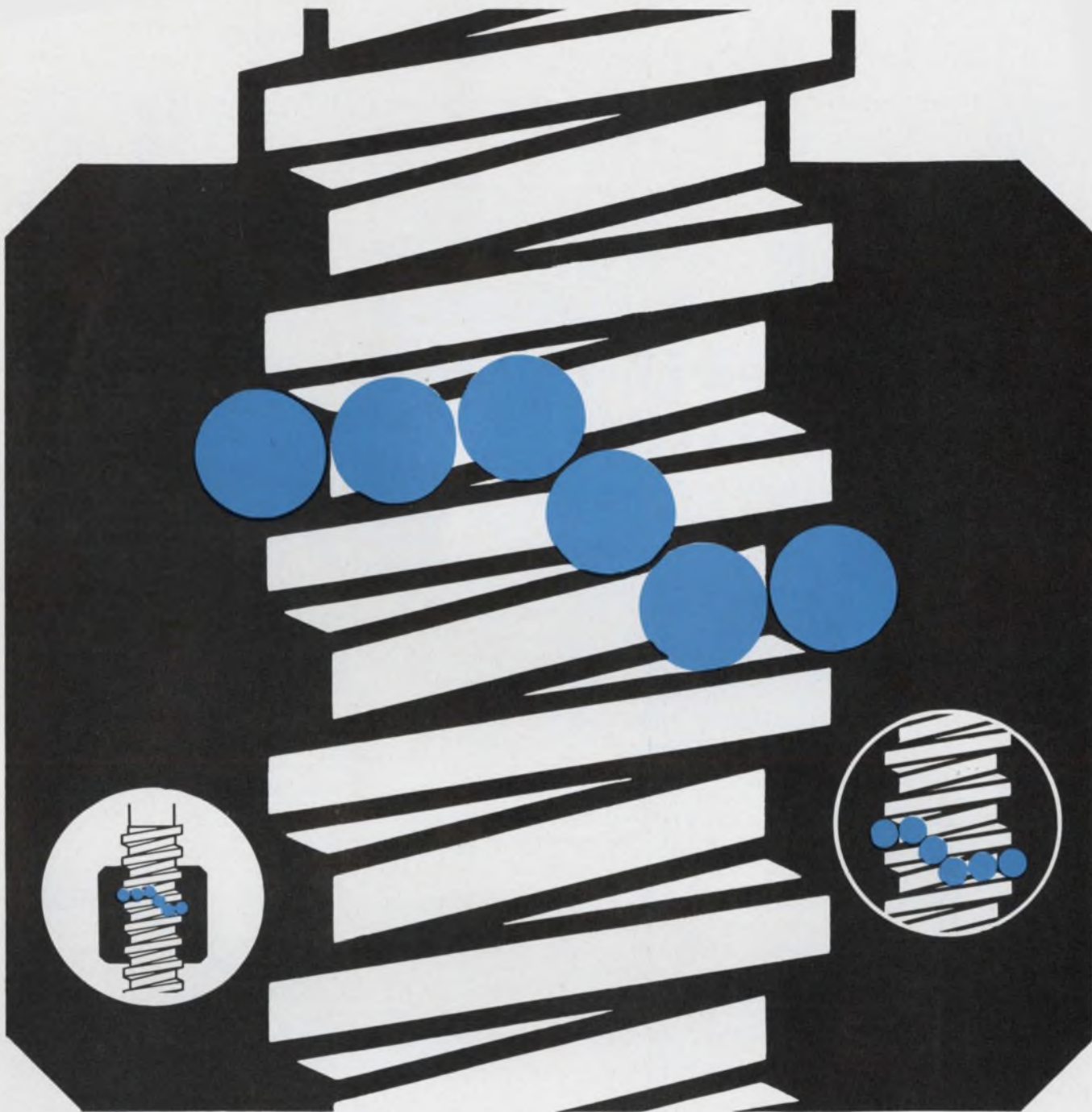

Kidde Ballscrews

SIZE AND WEIGHT PROBLEM SOLVERS

Kidde Ballscrews do more than solve friction problems of prime movers and drives. They can solve size and weight problems, too—and meet the demands for high efficiency transfer of motion and power. Here's why:

Their compact design results in smaller envelope dimensions. Weight is reduced because external tubes and fittings are eliminated. Kidde designs allow optimum usable power, up to extremely high efficiencies.

To solve these major problems, Kidde has designed a

wide range of Ballscrew sizes—from units less than 1" long to 32 foot custom assemblies. From 6" diameters down to 1/8"; sizes 3/16" to 1-1/2" (with various lead) are stocked.

Learn how Kidde Ballscrews can become your problem solver. Write for your free copy of "Standard and Precision Ballscrews." Walter Kidde & Company Inc., 675 Main Street, Belleville, New Jersey 07109.



ON READER-SERVICE CARD CIRCLE 72

ETRONIC DESIGN 3, February 1, 1967

gotta crazy curve?

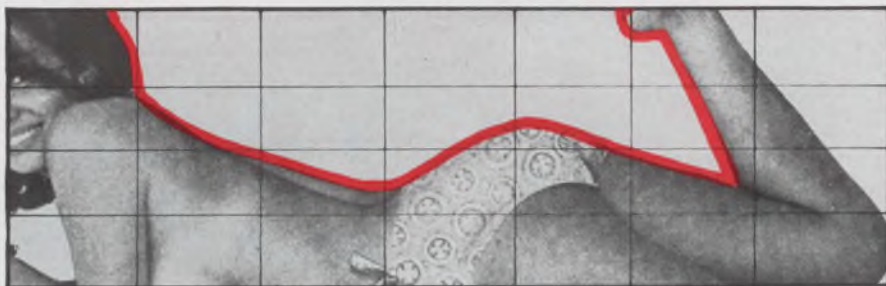

A DUNCAN NON-LINEAR POT CAN MATCH IT!

Even if your non-linear function looks like the Playmate of the Month in profile, Duncan can build a pot to match it. All you have to do is use the new "DUNCAN DO-IT-YOURSELF NON-LINEAR FUNCTION KIT," which we'll send you without obligation if you'll fill out and mail the coupon below. The kit includes a fabulous French curve* plus all other necessary ingredients and instructions. You supply us with the non-linear trace of your function and other supporting data. We'll feed it to our high-speed computer and analyze the data defining the pot's desired function. Then we'll enter the output tape into our servo-controlled machines to produce the variable-pitch winding to meet your function.

To be sure the output of the pot conforms to the specified tolerances, we'll compare it with the theoretical function on our unique conformity tester.

The result? A precision, accurate pot exactly to your specifications.

Our applications engineers can help solve your problems quickly and economically. In many cases they'll be able to match your function using pre-calculated data from our extensive tape library.

So forget about cams, differentials, and non-linear gears. For the direct approach to a complicated non-linear potentiometer problem — for airborne data computation or matching thermocouple curves — depend upon Duncan. You'll have more time to check out other interesting curves!

Send for your free Duncan "do-it-yourself" kit today. For literature only, circle the appropriate number and mail the inquiry card enclosed in this magazine.

DUNCAN ELECTRONICS INC.

Please send me my free "DUNCAN DO-IT-YOURSELF NON-LINEAR FUNCTION KIT" and complete technical literature on Duncan's family of non-linear potentiometers.

I understand that there is no obligation on my part.

Name _____ Title _____

Company _____

Address _____

City _____ State _____ zip _____

*French curve ruler by Birule Co.



DUNCAN electronics, inc.

2865 Fairview Rd., Costa Mesa, California 92626 Tel.: (714) 545-8261 TWX: 910-595-1128

ON READER-SERVICE CARD CIRCLE 73

COMPONENTS

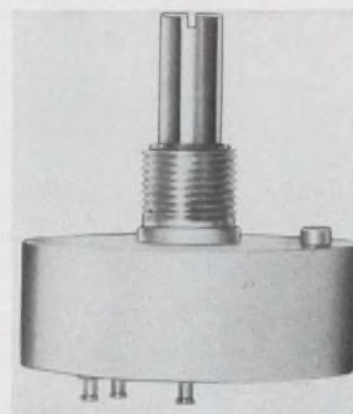

Industrial potentiometer meets divider needs

Maurey Instrument Corp., 4555 W. 60th St., Chicago. Phone: (312) 581-4555. Price: \$8 to \$15.

Without need of periodic maintenance, the Type 131-M16 potentiometer is said to meet voltage divider needs in industrial environments. The pot is offered at resistances from 50 to 100 k Ω with linearity to ± 0.3 and a power rating of 3 watts. An "O" ring seals the stainless shaft at the brass housing.

CIRCLE NO. 231



Tiny indicator lamps with prices to match

Industrial Electronic Engineers, Inc., 7720 Lemona Ave., Van Nuys, Calif. Phone: (213) 787-0311. P&A: 28¢ to 59¢; stock.

The above prices are said to be one-half that of competitive lamp series. This low-priced line includes 8 T-1 types at 5-V ratings of 0.06 to 0.115 A. Average life ranges from 100,000 to 40,000 hours, inversely with amp ratings. Mean spherical candle power ratings range from 0.048 to 0.147.

CIRCLE NO. 232

The Connector Thing



A periodical periodical designed, quite frankly, to further the sales of Microdot Inc. connectors and cables. Published entirely in the interest of profit.



In order to inform you about (very quietly, please) our Mini-Noise coaxial cable, Microdot Inc. is extending a bribe to catch your interest. We are offering as a beautiful prize in this contest a little teeny weeny Sony television set so that you can watch Peyton Place in the office. We are doing this, quite frankly, to impress you with the fact that Microdot Inc. makes the best coaxial cable in the whole wide world, and you won't really know that for sure until you ask, will you? You see how evil we are.



This is the Sony TV you will win

Entering this contest is terribly simple. See this illustration? Many of you are probably too young to remember it, but this fine broth of a man used to decorate the cover of almost every telephone book in the country. As the symbol of Electricity, he also perches atop the American Telephone and Telegraph Building in New York City. All you have to do is hold back tears of memory while you write your own original caption for this illustration. Then send it to Microdot Inc., Great American Cable Contest, 220 Pasadena Avenue, South Pasadena, Calif. 91030. The best caption (judged by a panel of men over forty) will receive the television set. Everybody entering will receive (a) an 11 x 14 repro-



This is the illustration you have to write the caption for

duction of the gentleman surrounded by his miles and miles of cable (b) a free 16-page, two-color catalog of Microdot Inc. miniature coaxial cable and cable assemblies, and (c) a lot of laughs.

To enter this contest, you should have a smattering of knowledge about Microdot Inc.'s Mini-Noise cable. As a design engineer, you are probably often faced with the problem of performance degradation under increasingly severe environmental conditions. Also, you've probably found that the transmission of extremely small signals through coaxial cable is often made unintelligible by audio frequency noise generated in the cable through shock and vibration. No longer. Through a unique proprietary treatment, the noise voltage magnitude in Mini-Noise cable has been reduced by a factor of more than 100 to 1 in comparison to untreated cable.

Some quick facts about two other Microdot Inc. cable products:

Miniaturized instrumentation means miniature coax cable (in most instances). By using a fine silver-plated copper covered steel wire, Microdot Inc. has been able to manufacture a miniature coax cable with an impedance of 50 ohms that—even with the addition of dielectric, outer shield and protective jacket—does not exceed nominal OD of .080".

Compare, please.

When you find it necessary to send two signals from a single source which must both terminate at a central point, use Microdot Inc. Twinaxial. No need to use two coax cables; therefore, greater flexibility at reduced cost.

One more point about Microdot Inc. cable products: if you've ordered them in the past, it will help you to know that we can now make more of them and make them faster. The reason is our recently completed new facility for cable products, which includes new braiders, new extruders—in short, new equipment and increased capacity for even faster deliveries.

There you have it. Be certain to enter the contest today (April 30, 1967 is your last day). Remember, just caption the illustration and send it to Microdot Inc., 220 Pasadena Avenue, South Pasadena, California 91030. We would hate for you to have to miss even one segment of Peyton Place.

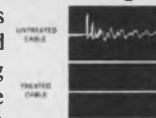

Comparison of untreated cable and treated Mini-Noise cable



Just because



MICRODOT INC. *Mini-Noise is a registered trademark of Microdot Inc.*

ON READER-SERVICE CARD CIRCLE 74

FAST response



direct-reading electrical thermometer RFL model 212

The portable Model 212 uses a miniature platinum resistance element to give precise liquid or gas temperature measurements traceable to NBS. Its response is within 2.5 seconds. These and the following features make it excellent for field or test table use:

- Choice of 7 temperature ranges from -100°C to 500°C
- Easy-to-read, 5-inch mirror scale meter
- Accuracy of 0.75%
- Operation on standard flashlight batteries
- Zener-referenced regulator that assures constant current to bridge circuit

Other Portable, Direct-Reading Electrical Thermometers for liquid or surface temperature measurements.



Model 380T.
You choose scale range.
Ultra-fast response.



Model 380S.
2 ranges: -25°C to
 280°C . Fast response.

For free literature write or call John Carson at RFL(201) 334-3100 or contact your nearest RFL Representative.



RFL Industries, Inc.
Boonton, New Jersey 07005

THERMOCONTROL DIVISION

COMPONENTS

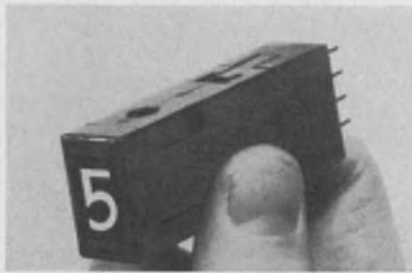

Readout modules for commercial/mil use

Industrial Electronic Engineers, Inc., 7720 Lemona Ave., Van Nuys, Calif. Phone: (213) 787-0311. Price: \$14 to \$20.

Series 345 front-plane readouts are designed for commercial use while also meeting MIL-202 requirements. Viewing area is $3/8 \times 11/32$ -in. and overall dimensions are $0.83 \times 0.505 \times 2.5$ -in. Character changes are said to be sharply defined and effectively instantaneous due to the character projection being formed within its own individual lenticular element.

CIRCLE NO. 233

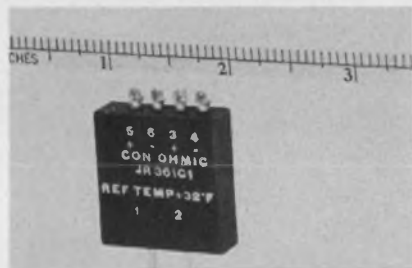

Reference junction for thermocouples

Consolidated Ohmic Devices, Inc., 115 Old Country Road, Carle Place, N. Y. Phone: (516) 741-1500. P&A: \$61 (1 to 10); 4 weeks.

A solid-state thermocouple reference junction is capable of withstanding radiation levels up to: Gamma 10^8 carbon rads; Neutron 10^{13} fast neutrons/cm². It is available in virtually any combination of thermocouple material, including chromel, alumel, copper, constantan and iron. Though any reference temperature can be obtained, the standard unit is adjusted to a reference of 32°F . Units are available in standard excitation voltages from 0.4 to 25 V.

CIRCLE NO. 234

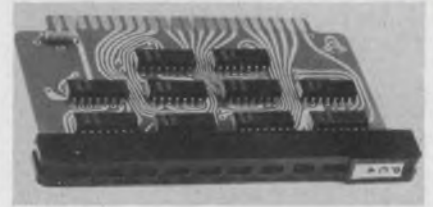

Logic cards operate from dc to 20 MHz

Control Logic, Inc., 3 Strathmore Rd., Natick, Mass. Phone: (617) 655-1170. P&A: \$145 for 4-stage card; 2 to 4 wks.

Part of a complete family of logic cards for counting, shifting and control functions at input or clock rates from dc to 20 MHz, the "Micro Logic Card" is a widely applicable, compact card designed for time base generation and frequency division. It provides 4 to 8 decade dividers connected in groups of 2 dividers each. The base card features two groups of 2 dividers each, providing two independent ($\div 100$) stages, or one 4-digit divider. Additional dividers, up to maximum of eight, may be added.

CIRCLE NO. 235



Control modules mate contactless meters

PMF Electronics, Inc., 124 E. 3rd St., Dayton, Ohio. Phone: (513) 224-1948.

A series of control modules are designed to operate with the manufacturer's standard contactless control meters. Using no relays, the solid-state circuitry is said to offer significant gains in reliability over previous designs. Control modules are available in all standard sensitivities and temperature ranges.

CIRCLE NO. 236

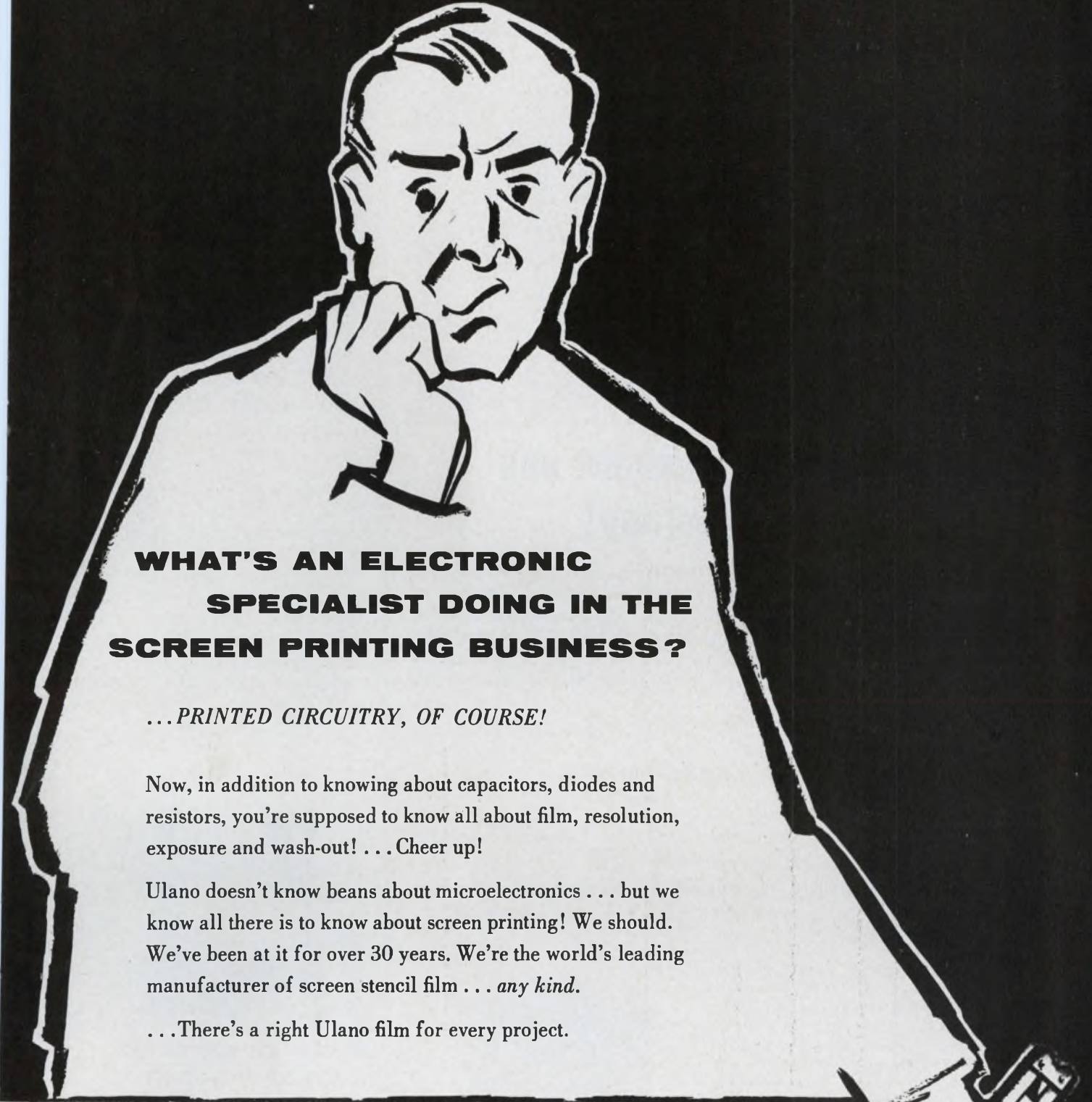

**WHAT'S AN ELECTRONIC
SPECIALIST DOING IN THE
SCREEN PRINTING BUSINESS?**

...PRINTED CIRCUITRY, OF COURSE!

Now, in addition to knowing about capacitors, diodes and resistors, you're supposed to know all about film, resolution, exposure and wash-out! . . . Cheer up!

Ulano doesn't know beans about microelectronics . . . but we know all there is to know about screen printing! We should. We've been at it for over 30 years. We're the world's leading manufacturer of screen stencil film . . . *any kind.*

. . . There's a right Ulano film for every project.

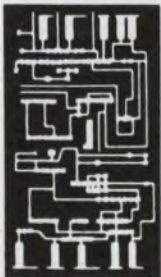

*In screen processing
of complex printed circuitry...
there's no margin for error!
That's why Ulano offers
a complete line of
Screen Process Stencil Films
especially designed for
the Electronics Industry.*

ulano

T.M.

610 DEAN STREET, BROOKLYN, N. Y. 11238

NEW YORK • CALIFORNIA • CHICAGO • ZURICH

In Europe: ULANO A. G., Untere Heselbachstrasse 22, Kusnacht 8700, Switzerland

Write on your letterhead for special electronic test kit (no charge) No. 5927



1 MHZ CAPACITANCE TESTER



MODEL 1201DS \$1995

...with digital readout and bridge accuracy!

The Micro Instrument Model 1201DS Capacitance Tester measures capacitance values to 1000 picofarads with an absolute accuracy of $1/2\%$ of reading and with a resolution of 0.01 picofarads. Coupled with this accuracy is an ease of operation that allows an untrained operator to test 1200 components per hour. And the Model 1201DS is fast — readout time is 0.5 seconds, as is the display time of the four-digit, in-line Nixie® readout.

Versatility is another feature of the 1201DS — its BCD output drives printers and other data loggers.

Other outstanding features of the Model 1201DS are:

- Signal level — less than 35mv rms
- Shunt resistance — no accuracy loss for 10K ohms or greater
- Bias — internal to 100v; external to 300v
- Optional transistor jig for Cob and Cib measurements
- Guarded front panel terminals for direct and 3-terminal measurements

ADD THIS OPTION FOR PRODUCTION LINE TESTING: The Model 6001 Go-No/Go Comparator allows selection of minimum and maximum limits, with no loss of basic instrument accuracy, by four-digit thumbwheel switches. Low, accept, and high readout lights are provided. Several Model 6001's may be stacked to allow simultaneous sorting to several tolerances. Price: \$695 each.



For capacitance testers from 120 Hz to 1 MHz, depend upon Micro Instrument Company. Write today for complete technical specifications on both the Model 1201DS and Model 6001. Also available is a four-page technical brochure — "The Theory and Applications of Capacitance Measurements."



12901 CRENSHAW BLVD., HAWTHORNE, CALIFORNIA 90250
TELEPHONES: (213) 679-8237 & 772-1275

ON READER-SERVICE CARD CIRCLE 77

COMPONENTS

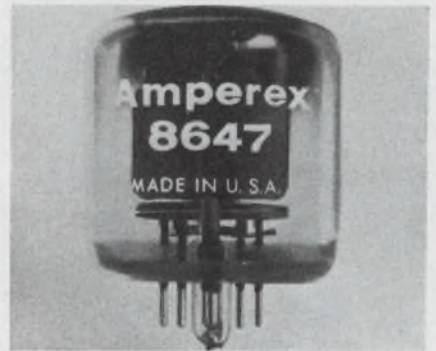

Standard 8505 tube now instant heating

Amperex Electronic Corp., Hicksville, N. Y. Phone: (516) 933-9045.

Offered as derivatives of the 8505, two new tubes are offered for power use in transistorized mobile equipment. Both use the "Harp" cathode which delivers full power after 0.5-s warm up without surge techniques. Tube 8603 is a beam power tetrode rated for 43 watts at 75 MHz and 40-dB third-order intermodulation distortion. Tube 8647 is an RF amplifier for service up to 250 MHz, Class C FM.

CIRCLE NO. 237

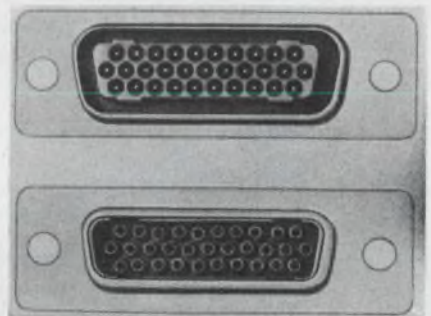

Miniature connector doubled in density

ITT Cannon, 3208 Humboldt St., Los Angeles, Phone: (213) 225-1251.

Called the DDD connector for Double-Density D shell, a miniature connector line offers five shell sizes with 19, 31, 52, 79 or 100 contacts. The manufacturer's standard line of D subminiature accessories can be used with the DDD line since shell dimensions and form are unchanged. Applications are seen in business machines, entertainment electronics and control.

CIRCLE NO. 238

Soliton

announces
another

FIRST!

300V · 275V · 250V
225V · 200V V_{CEO} (SUS)
in a 20 Amp. NPN
Silicon Planar Power
Transistor featuring
100 Watts at 100°C!

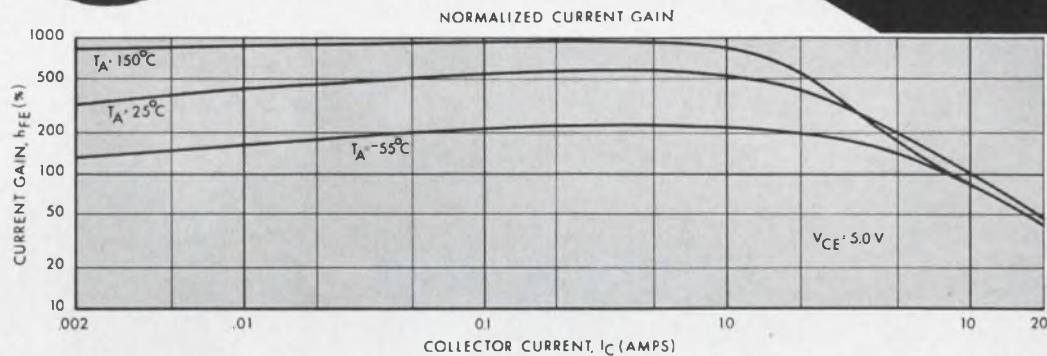

Type Number	Pkg. Size	DESIGN LIMITS						PERFORMANCE SPECIFICATIONS					
		T_J	θ	P_T Watts	BV_{CBO}	V_{CEO} (BUS)	BV_{EBO}	h_{FE}		V_{BE} (sat)	V_{CE} (sat)	I_{CBO}	f_T
		°C	°C/W		Volts	Volts	Volts	Min.	Max.	Volts	Volts	μA	
		Max.	Max.	Max.	Min.	Min.	Min.	Min.	Max.	Max.	Max.	Min.	
SDT8801	TO-63	200	1	100	200	200	8	15	60	1.4	0.70	1.0	30
SDT8802	TO-63	200	1	100	225	225	8	15	60	1.4	0.70	1.0	30
SDT8803	TO-63	200	1	100	250	250	8	15	60	1.4	0.70	1.0	30
SDT8804	TO-63	200	1	100	275	275	8	15	60	1.4	0.70	1.0	30
SDT8805	TO-63	200	1	100	300	300	8	15	60	1.4	0.70	1.0	30

TRANSISTOR DIVISION
Soliton DEVICES, INC.

1177 BLUE HERON BLVD. / RIVIERA BEACH, FLORIDA / (305) 848-4311 / TWX: (510) 952-6676

Leader in Germanium and Silicon Power Transistors, Cryogenic Thermometers, High Voltage Rectifiers, Hot Carrier Diodes, Temperature Compensated Zeners, Voltage Variable Capacitors, Random/White Noise Components, Microelectronic Circuits, and Power-Sink Interconnection Systems.

ON READER-SERVICE CARD CIRCLE 78

NOW...

Color-code and Teflon-wrap
in one operation with
Dilectrix "Fluorofilm"†

FULLY SINTERED

COLORED TEFLON* TAPES

—FUSES TO ITSELF, UNFUSED TFE
OR TO FEP

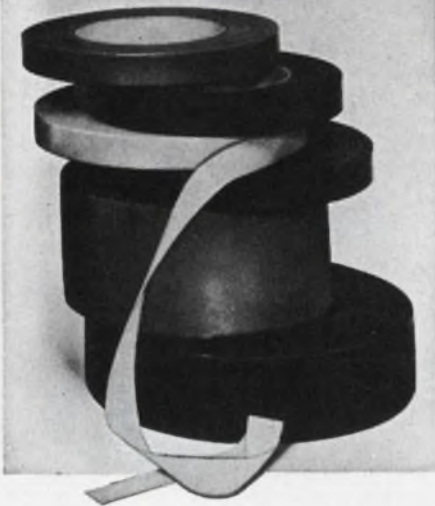

FEATURES

- Minimal pigmented layer protectively encapsulated within normal PTFE laminations
- Lowest pigment content for highest electrical and physical properties
- Will not peel, crack, wear or fade
- Void and pinhole-free multilaminar construction
- Low shrinkage after fusion—greater surface coverage POUND FOR POUND
- Choice of TEN permanent, vibrant Mil-spec colors
- AVAILABLE FROM STOCK in various thicknesses and widths, and in SPLICE-FREE lengths to 500 ft.

Dilectrix "Fluorofilm" color inter-laminated tapes and films are ideal for color coding and wrap-insulation applications, or as a low-friction surfacing material. Several types are supplied in plain PTFE, pressure-sensitive, and one side weldable for wrapping circular or rectangular conductors using standard fusion heat seal equipment. The savings are vivid, too!

WRITE FOR BULLETIN 1066.

COLORS: White, Black, Grey, Yellow, Green, Blue, Purple, Red, Orange and Brown.

*DuPont trademark
†Dilectrix trademark

Dilectrix

CORPORATION

FARMINGDALE, NEW YORK 11735
TEL: (516) 249-7800 • TWX: 694-1884

Advanced fabricators of Teflon—producers of multi-laminar autodeposited Teflon tapes, films and sheets

ON READER-SERVICE CARD CIRCLE 80

COMPONENTS

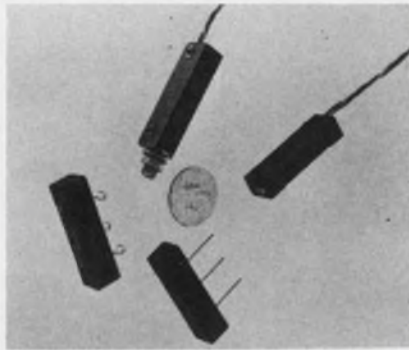

Cermet trimmer is interchangeable

Spectrol Electronics Corp., 17070 E. Gale Ave., City of Industry, Calif. Phone: (213) 964-6565. P&A: \$3.10 (1 to 9); stock.

A non-wirewound general purpose trimming potentiometer is produced in the standard rectangular size (style RJ 11 of MIL-R-22097) for easy interchangeability. All popular terminal and mounting configurations are available, including wire leads, solder hooks, printed circuit pins and panel mount. A termination pad of precious metal fired simultaneously with the cermet element's resistive track minimizes end resistance.

CIRCLE NO. 239



Low-pass filters use active components

Linear Networks Co., 1309 S. Black Ave., Bozeman, Mont. Phone: (406) 586-5597. P&A: \$45; stock to 30 days.

Where a low-frequency, low-pass filter is needed, the LPB4 series provides cutoff frequencies from 1 to 1000 Hz. Attenuation is 3 ± 0.5 dB at cutoff and 24 ± 2 dB at twice cutoff. Attenuation rolloff is 24 dB/octave and storage temperature is -55 to $+125^\circ\text{C}$. Operating temperature range is -40 to $+70^\circ\text{C}$. These units feature the 4-pole Butterworth gain and phase frequency response characteristic.

CIRCLE NO. 240



Wideband diff-amp has high current output

Burr-Brown Research Corp., International Airport, Industrial Pk., Tucson, Ariz. Phone: (602) 294-1431. P&A: \$135 (1 to 9); stock to 3 wks.

Its high current output and wideband characteristics make this op-amp suitable for differential current amplifier requirements. The differential current inputs adapt the circuit to current transducers such as photocells where one input might be monitoring a light source with the other connected to a reference cell to correct for changes in ambient lighting. Rated output is ± 10 V at 100 mA; bandwidth is 15 MHz at unity gain.

CIRCLE NO. 241

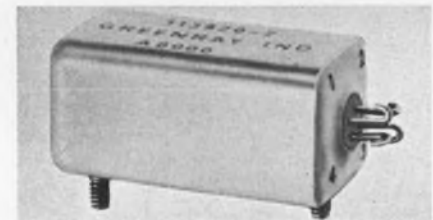

Small crystal oscillator made for space

Greenray Industries, Inc., East Simpson Road, Mechanicsburg, Pa. Phone: (717) 766-0223. Price: \$194.

Featuring small size and close regulation, the Model 1055004 crystal oscillator is designed for satellite and portable equipment applications. Frequency range of the unit is fixed between 2.5 and 30 MHz. Tolerance is $\pm 0.005\%$ over a temperature range of -25 to $+85^\circ\text{C}$. Wave form is sine with 10% maximum harmonic distortion. The completely solid-state unit is hermetically sealed in a metal case measuring $3/4 \times 3/4 \times 1-1/2$ -in.

CIRCLE NO. 121

SOLID STATE

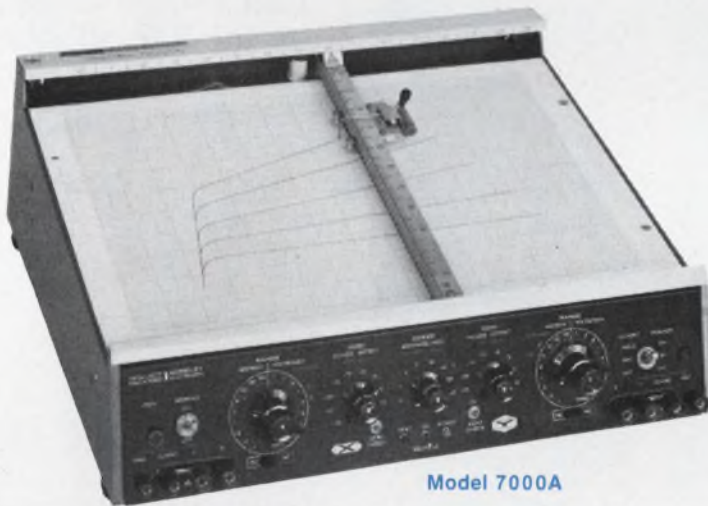

featuring
AUTOGRIP*
electric
holddown

All the advantages of solid-state design and construction are yours in a wide variety of Hewlett-Packard 8½" x 11" and 11" x 17" x-y recorders. Compact, rugged construction; solid-state reliability and long life; all with optional metric calibration and unprecedented performance characteristics. Check the list, then talk to your Hewlett-Packard field engineer about the models most useful for your task. Or write for complete information: Hewlett-Packard, Palo Alto, California 94304, Tel. (415) 326-7000; Europe: 54 Route des Acacias, Geneva.

Data subject to change without notice. Prices f.o.b. factory.

***EXCLUSIVE. CARE-FREE, DEPENDABLE PAPER HOLDDOWN.**

8-1/2" x 11" X-Y RECORDERS

- Bench/rack model in one, portable, 0.5 mv-5 v/in., X-axis time base; Model 135, \$1650.
- 2-pen version of 135, 0.5 mv-50 v/in.; Model 136A, \$2650.
- High-sensitivity model, 1 MΩ input impedance, time base either axis, 0.1 mv-20 v/in.; Model 7030A, \$1895.
- Economy model, 1 mv-10 v/in.; Model 7035A, \$895.

11" x 17" X-Y RECORDERS

- Versatile recorder, X-axis time base, 0.5 mv-50 v/in., high-impedance, computer reference models available; Model 2D Series, from \$1950.
- Economy model of 2D Series, 0.5 mv-10 v/in.; Model 2D-4, \$1490.
- 2-pen version of 2D Series; Model 2FA, \$3375.
- High-sensitivity ac/dc recorder, time base either axis, 0.1 mv-20 v/in. dc, 5 mv-20 v/in. ac; Model 7000A, \$2495 (also available without ac input, Model 7001A \$2175).
- Automatic data plotting system, null detector and character printer built in, 0.5 mv-10 v/in.; Model 7590C, \$1985.

**HEWLETT
PACKARD**  **MOSELEY
DIVISION**

ON READER-SERVICE CARD CIRCLE 81

ANY ENCLOSURE... ...ANY WEIGHT

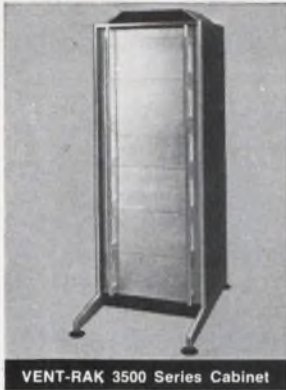

VENT-RAK 3500 Series Cabinet



VENT-RAK 1000 Series Cabinet

**FROM
CUSTOM
OR
STANDARD:**

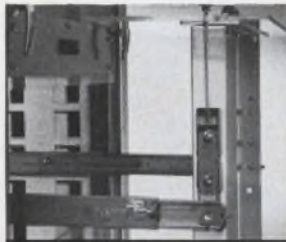

C-300 to 50 lbs.

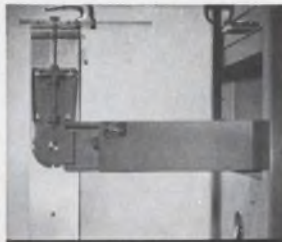

C-230 to 100 lbs.



D-600 to 125 lbs.



CTB to 175 lbs.



CTHRD to 275 lbs.



VCB to 350 lbs.



CB to 1000 lbs.



VENT-RAK Modular Chassis

From Chassis-Trak you get the broadest range of slide weight capacities and the ideal enclosure for your application. Flexibility . . . plus uncompromising Chassis-Trak quality . . . have made Chassis-Trak a part of the package on every major missile project.

Just make sure the slides you order have the Chassis-Trak of Indianapolis, Seal of Quality . . . your protection against inferior imitations . . . ask about Vent-Rak cabinets.

A Package for Every Major Missile Project from

525 South Webster Avenue, Indianapolis, Indiana
ON READER-SERVICE CARD CIRCLE 82

With Chassis-Trak, you get:

- Ultra-thin slides for standard racks and cabinets
- Choice of tilt, non-tilt, tilt-lock versions in most models
- Poxylube 75 dry-film lubricant
- Choice of solid or roller bearings
- Delivery from stock in standard models



COMPONENTS

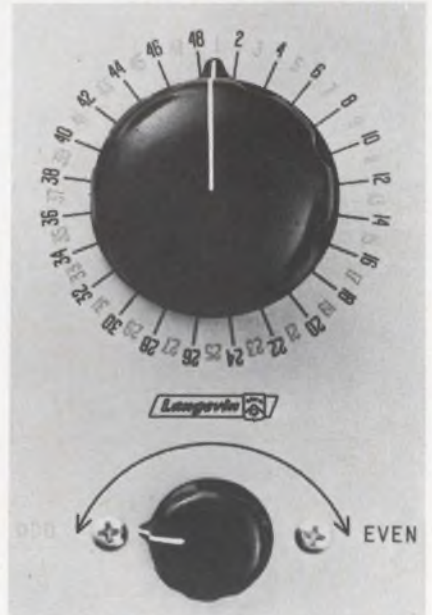

Rotary selector has up to 100 positions

Langevin, Inc., 503 S. Grand, Santa Ana, Calif. Phone: (714) 547-6204.

A rotary selector switch with up to 100 positions per pole has two separate groups of positions which are alternately placed between each other. With the selector on "even," the switch stops at every even number; when rotated to the "odd" position, it shifts the mechanism allowing the switch to stop at the odd numbers. This maintains a sufficient spacing between each position for positive operator control. It can be supplied with as many decks as required and with stops or continuous rotation.

CIRCLE NO. 242

Image-orthicon tube has 2-in. diameter

RCA, Electronic Components & Devices, 415 5th St., Harrison, N. J. Phone: (201) 485-3900.

A two-inch diameter image-orthicon tube designed specifically to operate with 16-mm film optics employs a bialkali photocathode. This photocathode has high sensitivity over the visible region of the spectrum but no response in the infrared. The tube has a field mesh with separate connection and a "dark heater" requiring only 0.6 W

CIRCLE NO. 243

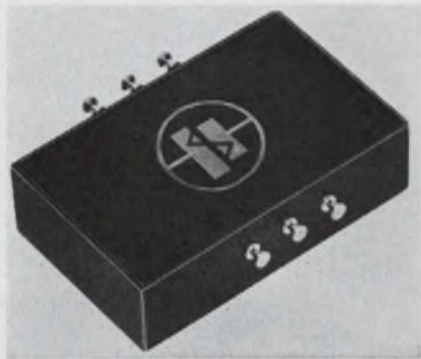

Flatpack computes root mean square

Transmagnetics, Inc., 134-08 36th Rd., Flushing 54, N. Y. Phone: (212) 539-2750. P&A: \$217 (1 to 9); 4 to 12 wks.

Intricate analog computation is easily performed with these miniature wide-band root-mean-square modules. They are available in a variety of package sizes from 0.58-in. flatpack. Full scale input and output levels are 10 V; output is $\pm(X^2 + Y^2)^{1/2}$ for both polarities of X and Y; conformity is 0.5%. Power required is 3-wire 15 Vdc for compatibility with operational amplifier circuitry. Applications are in rectangular-to-polar transformation, and true rms linear scale metering. The average value of the output is the true rms.

CIRCLE NO. 244

Miniature accelerometer completely integrated

Gulton Industries, 212 Durham Ave., Metuchen, N. J. Phone: (201) 548-2800.

A miniature, integrated accelerometer with self-contained signal conditioner integrates circuitry and transducers in a single unit. Also included is a calibration insertion circuit (voltage or current). The unit, hermetically sealed and making use of all-welded circuit construction, withstands aerospace environments and is particularly useful in applications where room for signal conditioning equipment is not available. Sensitivity is 30 mV/G, nominal, requiring less than 3 mA at 28 Vdc. The operating temperature range is -100 to 250°F .

CIRCLE NO. 245

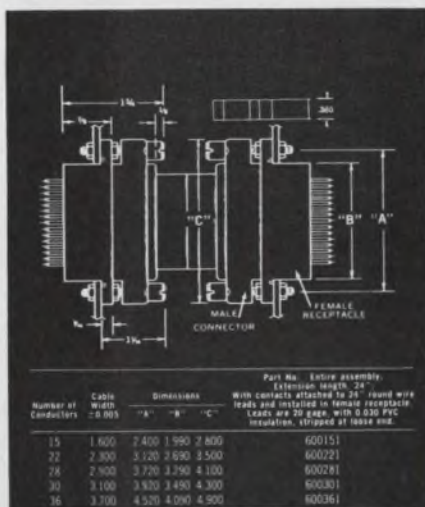

One end connects to the rack, the other to the sliding chassis. As the chassis is withdrawn the coil unwinds. As the chassis returns, slack is automatically taken up! There is no jamming, pinching, rubbing, misalignment or sagging. No mechanical devices such as springs or pulleys are necessary. There is no sag even when fully extended and . . . laboratory tests reveal an extremely long life to the spring action.

"Acknowledged leader in flat cable systems."



DIVISION OF KENT CORPORATION
206 Industrial Center, Princeton, N. J. 08540

RACK and PANEL WIRING Made Simple!

Single, double, triple, quadruple layered Signaflo expandable rack and panel systems for maximum wiring density. Photo shows 108 conductors in 3 layers!

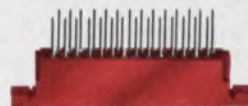

Transition connectors are also available with standard wire-rap pins.

Capacity: 0.75 amps per conductor
Voltage breakdown: 3000 V
Resistance, Voltage Drop or ohms per foot equal to #25 AWG.



ON READER-SERVICE CARD CIRCLE 83



Some connectors will go to any extreme.
Like our MIL-C-26482 plugs.

You name the commercial, industrial or military, aerospace/aircraft/ground support equipment application . . . ITT Cannon Electric probably makes a bayonet-coupling plug for it that meets or exceeds the performance requirements of MIL-C-26482.

ITT Cannon, backed by 50 years of experience in connector manufacture and a vast network of distributors, offers the widest range of MIL-C-26482 type plugs

. . . all competitively priced . . . all stocked by distributors . . . all immediately available in countless shell sizes and insert arrangements.

Call your ITT Cannon Distributor for circular miniatures or subminiatures . . . solder or crimp termination . . . front or rear release contacts. Specify KPSE, KPT, KPTM, PV or CENTI-K™ connectors. Or just tell your distributor the performance level you require. He'll meet your need.

ITT Cannon Electric, 3208 Humboldt Street, Los Angeles, California 90031. A division of International Telephone and Telegraph Corporation.



CANNON **ITT**



WE ARE YOUR AUTHORIZED MINNONS DISTRIBUTORS

- ALABAMA**
Son Radio & Supply Company, Inc.
Mobile
Phone: (205) 479-1471
- ARIZONA**
Ball Electronics, Inc.
Phoenix
Phone: (602) 264-4438
- CALIFORNIA**
Connectors, Inc.
10th Hollywood
Phone: (213) 875-0665,
65-8881, 983-1738
Ranics
Angeles
Phone: (213) 685-5888
Ruff Electronics, Inc.
Alto 94303
Phone: (415) 968-6292
Ry Electronics Corp.
Leewood
Phone: (213) OR 8-8111
Ry Electronics, Inc.
10th Hollywood
Phone: (213) 761-6133
R 877-2651
Delcor, Inc.
San Diego
Phone: (714) BR 4-3131,
276-2653
- CONNECTICUT**
Co Electronics
Meriden
Phone: (303) 322-7708
- CONNECTICUT**
Rector Corporation
of America
New Haven
Phone: (203) MA 4-0127
- FLORIDA**
Centro Air of Florida, Inc.
Tampa
Phone: (305) 241-5461
Industrial Electronics
Associates, Inc.
1000 Beach Gardens
Phone: (305) 848-8686,
WX-8686
- FLORIDA**
Centro Air Corp.
Tampa
Phone: (404) 351-3545
- ILLINOIS**
Equip Electronics, Inc.
Chicago
Phone: (312) AV 2-5400
Radio Distributing
Company, Inc.
Chicago
Phone: (312) 379-2121
- INDIANA**
Radio Distributing
Company
Indianapolis
Phone: (317) ME 7-5571
Radio Distributing Co., Inc.
North Bend
Phone: (219) 287-2911
- KANSAS**
Radio Supply Company, Inc.
Topeka
Phone: (316) AM 7-5214
- KENTUCKY**
Southern Radio Supply
Company, Inc.
New Orleans
Phone: (504) 524-2345
- MARYLAND**
Radio Distributing Co.
Baltimore
Phone: (301) 377-6402
or 377-4616
- MASSACHUSETTS**
Fayette Industrial
Electronics
Waltham 01762
Phone: Boston
(617) 969-6100
Natick
(617) 875-1358
Schweber Electronics
Waltham
Phone: (617) 891-8484
- MICHIGAN**
Detroit-Detroit
Electronics, Inc.
Detroit
Phone: (313) 548-0250
- MINNESOTA**
Lew Bonn Co.
(Industrial Sales Division)
Minneapolis
Phone: (612) 339-9461
- MISSISSIPPI**
Ellington Electronic
Supply, Inc.
Jackson
Phone: (601) 355-0561
- MISSOURI**
Electronic Components
for Industry Co.
St. Louis
Phone: (314) MI 7-5505
Radiolab, Inc.
Kansas City
Phone: (816) LO 1-9935
- MONTANA**
Electronic Supply Company
Billings
Phone: (406) 252-2197
- NEW MEXICO**
Waco Electronics, Inc.
Albuquerque
Phone: (505) 268-2409
- NEW YORK**
Progress Electronics, Inc.
Plainview, L.I.
Phone: (516) GE 3-1700
Schweber Electronics
Westbury
Phone: (516) ED 4-7474
Stack Industrial
Electronics, Inc.
Binghamton
Phone: (607) 723-6326
Summit Distributors, Inc.
Buffalo
Phone: (716) 884-3450
Time Electronic Sales
Great Neck, L.I.
Phone: (516) HU 7-0100
- NORTH CAROLINA**
Kirkman Electronics, Inc.
Winston-Salem
Phone: (919) 724-0541
- OHIO**
Hughes Peters, Inc.
Cincinnati
Phone: (513) 381-7625
Hughes Peters, Inc.
Columbus
Phone: (614) 294-5351
Radio Distributing
Company, Inc.
Cleveland
Phone: (216) 475-4770
- OKLAHOMA**
Oil Capitol
Electronics Corp
Tulsa
Phone: (918) TE 6-2541
Van Dusen
Aircraft Supplies, Inc.
Oklahoma City
Phone: (405) MU 5-5577
- PENNSYLVANIA**
Aercon, Inc.
Criston Heights
Phone: (215) MA 2-2500
Philadelphia
Electronics, Inc.
Philadelphia
Phone: (215) LO 8-7444
Radio Parts Co., Inc.
Pittsburgh
Phone: (412) 361-4600
- TENNESSEE**
Lavender Radio &
TV Supply, Inc.
Memphis
Phone: (901) BR 6-2756
- TEXAS**
Hall-Mark Electronics Corp.
Garland
Phone: (214) BR 6-8531
Harrison Equipment
Co., Inc.
Houston
Phone: (713) CA 4-9131
McNicol, Inc.
El Paso
Phone: (915) 566-2936
Sterling Electronics, Inc.
Dallas
Phone: (214) FL 7-9131
Wholesale Electronic
Supply, Inc.
Dallas
Phone: (214) TA 4-3001
- UTAH**
Kimball Electronics, Inc.
Salt Lake City
Phone: (801) 328-2075

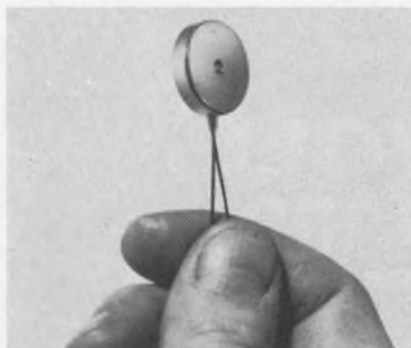

Heater buttons have many applications

Minco Products, Inc., 740 Washington Avenue North, Minneapolis, Minn. Phone: (612) 338-6753. Price: \$6.70 to \$24.50; stock.

Miniature heater buttons provide concentrated, localized heat in a small space, and are used for warming to operating temperature such mechanical, electrical, or electronic devices as valves, gyros, relays, crystal ovens, cryostats, instruments, circuit modules, thermal time delay devices, etc. They are easily mounted by means of a small machine screw or high temperature cement. In conjunction with temperature controls, they can be used to maintain precise temperature levels for critical applications. They are widely used as heat sources for aerospace, laboratory, and commercial applications. They can be operated to 500°F continuously.

CIRCLE NO. 246

Diff op-amp has 10-MHz bandwidth, noninverting

Analog Devices, 221 Fifth St., Cambridge, Mass. Phone: (617) 491-1650. P&A: \$185; 2 to 3 weeks.

This 2-1/2-in.³ differential op-amp ranges to 10 MHz in noninverting circuits. It has a ± 11 V output at 100 mA, and a common mode rejection ratio of 10^5 (100 dB). The differential input impedance is 500 M Ω . It is especially useful for driving inductive loads at fixed current values regardless of changes in load impedance with frequency. It is also useful as a fast-response precision power supply.

CIRCLE NO. 247



Wide-range cathode fitted to 5894 tube

Amperex Electronic Corp., Hicksville, N. Y. Phone: (516) 931-6200.

The 5894B/8737 twin-tetrode tube is fitted with a wide-range cathode to meet the operating conditions of the PTTS rating system. An improved version of the 5894, it features sufficient emission at low battery voltage for greater than 85% of full power output. Supply voltage can now vary from 10 to 16 volts. Under PTTS (Push To Talk Service) it is capable of providing 110 W of useful power from 5.5-W drive as a 174-MHz amplifier.

CIRCLE NO. 248

Subcarrier discriminator constructed modular

Defense Electronics, Inc., Rockville, Md. Phone: (301) 762-5700. P&A: Below \$500; 30 days.

Modular construction is used in an FM subcarrier discriminator providing interchangeable channel selectors and low-pass output filters. Silicon transistor circuitry and pulse-averaging detectors are said to assure quality without premium cost. Small size of the modules allows the placement of 14 discriminators in a standard 10-in. rack with a height of 3-1/2-in.

CIRCLE NO. 249

NEED A 3000 VOLT ZENER DIODE?

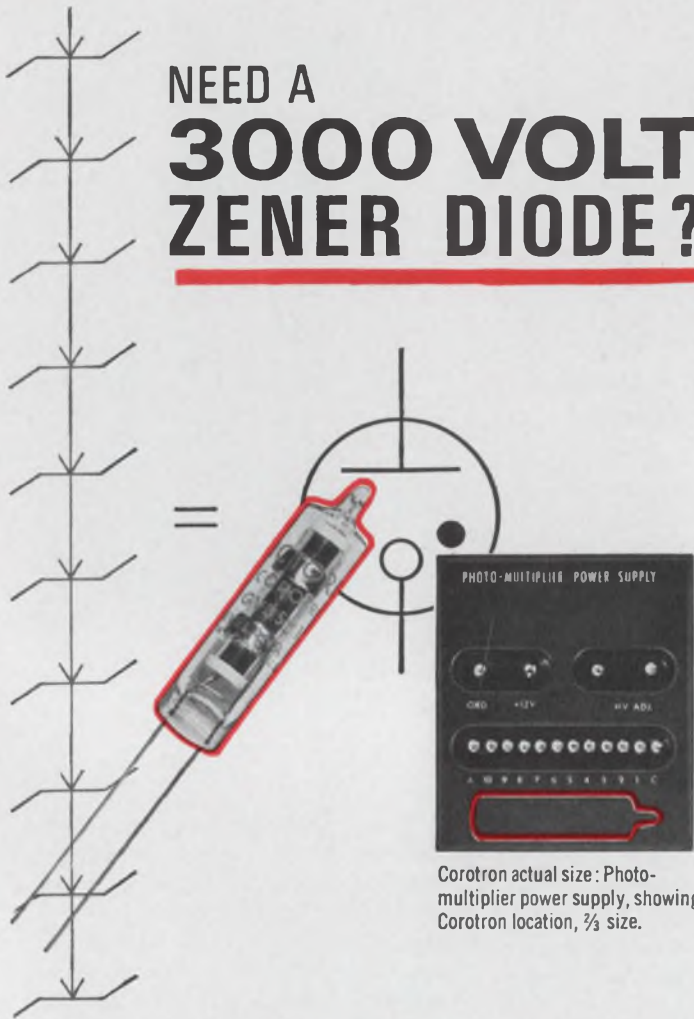

Corotron actual size: Photo-multiplier power supply, showing Corotron location, $\frac{2}{3}$ size.

You could string together several hundred zeners. Or you could specify one Victoreen Corotron. It is the gaseous equivalent of the zener with all the advantages of an ideal HV zener diode.

For space research and other rugged applications requiring absolute power supply stability, GV3S Series, shown, provide the ideal reference voltage anywhere in the range of 400 to 3000 volts. They enable circuitry to maintain constant high voltage regardless of battery source voltage or load current variations. Cubage and weight (GV3S Corotron weighs only 4 gm.) are important considerations. So is temperature variation (Corotrons operate from 200°C down to -65°C). Ruggedized versions withstand shock to 2000 G, vibration 10 to 2000 cps.

If you're trying to simplify circuits . . . to cut cost, size and weight . . . to upgrade performance—you need Corotron high voltage regulators. Models are available now from 400 to 30,000 volts. A consultation with our Applications Engineering Dept. will speed up the countdown.

8501-A



Components Division
THE VICTOREEN INSTRUMENT COMPANY
10101 WOODLAND AVENUE • CLEVELAND, OHIO 44104
 EUROPEAN SALES OFFICE: GROVE HOUSE, LONDON RD., ISLEWORTH, MIDDLESEX, ENGLAND
 ON READER-SERVICE CARD CIRCLE 85

COMPONENTS

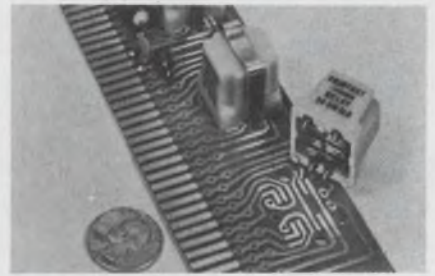

PC board for relay modules

Executone, Inc., 47-37 Austell Pl., Long Island City, N. Y. Phone: (213) 392-4800. Price: \$3.50.

A general purpose edge-connector PC board with plated conductors for mounting up to four of the manufacturer's magnetic standard and latching relays and other components, is adaptable to a variety of individual circuitry requirements. All circuits leading from the pads on the board have drilled holes for solder mounting of resistors, capacitors, diodes and other components.

CIRCLE NO. 250



Error signal detector in small case

Servo Products, Bulova Watch Co., Inc., 61-20 Woodside Ave., Woodside, N. Y. Phone: (212) 335-6000. P&A: from \$135; 8 to 10 wks.









The monitor circuit of this error signal detector is designed to meet the radio interference and susceptibility requirements of MIL-I-6181. The firing level of the detector is 150 mV nominal and is adjustable to ± 75 mV min within 5 mV at 25°C. Hysteresis is 10 mV min and 25 mV max at all firing levels and operating temperatures, which range from -54°C to 100°C. Input impedance is 30 k Ω ; power supply requirement is 28 Vdc, with 10 per cent maximum ripple.

CIRCLE NO. 251

Celco

DEFLECTION COMPONENTS

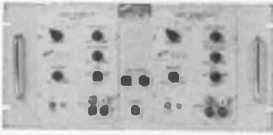
for the DISPLAY INDUSTRY

YOKES	AMPLIFIERS	INSTRUMENTS
<p>DEFLECTRONS Ultra High Resolution Yokes Type HD</p>  <p>For 40° Flat Faced Scanners, Computer Readouts, Side-Looking Radar, Mapping.</p>	<p>20V ALL SILICON DRIVERS Type DA-PPN-3</p>  <p>3, 6, 12 amp X-Y amplifiers matched to your yoke and response requirements. Available with regulated power supplies</p>	<p>DISPLAY MEASUREMENT LAB</p>  <p>Two-Slit CRT Spot Analyzer on X-Y Traverse quickly ascertains spot size, line width, and X-Y coordinates. Easily determines linearity and positional accuracies as well as phosphor characteristics.</p>
<p>PIN CUSHION CORRECTORS Electromagnetic</p>  <p>Straight Sides to 0.1%.</p> <p>Use with CELCO Micropositioner for optimum accuracy</p>	<p>40 VOLT DEFLECTION DRIVER All Silicon Type RDA-PP6N-1</p>  <p>With regulated Quadru-Power Supplies. 12 amp change in less than 9 μsec. 0.02% linearity.</p>	<p>X-Y TRAVELING MICROSCOPE Mounted on X-Y Traverse.</p>  <p>Line Straightness, spot positions and line positions measured with a high degree of repeatability. Use for aligning yokes, focus coils and field correctors.</p>
<p>TV CAMERA COILS for 3" Image Orthicons Type I.O.</p>  <p>Deflection Yoke, Focus and Alignment Coil Assemblies to meet your specs.</p>	<p>RASTER GENERATOR All Solid State Type 2 SG-1</p>  <p>Two Ramp Units in one panel. Ramps from 20 μsec to 100 msec. Adjustable dc offset. Compatible with CELCO Drivers.</p>	<p>CRT DEFLECTION SYSTEM</p>  <p>Contains all deflection, focus and corrective coils, micro-positioners for each, your CRT, complete shielding from all stray magnetic fields. Use for automating assembly lines, a reader of bubble-chamber photos.</p>

Celco YOKES

Constantine Engineering Laboratories Company

MAHWAH, N. J.
201-327-1123
TWX 201-327-1435

UPLAND, CAL.
714-982-0215
TWX 714-556-9550

the Cobehn
Spray Clean Process
makes

**PARTS
CLEANING**

A BREEZE



It's the easiest and most efficient cleaning system available. No matter what the application; small or large production, individual parts or assemblies, the Cobehn Spray-Clean Process provides critical cleanliness without film or residue.

HERE'S HOW IT WORKS:

(1) Atomized Cobehn Spray-Clean Solvent is sprayed through every section of the part or assembly to dissolve all oil, grease, silicone lubricants, rosin flux, fingerprints, and other soluble materials.

(2) A high velocity jet of warm filtered air blows away all insoluble foreign matter and leaves the component critically clean and dry. Cobehn Spray-Clean Solvent is nonflammable and never leaves a film or residue.

TYPICAL APPLICATIONS

Electrical contacts in relays, switches, choppers, and voltage regulators, semiconductors, crystals, slip-ring commutators, printed circuits, electronic assemblies, instrument bearings, jewel bearings, pivots, gear trains, lapped surfaces.

For demonstration or particulars, write:



ON READER-SERVICE CARD CIRCLE 87

COMPONENTS



4-digit counter-timer has accuracy, long life

Kessler-Ellis Products Co., 46 Center Ave., Atlantic Highlands, N. J. Phone: (201) 291-0500. Availability: stock.

This 4-digit electrical impulse counter has a minimum count-life of 300 million. Count accuracy is maintained at speeds of 50 counts per second, and, in some applications, 100 counts per second. All units operate from dc pulses from a relay, micro switch, or solid-state device at voltages from 4 to 220 Vdc. Built-in rectifiers are supplied for ac use. Zero reset is manual.

CIRCLE NO. 252



Precision pots have plastic elements

Duncan Electronics, Inc., 2865 Fairview Rd., Costa Mesa, Calif. Phone: (714) 545-8261.

Potentiometers with plastic resistance elements and turns-counting dials are available with linear or nonlinear functions.

The single-turn potentiometers combine long life, stability and infinite resolution. The conductive plastic element provides a wide, flat surface permitting the use of multiple-finger wiper contacts. The resistive track, which includes carbon compounds dispersed in plastic, is co-molded with a thermo-setting

epoxy substrate. Terminations and taps are completely metallic and feature optimal conductivity between the terminals and element.

CIRCLE NO. 253



Transponder-decoder in 10-in. package

Control Electronics Corp., 153 Florida Street, Farmingdale, N. Y. Phone: (516) 694-0125.

Two isolated delay lines are packaged in one housing for use as an electronic interrogation coding signal device for military ground and airborne equipment. A signal from a transceiver (the interrogating signal) activates the transponder which, in response, sends out a series of coded pulses, separated by the identifying delay spacings. The dual line is packaged in an envelope and mounted on a printed circuit board. Contacts extend from one end, permitting quick insertion and removal of the line.

CIRCLE NO. 254

Coax transfer relay has 80 dB isolation at uhf

United Standard Industries, Inc., 30 North LaSalle St., Chicago, Ill. Phone: (312) 332-1370. P&A: \$100 (1); \$52 (400); 10 to 30 days.

Reed switches with contact life expectancy of over 10 million cycles claim 80-dB isolation at 50 MHz, and 40 dB at 1000 MHz. The case is 1-1/16-in. dia. by 1-1/8-in. long. The switch will handle cw power to 100 W (cold switching), and is activated by 500 mW. Good isolation and small size make it useful for such applications as transfer of crystal filters or of high-gain amplifiers.

CIRCLE NO. 255



This is a naked YAES terminal.



We've stripped it to show why
Burndy YAES Insulug[®] terminals
are unique.

Once the insulation is off, it's easy to see that this terminal is a one-piece unit. That's a Burndy exclusive. Look closely and you'll see that the seam on the terminal body has been brazed. Another unique Burndy feature. And all YAES terminals are *fully* plated. You won't find any exposed copper edges. In fact, there are no unplated edges where the terminal is separated from the carrier. Look inside the terminal body, too. The surface has been serrated to insure intimate contact.

Additionally, each terminal is marked with the range of wire acceptable. As a double check, the tough, nylon insulation is color-coded to indicate wire size.

Installation is quick and easy with either MS 25037 or MR 8-83 ratchet-controlled hand tools.

Automatic installation tools are available, too. Burndy's Bandolug[®] equipment, the SME and the SME 10, handles wire ranging from 22 to 10. And they handle them quickly, simply and inexpensively. More so than any other tools.

Burndy YAES terminals meet both the Class I and II requirements of MIL-T-7928 when installed with appropriate tools.

There really is more than meets the eye when it comes to Insulug terminals and tools. Write for Bulletin YAES-66 and see for yourself.



INTERNATIONAL SALES HEADQUARTERS AND MANUFACTURING FACILITIES:

CANADA: Scarborough, Ontario / ENGLAND: St. Helens, Lancs. / BELGIUM: Mechelen / MEXICO: Nautalpan de Juarez / BRAZIL: Sao Paulo / JAPAN: Tokyo / Sales Offices in Other Major Cities

ON READER-SERVICE CARD CIRCLE 88

Designing Circuits with CERMET Passive Elements

Designers attracted by 10 to 300,000 ohms per square sheet resistance range and proven reliability record.

Economies realized from CTS mass production techniques and low tooling costs.

CTS CERMET resistance elements are produced by screening formulations of conductive, resistive, and insulating materials onto ceramic substrates. After firing above 650°C, a semiconducting matrix is formed which is permanently bonded onto the dielectric substrate.

Since the middle '50's, the CERMET resistance element has been designed successfully into many types of resistor-capacitor modules and microcircuits. Apollo, Tiros, Minute Man, Talos and numerous other high performance military and industrial applications use CERMET resistors.

Wide resistance range simplifies design, improves performance, saves space and provides design flexibility.

The designer is offered an unusually wide range of sheet resistance from 10 to 300,000 ohms per square. Short straight resistance paths, in a range from 10 ohms to 10 megohms, simplify design, reduce size and improve frequency capabilities. For example, at 100 ohms, resistance is constant to at least 250 mc. Other resistance values have limited predictable change through several hundred megacycles.

192,400,000 hours of unmatched reliability

See Table I for the story of unmatched reliability of the CERMET resistance element.

Tests are run continuously on sample quantities from current production.

Typical CERMET resistor module test data

CERMET resistors from 50 ohms to 100K ohms were applied to both sides of a .310" x .310" x .010" ceramic dielectric substrate.

1) **Temperature Cycling**—168 resistors tested: Substrates were subjected to 5 cycles from -65°C to +125°C. Each temperature noted was held for 30 minutes.

2) **Short Time Overload**—2876 resistors tested: Resistors were subjected to 6¼ times rated wattage for 5 seconds per MIL-R-10509B.

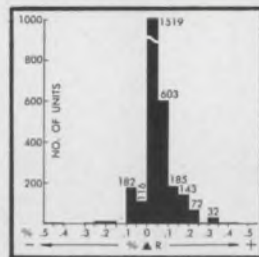
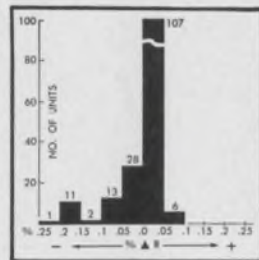

3) **Moisture Resistance**—168 resistors tested: Substrates were tested per Method 106A, MIL-STD-202B. ¼ watt per resistor, 93% to 95% RH, 10 cycles.

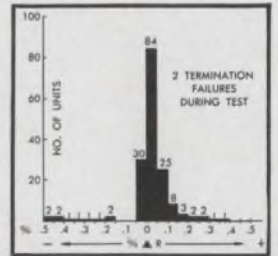

Economy

Low tooling and start-up costs effect significant economies for CERMET circuitry over integrated circuits. Cost savings are also substantial over discrete components, including elimination of interconnections, much smaller physical size, and the elimination of costs incurred in purchasing, stocking, handling and inserting various components. Additional economy is effected by efficient CTS proprietary mass production techniques.

Other design parameters

In addition to wide sheet resistance, unequalled reliability and economy, CERMET resistors and capacitors offer the designer these additional characteristics:

- 1) Stability at end of life: ±2% for resistors, ±3% for capacitors.
- 2) Low temperature coefficient over a wide temperature range: For resistors; ±200 PPM/°C (T.C. on individual substrates can be matched to ±25 PPM/°C.) For capacitors: -300 to -700 PPM/°C.
- 3) Low current noise: -30db at 100 ohms per square. -10 db at 10K ohms per square. +20db at 300K ohms per square.
- 4) Initial tolerances as low as ±0.10% for resistors, ±2% for capacitors.
- 5) Moisture resistance: less than ±1% change under ordinary humidities. For extreme humidity conditions, encapsulation or cover coat is recommended to maintain ±1% max.
- 6) Vibration, shock and abrasion resistant because all CERMET passive circuit elements and conductors are fused to the substrate and to each other.
- 7) High overload capacity due to superior heat sink capability.
- 8) Relatively low capacitance losses—dissipation factor less than .002 ("Q" greater than 500) @ 1 Meg C—before and after processing and throughout life.
- 9) Very low (0.5pf max.) parasitic capacitance introduced by CERMET crossover and parallel conductors.

Unaffected by severe environments

The CERMET resistance element is virtually indestructible. It remains unaffected by the most severe environmental conditions

TABLE 1 RELIABILITY DATA	RELIABILITY	FAILURE RATE	RESISTANCE	POWER DENSITY	
	95% Confidence Level ±3% Failure Criterion	95% Confidence Level ±3% Failure Criterion	RANGE	Watts/sq. inch of resistor area	Watts/sq. inch of substrate area
A. 12.4 million resistor hours documental 10,000 hours with ½ watt per substrate; 97° C ambient resulting in a 125° C hot spot temp.; encapsulated, 1236 resistors; ¼ watt applied to each resistor; 1½ hours ON, ½ hour OFF.	99.962% per 1,000 hours	0.038% per 1,000 hours	47 ohms to 100K ohms	9 to 55	5
B. 94 million resistor hours documented 10,000 hours with 1.2 watts per substrate; 25° C ambient resulting in a 116° C hot spot temp.; unprotected resistors; 9420 resistors; 0.1 watt applied to each resistor.	99.990% per 1,000 hours	0.010% per 1,000 hours	50,000 ohms	11.4	3.2
C. 86 million resistor hours documented 10,000 hours with 1 watt per substrate; 25° C ambient resulting in a 99° C hot spot temp.; unprotected resistors; 12,000 resistors; 0.1 watt applied to each resistor.	99.9946% per 1,000 hours	0.0054% per 1,000 hours	1K to 55K ohms	8.6	2.6

oxidizing atmospheres up to 500°C. Designers are using CERMET resistance elements successfully under such severe conditions as nuclear radiation, solvents and cesium spheres.

aging techniques

infinite array of package designs to fit every designer's need possible with CERMET circuitry. TO-5 headers, flatpacks, or various sizes and shapes of molded housings can be used. Round flat leads can be attached in any configuration parallel or perpendicular to the substrate. Leads can be bonded to pads, glued into the substrate or anchored through holes in the substrate.

the classes of CERMET elements available to designers

Element groupings: Resistor modules, capacitor modules, resistor/capacitor modules. All are available with or without embedded active devices such as dice, flip chips, and micro or conventional leaded types.

interconnections: In addition to the fired conductive network, pads can be provided for soldering, welding, alloying, die bonding, thermocompression, ultrasonic and wedge bonding, micro lead bonding, and flip chip bonding.

Auxiliary elements: Edge-around conductor, plated-through-hole conductor, lead crossover, insulative cover, and reconnect conductor.



Top view of CTS hybrid integrated circuit showing attached discrete components and terminal pins soldered through holes in substrate.



TO5 header showing cermet resistors and transistor dice.



Enlarged view of flip chip assembly on ceramic substrate with platinum gold conductors.

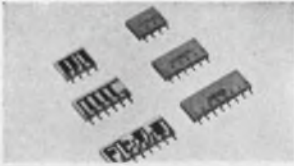

750 series resistor network package. Modules on left show circuitry before coating.



Typical cermet passive circuit modules with leads attached.

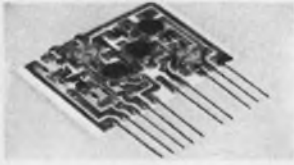

CTS hybrid integrated circuit showing attached discrete components soldered to terminating pads.

Delivery

5 weeks for prototypes, 5-6 weeks in production quantities. Several hundred thousand CERMET microcircuits are being shipped by CTS weekly.

Test data available to designers

Many of the nation's leading designers have already been attracted by the unique properties and design flexibility of CTS CERMET elements. Great strides have been made every year by CTS engineers in the art of microcircuitry. Send for the latest technical data or forward your circuit. CTS engineers will analyze your requirements and recommend a CERMET microcircuit design to your exact specification. Just contact your nearest CTS office or rep.

Sales offices and representatives conveniently located throughout the world. founded 1896

MICROELECTRONICS

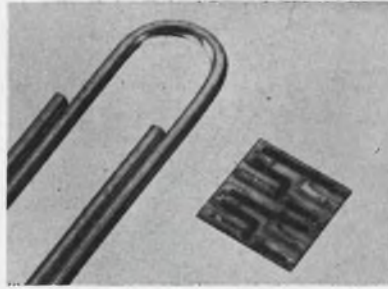

Thick-film modules for hybrid circuits

EMC Technology Inc., 1133 Arch St., Philadelphia. Phone: (215) 563-1340. P&A: from 15¢; 2 to 6 wks.

Thick-film modules, developed for hybrid circuit applications, feature a hermetic glass coating, a resistance range from 1 to 10 MΩ, power dissipation of 100 W per sq. in., and a temperature coefficient as low as 150 ppm. The units are available in tolerances from 1% to 20%, and in standard substrate sizes of 0.25 in. square and larger.

CIRCLE NO. 256

IC op-amp gains 86 dB at 10-MHz bandwidth

Fairlane Electronics, Inc., Box 335, Long Valley, N. Y. Phone: (201) 832-2116. P&A: \$45; stock.

This IC op-amp is constructed on a single monolithic silicon substrate. Compensation may be applied externally to control stability. The input drift is limited to $\pm 25 \mu\text{V}/^\circ\text{C}$ over the temperature range of -55 to 125°C . Open loop gain is typically 86 dB with a gain-bandwidth product in excess of 10 MHz. Input impedance is 500 kΩ with 4 μV rms of noise. The output is 10 V P-P into 1 kΩ. Power required is ± 12 Vdc at 5 mA.

CIRCLE NO. 257

Integrated circuit prices reduced

ITT Semiconductors, 320 Park Ave., New York, N. Y. Phone: (212) PL 2-6000.

Price reductions of about 50% on the entire ITT Semiconductor line

of integrated circuits are now in effect. ITT co-sources the Fairchild line of DTL ICs by agreement. The new prices range from \$8.00 for the 951 multivibrator to \$2.35 for the 933 dual 4-input extender in limited temperature range (0 - 75°C) at the 100-unit level. Similar devices in full temperature range (-55 to 125°C) are priced at \$13.85 to \$4.15. Prices are the same for dual in-line ceramic flatpack and TO-5 packages.

CIRCLE NO. 258

IC logic cards count to 5 MHz

Cambridge Thermionic Corp., 445 Concord Ave., Cambridge, Mass. Phone: (617) 876-2800. P&A: \$63.50 (10 to 49); stock.

A line of integrated-circuit logic assemblies are available as straight counters or as counters with decoders. Count rates up to 5 MHz are typical for the basic BCD counter, CDA-2204, using J-K flip-flops in all four bit-counting stages. The CDA-2209 counters with decoders include ten three-input gates interconnected for the desired decoding functions. The glass epoxy boards are spray-etched and wave-soldered and a 7-pin connector is provided.

CIRCLE NO. 259

Thin-film RC modules oscillate to 50 kHz

Alpha MicroElectronics Co., Inc., 10501 Rhode Island Ave., Beltsville, Md. Phone: (301) 474-1222. P&A: \$22 to \$200; stock.

Thin-film RC oscillators with fixed frequency in the range of 300 Hz to 50,000 Hz are available in packages of 1.2 x 1.1 x 0.5-in. weighing 0.3 ounces. A microminiature version is also available. Output is directly coupled 1.0 VPP from 200 ohms without visible distortion. At the rated power supply voltage of +15 Vdc, current is 0.75 mA. Design includes regulation to 0.1% frequency change when the supply varies between 10 to 20 volts.

CIRCLE NO. 260



CTS CORPORATION
Elkhart, Indiana

ON READER-SERVICE CARD CIRCLE 89

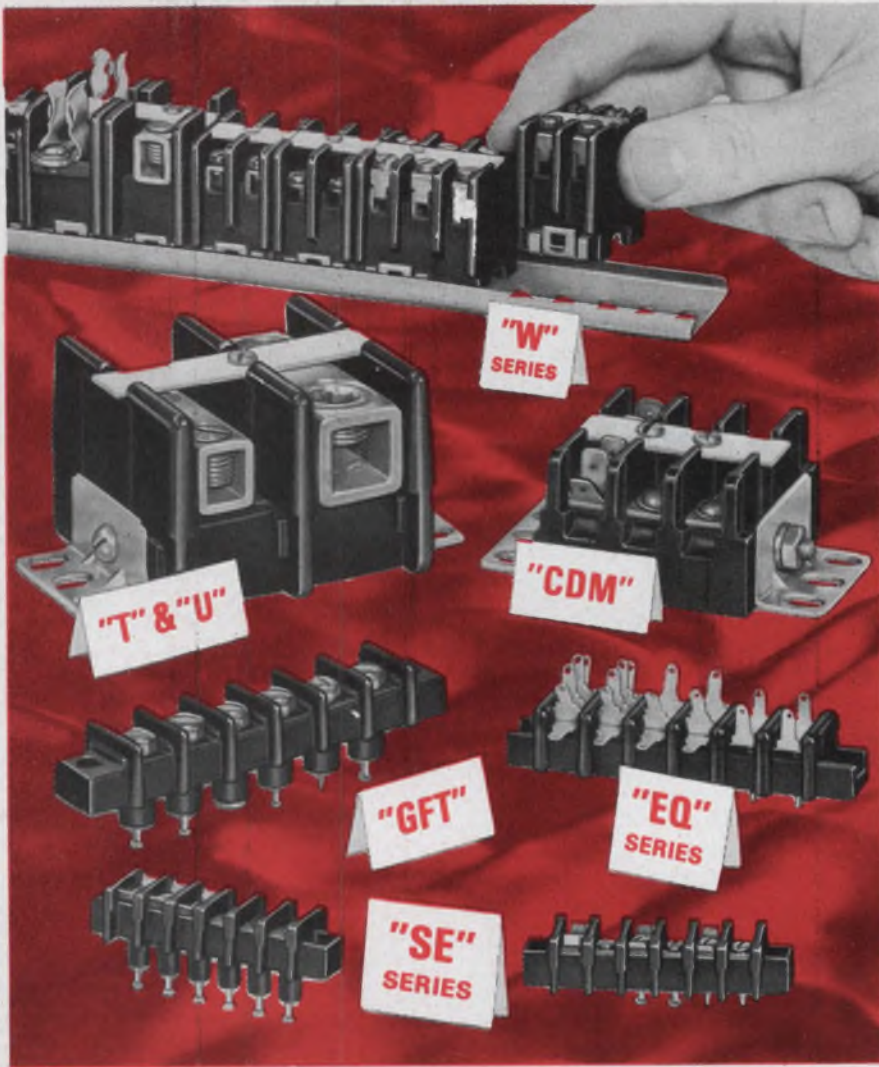

CURTIS

YOUR COMPLETE, DEPENDABLE SOURCE TERMINAL BLOCKS

The extremely wide choice of Curtis terminal blocks in various sizes, types, ratings and configurations is a result of progressive engineering and manufacturing to meet your particular terminal block requirements.

Since 1933, Curtis has engineered and manufactured quality electrical components for various industries throughout the world.

If you're looking for a source of quality, off-the-shelf terminal blocks which can be supplied in a variety of types to meet your exact requirements, remember . . . Curtis can.

FREE! CURTIS
24-page Terminal Block
Selector Catalog



CURTIS DEVELOPMENT & MFG. CO.
3236 North 33rd Street • Milwaukee, Wisconsin 53216

SEE US AT BOOTH 3K15, IEEE EXHIBITION, NEW YORK CITY
ON READER-SERVICE CARD CIRCLE 90

MICROELECTRONICS



Small chip resistor for IC or PC

Mepco, Inc., Columbia Rd., Morristown, N. J. Phone: (201) 539-2000.

These subminiature chip resistors with a resistance range of 100 Ω to 250 k Ω measures only 0.110 in. by 0.010 in. sq. The temperature coefficient is ± 150 ppm. Suitable for IC or PC, they have solder terminals and can be mounted directly on a ceramic PC board by heat sink attachment.

CIRCLE NO. 261

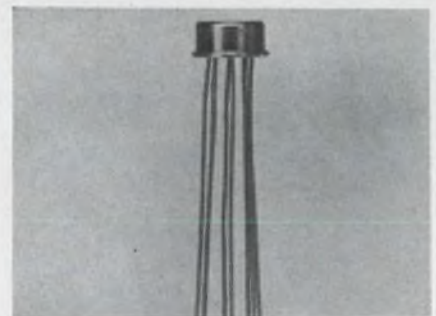

Low-level diff-amp claims low drift

Amelco Semiconductor, 1300 Terra Bella Ave., Mt. View, Calif. Phone: (415) 968-9241.

A low-level integrated differential amplifier claims low drift and excellent stability over a wide temperature range. Design of the new device features tight thermal coupling, close beta and V_{BE} match with common-mode feedback. Typical characteristics (at 25 $^{\circ}$ C) include output offset voltage (referred to input) of 10 mV, single-ended dynamic range (no load) of 6 V, single-ended output impedance of 7 k Ω and input impedance of 20 k Ω . The unit operates over a temperature range of 0 $^{\circ}$ C to 70 $^{\circ}$ C.

CIRCLE NO. 262

Tips on cooling off hot transistors

See how circuit designers use IERC heat dissipators to protect semiconductors...improve circuit performance and life.

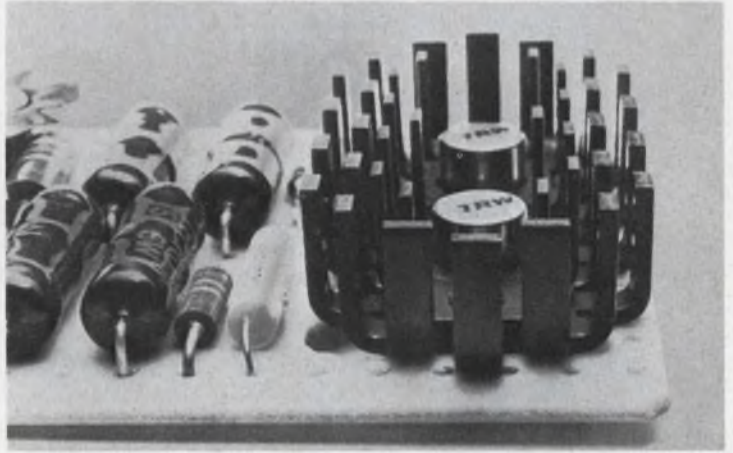
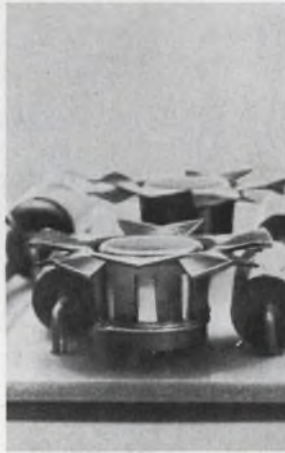
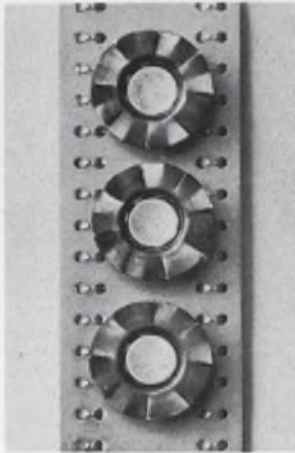

Fan-top dissipators for TO-5 and TO-18 cases drop temperatures dramatically; cost just pennies. T-shape adds almost nothing to board height; allows components to snuggle close to transistors. Spring fingers provide fast, press-on installation.

To cool off low-to-medium power transistors in TO-5 and TO-18 cases, use IERC's efficient LP's. Patented, staggered-finger design maximizes radiation and convection efficiency, radiates heat directly to ambient. Available in single or dual mounting for thermal mating of matched transistors.

IERC Therma-Link Retainers provide efficient thermal links between transistors and chassis or heat sinks. (Also, excellent dissipation when used on p-c boards.) Integral BeO washers reduce capacitance up to 2/3. Fast, no-snap installation; transistors are firmly held.

New! Dissipators and retainers for plastic and epoxy transistors. 3 new series for RO-97A, RO-97 and X-20's. Permit a jump of 10% to 33% in operating power.

Free 8-page short form catalog discusses IERC's complete line of dissipators, retainers and tube shields. Gives specifications, prices, how to order. Send for your copy today.

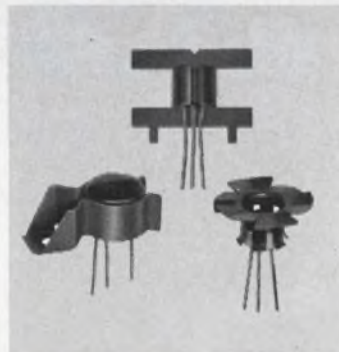
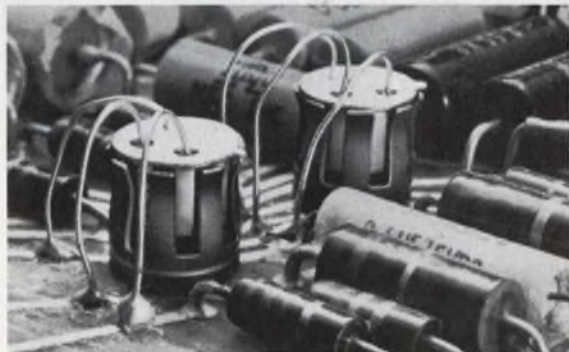

Special insulating coating — Insulube 448, a special non-hygroscopic finish developed by IERC, combines excellent dielectric properties, 50 K megs insulation resistance, and high heat emissivity. Also protects against salt spray, fungus, etc.

Tough heat dissipating problem? IERC engineers welcome your letter-head inquiry for specific information or assistance in selecting heat dissipators.

ierc
SEMICONDUCTOR
HEAT DISSIPATORS

NEW

COMPLETE LINE OF ELECTRONIC ALL SILICON COUNTERS...AS LOW AS \$445.



COUNTER TIMER MODEL CF-500R

If you have a counting application, then you need a counting device. Anadex has a complete new line of counting instruments



VARIABLE TIME BASE COUNTER MODEL CF-501R

for every function: preset counters, counter-timers, bi-directional counters, time interval counters, totalizers, frequency



FREQUENCY COUNTER MODEL CF-503R

counters, and variable time base counters. You have probably looked at other instruments and found they do more than you



TIME INTERVAL COUNTER MODEL CF-530R

need. And you pay more. It stands to reason that if all you need is an instrument for a specific function, why pay extra dollars



TOTALIZER MODEL DC-500R

for needless frill functions. Anadex counters have in common several unique features: all-silicon solid state, plug-in transis-



MULTI-CHANNEL VARIABLE TIME BASE COUNTER MODEL CF-502R

tors, 1 3/4" high panel space. If your interest is counting and you are tired of paying for things you don't need, Anadex has the instrument for you... you can count on it! Send for our new counter line catalog today.



RACK OR BENCH MOUNT



... THE NAME YOU CAN COUNT ON

7833 HASKELL AVENUE, VAN NUYS, CALIFORNIA 91406 PHONE 213-873-6620 TWX 213-781-6811

MICROELECTRONICS

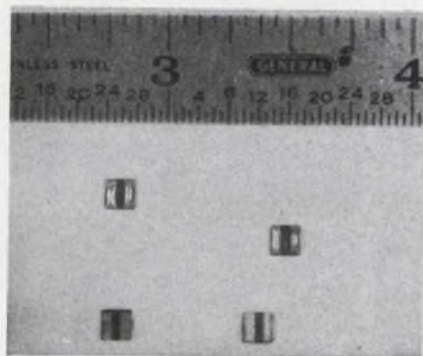

Capacitor chips mate laminates or thin-films

Plessey Inc., 170 Finn Ct., Farmingdale, N. Y. Phone: (516) 694-7377.

Miniature "chip" capacitors are offered in ranges from 3300 to 47,000 pF. Highlight of this line is physical size, only 3.3 mm square by 1.5 mm thick. The chips are designed for direct application to laminates or on thin-film substrates. Terminations are provided on the same face and on opposite edges. Barium titanate ceramic is multi-layered alternating with palladium.

CIRCLE NO. 263



Dc op-amp has large common-mode range

Opamp Labs., 172 S. Alta Vista Blvd., Los Angeles. Phone: (213) 934-3566. P&A: \$10 (1 to 999); stock.

This differential dc op-amp features a large common-mode voltage range (± 10 V with power supply voltage of 12 V) with high output voltage capability. The model 4009 is of hybrid construction, using silicon planar transistors and cermet resistors in a low-silhouette TO-5 can. The amplifier can be used in many applications and will operate at any supply voltage from ± 6 to ± 36 . It is designed for use in dc servo systems, voltage regulators and general utility applications.

CIRCLE NO. 264

ON READER-SERVICE CARD CIRCLE 93

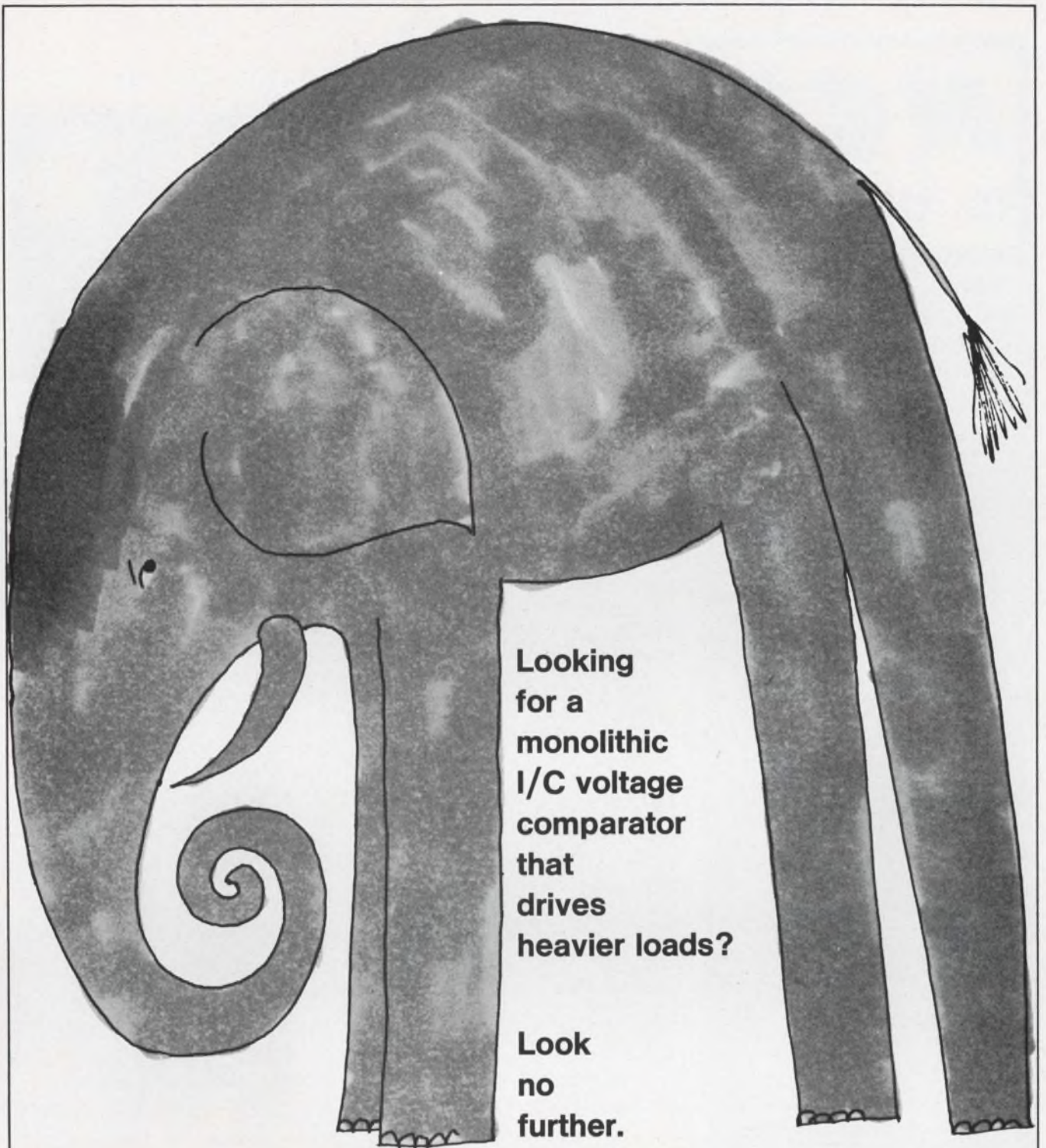

**Looking
for a
monolithic
I/C voltage
comparator
that
drives
heavier loads?**

**Look
no
further.**

Signetics SE518* provides much more than an unusual load-driving capability. It interfaces directly with all popular logic circuits—DTL, TTL, RTL, or any of several types of CML. For application ease and flexibility, the SE518 operates from standard logic power supplies, and provides a strobe control. No other I/C voltage comparator offers all these advantages in one package. We'd be happy to show you how to use it as a Schmitt Trigger, a Sense Amplifier, a Line Receiver, a Window Detector, or in dozens of other applications. Send for our application notes and data sheet today. Write Signetics, 811 E. Arques Ave., Sunnyvale, California.

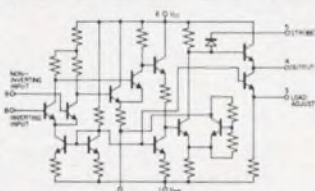

- Strobe Control
- Response time 55ns
- 10 msec overdrive
- Output Voltage Swing +5.1V
-1.4V
- Differential Input Impedance 3000 Ω

*Just one of the Signetics product family that is also available from Sprague Electric Co. under a technology interchange agreement.



A SUBSIDIARY OF CORNING GLASS WORKS

See us at the IEEE Show, rooms 3000A & B, New York Coliseum

ON READER-SERVICE CARD CIRCLE 94

NCC to be Sure

Here is a high quality capacitor "NCC" for space saving equipment and it costs no more than the one you are using!

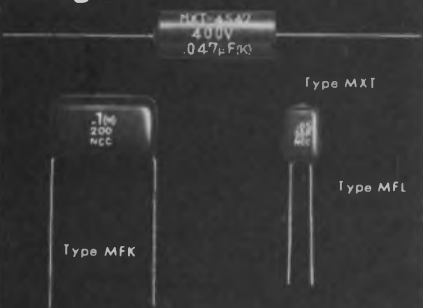

POLYESTER FILM CAPACITORS.

Type MXT In Plastic Tube.
Capacitance
Range: .001 MFD to .22 MFD
Voltages: 100v, 200v, 400v, 600v DC.

Type MFK Dipped Flat Shape. Non-Inductive Construction.
Capacitance
Range: .01 MFD to .22 MFD
Voltages: 100v, 200v, 400v, 600v DC.

Type MFL Dipped Flat Shape.
Capacitance
Range: .001 MFD to .47 MFD
Voltages: 35v, 50v, 100v, 200v, DC.

METALLIZED POLYESTER FILM CAPACITORS.

Type FNX-H Mylar Wrapped Serrival with Epoxy End Seal.
Capacitance
Range: 1 MFD to 10 MFD
Voltages: 50v DC.

Type TAX

Type TSL

SOLID TANTALUM CAPACITORS.

Type TAX Capacitance
MIL-C-26655A Hermetically Sealed. Range: 1 MFD to 220 MFD.

Type TSL Voltages: 3v, 6v, 10v, 15v, 20v, 25v, 35v DC.
Sealed with Epoxy Resin.

for full details, contact:

**MATSUO
ELECTRIC CO., LTD.**

3-chome, Sennari-cho, Toyonaka-shi, Osaka, Japan
Cable Address "NCC MATSUO" OSAKA

MICROWAVES



Backward-wave amplifier operates to S-band

Raytheon Co., Microwave and Power Tube Div., Waltham, Mass. Phone: (617) 899-8400.

An S-band backward wave amplifier tube, the QKS 1267, combines a gain of 16 dB at 2.9 to 3.1 GHz with 60-kW peak power. The amplifier is offered with average powers up to 3 kW. Nominal efficiency of the tube is 70% and anode voltage is 25 kV. It has a pulse width of 30 μ s or more and its weight is under 50 pounds.

CIRCLE NO. 265



Attenuator pads cover dc-to-4-GHz range

Texscan Corp., 51 Koweba Lane, Indianapolis. Phone: (317) 632-7351.

The FP-60 line of fixed attenuator pads cover a range of dc to 4 GHz. They can be supplied with type N connectors or special miniature connectors. They are available in standard attenuation values of 1, 2, 3, 6, 10, 20 and 30 dB with accuracies of $\pm 0.5\%$ or better to 4 GHz and vswr below 1.3. Each pad is calibrated at three frequencies and calibration is recorded on the body of the attenuator.

CIRCLE NO. 266

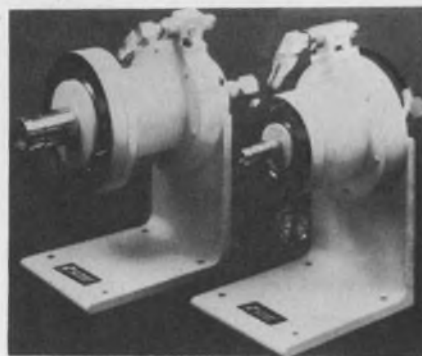

Coax diode limiters tune 20 to 200 MHz

Microwave Associates, Burlington, Mass. Phone: (617) 272-3000.

Particularly in high-power surface-base tracking radar, a series of vhf limiters provide receiver protection over any 20% bandwidth from 20 to 200 MHz. They can be operated at power levels up to 1 MW peak and 5 kW average. Unit recovery time is below 1 μ s, spike leakage is eliminated and insertion loss is rated 1 dB nominal.

CIRCLE NO. 267

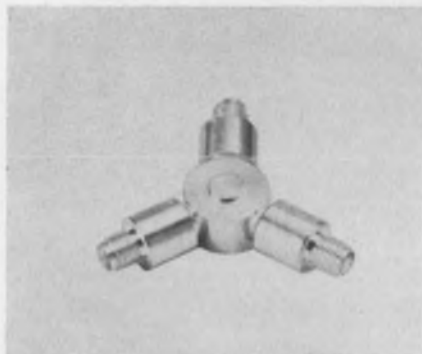

Power dividers offer reactive, resistive choice

Microlab/FXR, 10 Microlab Rd., Livingston, N. J. Phone: (201) 992-7700. P&A: \$50; stock.

Two lines of miniature power dividers offer a choice of either resistive or reactive operation. The resistive divider, type DA, is 2-in. in diameter and 1/2-in. high covering the frequency range of 12.4 GHz to dc with a vswr of 1.5. The reactive series D2 offers 10 watts average power rating to the 1 watt rating of the resistive type. Reactive frequency ranges are 2 to 8 GHz and 4 to 15 GHz.

CIRCLE NO. 268

ON READER-SERVICE CARD CIRCLE 95

ON READER-SERVICE CARD CIRCLE 96

This is the new Tally System 800 for verification and duplication of perforated tape. We call it the "Super Dupe".

It duplicates perforated tape on a bit-for-bit basis at 120 characters per second.

It verifies two tapes bit-for-bit.

It verifies two tapes and duplicates a completely error free third tape.

It detects perforation bit errors as they happen.



The Tally System 800 verifies and/or duplicates perforated tapes from one through eight channels in any code structure at 120 characters per second.

It uses bit echo techniques to make sure that every error is caught on the character and eliminated by comparing each perforated bit with with each bit read by the master reader.

Its price is remarkably low and delivery amazingly good. If it's your kind of baby and you would like the full story, please write our man Crawford.

Address Tally Corporation, 1310 Mercer Street, Seattle, Wash., 98109. Phone: (206) Main 4-0760. TWX 910-444-2039. In the U. K. and Europe, address Tally Europe, Ltd., Radnor House, 1272 London Road, London, S. W. 16, England.



TALLY

ELECTRONIC TIMING AT MOTOR TYPE PRICES!

...choose the packaging

look what \$15.50 buys (1-24 price)



REPLACES POPULAR MOTOR TYPES

±5% REPEAT ACCURACY

1-90 SECOND ADJUSTABLE DELAY

DPDT OUTPUT RATED 10A.

Packaged to directly replace all popular motor type time delay relays... far more reliable than motor types. Budget priced—real savings when critical timing parameters are not required. 117VAC input. DPDT output rated 10A. AEMCO type LC.

look what \$24.00 buys (1-24 price)



PLUG-IN CONVENIENCE

2% REPEAT ACCURACY

SCR TIMING CIRCUIT

0-100 SECOND ADJUSTABLE DELAY

The convenience of plug-in with precision timing parameters at moderate prices. Catalog units have delay periods up to 300 seconds. Reset time is 25 MS maximum. Only 2" x 2" x 3 1/2". 117VAC input. AEMCO type ED.

look what \$25.00 buys (1-24 price)



SCREW TERMINAL CONNECTIONS

2% REPEAT ACCURACY

SCR TIMING CIRCUIT

0-100 SECOND ADJUSTABLE DELAY

Screw terminal connections with precision timing parameters at moderate prices. Catalog units have delay periods up to 300 seconds. Reset time is 25 MS maximum. Only 3 1/4" x 2". 117VAC input. AEMCO type ES.

SPECIAL ORDER options include: fixed delay types; timing ranges to 10 minutes; other output relays; solid state output; push-on terminals; etc.

AEMCO CUSTOM PACKAGED & DESIGNED ELECTRONIC TIMERS

electronic multi-circuit cycle timer

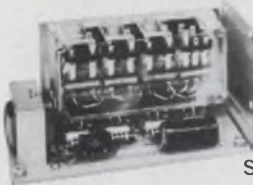

REMOTE CONTROLLED

4 OUTPUT CIRCUITS

EXCELLENT TIMING PARAMETERS

HIGH RELIABILITY AND LONG LIFE

Specially designed. Four output circuits with delay periods created by RC networks in conjunction with semi-conductor switches. Each output circuit timed individually from start of cycle. Approximately 7" x 3" x 4".

We solve unusual timing problems for OEM's.
We are eager to serve you, too.

Any unusual timing problems we can help you with?

AEMCO DIVISION

MANKATO, MINNESOTA 56001

formerly TELEX / AEMCO



ON READER-SERVICE CARD CIRCLE 97

MICROWAVES



Tunable tubes power Doppler radar units

Varian, Palo Alto Tube Div., 611 Hansen Way, Palo Alto, Calif.
Phone: (415) 326-4000.

Tubes in the VA-909 series are four-cavity klystron amplifiers for use in airborne cw or pulse Doppler radar systems. Each model delivers a peak output of 1 kW as a pulse amplifier or 300 W as a cw amplifier over its tunable range. Tubes can be ordered at center frequencies between 9.2 and 10.6 GHz. All tubes over a 100-MHz range are permanent magnet-focused, liquid cooled and weigh less than 6 pounds.

CIRCLE NO. 269



Impedance plotters cover 3 MHz to 12.4 GHz

Texscan Corp., 51 Koweba Lane, Indianapolis. Phone: (317) 632-7351.

Both coax and waveguide units are available in a Smith Chart automatic impedance plotter line. The coaxial models cover a 3-to-1 frequency range with a peak frequency of 3 GHz. Waveguide models range from 350 MHz to 12 GHz in waveguide frequency bands. Each plotter kit includes all needed accessories for a complete system.

CIRCLE NO. 270

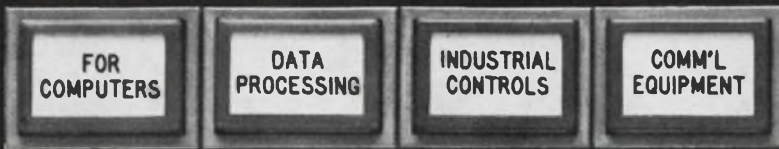

Master Specialties Company Miniature Tellite Switch!

FOUR-POLE/DOUBLE-THROW ILLUMINATED

PUSH-BUTTON SWITCH FOR

**WIDE VERSATILITY
IN LIMITED SPACE!**

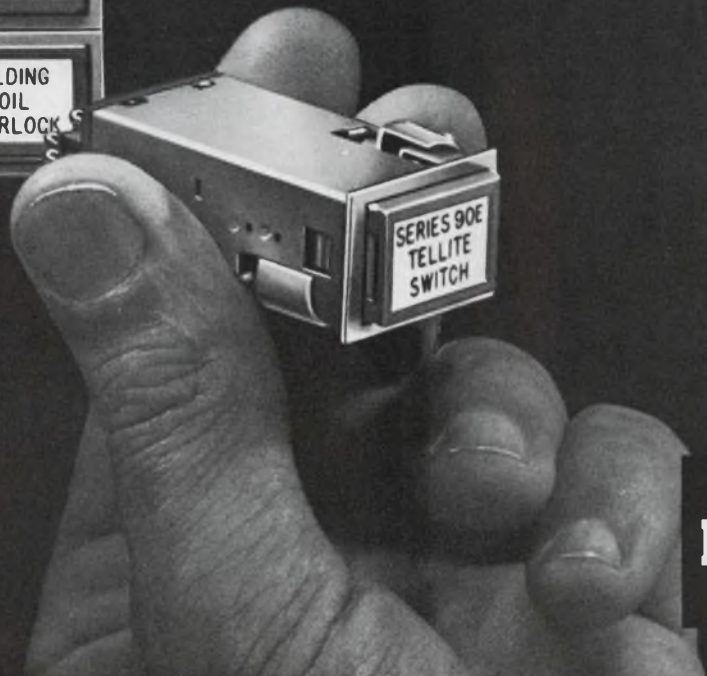

MSC

**Compare these advantages
of Master Specialties Series 90E
Miniature Tellite Switch**



■ **NO TOOLS REQUIRED FOR RE-LAMPING**
In case of lamp failure, the light capsule can be easily removed from the panel front . . . without tools of any kind!



■ **FILTERS, LEGENDS EASILY CHANGED**
Display arrangements, color filters or legends can be easily changed simply by sliding the holder or lens off from the removed light capsule. No tools needed. Optional lens styles for design esthetics.

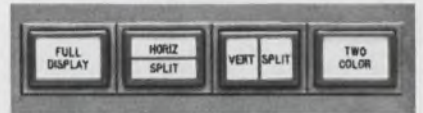

■ **VERSATILE DISPLAY ARRANGEMENTS**
Two-lamp illumination permits full, horizontally or vertically split display . . . or two-lamp reliability in full-screen, one-color display. Slab filters offer versatility and color-coded indication. Reverse-engraved legends withstand long wear without effacing.



■ **POSITIVE MOUNT . . . IN ANY GROUPING**
Positive mount is accomplished from the panel front using integrated mounting sleeves. Units mount in intimate contact in rows, stacks or matrices. No special brackets. No hardware to show from panel front.

■ **ALL TERMINALS AT REAR OF UNIT**
Each non-corrosive, gold plated terminal accepts 2 #20 wires.



■ **WIDE CHOICE OF SWITCH ACTIONS . . . VOLTAGES.** Symmetrically designed switches offer snap-action switching in 2PDT or 4PDT momentary or alternate action, and in momentary action with holding coil. Lamp voltages: 6, 12 or 28 volts and special neon lamp 115 volt.

Use the publication Reader Service to obtain complete technical data detailed in

Catalog 2008

**MASTER
SPECIALTIES
COMPANY**

1640 MONROVIA, COSTA MESA, CALIFORNIA
TELEPHONE AREA CODE 714: 642-2427

REGIONAL OFFICES AND TELEPHONE

ALABAMA: Huntsville	205-536-7415
CALIFORNIA: Costa Mesa	714-642-0114
CALIFORNIA: Sunnyvale	408-245-9292
FLORIDA: Winter Park	305-647-0100
ILLINOIS: Chicago	312-282-7112
MASSACHUSETTS: Waltham	617-893-1020
MISSOURI: Kansas City	816-363-4616
NEW JERSEY: Haddonfield	609-428-0701
NEW YORK: Syracuse	315-479-9191
NEW YORK: Valley Stream, L.I.	516-561-2334
OHIO: Cleveland	216-851-9700
TEXAS: Dallas	214-357-9459
TEXAS: Houston	713-288-2888

X_i-√

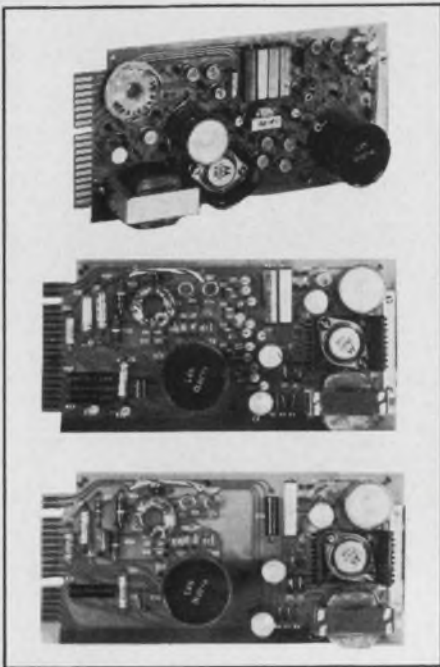

Top performance... bottom price

Start with the excellent design features and simplified construction of our completely self-contained printed-circuit cards (the magnetic operational amplifier... the magnetic square-root extractor... the magnetic multiplier/divider) that are now available for your industrial control, scientific and laboratory applications.

Then consider our field-proven advanced design features that give you these advantages:

- Self-contained power supply
- Full input-output signal isolation
- Compatibility with either current or voltage signals.

For good measure, add high reliability, excellent stability and maintenance-free operation... all on a single printed-circuit card. That's why we build them for use in our systems and for others who demand this type of performance... at low cost.

Need more information? Write to: Components Division, Leeds & Northrup, North Wales, Pa. 19454.



LEEDS & NORTHRUP
Philadelphia 44 • Pioneers in Precision

ON READER-SERVICE CARD CIRCLE 99

MICROWAVES



Bandpass filter tunes 7.1 to 8.4 GHz

Gombos Microwave, Inc., Webro Rd., Clifton, N. J. Phone: (201) 773-6633.

The Model GC384 bandpass filter tunes over a range of 7.1 to 8.4 GHz. The unit is a gang-tuned triple-filter module. It uses a waveguide mode for operation and is offered with either coax or waveguide accessibility. Specs run: 3-dB bandwidth at 33 MHz, 40-dB bandwidth to 165 MHz max and insertion loss at 1 dB max. Vswr with f_0 of ± 4 MHz is 1.5.

CIRCLE NO. 271

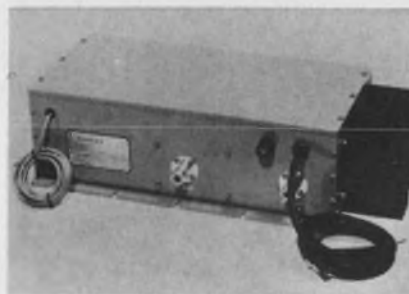

TWT amp package suits ground terminal use

Hughes Aircraft Co., Centinela Ave. & Teale St., Culver City, Calif. Phone: (213) 391-0711. Availability: 120 days.

The model 1122H TWT amplifier package is designed for ground terminal applications. The package consists of the tube and power supply in a single unit. It provides 10 watts RF power output over a frequency range of 1.7 to 2.4 GHz. A built-in time delay allows cathode warm-up time. Unit measurements are 14-in. long and 4.5-in. high and total weight is 20 pounds. The amplifier will mount in any position.

CIRCLE NO. 272

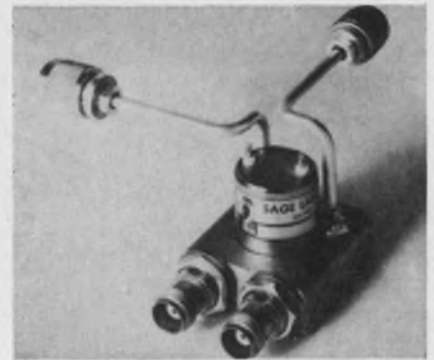

Remote coax switch has custom form-factor

Sage Laboratories, Inc., Natick, Mass. Availability: 60 to 90 days.

An electrically operated coax switch can be furnished to customers' form-factor, solenoid, port-arm orientation, or other requirements. Model F7075 provides 10-ms remote control switching from dc to 6 GHz with max vswr of 1.5 and max insertion loss of 0.5 dB. The connectors are hermetically sealed. The switch has a life of one million cycles, and will withstand 20-G vibration at 2 kHz.

CIRCLE NO. 273

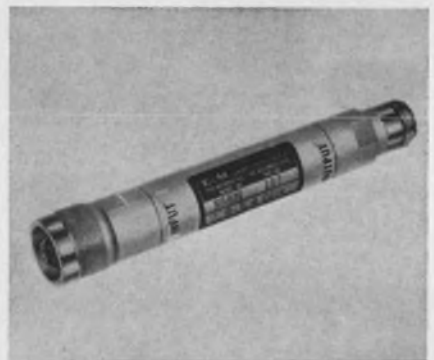

Coax isolators rated 0.5-dB loss

E&M Laboratories, 7419 Greenbush Ave., North Hollywood, Calif. Phone: (213) 781-1484. Availability: 30 days.

Covering the frequency range of 2 to 4 GHz, a new series of coaxial isolators offer a 40/1 front-to-back ratio. They are packaged in a magnetically shielded unit measuring 3/4 x 5-1/4-in. long. Electrical specs run: 20-dB min isolation, max loss 0.5 dB and vswr at 1.2. Applications are in aerospace and allied systems.

CIRCLE NO. 274

Now!

GUDEBROD

producer of the world's finest
flat braided lacing tape—

NOW
OFFERS
as
exclusive
U. S.
distributors

JERMYN

- ★ TRANSISTOR MOUNTING
PADS AND CLIPS
 - ★ HEAT SINK ADAPTORS
- and other electronic hardware

Write for catalog No. GJ100 furnishing
full technical data.

GUDEBROD BROS. SILK CO., INC.
12 South 12th Street • Philadelphia, Pa. 19107

ON READER-SERVICE CARD CIRCLE 100

Smallest 3-Phase Electronic Frequency Converters Ever Made!



Now, from CML, comes a series of the smallest 3-phase Electronic Frequency Converters ever made... featuring fixed or adjustable plug-in oscillators at frequencies ranging from 45 to 6,000 cycles. Write today for details on Models T500A through T2500A!

Model	3 Ø Output VA	Dimensions (For standard 19" relay rack mounting)
T500A	500	8¾" h x 21" d
T750A	750	14" h x 21" d
T1200A	1200	14" h x 21" d
T1750A	1750	14" h x 21" d
T2500A	2500	14" h x 21" d



CML, Inc.

A Subsidiary of Tenney Engineering, Inc.
350 Leland Avenue • Plainfield, New Jersey
Telephone (201) 754-5502 • TWX: 201-756-2064

ON READER-SERVICE CARD CIRCLE 101

ELECTRONIC DESIGN 3, February 1, 1967

Are you up to date... on dielectric tubing materials?



Send for your FREE copies



Tubing Materials Chart

This chart gives a complete listing of spiral-wound dielectric tubing uses and material features. A handy reference which, at a quick glance, points out facts you may overlook in tubing selection.



Dielectric Tubing Catalog

This 8 page catalog gives basic information on Precision's spiral-wound dielectric tubes. Illustrates end-product uses, covers, in detail, the advantages of each type of dielectric tube.



Precision

Paper Tube Company

1033 S. NOEL AVE., WHEELING, ILL. 60090

Phones: Chicago, 631-1445, Long Distance, 312-537-4250

Please rush my copies of the
tubing materials chart and tubing catalog

NAME _____
COMPANY _____
ADDRESS _____
CITY _____ STATE _____ ZIP _____

ON READER-SERVICE CARD CIRCLE 102



When you demand maximum temperature stability in a miniature size...

PAKTRON[®]
FILM/FOIL
POLYCARBONATE
capacitors
are your answer!



When your design calls for stability in a capacitor operating temperature range of -65°C . to $+105^{\circ}\text{C}$., then PAKTRON polycarbonate film/foil capacitors are your answer. Hot or cold, the inherent stability of polycarbonate will provide you with consistent reliability over the entire temperature range. PAKTRON polycarbonate capacitors are tough, too. You'll find them highly resistant to moisture, shock, vibration and contamination. Available in two lines. The epoxy dipped (shown above) line for values up to 0.5 mfd. and 400 WVDC and the molded line (not shown) for values to 0.1 mfd. and 200 WVDC.

PAKTRON dimensions are precise. Capacitance ranges are broad and tolerances exacting. See for yourself, ask for free details and free samples—no obligation.

"Remember, you're never more than a few feet away from a product of ITW"[®]



PAKTRON

DIVISION ILLINOIS TOOL WORKS INC.
 1321 LESLIE AVENUE • ALEXANDRIA, VIRGINIA 22301

ON READER-SERVICE CARD CIRCLE 103
 170

MICROWAVES

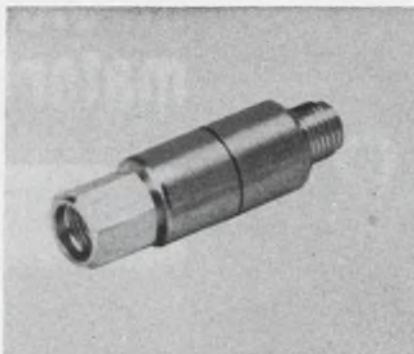

Low-cost attenuators cover broad range

Microlab/FXR, 10 Microlab Rd., Livingston, N. J. Phone: (201) 992-7700. P&A: \$55 to \$65; stock.

The series AH coaxial attenuators cover a frequency range from dc to 12.4 GHz. They measure as little as 1.4-in. and weigh as little as 0.5 ounce. The complete line includes 3-, 6-, 10-, 15- and 20-dB units with 0.75-dB accuracy and 30- and 40-dB units with 1.0-dB accuracy. All have a power rating of 1 W average and 1 kW peak.

CIRCLE NO. 275

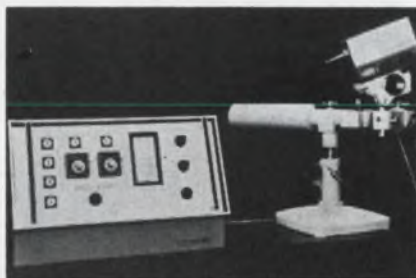

Gyro balancer uses laser as "grinder"

Korad Corp., 2520 Colorado Ave., Santa Monica, Calif. Phone: (213) 393-6737. P&A: \$20,000; 30 to 60 days.

The use of a laser for gyro balancing "eliminates the need to drill or grind rotors, as well as the frequent need to stop the rotor and remove it from the test stand for balancing," according to the manufacturer of the K-GB1 gyro-balancer. The K-GB1 laser can trim as much as 2.5 milligrams from the gyro at rotor speeds from 2000 to 24,000 rpm. A transducer "sees" a high spot and fires the ruby laser.

CIRCLE NO. 276

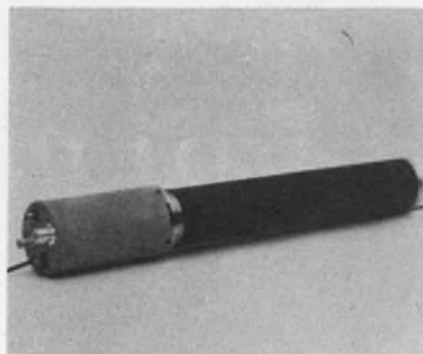

S-band pulsed TWT drives wideband radar

Varian Palo Alto Tube Div., 611 Hansen Way, Palo Alto, Calif. Phone: (415) 326-4000.

A pulsed traveling-wave amplifier tube has been designed for use as a driver or output stage in wideband radar systems. Over a 2.8 to 3.5 GHz band, this modulating-anode pulsed tube produces a peak output greater than 7 kW with less than 5 W of drive power. This is obtained, without mechanical or electrical adjustment, at pulse lengths up to 200 μs . The tube is liquid cooled, electromagnetically focused, of all metal-ceramic construction, and weighs 10 pounds.

CIRCLE NO. 277

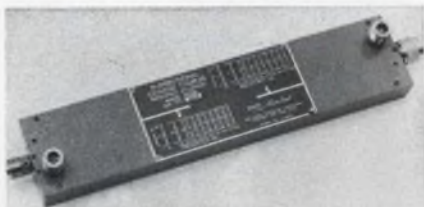

Coupling unit mates vhf/uhf antenna systems

Narda Microwave Corp., Plainview, N. Y. Phone: (516) 433-9000. P&A: \$200; 4 weeks.

A new extended-range, dual-directional coupler is designed for applications where a continuous comparison of incident and reflected power is required. The model 3020A coupler tracks to 0.3 dB with a directivity of 35 dB between forward and reverse coupling arms. Frequency coverage is 50 MHz to 1 GHz. The unit is rated at 500 W cw and 10 kW peak.

CIRCLE NO. 278

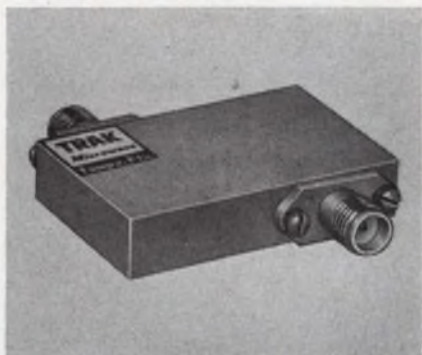

Interdigital bandpass filters for low power

Trak Microwave Corp., 4726 Kennedy Road, Tampa, Fla. Phone: (813) 877-8341. Availability: stock.

Lightweight interdigital filters are available at five pass-band frequencies between 1110 and 5900 MHz. The filters can be supplied with bandwidths up to one octave on request. Typical size is 3/8 x 3 x 3-in. Input and output impedance adjust to 50 Ω ; 25-W of cw signal power is typical.

CIRCLE NO. 279

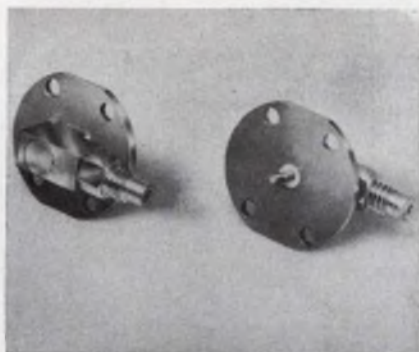

Stripline connector has low-pass filter

Micon Electronics, Inc., Roosevelt Field, Garden City, N. Y. Phone: (516) 741-4480. P&A: \$15; stock to 2 wks.

The right-angle stripline connector model 230001-1 incorporates a low-pass filter. Operational features include a minimum attenuation of 50 dB from 100 MHz to 10 GHz. Input impedance is 50 Ω . Fully gold-plated, the unit is said to be formed of materials exceeding requirements of pertinent MIL-specs.

CIRCLE NO. 280

ON READER-SERVICE CARD CIRCLE 104 ➔

COMPARE

THE VersaPac 67

WITH ALL OTHER COMPETITION

COMPANY	PRODUCT NAME	NO. OF POLES AVAILABLE (FORM C'S)				STANDARD CONTACT RATING (AMPS)			U.S. DESIGN	U.S. MFG.
		2	4	6	8	1	2	3		
ALLIED	T154	●	●	●				●		●
CLARE	VARLEY VP4	●	●					●		
PHILLIPS ADVANCE	VersaPac 67	●	●	●	●			●	●	●
RELAYMATIC	R2100	●	●					●		●
STRUTHERS DUNN	series G type 280	●	●					●		
ZETTLER	AZ	●	●					●		

The VersaPac 67 is the only relay of its type available with 8 Form C's and 3 Amp contacts. In addition, measure the contact pressure and you'll find twice that of competitive units. Since it is U.S. designed and manufactured, we can supply units tailored to meet your specific requirements such as bifurcated contacts, contacts rated at 5 and 7 Amps, sensitive adjustments, and special coils. We're so confident of our VersaPac 67 that we'll send you one FREE to test and compare for yourself. Write or call:

PHILLIPS-ADVANCE PRODUCTS

NOW MARKETING BY

HART MANUFACTURING CO.

110 BARTHOLOMEW AVE., HARTFORD, CONN. 06101

TELEPHONE: 203-525-3491

A SUBSIDIARY OF OAK ELECTRO/NETICS CORP.

SHOWN WITHOUT SOCKETS

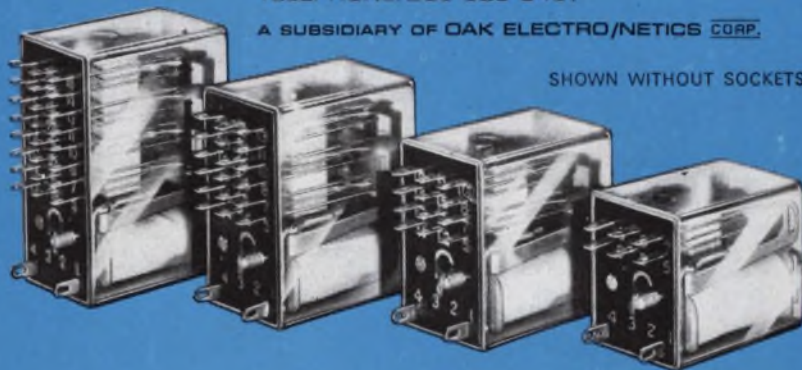

AVAILABLE FROM STOCK THROUGH FRANCHISED DISTRIBUTORS

All the necessary controls and supervisions may be performed by you alone!

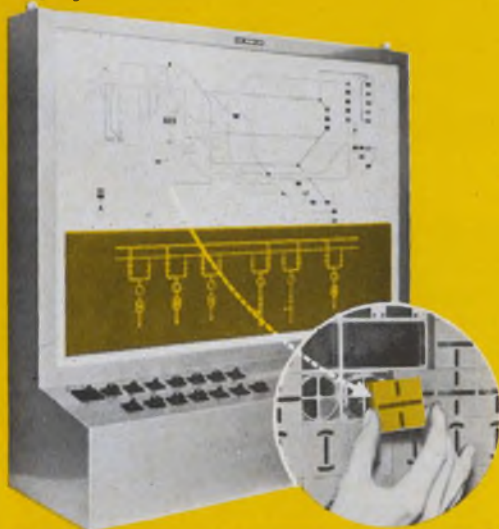

LUMIBLOCK MOSAIC PANEL

K.C.C. SHOKAI LTD.



Head Office: No. 71, 4-chome, Nishi-ku, Nishi-ku, Kobe, Japan
 Tokyo Office: No. 212, 2-chome, Nishi-Ukubo, Shinjuku-ku, Tokyo, Japan
 Cable: WMKCC KOBE Telephone: Kobe (8710271) 3 Tokyo (36914111)
 American Liaison Office: M. Kuroda, 1367, 32nd Avenue, San Francisco
 Representative: Western Switch-Board Co., Ltd., San Francisco



Principles

This switchboard, being equipped with multifarious standardized indications, and with the flow sheet applicable in accordance with the development of the plant construction, is capable of constantly supervising all such factors as the working conditions of the generator for the electric circuit, the working conditions of the branching system or an apparatus related thereto, the height and the direction of flows of filled materials in the vessel, and many other operational characteristics as a whole.

It is possible to mutually interchange the standardized constituents. Moreover, the range of indications by means of illumination is quite wide, the Lumiblock diagram is peculiarly well fit for numerous applications in various fields of industries.

In other words, Lumiblock may be advantageously used for the purpose of controls of power plants, mining industries, railroads, metallurgy, air fields, chemical plants, water-line pumps, etc.

Methods of Applications.

The switchboard of this company is completely wired within, and is provided with the terminals, by means of which it is coupled with the exterior wirings.

This is an instrument furnished independently, not attached to other implements or size. It is provided by arranging it in the shape of a board and in the form of a table.

These switchboards of this company are favorably received by the the company customers in France, England, Germany, Belgium, Italy, Switzerland and many other countries of the world to their entire satisfaction.

● For further details of the company's products, you are welcome to apply for a catalog.

ON READER-SERVICE CARD CIRCLE 105

MIDGET
 IN SIZE
GIANT
 IN POWER



TYPE LK rectangular high voltage CAPACITORS

"The little one" with the tremendous power!
 4 times the life of MIL-C-25A in case sizes reduced up to 80%! And you also get: superior resistance, better power factor, withstands greater overloads, may be operated to 125°C and voltage ratings from 600 to 500,000 volts.

Write today for Bulletin LK

Also ask for FREE pocket size "Comparator" and "Conversion" chart



**Engineering at
 Production Prices**

Plastic Capacitors, INC.
 2620 N. Clybourn • Chicago 14, Illinois
 DI 8-3735

ON READER-SERVICE CARD CIRCLE 106

MATERIALS



Flat-pack alloy etches to square-edge

Carpenter Steel Co., 101 W. Bern St., Reading, Pa. Phone: (215) 372-4511.

A square edge for flatpack lead preforms is said to be provided through a glass-to-metal sealing alloy strip. Previously, according to the company, photo-etch techniques have yielded a "hollow-ground" edge on preforms. This caused difficulty in predicting lead wire welding. Use of "Vacumet Nico-seal" and glass-sealing "52" alloys is said to provide an edge comparable to that obtained by stamping.

CIRCLE NO. 281



Lead-free glass seals miniature diodes

Corning Glass Works, Corning, N. Y. Phone: (607) 962-5011.

Particularly suited to diode sealing applications, the Code 4070 glass is lead-free, has a low alkali content and can be sealed quickly by an infrared source. It seals to both molybdenum and tungsten and absorbs well in the IR region of about 0.75 to 4.75 microns. Softening point is 810°C and annealing point is 620°C.

CIRCLE NO. 282

On your mark...get set...draw!

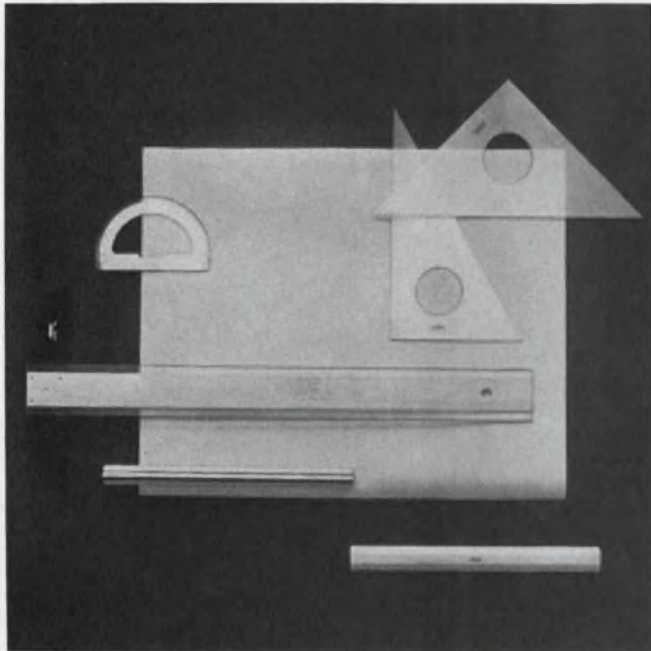

Tools: T square, straightedge, triangle, protractor, scale.

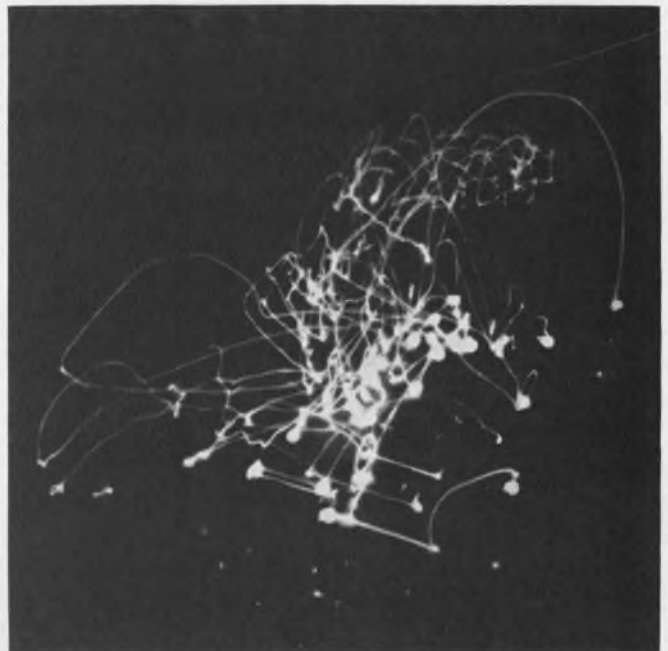

Here are the movements required to make a simple drawing with the "old, accepted" instruments. Photo was made by taping a light to a draftsman's wrist. Time: 2 hours, 11 minutes.

On your mark...get set...draw!

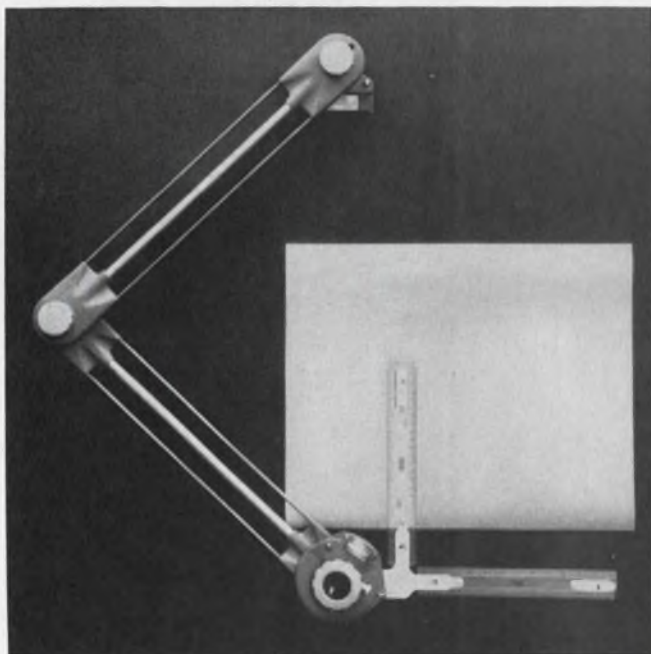

Tool: Bruning Equipoise drafting machine.



Here are the considerably fewer movements required with the Bruning Equipoise. Time: 1 hour, 31 minutes.

The winner: Bruning Equipoise. Your Bruning man can tell you all about the Equipoise (and other Bruning drafting machines). Give him a call. He's listed under Bruning or Addressograph Multigraph in the telephone directories of 155 major cities. Or write Dept. D, Mt. Prospect, Illinois.

Bruning is a U.S. Reg. Trademark of A. M. Corp.

 **Bruning**
Division of Addressograph Multigraph Corp.

ON READER-SERVICE CARD CIRCLE 107



As low as 10¢ a dozen

... when you buy G.E.'s new plastic platform headers in quantities of a million or more. Today, General Electric is selling plastic platform headers like these for less than 1¢ to 5¢ each depending on design.

Want to figure your savings? Better plug in a calculator.

And there's more than economy. You have flexibility in the number of leads and in pin configuration. General Electric engineers will work directly with you to develop the plastic header best for your application.

The new plastic platform header is an exceptional product designed for new plastic encapsulated devices. It's available with virtually any type wire desired, including gold plated Dumet. Continuous temperatures to 400°F are taken in stride. The plastic header is ideal for silicon transistors and a wide range of other devices.

Plastic platform headers. A breakthrough. The kind of progress you've come to expect from General Electric.

For more information, or for a quote on your requirements, call or write: General Electric Company, Lamp Metals & Components Dept., 21800 Tungsten Road, Cleveland, Ohio 44117. Tel: (216) 266-2971.

Progress Is Our Most Important Product

GENERAL  ELECTRIC

ON READER-SERVICE CARD CIRCLE 108

MATERIALS

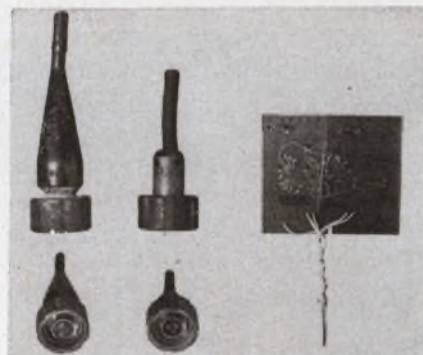

Two reactive solvents dissolve urethane

Dynaloy, Inc., 408 Adams St., Newark, N. J. Phone: (201) 622-3228. Price: from \$8.95/gallon.

Two recent additions to the "Uresolve" line are said to completely dissolve cured urethanes without harming metals and most plastics used in electronic packaging. Uresolve Gel is a thickened version of Uresolve HF for use where immersion is not practical. Uresolve Plus is specifically designed to remove amine-cured systems and is said to be a true solvent.

CIRCLE NO. 283



Identifying straps serve two purposes

The Thomas & Betts Co., 36 Butler St., Elizabeth, N. J. Phone: (201) 354-4321.

The dual purpose of tying and identifying large cable bundles is served by the TY-48 and TY-48M cable straps. The TY-48 is a twist-locking type and TY-48M is self-locking. Made of nylon, the straps are infinitely adjustable within a diameter range of 3/4 to 4-in. They provide a marking area which is 2-1/4 x 1/2-in. and they can be marked with any conventional nylon marking equipment.

CIRCLE NO. 284



Happiness is an Acopian power supply . . . because it's shipped in only 3 days.

Whether your application is op amps, ICs, logic circuits, relays, lamps or electronic measuring equipment, look to Acopian to meet your needs for AC to DC plug-in power supplies. Acopian's new catalog lists over 62,000 different supplies . . . all available for shipment within 3 days. Get your 16 pages of happiness by writing or calling Acopian Corp., Easton, Pennsylvania (215) 258-5441. 



ELECTRONIC and ELECTRICAL COMPONENTS

having axial leads (such as capacitors, fuses and resistors)

COATED

at rates of from 4,000 up to

12,000 PER HOUR

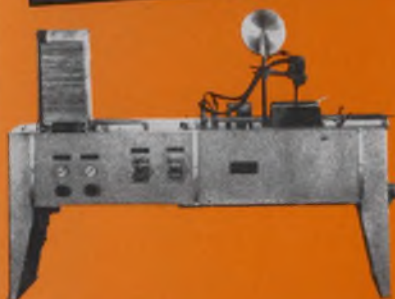

The automatic, remote masking C/M Model HD-3 applies a solvent and abrasion-resistant clear coating that protects color coding and labeling, or a light-tight seal for silicon diodes. Racks, loaded with diodes which are spun so as to assure even coating, move continuously through spray station. Diodes remain in racks for spraying and baking operations.

Also inquire about the C/M Model PR-1 automatic powdered resin coating machine, C/M Model TL-1 automatic tray loading machine, and C/M Model MI-1 magazine loader.

SEND FOR LITERATURE

Conforming Matrix CORPORATION

841 NEW YORK AVENUE
TOLEDO, OHIO 43611
Phone: (419) 729-3777



In Europe:
Conforming Matrix Division
Phoenix Telephones, Ltd.
Grove Park London, N.W. 9, England

ON READER-SERVICE CARD CIRCLE 181

SEMICONDUCTORS

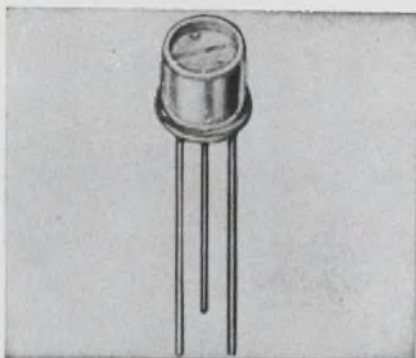

CdS chopper cells need little warm up

Clairex Corp., 1239 Broadway, New York. Phone: (212) 684-5512.

Two photochopper cells are said to combine high efficiency and low temperature coefficients with virtually no warm-up time. Efficiency levels of the CdS cells range from 72% at 1 kHz to 98% at 60 Hz. Temperature coefficient causes an efficiency change of only 15% from -25 to 60°C. Where CdSe cells require some 10 minutes to reach normal resistance, these new cells are ready to operate after one minute.

CIRCLE NO. 285

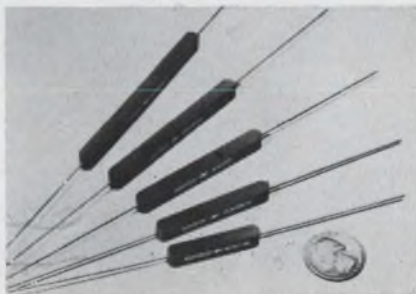

Silicon rectifiers have PIV to 45 kV

Semtech Corp, 652 Mitchell Rd., Newbury Park, Calif. Phone: (213) 628-5392.

A series of high voltage coaxial lead rectifiers have 5 PIV ratings from 15 to 45 kV. These units pass 50 mA at 55°C in free air. They have a leakage of 0.1 μ A at PIV at 25°C, and operating and storage temperatures of -55 to 150°C. The junctions are welded. The case measures 0.25-in. high, 0.25-in. wide and 1.5 to 3.5-in. long, depending on PIV rating.

CIRCLE NO. 286

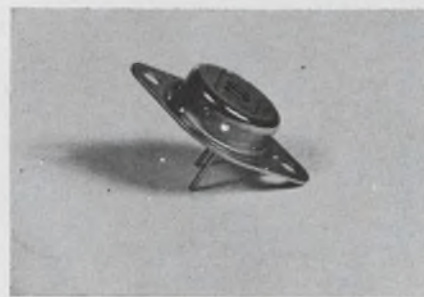

Pnp power transistors meet your gain spec

Solitron Devices, Inc., Transistor Div., 1177 Blue Heron Blvd., Riviera Beach, Fla. Phone: (305) 848-4311. Availability: stock.

Germanium pnp power transistors are available as replacements for the 2N301 and 2N301A. Packaged in a steel TO-3 case, they are designed for operation with collector supply voltages ranging from 12 to 40 volts, and have a usable gain to 10 A collector current. They are designed for Class A and Class B audio amplifier and power supply operations. They can be supplied to customer gain requirements from 50 to 250 with color coding identification.

CIRCLE NO. 287

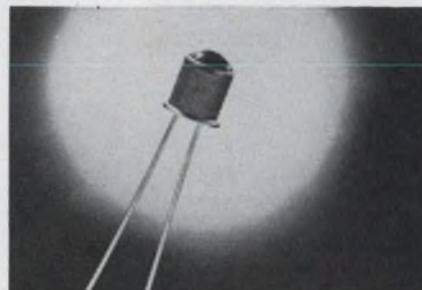

Silicon photodiodes read cards, tapes

Electro-Nuclear Labs., Inc., 115 Independence Dr., Menlo Park, Calif. Phone: (415) 322-8451. P&A: \$9.95 and \$24.95; stock.

The type 626 silicon photodiode is said to deliver ideal performance in punch-card reading, tape reading, encoding, fusing, communications and ranging applications. Sensitivity is 0.5 A/W and linearity extends over seven or more decades. Normal detectivity for the type 626B is 5×10^{12} or more.

CIRCLE NO. 288

MATRIX PROGRAM BOARDS

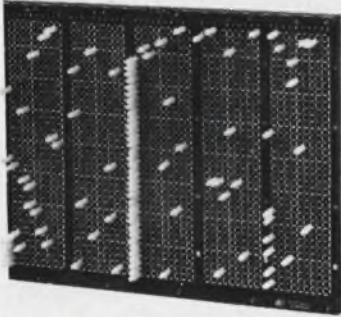

CO-ORD SWITCH matrix program boards provide a rugged and reliable method for X-Y, input-output programming. A single pin is inserted into a 2, 4 or 6 level matrix to connect a 1, 2 or 3 pole input to a 1, 2 or 3 pole output, thereby eliminating complex programming and reducing panel area requirements.

FEATURES INCLUDE

- .250" grid for compactness
- Tough phenolic block construction
- Reliable closed entry contacts
- Low interlead capacitance
- Standards available from stock

FEATURING RUGGED DIODE AND SHORTING PINS

The geometry of CO-ORD programming pins is the reason why they will not bend, break or malfunction, even under careless use. All pins are .106" diam. And a 6-D pin is only 1 1/4" long!

"CO-AX" component holding pins allow the insertion of diodes or other components into 2 and 3 level matrices. Shorting pins are available for 2 to 6 level boards.



3-D COAX PIN



2-D COAX PIN



2-D SHORTING PIN

APPLICATIONS INCLUDE: Variable diode matrices; Code generators; Communications distributors; Process programmers; Data channeling & logging; Numeric controlled machinery; Function generators; Switch control centers; Variable sequence selectors; Power distributors.



ON READER-SERVICE CARD CIRCLE 182

When it comes to leaf switches... CHICAGO SWITCH REALLY 'STACKS UP'

Whether you call them leaf switches, knife switches or stack switches, Chicago Switch makes them incomparably your best choice.

Stack up the reasons:

- Leaf switches produce far more switching per dollar
- If your specs call for leaf switches to actuate a few hundred or a hundred million cycles, Chicago Switch can deliver them
- Best of all, Chicago Switch can produce over 90% of the "customized" leaf switches you need from standard parts... another example of proved engineering and production know-how that can reduce your costs
- Extensive production, engineering and design facilities and experience assure reliability and prompt service.

Just off the press! Our new brochure that really shows you how we stack up. Write for your free copy today (while you're at it, send along specs or prints for our prompt quote).

CHICAGO SWITCH DIVISION
F & F ENTERPRISES, INC.
 2035 WABANSIA AVENUE
 CHICAGO, ILLINOIS 60647

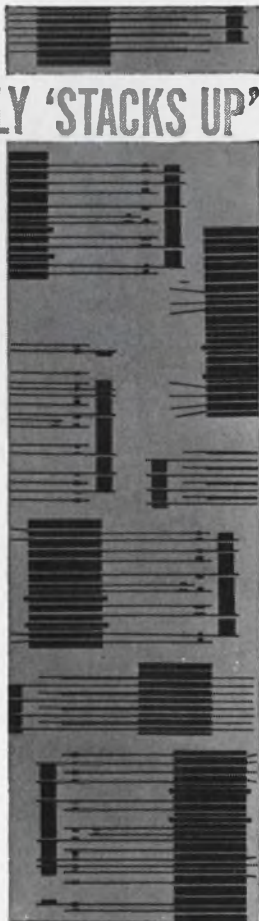

ON READER-SERVICE CARD CIRCLE 183

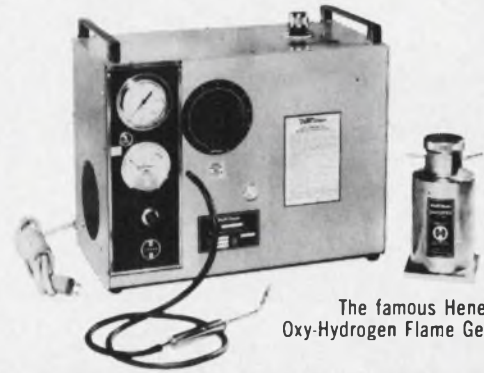

The famous Henes Oxy-Hydrogen Flame Generator.

WELD SOLDER BRAZE

for less than...
2¢ per hr.

As well as:

- DRILL
- CUT
- POLISH
- ANNEAL

all types of ...

**METALS
 PLASTICS
 GLASS
 CERAMICS**



Precision flame adjusts from .003" to .042" in diameter and from .01" to 6" long.

Henes Oxy-Hydrogen Flame Generators make tough jobs easy—for an operating cost of less than 2¢ per hour! These ideal production and lab tools generate their own gas by dissociating distilled water to provide you with a precise, economical heat source of 6000°F.

ALMOST LIMITLESS APPLICATIONS. Now improved for even greater convenience and economy, the Henes Flame Generator can: ■ weld resistance wire to copper ■ butt-weld the finest wires ■ braze contacts to relay blades ■ fuse tungsten to nickel ■ solder relay cans to headers ■ strip wires of Teflon, nylon, or ceramic insulation ■ anneal spring wires and blades ■ drill holes in quartz, ceramic, tungsten, glass ■ weld chromel and alumel wires ■ solder broken welds in electronic modules ■ fuse glass and quartz parts ■ polish glass, quartz, ceramics ■ solder coaxial connectors. (Your own needs will suggest other applications.)

FREE! Send for the new brochure which tells the complete story of Henes Oxy-Hydrogen Flame Generators. Five models available from \$250 to \$725 FOB Phoenix, Ariz.



HENES MANUFACTURING CO.
 4301 E. Madison St., Phoenix, Ariz. 85034, Ph. 602/275-4126

ON READER-SERVICE CARD CIRCLE 184

We're switching 5 amps—50 va for 1 million operations with a reed switch!

We've opened up some new possibilities for design engineers to consider when using reed relays. Power parameters for reed relay operations can now be considered to extend into the 5 amp switching range, thanks to ADC's remarkable new switch that can handle 5 amps—50 VA—and rated in excess of 1 million operations. ■ Write for more information.



ADC PRODUCTS

A DIVISION OF MAGNETIC CONTROLS CO.

6405 CAMBRIDGE STREET ■ MINNEAPOLIS, MINN. 55426

ON READER-SERVICE CARD CIRCLE 183



PRODUCTION EQUIPMENT

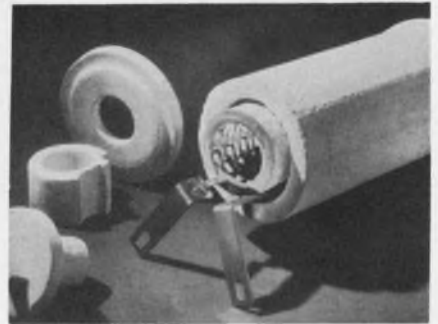

Furnace line adds tubular elements

Kanthal Corp., 3 Wooster St., Bethel, Conn. Phone: (203) 744-1440.

For a variety of production and development tasks, an expanded line of "REH" tubular furnace elements provide temperatures up to 2460°F. The "interior winding" technique of these furnace elements uses a Fe-Cr-Al-Co resistance element. Lengths from 6 to 24-in. are available with a 1.5-to-16-in. inside diameter. Power ranges up to 13.5 kW are offered with voltages in the 15-to-64-V range.

CIRCLE NO. 289



Electrical stripper handles coax cable

Eraser Co., Inc., P.O. Box 1342, 1068 S. Clinton St., Syracuse, N. Y. Phone: (315) 476-7441. Price: \$495.

The MSS 205 "Blue Arc Stripper" cuts through metal braid shielding on coaxial cable, thermocouple wires and other metal braids or tubular metal coverings. Two electrodes grip the braid and cut it with a low-current arc. Braid-type shielding is given a fused end in this process, preventing subsequent fraying.

CIRCLE NO. 290

ON READER-SERVICE CARD CIRCLE 186 ▶

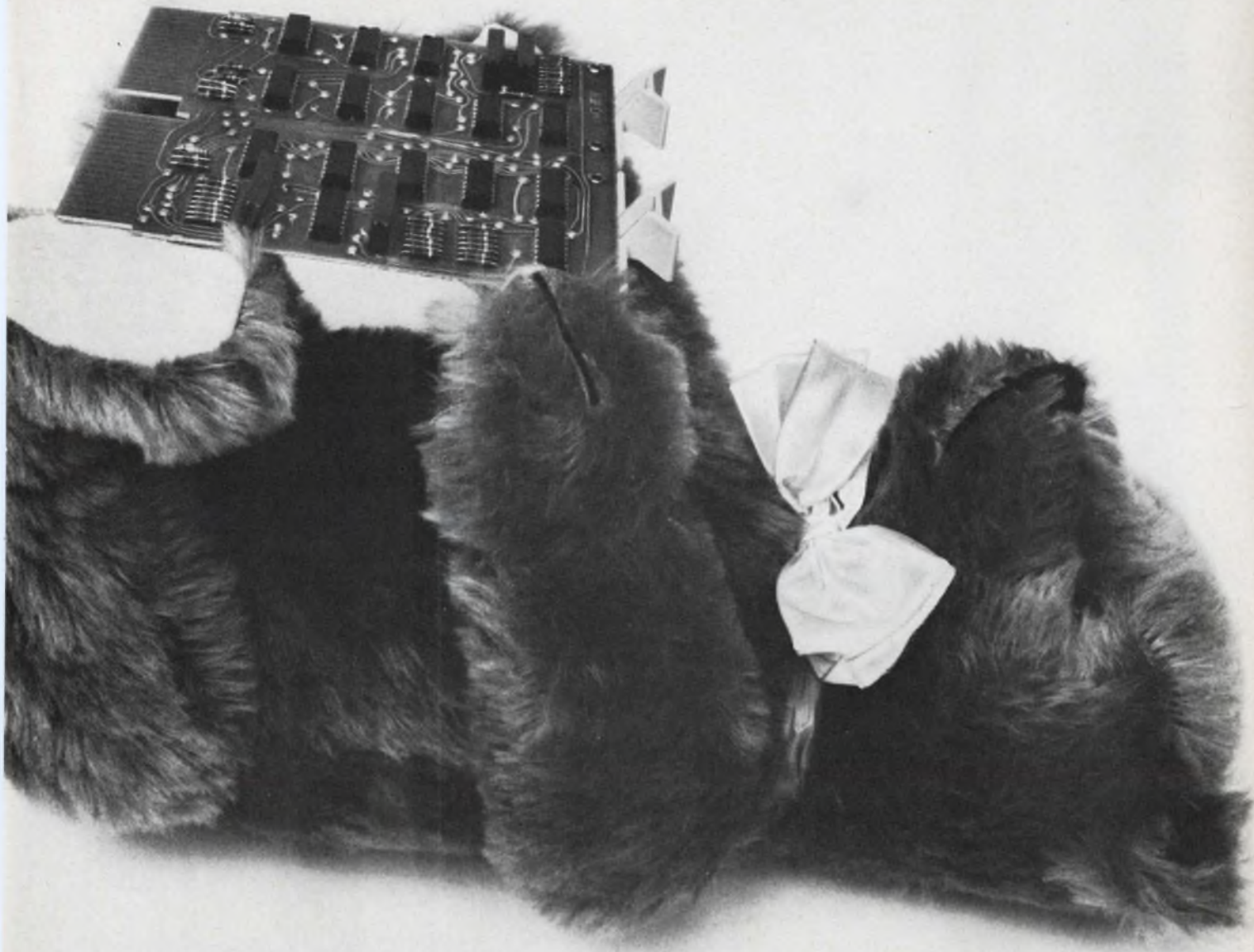

Security is having a module with a lot of compatible friends.

If you manufacture equipment, and price, delivery and reliability mean something to you, it's best to stay loose. Pick modules from a line that gives you options — so you can optimize the design for price, or speed, or ease of assembly, or something else that you're worried about.

DIGITAL'S module line is the broadest, most functional, most complete module line anywhere. Integrated circuits, discrete components, hybrids. More

than 120 of them. And each is electrically, physically, and logically compatible with each and every other.

It takes 330 pages of our Digital Logic Handbook to describe our series of Flip Chip* modules, details of the logic, and applications. It's yours for the asking.



And here's some added security: each of our modules is guaranteed for 10 years.

digital
MODULES • COMPUTERS

DIGITAL EQUIPMENT CORPORATION, Maynard, Massachusetts 01754. Telephone: (617) 897-8821 • Cambridge, Mass. • New Haven • Washington, D. C. • Parsippany, N. J. • Rochester, N. Y. • Philadelphia • Huntsville • Pittsburgh • Chicago • Denver • Ann Arbor • Houston • Los Angeles • Palo Alto • Seattle • Carleton Place and Toronto, Ont. • Reading, England • Paris, France • Munich and Cologne, Germany • Sydney and West Perth, Australia • Modules distributed also through Allied Radio

"How more rigid can quality control get?"



E-I GLASS-TO-METAL SEALS —

Specialized manufacture, with continual R & D pinpointed to absolute seal perfection

— PROVED IN CRITICAL AERO-SPACE PROJECTS!

Years of E-I specialized production, with research and development devoted exclusively to the ultimate in hermetic sealing, have resulted in electrical and mechanical characteristics compatible with today's highly sophisticated applications. Engineers and designers requiring high reliability in vacuum-tight sealing, should check these advantages:

- High dielectric strength, severe shock and vibration resistance
- Cushioned glass construction, maximum rigidity and durability
- Withstand wide fluctuations in temperature and humidity
- Miniaturization, design standardization

E-I sealed terminations include hundreds of stock items. Where custom seals or unusual lead configurations are required, E-I sales engineers will make recommendations from your blueprints, sketches or data.

Write for E-I Catalog — Complete data on standard types, custom seal components and sealing to your specifications. Address requests on company letterhead.

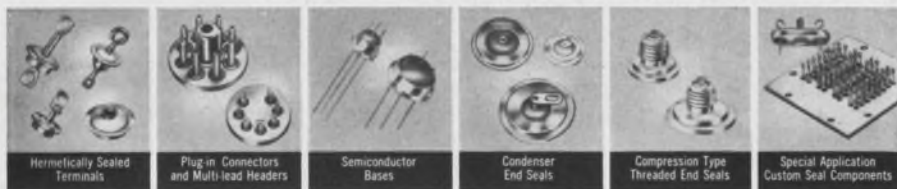

Electrical Industries

A Division of Philips Electronics and Pharmaceutical Industries Corp.
Murray Hill, N. J. 07971 — Tel. (201) 464-3200

Patented in U.S.A., No. 3,035,372; In Canada, No. 523,390; In United Kingdom, No. 734,583; other patents pending.

ON READER-SERVICE CARD CIRCLE 187

PRODUCTION EQUIPMENT



Coil tester gives go no-go readings

Avtron Manufacturing, Inc., 10409
Meech Ave., Cleveland. Phone:
(216) 641-8310.

The model T568A coil test set gives go no-go readings on a variety of coil specifications. The set consists of a high frequency coil tester, associated controls, readouts and safety devices. It will detect open circuits, shorts, wrong number of turns, wrong wire size, winding faults, defective insulation and crossed wires . . . all in one second.

CIRCLE NO. 291



Ferrite core handler is semi-automatic

Computer Test Corp., 3 Computer
Dr., Cherry Hill, N. J. Phone:
(609) 424-2400.

The Model CH-25 is a semi-automated core handler developed specifically for incoming inspection and quality control of ferrite memory cores. The handler will accommodate cores ranging in size from 12 to 80 mils and in thickness from 3 to 25 mils. Speed is 100 cores/minute and an electromechanical counter is provided to tally both accepted and rejected cores.

CIRCLE NO. 292

ANOTHER WORLD'S SMALLEST Soshin's Dipped Mica Capacitors/DM05

Developed by SOSHIN ELECTRIC, the only mica capacitor maker in Japan with MIL-C-5C qualifications. This newest and its bigger brothers will meet all your requirements. Volume orders accepted.

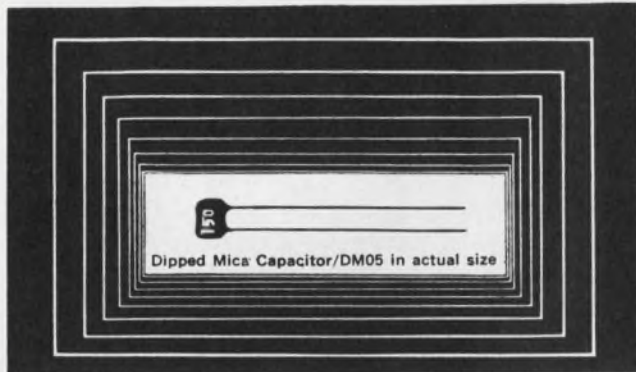

Types	Max Allowable Capacitance (pF)			Dimension (mm)								
	100 WV	300 WV	500 WV	100 WV			300 WV			500 WV		
Standard				L Max	W Max	T Max	L Max	W Max	T Max	L Max	W Max	T Max
DM05	200	130	—	7.0	5.0	3.5	7.0	5.0	3.5	—	—	—
DM10	440	390	330	8.5	5.5	3.5	8.5	5.5	3.5	8.5	5.5	3.5
DM15 (C.M05)	2000	1200	510	13.0	11.0	6.5	12.5	10.5	6.0	12.0	10.0	5.5
DM19 (C.M05)	10000	6800	5100	18.0	15.0	8.5	18.0	15.0	8.0	17.5	15.0	7.5

For further information, write to

SOSHIN **SOSHIN ELECTRIC CO., LTD.**
18-18, Nakamagome 1-chome, Ohta-ku, Tokyo, Japan
Cables: SOSHINCAPACITOR TOKYO

ON READER-SERVICE CARD CIRCLE 188

MINIATURE PUSH BUTTON SWITCHES.
WIPING, SNAP ACTION and BUTT CONTACTS.
SPST. SPDT. DPST. DPDT. PUSH-PULL.
LIGHTED. 25,000 to 1,000,000 OPERATIONS.

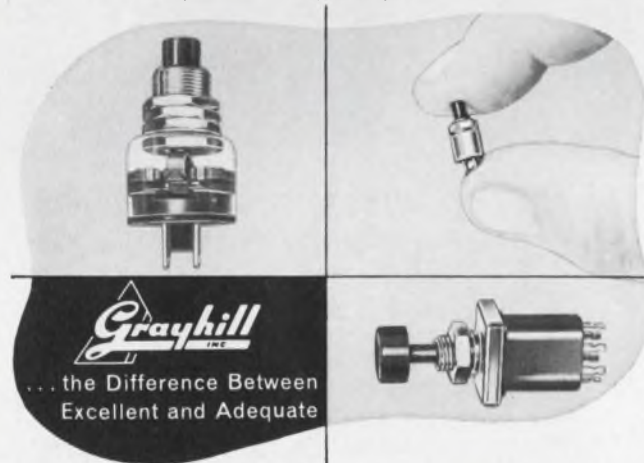

Grayhill
INC.

... the Difference Between
Excellent and Adequate

Typical Specifications:

- 1/4 Amp. to 10 Amps., 115 VAC Resistive
- Contact Resistance 10 Milliohms
- Insulation Resistance —
25,000 to 900,000 Megohms

All fully described in Engineering Catalog G304-Write

Grayhill
INC.

565 Hillgrove Avenue
LaGrange, Illinois 60525
Area Code 312, Phone 354-1040

"PIONEERS IN MINIATURIZATION"

ON READER-SERVICE CARD CIRCLE 189

ELECTRONIC DESIGN 3, February 1, 1967

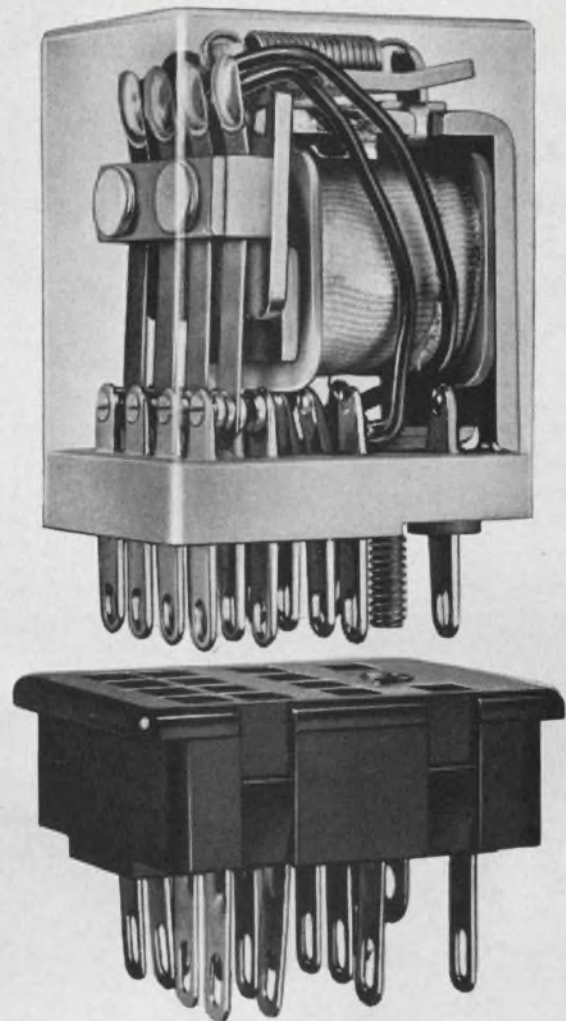

This is our Miniature
4-Pole Relay but we
magnified it 2½ times
to show you the kind
of quality you can buy
for \$4.10.

The Series JA is in all respects a high quality miniature 4 PDT relay for AC or DC operation. This is borne out by the fact that our customers have reported 40,000,000 mechanical operations without a single failure. The JA is excellent for computer, logic system and data processing applications. We could write an essay about its virtues but prefer to let the features and specifications speak for themselves.

LINE
RELAYS

Complete information including specifications and prices available in Bulletin #45.

LINE ELECTRIC COMPANY
Division of Industrial Timer Corporation
305 U.S. Highway 287, Parsippany, N. J.

an **AMERCON**
company

ON READER-SERVICE CARD CIRCLE 190

“Just building a lipstick size relay that worked would have been easy.”

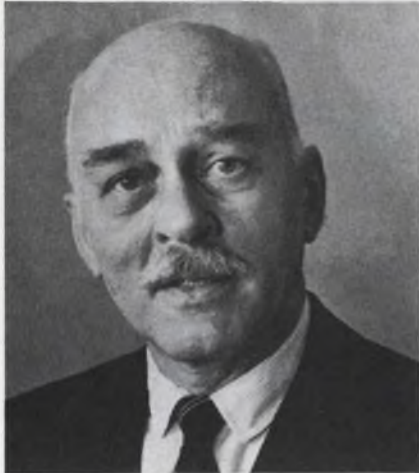

Building one around our great high-rel idea was another story.”

Wedge-action*, our great high-rel idea, is 8 years old. Our 2PDT lipstick-case size relay has been around for less than 2 years. But it's already a standard replacement for the competition in lots of MIL-R-5757/8 applications.



Why? Because it outperforms every spec requirement for both high and low-level loads. Like all our wedge-action relays, it combines long contact wipe with high contact force to give you continually clean precious-metal mating surfaces throughout life. Competitively priced with fast delivery.

The lipstick is just one of our family of wedge-action relays, which cover almost every dry-circuit to 2 amp application. When you need a high-rel relay that really works, test one of ours and try your darndest to prove we're wrong. You won't be able to.

* U. S. Patent No. 2,866,046 and others pending.



Electro-Tec Corp.
SLIP RINGS • RELAYS • SWITCHES • OPTICS

P. O. Box 667 • Ormond Beach, Florida
(904) 677-1771 • TWX 810-857-0305

Manufacturing Facilities:
Ormond Beach, Fla. • Blacksburg, Va.

ON READER-SERVICE CARD CIRCLE 191

PRODUCTION EQUIPMENT



Thin-film coater covers production needs

Temescal Metallurgical Corp., 2850 Seventh St., Berkeley, Calif. Phone: (415) 841-5720. Price: \$40,000.

An automated thin-film coater is said to do the work of eight conventional bell jars. The continuous vacuum system in this coater mechanically moves substrates from air through a lock to a vacuum processing chamber. It is said to provide high-rate production capabilities for evaporative coating, sputtering and glow-discharge cleaning applications.

CIRCLE NO. 293



IC system tests slices to systems

Texas Instruments, Inc., P.O. Box 66027, Houston. Phone: (713) 526-1411. P&A: \$28,000; 60 days.

Measurements as basic as slice probing or as complex as device evaluation within a system can be accomplished by the model 668 tester. The unit performs dc and diagnostic tests for the production, quality-control, inspection and probing functions. It also accommodates device evaluation tests on individual ICs and special tests on modules and arrays. No skilled op-

erators are required.

The 668 accommodates up to 16-lead devices, with Kelvin connections for each lead. It is normally supplied with a 1000 character/second paper-tape reader for programming. Normal tests are performed in 8 ms but test times up to 100 ms and programmable hold are also available.

CIRCLE NO. 294

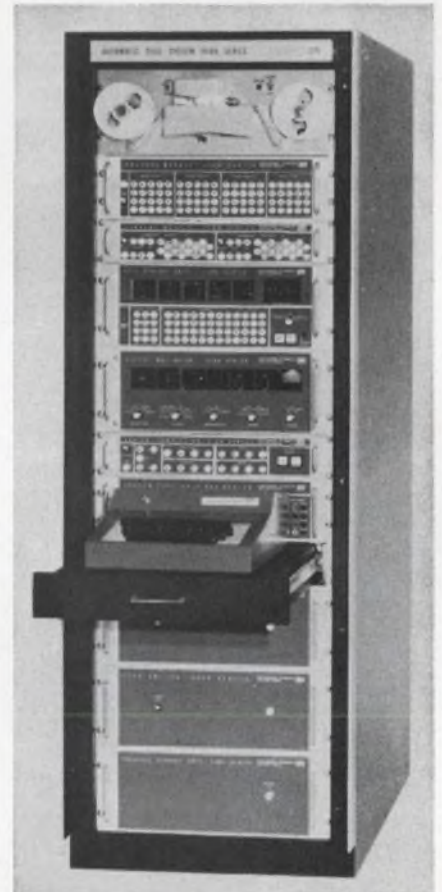

Automated test unit modular, flexible

3M Co., 2501 Hudson Rd., St. Paul, Minn. Phone: (612) 733-2925. P&A: \$40,000; 45 to 60 days.

A fully automated system provides test facilities for multilead units such as ICs, PC boards and modules. The "Auto Data 9400" is suggested for incoming inspection, engineering control and production and quality control applications. Programming of stimuli, measurement, comparison and switching functions are accomplished with a high-speed tape reader. A self-test capability is standard.

CIRCLE NO. 295

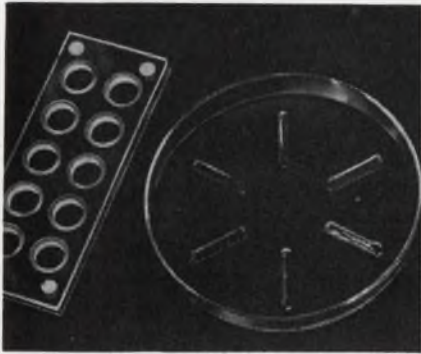

Glass transport trays protect components

Specialty Glass Products, Inc., 2558 Wyandotte Rd., Willow Grove, Pa. Phone: (215) 669-8400.

Custom fabricated glass transport trays are available to protect delicate mechanical or electronic components from dust, dirt, contamination and mechanical damage. The trays are offered in any size or configuration and a variety of glass compositions. They are said to be particularly suited to the production of microelectronic and semiconductor components.

CIRCLE NO. 296



Prefab chassis made of aluminum

Techmar Corp., 1124 S. Beverly Dr., Los Angeles. Phone: (213) 276-7216. Price: \$116.88 (kit).

Prefabricated aluminum chassis parts and kits are offered with pre-punched "erector set" hole patterns and captive nuts. The prefabricated chassis cover 8-3/4 and 10-1/2-in. heights for standard 19-in. racks. Basic "Omnicrolosure Kit" for either height consists of EIA front panel, two side frames, two cross plates, perforated sliding top and bottom covers, handles and the required screws and washers.

CIRCLE NO. 297



and now...the Fifth Freedom: FREEDOM FROM CAPACITOR PROBLEMS!

A continuous development program has refined the performance of these critical components to an unprecedented level of excellence. With our complete production tooling we can offer a standard line of subminiature ceramic capacitors with extremely large capacitance-to-size ratio and exceptional stability.

Designed to meet the highest custom standards of the missile, communications, computer, and navigational industries, they are available in volume quantities for immediate, off-the-shelf, delivery. In three complete lines:

DECI-CAP — a subminiature ceramic capacitor with an epoxy molded envelope 0.100" diameter by 0.250" long, axial leads with capacitance range 4.7 pf to 27,000 pf, tolerance $\pm 10\%$. Unit designed to meet MIL-C-11015.

HY-CAP — offers extremely high capacitance range .01 mfd to 2.5 mfd in $\pm 20\%$ tolerance. Voltage 100 WVDC, no derating to 125°C. Unit designed to meet MIL-C-11015.

NYT-CAP — an ultra high stability ceramic capacitor packaged in a miniature molded epoxy case 0.350" x 0.250" x 0.1". Capacitance range 100 pf to 1000 pf. Tolerance $\pm 10\%$. Voltage rating 200 volts D.C.

Our inventory of other standardized, high quality components includes inductors, delay lines and resistors. Custom component capability is also available. Write today for complete engineering data.



NYTRONICS

...for Precision Electronic Components

550 Springfield Ave., Berkeley Heights, N.J. 07922 ■ (201) 464-9300 ■ TWX: 710-984-7977

ON READER-SERVICE CARD CIRCLE 192

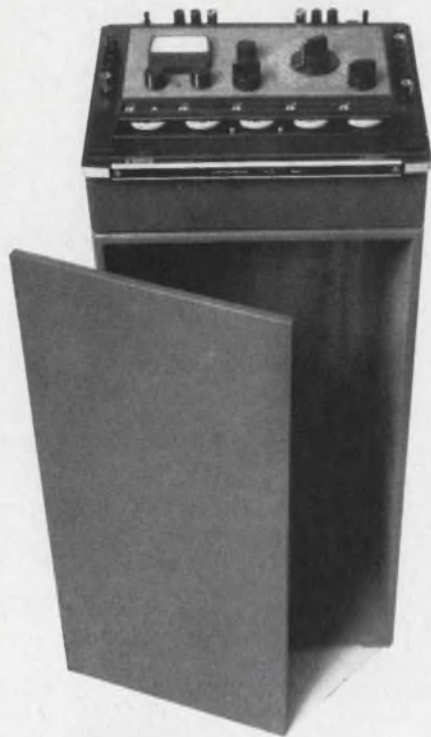

We thought of putting a false bottom on it.

We toyed briefly with the idea of making our PVB (Potentiometric Voltmeter-Bridge) bigger than it had to be. We were worried about the skeptics who wouldn't believe we could combine seven high-accuracy measurement functions in a portable case the size of a typewriter.

But we resisted temptation. We designed the PVB as compact as solid-state technology permits. And we said to the skeptics, "Seeing is believing. If you don't think that one \$750 instrument can deliver 0.02% accuracy or better on voltage, resistance, current and ratio measurements—just watch."

The skeptics watched and they became believers. They passed the word along to friends and made the PVB one of our best sellers. (If word hasn't reached you yet, write us direct.) They showed us this instrument has more uses than even we knew—including potentiometric temperature measurement, checking of dc power supplies, measuring pH and calibration applications galore.

We should have known that false bottoms went out with the bustle. ESI, 13900 NW Science Park Drive, Portland, Oregon 97229.

Electro Scientific Industries **esi**®

ON READER-SERVICE CARD CIRCLE 193

POWER EQUIPMENT



Programable supply linear to $\pm 0.2\%$

Arnold Magnetics Corp., 6050 Jefferson, Los Angeles, Calif. Phone: (213) 870-7014. P&A: \$1209 to \$1475; stock to 6 weeks.

A ± 5 -V signal controls the ± 2 -kV output of the STR-1 power supply with a linearity of $\pm 0.2\%$. The supply features differential input, balanced output, reversible polarity and rapid response. It is designed for use with electrostatic charged particle deflection systems, mass spectrometers, flying spot scanners and other sweep field applications.

CIRCLE NO. 298



Frequency converters provide stable 60 Hz

Astro-Metrix Corp., 125 W. Proviencia Ave., Burbank, Calif. Phone: (213) 849-4759. P&A: \$1795; stock to 2 wks.

A line of 400-to-60-Hz converters are designed to provide a low-distortion source of 60 Hz ac. In these instruments, all conversion and isolation is accomplished at high frequencies in order to reduce size and weight of the unit. They are available in either single or three-phase outputs from 500 VA to 10 kVA.

CIRCLE NO. 299



0- to 120-Vdc supplies modular, programable

Lambda Electronics Corp., 515 Broad Hollow Rd., Melville, N. Y. Phone: (516) 694-4200. Price: \$109 and \$119.

Two 0- to 120-Vdc silicon power supplies offer multiple current ratings based on ambient temperatures up to 71°C. The convection-cooled units are additions to the A-package line of the manufacturer's LM Series. The remotely programable units can be mounted on any of three vertical surfaces and measure 3-1/8 x 3-11/16 x 6-1/2. Model LM 267 is rated 0.1 A at 40°C and 0.07 A at 71°C. At the same ambients, LM 268 is rated 0.13 and 0.09 A.

CIRCLE NO. 300

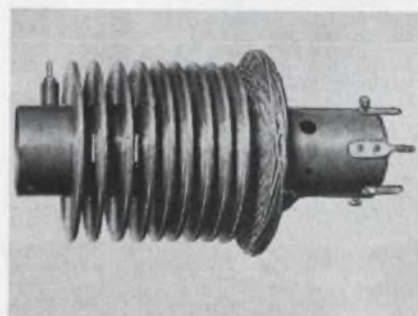

Step-up coil gives 10 kV and 1 mA at 120 kHz

Spellman High Voltage Co., Inc., 1930 Adee Ave., Bronx, N. Y. Phone: (212) 547-0306. P&A: \$15; stock.

This high-voltage step-up coil, driven by a single self-oscillating transistor, has an output of 10 kVdc at 1 mA and 24 Vdc at about 1 ampere. The coil has operating frequency of approximately 120 kHz and measures 4 1/4-in. high with a diameter of 3-in.

CIRCLE NO. 301

High torque, Self-shielded

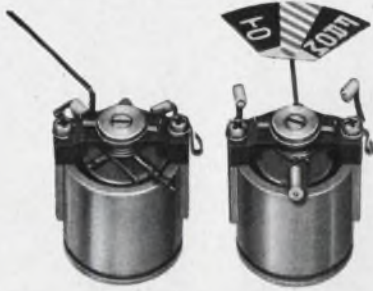

AI-2 (actual size)

moving coil mechanism

Versatile mechanisms for critical indicating and control systems have "On-off", "+, -", "Go-no go", null, left-right, or scale indicators. High torque, self-shielded core magnet design permits grouping of functions in small panel space. Moving coil weighs 100 mg less and provides at least 10% more torque than best previously available mechanism of this type. Wide choice of sensitivities; synchro or standard mounting.

AMMON

AMMON INSTRUMENTS, INC.
345 Kelley Street, Manchester, N. H. 03105

ON READER-SERVICE CARD CIRCLE 194

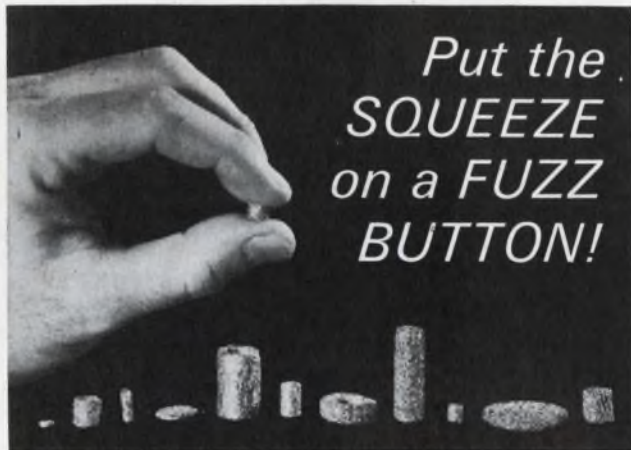

Put the
SQUEEZE
on a **FUZZ**
BUTTON!

Resilient, multi-point, non-inductive low resistance, springlike, low-cost contacts . . . interested?

Look at these TYPICAL APPLICATIONS . . .

Component Contacts, Diodes, Switches, Ear Phones, Printed Circuit Boards, Stripline, Waveguide, Connector Elements, Test Probe Points, Program Boards.



For personal squeezing sample and design sheet FB-001, write or call today.

TECKNIT®
Technical Wire Products, Inc.
129-B Dermody Street, Cranford, New Jersey 07016
(201) 272-5500

ON READER-SERVICE CARD CIRCLE 195

ELECTRONIC DESIGN 3, February 1, 1967

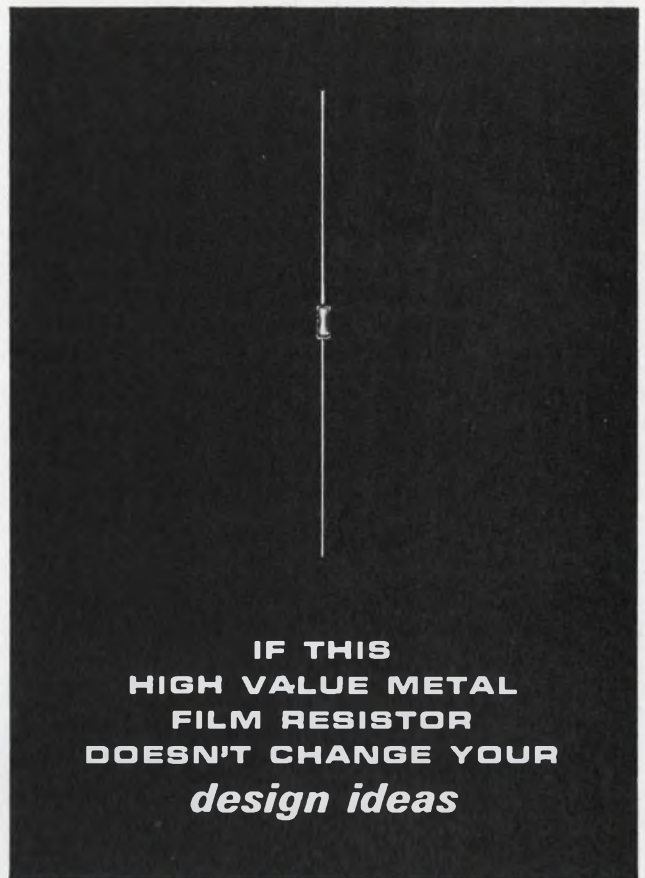

IF THIS
HIGH VALUE METAL
FILM RESISTOR
DOESN'T CHANGE YOUR
design ideas

...try one of these



Part No.	Power	Ohms	Tol.	Temp. Coef.
PME 50	1/20 W	10Ω to 1M	±1% to .1%	T-0, T-2, T-9
PME 55	1/10 W	10Ω to 3M	±1% to .1%	T-0, T-2, T-9
PME 60	1/8 W	49Ω to 7.5M	±1% to .1%	T-0, T-2, T-9
PME 65	1/4 W	49Ω to 20M	±1% to .1%	T-0, T-2, T-9
PME 70	1/2 W	24Ω to 30M	±1% to .1%	T-0, T-2, T-9
PME 75	1 W	49Ω to 50M	±1% to .1%	T-0, T-2, T-9

The stability and accuracy of Pyrofilm's PME metal film resistors makes their use ideal in applications where before only wire wound resistors could be used. These resistors are virtually unaffected by environmental conditions and withstand constant exposure to high moisture conditions without change in specifications. PME resistors meet or surpass all requirements of MIL-R-10509F.

Send for fact-filled literature sheet!

PYROFILM RESISTOR COMPANY, INC.

3 SADDLE ROAD • CEDAR KNOLLS, NEW JERSEY • 201-539-7110

ON READER-SERVICE CARD CIRCLE 196

New CDS Type 6C PHOTOCHOPPER CELLS

- High Efficiency
- Low Temperature Coefficient
- Resistance Tolerance $\pm 50\%$
- Internal Electrostatic Shielding
- Dumet Leads

Write for new
4-page Bulletin
110/170 866



CLAIREX

"The LIGHT Touch in Automation and Control"
1239 Broadway, New York, N. Y. 10001
212 MU 4-0940

ON READER-SERVICE CARD CIRCLE 197

USE
ZIP CODE
NUMBERS
IN ALL ADDRESSES

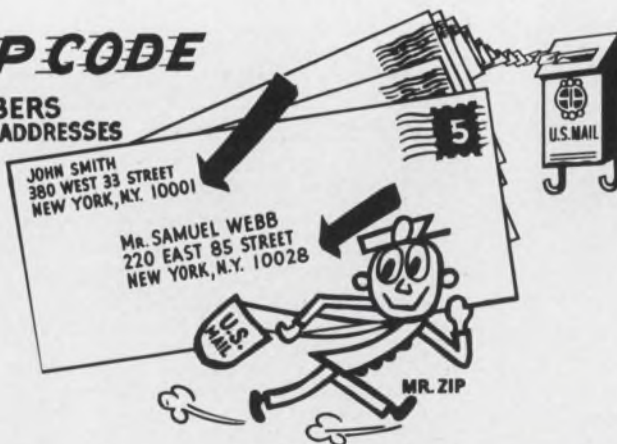

POWER EQUIPMENT

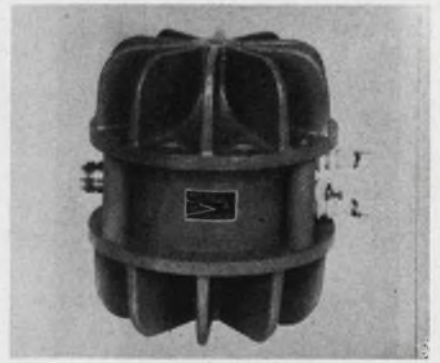

Power transformer operates 2 to 30 MHz

North Hills Electronics, Inc. Alexander Place, Glen Cove, N. Y. Phone: (516) 671-5700. P&A: \$295; stock.

Designed to handle 1 kW continuously, the Type KA power transformer operates over a frequency range of 2 to 30 MHz. Over this range vswr is below 1.3. Available impedance ratios range from 50 and 75 Ω unbalanced to 500 and 600 Ω balanced. Any ratio can be made to a customer's order. The transformer weighs less than 5 pounds and can be mounted in any position.

CIRCLE NO. 302

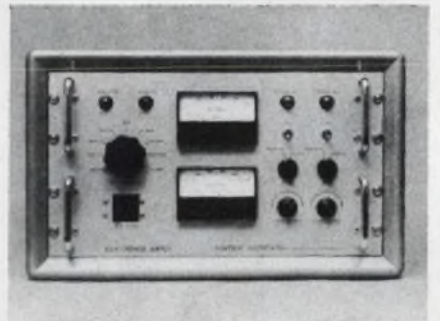

Dual supply for electron guns

Filmtech Associates, 12501 Ocean Breeze Drive, Garden Grove, Calif. Phone: (714) 539-1256.

The TG-P-1 is a 2.5-kW supply designed for manual or automatic control of single or dual evaporation from work-accelerated electron guns. It provides a variable voltage from 1 to 5 kVdc in 500-V increments at 0 to 500 mA. Average level output voltage is regulated to within 1% for simultaneous worst conditions of line and load.

CIRCLE NO. 303



Small supply regulated to 0.005% plus 1 mV

Radette Co., Fire Road, Route 2, Box 64E, Pleasantville, N. J. Phone: (609) 646-0197. Price: \$110.

For bench, modular or rack mounting, the series 2000 supplies feature voltage regulation to 0.005% plus 1 mV zero to full load. Current regulation is 0.03% plus 0.2 mA for load changes from 0 to 20 volts. Ripple and noise are below 100 μ V at constant voltage and 0.4 mA at constant current. Unit size is 4-3/16 x 5-3/8 x 9-1/2-in.

CIRCLE NO. 304



Regulated power supply gives 200- μ s recovery

Hewlett-Packard/Harrison Div., 100 Locust Ave., Berkeley Heights, N. J. Phone: (201) 464-2117.

With the CCB Series power supplies, less than 200 μ s are required for transient load recovery to within 0.1%, even for load changes requiring full rated output voltage changes. Features include all-silicon design, three-position output and meter range switch, ten-turn output control with resolution to 0.1 μ A, continuously variable voltage limiting, remote programming and ac modulation capability.

CIRCLE NO. 305

Who but Waters has a Rectilinear Trimmer with **TRULY** INFINITE RESOLUTION plus vernier lead screw?

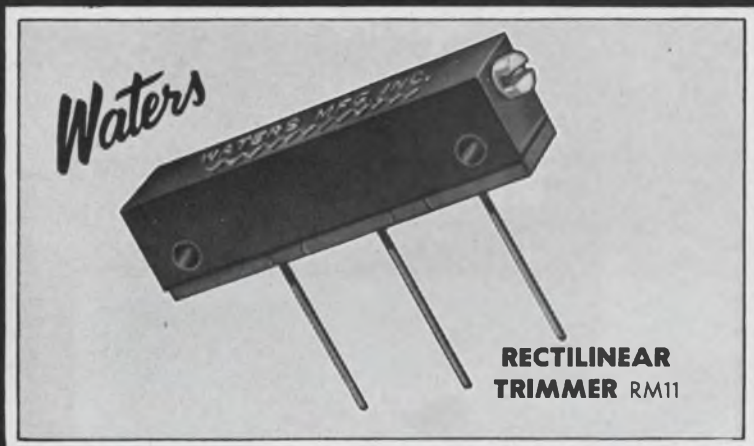
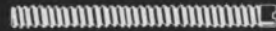

**RECTILINEAR
TRIMMER RM11**

Through the magic of MystR[®], fabulous thin-film resistance element, this new Waters Rectilinear Trimmer Potentiometer (RM11) makes possible true Infinite Resolution with simple vernier lead screw adjustment. Standard resistance values from 500 ohms to 1 megohm settings are adjustable with pinpoint accuracy and maintained with high stability. The RM11 is engineered, as are all Waters potentiometers, for the designer who demands the ultimate in component parts for his circuitries.

Plus!... these distinctive features

- High Impact Plastic Case
- Conductive Overtravel
- Low End Resistance (4 ohms maximum)
- No Solder or Pressure Connections
- Low Noise (static, ENR and CRV)
- 10-turn Lead Screw.



WATERS
MANUFACTURING INC.
WAYLAND, MASSACHUSETTS

EXPORT: Contact Charles H. Reed, Export Director, Waters Manufacturing, Inc., Wayland, Mass. 01778

Why are JFD Piston Trimmers used in Saturn Apollo Gemini Minuteman?



Capacitors shown enlarged 25%

JFD offers industry's largest selection of piston trimmer capacitors . . . over 3000 standard and special designs.

Choice of six dielectric materials.

Matched metalizing processes for homogeneous bonds.

Seven drive mechanisms engineered for greatest tuning linearity without reversals and for the ultimate in repeatability.

Among the panel-mount and printed-circuit piston capacitors offered by JFD are miniature telescopic types, three series of extremely high capacitance piston trimmers or tuners, inexpensive standard panel-mount piston capacitors, units for high-voltage applications, ultra-miniature trimmers, low-cost direct-traverse piston trimmers, differential and split-stator trimmers, and variable temperature-coefficient trimmers.

Write for catalog C-66.

JFD "TODAY'S COMPONENTS BUILT FOR TOMORROW'S CHALLENGES"

JFD ELECTRONICS CO. / COMPONENTS DIVISION 15th Avenue at 62nd Street
Brooklyn, N. Y. 11219 / Phone 212-331-1000 • Sales Offices—Arcadia, Calif.
Chi., Ill. / Balt., Md. / Saxonville, Mass. / Bklyn., N. Y. / New Hartford, N. Y.
Cinn., Ohio / Phila., Pa. / Pitts., Pa. / Paris, France / Azor, Israel

ON READER-SERVICE CARD CIRCLE 200

SYSTEMS

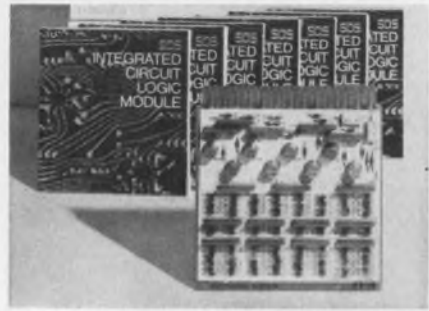

IC counter/register rated at 10 MHz

*Scientific Data Systems, 1649 17th
Santa Monica, Calif. Phone: (213)
451-4747.*

The 8-bit IC digital logic module FT19 is a counter register rated for 10-MHz operation. With back-panel connections, the module functions in any one of 14 modes including storage register, parallel or serial in or out shift register, and reversible up or down counter either binary or BCD. Other modes include dual 4-bit combinations of shift, count and store.

CIRCLE NO. 306



Acquisition system bars obsolescence

*Information Control Corp., 138 Ne-
vada St., El Segundo, Calif. Phone:
(213) 322-6930.*

Stressing flexibility, the SPDAS samples a number of analog and digital inputs, performs A/D conversions, formats data and records it on magnetic tape. Key to its operation is a fast-access core memory providing storage as a data buffer as well as for program steps. Standard SPDAS core memory is a 4000-word, eight-bit unit. Program steps are entered via keyboard as decimal digits.

CIRCLE NO. 307

PLASTIC SEALLESS PUMP

... for etching acids with no leakage
Standard capacities are from 1/3 to 40 gpm

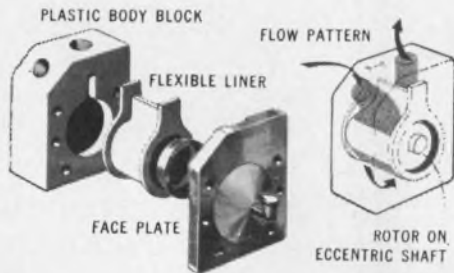

A rotor, mounted on an eccentric shaft in this plastic pump, rotates within a liner to create a progressive squeezing action on fluid trapped between the liner and the body block. All metal parts and mechanical action takes place inside the liner where fluid never reaches. This completely eliminates the need for stuffing boxes or shaft seals, guaranteeing no leakage.

The pump is self-priming, operates wet or dry and is suitable for extremely corrosive fluids, abrasive slurries or viscous materials. Applications include pumping of acids, alkalis, distilled water, diatomaceous earth slurries, electroplating solutions, ceramic tile glaze as well as shear sensitive emulsions.

Standard capacities are from 1/3 to 40 gpm with discharge pressure up to 50 psi. Materials of construction include Teflon, polypropylene, linear polyethylene, Bakelite or stainless steel for body blocks and Viton-A, Kel-F elastomer, Hypalon, Neoprene and Buna-N for the liner. These are the only parts in contact with the fluid.

For additional information, write Vanton Pump & Equipment Corporation, Hillside, New Jersey or telephone Area Code 201 926-2435.

ON READER-SERVICE CARD CIRCLE 201

Any knob will turn the equipment on. Kurz-Kasch design-oriented instrument knobs turn on the engineer, the designer, the user, 21 families, 347 stock knobs in a variety of thermosetting materials and colors brighten the products of 3,000 OEM's. You can be 3,001. Write for free catalog and samples!

Kurz-Kasch, Inc.
Standard Parts Division
1415 S. Broadway
Dayton, Ohio 45401
(513) 223-8161

Turn yourself on with
FREE
KNOB SAMPLES
from Kurz-Kasch

ON READER-SERVICE CARD CIRCLE 202

ELECTRONIC DESIGN 3, February 1, 1967

RESISTANCE-TYPE THERMOMETERS

DESIGNED FOR
COMMERCIAL — LABORATORY — INDUSTRIAL
MILITARY AND MISSILE APPLICATIONS



THERMAL-RIBBONS

Fast-response conversion of surface temperatures to accurate electrical readout for temperature measuring, recording, or control. Used with Thermal-Indicator or other lab equipment.

THERMOFOLDS

Laminated thin-film assemblies, flat or wrap-around, for heating, sensing, or both.

11 STANDARD PHYSICAL CONFIGURATIONS AVAILABLE FROM STOCK — CUSTOM MODIFICATIONS AND MOUNTINGS AVAILABLE

TYPICAL USES

- Air/Gas/Liquid Temperatures
- Equipment Temperatures
- Bearing Temperatures
- Process Control
- Plastic Mold Temperatures
- Oven Temperatures
- Medical Applications
- Wet/Dry Bulb Hygrometers
- Laboratory Bath or Environmental Chambers

THERMAL-INDICATORS

Used with Thermal-Ribbons, Res. Thermometers, and Temp. Probes. Six models, direct reading from -100°C. to +200°C. or -148° F. to +392°F.

PRECISION PLATINUM RESISTANCE THERMOMETERS

For highly precise measuring or control; long-term stability and accuracy.

BUTTON-HEATERS

Disc shaped units for controlled heat. Available up to 50 watts.

RESISTANCE TEMPERATURE DETECTORS

Rugged sensors for large motors, generators, transformers, etc. Permanently installed by molding or casting into equipment.

A convenient and economical means to accurately measure, control, or record temperatures in the range from -328°F (-200°C) to +500°F (+260°C), these units match the characteristics of Minco's Thermal-Ribbon® surface sensors and may be used with Minco's direct reading Thermal-Indicator electronic thermometer (described at right) or other accurate resistance measurement equipment. They are available in body-sensitive and tip-sensitive models, and feature relatively high impedance and a high resistance change of several ohms per degree, allowing the leads to be spliced, switched, or extended with minimum error in output signal. Prices range from \$11 to \$59 in moderate quantities. Request Bulletin RT for complete information and prices.

MINCO PRODUCTS, INC.

740 WASHINGTON AVENUE NORTH — MINNEAPOLIS, MINN. 55401

TELEPHONE: (612) 338-6753

PLEASE SEND INFORMATION ABOUT —

TWX: 910-576-2848

- | | | |
|---|---|--|
| <input type="checkbox"/> Thermal-Ribbons | <input type="checkbox"/> Thermofolds | <input type="checkbox"/> Res. Temp. Detectors |
| <input type="checkbox"/> Thermal-Indicators | <input type="checkbox"/> Precision Thermometers | <input type="checkbox"/> Send Complete Catalog |
| <input type="checkbox"/> Temperature Probes | <input type="checkbox"/> Button-Heaters | <input type="checkbox"/> Have Rep. Call |

NAME _____

COMPANY _____

ADDRESS _____

CITY _____

STATE _____

ZIP _____

TELEPHONE _____

EXTENSION _____

ON READER-SERVICE CARD CIRCLE 203

Ceramic Capacitors

MOLDED CERAMIC TUBULARS

for computer applications. The ultimate in reliability (failure rate 0.001%/1000 hours at 85° C and twice rated voltage.)



DISC CERAMICS

for all commercial and military applications. New production techniques give Skottie a big edge in price, quality and delivery. Ask for a quote and find out if it's not so.



Do you have a problem in ceramic capacitors with special designs, quality, reliability, guaranteed delivery or price? If you do, it might pay you to look into Skottie Electronics. We specialize exclusively in the design and manufacture of ceramic dielectric capacitors. Skottie is a major supplier of ceramic capacitors to the largest computer and radio, TV manufacturers in the world.

Sure we do the military and commercial standards. But in ceramics, when you have special needs (particularly design or delivery) we think you'll find Skottie Electronics your best supplier. Representatives in major cities throughout the United States.

SKOTTIE ELECTRONICS, INC. / Archbald, Pennsylvania 18403
Phone 717-489-4726 TWX-510-656-2979

ON READER-SERVICE CARD CIRCLE 204

Designed for utmost reliability...

PRESS-TO-TEST INDICATOR LIGHTS

Meet or Exceed Requirements of MIL-L-7961B and MIL-L-3661.

If your application for indication requires unflinching reliability... specify Dialco Press-to-Test Indicator Lights. **Positive safety factors are built-in.** Lamps can be checked instantly—without removing the lamps from the assembly.

Sub-miniature, miniature and large Press-to-Test assemblies are available—each requiring only slight finger pressure on the lens holder to determine if the lamp is satisfactory or defective.

Units may be obtained for mounting in 15/32", 5/8" or 1" clearance hole—with Neon or Incandescent light sources—with choice of lens shapes and colors (including patented shutter dimming action).

SAMPLES ON REQUEST—AT ONCE—NO CHARGE

Get all the data. Write for our new catalog today!

(Illus. approx. 75% actual size)



Foremost Manufacturer of Indicator Lights

DIALIGHT CORPORATION

60 STEWART AVE., BROOKLYN, N.Y. 11237 • AREA CODE 212 497-7600

ON READER-SERVICE CARD CIRCLE 205

SYSTEMS



Time code generator for analog or digital codes

Dynalectron Corp., Data Sciences Div., 2604 Pittman Dr., Silver Spring, Md. Phone: (301) 588-8488. Price: \$4050 (single time code).

This time code generator can generate and encode any five simultaneous analog (modulated carrier) time codes. It also will generate a digital level shift code, a parallel binary coded decimal indication of time, pulse rate outputs and a front panel display of time in days, hours, minutes and seconds. The normal application of the time code generator is for recording various standard time codes (NASA, IRIG, AMR, etc.) on one channel of one or more magnetic tape recorders while data is being recorded on other channels, thus permitting time correlation on subsequent playback.

CIRCLE NO. 308



Analog memory unit down 40% in price

Control Data Corp., 4455 Eastgate Mall, La Jolla, Calif. Phone: (714) 453-2500. Price: \$1320 for the basic chassis plus \$368/channel.

Cost per channel of the 420C Analog memory is 40% below that of previous models. Analog, using a hybrid of digital and analog circuitry, gives a small signal bandwidth from dc to 150 kHz and a hold-mode accuracy of better than $\pm 0.05\%$. Aperture error is less than 100 ns after an acquisition time of 6 μ s. Operation is analog in the track mode and hybrid in the hold mode.

CIRCLE NO. 309

WITH **KH** ALL-SILICON
R-C OSCILLATORS
YOU GET MORE
THAN ADJUSTABLE
FREQUENCY!



MODEL 4004, one of the new K-H all-silicon Variable R-C Oscillators, provides continuously adjustable frequency over the range of 0.001 Hz to 100 kHz. Programmed units also available.

A stable low-distortion signal source is essential for today's complex electronic measurements. You get unsurpassed signal stability and purity in K-H's new line of all-silicon broad band variable R-C Oscillators. Amplitude stability is described, below. Distortion is plotted.

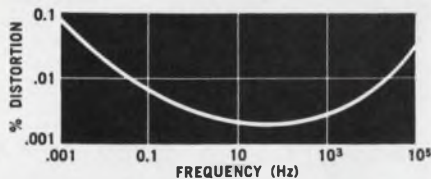

TYPICAL HARMONIC DISTORTION PLOT of K-H Series 4000 R-C Variable Frequency Oscillators.

Stability and signal purity are only two examples of the extra value you get from these modern Krohn-Hite electronic instruments. Other values increase user confidence further by providing simpler, faster and lower-cost operation.

Excellent Amplitude Stability: 0.01%, cycle-to-cycle; 0.01% per hour.

Sine- and Square-Wave Outputs: Pure sine-wave output — no diode-shaped approximations to produce step-function or waveform discontinuities. Square-wave rise and fall times less than 20 nanoseconds.

Quadrature Outputs: Sine and cosine outputs remain within $\pm 1^\circ$ of quadrature. Ideal as driver for polyphase variable power sources or simulators for rotary or linear encoders.

There's more in K-H Data Sheet 4000.

Write for a copy.

KH KROHN-HITE CORPORATION
580 Massachusetts Avenue, Cambridge, Mass. 02139
Telephone: 617/491-3211

ON READER-SERVICE CARD CIRCLE 206

ELECTRONIC DESIGN 3, February 1, 1967



Input converts graphics to digital

Bolt Beranek & Newman, Inc., Data Equipment Div., 2126 South Lyon St., Santa Ana, Calif. Phone: (213) 781-8350. P&A: \$9500; 90 days.

The Grafacon Model 1010A comprises a two-dimensional graphic to digital input system. Based on the Rand Tablet, the system consists of a "writing" surface, electronic pen and associated control circuitry. The 10 x 10-in. writing surface accommodates 10^6 input locations with 100-lines/inch resolution in both X and Y axes. Power supply and control module are packaged for a 19-in. rack mount.

CIRCLE NO. 310



Peripheral equipment checked while on-line

Scientific Data Systems, 1649 17th, Santa Monica, Calif. Phone: (213) 451-4747. P&A: \$5500; early 1967.

Called a "PET" by its developers, the Peripheral Equipment Tester is designed to independently exercise and diagnose operations of computer peripheral devices. It can detect and isolate interface problems between a Sigma computer and its peripheral units even while the computer is performing on-line, real-time problems. Fully portable, "PET" is housed in a 11 x 19 x 17-in. cabinet.

CIRCLE NO. 311

WITH **KH** ALL-SILICON
VARIABLE FILTERS
YOU GET MORE
THAN ADJUSTABLE
BANDWIDTH!



MODEL 3100, one of the new K-H all-silicon Broad Band Variable Electronic Filters providing continuously adjustable bandwidth over the range of 10 Hz to 3 MHz maximum bandwidth.

Frequency- or time-domain filter response is essential for today's complex electronic measurements. You get both, at the flip of a switch in K-H's new line of all-silicon Broad Band variable electronic filters. The frequency-domain characteristics are described, below. Time-domain response is illustrated.

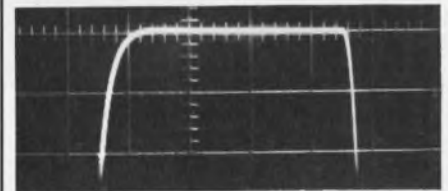

TRANSIENT-FREE RESPONSE to impulse signals demonstrates value of K-H Broad Band Filters for Time-Domain applications.

These responses are typical of the extra value you get from modern Krohn-Hite electronic instruments. Other values increase user confidence further by providing simpler, faster and lower-cost operation.

Frequency-Domain Characteristics: Fourth-order Butterworth with maximal flatness in the passband.

Zero-db Insertion Loss: All silicon amplifiers provide "lossless" passband response. Steep (24 db per octave) attenuation slopes extend to at least 80 db.

90-db Dynamic Range: Low hum and noise (100 microvolts) eliminates costly preamplifiers.

No Impedance Matching Problems: 100 k-ohms input impedance; 50 ohms output impedance (lower when specified).

There's more in K-H Data Sheet 3100/3103.

Write for a copy.

KH KROHN-HITE CORPORATION
580 Massachusetts Avenue, Cambridge, Mass. 02139
Telephone: 617/491-3211

ON READER-SERVICE CARD CIRCLE 207

191

Design Aids



Switch designer's rule

Check switch section designs without the delay or cost of engineering samples by using this switch design wheel. The wheel, for 12-point switches, allows you to change your section designs as often as necessary before finalizing any data. The rule is printed on translucent plastic so that both sides of the section can be drawn. It is then possible to give a "look-through" as the center blade section is moved across the marked-in long or short clips on the stationary wheel. Oak Manufacturing Co.

CIRCLE NO. 312



Graduated eyelet selector

An easy-to-use circular slide chart selector lists the complete line (69) of Stimpson's graduated size eyelets. All necessary dimensions are included. With the rule, engineers, designers and production men can select eyelets at a glance. Edwin B. Stimpson Co., Inc.

CIRCLE NO. 313

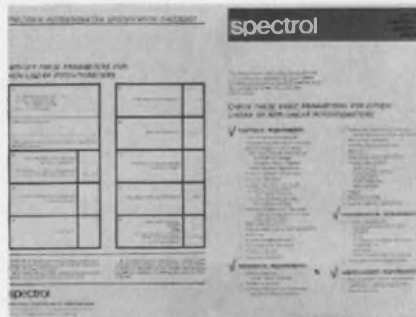

Pot specifier's checklist

A handy reminder and checklist aids in considering and specifying linear and/or nonlinear potentiometers. One side lists those parameters which describe completely a precision pot. The reverse side concerns itself exclusively with nonlinear pots. Spectrol Electronics Corp.

CIRCLE NO. 314

Pocket conversion chart

In problems involving metrology, quality control and inspection, this pocket-sized conversion chart is especially useful. It includes conversion of micro-inches to angles and vice versa, inches to millimeters, microns and angstroms and vice versa. Also shown are wave-lengths of monochromatic radiation for gauge interferometry, selected physical constants and other time-saving data. Engis Equipment Co.

CIRCLE NO. 315

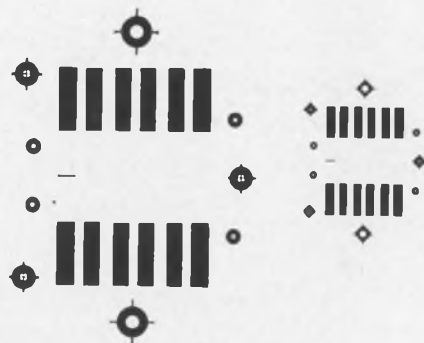

Stick-on conductor patterns

Stick-on conductor patterns are offered to aid in the design of PC boards for the manufacturer's relay. The patterns are used in conjunction with a preparation print which details the PC board design. Printact Relay Div., Executone, Inc.

CIRCLE NO. 316

Sine wave paper

In designing or analyzing 3-phase SCR systems, the engineer almost always starts by sketching sine waves. These two pads of sine wave and rectified sine wave paper make it easy to associate the firing of the firing circuits and the turn-on of the various SCRs.

Available for 25¢ each from Firing Circuits, Inc., Muller Ave., Norwalk, Conn.

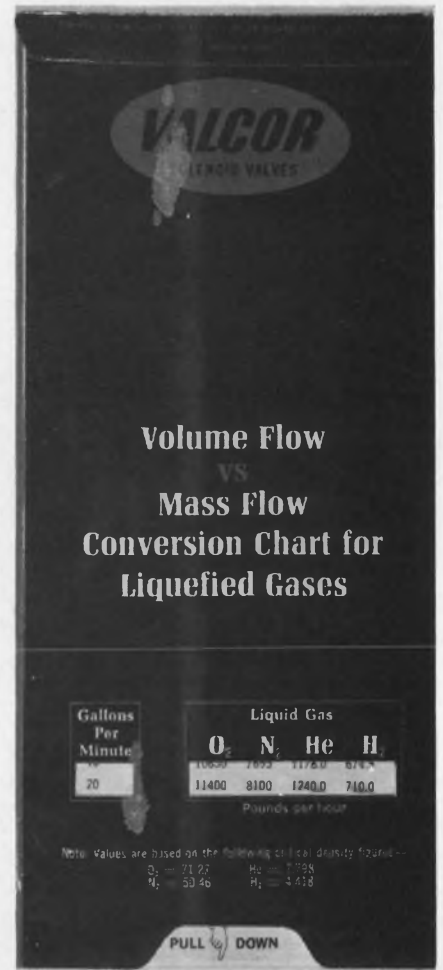

Cryogenic gas flow

The volume flow vs mass flow conversion for liquefied gases is performed by this slide chart. The chart converts gallons per minute to pounds per hour for liquefied oxygen, nitrogen, hydrogen and helium. The reverse side of the rule shows a cross-section of a cryogenic valve. As the slider is moved an "X-ray" of the valve very cleverly shows it in operation. Valcor Engineering Corp.

CIRCLE NO. 317

ARNOLD IS

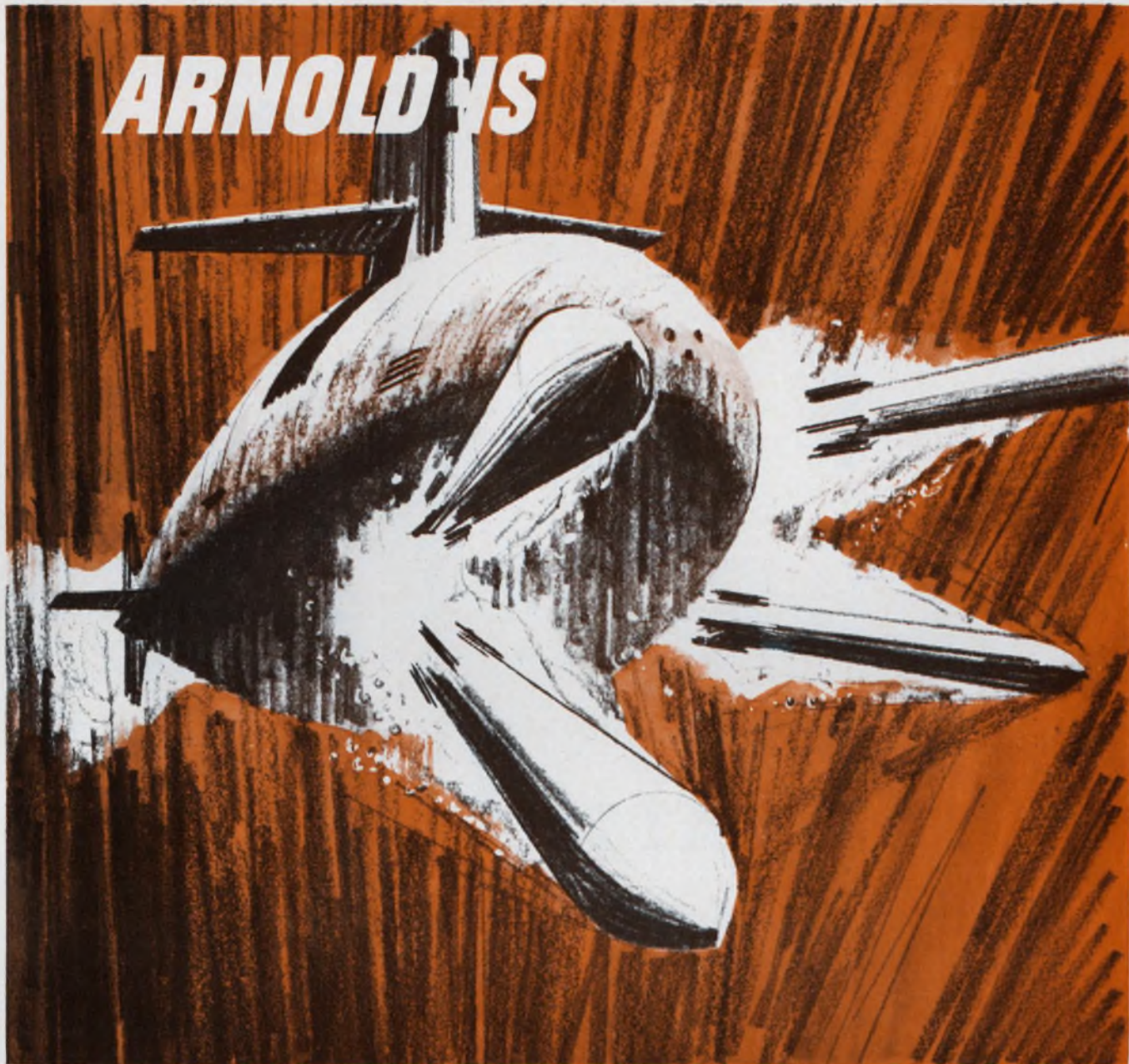

SILECTRON CORES

Standard and Custom Designed Cores With Highest Performance Characteristics

Arnold Silectron cores are fabricated from the highest grades of grain-oriented silicon steel. We maintain complete control over all phases of fabrication . . . processing, rolling, slitting, winding, annealing and final test are all "in plant" functions. Many are in stock ready for same day shipment.

Arnold is also ■ Permanent Magnets ■ Tape Wound Cores ■ Bobbin Cores ■ MPP Cores ■ Iron Powder Cores ■ Electrical Alloy Transformer Laminations ■ Transformer Cans & Hardware ■ Magnetic Shields ■ Special Magnetic Materials

Our facilities are complete



THE ARNOLD ENGINEERING COMPANY, Main Office MARENGO, ILL.
BRANCH OFFICES and REPRESENTATIVES in PRINCIPAL CITIES

See us at the IEEE Show, rooms 3000A & B. New York Coliseum

ON READER-SERVICE CARD CIRCLE 208

IT FLOATS!

Whether you are exciting a transducer or powering a sensitive "IC" circuit it is comforting to know that your power supply is completely Floating... and is free of line transients or common mode interference. The SRC 3569 gives you this protection. It's the closest thing to a "Perfect Battery" you can find. Even without this Floating Feature the SRC 3569 would still be industry's best power supply value at \$129. No wonder thousands of engineers are calling SRC "Mighty Mites" ... "MY PERSONAL POWER SUPPLY."



A HUSKY HALF AN AMP OUTPUT FROM 0 TO 30 VOLTS • Plenty of Power Packed into this Compact Supply. Output Current is a husky half an ampere over the output voltage range of 0 to 30 volts, continuously adjustable at the front panel in two convenient ranges.

LOW, LOW RIPPLE FOR "IC" POWERING • Production "Supermites" are coming off the line with less than 100 micro volts of peak to peak ripple... which is certainly important to you in this day of "ICs" and Sensitive Transducers.

0.02% REGULATION... BOTH LOAD AND LINE • When you set the Output Voltage of the 3569 it stays within

0.02% from no load to full load and over 10% line voltage variation. Time and Temperature Stability is great also. 0.005%/°F and less than 0.01% change over 8 hours.

"SUPERMITE" IS YOUR PERSONAL POWER SUPPLY • The SRC 3569 is Your Personal Power Supply because it's small enough to fit inside your desk drawer when you're not using it. It's only 2½ inches high, less than 5 inches wide, and 7¼ inches deep. The All-Silicon, Solid-State package weighs but 4 pounds, dripping wet!

SIX FOOT LINE CORD TOO • When SRC Engineers decide to build a top quality product they go all the way. A heavy duty Six Foot Power cord is provided, and Rubber Feet protect other equipment if you happen to set "Supermite" on top.

... AND DON'T FORGET THAT ISOLATION (OR THE PRICE) • Isolation really sets the 3569 apart from other power supplies. Ten thousand megohms DC and less than 0.1 pico farad AC. Some customers call it the "Perfect Battery!" So add up the features and the \$129 price tag and there's no doubt that the SRC 3569 is a whale of a buy. That must be why so many Engineers are ordering them by the dozen. One or a dozen, order your personal power supply today.

SYSTEMS RESEARCH CORPORATION

2309 Pontius Avenue • Los Angeles, California 90064 • Phone (213) 477-4573

ON READER-SERVICE CARD CIRCLE 209

Application Notes

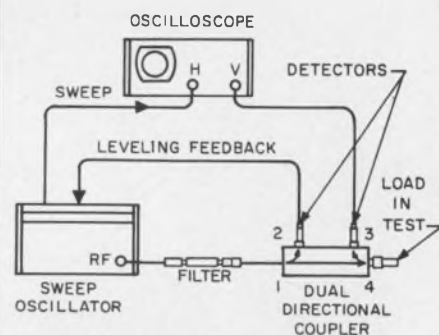

Swept frequency vswr

A 7-page brochure describes the measurement of vswr vs frequency, using a slotted-line dual directional coupler, sweep oscillator and variable-persistence oscilloscope. The scope displays a sweep pattern whose vertical thickness is proportional to vswr for any frequency along the horizontal axis. The brochure is well illustrated with photo and diagrammatic setups and scope patterns. Hewlett-Packard.

CIRCLE NO. 318

Electronic timers

A 2-page note gives specs and 5 applications on the manufacturer's model 484 summation timing module. Physical dimensions, wiring diagram and schematic of a dc power supply are supplied. Applications include batch counting, weighing systems, pulse generation circuits, pulse monitoring systems, production testing of time delay relays, and others. Artisan Electronics Corp.

CIRCLE NO. 319

Magnetic multipliers

Six sheets of data explain the application of magnetoresistive multipliers. Multiplication of two independent variables is accomplished by the interaction of a magnetic field with the imbalance of a magnetic flux-sensitive bridge. Formulas, circuitry and graphs are provided on a variety of applications. American Aerospace Controls, Inc.

CIRCLE NO. 320

have you noticed how everybody's just introducing big, fast, core-memory systems that we've been delivering for more than a year?

When we first introduced our NANOMEMORY™ 900 at the 1964 Fall Joint Computer Conference, we claimed an access time of 350 nanoseconds and a memory capacity of 16,384 words of 84 bits. A little later we developed the NANOMEMORY 650. Same capacity but with an access time of 300 nanoseconds.

Soon after we started shipping, reports came in calling our claims, if anything, too conservative. Operating margins were indeed wider. And with the stack connections reduced by 80%, the reliability gave maintenance managers no end of pleasure. But more gratifying than the compliments were the re-orders. Of the many systems being assembled on the floor right now, 80% are engaged. If you want to stay ahead of your competition, call or write us about the 20% that are still unattached. Ask for Litpak 6E.

EM electronic memories

12621 Chadron Avenue, Hawthorne, California 90250
Telephone (213) 772-5201

ON READER-SERVICE CARD CIRCLE 24



**nothing's
special
but the
delivery**



**special cables to solve
special problems are
an everyday job at
Columbia Wire. If
we don't have the
cable in stock for
immediate delivery
we have the knowledge
skill and facilities
for producing it fast.**

write for our fully-illustrated catalog



Columbia 
WIRE PRODUCTS COMPANY
2850 Irving Park Rd., Chicago, Ill. 60618
ON READER-SERVICE CARD CIRCLE 783

New Literature



Static inverters

Solid-state static inverters from watts to kilowatts is the subject of this 4-page brochure. Basic operation and performance characteristics for both single and 3-phase applications are presented. Oscilloscope photographs illustrate output wave shapes and the inverter system's dynamic response to load transfers and short circuit conditions. TRW, Equipment Operations.

CIRCLE NO. 321

Cleanliness in electronics

"How Clean Is Clean In Electronics?" is the title of a technical bulletin that concerns itself with the effects of dirt and moisture on soldering operations. The author, Howard H. Manko of Alpha Metals, discusses the relative merits of two basic approaches to clean soldering. Some common-sense guidelines and descriptions of cleaning processes are provided. Alpha Metals, Inc.

CIRCLE NO. 322

Applied research

A 44-page booklet entitled "Defense Electronics Products Applied Research" has articles on lasers, computers, high-speed digital circuits, automata theory, precision control systems and other timely subjects. Photographs, circuits and graphs illustrate the text. Radio Corp. of America.

CIRCLE NO. 323

IC packaging system

Four pages of photos and descriptive matter on an integrated circuit packaging system describe the system's capabilities in aerospace applications where maximum packaging density, reliability and standardization of components is a necessity. ITT Cannon Electric.

CIRCLE NO. 324

"Understanding the Atom"

The Atomic Energy Commission is publishing a series of booklets on "Understanding the Atom." The booklets are written in a simple and informative manner, and contain bibliographies covering pertinent books, booklets, articles and motion pictures.

"SNAP Nuclear Space Reactors" deals with the problem of furnishing space vehicles with power for operation, living conditions and communication facilities over long voyages. For small, highly efficient, light-weight sources, the answer is the nuclear space reactor. This booklet discusses the background and the future requirements of space power plants and their principles of operation.

CIRCLE NO. 325

"Computers" takes the reader from the most primitive methods of computation to the very advanced modern digital computers. The essential parts of the computer are analyzed: the control unit, the arithmetic unit, memory, input and output. Analog and digital methods, and how and when to use them, are discussed, and problems, with answers, are included.

CIRCLE NO. 326

"Nondestructive Testing" begins with an introductory discussion of what is meant by nondestructive testing, and carries us through a number of materials tests. Such tests, employing penetrants, ultrasonics, penetrating-radiation and fluorescent techniques, are outlined in detail, and their applications and relative advantages are discussed.

CIRCLE NO. 327

MAGNETIC INTERFERENCE STOPPED PERMANENTLY

by Netic Co-Netic Shields designed and fabricated by Magnetic Shielding Specialists

New shield designs meet the new shielding specifications... from a few gammas to several thousand gauss. Over 80% of all magnetic shield designs currently used were engineered and designed here. This design experience is at your service.

Sheet Stock also available.

Applications

Military Command & Control Systems • Strategic Systems • Tactical Systems • Computer Display Systems

Unique Features of Netic Co-Netic Shields

Provide permanently effective shielding • Insensitive to ordinary shock • Minimally retentive • Provide up to 80 db attenuation.

DELIVERY 3-4 WEEKS IN MOST INSTANCES

Request Short Form Catalog No. 67



Photomultiplier & CRT Shields



CRT Sectionalized Shields



Scan Converter Tube Shields



MAGNETIC SHIELD DIVISION

Perfection Mica Company

1322 N. ELSTON AVENUE, CHICAGO, ILLINOIS 60622

ORIGINATORS OF PERMANENTLY EFFECTIVE NETIC CO-NETIC MAGNETIC SHIELDING

ON READER-SERVICE CARD CIRCLE 784

FREE TECHNICAL MICA MANUAL K-6

gives electrical and physical data on all types of mica

No tooling cost on numerous fabricated parts of natural and built-up mica.

Pre-punched insulating wafers to electrically isolate transistors, diodes, etc. from heat sinks.

Corrugated mica to reduce handling and fabrication costs for thermal elements.

All grades of mica offered.

Immediate delivery from stock on many items.

PERFECTION MICA CO.

1322 No. Elston Ave.

Chicago, Illinois 60622

Phone: 312, EV 4-2122



NEW! DYNAMIC IC TESTER

simulates actual in-circuit conditions

The MONITOR Model 851 dynamically tests all commonly used integrated circuit types and package configurations.

It makes a full operational check on an IC in less than 15 seconds, at the actual in-circuit pulse rates, logic levels, and voltages called for by your system. The Model 851 is a complete, portable package (even includes a vacuum pickup for flatpack handling). All you need is a scope. It is obsolescence-proof, via interchangeable IC adapter sockets and test program plugs.

But the real clincher is the price: \$1,920. Descriptive literature? Get in touch with us.



MONITOR SYSTEMS INC. A subsidiary of Epsco, Inc.

Fort Washington, Pa. 19034 □ Phone 215-646-8100

3597

TWX 510-661-1520

ON READER-SERVICE CARD CIRCLE 785

ELECTRONIC DESIGN 3, February 1, 1967

to your exact specifications...



at stock prices

METALIZED MYLAR CAPACITORS

Unique, self-healing units that remain in circuit during voltage surges with little or no loss of electrical properties. Use the M2W's where size and weight are limiting factors and long life and dependability are required. The units utilize metalized Mylar* Dielectric with film wrap and custom formulated epoxy resin end fill. Available in round and flat styles.

*Du Pont Trademark for Polyester Film

Samples available on your letterhead request

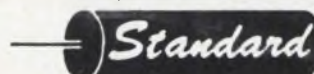

CONDENSER

CORPORATION

DEPT ED-2, 1065 W. ADDISON, CHICAGO, ILLINOIS 60613

ON READER-SERVICE CARD CIRCLE 786

**The
easiest way
to cut
component
costs.**

Farm them out!



**Read why
in Art Wire's
New Bulletin
501**

Learn why Art Wire consistently produces wire forms, small parts stampings and cut tubing at considerable savings over your in-plant costs. And how we can go into high-speed automatic production even faster. For your copy use the inquiry card. If you're in a hurry, call 201-621-7272.

ART WIRE & STAMPING CO.

17 Boyden Place, Newark, N. J. 07102

ON READER-SERVICE CARD CIRCLE 787

NEW LITERATURE

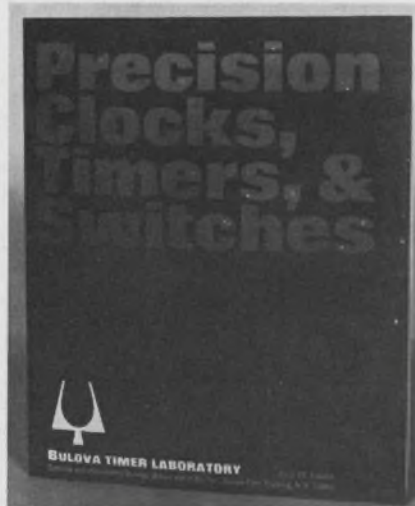

Clock-timer-switch catalog

A 15-page catalog lists and describes a line of non-consumer precision clocks, timers and switches.

The catalog details the characteristics and specifications of the electronic timekeeping unit used by all models in the line. Listed also are the effects of acceleration, attitude, magnetism, moisture, nuclear radiation, barometric pressure, RF field, temperature, shock and vibration. Timer Laboratory, Bulova Systems & Instruments.

CIRCLE NO. 328

Potentiometer line

An illustrated 64-page catalog describing a line of 15 potentiometers has been published by the company's Industrial Division. The brochure contains detailed data and specifications on circular and strip chart recorders, indicators and controllers, including dimensions. Information on operators' desks and consoles, primary measuring elements and special-purpose measurements is also included. Honeywell Industrial Division.

CIRCLE NO. 329

Liquid epoxy resins

Composition, characteristics and use of Dow's liquid epoxy resins are given in a 36-page brochure. Also discussed are curing agents, reactive diluents, modifiers, fillers and formulation processing techniques. The bulletin also includes comprehensive data on resin performance, plus information on storage and handling. Dow Chemical.

CIRCLE NO. 330

Infrared filters

A 2-page bulletin describing and showing curves for visible and near infrared filters is available. Seven curves showing filters with 0.7% to 25% bandwidth are provided. Transmissions of the filters described range from 30% to 60%. Spectrum Systems, Inc.

CIRCLE NO. 331

Anechoic chambers

A four-page folder describing some of the latest high performance anechoic chambers pictures seven recently built chambers. The folder contains some pertinent remarks about safety. Emerson & Cuming, Inc.

CIRCLE NO. 332



Computer literature

A new fold-out brochure covers a line of desktop computers. With specific applications for scientists, engineers, statisticians and civil engineers, these solid-state, core memory computers have special pre-wired programs for automatic solution of frequently used formulas. This three-color brochure includes information covering add-on peripherals for page printing, paper tape I/O and expanded memory. Mathatronics Div. of Barry Wright Corp.

CIRCLE NO. 333

**Standard
Wakefield
Packages
Customized:**

- Confined Airflow Series
- Open Airflow Series
- Liquid Cooled Plates

**Special Coolers
or Assemblies**

- engineered cooling packages
- special fabrications
- unique hole/fin patterns
- special extrusions

Write for
CATALOG NO. 17 . . .
24 pages of technical data.

**make
or buy?**

A great solution . . .
**SEMICONDUCTOR
COOLING PACKAGES**
by Wakefield



Open Airflow FCA-1100 Package
with customized mounting holes.

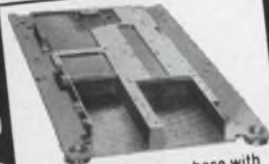

Machined aluminum base with
staked-in fins for cooling.

**WAKEFIELD
ENGINEERING, INC.**

WAKEFIELD, MASS. 01880 • (617) 245-5900 • TWX 617-245-9213
ON READER-SERVICE CARD CIRCLE 788

**-120°F to +350°F
on a bench!**



The New Improved Tenney Jr. Bench Model, Mechanically Refrigerated, High-Low Temperature Test Chamber features wider temperature range with $\pm 1/2^\circ$ F control throughout with indicator. Full 1,400 cu. in. test area. New, faster pull down. greater load dissipation. New fan guard. 2¢ per hour average operating cost! Hermetically sealed inside and out. Weighs only 200 lbs. Simple plug-in operation.

Still priced at only **\$990** complete.
Available immediately.

To order, or for more information, write to



Tenney
ENGINEERING, INC.

1090 Springfield Road • Union, New Jersey

Western div.: 15700 S. Garfield Ave. • Paramount, Calif. 90723
Oldest and Largest Manufacturer of Aerospace and Environmental Equipment

ON READER-SERVICE CARD CIRCLE 789

**IT'S HARD TO
CONTACT YOU
IF YOU DON'T
CONTACT US.**

It isn't that we don't have a phone or men out beating the bushes. It's just that, if you don't let us know about any electrical contact or sub-assembly problem you might have, we may not find you. And that would be a shame. You'd be depriving yourself of the opportunity of dealing with people who have seen enough contact problems to realize that yours may well be different from all the others. And, people who know what to do about your problem!

Once a solution is reached, it is executed with the finest, most modern, and in many cases, exclusive facilities in our industry. That's another reason it would be a shame not to get in touch with us. Two more are service (and our eager approach to it) and delivery (we break our necks to be prompt). So do us a favor by doing yourself a favor. Next time the subject of contacts comes up, contact Deringer. It's your best bet for quick, economical service.



FOR CONTACTS—CONTACT

DERINGER

METALLURGICAL CORPORATION

1250 Town Line Road - Mundelein, Illinois 60060

ON READER-SERVICE CARD CIRCLE 790

NOW FROM

A Complete Automotive and Ignition Tune-Up System



MARK TEN
Capacitive Discharge
Ignition System

\$44⁹⁵ Assembled
\$29⁹⁵ Kit Form

Get mileage you never dreamed of! 3 to 10 times spark plug life. Instant starts in all weather. Installs in only 10 minutes. Up to 20% gas savings. Dramatic increase in engine performance and acceleration.

2 NEW AUTO TUNE UP INSTRUMENTS



DWELL
METER
\$12.95
Ppd.



TACH
METER
\$14.95
Ppd.

These two new cousins to the world famous proven MARK TEN now give you the capability to tune your own car inexpensively, easily, with remarkable precision. These separate instruments are low cost, portable and the easiest to read you've ever seen.

- Delta's famous printed circuit design
- Superior in precision, quality and performance to instruments selling for FIVE TIMES as much
- Large dial, high quality jewel D'Arsonval meters
- Operates with standard, transistor or capacitive discharge systems as well as magnetos
- Instant readings — no confusing scales

Send Your Order Today



DELTA PRODUCTS, INC.

P.O. Box 1147 ED • Grand Junction, Colo.
Enclosed is \$_____. Ship prepaid.
 Ship C.O.D.

Please send:

- Dwell Meters @ \$12.95
 Tach Meters @ \$14.95
 Mark Tens (Assembled) @ \$44.95
 Mark Tens (Delta Kit) @ \$29.95
 (12 volt positive or negative ground only)

SPECIFY — Positive Negative
 6 or 12 Volt

Car Year _____ Make _____
Name _____
Address _____
City/State _____ Zip _____

NEW LITERATURE

Basic capacitor theory

A comprehensive 30-page book is exclusively devoted to capacitors. Starting with the basic parallel plate experiment, circuits are discussed, applications given and resonance curves and reactance tables are shown. ITT.

CIRCLE NO. 334



Fused quartz products

A new 48-page catalog covers the manufacturer's line of pure fused quartz laboratory and industrial ware and specialized quartz products. Also included are informative sections covering the physical properties of synthetic high-purity quartz. Thermal American Fused Quartz.

CIRCLE NO. 335

Computer age glossary

To facilitate common understanding of computer talk, "Words of the Computer Age," an abridged glossary of terms used in modern information processing, is designed to assist the "computer-using" executive. It is a streamlined, condensed version of the "USA Standard Vocabulary for Information Processing," published by the United States of America Standards Institute. The 320-term glossary is designed specifically for the "user."

Available for 25¢ (\$20 per 100) from Newsweek, 444 Madison Ave., New York, N.Y. 10022

Mercury switch use

A three-part, 16-page 8-1/2 x 11-in. publication gives detailed information about mercury switch application and specifications. Included in the specs are selections devoted to electrical ratings, resistance, performance characteristics, temperature characteristics, load vs life and circuitry information.

Circuitry information describes mercury to dry electrodes, mercury to wetted electrodes and mercury to mercury electrodes with an explanation of each installation. A handy lexicon of mercury switch terminology is included. Micro Switch Div. of Honeywell, Inc.

CIRCLE NO. 336

Metals monograph

"Clean" metals is the subject of a four-page brochure. The monograph concerns itself with the chemical, physical and medical problems caused by tiny foreign matter and voids in stainless alloy wire, especially in small sizes below 0.005-in. diameter. Fort Wayne Metals, Inc.

CIRCLE NO. 337

Solid-state timers

A 6-page catalog covers a line of solid-state counter-timers, and bidirectional, variable time base, and preset counters. Prices and specs for over 30 counters are included. Anadex Instruments, Inc.

CIRCLE NO. 338

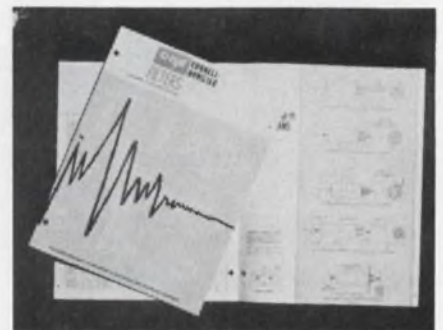

RFI filter catalog

A 16-page RFI filter catalog is available. This catalog has been designed to help the design engineer select the proper filter necessary to eliminate unwanted RFI. Cornell-Dubilier Electronics.

CIRCLE NO. 339

ON READER-SERVICE CARD CIRCLE 791

With EASTMAN 910[®] Adhesive...

Rubber-to-glass bonds— in seconds.

To protect the television receiver's delicate cathode ray tube during shipping and through years of normal use, EASTMAN 910 Adhesive is used to bond a protective rubber strip around the implosion shield.



The rapid set of EASTMAN 910 Adhesive is ideally suited for this production line operation. Just a few drops of EASTMAN 910 Adhesive for about 1/4¢ per drop and only hand pressure gives a strong, long lasting bond.

EASTMAN 910 Adhesive will form bonds with almost any kind of material without heat, solvent evaporation, catalysts, or more than contact pressure. Try it on your toughest bonding job.

For technical data and additional information, write Chemicals Division, EASTMAN CHEMICAL PRODUCTS, INC., subsidiary of Eastman Kodak Company, Kingsport, Tennessee. EASTMAN 910 Adhesive is distributed by Armstrong Cork Company, Industry Products Division, Lancaster, Pa.

Here are some of the bonds that can be made with EASTMAN 910 Adhesive

Among the stronger: steel, aluminum, brass, copper; vinyls, phenolics, cellulose, polyesters, polyurethanes, nylon; butyl, nitrile, SBR, natural rubber, most types of neoprene; most woods. Among the weaker: polystyrene, polyethylene (shear strengths up to 150 lb./sq. in.).

ON READER-SERVICE CARD CIRCLE 792



There is no adhesive like EASTMAN 910[®] Adhesive

SETS FAST—Makes firm bonds in seconds to minutes.
VERSATILE—Joins virtually any combination of materials.

HIGH STRENGTH—Up to 5,000 lb./in.² depending on the materials being bonded.

READY TO USE—No catalyst or mixing necessary.

CURES AT ROOM TEMPERATURE—No heat required to initiate or accelerate setting.

CONTACT PRESSURE SUFFICIENT.

LOW SHRINKAGE—Virtually no shrinkage on setting as neither solvent nor heat is used.

GOES FAR—One-pound package contains about 30,000 one-drop applications. (Or in more specific terms, approximately 20 fast setting one-drop applications for a nickel.)

The use of EASTMAN 910 Adhesive is not suggested at temperatures continuously above 175°F., or in the presence of extreme moisture for prolonged periods.

See Sweets' 1967 Product Design File 6a/Ea.

Now available! EASTMAN 910 Surface Activator. When certain surface conditions inhibit rapid bond formation, use of EASTMAN 910 Surface Activator is suggested to restore the rapid polymerization of EASTMAN 910 Adhesive.

Electrical Impulse Totalizing Counters



High Speed • Provide Printed Results

Series 481 electrical impulse counters measure fluid-flow, quantity, size, time, weight, speed or temperature. Pulses (up to 50 per second) can be added or subtracted and converted to running totals printed on cards, card sets or continuous paper rolls. Printing is electrical or manual.

Reset is electrical or push button. Standard voltage is 115 volts 60 cycles. Special voltages and photoelectric input equipment available.



Write for specifications on this and other ENM counters

ENM COMPANY

5306 W. Lawrence Ave., Chicago, Ill. 60630
PHONE: (312) 282-8787 TELEX: 02-5468

Representatives in principal cities

ON READER-SERVICE CARD CIRCLE 793

ELECTRONIC DESIGN 3, February 1, 1967



Littelfuse Indicating Microfuse Holders for military and commercial applications. Ranges 2-1/2 to 130 Volts. Also available with RFI shielding.



LITTELFUSE

DES PLAINES, ILLINOIS

ON READER-SERVICE CARD CIRCLE 890

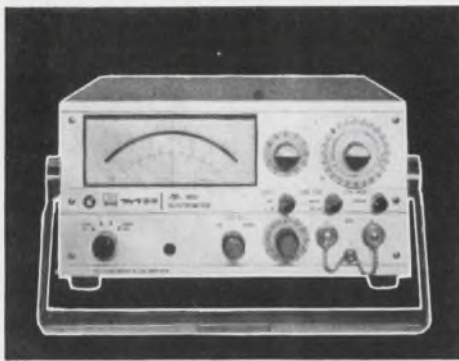

UNANNOUNCED NEW ELECTROMETER -TR- 8651 FOR EASY AND HANDY MEASUREMENT

FEATURES:

-TR- 8651 ELECTROMETER is conveniently used for:

Measurements of ● Semiconductor resistivity ● Insulation ● Piezo-electric charge ● Photo-electric current

-TR- 8651 ELECTROMETER measures:

● **Voltage** from 1 mV to 100 V f.s. (11 range) with $\pm 0.5\%$ accuracy ● **Charge** from 10^{-12} to 10^{-5} coulomb f.s. ● **Current** from 10^{-14} to 0.3 A f.s. ● **Resistance** from 100 to 10^{14} f.s.

SPECIFICATIONS:

RANGE:

● **Voltage:** 1, 3, 10, 30mV, 0.1, 0.3, 1, 3, 10, 30 and 100V f.s. ● **Charge:** 10^{-12} to 10^{-5} coulomb f.s. (1× and 3× overlapping ranges) ● **Current:** 10^{-14} to 0.3 A f.s. (1× and 3× overlapping ranges) ● **Resistance:** 10^2 to 10^{14} f.s. on linear 1× and 3× overlapping ranges.

For further details, write to:



**Takeda Riken
Industry Co., Ltd.**

285, Asahi-cho, Nerima-ku, Tokyo,
Japan Cables: TRITRONICS TOKYO
Phones: 930-4111

ON READER-SERVICE CARD CIRCLE 891

NEW LITERATURE



RF coaxial connectors

A 56-page illustrated catalog of RF connectors of BNC, TNC, N and C types is offered. The catalog contains more than 70 new additions to Sealectro's line. The literature describes over 400 connectors. Also included is a convenient cross-reference chart listing UG numbers vs Sealectro's part numbers. Subminiature coaxial cable charts are included as well. Sealectro Corp.

CIRCLE NO. 340

Precision switch catalog

This 28-page catalog offers "all the information a buyer needs to know" about 19 different series of Cherry precision switches. The book contains detailed illustrations accompanied by information on special features, button and terminal variations, and operating characteristics. Among the switches shown and described are general purpose, single and double pole, miniature, subminiature, low torque, open type cam follower, coin, stack type, one way action and alternate action type. Switches are categorized according to such characteristics as size, electrical capacity, operating force and mounting configuration. Cherry Electrical Products Corp.

CIRCLE NO. 341

Waterproof connectors

A 4-page catalog revision has been issued describing a line of electrical connectors designed for underwater duty. ITT Cannon Electric.

CIRCLE NO. 342

Semiconductor catalog

TRW Semiconductors offers their short form catalog for 1967. The 20-page publication covers several hundred items and introduces new communications transistors in the 1-GHz range, new fuse and log diodes, new micro diodes and numerous special types. TRW Semiconductors.

CIRCLE NO. 343

X-band noise generator

A miniature X-band noise generator is described in detail on a two-page illustrated data sheet. Included is a description of the manufacturer's noise generator and a discussion of excess noise ratio. Typical applications in the receiver arm and in the antenna arm are shown in block diagram form. Signalite, Inc.

CIRCLE NO. 344

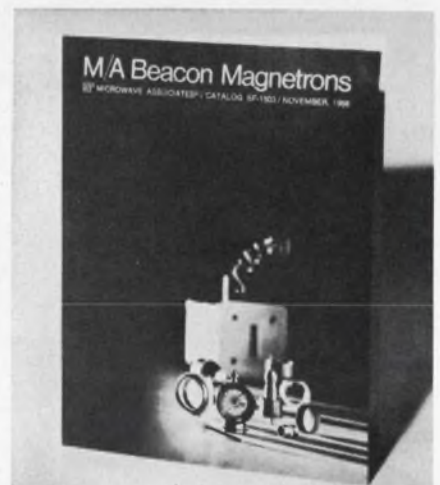

Beacon magnetrons

A four-page, illustrated booklet describes the company's complete line of fixed frequency and tunable beacon magnetrons. Full specs and typical applications are given. Microwave Associates.

CIRCLE NO. 345

Coax bulletin

"Styroflex" coaxial cable is described in a 12-page technical bulletin. The literature details electrical, physical and mechanical characteristics of the cable. Also included are data on connectors, performance curves and tables. Phelps Dodge Electronic Products.

CIRCLE NO. 346



**Perfectionists
praise
Gordos
zero-failure
switches.
How speedy,
durable,
and
bounce-free
they are!**

Write or
phone for
your free
catalog.

GORDOS
CORPORATION

250 Glenwood Ave., Bloomfield, N.J. 07003 (201) 743-6800

ON READER-SERVICE CARD CIRCLE 892

**NOW! 2 SUPERIOR
DRY FILM LUBRICANTS
tailored for your
specific industrial needs!**

1 **FEL-PRO C-300**
Air-dries and cures in 1 hour
while offering -65°F. to
1200°F. protection

2 **FEL-PRO C-200**
Bakes on to give outstanding
performance throughout -65°F.
to 2400°F. range

High-temperature and low-speed lubricating problems? Forget oils, greases and other short-life lubricants! These non-corrosive FEL-PRO products brush or spray on quickly, then dry to a solid yet slick film that fights friction, wear, abrasion, fretting. Either type provides positive, long-life protection for all metals and their derivative alloys. Ideally suited for heavy-load, low-speed applications that require excellent adhesion and extreme pressure resistance. Try C-300 or C-200 once . . . and you'll never settle for less!

Write on your letterhead for free sample, technical data, and price information. Please state which product desired and intended application.



FEL-PRO FEL-PRO, INC., A Division of Felt Products Mfg. Co.
7450 N. McCormick Blvd., Dept. 000, Skokie, Ill. 60076

ON READER-SERVICE CARD CIRCLE 893

**SCR FIRING
CIRCUIT
MODULE
UNDER \$40.**

*for
immediate
delivery*

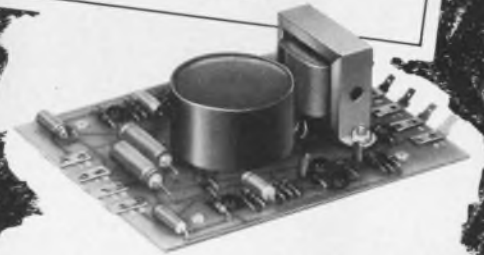

Would you believe that
Crydom's SCR FIRING CIRCUIT
MODULE is technically superior
to all others?

You say, "show me." That's exactly what we want to do! The completely new CRYDOM SCR FIRING CIRCUIT MODULE features hard gate firing, 50 micro-watt control sensitivity, high linearity, 100 nanosecond rise time and negative gate bias. In addition, fast response is combined with the ability to detect polarity, making an ideal component for closed loop applications. All of these features are now available at unprecedented **low prices**. Write for CRYDOM TECHNICAL BULLETIN 1.6 for a complete description of a truly superior SCR firing circuit module.



CRYDOM laboratories, inc.

3115 West Warner Ave., Santa Ana, California
Area Code 714 • 540-1390

ON READER-SERVICE CARD CIRCLE 894

Rundown on space

Based on involvement in nine out of ten space launches over the past year or so, TRW Systems has published a 22-page brochure on recent space efforts. The talent of staff artists is particularly evident in this attractive booklet. TRW Systems.

CIRCLE NO. 347

Power hybrid

A series of power hybrids designed to handle power levels useful for transmitter as well as receiver applications from 2 to 76 MHz is described in this data sheet. The units operate at 500 W cw in the 2- to 76-MHz range. Adams-Russell Co.

CIRCLE NO. 348

Accuracy Policy

It is the policy of ELECTRONIC DESIGN:

To make reasonable efforts to insure accuracy of editorial matter.
To publish promptly corrections brought to our attention.

To reserve the right to refuse any advertisement deemed misleading or fraudulent.

All editorial correspondence should be sent to:

Howard Bierman, Editor
ELECTRONIC DESIGN
850 Third Avenue
New York, N. Y. 10022

Subscription Policy

ELECTRONIC DESIGN is circulated free of charge to qualified design engineers in the U.S., Western European Continent and Britain. To establish your qualifications, send ELECTRONIC DESIGN the following information on your company's letterhead: Your name, engineering title, description of your design duties and a list of your company's major products. The letter must be signed by you personally.

Subscription rates for nonqualified subscribers—\$25 a year in the U.S., \$35 in all other countries. Single copy, \$1.50.

Change of Address

A subscriber's change of address requires a restatement of his qualifications. To expedite the change, and to avoid missing any issues, send along a label from a back copy.

Microfilm Copies

Microfilm copies of all 1961, 1962, 1963, 1964, 1965 and 1966 issues of ELECTRONIC DESIGN are available through University Microfilms, Inc., 300 N. Zeeb Road, Ann Arbor, Mich. 48106

Design Data from

New "Tape Lift" Printed Circuit Drafting

Aids

No engineer or draftsman should be without the most up-to-date cross-reference guide to better Printed Circuit Drafting Catalog. It is complete with prices and illustrations of over 1200 sizes of "Tape Lift" pads, shapes and other aids for faster, more accurate, distortion-free printed circuit master drawings.



By-Buk Company

4326 West Pico Blvd., Los Angeles, Calif. 90019

Telephone: (213) 937-3511

171

Quality Fasteners For All Design Applications

This 8-page catalog provides design data on the complete group of DZUS 1/4-turn self-locking fasteners for standard, high speed and panel applications, as well as universal high strength multiple thread fasteners for high tensile and shear stresses. Dzus stud assemblies, wire forms and receptacles offer an exceptional, wide variety of combinations from stock to fit specific fastening requirements. Diagrams and tables give full details for rapid, unlimited design selection. Condensed Catalog No. S-2 or comprehensive Catalog No. D-3 are available on request.



Dzus Fastener Co., Inc.

Division 32

425 Union Boulevard
West Islip, L. I., N. Y. 11795

173

High -Vacuum Pump Selector

Free 24-page technical bulletin gives complete specifications and prices on the internal vane vacuum pump line of Precision Scientific Co., a subsidiary of GCA Corporation. Single and two-stage models range from 25 to 1,500 liters/min. free air displacement. As low as 0.1 micron ultimate vacuum. New design features are: exceptionally quiet operation, higher pumping speeds, compact size, lighter weight. Bulletin includes section on new hand-tight, fast-opening vacuum fittings.



Precision Scientific Co.

3737 West Cortland Street
Chicago, Illinois 60647

175

Manufacturers

Advertisements of booklets, brochures, catalogs and data sheets. To order use Reader-ServiceCard.

Schweber Catalog Of Motorola Semiconductors

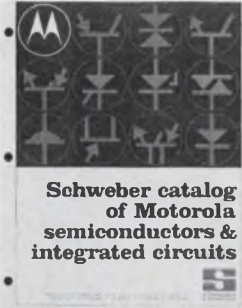

This is the new 1967 condensed catalog of Motorola Semiconductors and Integrated Circuits just off the press. There are 20 sections in this 36-page catalog—from Integrated Circuits to Photo-sensitive Detectors, and between these outposts the famous Motorola Zener diodes, FET'S Thyristors, Power transistors, and others. Easy-to-read parameter charts, pictures, outline dimensions. One of the industry's deepest and broadest line of semiconductors condensed in this single catalog.

Schweber Electronics

Westbury, New York 11591
516-334-7474

172

Adjustable 0-34V, 1.5A Power Supply



Regulation: 0.005% or 1 MV Ripple: 250 μ V
 Output: Adjustable 0-34V, to 1.5A Completely short circuit proof Designed to meet environment MIL-E-5272 All silicon semiconductors Operate to 71°C Compact 3 $\frac{1}{4}$ " x 3 $\frac{3}{8}$ " x 6 $\frac{7}{8}$ " size Top quality components & construction Units operate in series or parallel Temp. Coef: 0.01%/°C Response: less than 20 μ s MTBF: greater than 100,000 hrs. per MIL HDBK 217 Remote sensing Universal 3-position mounting Three year warranty Only \$88.00 F.O.B. Hackensack, N. J. Write today.

Power/Mate Corporation

163 Clay St., Hackensack, N. J. 07601
(201) 343-6294

174

New Magnetic Component Catalogue



PULSE ENGINEERING'S 1967 Magnetic Component Catalogue lists over 300 in-stock Pulse and High Frequency transformers. Designs extends from tiny Computer Transformers for Core Memories up to Transfer Molded Pulse Coupling Transformers that operate at 12 KV. Included are new technical data of value to the magnetic component user. Special sections describe specification and test procedures for component engineers and applications for circuit engineers. For your free copy of this valuable reference write:

Pulse Engineering Inc.

560 Robert Avenue
Santa Clara, California 95050

176

Electronic Design

Advertising Representatives

New York 10022

Robert W. Gascoigne
Thomas P. Barth
Samuel M. Deitch
Richard W. Nielson
850 Third Avenue
(212) PLaza 1-5530
TWX: 867-7866

Philadelphia

Fred L. Mowlds, Jr.
P. O. Box 206
Merion Station, Pa. 19066
(215) MO 4-1073

Boston

Richard Parker
7 Redstone Lane
Marblehead, Mass. 01945
(617) 742-0252

Chicago 60611

Thomas P. Kavooras
Berry Conner, Jr.
720 N. Michigan
(312) 337-0588

Cleveland

Robert W. Patrick
8410 Treetower Drive
Chagrin Falls, Ohio 44107
(216) 247-7670

Los Angeles 90303

Stanley I. Ehrenclou
Terrence D. Buckley
W. James Bischof
2930 W. Imperial Highway
Inglewood, Calif.
(213) 757-0183

San Francisco

Ashley P. Hartman
175 South San Antonio Rd.
Ste. 243
Los Altos, Calif. 94022
(415) 941-3084

Southwestern 75206

Tommy L. Wilson
6200 North Central Expressway
Dallas, Tex.
(214) EMerson 1-2311

London W. 1

Brayton C. Nichols
44 Conduit Street

Verviers, Belgium

Andre Jamar
1, Rue Mallar, 1
(087) 253.85

Tokyo

Yoshihiro Takemura
International Planning
Service, Inc.
Room 231 Tokyu-Mita Bldg.
1, Shiba-Mita Koun-cho
Minato-ku, Tokyo



Advertisers' Index

Advertiser	Page	Advertiser	Page	Advertiser	Page
ACI Division, Kent Corporation	151	Corporation	80A-B-C-D	Paktron Division,	
ADC Products, A Division of		Fel Pro, Inc.	203	Illinois Tool Works Inc.	170
Magnetic Control Co.	178	Fluke Mfg. Co., Inc., John	127	Pamona Electronics Co., Inc.	33
Acopian Corporation	175	General Electric Company,		Perfection Mica Company	197
Adams & Westlake Company	75	Electronic Components Division	28	Perkin Elmer Corporation	132
Alfred Electronics	95	General Electric Company,		Philbrick Researches, Inc.	7
Allen-Bradley Co.	6	Lamp Metals & Components Dept.	174	Phillips Advance Products	171
American Aluminum Company	73	General Instrument Corporation	8	Plastic Capacitors, Inc.	172
Ammon Instruments, Inc.	185	General Radio Company	117	Polaroid Corporation	108
Amperex Electronic Corporation	101	Gordos Corporation	203	Potter & Brumfield Division of American	
Amphenol Connector Division,		Grayhill, Inc.	181	Machine & Foundry Company	43
Amphenol Corporation	90, 91	Gudebrod Bros. Silk Co., Inc.	169	Power/Mate Corp.	205
Anadex Instruments, Inc.	162	Harowe Servo Controls, Inc.	89	Precision Paper Tube Company	169
Arnold Engineering Company, The	193	Henes Manufacturing Co.	177	Precision Scientific Co.	204
Art Wire & Stamping Co.	198	Hewlett-Packard, Moseley Division	149	Princeton Applied Research Corp.	16
Babcock Relays, A Division of		Hewlett-Packard	1, 25	Pulse Engineering, Inc.	205
Babcock Electronics Corporation	37	Hickok Electrical Instrument		Pyrofilm Resistor Co., Inc.	185
Ballantine Laboratories, Inc.	115	Co., Inc., The	Cover III		
Bendix, Corporation, The		Hoffman Electronics Corporation	131	RCA Electronic Components	
Electrical Components Division	23	Honeywell, Computer		and Devices	67, Cover IV
Borden Chemical Company, The		Control Division	32A-B-C-D	Radio Frequency Laboratories, Inc.	144
Mystik Tape Div.	15	IERC Division, International		Raytheon Company, Sorensen Operation	111
Bourns, Inc.	121	Electronic Research Corporation	161		
Branson Corp.	36	ITT Cannon Electric, Inc.	152, 153	Schweber Electronics	205
Bruning Company, Charles	173	ITT Semiconductors, A Division		Scientific Atlanta, Inc.	208
Burndy Corporation	157	of International Telephone &		Scientific Data Systems	99
Burr-Brown Research Corporation	80	Telegraph Corporation	123	Secor Metals Corporation	122
Burroughs Corporation	27	Industrial Electronic Engineers, Inc.	114	Signetics Integrated Circuits,	
Burton Research Laboratories	113	JFD Electronics Co./		A Subsidiary of Corning Glass Works	163
By-Buk Company	204	Components Division	188	Simpson Electric Company	31
CML, Inc.	169	Johanson Manufacturing Corp.	118	Skottie Electronics, Inc.	190
CTS Corporation	158, 159	KMC Semiconductor Corporation	172	Solitron Devices, Inc.	147
CELCO Constantine		Kearfoot Products Division,		Soshin Electric Co., Ltd.	181
Engineering Laboratories Co.	155	General Precision, Inc.	68, 69	Spectral Electronics Corporation	38
Chassis Trak, Inc.	150	Kester Solder Company	34, 35	Sprague Electric Company	10, 12, 20
Chicago Switch Division,		Kidde & Company, Inc., Walter	141	Standard Condenser Corporation	197
F & F Enterprises, Inc.	177	Krohn-Hite Corporation	191	Switchcraft, Inc.	116
Clairex Corporation	186	Kurz-Kasch	189	Systems Research, Inc.	194
Cobehn, Inc.	156	LVC Industries, Inc.	177		
Collins Corp., G. L.	136	Lambda Electronics Corp.	74	TRW Semiconductors	44
Columbia Wire Products Company	196	Leeds & Northrup Company	168	Takeda Ricken Industry Co. Ltd.	202
Computer Measurements Company	2	Licon, Division Illinois Tool Works, Inc.	125	Tally Corporation	165
Conforming Matrix Corporation	176	Line Electric Company	181	Technical Wire Products, Inc.	185
Consolidated Avionics,		Littlefuse	201	Tektronix, Inc., Oscilloscopes	129
A Division of Condec Corporation	53	Mac Panel Company	97	Teledyne Telemetry Company	112
Consolidated Vacuum Corporation	133	Master Specialties, Inc.	167	Telonic Instruments, A Division of	
Corning Electronics, Division of		Matsuo Electric Co., Ltd.	164	Telonic Industries, Inc.	126
Corning Glass Works	4, 5	Mergenthaler Advanced Systems	139	Tenney Engineering, Inc.	199
Crydon Laboratories, Inc.	203	Micro Instrument Company	146	Texas Instruments Incorporated, Semi-	
Curtis Development & Mfg. Co.	160	Microdot, Inc.	143	conductors-Components Division	60, 61
Cutler-Hammer	39	Microwave Expositions, Inc.	195	Transistor Electronics Corporation	135
Dale Electronics, Inc.	137	Midtex, Incorporated, Aemco Division	166	Triplet Electrical Instrument Company	119
Damon Engineering, Inc.	32	Minceo Products, Inc.	189		
Delta Products, Inc.	200	Monitor Systems, Inc.	197	U.S. Capacitor Corporation	140
Deringer Metallurgical Corp.	199	Monsanto Company	93	Ulano	145
Dialight Corporation	190	Motorola Semiconductor		Union Carbide Corporation	46
Digital Equipment Corporation	179	Products, Inc.	40, 41, 52	United Transformer Co.,	
Dilectrix Corp.	148	National Semiconductor Corporation	18, 19	Division of TRW, Inc.	Cover II
Duncan Electronics, Inc.	142	Nortronics, Inc.	128		
Dzuz Fastener Co., Inc.	204	Nytronics, Inc.	183	Vanton Pump & Equipment Corp.	189
ESI/Electro Scientific Industries, Inc.	184			Vector Division of	
ENM Company	201	Fairchild Controls, A Division of Fairchild		United Aircraft Corporation	120
Eastman Chemical Products, Inc.	201	Camera and Instrument Corporation	22	Victoreen Instrument Company, The	154
Electrical Industries	180	Fairchild Instrumentation, A Division of			
Electro Tec Corp.	182	Fairchild Camera and Instrument		Wakefield Engineering, Inc.	199
Electronic Memories, Inc.	195			Waters Manufacturing, Inc.	187
Erie Technological Products, Inc.	9			Wayne Kerr Corporation	138
Fairchild Controls, A Division of Fairchild				Wheelock Signals, Inc.	134
Camera and Instrument Corporation	22				
Fairchild Instrumentation, A Division of					
Fairchild Camera and Instrument					

Career Advertising

Hughes Aircraft Company	
Aerospace Divisions	106, 107
LFE Electronics Division,	
Laboratory for Electronics, Inc.	104
LTV ElectroSystems, Inc.	102
Lockheed Missiles & Space Company	106
McDonnell Aircraft	105



MANUFACTURER OF PRECISION ELECTRONIC INSTRUMENTS

RANKS Electronic Design 1st in READERSHIP

PUBLICATION	Rank	Percent Read		
	(Cumulative Total)	½ or more	¼ or more	Cumulative Total (½ & ¼)
ELECTRONIC DESIGN	1	37%	27%	64%
ELECTRONIC INDUSTRIES	6	24	20	44
ELECTRONICS	2	34	21	55
EDN	4	32	17	49
IEEE SPECTRUM	7	24	10	34
EEE	5	27	18	45
ELECTRO-TECHNOLOGY	8	17	10	27
ELECTRO-MECHANICAL DESIGN	Not included in survey.			
ELECTRONIC PRODUCTS	3	35	19	54
ELECTRONIC NEWS	9	17	8	25

Complete results are available from your *Electronic Design* Sales Representative.

READERSHIP STUDY BOX SCORE

STUDY NO.	NUMBER OF STUDIES TO DATE	NUMBER WON BY ELECTRONIC DESIGN
59	59	54

John Fluke Manufacturing Company, a leading maker of precision electronic instruments, wanted to know which publications are best read in the electronic instrument field. Fluke found out. In the Fall of 1965, Fluke's advertising agency, Bonfield Associates, Inc., mailed readership questionnaires to 502 customers and prospects throughout the United States. Names were supplied by the Fluke field sales organization without regard to title, function, or accessibility. Names were selected only on the basis that the recipient of the questionnaire was a key buying influence in the purchase of test instruments. When asked,

"Which of the following publications have you read ½ or more, ¼ or more, few or none of the issues in 1965," a record 97.4% return gave *Electronic Design* a substantial *first in readership!*

As part of this survey, Fluke also found out where their key buying influences look for new product information. 75% of respondents ranked technical publications in 1st or 2nd position. Salesmen's call came next with 32%, and manufacturers' literature, third, 23%. What better way to take the guesswork out of media selection? When you buy *Electronic Design*, you buy *readership.*

BEST-READ BY ELECTRONIC ENGINEERS



a HAYDEN publication 850 Third Avenue, New York, N.Y. 10022 (212) PL 1-5530

from stock . . .
Optima cases, consoles and racks
 enhance your instruments.
 Obviously.

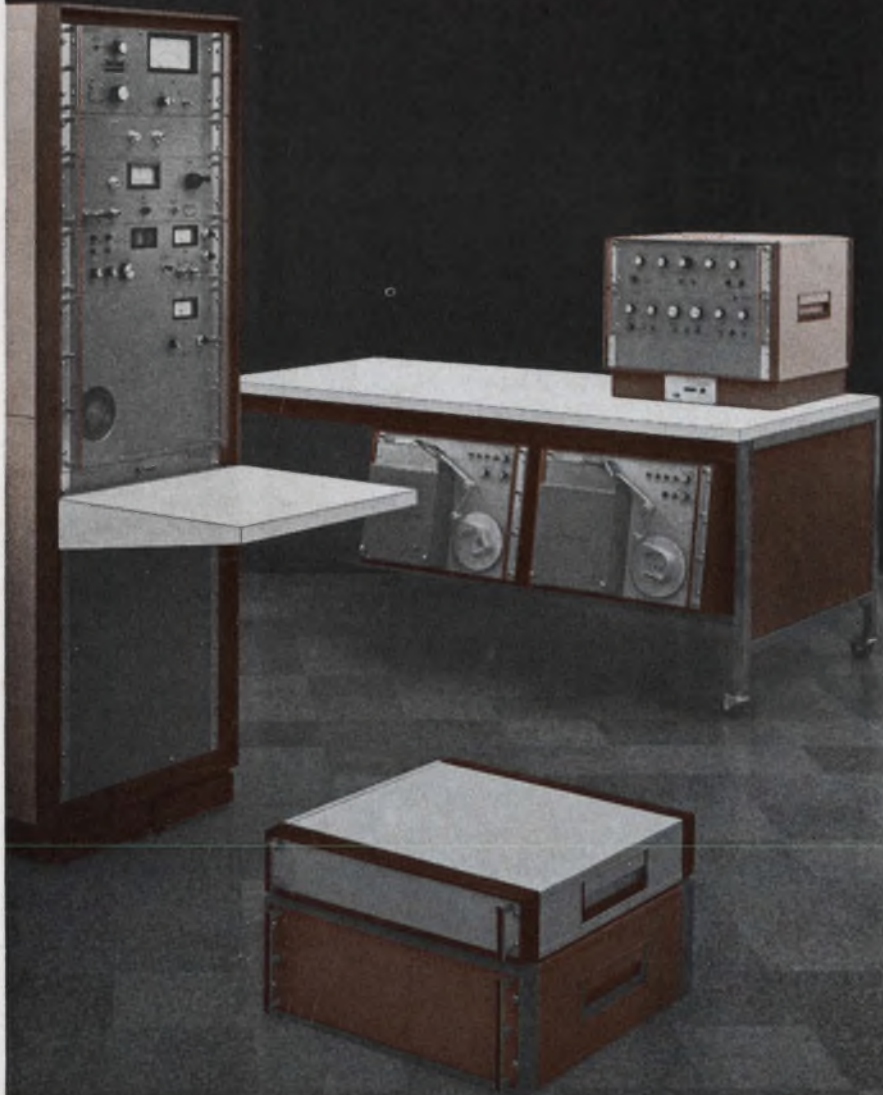

Ask for detailed catalogs.

Optima®

made by Scientific-Atlanta, Inc., Box 13654, Atlanta, Ga. 30324

Designer's Datebook

FEBRUARY						
S	M	T	W	T	F	S
			1	2	3	4
5	6	7	8	9	10	11
12	13	14	15	16	17	18
19	20	21	22	23	24	25
26	27	28				

MARCH						
S	M	T	W	T	F	S
			1	2	3	4
5	6	7	8	9	10	11
12	13	14	15	16	17	18
19	20	21	22	23	24	25
26	27	28	29	30	31	

Feb. 7-9

Winter Convention on Aerospace & Electronic Systems (Los Angeles) Sponsor: IEEE, G-AES; D. Traitel, Electro-Optical Systems, 300 N. Halstead, Pasadena, Calif.

Feb. 14-17

Electronic Packaging Conference (New York City) Sponsor: Society of Automotive Engineers, Inc.; A. J. Favata, SAE, 485 Lexington Ave., New York, N. Y. 10017

Feb. 15-17

International Solid-State Circuits Conference (Philadelphia) Sponsors: IEEE, University of Penn.; Lewis Winner, 152 W. 42 St., New York, N. Y. 10036

Feb. 20-24

Winter Institute on Advanced Control (Gainesville, Fla.) Sponsor: National Science Foundation, Univ. of Florida; Prof. O. I. Elgerd, EE Dept., Univ. of Fla., Gainesville, Fla. 32601

Mar. 1-3

Numerical Control Society's Meeting and Technical Conference (Detroit) Sponsor: NCS; Mary DeVries, Numerical Control Society, 44 Nassau St., Princeton, N. J.

Mar. 20-23

IEEE International Convention (New York City) Sponsor: IEEE; The IEEE, 345 E. 47 St., New York, N. Y. 10017

Mar. 29-31

Symposium on Microwave Power (Stanford, Calif.) Sponsor: International Microwave Power Institute; Dr. Donald Dunn, IMPI, P. O. Box 2335, Stanford, Calif.

Mar. 22-24

International Symposium on Modern Optics (New York City) Sponsor: Polytechnic Institute of Brooklyn, AFOSR, NOR; Symposium Committee, Polytechnic Institute of Brooklyn, 333 Jay St., Brooklyn, N. Y. 11201

AUTOMATION RECIPE

from **HICKOK**

1. Take from 50 to 540 S. P. S. T., 10-amp switches
2. Arrange them in the smallest space possible
3. Program them with a card. Now you have...

THE HICKOK CARD ACTUATED MULTIPLE CONTACT SWITCH

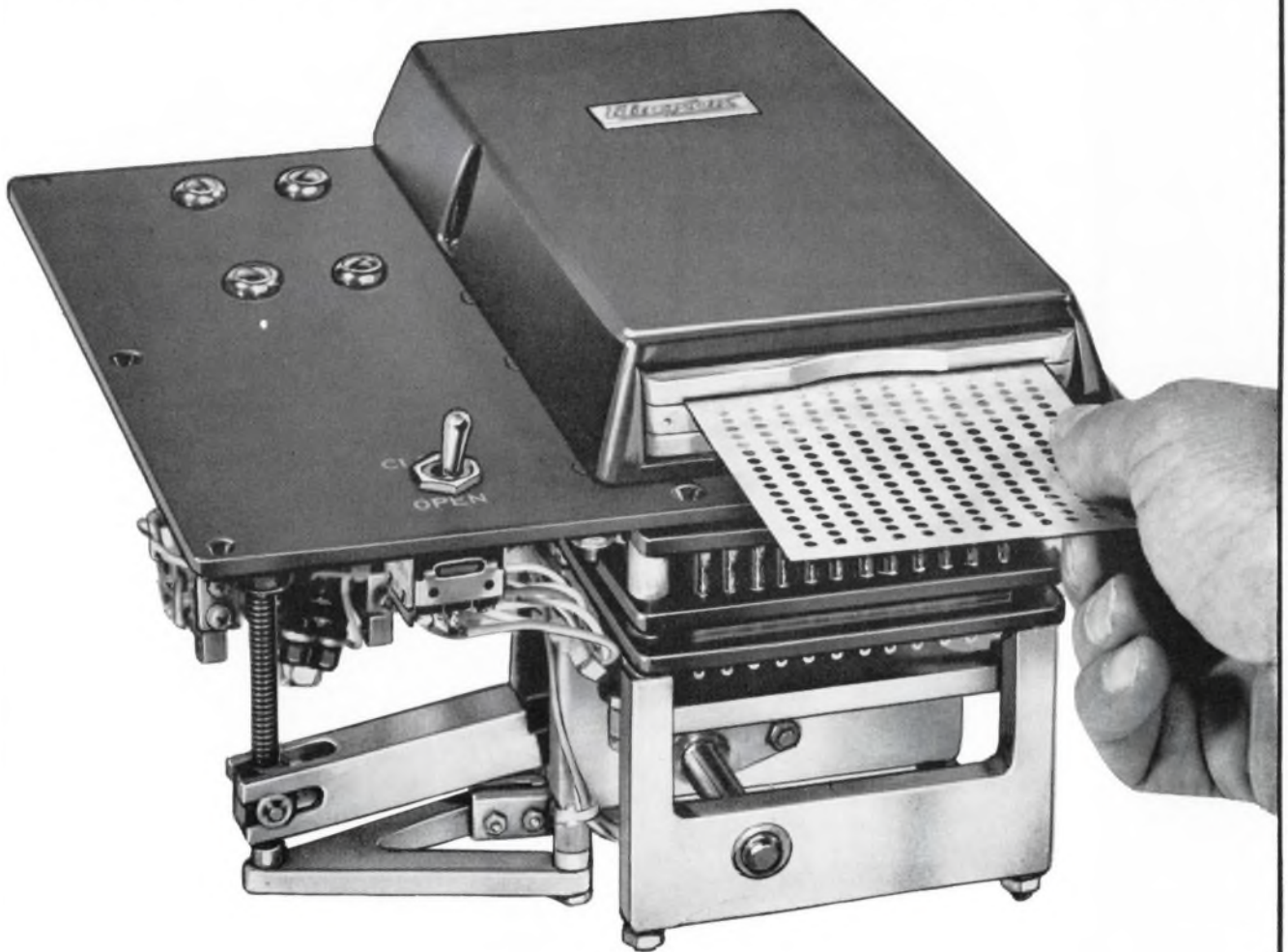

In a recipe—or in a control system—the quality of the ingredients determines the quality of the result. Hickok offers the most rugged industrial type Card Switch available. The Hickok Card Switch has been proven in hundreds of applications for over 10 years. Ask our customers—or write THE HICKOK ELECTRICAL INSTRUMENT CO. for complete information.

HICKOK

The Hickok Electrical Instrument Co.
10514 Dupont Avenue • Cleveland, Ohio 44108

SPECIFICATION SHEET, RCA ELECTRON TUBE TYPE 4060/4061

(The complete requirements for procuring the electron tube described herein shall consist of this document and the latest issue of Mil-E-1)

Method or Para.	Requirement or Test	Conditions	Sym.	Limits		Units
				Min.	Max.	
Mil-E-1 1236	Power Output	$F = 1090 \text{ MHz}$ <u>4060</u> - $E_f = 6.3\text{V}$, $E_b = 1000\text{V}_{\text{dc}}$, $E_{\text{cc}} = -80\text{V}_{\text{dc}}$, $du = 0.01$, $t_p = 450 \pm 100 \text{ ns}$ <u>4061</u> - $E_f = 6.3\text{V}$, $E_b = 1000\text{V}_{\text{dc}}$, $E_{\text{bias}} = +25\text{V}_{\text{dc}}$ Load VSWR = 1.1 max.	PPo	28	31	dBW
	Rise Time	Same as Power Output	t_r	50	100	ns
	Fall Time	Same as Power Output	t_f	50	200	ns
	Life Requirements	$F = 1090 \text{ MHz}$, $E_{\text{bb}} = 1000\text{V}_{\text{dc}}$, $E_f = 6.3\text{V}$, $du = 0.01$	t	500		hours
Mil-E-1 1236	Life Test End Points Power Output	Test at the following frequencies: $F_1 = 1075 \text{ MHz}$, $F_2 = 1090 \text{ MHz}$, $F_3 = 1105 \text{ MHz}$	PPo	25	-	dBW



Let's talk specifics about RCA AIMS/FAA interrogators and transponders

Right! Let's take RCA-4060/4061, as an example. This pencil-tube-in-cavity chain is designed to meet the stringent grid-pulsed requirements of AIMS/FAA interrogators and transponders. And RCA is one company where you can get both the tube and the cavity to assure optimum performance.

For traffic control and identification in aircraft, target drones, vehicles, and satellites, you may expect performance up to 500 watts at 1 kV with a pulse rise time of between 50 and 100 ns. And you get low heater power, improved life, smaller size, less weight, and increased stability.

For full information on RCA's line of devices which lend themselves to AIMS/FAA requirements, see your RCA Representative. For technical data on specific types, write: RCA Commercial Engineering, Section B18Q-1, RCA Electronic Components and Devices, Harrison, N.J.

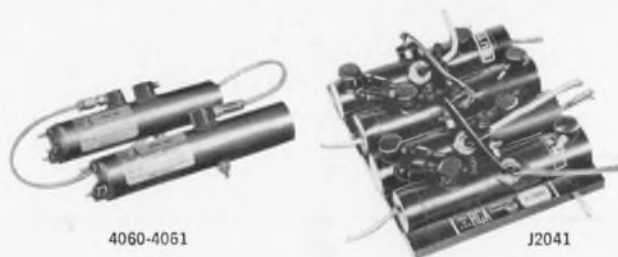

INTEGRAL CAVITY TYPES	PEAK POWER OUTPUT (Watts)	FREQUENCY (MHz)	PEAK PLATE POWER INPUT	TYPICAL SIZE	WEIGHT
4060-4061 (A15487-A15488) Osc./Amp	500	1090	2.0 kW	4 1/8" x 1 1/2" x 3 3/8" x 1/2"	7 oz. Total
J2041 4-Stage Amp.	200 45 dB Gain	1030	1.1 kW	4.5" x 5.5" x 1.25"	12 oz. Total
A15551-A15552 Osc./Amp	1000	1090	4.0 kW	4 1/2" x 1 1/2" x 3 1/2" x 1/2"	7 oz. Total
A15550	50	1030	0.3 kW	10" x 1 1/4"	3.5 oz. Total
PENCIL TRIODES					
4028A Ceramic-Metal	1000	3300	4.4 kW	1.5" x 0.5"	0.3 oz.
4055 Ceramic-Metal	1300	3300	5.2 kW	1.7" x 0.5"	0.4 oz.
4058 Glass-Metal	800	3300	5.2 kW	2.2" x 0.8"	0.4 oz.
4062A Ceramic-Metal	600	1090	1.2 kW	1.7" x 0.5"	0.4 oz.



The Most Trusted Name in Electronics