

# ELECTRONICS

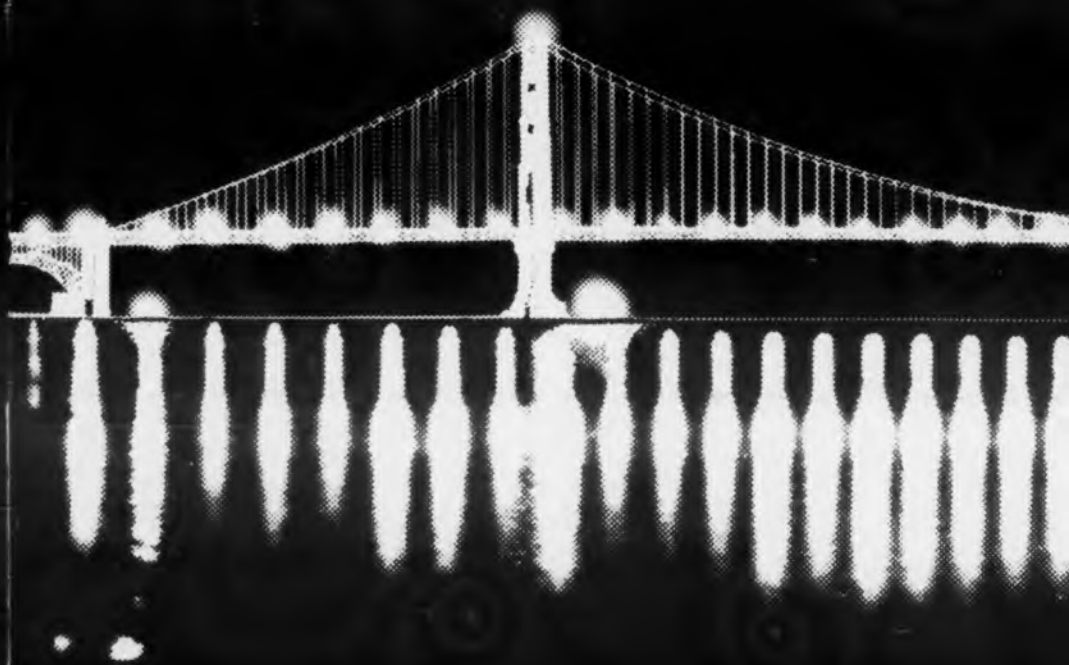

WESCON Product Round-up... p 62

DC Power Supplies... p 58 \*

Capacitor... p 59

SOLID-STATE FRE

Microcircuit Protection

Tester with Scope Readout... p 64 \*

SONIC  
SIGN

VOLUME 2, NUMBER 1



Convertron—a New Concept in

FREQUENCY COMPARATOR... P 65

Switching Time



MICROWAVES... p 153

**NOW!  
30 DAY  
DELIVERY**

# SIZE 8 & 10 INTEGRAL GEARHEAD MOTORS

## 3 Times Torque Load Capacity\* of comparable size 8 gearheads

\*Will sustain 20 in-oz torque load for 1,000 hours operation and 100 in-oz momentary overload at the maximum ratios.

CPPC one-piece gearhead housing eliminates separate gear plates and fastening posts, improves and maintains accuracy through exact alignment of gear clusters, assures smoother operation and more expedient inspection and servicing.



Gearhead and motor are selectable, individual parts enclosed in the same common motor housing.

Clifton Precision, pioneers in postless gearhead construction, introduces the finest in gearhead design—cage type, one piece gearhead housing machined from a single block of metal. In these units exact duplication of gear centers is accomplished through simultaneous boring of permanently integrated bearing plates (patent pending). Positive and permanent alignment of gear clusters composed of AGMA precision Classes II and III hardened steel gears integral with shafts journaled at both ends in ABEC class 5 bearings, minimize deflection and backlash, maximize torque load capacity, insure smoother operation and continued reliability of performance beyond normal endurance life requirements. Cage type construction facilitates inspection and lubrication while gearhead is mounted simply by removing motor. CPPC motors will stand greater heat than ever before due to the use of new materials. See box at lower right.

Write for our free pamphlet which gives detailed specifications of our entire gearhead motor and motor-tachometer line, sizes 8, 10 and 11.

STANDARD TYPES			
RATIOS		No. of Clusters	Dir. of Rotation
Size 8	Size 10		
12.09	19.92	2 (3 pass)	reverse
20.63	32.10	3 (4 pass)	direct
34.26	58.28	3 (4 pass)	direct
58.44	93.89	4 (5 pass)	reverse
97.07	169.97	4 (5 pass)	reverse
165.58	273.84	5 (6 pass)	direct
275.02	495.74	5 (6 pass)	direct
469.15	798.70	6 (7 pass)	reverse
779.22	1445.92	6 (7 pass)	reverse

Notes: 1. Any ratio ( $\pm 3\%$ ) is available within the limits of the ratio range at additional cost and may require longer delivery time.  
2. Max. backlash = 30 minutes at 2 in oz reverse gauge load in above units. Inquire if special tolerance is required.

### PERFORMANCE CHARACTERISTICS

SIZE 8 INTEGRAL GEARHEAD MOTOR  
SERVO MOTOR TYPE ALC-8-1

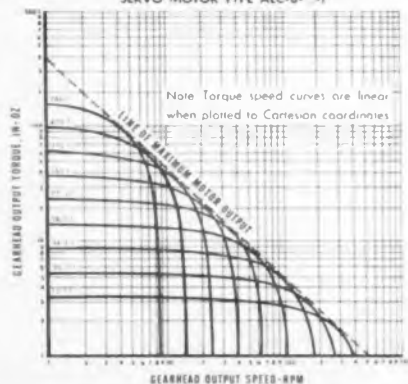

### MOTORS

The following CPPC standard motors, electrical characteristics of which can be found in the current CPPC Rotary Components catalog, are offered with our gearheads:

**SIZE 8**  
ACH-8-□-1 AMH-8-□-3  
ACH-8-□-4 ALC-8-□-1  
AMH-8-□-1 ALC-8-□-4

**SIZE 10**  
ACH-10-□-1 ALH-10-□-1  
ACH-10-□-4 ALH-10-□-5

### CURRENT LEAKAGE

Superiority of insulation in CPPC motors is illustrated by actual comparative curves shown at the right.

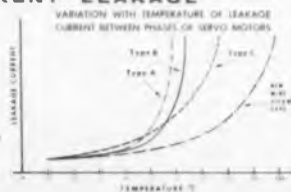

**CLIFTON PRECISION PRODUCTS CO., INC.**  
CLIFTON HEIGHTS, PENNSYLVANIA



CIRCLE 1 ON READER-SERVICE CARD



**COVER:** As the Golden Gate bridge dominates the scene in the Bay area of San Francisco, WESCON will dominate the attention of the electronics world. Items listed include product features and the leading new products to be found in this issue.

### WESCON

Are you on your way to San Francisco and four hectic days of WESCON? If you are, be sure to consult the New Products section of this issue of **ELECTRONIC DESIGN**. There you will find listed over 235 of the new products to be shown at the Cow Palace. Select those you are most interested in and, with the aid of the booth number listed at the end of each product description, make sure you see them first.

In the WESCON Round Up, p 62, we have summarized what manufacturers told us they thought were outstanding recent developments in their particular fields. They also predicted for us the developments which they thought were most likely in the near future. Along with these answers to our questionnaire we have listed some of the products to be seen in each of the categories discussed.

Product features in this issue include descriptions of the Convertron power supply and the Jaguar series of inexpensive paper capacitors which are moisture resistant. We believe these products will be of more than ordinary interest to our readers. Both will be on exhibit at the show.

And, whether you are, or are not, going to WESCON, remember to make use of our Reader-Service Card to obtain more information on any or all of the items contained in the New Products section.

### Transistor Data Chart

For your copy of **ELECTRONIC DESIGN**'s Ninth Annual Transistor Data Chart, which appeared in the July 5th issue, turn to the Reader-Service card and circle 300.



VIA  
AIR  
MAIL

FIRST CLASS

Permit No. 725

New York, N. Y.

B U S I N E S S   R E P L Y   M A I L

No Postage Stamp Necessary If Mailed In U. S.

POSTAGE WILL BE PAID BY

**ELECTRONIC DESIGN**

ONE DAY READERS INQUIRY SERVICE

830 Third Avenue

New York 22, New York

VIA  
AIR  
MAIL

FIRST CLASS

Permit No. 725

New York, N. Y.

B U S I N E S S   R E P L Y   M A I L

No Postage Stamp Necessary If Mailed In U. S.

POSTAGE WILL BE PAID BY

**ELECTRONIC DESIGN**

ONE DAY READERS INQUIRY SERVICE

830 Third Avenue

New York 22, New York

## Rx for Doctors

The horse-and-buggy physician's approach to diagnosing baffling ills ("Just give two soda bicarb pills and see what develops in the morning") may not be thoroughly obsolete, but it is yielding further ground to the fast-growing branch of medical electronics. The surrender is not as rapid or willing as some engineers would like, but the handwriting is on the wall.

Staunch supporters of the new system of substituting black boxes for black magic in the diagnosis of patient ills gathered by the thousands July 17-21 at the Waldorf-Astoria Hotel in New York City for the Fourth International Conference on Medical Electronics. Engineers, doctors, medical and biological researchers, educators and others swapped ideas and engaged in big and small talk as advances were unfolded.

The new equipment includes blood flowmeters; portable electrocardiographs and fm telemetry for remote cardiac monitoring; automatic blood analyzers and a new method for measuring blood pressure by using an artery behind the eye.

Some of the problems that designers face in this pioneering branch of the industry have little to do with electronics. Example: Operating-room equipment must stand at least 5 ft above the floor; otherwise there is danger of explosions from anesthetic gases (which are heavier than air and concentrate below the 5-ft level).

Much of the new equipment must be operated by persons with little or no mechanical skill—nurses or doctors' aides, for example. So the fewer controls there are on the outside panels of equipment the better.

More and more equipment is being turned out, the conferees agreed, but is the medical profession using it to the fullest? Complaints were heard that physicians still preferred to rely—too heavily, from the engineers' viewpoint—on intuition. Suggestions were made that a new, more scientific orientation on the part of the family doctor should be encouraged.

For an over-all design engineering appraisal of the conference, turn to p. 4.

## Another \$50 Winner

ED's sixth Most Valuable Idea of Issue award goes to Donald W. Bramer, an engineer with General Railway Signal Co., Rochester, N. Y., for his design suggestion: "Bypassed Bias Resistor Increases Emitter-Follower Input Z."

Want to be the next winner? See p. 196.



# NOW...count and control precisely

## with new decade counters from Raytheon



### RAYTHEON DECADE COUNTER TUBES

TYPES	CK6909 CK6910*	CK6476* CK6802	CK6476A* CK7978*
DC Supply	450 volts	425 volts	425 volts
Anode Resistor	0.27 meg ohms	0.82 meg ohms	0.82 meg ohms
Nominal Tube Drop	235 volts	187 volts	187 volts
Cathode Resistor	24 K ohms	100 K ohms	100 K ohms
Output (Across Cathode Resistor)	15 volts	30 volts	30 volts
Speed	to 100 kc	to 5 kc	to 5 kc
Maximum voltage between Electrodes (excluding Anode)	140 volts	140 volts	200 volts

\*All ten cathodes brought out independently for electrical readout.

More efficient equipment for precision counting and control of high-speed production machines can now be designed with Raytheon decade counter tubes. Because these tubes provide both visual and electrical readout, the functions of counting and stopping machinery at preprogrammed intervals can be combined with less circuitry and components.

The new Raytheon 13-pin CK7978 offers the advantages of small size, economical socket requirements, rugged construction, long life—and outstanding cost reductions both in lower initial purchase price and simpler circuitry requirements.

Frequency dividing, matrixing, telemetering, sampling, timing, and coding are other applications for Raytheon decade counter tubes. For full information please write: Raytheon, Industrial Components Division, 55 Chapel Street, Newton 58, Massachusetts.

For Small Order or Prototype Requirements See Your Local Franchised Raytheon Distributor

## RAYTHEON COMPANY

## RAYTHEON

INDUSTRIAL COMPONENTS DIVISION

# See Mallory for wire-wound controls



We've got 'em at



2 watts



4 watts



and 7 watts

in hundreds of resistance values, tapers, shafts and multi-ganged arrangements. And we're famous for engineering special models and delivering them at economical prices. Mallory Controls Company, Frankfort, Ind.

P. R. MALLORY & CO. Inc.  
**MALLORY**



plugs  
& jacks



carbon  
controls



vitreous  
enamel resistors



rotary  
switches

CIRCLE 3 ON READER-SERVICE CARD

<b>ELECTRONIC DESIGN News</b> .....	4
Human Body Furnishing Clues to Circuit Design .....	4
Thin-Film Hall Device Is Nearing Production .....	6
WESCON Field Trips To Feature Research, Automation .....	8
Two New Sessions Added by WESCON .....	10
Tiros III Carries New Solid-State Timer .....	12
Speech Recognized by Waveform-Matching System .....	16
<b>Washington Report</b> .....	20
Adapted Typewriter Digitizes Negatives .....	22
Selective Data Retrieval System Uses Keywords, Prints Abstracts .....	25
Thin-Film Cylinder Memory Gives Fast, High Output .....	26
Stereo Adapters Based on 2 Designs .....	30
Atomic Weather Station to Aid U. S. ....	34
<b>Space Successes Mounting; WESCON</b> .....	39
Editorial comment .....	
<b>Tunnel Diode Sine-Wave Oscillators</b> .....	40
The design equations for sine-wave oscillators are presented with several typical examples worked out. Device limitations and oscillator stability results are discussed—E. Gottlieb .....	
<b>Backlighting: Best for Electronic Control Panels</b> .....	46
The ways a designer can light an instrument panel from the back—A. M. Blumenfeld .....	
<b>How to Evaluate DC Differential Amplifiers</b> .....	50
A comparative evaluation of dc differential amplifiers, stressing the often overlooked—W. G. Royce .....	
<b>How to Choose Modifiers for Epoxy</b> .....	54
Flexibility, lower pouring viscosity, and lower cost can be achieved through the right additives—C. Harper .....	
<b>Product Features</b> .....	58
Newly available products of exceptional interest to design engineers .....	
<b>A New Concept in DC Power Supplies</b> .....	59
The Convertertron is a 2-kw regulated dc power supply, housed in a 7-in. high rack and using a "lossless" regulation technique .....	
<b>Inexpensive Paper Capacitor Is Moisture-Resistant</b> .....	60
Waxless, oil-free cardboard tubular operates to 125 C .....	
<b>Wescon Round-Up</b> .....	62
The response to an ELECTRONIC DESIGN questionnaire reveals what manufacturers, exhibiting at the show, believe to be the outstanding recent developments in the industry and their predictions for the future .....	
<b>New Products</b> .....	64
More than 230 of the new products described in this issue will be exhibited at WESCON. Leading the parade are an electro-optical pot, a switching-time tester, a convenient rack scope, and a solid-state frequency comparator .....	
<b>MicroWaves</b> .....	153
New interest in surface-wave transmission lines and a step-by-step design procedure for magnetic radar modulators are featured in this edition of MicroWaves. Beginning with this issue, microwave product features will appear regularly in the section .....	
<b>New Applications Being Developed for Surface-Wave Transmission Lines</b> .....	155
Long-known microwave transmission medium finds new uses .....	



# ELECTRONIC DESIGN

Hayden Publishing Company, Inc.  
850 Third Avenue, New York 22, N. Y.

<b>Practical Design of Magnetic Radar Modulators</b> .....	160
A step-by-step procedure for designing these increasingly used modulators— R. M. Philip	
<b>Doppler Modulation Systems—The Pros and Cons</b> .....	166
This article describes the factors involved in deciding which of the four major Doppler modulation systems is best suited for application in a par- ticular vehicle—D. Whitney, N. Laschever	
<b>Microwave Power Meter Accurate Within <math>\pm 0.5</math> Per Cent</b> .....	170
Direct-reading instrument measures power precisely from 0.5 $\mu$ w to 10 mw	

<b>Ideas for Design</b> .....	196	
Tuning-Fork Oscillator Produces Square Waves Directly .....		196
Voltage Comparator Uses Tunnel Diode Flip-Flop .....		196
Sine-Cosine Pots Form White-Noise Signal Generator .....		198
AF-Tuned Amplifier Has Adjustable Bandwidth .....		200
"See-Saw" Multivibrator Uses a Single Capacitor .....		201
RC Pair Safely Sets Initial State of Relay Driver .....		202
AC Amplifier Is Wide Band, Less Bulky .....		203
Trigger Pulse Generates Two Separate Outputs .....		204
Regenerative Switch Demodulates Sinusoid .....		205
Pulse Circuit Provides Sharp, Variable Pulse Delays .....		206
<b>Ideas for Design Entry Blank</b> .....	197	
<b>"Mechanize" Your Circuit Searches</b> .....	214	
How one engineer evolved a "sorting-needle-and-punch-card" system to locate the circuits in his collection—D. Schuster		
<b>New Literature</b> .....	188	
<b>Report Briefs</b> .....	208	
<b>Careers</b> .....	214	
<b>Advertisers' Index</b> .....	221	

## Coming August 30

One of the fastest moving and most challenging areas of electronic design, the design of digital data-processing equipment, will be featured in a special report in the August 30th issue of **ELECTRONIC DESIGN**. Within this broad field, the report will focus attention on three areas that have moved most rapidly and have received most concentrated attention in the past year: Logic and Timing, Matrix Memories, and Cyclic Memories.



**ELECTRONIC DESIGN** is published biweekly by Hayden Publishing Company, Inc., 850 Third Avenue, New York 22, N. Y. T. Richard Gascoigne, Chairman of the Board; James S. Mulholland, Jr., President; Edmund C. Grainger, Jr., Secretary. Printed at Poole Bros. Inc., Chicago, Ill. Accepted as controlled circulation at Chicago, Ill., and at New York, N. Y. Copyright © 1961, Hayden Publishing Company, Inc., 38,625 copies this issue.

# UTICA UNWRAPS A NEW BENT CHAIN NOSE PLIER

"Electronic Plier-of-the-Month" • July and August



Never before available on an industry-wide basis! This month's Utica special is the #25-5 . . . a new bent chain nose plier designed to grip, twist and loop very fine wire in closely confined areas. It's ideal for work on chassis as well as other subminiature electronic assemblies. Special features include 60° angle bent chain nose • Beveled edges full length of jaw • Fine serrations in jaws to prevent nicking or marking • Primer coated *dipped* cushion grip handles and Bauer spring to reduce operator fatigue • Induction hardened edges • Gleaming finish • Backed by Utica's famous full guarantee. Write for complete information on the #25-5 or the Utica Electronic Plier of the Month program. Or ask to have your Utica distributor call!

UTICA DROP FORGE & TOOL DIVISION • KELSEY-HAYES COMPANY, UTICA 4, NEW YORK

# UTICA

CIRCLE 4 ON READER-SERVICE CARD

# Human Body Furnishing Clues to Circuit Design

**Biological-electronic analogies presented; blood flowmeters discussed; and variety of medical-electronics equipment shown during Fourth International Conference on Medical Electronics.**

**A**NALOGIES between the operation of electrical circuits and parts of the body were presented in many of the technical sessions and exhibits at the recent medical electronics conference in New York.

The extent of work going on in this field was illustrated by the following presentations at the meeting:

- Lumped-circuit constants were used to represent the functioning of the heart and the circulatory system.
- A hydraulic-type reflex klystron was used to closely approximate heart action.
- Theoretical cell models, particularly for neurons, were presented by several speakers.

An electronic circuit exhibited by Dr. M. P. Spencer of the Roman Gray School of Medicine, Winston-Salem, N. C., performed like the human circulatory system and produced a waveform on a cathode-ray oscilloscope that almost duplicated that of an electrocardio-

gram. In his design, Dr. Spencer considers the left heart as a constant-voltage source discharging into a tuned circuit resonating at 3-6 cps. The tuned circuit represents the lumped-circuit compliance of the aortic arch, its branches, and the abdominal aorta and its branches. Inertance of blood in the descending aorta is represented as an inductance. When an electrical impulse is fed into the circuit, voltages and currents to match pressure and flow in the arteries are derived.

A hydraulic counterpart of a reflex klystron that functioned like a human heart was demonstrated by its inventor, Group Capt. John E. Malcolm of the Royal Air Force.

The model consisted of a system of plastic tubing, fed from a reservoir of fluid about one meter high. Pulsing was accomplished by passing a section of the tube through a larger tube. The air between the two tubes

## On Electronic-Medical Agenda

Imaginative design approaches to the measurement of blood flow and physical models for human organs and cells, particularly the neuron, were among the chief topics of discussion at the Fourth International Conference on Medical Electronics in New York City.

The week-long conference and exhibit, ending July 21, was held at the Waldorf-Astoria.

Technical sessions delved into a wide variety of electronic-medical combinations in nearly 300 papers. Equipment shown was largely aimed at heart measurements. Several manufacturers showed portable electrocardiographs or miniature fm telemetry units for transmitting cardiac signals to remote receivers.

was alternately compressed and rarified imparting a wave to the fluid. The purpose of the model was to show that abnormalities of cardiac rhythm were related to modes of oscillation in fluid-filled elastic systems.

Many presentations at the conference were concerned with the construction of cell models based on electronic theories.

Dr. J. Polonsky, of the French Society of Electronics and Radio Technicians, pointed out that owing to the periodic and quasi-crystalline structure of many sub-cellular components, cells might exhibit some of the properties of solid-state electronic devices, such as transistors, piezoelectric crystals, and others. He also compared neurons with coaxial-cable waveguide systems. The synapse was described as an electromagnetic radiation transfer.

W. B. Bishop of the Air Force Cambridge Research Laboratories discussed the relation-

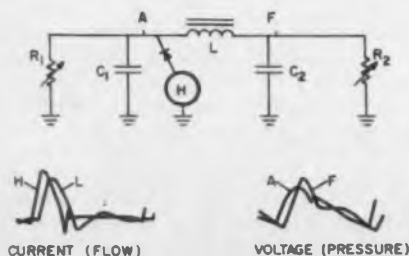

**Electronic circuit** representing the action of the arterial pulse and the circulatory system was exhibited at the conference. "Aorta" (A) discharges into an LC circuit, representing lumped compliance of the arterial system.  $R_1$  and  $R_2$  represent peripheral resistance when a current corresponding to the cardiac-ejection pulse (H) is fed into the circuit, voltages A and F and current L, which match current and pressure in the arteries, may be derived.



**Portable electrocardiographs** produced by Tokyo Shibura Electric Co., Ltd. (above) and Minneapolis-Honeywell Regulator Co. (right) represent the Japanese and American versions of this most widely shown instrument at the conference.

ship of the neuron loop to an information-processing electronic system. He explained that synchronizing pulses were probably radiated from neurons and that they helped the brain process information from the various sensory organs of the body.

An electric analogy for nerve impulse transmission was also proposed, using successively activated filaments of a distributed fuel cell. The filaments were compared to an electronic circuit consisting of a succession of blocks, each containing a switch, battery, and relay. The relay would have two sets of contacts. One set would be the switch of the next circuit, and the other would control the contacts of the previous block.

These circuits could be built up into complex networks and used to simulate the ordinary nervous activity in man according to J. Rothstein of Edgerton, Germeshausen, & Grier, Inc., Boston.

A number of approaches to measuring the flow of blood in the human body were discussed at the conference. They included the ultrasonic flowmeter, ac and dc types, and the square-wave system.

The newest blood-flowmeter design, described by scientists from the University of Chicago, uses the oldest principle of operation: a conducting fluid moving through a magnetic field generates an emf in a probe coil. The university's flowmeter incorporates a dc amplifier between the pickup electrodes and the meter. The electrodes are made of a silver-silver chloride compound that is electrochemically stable. Therefore no emf is induced in the probes by the electrolytic effect.

Several Japanese portable electrocardiographs as well as a number of American models were shown at the exhibits. Representatives of U. S. concerns said the Japanese equipment was well designed and reportedly gave good performance but had not yet sold well here because of the unavailability of spare parts and service representatives.

Birtcher Corp.'s model 300R, for example, sells for \$850 with a two-year service guarantee. If a unit fails, a serviceman will replace it with a new electrocardiograph the same day.

Among other U. S. models at the exhibit were Sanborn Co.'s Visette, priced at \$625, and Minneapolis-Honeywell's Cardioview.

Portable fm transmitters for telemetering cardiographic signals from a person to a remote fm receiver were also shown by several manufacturers. ■ ■

## new! low-cost self-contained TV camera provides 650 line resolution!



Control panel  
detaches from camera  
for remote operation  
via stock cable

High-quality closed circuit television is now more practical than ever. KIN TEL's new 20/20 camera is the reason. It contains its own control circuits. This eliminates the separate unit so long traditional with high-quality TV systems... lets you connect the camera directly to a monitor—or home TV receiver.

The 20/20 is easier and less expensive to install, operate, service. Yet it gives the sharpest, clearest pictures in the industry—650 lines of horizontal resolution. It is so sensitive that you can get usable pictures with as little as one foot candle of illumination—less than the light now falling on this page.

Trouble-free operation is designed into the 20/20. Transistor circuits are used wherever possible. Power consumption is only 25 watts. Protective circuits prevent vidicon damage in case of sweep failure. And the swing-out circuit boards make servicing easy.

Many standard accessories custom-fit the 20/20 to your exact needs. A light compensation circuit automatically adjusts the camera for light variations as great as 4000:1. Motors provide remote control of the lens turret, lens focus, and a lens-speed filter. Sync generators assure 2:1 interlace either in the standard industry-wide sweep/scan pattern, or in the FINELINE pattern that gives you greatly increased vertical resolution. RF modulators make the pictures available on standard TV channels 2 through 6.

Cut costs, reduce errors with one of KIN TEL's complete lines of high-quality, closed circuit TV. Other companies do. U.S. Steel uses KIN TEL TV to see inside open-hearth furnaces. E. F. Hutton uses one to transmit stock quotations. Los Angeles Department of Water and Power uses KIN TEL TV to check steam plant burners and to view remote water-level meters. The San Francisco Naval Shipyard uses one to guard against pilferage. American Potash & Chemical conveyor lines and warehousing operations are monitored by KIN TEL TV as are radiation studies at General Atomic. KIN TEL TV provides detailed surveillance of every type of ICBM outside the Iron Curtain. All told, hundreds of KIN TEL TV systems are performing critical and routine jobs safely, inexpensively, tirelessly.

Application help is free for the asking. At no obligation, KIN TEL field engineers will determine whether a TV system can be put to profitable use in your application. Just write direct for catalog 6-203 and the name of your closest KIN TEL representative. There is one in every major city.

5725 Kearny Villa Road  
San Diego 11, California  
BRowing 7-6700

**KIN TEL**  
A DIVISION OF  
**COHU**  
ELECTRONICS, INC.

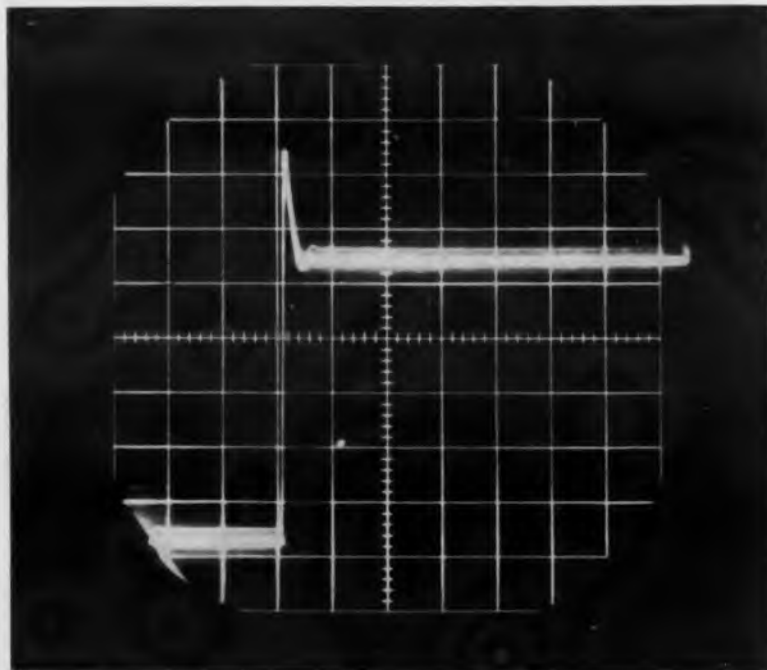

## TRANSISTOR-KILLER: THE VOLTAGE SPIKE TAMED BY PERKIN MTR DC POWER SUPPLIES

The "turn-on" transient above could destroy the transistors in your circuit in microseconds. Protect transistorized equipment against treacherous line and load transients with Perkin MTR tubeless power supplies. Combining the best of two solid-state regulation principles, they use magnetic amplifiers for high efficiency and transistors for instantaneous suppression of transients and ripple. No tubes, no moving parts, no trouble! Units sustain shorts and overloads indefinitely, resuming normal operation automatically. Ideal for continuous-duty and unattended operation. Prompt delivery anywhere.

HERE ARE JUST A FEW OF OUR MANY  
OFF-THE-SHELF UNITS  
WRITE FOR COMPLETE CATALOG

Model No.	D.C. Output		Static Regulation		Dynamic Regulation		A.C. Input 60 cps, 1 Phase	Ripple RMS
	Volts	Amps	Line	Load	Line	Load		
MTR036-5	0-36	5	±10MV	±10MV	±10MV	±.2V	105-125V	1MV
MTR036-15	0-36	15	±10MV	±10MV	±10MV	±.2V	105-125V	1MV
MTR636-15	6-36	15	±25MV	±50MV	±25MV	±.75V	105-125V	5MV
MTR636-30	6-36	30	±25MV	±75MV	±25MV	±.85V	105-125V	5MV
MTR28-5	24-32	5	±0.1%	±0.1%	±0.1%	±.3V	105-125V	5MV
MTR28-10	24-32	10	±0.1%	±0.1%	±0.1%	±.4V	105-125V	2MV
MTR28-30	24-32	30	±0.1%	±0.1%	±0.1%	±.5V	105-125V	5MV

# PERKIN

ELECTRONICS CORPORATION

345 Kansas Street, El Segundo, California □ SPpring 2-2171

Representatives in Principal Cities



### PERKIN SALES REPRESENTATIVES

**ALBUQUERQUE, N. M.**  
Brooks-Feeger Assoc.  
5510 Domingo Rd., N.E.  
AM 8-1724

**ANGOLA, IND.**  
Law Instrument Co  
Box 95  
217 & 8101-R

**ATLANTA 5, GA.**  
E. G. Holmes & Assoc.  
4969 Roswell Rd., N.E.  
BL 5-6660

**BALTIMORE, MD.**  
Gawler-Knoop Co.  
807 E. Seminary Ave.  
Townson 4, Md.  
EN 9-3151

**CHICAGO 25, ILL.**  
Saffro & Assoc.  
5209 N. Kimball Ave.  
JU 8-0905

**CLEVELAND, OHIO**  
Gaine Engineering  
29603 Bruce Drive  
Willowick (Cleveland), Ohio  
WHitney 3-3731

**DALLAS 20, TEXAS**  
Wallace Assoc.  
P. O. Box 13203  
FL 7-7080

**DENVER, COLO.**  
Brooks-Feeger Assoc.  
3041 S. Broadway  
Englewood, Colo.  
SU 1-7375

**DES MOINES, IOWA**  
Design & Sales Eng. Co.  
2702 41st Pl.  
BL 5-4584

**DETROIT 34, MICH.**  
Gaine Engineering  
E. 1474 Outer Drive  
Detroit 34, Michigan  
FOrest 6-5353

**GREENSBORO, N. C.**  
E. G. Holmes & Assoc.  
440 W. Market St.  
Suite B-1  
BR 2-0855

**INDIANAPOLIS, IND.**  
Law Instrument Co.  
P. O. Box 27062  
ST 7-0009

**KANSAS CITY 8, MO.**  
Design & Sales Eng. Co.  
2600 Grand Ave  
GR 1-1640

**LAWRENCE, MASS.**  
Richard D. Frink Assoc  
46 Amesbury St.  
MU 3-3252

**LOS ANGELES, CALIF.**  
Instruments for  
Measurements  
3455 Cahuenga Blvd.,  
Suite F  
Hollywood, Calif.  
HO 9-7294

**MINNEAPOLIS, MINN.**  
Northport Eng., Inc.  
1729 Selby Ave.  
St. Paul 4, Minn.  
MI 6-2621

**NEW YORK CITY AND  
NORTHERN NEW JERSEY**  
Gawler-Knoop Co.  
178 Eagle Rock Ave.  
Roseland, N. J.  
N. Y. Tele. DI 4-2997  
Roseland Tele. CA 6-4545

**ORLANDO, FLA.**  
E. G. Holmes & Assoc.  
1220 Edgewater Dr.  
CH 1-2128

**PHILADELPHIA, PA.**  
Gawler-Knoop Co.  
835 Glenside Ave.  
Wyncote, Pa.  
Phila. Tele. WA 7-1820  
Wyncote Tele. TU 4-8805

**PHOENIX, ARIZ.**  
Brooks-Feeger Assoc.  
34-A E. First St.  
Scottsdale, Ariz.  
WH 6-2111

**SALT LAKE CITY, UTAH**  
Brooks-Feeger Assoc.  
253 Rio Grande.  
Rm. No. 5  
EL 9-2427

**SAN DIEGO 4, CALIF.**  
Instruments for  
Measurements  
2420 University Ave.  
JU 3-1972

**SAN FRANCISCO, CALIF.**  
Cerruti & Assoc.  
P. O. Box 509  
116 Cypress St.  
Redwood City, Calif.  
EM 9-3354

**SEATTLE, WASH.**  
Testco  
Boeing Field - Rm. 108  
PA 3-9000

**ST. LOUIS 5, MO.**  
Design & Sales Eng. Co.  
7603 Forsyth Blvd.,  
Rm. 304-06  
PA 1-6403

**SYRACUSE, N. Y.**  
D-B Assoc.  
P. O. Box 284  
DeWitt (Syracuse), N. Y.  
GI 6-0220

**WASHINGTON, D. C. &  
MARYLAND**  
Gawler-Knoop Co.  
8732 Flower Ave.  
Silver Spring, Md.  
JU 5-7550

**WICHITA, KAN.**  
Design & Sales Eng. Co.  
400 N. Emporia  
Wichita, Kan.

**CANADA**  
Electromechanical  
Products  
Markham Rd.  
Agincourt, Ont., Canada  
AX 3-7011

**AUSTRALIA**  
Geo. H. Sample & Son  
(Electronics) Pty. Ltd.  
Sample House  
17-19 Anthony St.  
Melbourne C.I., Australia  
FJ 4138

**BELGIUM**  
Belram Electronics  
43 Ch. De Charleroi  
Brussels, Belgium  
38.12.40

**ISRAEL**  
Eastronics Ltd.  
48 W. 48th St.  
New York 36, N. Y.  
CO 5-8323

Eastronics Ltd.  
P. O. Box 2554  
Tel Aviv, Israel  
66890

**NEW ZEALAND**  
Geo. H. Sample & Son  
(Electronics) (N. Z.) Ltd.  
Box 3250  
431 Mount Albert Rd.  
Mount Roskill, S. I.  
Auckland, New Zealand  
89-4 39

**FRANCE**  
Mezer  
105, Quai Branly  
Paris 15, France  
Seg. 36 93

**SPAIN**  
ATAIO Ingenieros  
A. Aguilera No. 8  
Madrid, Spain  
23 27 42

**SWEDEN**  
Erik Ferner AB  
Box 56  
Bromma, Sweden  
87 01 40

## NEWS

### Thin-Film Hall Device Is Nearing Production

*Beckman Instruments Generator Said  
To Give Higher Voltage Outputs*

Thomas E. Mount  
West Coast Editor

**P**ILOT production of thin-film, indium-antimonide Hall-voltage generators, with outputs reported significantly greater than previously available, is being established at Beckman Instruments, Fullerton, Calif.

Kermit Heid, research engineer of the company's Helipot Div. and developer of the new Hall elements, says they will generate 1 v where conventional elements would only show 100 mv under the same circuit conditions. He attributed the greater output to the thinness of the elements.

Hall voltage is an inverse function of the thickness of the material used. With the exception of bismuth, materials showing a pronounced Hall effect (the appearance of a transverse electric potential gradient in a current-carrying conductor upon the application of a magnetic field) are quite brittle. Extremely thin elements have been impossible to use without costly hand-polishing, Mr. Heid said.

By evaporating thin (7-micron) films on substrates, Mr. Heid obtained elements with Hall constants of 120 cm<sup>3</sup> per coulomb and mobilities in the neighborhood of 10,000 cm<sup>2</sup> per v-sec. Input impedance of the new Hall elements is 150 ohms typical, and output impedance 200 ohms typical. Conventional units have about 1-ohm output impedance, Mr. Heid says, and as a consequence require more input power—400 mw nominal.

There are, however, advantages to the higher impedances, Mr. Heid continued.

"For a given configuration," he said, "the power available from an InSb Hall generator is 280 times as great as that from a germanium element if you can match the load to the Hall impedance. This is extremely difficult to do with input and output impedances on the order of 0.5 to 1 ohm, but somewhat easier with the same impedances in the range of 100 to 20 ohms."

In addition to the higher output voltage for the same input conditions, reports Mr. Heid, the advantages of the new elements include higher frequency operation, better

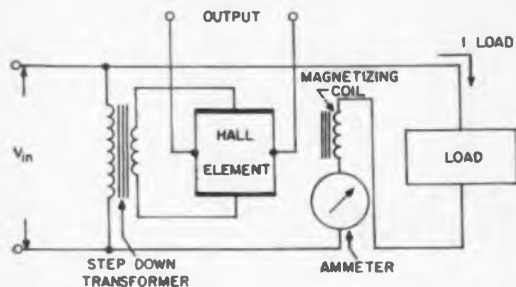

Output of this watt transducer is proportional to  $V_{in} I_{load} (\cos \phi - \cos [2\omega + \phi])$ , where  $\omega$  is  $2\pi f$ ;  $f$  is 60 cps and  $\cos \phi$  is the power factor of the load.

heat dissipation and the feasibility of unusual configurations in production devices.

Output frequencies on the order of 100 kc are possible now, the only limitation being in the magnetic circuitry associated with the device. According to Mr. Heid, watt transducers are being designed with responses far faster than those of conventional bolometers (see schematic). If the magnetic field in a waveguide is used, instantaneous-response watt transducers could be designed for microwave systems; response of the Hall element itself is in the nsec range.

Open-circuit output sensitivity—Hall coefficient—of the new elements is put at 0.7 v per amp-kilogauss, with 5.6 kilogauss magnetic induction and a control current of 50 ma. This is said to compare with 0.12 v per amp-kilogauss for conventional devices. Misalignment voltage is 5 mv maximum, Mr. Heid asserted, but 1 mv can be specified. Input power is 750 mw maximum, 400 mw nominal.

According to industry sources, among the applications for such Hall generators are function multipliers (varying both input current and magnetic field), magnetic field probes, current-measuring probes, frequency doublers, magnetometers, choppers, frequency spectrum analyzers and displacement gages. Since the output can be made to depend only on how the Hall element is oriented in a magnetic field—being a function of the cross product of  $I$  and  $B$ —an efficient ac or dc resolver could be constructed.

With the introduction of the thin-film Hall generator to the production line, Beckman Helipot Div. will join Westinghouse, Ohio Semiconductors and Siemens and Halske (Germany) as makers of Hall elements.

In addition to the elements themselves, Westinghouse and Ohio are marketing watt transducers using Hall generators, while Dyna-Empire and Radio Frequency Laboratories are selling Hall gaussmeters. Assembly Products, Inc., sells a wattmeter relay. ■ ■

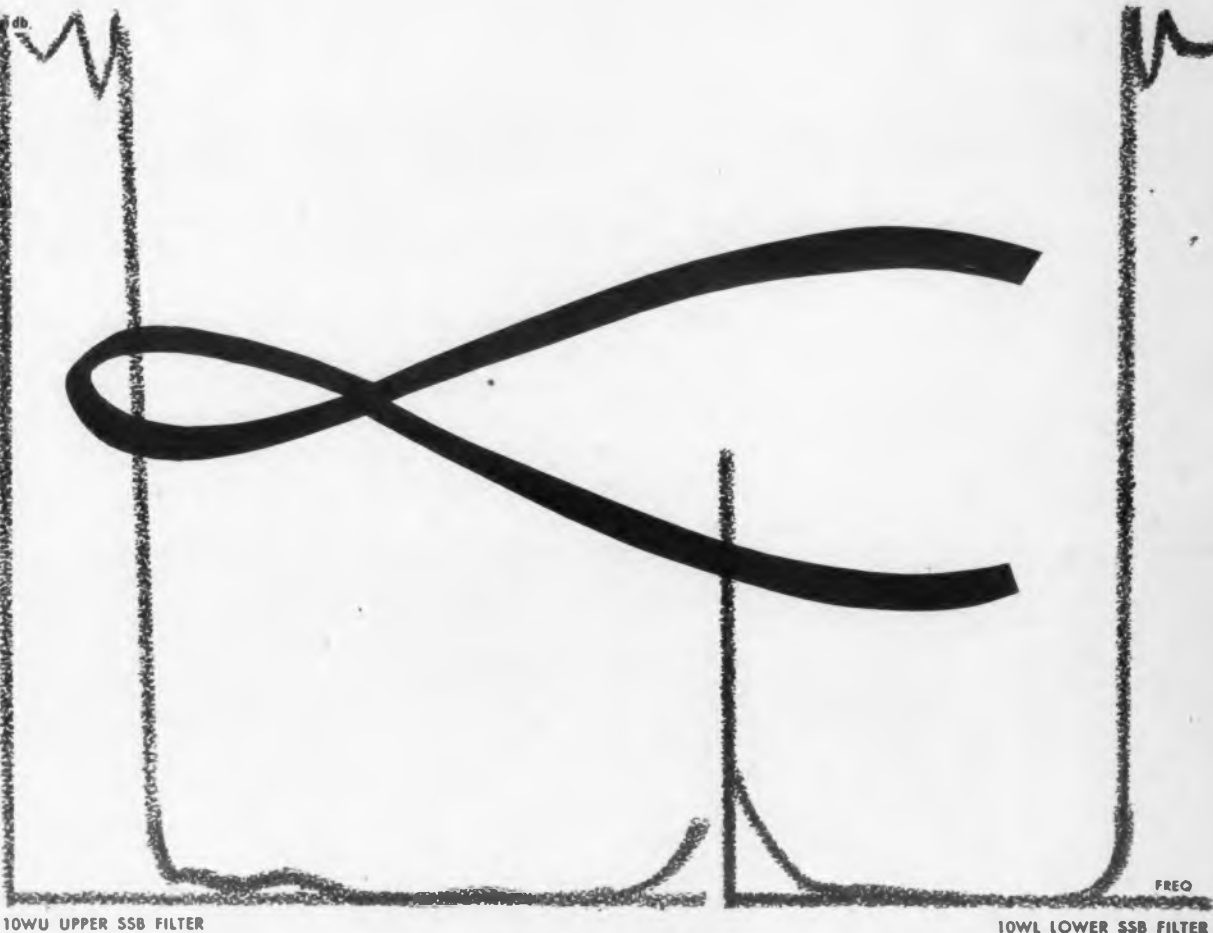

10WU UPPER SSB FILTER

10WL LOWER SSB FILTER

## BULOVA SINGLE SIDE BAND CRYSTAL FILTERS

With the ever increasing demand for Single Side Band Communication Systems for High Frequency Voice communications, facsimile and multi-channel frequency shift keying teletype operation, Bulova Electronics added Model 283 Single Side Band Filter to their standard line of crystal filters.

Designed to surpass the Signal Corps SM-D-180214 and SM-D-180215 Single Side Band Filter Specifications, the new Bulova Model 283 features an unusually flat passband, low insertion loss and operation over a large temperature range.

General Specifications include: Carrier Frequency—100kc; Carrier Attenuation—13 db; Maximum Ripple—±0.5 db; Insertion Loss—less than 5.0 db; Input Output Impedance—1.5 k  $\Omega$  balanced or un-

balanced; Operating Temperature Range —40°C to +70°C.

balanced; Operating Temperature Range —40°C to +70°C.

Type 10WL Lower Side Band—Model 283 features Passband—±0.5 db from 94kc to 99.875kc and Minimum 60 db Attenuation at 100.2kc and above.

Type 10WU Upper Side Band—Model 283 features Passband ±0.5 db from 100.125kc to 106kc. Minimum 60 db Attenuation at 99.8kc and below.

The new Bulova Model 283 can be driven from a balanced or unbalanced source and its low input and output impedance make it readily adaptable to transistor circuitry.

For additional information or application assistance, write Department 2155, Bulova Electronics, Woodside 77, N. Y.



**BULOVA**  
ELECTRONICS  
DIVISION

CIRCLE 8 ON READER-SERVICE CARD

## WESCON Field Trips To Feature Research, Automation

*Latest research projects and modern production methods will be featured during numerous field trips in the San Francisco Bay area during the Western Electronics Show and Convention, Aug. 22-25. Here are some representative samples of what the field-tripper will see during plant and laboratory visits.*



**Numerically controlled milling** equipment at Hewlett-Packard Co.'s Palo Alto plant represents some of the modern production techniques to be seen during the trips. H-P is scheduled for Field Trip 7 on Thursday afternoon, Aug. 24. The milling is being done by a Milwaukee-matic tape-programmed machine.



**Cavity-type maser** operating at 35 Gc using iron-doped rutile as the paramagnetic crystal, is under development at Melabs, Palo Alto. WESCON delegates will visit this microwave firm on Thursday morning, Aug. 24, Field Trip 6 on the planned schedule.



**Cesium plasma tube** operation is monitored on an oscilloscope, being adjusted by Dr. Matthew A. Allen, research associate in the microwave laboratory of Stanford University. This laboratory will be visited during Field Trip 4 on Wednesday afternoon, Aug. 23.

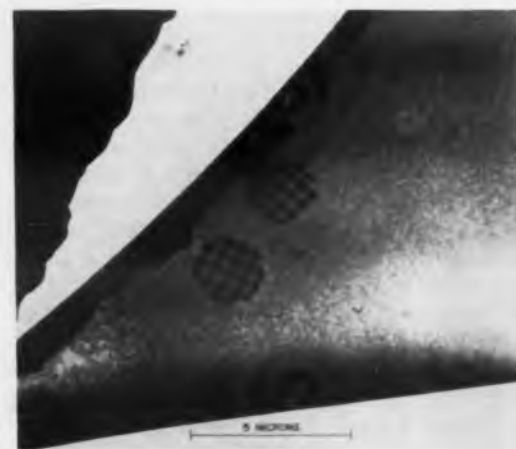

**Micro-machining** with an electron beam accomplished this neat slicing of silicon thin-film spots only about 1 micron thick. This work will be on view at Stanford Research Institute's Applied Physics Laboratory, Menlo Park, on Thursday afternoon, Aug. 24, during Field Trip 8. Photo is an electron micrograph.

# PHILCO EPITAXIAL SILICON MESA

**FIRST TO COMBINE**

**120 V ( $BV_{CBO}$ )**

**0.5 V(SAT)**

**150 mc.  $f_T$**



**2N2087 NPN  
CORE DRIVER  
LINE DRIVER**



**PHILCO  
2N2087  
EPITAXIAL  
SILICON  
MESA**

CORE DRIVER...LINE DRIVER

Available  
off-the-shelf  
in quantities 1-999  
at factory prices  
from

**SEMICONDUCTOR  
SPECIALISTS inc.**



5706 WEST NORTH AVENUE  
CHICAGO 39, ILLINOIS

for information call

**National 2-8860**

CIRCLE 226 ON READER-SERVICE CARD

CIRCLE 227 ON READER-SERVICE CARD ▶

#### ABSOLUTE MAXIMUM RATINGS

Storage Temperature ..... -65 to +300°C.  
 $BV_{CEX}$  ( $R_{\theta} \approx 10\Omega$ ) ..... 80 volts  
 $BV_{CBO}$  ..... 120 volts  
 $BV_{EBO}$  ..... 5 volts  
Collector Current  $I_C$  ..... 500 ma  
Total Device Dissipation (case 25°C) ..... 2 watts  
Total Device Dissipation (case 100°C) ..... 1 watt  
Total Device Dissipation (free air 25°C) ..... 0.6 watt

#### ELECTRICAL CHARACTERISTICS (@ 25°C.)

Characteristics	Conditions	Min.	Max.	
$h_{FE}$	$V_{CE} = 1V.$ $I_C = 150 \text{ ma.}$ $I_B = 15 \text{ ma.}$	40	120	
$V_{CE}$	$I_C = 150 \text{ ma.}$ $I_B = 15 \text{ ma.}$		1.2	volts
$V_{CE}(\text{SAT})$	$I_C = 150 \text{ ma.}$ $I_B = 15 \text{ ma.}$		0.5	volts
$f_T$	$I_C = 50 \text{ ma.}$ $V_{CE} = 10V.$	150		mc
$C_{ob}$	$V_{CE} = 10V.$ $I_B = 0 \text{ ma.}$		12	pf
$I_{CBO}$	$V_C = 60V.$ $T = 25^\circ C.$		2	$\mu A$
$I_{CBO}$	$V_C = 60V.$ $T = 150^\circ C.$		200	$\mu A$
$BV_{CEX}$	$R_{\theta} \approx 10\Omega$ $I_C = 20 \text{ ma.}$ pulsed	80		volts
$t_r$			85	nsec
$t_s$			100	nsec
$t_f$			55	nsec

Immediately available in  
quantities 1-999 from  
your Philco Industrial  
Semiconductor Distributor.

**PHILCO**

Famous for Quality the World Over

LANSDALE DIVISION, LANSDALE, PENNSYLVANIA

You would expect Philco, as inventor of industry's most capable germanium logic transistor—the MADT, to design Silicon memory components with extra capability, too. And Philco has done it. The 2N2087, forerunner of a broad line of Philco epitaxial silicon mesa transistors, offers an incomparable combination of parameters that may well be the special design solution you require: maximum  $BV_{CBO}$  of 120 V., minimum  $h_{FE}$  of 40 at  $1V_{CE}$ , maximum  $V_{CE}$  (SAT) of 0.5 V., minimum  $f_T$  of 150 mc., maximum  $C_{ob}$  of 12 pf., and maximum  $t_s$  of 100 nanoseconds.

The new Philco 2N2087 epitaxial silicon mesa delivers optimum drive for computer memory planes, serves as a medium power switch in airborne controls systems, and is ideally suited to a wide variety of other applications such as small power supplies, servo amplifiers, and automation controls. For complete information, write Dept. ED8261.





## KEY's molded resistors maintain precise stability ...regardless of environment!

Key's new molded resistors maintain precise stability—over a wide range of environmental conditions—without change in characteristics.

Key's new molding process permits the production of a larger size size for a given wattage, y provides environmental characteristics for mounting and other resistor requirements. Molded larger size resistors have increased surface area, resulting in high heat dissipation and stability through an efficient heat distribution.

Typical of the characteristics of Key's molding material is its precise water absorption resistance.

WATTAGE	RESISTANCE
1/2	100
1	100
2	100
5	100
10	100
25	100
50	100
100	100

There is a resistor which gives predictable performance under all environmental conditions. It's the only one possible in the marketplace. It's the KEY brand of Key's Molded Precision Film Resistors and the most applicable for any application—military, industrial or commercial—environmental use.

METAL FILM				
KEY TYPE	WATTS 125°C	VOLTS	NOMINAL SIZE DIAMETER LENGTH	
KM2	0.1	100	.095	.235
KM5	0.125	200	.120	.300
KM60	0.125	250	.155	.413
KM65	0.250	300	.217	.568
KM70	0.50	350	.261	.706
KM75	1.0	500	.396	1.045

CARBON FILM				
KEY TYPE	WATTS 125°C	VOLTS	NOMINAL SIZE DIAMETER LENGTH	
E2	0.1	100	.110	.230
E5	0.125	200	.133	.295
E10	0.250	300	.133	.420
E20	0.50	500	.195	.600
E25	1.0	1000	.333	.955



**KEY RESISTOR CORPORATION**

321 West Redondo Beach Boulevard Gardena, California • TWX CPT 6007

CIRCLE 11 ON READER-SERVICE CARD

## NEWS

### Two New Sessions Added by WESCON

*Panel Discussion of Arms Control,  
Meeting on Quantum Devices Slated*

**A** PANEL session on arms control and a technical session on quantum devices have been added this year to the Western Electronics Show and Convention, to be held in San Francisco Aug. 22-25.

Dr. John Grainger, technical chairman of WESCON, said the session on arms would be led by Dr. L. C. Van Atta, formerly Special Assistant for Arms Control in the Dept. of Defense and now director of Hughes Aircraft Co. Research Laboratories, Malibu, Calif. The quantum meeting will feature devices and technical papers.

Outlining the program on arms analysis, Dr. Van Atta said that experts would take up the nuclear, military, technical (other than nuclear), politico-economic and psychological aspects of control efforts.

Politico-economics and psychology will be discussed last, he observed.

"We consider these the most important aspects of the problem," he explained, "so we placed them last to stick in people's minds. We want to make members of the IRE aware that arms control is much more than how far you can throw a radar beam."

Dr. William H. K. Penofsky, a Stanford University Professor of Physics, will discuss the pros and cons of efforts to agree on limiting nuclear armament. He will outline the difficulty of monitoring nuclear stockpiles and testing, as well as techniques by which the Russians could cheat during a moratorium.

Military aspects of arms control will be presented by Rear Admiral Paul L. Dudley (Ret.), formerly Special Assistant to the Joint Chiefs of Staff.

Dr. Donald G. Brennan of the Massachusetts Institute of Technology, Lincoln Laboratories, will consider technical aspects of arms control other than nuclear. He will cover such fields as delivery and electronic detection systems.

Dr. Harold Rowen, formerly of Rand Corp. and now Deputy Assistant Secretary in the Office of the Assistant Secretary of Defense International Security Affairs will take up

the political-economic aspect of arms control.

Psychological problems will be presented by Charles E. Osgood, director of the Institute of Communications Research, University of Illinois. He is expected to urge a reciprocal program of tension reduction.

At the session on quantum devices Hughes Aircraft Co. will display its experimental Colidar—coherent Light Detecting and Arranging—system (see *ED*, March 29, p 18). The device uses an optical maser to transmit energy to targets as far away as seven miles. The design and operation of Colidar will be presented by Malcolm L. Stitch of Hughes.

Another aspect of bulk-effect devices to be discussed is "A Solid-State Spin-Echo Memory System for a Microwave Digital Computer," a paper by L. Kent Wanlass and J. R. Singer of the University of California at Berkeley. Electron spin echo was studied both experimentally and theoretically as a digital computer memory system at microwave frequencies. The authors have investigated in considerable detail a new method for storing the phase of microwave pulses as used in phase-script information systems of the Von Neumann type. Their work demonstrates that the storage of a single cubic centimeter crystal should exceed 10,000 bits. According to the authors, the spin-echo method is a feasible serial storage system for microwave computers. ■ ■

### Sylvania to Close Tube Plant; Expand Solid-State Production

Planned shutdown of the receiving-tube plant of Sylvania Electric Products, Inc., in Shawnee, Okla., marks the third big cutback in tube manufacturing operations in recent weeks.

Philco Corp.'s Lansdale Div. and the Electronic Div. of CBS, Inc., previously announced plans to drop out of the receiving-tube business to concentrate on solid-state device production. Raytheon Corp. has taken over the CBS line of tubes.

The Shawnee plant closing will take place over the next six months to ease the impact on the 500 workers there, according to a Sylvania spokesman. Other Sylvania plants in Emporium, Brookville and Altoona, Pa., and in Burlington, Iowa, will continue receiving-tube production.

At the same time Sylvania has announced plans to expand semiconductor production facilities by 42 per cent between now and next spring.

# Now! For the first time...



## TEST ELECTROLYTIC CAPACITORS

**Safely...  
Accurately...  
Simply!**

### SPECIFICATIONS

#### Capacitance

Range 0 to 120,000 $\mu$ F at 120 cps  
Accuracy  $\pm$  (1% of reading + 10 $\mu$ F)  
Sensitivity  $\pm$  0.1% of reading + 10 $\mu$ F

#### Dissipation Factor

Range 0 to 120% at 120 cps  
Accuracy  $\pm$  (2% of reading + 0.1% DF)  
Sensitivity  $\pm$  (0.2% of reading + 0.05% DF)

#### Maximum Voltage to Unknown

A-C 0.5v RMS at 120 cps  
D-C 0-600v (with optional power supply)

#### Null Detection

Built-in Galvanometer to  
Indicate Bridge Balance

#### Power Input

105-125v, 60 cps, 25w

#### Case

Sturdy Aluminum Cabinet with  
Blue Textured Finish, Grey Panel

#### Dimensions

12" Wide x 12" High x 6" Deep

Note: Five other models, with variations in power inputs and test frequencies, are also available

■ The Sprague Model 1W1 Capacitance Bridge introduces a new concept in bridge design. Built by capacitor engineers for capacitor users, it incorporates the best features of bridges used for many years in Sprague laboratories and production facilities.

■ Using a line-driven oscillator with but two active elements (diodes), the bridge has a transistorized detector whose sensitivity increases as the balance point is approached. It has provision for 2-terminal, 3-terminal, and 4-terminal measurements, which are essential for accurate measurement of capacitors with low, medium, and high capacitance values, respectively.

■ The Model 1W1 Capacitance Bridge will not cause degradation or failure in capacitors during test, as is the case in many conventional bridges and test circuits. The 120 cycle a-c voltage, applied to capacitors under test from a built-in source, never exceeds 0.5 volt! It is usually unnecessary to apply d-c polarizing voltage to electrolytic capacitors because of this safe, low voltage.

For complete technical data on this precision instrument, write for Engineering Bulletin 90,010 to Technical Literature Section, Sprague Electric Company, 347 Marshall Street, North Adams, Massachusetts.

### ELECTRONIC PRODUCTS by SPRAGUE

CAPACITORS

RESISTORS

MAGNETIC COMPONENTS

TRANSISTORS

INTERFERENCE FILTERS

PULSE TRANSFORMERS

PIEZOELECTRIC CERAMICS

PULSE-FORMING NETWORKS

HIGH TEMPERATURE MAGNET WIRE

CERAMIC-BASE PRINTED NETWORKS

PACKAGED COMPONENT ASSEMBLIES

FUNCTIONAL DIGITAL CIRCUITS

# SPRAGUE

THE MARK OF RELIABILITY

\*Sprague and  are registered trademarks of the Sprague Electric Co.

# RUGGED

## is the WORD!

The big  
difference in  
Sheet Metal Cabinetry  
for Electronics  
and Instrumentation  
is offered only  
by *Equipto*

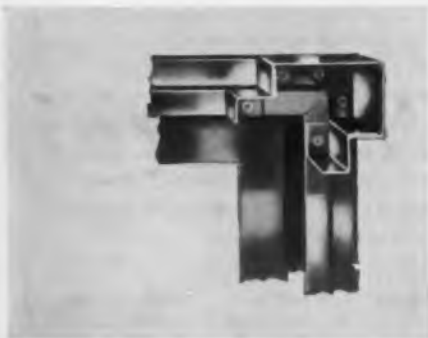

### SWAY — PROOF CORNER CONSTRUCTION

Double ledge, double plane corner construction\* provides greater structural stability with increased static load carrying capacity and the reduction of torsion to a minimum. Note the unique reinforced corner construction and points of weld — an exclusive Equipto feature.

\*U.S. PATENT APPLIED FOR

Get the Facts! Write today for descriptive Brochure No. 100.



**Equipto** ELECTRONICS CORPORATION

319 NORTH WEBSTER STREET • NAPERVILLE 6, ILLINOIS

CIRCLE 13 ON READER-SERVICE CARD

## NEWS

### Tiros III Carries New Solid-State Timer

*All Silicon Devices in Non-Pressurized Package Replace Mechanical Components in System for Weather Satellite*



Checking over instruments for the Tiros III payload is RCA engineer Glenn Corrington. The newest weather satellite carries a new solid-state timer and additional infrared instruments for solar radiation measurements. A second wide-angle lens vidicon camera replaces the narrow-angle one used in Tiros II.

**A**N all-solid-state timer on the newly orbited Tiros III weather satellite represents a significant electronic advance, ELECTRONIC DESIGN has learned. Radio Corp. of America engineers who designed the timer believe it and others like it will become widely used in space programs.

Tiros III is making possible studies of the formation of tropical storms over the Caribbean, Atlantic and Far East waters. Its completely solid-state timing system, using all silicon components, is probably the most significant design advance in the satellite's payload.

The timing system on earlier Tiros vehicles included mechanical sequencing and stepping switches, and germanium components.

#### Mechanical Components Face Severe Restrictions in Space

Serious problems are encountered with mechanical components in space environments, according to Walter Morgan, engineer in charge of the Tiros reliability program for RCA, Astro-Electronics Div., Princeton, N. J.

Mechanical switches must operate dry in the vacuum environment of space, since any oil on them is sucked away. Also, dust that might settle on contacts cannot be removed. These problems can lead to sticky contacts or cam wheels.

All-solid-state circuitry not only eliminates these difficulties but also gives significant savings in power dissipation.

The new system is built around an Incremental clock made by General Time Corp., Stamford, Conn., as was the previous mechanical version. The clock uses a high-precision quartz crystal oscillator (drift within 0.005 per cent over  $-25$  to  $+85$  C temperature range) operating at about 18 kc to provide signals for synchronism and timing of events in the satellite.

As an example of power savings achieved, the mechanical system required 2-amp pulses of about 100-msec duration to stepping-switch solenoids every 2 sec. The new sys-

tem substitutes 100-ma pulses of 10- $\mu$ sec duration every 2 sec to provide a similar function.

Further power savings were accomplished, according to Mr. Morgan, by using pnp-npn complementary flip-flops rather than conventional types. A saving of about 40 to 1 was realized through this choice. Use of transistors rather than diodes in 2- and 3-input AND gates also cuts down significantly on power dissipation.

The mechanical system was hermetically sealed in a pressure vessel for previous shots. This vessel was not sealed in the Tiros III package because of the elimination of the mechanical components.

The Tiros program is switching over to the new timer design, according to Mr. Morgan, and this approach is under consideration for future programs. General Time will produce solid-state versions of the Incremag timer for the program.

#### IR Sensors Carried on "Outriggers" Measure Radiation to and From Earth

New infrared equipment carried on the Tiros III includes an omnidirectional sensor system carried on outriggers extending from opposite sides of the satellite's circular base. These will be used for measurements of the radiation directed from the sun toward the earth, and the amount re-radiated from the earth's surface and atmosphere. Tiros III also has a second wide-angle camera in place of the narrow-angle type used in previous weather satellites.

The new Tiros is similar in size and shape to the first two—drum-like. Most instrumentation carried differs in very few details from the first two successful satellites.

Meanwhile Midas III, a missile-detecting satellite also hurled into orbit recently, is reported to have a more sophisticated infrared sensing system than those used in previous tests. Midas III is an experimental vehicle designed to provide recognition of hostile missiles rising above the earth's atmosphere through detection of their hot exhausts (*ED*, March 16, 1960, p 4). Technical details of the new satellite's sensing package, designed by Baird-Atomic, Inc., of Cambridge, Mass., are under tight security. ■ ■

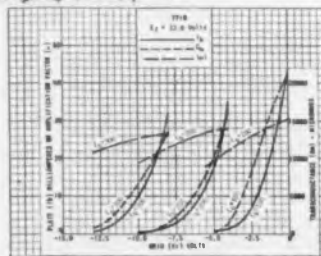

# TUNG-SOL HIGH PERFORMANCE

GENERAL PURPOSE  
MINIATURE COMPUTER TRIODE

## 7719

Directly replaces parallel-connected 5965 and 7062 twin-triodes while providing these added advantages for designers of computer circuits:

- Higher transconductance
- Very sharp cut-off
- Much higher plate dissipation
- Linear transfer characteristics
- Very high perveance
- Improved reliability

The Tung-Sol 9-pin miniature 7719 general purpose triode is the latest addition to the Tung-Sol family of top-rated, high-reliability tubes for computer service. Rated at 6 watts plate dissipation, the 7719 incorporates many design and construction features which assure computer users the maximum number of hours of trouble-free peak performance.

#### CHECK THESE ADDITIONAL BENEFITS:

- Freedom from cathode interface and reduced electrical leakage . . . Achieved through use of a passive cathode alloy and lower heater power per unit area.
- Minimization of grid emission . . . The 7719 is designed with heavy grid support wire and a double connection to the grid for cooler operation allowing use of 1 megohm grid circuit resistance.
- High stability . . . Use of heavier stock plate material assures more even distribution of heat and lower plate temperature. Cool operation further guaranteed by cool cathode and low bulb temperature (175°C at 6 watt dissipation).
- Very little "island" formation . . . Optimized geometry minimizes island formation thereby providing sharp cut-off, linearity and high perveance.

Typical applications of the 7719 are found in totem pole amplifiers to drive function-generating potentiometers, cathode followers, and multivibrators. Full technical details on the 7719 are available immediately on request.

RATINGS		
Heater Voltage (Series)	19.6±0.6	Volts
Heater Voltage (Parallel)	9.8±0.3	Volts
Maximum Plate Voltage	330	Volts
Maximum Plate Dissipation	6.0	Watts
Maximum DC Cathode Current	40	Ma.
Maximum Heater-Cathode Voltage:		
Heater Negative With Respect to Cathode		
Total DC and Peak	500	Volts
Heater Positive With Respect to Cathode		
DC	100	Volts
Total DC and Peak	206	Volts
Maximum Bulb Temperature	175	°C

**TUNG-SOL®**

Technical assistance is available through: Atlanta, Ga.; Columbus, Ohio; Culver City, Calif.; Dallas, Texas; Denver, Colo.; Detroit, Mich.; Irvington, N. J.; Melrose Park, Ill.; Newark, N. J.; Philadelphia, Pa.; Seattle, Wash. In CANADA: Abbey Electronics, Toronto, Ont.

## NEWS

### Ranger I Space Vehicle Designed For Data Rather Than Moon Impact

Design of the first Ranger spacecraft is directed at providing data useful in future lunar and planetary impacts rather than actual moon landing.

This vehicle, which contains some 19,520 electronic parts, is the most complicated yet attempted by the National Aeronautics and Space Administration. Some of the systems vital to moon and planetary landings include:

- an attitude stabilization system based on celestial references—the earth and sun.
- a high gain directional antenna which can be automatically directed in the right direction for transmission.
- 8 scientific experiments.
- two solar cell arrays (8,680 cells) which will provide from 155- to 210-w power.
- a solid-state timing system which takes 400-cycle power from the spacecraft power source and converts it to pulses at a rate of one per second for timing vehicle functions.

Calibration of the solar cell system is one of the primary objectives of the Ranger shot. Four specially calibrated cells on Ranger 1 will provide needed data on attenuation of solar energy by the earth's atmosphere.

Experiments carried by the first vehicle in the Ranger series will provide measurements of interplanetary plasma clouds, cosmic rays and charged particles of slightly lower energy, magnetic fields, solar X-rays, cosmic dust, and hydrogen glow outside of the atmosphere.

The large number of experiments and systems require a vehicle weighing 675 lbs.—with electronics accounting for 243 lbs.

### 10-60% Savings Reported With Wire Board Holders

Printed-circuit board holders made from wire weldments have proved 10 to 60 per cent less expensive for ground-based military and commercial equipment, according to a wire goods manufacturer who has been developing this new type of holder jointly with a number of electronics firms.

The resistance-welded wire holders are also said to be lighter in weight than conven-



### equals the ever growing family of CAPITRON® Capacitors

And plenty doesn't say enough! Now Capatron adds this silicone rubber encapsulated Wafer Capacitor to its more than 2,500 special capacitor designs, available as standard in our line. When your requirements go beyond this . . . we will create a capacitor to fit your requirements. If you're working in advanced areas of design—atomic energy, radar, communications and control—there's no need to let ordinary "off-the-shelf" capacitors freeze your design creativity . . . you may find exactly what you want in the big Capatron line. From single wafers to encapsulated multiple capacitors . . . whatever your choice or requirement . . . you can depend on Capatron products for:

- high resistance to thermal extremes (−65°C to +125°C)
- maximum stability, reliability and longevity with AMPLI-film® dielectric
- choice of waxdipped, encapsulated or armored types

Complete information on Capatron Capacitors available upon request.

®Reg. U.S. Pat. Off.

Visit us at  
the Wescon Show  
Booths 517-521,  
August 22-25, 1961

## CAPITRON DIVISION AMP INCORPORATED Elizabethtown, Pennsylvania

Capatron products and engineering assistance are available in Canada through Aircraft-Marine Products of Canada, Ltd., Toronto, Canada

CIRCLE 15 ON READER-SERVICE CARD

tional holding assemblies made from castings of sheet metal. And because of their open, skeleton-like construction, they permit easier circulation of convection cooling currents, the manufacturer reports.

The welded-wire holders were developed and evaluated by E. H. Titchener & Co. of Binghamton, N.Y., in conjunction with the General Electric Co.'s Heavy Military Electronics Dept., Syracuse, N.Y., for missile ground-support equipment. More recently other companies, such as Radio Corp. of America, Westinghouse, Sylvania, Martin, Philco and Bendix are reported to have either started to use or evaluate the welded-wire holders for racks and module nests.

The rack mounting assemblies consist of mounting frames, guide wires to receive tops and bottoms of circuit boards and provisions for mounting connectors. In applications where severe shock loads are expected, steel springs would be used between the guide wires. The edges of the boards would force these springs back as the boards were pushed into place and the resulting bearing friction would hold the boards securely.

### Telemetry Saves Valuable Data Despite Sinking of Space Capsule

Telemetry prevented the loss of vital data on both capsule performance and physical reactions of Astronaut Virgil Grissom despite the sinking of the Liberty Bell 7 vehicle July 21.

National Aeronautics and Space Administration spokesmen told ELECTRONIC DESIGN that the only important loss of data was the film of space pilot Grissom taken during the 16 minute flight. The loss of the \$2 million capsule was regrettable, they commented, because there were plans to reuse it for later tests.

The data provided by telemetry and Capt. Grissom's descriptions may permit fairly sound evaluations of possible malfunction of the capsule manual control system during the flight. Capt. Grissom said that the response of the vehicle to his control maneuvers was not good—particularly in the roll rate system. He told newsmen at Cape Canaveral that he felt that some control valve might have been sticking open and causing difficulty.

## SERIES 57EM HALF-INCH HIGH RELIABILITY POTENTIOMETERS

High Temperature Operation . . . 150° C

Here's performance to match those "beyond the usual" requirements in a compact, quality potentiometer. The Clarostat Series 57EM is now available with glass-sealed terminals to meet 150°C operating conditions.

Available in all common shaft configurations including set-and-forget types for trimming applications with split locking bushings.

These units are manufactured in accordance with the applicable sections of MIL-R-19, MIL-R-12934 and MIL-R-27208.

#### SPECIFICATIONS — SERIES 57EM WIRE-WOUND POTENTIOMETERS

- Diameter . . . . . 1/2"
- Body Length . . . . . 33/64"
- Maximum Resistance . . . . . 100,000 ohms
- Linearity . . . . . 2%
- Wattage . . . . . 2.0
- Weight . . . . . .25 ozs

WRITE  
FOR  
COMPLETE  
INFORMATION



Compare  
**CLAROSTAT**  
CLAROSTAT MANUFACTURING CO., INC.  
DOVER, NEW HAMPSHIRE

See us at WESCON Booth 1714  
CIRCLE 16 ON READER-SERVICE CARD

# Speech Recognized by Waveform-Matching System

*Completely Analog Circuitry and Stored Memory Is Used In 10-Word, Developmental Signal-Comparison Equipment*

Alan Corneretto  
News Editor

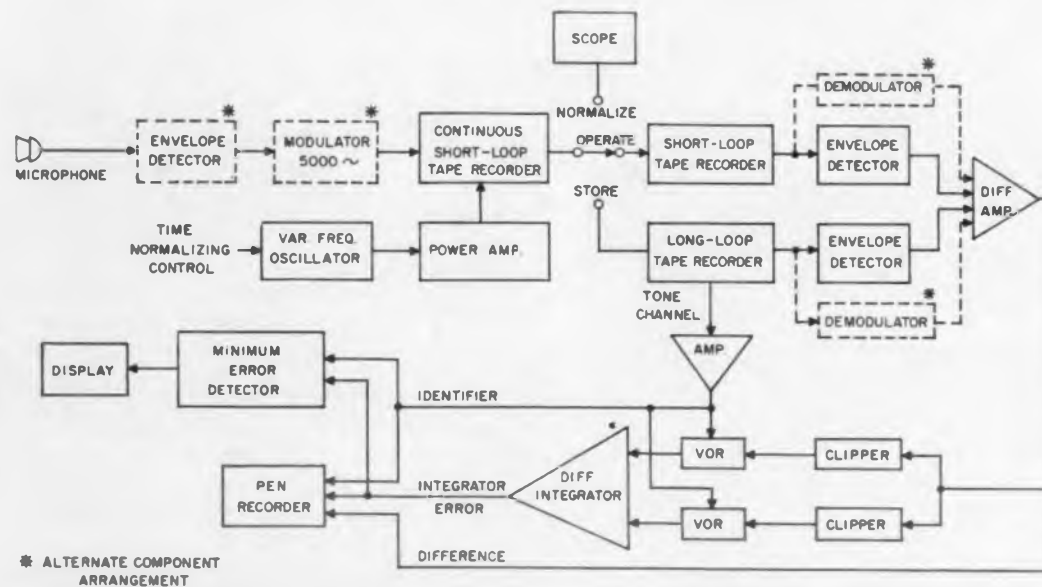

\* ALTERNATE COMPONENT ARRANGEMENT

**Analog speech-recognition system**, said to be suitable for recognition of sonar, radar and other types of signals, has been tested successfully at Bulova Research and Development Laboratories. One of ten words spoken into microphone is taped, normalized with aid of scope, and its envelope compared with that of reference words stored on tape. When correlation is sufficient, a match is signalled.

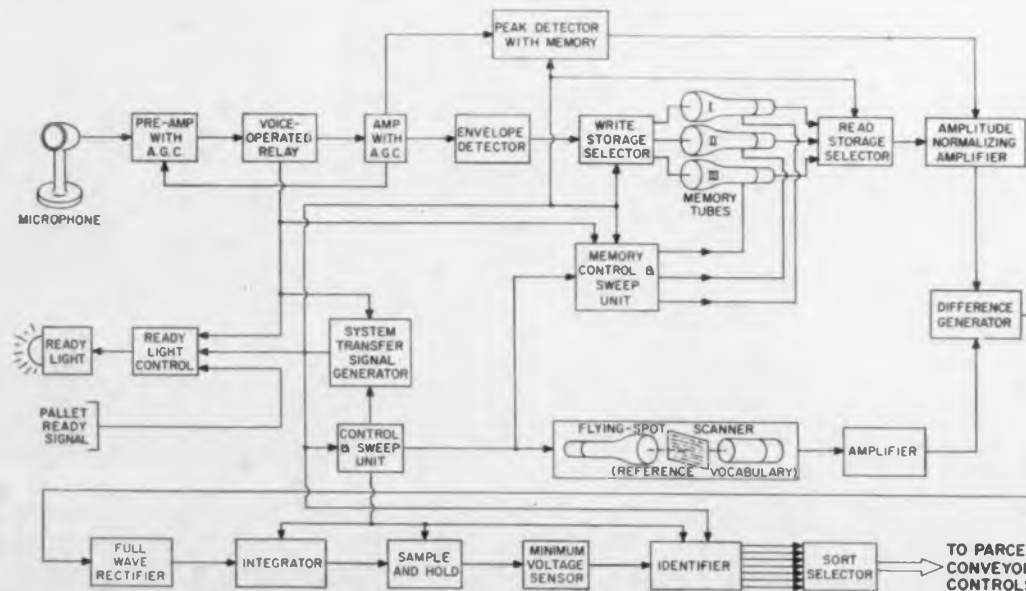

**Proposed design** of speech recognizer for an industrial control application, like post-office mail sorting, includes optical storage system. Newly developed fast-erase circuitry may permit the use of two rather than three tubes for write and read cycles.

**A** DEVELOPMENTAL signal recognizer that uses only analog techniques has automatically matched words spoken into it with the same words stored in its memory. Though equipment to recognize only 10 words has been built so far, the system is said to be readily expandable for use with hundreds of words and to be suitable for signals of any type.

The system is called Auditran, for Audio Information Transducer, and is under development at Bulova Research and Development Laboratories, Queens, N. Y. A Model I has been breadboarded with a tape memory, and detailed design is proceeding on a larger version that will have an optical memory, according to R. J. Bibbero, chief electronics engineer of Bulova. The company has applied for a patent on the Auditran concept, which is said to be based on an invention of Mr. Bibbero.

In operation, the equipment compares the waveform of an input word with a series of stored reference waveforms and selects the best match between input and storage. Best match is determined by the least value of a particular correlation function. In Auditran, this function is implemented with only analog circuitry, which is said to permit faster and less expensive processing than digital techniques. The system does not process raw waveforms; it uses internally generated envelopes based on amplitude or other characteristics to reduce bandwidth.

Input words are stored on a variable-speed tape assembly in the breadboard version of the system. By varying the tape speed, an operator is able to normalize the duration of each input word. The waveform is also normalized for amplitude with the aid of an oscilloscope. Although normalizing is now done manually, later systems will do it automatically, Bulova says. The normalized waveform is recorded on a continuous loop for further processing. The same technique is used to store reference waveforms.



**Model I Auditran** has tape memory and transistorized light-array output display. Equipment is being used to test envelope detectors and other circuitry and to compile statistical data on performance of the system.

The present 10-word memory is contained in a system of long loops of up to 300 in. moving at 15 in. per sec.

The input waveform, after being normalized, is rectified and traced in outline as preparation for envelope detection. Both the input and the reference waveforms pass through matched envelope detectors into a difference amplifier, so that the unknown waveform can be subtracted from each of the reference signals in turn. This is done in a continuous-loop operation.

#### Relative Phase of Waveforms Varied As Signal Is Matched to Each Reference

At each repetition, the relative phase of the two compared waveforms is varied to achieve a match similar to cross-correlation. At present this is done by adjusting the relative lengths of two tapes. In earlier versions of the equipment, phase was varied by rotating a three-phase synchro, which advanced or retarded the phase of the drive-motor power supply of the tape loop equipment and in turn advanced or retarded the tape containing the unknown waveform.

A differential amplifier subtracts the values of the unknown and reference envelopes. An integrator combines signals after they are separated into positive- and negative-going signals. Two integrator channels are used because of the difficulty of balancing out dc to the integrator from a single-ended rectifier, Bulova says.

This differential integration of the rectified value of the difference between waveforms provides a least-error integral that

## VITRAMON, INC. Develops Dramatically Improved Dielectric Material



**SOLID STATE  
PORCELAIN  
CAPACITORS**

with NEW #155 "FRIT"

# ASSURE 10 TIMES BETTER PERFORMANCE AFTER A LIFE TEST 10 TIMES MORE DEMANDING!

Three years of intensive product research, and the desire to impose a more exacting quality control during production, have resulted in the development of a new porcelain "frit." Completely formulated and produced within our own plant, this high quality dielectric material, utilized for the improved "VY" Porcelain Capacitors, has produced dramatic results.

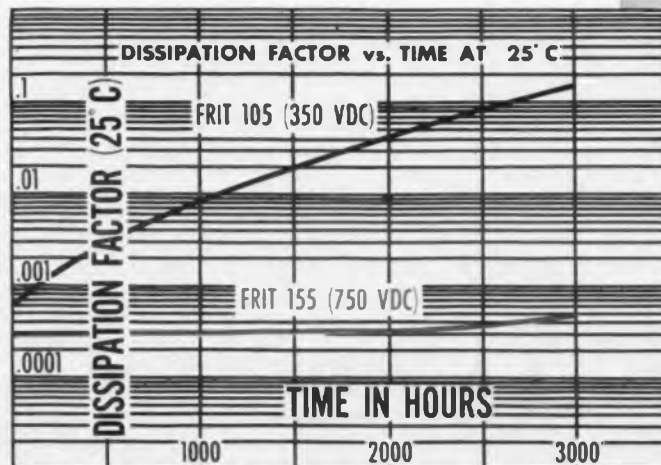
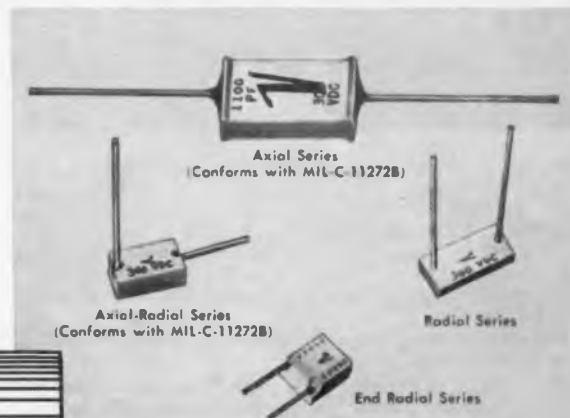

**NOTE:** Offered Exclusively For MIL-C-11272B Requirements.

© Vitramon, Inc.

When tested at 125°C with more than twice previous test voltages applied (750 VDC vs 350 VDC and 450 VDC vs 200 VDC) and with the time extended to 2000 hours (more than 10 times as stringent a test) post-test dissipation factor is .002 max. and insulation resistance is greater than 100,000 megohms (10 times better!)

**Vitramon®**  
INCORPORATED  
Box 544, Bridgeport 1, Conn.

CIRCLE 17 ON READER-SERVICE CARD



Recent  
USAF release  
makes

# MOTOROLA MINUTEMAN MESA TRANSISTORS

available  
for your military  
application



## NEWS

determines which reference waveform is the best match for the input waveform. This is done in a black box in which tones associated with each memory signal are gated through until best match is indicated. Then, a tone-sensitive reed relay activates an indicator light.

The Model I Auditran is being used to test various types of envelope detection. Bulova engineers have designed several different methods, including one based on generation of a frequency-formed envelope.

According to Bulova, initial tests indicate the system will have at least 99.96-percent reliability in identifying the right word when such place names as New York, Newark, Poughkeepsie and others are used. This reliability is not critically dependent on whether a male or female speaker is used, the company says.

The prototype Auditran under design is expected to be able to recognize one word a second from a memory of at least 300 words at less than 2-mc system bandwidth. This would almost be real-time recognition, with one word being spoken as the previous word is being recognized.

### Analog Method Faster, Requires Less Equipment Than Digital

Advantages cited for analog waveform recognition over digital methods include higher speed, compatibility with much existing equipment, less data to process, relatively small memory requirements, and lower equipment costs. The disadvantages are said to be the greater difficulty of coding speech by analog means and the greater bandwidth required. However, Bulova engineers say, although internal process is broadband, system output may be made as narrow as desired.

The existing Auditran engineering model is based on recognition of whole words. Bulova says this method appears best for memories of up to about 1,000 words. For larger memories the company expects that phonetic elements might prove a better key to recognition and that digital logic would have to be used. The system is said to be suitable for formant-tracking-type recognition, in which the characteristic waveforms of resonance points in speech are used as a basis for recognition. For very large capacities, the company reports, more than one Auditran can be paralleled. ■ ■

For the first time, Motorola Mesa transistors tested to the rugged requirements of the Minuteman high-reliability program (conducted by Autonetics Division, North American Aviation, Inc.) are available for *all* military applications. Every process and quality control procedure that made these units *the most reliable transistors* in this high-priority program can now help you achieve greater reliability in your military circuitry.

The Minuteman units immediately available from Motorola include:

101A, 101B and 101M — PNP germanium high-frequency switching transistors for high-speed computer and data processing applications.

201A, 201B and 201M — PNP germanium amplifier transistors for use in communications equipment, radar IF strips, fixed IF strips, wide-band amplifiers and precision oscillators.

These Motorola units have successfully demonstrated a failure rate of less than .003%/1000 hours under accelerated stress conditions to the three-year end points of the program\*. They are now in the final test phase to assure a .0007%/1000 failure rate level . . . the most stringent requirement of any transistor in the missile's guidance system. The same life-test data required with Minuteman devices is also available to you.

FOR COMPLETE TECHNICAL INFORMATION ON MOTOROLA MINUTEMAN MESAS OR INDUSTRIAL-TYPE MESAS call your Motorola Semiconductor district office or write Motorola Semiconductor Products Inc., Dept. 101, 5005 East McDowell, Phoenix 8, Arizona.

\*At a 60% confidence level with an assumed acceleration factor of 32.

MOTOROLA MINUTEMAN MESA TRANSISTORS				
Characteristic	Symbol	Type No. 101A, B&M	Type No. 201A, B&M	Unit
Collector-Base Voltage	BV <sub>ceo</sub>	15	15	Volts
Emitter-Base Voltage	BV <sub>eco</sub>	5	2	Volts
Collector Current	I <sub>c</sub>	100	100	mA
DC Base Current (Max. @ I <sub>c</sub> = 50 mA)	—	1.25	—	mA
Current Transfer Ratio (Min. @ f = 1 kc & I <sub>c</sub> = 1.5 mA)	h <sub>fe</sub>	—	45	—
T <sub>j</sub> = -65 to +100°C		P <sub>o</sub> (25°C Case Temp.) = 300 mW		

NOTE: "A" units supplied to Measurement Acceptance Tests group A & B.  
"B" units supplied and certified to complete Minuteman specifications.  
"M" units certified to complete Minuteman specifications and supplied board mounted and serialized with computer card data.

### INDUSTRIAL MESAS ALSO PRODUCED WITH MINUTEMAN PRODUCTION CONTROL TECHNIQUES

The same processes and quality control procedures used for Minuteman units are also applied to other Motorola Mesas. These germanium units incorporate the inherent reliability of the Minuteman process and are available in production quantities to industrial equipment manufacturers.



**MOTOROLA**  
Semiconductor Products Inc.

A SUBSIDIARY OF MOTOROLA, INC.

5005 EAST McDOWELL ROAD • PHOENIX 8, ARIZONA

LOOK TO MOTOROLA FOR ALL YOUR SEMICONDUCTOR REQUIREMENTS  
POWER TRANSISTORS • MESA SWITCHING & AMPLIFIER TRANSISTORS • MILLIWATT TRANSISTORS • SILICON RECTIFIERS • ZENER DIODES

CIRCLE 18 ON READER-SERVICE CARD

## MADT Transistor Encapsulation Increases Dissipation of Heat

A new encapsulating technique for potting the elements of Micro Alloy Diffused Technique (MADT) transistors is said to increase their heat-dissipating capabilities to double the normal rate while still maintaining normal electrical stability.

The encapsulating compound used is an alumina-loaded polysiloxane fluid. This medium increases thermal conductivity between the transistor's junction and case while maintaining electrical isolation.

The technique was developed by Dr. H. Thornton for Philco, Inc., Philadelphia. The use of alumina particles of varying sizes is said to have improved heat transfer.

Dr. Thornton said that encapsulated transistors would have a service range of -100 to +400 F. He also reported that the exact heat-dissipation and electrical stability characteristics had not yet been fixed.

The encapsulating technique is being used in a new line of MADT transistors for military applications by Philco, a company representative said.

## Tiny Detector Records Neutrons



Miniaturized fast-neutron dosimeter, held by researcher, consists of a 0.1 by 0.03-in. silicon disk mounted between two electrical contact pins. Called Radium Detector by its developers, Battelle Memorial Institute of Columbus, Ohio, the device records fast-neutron dosage cumulatively. The fast neutrons passing through the dosimeter knock silicon atoms from their normal positions, permanently changing the electrical properties of the silicon. The detector is reported insensitive to all other forms of radiation. Damage to human tissue can be measured quickly and easily, Battelle reports.

# Linde *materials & Coatings* News

LINDE COMPANY, DIVISION OF UNION CARBIDE CORPORATION

## Crystal tungsten opens up a new era for the metal in electronics



Typical electronic shapes fabricated from crystal tungsten (l. to r.): target emitter; zero-porosity tungsten anode for high-powered electron tubes with fluid cooling; high-power vacuum switch contact of zero-porosity tungsten mounted to copper.

A new method of consolidating tungsten powder into tungsten ingot has been created by LINDE's Crystal Products Department. This new material—in crystal form—changes the whole approach to use of tungsten in electronic applications.

Compared to metallurgically prepared (PM) tungsten, crystal tungsten offers 5 to 15 per cent higher electrical conductivity. Thermal conductivity is about 20 per cent higher at 500° F., resulting in improved heat dissipation. These properties can be advantageous in electronic design.

### Useful in vacuum devices

The high purity and zero porosity of the crystal tungsten also suggest its use not only in electrical contact points, but also in vacuum switches, electrical leads in vacuum tubes, and applications where outgassing or leakage is a problem. Their purity and lack of grain boundaries provide more even electron emission, making them valuable in several high pressure vacuum or open air switches. Other uses include: flexible sheet in electronic tubes; x-ray and anti-cathode targets.

LINDE crystal tungsten is considerably more ductile than undoped PM

tungsten. It can be drawn into wire as fine as 1 mil, giving greater yield of finished product from the starting ingot. Although undoped crystal tungsten has a lower recrystallization temperature, it does have a yield point at about 150° F.

### Material easily worked

Significant is the fact that it can be easily worked and at temperatures 800° F. lower than working temperature for powder metallurgy or vacuum-arc cast tungsten—making it useful for a wide range of non-electronic applications. Present shapes include swaged rods from 1/10 to 3/8-inch diameter, as grown ingots up to 3/4-inch diameter in production, and even larger diameters in development.

For more details on this new material, check the coupon below.

## Super-hot process metal-coats and fabricates intricate parts

Dense, high-purity metal coatings for certain base materials, and the fabrication of odd shapes, are accomplished with "Plasmaplate," a super-hot plasma stream process developed by LINDE's Flame-Plating Department.

In operation, a high-current torch uses temperatures up to 30,000° F. to produce a supersonic stream of ionized gas—melt and accelerate to high velocity particles of any inorganic material that melts without decomposition.

High-purity coating materials—such as tungsten or other refractory metals—are thus permanently fused to the surfaces of materials such as graphite, brass, copper, steel, molybdenum, titanium, aluminum and others.

Parts of intricate configuration can be fabricated by depositing the coating material on a mandrel machined to the desired internal shape of the finished part. After the desired thickness is obtained, the mandrel is dissolved out by chemical means.



Tungsten grid cage—one of many complex shapes made by LINDE's "Plasmaplate" Process.

Thin coatings of tungsten carbide and other hard materials can also be applied to base metals by the LINDE oxyacetylene Flame-Plating "gun" process, to increase surface wear as many as 40 times.

For details on either of these LINDE processes, check the coupon below.

CHECK—CLIP COUPON—ATTACH TO BUSINESS LETTERHEAD

Linde Company, Dept. ED-81  
270 Park Avenue  
New York 17, N. Y.

Please send details on the items checked:

- LINDE Crystal Tungsten
- LINDE "Plasmaplate" Process
- LINDE Flame-Plating Process

**LINDE  
COMPANY**

"Linde" and "Union Carbide" are registered trademarks of Union Carbide Corporation

**UNION  
CARBIDE**

**High-Capacitance,  
Small-Size 'Lytics  
Now Available for  
Computer Power Supplies**



The Sprague Electric Company offers two series of "block-buster" electrolytic capacitors for use in digital power supplies and allied applications requiring extremely large values of capacitance in relatively small physical size.

With metal cases ranging from 1 3/8" dia. x 2 1/8" long to 3" dia. x 4 3/8" long, Type 36D Powerlytic® Capacitors pack the highest capacitance values available in these case sizes. Intended for operation at temperatures to 65 C, their maximum capacitance values range from 150,000 F at 3 volts to 1000 µF at 450 volts.

Where 85 C operation is a factor, Sprague offers the Type 32D Compulytic® Series, the ultimate in reliable long-life electrolytic capacitors for digital service. These remarkably trouble-free units have maximum capacitance values ranging from 130,000 µF at 2.5 volts to 630 µF at 450 volts.

Both 32D and 36D Capacitors have low equivalent series resistance and low leakage currents, as well as excellent shelf life and high ripple current capability.

Tapped terminal inserts, often preferred for strap or bus bar connections, are available as well as solder lug terminals for use with permanently wired connections.

In addition to the standard bare case, either series may also be obtained with a new clear rigid plastic tube which adds very little to the bare case dimensions. They are also available with a Kraftboard tube.

For complete technical data on Type 36D Powerlytics, write for Engineering Bulletin 3431. For the full story on the "blue ribbon" Type 32D Series, write for Engineering Bulletin 3441B to the Technical Literature Section, Sprague Electric Company, 347 Marshall Street, North Adams, Massachusetts.

CIRCLE 224 ON READER-SERVICE CARD  
20

**PULSE-FORMING NETWORKS  
FROM WATTS**   
to **MEGAWATTS**



**... and everything in between!**

When it comes to pulse capacitors and pulse-forming networks, many complexities in parameters and design factors must be considered. These specialized units must be designed and manufactured by a specialized organization. And because Sprague maintains a highly-technical special engineering section devoted exclusively to pulse capacitors and networks, it has been, from the very beginning, a major supplier of these complex units for radar equipment (ground, marine, aircraft, missile), tube testing, and similar pulse circuit applications.

This special engineering section performs four important functions: One group designs custom units in accordance with required parameters. Another group builds pulse capacitors and networks to precise specifications. In another area, a group of specially-trained field engineers provides application assistance wherever needed. And yet another independent group works toward the future developing new materials, new design concepts, and new techniques for manufacture, enabling Sprague to introduce product improvements such as heliarc sealing of cases, rugged alumina bushing assemblies, Fabmika® dielectric, and improved hermetic sealing of closures.

Write for Engineering Bulletin No. 10,001 to Technical Literature Section, Sprague Electric Company, 347 Marshall Street, North Adams, Massachusetts.



CIRCLE 225 ON READER-SERVICE CARD

# WASHINGTON REPORT



**John J. Christie**  
Washington Editor

## ***AIR FORCE REORGANIZATION***

The Air Force is in the final stage of a major reorganization program that has a two-fold objective of streamlining management of systems projects and of upgrading the status of basic research. A reshuffling of field commands that began in April has been followed by a realignment of staff functions at the Pentagon.

Reorganization on the systems level is in recognition of the ever closer link between development and production. It began with the recent establishment of the Air Forces Systems Command, which combined the R&D responsibilities of the former Air Research Development Command and the production and procurement functions of the Air Materiel Command. The Pentagon has now combined the staff responsibilities for development, procurement, and logistic support of aircraft, missile, space and electronic systems under a newly designated Deputy Chief of Staff for Systems and Logistics.

The new set-up should enable defense contractors to get faster decisions on design and production problems that cannot be solved at the project level. It should also speed the Pentagon's review and approval of high priority programs.

By merging of development and production responsibilities in the supervision of individual projects, the Air Force hopes for more decisive action on such matters as weighing the feasibility of production changes against operational requirements, determining tradeoffs as between reliability and costs, etc.

***Basic Research Functions*** at Air Force field installations were placed under the new Office of Aerospace Research at the time the new Systems Command absorbed the R&D activities of the former Air Research Development Command. New Pentagon staff functions relating to basic research, study projects and applied research in new areas of technology have been combined under a Deputy Chief of Staff for Research and Technology.

This move should allay criticism that basic and applied research has been too much oriented to the requirements of specific weapons systems development programs. It is believed that under separate planning and direction the investigation of advanced technology will get higher priority and thus greater financial support.

## ***SPACE COMMUNICATIONS BELT NEARS TEST***

The military has high hopes for the distributed reflector version of a passive satellite communications system, which is scheduled to be tested this fall. Known as Project Westford, the test will involve orbiting a belt of tiny dipole reflectors, which will form a constant ring around the earth at an altitude of 2,000 miles.

Forming the reflector belt will be 500 million dipoles of 3/4-in. length and about 1/3 the thickness of a human hair. The 70 lb of dipoles will be ejected from a container, which is expected to be put in orbit by a Midas shot. Studies forecast the width of the belt at

20 to 40 miles, with spacing between the dipoles at from 500 to 1,000 ft.

Lifetime of the initial belt will be purposely limited to avoid space pollution, if the experiment does not pan out. At the projected 2,000-mile altitude, it is calculated that the combination of radiation pressure and gravitational effects will limit the life of the belt to from one to two years. At an altitude of only 200 miles less, the ring of reflectors would last an estimated two to three decades.

It is envisioned that this type of system would play a secondary role in military satellite communications because of economic limitations. Ground stations will require very large antennas and large amounts of power to pull signals from the extremely small reflecting surfaces. Moreover, unless developments prove otherwise, bandwidth capacity is unlikely to approach that of active systems.

The distributed reflector system, however, could give the military a foolproof backstop or auxiliary for the synchronous equatorial system being developed under the Army's Advent program. For obviously the dipole belt poses no reliability problems. And even more important from a military standpoint, it cannot be destroyed by enemy action.

### **STORM MONITORING STATIONS IN PRODUCTION**

Seven unmanned, floating weather stations of the NOMAD type, which last year provided a 48-hr alert on Hurricane Ethel from a mooring in the Gulf of Mexico, will go into production for Navy use in storm areas of the Atlantic and Pacific. The Air Force and Weather Bureau also plan storm-monitoring station networks.

Meanwhile NOMAD I, which has been conducting experiments for the last seven years, has been placed 300 miles out in the Gulf for another hurricane season. Each year some refinements have been made in sensing devices and data-transmission equipment developed by the Bureau of Standards. But it is acknowledged that considerably more development work is required to guarantee reliability for the desired two years or more of unattended operation. Also, certain mechanical devices now used are not suited for operations in Arctic waters.

An experimental compass-bearing transducer will be the principal new device to be tested during NOMAD I's current tour of duty. Since last year circuitry has also been transistorized to a greater extent.

Solar batteries, which last year were deck-mounted in plastic boxes, suffered heavy power loss through overheating. This year they are being floated in plastic tubing in an effort to cut down heat. Further efforts to improve power supply include development by General Instrument Corp. of a thermoelectric generator that will be fired by liquid butane (*ED*, Dec. 21, p 16) and work on a nuclear battery at the Martin Co.

### **ANOTHER ADVANCE IN PARTS RELIABILITY**

An industry-Government advisory committee will be named shortly to help implement DOD's parts reliability program, already beginning to have sharp impact on the component industry's design, production and testing functions.

The committee will provide continuing technical advice on the development of new quantitative reliability specifications and technical documentation. It will also advise on the establishment of priorities in the issuance of parts specs.

At Magnetic Controls Company...

where  
reliability  
is  
sacred



## RED/LINE timing relays "Pay Off"!

At Magnetic Controls Company, where power supply reliability is sacred, design engineers selected G-V Red/Line Thermal Relays over all others. According to Magnetic Controls, "The timing cycle does not change with ambient temperature change . . . a characteristic which is essential for maximum performance . . ." They have used the recognized quality of Red/Line in 13 different models of their power supplies without a single relay failure. That's reliability! So, at Magnetic Controls, the high quality of G-V Timing Relays is "paying off".

More and more companies are finding the reliable performance of G-V Red/Line Timing Relays makes them best for their products. G-V Red/Line Relays will pay off in your product, too. Your customers appreciate the importance of high quality, reliable components. G-V Red/Line Timing Relays are specially designed for industrial applications. They have the precision, reliability and long life needed to "pay off" in industrial use.

Your G-V distributor has them in stock now. Call him or write for Bulletin 131 today.



**G-V CONTROLS INC.**  
Livingston, New Jersey

## Adapted Typewriter Digitizes Negatives

*Pattern Converter Provides Maps Of Isodose Areas From X-Ray Photos*

WITH suitable electronics, biomedical researchers have been able to convert specialized X-ray negatives to maps that show areas of equal dosage. The analog-to-digital conversion is done automatically by an ordinary electric typewriter modified for the work at a rate of 10 readings or nearly 1/4-sq. in. per sec.

The automatic conversion system was developed at the Rosewell Park Memorial Institute, Buffalo, N. Y., to aid studies of optimum procedures in using super-high-voltage medical X-ray equipment. Exposed negatives showing gradations in transparency caused by different degrees of exposure are converted to typed maps. The areas and contours of the maps are formed by numbers corresponding to discrete levels of dosage at corresponding points on the original negative being processed.

### System Described at Rochester Meeting On Uses of Data in Medicine, Biology

The system was described at the Rochester Conference on Data Acquisition and Processing in Biology and Medicine, held at the University of Rochester, N. Y., on July 18 and 19.

Dr. Edwin Gordy of the Rosewell Park Memorial Institute reported that the mapping system provides a 1-to-1 scale, 10-level representation of a 14-by-17 in. exposed negative in about an hour. This was said to be a much faster performance than that of other types of converter-plotters. A total of 168 readings per sq. in., in per cent of maximum dose, are printed by the equipment, he said.

The system consists of an electric typewriter adapted to hold a sheet of paper over an X-ray negative so that a light behind the paper is focused through the film and paper to a photocell pickup that feeds a discriminator. This stage is connected to suitable amplifier, analog-to-digital, and print-rate-generation circuitry that operates

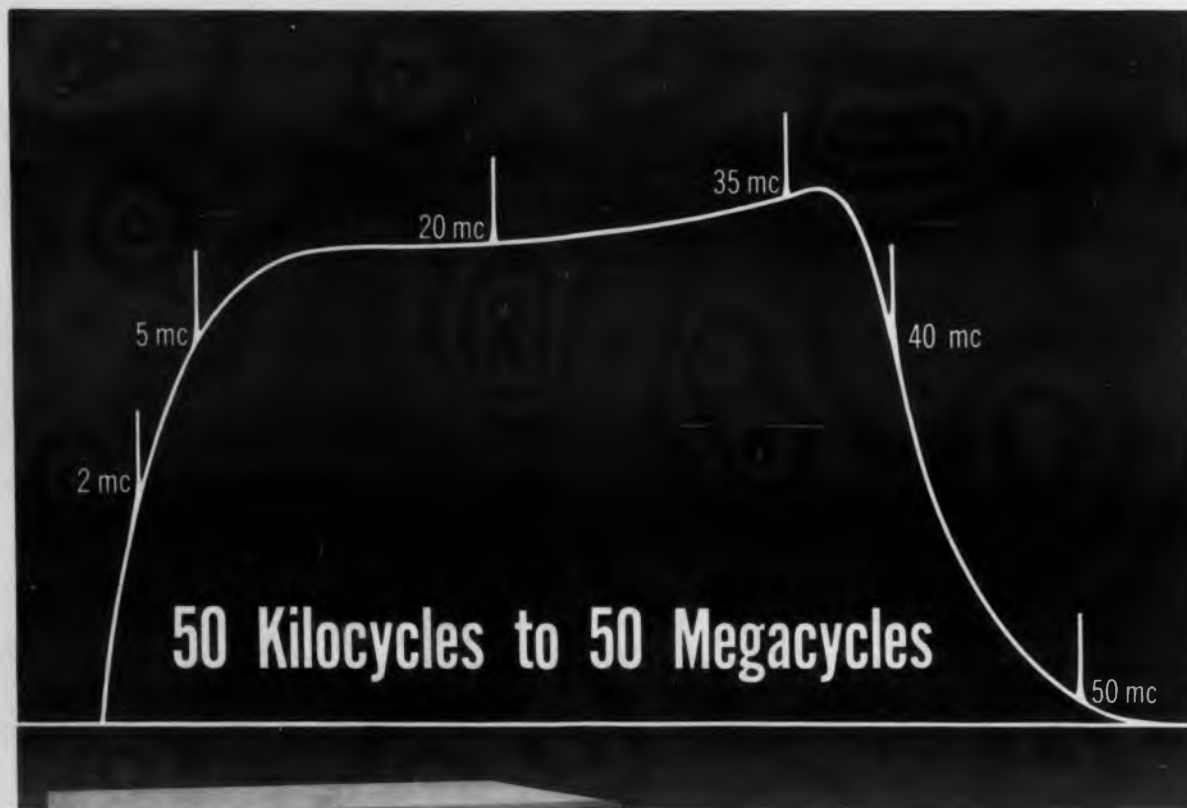

CAT. NO. 153-B

- ▶ Stable
- ▶ High, AGC'd Output
- ▶ Pulse Type "Crystal Markers"
- ▶ Controlled (Low) Harmonics
- ▶ From 50 kc to 50 mc in a Single Frequency Sweep

## KAY Marka-Sweep®

MODEL VIDEO 50

Sweeping Oscillator — Frequency Marker

### All Electronic Complete Video & IF Alignment System

A unique, wide range video sweeping oscillator, the Kay Marka-Sweep Model Video 50 provides higher output voltage and sweeps lower in frequency than customary wide range video sweeping oscillators. It provides a linear swept-frequency output, AGC'd for constant level over the frequency band. The unit includes a series of sharp, pulse-type crystal markers. In addition, a calibrated frequency dial permits the use of the Model Video 50 as an IF sweeping oscillator with continuously variable center frequency and sweep width.

### SPECIFICATIONS

**FREQUENCY RANGE:** Continuously variable, 50 kc to 50 mc.

**SWEEP WIDTH:** Linear, continuously variable, 4.0 mc to 50 mc.

**RF OUTPUT:** 1.0 V, peak-to-peak, into nom. 70 ohms. Flat to within  $\pm 0.5$  db over widest sweep.

**ATTENUATORS:** Switched 20 db, 20 db, 10 db, 6 db and 3 db steps plus 3 db (approx.) variable.

**MARKERS:** Eight sharp, pulse-type, crystal-positioned markers; usable singly or collectively. Produced either as positive pulses with separate amplitude control and separate output or as keying pulses in sweeping RF signal.

**PRICE:** \$845.00 F.O.B. FACTORY, \$930.00 F.A.S., N. Y. Substitute markers, \$12.50. Additional markers, \$20.00 each.

WRITE FOR COMPLETE CATALOG INFORMATION

**KAY ELECTRIC COMPANY**

VISIT US AT WESCON

DEPT. ED-8

MAPLE AVENUE, PINE BROOK, N. J.

CAPITAL 6-4000

BOOTH #'s 3105 & 3107

CIRCLE 22 ON READER-SERVICE CARD

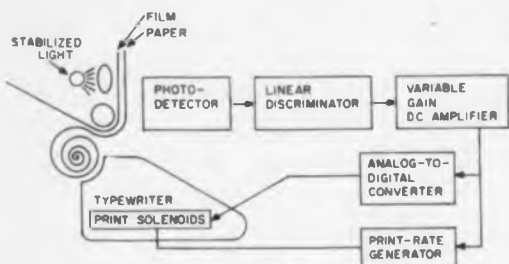

Typewriter and associated electronics are able to provide typed-map versions of X-ray photos to show areas of equal dose or exposure. The system, essentially an analog-to-digital pattern converter, aids studies of optimum X-ray procedures in medical research. Print-rate generation is initiated by carriage return and is inhibited by completion of each scan. Discriminator is linear over four decades. The equipment was developed at Rosewell Park Memorial Institute, Buffalo, N. Y.

the basic print solenoids of the electric typewriter.

As the carriage moves and the film is scanned, appropriate numbers are typed at points on the paper corresponding to variations in the transparency of the film under each number.

#### Distributed-State-Response Pattern Recognizers Described

Several other developments in pattern recognition and processing were discussed at the meeting. This speciality was said to be growing increasingly important to medicine as researchers seek to automate the processing of medical data.

A sophisticated pattern recognizer said to be theoretically capable of learning was described by D. F. Parkhill, General Dynamics/Electronics, Rochester. Called a distributed-state response (DSR) system, and actually a special-purpose digital computer, the pattern recognizer has operated successfully in computer simulations and is now being built.

#### System Uses Neural Nets Like Perceptron Machine

Like the perceptron developed at Cornell Aeronautical Laboratories, Buffalo, N. Y., the DSR design is a neural-net system. It has 1,024 sensory elements, 256 association elements and 32 response elements.

A related type of pattern recognizer is being built at Brooks Research, Inc., East Rochester, N. Y., according to Kurt Enslein, who described its development. This also will be a system in which memory will be distributed throughout the internal components. In most data-processing systems bits of memory data are stored in discrete locations in memory subsystems. ■ ■

Standardize with this multi-purpose film wire success!

Phelps  
Dodge

# POLY- Thermaleze®



Has replaced as many as  
six standard wires in  
these important  
applications!

Coils

Dry-type  
Transformers

Best balance of overall properties without sacrifice of any one property!

High dielectric for thermal protection at operating temperatures (Class F 155C)!

Cost reduction benefits through standardizing inventory to one wire for most applications!

Any time your problem is magnet wire, consult Phelps Dodge for the quickest, surest answer!

PHELPS DODGE COPPER PRODUCTS  
CORPORATION  
INCA MANUFACTURING DIVISION  
FORT WAYNE, INDIANA



Poly-Thermaleze®—Patent applied for.

CIRCLE 23 ON READER-SERVICE CARD



# HOLD IT!

THERE'S NO SUBSTITUTE FOR AN  
ELECTRONIC MEASUREMENTS  
CONSTANT-CURRENT POWER SUPPLY



## what every engineer knows about constant-current power supplies . . .

How do you check the peak inverse voltage rating of a solid state junction? the breakdown voltage of a reference diode at a specified current? the dynamic impedance of a reference diode? and the many other parameters that are so easily checked with constant-current power supplies?

It's an easy matter to convert some voltage-regulated power supplies to current-regulated operation. At least it's easy with an E/M® Regatron Programmable Power Supply. But for true constant-current performance, there's no substitute for a power supply specifically designed for constant-current operation.

Take Electronic Measurements' Model C638A shown here. It's an easy matter to set the current control to any value desired—from a few microamperes up to 100 ma—manually or programmably. And there's no juggling with makeshift, extra circuitry. Then you can adjust the voltage compliance to any value from 0 to 1500 V. There's no fear that the voltage may be

too great or not enough; the voltage control sets the upper limit.

Here are some additional features of the C638A: Output impedance is  $10^4$  megohms at 0.5  $\mu$ a to 0.5 megohms at 100 ma. Above 2.2  $\mu$ a, regulation is better than 0.15%, line or load, Ripple is less than 0.01% + 1  $\mu$ a rms. A modulation input is provided.

But to get back to the point; to check the peak inverse voltage rating of a solid state junction, simply set the output current control of an E/M Constant-Current Power Supply at the specified current. Connect the output to the junction, turn the power supply on, and measure the voltage drop across the junction. What could be easier? And other measurements can be made almost as easily.

For a complete discussion of constant-current power supplies with ratings up to 1A, ask for Specification Sheet 3072B. It lists all the models and specifications, too.

SEE THEM AT WESCON • BOOTHS 1324 & 1325

®Registered U. S. Patent Office. Patents Issued and Pending.



**ELECTRONIC**  
**MEASUREMENTS**  
COMPANY, INCORPORATED  
EATONTOWN • NEW JERSEY

CIRCLE 24 ON READER-SERVICE CARD

## NEWS

### 4,000-W Solar Power System Planned for Orbiting Satellites

A 4,000-w solar power system is being designed for earth-orbiting satellites.

The system is intended to operate for a minimum of one year and a maximum of five. It would differ from previous systems in its extremely high-power capacity.

The design work is under way at Westinghouse Aerospace Electrical Laboratories, Lima, Ohio, for the Aeronautical Systems Div., Air Force Systems Command.

### Navy Orders Research Ship For Antisubmarine Warfare

The Navy is spending more than \$10 million to find new, better approaches to building and equipping antisubmarine escort ships.

An experimental vessel, to be used as a floating research center, is under development. It will be fitted with the latest long-range sonar, and its armament will include Tartar and ASROC antisubmarine missiles, antisubmarine torpedoes and helicopters. The ship is to have an over-all length of about 415 ft and a beam of about 43 ft.

The ship will be built by the Bath Iron Works Corp., Bath, Me., under a \$10,227,300 contract.



### Solid-Stately

### Engineer Crowned

A triumph of design is Marlene Schmidt, electronic engineer (no kidding) from Stuttgart, Germany, crowned Miss Universe for 1961. Fraulein Schmidt's design dimensions are 36.5-24.0-36.0 in.  $\pm 1$  per cent. Resistance is not specified. The 24-year-old beauty, who fled from East to West Germany only a year ago, told reporters: "Engineering is my career, and I will return to my job [in West Germany at an equivalent of \$53 a week] after my year as Miss Universe."

CIRCLE 64 ON READER-SERVICE CARD ►



**CLEVITE TRANSISTOR**  
WALTHAM MASSACHUSETTS

RELIABILITY

IN  
VOLUME...

# Factors to consider in silicon diode selection

by DAVID E. HUMEZ

Technical Advisor to the Manager of Operations  
Clevite Transistor, Waltham, Mass.

If your circuit does not require the superior forward conductivity characteristics of germanium diodes or if you require extremely low reverse currents or must operate at temperatures above 50°C, you will probably select a silicon diode.

Of the bewildering array of silicon diode types available some will almost certainly suit your circuit better than others. Current silicon diode types fall into four main categories with many sub-categories. The first category historically was the general purpose alloy junction silicon diode. These diodes are principally useful in those applications in which good high voltage characteristics, very low leakage currents, even at high temperatures, are necessary. They are available with comparatively high forward conduction and over a wide range of voltages up to several hundred volts.

The next category is that of computing application silicon diodes. These differ from the general purpose diodes in that the material from which they are made is doped or otherwise treated in such a way as to reduce its bulk lifetime. Reduction of the lifetime of the material makes possible much faster operation, that is, faster recovery when switched from the forward to the reverse condition. Such diodes have found wide application in military and commercial computing circuitry which is expected to operate at high temperatures. A price is paid, however, for higher speed since reducing the lifetime of the material results also in an increase of the reverse current and a decrease in the forward conduction.

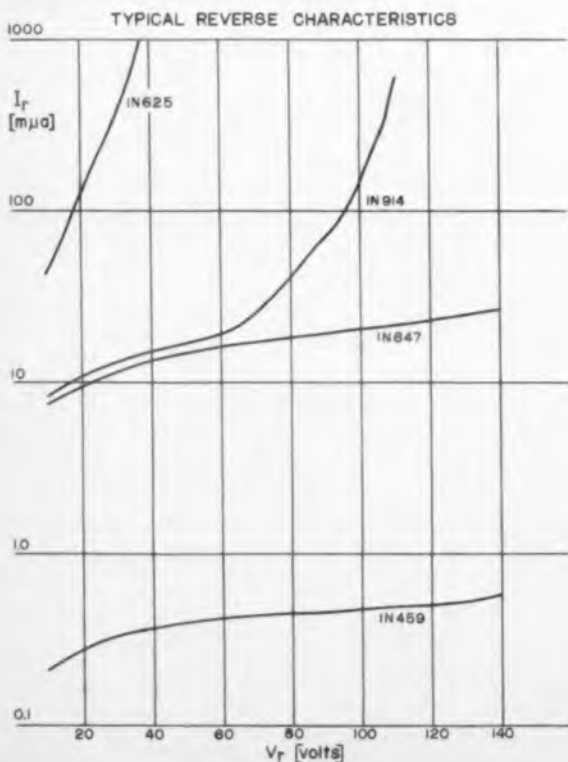

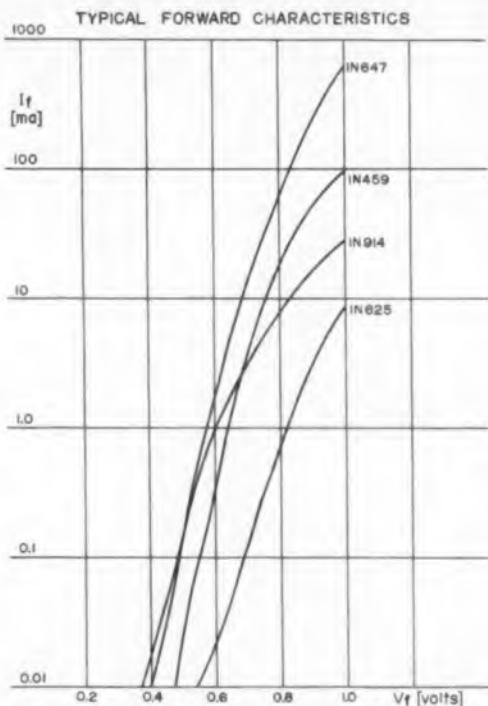

The third and fourth groups are the most recent and employ a different method, namely, solid state diffusion for producing the PN junction. The third group, sometimes called rectifiers, are devices fabricated in either the same subminiature glass package familiar in other diode types or this glass package modified by the inclusion of a larger diameter stud at one electrode for improved heat conduction. They are large area devices compared to the diodes in categories one and two and are designed for conduction of as much as 400 milliamperes at a volt. Since their area is substantially larger, their capacitance is also larger though not as large as would be expected by the ratio of areas, since the method of producing the junction results in less capacitance per unit area than is characteristic of alloyed junctions.

#### SWITCHING SPEED — REVERSE RECOVERY

Units switched by mercury wetted chopper from 15 ma forward current to 1.2 volts reverse in series with a 100 ohm load resistor. Recovery to 1 ma.

Unit	Time $m\mu$ sec.	Types
1N914	2.5	silicon mesa diode.
1N625	60.	high speed silicon alloy diode.
1N459	1500.	general purpose silicon diode.
1N647	8000.	silicon diffused rectifier.

The fourth and newest category is that of extremely small area devices made by the newer techniques of the mesa or planar constructions. These types are also manufactured by a diffusion process. They are designed primarily for applications in which the very fastest switching speeds are required. For this additional speed, compared to conventional computing alloyed junction types, a further price must also be paid. Because they are tiny, they are also less rugged. Because their area is smaller, both the resistance of the connecting wires and the spreading resistance are larger. Consequently, these devices as a group are characterized by somewhat poorer forward conduction than is true of the larger area computing diodes.

Ask for Silicon Diode Bulletins

**CT CLEVITE TRANSISTOR**  
Waltham, Massachusetts

## Selective Data Retrieval System Uses Keywords, Prints Abstracts

An information directing system that uses keywords to file and locate specific topics has been developed for use by the Central Intelligence Agency.

Coordinated indexing, the method used in the information handling system, catalogs the keywords that identify each document on file in the memory. The keywords, along with the location of the documents, are inserted into a punched card program. When a request is put in to the computer, it will print out an index of all documents in its memory concerning that topic, along with an abstract of each reference.

The actual information is stored as photographic images in a plastic file. Once located, the information can be viewed or reproduced without having to remove it from the file. Each file is made up of several modules, each containing 990,000 images.

Called Walnut, the system was built by International Business Machines Corp., White Plains, N. Y. A company representative reported that although the system is strictly for governmental use, it may become the forerunner of a commercially marketable unit.



**Image file** of Walnut Information Directing System, developed for the Central Intelligence Agency by IBM, is made up of 200 plastic cells loaded with film strips. Bin shown contains information equivalent to 3000 books.

◀ CIRCLE 64 ON READER-SERVICE CARD

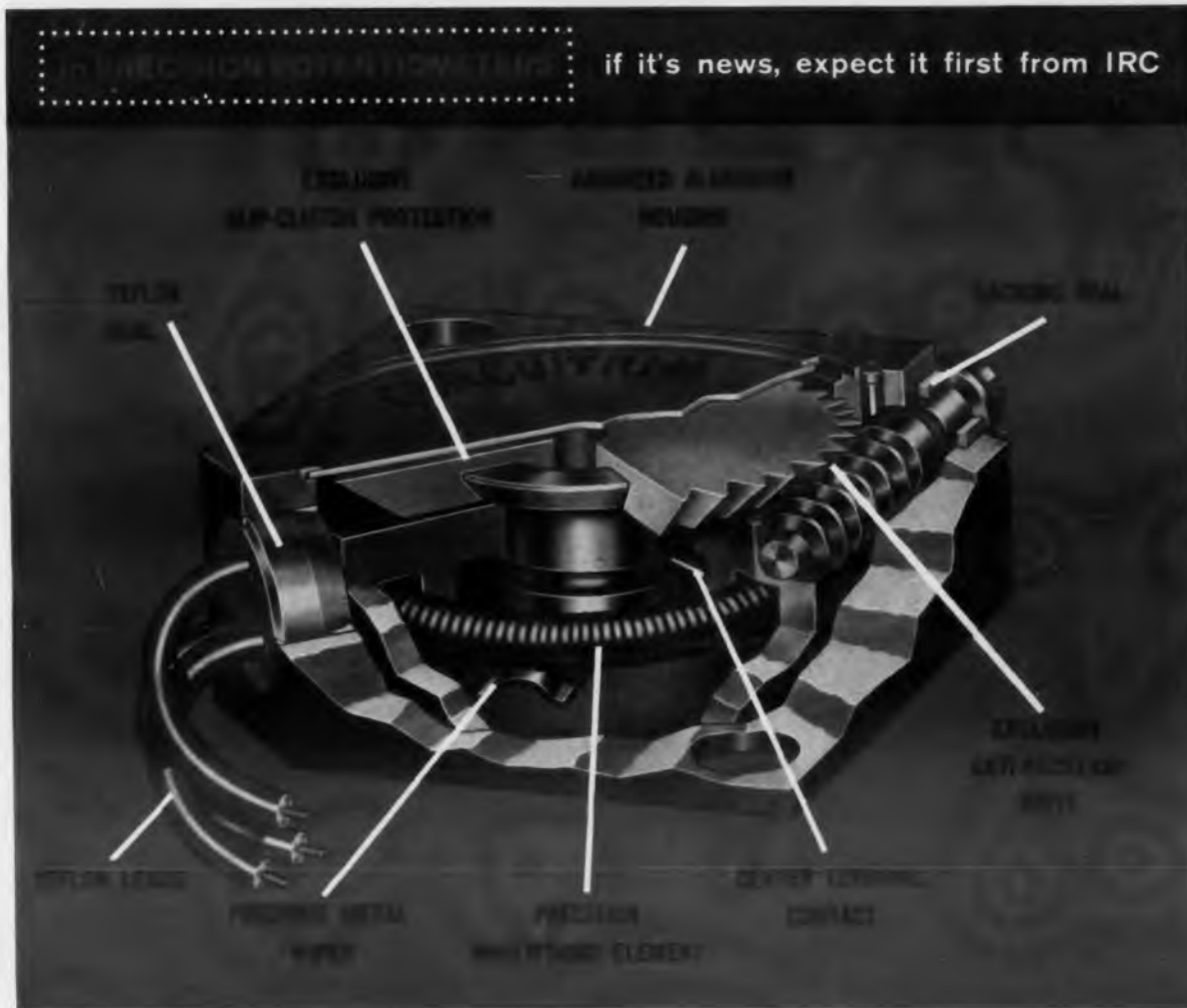

## EXPOSED... a reliable square trimmer design set it... forget it



**Superior shock and vibration characteristics** . . . made possible by an exclusive self-locking, anti-backlash gear. Once you set IRC's new  $\frac{1}{2}$ " square Circuitrim, forget it. The square trimmer remains at its set position even under conditions as severe as MIL-E-5272A, Procedure 1 vibration and MIL Standard 202 Method 202 shock test.

**Superior humidity characteristics** . . . pressure seals around leads and the drive screw make a lasting moisture barrier. Potting compound won't get in, silicone lubricant can't ooze out, even at the temperature extremes of dip soldering.

**Superior mechanical design** . . . fewer parts and inherently less noise. Rotation stops and slip clutch keep wiper from

traveling off end of winding and prevent mechanical abuse. 10 ohms to 50K ohms, 1 watt. Teflon leads standard; printed circuit terminals available.



**A NEW TRIMMER WITH INCREASED RELIABILITY ACHIEVED THROUGH SIMPLIFIED DESIGN.**

Possesses the same quality electrical assembly as the  $\frac{1}{2}$ " square Circuitrim. This unique design has eliminated the complex mechanical linkage used for adjustment, thereby giving a quality reliable trimmer for your highly competitive applications. 10 ohms to 50K ohms, 1 watt.  $\frac{1}{2}$ " diameter.

Write for technical bulletins. International Resistance Company, 401 North Broad Street, Philadelphia 8, Pa.

**COMPLETE LINE OF PRECISION POTENTIOMETERS • STOCKED BY IRC MAJOR INDUSTRIAL DISTRIBUTORS**  
Standard Single and Multi-Turn • Moisture-Sealed and High Temperature • Hermetically Sealed • Servo-Potentiometer • REVODUX 10-turn Dials



Leading supplier to manufacturers of electronic equipment

CIRCLE 25 ON READER-SERVICE CARD

## Thin-Film Cylinder Memory Gives Fast, High Output

*New Device, Combining Features of Dot, Core and Rod, Provides 15-Nsec Cycle, 250-Mv Readout and High Temperature Stability*



A single thin-wall cylinder memory with wiring. The film is 2 to 3 mm long, 0.5 to 0.7 mm diam and about 30,000 Angstroms thick. Conventional, thin-film dots are normally no more than 4,000 Angstroms thick and 3 mm diam. Photo, through the eye of a microscope, shows tiny bubbles in encapsulant.

**George Rosiky**  
Technical Editor

**A** MAGNETIC thin-film cylinder that contains features of the thin-film dot, the ferrite core and the magnetic rod is bidding for an important role in future computer memories. Under development by CBS Laboratories of Stamford, Conn., the device, called the Toristor, is composed of a plating of nickel-iron-cobalt composition on a substrate of glass or stainless steel.

Like the conventional, toroidal, ferrite core, the Toristor has wires passing through its center. Its output voltage range, 50 to 250 mv, includes the 40-to-120-mv range of cores. But its write-read cycle time, as short as 15 nsec, is substantially faster than the 3 to 5  $\mu$ sec of cores.

### **Very Rapid Cycle Times Combine With a High Output Voltage**

The Toristor's cycle time compares favorably with the very rapid 200 to 500 nsec of thin-film dots. And the rapidity of switching its magnetic domains, 10 to 15 nsec, compares well with the 5 to 40 nsec of dots. But its 50-to-250-mv output voltage range is a lot huskier than the 2 to 20 mv common with dots.

Like the magnetic rod, the Toristor takes a circumferential winding to provide a transverse interrogation field. But the Toristor also takes axial wires through its center for sense and digit write. The 300-ma digit-read current is the same as that required for other computer memories.

The principal advantage of the new development lies in its true nondestructive readout. Other nondestructive elements, like the multiaperture devices, require priming before each read operation. The Toristor requires only the interrogation pulse, which can be unipolar. To save time, information in the Toristor can be changed during the interrogation interval.

Output from the Toristor is bipolar; a "one" is in the opposite direction from a "zero." With cores, the output for a "one" is represented by magnetization in the same direction as a "zero"—but of significantly different amplitude.



**High output voltage** of this 64-bit, thin-wall cylinder memory—the Toristor—reduces the complexity of the sense amplifiers, which are similar to those found in conventional, word-organized core memories. CBS Laboratories is working on even simpler circuitry using tunnel diodes as sense amplifiers.

### Comparison Of Memory Properties

Line-Up	Toristor	Thin-Film Dot	Core	Rod
Output Voltage Range	50-250 mv	2-20 mv	40-120 mv	30-50 mv
Digit-Write Current	700 ma	0.5-2.5 amp	150-500 ma	0.5 amp
Digit-Read Current	300 ma	300 ma	300 ma	300 ma
Magnetization Switching Speed	10-15 nsec	5-40 nsec	700 nsec	15-20 nsec
Write-Read Cycle Time	15 nsec	200-500 nsec	3-5 $\mu$ sec	500 nsec

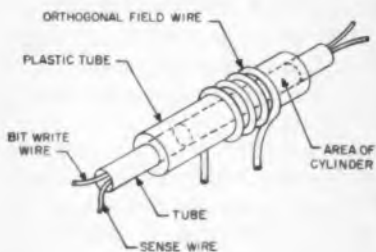

**The Toristor with its normal wiring.**  
The plastic tube here serves as encapsulation for the device.

The principal difference between the Toristor and other devices is that its magnetic domains are rotated through angles less than 90 deg—that is, through their hard directions. This makes for far less sensitivity to variations in temperature and in the composition of the magnetic material. The designer of the Toristor, George Henderson, manager of the CBS Memories and Subsystems Dept., says that it has much better temperature stability than other memory devices and substantially less internal heating. It can be operated at up to 150 C.

In a developmental model of a 64-bit Toristor memory, eight hollow-glass cylinders each support eight individual Toristors. The transverse-field interrogation coils—eight sets of them—are prepared by a weaving technique. The coils are woven so they look like a Lisajous pattern of a frequency comparison of 8 to 1.

Eight of these sets of windings are lined up and eight glass cylinders inserted through the individual loops. The sense and digit-write windings are easily inserted through the hollow cylinders.

To minimize noise, connections to all the wires are made through simple, flat, 50-ohm transmission lines. ■ ■

A revolutionary new concept in data presentation . . . a new technique for solving EDP printout and display problems in display sub-systems; digital to alphanumeric conversion; information retrieval systems; electrographic recording; high-speed facsimile systems; instantaneous, continuous tone recording.

Videograph is able to convert electrical signals into hard copy or display, at speeds that match the output capabilities of modern computers. It shatters the existing limits of mechanical, electro-mechanical or photo conductive type data presentation systems, as evidenced by:

A. B. Dick Videograph address-label printing equipment in use today by a leading publisher which permits the conversion of massive subscriber data files to digital magnetic tape and printout at over 200,000 characters per minute.

A. B. Dick Videograph digital-to-alphanumeric

0313233  
0492953  
0571865  
0858687  
1102103  
3114115  
5126127  
7131139

RSTU  
FGHIJ  
VWXYZ  
JKLMN  
ZABCO  
N9900

**NOW...FROM A.B. DICK  
ELECTRONIC, CHEMICAL  
AND MECHANICAL RE-  
SEARCH LABORATORIES  
VIDEOGRAPH  
DATA PRESENTATION  
SYSTEMS**



**A · B · DICK**  
ELECTRONIC DATA PRESENTATION

A. B. DICK ELECTRONIC RESEARCH LABORATORIES  
CHICAGO, ILLINOIS • PALO ALTO, CALIFORNIA

Videograph is a trademark of A. B. Dick Company

character generator in use today by U.S. defense agencies.

A. B. Dick Videograph printer-scanner equipment selected by a leading railway for the first high-speed facsimile transmission of documents via microwave.

The results of Videograph Data Presentation Systems have been achieved through the combined electronic, chemical and mechanical R & D capabilities of A. B. Dick Company . . . a combination of talents now available to help solve high-speed printing and display problems.

A. B. Dick Company offers its technical services and facilities for study, design and manufacture of systems and components. For further information, please contact: G. T. Gerlach, Marketing Manager, Videograph Data Presentation Systems, A. B. Dick Company, 5700 West Touhy Avenue, Chicago 48, Illinois.





## NEW FLEXIBLE PRINTED CIRCUITRY

from Garlock

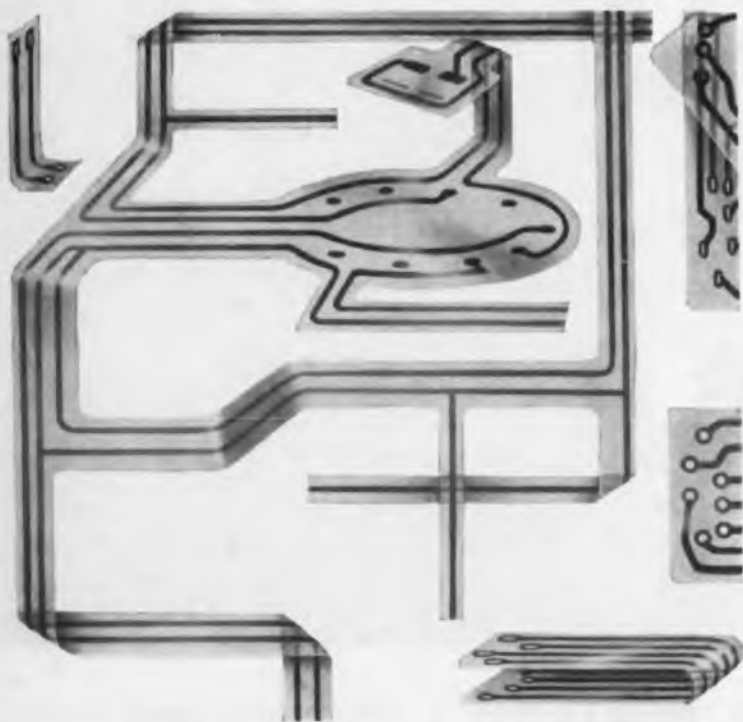

Garlock flexible printed circuitry can be economically induction soldered due to high temperature resistance of Teflon FEP.

# GARLOCK

ELECTRONIC PRODUCTS

**Teflon FEP®—and its outstanding electrical, physical and thermal properties—** has been incorporated by Garlock into an advanced circuit design that offers many distinct advantages over conventional wiring or rigid printed wiring boards.

**Greater design freedom.** Garlock Flexible Printed Circuitry can be bent or twisted into any desired shape to allow design freedom without compromise to overall reliability. It can be designed to conform exactly to package contours and component parts. Garlock offers terminations adaptable to common industry standards.

**Maximum reliability.** Garlock Flexible Printed Circuitry is made of etched copper completely encapsulated between two layers of Teflon FEP. Permanently bonded under pressure, this encapsulation affords both line-to-line and line-to-ground protection, and will resist penetration of harmful moisture and gases. No adhesive is used to effect the bond, eliminating any possibility of breakdown through aging.

**Reduced size and weight.** Garlock Flexible Printed Circuitry can often cut overall package dimensions by as much as 50%. Being extremely flexible, it will hug curves, go around corners, conform to the most eccentric layout. And, because of excellent electrical properties a thinner gauge of Teflon FEP can handle the same job that requires thick gauges of other insulating materials. This, combined with the use of less copper, greatly reduces package weight.

**For more information,** call your nearest Garlock Electronic Products representative for more data, or write Garlock Electronic Products, Garlock Inc., Camden 1, New Jersey.



**Canadian Div.:** Garlock of Canada Ltd.  
**Plastics Div.:** United States Gasket Company.

**Order from the Garlock 2,000 . . .** two thousand different styles of Packings, Gaskets, Seals, Molded and Extruded Rubber, Plastic Products.

®DuPont Trademark

## NEWS

### Balloon Will Hoist Copper Wire In LF Propagation Experiments

A balloon will hoist a copper-clad wire 20,000 ft into the atmosphere as part of an experiment in low-frequency propagation studies.

The experiment will be conducted for the Air Force by Pickard & Burns Inc., Needham, Mass., from an ocean-going schooner off the coast of Fort Pierce, Fla. A 1-million-v generator in the ship will be used to charge the wire with low-frequency pulses similar to lightning.

The wire, which acts as an efficient low-frequency antenna, has recently been carried aloft with a helicopter to an altitude of 12,000 ft, with a 200-ft polyethylene leader insulating the top of the antenna.

The 90-ft long balloon, called Aerocap, built and flown by General Mills, Inc., Minneapolis, Minn., will be sent up to supplement the helicopter operation. The balloon can lift the wire through cloud banks that have proven hazardous to helicopters.

### Superconductive Transformer Operates at 15-Kw Power

An experimental superconductive power transformer using windings made of lead has been successfully operated at 15 kw.

The transformer is much lighter than comparable conventional types and would probably be much less costly according to its developer, Dr. Richard McFee, associate professor in electrical engineering at Syracuse University and consultant to Arthur D. Little, Inc., Cambridge, Mass.

Before the superconductive power transformer could become feasible for widespread use, however, cryogenic refrigerating devices of sufficient reliability must be developed, Dr. McFee reported. He indicated that work on the Gifford-McMahon helium refrigerator showed promise of solving this problem. One of these units was operated at Arthur D. Little for 1,000 hours before failure.

The idea of a superconductive transformer is not new. It was not thought to be feasible, however, because of the superconductivity quenching effect of magnetic fields generated by alternating current in a transformer's windings.

Dr. McFee overcame this difficulty by in-

terleaving primary and secondary windings, so that the magnetic fields that were generated canceled each other.

The experimental transformer carried an alternating current of somewhat under 10 amps with a voltage near 2,000. Varnish paper was used for insulation between the primary and secondary layers.

The transformer consisted of about 2 miles of lead wire wound on a core of 2-by-2-in. cross-section. With about 0.5 amps dc and 10 amps ac through the experimental device, a dc galvanometer measured less than  $0.5 \mu\text{V}$  across it when it was operated in a superconductive state.

A special magnetizing winding was used for the outer layer of the transformer to balance voltages in all coils, so that they could be paralleled without generating circulating currents.

Newer superconductive materials, developed by Bell Telephone Laboratories, that maintain superconductivity with much higher magnetic fields than previously attainable also show promise for use in superconductive transformers. Studies of possible hysteresis losses in these materials with alternating currents are necessary to confirm the feasibility of their use, according to Dr. McFee.

## Argo D-4 Carried 48-Lb Payload



A 48-lb, 15-in.-diam payload (above) rode in the recently launched and recovered Argo D-4 sounding rocket. Included was a 28-v nickel cadmium battery, a two-frequency transmitter-receiver, a two-channel fm/fm telemetering subsystem, programing, and control equipment. Airborne Instruments Laboratory of Deer Park, L. I., N. Y., developed the equipment. Launching of the rocket was a major step forward in the international project to measure electron density above the F2 layer. (ED, Mar. 16, 1960).

ELECTRONIC DESIGN • August 2, 1961

## CUT CONTROL PANEL COSTS AND SAVE SPACE WITH COMBINED SIGNAL & SWITCH

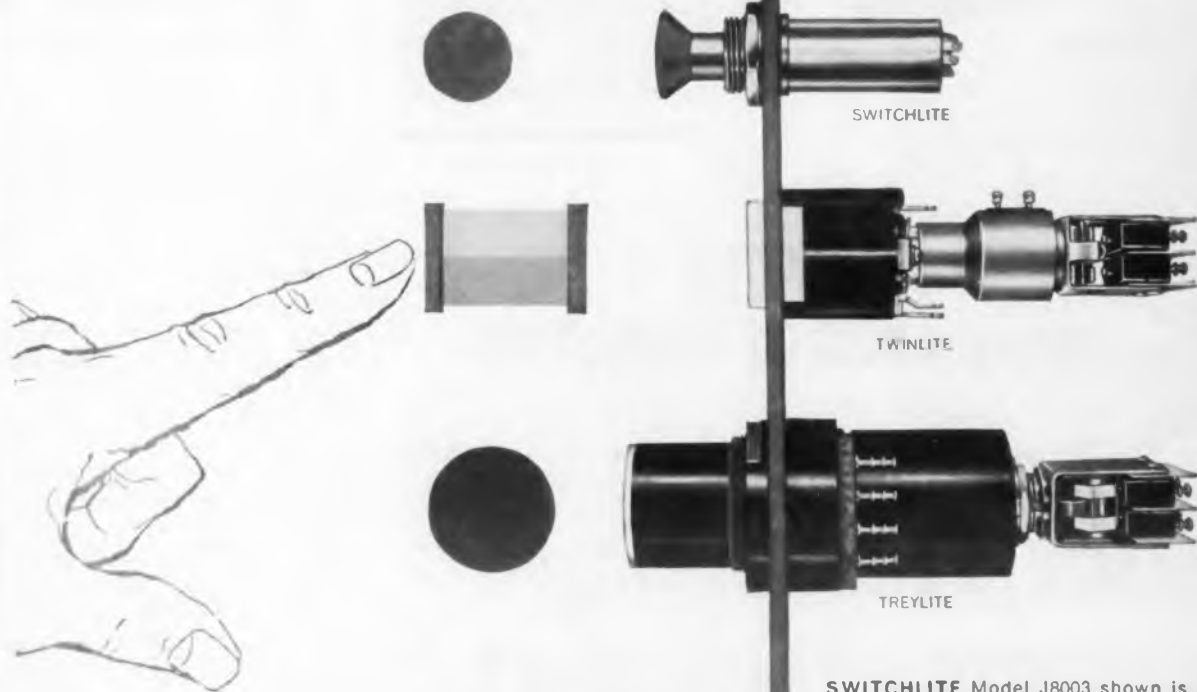

The most modern control panel designs combine indicator lights and pushbutton switches wherever possible. This cuts costs by reducing the number of components, and speeds assembly. Overall panel size can often be reduced as much as 75%. And these "human-engineered" controls sell better because operation is obviously simplified. Here are just three of the many lighted pushbuttons available from Control Switch Division...

Visit CONTROL SWITCH Division  
WESCON Booth 1319-21  
August 22-25, 1961

SWITCHLITE

TWINLITE

TREYLITE

**SWITCHLITE** Model J8003 shown is a single lamp, D.P.D.T., push-push. Independent lamp circuit for 6, 14 or 28 volts. Rated 3 amp res., 1 amp ind. @ 28 VDC or 115 VAC. Mounts in  $\frac{1}{8}$ " dia. hole. 4 button styles, several lens colors.

**TWINLITE** . . . two lamps with independent circuits for 2-color lighting. Lens  $1" \times .740"$  in solid or split colors, with or without nameplate slot. Momentary or push-push action, or solenoid-held switch shown above. Rated 4 amp res., 2.5 amp ind. @ 30 VDC; 5 amp @ 125/250 VAC. Mount in groups or singly, using barriers.

**TREYLITE** . . . three independent lamps, each with color filter so three colors can be sequenced on white pushbutton screen. D.P.D.T. switch rated 4 amp res., 2.5 amp ind. @ 30 VDC; 5 amp @ 125/250 VAC. Select momentary or push-push action. Models for flush-panel mounting (shown above) or sub-panel mounting.

**CONTROLS COMPANY OF AMERICA**

CONTROL SWITCH DIVISION

4216 W. Lake St. • Chicago 24, Ill. • Telephone: VAn Buren 6-3100 • TWX CG-1400

Manufacturers of a full line of switches, controls and indicators for all military and commercial applications. All standard units stocked for immediate delivery by leading parts Distributors.

CIRCLE 28 ON READER-SERVICE CARD

Write for FREE CATALOG  
on LIGHTED SWITCHES.



Type GAA

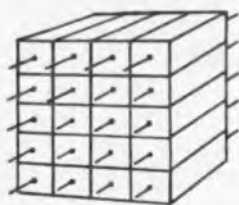

## HOPKINS epoxy encased capacitors

— high capacity in small  
size — plus rectangular  
shape — saves space

A typical .01 mfd unit occupies only 1/40th cubic inch of space. Type GAA units fit flat against printed circuit boards... are easily stacked, hence minimize waste space.

**Won't crack or break** under environment changes. Capacitors are encapsulated with epoxy in pre-molded epoxy cases — both seal and case have the same coefficient of expansion.

**Excellent moisture resistance** — unique epoxy-to-epoxy seal provides heat and moisture resistance closely matching that of hermetic sealing.

**High capacity** — up to 1.5 mfd at 200 VDC. Similar high capacities in 300 to 600 volt units.

**Wide temperature range:** from  $-55^{\circ}\text{C}$  to  $+100^{\circ}\text{C}$ .

**Long life** — units withstand 125% of rated voltage for 1000 hours at  $100^{\circ}\text{C}$ .

**Choice of terminals** — one lead out each end, or both leads out one end.

*Write for GAA data sheet.*



12900 Foothill Blvd., San Fernando, Calif. ■ EMpire 1-8691

See us at Wescon Show Booth No. 3109

CIRCLE 29 ON READER-SERVICE CARD

## Stereo Adapters Based on 2 Designs

*Sum and Difference, Time-Multiplex Approaches  
Both Pursued in Receiving Systems*

**T**HE stereo-multiplex fm broadcasting system recently approved by the Federal Communications Commission makes possible two design approaches for receiving equipment. Both approaches have been used in equipment now, or soon to be, on the market.

One approach, the sum-and-difference method, treats the signal as a mixed waveform with the sum (left plus right) of both channels received as conventional fm. The difference (left minus right) is detected as two am sidebands of a 38-kc subcarrier.

The second approach, time-multiplex, uses a switching device in the receiver to sample the carrier at a 38-kc rate, corresponding to the subcarrier frequency. Alternate samples are

fed to the left and right portions of the receiving system, thereby reconstructing the original left and right channels.

Most stereo adapters on the market at present use the sum-and-difference method of decoding the signal. This is done by a number of low-pass filters in a separating network. A few use the time-multiplex method, where decoding is accomplished by the use of a switching system controlled by an oscillator.

Stereo systems designer, D. R. Von Recklinghausen of the H. H. Scott Corp., Maynard, Mass., says there is no difference in bandwidth, linearity or gain in the two systems; they are merely a matter of the designer's prerogative. ■ ■

**The type 335 multiplex adapter** of H. H. Scott is more inclusive than most other makes. It incorporates a number of switching circuits in its design, permitting it to act as a control center for the multiplex system. The five-tube unit, which uses the time-multiplex method of decoding, also incorporates a stereo noise filter, said to remove noise from both channels while maintaining full separation. The 335 can be used only with existing Scott tuners. It measures 7 by 5-1/4 by 13 in. Priced at about \$100, it is now available.





**Bogen's model PX-60**, also self-powered, uses the same circuitry as the company's commercial multiplex receivers. Said to have a bandwidth of 23-53 kc and using the sum-and-difference decoding system, it is designed to operate with Bogen tuners. However, the company reports that after slight modifications the receiver can be used with many existing tuners. Measuring 4-1/16 by 3-1/4 by 8-1/16 in. and weighing less than 3 lb, the PX-60 is the smallest of the adapters reviewed. A company spokesman says the unit will sell for \$69.50.

**Adapter MX-101** built by Crosby Electronics, also uses the sum-and-difference method of detection. Its four-tube circuit includes separate noise filters for each channel, a diode-controlled automatic dimension circuit, and cathode follower output. Frequency response is said to be at least 15,000 cps while maintaining 20-db separation between channels. The adapter measures 5-1/4 by 4-1/2 by 9 in. The adapter is now on the market, selling for about \$80.



**The Fisher MPX-100** is a sum-and-difference type self-powered stereo multiplex adapter that can be used with all fm receivers and tuners having ratio detector design and MP output. Incorporated in the five-tube adapter is a Stereo Beacon, which indicates whether the program being transmitted is monaural or stereo. Included is a stereo balance control and cathode follower output. The MPX-100 measures 4-7/8 by 4-7/8 by 12-in. On the market now, it is priced at \$89.50.



## ELECTRONIC HIGH-VACUUM EQUIPMENT

### SYSTEMS

Ultek contaminant-free electronic vacuum systems are completely self-contained and movable; usually need only an electrical outlet for operation. Standard and custom-engineered models are available for general industrial evaporation, environmental testing, thin film deposition, vacuum tube processing, and space simulation. Operating pressures from  $10^{-4}$  to  $10^{-7}$  mm Hg and below. Write for details.



SPACE SIMULATOR

### FIELD SERVICE

Experienced Ultek sales engineers, devoted exclusively to the high-vacuum field, are available in major cities to evaluate your vacuum needs and demonstrate Ultek's leadership in electronic high-vacuum technology. For immediate information phone your nearest Ultek application engineer, or write direct.

### PUMPS

Ultek pumps are available in a wide range of capacities and configurations. They are designed for high efficiency and long life. Standard and custom-engineered models are available for general industrial evaporation, environmental testing, thin film deposition, vacuum tube processing, and space simulation. Operating pressures from  $10^{-4}$  to  $10^{-7}$  mm Hg and below. Write for details.



360 LITER PER SECOND PUMP



6" VALVE

**U L T E K** CORP.

820-D COMMERCIAL STREET - PALO ALTO, CALIFORNIA  
Phone: DAvenport 1-4117

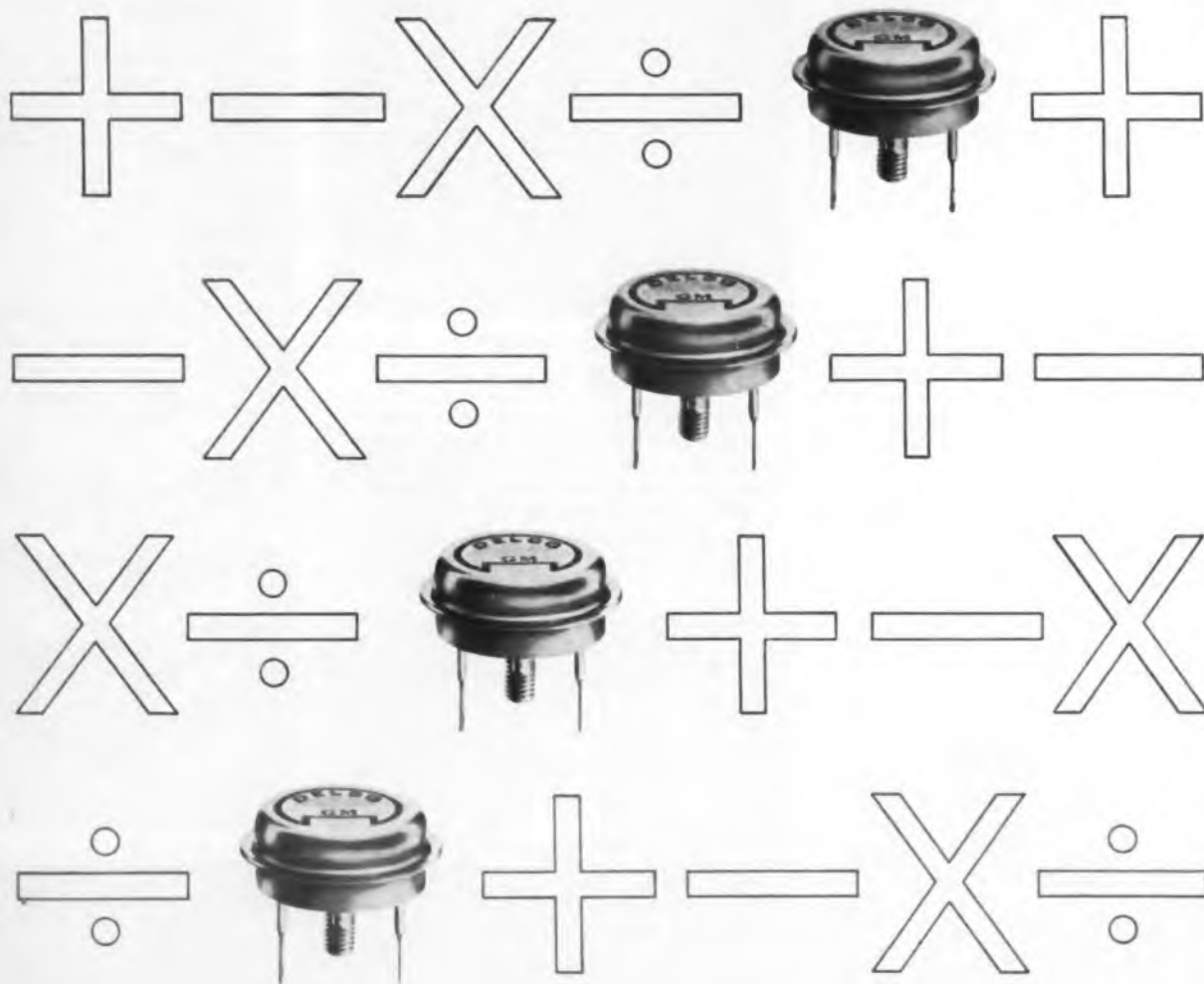

## DELCO POWER TRANSISTORS PROVED IN COMPUTERS by IBM, UNIVAC®, BURROUGHS, NATIONAL CASH REGISTER

Since Delco Radio produced its first power transistors over five years ago, no transistors have undergone a more intensive testing program to assure reliability—which accounts for their popular acceptance in hundreds of industrial and military uses. Before leaving our laboratories, Delco transistors must pass numerous electrical and environmental tests both before and after aging. This double testing, combined with five years of manufacturing refinements, enables us to mass produce any type of power transistors with consistent uniformity. And we can supply them to you quickly in any quantity at a low price. For complete information or technical assistance on our versatile application-proved family of transistors, just write or call our nearest sales office or distributor.

Union, New Jersey  
324 Chestnut Street  
MUrdock 7-3770

Santa Monica, California  
726 Santa Monica Blvd.  
UPTon 0-8807

Chicago, Illinois  
5750 West 51st Street  
PORtsmouth 7-3500

Detroit, Michigan  
57 Harper Avenue  
TRinity 3-6560

**DELCO**  
RELIABILITY  
**RADIO**  
RELIABILITY

Division of  
General Motors  
Kokomo, Indiana

CIRCLE 31 ON READER-SERVICE CARD

## NEWS

### New Cathode Reported To Heat in 100 Msec

A recently developed fast-heating cathode, called the Harp, is now being incorporated in a new line of rf power-output tubes.

The cathode, which consists of a rectangular frame, with fine wires strung across the length like the strings of a harp, is said to be capable of delivering full power in 100 msec. The use of extremely fine wires in the emitting element is said to make possible a very high surface-to-volume ratio, resulting in fast warm-up and thermal equilibrium. The cathode is applicable in transistor and mobile equipment.

Because of the many fine wires, which are electrically in parallel, the cathode has low inductance and therefore less hum. A low voltage, on the order of 1.6 v, is said to be sufficient for operation because of the multiple current paths. This makes it possible for tubes employing the new cathode to be powered by the same power supply that serves transistor stages.

The cathode, developed by the Amperex Corp. of Hicksville, N.Y., has been incorporated into the Type 8042 tube, a fast-warm-up version of the company's 6146 with the same electrical characteristics and price. In the near future a line of Harp cathode twin tetrodes will be produced and marketed, the company reports.

### Epitaxial Growth Research For Circuit Functions Slated

Investigation of epitaxial growth techniques as a means of obtaining single-crystal circuit functions will be carried out by Motorola Semiconductor Products Div., Phoenix, Ariz., under a new program.

Thin-film functions will also be studied as part of the search which is being conducted for compatible circuit techniques for integrated circuit functions.

Also to be investigated are various modes of junction formation, construction of multiple p and n layers with controllable lifetime and impurity concentrations, and compatible masking techniques.

The studies will be conducted under an Air Force systems contract, which was recently awarded.

CIRCLE 32 ON READER-SERVICE CARD ➤



INVITATION  
TO INVENTION

CIRCUIT  
DESIGN



WHERE HIGHEST QUALITY IS IN VOLUME PRODUCTION



1/2



ACTUAL

SIZE



1/2 SIZE

Listed below are silicon rectifiers representative of the Tarzian line. They are available in production quantities, at realistic prices, for both commercial and military applications.

Of particular importance in simplifying your power conversion circuitry assemblies are small size, high efficiency, mounting versatility and wide range of ratings offered by the Tarzian line.

In addition, the entire line features extremely low junction current density for maximum reliability and operating life. This is due to the special Tarzian alloy process with supported junction that produces the largest junctions available.

Altogether, the qualities and availability of the units cataloged here are invitations to invention in circuit design. Application engineering service is also available without obligation. Call the Sarkes Tarzian representative near you, or write Sarkes Tarzian, Inc., for complete catalog information.

## SILICON RECTIFIERS

	amps. DC (100°C)		peak inverse voltage	max. RMS volts	Max. amps.		Tarzian Type	Jedec No.	Tarzian Type	Jedec No.	dimensions 
					recurrent peak	surge 4MS					
Typical LOW CURRENT units	0.5		200	140	5	30	20M	1N1082			
			400	280	5	30	40M	1N1084			
			600	420	5	30	60M	—			
	0.5		200	140	5	75	F-2	1N2482			
			400	280	5	75	F-4	1N2483			
			600	420	5	75	F-6	1N2484			
	0.5		200	140	5	75	20H	1N2485			
400			280	5	75	40H	1N2487				
600			420	5	75	60H	1N2489				
0.45		800	560	4.5	27	80SM	1N1108				
		1600	1120	4	24	160SM	1N1110				
		2400	1680	3.5	21	240SM	1N1112				
		2800	1960	3.25	19.5	280SM	1N1113				
Typical MEDIUM CURRENT units	1.5		200	140	10	100	20J1	1N1618			
			400	280	10	100	40J1	1N1620			
			600	420	10	100	60J1	—			
	10		200	140	50	150	20J2	1N1622			
			400	280	50	150	40J2	1N1624			
			600	420	50	150	60J2	—			
	12		200	140	72	150	20J3	—			
			400	280	72	150	40J3	—			
			600	420	72	150	60J3	—			
	2		200	140	30	100	20LA	1N1086			
			400	280	30	100	40LA	1N1088			
			600	420	30	100	60LA	—			
Typical HEAVY CURRENT units	20								NEGATIVE	POSITIVE	
			200	140	120	200	20R3N		20R3P		
			400	280	120	200	40R3N		40R3P		
	35		200	140	210	350	60R3N		60R3P		
			400	280	210	350	20S3N	—	20S3P	—	
			600	420	210	350	40S3N	—	40S3P	—	
	50		200	140	300	500	60S3N	—	60S3P	—	
			400	280	300	500	20T3N	—	20T3P	—	
			600	420	300	500	40T3N	—	40T3P	—	
	100		200	140	600	1000	60T3N	—	60T3P	—	
			400	280	600	1000	20V3N	—	20V3P	—	
			600	420	600	1000	40V3N	—	40V3P	—	
	150		200	140	900	1500	60V3N	—	60V3P	—	
			400	280	900	1500	20W3N	—	20W3P	—	
			600	420	900	1500	40W3N	—	40W3P	—	
	250		200	140	1500	2500	60W3N	—	60W3P	—	
			400	280	1500	2500	20Y3N	—	20Y3P	—	
			600	420	1500	2500	40Y3N	—	40Y3P	—	
350		200	140	2100	3500	60Y3N	—	60Y3P	—		
		400	280	1500	2500	20G3N	—	20G3P	—		
		600	420	1500	2500	40G3N	—	40G3P	—		
1000			200	140	6000	10000	20ZB	—			

## HIGH VOLTAGE SILICON CARTRIDGE RECTIFIERS

Each of the two series of Tarzian Silicon Cartridge Rectifiers shown below includes 18 different types with operating temperatures ranging from  $-55^{\circ}\text{C}$  to  $150^{\circ}\text{C}$  ambient. Both the ferrule mounted series and the axial lead series feature low voltage drop and low reverse current. Tarzian High Voltage Cartridges are manufactured to meet standard Jedec classifications.

**FERRULE MOUNTED SERIES**—This high voltage series is equipped with a ferrule type mounting of silver plated brass and is available in both hermetically sealed glass or phenolic tubing in voltages ranging from 1000 to 10,000 peak inverse volts.

**AXIAL LEAD SERIES**—This high voltage series is available in units ranging in size from  $\frac{1}{2}$ " to  $2\frac{1}{2}$ " and lead lengths varying from 1" to  $2\frac{1}{2}$ ". Peak inverse voltage ratings are available from 1500 to 16,000 volts.



FERRULE MOUNTED SERIES			
Operating Temperature Range $-55^{\circ}\text{C}$ to $150^{\circ}\text{C}$ Ambient		Max. Ratings Half Wave Res. Load at $75^{\circ}\text{C}$ Ambient	
Jedec Type	Sarkes Tarzian Type	Peak Inverse Volts	Max. Rectified DC Output MA
1N1133	S-5490	1500	75
1N1140	S-5497	3600	65
1N1143A	S-5501	6000	65
1N1146	S-5504	8000	45
1N1148	S-5506	14000	50
1N1149	S-5507	16000	45

AXIAL LEAD SERIES					
Operating Temperature Range $-55^{\circ}\text{C}$ to $150^{\circ}\text{C}$ Ambient					
Jedec Type	S.T. Type	Peak Inverse Volts	Max. RMS Input Volts*	Max. Rect. DC Output (MA)	
				$25^{\circ}\text{C}$	$100^{\circ}\text{C}$
1N1730	S-5518	1000	700	200	100
1N1731	S-5519	1500	1050	200	100
1N1734	S-5522	5000	3500	100	50
1N2375	S-5525	1500	1050	200	100
1N2379	S-5529	4000	2800	100	50
1N2385	S-5535	10000	7000	70	55

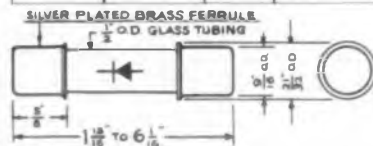

When ordering phenolic tubing as a substitute for glass tubing, add the letter "P" to S.T. Type No.

\*Derate 50% for capacitive load in half wave circuits. For capacitive, motor, or battery loads, derate DC current by 20%.

## MODULAR SILICON RECTIFIERS

Modular Silicon Rectifiers can be used individually—as open bridges—or in a variety of circuit combinations, and are designed for printed circuits on terminal strips. Each of the units illustrated and tabulated below is only one of a series of six in the 18-unit Tarzian line.

Tarzian Code Number	Individual Diode Current Rating	Circuit Connections	Piv
S-5541	500MA	Center tap, Doubler	600
S-5549	500MA	3 phase Half Wave	600
S-5467	500MA	Bridge	600

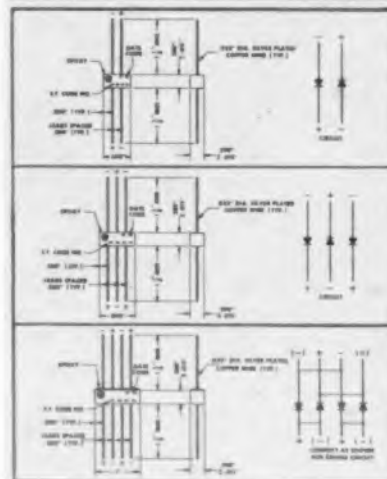

## TUBE REPLACEMENT SILICON RECTIFIERS

Tarzian tube replacement rectifiers, in addition to being directly interchangeable with over 95% of all popular vacuum tube rectifiers, are smaller, more compact, and carry dc current ratings as much as three times as great as the tubes they replace. They have proved highly satisfactory in applications requiring high efficiency,

long life, rugged construction and wide temperature ranges. Tarzian solid state rectifiers are available in ten standard models, with special designs and modifications on request. Special tube replacement units designed by Tarzian engineers include special designs with peak inverse voltages to 19,000 volts.

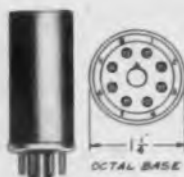

S-5018  
Pin Connection  
Pin #1 (Cathode)  
Pin #4 and #6 (Anode)  
Replacement for types  
5AU4, 5AW4, 5AZ4, 5T4,  
5U4, 5V4, 5W4, 5Y3, 5Z4,  
5931, 6007, 6106.



S-5019  
Pin Connection  
Pin #8 (Cathode)  
Pin #6 and #4 (Anode)  
Replacement for 5R4

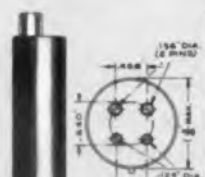

S-5130  
Pin No. 1 is Pos.  
Replacement for 866,  
866A, 3B28



S-5207  
Pin Connection  
Pins #1 and #6 are A.C.  
(Anode)  
Pin #7 is Pos. (Cathode)  
Replacement for 6X4,  
6063, 6202.





S-5367  
Pin No. 1 is Pos.  
Replacement for  
GL-8020 at reduced  
voltage

Tarzian Type	JEDEC Number	Max. Peak Inverse Voltage	Max. RMS Voltage	Max. Peak Current (ma)	Max. DC Current (ma)	Circuit	Type Load	Max. Ambient Temp.	Dimension "A" (inches)	Dimension "B" (inches)	Dimension "C" (inches)
S-5018	1N-1238	1,600	1,100	8,000	750	F.W.	Any	$100^{\circ}\text{C}$	$2\frac{21}{32}$	$1\frac{1}{4}$	$3\frac{3}{32}$
S-5019	1N-1239	2,800	1,950	5,000	500	F.W.	Any	$100^{\circ}\text{C}$	$3\frac{3}{8}$	$1\frac{3}{8}$	$4\frac{3}{16}$
S-5130	—	10,400	*7,400	3,000	300	H.W.	Res.-Ind.	$100^{\circ}\text{C}$	$4\frac{1}{16}$	$1\frac{1}{2}$	$8\frac{1}{2}$
S-5207	1N-2490	1,600	1,100	5,000	500	F.W.	Any	$100^{\circ}\text{C}$	$1\frac{1}{2}$	$1\frac{3}{16}$	$1\frac{1}{4}$
S-5367	—	19,000	13,400	2,500	250	H.W.	Res.-Ind.	$100^{\circ}\text{C}$	6	$2\frac{1}{16}$	$6\frac{19}{32}$

\*For capacitive loads derate input voltage 50%, and current 20%.



# SARKES TARZIAN SILICON VOLTAGE REGULATORS

 <b>1/4 WATT REGULATORS</b> Specifications 25°C.					 <b>1 WATT REGULATORS</b> Specifications 25°C.				 <b>10 WATT REGULATORS</b> Specifications 25°C.				
Tarzian Type	Zener Volt. (V)	Test Cur. (Ma)	Dyn. Imp. (Ohms)	Jedec Type	Tarzian Type	Zener Volt. (V)	Test Cur. (Ma)	Dyn. Imp. (Ohms)	Tarzian Type	Zener Volt. (V)	Test Cur. (Ma)	Dyn. Imp. (Ohms)	Jedec Type
.25T5.6	5.6	25	3.6	1N708	1T5.6	5.6	100	1.2	10T5.6	5.6	1000	1	1N1803
.25T6.2	6.2	25	4.1	1N709	1T6.2	6.2	100	1.5	10T6.2	6.2	1000	1	1N1804
.25T6.8	6.8	25	4.7	1N710	1T6.8	6.8	100	1.7	10T6.8	6.8	1000	1	1N1805
.25T7.5	7.5	25	5.3	1N711	1T7.5	7.5	100	2.1	10T7.5	7.5	1000	1	1N1806
.25T8.2	8.2	25	6.0	1N712	1T8.2	8.2	100	2.4	10T8.2	8.2	1000	1	1N1807
.25T9.1	9.1	12	7.0	1N713	1T9.1	9.1	50	3.0	10T9.1	9.1	500	1	1N1808
.25T10	10	12	8.0	1N714	1T10	10	50	3.5	10T10	10	500	2	1N1351
.25T11	11	12	9.0	1N715	1T11	11	50	4.2	10T11	11	500	2	1N1352
.25T12	12	12	10	1N716	1T12	12	50	5.0	10T12	12	500	2	1N1353
.25T13	13	12	11	1N717	1T13	13	50	5.8	10T13	13	500	2	1N1354
.25T15	15	12	13	1N718	1T15	15	50	7.6	10T15	15	500	2	1N1355
.25T16	16	12	15	1N719	1T16	16	50	8.6	10T16	16	500	3	1N1356
.25T18	18	12	17	1N720	1T18	18	50	11	10T18	18	150	3	1N1357
.25T20	20	4	20	1N721	1T20	20	15	13	10T20	20	150	3	1N1358
.25T22	22	4	24	1N722	1T22	22	15	16	10T22	22	150	3	1N1359
.25T24	24	4	28	1N723	1T24	24	15	18	10T24	24	150	3	1N1360
.25T27	27	4	35	1N724	1T27	27	15	23	10T27	27	150	3	1N1361
.25T30	30	4	42	1N725	1T30	30	15	28	10T30	30	150	4	1N1362
.25T33	33	4	50	1N726	1T33	33	15	33	10T33	33	150	4	1N1363
.25T36	36	4	60	1N727	1T36	36	15	39	10T36	36	150	5	1N1364
.25T39	39	4	70	1N728	1T39	39	15	45	10T39	39	150	5	1N1365
.25T43	43	4	84	1N729	1T43	43	15	54	10T43	43	150	6	1N1366
.25T47	47	4	98	1N730	1T47	47	15	64	10T47	47	150	7	1N1367
.25T51	51	4	115	1N731	1T51	51	15	74	10T51	51	150	8	1N1368
.25T56	56	4	140	1N732	1T56	56	15	88	10T56	56	150	9	1N1369
.25T62	62	2	170	1N733	1T62	62	5	105	10T62	62	50	12	1N1370
.25T68	68	2	200	1N734	1T68	68	5	125	10T68	68	50	14	1N1371
.25T75	75	2	240	1N735	1T75	75	5	150	10T75	75	50	20	1N1372
.25T82	82	2	280	1N736	1T82	82	5	175	10T82	82	50	22	1N1373
.25T91	91	1	340	1N737	1T91	91	5	220	10T91	91	50	35	1N1374
.25T100	100	1	400	1N738	1T100	100	5	260	10T100	100	50	40	1N1375

NOTES: Standard tolerance is  $\pm 10\%$  however, closer or wider tolerances are available on request.  
 Also available on request: (a) Special voltage ratings. (b) Symmetrical double anode types (for clippers).

The full line of constant voltage devices tabulated here are used to control output voltage of power sources and as voltage reference elements capable of operating over a wide temperature range. Hermetic sealing and mechanical ruggedness provide long term reliability even under the most adverse conditions. These three power classifications cover a wide range of applications. The regulators also are available in production quantities. Call your nearest Tarzian representative for application assistance.

## 1/4 WATT

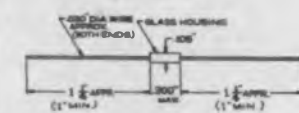

## 1 WATT

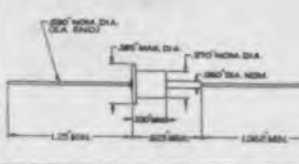

## 10 WATT

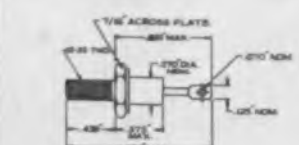

## SARKES TARZIAN SALES REPRESENT- ATIVES

**ALABAMA**, Birmingham  
Paul Hayden Assoc.  
P. O. Box 1931, ALpine 1-8271

**ARIZONA**, Phoenix  
W. Bert Knight Co.  
P. O. Box 11394, WH 6-2201

**CALIFORNIA**, Los Angeles 64  
W. Bert Knight Co.  
10377 W. Pico Blvd., BRadshaw 2-0101

**CALIFORNIA**, San Francisco 3  
Moulthrop & Hunter  
165 Eleventh St., UNderhill 3-7880

**COLORADO**, Colorado Springs  
Payser & Co.  
1501 N. Weber St., MEIrose 4-3401

**CONNECTICUT**, New Haven 15  
Gerber Sales Co.  
P. O. Box 2917, SPruce 7-6279

**FLORIDA**, N. Miami Beach  
Paul Hayden Assoc.  
1060 N. E. 180 Terrace, WIlson 5-5793

**GEORGIA**, Atlanta  
Paul Hayden Assoc.  
682 B Lindberg Dr. N. E., CEder 3-4743

**GEORGIA**, East Point  
Paul Hayden Assoc.  
P. O. Box 331, East Point  
POplar 6-0261-2

**HAWAII**  
Dougherty Enterprises  
334 Ilimalia  
P. O. Box 188, Kailua, Hawaii  
Phone 253-666

**INDIANA**, Indianapolis  
Leslie M. Devoe Co.  
4010 Washington Blvd., ATwater 3-1395

**ILLINOIS**, Chicago 45  
Industrial Sales  
KaDeil Sales Associates  
6140 N. Lincoln Ave., IRving 8-7920

**ILLINOIS**, Skokie  
Distributor Sales (Except Chicago)  
Mike Bermann  
8631 E. Prairie Rd., ORchard 5-3740

**IOWA**, Cedar Rapids  
George E. Harris Co., Inc.  
526 Merchants National Bank Bldg  
EMpire 2-6302

**KANSAS**, Wichita 8  
Industrial Sales  
George E. Harris & Co., Inc.  
2520 E. Douglas St.  
MUrray 2-2731/3-9226

**MARYLAND**, Baltimore  
Industrial Sales  
J & H Electronic Sales  
Box 6844, Towson, Md., VAlley 5-4441

**MASSACHUSETTS**, Boston  
Gerber Sales Co.  
48 Pearl St., Brookline 46, Mass.  
BEacon 2-2425

**MASSACHUSETTS**, East Longmeadow  
Gerber Sales Co.  
6 N. Main, LAurel 5-3059

**MICHIGAN**, Detroit 27  
Grant Shaffer Co.  
14241 Fenkell Ave., BRoadway 3-5390

**MINNESOTA**, Minneapolis 23  
Scott Electronic Sales  
5209 W. 60th St., WEst 9-2985

**MISSOURI**, Kansas City 14  
Kelly-Schmitz-Winkler  
Distributor Sales P. O. Box 8456  
407 W. 74th St. Terrace  
EMerson 1-5651

**NEW JERSEY**, Camden 1  
Industrial Sales  
J & H Electronic Sales  
P. O. Box 797, WOODLawn 6-0303

**NEW JERSEY**, Hoboken  
Simberkoff Sales Co.  
175 Oakwood Ave., ORange, N. J.  
Phone ORange 4-4100

**NORTH CAROLINA**, Burlington  
Paul Hayden Assoc.  
423 W. Fifth, CAnal 7-3479

**OHIO**, Cleveland 14  
Distributor Sales  
F. A. Dougherty & Co.  
6025 Mayfield Rd., Hillcrest 2-3311

**OHIO**, Cleveland 14  
Industrial Sales  
Chas. H. Dolfuss, Jr. & Co.  
2108 Payne Ave., Room 707  
PRospect 1-1270

**PENNSYLVANIA**, Philadelphia  
See Camden, N. J.

**PENNSYLVANIA**, Pittsburgh 14  
Industrial Sales  
Gene S. Root & Co.  
733 Valleevista Ave., LOcast 1-4125

**TEXAS**, Dallas  
John Guenther  
4533 N. Central Expressway  
LAkeside 8-6286

**WASHINGTON**, Seattle 9  
M. N. Widdelkind  
222 First Avenue N., ATwater 4-4869

**CANADA**  
A. T. R. Armstrong Co.  
P. O. Box 38, Sta. D. Toronto, Ontario  
ROger 2-7535

**Export Only**  
NEW YORK, New York 4  
Ad. Arriema, Inc.  
85 Broad St., BOwing Green 9-7750



**SARKES TARZIAN, INC.**

SEMICONDUCTOR DIVISION • BLOOMINGTON, INDIANA

Canada: 788 Weston Rd., Toronto 6 • Export Ad. Barilena, Inc., New York

World's Leading Manufacturers of TV and FM Tuners • Closed Circuit TV Systems • Broadcast Equipment • Air Trimmers • FM Studios • Magnet Recording Tapes • Semiconductor Business

## Micram Timer Has No Moving Parts



Digital timer for arming missile fuses, built with the Micram microminiature packaging technique, has no moving parts. (ED, July 5, p 7). The technique, developed by the Cleveland Metal Specialties Co. in Ohio and other electronic companies, provides packing density of 300,000 parts per cu ft. The modularized unit, developed by the Diamond Ordnance Fuze Laboratory of Washington, D. C., times up to 200 sec in increments of 1/10 of a sec.

### Additions to the Transistor Data Chart

*Specifications for several groups of npn silicon power transistors, manufactured by Fanon Transistor Corp., Newark, N. J., were received too late for publication in our July 5 transistor Data issue. Please add FN (Fanon) to the "Remarks" column as alternate source for the following types listed on page 52 of the Transistor Data Chart:*

2N389	2N1210	2N1490
2N424	2N1211	2N1616
2N1069	2N1487	2N1617
2N1070	2N1488	2N1618
	2N1489	

*Also add FN to the 2N424A and 2N1620 listed on page 58.*

*A series of 75 and 85w npn silicon devices are also available bearing house numbers F101 to F116.*

# high level capabilities for high power AC

When considering the need for high power AC equipment, consult CML — specialists in the development and production of tube type or transistorized units for systems or laboratory use.

**Another CML first... a new 3 kilowatt wide band sonar amplifier versatile enough to match any transducer load.**

Model S-3000 operates at full power from 50 to 20,000 cps into load impedances of 15, 30, 60, 120, 250, 500 and 1,000 ohms. Half power is delivered at 30,000 cps. Harmonic distortion is less than 2% over entire frequency range. Available in dual cabinet (each 47"x 25"x 27").



A Subsidiary of Tenney Engineering, Inc.

350 Leland Ave., Plainfield, N.J. PL 4-5502

For consultation on any HIGH POWER AC requirement, write today to:

**COMMUNICATIONS  
MEASUREMENTS  
LABORATORY, INC.**

TWX =  
PLFD 1772

CIRCLE 33 ON READER-SERVICE CARD

◀ CIRCLE 32 ON READER-SERVICE CARD

# 50 G VIBRATION



## COUCH RUGGED ROTARY RELAYS

### SPECIFICATIONS

**CONTACTS** — 4 PDT (4 form C) 5 A @  
30 VDC

**SIZE** — 1 $\frac{3}{32}$ " D. x 1 $\frac{1}{2}$ " H.

**WEIGHT** — 3.2 oz.

**PULL-IN-POWER** —  $\frac{1}{2}$  watt

**VIBRATION** — 50 G, 10 to 3,000 CPS

**SHOCK, Electrical** — 100 G minimum

**TYPE** — CVE with patented rotary  
armature

WRITE FOR DATA SHEET 7



**COUCH ORDNANCE, INC.**

A subsidiary of S. H. Couch Company, Inc.  
3 ARLINGTON STREET, NORTH QUINCY, MASS.

CIRCLE 34 ON READER-SERVICE CARD

## Atomic Weather Station to Aid U.S.

*Automatic Unit That Uses 60 Linked Thermocouples To Convert Energy to Be Set Up in Isolated Far North*

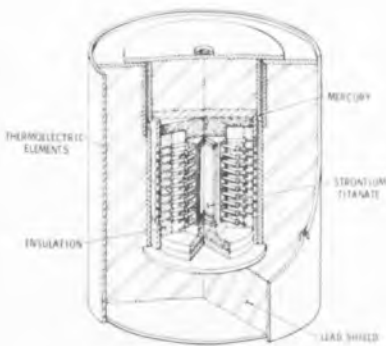

**Power supply** of automatic weather station consists of 60 lead-telluride thermocouples arranged like spokes around cylindrical strontium titanate heat source. Radiation is blocked by 4.4-in.-thick lead shield.

**A** NUCLEAR-POWERED automatic weather station, using thermocouples for power conversion, will be set up soon in a remote area of northern Canada.

The station was designed and built for the Office of Isotopes Development of the Atomic Energy Commission by the Martin Co., Baltimore. Recent tests of the equipment by the Weather Bureau included transmissions from Baltimore to Washington.

The unmanned weather station derives its power from about 1 lb of strontium titanate pellets, which generate heat spontaneously by radioactive decay. The heat is transformed directly into a continuous flow of electricity by a series of thermocouples. The electrical energy is stored in rechargeable batteries, which operate two transmitters.

The nuclear power source will be used to drive the transmitters with an output of 250 w on each of two frequencies. The effective range will be 250 to 1,500 miles. One transmitter will operate at about 3.4 mc and the other at about 5 mc. Both are crystal-



Thermocouples in the station transform heat directly into a continuous flow of electricity.





A core of strontium titanate pellets generates heat for thermoelectric conversion to 5 w at 4 v in the unattended weather station. The power charges batteries that drive 250-w transmitters.

controlled and completely transistorized, except for dual-output tubes. The two antennas used are 150 and 90 ft tall.

The transmitters will send data on four parameters: temperature, atmospheric pressure, wind speed and wind direction, to be measured by instruments in the station.

Because the radio-isotope-fueled power system uses no moving parts, long-term, maintenance-free reliability is possible, says Martin. The dumping of excess heat from the generator is regulated to keep electronic components within a constant narrow temperature range.

The thermoelectric assembly consists of 60 lead-telluride thermocouples arranged like spokes around the cylindrical heat source. They are connected in series to a single outlet. Output is 5 w at 4 v dc. This is converted to 28 v dc to trickle-charge the nickel-cadmium batteries.

Strontium titanate was selected because of its low solubility, which is said to minimize biological hazards.

In the operating generator, the fuel pellets are encased in several layers of an alloy called Hastelloy-C. It would take centuries to corrode, even if immersed in the ocean, studies indicate.

Radiation from strontium-90 in the working generator could be blocked by a variety of materials. Lead, 4.4 in. thick, has been used in the first unit. Final protection for the whole generator is an outer cladding of stainless steel. The generator weighs 55 lb and the shielding 1,625 lb.

With hundreds of serious gaps in the present world network of weather-reporting stations, particularly in polar regions accessible only during a brief time each year, the unmanned device fills a long-standing need. ■ ■

Look-Alikes...



But Are They Work-Alikes?

## Bendix-Pacific 300 Series Telemetry

## The Recognized Standard



### Experience earns leadership.

There are fifteen years of design and application experience behind Bendix-Pacific telemetry components — a depth of experience unmatched by any other manufacturer.

This is why the 300 Series equipment is the recognized standard — complimented by look-alike copies, but standing alone in accuracy, performance and extended reliability.

Bendix-Pacific Division  
NORTH HOLLYWOOD, CALIFORNIA



CIRCLE 35 ON READER-SERVICE CARD



### Important addition to the most complete submin line in the industry

More than 21 times smaller than the standard TO-5 case, these new Raytheon germanium NPN and PNP and silicon NPN types provide both the small size and mounting flexibility required for advanced techniques in miniature packaging. This double-ended feature lends itself to new design freedom in single and multiple-board configurations. New solutions are possible for feed-through construction applications, welded assembly needs, and other assembly problems, such as jump wiring, and input-output isolation.

You can now choose from 52 ultra-reliable submin transistors, NPN and PNP, germanium and silicon, single-end and double-end — immediately available for large quantity orders at low cost. Complete technical and sales information can be obtained from the Raytheon office nearest you.



#### GERMANIUM

TO-5	Double-Ended	TO-5	Double-Ended
2N404 PNP	2N800	2N422 PNP	CK22C
2N426 PNP	2N802	2N464 PNP	CK64C
2N427 PNP	2N804	2N465 PNP	CK65C
2N428 PNP	2N806	2N466 PNP	CK66C
2N582 PNP	2N808	2N467 PNP	CK67C
2N414 PNP	2N810	2N438 NPN	2N818
2N416 PNP	2N812	2N439 NPN	2N820
2N417 PNP	2N814	2N440 NPN	2N822
2N396 PNP	2N826	2N1605 NPN	2N824

#### SILICON

TO-5	Double-Ended	TO-5	Double-Ended
2N337 NPN	2N907	2N334 NPN	2N904
2N338 NPN	2N908	2N335 NPN	2N905
2N332 NPN	2N902	2N336 NPN	2N906
2N333 NPN	2N903		

For applications assistance, call offices listed below. For immediate availability and condensed data, call Distributors listed on opposite page.

**RAYTHEON**

**RAYTHEON COMPANY**

**SEMICONDUCTOR DIVISION**

**SILICON AND GERMANIUM DIODES AND TRANSISTORS • SILICON RECTIFIERS • CIRCUIT-PAKS**  
 BALTIMORE, MD., Southfield 1-6458 • BOSTON, MASS., Decatur 7-7177 • CHICAGO, ILL., National 5-0280 • DALLAS, TEXAS, Lakeside 6-7921 • DAYTON, OHIO, Baldwin 3-8128  
 DETROIT, MICH., Trinity 3-5336 • ENGLEWOOD CLIFFS, N. J., Lowell 7-4811 (Manhattan, Wisconsin 7-6600) • LOS ANGELES, CAL., Plymouth 7-3151 • ORLANDO, FLA., Garden 3-0518  
 PHILADELPHIA, PA. (Haddonfield, N. J.), Hazel 8-1272 • SAN FRANCISCO, CAL. (Redwood City), Emerson 9-5564 • SYRACUSE, N. Y., Howard 3-9141 • CANADA: Waterloo, Ont., Sherwood 5-6031  
 GOVERNMENT RELATIONS: Washington, O. C., Metropolitan 8-5205

CIRCLE 36 ON READER-SERVICE CARD

## NEWS

### 19-Barreled U.S. Camera Shoots Planets by Day

A camera system that resembles an anti-aircraft gun recently captured continuous bright views of Venus and Jupiter in daylight.

The giant Facet-Eye Camera System, developed by W. E. Woehl of the Air Force Missile Development Center, Holloman Air Force Base, N. M., was basically conceived for tracking missiles and satellites at extreme distances and in any kind of light.

The planetary images were transmitted to indoor viewing screens, where they were photographed with a plate camera. By using this method, distortion-free pictures were reported produced with a clarity and intensity ordinarily obtained only during night hours. The total field covered was reported to be many times the size obtainable by standard tracking telescopes.

The camera system, consisting of 19 long-barreled, 5-in. refracting telescopes linked to as many image-orthicon tubes, moves on a delicately balanced tracking mount. It is planned to increase the number of telescopes and oscilloscope screens to 25 to provide a viewing field of 2-1/2 by 7 deg.

The system has been installed at the Air Force Missile Development Center.



A battery of 19 optical telescopes linked to image-orthicon tubes forms the Air Force's new Facet-Eye Camera System. Bright views of Venus and Jupiter were shot in daylight with the system.

ELECTRONIC DESIGN • August 2, 1961

## U. S. to Orbit Satellite to Test New World Tracking Network

The National Aeronautics and Space Administration is planning a satellite launching to test the recently completed worldwide Mercury tracking network.

A Mercury-Scout I will be orbited to provide real-time calibration, training and operational experience for the new 16-station Mercury network. It will also provide a flight test of Mercury communications gear.

The satellite will be launched into an approximate 300-mile-high orbit by a Scout vehicle.

## Command Receiver Designed For Use in Skybolt Missiles

A new command destruct receiver for use in the Skybolt Missile Program is slated for production by the Ramo-Wooldridge Div. of Thompson Ramo Wooldridge, Inc., Canoga Park, Calif. The units will be delivered to Douglas Aircraft Corp., where the first engineering model is presently undergoing environmental testing.

The receiver, called the CR-10, weighs 2-1/2 lb. Reduction of the new receiver to one-third the size and one-half the weight of an earlier model was accomplished by using helically loaded cavities, magnetostrictive audio filters, and potted modular construction of basic circuitry.

## Electrically Suspended Gyros Due in Polaris Missile Program

An electrically suspended gyroscope with only one moving part is to be used in the inertial guidance system of the Navy's Polaris missile.

The gyroscope is composed of a beryllium rotor suspended in a vacuum by an electrical field. It is set in motion by an induced magnetic field, which is then turned off. Once started, the rotor will coast for about a year because of a lack of friction in the vacuum container.

According to C. L. Davis of the Minneapolis-Honeywell Regulator Corp., under contract to the Navy Bureau of Ordnance to produce the gyroscope, a test model has been operated successfully for more than 6,300 hr without being restarted.

Contact your Raytheon Distributor for off-the-shelf delivery at no penalty in price on Raytheon Double-Ended Submin Transistors and all Raytheon Semiconductors. Raytheon, Distributor Products Division, 411 Providence Turnpike, Westwood, Massachusetts.

**ALABAMA**  
Birmingham  
Forbes Distributing Company  
AL 1-4104

**ARIZONA**  
Phoenix  
Midland Specialty Co.  
ALpine 8-8254

**CALIFORNIA**  
Burbank  
Valley Electronic Supply Co.  
Victoria 9-3944  
Hollywood  
Hollywood Radio & Electronics, Inc.  
HO 4-8321  
Los Angeles  
Kierulff Electronics, Inc.  
Richmond 8-2444  
Oakland  
Elmar Electronics  
TEmplar 4-3311  
Palo Alto  
Zack Electronics  
DA 6-5432  
Sacramento  
Sacramento Electronic Supply  
GI 1-4821  
San Diego  
Radio Parts Company  
BE 9-9361  
San Francisco  
Fortune Electronics  
UN 1-2434  
Zack Radio Supply Co.  
MArket 1-1422  
San Jose  
Peninsula Electronic Supply  
CYprus 4-8781  
Santa Ana  
Richey Electronics Inc.  
TRiangle 2-2651

**COLORADO**  
Denver  
Ward Terry Company  
AMherst 6-3181

**DISTRICT OF COLUMBIA**  
Electronic Wholesalers Inc.  
HUDson 3-5200  
Empire Electronic Supply Co.  
OLiver 6-3300

**FLORIDA**  
Miami  
East Coast Radio & Television Co.  
FRanklin 1-4636  
Orlando  
East Coast Radio & Television Co.  
CHerry 1-9655  
West Palm Beach  
Goddard Distributors, Inc.  
TEmples 3-5701

**ILLINOIS**  
Chicago  
Allied Radio Corporation  
HAYmarket 1-6800

**IOWA**  
Cedar Rapids  
Mid-State Distributors  
337-3726  
Des Moines  
Mid-State Distributors  
ATlantic 8-7231

**MARYLAND**  
Baltimore  
Wholesale Radio Parts Co., Inc.  
MUlberry 5-2134

**MASSACHUSETTS**  
Boston  
Cramer Electronics, Inc.  
COpley 7-4700  
DeMambo Radio Supply Co., Inc.  
AL 4-9000  
Graybar Electric Co.  
HUBbard 2-9320  
Lafayette Radio Corp. of Mass.  
HUBbard 2-7850

Cambridge  
Electrical Supply Corp.  
UNiversity 4-6300

**MICHIGAN**  
Detroit  
Radio Electronic Supply Co.  
TE 4-8420  
Grand Rapids  
Radio Electronic Supply Co.  
GLendale 9-4611

**MINNESOTA**  
Minneapolis  
Northwest Electronic Corp.  
FE 8-7551

**MISSOURI**  
Kansas City  
Burststein-Applebee Company  
BALtimore 1-1155  
University City  
Olive Industrial Electronics  
VOLunteer 3-4051

**NEW JERSEY**  
Camden  
General Radio Supply Co., Inc.  
WO 4-8560 (in Phila.: WA 2-7037)  
Mountainside  
Federated Purchaser Inc.  
AD 2-8200

**NEW MEXICO**  
Albuquerque  
Midland Specialty Company  
CHapel 7-0236

**NEW YORK**  
Binghamton  
Stack Industrial Electronics, Inc.  
RA 3-6326  
Buffalo  
Wehle Electronics Inc.  
TL 4-3270  
Mineola, Long Island  
Arrow Electronics, Inc.  
Pioneer 6-8686  
New York City  
Milo Electronics Corporation  
BEekman 3-2980  
Sun Radio & Electronics Co., Inc.  
OREgon 5-8600  
Terminal-Hudson Electronics, Inc.  
CHelsea 3-5200

Troy  
Trojan Electronic Supply  
AS 4-4481

Utica  
Valley Industrial Electronics, Inc.  
RA 4-5168

**OHIO**  
Cincinnati  
United Radio Inc.  
CHerry 1-6530  
Dayton  
Strepco, Inc.  
BALdwin 4-3871

**OREGON**  
Portland  
Lou Johnson Company, Inc.  
CAPital 2-9551

**PENNSYLVANIA**  
Philadelphia  
Radio Electric Service Co.  
WALnut 5-5840

**TENNESSEE**  
Knoxville  
Industrial Electronics Inc.  
524-7368

**TEXAS**  
El Paso  
Midland Specialty Company  
KEYstone 3-9555  
Fort Worth  
SWIECO, Inc.  
ED 2-7157 (in Dallas: AN 2-5026)

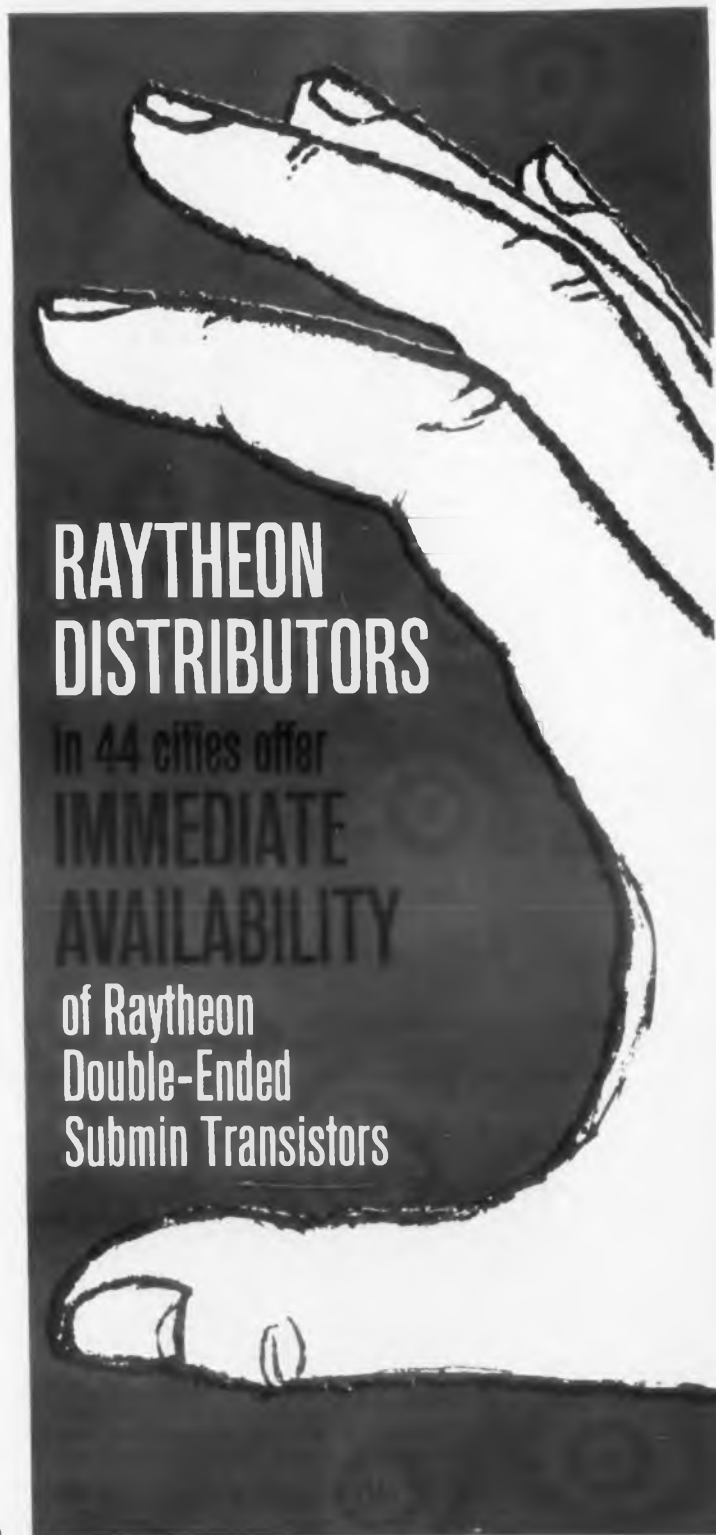

# RAYTHEON DISTRIBUTORS

In 44 cities offer  
IMMEDIATE  
AVAILABILITY  
of Raytheon  
Double-Ended  
Submin Transistors

RAYTHEON COMPANY

DISTRIBUTOR PRODUCTS DIVISION

CIRCLE 37 ON READER-SERVICE CARD

RAYTHEON

# A

2N1015  
2N1015A  
2N1015B  
2N1016  
2N1016A  
2N1016B



150 Watt

2N1212  
2N1208  
2N1616  
2N1617  
2N1618  
2N1616A  
2N1617A  
2N1618A  
2N1724



85 Watt

WESCON Booth 1224

## SILICON TRANSISTOR CORP. ADDS 2 NEW SERIES. THE COMPLETE LINE OF HIGH POWER SILICON TRANSISTORS

The series...

2N1015  
2N1015A  
2N1015B  
2N1016  
2N1016A  
2N1016B

are 150 watt single-end stud types. With collector-emitter voltages of 100 volts. Saturation resistance of 0.5 ohms. Minimum beta of 10 at 5 amps.

The series

2N1212  
2N1208  
2N1616  
2N1617  
2N1618

are double-ended 11/16" 85 watt hex stud types.

And...

2N1616A  
2N1617A  
2N1618A  
2N1724

are the most popular series in this package, with dramatic improvements from STC.

BVCEO of 80 volts. Saturation resistance of 0.5 ohms. Minimum beta of 10 at 5 amps.

Both STC series have the lowest leakage currents in the industry...high temperature stability...low thermal resistance and reliability at full power ratings. Write for Catalog listing complete line of STC's high and intermediate power silicon transistors and silicon diodes.

## SILICON TRANSISTOR CORP.

CARLE PLACE, LONG ISLAND, NEW YORK Pioneer 2-4100

CIRCLE 38 ON READER-SERVICE CARD



**FOR IMMEDIATE DELIVERY  
CONTACT THESE STC  
DISTRIBUTORS**

***in Alabama:***

MG Electronics & Equipment Co.  
Birmingham — FA 2-0449

***in Arizona:***

Southwest Industrial Electronics  
Phoenix — AL 2-1741

***in California:***

Hollywood Radio & Electronics, Inc.  
Hollywood — HO 4-8321  
Kierulff Electronics, Inc.  
Los Angeles — RI 8-2444  
San Diego — BR 6-3334  
Shanks & Wright, Inc.  
San Diego — BE 9-0176

***in Connecticut:***

Sun Radio & Electronics Co., Inc.  
Stamford — WH 9-7715

***in Florida:***

Gulf Semiconductors, Inc.  
Miami — MO 5-3574  
Hammond Electronics, Inc.  
Orlando — GA 5-0511

***in Indiana:***

Graham Electronics Supply, Inc.  
Indianapolis — ME 4-8486

***in Maryland:***

Valley Electronics, Inc.  
Towson — VA 5-7820

***in Massachusetts:***

Durrell Electronics, Inc.  
Waltham — TW 3-7020

***in New Jersey:***

Sun Radio & Electronics Co., Inc.  
Princeton — WA 1-2150

***in New York:***

Arrow Electronics, Inc.  
Mineola, L.I. — PI 6-8686  
Progress Electronics  
New York — CA 6-5611  
Stack Industrial Electronics, Inc.  
Binghamton — RA 3-6326  
Standard Electronics, Inc.  
Buffalo — TT 3-5000  
Sun Radio & Electronics Co., Inc.  
New York — OR 5-8600  
Valley Industrial Electronics, Inc.  
Utica — RA 4-5168

***in Pennsylvania:***

Philadelphia Electronics, Inc.  
Philadelphia — LO 8-7444

***in Tennessee:***

Electra Distributing Co.  
Nashville — AL 5-8444

***in Texas:***

All State Electronics, Inc.  
Dallas — RI 1-1295  
Lenert Company  
Houston — CA 4-2663

CIRCLE 39 ON READER-SERVICE CARD

# EDITORIAL

---

## Space Successes Mounting

Despite the mild public hullabaloo over recent space successes compared to the massive publicity effort accorded the Project Mercury suborbital flight, we would like to express high enthusiasm for the following notable U. S. achievements:

- Automated ship navigation is very close with the successful orbiting of Transit IV-A.
- Long-lasting power sources, formerly a bugaboo in our space program, may have arrived with the SNAP isotope generator used in Transit.
- Great worldwide benefit can be provided as Tiros III spots cloud formations that may permit early detection of vicious hurricanes and typhoons.
- The infrared eye of Midas should permit early warning of missile launchings. Although intensified effort is needed so that we can *do* something when we do spot a hostile shot, Midas must be considered an engineering achievement of high rank. Implementation of such a new concept is not often achieved on such a short time-scale.

A quick glance at the record shows 28 U. S. vehicles in orbit around the earth with 13 of them still transmitting. We have launched a total of 45 space vehicles compared with 12 launched by the Soviets. Currently only one of these Soviet satellites is still in earth-orbit, and it has ceased transmitting. (The recent rapid succession of space triumphs could conceivably alter these figures by our issue date).

The Russians certainly have shown perceptive foresight in planning space spectaculars, but our own program reflects a sounder approach to the imaginative utilization of this new dimension.

We remain strongly in favor of continued criticism of our space program where it is obviously weak. But it seems that the major advances of recent weeks should bring due credit to the men of good sense who have made them possible.—R. H.

## WESCON

As you browse through this WESCON preview issue you'll find some features of special interest. Product highlights are summarized on p 62, and descriptions of new products to be introduced at the show begin on p 64. Photographs of some of the research work to be viewed on WESCON field trips are presented on p 8.

If you make it to the show stop in and chat for awhile at our booth—P-1 & 2 in the Cow Palace Annex. We welcome your suggestions and any article ideas you may have. A crew of DESIGN editors will be on hand to talk over article possibilities and give you some help on getting them written.

Look for the new enlarged ELECTRONIC DAILY while you're at the show. For some time we've published an 8-1/2 x 11 in. magazine for visitors to the IRE Show and WESCON. With this year's West Coast show we are shifting to a tabloid sized magazine—10-3/4 x 16-1/2 in.—on quality paper. As in the past, coverage will be restricted to show and convention activities.—E. E. G.

**new applications  
for Sigma's Wonderful Electric  
Stepping Machine**

(Or, "Discrete ratchetless angular rotations from current reversals")

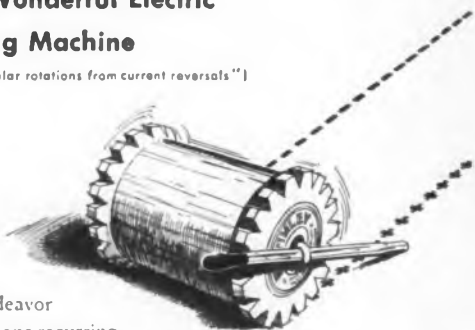

In the broad field of endeavor loosely called "instrumentation," one recurring problem is how to do a good job of converting *pulses*—or current reversals—into *shaft positions*. A dandy solution for present or future reference follows forthwith.

The Cyclonome<sup>®</sup> is a high speed *magnetic* stepping motor, whose shaft stays in one of 20 stable positions until a current reversal comes along; then it turns 18° ( $\pm \frac{1}{4}^\circ$ ). Because the precise incremental rotation is due solely to magnetic forces, the wear, noise, slowness, short life and high input power of ratchet-and-pawl devices are completely avoided. The Cyclonome will step up to 400 times per second (20 rps), using  $\frac{1}{3}$  to 40 watts depending on the speed and what's hitched to the shaft as well. Here are some current (reversing) examples of jobs being done by Cyclonomes.

In response to voltage variation, a Cyclonome precisely moves the electrode in an automatic welder to maintain a constant arc length. "Positioning" Cyclonomes also drive magnetic tape, strip charts and movie film in very discrete amounts to a particular section of interest, on pulsed commands. The motors are also expert knob twiddlers, turning gain controls on amplifiers and scopes and tuning receivers for automatic band sweeps. An electric utility uses a Cyclonome motor driving a wiper arm around a printed circuit switch deck (see Cycloswitch<sup>®</sup> illustration) to indicate tap positions on remotely located tap changing transformers; in a medical research application, a Cycloswitch monitors blood temperatures at several points in the patient's circulatory system.

As "pulse translators," Cyclonomes are: measuring fuel consumption or liquid flow from a pulse-generating rotor inside a pipe; remotely controlling mix in a petroleum blending machine; counting traffic by converting input pulses into successive positions of memory code discs; counting the numerical difference between pulses from two sources, in an "impulse difference relay;" indicating time as a "clock mechanism" in a precise time comparator.

In some cases we've done the "packaging," with due regard for Cyclonome input, output, coupling, and compatibility of components with our motor.

We'd be glad to tackle your problem this way, or just sell you the motor with almost no questions asked. Give it some thought, particularly for unattended field equipment and where its ability to eliminate other bugs and headaches can mean a simpler, less costly overall answer.

If that's too much to ask, just give Sigma some thought.

*In the palace with the cows at WESCOV,  
Aug. 22-25 — Booth 520-522.*



Unidirectional  
Cyclonome



Bidirectional  
Cyclonome



Series 9C Cycloswitch



**SIGMA**

**SIGMA INSTRUMENTS, INC.**

91 PEARL ST., SO. BRAINTREE 85, MASS.

**CIRCLE 40 ON READER-SERVICE CARD**

# Tunnel Diode Sine-Wave Oscillators—

## Part I

*Series-parallel tunnel diode sine-wave oscillators offer excellent frequency stability characteristics—4 parts/10,000 drift for a 1-mc oscillator operating from -50 to +100 C. The design procedure is presented with examples of 1-kc, 100-kc and 1-mc circuits. Device and circuit limitations are included in Part I. Part II, to appear in the August 16 issue, contains a complete circuit analysis of the starting and steady-state conditions as well as the derivation of the design equations. A wireless fm microphone and crystal controlled oscillator will also be described in Part II.*

### Erich Gottlieb

Applications Engineering  
Semiconductor Products Dept.  
General Electric Co.  
Syracuse, N. Y.

**B**ECAUSE OF its inherent negative conductance characteristic, the tunnel diode is ideally suited for oscillator operation. The temperature stability of its characteristics is excellent and the frequency stability of the resulting oscillator circuit primarily depends on the associated circuit components.

### Oscillator Configuration— “Series” vs “Series-Parallel”

The simplest tunnel diode oscillator circuit is the “series” type, see Fig. 1. In this circuit the diode, appropriately biased in the negative conductance region, is connected in series with an external inductor.

In such an arrangement, the analysis<sup>1,2</sup> shows that the circuit will oscillate freely in a sinusoidal manner when

$$\frac{R_T}{|g_d|} = \frac{L}{C} \quad (1)$$

at a frequency

$$f_o = \frac{1}{2\pi} \sqrt{\frac{1 - R_T \cdot g_d}{LC}} \quad (2)$$

Both the frequency and the stability of this circuit depend largely on  $|g_d|$ ; since this conductance is a time-average value which

varies with voltage and temperature, such a circuit is rather unstable.

Another circuit approach, much less subject to the various causes of instability, is shown in Fig. 2. The operating frequency of this “series-parallel” circuit can be made primarily dependent on the  $L$  and  $C$  of the tank circuit and can therefore be quite stable. A detailed analysis for this circuit (see Equation Derivation section) shows that the operating frequency is determined by

$$f_o = \frac{1}{2\pi} \sqrt{\frac{1}{L(C + C_1)} - \frac{g_d^2}{C_1(C + C_1)}} \quad (3)$$

and that for stable sinusoidal oscillations

$$R_T = \frac{g_d}{\omega^2 C_1^2 + g_d^2} \quad (4)$$

It should be pointed out that several approximations have been made in the analysis. First, the diode series resistance and series inductance have been neglected as they will generally be small compared to the external

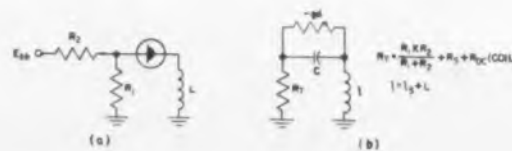

Fig. 1. Simple series-type oscillator and its equivalent circuit.

lumped constants. Secondly, the term  $g_d$ , in reality should be a time-average value where  $g_d$  be expressed in function of time as:

$g_d(t) = g_0 + g_1 \cos \omega t + g_2 \cos 2\omega t + \dots$  is only approximated. Presently, only an average value of  $g_d$  is being specified by the manufacturer. This parameter is measured in the following manner. While observing the  $V-I$  characteristic, the tunnel diode is shunted by a variable resistance. When  $R = 1/g_d$ , the slope of the negative conductance becomes zero over the active range and since  $R$  is known,  $g_d$  is thus established.

### Limitations Include Low Output and Poor Efficiency

The use of the tunnel diode as an active device in oscillator circuits has certain limitations. Obviously the first of these is the small amount of power output obtainable from such a circuit. It is apparent from a rough approximation of the  $V-I$  characteristics that the maximum power output available from the tunnel diode is

$$P_{o \max} = \frac{(V_r - V_p)(I_p - I_r)}{8} \quad (5)$$

$$\approx \frac{I_p^2}{35} \quad (\text{for germanium})$$

[For germanium,  $V_r - V_p = 350 - 65 = 285$  mv  
 $I_p/I_r = 5$  (typ)  $\therefore I_p - I_r = 0.8 I_p$  (typ)]

Hence it would take at least a 35-amp peak

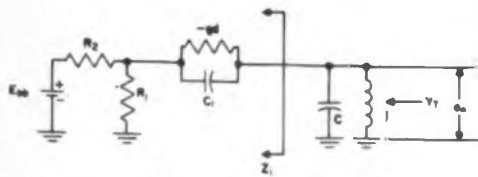

Fig. 2. Simplified equivalent circuit of series-parallel sine-wave oscillator.

current unit to obtain 1 w of power output or a 3.5-amp unit to obtain 100 mw of output power. A 3.5-amp germanium unit has a negative resistance of 0.1 ohm or less. Driving such a resistance from a stiff voltage source is difficult and inefficient.

Another problem is that such a high power unit has a rather large junction area, hence a relatively large junction capacitance. The magnitude of this capacitance seriously limits the frequency at which this power is available.

Further limitations can be found in coupling this oscillator to a load. The tunnel diode oscillator circuit only delivers a fraction of 1 v (rms) to the tank circuit. Generally, as this circuit is coupled into other low impedance semiconductor circuits, a stepdown transformer only serves to lower this output voltage swing.

Finally, the efficiency of such a circuit, driven from present conventional power supplies (relatively high dc voltages) is low. An efficient tunnel diode supply would provide a fraction of 1 v with a large current capacity—just the opposite of conventionally used supplies. On the other hand, solar cells and thermoelectric generators could probably be used to advantage in tunnel diode circuits.

#### Design Procedure for a 1-Kc Sine-wave Oscillator

Given the frequency and required output power, the choice of diode can be made. For 1 mw of rms power, a greater than 35-ma diode is required. Another consideration in the choice of diode is its capacitance and inductance for high-frequency applications, as these parasitic parameters can severely limit the frequency range. A further consideration is of a purely practical nature; at low frequencies, the size of the inductor becomes electrically and physically large. To mini-

## DESIGN WITH ARNOLD 6T CORES . . . SAME-DAY SHIPMENT OF STANDARD DELTAMAX CORE SIZES



Arnold 6T tape cores (aluminum-cased and hermetically-sealed) offer you three very important design advantages. *One:* Maximum compactness, comparable to or exceeding that previously offered only by plastic-cased cores. *Two:* Maximum built-in protection against environmental hazards. *Three:* Require no supplementary insulation prior to winding and can be vacuum impregnated after winding.

Now we've added a fourth vital advantage: Maximum availability. An initial stock of approximately

20,000 Deltamax 1, 2 and 4-mil tape cores in the proposed EIA standard sizes (See AIEE Publication No. 430) is ready on warehouse shelves for your convenience. From this revolving stock, you can get immediate shipment (*the same day order is received*) on cores in quantities from prototype lots to regular production requirements.

Use Arnold 6T cores in your designs for improved performance and reduced cost. They're guaranteed against 1000-volt breakdown . . . guaranteed to meet military

test specifications for resistance to vibration and shock . . . guaranteed also to meet military specifications for operating temperatures. The 6T hermetic casing method is extra rigid to protect against strains.

Let us supply *your* requirements. Full data (Bulletin TC-101A and Supplements) on request. • Write *The Arnold Engineering Company, Main Office and Plant, Marengo, Ill.*

ADDRESS DEPT. ED-8

**ARNOLD**  
SPECIALISTS IN MAGNETIC MATERIALS

BRANCH OFFICES and REPRESENTATIVES in PRINCIPAL CITIES • Find them FAST in the YELLOW PAGES



**READY  
TO ROLL!  
RIGHT  
FROM  
STOCK**

CIRCLE 41 ON READER-SERVICE CARD



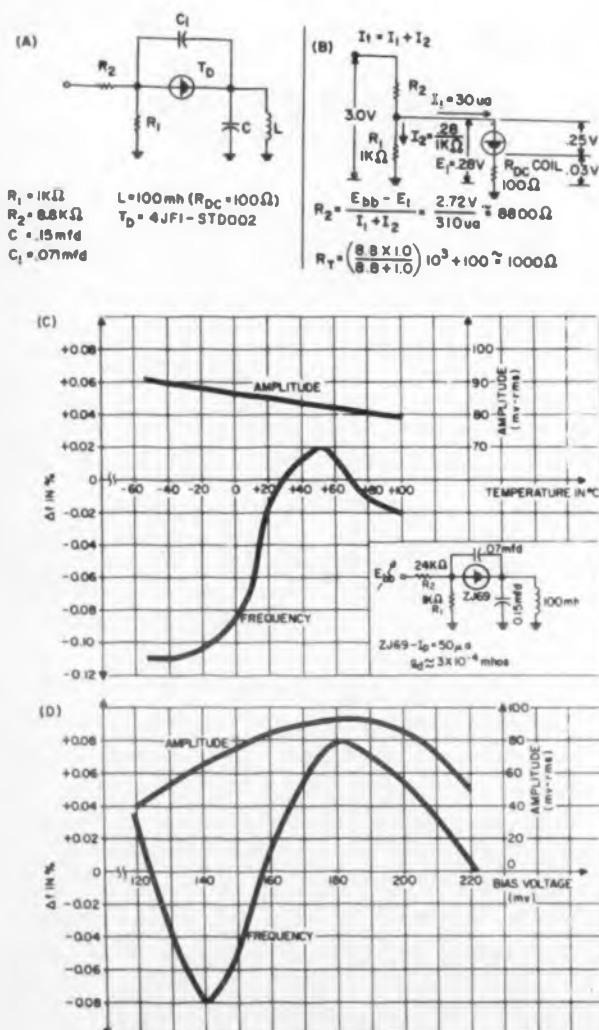

Fig. 3. (a) Schematic of a 1-kc oscillator with calculations shown in (b). Frequency and amplitude stability are shown as temperature (c) and bias voltage (d).

mize physical dimensions, smaller wire is used resulting in larger values of dc resistance. The tunnel diode must remain stably biased in the negative conductance region. Therefore,  $R_1$  must be smaller than  $1/g_d$ , and if the dc resistance of the coil were very large,  $g_d$  would have to be very small. This dictates the use of a very low-current tunnel diode since  $g_d = \Delta i/\Delta v$  and  $\Delta v$  is fixed.

For the first design example, consider a 1-kc sinusoidal oscillator having a limited

power output of about  $1 \mu w$ . A rough approximation indicates that a unit with  $I_p$  over  $35 \mu a$  will do the job. As tunnel diodes with  $I_p < 1 ma$  are not generally available, a backward diode (generally this device can be used as a low-current tunnel diode) is utilized. If a unit such as GE's gallium arsenide, 4FJ1-STD002, having a typical negative conductance of approximately  $3 \times 10^{-3}$  mhos, is used  $R_T$  can now be 1 to 2 K without seriously impairing the dc stability of the circuit (see Fig. 3a).

Once  $g_d$  is determined, the choice of  $R_T$  can be made. The limits are that  $R_T < 1/g_d$ , but if  $R_T$  is made very small, the dc power consumption of the circuit becomes too large. Hence  $R_T$  is chosen somewhere between 0.3 and 0.7 of  $1/g_d$ , as this will yield adequate stability with reasonable power consumption.

If  $R_T = 0.3/g_d$ ,  $R_T$  will be about 1,000 ohms for the particular example. At this point,  $C_1$  can be calculated, where (from Eq. 4)

$$C_1 = \sqrt{\frac{g_d(1 - R_T g_d)}{R_T \omega^2}}$$

$$= \sqrt{\frac{3 \times 10^{-3} (1 - 0.3)}{10^3 \times 4 \times 10^7}} = 0.071 \mu f$$

Since:

$$C + \frac{C_1}{1 - R_T \cdot g_d} = \frac{1}{L \omega^2}$$

If  $L$  is chosen somewhat arbitrarily at 100 mh with a  $R_{DC} \cong 100$  ohms

$$C = 0.25 - \frac{0.071}{1 - 0.3} \mu f = 0.15 \mu f$$

The dc bias circuit can now be calculated. Assume the circuit supply voltage  $E_{bb} = 3.0$  v. If  $R_1$  (see Fig. 3b) is 1,000 ohms, then

$$I_{total} = I_{diode} + E_{diode}/R_1 = 310 \mu a$$

and

$$R_2 = \frac{E_{bb} - (E_{diode} + E_{RDC})}{I_{total}}$$

$$= \frac{3 - (0.25 + 0.03)}{310 \times 10^{-6}} = 8,800 \text{ ohms}$$

$$R_T = \frac{R_1 \times R_2}{R_1 + R_2} + R_{DC} + R_s$$

$$= \frac{8,800 \times 1,000}{9,800} + 100 + 2 \cong 1,000 \text{ ohms}$$

The performance characteristics of such an oscillator meet the requirements used for tone generators of electronic organs as the stability data of Fig. 3c illustrate. In this figure, the frequency variation vs tempera-

ture is shown to be only in the order of 0.1 per cent from  $-50$  C to  $+100$  C, while over the more limited range of environmental conditions to which an electronic organ is normally subjected, the stability is considerably better. The amplitude variation is also minor while both the frequency and amplitude variation versus bias is quite acceptable over a wide range, Fig. 3d.

#### Performance of a 100-Kc Oscillator

Another example at 100 kc, would simply involve dividing  $L$ ,  $C$  and  $C_1$  by 100. Thus

$$C_1 = 710 \text{ pf}$$

$$C = 1,500 \text{ pf}$$

$$L = 1 \text{ mh}$$

If the same tunnel diode is used, the bias circuit remains the same as shown in Fig. 3a. At 100 kc however, the size of the inductance will easily permit the use of larger peak current tunnel diodes and hence the circuit can be designed to accommodate a 1-ma peak current unit with greater power output. The performance characteristics of a 100-kc oscillator is illustrated in Figs. 4 through 6. Fig. 4 shows the circuit diagram and the oscilloscope presentation of the output waveform across the tunnel diode (upper) and across the tank circuit (lower).

Fig. 5 indicates the frequency variation vs bias voltage and Fig. 6 shows the frequency variation vs temperature characteristic of the diode. In these tests only the tunnel diode was exposed to temperature change in order to establish its contribution to circuit instability. The external circuit can be designed to provide temperature compensation for even greater frequency stability.

As can be seen from the data, the frequency stability of this circuit is quite good over a wide range of temperature and bias voltage.

#### Fraction of Per Cent Frequency Drift In 1-Mc Oscillator

The next circuit, a 1-mc oscillator, was tested and showed considerable improvement, as illustrated in Figs. 7 through 9.

Fig. 7 illustrates the fact that by changing the bias voltage, the variation of frequency is only in the order of a few hundred cycles out of 1.14 mc, a change in the order of 0.05 per cent. Over the range of 155 to 200 mv, the amplitude of the output voltage varies only from 63 mv-rms down to 55 mv-rms.

Fig. 8 shows the temperature stability of this oscillator circuit over a range of  $-50$  C to  $+100$  C. It can be seen that the frequency



Fig. 4. 100-kc sine-wave oscillator circuit and output waveform across diode (upper) and tank circuit (lower).

varies only +18 to -16 millipercnt over this wide temperature range.

#### Amplitude and Distortion Unaffected by Variable Capacitor Tuning

The main variable creating the frequency shift versus bias and temperature is the negative conductance ( $-g_d$ ). As the operating frequency is increased, the variation of frequency ( $\Delta f$ ) caused by  $\Delta g_d$  remains the same; however, since  $f$  changes,  $\Delta f/f \times 100$  decreases, thus causing a lower percentage of frequency shift.

Finally, Fig. 9 shows that varying the capacitor  $C\Delta$  in the parallel tank circuit over an appreciable range accomplishes smooth tuning without change in amplitude or distortion. This latter point is especially important since in the "series" type oscillator circuit a change in either  $L$  or  $C$  affects stability and distortion greatly.

#### Limitations Imposed by High Power, High Frequency Demands

At higher power output requirements (in the milliwatt region) or at higher frequencies, further limitations cause the aforementioned sequence of design procedure to become somewhat impractical. After having chosen a tunnel diode with a sufficient peak current to furnish the required power output,  $g_d$  is essentially established. For example, it will take a 100-ma unit to furnish about 3 mw of available output power. A 100-ma unit has a negative conductance  $g_d$  in the order of 1 mho ( $-rd = 1 \text{ ohm}$ ). If one keeps the product of  $R_T \times g_d$  at 0.5 then  $C_1$  is established by Eq. 4.

The problem arises in the heretofore somewhat arbitrary choice of  $L$ . This inductance becomes much more restricted as  $g_d$  and the operating frequency increase. The inductance is determined by

$$L = \frac{1}{\omega^2 \left[ C + \frac{C_1}{1 - R_T \cdot g_d} \right]} \quad (6)$$

(continued on p 44)



## Eye-opening facts about miniature electrolytic capacitors

Many electronic designers and buyers already depend on iei for higher reliability capacitors and dependable service. If iei is a new name to you, here are the facts.

**iei** offers full polar, partial polar and non-polar construction in aluminum foil, 85° and 125° tantalum foil, tantalum wet slug and solid tantalum types. For many years iei has been the only company specializing in low-voltage, miniature electrolytic capacitors for transistor applications.

**iei** units cover the range from 3 to 150 WVDC, from 2 to 5000 mfd, and offer the greatest range of standard types and ratings. The 85° Tantalum Foil and Tantalum Solid capacitors are Q.P.L. (Qualified Product List) approved.

**iei** 85° Tantalum Foil units are the only capacitors available in 5 MIL case sizes—and, 5 smaller case sizes with equal capacity—for optimum space utilization.

**iei** and local distributors stock standard values of these miniature electrolytic capacitors.

**iei** has prepared a new technical bulletin for specifying and buying personnel. Write for Form 2773.

**International Electronic Industries, Inc.**  
BOX 9036-12 NASHVILLE, TENNESSEE

AN **SPS** COMPANY

where reliability replaces probability

CIRCLE 42 ON READER-SERVICE CARD

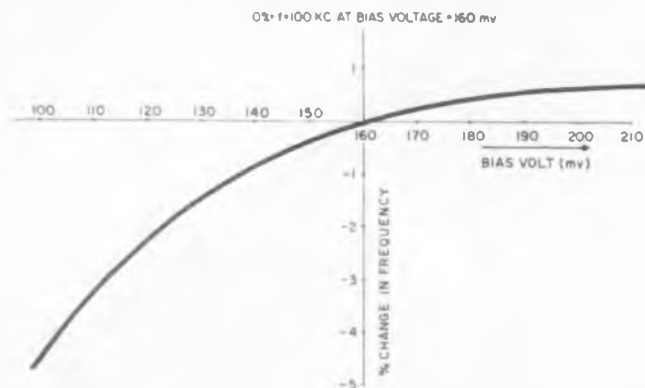

Fig. 5. Frequency variation of the 100-kc oscillator vs bias voltage at 25 C.

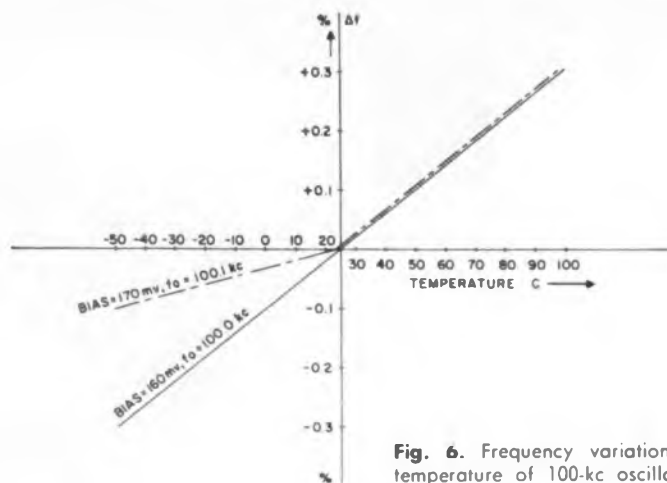

Fig. 6. Frequency variation vs temperature of 100-kc oscillator.

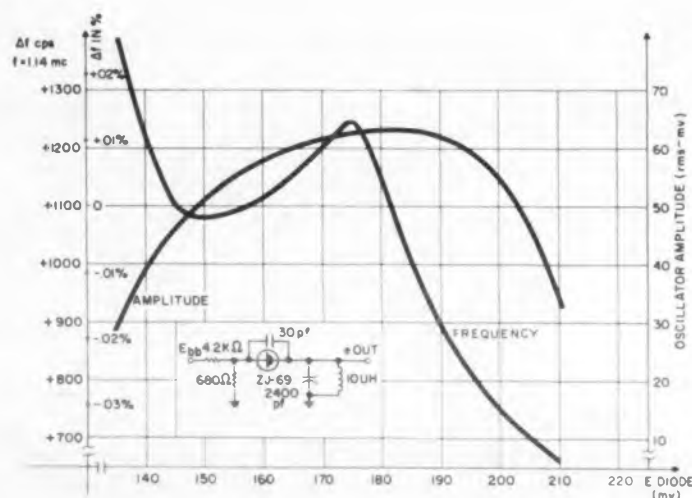

Fig. 7. Frequency stability vs bias voltage of 1-mc oscillator.

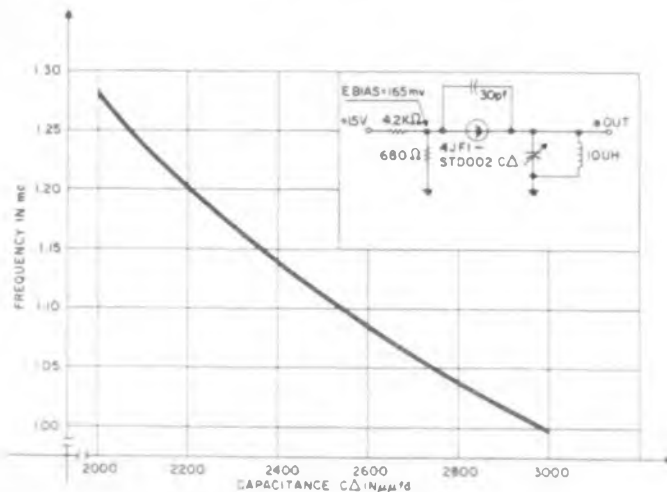

Fig. 9. Frequency tuning by means of variable capacitor  $C_{\Delta}$  provides a smooth variation without change in amplitude (60 mv) or distortion.

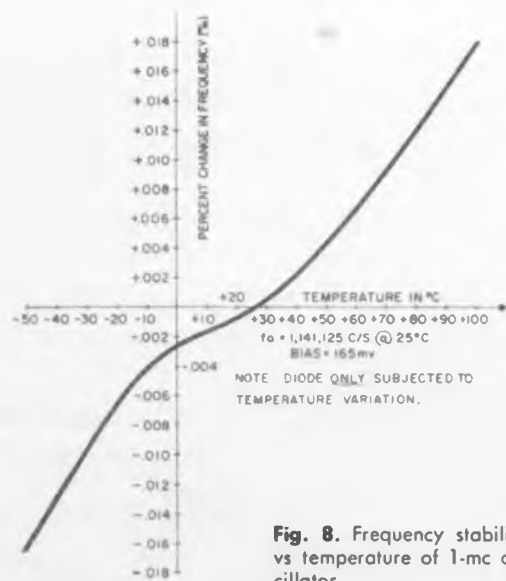

Fig. 8. Frequency stability vs temperature of 1-mc oscillator.

The maximum value of  $L$  is realized when  $C$  becomes zero, at which time

$$L_{max} = \frac{1}{\omega^2 \frac{C_1}{[1 - K_T \cdot g_j]}} \quad (7)$$

If this value is now found by using a higher power example at, for example, 1 mc, then:

$$L_{max} = \frac{1}{39.6 \times 10^{12} \times 0.32 \times 10^{-6}} \cong 78 \text{ nh}$$

If a small capacitance is now added and/or if the operating frequency is further increased,  $L$  will quickly reach the package limitations of the tunnel diode.

For example, if  $f = 10$  mc and  $C$  is 10 pf, then:

$$C_1 = \sqrt{\frac{1(1-0.5)}{0.5 \times 39.6 \times 10^{14}}} = 0.016 \mu\text{f}$$

and

$$L = \frac{1}{39.6 \times 10^{14} \times 10 \times 10^{-12} + \left(\frac{16 \times 10^{-9}}{0.5}\right)} = 7.88 \text{ nh}$$

For the TO-18 packaged devices, this is the magnitude of the case and lead inductance and a further reduction would be difficult to achieve. Naturally lower inductance tunnel diode constructions as well as techniques for tuning out some of the inductance (in coaxial or triplate arrangement for microwave applications) might extend these limits somewhat.

The inductance  $L$  can be further increased, however, if  $C_1$  is reduced. The limit of  $C_1$  is the tunnel diode capacitance  $C_D$ , at which time the circuit simplifies down to the simple

"series" type:

$$L_{mar} = \frac{1}{\omega^2 \left( \frac{C_D}{1 - R_T g_d} \right)} \quad (8)$$

Rewriting this equation for frequency gives us, once again, Eq. 2 of the "series" circuit.

$$\omega = \sqrt{\frac{(1 - R_T g_d)}{L_T C_D}}$$

$$\text{Since } C_D = C_1 = \sqrt{\frac{g_d (1 - R_T g_d)}{R_T \omega^2}} \quad (9)$$

the ratio of  $g_d/R_T$  will have to be reduced if  $C_1$  is reduced considerably. As  $R_T$  is dependent on  $g_d$ , this essentially means that a lower  $g_d$  should be used; hence, a lower current tunnel diode. The use of  $C$  and  $C_1$  as stabilizing (or swamping) components being so desirable, one might not want to carry  $C_1$  to the limit and hence another design example might prove interesting.

$$\text{Let } C = C_1 = 10 C_D$$

In this new circuit, Eq. 4

$$\frac{g_d}{R_T} = \frac{C_1^2 \omega^2}{(1 - R_T g_d)}$$

$$\text{if } R_T = \frac{R_D}{2}, \quad \frac{2}{R_D^2} = 2C_1^2 \omega^2$$

$$\text{and hence } R_D = \sqrt{\frac{1}{\omega^2 C_1^2}}$$

$R_D$  (for the previous 10-mc example) now becomes; (assume  $C_D = 5$  pf, thus  $C_1 = 50$  pf)

$$R_D \approx \frac{1}{40 \times 10^{11} \times 2,500 \times 10^{-24}} \approx 320 \Omega$$

$$R_T = \frac{R_D}{2} = 160 \Omega$$

$$\text{and } L_T = \frac{1}{40 \times 10^{11} (50 \times 10^{-12} + \frac{50 \times 10^{-12}}{0.5})} = 1.67 \mu\text{h}$$

The result is a circuit, with reasonable  $L/C$  and the tunnel diode capacitance and its variation vs temperature and bias is swamped out. ■ ■

#### References

1. Davidsohn, U. S., Hwang, Y. C., Ober, G. B., "Designing With Tunnel Diodes", *ELECTRONIC DESIGN*, Feb. 3 & 17, 1960.
2. Chow, W. F., Davidsohn, U. S., Hwang, Y. C., Kim, C. S., Ober, G. B., "Tunnel Diode Circuit Aspects and Applications", *A.I.E.E. Conference Paper CP 60-297*, Jan. 1960.

# 35G VIBRATION

## A SENSITIVE RELAY WITH 0.2 INCH GRID SPACED TERMINALS

## RELAY

#### SPECIFICATIONS:

Contact Arrangement: DPDT, 20A  
 Contact Rating: 3 amps resistive at 28VDC  
 Operating Power: 250 mW (standard)  
 100 mW (special)  
 Vibration: 150g to 3000 GPM  
 Shocks: 100G's standard  
 150G's (special)  
 Dielectric Strength: 1000V RMS  
 750V RMS (ac) with open contacts  
 Ambient Temperature Range: -55°C to +125°C  
 Terminals: plug-in pins, solder hooks, 3-inch leads  
 Mounting: a variety of popular brackets and stud arrangements  
 Dimensions: 0.875 inches high, by 0.800 inches wide, by 0.896 inches thick  
 Weight: 0.6 ounces maximum



VR SERIES RELAY

ELGIN advance RELAYS

ELGIN  
ADVANCE  
RELAYS

THE ELECTRONICS DIVISION OF ELGIN NATIONAL WATCH COMPANY  
 2421 NORTH MADRI STREET, SYRACUSE, CALIFORNIA

SEE THIS AND OTHER NEW PRODUCTS AT

WESCON BOOTH 1802-04

CIRCLE 43 ON READER-SERVICE CARD

# Backlighting:

## Best for Electronic Control Panels

*Backlighting is about the best way for an electronic designer to add another "information channel" to an already crowded, confusing, instrument panel, says Rohm & Haas's A. M. Blumenfeld. Here, he starts the designer off with the basics of panel selection and marking, and light placement.*

**A. M. Blumenfeld**  
Rohm & Haas Co.  
Philadelphia, Pa.

**B**ACKLIGHTING is often the most efficient method for illuminating a control console panel. For the job it can do, it is often the optimum solution, eliminating the shortcomings of front floodlighting, and the technical complexity and low brightness limitations of edge lighting, in man-machine communications.

This article will cover the basics of backlighting. Knowing the basics, the engineer will be able to estimate how he can tackle the more sophisticated man-machine communication and appearance problems.

For backlighting, you need only three things: a transparent or translucent panel on the instrument face, a graphic display on the panel, and sources of light behind the panel. From this basic start, you can gain other degrees of freedom by adding more than one pattern, colored lights, and logical

switching for the lights. According to the number of different patterns and the amount of interrelated switching you add to the lighting circuits, you can end up with a panel, see photos, which is capable of transmitting a large amount of "human-engineered" information about the machine's status to the operator and do this within the confines of a fairly small panel.

### Designing the Panel for Backlighting

The first choice of material for a backlit "image panel" is usually a translucent (opalescent) acrylic plastic sheet, Fig. 1a. Suitable acrylic sheets are available in a broad range of transmission densities and colors. On the other hand, for certain effects, a clear acrylic sheet with translucent or opaque coatings on either or both surfaces may prove better, Fig. 1b.

If crisp outlines are essential, and translucent acrylic panels are used, the coating which forms the image must be applied to

the front surface of the panel. Front coatings present durability problems, however, when the panel is handled or cleaned frequently. But when transparent plastic panels are used, patterns in coatings are sharp and clear on either side, and the coating can be put on the back for better protection.

Components and surfaces inside the light-box plenum behind the panel should be either of silver-colored metal (but not highly polished) or be coated with a white matte finish of "high-reflectance" properties.

### Placement of Back Lights

Light may be flooded from the top or sides onto a reflecting panel, Fig. 2, and thence through the transmitting image panel. Reflectors may be parabolic or simply flat (the angles are best established by experiment). Reflected backlighting produces less brightness than direct backlighting, but is useful where lamp access is a problem, or limited depth is available behind the image panel, or



**This traffic control** center for directing train movements is a good example of the use of backlighting for sophisticated communication with the operator. Here (left) the miniature track diagram contains small backlights that indicate the operational condition of the switches and signals as well as indicator numbers. Backview (right) gives idea of the wiring arrangement used. Union Switch & Signal division of Westinghouse Air Brake was the builder.

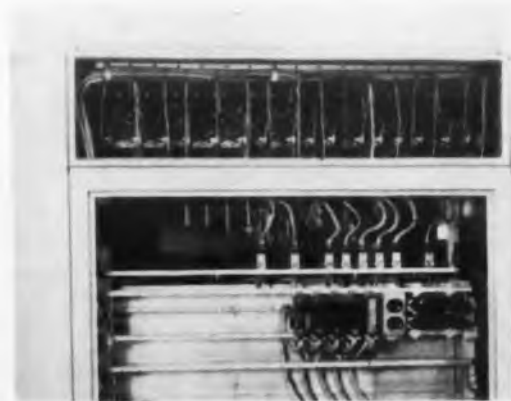

some indicator mechanism is in the way.

The dual-panel system shown in Fig. 3a is a combination of edge lighting and back-lighting and is useful where:

- Space behind image panel is severely limited.
- Image panel is predominantly dark but markings are illuminated.
- Extreme brightness is not required.

These conditions are common in military electronics and in the general run of communications equipment.

As Fig. 3a shows, the transparent image panel is coated on the back (or front) surface with an opaque material which carries the markings in negative (dropped-out) form. This coating is then backed with a high light-transmitting and uniform layer of white translucent paint. An edge-lighted panel is located immediately behind the image panel, but not adhered to it. This edge-lit panel has small areas of white paint on its back surface behind each marking or pattern to catch and diffuse the light rebounding inside the edge-lit panel. These white-painted areas should not exceed 20—30 per cent of the edge-lit panel's total surface. Long strips of markings parallel to the illuminated edge are acceptable, but 3/8-in. to 1/2-in. should be the maximum width of such strips.

#### Avoid Totally Transparent Areas

When designing back-lit image panels, totally transparent areas are generally to be avoided—to prevent glare and exposure of lamps and structures behind the panel. Accordingly, translucent paints on the backs of transparent panels are employed in combination with the opaque paints which form the images. Three variations are illustrated in Fig. 3, one in Fig. 3a and two in the upper part of Fig. 3b.

#### "Hidden Message" Technique with Backlighting

Specific segments of backlit panels are often selectively illuminated by locating lamps within their own light-proof dividers, which may be labyrinths, egg crates, etc., Fig. 3b bottom.

Annunciator panels for control systems and count-down status boards in missile

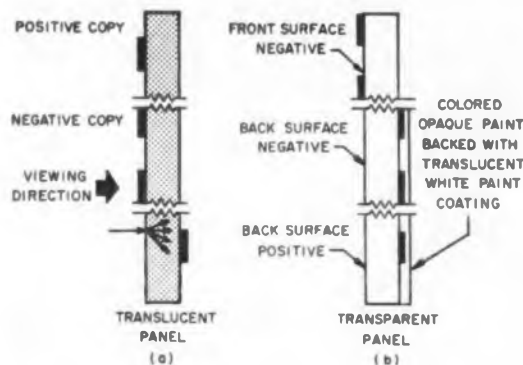

Fig. 1. Both translucent and clear panels can be used for backlighting.

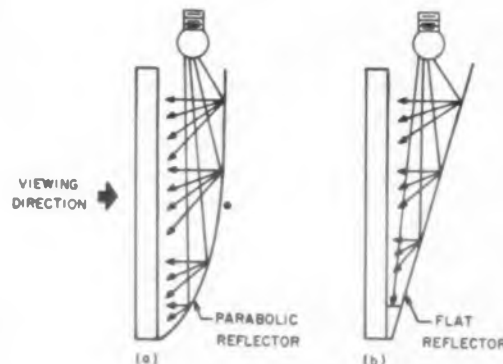

Fig. 2. Light sources for backlighting do not have to take up space directly behind the panel. They can be used in conjunction with parabolic or flat reflectors.

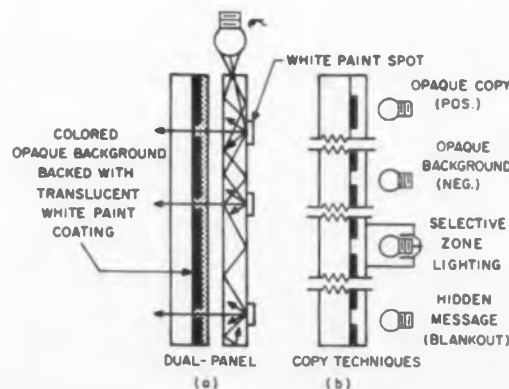
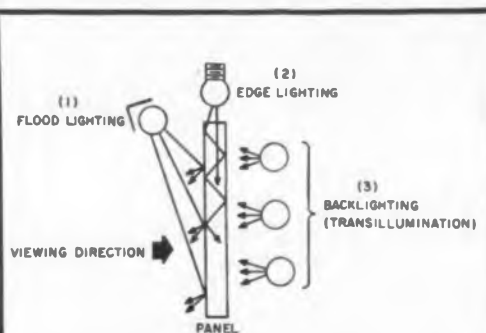

Fig. 3. Where behind-panel space is really limited, a "dual panel" combination of edge-lighting and back-lighting can be used (a). Design variations with back-lighting (b) include the useful "hidden message" technique.



#### Three Methods for Lighting Panels; Why Backlighting is Best

1. **Floodlighting:** This is the "brute force" approach. But while the designer needs no special knowledge and regular opaque panels can be used, a high contrast between the image and background is mandatory and excessive stray light and glare which may bother the operator or others in the area is difficult to eliminate.
2. **Edge-lighting:** Transparent plastic, usually acrylics, must be employed. This is excellent for low ambient light conditions, but poor for high-light conditions. A moderate amount of specialized knowledge is needed by the designer. This type of lighting is more widely used in consumer products such as home appliances than in electronic products. It does have limited application for illuminated sector dials, scales and digital readouts. (It is somewhat related to the bundles of optical fibers being developed for image transmission and light amplification.)
3. **Backlighting:** Transillumination, as it is sometimes called, is the best method for most electronic equipment because the same visual effectiveness is achieved whether the equipment is unlit during the day or lit by night. In addition, backlighting is best for illuminating elements such as control and warning devices which must appear luminous when observed under high ambient light conditions. Finally, backlighting is not too difficult for the designer to tackle. Such simple rules as the one for lamp spacing, "provide equal distances between adjacent lamps, and between lamps and control panel," can be used.

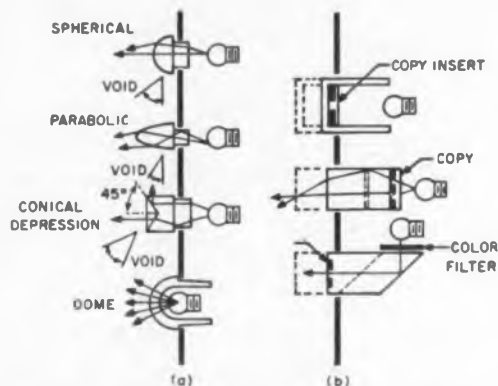

Fig. 4. On-off indicators and warning lights are familiar forms of backlighting.

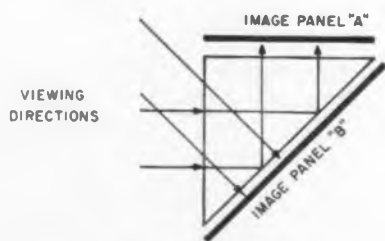

Fig. 5. The optical "tricks" possible with prisms may be important where panel frontal area is limited.

blockhouses are excellent examples of use of "hidden messages." When the copy is negative in an opaque coating which is applied behind a continuous translucent coating, a very effective "hidden message" becomes possible, since the existence of the message is not apparent until the lamp is lit. These coatings should be applied in the prescribed sequence to the front of translucent plastics or to the rear of transparent plastic panels.

#### Jewel Lights and Pushbuttons Widely Available with Built-In Backlighting

Electronic designers are commonly familiar with jewel lights as on-off indicators and as warning lights. Such lights are available in many forms, but the four shown in Fig. 4 a & b are typical of those used with transparent materials. They are easily produced in acrylic plastics, in almost any hue and in almost any desired intensity.

Transparent jewels should be designed for the emerging ray pattern which will best correspond to the viewing position of the operator. If the viewer's eye will customarily be within a narrow cone straight ahead of the jewel, a protruding spherical design will work well. If the viewer moves about more, but is commonly located between 30-60 deg off the center line of the jewel, a protruding

parabolic shape is better. If the viewer must sight along the face of the panel, a cylinder with a conical depression in the front face works best.

Finally, if the design requires equal illumination at all angles in front of the panel, the lamp should be mounted forward, projecting through the front panel surface, and should be covered with a transparent or translucent plastic dome. Dark adjacent areas, hoods and shallow wells aid in discrimination of the light when low brightness lamps must be used.

Reflector jewels or reflex lens designs are generally poor for backlighting. Fresnel patterns, radial grooves, faceting and combinations of polishing with frosting are all helpful, but require experiment with prototypes to assure that the desired optical effect is actually obtained.

Translucent plastics of high transmission value and brilliant color give excellent results as jewels, but lack the sparkle of colored fully transparent materials. Maximum brightness, of course, comes from a direct view of the lamp filament itself, and the intention of the designer should be to preserve as much of this brightness as possible.

Colors at the warm end of the spectrum (reds) are more readily discriminated under poor contrast conditions than colors at the cool end of the spectrum (blues).

#### What Type of Lighted Pushbutton to Use

If pushbuttons are to be individually lighted, they are generally designed so that the lamp is located directly behind the transparent button. Such buttons are in a sense jewels and give the brightest results when they are in the form of hollow cups over the lamps.

The selection of the physical type of pushbutton has a number of ramifications:

- Cup-shaped transparent buttons (top sketch, Fig. 4b), permit images and markings to be located on the rear surface of the frontal plane and permit changeable back-lighting inserts.
- Solid buttons which are backlit (middle sketch, Fig. 4b) require longer mechanical connections to clear the lamp during action. When of transparent materials, with copy markings located on the back face, they suffer from the "deep-well" look.
- Long translucent buttons transmit light poorly unless very thinly dispersed colorants are specified and even then the markings must be on the front to be

legible. Hence wear or damage may be a problem. Some designers have used thin diffuser disks cemented to the front of a clear button, but this is not a recommended technique.

- For long service life, the lamp should be stationary to prevent jarring of the filament every time the button is operated. Ventilation to increase lamp life as well as to prevent heat distortion of the thermoplastic acrylics can be an important design consideration.

When multibutton switch assemblies are used, the button shape and lamp position must often be planned around the switch configuration. One approach is to sidelight the buttons by means of a 45-deg facet for total internal reflection as shown in the bottom of Fig. 4b. However, the markings must be located on the front face of the button, and the long light travel restricts the merging ray pattern so that effective viewing is limited to the nearly dead-ahead position.

Another solution is to sidelight a button of slightly translucent plastic, without providing optical control facets. The effect will be that of a smoke-filled room. Light is scattered by the translucent pigment and enough of it glows out the front of the button to do the job. This eliminates the "deep well" effect.

When space behind the panel is very tight, buttons may be lighted from the light "flux" emerging from a secondary brightly lighted panel. The light-receiving surfaces of the buttons must fall in the plane of the edge-lighted panel when they are actuated. This is useful only for buttons which remain depressed during the selected function. Where there are rows of such buttons, the accommodating holes in the edge-lighted panel must be in a line parallel to the light-entering edge of that panel, or radially around a central lamp to prevent shadowing of the button that is furthest from the light source.

#### Optical Control of Visual Images

Acrylics (as well as some other plastics to varying degrees) present challenging opportunities to the electronic designer. It is practical to incorporate, without great additional cost, many optical refinements such as magnifiers, reducers, collimators, and prisms as integral elements of molded panels and panel components. Pointer scale magnifiers and reflex prisms are probably the most useful, yet they are relatively simple to design and can be worked into backlit panel designs to advantage.

## Designer Should Keep Eye Out For New Backlighting Materials, Devices

Besides the acrylics mentioned by author Blumenfeld (his company, Rohm & Haas, produces the well-known Plexiglas brand), a designer should keep his eye out for other transparent and translucent panel materials. Some which come to mind are: clear epoxies and polyesters (Mylar film) and clear silicones. There is no reason, for example, that a throw-away subsystem couldn't have its own indicating lights potted along with the rest of the electronics in one of the new clear silicones.

Lamp and indicator device manufacturers are continually developing new units which may be attractive for backlighting applications. Pushbuttons with integral indicating lamps are mentioned in the text. Others would be translucent indicator tapes and miniature readout wheels.

For example, the prism of Fig. 5, designed as an isosceles right triangle, permits two different images to appear alternately in the same frontal area of the instrument panel, either because the viewer has changed his viewing angle, or because the prism has been pivoted (as by a linkage connected to a scale-changing knob).

Viewing perpendicularly to the plane of one of the short sides (see arrows coming in horizontally from right) will cause the sight line to reflect totally at the long side, to reveal an image or scale beyond the other short side. Viewing at a slightly different angle to the short side (downward-slanted arrows from right), however, will permit copy behind the long surface (and separated from it by an air interface) to be viewed. Prisms such as these are useful for reducing clutter in panels where only small frontal areas are available for multiple scale or message observations. Common applications are for switching to different frequency bands on communications equipment and from regular to vernier scales on instruments.

In the case of molded lenses, it is generally better to design double convex, rather than plano-convex types, since molding sinks in the flat surface might cause objectionable image aberrations with plano-convex lenses.

A little attention to more attractive, more useful panels can add a lot of sales appeal. Backlighting is one of the most practical approaches for the designer in making panels more attractive and more useful. ■ ■

# How G.E. Alnico 8 permanent magnets can help you DESIGN MORE COMPACT TWT PACKAGES!

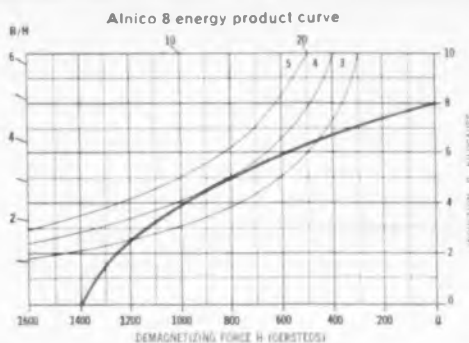

**1 HIGH ENERGY PRODUCT**—Alnico 8 by G-E, Edmore represents a significant breakthrough in permanent magnet materials. The design engineer now has at his disposal a material of high coercive force (1400), high energy product ( $4 \times 10^6$  gauss-oersted), excellent temperature stability, and economical cost.

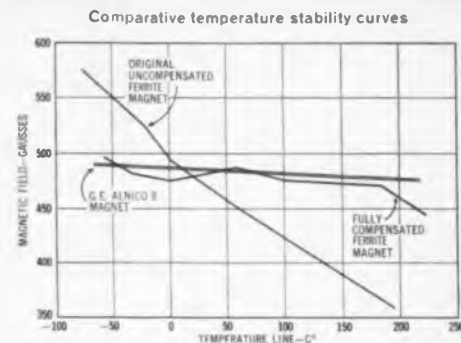

**2 LOW IRREVERSIBLE TEMPERATURE LOSS** — Only .6 of 1% from 20°C. to -193°C. Either of these factors alone will reduce the amount of "over-design" required in a permanent magnet for a given performance in a traveling wave package. Together, they can effect important economies without impairing performance.

**3 EXTREMELY LOW REVERSIBLE TEMPERATURE COEFFICIENT** — Only 0.013%/°C. This represents a stability up to 15 times greater than that of barium-ferrite materials and means that temperature compensating elements on magnet stacks can be completely eliminated.

Approximate reduction in size with Alnico 8 magnet stack

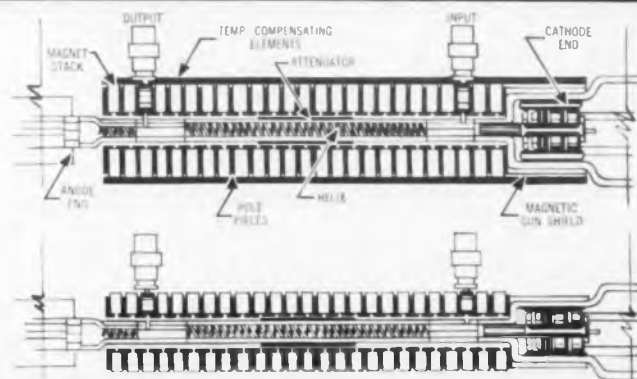

In these three ways, then, G-E Alnico 8 eliminates expensive design time for compensators, saves costs of material, fabricating and assembly — and lets you design compact, high-performance TWT packages at lower cost.

**There's more!** To see how Alnico 8 by G-E, Edmore fits your specific requirements, send for full information today. Request Product

Engineering Data 1108 and 1109. A letter or phone call will do fine. Or we would be pleased to have you visit us here:

Magnetic Materials Section, General Electric Company, 7854 N. Neff Ave., Edmore, Michigan. In Canada, contact Canadian General Electric Company, 940 Lansdowne Avenue, Toronto 4, Ontario.

MAGNETIC MATERIALS SECTION

GENERAL  ELECTRIC

MAGNETIC MATERIALS • THERMISTORS • THYRISTERS • VARISTORS

CIRCLE 44 ON READER-SERVICE CARD



# How to Evaluate DC Differential Amplifiers



*The principal features of dc differential amplifiers are much talked of, according to author William Royce, but they are little understood. Precise terms are being bandied about more and more loosely. As a result, design engineers are hard pressed to interpret manufacturers' data intelligently. In addition to the evaluation criteria he presents here, Mr. Royce gives simple tests for checking important features.*

**William G. Royce**  
Kin Tel  
Division of Cohu Electronics, Inc.  
San Diego, Calif.

**T**HE WORD "differential" is today being applied to more and more amplifiers. Most of the manufacturers' listed specifications differ so widely in terminology that a comparative evaluation of characteristics is impossible. Indeed, in some cases, the manufacturers' data sheets are so clouded with unclear terms and ambiguous qualifications and implications as to be misleading.

Consequently there is a need for a clear interpretation of all terms, a precise specification saying exactly how an amplifier is *guaranteed* to perform. Any implied, unstated, or nondefinitive specification can be ignored. It is better to have guaranteed exact limits on performance than implied or "typical" performance which may seem better. Typical performance information is very valuable, but thorough applications engineering must evaluate "worst-case" conditions.

One point in particular should be established about the specifications: do they apply simultaneously? One sometimes encounters examples of specifications which apply only for limited circumstances (not spelled out) which require modification to the standard amplifier normally supplied. For example, the bandwidth may be stated in one paragraph, and the common-mode rejection in another. Quite possibly this rejection represents a maximum, achieved only with filters that narrow the bandwidth considerably from the first value. Performance may also

vary with gain setting. If such variation is not stated, then it must be assumed there is none, and evaluation tests must therefore be considered accordingly.

## Differential Amplifiers Available In Three Basic Types

What is a "differential amplifier"? Actually, the term is now virtually meaningless. The three most commonly encountered data-amplifier types are the single-ended, the balanced, and the isolated input. Ignoring for the moment nonessential differences in detail performance, let us examine these for type distinction.

The single-ended has two input terminals, one of which is connected directly to one output terminal. The balanced-input amplifier has a three-terminal input, with one pair balanced (i.e., symmetrical) to the third or common terminal. The isolated-input amplifier has a pair of input terminals not connected, except for leakages, to the output terminals. In general, the input system of the isolated-input amplifier is shielded and the shield connection is brought out as a third terminal along with the signal pair.

## Three Types Distinguished By Common-Mode Rejection

Operationally, these three types are distinguished by their relative ability to disregard an unwanted, interfering signal, appearing between the input and output terminals. This unwanted signal is termed "common-mode voltage" because it is common to all input leads and signal sources. Ideally, an

amplifier would respond only to the signal applied to the input terminals and would neither connect this signal source to any other terminals nor respond to an extraneous voltage appearing between the desired signal source and other terminals.

Obviously, the single-ended amplifier does not meet these requirements at all with its direct connection to an output terminal. The balanced input, though not nearly meeting the ideal, can be used in limited applications to achieve some rejection of the spurious voltages. The isolated-input amplifiers now available are approaching the ideal in their ability to reject the spurious signal under general conditions.

In systems having only one "ground" point, the single-ended amplifier may generally be used. Typical of this type of system is an isolated, strain-gage bridge, excited by an isolated supply as a source, permitting a single ground near the amplifier regardless of the load. Because it generally has greater simplicity, reliability, and better performance, the single-ended amplifier is the preferred type if the system permits its use.

Systems having, of necessity, more than one ground connection seldom work satisfactorily with the single-ended amplifier. Such a system is typified by a bonded thermocouple source far from the amplifier, with the amplifier driving a grounded load. Multiple ground points never have the same potential; indeed, they may differ by volts. Sampling a portion of this difference will degrade the desired signal materially—even masking it completely in severe cases. For these sys-

tems, only the balanced or isolated-input amplifier is practical.

### Balanced Input Amplifier Cancels Common-Mode Voltage

The balanced-input amplifier represents a bridge technique for canceling out the common-mode voltage (CMV). As with any practical ac bridge, there is a maximum dependable degree of balance. A data system deployed over hundreds of feet of distance, with varying temperature and other disturbances is a very difficult bridge to maintain balanced. Common-mode rejection (CMR) is the attenuation factor for the common-mode voltage, usually expressed in db. Under favorable conditions, the CMR may run 30 to 40 db.

The factors contributing to balance difficulties are resistive unbalance at the source, capacitive line and connector unbalance, and limitations inherent in the amplifier with gain switching, time, and temperature. There is also a limit on the maximum magnitude of CMV which may be applied. In some cases this may be well below the typical CMV present in a system.

For most systems, dependence on a questionable balance to reject typically large common-mode voltages is quite undesirable. This is not to say that the balanced-input amplified is not useful. There are systems having very low common-mode voltages and relatively invariant signal sources. Here the practical CMR is adequate without resorting to the more complex isolated-input amplifier.

### Isolated-Input Amplifier Offers Systems Flexibility

It is for the more general case involving varying source-impedance balance and rather large common-mode voltages that the iso-

lated-input amplifier is intended. Although more complex and costly, it offers very great flexibility in system usage. In effect, the isolation and shielding of the input allow one to do electrically what is not possible physically—locate the amplifier input at the source and the output at the load.

It is for this type of amplifier that we shall outline a few simple tests which most quickly show its application possibilities. Certainly, before final acceptance of a chosen amplifier, its full compliance with specifications should be demonstrated. These full tests, however, can be lengthy. If an amplifier shows poor performance on the quick tests, then the full tests may be neglected.

No comparison of chopper-stabilized and straight-carrier or direct-coupled amplifiers is made here, principally because only chopper-stabilized or straight-carrier types are capable of the low dc drift required of modern systems, and secondly, because the direct-coupled amplifier (for example, an oscilloscope preamplifier) is not capable of isolated-input operation.

### Tests for Common-Mode Rejection

The single unique feature of a "differential" amplifier is its ability to reject a common-mode voltage. The most troublesome CMV is usually at 60 cps, the power line frequency. Typically, the rejection for dc is greater than for 60 cps, and lower for higher frequencies. The common-mode rejection is most often defined as the ratio of applied CMV to the equivalent normal-mode signal it produces; that is:

$$CMR = \frac{CMV}{E_{q. Input}} = \frac{CMV}{E_o/A} = \frac{A(CMV)}{E_o}$$

where  $A$  = differential gain of the amplifier

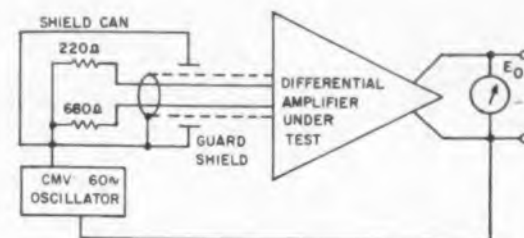

Fig. 1. Set-up for measuring common-mode rejection with unbalanced input.

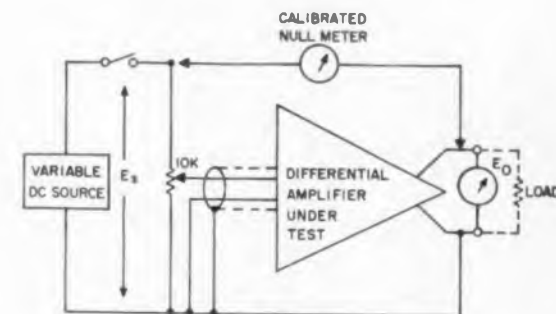

Fig. 2. Set-up for measuring dc linearity and gain.

and  $E_o$  = amplifier output resulting from CMV.

In Fig. 1 we have a set-up simulating an unbalanced source. This test should be made first as shown, then again with the input leads reversed; i.e., the 680-ohm and 220-ohm resistors interchanged. A good value of CMR at 60 cps in this test is 130 db (3 million: 1) for either lead unbalanced. Although 130 db CMR at 60 cps is seldom needed, the corresponding rejection at higher frequencies (e.g., 120 cps or 400 cps) is very helpful. (Typically, CMR will drop at a 6 db per octave rate.)

As a second set of tests, repeat these tests using a 10-K resistor instead of the 680 ohms, retaining the 220 ohms. Again, test first one way then with the input leads reversed. This test gives as great an unbalance as is generally encountered with normalizing potentiometers on the input lines. For this test, a CMR of 120 db at 60 cps is excellent.

### Test for Linearity

With the set-up of Fig. 2, one can determine the dc linearity and gain. Actually, the dc-gain accuracy is seldom very important since the amplifier may incorporate variable-gain controls or system gain may be controlled at several points. The linearity, or constancy of gain vs signal level and polarity,

### Relative Merits of Differential-Amplifier Types

Amplifier Classification	No. of Input Terminals	Relative Cost & Complexity	Allowable System Ground Points	Practical Common-Mode Rejection (CMR)	Relative Sensitivity of CMR to System Variations	Common-Allowable Mode Voltage (CMV)
Single-ended	2	Lowest	1	None	—	None
Balanced-differ	3	Medium	2	30-40 db from dc to 60 cps	High	Low
Isolated Input	2	High	2	100 db at dc 30-60 at 60 cps	Low	High at dc Low at 60 cps
Shielded & Isola	2 signal 1 shield	Highest	2	180 db at dc 130 db at 60 cps	Very low	High at dc and 60 cps



*New Zener-like characteristic of the improved Vickers Captivolt lets you build maximum surge protection into your silicon rectifier circuits... eliminates costly de-rating*

The improved Captivolt responds faster to destructive voltage surges (see graph), provides greater rectifier reliability, and lengthens rectifier life better than any other protective device. *Better* for one very good reason: the Captivolt is produced by a unique process developed specifically to give the device its Zener-like characteristic.

Now check this: because the protective capability of the Captivolt lets you end expensive de-rating, you can often save more than \$50 in initial rectifier cost by using a Captivolt that costs less than three dollars. And you can get immediate delivery of the improved Captivolt in production quantities. There are 10 standard Captivolts in a range from 25 through 600 rated peak volts.

Get the whole Captivolt story. Write for Bulletin 3506-1. Then the next time you need to control transient high voltages (even in other circuits such as transistors, controlled rectifiers, meters, solenoids, relays, etc.) specify Vickers Captivolts.

*For those extremely rugged rectifier applications, top quality Vickers Selenium Rectifiers with built-in surge protection are available from stock.*

**VICKERS INCORPORATED**  
*Division of Sperry Rand Corporation*  
**ELECTRIC PRODUCTS DIVISION**

1841 LOCUST STREET • SAINT LOUIS 3, MISSOURI  
 CIRCLE 45 ON READER-SERVICE CARD

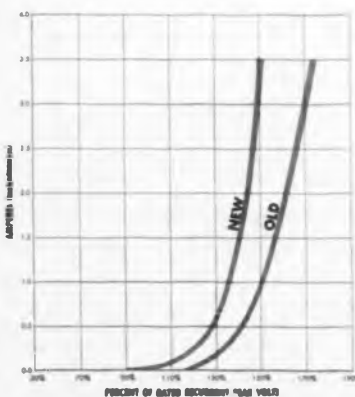

IMPROVED PERFORMANCE CHARACTERISTICS OF THE NEW VICKERS CAPTI VOLT

is quite important since no adjustment for nonlinearity is practical. Good linearity, particularly for a change of polarity, is difficult to achieve in isolated-input amplifiers.

To make the test, choose a moderately low gain setting and with  $E_s$  disconnected, adjust the amplifier zero control to give a zero reading on the null detector. Set the divider to a value equal to the reciprocal of the amplifier gain. Connect  $E_s$ , and set to a value approximately equal to the amplifier's rated output. Adjust the divider to give zero on the null meter. Now, without changing any adjustment, vary the supply voltage and polarity, observing the null meter reading. Dividing the error by the full-scale output will give the nonlinearity as a fraction of full scale (the commonly used rating). The effects of loading can also be readily observed on the null meter (which should have a minimum sensitivity of  $\pm 10$  mv).

A particularly bad effect arising from poor plus-to-minus linearity is the addition of the dc component to the output, due to the even-ordered distortion. Thus, if the amplifier is required to handle large ac signals—whether or not the output load responds to them—the resulting zero shift may be large enough to cause a serious error in the low-frequency data.

### Test for DC Shift

A simple test for the dc shift is shown in Fig. 3. The sine-wave signal is applied through a capacitor to eliminate possible dc output from it. The output signal is averaged by a low-pass filter. After a few seconds of operation, the dc level at the filter output is a measure of the distortion. Choose a low to medium gain setting, adjusting the amplifier to zero dc output before applying the sine-wave input. The scope is used to monitor the ac output. Choose a frequency of, say, one-half the bandwidth, and set the input to give an output equal to the maximum rating for the particular frequency.

### Test for Noise

As with common-mode rejection and linearity, there is no practical adjustment to compensate for noise. In practice, the over-all noise also depends on the CMR, but a separate determination of amplifier noise sets a minimum level. The most significant way to measure noise is to simulate a typical source with a shielded resistor, set the amplifier at the maximum anticipated gain, and load the output with the output device normally used (e.g., oscillograph, meter, A/D converter). If

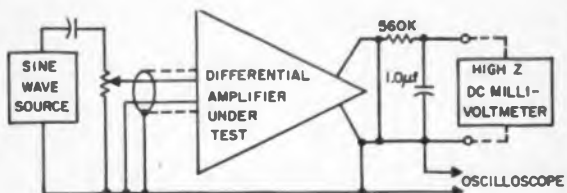

Fig. 3. Set-up for measuring dc drift.

the output device is not available, insert a low-pass filter (simple one-section  $RC$ ) between the output and a suitable scope or meter. The filter should have a bandwidth approximating that of the typical load device which is likely to be used.

### No "Ideal" Amplifier Serves All Applications

Consider the application carefully in choosing an amplifier, as there is no "ideal" type. The balanced or isolated-input types increase the connection possibilities greatly, but also increase cost and complexity. There are other factors to be considered, also. Among these are general flexibility, performance in up-graded systems at a later date, and completeness of a unit. This latter concerns such matters as self-contained vs group power supplies, and internal vs external means of achieving common-mode rejection.

The use of a single power supply for several amplifiers has only two significant advantages: less crowding of the amplifier package, and fewer over-all components. There are several disadvantages:

The module wiring is considerably more complex, lowering the reliability. There is an increased need for the power supply to perform well, since its failure may cause all channels to be lost. Common power supply and wiring impedances can lead to crosstalk, ground loops, or even instability depending on the quantity of amplifiers and individual operating conditions. There is no chance to "float" individual channel outputs.

System performance or power-supply reliability may depend on the number of channels loading the supply. Maintenance and calibration is more difficult and questionable since the amplifiers are not tested with the supply normally used, nor the supply with the load normally used.

After choosing an amplifier type and possible suppliers, perform the suggested test which simulates system requirements. If these tests are insufficient to pick a single unit as preferred, then run full tests and compare performance and *guaranteed* specs. ■ ■

# CORROSION-FREE RUST-FREE DRYING

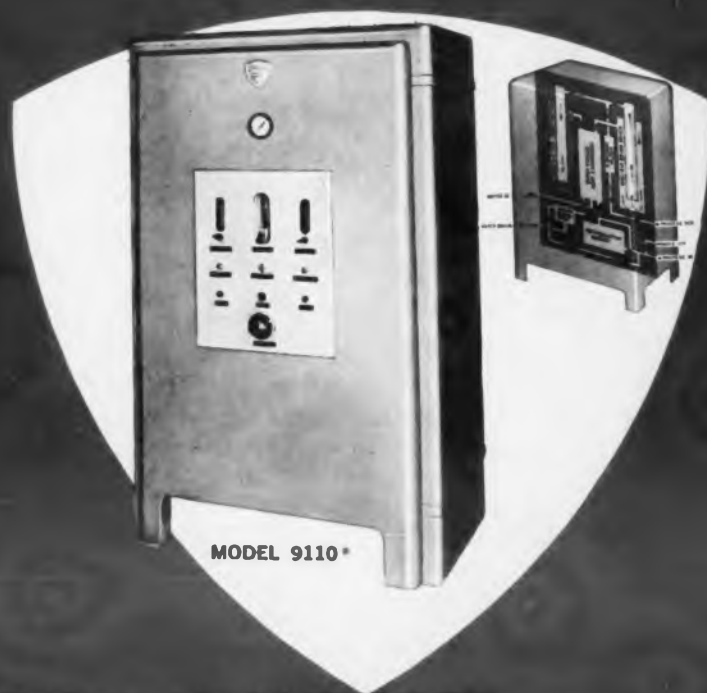

## NEW TEMPCOR ALL-ALUMINUM CONSTRUCTION FOR THE FIRST AND ONLY ABSOLUTELY CLEAN

## AUTOMATIC RECYCULATING DRYER

MODEL 9110\*

- For continuous operation at 2000 ACFT at 1000 lbs. dry weight
- For operation and maintenance ... 2 hours per month ... 2000 lbs. dry weight
- See sheet of 10 test requirements to meet with minimum ... completely automatic gas drying

- Even feed, automatic drying
- Double-walled drum
- 1000 F.O.E. (1000 lbs. dry weight)
- Other recirculating and drying units with other sizes from 100 to 1000

Manufacturers of Custom-designed and Production Equipment  
for Constant Temperature, Vacuum and Controlled Atmosphere



TEMPCOR ENGINEERING  
CORPORATION

1000 F.O.E. (1000 lbs. dry weight)

BE SURE TO STOP AT BOOTH #4922 . . . WESCON . . . AUGUST 22-25 . . . SAN FRANCISCO

CIRCLE 46 ON READER-SERVICE CARD

# How to Choose Modifiers for Epoxy

*Two previous articles by Mr. Harper (ED, May 10 and July 19) have outlined the basic epoxies and their many curing compounds. In this final article, author Harper tells of the modifiers, fillers and special formulations, such as flexible resins, which round out his presentation of the very large range of possibilities for this versatile electronic material.*

## Charles A. Harper

Air Arm Div.  
Westinghouse Electric Corp.  
Baltimore, Md.

**T**HE DESIGNER who wishes to use the many remarkable qualities of epoxy resins has not only the handful of basic resins and the large number of curing agents listed in the first parts of this series to choose from, he has, in addition, many varieties of *modifiers* for epoxies.

These modifiers are classed as *flexibilizers*, *diluents*, *fillers* and *colorants*.

### Epoxy-Polysulfide Blends For High Impact Strength and Crack-Resistance

Polysulfide flexibilizers such as Thiokol LP-3 are capable of reacting with epoxy resins to produce resilient and flexible high-impact, crack-resistant, cured epoxy-polysulfide end products. Epoxies and polysulfides can be reacted in widely varying proportions to yield considerably varied end properties. An aliphatic amine catalyst is also used in the reaction. Several properties of various epoxy-polysulfide blends are given in Table 1. Note how the properties vary according to the percentage of polysulfide modifier. Polysulfides in an epoxy formulation can easily be detected by a sulfur-like odor. Compound formulators market these compounds as two- or three-package systems.

### Epoxy-Polyamide Blends Provide Range of Flexibility

Polyamide resin flexibilizers of the type marketed by General Mills under the trade name of Versamid represent another type of flexible resin material which is reactive

with epoxy resins and can be blended with rigid epoxy to provide varying degrees of flexibility, again depending upon the blending ratio. One practical difference between the use of polysulfide resins and polyamide resins for blending with epoxies is that the polyamide resins have amine groups in their chemical structure. As this amine group serves as a curing agent for the epoxy resin, chemical reaction starts as soon as the epoxy and the polyamide are blended together.

The commonly used polyamides are Versamid 115 and Versamid 125. Versamid 115

has a viscosity in the range of 80,000 to 120,000 centipoises at 40 C. Versamid 125 has a viscosity of 40,000 to 60,000 centipoises at 25 C. These viscosities are quite a bit higher than the 5,000 to 19,000 values of conventional epoxies and could prove troublesome in potting operations where the epoxy should be able to flow around closely spaced parts. The gain in flexibility must be balanced against the loss of workability. Heating will reduce the viscosity of Versamid modified resin systems, however.

*(continued on p 56)*

Table 1. Properties of Epoxy-Polysulfide Blends

	LP-3 Polysulfide	Polysulfide/Epoxy Blends				Epoxy Resin
		3/1	2/1	1/1	1/2	
Elongation, %	200	100	50	30	10	—
Hardness, Shore A	35	50	70	95	98	100
Volume Shrinkage, %	5	2.5	2.8	3.5	4.5	6
Dielectric Constant (at 10 <sup>6</sup> cps)	7.5	6.5	5.5	4.0	3.8	3.5
Volume Resistivity, meg/cm	10 <sup>1</sup>	10 <sup>1</sup>	10 <sup>2</sup>	10 <sup>3</sup>	10 <sup>4</sup>	10 <sup>5</sup>

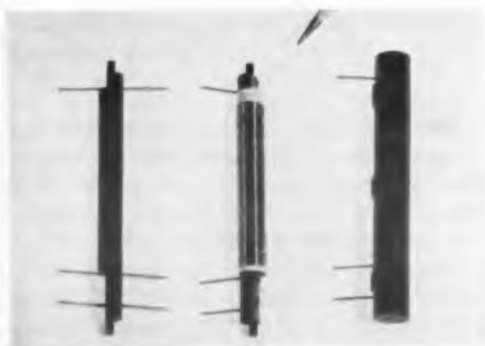

**Delay line** (above) in which both coil bobbin and final encapsulation were machine-molded from dry epoxy powders. Motor stator (below) illustrates a more complex part made by machine-molding.

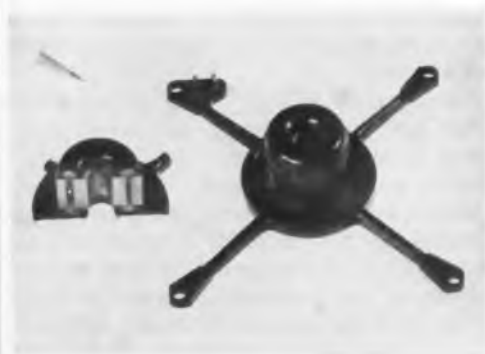

## Machine-Moulding With Epoxies

Most electronic designers think of epoxies mainly for hand operations—hand pouring (potting), hand dipping, or hand lay-up (laminating). These hand operations require little, if any, tooling or capital equipment and thus fit in ideally with short production runs.

However, at least one epoxy formulator claims that machine-molding with epoxy in dry powder form should also be considered by electronic designers, even for relatively short runs.

Paul S. Byrd of the American-Marietta Co., Newark, Ohio, explains that because his company's EMC molding powders become "watery-thin" in the molding operation, they are able to "soft flow" into the molding cavities at moderate temperatures and pressures. This means that inexpensive molds of aluminum, kirksite, copper, or even epoxy, can be used for short production runs, he said. In addition, for electronic applications, the "soft" transfer flow and moderate mold temperatures (300 F) do not disturb the placement or properties of delicate parts. (In this latter respect it may encourage new packaging schemes, he said.)

The main benefit of epoxy machine molding is the possibility of high production rates (each mold cycle takes only 15 sec to 1-1/2 min), he said. The closer manufacturing tolerances usually associated with machine molding can also be an advantage in some applications.

Mr. Byrd believes that in some cases epoxy molding powders can compete with Diallyl Phthalates. He said that epoxies have shorter molding cycles than DAP and that they can be machined after molding without destroying their surface properties. Machining after molding might be important for finishing potentiometers, motor parts or slip ring assemblies where an embedded conductor must be exposed for a moving electrical contact.

## How to Choose Modifiers for Epoxy (continued)

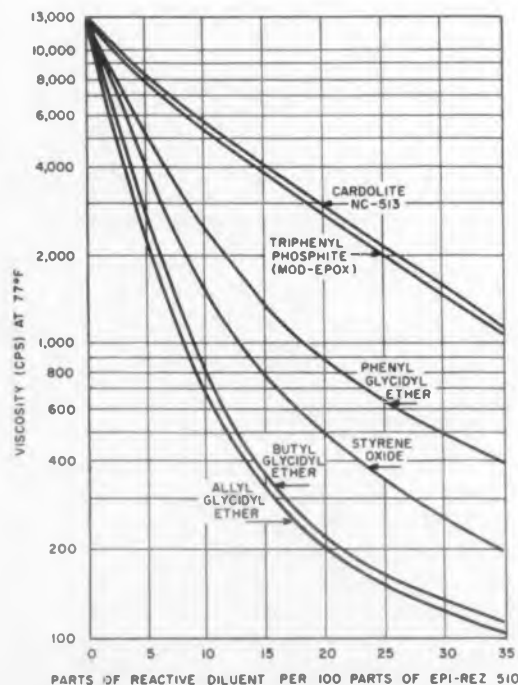

Fig. 1. Effects of various reactive diluents on the viscosity of a basic epoxy resin (Epi-Rez 510).

### Protect Proprietary Designs With Epoxy

An unpublicized use for epoxy is in potting proprietary circuit designs. Would-be imitators will have a hard time breaking apart the rugged epoxy encasement without pulverizing the circuit.

Sounds crude? One electronic engineer says this is the main reason he favors epoxy potting for commercial as well as military products. Of course the epoxy must be pigmented, not clear.

Table 2. Properties of Epoxy-Polyamide Blends

Composition	Ratio	Barcol Hardness	Heat Distortion Temp. F*
Versamid 125: Bakelite ERL 2795	40:60	60-65	122
Versamid 125: Araldite 502	30:70	55-65	122
Versamid 125: Araldite 6010	30:70	65-75	132
Versamid 125: Epon 815	35:65	65-70	144

\*ASTM D648 (264 psi)

Epoxy compound formulators market epoxy-polyamides as two-package systems. The polyamide can be identified by its distinctive amine (fishy) odor and its viscosity.

Flexible epoxy adhesives are also based on polyamide blends in many instances. Data on several epoxy-polysulfide blends is given in Table 2.

Several other flexibilizing materials which are reactive with epoxy systems are: trimer acids, Cardolite NC-513, and Lancaster A. Trimer acids are flexibilizing curing agents, Cardolite is an epoxide type modifier (requiring one of the epoxy curing agents for its cure), and Lancaster A is a reactive modifying agent.

There are numerous other acid or modified acid flexibilizing curing agents. Also, there are numerous unmodified flexible epoxy resins, such as Jones-Daney Epi-Rez 507.

#### Diluents Lower Viscosities and Cost

Diluents are used with higher viscosity resins primarily to reduce the viscosity for improved working and handling properties. Lower viscosities improve the ability of the resin to impregnate glass reinforcing cloth when the resin is being used for laminating and the ability of the resin to completely fill all voids when used for potting electronic components.

Another reason for adding diluents would be to permit a higher concentration of filler into the compound. The effects of diluents and the fillers can be combined to reduce the cost of embedment compounds.

Both reactive and nonreactive diluents have been proposed for use with epoxies. A reactive diluent is normally desired since it is considered less apt to degrade the cured resin properties. Nonreactive diluents, such as xylene, are used, however, in low concentrations (under 5 to 10 per cent) without degrading the resin so far as electronic packaging uses are concerned. Nevertheless, it is generally conceded that most diluents will to some degree affect the properties of the final cured resin.

A prime consideration for diluents is that they give the maximum viscosity reduction with minimum diluent addition. This will assure better retention of the original epoxy's properties. Fig. 1 shows the effect of several reactive diluents on viscosity. Compatibility of the diluent with the resin and ability of the resulting mixture to wet the fillers are also important considerations.

#### Thin Epoxies Their Own Best Diluent

The most effective reactive diluents are the low viscosity epoxy compounds. Most basic epoxy suppliers also market low viscosity

### Titles and Dates for Epoxy Series

1. What the Electronic Engineer Should Know About Epoxies  
..... May 10, page 30
2. How to Choose a Curing Agent for Epoxy  
..... July 19, page 52
3. How to Choose Modifiers for Epoxy  
..... This article ...

resins. They give maximum viscosity reduction, good filler wetting and penetration, and minimum degradation of the properties of the original high-viscosity epoxy. Consequently, formulations involving combinations of high and low viscosity epoxy resins are quite common.

#### Fillers and Colorants Improve Properties and Appearances

Fillers and colorants are the nonreactive parts of an epoxy system. However this does not mean that they cannot have significant effects upon the final product. Fillers are added for improved crack resistance, improved mechanical properties, increased thermal conductivity, reduced exothermic temperatures, better flame retardancy, and reduced cost of the resin compound. Some general purpose fillers in use are silica, mica and calcium carbonate. Special hollow or spheroid fillers are also used to reduce compound density. Metallic fillers are often used for epoxy tooling compounds. Antimony trioxide is often used as a flame-retardant filler.

Colorants, as the name implies, are used to add color to resin systems. Most formulated systems incorporate some colorant. The wide range of colors possible, from clear epoxies to bright hues, can be used to advantage by the designer in color-coding equipment.

#### Full Use of Epoxy Qualities Has Not Been Achieved

In the three articles of this series, we have shown the whole picture of this ideal electronic material. It is now up to the designer, knowing something about the breadth of obtainable variations, to ask himself where and how he can put the material to work in his designs. The new formulations, the new design approaches which are constantly appearing should keep him busy. ■ ■

#### Acknowledgment

Table 1: Thiokol Chemical Corp.  
Table 2: General Mills, Inc.  
Fig. 1: Jones-Dabney Co.

Nowhere is this closeness more apparent than at Lockheed. Here, with each passing day, new technological advances help bring nearer the exploration of Mars, the Moon and Venus.

As the time grows shorter, the pace grows faster. New designs in Spacecraft and Aircraft are rapidly being developed—and the number continues to mount. Included are: Missiles; satellites; hypersonic and supersonic aircraft; V/STOL; and manned spacecraft.

For Lockheed, this accelerated program creates pressing need for additional Scientists and Engineers. For those who qualify, it spells unprecedented opportunity. Notable among current openings are: Aerodynamics engineers; thermody-

namics engineers; dynamics engineers; electronic research engineers; servosystem engineers; electronic systems engineers; theoretical physicists; infrared physicists; hydrodynamicists; ocean systems scientists; physio-psychological research specialists; electrical—electronic design engineers; stress engineers; and instrumentation engineers.

**Scientists and Engineers** are cordially invited to write: Mr. E. W. Des Lauriers, Manager Professional Placement Staff, Dept. 1304, 2407 N. Hollywood Way, Burbank, California. All qualified applicants will receive consideration for employment without regard to race, creed, color, or national origin. U.S. citizenship or existing Department of Defense industrial security clearance required.

**LOCKHEED**  
CALIFORNIA DIVISION



Reading clockwise: Venus, Moon, Mars. Approximate distance from Venus to Earth, 25,000,000 miles; from Moon, 240,000 miles; from Mars, 50,000,000 miles.

Photos courtesy of Mount Wilson and Palomar Observatories.



# AMCO 1000 G's CERTIFIED SHOCK TESTS

## Amco Aluminum and Semi-Custom Modular Frames qualify for Airborne, Shipboard and Ground Support Applications

Certified Independent Tests prove Amco Aluminum and Semi-Custom Frames withstand shock & vibration under Mil E-5272C; Procedure XI (5-500cps), Procedure III (approx. 1000g's shock Mil-S901), Procedure II (15g's and drop Mil-S4456). Write for Test Report Supplement E.



Aluminum

**ALUMINUM . . . Unique! Meets any size . . .** Flush or recessed mounting of panels. Almost any shape from 13 basic parts . . . 3 castings & 10 extrusions. Units from 6" to 20 ft.; slopes from 0° to 90° standard. MilSpecs 6062-T6 extrusions and 356-T6 castings.

**SEMI-CUSTOM . . . Heavy-duty, more internal clearance . . .** 14 ga. box-channel steel frames, 12 ga. gusseting provides exceptional rigidity both front-to-back and side-to-side. Frames based on 22 $\frac{1}{16}$ " increments provides clearance for recessing 19" wide panels. Meets EIA Standards.



Semi-Custom

**CUSTOM . . . When space and appearance are critical . . .** 16 ga. double-channel steel frames, based on increments of 19 $\frac{1}{16}$ " widths, supports in excess of 3000 lbs. Multi-width panels and cowlings give single-unit appearance with series mounted racks. Meets EIA Standards.

Amco manufactures all necessary blowers, chassis slides, doors and drawers, writing surfaces, cowling lights and other accessories. **Check the extra savings you get thru Amco's combined-discount system of racks and accessories. PLUS FREE ASSEMBLY.**

Amco is your one complete source of Modular Instrument Enclosure Systems and Accessories. Write today for catalog of complete specifications.



Custom



REALISTIC 3 WEEK DELIVERY

Factory trained representatives in principal cities of U.S. and in Canada.



**AMCO ENGINEERING CO.**

7333 West Ainslie Street, Chicago 31, Illinois



CIRCLE 48 ON READER-SERVICE CARD

## A New Concept In DC Power Supplies

**A** 2-KW regulated power supply, utilizing a "lossless" regulation technique, can now be housed in a standard 7-in. high panel. This development promises to revolutionize the design and manufacture of dc power supplies for a variety of electronic applications, from computers to navigational equipment.

The new concept has been pioneered by the Electronic Energy Conversion Corp., located in Bethpage, L.I., N. Y. The key to the Convertron's drastic reduction in size and weight is a unique circuit developed by Dr. Victor Wouk, president of the firm.

Power supplies of 2 kw and over usually weigh 200 lb and more and are extremely bulky. This is due primarily to the size and weight of the input transformer. As the power level of the supply goes beyond the 2-kw range, the transformer increases sharply in volume to accommodate the increase in power capacity. Additionally, heating effects pose many problems from the standpoint of materials of construction and installation geometry.

Another disadvantage of existing

power supplies is a necessary loss in efficiency to gain voltage regulation. The regulation is normally accomplished through the use of an impedance or power dissipating network. At high power levels, a small change in voltage can mean a considerable loss of power in the impedance network.

In the Convertron the 115-v ac input power is converted immediately to dc with a full-wave bridge rectifier. The dc is then fed to silicon-controlled-rectifier switches which chop the dc into a 1,200-cps rectangular waveshape. The high-frequency wave is then fed to a transformer to increase or decrease the voltage to meet application requirements. By stepping up the frequency of the input power to 1,200 cps, the size and weight of the transformer is greatly reduced over comparable units of equal power-handling capacity.

The Convertron's circuitry allows voltage regulation without the penalty of power loss. The voltage range of the dc output is determined by the "on" time of the SCR switches; increasing it raises the voltage lev-

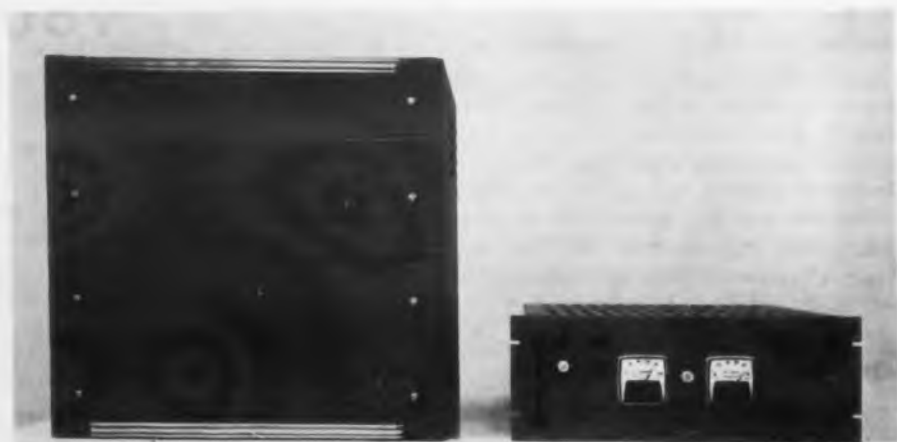

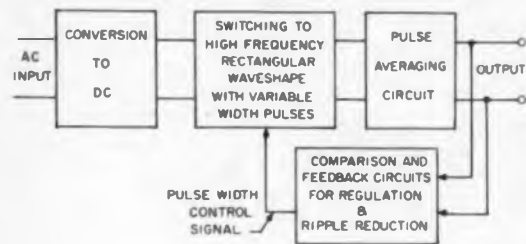

el of the pulse averaging circuit. The pulse averaging circuit consists basically of inductive and capacitive elements. This is a deviation from the conventional techniques which utilize dissipative elements to produce the desired output voltage. The pulse width is also used to control ripple. The dc output voltage is compared with a standard voltage reference and the error signal is used to control the pulse width of the SCR switching network. Using this technique, units now being tested are capable of regulation accuracy of one per cent. The company has plans to substantially increase the regulation of the output beyond this figure, according to Dr. Wouk.

The SCR switching technique results in improved efficiency because there is very little voltage drop when the SCR's are "on" and therefore low power loss. When the SCR's are "off" there is negligible current flow and therefore negligible power loss. If the line voltage to the unit is increased the amperage drawn from the line is actually decreased.

The unit has been designed for application as a supply for computers, industrial and electronic apparatus, navigational equipment test systems and other areas where a demand exists for a dc current of more than 2 kw.

In a prototype model to be shown at WESCON the nominal output can be specified from 10 to 500 v, with adjustability above and below the rated output voltage. The 2-kw unit weighs approximately 80 lb and measures 7 x 19 in. on the panel face. It is priced from \$1,500 and is available with a four-month delivery.

For more information on this dc power supply turn to the Reader-Service Card and circle 251.

See at Show Booth 802-04.

## Westinghouse announces new *VOLTRAP* surge suppressor

The Westinghouse VOLTRAP is a unique voltage limiting device which has been designed and constructed for the sole purpose of providing a shunt path for transient overvoltages. It provides positive protection, year after year for all static devices such as silicon and germanium cells and silicon controlled rectifier cells.

Westinghouse now offers a complete line of VOLTRAP surge suppressors. Most units are available for quick shipment.

### Ratings:

A-c rms voltage ratings in 30 volt steps: 30 to 480 volts.

Clamping range: 75 to 1360 volts peak.

Max. discharge current range: 2 to 80 amps.

Polarized and non-polarized units available in all common rectifier circuit connections from 1 to 6 circuit elements.

Suitable for operation in ambient to 50°C.

Special units can be constructed to meet specific requirements.

VOLTRAP has these exclusive advantages.

- Special open construction provides free air circulation for most effective cooling and longer life.
- Use of spring washer against alloy creates wide air gap to practically eliminate possibility of shorts due to overloads.
- No aging problem when operated within its rated value.

VOLTRAP improves greatly the reliability of static device circuitry, and permits the use of lower PRV silicon cells. No other surge protection needed.

Protect your static circuits with exclusive Westinghouse VOLTRAP. Your local Westinghouse sales engineer has complete circuitry and pricing information. Or, write Westinghouse Electric Corporation, General Purpose Control Department, P.O. Box 2025, Buffalo 5, New York.

*You can be sure . . . if it's Westinghouse.*

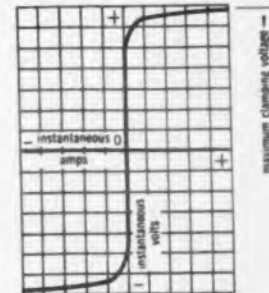

**HOW IT WORKS:** At normal RMS voltage Voltrap power loss is insignificant. As indicated in the graph, when a voltage surge occurs, VOLTRAP provides a shunt path which permits a current flow of as much as 1000 times the steady state current while limiting the PRV to a value between 2.5 to 2.8 times the RMS voltage.

Once a surge is discharged, the unit returns to its steady state condition, drawing only a small current from the line.

The practically ideal voltage clamping characteristic of Voltrap provides effective, positive protection for static devices.



Westinghouse



J-25006

To: Westinghouse Electric Corporation  
General Purpose Control Dept., P.O. Box 2025, Buffalo, N. Y.

- Please send me your Technical Data 19-160 on Voltrap.
- Please have a Westinghouse electronics engineer call for an appointment.

Name \_\_\_\_\_

Address \_\_\_\_\_

Company \_\_\_\_\_

City \_\_\_\_\_ State \_\_\_\_\_

CIRCLE 49 ON READER-SERVICE CARD

...variations  
on a  
theme

POWER



BR-12P (case removed)

In one versatile new BR-12 micro-miniature series, Babcock offers relay types suitable to a wide range of novel uses in extreme environments.

The BR-12P is an especial boon to those designing for both sides of the component card due to low profile and side header mounting arrangement. A second type, the BR-12K, provides sensitivity down to 20 mw. Both types have contacts rated at dry circuit through 3 amps resistive.

Performance characteristics are generally shared with other types in the BR-12 Series. All are available with activated getter material, providing lifetime prevention of contamination effects at dry circuit to rated current on contacts.

You are invited to request complete technical data.



BR-12



BR-12K

PERFORMANCE  
CHARACTERISTICS - BR-12 SERIES

Contact Rating: 3 amps resistive  $\vee$  32 VDC Standard  
Vibration: Minimum 30g to 3000 cps.  
to 50g on special units.

Shock: Standard, 75g or special, 125g.

Temperature:  $-65^{\circ}\text{C}$  to  $+125^{\circ}\text{C}$

Note: All Babcock Relays are checked out for  
leakage rate of 10<sup>-6</sup> cc per second  
on mass spectrometer

BABCOCK RELAYS, INC.

1645 Babcock Avenue  
Costa Mesa, California

CIRCLE 50 ON READER-SERVICE CARD



PRODUCT FEATURE AT WESCON

## Inexpensive Paper Capacitor Is Moisture-Resistant

**P**APER tubular capacitors, housed in a three-layer cardboard casing, offer characteristics approaching those of molded capacitors. Use of a solid resin impregnant and a rugged, wax-free case results in a moisture-resistant, high-temperature component at very low cost.

Made by Cornell-Dubilier Electronics Div., Federal Pacific Electric Co., Sanford, N. C., the Jaguar series type PTL capacitor is available in voltage

ratings up to 1.6 kv, capacitances from 0.001 to 1.0  $\mu$ f. Case construction is glossy black kraft paper wound against polyester film and aluminum foil. Accidental contact with a soldering iron will not affect the case. The capacitors will withstand a moisture resistance test of more than 48 hours at 95 to 100 per cent relative humidity, temperature 75 C. Original insulation resistance is 10,000 meg- $\mu$ f at 25 C, 100 meg- $\mu$ f at 100

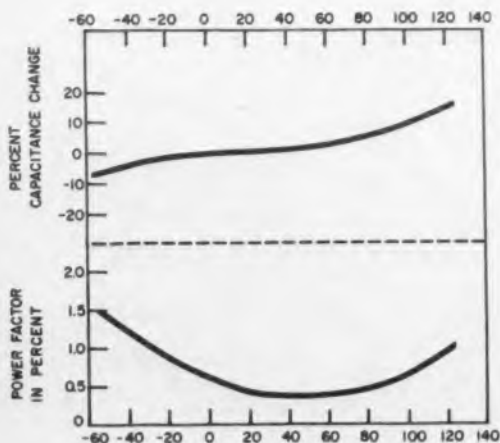

Capacitance change and power factor of the PTL Jaguar cardboard tubular capacitor are plotted in relation to temperature. All measurements are made at 1 kc.

## General Instrument Planar Transistors

C; four hours after moisture testing, insulation resistance is not less than 1/3 the initial value.

Dielectric combination of kraft paper and polyester film impregnated with Dykanol Y resin allows operation over a temperature range of  $-40$  to  $+125$  C with no derating in the wide-tolerance models. In applications requiring temperature stability to  $\pm 4\%$  or less, type PTL-W is suitable. A mineral wax impregnant is used; temperature range is  $-40$  to  $+100$  C, with no derating. Both types avoid the leakage problems of oil-filled capacitors.

All ratings will withstand... dc potential of 250 per cent of rated voltage applied for 5 sec, and 150 per cent of rated voltage applied at  $85$  C for 500 hours. Units rated at 600 wvdc and above are capable of withstanding a flash test of 900 v ac. Dissipation factor is less than 1 per cent. Axial leads, 1-1/2 in. long, withstand pull and bending tests.

Standard capacitances range from 0.001 to 1.0  $\mu$ f in series rated at 200, 400, and 600 wvdc, to 0.22  $\mu$ f at 1 kv and 0.047  $\mu$ f at 1.6 kv. Size is 1/4 x 1 in. at 0.001  $\mu$ f, 1 kv; the largest unit in the group is 1.0  $\mu$ f at 600 v, measuring 1 x 2-5/8 in. With specified tolerance of  $\pm 20$  per cent, price per 1,000 units ranges from \$41 to \$177. Production quantities are available.

For more information on these paper tubular capacitors, turn to the Reader-Service Card and circle 252.

See at Show Booth 3405-09.

CIRCLE 51 ON READER-SERVICE CARD ►



## At last! A truly passivated planar! New 2N708 silicon switch

For high speed logic switching with assured reliability, the General Instrument 2N708 npn silicon planar switch features the unique Molecular Shield™ surface-passivation process. ■ Here's a planar that is stable, reliable and uniform...lot by lot...with excellent gain characteristics as well as extremely low leakage current. Designed for switching applications, this type, as well as others in the popular 2N706 class, utilizes the latest planar techniques. ■ Extensive tests have proved that this type of transistor construction offers definite circuit advantages. Life tests, for example, indicate little degradation as a result of operation and storage at high temperatures. ■ The immediate availability of the 2N706 series in production quantities should be of interest to designers now using our silicon mesa transistors. The 2N708 is also available in limited quantities. For microtransistors, pancake-package transistors...for all your silicon planar and mesa transistors, call the sales office or franchised distributor nearest you. Or write for complete details to General Instrument Semiconductor Division, 65 Gouverneur St., Newark 4 N. J.

Abbreviated Specifications—General Instrument NPN Silicon Planar Transistors

Type	V <sub>CEO</sub>	V <sub>CER</sub>	h <sub>FE</sub>	T <sub>s</sub>
2N706	25v	20v	20	60 nsec
2N706A	25v	20v	20	25 nsec
2N706B	25v	20v	20	25 nsec
2N708	40v	20v	30	25 nsec

**GENERAL INSTRUMENT SEMICONDUCTOR DIVISION**  
**GENERAL INSTRUMENT CORPORATION**



JEDEC TO-18 CASE ACTUAL SIZE

# WESCON Round Up

*Equipment manufacturers, in response to a questionnaire sent out by ELECTRONIC DESIGN, volunteered information on what they thought were outstanding recent developments and what they believe will be the future developments in their fields of endeavor. We have summarized the responses received for several categories of products and, for comparison, listed several products in each category which will actually be shown at WESCON.*

THE Cow Palace of San Francisco will soon be the center of attraction for engineers from every part of the U.S.A. Electronic equipment manufacturers will be placing on display there the products which they hope will excite the interest of the industry's leaders.

What will WESCON offer to justify the expenditure of time by many of the industry's leading design engineers and managers? Most of the products they will see will be short of revolutionary but many will feature clever and worthwhile innovations on existing equipment.

The companies' top salesmen and engineers will be there to explain and demonstrate, to all who will stop and listen, the merits of the products they are showing. Customer curiosity will be, to them, an indication of the appeal and marketability of their wares. Indeed, Sangamo Electric Co. changed its evaluation of trade shows quite radically because of the response to its 406 series magnetic tape reproducer-recorder at another show. They had so many engineers watching the demonstration that the aisle was blocked during most of the day. The same unit, with major improvements, will be shown at the current WESCON, Booth 2207-09.

Touring engineers will see what the competition has to offer, new approaches to the solution of problems common to the entire industry and new tools to use in the production of better, more reliable, more us-

able equipment in every field from computers to cable connectors.

In response to a questionnaire sent out by ELECTRONIC DESIGN manufacturers outlined what they thought were the outstanding recent developments in their particular lines, and what they felt the future would bring in the way of improvements and pricing. The great majority felt that improved products would cost less in the future. Smaller size, greater reliability and more universal use combined with simpler-to-use, more accessible controls are the goals of the industry's planners. How well they are succeeding and how far they have to go will be evidenced in the wares that they will show.

## Control Equipment

All responses in this category agreed that miniaturization, reliability and flexibility have been the outstanding recent developments in relays, switches, timers, counters and servos. Future development predictions were for increased reliability and further miniaturization. Price trends were indeterminate based on the complexity of the product, but the predominant feeling was that prices would be slightly higher at first cost but lower for the ultimate user due to longer life and reliability which would eliminate repairs and replacement. The Electro-Mechanical Specialties Co. is showing at Booth 1422, a 2-amp relay that weighs less than 0.017 oz and is 0.275 in. in diam x 0.9 in.

long. Automatic Electric Co. will feature at Booth 2201-03 their MM-22 microminiature dpdt relay which has a life of 10 million operations in dry circuit applications and 100,000 cycles at 3 amp. The type A switching relay shown for the first time at Booth 2502-04 by North Electric Co. has a life of 30 million cycles and an operate time as fast as 3 msec. Trans-Sonics, Inc., Booth 4414, has developed a pressure potentiometer which will deliver a 75-v output without amplification.

## Semiconductors

The recent introduction of the epitaxial process is the choice of all as the outstanding recent development in the semiconductor field. Four-layer devices, particularly controlled rectifiers, were also mentioned as being in the fore of exciting developments. Faster devices with lower noise and more reliability are the goals of the semiconductor people. They would also like to see the early development of units capable of combining higher frequencies and power in one device.

Motorola, Booth 914-16, has developed pnp epitaxial transistors which handle 1/2 amp at switching speeds of a few sec. A high-speed silicon planar switching transistor by Fairchild Semiconductor is rated at 300-mw power and can be seen at Booth 814-16. A multiple diode for computer logic circuits by Delta Semiconductors, Inc., Booth 4512, consists of five separate diode junctions formed on a single silicon slice. The entire circuit is glass encapsulated.

## Telemetry

Improved reliability, pcm circuits and radically new space instruments have caught the eye of the telemetry manufacturers. The consensus of opinion indicates that new approaches to transducer design and data handling are the improvements they will try for in the near future.

On hand at Booth 312 will be a receiver-decoder by Babcock Electronics which has up to 20 IRIG channels for remotely controlling missiles and pilotless aircraft. Up to six channels can be used simultaneously. Telemetry modules by Lockheed Missile Space Co., Booth 2711-15, are welded into their circuits and will stand severe temperature, shock and vibration environments. An inflatable, helical telemetry antenna, shown at Booth 182, weighs less than 10 lb and can be put into use with a hand pump. Manufactured by the Andrew Corp., it has a vswr

of less than 1.5 to 1 over the range of 215 to 265 mc.

### Test Equipment

Improvements in performance, particularly in accuracy and stability have been the outstanding contributions to the test equipment field according to the producers of these units. With the introduction of many semiconductor test instruments, manufacturers no longer have to improvise their own test equipment. The extension of electronic frequency modulation techniques to audio frequencies continues the trend established at hf and vhf in eliminating the older mechanical modulating systems. Future developments are expected to include greater reliability and capabilities.

An increase is looked for in the amount of information which can be made available automatically by instrumentation.

Sierra Electronic Corp. is offering at Booth 2006-08 a frequency selective voltmeter which covers a range of 2 to 350 kc. A digital multimeter shown at Booth 3610 by Adage measures dc and ac absolute voltages for missile checkout. Atlantis Electronics Corp.'s semiconductor tester, shown at Booth 4508, will perform 12 tests in 0.6 sec on either diodes or transistors. All control functions can be remotely operated in the volt-ohmmeter which Non-Linear Systems, Inc., will show at Booth 1518-20. It is accurate to  $\pm 0.01\%$   $\pm 1$  digit.

### Power Supplies

The continuing displacement of vacuum-tube types by solid-state designs, including the increasing use of scr's and the packaging of more and more power into smaller and smaller size units seem to be outstanding developments in this category. Close regulation also demands the respect of a good segment of the manufacturers. For the future, the prediction is that the use of tunnel diodes will be explored in various types of microminiature power supplies.

The Thermador Electrical Manufacturing Co., Booth 1811, has a precision 800-cps inverter which is regulated to  $\pm 4$  cps for all changes of line, load or temperature.

WESCON is the showcase in which the electronics industry displays the harvest of its relentless self-improvement program. The engineer who wishes to freshen his point of view and increase his knowledge of recent developments will find no better investment of time than that which he will spend at the show. ■ ■

Now!

## Type RM561 Oscilloscope

with 5-inch CRT  
—basically an Indicator  
which accepts a wide range  
of plug-in units in  
both channels.



... in a low-cost Tektronix Oscilloscope ...  
you choose the type and degree of performance you  
demand for a particular rack-mount application.



## easily interchangeable PLUG-IN UNITS

- ... which drive the crt deflection plates directly.
- ... which house approximately  $\frac{2}{3}$  of the circuitry.
- ... which contain minimum components and controls.

### AVAILABLE NOW

Plug-in units presently available include:

<b>Type 50 Vertical Amplifier</b> Passband—15 cps to 200 kc. Sensitivity—1 mv/cm.	\$115	<b>Type 67 Time-Base Unit</b> Sweep rates—21 calibrated steps from 1 $\mu$ sec/cm to 5 sec/cm, accurate within 3%. Magnifier—5X. Triggering—Amplitude-level selection, automatic, or free-run, ac-coupled or dc-coupled, rising or falling slope, internal source, external source, or line frequency. External Input to Sweep Amplifier—1 v/cm sensitivity.	\$150
<b>Type 51 Time-Base Unit</b> Sweep rate—5 mc/cm, calibrated. Magnifier—Variable, uncalibrated, from 1X to 20X. Triggering—Automatic or free-run.	\$135	<b>Type 72 Dual-Trace Unit</b> Identical Channels—5 operating modes: alternate sweeps, chopped, Channel A only (may be inverted), Channel B only, both channels combined at output (B $\pm$ A). Passband—dc to 650 kc. Sensitivity—10 mv/cm to 20 v/cm in 11 calibrated steps, with variable control.	\$250
<b>Type 59 Basic Amplifier</b> Passband—dc to 400 kc, at maximum sensitivity. Sensitivity—approximately 1 v/cm, attenuation provided by variable potentiometer at the input. Maximum Input Voltage—600 volts.	\$90	<b>Type 75 Wide-Band Unit</b> Passband—dc to 4 mc. Sensitivity—50 mv/cm to 20 v/cm in 9 calibrated steps, with variable control. Risettime—approximately 85 nanoseconds.	\$175
<b>Type 60 1-MC Amplifier</b> Passband—dc to 1 mc. Sensitivity—50 mv/cm to 50 v/cm, calibrated decade-step attenuator (4 steps), with variable control.	\$99.50	<b>Skeleton Plug-In Unit</b> Contains 24-pin connector, latch, front-panel overlay ... for constructing your own circuits.	\$15
<b>Type 63 Differential Unit</b> Differential input, 50-to-1 rejection ratio at maximum sensitivity. Passband—dc to 300 kc. Sensitivity—1 mv/cm to 20 v/cm in 14 calibrated steps, with variable control.	\$125		

Prices F.O.B. Factory

### AVAILABLE SOON

Plug-in units under development include those for pulse-sampling, four-trace work, high-gain measurements, strain gage and other transducer applications.

For a demonstration, please call your Tektronix Field Engineer.

## Tektronix, Inc. P. O. BOX 500 • BEAVERTON, OREGON / Mitchell 4-0161 • TWX-BEAV 311 • Cable: TEKTRONIX

**TEKTRONIX FIELD OFFICES:** Albuquerque, N. Mex. • Atlanta, Ga. • Baltimore (Towson) Md. • Boston (Lexington) Mass. • Buffalo, N.Y. • Chicago (Park Ridge) Ill. • Cleveland, Ohio • Dallas, Texas • Dayton, Ohio • Denver, Colo. • Detroit (Lathrup Village) Mich. • Endicott (Endwell) N.Y. • Greensboro, N.C. • Houston, Texas • Indianapolis, Ind. • Kansas City (Mission) Kan. • Los Angeles, Calif. Area (East Los Angeles, Encino • West Los Angeles) • Minneapolis, Minn. • Montreal, Quebec, Canada • New York City Area (Albertson, L.I., N.Y. • Stamford, Conn. • Union, N.J.) • Orlando, Fla. • Philadelphia, Pa. • Phoenix (Scottsdale) Ariz. • Poughkeepsie, N.Y. • San Diego, Calif. • San Francisco, Calif. Area (Lafayette, Palo Alto) • St. Petersburg, Fla. • Syracuse, N.Y. • Toronto (Willowdale) Ont., Canada • Washington, D.C. (Annandale, Va.).

**TEKTRONIX ENGINEERING REPRESENTATIVES:** Hawthorne Electronics; Portland, Oregon; Seattle, Washington • Kentron Hawaii Ltd., Honolulu, Hawaii. Tektronix is represented in twenty overseas countries by qualified engineering organizations.

In Europe please contact Tektronix International A.G., Terrassenweg 1A, Zug, Switzerland, Phone (042) 4-91-92, for the address of the Tektronix Representative in your country.

CIRCLE 52 ON READER-SERVICE CARD



# NEW PRODUCTS

## Featuring those to be displayed at WESCON

Covering all new products generally specified by engineers designing electronic original equipment. Use the Reader-Service Card for more information on any product. Merely circle number corresponding to that appearing at the top of each description.

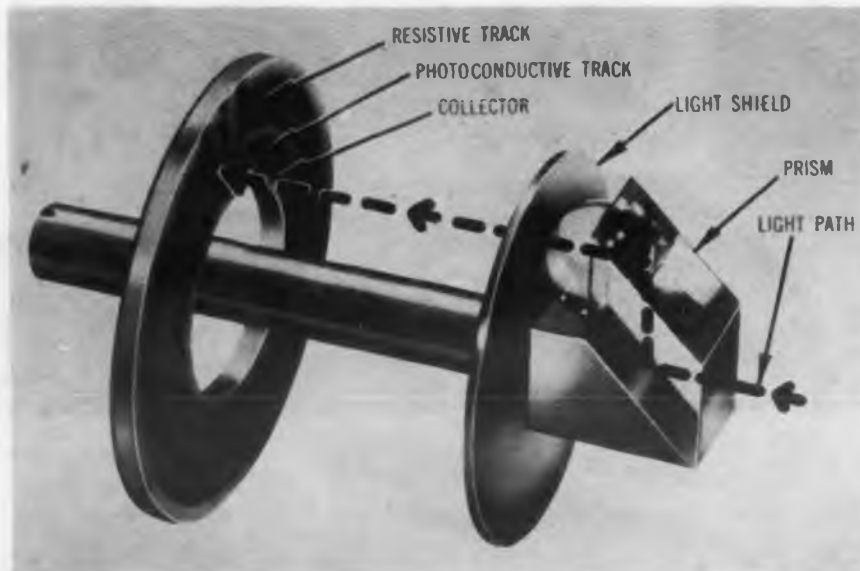

### Electro-Optical Potentiometer Offers Frictionless Pick-Off

257

Virtually unlimited life is claimed for the Betapot electro-optical potentiometer. Frictionless, torqueless operation makes the device ideal for gyro systems requiring negligible drift. Resolution is infinite, contact noise absent. Photoconductive material used for the resistance element is CdS or CdSe, with light-to-dark conductivity ratios ranging from  $10^6$  to  $10^8:1$ .

Duncan Electronics, Inc., Dept. ED, 2865 Fairview Road, Costa Mesa, Calif.

*P&A: Less than \$100; samples, Sept. 1961.*

See at Show Booth 808.

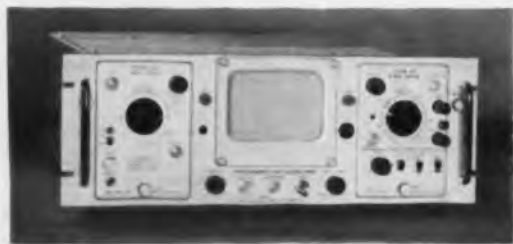

### Rack-Mounted Scope Has 7-In. Panel Height

256

Oscilloscope indicator unit type RM561 provides a 5-in. rectangular cathode-ray tube in a rack-mounting chassis requiring 7-in. vertical mounting space. It accepts eight plug-in units: two time-base, six signal amplifier. Bandwidth is dc to 4 mc, accelerating potential 3.5 kv. Six calibrated square-wave voltages, from 1 mv to 100 v, are available at the front panel.

Tektronix, Inc., Dept. ED, P. O. Box 500, Beaverton, Ore.

*Price: \$450*

See at Show Booth 1726-28.



### Switching Time Tester Provides Scope Readout

255

Automatic switching time test set model 205 covers times of 1 nsec to 1  $\mu$ sec. An oscilloscope is provided for ease in setup and for observing switching waveform. Bandwidth is 800 mc. Go, no-go lights are incorporated for rapid checking. Test circuit uses rf connectors for best transmission of fast pulses.

Wiltron Co., Dept. ED, 717 Loma Verde Ave., Palo Alto, Calif.

*P&A: \$3,800; 7 weeks.*

See at Show Booth 1212.



**ELECTROLYTIC CAPACITORS**—Reliability is our first ingredient



### Frequency Comparator 258 For Process Control

Solid-state frequency comparator type 35-2001 is used in process systems where the parameter to be controlled can be expressed as a frequency. Input frequency range is 1 to 50,000 cps. Parameters such as rpm, flow rate, temperature, pressure, force, and acceleration can be accommodated. Output signal can be used to drive a control device.

Daystrom-Wiancko Engineering Co., Dept. ED, 255 N. Halstead, Pasadena, Calif.

P&A: \$755; 8 weeks.

See at Show Booth 2911.

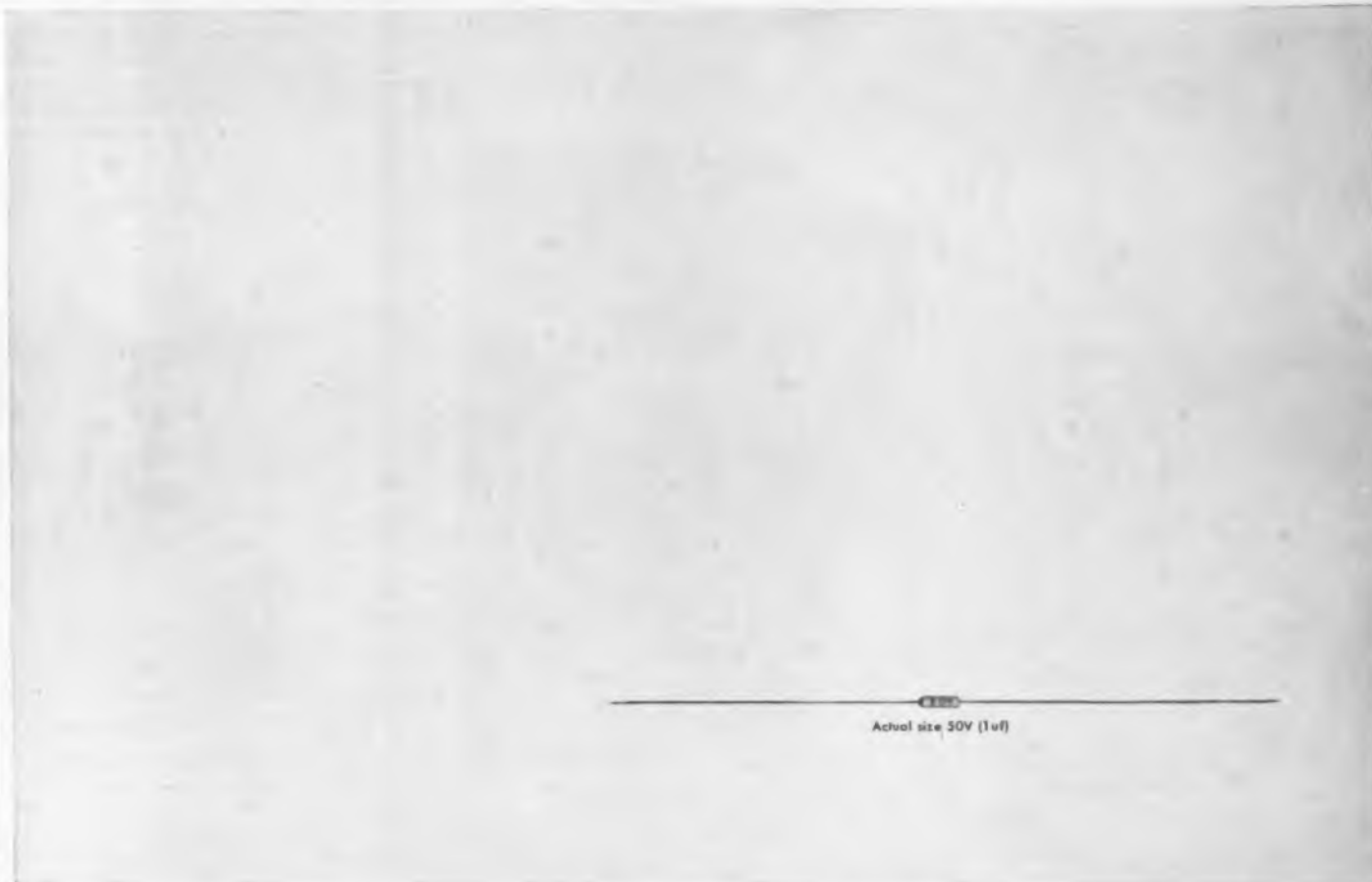

Actual size 50V (1uf)

## The "space saver" of Tantalytic\* Capacitors

Because it packs the most uf into the smallest package, the General Electric 62F510 Porous Anode Tantalytic Capacitor frees up valuable circuit space. It's the smallest (.075" x .250"), lightest (15 grams) 85C tantalum capacitor.

Though small, it provides more V-uf than larger units. In fact, it has almost four times greater volumetric efficiency than the smallest solid type.

\* Reg. Trade-mark of General Electric Co.

But it offers superior reliability because of these special features:

1. **Non-acid electrolyte.** No free liquids are used. "Gel" electrolyte eliminates acid-attack problems.
2. **Paper spacer** between case and anode prevents impurity migration and scintillation at the anode.
3. **Re-healing capability** contributes to long life in rugged applications includ-

ing high ripple and low impedance. And it's used at full-rated voltage at 85C!

Yet, this G-E unit is lower in price than other tantalum types, and the low price includes insulated sleeving.

Ask your G-E Sales Engineer about the five case sizes rated from 60V (2.5uf) to 6V (325uf). Or write for bulletin GEA-7008 to General Electric Co., Schenectady, N. Y. Capacitor Dept., Irmo, S. C. 430-04

*Progress Is Our Most Important Product*

**GENERAL  ELECTRIC**

General Electric also offers these reliable Tantalytic capacitors

**HIGH-RELIABILITY  
FOIL AND SOLID  
CAPACITORS**  
Bulletin  
GEA-7227



**"A CASE"  
TANTALYTIC  
CAPACITORS**  
Bulletin  
GEA-7226



**125C KSR\*  
TANTALYTIC  
CAPACITORS**  
Bulletin  
GEA-6258



**HIGH-VOLTAGE  
TANTALYTIC  
CAPACITORS**  
Bulletin  
GEA-7065



**125C CYLINDRICAL  
TANTALYTIC  
CAPACITORS**  
Bulletin  
GEA-7085



CIRCLE 53 ON READER-SERVICE CARD →

## NEW PRODUCTS

AT WESCON



### Automatic Welding System Is Tape-Programmed

349

Made for work-station use, automatic welding system PAWS-1 provides tape-programmed or manual sequencing of up to 10 weld conditions, with pre-determined force and energy value. Electrode force is adjustable from 4 oz to 15 lb, energy up to 80 w-sec. Housed in a movable console, the system operates from 115 v ac.

Weldmatic Div./Unitek Corp., Dept. ED, 950 Royal Oaks Drive, Monrovia, Calif.

**P&A:** \$4,750; 90 days.

See at Show Booth 4808-10.



### NPN Epitaxial Transistor Operates Beyond 600 MC

348

Silicon npn epitaxial mesa transistor 2N707A is said to offer a 60% improvement in gain-bandwidth product over existing types. Collector-base voltage rating is 70 v, power dissipation 1 w. Capable of oscillating at frequencies in excess of 600 mc, the device is intended for vhf oscillator and Class C amplifier applications. Collector saturation voltage is 0.18 v, collector capacitance 4 pf.

Motorola Semiconductor Products Inc., Technical Information Center, Dept. ED, 5005 E. McDowell Road, Phoenix 8, Ariz.

**P&A:** \$15 ea, 100 to 999; stock.

See at Show Booth 914-16.

### DC Power Supply Has Dual Outputs

350

Transistor dc power supply model TQ35-2 has dual output voltages continuously variable from 0 to 35 v dc, 0 to 2 amp, each side. Each is independent; outputs may be added to give a range of 0 to 75 v at 2 amp. Regulation is held to 7 mv per 10% line change, and 7 mv no-load to full-load. Ripple is less than 500  $\mu$ v rms. Two ammeter and one voltmeter which may be switched to either output are mounted on the 5-1/4 in. panel.

Universal Electronics Co., Dept. ED, 1720 22nd St., Santa Monica, Calif.

**Price:** \$575.

See at Show Booth 807.





**Latching Relay 346  
Simplifies Circuitry**

Subminiature magnetic latching relay type LF uses two coils for complete internal control of the latching operation. Sensitivity is 150 mw per coil with an operate time of 5 msec at +25 C. Contact load life at 28 v dc resistive is 100,000 operations at 3.0 amp, 1 million operations at 1.0 amp or less.

C. P. Clare & Co., Dept. ED, 3101 Pratt Blvd., Chicago 45, Ill.

**P&A:** \$8 to \$15; 2 to 3 weeks.

See at Show Booth 1009-11.

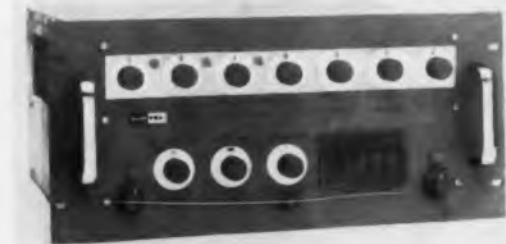

**DC Voltage Standard 347  
Has Seven-Digit Resolution**

Adjustable voltage source 303 has seven panel dials to provide seven-digit resolution in three ranges from 0 to over 1,000 v, positive or negative. Output voltage is within 0.01% of dial setting and stable within 50 ppm. Noise and ripple are less than 0.0001% peak to peak. Power is 105 to 125 v, 210 to 250 v, 50 or 60 cps, 125 va. Rack panel height is 8-3/4 in.

Kin Tel Div. of Cohu Electronics, Inc., Dept. ED, Box 623, San Diego 12, Calif.

**Availability:** from stock, fall 1961.

See at Show Booth 2019.



## How to shrink a filter!

Magnetics Inc. "120" solves the problem of core size vs. inductance in miniaturized circuits

Trying to squeeze high core inductance into a small space for use in miniaturized resonance, filter, audio, or carrier frequency circuits usually ends in a compromise. You either force more out of a smaller core, or you use a larger one. Not so, however, if you're familiar with the Magnetics Inc. "120."

This molybdenum permalloy core has a .655 inch outer diameter—is just between the .500 and the .800 inch core you may be using. What makes this little fellow unique is its inductance per 1,000 turns . . . higher than either of its neighbors, whether 60, 125 or 160 permeabilities.

Note, too, that like all Magnetics Inc. powder cores, the "120" is performance-proved and rated within realistic

inductance limits. All permeabilities are available from stock now. What's more, the 125 permeability core is inductance stabilized within  $\pm 0.1\%$  from 0° to 55°C.

More information on this and other cores in the Magnetics Inc. line is contained in design bulletin PC-203 R. It's yours by writing *Magnetics Inc., Department ED-91, Butler, Pennsylvania.*

**MAGNETICS Inc.**

See Magnetics Inc., Booth 1915 at WESCON

CIRCLE 54 ON READER-SERVICE CARD

## NEW PRODUCTS AT WESCON

### Tape Recorder

594



**Concentric reel instrumentation tape recorder model M-101** has a dual-differential capstan drive system. Transport handles standard 10-1/2 in. NAB and precision reels with the option of 1/4-, 1/2-, or 1-in. tape. Tape speeds up to 60 ips are available. Typical wow and flutter is 0.1% rms at 15 ips. Made for rack mounting, unit measures 19 x 12-1/4 x 14-1/2 in.

American Concertone, Inc., Dept. ED, 9449 W. Jefferson Blvd., Culver City, Calif.

See at Show Booth 121.

### Commutation Switch

606

**Handling 180 channels** of information with a plate 1-3/4 in. in diameter, this switch can be operated up to 1,800 rpm. Unit is designed for telemetry applications in adverse environments. Contacts are gold plated. Noise level is less than 1 mv when 5-v signals are switched into a 150-ohm load.

Mycalex Corp., Dept. ED, 125 Clifton Blvd., Clifton, N. J.

See at Show Booth 902-04.

### Four-Element Meter

720



**Four independent inputs** are measured by this meter for readout or comparison. Called the Quad-Indicator, the instrument can be supplied with or without lighting. Self-shielded, coaxial movements are as sensitive as 100  $\mu$ a. Rectangular, panel-mounted unit measures 3 x 2.75 x 3.25 in.

Minneapolis-Honeywell Regulator Co., Precision Meter Div., Dept. ED, Grenier Field, Manchester, N. H.

**Availability:** made to order only.

See at Show Booth 3501-07.

### Electro-Optical Components

718



**Printed-circuit mounting electro-optical components**, known as Raysistors, measure 1.94 x 0.37 x 0.40 in. types CK1101P and CK1111P switch 300 and 60 v with closed-circuit resistances of 13 and 0.6 K respectively. Types CK1102P through CK1112P serve as variable resistances, and have control voltages up to 10 v.

Raytheon Co., Industrial Components Div., Dept. ED, 55 Chapel St., Newton 58, Mass.

**P&A:** \$7.35 for 25 to 100; from stock.

See at Show Booth 3404-22.

### Conductive Molding Compound

601

**Thermosetting plastic material** called Diall 1610 is a conductive molding compound with electrical resistance less than 1/2 ohm per cm. The material can be electroplated. The compound is available in granular form for compression or transfer molding at 500 to 2,000 psi. Cure time is 2 min.

Mesa Plastics Co., Dept. ED, 12270 Nebraska Ave., Los Angeles 25, Calif.

See at Show Booth 5021.

### Oscilloscope Camera

609



**Interchangeable camera backs and lenses** permit reordering of oscilloscope traces on Polaroid or standard films, in sizes from 4 x 5 in. to 35 mm, with object-to-image ratio ranges from 1:1 to 1:0.222. Sliding back with detented lock enables spaced multiple exposures per frame. Synchro shutters allow remote arming of scopes for single sweeps.

Allen B. DuMont Laboratories, Dept. ED, 750 Bloomfield Ave., Clifton, N. J.

See at Show Booth 1614-20.

### Transmitter Converter

603



**Range is 2,200 to 2,300 mc.** Type 1090 transmitter converter provides an output of 9 w when driven by a standard telemetry transmitter having a range of 215 to 260 mc. Gain is unity with up to 6 w into 50 ohms at 500 v dc or 2 db with up to 9 w into 50 ohms at 1,000 v dc.

American Bosch Arma Corp., Tele-Dynamics Div., Dept. ED, 5000 Parkside Ave., Philadelphia, Pa.

**Availability:** in samples.

See at Show Booth 4126-28.

### Portable Electrocardiograph

515

**Self-contained portable electrocardiograph** called Cardioview is enclosed by a leather carrying case which contains all accessories. The unit is powered by a rechargeable battery. Chart speeds are 5, 25, and 50 mm per sec. A hot-stylus pen volatilises wax-paper surface to produce a dark black line. Amplifier, transistorized, has a response of dc to 60 cps,  $\pm 3$  db. Carrying case measures 9-3/4 x 4-1/2 x 7 in.

New Electronic Products Ltd., Minneapolis-Honeywell Regulator Co., Dept. ED, 2747 Fourth Ave., South, Minneapolis 8, Minn.

See at Show Booth 3501-07.

### Precision Fluxmeter

597



**Accurate within 10 ppm.** Fluxmeter model 611, with readout and remote control provision, can measure fields with an accuracy to 1 part in 10<sup>5</sup>. Four standard probes cover the 500- to 30,000-gauss range. The instrument can be used as a control unit to regulate a magnetic field. Fields need not be homogeneous for measurement. Special probes are available.

The J. C. Carter Co., Dept. ED, 671 W. 17th St., Costa Mesa, Calif.

See at Show Booth 111.

Continued on Galley 373

## SCR Test Set

604



Dynamic evaluation of silicon-controlled rectifiers is provided by the model OA-1 test set. Instrument measures forward breakover voltage and gate current to fire at any anode voltage, forward and reverse leakage current, voltage drop and holding current. Power supplies have limiting load resistors, and are rated to 600 v, 10 amp.

Baird-Atomic, Inc., Dept. ED, 33 University Road, Cambridge 38, Mass.

**Availability:** from stock in October.

See at Show Booth 3720-22.

## Digital Oscilloscope

600

Automatic digital oscilloscope model 5000 has all-solid-state circuitry and 10-mc vertical bandwidth. Sweep speed, vertical sensitivity, positioning, and triggering are automatic. Vertical sensitivity and horizontal sweep speed are indicated digitally on Nixie readouts. Dc positioning is calibrated, with offset displayed on digital readout. Unit measures 8-3/4 x 14 x 22-1/2 in.

California Instruments Corp., Dept. ED, 3511 Midway Drive, San Diego, Calif.

**P&A:** about \$1,500; from stock on October.

See at Show Booth 4412.

## Spectrum Analyzer

707



Continuous, real-time spectrum and analyzer makes simultaneous, multi-channel graphic recording of all relative amplitudes and frequencies in any bandwidth. Recording electrode is on a loop. Bandwidths are 3 to 450 cps. Paper advance rates are 1 ft per hr to 1 ft per sec.

Alden Electronic & Impulse Recording Equipment Co., Inc., Dept. ED, Westboro, Mass.

See at Show Booth 4314.

New **BA** model NC-1 performs transistor tests up to

50 amps at 750 watts peak power!



Here's the only direct reading, variable duty cycle test set for non-destructive measurement of medium and high power transistors. The B A Model NC-1 applies suitable pulse drive signals to the transistor under test and then peak detects the resulting current pulses so they have the same measuring value as steady state DC. Because the average pulse signal power is considerably lower than that of steady state DC, less stress is put on the transistor. This permits power tests to be made at a level many times that of rated dissipation.

- Minimizes heat sink requirements.
- Under optimum conditions, requires only 6/10ths of 1% of the input power used in conventional DC current tests
- Permits 750 watts max. power with max. current of 50A or max. voltage of 250V.

- Provides DC meter readings of  $V_{BE}$ ,  $I_B$ ,  $V_{CE}$ , and  $I_C$  — common emitter configuration under pulse conditions.
- Measures leakage and breakdown currents by standard DC techniques.
- Evaluates switching capabilities of device under dynamic conditions.
- Pulsed breakdown measurements at low duty cycle with simple external hook-up.

Write today for additional information and name of your nearby Baird-Atomic representative.

Engineers and scientists: Investigate challenging opportunities with Baird-Atomic. Write Industrial Relations Director. All qualified applicants will receive consideration for employment without regard to race, creed, color or national origin.



**BAIRD-ATOMIC, INC.**

33 University Road · Cambridge 38, Mass.

ADVANCED OPTICS AND ELECTRONICS . . . SERVING SCIENCE

# DRAFTING TRENDS

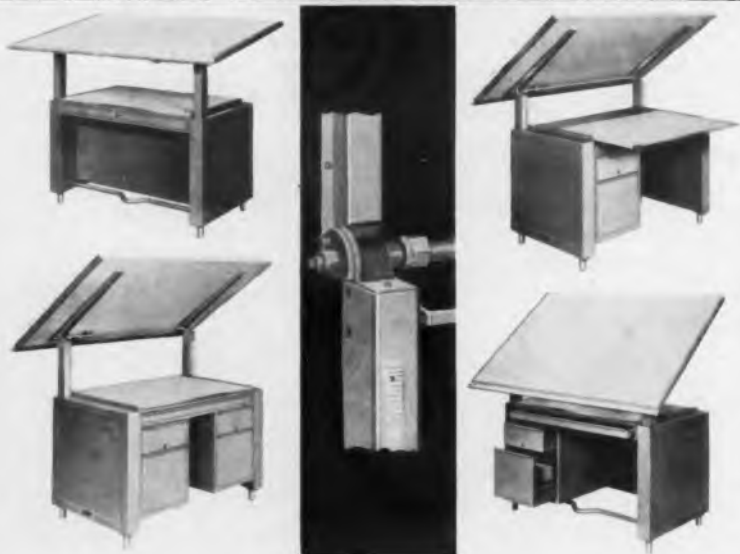

Four views of the versatile new Torsion Auto-Shift Table and the heart of its exclusive new design principle.

## Efficient, Convenient, Contemporary ... New Torsion Auto-Shift Table

**Advanced design**—A searching look will tell anyone who uses a drafting table that this is the equipment he'd create, given the time.

As any designer knows, simplicity is often difficult to achieve, and the appearance of simplicity even more difficult. Both are found in exclusive features of the new Hamilton Torsion Auto-Shift.

**Tailored to the user**—Unlike other designs, this is engineered, functional equipment for drafting, not just a drawing board slung on four legs or hung on a modified office desk. *It is designed without compromise to promote greatest efficiency by adapting to the work habits and convenience of the individual using it.* Its special characteristics will speed drafting substantially over conventional equipment in a one-man or one hundred-man department.

**Unique features**—The Hamilton Torsion Auto-Shift will counter-balance, regardless of table angle or weight of board accessories. It is attached and pivots at only two points—atop twin elevating columns, easily raised or lowered by foot pressure through a 12" vertical

range. Operating and adjusting mechanisms are readily accessible—without the need for bulging sheet metal covers or protruding hardware.

**Stratacore® board**—Further features include the new Stratacore drawing board . . . a light weight, linoleum-surfaced top of remarkable strength and stability. Slide-type reference surface can be used from front or rear. All drawers are reversible for use from one side or the other. Tool and catalog drawers may be installed at left or right, or on both ends.

Clearly, the new Hamilton Torsion Auto-Shift now offers even greater dividends for long-term investment in space economies, increased drafting output and improved user comfort.

Ask your Post dealer for full details, layout aids and planning assistance to put this prestige drafting furniture in your near future. Or, write Frederick Post Company, 3644 No. Avondale Ave., Chicago 18, Ill.



SENSITIZED PAPERS & CLOTHS • TRACING & DRAWING MEDIUMS • DRAWING INSTRUMENTS & SLIDE RULES  
ENGINEERING EQUIPMENT & DRAFTING SUPPLIES • FIELD EQUIPMENT & DRAFTING FURNITURE

CIRCLE 56 ON READER-SERVICE CARD

## NEW PRODUCTS AT WESCON

### Ceramic Capacitor 710

From 0.05 to 0.15  $\mu\text{f}$  capacitances are available in this line of ceramic capacitors. Maximum working voltage is 600 v dc. Units are 1/2 in. in diameter and 1 to 2.2 in. long.

Dale Electronics, Inc., Dept. ED, Columbus, Neb.

**Availability:** made to order only.

See at Show Booth 2112 and 2123.



### Flexible Printed Circuits 714

Mounted on Teflon FEP, these flexible printed circuits are electrically insulated and protected from moisture and gases. Circuits, etched copper sandwiched between two layers of the plastic, can be bent or twisted without disturbing the conductors. Temperature range is  $-122$  to  $+400$  F.

Garlock Electronic Products, Dept. ED, Camden 1, N. J.

See at Show Booth 4118.



### Wire Cutting Pliers 570

For subassembly work. Type 265-5 wire-cutting pliers loop and twist as well as cut fine solid or stranded wire, eliminating the need for several tools. Tips are designed to grip without scratching and can be used to attach connections in confined areas.

Kelsey-Hayes Co., Utica Drop Forge & Tool Div., Dept. ED, Utica 4, N. Y.

**P&A:** \$4.85; stock.

See at Show Booth 5031.



### Program Relay 706

Requires 0.05 w-sec for pulse operation or 2 w for conventional actuation. Series 1450 program relay is a 5-pole, 12-position switch for sequential control of computer, machine tool or TV remote or supervisory circuits. Speed is 10 msec for a 0.055-w-sec pulse.

Cornell-Dubilier Electronics, Dept. ED, Fuquay Springs, N. C.

See at Show Booth 3405-09.



### Resolvers and Pancakes 704

High-accuracy resolvers and pancakes are manufactured with stainless-steel ball bearings and housings. Laminations material is nickel iron. The units are for use in ballistic-missile guidance control systems.

Daystrom Inc., Transicoil Div., Dept. ED, Worchester, Pa.

**Availability:** 75 to 90 days.

See at Show Booth 2915.





CUSTOM SERVICE FROM

**C**annon  
**A**uthorized  
**P**lug  
**S**pecialists

CAPS offer you custom service—Cannon Plugs assembled to your order at locations near you. CAPS carry the most extensive and complete line of plugs in the industry, specials as well as standards. Available for fast delivery at factory prices. Call your nearest CAPS for more information:

Atlanta, Georgia  
ELECTRO AIR CORPORATION

Chicago, Illinois  
UNITED AIRCRAFT SUPPLY CORP.

Dallas, Texas  
TEKKO, INC.

Denver, Colorado  
KIMBALL ELECTRONICS

Great Neck, L.I., New York  
TIME ELECTRONIC SALES

Inglewood, California  
LIBERTY ELECTRONICS

Mineola, L.I., New York  
SCHWEBER ELECTRONICS

North Hollywood, California  
RICHEY ELECTRONICS

Philadelphia, Pennsylvania  
AERCON, INC.

South Bend, Indiana  
RADIO DISTRIBUTING CO.



# NEW

## CANNON KPT/KSP MINIATURE DESIGNED TO MIL-C-26482

Quick disconnect plugs for aircraft, missiles, and all applications requiring miniature plugs. Our standard solder-pot versions, including hermetic seals, are completely interchangeable with all bayonet-lock plugs designed to MIL-C-26482I

*Solder pot version now available from  
Cannon CAPS Distributors*

### ALSO KPT/KSP PLUGS WITH CRIMP SNAP-IN CONTACTS AND TWO SHORE INSULATOR.

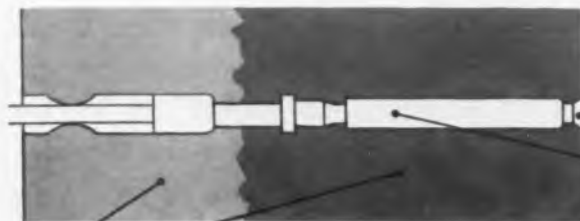

Maximum lead-in chamfer for positive alignment.

MIL-C-26636 contacts (plating gold over silver)

Two shore resilient insulators molded out of two different hardness materials (polychloroprene) into a homogenous piece. The rear portion of the insulator is the softer in order that the conductors can be sealed properly, and the front portion is the harder to retain the snap-in contacts. The two shore insulator insures a continuous moisture and pressure

seal from front to back to provide superior electrical performance at high altitudes. This method of sealing and contact retention offers the industry a most reliable crimp series meeting the requirements of MIL-C-26482. Write for catalog KPT/KSP-1 to:

SEE CANNON AT WESCON BOOTH 2302-2306

**CANNON ELECTRIC COMPANY**, 3208 Humboldt St., Los Angeles 31, Calif.



CIRCLE 98 ON READER-SERVICE CARD  
ELECTRONIC DESIGN • August 2, 1961

CIRCLE 99 ON READER-SERVICE CARD

## NEW PRODUCTS

AT WESCON

Fan

709



Moves 100 cu ft of air per min under free delivery conditions. Called the Gold Seal Muffin Fan, the fan has an aerodynamically designed grille which has a low noise level and does not collect dust. Skeleton, venturi, gridded, or filtered styles are available.

Rotron Manufacturing Co., Dept. ED, Woodstock, N. Y.

See at Show Booth 3006-08.

Diallyl Phthalates

599

Flame-resistant Diall FS-80 is a diallyl meta-phthalate filled with 1/2-in. glass fibers. Type FS-10 is supplied in granular form. Type FS-60, a diallyl orthophthalate, is asbestos-filled and in granular form, providing high flame and heat resistance, but does not survive heavy loads or stresses. Type 50-52 is dacron-filled, providing high impact strength.

Mesa Plastics Corp., Dept. ED, 13370 Nebraska Ave., Los Angeles 25, Calif.

Availability: from stock.

See at Show Booth 5021.

Straight Variable  
Delay Line

370



Range is 0.2 to 1  $\mu$ sec. Designed to meet MIL-STD 202 environmental specs, the straight variable delay line has an impedance range of 500 to 1,000 ohms. Units with special characteristics can be made on order.

PCA Electronics, Inc., Dept. ED, 16799 Schoenborn St., Sepulveda, Calif.

P&A: \$95; 3 weeks.

See at Show Booth 1423.

*For Long Life and Power Economy*

Specify the **NEW**



**CLARE LATCHING**  
**SUBMINIATURE**  
*crystal can*  
**RELAY**

The new CLARE Type LF, magnetic latching subminiature relay offers designers simplified circuitry in small space by providing latching effect without transistors. Magnetic latching results in power economy.

The Type LF is available with either 2-coil or 1-coil configuration. The 2-coil relay allows complete control of the latching operation within the relay and provides an extremely compact operating unit. The 1-coil relay is somewhat more sensitive; it is adaptable to existing circuits where outside control is provided. (See opposite page for specifications and circuit diagrams.) The Type LF provides the same wide range of mounting arrangements and terminals as the CLARE Type F relay.

**FOR NON-LATCHING  
OPERATION**



**CLARE Type F Subminiature  
Crystal Can Relay**

The CLARE Type F relay is extremely fast and more than moderately sensitive. It is built to withstand temperature extremes, heavy shock and extreme vibration. Contacts, rated at 3 amperes, are excellent for low-level circuit operations. Send for Design Manual 203.



### TYPE LF

relay shown (cover removed) is the 2-coil design which controls the entire latching operation within the relay. Shown twice actual size.



2-Coil Circuit Diagram



1-Coil Circuit Diagram

### PHYSICAL FEATURES

#### Life Expectancy

##### Wet Circuit:

3.0 amperes, 28VDC resistive—100,000 operations  
 2.0 amperes, 28VDC resistive—250,000 operations  
 1.0 ampere, 28VDC resistive—1,000,000 operations  
 1.0 ampere, 28VDC inductive (100 millihenry)—100,000 operations  
 1.0 ampere, 115 VAC resistive—100,000 operations

##### Dry Circuit:

1,000,000 miss free operations when subject to conventional dry circuit requirements.

#### Temperature—+125° C to -65° C

#### Shock—100g's for 1/2 sine wave $11 \pm 1$ MS pulse

#### Linear Acceleration—100g's minimum

#### Vibration—.250" DA or 30 g's, 5-2000 cps.

#### Humidity & Salt Spray—MIL-R-5757D

#### Enclosures: Tinned brass cover with fungus-resistant finish. Hermetically sealed and filled with dry nitrogen at atmospheric pressure.

#### Contact Arrangement—2PDT latching

#### Terminals—Plug-in (3/16" straight), solder hook, 3" straight

#### Wiring—Two coils (as shown on drawing above)

One coil (as shown on drawing above)

#### Weights—.54 oz. for plug-in

.82 oz. for 2 studs, 3" leads

### ELECTRICAL FEATURES

**Operate Time—Two coil:** When applying—for a minimum of 5 milliseconds—a voltage of at least two times the must operate voltage, the operate time including bounce will not exceed 5 milliseconds. **One Coil:** operate time will not exceed 8 milliseconds.

**Sensitivity—Two coil,** approximately 150 milliwatts

One coil, approximately 75 milliwatts

#### Dielectric Strength

Sea level: 1000 volts rms—all terminals to case  
 1000 volts rms—between contact sets  
 600 volts rms—between open contacts of a set  
 70,000 ft.: 350 volts rms—all terminals to case

**Insulation Resistance—1000 megohms minimum at +125° C between any two terminals and between all terminals and case.**

#### Maximum Interelectrode Capacitance—

Closed contacts to case ..... 3.7 picofarads  
 Open contacts to case ..... 2.0 picofarads  
 Between contacts of a set ..... 2.0 picofarads  
 Between adjacent contact sets ..... 3.5 picofarads

#### Maximum Coil Dissipation

Two Coil: .50 watts at +125° C  
 .75 watts at +25° C  
 One Coil: 1.25 watts at +125° C  
 2.0 watts at +25° C

**Standard Adjustment—Relay will operate and hold when the must operate voltage is applied**

#### Contact Resistance:

Maximum: 50 milliohms at 6 volts, 100 milliamperes.  
 Typical: 25 milliohms at 6 volts, 100 milliamperes.

For coil and mounting data on CLARE Type LF relay send for CPC-12. Address: C. P. Clare & Co., 3101 Pratt Blvd., Chicago 45, Illinois. In Canada: C. P. Clare Canada Ltd., 840 Caledonia Road, Toronto 19, Ontario. Cable Address: CLARELAY.



**C. P. CLARE & CO.** Relays and related control components

### Linear Amplifier

708



Model HFL-2500 linear amplifier, has continuously variable tuning between 2 and 30 mc. Unit, including self-contained power supply, measures 60 x 24 x 24 in. and operates continuously at 10,000 ft. Signal modes A1, A2, A3, SSB, ISB, and TSB can be accommodated.

Gates Radio Co., Dept. ED, Quincy, Ill.

See at Show Booth 514.

### Magnetic Shield

727

For use with a crt, this magnetic shield can be furnished in sizes from 5 to 21 in. to fit tubes of various shapes and sizes. It is basically a thin laminar metallic enclosure to provide protection from nearby magnetic fields and other spurious electromagnetic influences.

General Dynamics/Electronics, Information Technology Div., Dept. ED, P. O. Box 2449, San Diego 12, Calif.

See at Show Booth 201-03.

### Synchro Resolver

548



Size 11 synchro resolver has a built-in dual buffer amplifier to stabilize resolver operations. This arrangement improves signal-to-noise ratio and eliminates the need for chassis mounting of electronics.

General Precision, Inc., Kearfott Div., Dept. ED, 1150 McBride Ave., Little Falls, N. J.

See at Show Booth 3309-21.

accurate  
**400 CYCLE  
POWER  
SUPPLY**  
for  
rate  
gyros



This exceptionally small, lightweight single-phase static inverter supplies accurate 400 cycle power to rate gyros — and maintains it precisely throughout the entire temperature and environment range. ■ For telemetry and guidance systems, the inverter offers the outstanding features of low distortion — less than 4%; an efficiency of more than 55% at full load; operation into variable power factor loads; non-dissipative regulation for greater dependability; lightweight — only 1¾ pounds; small size — 20-cubic-inch volume. ■ Designed, developed and produced by Temco Electronics, this rate gyro inverter is a solid state, off-the-shelf unit that meets or exceeds all applicable portions of MIL-E-5272. We invite your inquiries on this unit, as well as for information on higher power units also available.



See us at WESCON Booths 4121 & 4123

**LING-TEMCO ELECTRONICS, INC.**

Temco Electronics Division • Dept. 221N • P. O. Box 6191 • Dallas 22, Texas

CIRCLE 58 ON READER-SERVICE CARD

## NEW PRODUCTS AT WESCON

### Nonlinear-Potentiometer Tester 722

**Tape-programed** conformity-tester measures deviation of nonlinear potentiometers from theoretical values. Potentiometer resistance is measured at 5-deg shaft increments, the measured value is compared to a predetermined resistance, and error up to 1% is indicated on a panel meter. Dual-channel oscillograph output is also provided.

Jonathon Electronics Corp., Dept. ED, 720 E. Walnut St., Fullerton, Calif.

See at Show Booth 4830.



### Character Generator 715

**High-speed** character generator, model TD-549, can display over a million words per minute in any alphabet. Output is 100,000 characters per sec. There are 64 plug-in characters and codes available. Display is on a cathode ray tube face.

Transdata, Inc., Dept. ED, P. O. Box 1369, San Diego 12, Calif.

**P&A:** \$8,860; 30 days.

See at Show Booth 114.



### Cleaning Device 574

**For semiconductors, switches, relays and other components**, model RT-S-8-6 cleaning device processes up to 600 units per hr. An atomized spray of solvent is combined with filtered steam. The turntable indexes automatically.

Cobehn, Inc., Dept. ED, 226 Passaic Ave., Caldwell, N. Y.

**P&A:** about \$5,750; made to order.

See at Show Booth 4824.



### Chassis Fixture 573

**Rotates, positions and transports** electronic chassis for assembly, test and servicing. The TD model A chassis fixture has adjustable spindle height, eight-point clamping and nylon glides. It can be adapted for a wide range of chassis sizes.

Technical Devices Co., Dept. ED, 11242 Playa Court, Culver City, Calif.

See at Show Booth 4802.



### Size 5 Synchros 703

**For 400-cps use.** These size 5 synchros are housed in stainless-steel cases 1/2 in. in diameter. They meet all applicable requirements of MIL-E-5272. Operating temperature range is -55 to +95 C. Excitation voltage is 10.2 v.

Daystrom, Inc., Transicoil Div., Dept. ED, Worcester, Pa.

**Availability:** 75 to 90 days.

See at Show Booth 2915.



## Semiconductor Slicer

575



With variable speeds. Model 612 semiconductor slicer has a cross-feed index within  $\pm 0.0001$ . It is driven by a dc motor and controlled by full-wave rectified ac with dc ripples filtered in an lc circuit. The ac supply is regulated with a voltage-regulator transformer.

Reid Brothers Co., Inc., Dept. ED, 140 Elliott St., Beverly, Mass.

See at Show Booth 4425.

## Cathode-Ray Tubes

610

Space-saving crt type K1988 has electrostatic focus and magnetic deflection with grid drive of 10 to 20 v. Type K1813 has a 7-in. diameter flat face and multigun spiral accelerator. High-sensitivity crt type 3BFP has high deflection sensitivity at full scan. Flat face size is 3 in.

Allen B. DuMont Laboratories, Dept. ED, 750 Bloomfield Ave., Clifton, N. J.

See at Show Booth 1614-20.

## Delay Line

607

Miniature delay line, model 37-34, has better than 35 to 1 delay to rise time ratio and an attenuation of 2 db. Unit operates from -55 to +125 C. The case occupies 3-1/2 cu in.

ESC Electronics Corp., Dept. ED, 534 Bergen Blvd., Palisades Park, N. J.

See at Show Booth 2609.

## Transistor Retainer

598



Heat is dissipated from TO18-packaged transistors by the type TXBP-018-28 retainer. Device accommodates transistor cases from 0.175 to 0.19 in. in diameter. Retainer is pressed onto transistor, and does not damage case.

International Electronic Research Corp., Dept. ED, 135 W. Magnolia Blvd., Burbank, Calif.

P&A: \$1.05 to \$0.50; from stock.

See at Show Booth 1504-05.

# CORDLESS PATCHBOARDING CUTS COSTS, SIMPLIFIES OPERATIONS, SAVES SPACE, EXTENDS VERSATILITY OF SYSTEMS

As every electronics engineer knows, programming and switching capabilities determine the parameters of a system or a piece of equipment. Until recently, field programming was an expensive, cumbersome and involved affair employing a confusing array of patchcords and plugs. Switching multiple functions in various combinations required expensive, and very limited multi-point switches.

A year ago, the Sealectro Corporation introduced the Sealectoboard. This device, so simple in concept, yet so functional to the design and operation of electronic systems, is now used by manufacturers of a wide range of equipment. Its dependability, versatility and performance has been proved beyond the doubts of the most critical users.

The Sealectoboard offers a degree of versatility beyond that at any other switching device. It permits the interpositioning of components; the switching of functions in parallel or series operations; the interposing of associated circuitry at any point; test equipment analysis of any point in the system.

All these functions are carried out in minimum space. Function points are laid out in .250" matrix, providing 16 points in a square inch of panel area.

In operation, any function through the Sealectoboard may be actuated by merely pushing a pin in at the desired X- and Y-axis coordinate point. There is no cord clutter, no polarization dual plugs. The Sealectoboard automatically makes the desired circuit connections upon insertion of the single pin.

If you use multi-point switching, component interposing, programming in the field, or any of a host of other functions, it will pay you to investigate the Sealectoboard.



Cross-sectional view of Sealectoboard. Two rows of contacts are run at 90° angles permitting interconnections and interposing associated circuitry at any coordinate. Beryllium copper, silver plated, or gold plated upon special order, provide contacts of low resistance, long life.



Sealectoboards can be made up in any configuration, to best fit the customer's requirements. Panel coding is available according to application needs. Sealectoboard is Patent Pending.

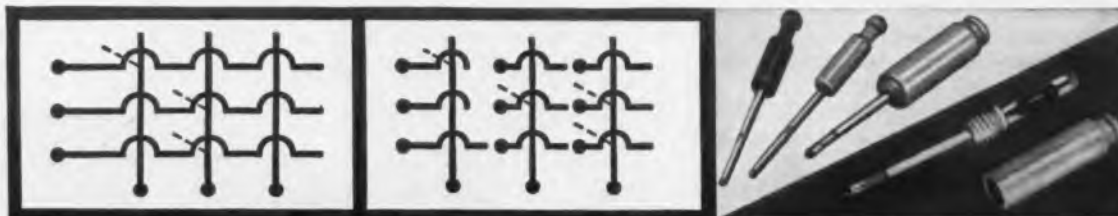

Standard Sealectoboard design incorporates contacts bussed together in each X- and Y-point. Sealectoboards are also available with each contact point on the bottom deck brought out individually for specialized applications. Special designs may be made up bussing pairs, or any specified number of points on the bottom deck. The application possibilities of these various designs are virtually unlimited.

Pins are either of the straight shorting design connecting the two contact decks, or insulated coaxial design which brings both contacts out through the handle of the pin. These are used as component holders, or test lead pins.

**PROTO-KIT** Try one and see. An 8 x 9 or 10 x 10 Sealectoboard with shorting pins and component holders permitting you to try and evaluate the versatility of the Sealectoboard. Ask your Sealectro distributor, or order directly . . . \$19.70 or \$28.00 respectively

WRITE FOR COMPLETE DETAILS . . .



**Sealectro** CORPORATION  
139 HOYT STREET • MAMARONECK, N. Y.  
**SEALECTOBOARD**

**PRESS-FIT**  
TEFLON TERMINALS

**CON-HEX**  
RF CONNECTORS

BRITISH BRANCH: SURREY, ENGLAND

See us at WESCON Booth 716  
CIRCLE 59 ON READER-SERVICE CARD

## NEW PRODUCTS AT WESCON

### Telemetry Modules

713



Welded into their circuits, the Weld-Stick series telemetry modules are made for missile applications. Units are said to withstand more severe temperature, shock, and vibration environments than soldered printed-circuit boards.

Lockheed Aircraft Corp., Missiles and Space Div., Dept. ED, Sunnyvale, Calif.

**Availability:** from stock in September.

See at Show Booth 2711-15.

### Photosensitive Devices

611

Ten-stage photomultiplier tube 7860 is 3/4 in. in diameter and 3-7/8 in. long. Fourteen-stage type 6810A has fast transient time and high gain. Ten-stage, tri-alkali tube type K1927, with S20 response, has photocathode with high luminous sensitivity and low thermionic dark current. Image dissector type K2035, 5 in. in diameter, can observe events as short as  $10^{-7}$ . Response is S11.

Allen B. DuMont Laboratories, Dept. ED, 750 Bloomfield Ave., Clifton, N. J.

See at Show Booth 1614-20.

### Air Dryer

614



Handling from 500 to 16,000 cu ft per hr, the series MS-RD dryers recirculate air or gas through dessicant beds. Dew points of  $-100$  F are obtained. Units weigh from 460 to 3,250 lb and have blowers of 3/4 to 7.5 hp.

C. I. Hayes, Inc., Dept. ED, 800 Wellington Ave., Cranston 10, R. I.

See at Show Booth 5030.

## largest selection of adjustment potentiometers...

More engineers specify Trimpot because:

Trimpot line is complete

Bourns offers you the largest selection of leadscrew actuated potentiometers... 23 basic models—4 terminal types—three mounting methods.

Trimpot is small

Space saving size and rectangular shape permit the installation of 12 to 17 units in one square inch of panel area.

Trimpot is accurate

Multi-turn screwdriver adjustment provides up to 9000° of rotation... you can make and repeat the finest adjustments.

Trimpot is stable

Adjustment shaft is self-locking... settings are virtually immune to severe acceleration, vibration and shock.

Trimpot is fully tested

All instruments are 100% inspected before shipment to assure you of reliable performance.

Trimpot is proved

It is used in more military and commercial equipment than any other leadscrew actuated potentiometer.

# Trimpot<sup>®</sup>

See these products and more at WESCON—Booth 3102-3104.

Only Trimpot potentiometers give you all of these outstanding features

**TERMINATION**—Alloyed with multiple turns of the resistance wire, the exclusive Bourns Silverweld<sup>®</sup> termination is virtually indestructible under thermal or mechanical stress.

**ELEMENT**—Special metal mandrel is precision wound with low-temperature-coefficient resistance wire.

**WIPER PICK-OFF**—Spring pick-off provides positive electrical contact with wiper to improve potentiometer performance, reliability.

**"O" RINGS**—Two high-temperature silicone rubber "O" rings provide effective double seal against humidity.

**ADJUSTMENT SCREW**—Stainless steel leadscrew accommodates standard screwdriver, meets military requirements for salt spray.

**TERMINALS**—Three terminals are Teflon-insulated stranded leads. (Most Trimpot potentiometers available with leads, pins or solder lugs.)

**CONTACT**—Precious metal wiper provides constant, positive contact under extreme environmental conditions.

**BODY**—High-temperature, thermosetting plastic body is sealed, enabling potentiometer to meet Mil Specs for humidity, sand, dust, fungus, salt spray, etc.

**CLUTCH ASSEMBLY**—Exclusive clutch design and positive stop at ends of wiper travel prevent internal mechanical damage.

This cutaway of Model 3250 is typical of the design of all Bourns Trimpot potentiometers though some features may vary from model to model.

longest record of reliability

# Potentiometers

NUMBER — 17 PRODUCT SERIES



High-Temperature, Humidity-Proof Wirewound Trimpot—Model 3010. Operates at 175°C / L, P terminals / 1 watt / 10 ohms to 100K. Meets Mil Specs for humidity. Available in carbon as Model 3011 / 20K to 1 Meg.



Low-Cost Commercial Wirewound E-Z Trim®—Model 3067. Operates at 85°C / L, S terminals / 0.5 watt / 100 ohms to 20K. Meets steady state humidity. Available in Resiston carbon as Model 3068 / 20K to 1 Meg. Priced under \$1 in production quantities.



Subminiature Humidity-Proof Wirewound Trimpot—Model 3250. Operates at 175°C / L, 3 types of P terminals / 1 watt / 100 ohms to 50K. Meets Mil Specs for humidity.



1/2" Wirewound Single-Turn Potentiometer—Model 3367. Operates at 105°C / P, S terminals with panel mount collar / 0.5 watt / 100 ohms to 20K. Meets steady state humidity.



High-Power Wirewound Trimpot—Model 3030. 15 watts. Operates at 265°C / L terminals / 10 ohms to 10K.



PANEL MOUNTED UNITS—All models except 3250 are now available with panel mounting. Unique design permits quick factory assembly to "on-the-shell" units. In addition, mounting screws, mounting brackets and clip brackets are available from factory or distributor stock to meet virtually any mounting situation.

Key to terminal types:  
L = Insulated stranded leads  
S = Solder lugs (includes 3367S, panel mount bushing only)  
P = Printed circuit pins  
W = Uninsulated wires

The following resistances are standard if they fall within the limits listed: 10 20 50 100 200 500 1K 2K 5K 10K 20K 25K (wirewound only) 50K 100K 200K 500K 750K 1 Meg. Other resistances available on special order.



BOURNS, INC., TRIMPOT DIVISION  
6135 MAGNOLIA AVE., RIVERSIDE, CALIF.  
PHONE: OVERLAND 4-1700 • TWX: RZ9222  
CABLE: BOURNSINC.

## Program Relay

595



Miniaturized program relay series 1450 is a 5-pole, 12-position switch said to have fast, quiet operation, and high reliability in severe environmental conditions. Measuring 2 x 2 x 1-5/8 in. and weighing 4-1/2 oz, the relay operates in 10 msec max for a 0.055-w-sec pulse. Coil ratings are 6 to 220 v, 60 cps.

Cornell-Dubilier Electronics, Dept. ED, Fuquay Springs, N. C.

See at Show Booth 3405-09.

## RF Shielding Assembly

726

Ready-to-install honeycomb structure with integral rf gasketing, called Teckcell, provides cool air flow and excellent rf shielding. Also offered, Teckstik combines an rf seal with a fluid gasket for simple installation.

Technical Wire Products, Inc., Dept. ED, 129 Dermody St., Cranford, N. J.

See at Show Booth 215.

## Wafer Resistors

724

Measuring 0.31 x 0.31 x 0.01 in., these wafer resistors are available with resistance values from 100 ohms to 100 K. Tolerance is 1% and power dissipated is 1/2-w max. Four resistive elements can be placed in a single wafer.

Dale Electronics, Inc., Dept. ED, Columbus, Neb.

Availability: in sample quantities.

See at Show Booth 2112 and 2123.

## Strain-Gage Pressure Transducer

608



High-line, low-differential strain-gage pressure transducer, model 3S-G, operates in corrosive media. Silicon sensing elements operate from -65 to +250 F, has combined linearity and hysteresis of  $\pm 0.25\%$ . Ranges are 0-10 to 0-10,000 psid, or  $\pm 10$  to  $\pm 10,000$  psid. Standard electrical outputs are 0.05, 0.25, and 5 v dc.

Fairchild Controls Corp., Dept. ED, 219 Park Ave., Hicksville, L. I., N. Y.

See at Show Booth 820-22.



General-Purpose Wirewound Trimpot—Model 200. Operates at 105°C / L, S, P terminals / 0.25 watt / 10 ohms to 100K. Available as a rheostat. Model 201.



General-Purpose Resistor Carbon Trimpot—Model 215. Operates at 125°C / L, S, P terminals / 0.25 watt / 20K to 1 Meg.



Subminiature Wirewound Trimpot—Model 220. Operates at 175°C / L, W, terminals / 1 watt / 100 ohms to 30K. Meets Mil Specs for humidity.



High-Temperature, Humidity-Proof Wirewound Trimpot—Model 224. Operates at 175°C / L, S, P terminals / 1 watt / 10 ohms to 100K. Meets Mil Specs for humidity. Also available in Resiston carbon as Model 3051 / 20K to 1 Meg.



General-Purpose Resistor Carbon Humidity-Proof Trimpot—Model 235. Operates at 125°C / L, S, P terminals / 0.25 watt / 20K to 1 Meg. Meets Mil Specs for humidity.



Humidity-Proof Wirewound Trimpot—Model 236. Operates at 135°C / L, S, P terminals / 0.8 watt / 10 ohms to 100K. Meets Mil Specs for humidity.



High-Temperature Wirewound Trimpot—Model 260. Operates at 175°C / L, S, P terminals / 1 watt / 10 ohms to 100K.



High-Quality Commercial Wirewound Trimpot—Models 271, 273, 275. Operate at 85°C / L, S, P terminals / 0.25 watt / 100 ohms to 10K. Resiston carbon versions also available. Models 272, 274, 276 / 20K to 1 Meg.



Subminiature High-Temperature Wirewound Trimpot—Model 3000. Operates at 175°C / tapered pin terminals / 0.5 watt / 50 ohms to 20K. Resiston carbon version available. Model 3001 / 20K to 1 Meg. Only 1/4" long.

Write for detailed specifications and list of stocking distributors.

Manufacturer: Trimpot® potentiometers; transducers for position, pressure, acceleration. Plants: Riverside, California; Ames, Iowa; and Toronto, Canada

CIRCLE 60 ON READER-SERVICE CARD



VERY NARROW TO VERY WIDE

10 kc

400 mc

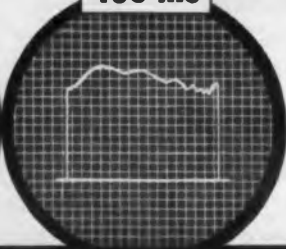
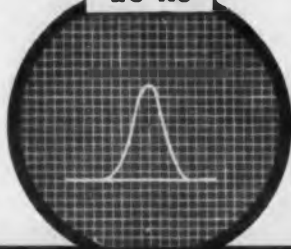

SWEEP WIDTHS\*



... ALL IN ONE INSTRUMENT

NEW

**JERROLD**<sup>®</sup>

**900B**

## SWEEP SIGNAL GENERATOR

Here's the last word in versatility and precision, the ultimate instrument for all your IF-VHF-UHF requirements. The new Jerrold 900B offers unusual stability in sweep widths as narrow as 10 kc and as wide as 400 mc. Frequency range 500 kc to 1200 mc.

**\$1980<sup>00</sup>** f.o.b. Philadelphia\*\*

\*Illustration of scope at left shows typical communications receiver response 4 kc bandwidth at 7 mc. Illustration at right shows typical distributed amplifier response 2-220 mc.

\*\*Prices and specifications subject to change without notice.

- Built-in crystal-controlled harmonic markers at 1, 10, and 100mc intervals.
- Each marker output individually controls from front panel.
- Built-in variable-gain dc-coupled scope preamplifier with 200X gain.
- Built-in precision attenuator from zero to 50db in 10db steps.
- Accurately calibrated frequency dial.
- High-level metered output.

Write for complete technical data.

**JERROLD**

**ELECTRONICS CORPORATION**

Industrial Products Division, Dept. ITE-109  
The Jerrold Building, Philadelphia 32, Pa.

Jerrold Electronics (Canada) Ltd., Toronto •

Export Representative: Rocke International, New York 16, N.Y.

**WESCON BOOTHS 1002-1004**

CIRCLE 61 ON READER-SERVICE CARD

## NEW PRODUCTS AT WESCON

### Coaxial Termination Resistors 721

For 3/8 in. type N connectors, the type 5127 coaxial termination resistor assembly has a standard resistance of 50 ohms. A vswr of 1.05 is achieved from dc to 4 Gc; with impedance matching the range can be extended to 10 Gc. Tolerances to 2% are available, and units dissipate 1 w.

Filmohm Corp., Dept. ED, 48 W. 25th St., New York 10, N. Y.

**Availability:** from stock.

See at Show Booth 1006.



### Power Wire Cutter 572

Air-activated, diagonal head wire cutter type UA-100 is for high-volume production work. Equipped with an 8-ft air hose, it operates on existing air supplies with 90-psi line pressure. Portable gas supply can also be used. No special valves or controls are needed.

Kelsey-Hayes Co., Utica Drop Forge & Tool Div., Dept. ED, Utica 4, N. Y.

**P&A:** \$69.50; stock.

See at Show Booth 5031.



### Servo Motors 705

Size 8 servo motors eliminate the need for damping tachometers. Theoretical acceleration is 130,000 radians per sec<sup>2</sup>; no-load speed is 10,000 rpm; stall torque is 0.35 min; maximum output power is 0.6 w.

Daystrom, Inc., Transicoil Div., Dept. ED, Worcester, Pa.

**Availability:** 75 to 90 days.

See at Show Booth 2915.



### Power Resistors 711

From 0.05% to 3% tolerances are available for this series of power resistors. Wattage ratings are from 5 to 11 w at 25 C, and resistances range from 10 ohms to 200 K. Temperature coefficient is 20 ppm per C between -55 and +350 C. MIL specs are met.

Dale Electronics, Inc., Dept. ED, Columbus, Neb.

**Availability:** made to order.

See at Show Booth 2112, 2123.



### Ratio Box 596

Miniature ratio box model RB-521, an auto-tapped transformer, offers a ratio range of 0 to 1.111 at 50 to 3,000 cps with an accuracy of 10 ppm. Device is made for calibrating resolvers, synchros, and related components in ground support equipment. Unit measures 3-3/16 x 2-7/8 in.

North Atlantic Industries, Inc., Dept. ED, Plainview, N. Y.

See at Show Booth 2812-14.





Made for rapid ejection, these spring-action printed-circuit-board fasteners hold plug-in boards securely in place, but automatically eject the boards when lever arms are raised. Each board uses two fasteners.

Southco Div., South Chester Corp., Dept. ED, Lester, Pa.

See at Show Booth 4804.

**Nanosecond Pulser 605**

Providing 0 to 2,000 v amplitude, the model 961 nanosecond pulser has a repetition rate of 60 pps and an output impedance of 51 ohms. A light pulse is generated simultaneously with the electrical pulse, enabling phototure evaluation. Light output jitter is less than 4%.

Menlo Park Engineering, Dept. ED, 711 Hamilton Ave., Menlo Park, Calif.

See at Show Booth 2411.

**Sampling Plug-Ins 612**

Recurrent signals with rise times to 0.35 nsec can be observed with the type 4210 plug-ins, made for use with the 425 oscilloscope. Sweep speeds from 0.2 nsec per cm to 10 nsec per cm in 1, 2, and 5 steps are provided.

Allen B. DuMont Laboratories, Dept. ED, 750 Bloomfield Ave., Clifton, N. J.

See at Show Booth 1614-20.

**Solid-State Chopper 712**



Miniature chopper is all transistorized, has no moving parts. Noise level at 60 cps is 100  $\mu$ v. Unit is encased in a standard seven-pin miniature plug assembly.

Hughes Aircraft Co., Semiconductor Div., Dept. ED, 500 Superior Ave., Newport Beach, Calif.

See at Show Booth 2421-27.



**FROM TUNG-SOL...  
MIL TYPE GERMANIUM  
COMPUTER TRANSISTOR\***

Type JAN 2N526 is a PNP alloy-junction germanium transistor designed for use in small signal audio amplifiers, low to medium power amplifiers, and medium speed switching circuits. The exceptional stability of Tung-Sol 2N526 has been proved by 1,000-hour life tests.

Others in the Tung-Sol family of PNP alloy-junction germanium transistors are 2N381, 2N382, 2N383, 2N460, 2N161, 2N1705, 2N1706 and 2N1707.

Rigid quality control at Tung-Sol is your assurance of rugged long life and superior performance. Tung-Sol is a reliable source of audio and switching transistors.

Write for complete technical details: Tung-Sol Electric Inc., Newark 4, N.J. TWY:NK193.

\*Meets all requirements of MIL-S 19500,60C

**RELIABILITY DATA**

An analysis of 800 life test samples selected from latest production (several hundred thousand units) indicates the following:

- 1. **ELECTRICAL LIFE**
  - no catastrophic failures
  - no end point failures
- 2. **85°C STORAGE LIFE**
  - no catastrophic failures
  - no end point failures
- 3. **100°C STORAGE LIFE**
  - no catastrophic failures
  - no end point failures
- 4. **HUMID LIFE**
  - no catastrophic failure
  - 1 end point failure

MAXIMUM RATINGS				ELECTRICAL CHARACTERISTICS				
TYPE	Pc mW	Vcb V	Vce Ic V mA	Tj °C	MAX. Icsc μA	TYPICAL CONDITION	CONDITION	TYPICAL fmax (Mc)
<b>MILITARY</b>								
2N526	225	45	—	500	100	10 VCB=-30V	73 Ic=20mA VCE=-1V	3
<b>INDUSTRIAL</b>								
2N381	200	50	35	400	100	10 VCB=-25V	50 Ic=20mA VCE=-1.0V	3
2N382	200	50	35	400	100	10 VCB=-25V	50 Ic=20mA VCE=-1.0V	4
2N383	200	50	35	400	100	10 VCB=-25V	100 Ic=20mA VCE=-1.0V	3
2N460	200	45	—	400	100	15 VCB=-45V	25 IE=1 mA VCB=-6.0V	1.2
2N461	200	45	—	400	100	15 VCB=-45V	50 IE=1 mA VCB=-6.0V	4
2N1705	200	18	—	400	100	10 VCB=-10V	110 Ic=1 mA VCE=-6V hfe) T = 1 K0	4
2N1706	200	25	—	400	100	10 VCB=-25V	50 Ic=20mA VCE=-1V	3
2N1707	200	30	—	400	100	15 VCB=-25V	50 Ic=20mA VCE=-1V	3

TECHNICAL ASSISTANCE IS AVAILABLE THROUGH THE FOLLOWING SALES OFFICES: ATLANTA, GA.; COLUMBUS, OHIO; CULVER CITY, CALIF.; DALLAS, TEX.; DENVER, COLO.; DETROIT, MICH.; IRVINGTON, N.J.; MELROSE PARK, ILL.; NEWARK, N.J.; PHILADELPHIA, PA.; SEATTLE, WASH. IN CANADA: ABBEY ELECTRONICS, TORONTO, ONT.



CIRCLE 62 ON READER-SERVICE CARD

# NEW 1" DIAL

## BORG 3000 SERIES MICRODIAL®

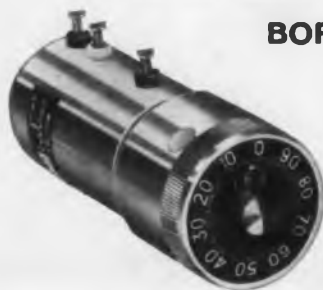

Model 3021  
Without Brake  
With 2100 pot  
Actual Size



Model 3021-3  
With Brake  
Actual Size

The new Borg 3000 Series concentric-scale Microdial is a 1" diameter, ten-turn, precision turns-counting dial. Ideal companion units for the 7/8" Borg 2100 Series and 2440 Series Micropot® potentiometers, these dials can be mounted on 1/4" centers — 40 brakeless models would fit conveniently on this page! □ The 3000 Microdial offers the instrument designer functional color-keying versatility and distinctive panel enrichment. Five brake knob colors and three combinations of numeral and background colors are standard. Custom treatment can be given to control knobs, brake knobs, numeral configuration and color. □ Despite miniaturization, the 3000 Microdial is easy to read and offers the same smooth, silent gear action inherent with all Borg Microdial Series. Contact your nearest Borg technical representative, distributor or write for complete data.

### STANDARD MODELS

For 1/4" Dia. Shafts (without brake):	
Models	Numeral Colors
3021	White numerals on black
3022	Black numerals on white
3023	Fluorescent numerals on black
For 1/4" Dia. Shafts (without brake):	
Models	Numeral Colors
3041	White numerals on black
3042	Black numerals on white
3043	Fluorescent numerals on black

For Models With Brake:

Add one of these dash numbers: 1=White brake knob 2=Black brake knob  
3=Red brake knob 4=Dark gray brake knob 5=Light gray brake knob

### BORG EQUIPMENT DIVISION

Amphenol-Borg Electronics Corporation  
Janesville, Wisconsin • Phone Pleasant 4-6616

*See them at Wescon!! Booths 3411-3413*

CIRCLE 63 ON READER-SERVICE CARD

## NEW PRODUCTS AT WESCON

### Test Equipment

602

Clean, functional styling is featured in this line of test instruments, including vtvm's, vom's, vswr indicators, rf power meters, and signal generators operating from hf to shf frequencies. Cabinets with low silhouettes have fold-away handles. Units have wind-up power cords. Panel meters are large and recessed.

Borg-Warner Controls, Dept. ED, P. O. Box 1679, Santa Ana, Calif.

See at Show Booth 2717-21.

### Fault Indicator

719



Miniature magnetic latch-in fault indicator, model HCM 3/4, is held permanently in off position until it receives an energizing signal, when it switches to on position, where it remains until reset. Indicating flag may be imprinted or color-coded. Indication is maintained under 500 cps vibration at 10 g.

Minneapolis-Honeywell, Precision Meter Div., Dept. ED, Grenier Field, Manchester, N. H.

Availability: 30 to 60 days.

See at Show Booth 3501-07.

### Digital Oscilloscope

613

A 35-mc general-purpose oscilloscope, model 425 accepts a variety of plug-ins. It has direct digital readout on both axes, plus universal controls for one-hand positioning of wave forms. The instrument can be used as an analog-to-digital converter.

Allen B. DuMont Laboratories, Dept. ED, 750 Bloomfield Ave., Clifton, N. J.

See at Show Booth 1614-20.

### Convergence Coils

728

For crt use. Convergence coils are solenoids which produce a magnetic field to return the crt magnetic beam exactly to the tube axis. Originally designed for use with the firm's Charactron tubes, they can be supplied for a variety of tubes having a 2-in. neck diameter.

General Dynamics/Electronics, Information Technology Div., Dept. ED, P. O. Box 2449, San Diego 12, Calif.

See at Show Booth 201-03.

# ELECTRON TUBE NEWS from SYLVANIA

**Strap Frame Grid Performance**



**Gold Brand Reliability**

Now in 5 New Sylvania  
Subminiature Tubes!

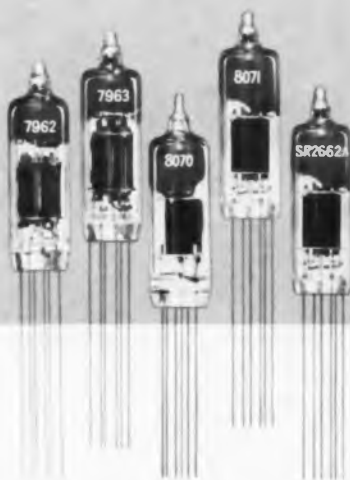

If you've been seeking tubes with an optimum combination of high performance, resistance to environmental stresses, genuine interchangeability, small size/weight, assured reliability...let Sylvania shorten your search.

Few devices can fill those requirements so impressively as these five new Gold Brand Subminiature Tubes featuring Strap Frame Grids...Sylvania-7962, 7963, 8070, 8071, SR-2662A. Here's why—

**HIGH PERFORMANCE**—Sylvania Strap Frame Grid design significantly improves tube characteristics for Gm, Gm:Ib, gain, bandwidth, and noise. (Fig. 1)

**ELECTRICAL STABILITY**—rugged Strap Frame Grids retain precise physical dimensions and, therefore, electrical stability, over an exceedingly long, useful life. Specially designed heaters tolerate wide voltage variations of  $\pm 10\%$  of specified ratings. Too, Gold Brand Subminiature types exhibit an inherent resiliency to plate and screen voltage surges.

## DURABILITY

**Shock**—Sylvania Gold Brand Subminiature Tubes are designed to withstand impact acceleration tests of 500g and fatigue tests of 2.5g for periods of 96 hours.

**Radiation**—they demonstrate remarkable resistance to radiation effects, tolerate dose rates of  $10^{12}$ nv, total dosage of  $10^{16}$ nvt.

**Temperature**—not susceptible to thermal runaway, they perform at ambient bulb temperatures of as high

as 220°C, withstand prolonged storage temperatures.

**INTERCHANGEABILITY**—exceptionally low dispersion of characteristics (electrical uniformity) from tube to tube within a given type offers genuine interchangeability without costly preselection and testing.

**RELIABILITY**—several authoritative, documented examples of reliability under field and laboratory conditions are cited on the following page.

# NEW DESIGN SYLVANIA SUBMINIATURE TUBES FEATURE STRAP FRAME GRIDS

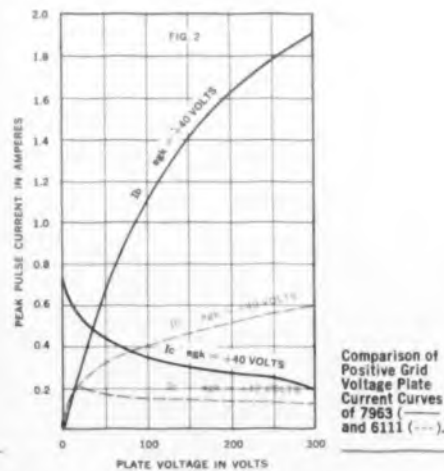

FIG. 1 AVERAGE CHARACTERISTICS

	7962 double triode	7963 double triode	8070 triode	8071 triode	SR-2662A double triode	Units
Ef	6.3	6.3	6.3	6.3	26.5	V
If	235	350	125	125	90	mA
Eb	60	100	110	150	55	V
Rk	220*	270*	—	100	—	Ohms
Ib	9.0*	7.5*	9.0	13.0	5.0*	mA
Gm	9,500*	13,000*	11,000	13,000	9,000*	μmhos
Gm:Ib	1,055*	1,730*	1,222	1,000	1,800*	μmhos:mA
Mu	20*	40*	58	55.2	20*	

Noise-matched Conditions						
	Grounded Cathode Circuit (200mc)		Grounded Grid (480mc)	RF Cascade Amp. (213mc)		
Gain	14.8*	15.1*	17.5	14.0	21*	db
BW	8.0*	9.5*	11.8	9.5	8.5*	mc
NF	4.0*	4.0*	4.4	7.2	6.4*	db

\*SINGLE SECTION VALUES

### Sylvania-7963, medium-mu double triode . . .

For use as an RF or pre-IF amplifier in missiles, radar, radiosonde and beacon receivers, telemetering equipment or as a blocking tube oscillator. It's a high-performance version of the general-purpose 6021 with higher heater power and huskier cathode. Per section: Gm is 13,000 μmhos, Gm:Ib is 1,730.

### Sylvania-7962, medium-mu double triode . . .

Featuring very low heater power of 0.7W per section, low Eb of 30V per section. It's designed for application as an RF or pre-IF amplifier or multivibrator in conjunction with low B<sup>+</sup> supplies. Per section: Gm is 9,500 μmhos (80% higher than conventional prototypes), Gm:Ib is 1,055.

### Sylvania-8070, high-mu triode . . .

Draws only 125mA @ 6.3V heater power. It's used as an RF amplifier in communication equipment, pre-IF amplifier in navigational radar and beacon receivers, telemetering receivers. Gm is 11,000 μmhos, Gm:Ib is 1,222. 8070 provides 2.5 db better gain than usually encountered in present high-performance types.

### Sylvania-8071, high-mu VHF triode . . .

Is the industry's first subminiature tube for grounded grid amplifier applications. It offers very low heater power of 125mA @ 6.3V, as much as 50% less than types with comparable Gm and Ib. Gm is 13,000 μmhos. 8071 exhibits a 2.5 to 7 db gain improvement, 1.5 to 4 db noise improvement at 480mc than normally encountered with popular grounded-grid RF amplifier types.

### Sylvania SR-2662A, medium-mu VHF double triode . . .

Features 26.5V heater and plate operation. Designed for use as a cathode-follower or RF amplifier-mixer in hybrid systems. In airborne or mobile equipment using a 26.5V energy source, SR-2662A eliminates the need for special plate and heater supply circuits, enhancing equipment compactness and reliability. Per section, Gm is 9,000 μmhos.

Examine the extraordinary performance advantages of Sylvania Strap Frame Grid Subminiature Tubes for your design. Ask your Sylvania Sales Engineer for full information, or write for technical data to Electronic Tubes Division, Sylvania Electric Products Inc., 1100 Main St., Buffalo 9, N. Y.

# How to predict reliability of end-equipment!

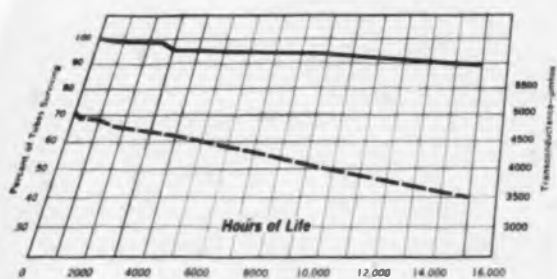

FIG. 4

6111 Survival curve for inoperatives through 15,000 hours (—). Median for Gm through 15,000 hours (---).

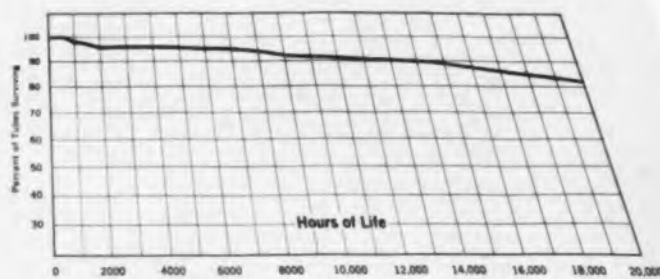

FIG. 3

5718 Survival curve for inoperatives through 20,000 hours.

A laboratory-proven design transferred to production line—then to actual field-use—may sometimes perform in an unexpected, erratic manner. Yet Management and Military are demanding increased assurances of reliability. How do you solve the dilemma for your design? One way: specify components offering documented, field-proven reliability.

**Take the case for tubes.** Tests by ARINC Research Corp.\* illustrate the dramatic improvements in tube reliability since 1954. The results of tests conducted aboard naval vessels show a combined tube removal rate of 15% per 1000 hours in 1954. By 1960 this figure dropped to 1.2% for miniature tubes and a remarkable 0.19% for subminiature tubes. All the controlled subminiature types were Sylvania tubes.\*

Survival tests by Sylvania (Figs. 3 & 4) on Gold Brand Subminiature types 5718 and 6111 demonstrate similar outstanding results. Sylvania-5718, UHF medium-mu triode, shows better than 90% survival at 12,000 hours. Sylvania-6111, medium-mu double triode, shows an average decline in Gm of only 2.4% per 1000 hours and better than 90% tube survival at 12,000 hours.

Further quantitative measure of reliability is provided by Sylvania acceptance criteria for Gold Brand Subminiature Tubes. Based on the average number of cumulative failures per 1000 hours for a 5-lot moving average, instead of the customary 1-lot, it offers a stringent control over an exceptionally wide range of production. And, it provides a highly accurate basis for statistical prediction of % failure rate in 1000 tube hours.

If you're being asked to predict reliability of your military or industrial design, call upon the expert assistance of Sylvania. Your Sylvania Sales Engineer will gladly supply detailed documentation of Gold Brand Subminiature Tube reliability.

\*Sylvania-5636, 5644, 5647, 5718, 5719, 5840, 5899, 5902

The subminiature tubes were use-tested in SRR-13A receivers.

†Courtesy ARINC Research Corp. as published in publication #101-28-166, #101-26-160

# MICROWAVE DEVICE NEWS from SYLVANIA

**50%  
SMALLER!  
75%  
LIGHTER!**



**Low Cost, High Performance**

**PPM-  
FOCUSED  
TWT's**

**for operation from 1 to 12Gc**

Now available from Sylvania—a new family of traveling wave tubes designed for high-performance microwave amplifier applications where economy, compactness, light weight are vital design considerations.

Less than 4 lbs. in weight and 2¼" in maximum diameter, these TWT's present unusual opportunities for compact design of such end-products as microwave test equipment. No electrical performance is sacrificed in attaining these advantages over bulky, 12-16 lb. solenoid types. In addition, they are priced at less than \$1,000 each in quantity.

For further information contact your nearest Sylvania Sales Engineering Office, or write Electronic Tubes Division, Sylvania Electric Products Inc., 1100 Main St., Buffalo 9, N. Y.

Frequency Range (Gc)	Sylvania Type	Power Output	Min. Gain (db)
1-2	TW-4267	15mW	35**
1-2	TW-4268	1W	30*
2-4	TW-4261	10mW	35**
2-4	TW-4260	1W	30*
4-8	TW-4281	10mW	35**
4-8	TW-4278	1W	30*
8-12	TW-4282	5mW	35**
8-12	TW-4273	1W	30*

\*\*small signal gain      \*at saturation



**Hewlett-Packard specified Sylvania TWT in the new versatile 1-Watt amplifiers, Models 489A (1 to 2 Gc) and 491C (2 to 4 Gc).**

AT WESCON — see the Sylvania exhibit, Booth #3201, 3, 5, 7, 9, 11, 12, 3302, 4, 6, 8.

#### EQUIPMENT SALES OFFICES

**CHICAGO:** 2201 N. Cornell Ave., Melrose Park, Ill.; **ESHERINGHAM:** 9-2525, **GREENWICH:** 411 Oak St., Plaza 1-8454; **DALLAS:** 100 Farleya St., Riverside 1-4836; **DAYTON:** 333 W. First St., **MEMPHIS:** 3-6227; **FORT WORTH:** 4740 Coldwater Rd., TS-1145; **LINCOLN:** 6505 E. Gayhart St., **MEMPHIS:** 3-5371; **NEW YORK CITY:** 3600 Huxley St., **Teterboro, N. J.:** AT-8884; **N. Y. -UPSTATE:** Seneca Falls, LD-8881; **PHOENIX:** Suite C, 1500 Edgewater Dr., P.O. Box 7248, **Orlando, Fla.:** **CHARLOTTE:** 4-8245; **SAN FRANCISCO:** 1811 Adrian Rd., **Berkeley, Calif.:** **OTTAWA:** 7-3500; **WASHINGTON, D. C.:** 1120 Connecticut, N.W.; **Federal:** 7-6600; **WILMINGTON, DEL.:** 281 Main St., **CL: 3357**

# SYLVANIA

SUBSIDIARY OF

**GENERAL TELEPHONE & ELECTRONICS**





## Zener Diodes

480

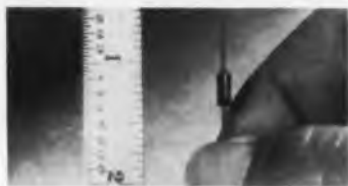

Cover 3.9 to 33 v. Rated at 250 mw, types 1N1313 to 1320 subminiature glass Zener diodes cover 8.2 to 33 v; types 1N1927 to 1937 cover 3.9 to 27 v. Temperature coefficient is 0.06% per deg C and impedance is to 8 ohms at 10 ma. Both 5% and 10% tolerances can be furnished.

International Rectifier Corp., Dept. ED, 233 Kansas St., El Segundo, Calif.

P&A: \$1.93 to \$3.60; stock.

See at Show Booth 1701-03.

## Mounting Blocks

687

Of beryllium oxide. These mounting blocks insulate components electrically while providing a path for heat flow away from them. In some cases, blowers and other cooling devices can be eliminated.

National Beryllia Corp., Dept. ED, First & Haskell Aves., Haskell, N. J.

See at Show Booth 4624.

## Telephone Pickup Coil

404

To eliminate stray hum pickup. This telephone pickup coil is for use with high-impedance input tape recorders, amplifiers and dictating machines used in transcribing telephone conversations. Model HP-71 is with a molded phone plug and model HP-70, without.

Microtran Co., Inc., Dept. ED, 145 E. Mineola Ave., Valley Stream, N. Y.

Price: \$7.50 and \$6.95.

See at Show Booth 911.

## Time-Delay Relay

477



For up to 5 amp with spdt or dpdt contacts. Type B hydraulic-magnetic time-delay relay can have delays of 1/4 to 120 sec. Snap-action contacts are completely enclosed. A continuous-duty coil is used. The relay can be furnished for ac or dc operation.

Heinemann Electric Co., Dept. ED, 229 Magnetic Drive., Trenton 2, N. J.

Availability: sample quantities by September.

See at Show Booth 3701-3703.



RCA Service Company maintains Points of Service from coast-to-coast.

*If you manufacture electronic or integrated data processing equipment...*

# Expand your sales opportunities with expert nation-wide service

- without investing in service personnel or training!
- without spending for equipment and service overhead!

If your sales growth has been restricted due to lack of service facilities, RCA Service Company can open new frontiers of opportunity for you.

Through its network of Service Points from coast-to-coast, this highly skilled electronic service organization will function as *your own service department* to install and maintain your equipment on a regular basis. We'll work for you on a contract basis at a fixed annual rate which will provide Scheduled Preventive Maintenance, as well as Demand Service Requirements. More than this, we'll assume your warranty obligations covering both installation and maintenance, if you wish.

Many manufacturers of electronic products have found RCA Service Company to be a highly profitable adjunct to their sales efforts—for good service means satisfied customers, and satisfied customers mean more business.

**FREE BOOKLET!** For full information on how RCA Service Company can help you expand your sales opportunities, send for our free booklet, "NEW PROFIT FRONTIERS FOR ELECTRONIC EQUIPMENT MANUFACTURERS." Just clip the coupon, and attach it to your company letterhead.

**RCA SERVICE COMPANY**  
A Division of Radio Corporation of America  
Dept. A, Bldg. 206-1  
Camden 8, New Jersey

Yes! I'd like to receive a copy of your new booklet, "New Profit Frontiers for Electronic Equipment Manufacturers," without obligation.

NAME \_\_\_\_\_ TITLE \_\_\_\_\_

COMPANY \_\_\_\_\_

ADDRESS \_\_\_\_\_

CITY \_\_\_\_\_ ZONE \_\_\_\_\_ STATE \_\_\_\_\_



The Most Trusted Name in Electronics  
RADIO CORPORATION OF AMERICA

CIRCLE 65 ON READER-SERVICE CARD

## NEW PRODUCTS AT WESCON

### Circuit Breaker

476



For severe environments. Series SM military-type circuit breaker is offered in two and three-pole types. Current ratings are from 0.05 to 15 amp; voltage ratings are 120 v ac at 60 or 400 cps or 50 v dc. Units can have fast or slow inverse-time delay.

Heinemann Electric Co., Dept. ED, 229 Magnetic Drive, Trenton 2, N. J.

*Availability: sample quantities, September.*

See at Show Booth 3701-03.

### Magnetically Held Switches

424



DPDT magnetically held switches, type 6ET1-T are sealed momentary-action toggle switches with a built-in solenoid. The solenoid permits conversion to a maintained-contact type switch and provides remote electrical release of the toggle.

Minneapolis-Honeywell Regulator Co., Micro-Switch Div., Dept. ED, Freeport, Ill.

See at Show Booth 3501-07.

### FM Transmitter

474



Rated at 12 w, type 1009 fm transmitter covers 215 to 260 mc. It has a 0.01% crystal-stabilized carrier. Sensitivity is 0.01 v per kc; modulation range is 20 cps to 100 kc. The rf power output can be increased to 20 w with plate voltage input. Volume is 37.5 cu in.

American Bosch Arma Corp., Tele-Dynamics Div., Dept. ED, 5000 Parkside Ave., Philadelphia, Pa.

*Availability: samples.*

See at Show Booth 4126-28.

## BRAND-REX CABLEMANSHIP\*

### BOEING'S Communications Link between Minuteman Systems!

America's first "push-button" missile system, the Minuteman is predicated upon high reliability, maximum simplicity and greatly improved cost effectiveness. Supporting the effective missilemanship of Boeing, the Minuteman systems integrator, is the Cablemanship of Brand-Rex.

Linking the vast complex of Minuteman Communications systems are a broad range of Brand-Rex multi-conductor cables. By combining the most suited plastics for the specific purpose, they insure functional and environmental integrity. Polyethylene, with its excellent electrical characteristics, is used as primary insulation; nylon jackets impart dimensional stability to single conductors as temperature increases; and over-all neoprene jackets provide low tem-

perature flexibility, abrasion resistance and resiliency. The processing problems inherent in such material combinations have been successfully solved by Brand-Rex technicians.

If your requirements for wire, cable and insulating materials demand the reliability, uniformity, and adherence to specifications of the Communications system of the Minuteman project, call on the Cablemanship of Brand-Rex!

\*Brand-Rex Cablemanship — a combination of technology, skill, design engineering, 3-plant production capability and technical service provided by a tightly knit organization of cable specialists . . . all backed by the vast resources of American Enka Corporation.



DIVISION OF American ENKA Corporation  
DEPT. NC, 39 SUDBURY ROAD, CONCORD, MASSACHUSETTS  
TELEPHONE: EMERSON 9-9630

VINYL, TEFLON, POLYETHYLENE, NYLON WIRE AND CABLES, ELECTRICAL TUBING AND SLEEVING — UHF CAST PLASTICS

See us at the Wescon Show . . . Booth 4604  
CIRCLE 66 ON READER-SERVICE CARD

## BRAND-REX CABLEMANSHIP

the big difference  
in Teflon® Insulated  
Wire and Cable!

From the smallest single U/L approved hook-up wire to the most complex Teflon primary insulated and jacketed multiconductor cable, Brand-Rex Cablemanship makes the big difference.

Brand-Rex Cablemanship is a combination of technology, skill, progressive cable design engineering, the production capability of three modern plants and technical field service . . . all delivered through a tightly-knit organization backed by the vast resources of the American ENKA Corporation.

Regardless of how varied your requirements may be for conductors, lay-up patterns, shields, armors or jackets, your specifications will be met when you place your confidence in Brand-Rex!



Write for complete information and samples today.

®Registered Trademark of DuPont



DIVISION OF

American ENKA Corporation  
SUDBURY ROAD, CONCORD, MASSACHUSETTS  
TELEPHONE: EMERSON 9-9630

CIRCLE 67 ON READER-SERVICE CARD  
ELECTRONIC DESIGN • August 2, 1961

## Carbon Potentiometers

426



Rating is 3/4 w. Model N hot-molded carbon composition potentiometers have rotation of  $300 \pm 3$  deg with a rotational torque of 5 oz-in. They meet environmental and test requirements of MIL-R-94B. Units with lock bushing or standard shaft can be furnished.

Globe-Union Inc., Centralab Electronics Div., Dept. ED, 900 E. Keefe Ave., Milwaukee 1, Wis.  
**Availability:** stock.

See at Show Booth 920-22.

## Tuning Fork Oscillator

543



Output is 10 w. Series DFO-71 tuning fork oscillator has less than 5% harmonic distortion in the range of 60 to 6,500 cps. Frequency tolerance is  $\pm 0.005\%$  to  $\pm 0.04\%$ , depending on temperature and frequency. The unit uses silicon semiconductors and is encapsulated in a package 2 x 6 x 5 in.

Delta-F, Inc., Dept. ED, 113 E. State St., Geneva, Ill.

**Availability:** 6 to 7 weeks.

See at Show Booth 4503.

## Power Supply

418



Output is 24 to 30 v dc at 35 amp max. Model EA-267 power supply has a regulation of  $\pm 0.1\%$  for line changes of  $\pm 10\%$  with constant load,  $\pm 1\%$  for load changes of 2 to 35 amp. Input is 208 v ac, 60 cps, three-phase. Ripple is 100 mv max. Mil specs are met.

Thermador Electrical Manufacturing Co., Div. of Norris-Thermador Corp., Dept. ED, 715 S. Raymond Ave., Alhambra, Calif.

**P&A:** \$2,870; 4 weeks.

See at Show Booth 1811.

## CAL-R POWER RESISTORS

offer Reliability & Proven Performance

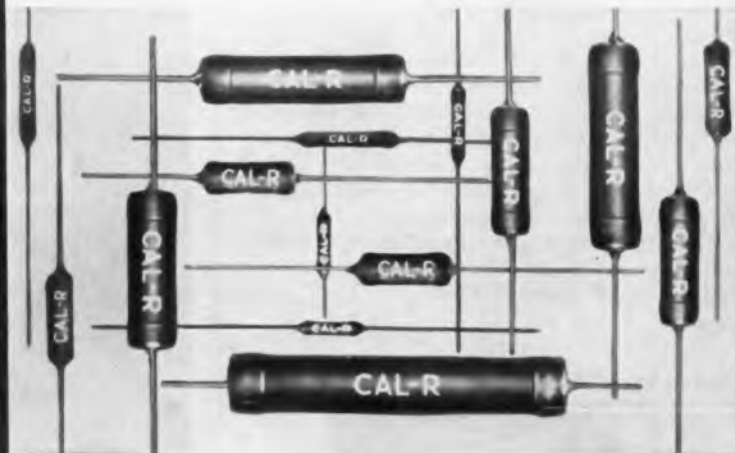

## SILICONE COATED SERIES "SR" MINIATURE PRECISION WIRE WOUND POWER RESISTORS

For the Engineer who Demands Accuracy

15 types from .5 to 10 watts meet or exceed applicable requirements of MIL-R-26C, Characteristic "G."

**SPECIFICATIONS** Small size for wattage rating. Single layer space wound with largest wire permissible. Maximum wire coverage of core for cooler operation and reliability. Thermal shock proof of  $275^{\circ}\text{C}$  to  $-55^{\circ}\text{C}$ . Impervious to moisture and Salt spray. Insulation strength 1000 VAC. Temperature coefficient .00002 /degree C. Close tolerance to .05%. Low noise and thermal EFM. High stability, less than 1% drift in 1000 hours operation at full wattage rating. Resistance range from .05 to 210,000.

Write or call for complete Data. Unsurpassed design characteristics for highest performance and new standards of stability and reliability.

## CALIFORNIA RESISTOR Corporation

1631 Colorado Avenue, Santa Monica, California  
UPTon 0-6867 • EXbrook 3-9861

CIRCLE 68 ON READER-SERVICE CARD

## NEW PRODUCTS AT WESCON

### Switches and Indicators

425



Miniature series 302PB1 pushbutton switches maintain operation when the button is depressed and released with the operating mechanism assuming a nonoperative position the second time the button is depressed. Series 302LT indicators are similar in appearance.

Minneapolis-Honeywell Regulator Co., Micro-Switch Div., Dept. ED, Freeport, Ill.

See at Show Booth 3501-07.

### Connector Blocks

470



Permit solderless connection between chassis and terminal-card modules. Crossover connector blocks mount to the underside of the chassis and hold circuit cards carrying all interconnections. Circuits may be printed, etched or wired.

Alden Products Co., Dept. ED, 117 N. Main St., Brockton, Mass.

Availability: stock.

See at Show Booth 4219.

### Axial-Lead Resistors

422



Wirewound, military-grade axial-lead resistor types RW67, 68 and 69 have resistance ranges of 0.1 to 3.6 K, 8.2 K and 910 ohms. Temperature coefficient is 20 ppm per deg C. Tolerance is  $\pm 5\%$ .

Ohmite Manufacturing Co., Dept. ED, 3646 Howard St., Skokie, Ill.

See at Show Booth 1601-03.



# NOW...A STATIC INVERTER TO WITHSTAND PUNISHMENT LIKE THIS ON





## TANKS AND HEAVY-DUTY COMBAT VEHICLES

### New Hamilton Standard steam-proof inverter designed to meet rugged secondary power requirements in ambients to 150°F... shocks to 50G's

A new solid-state inverter has been developed by Hamilton Standard to meet the full range of combat conditions in tanks and other ordnance vehicles. This unit is the result of a comprehensive development program in which the primary design criteria were exceptional reliability in temperatures as high as 150°F and dependable performance despite shocks to 50G's and constant vibration.

Rated at 18-30 V DC input; 115 +5, -3 V AC output, the inverter operates at 400 cycles  $\pm 1\%$  and in ambients from -65°F to +150°F. The unit is silent, fully silicon-transistorized, and utilizes conservatively rated components throughout. It is completely sealed against water, dirt, dust

...and impervious even to steam cleaning. Because the inverter is self-enclosed, internal temperatures may attain 285°F, yet performance is unaffected.

Although designed specifically for tanks, this static inverter suits power requirements for a variety of ordnance vehicles. It is an ideal power supply for gyros, servos, control motors, and power computers in such vehicles as: weapon or personnel carriers, missile launchers, tank destroyers, and gun directors.

An illustrated static power conversion guide is available on request. For your copy, write: Hamilton Standard Electronics Section 120, Broad Brook, Connecticut.

**UNITED AIRCRAFT CORPORATION**  
**HAMILTON STANDARD DIVISION**

**ELECTRONICS**

CIRCLE 69 ON READER-SERVICE CARD

ELECTRONIC DESIGN • August 2, 1961

### Switching Transistor

420



Dissipation is 150 mw, saturation voltage is 0.05 v and gain bandwidth product is  $f_t$  of 150 mc. Type 2N2048 switching transistor is designed for applications in saturated switching circuits in high-speed computer logic and automation equipment.

Philco Corp., Lansdale Div., Dept. ED, Lansdale, Pa.

**P&A:** \$1.32; stock.

See at Show Booth 919-21.

### Indicator Lights

379



Water-tight indicator lights type 177-8430-971 have two 1/16-in. neoprene retained O-ring seals. Units measure 1-3/16 in. in overall length and mount in single 15/32-in. clearance holes. They are fully insulated with military-grade phenolic material.

Dialight Corp., Dept. ED, 60 Stewart Ave., Brooklyn 37, N. Y.

**Availability:** samples, 5 to 15 days.

See at Show Booth 2519-21.

### RF Power Amplifier

693



For 215 to 260 mc. Model 1114 power amplifier has an output of 15 w at 400 v dc from an input of 2 w, or 15 w at 250 v dc from 3.5 w. It withstands 100-g shock, 100-g acceleration and 15-g vibration from 20 to 2,000 cps. Temperature range is -55 to  $\pm 100$  C.

American Bosch Arma Corp., Tele-Dynamics Div., Dept. ED, 5000 Parkside Ave., Philadelphia, Pa.

**Availability:** samples.

See at Show Booth 4126-28.

DC to 5000 cycles  
over an amplitude  
of 4" peak to peak



#### NEW SANBORN "650" SYSTEM

OFFERS DIRECT READOUT, 8 TO 24 CHANNELS, ALL SOLID STATE CIRCUITS, FOR RACK MOUNTING OR INDIVIDUAL CASES.

**SENSITIVITY** 20 mv input gives 8" deflection; 12 attenuator steps to X5000. smooth gain control.

**INPUT RESISTANCE** 100,000 ohms all ranges, floating and guarded; DC source resistance must be kept below 1000 ohms on mv ranges only.

**COMMON MODE PERFORMANCE** Rejection at least 140 db at DC, tolerance to  $\pm 500$  volts, max.

**GAIN STABILITY** Better than 1% to 50° C. and for line voltage variation from 103 to 127 volts.

**LINEARITY** 1½% of full scale (8 in.)

**NOISE** 0.02" peak-to-peak, max.

**MONITOR OUTPUT** On front panel; provides  $\pm 1v$  full scale across 100,000 ohm load

**POWER REQUIREMENTS** 103-127 volts, 60 cycle AC, 625 watts



Contact your Sanborn Sales-Engineering Representative for complete specifications and applications engineering assistance. Offices throughout the U. S., Canada and foreign countries.

Here's the *one* system that lets you record inputs from DC to 5 KC within 3 db at 4" peak-to-peak amplitudes, without changing galvanometers. The "650" system consists of an 8-channel medium gain, general purpose amplifier unit driving a high speed, high resolution optical oscillographic recorder. It can be easily built into your system, packaged in a mobile cabinet or housed in individual cases. The single-chassis, 7" high amplifier module has 8 separate channels, *complete from floating and guarded inputs to galvanometer outputs*; each channel comprises a front end modulator and input transformer, carrier amplifier, demodulator, filter and driver amplifier. Power Supply and Master Oscillator Power Amplifier are built-in. All amplifier elements are plug-in transistorized units for easy servicing.

Immediately readable recordings are made on 8" wide daylight-loading ultra-violet-sensitive charts which require no chemical development. Features of the 12¼" high recorder unit include 9 electrically controlled chart speeds from ¼" to 100"/sec; calibrated monitoring screen; automatic trace identification and timing lines at 0.01 or 0.1 sec. intervals; amplitude lines spaced 0.1" apart which can be blanked from ¼, ½, ¾ or all of chart. Recorder is available with an 8-, 16- or 24-channel galvanometer block which is then equipped with the number of galvanometer elements desired by the customer. Either the Recorder or Amplifier are also available as individual units for use with other equipment.

**SANBORN COMPANY**  
INDUSTRIAL DIVISION  
175 Wyman St., Waltham 54, Massachusetts

## NEW PRODUCTS

AT WESCON

### Subminiature Relay 432



Sensitivity is 20 mw. Designed for an operational life of over 100,000 cycles, model BR-12K subminiature relay withstands 50-g vibration through 3,000 cps and 125-g shock for 11 msec. It meets all requirements of MIL-R-5757D.

Babcock Electronics Corp., Babcock Relay Div., Dept. ED, 1645 Babcock Ave., Costa Mesa, Calif.  
P&A: \$14.50; 2 to 3 weeks.

See at Show Booth 312.

### Silicon Transistors 408

Rated at 150 w, types 2N1015 and 2N1016 silicon transistors are diffused-junction npn devices with a collector-emitter voltage of 100 v, a saturation resistance of 0.5 ohm and a minimum beta of 10 at 5 amp. Uses include in power converters, power-supply regulators and servo amplifiers.

Silicon Transistor Corp., Dept. ED, Carle Place, N. Y.

See at Show Booth 1224.

### High-Speed Multiplexer 435



A 50-channel unit, the MXV5 solid-state multiplexer has a rate of over 20,000 independent samples per sec. Comprised of five 10-channel 5 x 8 in. cards, it operates in conjunction with the firm's V16-AD converter which has conversion rates up to 1,400 per sec.

Adage Inc., Dept. ED, 292 Main St., Cambridge 42, Mass.

See at Show Booth 3610.

## RF Wattmeter and Load 427



For milliwatt ranges, model 6254 rf wattmeter and load can be furnished with ranges to 25, 50, 100, 250, 500 or 1,000 mw. It measures power output and terminates low-power 50-ohm systems. Power is direct reading from 30 to 500 mc with a vswr of less than 1.15.

Bird Electronic Corp., Dept. ED, 30303 Aurora Road, Cleveland 39, Ohio.

P&A: \$85; stock.

See at Show Booth 1922-24.

## Microminiature Relay 391

For military use. Type MM-22 microminiature dpdt relay has a life of 10 million operations in dry circuit applications and a contact life of 100,000 cycles at 3 amp or 500,000 at 2 amp. Operate and release times are 5 msec max. Dimensions are 0.9 x 0.4 x 0.961 in.

Automatic Electric Co., Dept. ED, Northlake, Ill.

P&A: \$20; by December.

See at Show Booth 2201-03.

## Sonic Cleaning System 428



Cleaner, rinse and dryer comprise the 1420-A sonic cleaning system. Dimensions of the cleaning chamber are 14 x 20 x 11-1/2 in. Frequency is 21 kc; generator output is 800 w. Input is 205 to 250 v, 60 cps, single-phase. Each of the three units can be furnished separately.

The Bendix Corp., Pioneer Central Div., Dept. ED, Davenport, Iowa.

See at Show Booth 2606.

CIRCLE 71 ON READER-SERVICE CARD ►

Compact chassis of Osborne 300 CBT Citizens Band Transceiver. "Transfilter" Combinations eliminate need for critical tuned transformers.

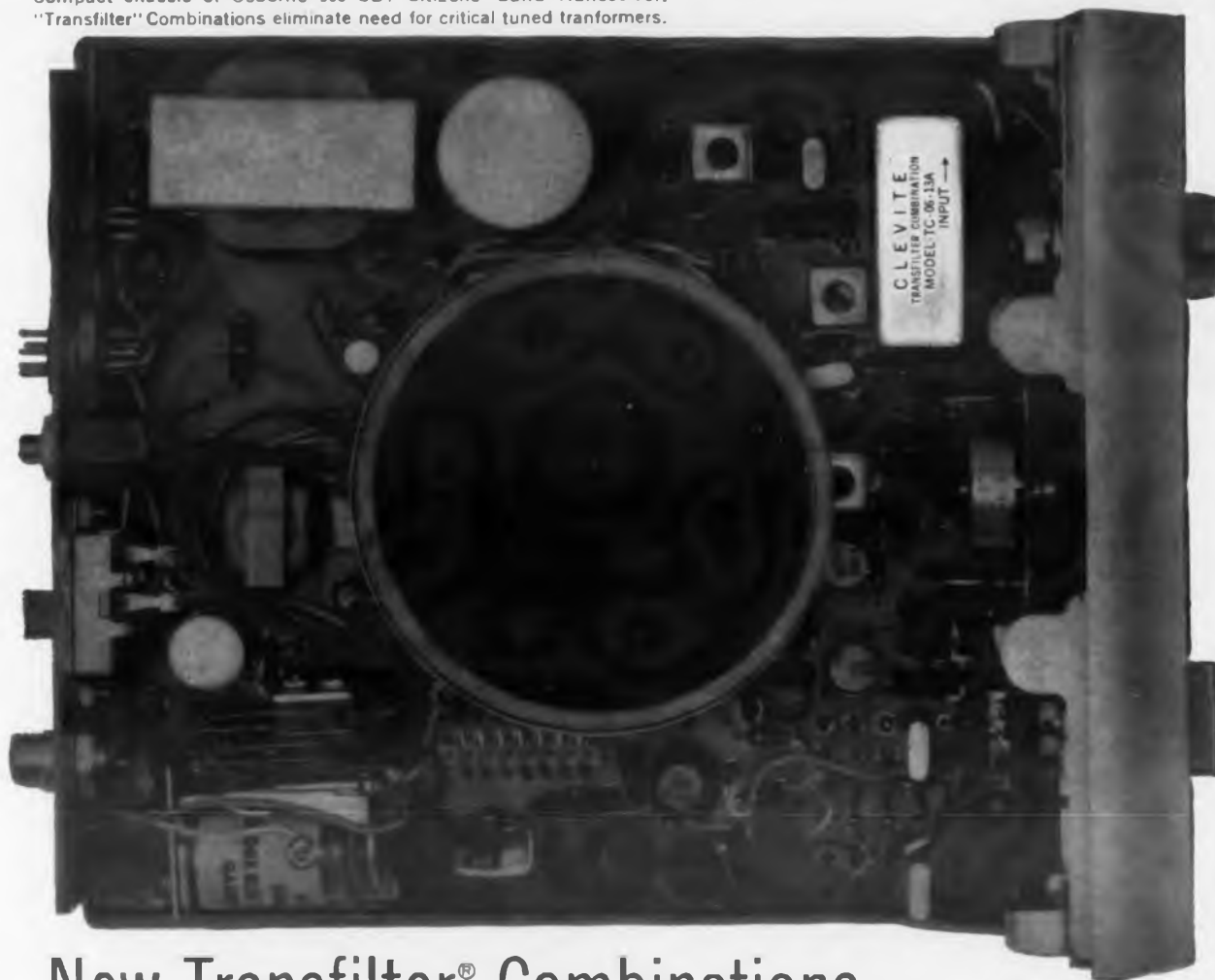

## New Transfilter® Combinations

## Greater selectivity in a miniature package

... and increased stability at a decreased cost. Further, magnetic shielding can be eliminated as well as the necessity for factory and field alignment. That's why CLEVITE'S ceramic i-f filters are rapidly replacing conventional components in today's mobile or high quality commercial receivers. Basic component of these rugged fixed-tuned devices is the CLEVITE piezoelectric "Transfilter" developed especially for great stability of resonant frequency with respect to time and temperature. Cascading and coupling these resonators provide excellent selectivity at desired bandwidths. Size, 1 1/2" x 3/4" x 2.0" high; Center Frequency, 455 kc; Shape Factor (60/6db), 3:1 to 6:1; Bandwidth, 4 to 20 kc; Insertion Loss, 6 to 12 db max. (depending on bandwidth); Impedance, 2700 ohms in and out; Temperature Range, -20°C to +90°C. Call, write or wire for complete details.



## CLEVITE ELECTRONIC COMPONENTS

232 Forbes Road, Bedford, Ohio / Division of CLEVITE Corporation

# Do you have any of these transient analysis problems?

Development of a unique new instrument—the Hughes High-frequency Memo-scope® Oscilloscope—now makes solving transient analysis problems quicker, easier and more economical. Secret of this instrument is its ability to freeze high frequency impulses until intentionally erased. It is the only instrument on the market today that can give you stored response at fast writing speeds! Here are six case histories which demonstrate the types of problems which can be solved:

**Low Level Signal Data Processing**—A leading West Coast research facility used the Memo-scope oscilloscope for passive satellite tracking. The instrument was able to integrate very small signal levels over a very high random noise level. Result: the company was able to track satellites in an environment where the noise amplitude actually exceeded the signal amplitude.

**Quality Control Inspection**—A large Eastern firm uses the Memo-scope oscilloscope to dramatically improve the reliability levels of incoming components and systems which were subject to transient behavior. Typical items tested included relays, switches, coils, capacitors, diodes, transistors, transformers, and complete computer and servo systems.

**Shock and Impact Testing**—A well-known missile manufacturer used the Memo-scope oscilloscope to calibrate accelerometers. Using a Model 105 Memo-scope oscilloscope, with a Multitracer Unit, this firm was able to compare a shock signal from a "calibrated standard" accelerometer against newly purchased units and those undergoing their periodic checks.

**Medical Research**—A large Texas medical institution used this unique Hughes instrument for a study of the human nervous system. They were able to obtain an early diagnosis of nervous system deterioration by measuring the exact elapsed time that an electrical pulse takes to pass between two points in the central nervous system.

**Welding Control**—To permit high-reliability welding of metals, a leading Southern California aircraft and missile



manufacturer uses the Memo-scope oscilloscope as a precision monitoring device. They were able to precisely control heat, pressure and time throughout the entire welding process.

**System Check-out: Production and Field**—A well-known aircraft manufacturer used the Memo-scope oscilloscope as a key element in a check-out console. The communications and radar automatic gain controls, as well as the servo systems adjustments, were precisely monitored. It was also used in cross-talk analysis; interference monitoring; stress, vibration and flutter analysis; and general trouble-shooting.

## SPECIFICATIONS

### Conventional Mode:

- DC to 10 mc Band Pass
- Sweep Range: 0.1  $\mu$  secs/division to 1 sec/division; 5X Magnifier for speeds to .02  $\mu$  secs/division; Multiplier for sweeps long as 10 secs/division
- Rise Time: 35 nanoseconds
- Built-in Delay Line (0.25  $\mu$  secs)
- Numerous Trigger Selections
- Plug-in Preamplifiers

### Storage Mode:

- (All features of Conventional Mode, PLUS:)
- One million inches per sec Writing Speed
  - Unlimited Storage Time
  - Fast Erase (less than 150 milliseconds)
  - X-Y Plotting
  - Single Shot Trigger
  - Photographer Trace Directly Off Scope Face

If you have a transient analysis problem and would like a complete technical data sheet, you are urged to write: Memo-scope Oscilloscope, Hughes Industrial Systems Division, Hughes Aircraft Company, Box 90904, Los Angeles 45, California.

CIRCLE 72 ON READER-SERVICE CARD

## NEW PRODUCTS AT WESCON

### Power Supplies

421



With outputs of 500 ma or 30 amp at 0 to 40 v dc. Model TVCR-040-0.5 power supply has a response time of 25  $\mu$ sec; model TVCR-040-30, 50  $\mu$ sec. Line regulation is  $\pm 0.01\%$  or 2 mv,  $\pm 0.02\%$  or 50  $\mu$ a; load regulation is the same. Remote programing and remote sensing are possible.

Perkin Electronics Corp., Dept. ED, 345 Kansas St., El Segundo, Calif.

**P&A:** type 040-0.5, \$198; 040-30, \$1,598; to 120 days.

See at Show Booth 516-18.

### Radiation Thermometers

380



For airborne or field use, models 14-310 and 14-311 portable radiation thermometers measure radiation from remote water surfaces, clouds, backgrounds or other targets. Range is 15 to 85 F; accuracy is  $\pm 1.5$  F; sensitivity is 0.5 F. Power required is 70 w.

Barnes Engineering Co., Dept. ED, 30 Commerce Road, Stamford, Conn.

**Availability:** stock.

See at Show Booth 1308-09.

### Power Supply

419



Regulation is  $\pm 0.01\%$  +1 mv and ripple is 0.5 mv rms max. Model QCR 36-30 power supply has an adjustably output of up to 36 v dc. Remote programing is provided for. Dimensions are 8-3/4 x 19-1/8 x 13-1/2 in.

Raytheon Co., Sorensen Products, Dept. ED, Richards Ave., S. Norwalk, Conn.

See at Show Booth 3404-22.





"Leadership in  
semiconductors"

FOR TECHNICAL ASSISTANCE AND SERVICE  
CONTACT THE TRANSITRON FIELD OFFICE  
NEAREST YOU AS LISTED BELOW.

**BALTIMORE**, Maryland  
2319 Maryland Ave. ....CHesapeake 3-3220

**BOSTON**, Massachusetts  
168-182 Albion St.  
Wakefield, Mass. ....245-5640

**CAMDEN**, New Jersey  
227 S. Sixth St. ....WOOdlawn 6-2877

**CHICAGO**, Illinois  
6641 W. North Ave.  
Oak Park, Ill. ....Village 8-5556

**CLEVELAND**, Ohio  
14625 Detroit Ave.  
Lakewood, Ohio. ....ACademy 1-9191

**DALLAS**, Texas  
511 Braniff Airways Bldg.  
Dallas 35, Texas. ....FLeetwood 7-9448

**DAYTON**, Ohio  
379 W. First St. ....BALdwin 4-9651

**DENVER**, Colorado  
First National Bank Bldg.  
621 Seventeenth St. ....AComa 2-1686

**DETROIT**, Michigan  
2842 West Grand Blvd. ....TRinity 5-2440

**KANSAS CITY**, Missouri  
Wirtham Bldg.  
31st and Troost Sts. ....VALentine 1-1819

**LOS ANGELES**, California  
6362 Hollywood Blvd.  
Hollywood 28, Calif. ....HOLlywood 2-2381

**NEWARK**, New Jersey  
1060 Broad St. ....MARket 3-3151

**ORLANDO**, Florida  
#10 Jacklind Bldg.  
205 E. Jackson St. ....CHerry 1-4526

**PHOENIX**, Arizona  
2727 North Central Ave. ....CRestwood 7-3366

**ST. PAUL**, Minnesota  
Griggs-Midway Bldg.  
1821 University Ave. ....MIdway 6-1891

**SAN DIEGO**, California  
3620 30th St. ....CYpress 7-3708

**SAN FRANCISCO**, California  
535 Middlefield Rd.  
Palo Alto, Calif. ....DAvenport 1-2064

**SEATTLE**, Washington  
3466 East Marginal Way. ....MAin 4-0783

**SYRACUSE**, New York  
2360 James St. ....HOward 3-4502

**WINSTON-SALEM**, North Carolina  
Nissen Building  
310 W. Fourth St. ....PARk 3-0363

**Transitron**  
electronic corporation  
wakefield, massachusetts  
Sales offices in principal cities throughout the U.S.A. & Europe  
cable address: Trelco

CIRCLE 73 ON READER-SERVICE CARD  
CIRCLE 246, 247, 248, 249 ON

READER-SERVICE CARD ►

## Transitron ANNOUNCES NEW DEVELOPMENTS IN ITS ADVANCED LINE OF...

# SILICON POWER TRANSISTORS

### IN THE HIGH POWER RANGE, THE TRANSITRON UNITS FEATURE:



- the widely accepted stud-mounted package, pioneered by Transitron
- low saturation resistances
- voltages to 100 volts
- reliability-tested specifications

Write for Bulletin TE-1355-1210

Type	Maximum Power Dissipation at 100°C Case (Watts)	Maximum Collector Voltage V <sub>ce</sub> (Volts)	Minimum DC Common Emitter Current Gain at 2 Amps β	Typical Collector Saturation Resistance (Ohms at 2 Amps)
2N1616	30	60	15	0.7
2N1617	30	80	15	0.7
2N1618	30	100	15	0.7
2N1210	30	60	15	0.7
2N1211	30	80	15	0.7
2N1620	30	100	15	0.7

Circle 246 on Reader-Service Card

### IN THE INTERMEDIATE POWER RANGE, THE NEW TRANSITRON UNITS FEATURE:



- 1/8" hex base stud-mounted package
- saturation resistances under 3 ohms (2N1647-50 series)
- guaranteed Betas over normal operating range
- voltage ratings as high as 200 volts (2N2018-21 series)
- true intermediate power capability

Write for Bulletins TE-1355S and TE-1355-2018

Type	Maximum Collector Voltage BV <sub>ce</sub> (Volts)	Maximum Power Dissipation at 100°C Case (Watts)	Minimum DC Common Emitter Current Gain at 500 mA β	Minimum Collector Breakdown Voltage at 50 mA BV <sub>ceo</sub> (Volts)	Typical Saturation Resistance (Ohms)
2N2018	150	20	20	125	3.5
2N2019	200	20	20	140	3.5
2N2020	150	20	40	125	3.5
2N2021	200	20	40	140	3.5
2N1647	80	20	15	60	1.9
2N1648	120	20	15	80	1.9
2N1649	80	20	30	60	1.9
2N1650	120	20	30	80	1.9

Circle 249 on Reader-Service Card

MEET US AT WESCON • BOOTHS 3502-3504

The widest range of silicon power transistors is now available as the result of Transitron's development of an advanced line of competitively priced silicon transistors in the intermediate and high power ranges.

Electrical and mechanical advantages of the Transitron devices include low saturation resistances, voltages up to 200 volts, and solutions to heat dissipation problems that have long plagued designers. Included in this broad line are a number of silicon power transistors that Transitron is marketing at prices geared to the budget of the industrial designer!



ALSO AVAILABLE 2N1047-50  
and 2N1047A-50A SERIES OF  
INTERMEDIATE POWER  
SILICON TRANSISTORS ...  
for applications which require  
the single-ended, stud package.

Write for Bulletin TE-1355-1047

Circle 247 on Reader-Service Card

ANOTHER  
TRANSITRON  
EXCLUSIVE:

## NEW STANDARD LINE OF NATURAL CONVECTION COOLERS



Circle 248 on Reader-Service Card

Transitron has recently canvassed the market for the best available natural convection coolers. Under laboratory conditions, research engineers conducted a series of unbiased tests to determine which coolers possess the best heat dissipation capabilities for Transitron power semiconductors.

As a result, Transitron now offers a new standard line of four natural convection coolers, backed by extensive applications know-how. Transitron is thereby the first company to offer its customers a systematic and continuing program of service for the solution of annoying heat dissipation problems.

For further information, write for Application Notes AN-1355C and Bulletin TE-1355-1.

# Transitron

electronic corporation  
wakefield, melrose, boston, mass.

SALES OFFICES IN PRINCIPAL CITIES THROUGHOUT THE U.S.A. AND EUROPE • CABLE ADDRESS: TRELCO



## NEW PRODUCTS

AT WESCON

### Sonic-Energy Cleaners 429



Two types offered. Type 48 sonic-energy cleaner with one transducer has a tank measuring 4 x 8 x 6 in. Type 128 with three transducers has a tank 8 x 12 x 10 in. Frequency for both is 20 kc; both employ solid state generators and operate from an input of 117 v, 60 cps, single-phase.

The Bendix Corp., Pioneer-Central Div., Dept. ED, Davenport, Iowa.

P&A: \$295; stock.

See at Show Booth 2606.

### Digital Calendar 393

With BCD output. Model 2800-BCD digital calendar provides an 8-4-2-1 binary-coded-decimal output representing the month and day. Logic circuits adjust for different lengths of months.

Chrono-Log Corp., Dept. ED, Box 4587, Philadelphia 31, Pa.

P&A: \$460; 4 weeks.

See at Show Booth 4503-05.

### Permanent-Magnet Motor 430



With 1-in. diameter. The HYLM permanent magnet dc motor has ratings of 1 lb-in. of torque; 0.017 hp; 1,700 rpm; 0.85 amp; 23 w; 53% efficiency. Uses include program switches, tuning mechanisms, timing devices, cooling fans, blowers and electromechanical actuators.

Barber-Colman Co., Dept. ED, Rockford, Ill.

P&A: \$50; 45 to 60 days.

See at Show Booth 3601-03.

# a New and superior latching P&B relay...



LIES FLAT FOR GREATER PACKAGE DENSITY, HIGHER PERFORMANCE



This DPDT, permanent magnet, latching relay is superior on these counts: (1) shorter height for maximum compactness between stacked circuit boards; (2) greater sensitivity (80 milliwatts); (3) better vibration resistance (30 g to 2000 cps); (4) better shock resistance (100 g).

Designated the FL Series, this relay meets all applicable sections of MIL-R-5757D, MIL-R-6106C and ABMA #PD-R-187.

#### FL SERIES SPECIFICATIONS

##### Contact Arrangement: DPDT

Shock: 100 g for 11 milliseconds with no contact openings.

Vibration: 195' max. excursions, 10 to 35 cps, 30 g from 55 to 2000 cps. No contact openings.

Linear Acceleration: 400 g minimum with no contact openings.

Pull-In: 150 milliwatts, approx. (standard) at 25°C. coil temperature. 80 milliwatts, approx. (sensitive) at 25°C. coil temperature

Operate Time: 3 milliseconds max. at nominal voltage at 25°C. coil temperature

Dimensions: .485" high, 1.100" long, .825" wide.



Printed circuit board using 4 FL relays was designed by the Martin Company, Orlando, as part of ground support equipment for a major missile project.

# HOW P & B microminiature RELAYS can be tailored to your requirements

This large family of dual coil, permanent magnet relays

can be supplied with built-in diodes,  
special terminals and mounting brackets.

- A Non-latching or latching relays can be supplied in conventional crystal cases with or without shoulder brackets, studs or mounting plates. Straight pin, hook-end or 3" flexible terminals are available.
- B Potting 3" terminals with epoxy resin at the relay's header keeps glass beads from cracking through mishandling during installation . . . adds only .25" max. to height of case. Your production is speeded, reliability is increased.
- C A diode becomes an integral part of the relay circuit in SC or SL relays. It is incorporated in the relay case and is used to minimize arcing in special applications. Four diodes can be used as a full-wave bridge rectifier for 400 cycles.
- D Terminals spaced on .200" grids are available on all P&B microminiature relays. These carry a "G" suffix (SCG and SLG) and are only slightly larger in size, measuring .830" high, .800" wide, .400" deep, max.

#### SC/SL SERIES SPECIFICATIONS

##### GENERAL:

Shock: 100g for 11 millisecc.  
Vibration: 20g from 80 to 2000 cps, .165" max. excursions from 10 to 95 cps.  
Ambient Temperature Range: -60°C. to +125°C.  
Contact Arrangement: DPDT.  
Contact Load: 2 amps at 30 vdc, 1 amp at 110 vac, 60 cycle.  
Sensitivity: SL—220 milliwatts at 25°C.  
SC—600 milliwatts at 25°C.  
COIL VOLTAGES to 30 vdc.

##### TERMINALS:

Straight Pin: SC11D (8 pins)  
SL11D (10 pins)  
Hook Ends: SC11DA & SL11DA  
SC11DB & SL11DB  
SC11DC & SL11DC  
SC11DD & SL11DD

##### MOUNTINGS:

Plug In: SC11D & SL11D  
Shoulder Bracket: SC11DA & SL11DA  
Flat Plate: SC11DB & SL11DB  
Back Mount: 2 4-40 Studs; SC11DC & SL11DC

P&B STANDARD RELAYS ARE AVAILABLE AT YOUR LOCAL ELECTRONICS PARTS DISTRIBUTOR



## POTTER & BRUMFIELD

DIVISION OF AMERICAN MACHINE & FOUNDRY COMPANY • PRINCETON, INDIANA  
IN CANADA: POTTER & BRUMFIELD, DIVISION OF AMF CANADA LIMITED, GUELPH, ONTARIO

## Printed-Circuit-Board Relay 431



With seated height of 0.45 in. Features of model BR-12P printed-circuit-board relay include dry-circuit current requirement of 1  $\mu$ A at 1 mv with 100-ohm max contact resistance, 3-amp contact rating at 32 v dc resistive, 5 msec max operate-release time.

Babcock Electronics Corp., Babcock Relays Div., Dept. ED, Costa Mesa, Calif.

P&A: \$14; 2 to 3 weeks.

See at Show Booth 312.

## AC-DC Calibration Standard 411

A precision voltage-current meter, model 1605A ac-dc calibration transfer standard measures dc to 1,500 v and 15 amp, and frequencies from 20 cps to 50 kc. Ac accuracy is  $\pm 0.05\%$ ; dc accuracy is  $\pm 0.04\%$ . The unit is housed in a single package and can be used in mobile and field service.

Radio Frequency Laboratories, Inc., Dept. ED, Powerville Road, Boonton, N. J.

P&A: \$3,150; stock.

See at Show Booth 2912-14.

## Semiconductor Tester 433



Performs 24 tests, 12 on diodes and 12 on transistors. Model T-350A semiconductor tester automatically makes 12 tests in 0.6 sec. The tests are interchangeable and may be programed in different combinations during any test sequence. Provision is made for ac beta tests.

Atlantis Electronics Corp., Dept. ED, P. O. Box 451, Garland, Tex.  
See at Show Booth 4508.

To Contractors and Subcontractors  
on U. S. Government Projects

## Western Electric offers high reliability semiconductors from Laureldale

- Western Electric's Laureldale, Pennsylvania, plant is now in its ninth year of producing semiconductor devices of ultra-high quality and reliability for government applications.
- Devices designed by a resident Bell Telephone Laboratories group have performance standards exceeding specification requirements which are based on MIL-S-19500B.
- Mechanized production facilities and a comprehensive statistical quality control program assure uniformity and contribute to obtaining ultimate process capabilities.
- Reliability requirements specify 1000-hour elevated temperature life storage tests on all products shipped from Laureldale.

### Typical High Reliability Laureldale Semiconductors:



2N559

Diffused Base Germanium p-n-p Mesa Transistor. For ultra-high reliability in large computer systems. Rise times of 1-2 nanoseconds and storage and fall times of 3-4 nanoseconds obtainable.



2N1195

Diffused Base Germanium p-n-p Mesa Transistor. Excellent for video or rf applications and as a non-saturating switch. 100 MC gain is  $\geq 12$  db. Alpha cut-off frequency is  $\sim 750$  MC.

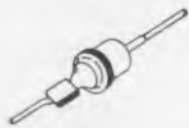

1N696

Diffused Silicon Junction Diode. Outstanding high-speed, low-capacity diode, with a maximum recovery time of 5 nanoseconds and a maximum capacitance of 4 picofarads.



2N1645

Diffused Base Germanium p-n-p Mesa Power Transistor. This transistor is designed to provide 1 watt of power output at 100 megacycles with an efficiency of 50%.



2N1072

Double Diffused Silicon n-p-n Mesa Transistor. This switches a current of 1 ampere with rise and fall times of 50 nanoseconds. The 2N1072 is an excellent core driver.



Western Electric and Bell Laboratories have an applications engineering group in residence at Laureldale. The codes shown above (and a complete range of other high reliability semiconductor devices) can be purchased in quantity from Western Electric's Laureldale plant. For technical information on these and other codes, please address your request to Mr. F. A. Mark, Regional Sales Manager, Room 103, Western Electric Company, Incorporated, Laureldale Plant, Laureldale, Pa. Telephone—Area Code 215—Walker 9-9411.



CIRCLE 76 ON READER-SERVICE CARD

## NEW PRODUCTS AT WESCON

### Infrared Reference

385



Range is 200 to 1,000 C. Model 11-201 infrared radiation reference source comprises a black-body simulator with 28-deg conical cavity radiator plus a temperature control that provides an accuracy of  $\pm 5\%$ . An aperture plate with a selector disk containing seven etched aperture diameters is optional.

Barnes Engineering Co., Dept. ED, 30 Commerce Road, Stamford, Conn.

See at Show Booth 1308-09.

### Pushbutton Switches

686

Lighted pushbutton switches in the 50PB series can be furnished in momentary and alternate-action designs. They have bush mounting and provide one-button control of two isolated circuits. Rating is 10 amp.

Minneapolis-Honeywell Regulator Co., Micro Switch Div., Dept. ED, Freeport, Ill.

See at Show Booth 3501-07.

### Mica Capacitor

490

Welded-seal button mica capacitors can be furnished with capacitances up to 1,500 pf at 500 wvdc in a wide variety of mounting configurations. Solder-free design permits the use of high-temperature soldering for circuit installation.

Sangamo Electric Co., Dept. ED, Springfield, Ill.

See at Show Booth 2207-09.

### Telemetry Antenna

386



Inflatable, helical antenna type 53000-2N can be put into use with a hand pump. Gain is better than 9.5 db over isotropic with a vswr of less than 1.5:1 over the range of 215 to 265 mc. Weighing less than 10 lb, the 4-ft antenna is for mobile tracking systems.

Andrew Corp., Dept. ED, P. O. Box 307, Chicago 42, Ill.

See at Show Booth 1821.

## Sunlight Sensing Device

541



For attitude control and orientation in space vehicles. Accuracy is  $\pm 0.05$  deg. Called the Sun Sensor, this sunlight sensing device consists of a four-section photodetector and an optical system, which provides proportional displacement error signals. The optical system projects light on the detector elements by means of four light pipes, each covering 90-deg azimuth and 82.5-deg elevation.

The Bendix Corp., Eclipse-Pioneer Div., Dept. ED, Teterboro, N. J.

See at Show Booth 2801-03.

## Military Resistors

423



Meet MIL-R-19365C. These adjustable military resistors are similar to the Dividohm industrial units. Resistance wire is wound on a ceramic core and covered with vitreous enamel. A complete range of sizes and resistances is offered.

Ohmite Manufacturing Co., Dept. ED, 3675 Howard St., Skokie, Ill.

See at Show Booth 1601-03.

## Bandswitching Discriminator

390



For all IRIG channels. This bandswitching discriminator includes 23 frequency detectors and 23 input bandpass filters. Frequency deviation is  $\pm 7.5\%$ ; input impedance is at least 51 K; input sensitivity is 10 mv rms; input dynamic range is 60 db to 10 v rms, 30 v peak-to-peak.



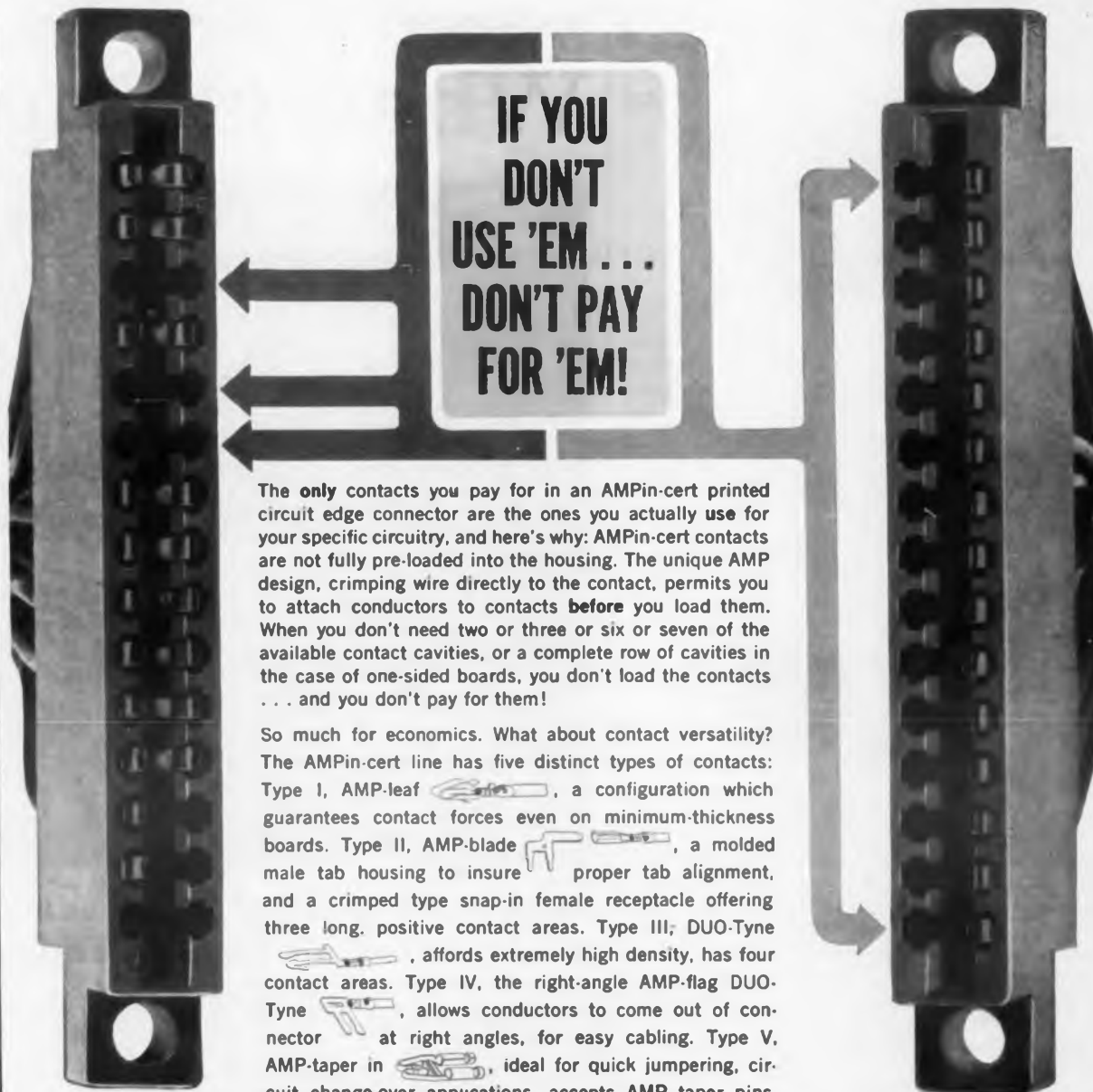

Airpax Electronics Inc., Seminole Div., Dept. ED, Fort Lauderdale, Fla.

Availability: 3 to 6 weeks.

See at Show Booth 1716-18.

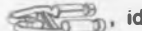

The only contacts you pay for in an AMPin-cert printed circuit edge connector are the ones you actually use for your specific circuitry, and here's why: AMPin-cert contacts are not fully pre-loaded into the housing. The unique AMP design, crimping wire directly to the contact, permits you to attach conductors to contacts before you load them. When you don't need two or three or six or seven of the available contact cavities, or a complete row of cavities in the case of one-sided boards, you don't load the contacts . . . and you don't pay for them!

So much for economics. What about contact versatility? The AMPin-cert line has five distinct types of contacts: Type I, AMP-leaf , a configuration which guarantees contact forces even on minimum-thickness boards. Type II, AMP-blade , a molded male tab housing to insure proper tab alignment, and a crimped type snap-in female receptacle offering three long, positive contact areas. Type III, DUO-Tyne , affords extremely high density, has four contact areas. Type IV, the right-angle AMP-flag DUO-Tyne , allows conductors to come out of connector at right angles, for easy cabling. Type V, AMP-taper in , ideal for quick jumpering, circuit change-over applications, accepts AMP taper pins.

Quality? AMPin-cert is quality, in the contacts and the housings:

- Contacts are phosphor bronze, gold over nickel plating
- Contacts accept single, multiple leads, and "snap-in" the housing without insertion tools
- Contacts are recessed in housing—no post insulation required
- AMPin-cert connectors will accept one-sided and two-sided boards

Ask us for the full AMPin-cert printed circuit connector story.

Visit us at the  
Wescon Show  
Booths 517-521  
August 22-25, 1961

# AMP INCORPORATED

GENERAL OFFICES: HARRISBURG, PENNSYLVANIA

AMP products and engineering assistance are available through subsidiary companies in: Australia • Canada • England • France • Holland • Italy • Japan • Mexico • West Germany

CIRCLE 77 ON READER-SERVICE CARD

## NEW PRODUCTS AT WESCON

### Silver-Zinc Battery

569



Two-section silver-zinc battery model P134A provides 29 v at 1 amp for 25 min and 28 v at 8 amp for 3 min. Designed as an auxiliary power source for an ICBM decoy system, the unit exceeds MIL-E-5272, has an activation time of 1 sec or less and weighs 3 lb.

Telecomputing Corp., Power Sources Div., Dept. ED, 3850 Olive St., Denver, Colo.  
See at Show Booth 2022-24.

### Horizon Sensors

381



For space vehicles, series 13-160 horizon sensors detect thermal discontinuity between the atmosphere of the earth and that of outer space. They sense a local vertical to within 0.1 deg, sense pitch and roll errors relative to this reference axis, and produce control signals proportional to these errors.

Barnes Engineering Co., Dept. ED, 30 Commerce Road, Stamford, Conn.  
See at Show Booth 1308-09.

### Magnetostrictive Delay Lines

563



Long delays are featured in small units. Models 192, 157, 158 and 159 magnetostrictive delay lines include fixed-output types as well as adjustable-time and multiple-output laboratory types.

Delttime Inc., Dept. ED, 608 Fayette Ave., Mamaroneck, N. Y.  
See at Show Booth 714.

## SILICONE NEWS from Dow Corning

# When Going Is Rough



## For Environmental Engineering... Select Silicone-Glass Laminates

LOX cold . . . high Mach heat . . . corona . . . ozone . . . launching and sonic shock — more and more environmental challenges are being met by Dow Corning Silicones.

Take glass laminates bonded with Dow Corning silicone resins, as examples. Silicone glass laminates have good mechanical strength, low loss factor, low moisture absorption, excellent resistance to arcing, corona, corrosive atmospheres, fungus and contaminants. What's even more important, they retain these properties despite elevated temperatures, storage, environmental aging, rapidly changing ambients, vibration and shock. Heat resistance of silicone-glass laminates is exceptional . . . up to 250 C continuous for years . . . much higher for short time periods. Lastly, silicone-glass laminates, even in thin sections, have fine machinability and resist creep under pressure of terminal fasteners.

Lear, Inc., Grand Rapids, Michigan mounts the mica capacitors of their Model 2013J Stable Platform on this formed silicone-glass laminate terminal board. Lear engineers chose glass laminates after an intermediate material had been tried. Tolerance requirements, plus assembler variations, dictated a material that could be formed . . . would withstand soldering temperatures . . . would hold its form despite environmental extremes. Environmental conditions are: —40 to 160 F; shocks of 30 G's for about 11 milliseconds each; complex wave vibration for 20 minutes in each plane as follows — 30-100 cps: 0.46 g<sup>2</sup>/cps and 100-2000 cps: 0.015 g<sup>2</sup>/cps.

Silicone-glass laminates made with Dow Corning resins are available from leading laminators. Write for a list.

For 12-page manual  
"Silicones for the Electronic Engineer"  
Write Dept. 4020



## Dow Corning

CIRCLE 800 ON READER SERVICE CARD

# ...Specify Silicones

## Flexible from -100 to 300F

Silastic®, the Dow Corning silicone rubber, is specified by Airtron, a division of Litton Industries, for the jacket of their silver-plated brass, and all-aluminum flexible waveguide designed to resist operating temperatures from -100 to 300 F. With its Silastic jacket, Airtron's Flexaguide is particularly suited for applications in the missile field where environmental operating conditions are severe. In addition, the jacket supports the waveguide during flexure, insures airtightness for pressurized applications. Silastic resists a long list of environments including: cold, heat, ozone, oxygen, voltage stress, thermal cycling, corona, corrosive atmospheres, and weathering.



CIRCLE 801 ON READER SERVICE CARD

## Rigid, Void-Free Protection

This induction heating coil is used to keep metal molten. Metal splatter caused frequent insulation and coil failure until the decision was made to encapsulate the unit in Dow Corning solventless silicone resin. The resin — with zirconium orthosilicate filler — forms a tough, rigid armor that withstands temperatures as high as 300 C indefinitely . . . much higher for short time periods. With no solvents to evaporate, the resin cures without voids. Note the excellent fill between plates of an encapsulated test capacitor.



CIRCLE 802 ON READER SERVICE CARD

## For Rapid Heat Dissipation

Dow Corning silicone fluids are used as dielectric coolants for rapid heat dissipation because of their thermal stability and relatively flat viscosity-temperature curves. They can be pumped at high speeds without breakdown due to shear; maintain consistency from -65 to 250 C; and they will not oxidize or act as corrosives to metals even at high temperature. For these reasons and because of low vapor pressure, Sierra Electronics, Menlo Park, California specifies Dow Corning 200 Fluid as the heat transfer medium in their 100 and 500 watt, 60 ohm coaxial RF loads.

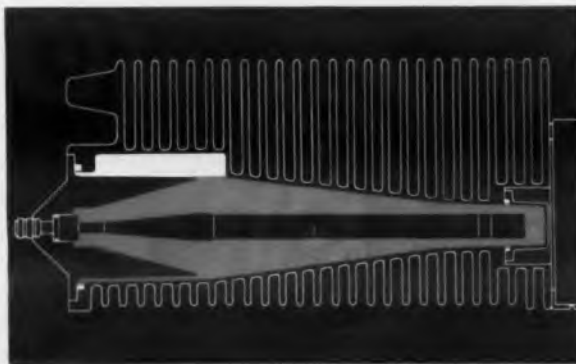

CIRCLE 803 ON READER SERVICE CARD

VISIT OUR BOOTH 5102-06, AT WESCON SHOW

**CORPORATION** MIDLAND, MICHIGAN

branches: ATLANTA BOSTON CHICAGO CLEVELAND DALLAS LOS ANGELES NEW YORK WASHINGTON, D.C.

CIRCLE 800, 801, 802, 803 ON READER-SERVICE CARD

ELECTRONIC DESIGN • August 2, 1961

## Subminiature Switches

561



**Snap-action**, subminiature switches have uniform stress distribution throughout the spring. Called Cricket switches, they are rated at 5 amp at 125 to 250 v ac, inductive and resistive; 4 amp at 30 v dc, resistive; 2.5 amp at 30 v dc, inductive. These ratings are valid for altitudes to 50,000 ft. Weight is less than 0.08 oz.

Fansteel Metallurgical Corp., Contacts & Specialties Div., Dept. ED, North Chicago, Ill.  
See at Show Booth 606-10.

## Microfilm Readout

396

**Magnification of 300 times or more** is provided on a closed-circuit TV screen by this microfilm readout device. Any detail of the picture can be selected for examination. A continuous range of 10 to 300 diameters of magnification is available.

General Precision, Inc., GPL Div., Dept. ED, Pleasantville, N. Y.  
See at Show Booth 3309-21.

## Pushbutton Switches

405

**With millisecond pulse**, Series 1PB3000 pushbutton switches produce a square wave pulse which is factory adjustable from 30 to 500 msec and 6 to 55 v. Temperature range is 0 to 55 C; contact arrangement is spdt. Power required is 6 to 20 ma.

Minneapolis-Honeywell Regulator Co., Micro Switch Div., Dept. ED, Freeport, Ill.

See at Show Booth 3501-07.

## Binary-Decimal Modules

567

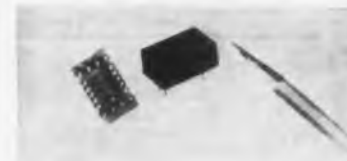

**For 1-2-2-4 and 1-2-4-8 systems**, types BIP-5501 and BIP-5502 modules convert binary-coded decimal information to decimal form. Called BIPCO Modules, they operate with transistor amplifiers such as the firm's Trixie driver modules.

Burroughs Corp., Electronic Components Div., Dept. ED, P. O. Box 1226, Plainfield, N.J.  
P&A: \$45; stock.

See at Show Booth 2507-09.

# FOR PRECISION MEASUREMENTS

## RESISTANCE DECADES—MODEL DR

Available in a wide variety of standard models. Accuracy at 1.0 and 0.1 ohm steps is  $\pm 0.25\%$ . Accuracy of all other resistors is  $\pm 0.1\%$  of indicated value. Self-cleaning, molded nylon and silver plated brass switch mounted below panel. Zero resistance is less than .003 ohms per dial. Hardwood case. Models DR-10 to DR-40, 8" x 5 1/2" x 4 1/2" h. Weight 4 lbs. net, 6 lbs. shipping. Models DR-500 to DR-520, 9" x 6" x 4 1/2" h. Weight 5 lbs. net, 7 lbs. shipping. Models DR-700 and DR-710, 17 1/4" x 5" x 4 1/2" h. Weight 6 lbs. net, 8 lbs. shipping.



### ELECTRICAL SPECIFICATIONS

Model No.	Total Res. Ohms	Decade Steps	Accuracy
DR-10	1,110,000	10x(1,000+10,000+100,000)	$\pm 0.1\%$
DR-20	111,000	10x(100+1,000+10,000)	$\pm 0.1\%$
DR-30	11,100	10x(10+100+1,000)	$\pm 0.1\%$
DR-40	1,100	10x(1+10+100)	$\pm 0.25\%$ & $\pm 0.1\%$
DR-500	11,111	10x(.1+1+10+100+1,000)	$\pm 0.25\%$ & $\pm 0.1\%$
DR-510	111,110	10x(1+10+100+1,000+10,000)	$\pm 0.25\%$ & $\pm 0.1\%$
DR-520	1,111,100	10x(10+100+1,000+10,000+100,000)	$\pm 0.1\%$
DR-700	1,111,111	10x(.1+1+10+100+1,000+10,000+100,000)	$\pm 0.25\%$ & $\pm 0.1\%$
DR-710	11,111,110	10x(1+10+100+1,000+10,000+100,000+1,000,000)	$\pm 0.25\%$ & $\pm 0.1\%$

## WHEATSTONE BRIDGES — MODEL RN

Universally used for the measurement of all types of resistance devices and circuits where high accuracy is required. Models available for performing Murray-Varley Loop tests.



### ELECTRICAL SPECIFICATIONS

Model	Total Res. of Decade	Ratio Dial Settings	Circuits	Dimensions
RN-1	9X(1+10+100+1000)	.001, .01, .1, 1.0, 10, 100, 1000	Murray & Varley	9"x8"x6 1/2"
RN-2	9X(1+10+100+1000)	.001, .01, .1, 1.0, 10, 1000, M10, M100, M1000	Murray & Varley	9"x8"x6 1/2"
RN-3	10X(1+10+100)+9(1000)	1/1000, 1/100, 1/10, 1/9, 1/4, 1/1, 10/1, 100/1, M10, M100, M1000	Murray & Varley	9 1/2"x8"x6 1/2"

## CAPACITANCE DECADES — MODEL DK

These are 3-dial units with the sum of the dial setting indicating total capacity in microfarads. Mylar and silver-mica capacitors are used for high stability, low-loss characteristics. Polished hardwood case, engraved dial graduations.



### ELECTRICAL SPECIFICATIONS

Model	Decade Steps (MFD)	Accuracy	Dielectric	Power Factor	Peak Volts
DK-2A	0.001, 0.01, 0.1	$\pm 1.0\%$ , $\pm 1.0\%$ , $\pm 1.0\%$	Silver Mica	0.2%, 0.2%, 0.2%	700, 700, 500
DK-4	0.001, 0.01, 0.1	$\pm 1.0\%$ , $\pm 1.0\%$ , $\pm 3.0\%$	Silver Mica, Mica & Foil, Mylar	0.2%, 0.2%, 1.0%	700, 700, 400
DK-5A	0.01, 0.1, 1.0	$\pm 1.0\%$ , $\pm 3.0\%$ , $\pm 3.0\%$	Mica & Foil, Mylar, Mylar	0.2%, 1.0%, 1.0%	700, 400, 400
DK-11A	0.01, 0.1, 1.0	$\pm 0.5\%$ , $\pm 0.5\%$ , $\pm 2.0\%$	Silver Mica, Silver Mica, Mylar	0.2%, 0.2%, 1.0%	700, 500, 400
DK-10	0.0001, 0.001, 0.01	$\pm 0.5\%$ or 10 mmf	Silver Mica	2.0%, .2%, .2%	700, 700, 700

### PHYSICAL SPECIFICATIONS

Model	Over-all Dimensions	Weight (Lbs.)	
		Net	Shipping
DK-2A, DK-4, DK-10	8 x 5 1/2 x 7 1/2	8	10
DK-5A, DK-11A	10 3/4 x 7 3/4 x 7 3/4	10	12



**Industrial Instruments**

89 COMMERCE ROAD, CEDAR GROVE N. J.

CIRCLE 70 ON READER-SERVICE CARD

## NEW PRODUCTS AT WESCON Brake-Clutches

562



Size 8 and 11 electrically operated brake-clutches have BuOrd mountings. Type size 11 has minimum brake or clutch torque of 16 oz-in. and a total response time from brake-engage to clutch-engage of 23 msec. The size 8 is similar with a brake-engage, clutch-engage time of 12 msec.

Bowmar Instrument Corp., Dept. ED, 8000 Bluffton Road, Fort Wayne, Ind.

See at Show Booth 2922.

## Static Inverter

559



Rated at 2.5 kw. This silicon-controlled rectifier static inverter operates from submarine batteries and delivers three-phase, 400-cps power. Regulation is 1.75% for voltage, 0.1% for frequency. Load range is no load to 150% and power factor is 0.8 to unity.

Varo Inc., Dept. ED, 2201 Walnut St., Garland, Tex.

See at Show Booth 3609-11.

## Integrating Gyro

568



Angular rate and position are provided by this integrating gyro, a single-degree-of-freedom instrument. The algebraic sum of the individual signals is provided on a single pickoff. Gimbal drift is 0.1 to 0.2 deg.

Telecomputing Corp., Whittaker Gyro Div., Dept. ED, 16217 Lindberg St., Van Nuys, Calif.

## miniature ratchet terminals



For mounting circuitry, they're neater -- quicker -- and cost a lot less



What could be neater? Or quicker? Leads are locked firmly. There's no pre-forming. No feeding through holes. No wrapping around a post. In experimental circuitry, components can be snapped out, re-used. In production equipment, terminals can be staked quickly, automatically or by hand. Components can be mounted in place and soldered on production line basis. Heat is dissipated faster — in the terminal, not in the component.

Best news: the cost ... far lower than conventional terminals. Average price: about 1/4¢ apiece.

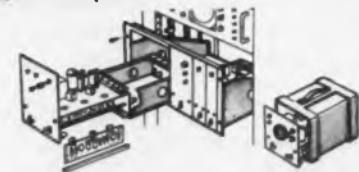

Alden miniaturized ratchet terminals are part of an integrated building block system that lets you lay out and package a single unit or a complete electronics system with "off-the-shelf" Alden components for plug-in, modular construction.

For complete information, write:

**ALDEN**

PRODUCTS COMPANY  
8139 North Main Street, Brockton, Mass.  
WESCON BOOTH #4219

CIRCLE 79 ON READER-SERVICE CARD

ELECTRONIC DESIGN • August 2, 1961



## Frequency Standard 371



Stability is  $\pm 2 \times 10^{-9}$ . The vlf synchrophase receiver frequency standard provides simultaneous outputs of 10, 100 and 1,000 kc. The local reference source, a high-stability oscillator, is adjusted through a servo system to a signal from NBA or WWVL.

Motorola Inc., Communications Div., Dept. ED, 4501 W. Augusta Blvd., Chicago 51, Ill.

P&A: \$5,850; 3 months.

See at Show Booth 1116.

## Name Plates 392

Two types are offered: aluminum foil and polyvinyl chloride. These self-adhesive name plates are mounted on dispenser cards. The aluminum foil type resists temperatures to 350 F as well as solvents, oil and dirt. The vinyl plates are for use where color coding is needed.

W. H. Brady Co., Dept. ED, 727 W. Glendale Ave., Milwaukee 9, Wis.

See at Show Booth 4831-33.

## Two-Channel Dynograph 373

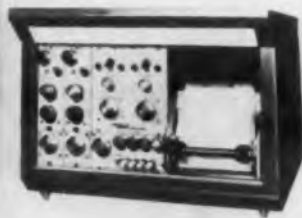

Sensitivity is to  $1 \mu\text{v}$  per mm with preamplifiers and 1 mv without. Model RS two-channel dynograph has selectable paper speeds of 1, 5, 20 and 100 mm per sec. Frequency response is within 10% for 150 cps and 20% to beyond 200 cps for ink and electric recording. Transistorized, it can be rack mounted or portable.

Offner Electronics Inc., Dept. ED, 3900 River Road, Schiller Park, Ill.

Availability: 30 days.

See at Show Booth 1513-14.

## RAYTHEON TRANSFORMER TALK

Facts about transformers that have solved equipment design problems • No. 4 in a series.

# Look at what epoxy encapsulation has done for high-voltage plate transformers

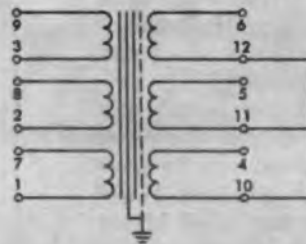

50% SMALLER, 30% LIGHTER than its predecessors, this 3.25 KVA plate transformer has proven itself in continued performance under actual environmental conditions.

Raytheon encapsulation techniques are successfully applied to 3.25 KVA units for startling reductions in size and weight.

The transformer illustrated at left measures just  $9\frac{1}{8} \times 15\frac{3}{8} \times 9\frac{1}{8}$  in. Yet, it will deliver 11,750 dc volts at 0.275 dc amperes in a full-wave bridge rectifier circuit.

Reliability? Raytheon produced over 500 units of this design for military applications without a single reported failure.

Epoxy encapsulation, now commonly used in small transformers, had never before been successfully applied to large high-voltage power transformers. Now, with newly developed techniques in casting and curing epoxy, Raytheon has solved one of the toughest encapsulation problems known.

This same kind of engineering experience and skill is being applied to a wide range of transformer design and production problems from small silicone rubber impregnated units for high-temperature application to high-voltage designs like the one described here.

Write today for descriptive folder and technical article describing Raytheon encapsulated transformers. Address Magnetics Operation, Microwave and Power Tube Division, Raytheon Company, Foundry Avenue, Waltham 54, Massachusetts.

RAYTHEON

RAYTHEON COMPANY

MICROWAVE AND POWER TUBE DIVISION

## RF Shielding News!

Old Company  
New Name!



### TO PROVIDE IMPROVED SERVICE AND DESIGN IN ENGINEERED SHIELDING!

Now, a new name from an old Company in the field of RF Shielding brings you a complete line of fine products, developed and produced by specialists in engineered shielding. The "old company" is the Electronics Division of Metal Textile Corporation—the "new name" is *Metex Electronics Corporation!*

Born of industry's growing acceptance and demand for Metex Shielding, Metex Electronics Corporation takes with it all the skilled key engineering and production per-

sonnel of the Electronics Division of Metal Textile Corporation. This is your assurance of continued and even better product performance and service.

With this new broadened operation, Metex Electronics can definitely deliver the finest materials and latest advancements to solve your present and future RF problems. Write today for a complete *new* fact-filled Metex Data File and the name of your local representative. No obligation of course.



**METEX ELECTRONICS CORP.**  
WALNUT AVENUE, CLARK, NEW JERSEY

APPLICATION PROVED ENGINEERED SHIELDING  
CIRCLE 81 ON READER-SERVICE CARD

## NEW PRODUCTS AT WESCON

### Frequency Converter

555



Range is to 220 mc with an accuracy of  $\pm 1$  count when the unit is used with a 10-mc digital frequency meter. Model 420 frequency converter has an input impedance of 50 ohms, an input sensitivity of 2 mv and an output amplitude greater than 1 v.

Transistor Specialties, Inc., Dept. ED, Terminal Drive, Plainview, L.I., N.Y.

P&A: \$710; 30 days.

See at Show Booth 4101.

### Primary AC Shunts

495

Range is 5 ma to 26 amp. Model HCS-1 primary ac shunts are coaxial, four-terminal resistors with a minimum of self-induction. Accuracy of ac-dc difference from 5 cps to 50 kc is 0.02%. Since no ratio calculation is used, the absolute resistance of the shunt does not affect the measuring accuracy. Connectors are uhf-type.

Holt Instrument Laboratories, Div. of Holt Hardwood Co., Dept. ED, Oconto, Wis.

P&A: \$700; 45 days.

See at Show Booth 3305-07.

### Vacuum Oven

378



Range is to  $10^{-6}$  mm Hg with temperatures to 400 C. Model 1631 vacuum oven has Fiberglass insulation and an all stainless steel interior. A thermocouple indicating-controlling pyrometer is used. The control box, mounted on top, contains all electrical equipment.

Temperature Engineering Corp., Dept. ED, 1 Tempcor Blvd., Riverton, N. J.

P&A: \$1,695; 30 days.

See at Show Booth 4922.

## Precision Inverter

566



Provides 800-cps power regulated to  $\pm 4$  cps for all changes of line, load and temperature. Model EA-276 precision inverter has power channel outputs of 103.5, 115.0 and 126.5 v at 0.5 amp, single phase, externally programable. Single-channel output is 0.1 to 39.999 v at 0.8 ma, single-phase, externally programable in 1-mv steps.

Thermador Electrical Manufacturing Co., Div. of Norris Thermador Corp., Dept. ED, 715 S. Raymond Ave., Alhambra, Calif.

P&A: \$3,250; 4 weeks.

See at Show Booth 1811.

## Oscilloscope Cameras

492

For Polaroid cut film. The 4 x 5 in. prints make it possible to multiple-expose a 10-cm time-base. Types 3006 and 3007 oscilloscope cameras have F/1.9 flat field and F/4.5 lenses, respectively. Types 3008 and 3009 are similar but have data chambers to record identifying information on the film.

Analab Instrument Corp., Dept. ED, Cedar Grove, N. J.

P&A: \$430 to \$585; stock.

See at Show Booth 1218.

## Counter Module

564



For 1-mc use, type DC-116 Beam-X counter module has 10 outputs for functions such as operating printers and presetting. Consisting of three silicon transistors, a shielded Beam-X switch and a Nixie indicator tube, the unit is compatible with the firm's 100-kc, type DC-114 counter.

Burroughs Corp., Electronic Components Div., Dept. ED, P. O. Box 1226, Plainfield, N. J.

P&A: \$125; October.

See at Show Booth 2507-09.

# NEW-Fluke Precision Potentiometers Provide 10 TURN RESOLUTION...



## -Save: Time-Space-Effort-Cost

The **FLUKE** Model 20A Vernier Potentiometer provides resolution equivalent to that of 10 turn helical potentiometers with only 550° of shaft rotation. At the same time, the 20A requires only a fraction of the space occupied by helical potentiometers, and, in fact, occupies less space than many single turn, low resolution potentiometers.

This high resolution, small size, and ease of operation, is achieved by a unique **FLUKE** patented design. A schematic of the Model 20A is shown below. Basically, the Model 20A consists of a main resistance element and a concentric smaller vernier. The vernier element is connected to the main element through two contacts spaced 30° apart. This spreads any 30° segment of the main winding over the 270° of vernier rotation. The vernier slider is rotated by the potentiometer shaft. As the shaft is turned and the vernier slider completes its rotation, a mechanical stop causes the vernier frame to turn, moving the spaced vernier contacts along the main element. This method provides a coarse adjustment at either end of the vernier adjustment.

This unique design results in a versatile, high performance potentiometer. For example, thin card-type windings reduce residual reactance and allow operation at much higher frequencies than other potentiometers with similar DC specifications. The one and one-half turn control of

the entire adjustment range allows substantial time savings in frequently adjusted or multiple potentiometer installations such as analog computers and data logging systems. Equipped with a screwdriver slotted shaft, the Model 20A also makes an ideal high resolution trimmer.

The Model 20A is available from stock in resistance values ranging from 100 ohms to 25 K ohms, and can be provided with a calibrated readout dial and lock-type knob.

If greater resistance values are required, write for information on the **FLUKE** Models 21A, 22A, and 30A. The Model 21A and 22A have increased power ratings and are available in resistance values to 100 K. The Model 30A features resolution of 20 times that of the 20A series, resistance values from 1 K to 100 K, and a power rating of 5 watts.

### MODEL 20A PARTIAL SPECIFICATIONS

**Standard Tolerance:**  $\pm 5\%$ , available to  $\pm 1\%$  on special order. **Linearity**  $\pm 0.5\%$ .

**Resolution:** 1000 ohms, 1 part in 5600. Increased resolution for higher values.

**Power Rating:** 2 watts at 20° C, derated to 0 at 100° C.

**Price:** As shown, \$8.50.

### NEW FLUKE MODEL 20A

Vernier Potentiometer

Complete with dial, knob and lock

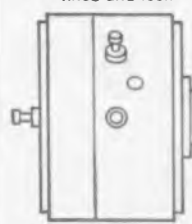

ACTUAL SIZE



JOHN FLUKE

### JOHN FLUKE MFG. CO. INC.

P. O. Box 7428

Seattle 33, Washington

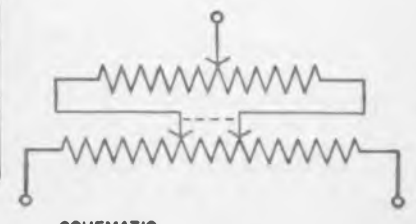

SCHEMATIC

MANUFACTURERS OF ELECTRONIC TEST AND MEASURING INSTRUMENTS FOR LABORATORY-PRODUCTION LINE

CIRCLE 82 ON READER-SERVICE CARD

## NEW PRODUCTS

AT WESCON

### Variable-Speed Drives 372



For 1/8 to 3/4-hp motors, the 400 series variable-speed drives have outputs from 0 to 1,200 rpm with 1,800 rpm input. Features include built-in overload protection, lever control for speed with no slipping and venting of the motor to reduce heat rise.

Zero-Max Co., Dept. ED, 2845 Harriet Ave., S., Minneapolis 18, Minn.

**P&A:** \$45 to \$500; stock.

See at Show Booth 416.

### Logic Pack 407

Silicon transistor-diode logic pack, housed in a TO-5 case, provides an integrated circuit component with a fan-out of five diodes. Switching times are on the order of 20 nsec.

Philco Corp., Lansdale Div., Dept. ED, Lansdale, Pa.

See at Show Booth 919-21.

### Military Relay 374

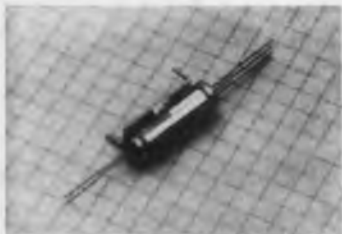

High-speed, spdt, 2-amp military relay weighs less than 0.017 oz and measures 0.275 in. in diameter and 0.9 in. long. Called the Micro-Mite, it is offered in a wide range of ac and dc coil voltages and in several mounting designs.

Electro-Mechanical Specialties Co., Inc., Dept. ED, Whittier, Calif.

**P&A:** \$24; stock.

See at Show Booth 1422.



greater derating margin  
for higher reliability...at lower cost  
than lower rated types

**Westinghouse 2N1015 and 2N1016 transistors—**Circuits which use power transistors can be upgraded in reliability by changing to the Westinghouse 2N1015-2N1016 series. The low saturation resistance and high dissipation rating (150 watts) of these transistors mean cooler operation—more safety factor in service. In fact, the 2N1015-2N1016 series offers twice the derating margin you can get in competitive types. Their high voltage ratings—up to 200 volts  $V_{CE}$ —also mean an end to series connections of lower rated types. Yet all this is yours at less cost than you are now paying. In addition to these many circuit advantages, the 2N1015-2N1016 transistors give you the reliability assurance of

REPLACE 2N1489  
 CAN REPLACE 2N389  
 2N1490  
 CAN REPLACE 2N1070  
 REPLACE 2N1069

True Voltage Ratings verified by 100% Power Testing under full operating conditions. You also get the advantages of reduced inventory, and the convenience of single-source purchasing. Next time you buy transistors in the 2N1015-2N1016 family make sure they're 100% power tested. You can be sure . . . if it's Westinghouse. For complete information, write or call: Westinghouse Electric Corp., Semiconductor Dept., Youngwood, Penna.

SC-1042

Westinghouse



For "off the shelf" delivery, order from these Westinghouse Distributors:

**EASTERN**

ACK SEMICONDUCTOR, INC.  
 Birmingham 5, Ala./FA 2-0588  
 CAMERADIO  
 Pittsburgh, Pa./EX 1-4000  
 CRAMER ELECTRONICS, INC.  
 Boston, Mass./CC 7-4700  
 ELECTRONIC WHOLESALERS, INC.  
 Melbourne, Florida/PA 3-1441  
 GENERAL RADIO SUPPLY CO., INC.  
 Camden, N.J./WO 4-8560  
 GENESSEE RADIO PTS. CO.  
 Buffalo, N.Y./TR 3-9661  
 KANN-ELLERT ELECTRONICS, INC.  
 Baltimore, Md./TU 9-4242  
 MILGRAY ELECTRONICS  
 RADIO & ELECTRONIC PTS. CORP.  
 New York, N.Y./RE 2-4400  
 SCHWEBER ELECTRONICS  
 Cleveland, O./UT 1-6060  
 Long Island, N.Y./PI 6-6520  
 Silver Spring, Md./JU 5-7023

**MIDWESTERN**

E.C.I. SEMICONDUCTORS, INC.  
 Kansas City, Mo./WE 1-0829

**ELECTRONIC COMPONENTS FOR INDUSTRY CO.**

St. Louis, Mo./WO 2-9916  
 HALLMARK INSTRUMENTS CORP.  
 Dallas, Texas/RI 7-8933  
 INTER-STATE RADIO & SUPPLY CO.  
 Denver 4, Colo./TA 5-8257  
 Houston, Texas/CA 4-2663  
 LENERT CO.  
 El Paso, Texas/KE 3-9555  
 MIDLAND SPECIALTY CO.  
 Phoenix, Ariz./AL 8-8254  
 Albuquerque, N.M./CH 7-0236  
 Indianapolis, Ind./ME 7-5571  
 RADIO DISTRIB CO.  
 SEMICONDUCTOR SPECIALISTS, INC.  
 Chicago, Ill./NA 2-8860  
 S. STERLING CO.  
 Detroit, Mich./DR 3-3909  
 UNITED RADIO, INC.  
 Cincinnati, O./NA 1-6530

**WESTERN**

ALMAC ELECTRONICS CORP.  
 Elmar Electronics  
 Hamilton Electro SLS  
 Newark Electronics Co.  
 Seattle, Wash./PA 3-7310  
 Oakland, Cal./TE 4-3311  
 Los Angeles, Cal./BR 2-9154  
 Palo Alto, Cal./DA 1-7541  
 Inglewood, Cal./OR 4-8440

**Silicon Mesa Transistor 406**

High-voltage high-speed type. This double-diffused, epitaxial silicon mesa transistor is for core driver and similar applications. It has a power dissipation of 2 w at 25 C and a maximum collector current of 500 ma.

Philco Corp., Lansdale Div., Dept. ED, Lansdale, Pa.

See at Show Booth 919-21.

**Digital Multimeter 434**



For missile checkout, the DMM digital multimeter measures dc and ac absolute voltage; dc to dc, ac to ac, ac to dc and dc to ac voltage ratios. It is comprised of the V16-AD converter with signal conditioner and programing modules. Military designation is AN/TS-5022.

Adage, Inc., Dept. ED, 292 Main St., Cambridge 42, Mass.  
 See at Show Booth 3610.

**Metal Pull Handles 409**

In 3, 4, or 6-in. lengths. These metal pull handles can be furnished in stainless steel aluminum, in bright or nonreflective finishes. Diameter is 5/16 in.

Raytheon Co., Industrial Components Div., Dept. ED, 55 Chapel St., Newton 58, Mass.

P&A: \$0.86; stock.

See at Show Booth 3404-22.

**Magnetic Tape 394**

For audio use, this magnetic tape has a signal output strength regulated to less than 0.5 db. Base material is acetate or Mylar and is precoated. A static coating process is also used as the final prevention against dust. Tape is 1/4 in. wide; standard reel lengths can be furnished.

Burgess Battery Co., Div. of Servel, Inc., Dept. ED, Freeport, Ill.

See at Show Booth 1719.

► **CIRCLE 83 ON READER-SERVICE CARD**

the pressure's on for '61



## MULTI-STAGE BLOWER

60 cps or 400 cps

1"  $\phi$  or 3"  $\phi$

To 440 Volts

10" O.D. by lengths up to 14"

Ambient Range:  $-55^{\circ}$  +  $85^{\circ}$  C

Commercial or Military

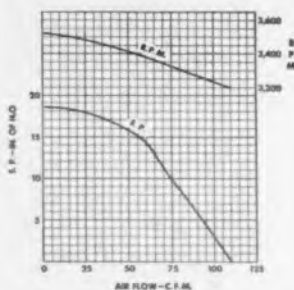

MULTISTAGE BLOWER  
60 cps - 6 Stages

When engineering specifications require continuous duty and quiet long life, Air Marine offers multistage blowers for low volume, higher pressure applications to 1 psi with air delivery to 100 CFM. Featured is long life with low noise. Where high pressure is required or on such vacuum applications as tape retention, the Air-Marine multistage blowers are the efficient answer.

Our field engineers will gladly assist you in the selection and application of motors, blowers or fans.

Air Marine motors, blowers and fans have been designed and tested to meet the specifications of both the military and industry.

WRITE TODAY FOR OUR NEW CATALOG

**air marine**  
motors, inc.



369 Bayview Avenue  
Amityville, L. I., N. Y.  
2221 Barry Avenue  
Los Angeles, California

CIRCLE 84 ON READER-SERVICE CARD

## NEW PRODUCTS AT WESCON

### Electronic-Flash Unit 395

Exposure time is  $1/2 \mu\text{sec}$  for photography of bullets and other high-velocity objects. With an adaptor, the Microflash electronic-flash unit becomes a light source of silhouette photography and shadowgraphy. A  $1/16$ -in. aperture delivers 400,000 candle-power for  $1 \mu\text{sec}$ .

Edgerton, Germeshausen & Grier, Inc., Dept. ED, 160 Brookline Ave., Boston, Mass.

See at Show Booth 3518-20.

### Zener Diodes 479



Rated at 400 mw, these subminiature glass Zener diodes have a dynamic impedance of 5 ohms with an  $I_z$  of 20 ma. Voltage range is 6.8 to 33 v. Types 1N957 to 973 have  $\pm 20\%$  tolerance; 1N957A to 973A have  $\pm 10\%$  tolerance; types 1N957B to 973B,  $\pm 5\%$ . Types 1N962B to 973B meet MIL-S-19500/117.

International Rectifier Corp., Dept. ED, 233 Kansas St., El Segundo, Calif.

P&A: \$2.25 to \$4.00; stock.

See at Show Booth 1701-03.

### General-Purpose Relays 402

Are 1, 2 or 3-pole, single or double throw with a contact rating of 5 amp at 115 v ac or 32 v dc. Model GR relays are available with coil voltages to 440 v ac at 60 cps or 230 v dc. They can be used in printed-circuit assemblies, for below-chassis, above-chassis or plug-in connections.

Ohmite Manufacturing Co., Dept. ED, 3672 Howard St., Skokie, Ill.

Availability: stock.

See at Show Booth 1601-03.

### Oscilloscope Plug-In 491

Dual-channel plug-in type 300 has a bandwidth of dc to 500 kc with a sensitivity of 1 mv per cm. Sweep range is from 0.5 sec to  $1 \mu\text{sec}$  per cm in 18 ranges. Trigger and sweep circuits are built-in. It can be used with the firm's main frames.

Analab Instrument Corp., Dept. ED, 30 Canfield Road, Cedar Grove, N. J.

P&A: \$260; stock.

See at Show Booth 1218.



## accuracy on all ranges

For the first time, accuracy of  $\pm 1$  percent is now available in multi-range Panel-Mounting Electronic Voltmeters (PMEV's)

Metronix offers two such instruments: Model 300-1 for DC measurements and Model 311-1 for AC measurements.



Model 311-1

These instruments, like all Metronix PMEV's, also offer these familiar advantages:

- Continuous monitoring of critical parameters
- Minimum panel space—no larger than the meter itself
- Maximum reliability
- Easy adaptability to special needs

Call, wire or write for data sheets. We welcome inquiries on special voltage monitoring problems.



**METRONIX, INC.**

a subsidiary of Assembly Products, Inc.  
Chesterland, Ohio

Telephone: HAMILTON 3-4440

Visit Booth 111, NEC

CIRCLE 85 ON READER-SERVICE CARD

ELECTRONIC DESIGN • August 2, 1961

## Magnet Wires

397

**High-permeability** Netic, Co-Netic AA and Co-Netic B alloy magnet wires are available flat or round in sizes 3 to 40 AWG. They offer a low reluctance path to the magnetic flux concentrating the field in transformer and other inductance applications.

Perfection Mica Co., Magnetic Shield Div., Dept. ED, 1322 N. Elston Ave., Chicago 22, Ill.

**Availability:** stock.

See at Show Booth 4606.

## Transistor Drivers

565



**For Nixie tubes.** Called Trixie Modules, these silicon transistor drivers use 10 npn silicon transistors to amplify low-level signals. Type 41 operates miniature indicator tubes and type 58 operates standard and large sizes. They are suitable for both industrial and military equipment.

Burroughs Corp., Electronic Component Div., Dept. ED, P. O. Box 1226, Plainfield, N. J.

**P&A:** \$40; stock.

See at Show Booth 2507-09.

## Electronic Drawer Handles

398

**With finger-tip action.** The Power-Lock handles have a recessed lever which cams the last 3/4-in. of drawer travel with a mechanical advantage of 6.6:1. They provide a secure panel-to-rack lock and meet applicable Mil specs.

Jonathan Manufacturing Co., Dept. ED, 720 E. Walnut Ave., Fullerton, Calif.

**P&A:** \$18; stock.

See at Show Booth 4830.

## Tape Punch and Reader

489

**Speed is 100 characters per sec.** The BRPE tape punch and the CS tape reader operate together in tape-to-tape communications systems. The punch produces perforated tape and can be furnished for 5-level code or for 6, 7 or 8-level codes. The tape reader can read perforated or chadless tape and transmit data from the BRPE or slower-speed equipment.

Teletype Corp., Dept. ED, 5555 Touhy Ave., Skokie, Ill.

See at Show Booth 4418-20.

**NEW**  
from Belden  
for the  
WESCON  
SHOW

**NEW! HOOK-UP WIRE**  
Complete Range of New Mil-Spec Numbers

**new!**  
Mil-W-76B-Plastic  
MW-Vinyl-1000V-80C  
MW-Shielded-1000V-80C  
MW-Shielded-Nylon Jacket-1000V-80C  
MW-Glass Braid-1000V-80C  
MW-Glass Braid-Shielded-1000V-80C  
MW-Nylon Jacket-1000V-90C  
HW-Vinyl-Gauges 16-22 2500V  
Gauges 6-14 -600V-80C  
HW-Glass Braid-600V-80C  
LW-Vinyl-300V-80C  
LW-Nylon Jacket-300V-90C

**new!**  
Mil-W-1687D-Plastic  
B-Vinyl-600V-105C  
B-Vinyl-Nylon Jacket-600V-115C  
C-Vinyl-1000V-105C  
C-Vinyl-Nylon Jacket-1000V-115C  
D-Vinyl-3000V-105C

**new!**  
Mil-W-5086A & Mil-C-7078A  
Aircraft Power and Lighting  
Cables  
Mil-W-5086A-Types 1 & 2-600V  
Mil-C-7078A-Type 1-600V

Just published—new electronic catalog—4000 new items! Available at the Wescon Show. Request your copy.

**Belden**  
ELECTRONIC WIRE  
WIREMAKER FOR INDUSTRY  
SINCE 1902 CHICAGO



**NEW!**

## COILED RETRACTILE CABLES

Microphone—Telephone

A variety of new types and lengths for most applications. Microphone cables offered with 1, 3, and 4 conductors in vinyl and neoprene—telephone cords with 3 and 4 conductors, vinyl only.

One wire source for everything electronic and electrical



magnet wire • lead wire • electronic wire • control cables • power supply cords • welding cable • automotive and aircraft wire & cable



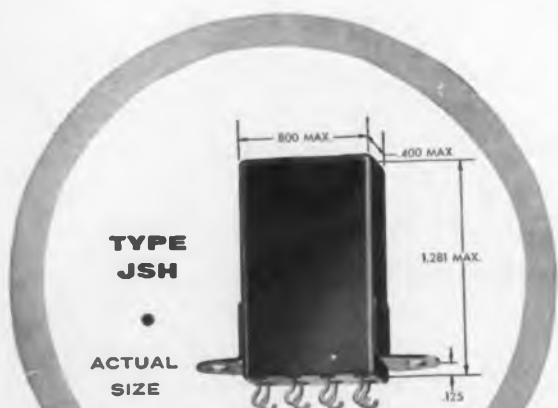

# ALLIED CONTROL'S NEW

**SENSITIVE 2 AMP RELAY**  
for  
**\*15 g to 2000 cps vibration**

**OPERATING CONDITIONS:**

**AVERAGE PULL-IN POWER:**

SPDT 25 milliwatts at 25°C  
DPDT 40 milliwatts at 25°C

**CONTACT RATINGS:**

Non-inductive — 2 amperes at 29 volts d-c  
or 1 ampere at 115 volts a-c  
Low level contacts are available on request

**VIBRATION:**

5-55 cps at 0.12 inch double amplitude  
55-2000 cps at a constant 15 g  
\* 20 g available on request

**SHOCK:**

50 g operational

**TERMINALS:**

0.2 inch grid spaced

**WEIGHT:**

1.1 ounce maximum

Write for Bulletin JSH #62

**ALLIED CONTROL**

ALLIED CONTROL COMPANY, INC.

2 EAST END AVENUE, NEW YORK 21, N. Y.

CIRCLE 97 ON READER-SERVICE CARD

AL-206

## NEW PRODUCTS AT WESCON

### Oscilloscope Camera 493

With F/4.5 lens. Type 3005 oscilloscope camera is for use in applications not requiring the fastest possible recording capabilities. It provides prints in 10 sec with type 47 Polaroid film.

Analab Instrument Corp., Dept. ED, Cedar Grove, N. J.

P&A: \$370; stock.

See at Show Booth 1218.

### Voltohmmeter 558



Five-digit model M25 has an accuracy of  $\pm 0.01\%$   $\pm 1$  digit in ranges of  $\pm 9.9999$ , 99.999, 9999.9 v; 0.99999; 9.9999, 99.999 voltage ratio; 9.9999, 99.999, 999.99 K. All control functions can be remotely operated. Digital output signals are furnished to operate printed, tape and card punch systems and voltage comparators.

Non-Linear Systems, Inc., Dept. ED, Del Mar, Calif.

P&A: \$6,000; by September.

See at Show Booth 1518-20.

### Variable Inductor 534

Frequency drift is less than 1% over a wide temperature range due to built-in heater. Based on 1-w control power, model OM-101 variable inductor has a range of 10 to 20 mc min and 40 to 80 mc max. Maximum inductance is 1.6  $\mu$ h, with 0.4  $\mu$ h at saturation.

Vari-L Co., Inc., Dept. ED, 207 Greenwich Ave., Stamford, Conn.

P&A: \$60; stock.

See at Show Booth 4312.

### Military Blower 532

Provides 12 cfm at 0.2-in. SP. Equipped with a 60-cps blower, the STA-300-11050 blower is designed for military ground applications and can be used in test equipment, power supplies, radar, transmitters and other equipment. Weight is 0.5 lb.

The Torrington Manufacturing Co., Dept. ED, Torrington, Conn.

Availability: 5 to 8 weeks.

See at Show Booth 4117.

## REDUCE TOROIDAL COIL WINDING COSTS with these NEW WINDING MACHINES

**MODEL S** — first to have fully transistorized in-line digital "read-out" counter and photoelectric turns and footage counting pick-ups. Toroidally winds #16-#50 wire and down to .065" ( $\pm$ ) finished I.D. 9 new twist-locking interchangeable heads for random and precise layer winding.

**MODEL LS-1** — has high speed, 4-digit predetermining electro-mechanical transistorized counter and photo-electric turns and footage counting pick-ups. Wire range #20-#46 AWG. Finished I.D. .065" ( $\pm$ ). Model S twist-locking interchangeable winding heads. \$2750. Complete.



See us at  
**WESCON SHOW**  
Booth No. 4532



**UNIVERSAL**

Send for further information

**MANUFACTURING COMPANY, Inc.**

1168ED Grove Street, Irvington 11, N. J. Essex 4-9800

The most COMPLETE line of TOROIDAL equipment in the world.

CIRCLE 88 ON READER-SERVICE CARD

## GURLEY Photoelectric PULSE GENERATORS Add...Subtract...Count

Gurley photoelectric pulse generators are shaft-driven, deliver electrical pulses at terminals. Pulse frequency is directly proportional to shaft speed; pulse amplitude is independent of shaft speed. Used basically as rate generators or angle-measuring devices. All available with direction-sensing photo cells.



**Model 8601**

Synchro Mount .... 1.437" dia.  
Length ..... 1.875"  
Up to 1024 apertures  
Inertia ..... 2.8 Gm-Cm<sup>2</sup>  
Torque ... less than 0.1 in.-oz.



**Model 8602**

Housing Diameter .... 1.375"  
Length ..... .844"  
Up to 1024 apertures  
Inertia ..... 2.8 Gm-Cm<sup>2</sup>  
Torque ... less than 0.1 in.-oz.



**Model 8603**

Synchro Mount ..... 3.4" dia.  
Length ..... 2.6"  
Up to 5000 apertures  
Inertia ..... 340 Gm-Cm<sup>2</sup>  
Torque ... less than 0.1 in.-oz.  
Built-in amplifiers available.

Write for information on one or all. **W. & L. E. GURLEY, TROY, N. Y.**  
525 Fulton Street

FOR THE ELECTRONIC ENGINEER  
**FREE-\$2,800.00**

EXTRA IN 1961

It's true. This is the average increase in salary of the Electronics Men placed through Cadillac in 1961.

The nation's largest placement service, Cadillac is employed by 520 of the nation's leading electronic firms—from coast-to-coast. Our service is *completely confidential* and available to you *absolutely free of charge*. In all probability, at least 3 dozen of our clients are looking right now for a man of your background.

**FREE-Opportunities Bulletin**

Find out the top positions in electronics every month. Send us your name and home address direct or circle Reader Service Card No. 890



**LON D. BARTON**  
President  
**CADILLAC ASSOCIATES, INC.**

29 East Madison Bldg.  
Chicago 2, Illinois  
Financial 8-9400

CIRCLE 890 ON READER-SERVICE CARD

**BEFORE** 1.25 cubic inch



**NOW** .66 cubic inch



**POWERTRIM™ ADJUSTABLE POWER RESISTOR**

- Make precise adjustment with circuit ON—no cool-down time necessary—no burn or shock hazards.
- Power rating—up to 20 watts.

Ask your local distributor today!



**INVAR ELECTRONICS CORP.**  
1723 Cloverfield Blvd. • Santa Monica, Calif. • EX 3 9611

CIRCLE 91 ON READER-SERVICE CARD

ELECTRONIC DESIGN • August 2, 1961

**Brushless Encoder**

662



Output is true binary and has a total count of  $2^{13}$  for each input-shaft revolution. The Di-cap single-shaft encoder provides a serial or parallel output from pulse or step command. The output level is about +10 v for a "1" and about +1/2 v for a "0". Output impedance is about 2,000 ohms.

General Precision, Inc., Kearfott Div., Dept. ED, 1150 McBride Ave., Little Falls, N. J.

See at Show Booth 3309-21.

**Frequency Meters**

668

Two types. Model 1130-A digital-time and frequency meter include data storage for continuous display. Model 1142-A frequency meter and discriminator is an analog meter with a direct-reading accuracy of  $\pm 0.01\%$

General Radio Co., Dept. ED, W. Concord, Mass.

See at Show Booth 2202-04.

**Plug-In Unit**

643

Vertical amplifier and two independent operational amplifiers comprise type O plug-in unit, for use with the firm's oscilloscopes. The preamplifier has a 20-mc passband and a sensitivity of 50 mv per cm. The operational amplifiers have 12-mc gain-bandwidth product and open-loop dc gain of 2,500.

Tektronix, Inc., Dept. ED, P. O. Box 500, Beaverton, Ore.

See at Show Booth 1726-28, 1823.

**Digital Clocks**

659



Output is 8-4-2-1 binary-coded decimal and decimal in the same clock. Model 2000 digital clocks have parallel outputs with a separately wired common for each decimal digit position for easy conversion to serial form. Time resolutions of minutes, tens of seconds or seconds are available.

Chrono-Log Corp., Dept. ED, Box 4587, Philadelphia 31, Pa.

P&A: \$335 to \$600; 2 to 6 weeks.

See at Show Booth 4503-05.

**COLOR ILLUMINATED LEVERS!**

A NEW LEVER SWITCH WITH "INDICATOR-TYPE" LIGHTING



**THE SWITCHCRAFT "LEVER-LITE"**

For the first time, an illuminated switch designed to color code your switching positions! One switch, one lamp—replaces an ordinary switch and up to 3 indicator lamps. Reduces panel space! Eliminates costly wiring!

The "Lever-Lite" Switch, Series 25000, combines fast action multiple-circuit switching—in 2 or 3 position action—locking or non-locking types with "human-engineered" illuminated colors. The serrated lever actuator adds dimensional visibility for greater operator reaction. Your choice of these colors—Red, Green, Amber, White. Two lamp voltages—6V and 28V.

The "Lever-Lite" is applicable to many control panels where space is at a premium—illumination is desirable and where the proven dependability of leaf-type switching is needed. Write for details.

Booth 1510 Wescon Show • August 22-25 • Cow Palace • San Francisco

**SWITCHCRAFT**

3329 N. Elston Ave., Chicago 34, Ill.  
Branches: Philadelphia, Boston, St. Louis, St. Paul

CIRCLE 92 ON READER-SERVICE CARD

NEW FROM FAIRCHILD

6 NSEC  $T_s$  M

SILICON  
PLANAR  
2N709

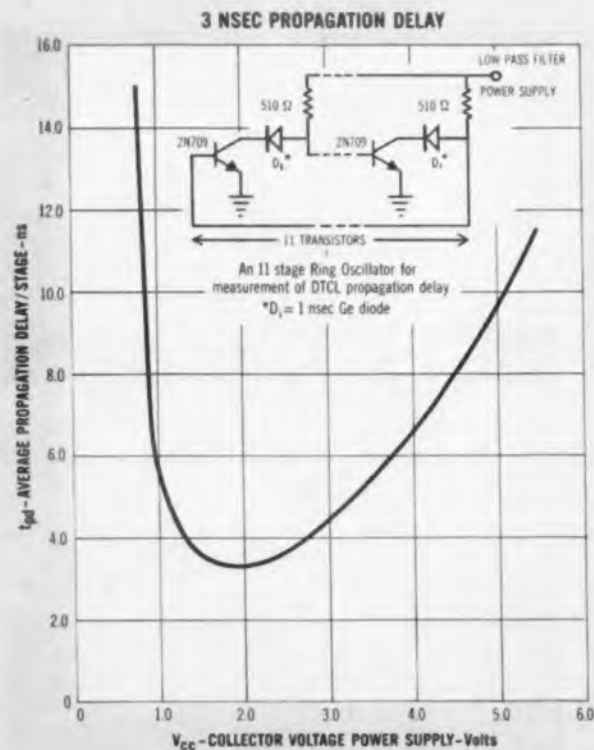

# AX. MADE POSSIBLE BY FAIRCHILD PLANAR PROCESS

## ULTRA-FAST SPEED

100-200 mc saturated switching circuits are now made possible and practical because of: typical  $f_T$  of 800 mc, average DC propagation delay time of 3 nsec. (6 nsec. max.), 3 pf  $C_{ob}$  (max.) and 2 pf CTE (max.).

## LOW LEAKAGE

With the 2N709 you can design micropower high speed satellite circuits with minimum allowances for leakage. Provides the parameter stability and uniformity characteristic of Fairchild's silicon Planar devices.

## LOW COST

2N709 is on distributor shelves, ready for immediate delivery. You can have this ultra-fast, guaranteed, high-performance device at prices practical for the "breadboard" budget as well as quantity production.

Contact your Fairchild Distributor or Field Office. Or write for complete specifications and pricing information.

		2N709				
		VERY HIGH SPEED NPN SILICON PLANAR TRANSISTOR		ULTRA-FAST SWITCHING APPLICATIONS		
		JEDEC TO-18 PACKAGE				
		300 mW POWER DISSIPATION AT 25° C. FREE AIR TEMPERATURE				
ELECTRICAL CHARACTERISTICS (25° C unless otherwise noted)						
Symbol	Characteristics	Min.	Typ.	Max.	Units	Test Conditions
$h_{FE}$	DC Current Gain	20		120		$I_C = 10 \text{ mA}$ $V_{CE} = 0.5 \text{ V}$
$V_{BE(sat)}$	Base Saturation Voltage	70		85	Volts	$I_C = 3.0 \text{ mA}$ $I_B = 0.15 \text{ mA}$
$V_{CE(sat)}$	Collector Saturation Voltage			40	Volts	$I_C = 3.0 \text{ mA}$ $I_B = 0.15 \text{ mA}$
$C_{ob}$	Output Capacitance			3.0	pf	$I_C = 0$ $V_{CB} = 5.0 \text{ V}$
CTE	Emitter Transition Capacitance			2.0	pf	$I_C = 0$ $V_{CB} = 5.0 \text{ V}$
$I_{CBO}$	Collector Cutoff Current			100	$\mu\text{A}$	$I_E = 0$ $V_{CB} = 5.0 \text{ V}$
$I_{CBO}(150^\circ \text{C})$	Collector Cutoff Current			5.0	$\mu\text{A}$	$I_E = 0$ $V_{CB} = 5.0 \text{ V}$
$BV_{CBO}$	Collector to Base Breakdown Voltage	12			Volts	$I_C = 10 \mu\text{A}$ $I_E = 0$
$V_{CEO}(sust.)$	Collector to Emitter Sustaining Voltage	5.0			Volts	$I_C = 10 \text{ mA}$ (pulsed) $I_B = 0$
$BV_{EBO}$	Emitter to Base Breakdown Voltage	3.0			Volts	$I_C = 0$ $I_E = 10 \mu\text{A}$
$T_s$	Charge Storage Time Constant		3.0	6.0	nsec	$I_C = I_{B1} = I_{B2} = 5.0 \text{ mA}$
$t_d + r$	Turn On Time ( $V_{BE(0)} = -1.0 \text{ V}$ )			15	nsec	$I_C = 10 \text{ mA}$ $I_{B1} = 2I_{B2} = 2.0 \text{ mA}$
$t_s + f$	Turn Off Time			15	nsec	$I_C = 10 \text{ mA}$ $I_{B1} = I_{B2} = 1.0 \text{ mA}$
$f_T$	Gain-bandwidth Product ( $f = 100 \text{ mc}$ )		800		mc	$I_C = 5.0 \text{ mA}$ $V_{CE} = 4.0 \text{ V}$

SEE US AT WESCON  
BOOTH NO. 814-14

**FAIRCHILD**  
**SEMICONDUCTOR**

545 WHISMAN ROAD, MOUNTAIN VIEW, CALIF. - YORKSHIRE 8-8161 - TWX: MN VW CAL 853  
A DIVISION OF FAIRCHILD CAMERA AND INSTRUMENT CORPORATION

CIRCLE 93 ON READER-SERVICE CARD

THE  
POTTER  
906 II  
HIGH SPEED DIGITAL  
MAGNETIC TAPE HANDLER  
PROVIDES . . .



...a  
**dramatic  
break through**

in

# HIGH DENSITY RECORDING

Each reel of 1-inch tape recorded by the new Potter High Density Recording System will hold as much data as eleven reels recorded by the most common computer system! This dramatic break-through makes recording so reliable that in 40 hours of continuous operation, less than 2 seconds of re-read time is required to recover drop-outs due to transient error! And you get data transfer rates of 360,000 alpha-numeric characters per second at densities to 1500 bits per inch on 1-inch tape with drop-outs fewer than 1 in  $10^6$ .

In the BENDIX G-20 COMPUTER SYSTEM delivered to the Carnegie Institute of Technology, the Potter HI-D technique has proved completely reliable. To learn how High Density Recording can be applied to your data handling problem . . . write for details today.

The 906 II  
High-Speed Digital  
Magnetic Tape Handler,  
employing the latest de-  
velopments in solid-state  
electronics, provides in-  
dividual transistorized  
circuit plug-in  
cards.

**POTTER**



**INSTRUMENT COMPANY, INC., PLAINVIEW, NEW YORK**

Visit our booths at the Wescon Show

CIRCLE 94 ON READER-SERVICE CARD

## NEW PRODUCTS AT WESCON

### Transistorized Instruments

635



Use submodules including differential and chopper stabilized operational amplifiers to provide a variety of ranges. A typical instrument in the 1800 series provides a variable gain of 0 to 1,000 from 0 to 20,000 cps with an input impedance of greater than 1 meg and an output impedance suitable for driving a 100-ma galvanometer.

Burr-Brown Research Corp., Dept. ED, Box 6444, Tucson, Ariz.

**P&A:** \$225 to \$575; stock to 60 days.

See at Show Booth 3320.

### Silver-Zinc Battery

675

Long-life Silvercel silver-zinc battery can achieve more than 440 cycles during 30 months of application. The compact unit is suitable for a wide variety of uses.

Yardney Electric Corp., Dept. ED, 40-52 Leonard St., New York 13, N. Y.

See at Show Booth 3402.

### DPDT Chopper

639

For 400-cps use. This dpdt chopper has less than 1-mv spurious signal caused by both noise and thermal drift. Action is make-before-break. Maximum difference in phase lag is 3 deg. Vibration limit is 30 g at up to 2,000 cps.

The Bristol Co., Dept. ED, Waterbury 20, Conn.

See at Show Booth 3316-18.

### Power Resistors

633



Rated at 10, 25, and 50 w. Types MC and MCX miniature, wirewound power resistors are inductive and noninductive units, respectively. Operating temperature range is  $-55$  to  $+275$  C; tolerance is 0.05%; insulation is better than 1,000 v ac; temperature coefficient is 0.00002 per deg C.

California Resistor Corp., Dept. ED, 1631 Colorado Ave., Santa Monica, Calif.

See at Show Booth 3306-08.



## MANUFACTURED TO YOUR SPECIFICATIONS



One of a kind, or millions of parts ... you get the closest tolerances from GARNER—tolerances which have led the field in the redrawn glass industry since 1953.

Large stocks of many different glass types and sizes—including the unusual. Available for immediate redraw.

Customer minded—We constantly upgrade equipment and techniques to keep ahead of your needs. You'll find us especially helpful on difficult requirements.

On-time deliveries—GARNER is geared for volume production to tight specifications—on a day-to-day basis. You get the parts you need... when you need them.

Send for complete data.



## T. H. GARNER COMPANY

177 S. Indian Hill Blvd.  
Claremont, Calif. • National 6 3526

CIRCLE 95 ON READER-SERVICE CARD  
ELECTRONIC DESIGN • August 2, 1961

## Vacuum-Tube Voltmeter 485



Direct-reading model 375 vacuum-tube voltmeter has ranges of 1.5, 5, 15, 50, 150, 500 and 1,500 v dc and ac, rms and peak to peak; 5, 50 and 500 ma; 0.5, 5, 50, 500 K, 5, 50 and 1,000 meg. Accuracy is  $\pm 3\%$  full scale; input resistance is 11 meg on all dc ranges.

B&K Manufacturing Co., Dept. ED, 1801 W. Belle Plaine Ave., Chicago 13, Ill.

P&A: \$89.95; stock.

See at Show Booth 4122.

## Punched-Tape Reader 524

Speed is 8,000 bits per min. Using 70-mm Mylar tape, this punched-tape reader simultaneously processes 32 parallel Form A contacts rated at 28 v, 150 ma. It is claimed to have a reliability of 99.99997%. It can be rack mounted or sealed for remote installation. Mil specs are met.

Chalco Engineering Corp., Dept. ED, 6043 Hollywood Blvd., Los Angeles 28, Calif.

See at Show Booth 2703.

## Energy-Storage Capacitors 488



Inductance is 0.04  $\mu$ h or less. This 2,800-J energy-storage capacitor has a life expectancy of better than 100,000 ringing train discharges. Voltage reversal above 90% is possible. Units rated at 50 kv dc with an inductance of 0.015  $\mu$ h are also available.

Sangamo Electric Co., Dept. ED, Springfield, Ill.

See at Show Booth 2207-09.

CIRCLE 96 ON READER-SERVICE CARD

## Variable Delay Timing Circuit

### Typical Applications

- Safety device for sequential application of signals
- Warm-up delay mechanism for starting complex machinery
- Automatic on/off control to facilitate adjustment of process machinery at irregular intervals
- Sequence control of signals as a function of time
- Delay mechanism for sequential sampling and measuring purposes at accurate intervals
- Element to provide required delays for computer or logic circuitry

### Features

Time Delay From 25 milliseconds to 3 minutes  
Self Resetting or Externally Cycled  
Temperature Range  $-40^{\circ}\text{C}$  to  $+125^{\circ}\text{C}$   
ON/OFF Relay Actuator

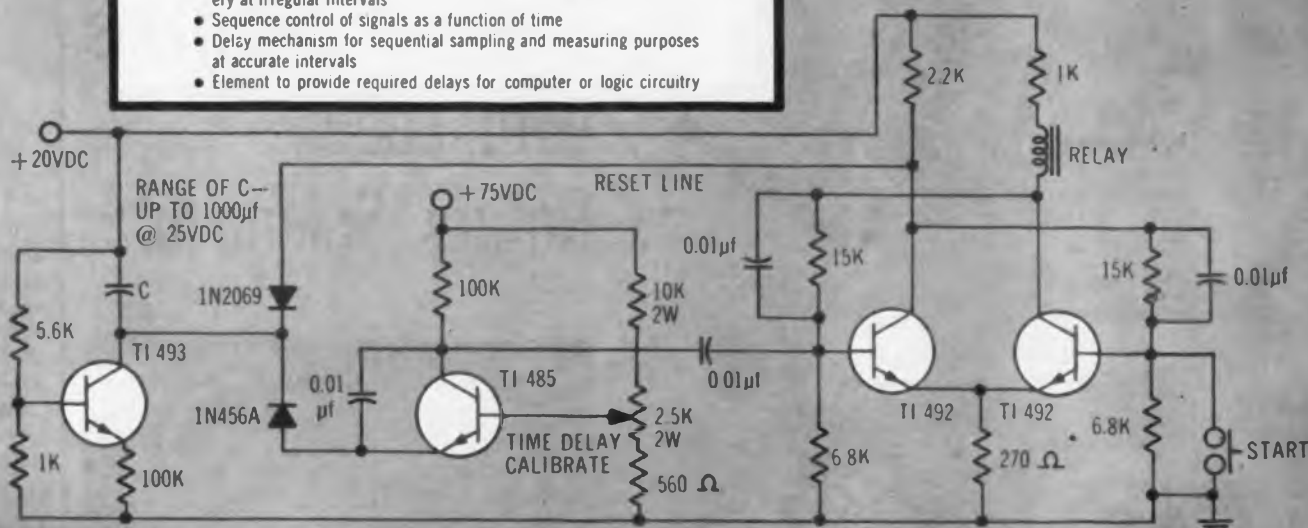

## HOW TO GET HIGH TEMPERATURE STABILITY AND INDUSTRIAL ECONOMY

## With New TI Low-Cost Silicon Industrial Transistors...

You can assure your customers optimum circuit performance up to  $125^{\circ}\text{C}$  when you design-in new, low-cost TI silicon industrial transistors. Priced comparable to lower-temperature industrial devices, these new TI silicon industrial units provide the high performance your industrial designs require.

Get greater margins of operational safety by applying these new silicon industrial transistors to your process control, communication, aviation system, electronic instrumentation, and computer applications today.

CHARACTERISTICS					APPLICATIONS					
TYPE	MIN $V_{CE0}$	DC Beta Range	MAX $I_{C0}$ @ $100^{\circ}\text{C}$	$f_{\alpha B}$ (typ)	Power Amp	Logic Amp	Switch Amp	TV Amp	Video Amp	Other
TI 480	50 v	9-36* @ 5 ma	50 $\mu$ a @ 30 v	1 mc	TI 480					
TI 481	80 v	9-36* @ 5 ma	50 $\mu$ a @ 30 v	1 mc	TI 481					
TI 482	20 v	>20 @ 30 & 150 ma	50 $\mu$ a @ 10 v†	60 mc		TI 482		TI 482		
TI 483	40 v	20-60 @ 150 ma	50 $\mu$ a @ 30 v†	60 mc		TI 483		TI 483		
TI 484	40 v	40-120 @ 150 ma	50 $\mu$ a @ 30 v†	60 mc		TI 484		TI 484		
TI 485	20 v	15-60 @ 10 ma	20 $\mu$ a @ 15 v†	200 mc					TI 485	
TI 486	80 v	20-80 @ 200 ma	300 $\mu$ a @ 60 v‡	15 mc		TI 486				
TI 487	80 v	20-80 @ 200 ma	300 $\mu$ a @ 60 v‡	15 mc		TI 487				
TI 492	40 v	15-45* @ 1 ma	50 $\mu$ a @ 30 v	8 mc		TI 492				
TI 493	40 v	15-45 @ 10 ma	50 $\mu$ a @ 20 v	20 mc		TI 493				
TI 494	40 v	40-125 @ 10 ma	50 $\mu$ a @ 20 v	20 mc		TI 494				
TI 495	40 v	120-250 @ 10 ma	50 $\mu$ a @ 20 v	20 mc		TI 495				
TI 496	40 v	>10 @ 3 ma	75 $\mu$ a @ 40 v	1 mc						TI 496

\*AC Beta †  $I_{C0}$  @  $125^{\circ}\text{C}$  ‡  $I_{C0}$  @  $150^{\circ}\text{C}$  § 100  $\mu$ a to 20 ma \*\*20 ma to 500 ma #  $V_{CEX}$  ® TRADEMARK OF BURROUGHS CORPORATION



SEMICONDUCTOR COMPONENTS  
DIVISION  
PLANTS IN DALLAS, TEXAS  
BEDFORD, ENGLAND  
AND NICE, FRANCE



TEXAS INSTRUMENTS  
INCORPORATED  
13500 N. CENTRAL EXPRESSWAY  
P. O. BOX 5012 DALLAS 22, TEXAS

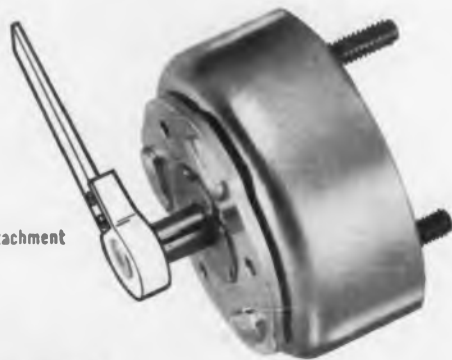

knife attachment

## CUTTING

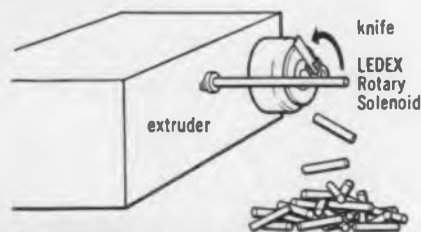

## SORTING

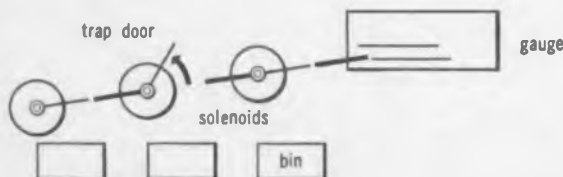

## PUNCHING

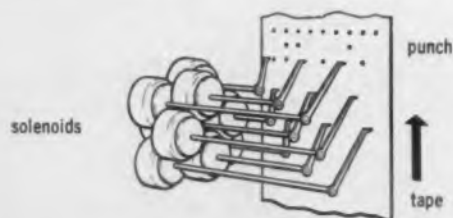

The examples shown above have one thing in common. They fit into compact space. Design engineers, for example, often find that a Ledex Rotary Solenoid will fit into one-quarter to one-half the space of a straight pull solenoid.

This compactness results from the unique Ledex design which converts an efficient short axial stroke into a high torque to size rotary motion. A more uniform force is produced throughout the stroke, making use of otherwise wasted energy at the end of the stroke. This rotary motion can be used directly as in the cutting and sorting examples above, or can be



High-torque-to-size rotary motion  
High-thrust-to-size piston motion

CIRCLE 97 ON READER-SERVICE CARD

# Compact Solutions with Ledex Rotary Solenoids

## NEW PRODUCTS AT WESCON

### FM Transmitter

657



Range is 215 to 260 mc. Type 1053A 1-w fm transmitter has a sensitivity of 0.01 v per kc, carrier deviation of  $\pm 150$  kc and a modulation range of 100 cps to 150 kc. It operates at unlimited altitudes and withstands 20-g random vibration from 20 to 2,000 cps, 60-g acceleration and 100-g shock.

American Bosch Arma Corp., Tele-Dynamics Div., Dept. ED, 5000 Parkside Ave. Philadelphia Pa.

See at Show Booth 4126-28.

### Lever Switch

583



Illuminated lever switch, called Lever-Lite, is designed to color code switching positions. It replaces an ordinary switch and up to three indicator lamps. It can be furnished in the series 25000, two and three-position, nonlocking types and the series 25000L locking types.

Switchcraft, Inc., Dept. ED, 5555 N. Elston Ave., Chicago 30, Ill.

Availability: 30 days.

See at Show Booth 1510.

### Ratio Transformer

655



Range is 50 cps to 10 kc. Model RT-60 general-purpose ratio transformer is an inductive ac voltage divider with an accuracy of 0.001%. Five decades of transformer switching are provided, enabling the unit to be used for checking resolvers and servos, voltmeter calibration, computer testing and transformer-returns ratio measurements.

Gertsch Products, Inc., Dept. ED, 3211 S. La Cienega Blvd., Los Angeles 16, Calif.

See at Show Booth 1602-04.

ELECTRONIC DESIGN • August 2, 1961



## Weld Strength Testers

716



Portable weld strength testers are made to develop weld schedules in component packaging as well as for quality control in production welding. Model VTA-46 has a test range of 0 to 50 lb, and model VTA-47 has a range of 0 to 100 lb. Device has a jeweled meter movement, interchangeable jaws, and anti backlash provisions.

Hughes Aircraft Co., Vacuum Tube Products Div., Dept. ED, 2020 Short St., Oceanside, Calif.

**P&A:** \$325; from stock.

See at Show Booth 2427.

## Digital Circuit Modules

717



From 0 to 25 kc are handled by the U-series universal NOR digital circuit modules. Devices have welded electrical connections and are encapsulated. Rectangular units measure 0.95 x 0.95 x 0.5 in., and cylindrical units measure 7/8 in. in diameter and 1 in. high. MIL-STD-202B requirements are met.

Engineered Electronics Co., Dept. ED, 1441 E. Chestnut Ave., Santa Ana, Calif.

**P&A:** \$10 to \$14; from stock.

See at Show Booth 2320-26.

## Size 8 Resolvers

702



Weigh 38 g. These size 8 resolvers are stable over the temperature range of -55 to +125 C. Constructed of corrosive-resistive materials, they meet applicable requirements of MIL-E-5272.

Daystrom Inc., Transicoil Div., Dept. ED, Worcester, Pa.

**Availability:** 75 to 90 days.

See at Show Booth 2915.

From Indiana Steel Products Division of  
**INDIANA GENERAL CORPORATION**

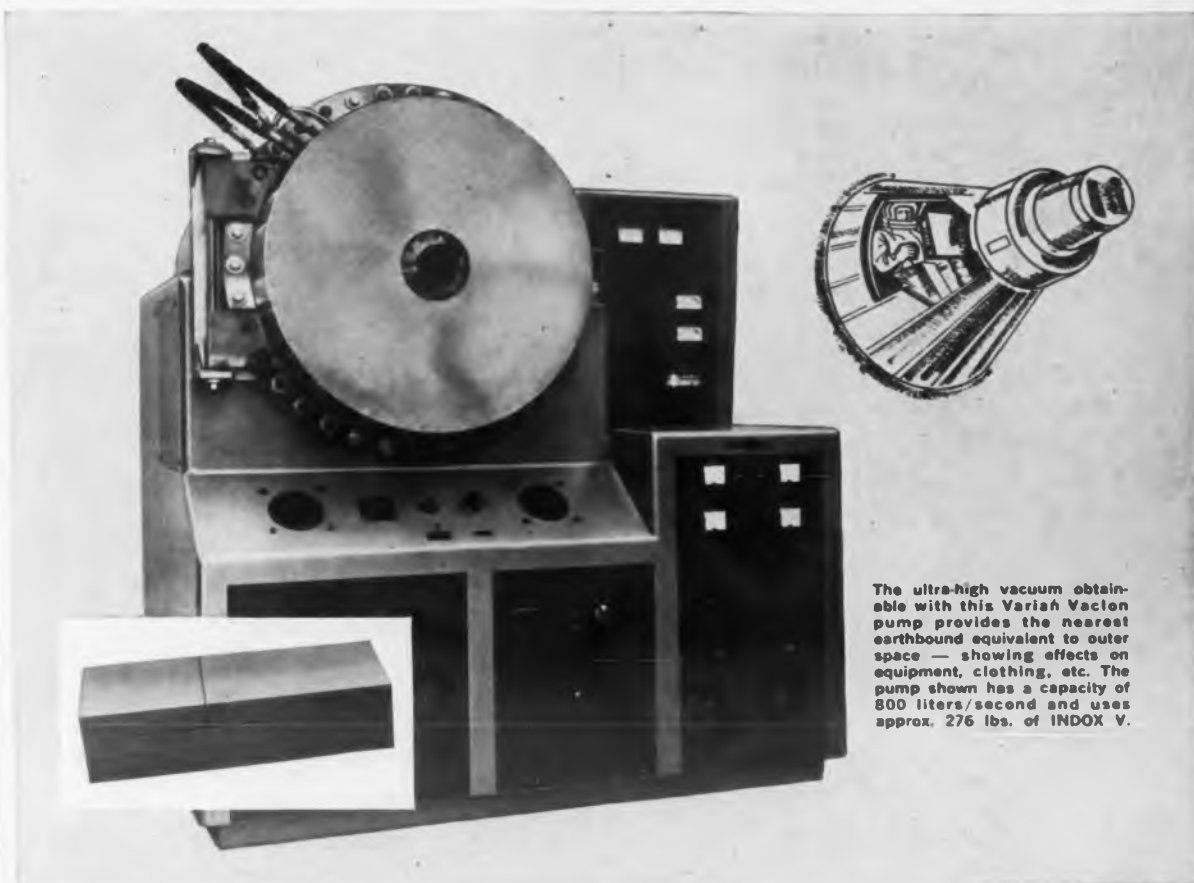

The ultra-high vacuum obtainable with this Varian Vaclon pump provides the nearest earthbound equivalent to outer space — showing effects on equipment, clothing, etc. The pump shown has a capacity of 800 liters/second and uses approx. 276 lbs. of INDOX V.

## INDOX<sup>®</sup> V magnets improve space chamber vacuums

Indiana Steel's INDOX V permanent magnets are helping Varian Vaclon pumps obtain verified vacuums past  $10^{-9}$  mm Hg. Result: better space chambers, plus many additional critical vacuum applications.

Advanced design ion pumps, manufactured by Varian Associates, Palo Alto, Calif., are providing ultra-high vacuums with greater efficiency. In fact, these pumps, using powerful INDOX V magnets, are largely replacing diffusion pumps on critical vacuum applications.

After a mechanical roughing pump removes most of the air from a given vessel, the ion pump goes into operation. High voltage is applied, ionizing some of the gas particles and forcing electrons toward the anode. The powerful magnetic field of the INDOX V permanent magnet deflects the traveling electrons into spiral paths, increasing path lengths and, therefore, the number of particle collisions and degree of ionization. Finally, the

ions bombard titanium cathode plates which frees titanium atoms to form stable compounds with the atoms of oxygen and nitrogen which are then deposited on the anode grid. Inert gases are also removed by burial in the cathode and entrapment on the anode.

Varian selected Indiana Steel INDOX V magnets both for their magnetic characteristics and their uniform quality. INDOX V is a highly oriented ceramic magnet material with a peak energy product  $3\frac{1}{2}$  times greater than conventional unoriented barium ferrite materials. It is lightweight and extremely resistant to the effects of demagnetization.

Whether it's a question of choice of magnet or a design problem, why don't you take advantage of Indiana's wealth of experience, research leadership and specialized engineering "know-how"? Write today, outlining your needs. For further details on the INDOX family of magnetic materials, ask for Bulletin 18A, Dept. M-8.



## INDIANA STEEL PRODUCTS

Phone HOward 2-3111 • Direct Distance Dialing Code 219

VALPARAISO, INDIANA

INDIANA PERMANENT MAGNETS

CIRCLE 244 ON READER-SERVICE CARD

Itek

## Crystal Filters do Wonderful Things



A toast to Itek for a wonderful thing . . . Itek Crystal Filter 968B, with a near-Gaussian attenuation characteristic makes possible a 10,000 channel receiver! In antenna circuits, this 5 MC Filter optimizes pulse response, minimizes overshoot, and eliminates adjacent channel interference.

Perhaps you don't need a Gaussian crystal filter. But could you use the ingenuity that built one? Could Itek technical leadership help you?

Of course, the world's largest and most complete selection of stock filters is available, too. Choose from more than 3,000 Itek-Hermes designs.

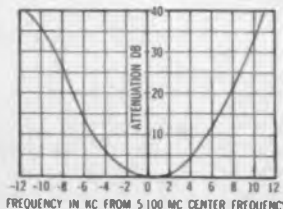

Write for free Brochure "WESKACFAACP" or, *What Every Engineer Should Know About Crystal Filters At A Cocktail Party. You'll enjoy it.*

**Itek Electro-Products Company**

75 CAMBRIDGE PARKWAY, CAMBRIDGE 42, MASS. A DIVISION OF

Itek

CIRCLE 100 ON READER-SERVICE CARD

## NEW PRODUCTS AT WESCON

### Microminiature Relay

647



Rating is 2 amp, resistive, at 28 v dc. Series A pillbox microminiature relays are especially suited for use on printed-circuit boards. Dielectric strength is 1,000 v; insulation resistance is 150 g for 11 msec; design is dpdt.

Filtors, Inc., Dept. ED, 30 Sagamore Hill distance is 10,000 meg min at 25 C; shock limit Drive, Port Washington, N. Y.

See at Show Booth 513-515.

### Plug-In Unit

642

Dual-trace sampling plug-in unit type 76 contains identical amplifiers having a sensitivity of 10 mv per cm. Each channel has a dc-coupled vertical output of 1 v per cm. Modes of operation include channels A or B, chopped and added. The unit is for use with the firm's 561 oscilloscope.

Tektronix, Inc., Dept. ED, P. O. Box 500, Beaverton, Ore.

See at Show Booth 1726-28, 1823.

### Tuned Amplifier

669

With null detector in a single unit measuring 8 x 6 x 7-3/4 in. Type 1232-A tuned amplifier and null detector is for use as a bridge detector, preamplifier, tuned audio amplifier and audio spectrum analyzer. Completely transistorized and battery operated, the unit is housed in a rack bench cabinet.

General Radio Co., Dept. ED, W. Concord, Mass.

See at Show Booth 2202-04.

### Pulse Generator

627



Remotely programmable pulse generator type B-11 can provide repetition rates of 20 to 2,000,000 pps, pulse delays of up to 10,000  $\mu$ sec and pulse widths of 0.05 to 10,000  $\mu$ sec. Pulse amplitude is 50 v to 60 db below 50 v; pulse risetime is 0.015 to 1  $\mu$ sec.

Rutherford Electronics Co., Dept. ED, 8944 Lindblade St., Culver City, Calif.

See at Show Booth 1501-02.



## General Electric Silicone dielectric grease

An excellent electrical insulating compound that's easily applied and stays in place.

Water repellency protects terminals connections from failure due to moisture.

Good heat transfer for transistor applications.

Maintains protection from -65 F to 400 F. won't solidify or evaporate.

Chemically inert

Protects copper, other metals against corrosion

For full information on G-E silicone dielectric grease, plus a free 2 oz sample tube, write on your company stationery to: General Electric Company, Silicone Products Department, Section 4, Waterford, New York.

GENERAL ELECTRIC

CIRCLE 101 ON READER-SERVICE CARD  
ELECTRONIC DESIGN • August 2, 1961

# Taurus Terminals of Teflon\*

ARE



## Rapidly Delivered

TO THESE

## Quality-Conscious

CUSTOMERS

AIRCRAFT RADIO CORPORATION  
 BAIRD-ATOMIC, INC.  
 BENDIX RADIO DIVISION  
 CURTISS-WRIGHT CORPORATION  
 EMERTRON, INC.  
 A SUBSIDIARY OF EMERSON RADIO &  
 PHONOGRAPH CORP.  
 GENERAL DEVICES, INC.  
 GENERAL MILLS, INC.  
 THE HALLCRAFTER CO.  
 LORAL ELECTRONICS CORPORATION  
 LYNN ELECTRONICS PRODUCTS CORP.  
 THE MAGNAVOX COMPANY  
 THE MARTIN COMPANY  
 MECH-TRONICS CORPORATION  
 MELPAR, INC.  
 METALCRAFT, INC.  
 U. S. NAVAL AVIONICS  
 NORDEN  
 NORTH AMERICAN AVIATION INC.  
 PHILCO CORPORATION  
 PRECISE METAL PRODUCTS CO.  
 PRINCETON UNIVERSITY  
 RAYTHEON COMPANY  
 RAYTOR CORPORATION  
 SPERRY GYROSCOPE COMPANY  
 THE STANDARD REGISTER CO.  
 TRACERLAB, INC.

Write today for our complete catalog . . .



**TAURUS**  
CORPORATION

Academy Hill, Lambertville, N. J.  
 Export 7-2390 — TWX LVL 8526U

\*REG. T. M. OF E. I. DUPONT

CIRCLE 102 ON READER-SERVICE CARD

## Molded Film Capacitors

650

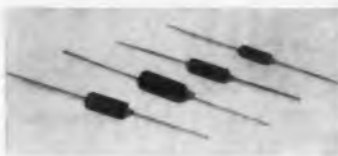

With high humidity resistance. Type 157P Filmite "E" polyester-film capacitors have a rating of 100 v dc and may be operated at up to 105 C with derating working voltages of 75 v. They withstand 95% RH at 40 C for 250 hr. Molded housing also offers protection from shock and heat.

Sprague Electric Co., Dept. ED, North Adams, Mass.

See at Show Booth 1904-08.

## Teflon-Insulated Wire

676

For use at 260 C, continuous. This Teflon-insulated hook-up wire meets requirements of MIL-W-27300 and is available in AWG sizes 26 to 12. Nickel-plated copper conductors, manufactured to close dimensional and resistance tolerances, are used.

Tensolite Insulated Wire Co., Inc., Dept. ED, Tarrytown, N. Y.

See at Show Booth 4608.

## Dual-Range Voltmeter

672

Frequency-selective voltmeter model 127A covers 2 to 350 kc and has a selectivity of 250 cps with audio monitoring capability. It measures -80 to +22 dbm. Powered by a rechargeable battery, the unit weighs less than 15 lb and has dimensions of 7-3/4 x 7-3/4 x 13 in.

Philco Corp., Sierra Electronic Corp., Dept. ED, 3885 Bohannon Drive, Menlo Park, Calif.

See at Show Booth 2006-08.

## Counter-Timer

654



Range is dc to 20 mc. Model 925 solid-state counter timer has a sensitivity of 0.1 v rms on all three channels. Stability is 1 part per 108 per day; 5 parts per 108 per week. Time interval is 0.3  $\mu$ sec to 108 sec. Accuracy is  $\pm 1$  count, varying with time-base stability for all operating modes.

Erie-Pacific, Div. of Erie Resistor Corp., Dept. ED, 12932 S. Weber Way, Hawthorne, Calif.

See at Show Booth 1710-12.

# DESIGN FOR PERFORMANCE

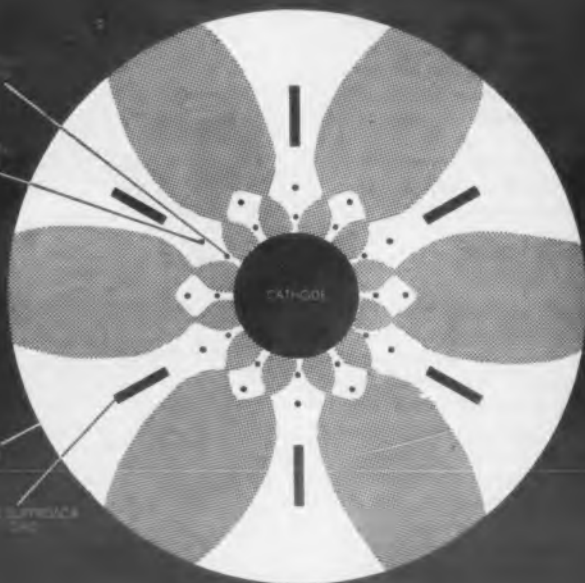

■ **HERE IS A STRAIGHTFORWARD** approach to the problem of preventing electrons from returning to the screen region of a transmitting tube. When channeled into beams like those above, electrons reach the anode, where they do their useful work. Penta's exclusive, patented vane-type suppressor grid does the trick.

■ **THE CHARACTERISTICS** of Penta tubes employing this electrode geometry approach those of the theoretically perfect beam tube. Plate current is practically independent of plate voltage. Kinks and wiggles are absent. Plate voltage can swing well below screen voltage without appreciable loss of current.

■ **THE RESULT IS OUTSTANDING LINEARITY,** efficiency, stability. Penta's PL-172, for example, delivers 1000 watts of Class AB<sub>1</sub> useful output at only 2000 plate volts... more than 1500 watts at maximum Class AB<sub>1</sub> ratings. Introduced in 1955, Penta tubes with vane-type suppressor grids are in important equipment the world over, and their use in high-quality linear amplifiers is growing daily.

■ **YOU TOO CAN ENJOY** the advantages of this years-ahead design by specifying the PL-177A, PL-175A or PL-172 for 100-watt to 1.5 kilowatt power output applications. Detailed, factual data sheets are available for the asking. Ask also for your copy of "Transmitting Tubes for Linear Amplifier Service," which explains how and why this exclusive Penta design provides outstanding performance.



 **PENTA LABORATORIES, INC.**

312 North Nopal Street, Santa Barbara, Calif.

Trade Mark Reg. U. S. Pat. Off.

**VISIT US AT WESCON — BOOTH 1115  
CIRCLE 103 ON READER-SERVICE CARD**

## NEW PRODUCTS

AT WESCON

### Potentiometer

582



Molded carbon potentiometer type 63M is a 1/2-in. unit designed for use in better grade commercial equipment. A wide range of resistance values is offered.

Clarostat Manufacturing Co., Inc., Dept. ED, Dover, N. H.  
See at Show Booth 1714.

### Magnetic-Detector Test Set

530

For rapid testing. The CO 5 5495000 magnetic-detector test set determines whether magnetic detector windings are balanced or unbalanced, open or shorted. It can also be used to check wiring to the flux gate. It is powered by a rechargeable nickel-cadmium battery and is suitable for military use.

General Precision, Inc., Kearfott Div., Dept. ED, 1150 McBride Ave., Little Falls, N. J.

See at Show Booth 3309-21.

### Transistor Adaptor

554



For use with diagraphs. Type BN 35616 transistor adaptor, for measurement of small circuit elements, has a range of 30 to 3,000 mc. Types ZDU and ZDD diagraphs, also available, have high or low frequency ranges. They are for the measurement of impedance and admittance, transmission characteristics and phase angles.

Rohde & Schwarz Sales Co., Dept. ED, 516 Bloomfield Ave., Montclair, N. J.

P&A: \$4,990 to \$5,300 for diagraphs; stock.

See at Show Booth 2526-28.



# COMPLETE PANEL METER

### BAR-RING TYPE MOVEMENTS (Exclusively Triplet)

- Self Shielded
- Not affected by magnetic panels or substantially by stray magnetic fields.
- More Torque
- Lower Terminal Resistance
- Faster Response
- Exceedingly Rugged and Accurate
- All Case Sizes

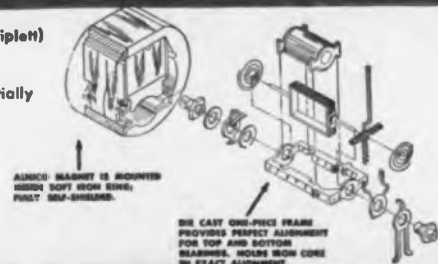

BURTON BROWSE ADVERTISING



Rectangular Flush Mounting (2 1/2")  
Model DC 227-T, AC 237-S, RF 247-Y

Rectangular Flush Mounting (4 1/2")  
Model DC 420-PL, AC 430-PL,  
RF 440-PL

Rectangular Flush Mounting  
(2 1/2")  
Model DC 227-PL, AC 237-PL,  
RF 247-PL

Rectangular Flush Mounting (6")  
Model DC 626, AC 636, RF 646



For complete details see your Electronic Parts Distributor, or write

# LINE FULLY MEETS YOUR NEEDS

The name TRIPLETT has been on instruments of our manufacture for more than 55 years, and is regarded as a symbol of customer satisfaction to industrials and distributors in all parts of the world. Our instruments can be built to customer

specifications or provided from our large stocks of standard ranges in hundreds of sizes and types. We also carry in stock many semi-finished movements which can be converted readily to special customer needs.

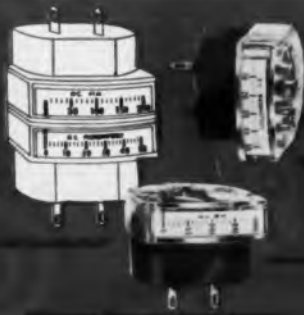

Model 254 Relay

Tilting Case Portable  
Model: 225 (DC), 225 (AC)

Model 420-M Unimeter 4 1/2" with mirror scale

Model 234 Unimeter Stand



**Triplett**  
Quality...  
First to last

TRIPLETT ELECTRICAL INSTRUMENT COMPANY  
BLUFFTON, OHIO

## Digital Voltmeter

542



Accuracy is 0.01%  $\pm 1$  digit, absolute, for a range of 1 mv to 1,000 v dc. Model V-46 digital voltmeter has an input impedance of 10 meg at balance, a sensitivity control continuously variable from 1 to 10 digits and a balancing time of less than 2 sec on any range.

Cubic Corp., Industrial Div., Dept. ED, 5575 Kearny Villa Road, San Diego 11, Calif.

Price: \$1,340.

See at Show Booth 3001-03.

## Wideband Amplifier

499

Voltage gain is 20 min; frequency response, 150 cps to 300 kc. Type 1170 transistorized wideband amplifier is used to amplify mixed signal outputs of subcarrier oscillators. It operates from -20 to +100 C at unlimited altitudes and withstands 30-g random vibration, 100-g acceleration and 100-g shock.

American Bosch Arma Corp., Tele-Dynamics Div., Dept. ED, 500 Parkside Ave., Philadelphia, Pa.

See at Show Booth 4126-28.

## Soldering Iron

545



In ratings of 30, 40 and 50 w, at 120 v. The 30- and 50-w soldering irons have an integral iron-clad tip and heater assemblies for maximum heat at the tip and fast recovery. The 40-w type has a dip holder and heater assembly to accommodate 20 different ironclad and copper screw-on tips.

General Electric Co., Dept. ED, 903 W. Burlington Ave., Western Springs, Ill.

P&A: Under \$5; 30 and 50-w types, stock.

See at Show Booth 2214-16.

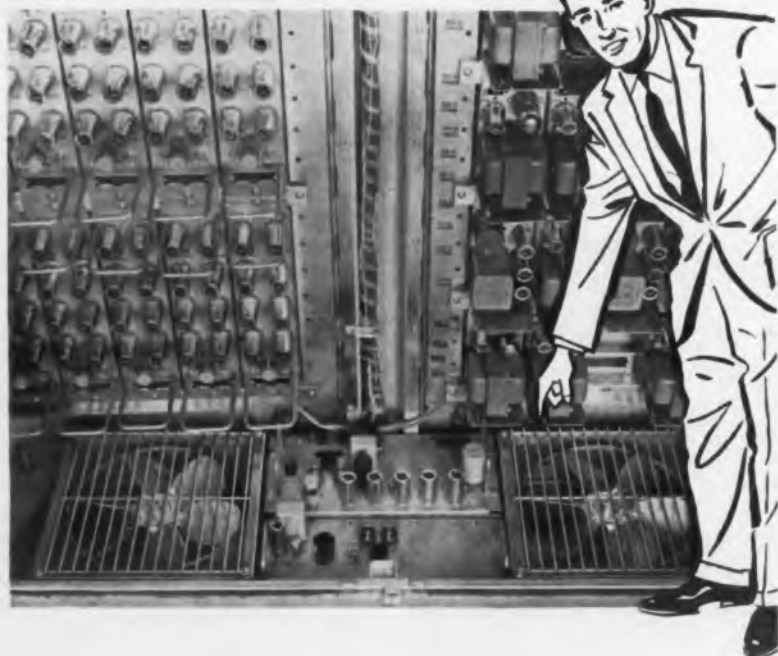

# McLEAN REVERSIBLE FANS

COOL COMPUTER RACKS IN  
CURTISS-WRIGHT FLIGHT SIMULATORS



McLean Reversible Fans cool computer racks in Curtiss-Wright Flight Simulator. Similar fans are included in various simulators for commercial and military aircraft.

A lot rides with a Curtiss-Wright Simulator besides the trainees. Accuracy of data from the simulated flight is critical. And one way to insure this accuracy is to prevent fluctuating temperatures in the computer racks. The Electronics Division of Curtiss-Wright Corporation selected McLean cooling equipment to do this important job. By keeping temperatures uniform, McLean fans maintain accuracy and critical calibration . . . prevent system failure . . . and extend the life of sensitive and expensive electronic components.

Choose from over 100 models in various panel heights and CFM's.

*Also a complete line of fractional horsepower motors*

**McLEAN** ENGINEERING LABORATORIES

*World Leader in Packaged Cooling*

Princeton, N. J. - WAInut 4-4440

TWX Princeton, New Jersey 636



**WRITE TODAY**

44 Page Packaged Cooling Catalog

See us at the WESCON Show—Booth 217

CIRCLE 105 ON READER-SERVICE CARD

## NEW PRODUCTS AT WESCON

### Magnetic Latching Relay

634

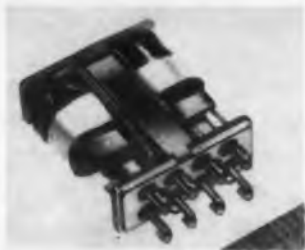

With 10 pins. Type BR-9FX magnetic latching relay can be installed without regard to polarity. Contacts enable usage from dry circuit to 10-amp resistive loads at 28 v dc or 110 v ac, 400 cps. Response time for a 10-msec, square wave or capacitor-discharge pulse is 12 msec max.

Babcock Electronics Corp., Babcock Relays, Dept. ED, 1645 Babcock Ave., Costa Mesa, Calif.

**P&A:** \$27; 3 to 4 weeks.

See at Show Booth 312.

### FM Discriminator

648

With up to 18 channels, mounted in a 19-in. rack with a height of 5-1/4 in. Model AD 8001 operates on input signal levels of 10 mv to 10 v rms with an input impedance of 10 K. The bandpass filter and discriminator select one channel frequency and provide an output of  $\pm 2.5$  v dc into 1 K.

Natel Engineering Co. Inc., Dept. ED, 15922 Strathern St., Van Nuys, Calif.

**P&A:** \$8,500, complete; 30 to 90 days.

See at Show Booth 910.

### Oscilloscope

653



Range is dc to 7.5 mc. Model S32 portable oscilloscope is designed around a crt with post-deflection acceleration and operating at 3.5 kv. Balanced dc-coupled amplifier has a sensitivity of 100 mv per cm and risetime of 50 nsec. Time-base speeds are to 0.1  $\mu$ sec per cm.

The Scopes Co. Inc., Dept. ED, P. O. Box 56, Monsey N. Y.

See at Show Booth 207.

## Tucor Electronically primes TR Tubes



Wilton, Conn.—Tucor announces a breakthrough in TR tube design. The conventional TR tube requires the build-up of large RF voltages before the TR tube will "fire" and provide the high attenuation of which it is capable. These initial high RF voltages appear on the transmitted pulse as a spike containing large amounts of energy. This energy is often sufficient to damage the sensitive circuits which follow.

Tucor has now developed a type of TR tube which does not require the build-up of high RF voltages in order to initiate its attenuating function and, therefore, performs in such a fashion as to virtually eliminate spike leakage. In most cases this technique also allows an improvement in total attenuation characteristics and in recovery time characteristics.

In specific cases, Tucor's new electronically-primed TR tubes have been built to have a spike leakage only 3 db above flat leakage and a recovery time without sweeping voltages superior to conventional tubes with sweeping voltages.

The new technique of electronically priming can be incorporated in tubes of conventional size which are interchangeable with most standard units. Tubes have been built in a variety of sizes suitable for use in 7/8" coax line (above), 1 1/2" coax line, 3 1/2" coax line and L-band waveguide cavities.

If your application suffers due to spike leakage, these tubes are undoubtedly your cure. Please let us know your problems.



**TUCOR  
INC.**

59 Danbury Road (Route 7), Wilton, Connecticut

CIRCLE 106 ON READER-SERVICE CARD  
ELECTRONIC DESIGN • August 2, 1961



Signal-Comparator  
Amplifier

549



Meets Mil specs. Type CO70 3141 002 signal-comparator amplifier opens an external circuit and closes a second one by means of a spdt relay when the input is 1,000 mv min. Input impedance is 2 meg. Applications include use as a null sensing device and synchro displacement indicator.

General Precision, Inc., Kearfott Div., Dept. ED, 1150 McBride Ave., Little Falls, N. J.

See at Show Booth 3309-21.

## Copper-Clad Laminate 527

For critical applications such as missiles, radar, aircraft and ground instruments. Grade 11584 copper-clad laminate withstands severe mechanical and thermal shock and has good resistance to solvents and etching solutions. Bond strength and flex strength are high.

General Electric Co., Laminated Products Dept., Dept. ED, Coshocton, Ohio.

See at Show Booth 4811.

Voltage-Phase  
Comparator

540



Range is 25 cps to 10 kc. Accuracy is  $\pm 0.1$  deg. Primary applications of type IPN-400 self-contained voltage and phase comparator include measuring in-phase and quadrature voltage components, harmonic content and noise. Input impedance is 10,000 meg; potentiometer resolution is 0.0003%.

Autonetics, Div. of North American Aviation, Inc., Dept. ED, 9150 E. Imperial Highway, Downey, Calif.

See at Show Booth 1418-20.

CIRCLE 107 ON READER-SERVICE CARD ►

# High-Speed Switching at HALF THE COST with New CBS 2N2059 Economy MADT\* Transistors

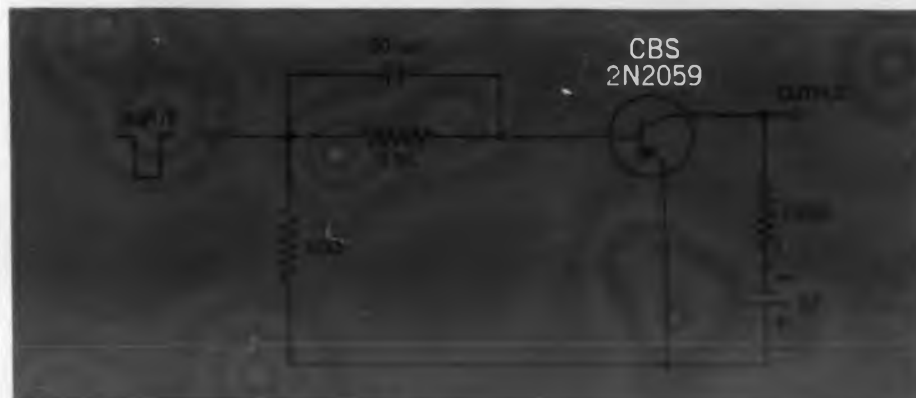

SWITCHING TIME is 22 nanoseconds in this high-speed circuit.

High-speed switching... lower saturation voltage and resistance... high current gain... lower collector capacitance... more uniform performance... all the advantages of automatically produced Micro Alloy Diffused-base Transistors are available at half the cost of other commercially available high-speed transistors in the new CBS MADT 2N2059.

Check the high-speed switching circuit above. It is easily cascaded and permits a reduction in the size and cost of power supply because it operates at only three volts. The CBS 2N2059 is a particularly economical choice for logic, pulse generating and shaping circuits as well as high-current pulse amplifiers.

Call or write your nearest CBS Electronics sales office or Manufacturer's Warehousing Distributor for data, price and delivery information... and order your engineering samples today.

\*Micro Alloy Diffused-base Transistor, Trade-mark, Philco Corp.



## CBS 2N2059 SPECIFICATIONS

### Ratings

$T_J$ ... -65° to 100°C

$V_{CE0}$ ... 10 V.

$V_{BE0}$ ... 2 V.

$I_C$ ... 50 ma.

### Typical Characteristics

$h_{FE}$ ... 100

$V_{CE(sat)}$ ... 0.1 V.

$f_T$ ... 70 mc.

$C_{ob}$ ... 2.5 pf.



## CBS ELECTRONICS

Lowell, Massachusetts A Division of Columbia Broadcasting System, Inc.  
MORE RELIABLE PRODUCTS THROUGH ADVANCED ENGINEERING

Sales Offices: Lowell, Mass., 900 Chelmsford St., GLenview 2-8961 • New York, N. Y., 46 E. 52nd St., PLaza 1-2345 • Melrose Park, Ill., 1990 N. Mannheim Rd., EStebrook 9-2100 • Los Angeles, Calif., 2120 S. Garfield Ave., RAYmond 3-9081 • Dallas, Tex., Robert R. Thomas Co., 3603 Lemmon Ave., Suite 103, LA 8-1767 • St. Petersburg, Fla., ECRA Inc., P.O. Box 8215, Madeira Beach, WAverly 1-9735 • Maitland, Fla., ECRA Inc., P.O. Box 656, Midway 7-7830 • Coral Gables, Fla., ECRA Inc., 123 Madeira Ave., Highlands 3-7439 • Decatur, Ga., ECRA Inc., P.O. Drawer 150, 378-7516 • Philadelphia, Pa., WCAU Building, City & Monument Aves., MOhawk 7-0464.

→ See us at Wescon! CBS Booths 2903 & 2905/Room 4

## NEW PRODUCTS AT WESCON

### Storage Tube

663



With 10-in. view screen. Type H-1059 storage tube has two writing guns, electrostatic focus and deflection and a Netic-Conetic laminated metal shield. The tube is 19-1/2 in. long and 11-1/4 in. in diameter. Useful screen diameter is 8-1/2 in.

Hughes Aircraft Co., Vacuum Tube Products Div., Dept. ED, 2020 Short St., Oceanside, Calif.

*Availability: 90 days.*

See at Show Booth 3106-08.

### Pressure-Sensitive Tapes

678

Have silicone adhesives for high-low temperature use. Three types of pressure-sensitive tapes are offered. One is a thin glass cloth. Another is an aluminum-foil, glass-cloth laminate with unusual heat-reflective properties. The third is a thermosetting Mylar tape with a special coating which bonds to encapsulating resins.

Mystik Adhesive Products, Inc., Industrial Div., Dept. ED, 2635 N. Kildare Ave., Chicago 39, Ill.

*P&A: \$5.91 per roll (36 yd); 21 days.*

See at Show Booth 5016.

### Mica Capacitor Packages

632

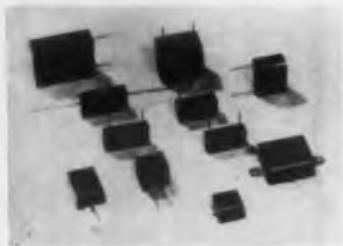

Resin-encapsulated mica capacitor packages meet MIL-C-5. Called REMC packages, they provide temperature coefficients as close as  $\pm 5$  ppm per deg C and tolerances as close as  $\pm 0.1\%$ . A typical unit containing five capacitors measures 1/8 in. thick and less than 9/16 in. sq.

Cornell-Dubilier Electronics Div., Federal Pacific Co., Dept. ED, 50 Paris St., Newark, N. J.

*Availability: made to meet customer specs.*

See at Show Booth 3405-09.

## TANTALUM CAPACITORS

- ... "wet slug," high temperature (to 200°C)
- ... "wet slug," microminiature to miniature
- ... solid electrolyte, metal case or encapsulated
- ... foil type, polarized and non-polarized

... Mallory has what you want. Industry's broadest line. 13 types, hundreds of ratings. Write for complete catalog.  
Mallory Capacitor Company,  
Indianapolis 6, Indiana.

TAF



TAS



TAP



MTF



TAH



XTL

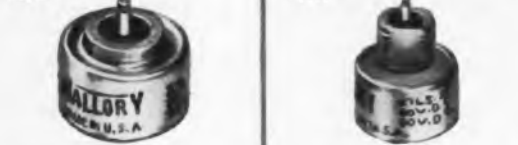

XTK



XTV



XTH



TNT

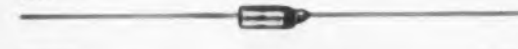

XTM



TAM



Complete line of aluminum and tantalum electrolytics, motor start and run capacitors

CIRCLE 108 ON READER-SERVICE CARD

**Mallory Tantalum Capacitors  
Stocked by these distributors**

- Arlington, Va.  
Rucker Electronic Products
- Baltimore, Md.  
Radio Electric Service
- Binghamton, N.Y.  
Federal Electronics
- Boston, Mass.  
Cramer Electronics, Inc.  
DeMambo Radio Supply Co.  
Lafayette Radio
- Bridgeport, Conn.  
Westconn Electronics
- Buffalo, N.Y.  
Wahls Electronics
- Chicago, Ill.  
Allied Radio Corp.  
Newark Electronics Corp.
- Cincinnati, Ohio  
United Radio
- Cleveland, Ohio  
Pioneer Electronics
- Dallas, Texas  
Engineering Supply Co.
- Dayton, Ohio  
Allied Supply Co.
- Denver, Colo.  
Denver Electronics
- Houston, Texas  
Harrison Equipment Co., Inc.  
Lenert Company
- Indianapolis, Ind.  
Graham Electronics
- Los Angeles, Calif.  
California Electronics  
Kieruff Electronics, Inc.  
Electronic Supply Corp.  
Radio Product Sales
- Minneapolis, Minn.  
Northwest Radio
- Montreal, Que.  
Canadian Electrical Supply Co.
- Mountainside, N.J.  
Federated Purchaser, Inc.
- Nashville, Tenn.  
Electra Dist. Co.
- Newark, N.J.  
Lafayette Radio
- New York, N.Y.  
Harrison Radio Corp.  
Harvey Radio Co., Inc.  
Lafayette Radio  
Milo Electronics  
Terminal Hudson Electronics
- Oakland, Calif.  
Elmar Electronics, Inc.
- Oriando, Fla.  
East Coast Radio
- Ottawa, Ont.  
Wackid Radio-TV Lab.
- Palo Alto, Calif.  
Zack Electronics
- Parth Amboy, N.J.  
Atlas Electronics
- Philadelphia, Pa.  
Herbach & Redeman  
Philadelphia Electronics
- Pittsburgh, Pa.  
Radio Parts Co.
- St. Louis, Mo.  
Olive Electronics
- Seattle, Wash.  
F. B. Connelly Co.
- Tampa, Florida  
Thurow Distributors, Inc.
- Toronto, Ont.  
Alpha Aracon Radio Co.  
Electro Sonic Supply  
Wholesale Radio & Electronics
- Tucson, Ariz.  
Standard Radio Parts
- Tulsa, Okla.  
Engineering Supply Co.
- Washington, D.C.  
Capitol Radio Wholesalers  
Electronic Industrial Sales
- White Plains, N.Y.  
Westchester Electronic Supply Co., Inc.
- Winston-Salem, N.C.  
Dalton-Hege Radio

**IF Test Set**

**665**

Sweep-frequency if filter test set model 1701 has a dynamic range of 76 db with three narrow-band heads covering 2 to 50 mc. Sweep output is flat to  $\pm 5$  per 100 db over the highest single octave. Sweep rate is 60 per sec to 1 every 2 min. Rf reference is 2 mc calibrated, variable from 1 mv to 12 v rms; dc reference is positive or negative from 1 mv to 12 v.

Jerrold Electronics Corp., Industrial Products Div., Dept. ED, 15th and Lehigh Ave., Philadelphia 32, Pa.

**Price: \$3,925.**

**See at Show Booth 1002-04.**

**Logic-Circuit Tester**

**631**



Automatic logic-circuit tester model 720 measures voltages, resistances and currents on a high-go-low basis. Test capacity of the standard model is 22 pins. For a given test, parameters such as input resistance, driving current at specified voltages and output levels with or without loading can be programmed.

DIT-MCO, Inc., Dept. ED, 911 Broadway, Kansas City 5, Mo.

**P&A: \$19,500; 90 days.**

**See at Show Booth 2625-26.**

**Plug-In Unit**

**640**

Dual-trace plug-in oscilloscope unit type 82 has independent, dc-coupled amplifiers for each channel. Maximum sensitivity is 100 mv per cm; risetime is 3.5 nsec. For channel A, a dc-coupled X10 amplifier extends sensitivity to 10 mv per cm, risetime to 4.5 nsec.

Tektronix, Inc., Dept. ED, P. O. Box 500, Beaverton, Ore.

**See at Show Booth 1726-28, 1823.**

**Potentiometer**

**649**

Electro-optical potentiometer, called Betapot, uses a light source for pick-off, beaming a stream of photons through the semiconductor material. The movable light beam defines a path of high conduction between the annular collector and resistive elements. Uses include in gyro systems, where negligible drift is required.

Duncan Electronics, Inc., Dept. ED, 2865 Fairview Road, Costa Mesa, Calif.

**See at Show Booth 808.**

## BALLANTINE Battery-Powered Vacuum Tube VOLTMETER

model  
302C  
Price: \$255



**MEASURES  
VOLTAGES  
100  $\mu$ V  
to 1000V at  
Frequencies from 2 cps to 150 kc**

This is a vacuum tube voltmeter capable of measuring 100 microvolts to 1000 volts in seven decade ranges with an accuracy better than 3% at any point on the scale. No other battery-operated instrument on the market meets this performance. It may be used as a hum-free amplifier with a maximum gain of 60 db, a high input impedance and an equivalent short-circuit input noise of less than 10 microvolts, which is considerably better than a transistorized amplifier with similar input impedance and bandwidth. Panel controls are available to vary the preamplifier gain continuously or to select the more appropriate of two meter damping positions. Excellent as a null detector. Battery life exceeds 100 hours of normal operation.

### SPECIFICATIONS

Voltage Range	100 $\mu$ V-1000 V	Input Impedance	2 M $\Omega$ shunted by
Frequency Range	2 cps-150 kc		10 pF or 25 pF
Accuracy	3% 5 cps-100 kc	Noise Level	Less than 10 $\mu$ V referred to
	and 5% elsewhere ANY POINT ON SCALE		shorted input circuit
	Scales	Logarithmic voltage scale from 1-10;	
		linear decibel scale from 0 to 20	

Write for brochure giving many more details

— Since 1932 —

**B** BALLANTINE LABORATORIES INC.  
Boonton, New Jersey

CHECK WITH BALLANTINE FIRST FOR LABORATORY AC VACUUM TUBE VOLTMETERS, REGARDLESS OF YOUR REQUIREMENTS FOR AMPLITUDE, FREQUENCY, OR WAVEFORM. WE HAVE A LARGE LINE, WITH ADDITIONS EACH YEAR. ALSO AC/DC AND DC/AC INVERTERS, CALIBRATORS, CALIBRATED WIDE BAND AF AMPLIFIER, DIRECT READING CAPACITANCE METER, OTHER ACCESSORIES. ASK ABOUT OUR LABORATORY VOLTAGE STANDARDS TO 1,000 MC.

CIRCLE 109 ON READER-SERVICE CARD

## NEW PRODUCTS AT WESCON

### Frequency-Selective Voltmeters 673

Cover 3 to 620 kc with continuous tuning. Model 125B-CR frequency-selective voltmeter provides variable selectivity, flat ac vtvm covering 1 to 620 kc and crystal calibrator. Model 125B-Y is similar with a 20-pin front-panel connector and expanded input circuitry for use with carrier rack fast-patch panels.

Philco Corp., Sierra Electronics Corp., Dept. ED, 3885 Bohannon Drive, Menlo Park, Calif.  
See at Show Booth 2006-08.

### Crystal Mixers 628



Cover 225 to 6,000 mc in seven overlapping ranges. The XR series single-ended coaxial crystals are fixed tuned and require no rf adjustment. They use standard ceramic cartridge-type crystals and meet Mil environmental specs. Local oscillator coupling may be varied over a 13-db range.

Microlab, Dept. ED, 570 W. Mount Pleasant Ave., Livingston, N. J.

P&A: \$120; stock.

See at Show Booth 4306.

### SPDT Chopper 666

Range is 0 to 1,050 cps. Dwell time is constant within  $\pm 5$  deg from 60 to 1,050 cps; phase lag is  $76 \pm 15$  deg at 1,000 cps. Model 2C-10 chopper has break-before-make action and model 2C-10M, make-before-break. Both are for operation at 6.3 v. Drive-coil resistance is 85 ohms; drive-coil current is 36 ma.

Collins Electronics, Inc., Dept. ED, Stevensville, Md.

See at Show Booth 1110.

### Oscilloscope Camera 677

For any 5-in. scope, the Mark II Oscillotron oscilloscope camera provides external rack-and-pinion focusing, direct-viewing port, electric shutter, shutter-open indicator light, rotating back for vertical or horizontal pictures and Polaroid dark slide. Object-to-image ratio is 1:1 through 1:0.5.

Beattie-Coleman, Inc., Dept. ED, 1006 N. Olive St., Anaheim, Calif.

See at Show Booth 2426.

## METERS

You can SEE and READ



**New** Series 1025-1026  
Interchangeable with Round  
Bakelite Case Types

Brilliantly new in their high visibility polystyrene cases are these modern type Meters by HOYT which give a true reading at a glance! Here longer scale length and the elimination of shadows plus clean design add up to a topnotch combination to incorporate in any panel.

The famous HOYT high torque movement with precise and rugged craftsmanship gives you what you've been looking for in Meters. These models are directly interchangeable with all round Bakelite meters, and are available in all AC and DC ranges as Ammeters, Milliammeters, Microammeters, Voltmeters and Millivoltmeters. Similar styles #1037 3 1/2" and #1060 6" meters are also available for any modern panel meter application.



The HOYT square plastic case series (#649 and #653 shown) is available in 2 1/2", 3 1/2" and 4 1/2" types. Just right for use where equipment needs to be revised to meet modern design requirements. These instruments are interchangeable with square Bakelite meters and can be supplied with a frosted or colored band on the case front in any AC and DC range. Extra long scales in shadow free cases give you the most value and quality for your money.

Write us for the NEW HOYT PANEL METER Brochure showing a complete line of plastic and Bakelite models.

VISIT US AT THE WESCON SHOW



**BURTON-ROGERS COMPANY**

Sales Division, Dept. ED-8

42 Carleton Street, Cambridge 42, Mass.  
CIRCLE 110 ON READER-SERVICE CARD

### Angle Positioner

546



Accuracy is  $\pm 3$  sec. Type CO-56402004 angle positioner can be used in a variety of laboratory and production-line applications. Features include a dial indicator, synchro or resolver bridges as integral parts and aluminum housing.

General Precision, Inc., Kearfott Div., Dept. ED, 1150 McBride Ave., Little Falls, N. J.

See at Show Booth 3309-21.

### Melamine-Resin Laminate

525

Glass-cloth, melamine-resin laminate grade 11588 offers good moisture resistance and flexural strength, high arc resistance, flame retardance, plus good impact and dielectric strength. Developed primarily for electric apparatus and appliance manufacturers, it can be used in a wide variety of applications.

General Electric Co., Laminated Products Dept., Dept. ED, Coshocton, Ohio.

See at Show Booth 4811.

### Printed-Circuit-Card Cage

375

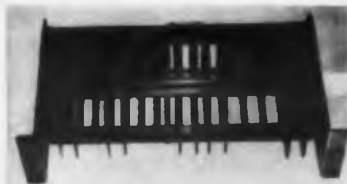

Of aluminum construction, made in 16 sizes, the Varipak II printed-circuit-card cage makes it possible to package boards and connectors in correct alignment. The guides are polycarbonate plastic rated for temperatures to 300 F.

Elco Corp., Dept. ED, M Street below Erie Ave., Philadelphia 24, Pa.

P&A: \$19.50; stock.

See at Show Booth 2124-25.

# Narrow tapered nose... ideal for confined places

## DIAMALLOY

# DIAGONAL CUTTING PLIERS

Edges ground for flush cutting, hand honed to stay sharp.

Ask your Industrial or Electronic Distributor for Diamalloy Pliers.

*"There is nothing finer than a Diamond"*



DULUTH, MINNESOTA • TORONTO, ONTARIO

### 3 SIZES

S54 RG • 4 inch

S55 RG • 5 inch

S56 RG • 6 inch

### Many Other Pliers

Designed for the Electronic Industry are Made by

**Diamond Tool and Horseshoe Co.**



Long Nose Plier  
LN54



Long Nose Side Cutting Plier  
SN54



Curved Long Nose Plier  
CN54



Duck Bill Plier  
DN54



Transverse End Cutting Plier  
EC54



Diagonal Cutting Plier  
MS54



Wire Stripping Plier  
ST55



Long Nose Special Wire Cutter  
LC56

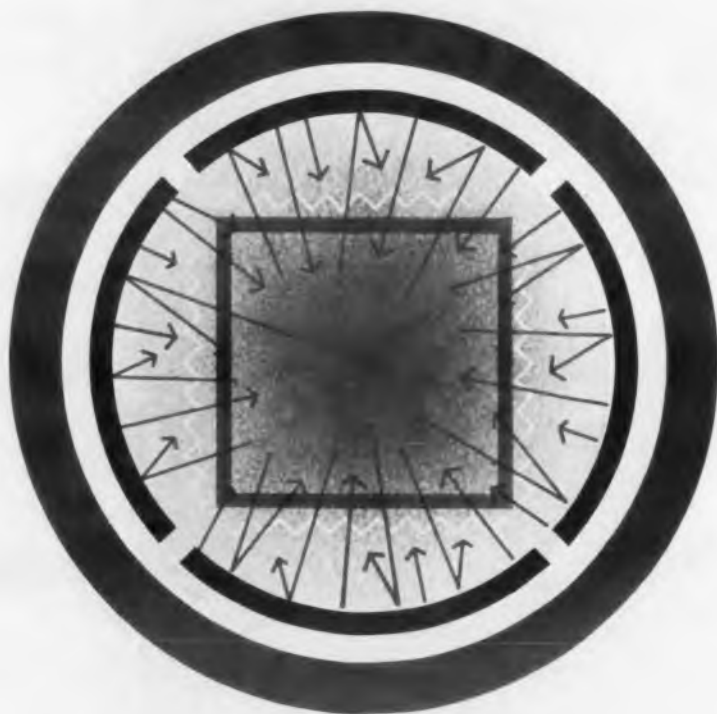

## HIGHER TEMPERATURE HIGH VACUUM OVEN

New and now available to industry—a low cost, high temperature, high vacuum bake oven. Tri Metal's 0-8 oven operates at 800°C while maintaining pressures as low as  $1 \times 10^{-6}$  mm Hg.

The 0-8 achieves temperature uniformity of 3° at 0 to 800°C and is the low cost oven that functions perfectly at temperatures above 250°C and pressures on the 6th scale without custom modification.

Tri Metal's new oven not only saves you money at purchase time, it is also extremely economical to operate and easy to maintain.

No water-cooling of the door is required. Accepts bench or dry box mounting.

Tri Metal Works has been engaged in the custom fabrication of high vacuum components and equipment for leading manufacturers and users since 1946. You are invited to see a demonstration of 0-8 in our plant laboratory. Call or write for appointment.

### HIGHER TEMPERATURES

Up to 800°C.

### BETTER UNIFORMITY

Plus or minus 3°C. ●

### LESS MAINTENANCE

Low-Cost. Neoprene "O" ring gaskets guaranteed one year.

### FASTER HEAT UP

500°C in 23 minutes.

### CLOSER CONTROL

1°C Thermocouple INSIDE the work zone.

### HIGHER VACUUM

$1 \times 10^{-6}$  Torr\* (mm Hg) @ 500°C.

### COOLER EXTERIOR

All surfaces cool to the touch.



## TRI METAL WORKS INC.

For a Free Detailed Brochure Write To:  
TRI METAL WORKS INC., Industrial Division  
1600 Bannard Street, East Riverton, New Jersey,  
or Phone 829-2000.

\*Terminology recommended by Standards Committee of American Vacuum Society

See us in Booth #5117 WESCON Show, Cow Palace, San Francisco, Aug. 22-25

CIRCLE 112 ON READER-SERVICE CARD

## NEW PRODUCTS AT WESCON

### Character Generator

637

High-speed type TD-549 character generator displays up to 100,000 characters per sec. Accepting digital signals from computers, high-speed tape readers and high-speed data links, it presents information on a CRT. It has 64 plug-in characters and codes.

Transdata, Inc., Dept. ED, P. O. Box 1369, San Diego 12, Calif.

P&A: \$8,860; 30 days.

See at Show Booth 114.

### Latching Relays

660



Dual-coil, rotary-motor type PL Microlatch latching relays require a 6-msec pulse at nominal coil voltage to switch positions. The four coil leads are brought out through a 10-terminal header. The relay maintains its switch position under 20-g vibration at 2,000 cps and shock of 50 g for 11 msec. Design is dpdt.

Filtors, Inc., Dept. ED, Port Washington, N. Y.

See at Show Booth 513.

### Switching Transistor

638

High-speed silicon planar switching transistor, type 2N709, is rated at 300 mw power. Typical charge storage time constant is 3 nsec; average propagation time delay is 2.5 nsec in direct-coupled transistor logic circuits, 7.5 nsec with 3.5 nsec rise time in diode-transistor logic circuits. Ratings include:  $BV_{CBO}$ , 12 v min;  $h_{FE}$ , 20 min, 120 max at 10 ma;  $f_T$ , 800 mc.

Fairchild Semiconductor, Dept. ED, 545 Whisman Road, Mountain View, Calif.

P&A: \$8.50 ea, 100 to 999; from distributors.

See at Show Booth 814-816.

### Plug-In Unit

641

Sampling sweep plug-in type 77 provides a calibrated sweep range of 1 nsec to 10  $\mu$ sec per cm, continuously variable between the 13 steps, uncalibrated. Single-sweep facilitates photographic recording. The unit is for use with the firm's 561 oscilloscope.

Tektronix, Inc., Dept. ED, P. O. Box 500, Beaverton Ore.

See at Show Booth 1726-28, 1823.



**AVAILABLE  
FROM STOCK!**

## **C. I. C. PRECISION FILM POTS**

You can have any of these precision film pots on their way to you within hours. No need to wait for "custom" pots.

### **LINEAR SINGLE TURN FILM POTENTIOMETERS**

Diameter	Resistance	Linearity
1/2"	1K	± .5%
	10K	± .5%
	50K	± .5%
7/8"	1K	± .5%
	10K	± .5%
	50K	± .5%
	1K	± .25%
	10K	± .25%
1-3/32"	1K	± .5%
	10K	± .5%
	50K	± .5%
	1K	± .25%
	10K	± .25%
2"	5K	± .25%
	20K	± .25%
	50K	± .25%
	5K	± .1%
	20K	± .1%
3"	5K	± .1%
	20K	± .1%
	50K	± .1%
	5K	± .05%
	20K	± .05%

### **SINE-COSINE SINGLE TURN FILM POTENTIOMETERS**

Diameter	Resistance	Conformity
1-3/32"	10K	± .75%
	20K	± .75%
2"	10K	± .25%
	20K	± .25%
3"	10K	± .15%
	20K	± .15%

### **LINEAR MOTION FILM POTENTIOMETERS**

Size	Resistance	Stroke	Linearity
1" Sq.	10K	1" Stroke	± .5%
		2" Stroke	± .5%
	20K	1" Stroke	± .25%
		2" Stroke	± .25%
	10K	3" Stroke	± .1%
		20K	3" Stroke

**WRITE OR CALL IN YOUR ORDER! POTENTIOMETERS WILL BE IN YOUR PLANT WITHIN 24 HOURS!**

FIRST IN FILM POTS



**COMPUTER INSTRUMENTS CORPORATION**  
92 MADISON AVE., HEMPSTEAD, L. I., N. Y.

CIRCLE 113 ON READER-SERVICE CARD  
ELECTRONIC DESIGN • August 2, 1961

HERE'S ONE WAY  
TO GET WORK DONE WHEN WIRE-WOUND POT  
FAILURES OCCUR...

## **C. I. C. PRECISION FILM POTENTIOMETERS ...**

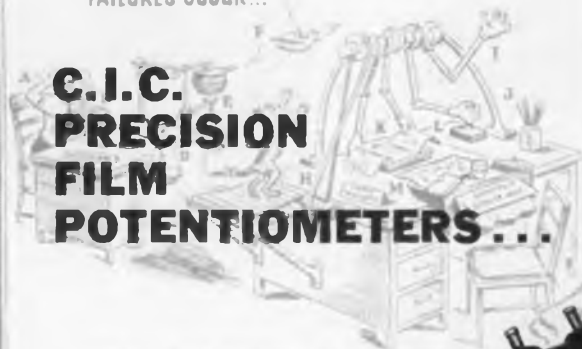

... (Small text describing the benefits of film pots over wire-wound pots, including reliability and precision.)

HERE'S ONE WAY TO SOLVE SERVO "HUNTING" PROBLEMS...



... (Small text explaining how film pots solve servo hunting problems by providing smoother control.)



How To Improve Response  
Servos Using Wire-Wound Pots...



... (Small text providing technical details about potentiometer response and servo hunting.)

... (Small text discussing the advantages of film pots for servo applications.)



... (Small text providing technical details about potentiometer response and servo hunting.)



## **THE EASY SOLUTION TO ALL POT PROBLEMS**

\* Only C.I.C. Film Potentiometers can meet your most demanding specifications because they feature:

- Infinite Resolution
- Inherent Reliability
- Precision Linearity
- Low Operational Noise
- Multi-Million Cycle Life

Write for Your **FREE** Copy, Today...



This booklet presents some novel "fixes" for frantic users of wire-wound pots who just can't tolerate the resulting problems. More important — you'll find the one good solution to all pot problems.

**COMPUTER INSTRUMENTS CORPORATION**  
92 MADISON AVENUE • HEMPSTEAD, L. I., NEW YORK



CIRCLE 114 ON READER-SERVICE CARD



A BASIC CONTROL IDEA

as simple as

1+2=3



DESIGN YOUR  
NEXT MACHINE  
OR PROCESS  
CONTROL CIRCUIT  
THIS EASY WAY



*Start with*

THE BULLETIN 780 STEP SWITCH  
FOR STEP-BY-STEP  
SEQUENCE CONTROL

1 INPUT SIGNALS + 2 BULLETIN 780 STEP SWITCH = 3 PROGRAMMED SEQUENCE CONTROL

Closure of a control device, actuated upon completion of an operation, advances control to next position.

Circuits are opened or closed at each position or step according to preselected cam action.

Loads are interlocked thru step switch cams without complicated relay circuitry.

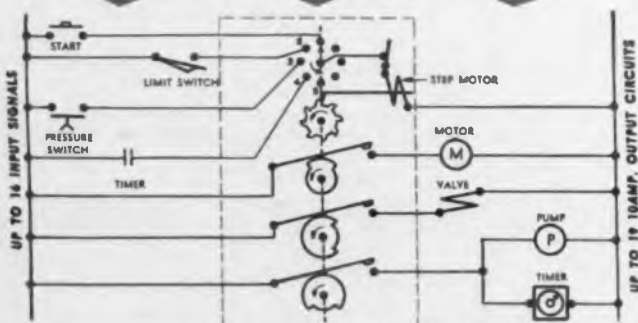

Write for Bulletin 780 or call your local Representative. He's listed in Sweet's Product Design File, Section 7d/EA, or in Thomas Register.



Precision Interval Timers



Plug-in Reset Timers



Multiple Circuit Timers



Multiple Cam Timers



Predetermined Counters



Hermetically Sealed Timers

MANUFACTURERS OF THE MOST COMPLETE LINE OF INDUSTRIAL TIME-COUNT CONTROLS AVAILABLE

BLISS



**EAGLE SIGNAL COMPANY • Moline, Illinois**  
INDUSTRIAL DIVISION

DIVISION OF THE GAMEWELL COMPANY, AN E. W. BLISS COMPANY SUBSIDIARY  
CIRCLE 115 ON READER-SERVICE CARD

## NEW PRODUCTS AT WESCON

### Coolant Pumping System

651



Provides 7 gal per min at 135 psi. Model 6449 coolant pumping system contains a centrifugal pump with an electric motor and an integral reservoir expansion chamber. Immersion heaters bring the fluid to an operating temperature of  $41 \pm 5$  F.

J. C. Carter Co., Dept. ED, 671 W. 17th St., Costa Mesa, Calif.

See at Show Booth 111.

### Frequency Standard

670

Stable to 1 or 2 pp  $10^{10}$ . Model 1120 frequency standard is available in two types: 1120-A with outputs of 5 and 1 mc and 100, 10 and 1 kc (400 and 60 cps optional); 1120-AH with additional outputs of 10, 100 and 1,000 mc.

General Radio Co., Dept. ED, W. Concord, Mass.

See at Show Booth 2202-04.

### Plug-In Unit

644

Up to four signals can be viewed separately or in any combination with type M plug-in oscilloscope unit. It consists of individual input amplifiers, each having separate attenuator, variable gain and vertical position controls. Sensitivity is 20 mv per cm.

Tektronix, Inc., Dept. ED, P. O. Box 500, Beaverton, Ore.

See at Show Booth 1726-28, 1823.

### Encapsulated Transformers

652



Resist thermal shock, meeting the requirements of MIL-T-27A, class V. The encapsulation can be used with units of all configurations. It is resilient, resists abrasion, and has good adhesion characteristics. The coating thickness can be controlled to within 1/64 in.

Collins Radio Co., Dept. ED, P. O. Box 1891, Dallas 21, Tex.

See at Show Booth 1301-02.

— the ultra  
new YOKE!



**Deflectron\***  
By **Celco**

**MAJOR ADVANCE IN  
THE SCIENCE OF  
ELECTRON BEAM DEFLECTION!**

**SPOT RECOVERY**

**Fastest! to 1  $\mu$ S**

**SPOT SIZE**

**Smallest — Reduced 25%**

**SPOT SWEEP**

**Straightest .....**

**\* DEFLECTRONS for DISPLAYS**

Where ordinary precision  
yokes **FAIL** to meet your  
requirements.

Write for NEW "DEFLECTRON"  
Data and Standard Yoke  
Catalog. 

**Celco**

*Constantine Engineering  
Laboratories Co.*

Main Plant: MAHWAH, N. J. DAVis 7-1123  
PACIFIC DIV.—UPLAND, CALIF. YUKon 2-0215  
CENTRAL DIV.—LANESBORO, PA. ULYSses 3-3500

CIRCLE 116 ON READER-SERVICE CARD

## Rectifier Columns 694

For radar and research. These rectifier columns provide voltages to 100 kv at up to 250 amp with dc surge capacities to 2,500 amp. A typical unit, consisting of two three-phase bridge rectifiers, produces 70 kv at 55 amp and withstands a 1,000-amp dc short circuit for 10 cycles.

International Rectifier Corp., Dept. ED, 233 Kansas St., El Segundo, Calif.

Availability: 4 to 10 weeks.

See at Show Booth 1701-03.

## Accelerometers 547



Single-axis accelerometers employ fluid damping and torsion-bar spring restraint. Types C 70 2006001 and C 70 2408000 have scale factors of 1 and 2 v per g, respectively; a range of  $\pm 1$  and  $\pm 0.5$  g; linearity of 0.5% of reading,  $\pm 0.5\%$  of full scale and 1% of reading,  $\pm 0.1\%$  of full scale.

General Precision, Inc., Kearfott Div., Dept. ED, 1150 McBride Ave., Little Falls, N. J.

See at Show Booth 3309-21.

## Laminate 529

For computer, TV, radio and other circuit applications where UL requirements must be met. Grade 11586 laminate, available in standard or copper-clad sheets, has good electrical properties under severe humidity, high dielectric reliability, good impact resistance and easy machinability.

General Electric Co., Laminated Products Dept., Dept. ED, Coshoc-ton, Ohio.

See at Show Booth 4811.

## Molding Resins 498

For compression molding. The Epocast H-1469 series epoxy molding resins will mold under pressures of 200 psi or lower. Complicated moldings with or without inserts can be reproduced from thermosetting epoxy molding compounds.

Furane Plastics Inc., Dept. ED, 4516 Brazil St., Los Angeles 39, Calif.

P&A: \$1.55 per lb, 100 lb; stock.

See at Show Booth 4806.

*For RCA Receiving Tubes.....R.I.Q.A.P.*  
THE HIGHEST HONOR FOR QUALITY THE U.S. ARMY SIGNAL CORPS CAN BESTOW

On May 17, 1961, the receiving tube manufacturing activity of the RCA Electron Tube Division received the coveted U.S. Army Signal Corps R. I. Q. A. P. award for product quality. Signifying "Reduced Inspection Quality Assurance Plan", the award means the Army Signal Corps accepts RCA tubes under R.I.Q.A.P. with a minimum of inspection. Conferred only after long and consistent delivery of "Quality" tubes, the award indicates the Army Signal Corps' acceptance of the quality control techniques in effect at RCA.

Why not assure your own circuits the same high standard of performance? Specify RCA tubes throughout! For information on specific tube types, see your RCA Field Representative or write Commercial Engineering, Section H-18-Z-1, RCA Electron Tube Division, Harrison, N. J.

### RCA FIELD OFFICES

**EAST:** 744 Broad Street, Newark 2, N. J.  
HUmboldt 5-3900.

**MIDWEST:** Suite 1154, Merchandise Mart  
Plaza, Chicago 54, Illinois, WHitehall 4-2900

**WEST:** 6801 E. Washington Blvd., Los Angeles  
22, California, RAymond 3-8381.



The Most Trusted Name in Electronics

VISIT THE RCA EXHIBIT AT WBSCON

## NEW PRODUCTS AT WESCON

### Frequency-Selective Voltmeter 671

Covers 5 kc to 1,620 kc in two bands. Model 126A frequency-selective voltmeter is designed for measuring frequencies in carrier systems with several hundred channels as well as laboratory wave analysis. It has a dual selectivity of 250 to 2,500 cps and bridging inputs of 75, 135 and 600 ohms. It measures -90 to +32 dbm.

Philco Corp., Sierra Electronic Corp., Dept. ED, 3885 Bohannon Drive, Menlo Park, Calif.  
See at Show Booth 2006-08.

### Receiver-Decoder 658



Range is 406 to 549 mc. Model BCR-50 receiver-decoder has up to 20 IRIG channels for remotely controlling missiles and pilotless aircraft. Up to six channels can be used simultaneously with each channel having  $\pm 20$ -kc deviation. A 10- $\mu$ v signal energizes all six channels with 7.5 w input power.

Babcock Electronics Corp., Dept. ED, 1640 Monrovia Ave., Costa Mesa, Calif.  
See at Show Booth 312.

### Silicon Rectifiers 646

Rated at 6 and 12 amp in ranges of 600 to 1,000 v, the Golden Line silicon power rectifiers are improved versions of the 1N1199 to 1N1206 series. Reverse leakage is less than 1  $\mu$ a. Typical units have a forward voltage drop of less than 1 v and a dynamic impedance of as low as 0.0035 ohm.

Hughes Aircraft Co., Semiconductor Div., Dept. ED, 500 Superior Ave., Newport Beach, Calif.

Availability: stock.

See at Show Booth 2421-27.

### Depth Recorder 667

Precision survey depth recorder model 418 provides dynamic tone shade response. Ranges are 400 ft, 400 and 4,000 fathoms at rates of 360, 60 and 6 rpm, respectively. Resolution on the 400-fathom range is better than  $\pm 1$  fathom. Power consumption is less than 200 w at 115 v, 60 cps.

Alden Electronic & Impulse Recording Equipment Co., Inc., Dept. ED, Westboro, Mass.  
See at Show Booth 4314.

• Reduced Saturation Voltage! • Reduced Storage Time!

# epitaxial

## • GERMANIUM

### 2N781 2N782

Refined by intensive research, proven by extensive testing—Sylvania Epitaxial Mesa Transistors offer extraordinary performance characteristics. They combine the high electrical and mechanical reliability, power dissipation capabilities, and fast switching speed of the mesa with the low saturation voltage, reduced collector capacitance, decreased storage time, and high gain at high current levels that are characteristic of the epitaxial process. Electrical uniformity, too, is superior because the epitaxial technique is ideally suited to the highly automated, modern production facilities of Sylvania. Result: remarkable high-speed switching and high-frequency amplifying devices that illustrate the dramatic advances being made in the solid state art at Sylvania.

#### SYLVANIA 2N781—WORLD'S FASTEST PNP GERMANIUM SWITCHING TRANSISTOR

... is designed specifically for circuits with high speed and low saturation voltage as prime performance features. Sylvania 2N782 offers similar electrical characteristics at lower unit cost.

#### ABSOLUTE MAX. RATINGS (AT 25°C)

	2N781	2N782	UNIT
Collector to Base Voltage	-15	-12	V
Collector to Emitter Voltage	-15	-12	V
Emitter to Base Voltage	-2.5	-1.0	V
Collector Current	100	100	mA
Power Dissipation (free air)	150	150	mW
Power Dissipation (case at 25°C)	300	300	mW
Storage Temperature	-65 to +100	-65 to +100	°C
Junction Temperature	+100	+100	°C

#### ELECTRICAL CHARACTERISTICS (AT 25°C)

Symbol	Conditions	2N781		2N782		UNIT
		Min.	Max.	Min.	Max.	
$V_{CE0}$	$I_c = -100 \mu A, I_E = 0$	-15	-	-12	-	V
$V_{EB0}$	$I_c = -100 \mu A, I_E = 0$	-2.5	-	-1.0	-	V
$V_{CE3}$	$I_c = -100 \mu A, V_{BE} = 0$	-15	-	-12	-	V
$h_{FE}$	$I_c = -10 \text{ mA}$					
	$V_{CE} = -0.22 \text{ V}$	25	-	-	-	
$h_{FE}$	$I_c = -10 \text{ mA}$					
	$V_{CE} = -0.25 \text{ V}$	-	-	20	-	
$V_{BE}$	$I_c = -10 \text{ mA}, I_B = 0.4 \text{ mA}$	-0.34	-0.44	-0.34	-0.50	V
$I_{CBO}$	$V_{CB} = -5 \text{ V}, I_E = 0$	-	-3.0	-	-3.0	$\mu A$
$V_{CE}(\text{Sat.})$	$I_c = -10 \text{ mA}, I_B = -1 \text{ mA}$	-	-0.16	-	-0.20	V
	$I_c = -100 \text{ mA}, I_B = -10 \text{ mA}$	-	-0.25	-	-0.45	V
$t_d + t_r$	$V_{BE(s)} = 0.5 \text{ V}, I_{B(1)} = -1 \text{ mA}$	-	60	-	75	nSEC
$t_s$	$V_{CC} = -3.5 \text{ V}, R_c = 300 \text{ ohms}$	-	20	-	35	nSEC
$t_f$	$I_{B(2)} = 0.25 \text{ mA}$	-	50	-	75	nSEC

AT WESCON—see the Sylvania exhibit. Booth #3201, 3, 5, 7, 9, 11, 3302, 4, 6, 8.

Explore the advantages offered your designs by performance-proved Sylvania Epitaxial Mesa Transistors. Available from your Sylvania Sales Engineer or Sylvania Franchised Semiconductor Distributor now! For technical data, write Semiconductor Division, Sylvania Electric Products Inc., Dept. 188, 1100 Main Street, Buffalo 9, N. Y.

# mesas

• **SILICON**  
**2N783 2N784**

*Sylvania offers both!*

TO-18 shown three times actual size

**SYLVANIA 2N783 - WORLD'S FASTEST NPN SILICON SWITCHING TRANSISTOR**

... is designed specifically for circuits with high speed as a prime performance feature. Sylvania 2N784 delivers low saturation voltage combined with exceptional high-speed capabilities.

**ABSOLUTE MAX. RATINGS (AT 25°C)**

	2N783	2N784	UNIT
Collector to Base Voltage	40	30	V
Collector to Emitter Voltage	20	15	V
Emitter to Base Voltage	5	5	V
Collector Current	50	50	mA
Power Dissipation (free air)	300	300	mW
Power Dissipation (case at 25°C)	1	1	W
Storage Temperature	-65 to +300	-65 to +300	°C
Junction Temperature	+175	+175	°C

**ELECTRICAL CHARACTERISTICS (AT 25°C)**

Symbol	Conditions	2N783		2N784		UNIT
		Min.	Max.	Min.	Max.	
$V_{CBO}$	$I_C = 100 \mu A, I_E = 0$	40	-	30	-	V
$V_{EBO}$	$I_C = 100 \mu A, I_C = 0$	5	-	5	-	V
$V_{CER}$	$I_C = 10 \mu A, V_{BE} = 0, R_{BE} = 10 \text{ ohms}$	20	-	15	-	V
$I_{CBO}$	$V_{CB} = 25 \text{ V}$	-	250	-	250	$\mu A$
	$V_{CB} = 25 \text{ V}, T = 150^\circ C$	-	30	-	30	$\mu A$
$h_{FE}$	$I_C = 10 \text{ mA}, V_{CE} = 1 \text{ V}$	20	60	25	-	
$V_{BE}$	$I_C = 10 \text{ mA}, I_B = 1 \text{ mA}$	0.7	0.9	0.7	0.9	V
$V_{CES}$	$I_C = 10 \text{ mA}, I_B = 1 \text{ mA}$	-	.25	-	.16	V
$C_{ob}$	$V_{CB} = 10 \text{ V}, I_E = 0, F = 1 \text{ MC}$	-	3.0	-	3.5	$\mu f$
$h_{fo}$	$V_{CB} = 15 \text{ V}, I_C = 10 \text{ mA}, F = 100 \text{ MC}$	2.0	-	2.0	-	
$t_{on}$	$I_{B(1)} = 3 \text{ mA}, I_{B(2)} = 1 \text{ mA}$	-	18	-	20	nsec
	$V_{CC} = 3 \text{ V}, R_L = 270 \Omega$					
$t_s$	$I_{B(1)} = 10 \text{ mA}, I_{B(2)} = 10 \text{ mA}$	-	10	-	15	nsec
	$V_{CC} = 10 \text{ V}, I_C = 10 \text{ mA}, R_L = 1000 \Omega$					
$t_{off}$	$I_{B(1)} = 3 \text{ mA}, I_{B(2)} = 1 \text{ mA}$	-	30	-	40	nsec
	$V_{CE} = 3 \text{ V}, R_L = 270 \Omega$					

# SYLVANIA

SUBSIDIARY OF

**GENERAL TELEPHONE & ELECTRONICS**



CIRCLE 118 ON READER-SERVICE CARD

ELECTRONIC DESIGN • August 2, 1961

**Pressure Potentiometers**

664



For airborne applications. Type P105 pressure potentiometers measure 0 to 10 up to 350 psia and deliver 75-v, full-scale output without amplification. They operate at vibration levels to 35 g at 2,000 cps and withstand 75-g shock and acceleration.

Trans-Sonics, Inc., Dept. ED, P. O. Box 328, Lexington 73, Mass.

P&A: \$400; stock.

See at Show Booth 4414.

**Capacitance Bridge**

674

Precision capacitance bridge type 1615-A has a measurement range of  $10^{-17}$  to  $10^{-6}$  f. The resolution is 1 pp 10<sup>6</sup>. Direct-reading accuracy is 0.02%.

General Radio Co., Dept. ED, W. Concord, Mass.

See at Show Booth 2202-04.

**Deflection Yokes**

729

With push-pull operation from constant-current sources, these deflection yokes provide horizontal and vertical electron-beam deflection in a crt. Magnetic damping allows rapid writing rates.

General Dynamics/Electronics, Information Technology Div., Dept. ED, P. O. Box 2449, San Diego 12, Calif.

See at Show Booth 201-030.

**Two-Way Radio**

656



Transmitter power is 1 w. The Duo-Com 120, class D, pocket size two-way radio is fully transistorized, using 11 transistors and two diodes. The crystal-controlled receiver has a sensitivity of better than 1 mv. Power is from a 12-v, rechargeable battery.

Osborne Electronics Corp., Communications Div., Dept. ED, 13105 Crenshaw Blvd., Hawthorne, Calif.

P&A: \$149.50; stock.

See at Show Booth 612.

127

first from **triolab**...  
a new standard of precision in  
**AC VTVMs**



## now measure both complex and sine waves with 0.25% accuracy

'Til now, no VTVM has been able to measure complex waves with high laboratory standard accuracy. Average-reading and peak-reading instruments are subject to significant distortions created by spikes and harmonics.

New triolab Model 120 achieves direct-reading, true RMS values of both sine and complex waves with deflection directly proportional to the square of the current—by use of a special dynamometer movement.



- **DIRECT-READING**  
No knobs to twist or tedious balancing.
- **INSTANT MEASUREMENT**  
No sluggish, thermo-couple response.
- **HIGHEST LEGIBILITY**  
Full 7" custom-calibrated, mirror scale.
- **CONSTANT OVERALL GAIN**  
For long life.
- **DIAMOND BEARINGS**  
For perfect balance, smooth scale motion.

Ranges: 10MV to 500V rms, full scale. Input impedance: 1 meg. Fundamental freq. response: 50-2000 cps. Accuracy (above 50% electrical deflection): 1/4% f.s. at 400 cps; 1/2% f.s. at all other frequencies. Power: 115 VAC, 50-400 cps.

### **AVAILABLE RACK-MOUNTED OR PORTABLE**

triolab other laboratory and build-in miniature precision instruments can help you. Write for Catalog ED-8

# **triolab**

TRIO LABORATORIES, INC., Plainview, L. I., N. Y.  
Export Dept: EMEC, 127 Grace St., Plainview, N. Y.

CIRCLE 119 ON READER-SERVICE CARD

## NEW PRODUCTS AT WESCON

### Miniature Chopper

636

For airborne servo systems. Series C1425 Syncroverter miniature chopper has an 83-deg nominal phase lag at 400 cps which eliminates the use of phasing networks. Designed to resist shock and vibration, the unit measures 1-3/8 x 3/4 in. and can be furnished with a variety of mountings.

The Bristol Co., Dept. ED, Waterbury 20, Conn.

See at Show Booth 3316-18.

### Trimming Potentiometers

661



High resolution and precision trimming are features of series 150 trimming potentiometers. Standard resistance range is 10 to 50 K; power rating is 1 w at 60 C. Environmental requirements of MIL-E-5272A and MIL-STD-202 are met. Mechanical ratio is 30:1 for screw-driver adjustment.

Duncan Electronics, Inc., Dept. ED, 2865 Fairview Road, Costa Mesa, Calif.

P&A: \$3.70 to \$7.80; stock.

See at Show Booth 808.

### Oscilloscope

645

Dual-beam oscilloscope type RM565 has two separate vertical systems and two separate horizontal systems. Sweep ranges are 1  $\mu$ sec to 5 sec per cm in 21 calibrated steps, continuously variable between steps and to 15 sec per cm, uncalibrated with magnification of 10 times.

Tektronix, Inc., Dept. ED, P. O. Box 500, Beaverton, Ore.

See at Show Booth 1726-28, 1823

### Resistor Decade Boxes

725

In-line, digital readout is provided by the Dekabox decade resistor boxes for four to six decades with resolution of 0.1 to 100 ohms per step. Individual resistors have temperature coefficient of  $\pm 10$  ppm per C above 100 ohms,  $\pm 20$  ppm per C below 100 ohms. Decade adjustment accuracy is  $\pm 0.03\%$  +0.01 ohm per decade.

Electro Scientific Industries, Inc., Dept. ED, 7524 S. W. Macadam Ave., Portland 19, Ore.

P&A: \$100 to \$195; 30 days.

See at Show Booth 1928-29.

## How to buy a down payment on a new home for \$1.25 a day



Will he ever save the down payment? He'll be in his new home sooner than he thinks, if he saves something every payday. The effortless, automatic way is the Payroll Savings Plan for U.S. Savings Bonds.

Saving for a new home, or anything else in fact, is simply a matter of spending less than you earn. Thousands of Americans have found an automatic way: the Payroll Savings Plan where they work. Through this plan your payroll clerk sets aside a certain amount each payday for U.S. Savings Bonds. As little as \$1.25 a day buys a \$50 Bond a month (cost \$37.50). In 5 years you'll own Bonds worth \$2,428.00 —enough for a substantial down payment and closing costs.

Six nice things about  
U.S. Savings Bonds

- You can save automatically on the Payroll Savings Plan or buy Bonds at any bank
- You now earn 3 $\frac{3}{4}$ % to maturity
- You invest without risk
- Your Bonds are replaced free if lost or stolen
- You can get your money with interest anytime you want it
- You buy shares in a stronger America.

You save more  
than money with  
U. S. Savings Bonds



This advertising is donated by The Advertising Council and this magazine.



## Shipboard Blower

533

Output is 350 cfm, 5.8 in. static pressure, 0.075 density. Designed for naval applications, type SVA-475-11000 blower can be furnished in speeds of 5,400, 7,500 and 11,500 rps, for ac or dc use. It weighs 5-3/4 lb.

The Torrington Manufacturing Co., Dept. ED, Torrington, Conn.

*Availability: 5 to 6 weeks.*

See at Show Booth 4117.

## Zener Diodes

478



Rated at 250 mw. These JEDEC glass Zener diodes include: types 1N465 to 1N479, covering 2.6 to 7.1 v, with tolerances of  $\pm 1\%$  in the B series and  $\pm 5\%$  in the A series; types 1N702 to 1N716, covering 2.6 to 12 v, with  $\pm 5\%$  and  $\pm 10\%$  tolerances; types 1N761 to 1N766, covering 4.8 to 13 v,  $\pm 10\%$  tolerance.

International Rectifier Corp., Dept. ED, 233 Kansas St., El Segundo, Calif.

*P&A: \$2.60 to \$12.50; stock.*

See at Show Booth 1701-03.

## Magnetic Alloy

410

Energy product is 7.5 megagauss-oersteds. Columax magnetic alloy has a residual induction of 13,500 gauss and a coercive force of 760 Oersteds. Tensile strength is 5,500 psi along magnetic axis. Weight is 0.264 lb per cu in.

Thomas & Skinner, Inc., Dept. ED, 1120 E. 23rd St., Indianapolis 7, Ind.

See at Show Booth 1819.

## Silicon Rectifiers

536

Piv is up to 3,000 v. Measuring 0.27 in. long and less than 0.1 in. in diameter, these silicon rectifiers handle currents of 100 ma. They use three junctions in a hermetically sealed glass enclosure and have a forward voltage drop of 2.5 v at 100 ma.

Motorola Semiconductor Products Inc., Dept. ED, 5005 E. McDowell Road, Phoenix, Ariz.

See at Show Booth 914-16.

## Silicone-Resin Laminate

526

Glass-cloth, silicone-resin laminate grade 11589 combines good machining properties with high heat-resistance which permits operation at 250 C. It has high bond, mechanical and flexural strength.

General Electric Co., Laminated Products Dept., Dept. ED, Coshocton, Ohio.

See at Show Booth 4811.

## EVEN AT HIGH HUMIDITIES, MYLAR® GIVES CAPACITORS LONG-LASTING STABILITY!

Mylar\* polyester films resist the three main causes of capacitor failure—humidity, high temperatures and voltage stress. "Mylar" has 35 times the moisture resistance of rag paper and can't dry out because it contains no plasticizer.

Because "Mylar" is so stable, capacitors retain high electrical characteristics ... last longer ... offer the highest reliability. And you get these benefits in capacitors insulated with "Mylar" at a cost comparable to the lowest-priced capacitor types. Motors benefit from "Mylar", too. Run service-free 50 to 100% longer.

In a wide variety of electrical applications, "Mylar" can improve performance, lower costs. Here are some more reasons: dielectric strength of 4,000 v/mil † • thermal stability from -60°C. to over 150°C. • resistance to chemicals, aging, abrasion and tearing. Best of all, you can use less, often pay less ... because you get all these advantages in thinner gauges.

Evaluate "Mylar" for your product. Write for free booklet (SC) detailing properties and applications. Du Pont Co., Film Department, Wilmington 98, Delaware.



BETTER THINGS FOR BETTER LIVING  
... THROUGH CHEMISTRY



\*"Mylar" is Du Pont's registered trademark for its polyester film. Only Du Pont makes "Mylar."  
†ASTM D-149.

## NEW PRODUCTS AT WESCON

### Potentiometric Transducer 538

Ranges are 0 to 10, to 350 psia. Model L-113 potentiometric pressure transducer withstands 100-g acceleration and is suitable for space satellite applications. High-level ac or dc output can be used without amplification for control or telemetry circuits.

Servonic Instruments, Inc., Dept. ED, 1644 Whittier Ave., Costa Mesa, Calif.

See at Show Booth 4107.

### Frequency Generator 560

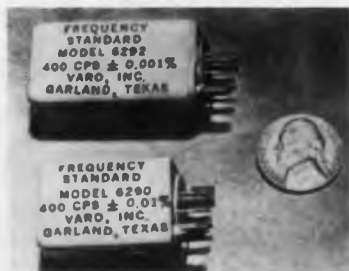

Range is 25 cps to 1 mc. This crystal-controlled microcircuitry frequency generator has a standard accuracy of 0.01% or 0.001% on special order. It weighs 1.75 oz and occupies 1.3 cu in. Models are available for chassis mounting, for soldering or plug-in connections.

Varo Inc., Dept. ED, 2201 Walnut St., Garland, Tex.

See at Show Booth 3609-11.

### Cable Carrier 494

Mounts to chassis slides. This cable carrier consists of two telescopic-action supporting arms which expand with slide movement, providing uniform support. When retracted, it occupies about 1 in. of storage space. It meets applicable Mil specs.

Jonathan Manufacturing Co., Dept. ED, 720 E. Walnut Ave., Fullerton, Calif.

P&A: \$15 to \$30; 30 days.

See at Show Booth 4830.

### Subcarrier Oscillator 500

Low-level subcarrier oscillator type 1274A can be activated by a  $\pm 5$ -mv differential signal with an input impedance of greater than 90 K. Time drift is less than 0.2% for 48 hr. True differential input allows the transducer to operate at ground potential, at any level to  $\pm 50$  v dc, or it may be floated.

American Bosch Arma Corp., Tele-Dynamics Div., Dept. ED, 5000 Parkside Ave., Philadelphia, Pa.

See at Show Booth 4126-28.

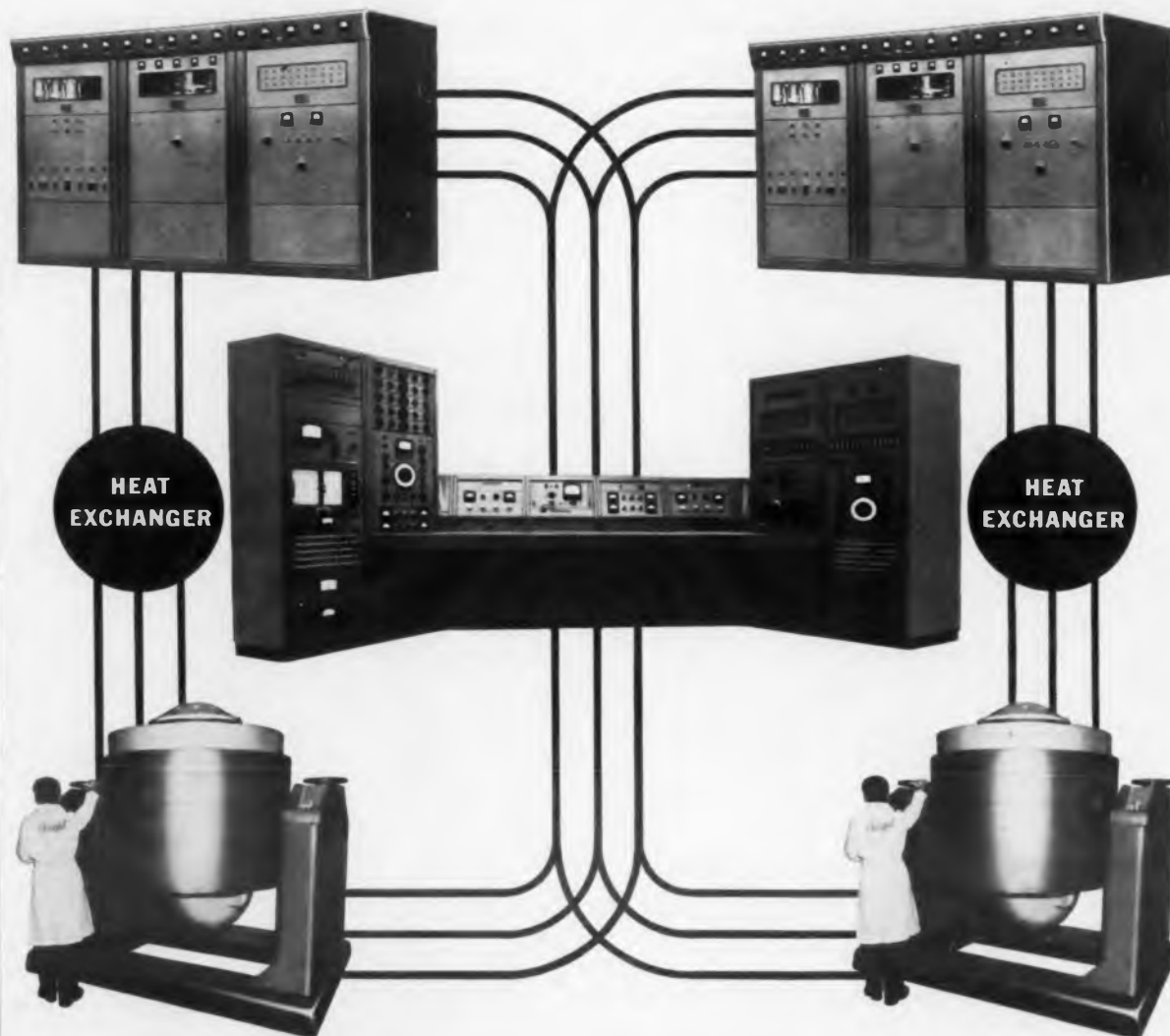

## A BETTER SHAKE FOR POLARIS... Aerojet-General installs Ling vibration system with world's highest force rating - 60,000 pounds

When faced with unsolved vibration testing problems on its vital part of the Polaris program, Aerojet-General Corporation, a subsidiary of The General Tire and Rubber Company, turned to Ling Electronics. To give its solid propellant rocket engines the severest shake-up, Aerojet-General improved its test facilities with two Ling vibration systems—controlled simultaneously or independently by one console. The system, now operating, includes two Model 249 shakers delivering 30,000 pounds force each and two Model PP 120/150, 120 KVA water-cooled amplifiers—for a total force delivery of 60,000 pounds. The special random/sine wave console not only provides simultaneous or independent control of both exciter systems, but features Ling's famous ESD-ASD 20 spectral density equalizer/analyzer, the industry standard. Like Aerojet-General, you too may find the superior quality and rugged reliability of Ling systems answer your testing problems. For more information, write Department ED-861 at the address below.



**LING-TEMCO ELECTRONICS, INC.**

LING ELECTRONICS DIVISION

1515 SOUTH MANCHESTER, ANAHEIM, CALIFORNIA • PRespect 4-2900

CIRCLE 122 ON READER-SERVICE CARD

ELECTRONIC DESIGN • August 2, 1961

## LING ELECTRONICS

**T**he powerful Ling vibration system shown at the left is just one more example of the way Ling's continuing program of research serves industry and defense programs.

As package weights rise, so does the need for vibration testing systems of higher performance and reliability. And Ling engineers have consistently anticipated these demands with designs that keep pressing toward higher ratings.

The powerful Model 249 shaker shown below delivers 30,000 pounds of force when combined with its mating amplifier. Only the high force rating of the 249 shaker made it possible to meet the big systems needs of Aerojet-General as described at the left.

Ling amplifiers offer equally impressive ratings. Ling pioneered in the manufacture of electronic amplifiers for driving electro-dynamic shakers and has produced liquid-cooled amplifiers that deliver from 10,000 to 5,000,000 watts.



Listed below are performance ratings of high power Ling vibration systems employing the Model 249 shaker:

LIQUID-COOLED SHAKER	LIQUID-COOLED AMPLIFIER	FORCE LBS. SINE	FORCE LBS. RANDOM
249	PP 175/240	30,000	32,000
249	PP 120/150	30,000	28,000
249	PP 75/90	23,000	21,000

Whatever your needs in high power electronics—vibration testing, acoustics or sonar, you'll find Ling systems offer high performance, high reliability, and quality that sets the standard.



**LING-TEMCO ELECTRONICS, INC.**

LING ELECTRONICS DIVISION

HIGH POWER ELECTRONICS FOR  
VIBRATION TESTING • ACOUSTICS • SONAR  
CIRCLE 123 ON READER-SERVICE CARD

ELECTRONIC DESIGN • August 2, 1961

## Computer-Console Blower 531

Provides 400 cfm at 0.8-in. SP at a density of 0.075, with a 3,100-rpm motor. Type SC-400-400-11112 blower can also be furnished with motors having speeds of 3,450 and 1,550 rpm, in 115 and 230-v models.

The Torrington Mfg. Co., Dept. ED, Torrington, Conn.

*Availability: 6 to 7 weeks.*

See at Show Booth 4117.

## Rotary Stepping Switch 557



Plug-in rotary stepping switch provides 240 individual connections. It has bridging type wipers, is completely wired to connectors and measures 6-5/16 x 6 x 4-9/16 in. Applications include programing, sequence control and test equipment.

North Electric Co., Electronics Div., Dept. ED, Galion, Ohio.

*P&A: \$125; 6 weeks.*

See at Show Booth 2502-04.

## Fan and Driver 552



Output is 100 cfm or better. Both fan and driver operate from -20 to +40 C. Type 8-1003 driver unit requires 12 v dc and supplies a 60-cps output to operate any ac fan. Power consumption is 24 w and over-all efficiency is 85%. Total weight of both units is 2.2 lb.

Palo Alto Engineering Co., Dept. ED, 620 Page Mill Road, Palo Alto, Calif.

*P&A: \$25 for both units; stock.*

See at Show Booth 512.

## Power Transistors 537

Dissipate 170 w. The eight power transistors in this series have maximum junction temperature ratings of 110 C. They will be available under the firm's Meg-A-Life program which provides lot-test data with each order.

Motorola Semiconductor Products Inc., Dept. ED, 5005 E. McDowell Road, Phoenix, Ariz.

See at Show Booth 914-16.

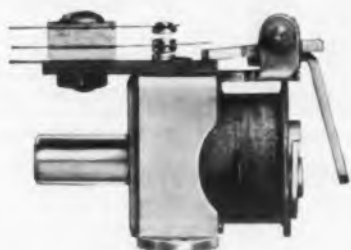

## “twofer”

With Heinemann's Type A Silic-O-Netic<sup>®</sup>, you get two relays for the price of one: a time-delay relay and a load relay. In one small package (shown actual size above), you get a time-delay relay that can double, if you wish, as a load carrier, too. (It's got a continuous-duty coil; you don't have to use auxiliary lock-in circuits or slave relays.)

The Type A tips the scale—barely—at three ounces. It comes with any delay you spec, from a quarter-second to two minutes, can be supplied for use on any one of twenty standard AC or DC voltages. Contact capacities range up to three amps. Maximum power consumption is two watts AC, three watts DC. Switching is SPDT or DPDT. Operating life is somewhere in the millions (the hydraulic-magnetic delay element is hermetically-sealed, fatigue-free).

The Type A (and the entire line of Heinemann time-delay relays) is described in full in our Bulletin 5003. A copy is yours for the asking.

## HEINEMANN ELECTRIC COMPANY

156 BRUNSWICK PIKE



TRENTON 2, NEW JERSEY

SA-2466

CIRCLE 124 ON READER-SERVICE CARD



\*  
CALIBRATES A. C.  
**twice as fast  
twice as fast  
twice as fast**

\* measures changes in A.C. input without transferring to D.C. . . . this permits operator to make frequency response checks in less than half the time previously required.

MODEL TV-1

### THERMAL TRANSFER VOLTMETER NBS CERTIFIABLE

A new AC-DC transfer standard. Transfer measurement is made to a calibrated DC supply of the same voltage as the unknown AC being measured; thus eliminates ratio errors in the high frequency multiplier resistors.

**Range** — Three decade range multiplier. .5 volt to 1200 volts. Full resolution in 1 volt steps from 1 to 999 volts.

**Frequency Response** — .5 to 290 volts .02% to 50KC. 300 to 1200 volts .02% to 10KC.

**Null Sensitivity** — .004%/mm.

**Thermocouple** — DC reversal error less than .02%. Couples, plug in replaceable, at \$40.00.

**Input Resistance** — 143 ohm/volt.

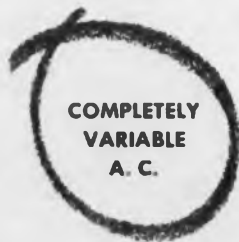

COMPLETELY  
VARIABLE  
A. C.



MODEL AVS-321

### AUDIO VOLTAGE STANDARD NBS CERTIFIABLE

The output is continuously variable in frequency as well as voltage so that complete information about the response of the unit or system under test may be obtained.

**Range** — 1 to 1000 volts RMS 35 cps to 2 KC. 1 to 300 volts RMS 35 cps to 10 KC. **Accuracy** — Regulated voltage equal to dial setting  $\pm (0.1\% + 2 \text{ mv})$  From 300 to 1000 volts accuracy is  $\pm 0.25\%$ .

**Stability** — 30 days. Long-term drift may be corrected by simple adjustment. **Internal Oscillator** — 60 cps, 400 cps or 1000 cps.

See us at WESCON BOOTH 3305 - 3307

**HOLT INSTRUMENT LABORATORIES**  
OCONTO, WISCONSIN  
CIRCLE 125 ON READER-SERVICE CARD

## NEW PRODUCTS AT WESCON

### Power Supply

487



Output is 245 to 255 v at 0 to 200 ma. Model PS4241M power supply with convection cooling operates at 71 C. Input is 105 to 125 v at 50 to 63 cps; line regulation is less than 0.05%; load regulation is less than 0.1%.

Power Sources, Inc., Dept. ED, Northwest Industrial Park, Burlington, Mass.

See at Show Booth 2816-18.

### Hand Tools

496

Custom made for special applications, tools include: the 740-1372 combination screwdriver-nut-driver for adjusting recording equipment; the 2201357 long-shank, prong tipped tool for adjusting computers; and the 300-1675 insulated nutdriver-hammer for aligning and adjusting calculating machines.

Xcelite, Inc., Dept. ED, Orchard Park, N. Y.

**Availability:** Made on order.

See at Show Booth 402.

### PNP Epitaxial Transistors

535

For switching use. These pnp epitaxial germanium transistors handle 1/2 amp at switching speeds of a few nanoseconds. Current gain in the region of 100 mc has been improved 10-fold over previous models.

Motorola Semiconductor Products Inc., Dept. ED, 5005 E. McDowell Road, Phoenix, Ariz.

See at Show Booth 914-16.

### Transistor Fault Counter

481



With 10 indicators, model C-10 transistor fault counter displays the number of transistors which do not pass tests 1 to 10. Also offered, model C-2 displays the total number of units tested and the total number which pass tests.

Optimized Devices, Inc., Dept. ED, 864 Franklin Ave., Thornwood, N. Y.

**P&A:** \$850; 6 weeks.

See at Show Booth 1210.



## Ultra-sensitive relays

### HELPFUL DATA FOR YOUR CIRCUITRY IDEA FILE

The circuit drawing below indicates just one of the hundreds of ways many manufacturers utilize Micropositioner® polarized relays to solve complex control problems.

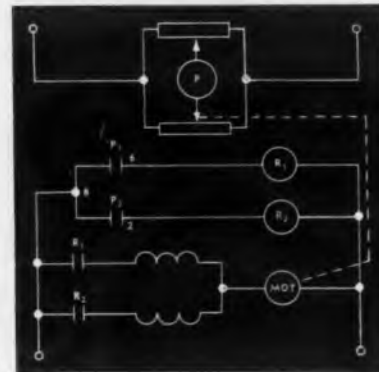

### SERVOMECHANISMS APPLICATIONS

Many remote positioning applications can be solved by utilizing the Barber-Colman Micropositioner ultra-sensitive relay either as a null detector or a differential relay. In the circuit shown above, movement of the transmitting potentiometer introduces an error signal in Micropositioner coil P, which in turn energizes the positioning motor until balance is restored. Secondary relays R<sub>1</sub> and R<sub>2</sub> operated by the Micropositioner handle larger loads. This circuit can also be applied to synchronization . . . or the Micropositioner can be utilized in the output of an electronic servo control.

Among the many applications for this simplified servo control relay are positioning of antenna rotators and tuning condensers . . . aerial camera mounts . . . valves . . . test cell apparatus.

If your projects involve servomechanisms, why not make a test with a Micropositioner designed for circuits similar to that shown above? Write for Engineering Bulletin No. 9.

### BARBER-COLMAN MICROPOSITIONER® POLARIZED D-C RELAYS

Operate on input power as low as 40 microwatts. Available in three types of adjustment: null seeking . . . magnetic latching "memory" . . . and form C break-make transfer. Also transistorized types with built-in preamplifier. Write for new quick reference file.



**BARBER-COLMAN COMPANY**  
DEPT. T, 1883 ROCK STREET, ROCKFORD, ILLINOIS  
CIRCLE 126 ON READER-SERVICE CARD

ELECTRONIC DESIGN • August 2, 1961

## Power Relay

486



Rated at 50 amp. Class 88D miniature power relay is for ac or dc use at 6, 12, 24 and 115 v. Contacts are spst, normally open or normally closed, double break, with silver-alloy points. Contact arms provide positive contact wiping.

Magnecraft Electric Co., Dept. ED, 3350D W. Grand Ave., Chicago 51, Ill.

P&A: \$4.25 to \$6.75; most types, stock.

See at Show Booth 3017.

## FM Transmitter

482

For 215 to 260 mc. Type 1008, a 2-w fm transmitter, provides 0.01% crystal-stabilized frequency control. Sensitivity is 0.01 v per kc; carrier deviation is  $\pm 150$  kc; modulation range, 20 cps to 100 kc. It operates over the temperature range of  $-55$  to  $+100$  C.

American Bosch Arma Corp., Tele-Dynamics Div., Dept. ED, 5000 Parkside Ave., Philadelphia, Pa.

See at Show Booth 4126-28.

## Glass-Epoxy Laminate

528

Self-extinguishing grade 11587 glass-epoxy FR-4 laminate is especially suitable for applications where cyanide plating is required. It has high flexural and impact strength, insulation resistance of 1,000,000 meg and meets the humidity conditions of C-96/35/90

General Electric Co., Laminated Products Dept., Dept. ED, Coshocton, Ohio.

See at Show Booth 4811.

## Trimming Potentiometers

539



Ranges are 10 ohms to 50 K. A monocrystal thick film with stable temperature characteristics provides these trimming potentiometers with long life, high power and infinite resolution. Units have the same dimensions as wire-wound models 110, 120, 210, 220 and 320.

Atohm Electronics, Dept. ED, 7648 San Fernando Road, Sun Valley, Calif.

See at Show Booth 3506-08.

# You wire this new General Electric Silicon Controlled Rectifier as easily as a resistor!



## IN LOW POWER SWITCHING AND CONTROL APPLICATIONS REQUIRING BLOCKING VOLTAGES UP TO 200 VOLTS AND DC LOAD CURRENTS UP TO 1.1 AMPS

The unique double-ended mechanical design of the new General Electric 2N1929-1933 low current SCR's now gives you the advantage of point-to-point wiring flexibility in circuit layout design . . . and you don't need any external heat sink whatsoever even for relatively high current loads! Other important advantages: transient PRV ratings up to 300 volts; maximum gate current to fire, 15 ma at 25°C.

For complete technical information on this new SCR, call your Semiconductor Products District Sales Manager or write Rectifier Components Department, Section 23H27, General Electric Company, Auburn, New York. In Canada: Canadian General Electric, 189 Dufferin Street, Toronto, Ontario. Export: International General Electric, 150 E. 42nd Street, New York 17, New York.

FOR FAST DELIVERY OF GERMANIUM, SELENIUM AND SILICON RECTIFIERS, CALL YOUR AUTHORIZED G-E SEMICONDUCTOR DISTRIBUTOR

*Progress Is Our Most Important Product*

**GENERAL  ELECTRIC**

CIRCLE 127 ON READER-SERVICE CARD



MONTROSE DIVISION

# SYNCHROS

MIL-S-20708 | MIL-S-2335



Your complete source for all military type synchros with "off the shelf" delivery

SIZE 11	CT4c, 26V-CT4c, CX4c, 26V-CX4b, CDX4a, 26V-CDX4b, TR4b, 26V-TR4b, TX4b, 26V-TX4b
SIZE 15	CT4b, CX4b, CDX4b, TR4c, TX4b, TDX4b, CT6b, CX6b, CDX6b, TR6a
SIZE 18	CT4b, CX4b, CDX4b, TR4b, TDX4b, CT6b, CX6b, CDX6b, TX6a, TRX6a
SIZE 23	CT4, CT4a, CT4b, CX4, CX4a, CX4b, CDX4, CDX4a, CDX4b, TR4, TR4a, TR4b, TX4, TX4a, TX4b, TDX4, TDX4a, TDX4b, TDR4, TDR4a, TDR4b, CT6, CT6a, CT6c, CX6, CX6a, CX6c, CDX6, CDX6a, CDX6b, TR6, TR6a, TX6, TX6a, TX6b, TDX6, TDX6a, TDX6b, TDR6, TDR6a, TRX6a
SIZE 31	TR4d, TX4a, TX4d, TDX4b, TDR4b, TR6b, TX6b, TDX6b, TDR6b
SIZE 37	TR4a, TX4b, TDX4a, TDR4a, TR6b, TX6b, TDX6a, TDR6a
TYPE 1	1D, 1F, 1MCT, 1HDG, 1HG
TYPE 3	3D, 3F, 3HCT, 3HDG, 3HG
TYPE 5	5D, 5F, 5HCT, 5HDG, 5HG, 5N
TYPE 6	6HDG, 6HG

## WRITE FOR FREE

Rapid Reference Guide to Military Synchros. —▶

Write on company letterhead for Synchro Engineering Catalog.



West Coast Sales and Service Office—117 East Providence Avenue, Burbank, California  
Canadian Sales Office—Aviation Electric Limited, 200 Laurentien Blvd., Montreal, Quebec, Canada  
Export Sales and Service—Bendix International, 205 East 42nd St., New York 17, New York

Montrose Division  
SOUTH MONTROSE, PA.



CIRCLE 128 ON READER-SERVICE CARD



## NEW PRODUCTS AT WESCON

### Digital Voltmeter

484



Range is 0.0001 to  $\pm 1,200$  v with an accuracy of  $\pm 1$  count. Model 550 digital voltmeter has automatic polarity indication, effectively infinite input impedance and instantaneous reading. Modular plug-in construction is used.

Franklin Electronics Inc., Dept. ED, Bridgeport, Pa.

Price: \$1,370.

See at Show Booth 3510.

### FM Signal Generator

553



Range is 400 to 550 mc. Model 1001 fm signal generator is continuously tunable and has a frequency drift of less than 0.015% per hr. Dial calibration accuracy is  $\pm 0.5\%$ . Fm deviation is controlled on two ranges, 0 to 35 kc and 0 to 350 kc, accurate to  $\pm 5\%$  full scale.

R S Electronics Corp., Dept. ED, P. O. Box 11386, Station A, Palo Alto, Calif.

Availability: 45 days.

See at Show Booth 3322.

### Miniature Amplifier

550



Rated at 5 w, type C70 3146 001 amplifier is for use in ambient temperatures to 125 C. It occupies 1 cu in. Features include high stiffness-to-weight ratio for missile and aircraft environments and resistance spot welding.

General Precision, Inc., Kearfott Div., Dept. ED, 1150 McBride Ave., Little Falls, N. J.

See at Show Booth 3309-21.

### READALL READOUT NEWS from Union Switch & Signal



### New 64-Character READALL® Readout Instrument designed for use in low-level and solid-state circuitry

The new sealed case 64-character READALL Readout Instrument was designed especially to meet the severe environmental requirements of MIL-E-5422D and other military specifications. The sealed case provides reliable operation at 100% humidity and at altitudes up to 50,000 feet.

The great reduction in the amount of associated equipment required when READALL Readout Instruments are used simplifies circuitry. Outstanding features in this one small package are: readability of display, binary decoding, data storage and electrical readout.

This new READALL is back-lighted with two miniature aircraft-type lamps. Even if one lamp fails, readability is assured. Under normal conditions the black-and-white character belt is readable even without internal illumination.

The new UNION sealed case 64-character READALL is  $8\frac{1}{2}''$  long and weighs just 14 ounces. It will mate with military standard connector MS-24013, and is a companion to the UNION sealed case 12-character READALL. Write for Bulletin 1066.

### READALLS reduce equipment requirements... simplify circuitry

Because READALLS are capable of so many functions, there is no need for the transistors, relays, magnetic cores and diodes and membrane translator units required to back up less sophisticated readout devices. Write for Bulletin 1057.



**UNION SWITCH & SIGNAL**  
DIVISION OF WESTINGHOUSE AIR BRAKE COMPANY—  
PITTSBURGH 18, PENNSYLVANIA

CIRCLE 129 ON READER-SERVICE CARD  
ELECTRONIC DESIGN • August 2, 1961

## Synchronous Motor

551



Reversible synchronous motor type 46100 delivers 30 oz-in. torque at 1 rpm. Designed for computer applications, it can be used with printed circuitry, potentiometer drives and other devices. No external breaks, quenching circuits or phase-shift networks are needed. It can be furnished with outputs of 300 rpm to 1/6 rph.

A. W. Haydon Co., Dept. ED, Waterbury, Conn.

Availability: 60 days.

See at Show Booth 2802-04.

## Switching Relay

556



Life is 30 million cycles. Type A miniature switching relay has dpdt contact arrangement with a 4-40 by 3/8-in. stud. Coils are from 100 to 2,500 ohms  $\pm 20\%$ . Operate time is as fast as 3 msec; release time, to 6 msec. Contact resistance is 60 milliohms at rated load.

North Electric Co., Electronics Div., Dept. ED, Galion, Ohio.

P&A: \$1.55; sample quantities.

See at Show Booth 2502-04.

## Multiple Diode

544



For computer logic. This plug-in multiple diode, called the Poly-Diode, consists of five separate diode junctions with individual leads, formed on a single silicon slice. The entire circuit is glass encapsulated.

Delta Semiconductors, Inc., Dept. ED, 835 Production Place, Newport Beach, Calif.

See at Show Booth 4512.

**WESCON**  
VISIT US AT BOOTH No. 3101-03



## RELAY NEWS from Union Switch & Signal

### Contact Redundancy in New UNION Crystal Case Relays

The UNION 2-pole double throw General Purpose Crystal Case Relay is designed to consistently meet the requirements of Mil-R-5757D and Mil-R-5757/10. Its essential features . . . from minimum size to optimum reliability . . . permit it to be used in aircraft, guided missiles, shipboard and ground control electronic equipment.

A unique torsion-wire armature suspension system and a rugged all-welded frame construction provide a high level of vibration and shock immunity. Contact redundancy, which assures reliability in dry circuit and higher level contact loads, is provided through the use of bifurcated contacts.

Available with 0.2" grid-spaced header or "S" type header, with various mountings, terminals, and operating voltages. Write for Bulletin 1064.



### Why UNION Relays Are So Dependable

There's a good reason why our relays are the standard for reliability. For years, we've been building tough, reliable relays for use in airborne and guided missile electronic equipment and similar vital applications where perfect operation under severe environmental conditions is mandatory.

Our engineers created a compact 6-PDT miniature relay with just three major assemblies . . . instead of a fistful of small parts. This was accomplished by using a balanced rotary-type armature that provided a maximum resistance to the severe shock and vibration environment of aircraft and guided missiles. The rotary principle of operation is utilized in all our relays.

We have a reputation for building reliable electronic components and we intend to maintain our tradition for building reliable relays. And we supply these quality relays in quantity. Stocks are now available for prototype requirements in New York, Pittsburgh, Dallas and Los Angeles.



For additional information, write for Bulletin 1017 or call Churchill 2-5000 in Pittsburgh.

MEMBER OF THE NATIONAL ASSOCIATION OF RELAY MANUFACTURERS



**UNION SWITCH & SIGNAL**  
DIVISION OF WESTINGHOUSE AIR BRAKE COMPANY

PITTSBURGH 18, PENNSYLVANIA

CIRCLE 130 ON READER-SERVICE CARD

### New 4-PDT-10-amp Relay Most Compact Rotary Type Available

This new durable relay is designed to meet the requirements of Mil-R-6106. It's a rugged relay featuring exceptionally sturdy terminals and husky contacts for high current applications. Glass-coated cylindrical contact actuators attached to the rotary armature provide square mating of contact surfaces, thereby assuring longer relay life. The balanced rotary armature provides maximum resistance to severe shock and vibration.

This small 4-PDT-10-Ampere relay is currently available with 115VAC and various DC operating voltages. Various mounting styles are provided. Write for bulletin 1069.

**DOT**

Specialists in Electro-Mechanics

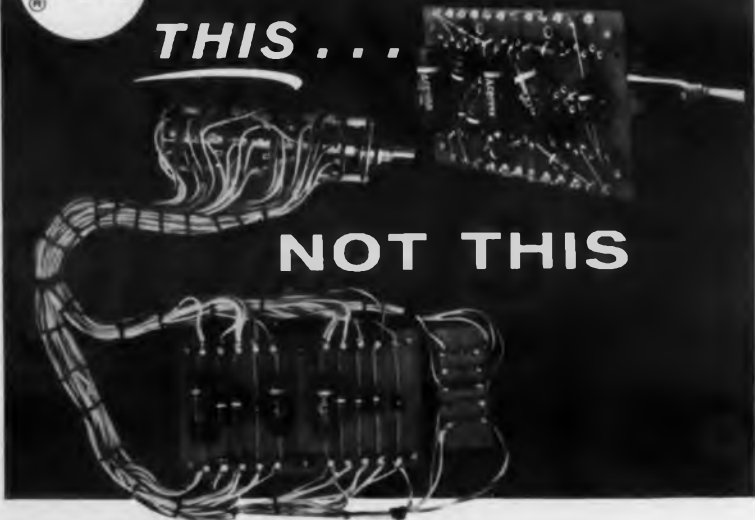
**THIS . . .****NOT THIS**

## DOT UNIPLANE SWITCH CUTS COST 50-75%

■ **Monoplanar Switching** Ucinite's exclusive technique replaces bulky, multi-pole switch, component board and interconnecting harness with compact, accessible assembly for rapid, error-free, low-cost wiring.

■ **Saves Time and Money, Enhances Reliability** All wiring and assembly is done on single printed board. Switch patterns are in plain view. Components are dropped into position and soldered in. In typical applications, 75% savings are accomplished by reducing labor, materials test-time, rejects, repairs. Solder joints typically reduced by 65%, for much higher reliability. Patented DOT UNIPLANE low-torque design eliminates many sources of rotary switch failure.

■ **Creates Additional Degree of Freedom** Space savings of 30% to 80% plus the flexibility of orientation possible with Ucinite's exclusive 3-axis drive assembly, create a new degree of freedom in layout, often permit utilization of "waste space".

■ **Convenient Standard Kits** Basic UNIPLANE parts are available in an inexpensive kit from which over 1000 different combinations of poles, positions, drive-axes and mounting surfaces can be assembled. In production selected kit-parts are factory-assembled by Ucinite at additional savings.

■ **Custom Designs** Ucinite designs custom UNIPLANE assemblies with printed interconnections, special test points, edge connectors, etc., to your specifications.

Write Dept. EBG-1 or use Reader Service Card.

*Application-engineered, standard electronics products: Printed Circuit Test Jacks • Printed Circuit Connectors • Monoplanar Switches • Printed Circuit Guide Channels, Polarizing Plugs and Keys • MIL STD and Commercial Jacks, Plugs, Switches • Molded Rotary Switches • Shock and Vibration Mounts • Magnetron Connectors • Anode Connectors and Grid Caps.*

**DOT**

®

## The UCINITE COMPANY

Division of United-Carr Fastener Corporation

Newtonville 60, Massachusetts

LAsell 7-8400

CIRCLE 131 ON READER-SERVICE CARD

## NEW PRODUCTS

### Transistor Analyzer

469



Digital readout is available on model 2002 transistor dc analyzer. Measured parameters and operating ranges include: 0 to 100 v breakdown voltage; 0 to 10 v saturation voltage; 1.0  $\mu\text{A}$  to 100  $\mu\text{A}$  reverse current; and 5 to 1,000 dc beta. Variable test currents from 10  $\mu\text{A}$  to 100 ma and voltages from 0 to 100 v are available. Accuracy is better than 1%.

Merrithew and Syphers, Inc., Dept. ED, P. O. Box 178, Syracuse 11, N. Y.

P&A: \$2,975; six weeks.

### Biotelemetry System

579

Six data channels are provided by vest-type biotelemetry system model 99. Parameters include electrocardiogram, respiration, temperature, galvanic skin response, electro-encephalogram and voice. Range is 200 yards with 10 hr of continuous transmission. Complete unit weighs less than 3 lb. Standard IRIG frequencies are used.

Spacelabs Inc., Dept. ED, 15521 Lanark St., Van Nuys, Calif.

Availability: 90 days.

### Portable Antenna

503



Light-weight helical antenna has 4 or 7 turns, and is made for space and missile telemetry systems. Unit, consisting of 15 x 51 in. cylinder and 48-in. sq aluminum honeycomb plane, weighs 24 lb. Gain at band center is 10.5 and 13.5, beam width is 52 and 40 deg for 4- and 7-turn units respectively. Frequency range is 215 to 165 mc.

Temco Electronics Div., Dept. NB6237, Dept. ED, P. O. Box 6191, Dallas 22, Tex.

## TELEMETRY BY TELE-DYNAMICS

### Voltage Controlled Oscillator



Positive, reliable oscillator performance is essential to your aerospace telemetry needs. And Tele-Dynamic's newest—the Type 1270A Voltage-Controlled Oscillator is representative of Tele-Dynamic's creative effort in the complete telemetry field.

Characterized by excellent overall specifications, this new oscillator is high in electrical performance and environmental characteristics. Input 0 to 5 volts or  $\pm 2.5$  volts, linearity  $\pm 0.25\%$  best straight line . . . a power requirement of 28 volts at 9 milliamps maximum. Distortion is 1% and amplitude modulation 10%.

Environmental characteristics include thermal stability of  $\pm 1.5\%$  design bandwidth from  $-20^\circ\text{C}$  to  $+85^\circ\text{C}$ , unlimited altitude, 30G random vibration and 100G acceleration and shock. The 1270A weighs less than two ounces and has a volume of two cubic inches.

For detailed technical bulletins, call the American Bosch Arma marketing offices in Washington, Dayton or Los Angeles. Or write or call Tele-Dynamics Division, American Bosch Arma Corporation, 5000 Parkside Avenue, Philadelphia 31, Pa. Telephone TRinity 8-3000.

611

## TELE-DYNAMICS DIVISION

AMERICAN BOSCH ARMA  
CORPORATION

5000 Parkside Ave., Philadelphia 31, Pa.

CIRCLE 132 ON READER-SERVICE CARD

## Power Supply

451



All-silicon power supply operates at 71 C ambient air. Designated model PS4241-M, the supply provides 245 to 255 v dc at 0 to 200 ma, with line regulation of 0.05% and load regulation of 0.1%. Transformer and choke are hermetically sealed, and meet MIL-T-27 requirements. Cooling is by convection, without blowers.

Power Sources, Inc., Dept. ED, Northwest Industrial Park, Burlington, Mass.

## Delay Line

690

A 224- $\mu$ sec delay for automatic machine control is designed into the FM-400-224 Magline series of magnetostrictive delay lines. Unit accommodates two information channels which can be separated by clocking. Bit rate is 250 kc per channel. Output is 40 mv min with a 50 ma peak driving current. Units are mounted on printed circuit cards measuring 6 x 4-3/4 x 1 1/2 in.

Control Electronics Corp. Inc., Dept. ED, 10 Stepar Place, Huntington Station, L. I., N. Y.

## Oscillograph

452



Dual-channel direct-writing oscillograph, model 500, has a measurement range from 0.0001 to 400 v and frequency response from dc to 100 cps. A variety of interchangeable plug-in preamplifiers are available. Chart speeds of 1, 5, 25, and 100 mm per sec have push-button selection.

Photron Instrument Co., Dept. ED, 6516 Detroit Ave., Cleveland 2, Ohio.

P&A: \$1,325.00; 30 days.

CIRCLE 133 ON READER-SERVICE CARD ►



# THE MOST

## SILICON CHOPPERS

From 1 mV "on"  
to 80 V "off"

# SPERRY

SPERRY SEMICONDUCTOR  
DIVISION

OF  
SPERRY RAND CORPORATION  
NORWALK, CONNECTICUT



# NEARLY PERFECT SWITCH

(And we don't mean a shell game)

## HERE ARE THE FACTS IN A NUTSHELL . . .

- High breakdown ratings - 50 to 80 volts
- Two point control of current/voltage offset parameters
- Matched pairs to standard tolerance of 100  $\mu$ v
- 10 million-to-1 minimum "off" to "on" resistance ratio
- Typically 30,000 megohms reverse resistance
- Typically 50 ohms forward resistance
- High temperature stability
- Unlimited quantities available
- Available from local Sperry Authorized Distributors

Don't gamble — you put your experience on the line when specifying for analog computers, D.C. amplifiers, electronic commutators and multiplex equipment.

Sperry now offers you a complete series of silicon transistors for single use or matched pairs that have the best combination of chopper characteristics — plus an extra margin of safety which provides true design flexibility.

Type Number	BV <sub>CEO</sub> (Volts)	BV <sub>CES</sub> (Volts)	BV <sub>EB0</sub> (Volts)	V <sub>BE</sub> (max)	I <sub>BE</sub> (max)	Price	PRICE
				Offset Voltage (mV)	Offset Current (m $\mu$ A)		
2N1917	-8	-25	-25	1.0	1.0	\$ 9.75	\$7.50
2N1918	-8	-25	-25	3.0	3.0	7.80	6.00
2N1919	-18	-40	-40	2.0	1.0	12.35	9.50
2N1920	-18	-40	-40	3.0	1.5	8.77	6.75
2N1921	-50	-50	-50	4.0	2.0	5.20	4.00
2N1922	-80	-80	-80	4.0	2.0	6.50	5.00

Write for 16 page Technical Application Bulletin #2107 and new Chopper transistor data sheets on types 2N1917 through 2N1922.

**SEMICONDUCTOR IS OUR MIDDLE NAME** . . . SEMICONDUCTOR INTEGRATED NETWORKS (SEMI-NETS®), TUNNEL DIODES, MESA AND ALLOY SILICON TRANSISTORS AND DIODES  
 SALES OFFICES: CHICAGO, ILLINOIS; EL SEGUNDO, CALIFORNIA; WESTWOOD, NEW JERSEY; TEWKSBURY, MASSACHUSETTS; STAMFORD, CONNECTICUT; TOWSON, MARYLAND; MASSAPEQUA PARK, NEW YORK.  
 SEMICONDUCTOR OPPORTUNITIES AVAILABLE TO QUALIFIED ENGINEERS

\*Trade Mark, Sperry Rand Corporation

visit our booth  
NO. 3718  
WESCON

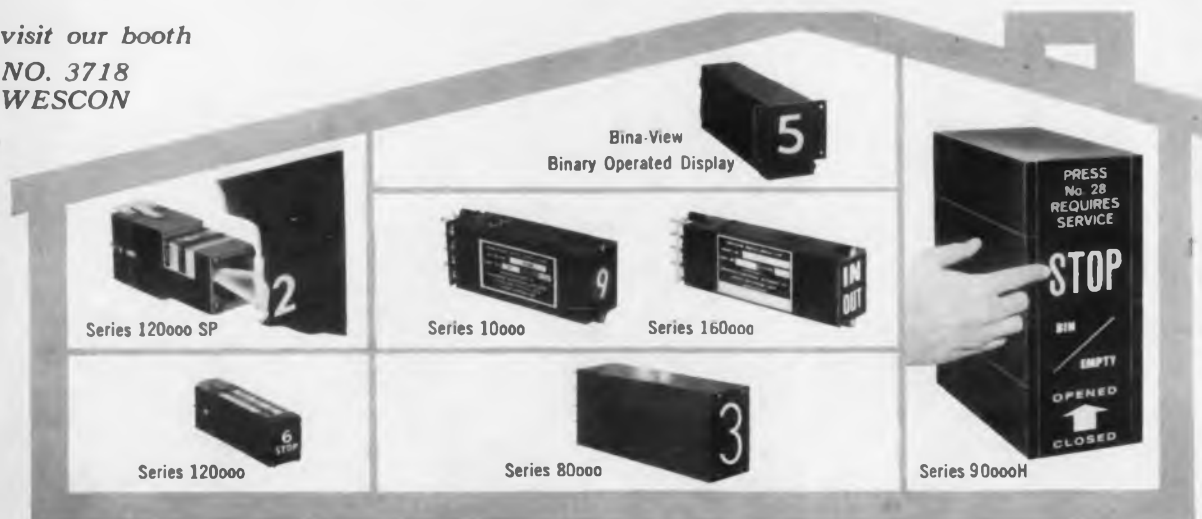

## READOUTS THAT DO MORE THAN DISPLAY NUMBERS

I.E.E.'s complete line of rear-projection readouts display words, numbers, symbols, and color. The alpha-numeric Bina-View readout is self-decoding and operates direct from binary output. And all can satisfy human factors requirements!

The engineering staff and facilities of Industrial Electronic Engineers, Inc. have approached the problem of readouts as one of visual communications, the case in point being that

complete!  
under  
the  
  
roof

numbers are only one form in a host of methods in visual communications. The engineering talent at I.E.E. work under the formula that the more forms of visual communications that are available the less chance there is for communicative breakdown. *In a word; complete.*

Your inquiry to complete readout visual communications is invited.

 **INDUSTRIAL ELECTRONIC ENGINEERS, Inc.**  
5528 Vineland Avenue, North Hollywood, California

CIRCLE 134 ON READER-SERVICE CARD

POWER-O-MATIC 60 • POWER-O-MATIC 60 • POWER-O-MATIC 60 • POWER-O-MATIC 60 • POWER-O-MATIC 60



**NO MOVING PARTS**

**RELIABILITY**

**EFFICIENCY**

**POWER-O-MATIC-60**

**SATURABLE REACTOR CONTROL**

AND Range-Lock PROTECTION

**INDUSTRIAL BATCH OVENS**

FOR PRODUCTION OR RELIABILITY TESTING

MECHANICAL  
HORIZONTAL  
AIRFLOW

**4 SIZES: 16 to 36 CU. FT.**

**2 RANGES: 400° or 600°F.**

**ULTRA RELIABILITY PERFORMANCE**

MAXIMUM DRIFT  
OVER 24 HR. PERIOD  
**±2° F.**



NO CONTACTS  
SAFER  
ECONOMICAL

Write for  
FREE LITERATURE

POWER-O-MATIC 60

POWER-O-MATIC 60

POWER-O-MATIC 60

POWER-O-MATIC 60



**BLUE M Electric Company**

138th and CHATHAM STREET • BLUE ISLAND, ILLINOIS • U.S.A.

DIVISION: BLUE M ENGINEERING COMPANY, 2312 So. Main Street, Los Angeles 7, California

CIRCLE 135 ON READER-SERVICE CARD

## NEW PRODUCTS

### Memory System

509



This 8,000-character, 56 bit-per-character random access core memory system, model 8000 K56 R, operates with a cycle time of 6  $\mu$ sec. Access time is 2.5  $\mu$ sec. Uncompensated temperature range is 15 to 40 C. The system contains 448,000 cores, and is available with a memory test unit.

General Ceramics Div., Indiana General Corp., Dept. ED, Keasbey, N. J.

### Gate Drive

689

Made for silicon-controlled rectifiers, the Flat Top gate drive has a pulse rise time of 1 to 5  $\mu$ sec. Pulse leading edge advances linearly with control signal until the phase shift is 180 deg. This 180-deg phase shift is maintained even for excessive control signals. Unit is housed in a hermetically sealed metal case measuring 4-1/4 x 3-1/4 x 3-1/2 in.

VeeTrol Engineering, Inc., Dept. ED, 87 Magee Ave., Stamford, Conn.

### Epoxy Cement

578

For strain gages. The three-hour setting time of B-3 epoxy cement allows strain gage alignment while cement is setting up. Temperature limits are 200 F static, 250 F dynamic. Cement can be applied to porous or smooth surfaces.

The Budd Co., Dept. C, Instruments Div., Dept. ED, P. O. Box 245, Phoenixville, Pa.

### Pulsed Ruby Laser

501



Less than 200 J are required to fire this pulsed laser. Chromium-doped ruby is activated by a single flash tube housed in an elliptical

ELECTRONIC DESIGN • August 2, 1961

reflector. Laser head measures 8 in. long and 5 in. in diameter. Power supply provides 2,000 v from a 400- $\mu$ f reservoir. Instrument is made for industrial and institutional research.

Raytheon Co., Special Microwave Devices Operation, Dept. ED, 130 Second Ave., Waltham, Mass.

**P&A:** \$5,580; 3 to 4 weeks.

### Wirewound Resistors

505



Less than 1 pf distributed capacitance for resistances up to 800 K, and less than 1.5 pf up to 1.25 meg is held by these precision wirewound resistors. Units are noninductive, encapsulated, and have a temperature range of -65 to +125 C. Sizes up to 5 meg, 2 w dissipation are available, with tolerances as low as 0.01%. Units measure 3/4 in. long and 1/4 in. in diameter.

Kelvin Electric Co., Dept. ED, 5907 Noble Ave., Van Nuys, Calif.

### Isolation Transformers

504



Dual-shielded isolation transformers have input-output capacitance less than 0.05 pf. Units are available in 1 to 2.5 kva sizes for laboratory isolation. Test equipment isolation can be achieved with 5-va to 500-va units, packaged in MIL-T-27A cases with shielded leads.

L J Products, Dept. ED, 7464 Girard Ave., La Jolla, Calif.

### Multiplex Stereo Generator

458

Tests multiplex equipment. Multiplex stereo generator, model 830, operates with an fm signal generator, an audio oscillator, and an oscilloscope to provide a composite stereo signal. Stereo records or tapes may serve as input for listening tests.

H. H. Scott, Inc., Dept. ED, 111 Powdermill Road, Maynard, Mass.

**P&A:** \$1,000; regular production in September.



# AND 67 SIZES IN BETWEEN

to meet your printed circuit specs...exactly

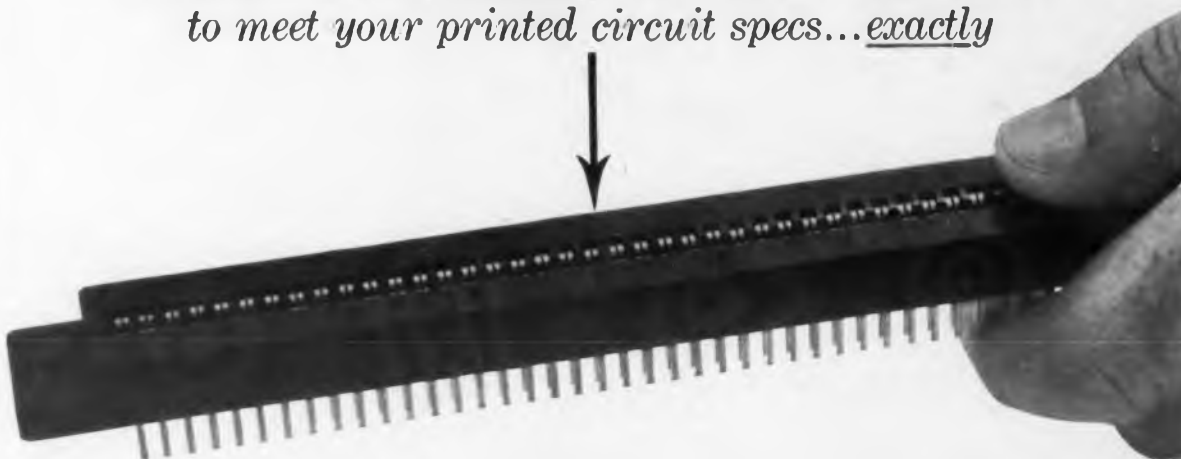

Continental's line of PC connectors include nearly seventy sizes and types. Name your requirement—and the chances are Continental has a standard production type that meets it *exactly*.

These service-proven connectors are available with up to 210 contacts, for 1/32, 3/64, 3/32, 1/16 and 1/8" PC boards, in both single- and double-row construction. Wiring styles include eyelet lug, wire wrap lug, taper tab and contacts for dip soldering. Continental's patented Bellowform contacts permit use of undersized or oversized boards while maintaining low contact resistance.

New PC connector designs are constantly under development. Our Engineering Department will be pleased to assist you in solving special connector problems. Simply call or write, stating your requirements.



### DESIGNERS' DATA FILE

If you're designing around printed circuits you'll want to have Continental's Con-Dex File PC, compiled to help you select and specify the PC connectors best suited to your needs. For your copy, please write to: Electronic Sales Division, DeJur-Amsco Corporation, Northern Boulevard at 45th St., Long Island City 1, New York (Exclusive Sales Agent) RAvenswood 1-8000.

MICRO-MINIATURE • SUB-MINIATURE • MINIATURE • PRINTED CIRCUIT • RIGHT ANGLE PIN & SOCKET • CENTER SCREWLOCK

# CONTINENTAL CONNECTORS

CONTINENTAL CONNECTOR CORPORATION • WOODSIDE 77, NEW YORK

VISIT US AT WESCON SHOW • BOOTHS 1919-1921

CIRCLE 136 ON READER-SERVICE CARD





## **PROTECT UNDERWATER CIRCUITRY WITH SPECIAL BENDIX CABLES AND CONNECTORS**

Based on a concept developed by Portsmouth Naval Shipyard, special cable and connector assemblies offering maximum protection for underwater circuitry are now available from the Scintilla Division of The Bendix Corporation.

These watertight assemblies are available in a variety of configurations. The specification covering this design stipulates that the cable and connector assembly must be capable of operation, mated or unmated, at high pressures. Connector receptacle shells are fabricated of non-corrosive metal. Connector plugs are sealed to the cables by watertight, pressure-tight molding.

Bendix has a wealth of experience in fabricating cables and connectors for underwater applications. If you have needs in these areas—and want top quality at no premium in price—write today for complete information.

**BENDIX CONNECTORS**  
**BENDIX CABLES . . .**

*Designed together  
to work best together!*

Scintilla Division  
Sidney, New York



CIRCLE 137 ON READER-SERVICE CARD

## NEW PRODUCTS

### Transistor Straightener

445



One thousand transistor leads an hour are straightened by model AL3S, or cut and notched by model AL3NS machines. Machines do not roll, twist or affect the seals or leads electrically. When a transistor is inserted into the machine, the leads are straightened, or cut and notched, and the transistor is ejected. Power requirements: 110 v, 60 cps, and 80 psi of compressed air.

Design Tool Co., Dept. ED, 1055 Stewart Ave., Garden City, L. I., N. Y.

**Price:** Straightener, \$2,490; cutter-notcher, \$2,790.

### Glass-Epoxy Laminate

576

Copper-clad glass-epoxy laminate Textolite grade 11584 withstands severe mechanical and thermal shock. It retains 50% of room-temperature flexural strength at 150 C and 50% of the copper bond strength after seven days at 325 F, and is resistant to solvents and etchants. Thickness range is 0.010 to 1.000 in. unclad, 0.010 to 0.250 in. copper-clad.

General Electric Co., Laminated Products Dept., Dept. ED, Coshocton, Ohio.

### Power Regulators

475



Ovens and furnaces can be controlled by these multi-channel ac power regulators. Up to 10 channels can be installed in a standard instrument rack. Model Y4079 is a single-channel, plug-in module rated at 40 amp. Model G4078 is rated at 100 amp per channel. Overloads of 200% can be tolerated for short periods. Cooling apparatus is contained in the rack.

Research, Inc., Dept. ED, P. O. Box 6164, Minneapolis 24, Minn.

IT'S  
**SHOW  
TIME**  
AGAIN

at WESCON Booth 2412-14

WHERE  
**Boonton Electronics**

WILL SHOW

A NEW  
**SENSITIVE  
RF  
VOLTMETER**  
300  $\mu$ v to 3 volts  
1.2 KC to 1200 MC  
Accuracy to 3%

WE WILL ALSO DISPLAY

- Capacitance Bridges
- Inductance Bridges
- DC Voltmeters
- RF Microwatt Meter
- AC & DC Null Detectors
- Grid Dip Meters
- Distortion Meters

**Boonton  
ELECTRONICS  
Corporation**

Morris Plains, N. J. • Jefferson 9-4210

CIRCLE 138 ON READER-SERVICE CARD  
ELECTRONIC DESIGN • August 2, 1961

## Serial Memories 629

Five types are offered, with delays from 19 to 100 up to 1,501 to 2,000  $\mu$ sec. Type SM-10 serial memories contain a driver circuit, a magnetostrictive delay line and an amplifier reshaper. Storage capacity is to 2,000 bits; greater loop storage can be obtained by cascading.

Computer Control Co., Inc., Dept. ED, 983 Concord St., Framingham, Mass.

P&A: \$294 to \$427; from stock.

## Audio Tone Oscillators 457

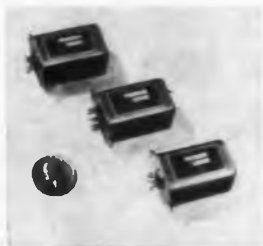

Specific frequencies from 50 cps through 30 kc are generated by these transistorized tone-oscillator packages. Plug-in and solder-terminal versions are available. Output load is 600 ohms or 10 K. Typical frequency accuracy is  $\pm 2\%$ . Units, hermetically sealed, occupy 1-1/2 cu in. and are rated from  $-29$  to  $-55$  C.

M F Electronics Corp., Dept. ED, 118 E. 25th St., New York 10, N. Y.

Availability: one to two weeks.

## Plastic Tubing 679

Shrinkable plastic tubings, called Flexite, shrink on application of heat to provide snug fittings around wires, components, and irregular shapes.

L. Frank Markel and Sons, Dept. ED, Norristown, Pa.

## Subcarrier Oscillator 691

Miniature subcarrier oscillator, model VOG-100-002, is designed for guided-missile and aircraft applications. Device measures 1-7/8 x 1-27/64 x 2-3/16 in. and weighs less than 7.4 oz. Dc voltage information is converted to an fm subcarrier signal on any standard RDB channel. Controls and test point are on front of oscillator. All MIL specs are met.

Astronautics, Inc., Dept. ED, Melbourne, Fla.

## Only Ampex AR-300/FR-700 systems make all these wideband recording techniques practical and routine

It takes 4 mc response to fully encompass all the above applications. Increasing tape speed past static heads would demand 1,300 ips and record only 3 minutes, using massive 19" reels . . . but Ampex puts a full hour on standard 10 1/2" reels, by rotating the recording heads at 12,000 rpm transversely across slow-moving tape (12 1/2 and 25 ips) to get the needed relative head-to-tape speed for 4 mc. In so doing, the AR-300 and FR-700 recorders borrow from Ampex's VIDEOTAPE® Recorders, which use an identical technology to capture TV frequencies.

More bits per hour, another bonus from rotating heads. Rotating heads reconcile two ideals: relative freedom from information dropout, and maximum information recorded per reel of tape. With head-to-tape speed to spare, each bit of information can be permitted to occupy a greater wave length along the track to minimize dropout. At the same time, rotating heads are ideal for recording very narrow, closely-spaced tracks across the tape. This narrow spacing puts 64 tracks into each inch. Up to 5,000,000 bits of PCM data can be recorded per second, or  $1.8 \times 10^{10}$  bits on a one-hour reel.

750 similar recorders have written the reliability record. Better than 99% reliability from over 750 VIDEOTAPE Recorders in worldwide use is a matter of record. Sole routine replacements necessary are heads and tapes. On a megacycle-hour basis, life compares favorably with lower performance recording methods.

Some significant specifications. One or two tracks available. Tape speeds: 12 1/2 ips for single track and 1 hour—25 ips for two tracks and 1/2 hour. Models: AR-300 Mobile or Airborne for record only—FR-700 single rack laboratory record/playback. Response: by FM 10 cps to 4 mc ( $\pm 3$  db). Tape: 1.0 mil Mylar (DuPont T. M.), 2" wide on 10 1/2" reels. Electronics: all solid state. Environmental (AR-300): 50,000 feet altitude, temperatures  $-54^\circ\text{C}$  to  $+55^\circ\text{C}$ . Tape interchangeability between all AR-300 and FR-700 recorders.



\*TM Ampex Corp.



AMPEX INSTRUMENTATION PRODUCTS CO.  
Box 5000 • Redwood City, California

Radar reconnaissance and tracking  
Radar simulation and training  
Pre- and post-detection recording  
Wideband communications  
Infrared recording



# QUADRATURE-FREE AC SIGNALS!

...now possible with two entirely new AC pots  
—precision-built by Helipot!

Even though today's potentiometers are developed to a level of performance never before achieved, their use as AC voltage dividers introduces several problems not present under DC conditions. Most important of these are quadrature voltage and phase shift—the extraneous voltage 90° out of phase with the input signal, which results from capacitance between wire turns and metallic mandrel.

How do you eliminate quadrature? And the many other considerations associated with AC applications—what about them? Helipot solves all these problems with two new AC potentiometer series.

Let's talk specifics.

## YOU'LL WANT THE ANSWERS TO THESE 5 QUESTIONS...

### 1. WHAT IS AN AC POTENTIOMETER?

Simply stated, a pot that's specifically designed for AC-excited circuits. It differs from ordinary wire-wound pots in that quadrature effects are eliminated without the addition of elaborate compensating networks. At the same time, it provides lower output impedance, and improves linearity and reliability.

### 2. HOW DO AC POTS ELIMINATE QUADRATURE ERROR?

Helipot combines a multi-tapped pot with a multi-tapped autotransform-

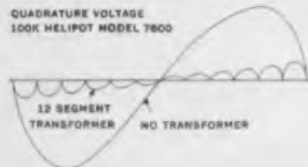

er. The voltage existing at each pot tap point is determined by the reference voltage at the corresponding

autotransformer tap. The pot resistance element is divided into a series of independent low-resistance elements—hence a reduction in quadrature.

The figure shown plots quadrature error against rotation. It illustrates the difference in phase shift between ordinary wire-wound pots and a Helipot AC unit with 12-segment autotransformer. You'll note that quadrature error is at its maximum near the midpoint between taps and is nearly zero at tap points. The result: negligible quadrature error and phase shift.

### 3. HOW ARE INPUT AND OUTPUT IMPEDANCE AFFECTED?

Input impedance remains high. Under AC applications, total pot resistance is paralleled by the AC impedance of the autotransformer. Since this impedance is 10 to 100 times greater than that of the pot, the addition of an autotransformer has a negligible effect on the input impedance.

Output impedance is much lower. The addition of an autotransformer to the basic pot results in a maximum output impedance occurring midway between each set of adjacent taps. It follows that total output impedance is greatly reduced—any energy required by the load is fed from the nearest auto-transformer tap.

### 4. HOW DOES THE AC POT IMPROVE LINEARITY?

The overall linearity of AC pots is dependent on the linearity of pot sections between taps—not total pot linearity.

An important feature of autotransformer application is the ability to easily adjust the voltage appearing at each pot tap—without affecting

the voltage ratio at any other tap. It is therefore possible to pull all tap points into the desired linearity band, regardless of basic pot linearity.

Another AC pot feature: It is capable of truly zero electrical "end coil."

### 5. ARE AC POTS MORE RELIABLE THAN BASIC POTS?

Yes—much more so. That's because a pot winding or tap lead going open affects only that portion of the pot between taps adjacent to the open. Even the opening of CW or CCW terminals has no effect beyond the adjacent tap point. Or, simply stated—the more taps, the greater the inherent reliability. Models with up to 28 taps are available as special from Helipot.

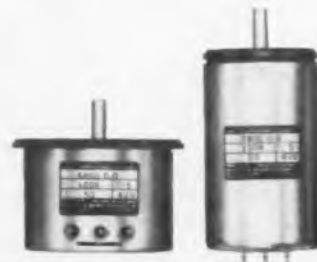

Helipot offers two AC pot series and 26 standard models with frequency ranges from 20 to 20,000 cps. Choose your linear or non-linear version of either the 3" diameter single turn Series 5800 or the 2" diameter multi-turn Series 7800. They're precision-built by Helipot to meet unusual conformities and perform in most any desired function.

Any more questions? Detailed specs and additional product information are included in a new 32-page potentiometer catalog. To get a copy, call your nearest Helipot Sales Engineering Representative...or write direct:

**Beckman**

INSTRUMENTS, INC.  
**HELIPOT DIVISION**  
Fullerton, Calif.  
POTS • MOTORS • METERS

## NEW PRODUCTS

### Variable Transformer

680



Panel-mounted variable transformer, model 250BU, is rated at 2.5 amp and 0.33 kva max. Input voltage is 120 v, and output is 0 to 132 v. Transformer is 2-13/16 in. in diameter and 2-1/16 in. deep. Brush and brush track, within the coil, are protected from damage.

Standard Electrical Products Co., Dept. ED, 2240 E. 3rd St., Dayton, Ohio.

P&A: \$9.50; from stock.

### Antenna Tower

581

Light-weight tower, type G-10, is made for rapid, simple installation and low maintenance. Each 10-ft section weighs 29 lb. A climbable ladder is on each side. Withstands 55,000 psi. E-Z Way Towers, Inc., Dept. ED, Tampa, Fla.

P&A: \$16.95 per 10-ft section; from stock.

### Pulse Generator

577

All-transistor laboratory pulse generator switches up to 30 amp at 75 v. Repetition rate is variable from 1 to 5 pulses per sec, pulse width variable from 2 to 15 msec. Panel height of the rack-mounted instrument is 7 in.

Crane Electronics Co., Dept. ED, 4345 Hollister Ave., Santa Barbara, Calif.

### Frequency Synthesizer

502



Provides 2,000 frequency channels for radar, telemetry, navigation, and communications systems. The model NC-3800 frequency synthesizer occupies less than 30 cu in. and has all solid-state circuitry, without mechanical elements. Power output is 30 mw. Frequency readout is in 23-bit binary code.

National Co., Inc., Dept. ED, 61 Sherman St., Malden, Mass.

## Filament Power Supply

497



Regulated filament power supply, model PS-130, gives 6.3 v ac, 5 amp regulated within 0.5% for an input range of 95 to 135 v, 360 to 440 cps. Regulator circuit is magnetic-amplifier, Zener-diode type. Response time is 10 msec. Components meet MIL specs, are rigidly mounted and encapsulated. Unit, hermetically sealed, meets MIL-E-5272 specifications.

Dynex Industries, Inc., Dept. ED, 170 Eileen Way, Syosset, N. Y.

## Extensible Cable

681

For up to 1,000 conductors. The extensible cable consists of two multiconductors, helical wound cables one wound inside the other. They spiral in opposite directions, resulting in a flexible assembly. A number of wire types can be used.

Spectra-Strip Wire & Cable Corp., Dept. ED, P. O. Box 415, Garden Grove, Calif.

Availability: from stock or made to order.

## Teflon Terminals

580

Stand-off and feed-through terminals are of one-piece Teflon construction. Press-fit mounting is simple and permanent. Dissipation factor is less than 0.0003 from 60 cps to over 10 Gc. Devices are made for nuclear instrumentation.

Tri-Point Industries, Dept. ED, Albertson, L. I., N. Y.

## High-Voltage Capacitors

682



Miniature, encapsulated high-voltage capacitors function under severe environmental conditions. Capacitance values of series EF range from 0.005  $\mu$ f through 1.0  $\mu$ f; voltages range from 2 to 30 kv. No derating is required up to 85 C. Requirements of MIL-C25C are met.

Dearborn Electronic Laboratories, Inc., Dept. ED, P. O. Box 3431, Orlando, Fla.



THE RAW MATERIALS OF PROGRESS



## Coolant helps cut 800 lbs. "fat" from amplifier design

The exceptional heat dissipation properties of 3M Brand fluorochemical coolant FC-75 make it possible for designers to achieve impressive advances in the miniaturization of airborne electronics equipment. Take the experience of The Martin Company . . .

A VHF amplifier was of conventional design, weighed over half a ton, took a standard six-foot high relay rack for installation. At the time of design, overall size and weight were necessary factors of the cooling problem . . . to handle internally generated heat buildup encountered at extremes of temperature, aircraft speed, and altitude.

At work on miniaturizing the amplifier's design, Martin

designers found 3M fluorochemical coolant FC-75 can effect heat removal at seven times or more the rate of non-volatile organic liquid coolants! Thus amplifier size and weight could be drastically reduced. Martin engineers designed a new VHF unit using FC-75 as coolant; it weighed less than 200 lbs., occupied less than 3 cu. ft. The new design completely eliminated heat buildup, saved 800 lbs. weight and many feet of rack space.

Other properties of FC-75 (as well as its companion product FC-43) are high dielectric strength, low solubility, great thermal stability, very low pour point. See "Profile" column (right) for details. Then write for further information.

## PROPERTIES PROFILE

### on 3M Brand Inert Liquids FC-75 AND FC-43

These unique dielectric coolants possess unusual properties that can prove advantageous to the designer of electrical devices and instruments, as well as to the manufacturer. Increased range of operating temperatures, improved heat dissipation which permits miniaturization, and greatly increased protection from thermal or electrical overload are possible with their use.

FC-75 and FC-43 are non-explosive, non-flammable, non-toxic, odorless and non-corrosive. They are stable up to 800°F., and are completely compatible with most materials . . . even above the maximum temperatures permissible with all other dielectric coolants. Both are self-healing after repeated arcing in either the liquid or vapor state.

#### ELECTRICAL PROPERTIES

	FC-75	FC-43
Electrical Strength	35KV	40KV
Dielectric Constant	1.86	1.86
Dissipation Factor	0.0005	0.0005

#### PHYSICAL PROPERTIES

	FC-75	FC-43
Pour Point	<-100°F.	-58°F.
Boiling Point	212°F.	340°F.
Density	1.77	1.88
Surface Tension (77°F.) (dynes/cm)	15	16
Viscosity		
Centistokes	0.65 min.	2.74
Thermal Stability	750°F.	600°F.
Chemical Stability	Inert	Inert
Radiation		
Resistance	25% change @ 1 x 10 <sup>6</sup> rads	25% change @ 1 x 10 <sup>6</sup> rads

FC-75 and FC-43 have a nearly equivalent heat capacity in the liquid and gaseous state.

For more information on FC-75 and FC-43, write today, stating area of interest, to: 3M Chemical Division, Dept. KAP-81, St. Paul 6, Minn.

CHEMICAL DIVISION  
**MINNESOTA MINING AND MANUFACTURING COMPANY**  
...WHERE RESEARCH IS THE KEY TO TOMORROW

CIRCLE 142 ON READER-SERVICE CARD





## **LINDE** High-Purity **RARE GASES** & High-Accuracy **MIXTURES**

*keep pace with the expanding  
needs of electronic progress*

LINDE special mixtures of monoatomic and diatomic gases—with purity as high as 99.9975 per cent—serve as fills in many electronic devices. These include thyratrons, Geiger-Muller, and high-voltage regulator tubes; x-ray fluorescence analyzers, high-voltage insulation, incandescent and special-type lamps and many other uses.

Optimum *purity* is the keystone of all LINDE produced gases—optimum *accuracy* the keystone of LINDE gas mixtures.

Whatever your rare gas mixture requirements, LINDE'S huge productive capacity can supply them—and LINDE'S widespread distribution system is ready to make fast delivery throughout the country.

For complete data on rare gases or combinations, write for a copy of F-1002C, "Linde High Purity Gases." Address Dept. ED081, Linde Company, Division of Union Carbide Corporation, 270 Park Avenue, New York 17, N. Y. *In Canada:* Linde Company, Division of Union Carbide Canada Limited, Toronto 7.

**LINDE  
COMPANY**

**UNION  
CARBIDE**

LINDE and UNION CARBIDE are  
registered trade marks

CIRCLE 143 ON READER-SERVICE CARD

## NEW PRODUCTS

### Potentiometer

507



Up to 13 preset taps are available on the model 200-CEUS precision potentiometer, allowing it to be tapped and phased in the field. Nonlinear functions can be produced from stock potentiometers, or nonlinear units can be wound to any specified function. Up to 15 units can be stacked without decentering.

George Rattray and Co., Dept. ED, Hicksville, N. Y.

*Availability: From stock.*

### Potentiometer

683



Encapsulated, molded-composition potentiometer model R1 is rated at 3 w standard and 2 w military (MIL-R-94B). Resistance range is 100 ohms to 5 meg, with 10% tolerance. Maximum operating temperature is 125 C, life is 100,000 rotations under full load. Size is 1-1/2 x 1-1/2 in.

Reon Resistor Corp., Dept. ED, 155 Saw Mill River Road, Yonkers, N. Y.

*P&A: \$2 to \$10; 4 to 8 weeks.*

### Chopper

446



Transistorized chopper, model 20, switches or chops voltages up to  $\pm 10$  v, and can be driven from dc to 100 kc. Output noise is about 20  $\mu$ v rms, and does not increase with age. Device is housed in a transistor case and plugs into a standard 5-pin socket or can be soldered into a circuit. Unit is suitable for military, missile, and portable applications.

Solid State Electronics Co., Dept. ED, 15321 Rayen St., Sepulveda, Calif.

*P&A: \$39.00; from stock.*



**EYES**  
THAT NEVER SLEEP



## NEW! CETRON

LEAD SULFIDE

## PHOTO CELLS

WITH INFRA-RED SENSITIVITY

### FOR USE IN:

- Electronic Computers
- Sound Projectors
- Temperature Measurement
- Infra-Red Communications
- Missile Guidance Systems
- Fire Detection
- Computing Solar Temperatures

These new developments in the semiconductor field are especially sensitive to infra-red radiation. Cetron's careful production control insures reliable performance characteristics in all of your photo cell requirements.

*Cetron engineers are always available to help in your tube requirements—just write, wire or phone.*

YOUR DEPENDABLE SOURCE FOR  
RECTIFIER, THYRATRON AND PHOTO TUBES

**CETRON**  
ELECTRONIC  
CORPORATION



715 Hamilton Street • Geneva, Illinois  
CIRCLE 144 ON READER-SERVICE CARD

ELECTRONIC DESIGN • August 2, 1961



## Time Delay 698

Range is 1/2 to 90 sec. Having instantaneous reset, this time delay can be used in teletype circuits, heli-arc welding and process control. It can also be used for time delay between operation of an initiating relay or switch and the opening or closing of up to three circuits.

Pioneer Electric & Research Corp., Dept. ED, 743 Circle Ave., Forest Park, Ill.

## Accelerometer 415



Three-axis linear accelerometer, type LA39-0301-1, has a range from  $\pm 2$  to  $\pm 200$  g. Accuracy is 1%. Device, suitable for missiles, measures 2-1/2 in. in diameter and 2 in. high, and weighs 10 oz.

Humphrey, Inc., Dept. ED, 2805 Canon St., San Diego 6, Calif.

## Low-Temperature Chamber 630

Capacity is 250 cu ft for model 6SR-110-250-R recessed chamber, measuring 120 x 60 x 60 in. Designed for metallurgical processing of ferrous and nonferrous aircraft materials at  $-110$  F, it chills 1/2 ton of steel from ambient in 2 hr. Two 16-in. fans are flush-mounted in the backwall.

Cincinnati Sub Zero Products, Dept. ED, 3932 Reading Road, Cincinnati 29, Ohio.

## Transistor Clip 700

For TO-23 cases. Type 100-320 cadmium-plated beryllium copper clip designed for holding the 2N535B, 2N799 and other transistors, has two annealed tabs for insertion in printed-circuit boards. Tab lengths are 1/32 to 1/4 in. It is slotted to provide cooling area and to prevent shock and vibration.

Atlee Corp., Atlas Div., Dept. ED, 47 Prospect St., Woburn, Mass.

P&A: \$0.27 to \$0.33; from stock.

# THE BIG LOOK

in  
small  
panel  
meters



## designed for style

Distinctively styled for the 60's, General Electric BIG LOOK panel meters offer you modern *appearance*, excellent *readability*, and improved *reliability* . . . for all your products and equipment. Complete line includes 2 1/2, 3 1/2, and 4 1/2-inch AC, DC and rectifier designs . . . all 2% accuracy class (rectifier types, 3%). Self-shielded DC mechanism eliminates interaction, ends special calibration, minimizes effect of stray magnetic fields. Sealed cases on 2 1/2 and 3 1/2-inch meters protect internal mechanism in corrosive atmospheres . . . 4 1/2-inch design features snap-on, snap-off cover. Priced right, BIG LOOK panel meters are available from stock for on-time delivery. Like to know more? Contact your nearest G-E Sales Office or Distributor. For informative bulletin GEA-7034, write to Sect. 597-13, General Electric Co., Schenectady 5, N. Y. In Canada, contact Canadian G.E. Co., Ltd., 940 Lansdowne Ave., Toronto 4, Ontario.

AT THE WESCON SHOW, discuss BIG LOOK applications with General Electric engineers in Booths 703 & 705, The Cow Palace, San Francisco, California, August 22-25.

INSTRUMENT DEPARTMENT

GENERAL  ELECTRIC



# TRANSISTOR HEAT SINKS

FOR TO-5, TO-9 AND TO-18 CASES!

Stud-mounted types for TO-5 and TO-9 packages. 1101A — insulated 1101 — uninsulated

- approaching 25°C case temperature ratings!
- positive contact — not a friction fit!
- electrical insulation for "hot" cans!



Stud-mounted types for TO-18 package 1107—insulated 1106—uninsulated



Finned types for TO-5 and TO-9 printed board applications 2209—insulated 2208—uninsulated



for Complete Details Send for Technical Bulletin No. 6100-A ▶

**Thermolloy Company**

2130 IRVING BOULEVARD  
BOX 4341 • DALLAS 8, TEXAS

CIRCLE 146 ON READER-SERVICE CARD



"We'll Call it 'Electronic Highway'."

(ELECTRONIC DESIGNERS' CATALOG has 100% coverage among design engineers located along this route.)

## NEW PRODUCTS

### Digital Tape System

508



Portable digital magnetic tape recorder and playback system has direct decimal data entry, all-solid-state electronics, and playback compatible with all data-processing systems. Model R-1 recorder, designed for remote data recording, and model P-1 playback comprise the system. Recorder measures 8-3/16 x 4-7/16 x 3-5/8 in.

Infotronics Corp., Dept. ED, 1401 S. Post Oak Road, Houston 27, Tex.

### Switching Transistor

463

Epitaxial mesa switching transistor, type 2N835, has a storage time of 16 nsec and an over-all switching time of 47 nsec. Typical collector capacitance is 2.8 pf. Saturation voltage is 0.15 v at 10 ma, and gain bandwidth product is 300 mc min. Junction and storage temperature is 175 C max. Dissipation is 1 w. Device replaces type 2N706.

Motorola Semiconductor Products, Inc., Dept. ED, 5005 E. McDowell Road, Phoenix 8, Ariz. P&A: \$5.10; from distributors.

### Heavy-Duty Switches

442



Snap-acting precision switches for heavy-duty operations have screw terminals, so that wires can be attached to either face of the switch. Designated series 2HL, the switches include plunger-operated, leaf, and lever-actuator types for operation at 2 hp, 250 v ac; 1 hp, 125 v ac; 20 amp, 125, 250, or 480 v ac; and inrush current of 75 amp, 480 v ac.

Unimax Switch, Dept. ED, Ives Road, Wallingford, Conn.

## Germanium Transistors

444

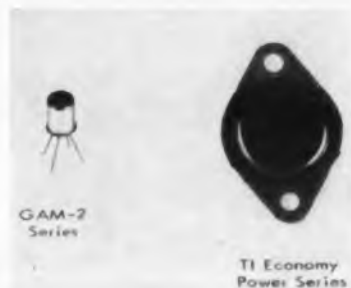

Consumer germanium transistors are available in three series. Series GAM-1, made for radio receivers, have a current gain of 32 to 40 db at 455 kc and an output impedance greater than 1 meg. Series GAM-2, for fm applications, have a high-frequency response of 120 mc and collector-base time constant less than 20 psec. Power transistors for audio applications have breakdown voltages of 30, 45, or 60 v, dissipation of 25 w, and beta from 30 to 150 at 0.5 or 1 amp collector current.

Texas Instruments Inc., Dept. ED, P. O. Box 5012, Dallas 22, Tex.

## Transmission Line

462

Broadband coaxial cable, Spri-O-foam, is foam-polyethylene insulated, aluminum-sheathed, semi-flexible transmission line. Lengths up to 1,000 ft are available. Connectors are electrically matched to the cable.

Prodelin, Inc., Dept. ED, 307 Bergen Ave., Kearny, N. J.

Availability: Immediate.

## Stroboscopes

447



High-intensity stroboscopes offer up to 4,000 flashes per min. Series 161 are triggered flash units with push-to-see switch, for permanent or semi-permanent inspection installations. Series 163 are general purpose units for motion study, having a built-in oscillator and triggered flash. Series 165 has a precision frequency meter and is suited for tachometer measurements. Both series 163 and 165 have synchronizing, triggered flash, and output pulse circuitry.

Slaughter Co., Dept. ED, Piqua, Ohio.

Price: \$119.50, \$147.50, and \$245.00.



# Immediate Minuteman and Dyna-Soar openings for Electronic and Electrical Engineers

Electronics is one of the fastest growing areas of engineering at Boeing. Electronic and electrical engineers interested in the advancement of space-age technologies will find challenging and deeply rewarding opportunities in advanced Boeing programs, including the Dyna-Soar manned space glider and the solid-fuel Minuteman ICBM. Assignments exist in your particular area of interest and at the level you require for career satisfaction and advancement. For your convenience, a professional application form appears at the right, and continues on the following page.



RETURN TO: MR. W. B. EVANS  
THE BOEING COMPANY  
P. O. BOX 3707-ESG  
SEATTLE 24, WASHINGTON

## PROFESSIONAL POSITION APPLICATION (All replies held in strict confidence)

Date of this Application \_\_\_\_\_

Name \_\_\_\_\_  
LAST FIRST MIDDLE (USE NO INITIALS)

Social Security No. \_\_\_\_\_

Present Address \_\_\_\_\_  
NO. STREET

CITY ZONE STATE

Telephone No. \_\_\_\_\_

Ht. \_\_\_\_\_ Wt. \_\_\_\_\_ Age \_\_\_\_\_ U.S. Citizen \_\_\_\_\_

Male \_\_\_\_\_ Female \_\_\_\_\_ Marital Status \_\_\_\_\_

No. of Children \_\_\_\_\_ Other Dependents \_\_\_\_\_

U.S. Veteran \_\_\_\_\_ Entry Date \_\_\_\_\_

Discharge Date \_\_\_\_\_

Type of Discharge \_\_\_\_\_

Spouse's Maiden Name \_\_\_\_\_

Employer \_\_\_\_\_

Previous Boeing Employee? \_\_\_\_\_

If the answer to following three questions is "yes," explain on supplementary sheet:

1) Have you any physical defects? \_\_\_\_\_

2) Have you ever been arrested (except traffic and juvenile)? \_\_\_\_\_

3) Have you ever received disability or accident compensation? \_\_\_\_\_

TURN PAGE →

## HIGHER EDUCATION

College and Location	Dates Attended	Degree and Major
1.		
2.		

## EMPLOYMENT HISTORY (Attach Resume)

Firm Name and Address	Base Pay \$0 hr/Wk	Dates Employed Month/Year
1. _____ Position & Duties _____		
2. _____ Position & Duties _____		
3. _____ Position & Duties _____		
4. _____ Position & Duties _____		

REFERENCES. Give full names, occupations and addresses. Professional (previous supervisor preferred):

- \_\_\_\_\_
- \_\_\_\_\_

Character (other than relatives or former employers):

- \_\_\_\_\_
- \_\_\_\_\_

LIST TYPE OF WORK PREFERRED UPON EMPLOYMENT:

---



---

Have you ever been cleared for classified military information? \_\_\_\_\_. If yes, give date, level and company.

May we contact your former and present employer prior to completion of employment negotiations? Yes \_\_\_\_ No \_\_\_\_

If "yes," I authorize, without liability, the release of all employment and personal information.

SIGN YOUR NAME HERE

All qualified applicants will receive consideration for employment without regard to race, creed, color or national origin.

RETURN TO: MR. W. B. EVANS  
THE BOEING COMPANY  
P. O. BOX 3707-ESG  
SEATTLE 24, WASHINGTON

Form  
begins  
on  
previous  
page



Boeing-developed command control console in Minuteman Subsystem Test Laboratory, Boeing Developmental Center.

Electronic and electrical engineers will find unique opportunities at Boeing. Activities in research, design and test are making significant contributions to the state-of-the-art as well as to the development, manufacture and installation of systems associated with Dyna-Soar, Minuteman, Bomarc, advanced aircraft, and orbital vehicle programs.

Assignments encompass broad areas of electronics activities including surveillance, communications, guidance and control, systems engineering, systems integration, antennas, cabling, circuit design, electromagnetic warfare, electronic packaging, electronics ground support, instrumentation, radio frequency interference control, reliability, systems test, solid state circuit design and many others.

Exceptional opportunities exist for logical designers and for specialists in systems design; in data processing associated with telemetry, and in digital design techniques embracing circuit and systems design, miniaturization, test and evaluation of airborne computers and supporting ground electronics.

You'll find space in the application at the left to indicate your special interests. Fill in and mail today.

\* \* \*



Sailing on 23-mile Lake Washington in Seattle.

Matching the career advantages at Boeing are the family living advantages of the Pacific Northwest. This uncongested, evergreen area is famous for mild, year-round climate, unexcelled recreational facilities, fine modern homes, excellent educational and cultural institutions and healthful outdoor Western living for the entire family.

**BOEING**

CIRCLE 916 ON CAREER INQUIRY FORM, PAGE 217

## NEW PRODUCTS

### Tank Circuits

506



Frequencies from 165 to 1,000 mc are covered by this series of tank circuits, models LC-371 through LC-375. Units consist of a precision miniature piston capacitor soldered across an air-core coil. Nominal Q is above 230. Resonant frequency of each coil is variable over a range of about 400 mc.

JFD Electronics Corp., Dept. ED, 6101 16th Ave., Brooklyn 4, N. Y.

Availability: Four weeks.

### Compact Terminations

412



Narrow band, ultra-compact terminations, series 2300, are suitable for use in S, C, X and K-type waveguides. They cover any 6% bandwidth with a max vswr of 1.5 and an attenuation of 30 db or greater. They are available in a variety of materials.

Custom Components, Inc., Dept. ED, Caldwell, N. J.

Availability: 30 days.

### Swept Signal Sources

417



A line of 17 swept microwave signal sources has frequency ranges from a low of 0.4 to 1.2 to a high of 63.0 to 75.0 Gc. Models measure 19 x 13 x 7 in. and weigh about 40 lb. Auxiliary microwave levelers are available to maintain power output at a constant level. Single control adjusts sweep width.

Wave Particle, Dept. ED, 150 S. Second St., Richmond, Calif.

Price: From \$2,750 to \$9,000.

## Bi-Directional Couplers

684

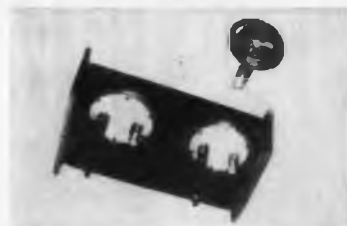

Resistive-loop, bi-directional couplers, model S-61, are intended for power and vswr monitoring. Coupling value is 45 db  $\pm$  0.5 db including frequency sensitivity over a 10% band. Directivity is 30 db min over the band from 1.27 to 1.40 Gc. Main-line vswr is less than 1.05 db while secondary vswr is less than 1.30 max. Coupling ratios are in values from 30 to 45 db.

Amphenol-Borg Electronics Corp., FXR Div., Dept. ED, 25-26 50th St., Woodside 77, N. Y. P&A: \$1,200 approx; 60 to 90 days.

## Cutter Kit

448



Wire and ribbon cutters available in a kit include three hand-honed, hand-filed cutting tools for precision clipping of small wire and ribbon stock, and two tweezers for clip removal, wire bending and straightening. Cutters are guaranteed against failure.

The Sippican Corp., Dept. ED, P. O. Box 537, Marion, Mass. P&A: \$35.00; from stock.

## Rack and Panel Connectors

449



"Do it yourself" connector components press into a 0.136 in. diameter hole in the mounting panel. Probe type PR-400 and jack type SKT-400 comprising the series have Teflon bodies and floating contacts which allow for normal misalignment and rocking motions in connecting and disconnecting. No special tools are needed.

Sealectro Corp., Dept. ED, 610 Fayette Ave., Mamaroneck, N. Y.

## Standard 'Specials' in Shallcross Miniature Switches



PRE-WIRED & HARNESSED SWITCHES — Decks pre-wired before ganging to reduce your production costs and time.



GOLD PLATED CONTACTS & TERMINALS—for the ultimate in maintaining low, stable contact resistance under corrosive conditions.



PRINTED CIRCUIT TERMINALS—available on single-deck or last deck of multi-deck switches.



CLUSTER ARM ROTORS—for progressive shorting or progressive-making circuits.

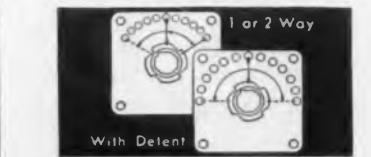

SPRING RETURN ROTORS—on either or both directions of rotor travel.

## Shallcross Manufacturing Co.

Selma, North Carolina

Precision wirewound resistors, switches, instruments, delay lines, resistance networks, audio attenuators.

# Shallcross

precision  
circuit  
news

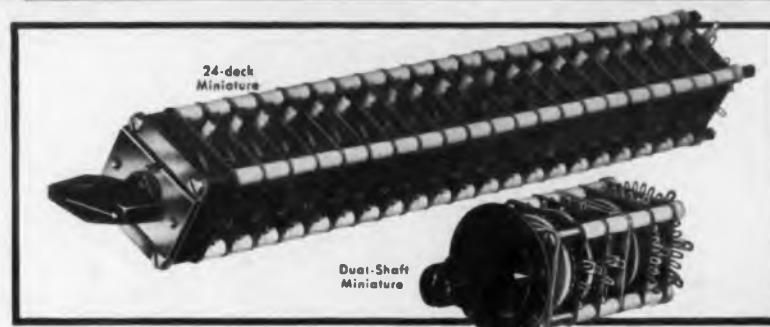

## MAXIMUM CIRCUIT SWITCHING IN MINIMUM SPACE

Here's a positive approach to miniaturization—a way to handle more circuits per cubic inch! Conservatively estimated, over 650 circuits may be switched in only 38 cubic inches by a Shallcross Miniature Series switch... and with the quality and reliability only a button-contact, multi-leaf wiper arm switch can provide. In one recent application, the single 24-deck Shallcross Miniature switch shown above replaced four "subminiature" units.

Equally impressive space advantages are possible with dual concentric shaft versions of the Shallcross Miniature Series. Either shaft may

operate up to five of a total of ten decks. The inner shaft may also control a rheostat, variable capacitor, or other device.

If, in addition to size, switch quality is also your concern, the following highlights substantiate why Shallcross Miniature Switch users repeatedly specify these switches, and no others, for critical airborne, missile control, and computer applications.

**Low initial contact resistance**—less than 0.002 ohm.

**Stable contact resistance**—0.5 milliohm for 10,000 operations.

**Highly immune to vibration damage**—exceeds MIL-S-3786 requirements.

**Uncompromised material quality**—silver button contacts; silver alloy, multi-leaf, self-cleaning wipers; diallyl phthalate rotors; epoxy-laminate decks (filament woven with glass fiber).

**Designed to applicable MIL-S-3786 Specifications.**

**Minimum thermocouple effects**—similar materials for all current-carrying parts.

**Excellent RF characteristics.**

**Minimum depth**—1" first deck, 5/8" each additional deck.

**Maximum Versatility**—up to 32 positions, 1 to 4 poles, shorting or non-shorting in the same switch, 1 to 24 decks, ball detents, many special modifications.

For complete details, write for Shallcross Switch Bulletin

## Solenoid-Operated Switches



For indirect switching of complex circuits, or to avoid "over stepping" positions in critical circuits, most Shallcross Miniature Switches can be furnished with solenoid operation. Outline your circuit requirements for a prompt recommendation by Shallcross engineers.

CIRCLE 149 ON READER-SERVICE CARD

## NEW Midget Rotary Tap Switch

### Grayhill Series 45

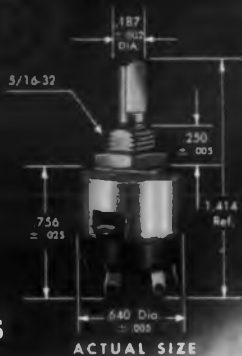

—meets most environmental requirements  
per MIL-E-5272 and MIL-S-3786

**COMPLETELY NEW** — A real midget — genuine Grayhill quality. Conservatively rated to break one ampere at 115 VAC, resistive circuit, and to carry 5 amperes — life expectancy 100,000 cycles. Single deck, single pole, shorting or non-shorting, totally enclosed — provided with 2 to 6 positions (stop standard on 2 to 5 positions) and 6 positions normally supplied as continuous rotation. The Series 45 incorporates 60° indexing with a stop strength of 10 pound inches, and a rotational torque of approximately 12 ounce inches.

Complete specifications and prices available on request.

Switch  
with  
GRAYHILL



"N. Gineer"

Grayhill offers a full line of Rotary Tap Switches, Push Button Switches, Test Clips, Binding Posts, and other miniature electrical and electronic components. Ask for current catalog



**Grayhill**  
INC

Phone: Fleetwood 4-1040  
565 Hillgrove Avenue,  
LaGrange, Illinois

"PIONEERS IN MINIATURIZATION"

CIRCLE 151 ON READER-SERVICE CARD

## NEW PRODUCTS

### Rotary Acceleration Generator 472



From 3 to 500 g are provided by model RA-ATC-500-1 rotary acceleration generator. Spin table is 20 in. in diameter. Variable speeds from 10 to 2,000 rpm  $\pm 0.5\%$  are available. Above 40 rpm, wow is 0.5% and drift is 0.1%.

Pacific Southwest Instrument Laboratories, Dept. ED, 5705 Centinella, Culver City, Calif.  
P&A: \$3,400 fob Culver City; six weeks.

### Coaxial Connectors 416



Aluminum, rf coaxial connectors are available in both TNC and TM types. Features include: heat treated beryllium copper contacts; gold plate over silver plate on all contacts; low vswr and insertion loss.

General RF Fittings, Inc., Dept. ED, 702 Beacon St., Boston 15, Mass.

Availability: Immediate.

### Solenoid Selector Assembly 471



Hermetically sealed, miniaturized solenoid selector assembly meets MIL specs and is protected from sand, dust, salt spray, explosion, humidity, altitude, and fungus. Device has a 12-position rotary switch coupled to a rotary solenoid. Switching circuits, arranged to customer's requirements, can have 28 external connections. Unit measures 3-1/4 in. long and 1-1/2 in. in diameter.

Oak Manufacturing Co., Dept. ED, Crystal Lake, Ill.

## NEW FROM MELPAR

High  
Accuracy,  
Small  
Package  
FREQUENCY  
STANDARDS  
At New

Low  
Cost.

0.01%

0.01%

0.01%

0.01%

### CHECK THESE OUTSTANDING PRODUCT FEATURES:

- High Accuracy ( $\pm 0.01\%$  and better)
- Small Package Size (under 2.9 ounces and 2.8 cubic inches)
- Simultaneous square wave and sine wave output
- Thermal stability without an oven
- Wide Frequency Range
- Resistance to thermal shock, mechanical shock and vibration

Whatever your application . . . . . from missile guidance systems to seismic geophysical probing equipment . . . . . MELPAR'S new precision tuning fork frequency standards feature a unique design concept which combines accuracy and economy. Remarkable frequency accuracy is obtained without an oven:

$\pm 0.01\%$  (0°C/+85°C) to  $\pm 0.05\%$  (-55°C/+85°C) from 400 to 3000 cps.

Both a sine wave and square wave output can be obtained simultaneously from this miniature package. Tuning forks and frequency dividers also are available in the same size case.

Write today for detailed specifications and prices:

SPECIAL PRODUCTS DIVISION  
**MELPAR** INC  
A SUBSIDIARY OF WESTINGHOUSE ELECTRIC COMPANY

3000 ARLINGTON BOULEVARD, FALLS CHURCH, VIRGINIA

CIRCLE 152 ON READER-SERVICE CARD  
ELECTRONIC DESIGN • August 2, 1961



Designed for the commercial frequency ranges in C-band, this line of 24 isolators ranges in length from 2.1 to 4.5 in. All are bilaterally matched with a max vswr of 1.10. Typical mid-band isolation: insertion loss ratios range above 60 to 1.

E & M Laboratories, Dept. ED, 15145 Califa St., Van Nuys, Calif.  
P&A: \$150 ea; immediate.

## Shaker

461

For production testing of miniature components. Type VS-10 shaker is a bench instrument with a frequency range from 20 cps to 27 kc at full thrust, flat from 50 cps to 10 kc, and with useful power up to 100 kc. Force is 5 lb per amp. Shaker is 8 in. high and 6 in. wide, and weighs 45 lb.

Vibrasonics, Inc., Dept. ED, 10 High St., Boston, Mass.

## Marking Ink

459

Permanent epoxy marking ink, series M, adheres to glass, metal, and thermosetting plastic surfaces and resists abrasion, solvents, chemicals, acids, and alkalis. Can be applied by marking machines, stamp pad, or roller printing.

Wornow Process Paint Co., Dept. ED, 1218 Long Beach Ave., Los Angeles 21, Calif.

## Power Connector

685



Rack and panel power connector is designed for convenient mounting. Four No. 16 AWG conductors may be mounted, to carry maximum current of 12 amp. Molded-in positive polarizing guide pins and bushings are provided.

Precision Connectors Inc., Dept. ED, P. O. Box 96, Mineola, L. I., N. Y.

CIRCUIT  
IDEA FILE

New Transistor Applications

## Looking for closer gain-matching?

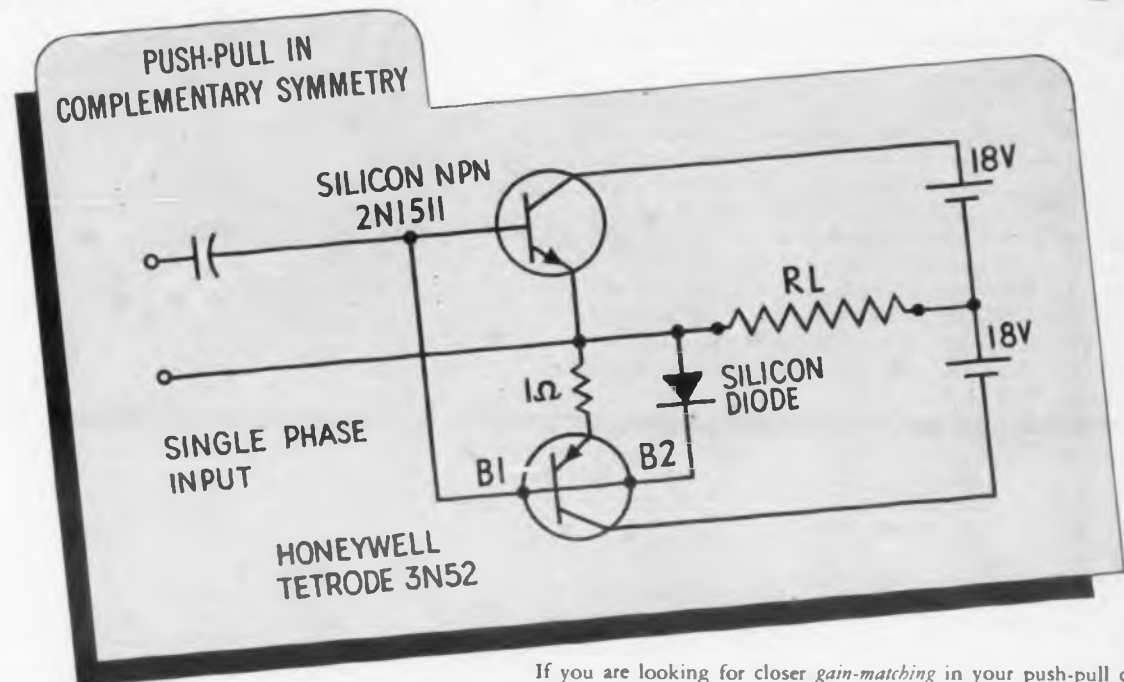

If you are looking for closer gain-matching in your push-pull complementary Symmetry circuits, you will find the answer in these Honeywell Power Tetrodes.

	THE PROBLEM		THE ANSWER
	PNP	NPN	TWO-BASE PNP TETRODE
POWER TRANSISTORS	PNP	NPN	TWO-BASE PNP TETRODE
CURRENT GAIN	HIGH	AVERAGE	AVERAGE*
TRANSCONDUCTANCE	HIGH	AVERAGE	AVERAGE*
LEAKAGE	AVERAGE	LOW	LOW



3N49, 3N50, 3N51, 3N52

Power Tetrodes: single-ended, cold welded package mechanically interchangeable with TO-36 case.

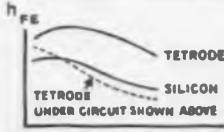

\*Because of its controllable gain feature, the Honeywell Power Tetrode is capable of closely matching the current gain, the transconductance, and the leakage of either silicon or germanium NPN transistors when used in the push-pull complementary Symmetry circuit shown above.

# Honeywell

First in Control  
SINCE 1889

Sales and Service offices in all principal cities of the world.

## MAY WE HELP YOU?

- Please send me your Application Data on Power Tetrodes.
- I have an application problem with Power Transistors. I would welcome the assistance of your field engineer and Applications Lab.

NAME \_\_\_\_\_

ADDRESS \_\_\_\_\_

COMPANY \_\_\_\_\_

CITY \_\_\_\_\_ STATE \_\_\_\_\_

Send coupon to Honeywell, Dept. ED-8-120, Minneapolis 8, Minn.

another  
microwave memo  
from

SPERRY

ELECTRONIC  
TUBE  
DIVISION

## Announcing 30-Day Delivery on U Band, Two-Cavity Oscillators For Parametric Amplifier Pumping

Sperry Electronic Tube Division, Gainesville, Florida, announces an *immediate* solution to the drive source problems which have plagued developers of parametric amplifiers for some time. Now Sperry can deliver a U band, two-cavity klystron oscillator in just 30 days.

Fast delivery is possible because development work is completed on all tubes within the frequency and power output parameters described below. Soundness of the development work is already proved, since tubes of this type have been operating in several systems for some time.

Sperry has developed a whole family of these oscillators. They cover the entire U band, and deliver output powers from 200 mW to 1.5 W.



### APPLICATIONS

All tubes in the new Sperry family operate with a characteristic flat-top mode. This constant relationship between beam voltage and output power makes tubes in the series particularly suited for driving parametric amplifiers, and for use in doppler radars and FM communication systems.

One important benefit of the flat-top mode characteristic is the availability of frequency modulation with very low incidental amplitude modulation. This inherent amplitude stability, together with high power output levels, makes the new oscillator family particularly useful for parametric amplifier applications. The same characteristics contribute to the desirability of these tubes for use in doppler radars and FM communication systems.

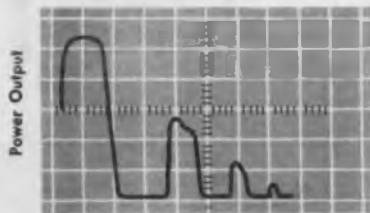

Beam Voltage

Typical mode shapes of two-cavity oscillator.

### RATINGS

Two-cavity oscillators in the Sperry series completely blanket the 12.5 to 18 kMc frequency range covered by the U band. The "family" of

tubes is divided into two branches, one ranging from 12.5 to 15.5 kMc, and the other covering the 15.5 to 18 kMc area.

Output power ranges from 200 mW to 1.5 W in the lower frequency group, and from 200 mW to 1 W at the higher frequencies.

If optimum tuned, rather than flat-top mode operation is desired, power output may be increased 25%.

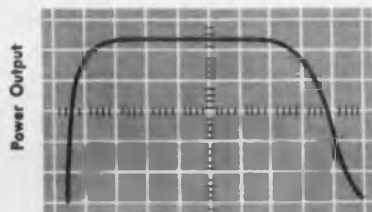

Beam Voltage

A typical main mode, adjusted for optimum flat-top operation.

### INHERENT BENEFITS

Tubes in the new Sperry family enjoy all the inherent benefits of two-cavity klystron design. These

include precision tuning, high stability, amazing ruggedness and unusual stability at high output levels.

The series incorporates two design features which result in significant size and weight savings.

1. Electrostatic focusing, eliminating the heavy focusing magnets required in many designs.

2. A unique fixed-tuned design, in which the cavities are pressed into a configuration which delivers the customer's specified frequency.

All the tubes in this series show efficiencies in the area of 3.4% with the flat-top mode, and all have low levels of vibration-induced AM and FM noise.

### PRICE AND AVAILABILITY

At power output levels from 0.2 to 0.5 watts, tubes in the new Sperry family are priced at \$2,295 each. With output from .5 to 1.5 watts, the price is \$2,795 each. Tubes will be tuned to your specified center frequency, and they will deliver your specified power output level. All oscillators in this U band series will be shipped within thirty days of receipt of order.



WRITE FOR SPERRY'S NEW BROCHURE which describes the new U band oscillator family in greater detail. For the brochure, or for application assistance and quotation, contact:

R. F. Forlaw, Section 501  
Sperry Electronic Tube Division  
Sperry Rand Corporation, Gainesville, Fla.

SPERRY ELECTRONIC TUBE DIVISION  
GAINESVILLE, FLORIDA • GREAT NECK, N. Y.

SPERRY

ELECTRONIC  
TUBE  
DIVISION

## NEW PRODUCTS

### Printed-Circuit Connector

371



For 1/16-in. boards. Series 062 printed circuit connector is available with 6, 10, 15, 18, 22, 28, 30 and 43 single or dual-row contacts with eyelet, dip solder or other terminations. Contacts are self-aligning to residual warping along the length of the board.

Precision Connectors Inc., Dept. ED, P. O. Box 96, Mineola, L. I., N. Y.

Availability: immediate.

### Digital Data Recorder

467



With 50 or 100 channels. Digital data recorder LP 981A commutates, digitizes and prints voltage outputs from 50 or 100 channels at a 2-per-sec rate with accuracy of 0.1%. Analog signals of either polarity can be converted into digital form for driving the printer. A four-digit voltmeter visually presents the output of each channel.

Solartron, Inc., Dept. ED, 1743 S. Zeyn St., Anaheim, Calif.

### Automation Device

443



Assembly-line operations can be carried out by the TransfeRobot 200 which operates under the command of its own electronic brain. Device consists of an arm and actuator which can be fitted with various types of fingers and jaws. Machine is said to perform operations normally done by custom-built machines.

U. S. Industries, Inc., Dept. ED, 250 Park Ave., New York 17, N. Y.

Price: \$2,500.

ELECTRONIC DESIGN • August 2, 1961



# M I C R O W A V E S



FOR CW ILLUMINATORS  
AND NAVIGATION

# LOW NOISE OSCILLATORS

1 WATT TO 50 WATTS

Varian Associates' family of low-noise oscillator klystrons assures superior performance in such applications as CW illuminators, fixed-frequency doppler navigation transmitters, and similar uses.

All tubes in this low-noise family are two-cavity klystron oscillators. All are fixed-frequency. All are electrostatically focused. They cover a wide power range (from 1 W to 50 W). Tubes in K<sub>u</sub>-band include the air-cooled VA-503B and the liquid-cooled VA-504B. Tubes in X-band include the air-cooled VA-514 and VA-508 and the liquid-cooled VA-511. All are available now.

Characteristics of the VA-511 are typical of the oscillators in this group. The VA-511 produces 50W minimum power at 10 kMc, and operates at 10 kV, 60 milliamperes. FM noise is less than 1 cycle. Weight, less than 24 oz.; size: 6¼ in. x 2¼ in. x 1¾ in.

For additional technical information on this fine family of klystron oscillators, address Tube Division.

SCALE: 2/3 ACTUAL SIZE



VA-503B  
1 W min.  
13.5 kMc

VA-504B  
15 W min.  
13.3 kMc

VA-508  
1 W min.  
8.8 kMc

VA-514  
2 W min.  
10.0 kMc

VA-511  
50 W min.  
10.0 kMc

**AVAILABLE NOW!**



**VARIAN associates**

PALO ALTO 21, CALIFORNIA

*Subsidiaries:*

BOMAC LABORATORIES, INC.  
VARIAN ASSOCIATES OF CANADA, LTD.  
S-F-D LABORATORIES, INC.  
SEMICON ASSOCIATES, INC.  
SEMICON OF CALIFORNIA, INC.  
VARIAN A. G. (SWITZERLAND)



MICROWAVES

## That Extra Something

Renewed interest in the G-line, described in the article on the facing page, is merely one aspect of increasing research into new microwave transmission media—particularly for millimeter waves. In recent weeks there have been reports of new work in beam waveguides, dielectric waveguides, plastic waveguides, Fresnel zone plates and ultra-thin coaxial cables.

One can foresee an increasing number of alternatives to waveguides and coax cables in their present form. While these new techniques may not challenge the dominance of coax cables and rectangular metallic guides, the designer will in time have recourse to that extra something in meeting those especially difficult performance specs.

*New interest in a long-known but little applied microwave transmission medium is reported in*

### New Applications Being Developed for Surface-Wave Transmission Lines ..... p 155

*Magnetic radar modulators are being increasingly applied in radar systems because of their inherently superior reliability. A step-by-step procedure for design of these modulators is presented in*

### Practical Design of Magnetic Radar Modulators ..... p 160

*Straight talk on Doppler modulators by two designers well-qualified to speak on*

### Doppler Modulation Systems—The Pros and Cons ..... p 166

*The featured microwave product this issue is a*

### Microwave Power Meter Accurate Within ±0.5% ..... p 170

*The newest in direct-reading frequency meters, backward wave oscillators and spectrum analyzers is described in*

### Microwave Products ..... p 172

## New Applications Being Developed For Surface-Wave Transmission Lines

**Manfred Meisels**  
Technical Editor

**P**OTENTIAL competition to coaxial cables, waveguides and relay links for broad-band and high-power microwave communications is being posed by renewed design interest in surface wave transmission lines.

Advantages claimed for the so-called G-line (named after its inventor, Dr. Georg Goubau of the Army Signal Corps R&D Laboratory) include:

- Low propagation loss.
- Broad-band transmission characteristics.
- High power-handling capability.
- Convenient tap-off anywhere along the line without physical contact.
- Reduced weight.
- Lower cost.

Since its invention some 10 years ago, the G-line has been occasionally, but increasingly applied in antenna lines and in feeder lines for community antenna television systems. Until recently, the greater commercial and technical interest in G-lines has been evidenced overseas.

Of late, however, American advocates of the G-line have been stressing its advantages in railway and industrial applications and in long-haul microwave communications over existing pole lines. Simple probes can cou-

ple energy into and out of the G-line without physical interruption; and the line can be strung along existing pole routes.

The New York Central Railroad has recently completed extensive tests of a 4.5-mile G-line erected along its tracks. Television and vhf communications were successfully transmitted along the entire length of the line as well as to and from a specially equipped cart moving on the rails. Remote control of trains via television has been considered with a G-line system.

"Results of our test line have been extremely promising and we would like to conduct more conclusive tests over a 150-mile length of G-line," Robert C. Karv-watt, the Central's director of communications told *ELECTRONIC DESIGN*. "Other railroads, especially those not already committed to microwave relays are also interested, but are waiting to see what luck we're having with the G-line," he added.

The Central's line is suspended from the poles by nylon strings—the generally accepted method of supporting G-line, though rigid plastic rods have also been used. No repeaters are required as propagation losses at uhf frequencies average only 10 db per mile. The line itself consists of polyethylene-coated No. 6 wire terminated at each end by launching horns. Installation cost averaged



**Surface-wave antenna line** on German television transmitter. The G-line is supported within the metal rings by nylon cords. Note the parallel coupling method used (lower half of photo) between two G-lines in close proximity. Such applications, while popular abroad, have lagged in this country despite major cost savings claimed for the G-line. Renewed interest in uhf television may, however, provide new impetus for G-line use here.



Nonradiating surface waves in conducting wire are excited by the finite resistivity of the wire. This causes a reduction in the phase velocity of the field as compared to the free-space velocity. By coating the wire with a suitable dielectric, phase velocity is further reduced and the surface wave is propagated with greater efficiency.

The G-line can also be derived from a coaxial cable in which the diameter of the outer conductor is gradually increased. Ultimately, the conductor becomes so large that its effect on the field is negligible and the coaxial wave is thus gradually transformed into a surface wave.

This is in fact achieved by the launching horn and tapered wire that terminate the G-line.

The surface wave extends only a few wave lengths from the line. Within this region, however, signals can be coupled into and out of the wave by radial or parallel-wire probes.

Cross-talk among several parallel G-lines could occur if they are not separated by several wavelengths. It can be minimized, however, by using a different thickness of dielectric for each line so that each surface wave has a different velocity. There is little or no cross-talk between signals propagating in opposite directions.

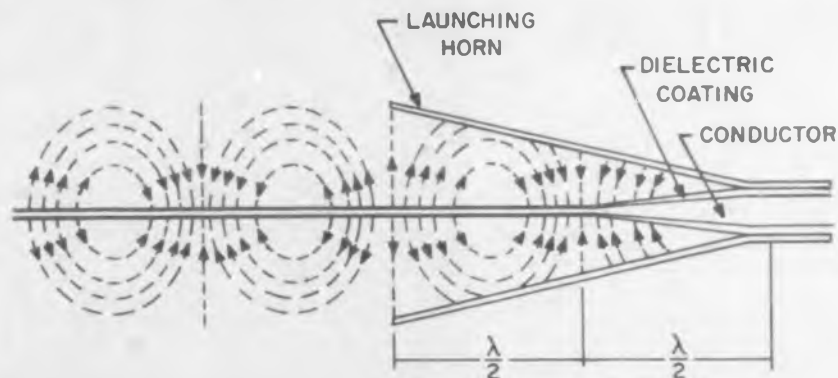

**Termination and wave propagation** of G-line. Note the taper of wire and insulation at the narrow end of the horn. This structure converts the coaxial wave to a surface wave. Radiation extends a few wavelengths from the line.

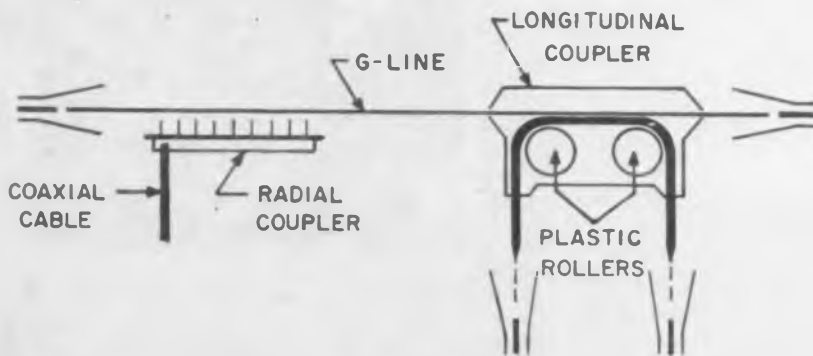

**Coupling methods** for the G-line. Radial coupler at left is suitable for communication to moving vehicles such as trains and mobile TV cameras. Longitudinal coupler at right, developed in Russia, is for fixed applications. The several types of longitudinal couplers that have been designed are considerably more efficient than the radial couplers.

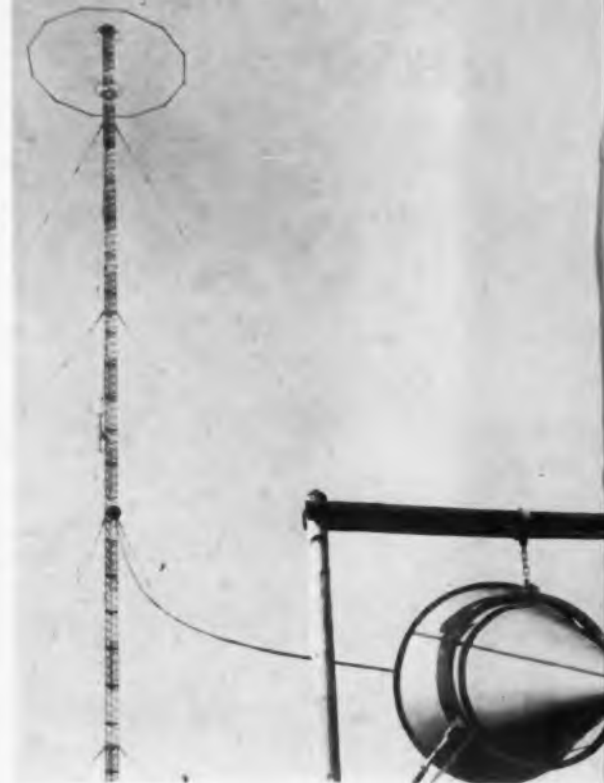

**G-line system** for 10-kw, 500-mc television station in Munich. The line runs from launching horn at lower right to receiving horn near middle of the tower.

approximately \$750 per mile.

In industry, G-lines are being proposed in lieu of coaxial cables and open lines for mobile, closed-circuit television. Steel mills and atomic installations are considering use of G-line in such systems. A security fence, where the presence of intruders would disturb wave propagation along the surface of the line, has also been proposed.

Long-haul communications via G-line are presently limited to a few community antenna TV systems here and abroad and to an experimental telephone circuit in Paris installed by Lignes Telegraphiques et Telephoniques.

In this country, a 14-mile G-line provides community TV for Helena, Mont. The line, which has been operating reliably for almost five years employs eight intermediate repeaters. These were not, however, specifically designed for use with the G-line, and a lesser number of more efficient units would be adequate. Other G-lines for community TV and broadcasting have been installed at Muscle Shoals, Ala., France, England, Ger-

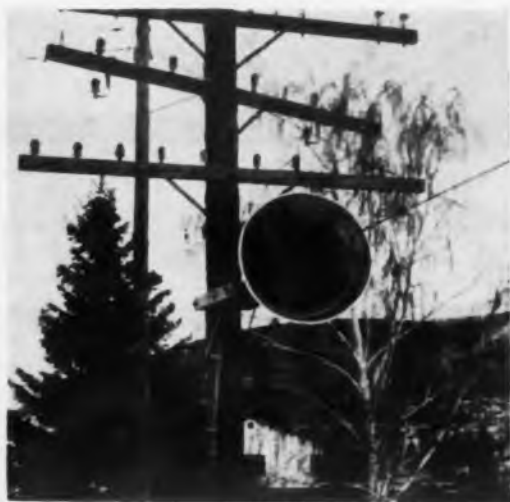

Launching horn at repeater along the community TV feeder system for Helena, Mont. The 14-mile-long G-line was strung on existing poles at a total cost of \$890 per mile.

many, Austria and Japan. Costs are said to be a fraction of those for coaxial or microwave relays.

An apparent disadvantage of G-line for long-haul systems is that it cannot be buried but must be strung on poles.

"In this age of satellites, I suppose that telephone poles seem primitive, but it is unfortunate that this psychological barrier prevents designers from realizing the broadband, low loss and low cost advantages of G-line," declares Theodore Hafner, president of Surface Conduction, Inc., N. Y., licensors of the G-line. Dr. Hafner has proposed a world-wide "information thruway" of lines across the U.S., Latin America, and Eurasia, connected by a microwave link across the Bering Strait.

Dr. Hafner believes that such a system would be more reliable than communications satellites and do the job at a fraction of their cost. "For underdeveloped nations, the low cost and installation ease of G-line makes it an ideal transmission medium," Dr. Hafner added. He also noted that surface wave trans-

## New multi-purpose BROADBAND FERRITE AM MODULATOR

**First to cover the entire X-band,  
8.2 to 12.4 Gc**

FXR's new X158A broadband ferrite modulator is the first absorption amplitude modulator to provide full coverage of X-band, 8.2 to 12.4 Gc. A primary use of this unit is to provide a clean AM microwave signal for high accuracy measurements. Previously any attempt to modulate a microwave oscillator left much to be desired because of error-producing FM, jitter and double moding.

The modulator coil of the X158A has been designed so that any standard, 1 watt, commercial audio oscillator will provide substantially 100% modulation at 1,000 cps.

### APPLICATIONS

#### Microwave Measurements

As an amplitude modulator for high accuracy microwave measurements

#### Microwave Transmitter Modulation

With proper biasing of the control solenoid low distortion modulation is obtained over the audio range

#### Fast Microwave Switching

For front panel or remote switching of signal generators and other low power units

#### Electrically Controlled Microwave Attenuation

For electrically controlled microwave attenuation of system energy from either remote or local positions

DELIVERY FROM STOCK



MODEL X158A  
Price: \$250.00

- Covers entire X-band, 8.2 to 12.4 Gc
- Metallized plastic construction for high frequency audio response
- Low driving power required
- 30 db minimum dynamic attenuation
- Low insertion loss—with no coil current

### ATTENUATION- SOLENOID CURRENT

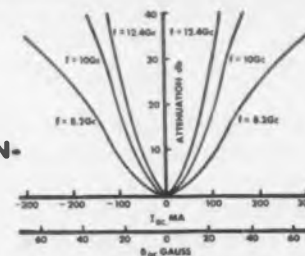

### SPECIFICATIONS FOR MODEL X158A FERRITE MODULATOR

Freq. range: 8.2 to 12.4 Gc

Max. insert loss: 1.0 db

Min. dynamic attenuation: 30 db

Max. input and output VSWR: 1.20

Max. average RF input power: 2 watts

Coil characteristics: 35 millihenries  
55 ohms @ 1 kc

Max. solenoid current: 300 ma DC

Insertion length: 4 7/8"

Cover flanges to mate with: UG-39/U

Waveguide type: WR90

FXR OFFICES IN NEW YORK • BOSTON • LOS ANGELES  
REPRESENTATIVES IN ALL MAJOR CITIES THROUGHOUT THE WORLD.



**FXR** a division of

Amphenol-Borg Electronics Corporation  
25-26 50th STREET RA 1-9000  
WOODSIDE 77, N. Y. TWX: NY 43745

SEE US AT OUR WESCON SHOW BOOTHS 220, 222

West Coast Office: 4134 Del Rey Ave., Venice, California  
EXmont 1-7141-2, TWX: SMON 7725

Branch: 701 Welch Rd., Palo Alto, Calif.  
DAvenport 6-9026

PRECISION MICROWAVE EQUIPMENT • HIGH-POWER PULSE MODULATORS • HIGH-VOLTAGE POWER SUPPLIES • ELECTRONIC TEST EQUIPMENT  
CIRCLE 156 ON READER-SERVICE CARD



mission lines are being developed by Russia and Communist China.

Because the G-line propagates information via closed surface waves, it provides an essentially radiationless "private atmosphere" for broad-band transmission not regulated by the FCC. This, together with acceptably low loss over a wide part of the spectrum, has stimulated interest in the line for high-density microwave communications. With a 500-mc carrier, up to 250 mc of band-width would be available, it is claimed.

Somewhat wider acceptance of the G-line has occurred in antenna line applications. The Signal Corps has specified G-lines for its TRC-29 and AN/GRC-59 radio relay equipment. The first operates in the 2-Gc range, while latter covers 4.4 to 5.0 Gc. The line for the AN/GRC-59 has a loss of 3 db per 100 ft in contrast to 14 db for coaxial cable, according to the Signal Corps.

The G-line is also smaller and more flexible than coaxial cable and can thus be easily reeled. It consists of 37 strands of No. 36 silver-plated, copper-clad steel and is Teflon-coated.

Above 5 Gc rain and ice accumulating on the line tends to affect performance since water droplets act as radiating dipoles. Losses of up to 15 db per 100 ft have been recorded under these conditions. However, Signal Corps engineers have designed a mechanical hammer that vibrates the line sufficiently to dislodge the droplets. In addition, a de-icing current equivalent to 3 w per ft is applied to the cable.

The G-line has also been used overseas in several vhf and uhf television transmitters, notably in a 10-kw system erected in Germany by Rohde & Schwartz. Considerable economy over coaxial lines is claimed and Surface Conduction, Inc., is preparing several bids for forthcoming vhf and uhf transmitters in this country. Dr. Hafner believes that the higher powers required in uhf television will increase the attractiveness of G-line to designers. Plans are also under way to market a complete uhf lead-in system for home and amateur use. This would consist of the line itself and launching and receiving horns.

Surface wave transmission lines may also prove useful in millimeter-wave work. Experiments in the 100- to 300-Gc range by

# ULTRAMICROWAVE®



Size Designation Frequency Band in mc Waveguide Nomenclature	DBW 90-140 RG-138/U	DBA 60-90 RG-99/U	DBB 50-75 RG-98/U	DBC 30-60 RG-97/U	DBD 26.5-40 RG-96/U	DBE 18-25 RG-93/U	DBF 12-18 RG-91/U	DBG 8-12.4 RG-82/U	DBH 7.05-10 RG-51/U	DBI 5.85-8.2 RG-49/U	DBJ 3.95-5.85 RG-48/U	DBK 2.6-3.95 RG-48/U
	Cat No.	Price	Cat No.	Price	Cat No.	Price	Cat No.	Price	Cat No.	Price	Cat No.	Price
<b>Tube Mounts</b>												
Klystron Tube Mount					DBC-140 T	\$2.15	DBD-140 T	\$2.25	DBE-111	\$4.2	DBF-140 T	\$2.85
Nose Tube Mount with Tube									DBC-111 T	\$2.15	DBH-140 T	\$2.15
									DBI-140 T	\$2.15	DBJ-140 T	\$2.15
									DBK-140 T	\$2.15	DBL-140 T	\$2.15
									DBM-140 T	\$2.15	DBN-140 T	\$2.15
									DBO-140 T	\$2.15	DBP-140 T	\$2.15
									DBQ-140 T	\$2.15	DBR-140 T	\$2.15
									DBS-140 T	\$2.15	DBT-140 T	\$2.15
									DBU-140 T	\$2.15	DBV-140 T	\$2.15
									DBW-140 T	\$2.15	DBX-140 T	\$2.15
									DBY-140 T	\$2.15	DBZ-140 T	\$2.15
									DBAA-140 T	\$2.15	DBAB-140 T	\$2.15
									DBAC-140 T	\$2.15	DBAD-140 T	\$2.15
									DBAE-140 T	\$2.15	DBAF-140 T	\$2.15
									DBAG-140 T	\$2.15	DBAH-140 T	\$2.15
									DBAI-140 T	\$2.15	DBAJ-140 T	\$2.15
									DBAK-140 T	\$2.15	DBAL-140 T	\$2.15
									DBAM-140 T	\$2.15	DBAN-140 T	\$2.15
									DBAO-140 T	\$2.15	DBAP-140 T	\$2.15
									DBAQ-140 T	\$2.15	DBAR-140 T	\$2.15
									DBAS-140 T	\$2.15	DBAT-140 T	\$2.15
									DBAU-140 T	\$2.15	DBAV-140 T	\$2.15
									DBAW-140 T	\$2.15	DBAX-140 T	\$2.15
									DBAY-140 T	\$2.15	DBAZ-140 T	\$2.15
									DBBA-140 T	\$2.15	DBBB-140 T	\$2.15
									DBBC-140 T	\$2.15	DBBD-140 T	\$2.15
									DBBE-140 T	\$2.15	DBBF-140 T	\$2.15
									DBBG-140 T	\$2.15	DBBH-140 T	\$2.15
									DBBI-140 T	\$2.15	DBBJ-140 T	\$2.15
									DBBK-140 T	\$2.15	DBBL-140 T	\$2.15
									DBBM-140 T	\$2.15	DBBN-140 T	\$2.15
									DBBO-140 T	\$2.15	DBBP-140 T	\$2.15
									DBBQ-140 T	\$2.15	DBBR-140 T	\$2.15
									DBBS-140 T	\$2.15	DBBT-140 T	\$2.15
									DBBU-140 T	\$2.15	DBBV-140 T	\$2.15
									DBBW-140 T	\$2.15	DBBX-140 T	\$2.15
									DBBY-140 T	\$2.15	DBBZ-140 T	\$2.15
									DBCA-140 T	\$2.15	DBCB-140 T	\$2.15
									DBCC-140 T	\$2.15	DBCD-140 T	\$2.15
									DBCE-140 T	\$2.15	DBCF-140 T	\$2.15
									DBCG-140 T	\$2.15	DBCH-140 T	\$2.15
									DBCI-140 T	\$2.15	DBCJ-140 T	\$2.15
									DBCK-140 T	\$2.15	DBCL-140 T	\$2.15
									DBCM-140 T	\$2.15	DBCN-140 T	\$2.15
									DBCO-140 T	\$2.15	DBCP-140 T	\$2.15
									DBCQ-140 T	\$2.15	DBCR-140 T	\$2.15
									DBCS-140 T	\$2.15	DBCT-140 T	\$2.15
									DBCU-140 T	\$2.15	DBCV-140 T	\$2.15
									DBCW-140 T	\$2.15	DBCX-140 T	\$2.15
									DBCY-140 T	\$2.15	DBCZ-140 T	\$2.15
									DBDA-140 T	\$2.15	DBDB-140 T	\$2.15
									DBDC-140 T	\$2.15	DBDD-140 T	\$2.15
									DBDE-140 T	\$2.15	DBDF-140 T	\$2.15
									DBDG-140 T	\$2.15	DBDH-140 T	\$2.15
									DBDI-140 T	\$2.15	DBDJ-140 T	\$2.15
									DBDK-140 T	\$2.15	DBDL-140 T	\$2.15
									DBDM-140 T	\$2.15	DBDN-140 T	\$2.15
									DBDO-140 T	\$2.15	DBDP-140 T	\$2.15
									DBDQ-140 T	\$2.15	DBDR-140 T	\$2.15
									DBDS-140 T	\$2.15	DBDT-140 T	\$2.15
									DBDU-140 T	\$2.15	DBDV-140 T	\$2.15
									DBDW-140 T	\$2.15	DBDX-140 T	\$2.15
									DBDY-140 T	\$2.15	DBDZ-140 T	\$2.15
									DBEA-140 T	\$2.15	DBEB-140 T	\$2.15
									DBEC-140 T	\$2.15	DBED-140 T	\$2.15
									DBEE-140 T	\$2.15	DBEF-140 T	\$2.15
									DEBG-140 T	\$2.15	DEBH-140 T	\$2.15
									DEBI-140 T	\$2.15	DEBJ-140 T	\$2.15
									DEBK-140 T	\$2.15	DEBL-140 T	\$2.15
									DEBM-140 T	\$2.15	DEBN-140 T	\$2.15
									DEBO-140 T	\$2.15	DEBP-140 T	\$2.15
									DEBQ-140 T	\$2.15	DEBR-140 T	\$2.15
									DEBS-140 T	\$2.15	DEBT-140 T	\$2.15
									DEBU-140 T	\$2.15	DEBV-140 T	\$2.15
									DEBW-140 T	\$2.15	DEBX-140 T	\$2.15
									DEBY-140 T	\$2.15	DEBZ-140 T	\$2.15
									DECA-140 T	\$2.15	DECB-140 T	\$2.15
									DECC-140 T	\$2.15	DECD-140 T	\$2.15
									DECE-140 T	\$2.15	DECF-140 T	\$2.15
									DECG-140 T	\$2.15	DECH-140 T	\$2.15
									DECI-140 T	\$2.15	DEBJ-140 T	\$2.15
									DECK-140 T	\$2.15	DECL-140 T	\$2.15
									DECM-140 T	\$2.15	DECN-140 T	\$2.15
									DECO-140 T	\$2.15	DECP-140 T	\$2.15
									DECQ-140 T	\$2.15	DECR-140 T	\$2.15
									DECS-140 T	\$2.15	DECT-140 T	\$2.15
									DECU-140 T	\$2.15	DECV-140 T	\$2.15
									DECW-140 T	\$2.15	DECX-140 T	\$2.15
									DECY-140 T	\$2.15	DEBZ-140 T	\$2.15
									DEDA-140 T	\$2.15	DEDB-140 T	\$2.15
									DEDC-140 T	\$2.15	DEDD-140 T	\$2.15
									DEDE-140 T	\$2.15	DEDF-140 T	\$2.15
									DEDG-140 T	\$2.15	DEDH-140 T	\$2.15
									DEDI-140 T	\$2.15	DEDJ-140 T	\$2.15
									DEDK-140 T	\$2.15	DEDL-140 T	\$2.15
									DEDM-140 T	\$2.15	DEDN-140 T	\$2.15
									DEDO-140 T	\$2.15	DEDP-140 T	\$2.15
									DEDQ-140 T	\$2.15	DEDR-140 T	\$2.15
									DEDS-140 T	\$2.15	DEDT-140 T	\$2.15
									DEDU-140 T	\$2.15	DEDV-140 T	\$2.15
									DEDW-140 T	\$2.15	DEDX-140 T	\$2.15
									DEDY-140 T	\$2.15	DEBZ-140 T	\$2.15
									DEDA-140 T	\$2.15	DEDB-140 T	\$2.15
									DEDC-140 T	\$2.15	DEDD-140 T	\$2.15
									DEDE-140 T	\$2.15	DEDF-140 T	\$2.15
									DEDG-140 T	\$2.15	DEDH-140 T	\$2.15
									DEDI-140 T	\$2.15	DEDJ-140 T	\$2.15
									DEDK-140 T	\$2.15	DEDL-140 T	\$2.15
									DEDM-140 T	\$2.15	DEDN-140 T	\$2.15
									DEDO-140 T	\$2.15	DEDP-140 T	\$2.15
									DEDQ-140 T	\$2.15	DEDR-140 T	\$2.15

# EQUIPMENT

Precision Cavity Wavemeter

Variable Stub Tuner

Rotating Joint

Waveguide Switch

—on display at the WESCON show  
SEE US AT BOOTH

Ultramicrowave Cavity Wavemeter

Standing Wave Detector

Ferrite Isolator

Size Designation	DBA	DBB	DBC	DBD	DBE	DBF	DBG	DBH	DBI	DBJ	DBK	DBL
Frequency Band - MHz	30-140	30-90	30-75	33-50	76-5-40	18-26.5	17-4-18	8.7-12.4	7-65-100	5-85-8.7	3-95-5.95	2-6-3-95
Waveguide Nomenclature	RG 158/U	RG 97/U	RG 98/U	RG 97/U	RG 96/U	RG 53/U	RG 52/U	RG 51/U	RG 50/U	RG 49/U	RG 48/U	RG 47/U
	Part No.	Price	Part No.	Price	Part No.	Price	Part No.	Price	Part No.	Price	Part No.	Price
<b>Frequency Meters</b>												
Precision Cavity Wavemeter	DBA 715.1	\$1.44	DBB 715.1	\$1.44	DBC 715.1	\$1.44	DBD 715.1	\$1.44	DBE 715.1	\$1.44	DBF 715.1	\$1.44
Absorption Type	DBA 715.2	\$1.44	DBB 715.2	\$1.44	DBC 715.2	\$1.44	DBD 715.2	\$1.44	DBE 715.2	\$1.44	DBF 715.2	\$1.44
Reference Cavity Absorption Type	DBA 715.3	\$1.44	DBB 715.3	\$1.44	DBC 715.3	\$1.44	DBD 715.3	\$1.44	DBE 715.3	\$1.44	DBF 715.3	\$1.44
Reference Cavity Transmission	DBA 715.4	\$1.44	DBB 715.4	\$1.44	DBC 715.4	\$1.44	DBD 715.4	\$1.44	DBE 715.4	\$1.44	DBF 715.4	\$1.44
<b>Impedance Meters</b>												
Precision Standing Wave Detector	DBA 825	\$1.44	DBB 825	\$1.44	DBC 825	\$1.44	DBD 825	\$1.44	DBE 825	\$1.44	DBF 825	\$1.44
Carriage Mount Only	DBA 826	\$1.44	DBB 826	\$1.44	DBC 826	\$1.44	DBD 826	\$1.44	DBE 826	\$1.44	DBF 826	\$1.44
Waveguide Section	DBA 827	\$1.44	DBB 827	\$1.44	DBC 827	\$1.44	DBD 827	\$1.44	DBE 827	\$1.44	DBF 827	\$1.44
Bracketed Probe	DBA 828	\$1.44	DBB 828	\$1.44	DBC 828	\$1.44	DBD 828	\$1.44	DBE 828	\$1.44	DBF 828	\$1.44
<b>Phase Shifters, Tuners &amp; Slits</b>												
Phase Shifter	DBA 915	\$1.44	DBB 915	\$1.44	DBC 915	\$1.44	DBD 915	\$1.44	DBE 915	\$1.44	DBF 915	\$1.44
Variable Wave Tuner	DBA 916	\$1.44	DBB 916	\$1.44	DBC 916	\$1.44	DBD 916	\$1.44	DBE 916	\$1.44	DBF 916	\$1.44
Cylindrical Phase Shifter	DBA 917	\$1.44	DBB 917	\$1.44	DBC 917	\$1.44	DBD 917	\$1.44	DBE 917	\$1.44	DBF 917	\$1.44
Fixed Slit	DBA 918	\$1.44	DBB 918	\$1.44	DBC 918	\$1.44	DBD 918	\$1.44	DBE 918	\$1.44	DBF 918	\$1.44
Variable Slit	DBA 919	\$1.44	DBB 919	\$1.44	DBC 919	\$1.44	DBD 919	\$1.44	DBE 919	\$1.44	DBF 919	\$1.44
Monolithic Slit with Variable	DBA 920	\$1.44	DBB 920	\$1.44	DBC 920	\$1.44	DBD 920	\$1.44	DBE 920	\$1.44	DBF 920	\$1.44
Monolithic Slit with Extension	DBA 921	\$1.44	DBB 921	\$1.44	DBC 921	\$1.44	DBD 921	\$1.44	DBE 921	\$1.44	DBF 921	\$1.44
Monolithic Slit with Ext. & Variable	DBA 922	\$1.44	DBB 922	\$1.44	DBC 922	\$1.44	DBD 922	\$1.44	DBE 922	\$1.44	DBF 922	\$1.44
F.H. Plane Tuner	DBA 923	\$1.44	DBB 923	\$1.44	DBC 923	\$1.44	DBD 923	\$1.44	DBE 923	\$1.44	DBF 923	\$1.44
F.H. Plane Tuner with Variable	DBA 924	\$1.44	DBB 924	\$1.44	DBC 924	\$1.44	DBD 924	\$1.44	DBE 924	\$1.44	DBF 924	\$1.44
<b>Accessories</b>												
Adjustable Waveguide Supports	DBA 101C	\$1.44	DBB 101C	\$1.44	DBC 101C	\$1.44	DBD 101C	\$1.44	DBE 101C	\$1.44	DBF 101C	\$1.44
Adjustable Waveguide Supports	DBA 101D	\$1.44	DBB 101D	\$1.44	DBC 101D	\$1.44	DBD 101D	\$1.44	DBE 101D	\$1.44	DBF 101D	\$1.44
Waveguide Chassis Mounting	DBA 101E	\$1.44	DBB 101E	\$1.44	DBC 101E	\$1.44	DBD 101E	\$1.44	DBE 101E	\$1.44	DBF 101E	\$1.44
Waveguide Fastening Supports	DBA 101F	\$1.44	DBB 101F	\$1.44	DBC 101F	\$1.44	DBD 101F	\$1.44	DBE 101F	\$1.44	DBF 101F	\$1.44
Waveguide Window Lens	DBA 101G	\$1.44	DBB 101G	\$1.44	DBC 101G	\$1.44	DBD 101G	\$1.44	DBE 101G	\$1.44	DBF 101G	\$1.44
<b>Electronic Equipment</b>												
1. Transformer Box	DB 102	\$1.44										
Remote Control Box	DB 103	\$1.44										
Non-Drain Power Supply	DB 104	\$1.44										

Deliveries: 2 weeks to 30 days on most items. New 1961 catalog on request.

# BONARDI

DE MORNAY-BONARDI  
780 South Arroyo Parkway, Pasadena, California

CIRCLE 157 ON READER-SERVICE CARD

ELECTRONIC DESIGN • August 2, 1961

## MICROWAVES

Electronic Communications, Inc., Timonium, Md., indicate that such lines exhibit much less attenuation than do rectangular waveguides. At 150 Gc, loss in the surface lines tested averaged about 0.03 db per ft.

These lines are uninsulated, solid copper. It is believed that surface irregularities and contamination provide sufficient wave slowing at the surface to excite the nonradiating modes. ■ ■

## Plastic Waveguides Under Test in Labs

Experimental plastic waveguides said to cost approximately \$10 per ft are being tested by the Bell Telephone Laboratories and the Bendix Corp. The guides consist of copper-plated epoxy pipe manufactured by Resisto Chemical, Inc., of Wilmington, Del.

Resisto developed the pipe primarily for handling corrosive fluids, but the highly polished interior surface achieved in extruding the pipe suggested waveguide applications. For this purpose the interior is either copper-plated or silver-plated, with the metallic finish retaining the high lustre of the unplated pipe.

Samples of 2-in. ID copper-plated circular pipe are being tested by Bell, which for some years has done considerable research into metallic circular waveguides. These tests have just begun, and the findings are not available at this time.

Bendix, on the other hand, has ordered a rectangular pipe of 0.4-in.-by-0.9-in. interior cross-section for its test program.

Advantages claimed for the epoxy waveguide include low cost, uniform interior finish and good environmental characteristics.

Resisto has also developed an epoxy-carbon composition pipe of unusual electrical characteristics. Because of the orientation of the carbon particles achieved in extrusion, electrical resistance along the length of the pipe is much lower than resistance through the wall. Longitudinally the pipe has good relative electrical conductivity, while transversely it is an insulator.



# Practical Design of Magnetic Radar Modulators



**Ralph M. Philip**  
Light Military Electronic Dept.  
General Electric Co.  
Utica, N. Y.

**T**HE BASIC ac resonant magnetic modulator (first proposed by Melville)<sup>1</sup> is shown in Fig. 1. Circuit consists of the following:

- Ac input source.
- Ac resonant charging circuit ( $L, C_1$ ).
- First compression stage ( $C_1, P_1, P_2$ ).
- Intermediate compression stage ( $C_2, P_2, P_3$ ).
- Final pulse forming network ( $C_3, P_3$ ).
- Bias circuit.

The pulsactor in each of the compression stages acts as a closed switch when it is unsaturated and as an open switch when saturated. A sine wave from the input source thus passes through the modulator as a series of successively narrower half-sine waves. Sufficient compression stages are included to narrow the half-sine wave to the

*Because of their high reliability, series-type magnetic modulators are being increasingly applied in radar systems. In this article, author Philip gives a step-by-step procedure for designing such modulators and indicates the areas of possible compromise among weight, efficiency and other operating characteristics. A dc-operated version, made practical by the recent development of heavy-duty silicon controlled rectifiers, is also discussed.*

approximate pulse end value. The pulse forming network then generates the wave form required for the proper firing of the particular magnetron specified in the radar system.

Typical voltage and current waveforms for successive portions of a magnetic modulator are illustrated in Fig 2. In a typical radar system the output pulse may have the following characteristics:

- Length—0.5  $\mu$ sec
- Pulse repetition frequency—2,000 pps
- Peak voltage—1,500 v
- Peak current—15 amps

Design of the modulator is generally constrained by several pre-established system parameters. These include:

- Modulator load impedance ( $R$ ), in ohms
- Modulator load voltage ( $V_R$ ), in volts
- Pulse width of the modulator load voltage ( $\tau$ ), in seconds

- Angular frequency of the input source ( $\omega_{supply}$ ), in radians

For rapid design of the modulator within these parameters, the following procedure is suggested:

1. Determine required number of compression stages.
2. Design pulsactors for each stage.
3. Compute the capacitance values for each stage.
4. Determine the bias for the first pulsactor.
5. Calculate the inductance of the resonant charging choke.
6. Determine the required supply voltage.
7. Breadboard modulator and modify component values to improve performance.
8. Redesign the modulator to contain one more and one less compression stage than initially chosen; then calculate performance and physical characteristics of the new designs.
9. Select final configuration from these designs to satisfy the most important requirement (weight, size, efficiency).

The methods detailed for each step assume lossless components in the initial design.

**First Step — Determine Required Number of Compression Stages.** The number of stages required in the modulator is to some extent a function of the over-all compression ratio ( $\rho$ ) achieved by the unit.

$$\rho = \frac{1}{2f_{supply} \tau} \quad (1)$$

A fairly typical  $\rho$  of 400 is assumed in this article.

From the standpoint of minimum core ma-

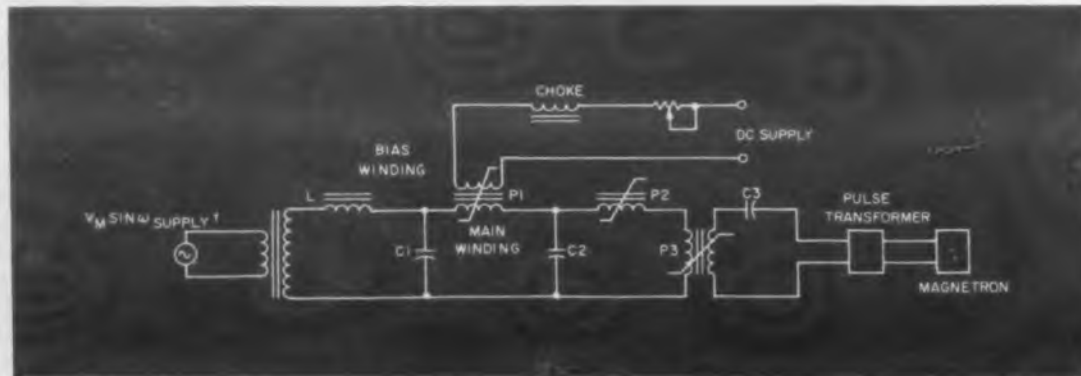

**Fig. 1.** Ac resonant magnetic modulator. Circuit includes three compression stages with final stage ( $C_3, P_3$ ) also serving as pulse-forming network. Bias is shown only for the first stage, though the designer may elect to bias subsequent compression stages as well.



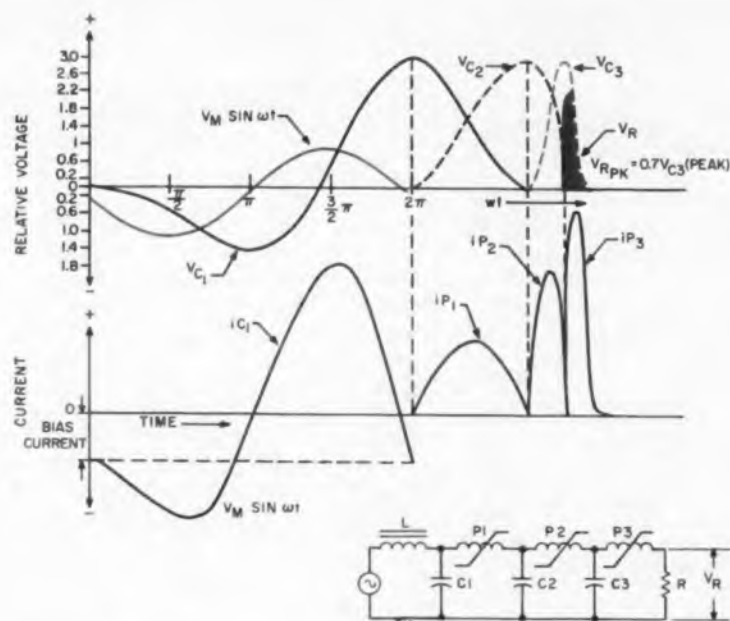
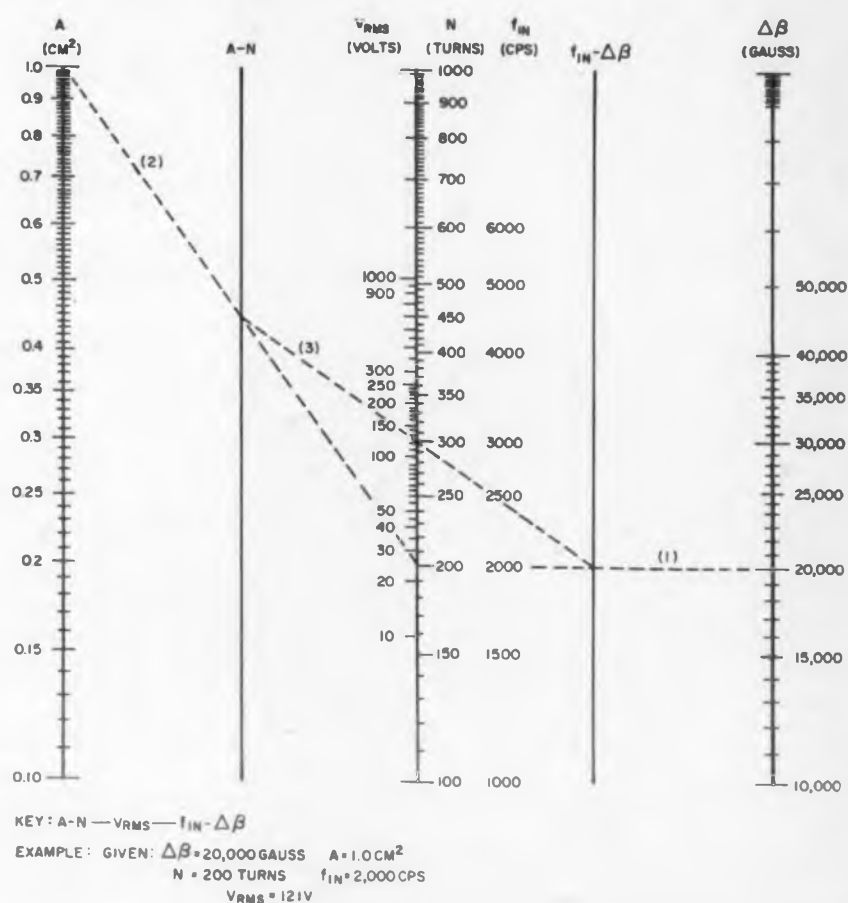

Fig. 2. Voltage and current waveforms in various elements of the modulator. Note progressive compression of the voltage and current waves from input to output. The auxiliary schematic is a simplified version of Fig. 1.

Fig. 3. Nomogram to determine supply voltage for initial design of the modulator. To use the nomogram: (1) draw a line between known circuit values of  $\Delta\beta$  and  $f_{in}$  and mark its intersection on the  $f_{in} - \Delta\beta$  line; (2) draw a second line between known circuit values of  $A$  and  $N$  for the first pulsactor and mark its intersection on the  $A-N$  line; (3) connect the points on the  $f_{in} - \Delta\beta$  and  $A-N$  lines and read intersection on the  $V_{rms}$  scale.



terial, Mathias and Williams<sup>2</sup> have derived the following optimum number of compression stages as a function of  $\rho$ .

$\rho$	Optimum Number of Stages (n)
10	4
50	7
100	9
200	10
500	12

If one considers the weight of the associated capacitors, chassis, wiring, etc., minimum total weight is achieved by selecting a lesser number of stages than  $n$ . A feel for this trade-off can be obtained from the following table<sup>3</sup> which illustrates the effect on core weight when using a lesser number of stages in an optimally 11-stage design.

Number of stages	Core Weight (Referenced to three stages)
1	1,150.00

2	5.10
3	1.00
4	0.48
5	0.33
6	0.26

The weights are expressed with reference to a three-stage design, as it has been found from experience that this number of stages is a good compromise in most applications requiring a compression ratio between 150 and 300. The selection of three or four stages is strongly suggested for the initial design.

**Second Step — Design Pulsactors for Each Stage.** To assure satisfactory matching between the modulator and its load, it is preferable to begin the design from the load end and work back toward the supply. Proper matching is, in fact, the major consideration in design of the last stage. The design equations presented here for the last stage have been modified from generalized equations by

inclusion of constants specifically calculated to result in optimum matching.

Melville<sup>4</sup> shows that for maximum unidirectional current through the load,  $L_{s3}$  (the saturated inductance of the pulse transformer secondary winding) is

$$L_{s3} = 0.265 R_{load} \tau \text{ henries} \quad (2)$$

The turns-area product of this winding is

$$N_s A_s = \frac{13.7 V_{load} \tau}{2\beta_s} \times 10^6 \text{ turns} - \text{cm}^2 \quad (3)$$

where  $\beta_s$  is the saturation flux density of the core material in  $P_s$ .

This turns-area product is chosen to permit  $C_3$  to charge fully in an interval of  $10\tau$  and represents a compromise between efficiency of the final compression stage and application of minimum reverse voltage to the load. A charging interval shorter than  $10\tau$  tends to increase the reverse voltage,

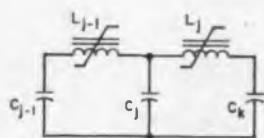

Fig. 4. Circuit showing nomenclature used in computing capacitances.

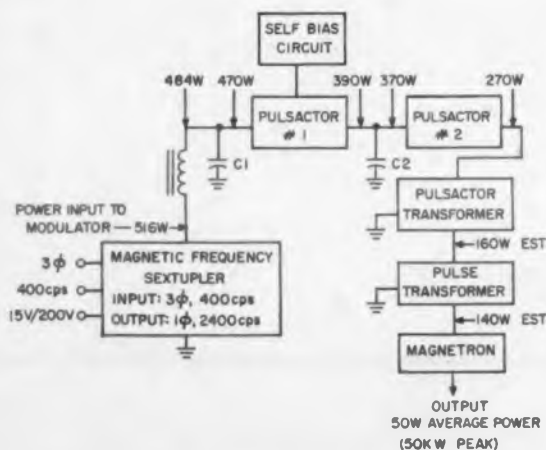

Fig. 5. Power loss breakdown in a typical ac magnetic modulator.

while one longer than  $10\tau$  reduces efficiency.

Core volume for the pulsactor in the final stage is given by

$$v_3 = \frac{4\pi(N_3 A_3) \mu_{s3} \text{ cm}^3}{L_{s3}} \quad (4)$$

where  $\mu_{s3}$  is the permeability of  $P_3$  at saturation. At this point in the design a value of 1.0 can be safely assumed for  $\mu_{s3}$ .

For minimum initial total core volume in the three-stage modulator, the three pulsactors should have equal core volumes.

$$v_1 = v_2 = v_3 \quad (5)$$

Assuming that identical magnetic cores are used in each stage, the turns on each pulsactor are related by the equation

$$N_1 = 10N_2 = 100N_3 \quad (6)$$

The progressive decrease of inductance between successive stages results in voltage compression from stage to stage. However, the unsaturated inductance of the third pulsactor should be much greater than the saturated inductance of the second pulsactor for efficient discharge of  $C_2$  into  $C_3$ .

The saturated inductance ( $L_{s1}$ ) of the first pulsactor should be such that the circuit  $C_1 P_1 C_2$  will resonate at  $n$  times the input frequency. The term  $n$  is known as the compression factor and is typically chosen between 5 and 10. Thus,

$$L_{s1} = \frac{1}{4\pi^2 f_2^2 \left( \frac{C_1 C_2}{C_1 + C_2} \right)} \text{ henries} \quad (7)$$

where  $f_2 = n f_1$

Similarly, the saturated inductance of the second pulsactor must form a series resonant circuit with  $C_2$  and  $C_3$  at  $n f_2$ , where  $n$

is the compression factor for the second stage. Therefore,

$$L_{s2} = \frac{1}{4\pi^2 f_3^2 \left( \frac{C_2 C_3}{C_2 + C_3} \right)} \text{ henries} \quad (8)$$

where  $f_3 = n f_2$ .

With core volume and inductance for the first pulsactor now established, the designer must determine the most practical number of turns for the core. Several considerations involved in arriving at a compromise between relatively many or few turns are listed in Table I.

**Third Step — Compute the Capacitance Values for Each Stage.** For maximum unidirectional current through the load, the capacitance of the third stage is

$$C_3 = \frac{1.06\tau}{R_{load}} \text{ farads} \quad (9)$$

Maximum energy transfer between stages is theoretically obtained when all stages have equal capacitance.

$$C_1 = C_2 = C_3 \quad (10)$$

This approximation is adequate for the initial design. In practice, however, there should be slight, progressive increases of capacitance between stages.

**Fourth Step — Determine the Bias for the First Pulsactor.** The first pulsactor core must be biased via a separate winding so that saturation is not reached until one full cycle of input current has elapsed. The bias sets the operating point on the magnetization loop of the core and provides for stable, cyclic operation of the circuit.

The magnetizing force ( $H_p$ ) that must be developed by the bias winding for proper operation of the modulator is

$$H_p \approx \frac{0.4\pi N_1 (C_1 V_{c1} f_{supply})}{l} \text{ oersteds} \quad (11)$$

where

$l$  = mean length of the magnetic path of core  $P_1$  in cm,

$V_{c1}$  = peak charged voltage across  $C_1$  ( $\pi\sqrt{2} V_{rms supply}$ ) and

$N_1$  = Number of turns on main winding of  $P_1$ .

**Fifth Step — Calculate Inductance of the Resonant Charging Choke.** The modulator described here employs full-cycle charging in which the voltage across the resonant charging capacitor  $C_1$  reaches a theoretical (lossless) peak of  $V_m \pi$  where the input

Table 1. Factors in determining number of bias turns on the first pulsactor.

Many Turns on a Core Of Small Cross-Sectional Area	Few Turns on a Core Of Large Cross-Sectional Area
Input circuit power factor is improved if $\sigma > 2.1$	Input circuit power factor is poor if $\sigma < 2.1$
Compression of the first stage is small. ( $L_{s1}$ is large)	Compression of first stage is large. ( $L_{s1}$ is small)
I <sup>2</sup> R loss is large and larger $C_1$ may be required.	I <sup>2</sup> R loss is small.
Unit may be heavier (more copper) but core may be smaller.	Unit may be lighter (less copper) but core loss may increase.
Larger bias is required to reset core, larger rectifiers are thus needed.	Smaller bias is required to reset the core.
Resonant frequency of a-c resonant charging circuit is affected only slightly.	Resonant frequency of a-c resonant charging circuit is affected.

voltage is  $V_m \sin \omega t$ . The charging choke is thus designed to resonate with the  $C_1$  at the supply frequency. Accordingly,

$$L = \frac{1}{4\pi(f_{supply})^2 C_1} \text{ henry} \quad (12)$$

**Sixth Step — Determine the Required Supply Voltage.** There are two separate methods the designer can employ to determine the required input voltage. He can note the energy required to saturate the first pulsactor, allow for losses in the charging circuit, and specify an input voltage that will deliver the required energy at the output.

Since over-all efficiency cannot be readily calculated before the breadboard is assembled, the first method is more suitable for the initial design. It has been found in practice that the equation

$$V_{rms} = \frac{\Delta\beta N_1 A_1 f_{in} \times 10^{-9}}{0.66} \text{ volts} \quad (13)$$

where all terms refer to the first pulsactor, is a useful approximation for the required supply voltage. This equation has been reduced to the nomogram of Fig. 3.

In the second method it can be shown that

$$V_{rms} = \frac{0.707}{\pi} \sqrt{\frac{2(V_R \text{ peak})^2 \tau}{C_1 R \eta / \text{modulator}}} \quad (14)$$

**Seventh Step — Breadboard Modulator and Modify Component Values to Improve Performance.** Due to inefficiency in each stage, capacitor values should increase progressively from the supply end to the load end. In the three-stage modulator described here,  $C_3 > C_2 > C_1$ . The increase in capacitance is inversely proportional to the efficiency. In the circuit of Fig. 4, for example,

$$C_k = \frac{C_j}{\eta_j} \quad (15)$$

The total loss in each stage is the sum of the hysteresis and eddy current losses<sup>5</sup> in the pulsactor core and the copper loss in the winding. Losses in the capacitors can generally be neglected.

$$\eta_c = \frac{Q}{\pi} \left(1 - e^{-\frac{\pi}{Q}}\right) \quad (16)$$

where

$$Q = \frac{\omega L}{R}, \text{ and}$$

$R =$  all losses of the input circuit.

## 124 completely hermetically sealed Microwave Mixer and Video Diodes

ALL ARE DIRECTLY SUBSTITUTABLE FOR CONVENTIONAL DIODES TO ASSURE UNPRECEDENTED SYSTEMS RELIABILITY.



Microwave Associates has answered your need for truly hermetically-sealed diodes. For the first time, both fixed-base and reversible polarity types have CERAMIC-TO-METAL SOLDER SEALS plus SOLDER END SEALS.

Whatever the requirement—from 1 Mc to 18 kMc, a new diode is available to replace the present diode — extra high burnout types for high signal level circuits and behind radar duplexers—new low-noise types for doppler receivers.

The MA-458F, for example, replacing the 1N23E, has a calculated overall noise figure of 7.0 db — the lowest noise figure available for high reliability applications.

These diodes (and coaxial case and subminiature glass packaged diodes) assure military and commercial applications the reliability essential to uninterrupted service for exceptional time spans. They perform to 150°C and meet the applicable environmental requirements of MIL-S-19500.



**MICROWAVE ASSOCIATES, INC**  
SEMICONDUCTOR DIVISION

BURLINGTON, MASSACHUSETTS • WESTERN UNION FAX  
TWX: BURLINGTON, MASS. 942 • BROWNING 2-3000

Export Sales: Microwave International Corp.  
36 W. 44th St., N.Y.C., N.Y., U.S.A. Cable: Microcon

### SILICON MIXER DIODES

1 Mc — 4,000 Mc

CARTRIDGE CASE

Improved Types  
For low noise superheterodyne mixer performance  
• Replace 1N21 series

Fixed Base Types		Matched Pair		Reversible Polarity Types	Calc Overall Recr Noise Figure N = 1.5db (db)	Burnout Rating (rgrs)
Forward Polarity	Reversed Polarity	Forward Pair	Forward & Reversed			
MA 449B	MA 449BR	MA 449BM	MA 449BMR	MA 459B	10.3	5.0
MA 449C	MA 449CR	MA 449CM	MA 449CMR	MA 459C	8	5.0
MA 449D	MA 449DR	MA 449DM	MA 449DMR	MA 459D	7.3	5.0
MA 449E	MA 449ER	MA 449EM	MA 449EMR	1N21WE	7.0	5.0
MA 449F	MA 449FR	MA 449FM	MA 449FMR	MA 459F	6.0	5.0

Higher Burnout Types

For use in pulse radars or other receivers exposed to high RF radiation fields  
• Interchangeable with 1N21 series

MA 4127	MA 4127R	MA 4127M	MA 4127MR	MA 4132	8.3	10
---------	----------	----------	-----------	---------	-----	----

Lower Noise Types

For best signal to noise performance in low frequency IF doppler systems

MA 4126	MA 4126R	MA 4126M	MA 4126MR	MA 4131	—	7.0
MA 4126A	MA 4126AR	MA 4126AM	MA 4126AMR	MA 4131A	—	2.0

4,000 Mc — 10,000 Mc

Improved Types

For low noise superheterodyne mixer performance

• Replace 1N23 series

MA 451B	MA 451BR	MA 451BM	MA 451BMR	MA 458B	11.4	2.0
MA 451C	MA 451CR	MA 451CM	MA 451CMR	MA 458C	9.8	2.0
MA 451D	MA 451DR	MA 451DM	MA 451DMR	MA 458D	8.2	2.0
MA 451E	MA 451ER	MA 451EM	MA 451EMR	1N23WE	7.5	2.0
MA 451F	MA 451FR	MA 451FM	MA 451FMR	MA 458F	7.0	2.0

Higher Burnout Types

For use in pulse radars or other receivers exposed to high RF radiation fields  
• Interchangeable with 1N23 series

MA 4133	MA 4133R	MA 4133M	MA 4133MR	MA 4134	9.8	5.0
---------	----------	----------	-----------	---------	-----	-----

Lower Noise Types

For best signal to noise performance in low frequency IF doppler systems

MA 4125	MA 4125R	MA 4125M	MA 4125MR	MA 4130	—	2.0
MA 4125A	MA 4125AR	MA 4125AM	MA 4125AMR	MA 4130A	—	2.0

10,000 Mc — 18,000 Mc

COAXIAL CASE

Improved Types

For low noise superheterodyne mixer performance

• Replace 1N78 series

MA 443	MA 443R	MA 443M	MA 443MR	—	—	0.6
MA 443A	MA 443AR	MA 443AM	MA 443AMR	—	9.8	0.6
MA 443B	MA 443BR	MA 443BM	MA 443BMR	—	8.8	0.6
MA 445	MA 445R	MA 445M	MA 445MR	—	—	1.0
MA 445A	MA 445AR	MA 445AM	MA 445AMR	—	9.8	1.0
MA 445B	MA 445BR	MA 445BM	MA 445BMR	—	8.8	1.0

Lower Noise Types

For best signal to noise performance in low frequency IF doppler systems

MA 4124	MA 4124R	MA 4124M	MA 4124MR	—	—	0.6
MA 4124A	MA 4124AR	MA 4124AM	MA 4124AMR	—	—	0.6

SILICON VIDEO DIODES

1 Mc — 10,000 Mc

Improved Types For high tangential signal to noise sensitivity in simplified beacon receivers, test equipment and other uses

• Replace MA 408 series CARTRIDGE CASE

Fixed Base Types		Reversible Polarity	Burnout (rgrs)
Forward Polarity	Reversed Polarity		
MA 462	MA 462R	MA 461	1.0
MA 462A	MA 462AR	MA 461A	1.0
MA 462B	MA 462BR	MA 461B	1.0

Higher Burnout Wide Dynamic Range Types

For use in video receivers exposed to high RF radiation fields

• Interchangeable with MA 408 series

MA 4128	MA 4128R	MA 4129	5.0
---------	----------	---------	-----

## NEW DIMENSIONS IN MEASURING RFI

### with the STODDART NM-62A

1 gc to 10 gc  
(1 kmc to 10 kmc)

Even our Benign Sun is often a nuisance to missile guidance systems. A successful count down and launching can occur only after a "path" is cleared through a limitless sky filled with interference. And STODDART—leader in the field of radio interference control—now adds the needed new dimensions to RFI measurement techniques with the NM-62A Interference Measuring Instrumentation.

The NM-62A is designed and manufactured to rigid military equipment specifications for use by all government services, as well as industry. This completely self-contained, compact unit cuts operating time and cost, and advances the state of the art by providing:

- AUTOMATIC FREQUENCY SCANNING over entire range of 1 to 10 gc
- AUTOMATIC TUNER SELECTION
- AUTOMATIC RECORDING of amplitude vs. frequency
- MOTORIZED TUNER SCANNING

See this new and revolutionary instrument at the Wescon Show Booth 205. We invite your immediate request for complete details and specifications.

## STODDART

AIRCRAFT RADIO CO., INC.  
6644 SANTA MONICA BLVD.  
HOLLYWOOD 38, CALIFORNIA  
HOLLYWOOD 4-9292

servicing 33 countries in Radio Interference control.

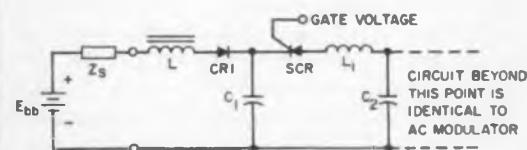
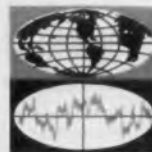

Fig. 6. Input section of a dc resonant magnetic radar modulator. Pulse width and prf can be readily varied by means of the silicon controlled rectifier.

Power loss breakdown in a typical magnetic modulator is illustrated in Fig. 5. The final stage generally has the greatest core loss which varies directly as the core volume of the final pulsactor.

The pulsactor in the first stage, however, has many more turns than does the final pulsactor. Thus, the core initially chosen may not accommodate both the main and the bias windings. In this event, a core with a larger window area must be chosen.

The main winding of each pulsactor performs two functions. In the unsaturated state, the turns-area product must be such that the pulsactor can absorb the volt-second product applied to the core. In the saturated state, inductance must be sufficiently small to provide the required pulse compression. The turns on each core may have to be modified to arrive at a suitable compromise between saturated and unsaturated inductance requirements.

In some instances bias of subsequent pulsactor stages may be desirable. However, the designer must weight the advantage of increased efficiency against the disadvantages of added weight, size and circuit complexity if separate bias schemes are used for each pulsactor.

In practice, a self-biasing circuit can be used in preference to the separate dc supply shown in Fig. 1.

**Final Design Steps.** At this point the designer can consider alternate choices containing one stage more and one stage less than the trial breadboard. These can be de-

veloped on paper and the trends in weight, size and efficiency noted. If either of the alternate designs appears particularly promising, it should be breadboarded and performance evaluated before arriving at a final choice.

A disadvantage of the ac resonant magnetic modulator is that the pulse repetition rate is identical to the input frequency. Pulse width may be varied by switching different components into the circuit, but this is at best a cumbersome process.

Greater flexibility of operation is possible through dc resonant charging in which pulse rate and width can be controlled by switching the input current. Until recently, however, such switching could be accomplished only with thyratrons, whose use is not consistent with the reliability desired of a solid-state device. However, the recent advent of high-power silicon controlled rectifiers has led to renewed interest in dc resonant magnetic modulators.

A typical dc resonant modulator is shown in Fig. 6. Apart from greater operating flexibility, replacement of the first pulsactor by the silicon controlled rectifier provides greater pulse compression in the first stage.

In Fig. 6, the dc resonant charging capacitor  $C_1$  charges to  $2 E_{bb}$  through resonant charging choke  $L$  and hold-off diode  $CR_1$ . The charge remains until a gating pulse is applied to the silicon controlled rectifier  $SCR$ . Energy is discharged into  $C_2$  and pulse compression occurs in the same manner as described for the ac modulator. The circuitry beyond  $C_2$  is identical to that in the ac modulator.

Detailed design procedures for the input stages of the dc magnetic modulator are described in the literature by Manteuffel and Cooper.<sup>6</sup> ■ ■

#### References

- Melville, W. S., "The Use of Saturable Reactors as Discharge Devices for Pulse Generators," *I.E.E. Proceedings*, 98:185-207, Part III, 1951.
- Mathias, R. A., and Williams, E. M., "Economic Design of Saturating Reactor Magnetic Pulsers," Transaction Paper No. 55-179, AIEE Committee on Special Communication Applications, 1955.
- Ibid.
- Melville, W. S., op cit, p. 190.
- Mathias, R. A., Taylor, M. E., and Walker, J. M., "An Investigation of Magnetic Pulse Generators," Interim Monthly Report for Contract AF-30(602)-904, Feb. 1955.
- Manteuffel, E. W., and Cooper, R. E., "DC Charged Magnetic Pulse Modulator," *Communications and Electronics*, Jan. 1960.

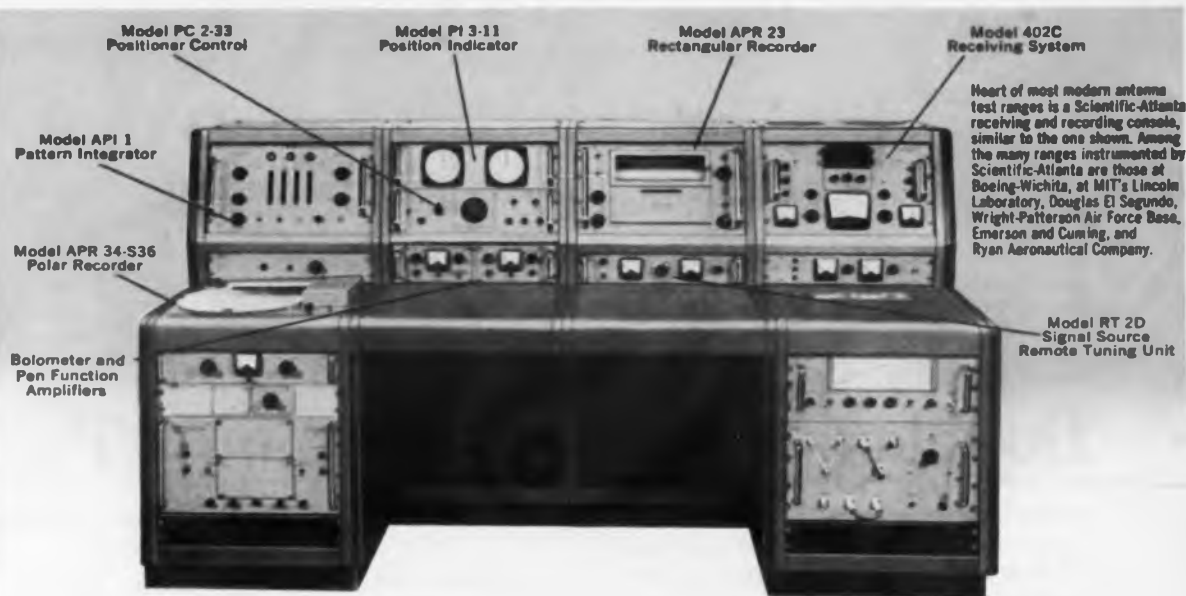

## ONE SOURCE For Complete Antenna Instrumentation Systems

### Recording, Receiving, Transmitting and Control Equipment, Antenna Positioners, Microwave Components, and Recorder Supplies

**PATTERN RECORDERS**—Two basic pattern recorders are available: the Series APR 20 Rectangular, and Series APR 30 Polar. They can be combined to form the popular APR 20/30 Polar-Rectangular Recorder. Pen responses include logarithmic, linear, and square root.

Features include servo control with tachometer feedback, a noise compression circuit, an electric pen lift, and a three-axis synchro input selector. The rectangular recorder has an automatic chart-cycle advance, illuminated chart, three chart scale expansions with forward-reverse, and chart position control. The polar recorder features a recording diameter of 7 and 13 inches, a turntable slip-clutch, pen standby and load switch, calibrated turntable, and chart center light.

**WIDE RANGE RECEIVING SYSTEM**—A double conversion super-heterodyne receiver, the Scientific-Atlanta Series 402 covers the range from below 30 mc to more than 100 kmc.

Features include a sensitive AFC circuit which prevents the receiver from losing track during transmitter frequency drift. One coaxial cable eliminates costly lossy wave guides and rotary joints. Antennas can be located up to 75 feet away with negligible loss in sensitivity, or more than 200 feet away with low loss cables. Reception of cw signals from simple sources eliminates need for precise modulation.

Excellent employment opportunities exist for electronic, microwave, and mechanical engineers.

Modification P-4 adds 20 db to the normal 40 db dynamic range providing 1 db linearity over a full 60 db dynamic range. Modification Z adds a precision IF attenuator and VTVM appreciably reducing the number of components and instruments required for level, gain, and isolation measurements.

**ANTENNA POSITIONERS**—Scientific-Atlanta offers medium and heavy duty azimuth and multi-axis antenna positioners. Standard models range from the PMA-3 medium duty azimuth positioner designed for a maximum vertical load of 200 pounds with a maximum bending moment of 200 foot pounds to the large PAEA 29 H azimuth over elevation over azimuth for vertical loads of 15 tons and a bending moment of 30,000 foot pounds.

Features include use of Kaydon four-point contact bearings which minimize sliding friction, weather and dust proof design, and 1:1 and 36:1 speed synchros for each axis of rotation. Slip rings, rotary joints, and limit switches can be provided in any axis of any positioner.

**MICROWAVE COMPONENTS**—Scientific-Atlanta also offers a coaxial rotary joint for dc to 16 kmc at speeds up to 2000 rpm, a series of coax to waveguide adaptors, standard gain horns, crystal mixers, transmitting antennas, polarization positioners, model range towers and recorder supplies.

#### WRITE FOR OUR NEW CATALOG

Ask your Scientific-Atlanta engineering representative for a copy of our new catalog or write directly to the factory.



**SCIENTIFIC  
ATLANTA, INC.**

2162 Piedmont Road, N.E. • Atlanta, Georgia  
See Us at WESCON — Booth 3522

CIRCLE 161 ON READER-SERVICE CARD



# Doppler Modulation Systems—The Pros and Cons

*Choice of modulation systems is a major element in the keen competition among manufacturers of Doppler equipment. Each of the four major systems now in use has inherent advantages and limitations with respect to its applications in a particular class of vehicle. Doppler experts Whitney and Laschever analyze the four modulation systems in a concise but to-the-point article that should be of value to designers interested in the fast-growing Doppler field.*

**Douglas Whitney, Norman Laschever**  
Laboratory For Electronics  
Boston, Mass.

**T**HE WAY in which the transmitted signal is modulated is the most important factor in determining whether a Doppler velocity sensor will perform satisfactorily in a given aircraft or space vehicle.

Four basic modulation systems are used. They are:

- Cw—continuous wave
- Self-coherent pulse
- Fm/cw—frequency modulated cw
- Icw—Interrupted cw

Block diagrams of the four systems are illustrated in Figs. 1 through 4. Each system employs several microwave beams and associated receiver/frequency tracker channels so as to measure velocity along more than one coordinate axis. However, Figs. 1 through 4 illustrate only one channel for each system as other channels operate in a similar manner.

The cw system transmits and receives continuously. The self-coherent pulse system transmits low-duty-cycle rf pulses and receives for the rest of its operating cycle.

The fm cw system receives continuously while continuously transmitting a cyclical frequency-swept carrier. The icw system alternately transmits and receives during nearly equal periods whose durations vary with the altitude of the vehicle.

Cw and fm cw systems derive the Doppler shift,  $f_D = 2/\lambda_i v_i$  cps by continuous comparison of the transmitted and received signals. ( $\lambda_i$  is the transmitted wavelength and  $v_i$  the velocity along the  $i$ -th beam).

An icw system operates in much the same manner except that the sample of the transmitted signal is derived from a cw oscillator coherent with the transmitted pulse during the receiving interval.

In the self-coherent pulse system signals

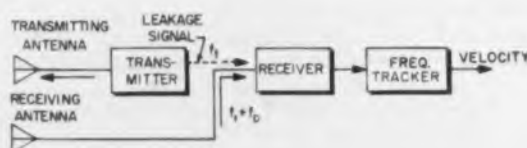

**Fig. 1.** Cw Doppler system transmits and receives continuously. Velocity is determined merely by tracking the Doppler frequency shift  $f_D$ . Signal leakage from transmitter to receiver is noted in the diagram.

from a forward pointing and rearward pointing antenna are compared (providing twice the Doppler shift noted above).

The pros and cons of each system are summarized in Table 1. Generally, advantages such as design simplicity, good utilization of transmitted power and stable operation are accompanied by such drawbacks as noise, signal leakage, complex antenna structures and altitude "holes".

Cw systems offer simple design (a modulator is not needed) and maximum use of transmitted power. The performance penalties result from:

- Signals leakage from the transmitting to the receiving antenna.
- Uncontrollable noise content of the transmitted signal.
- Inability to discriminate between near and distant signals.

The advent of progressively quieter transmitting tubes should to some extent alleviate the signal noise drawbacks of cw Doppler. However, random, low-frequency modulation of the leakage signal induced by vibrating surfaces near the antennas introduces a masking noise level that remains a problem.

Lack of range discrimination results in noise figures of 30 db or greater above receiver thermal noise for cw Dopplers. High-altitude and low-velocity performance are thus limited.

In general, system performance of cw Dopplers can be considered signal-to-leakage limited rather than signal-to-noise limited. Increasing transmitter power is of little avail as working noise level is similarly increased.

Self-coherent pulsed Doppler overcomes tube noise and leakage problems by shutting

off the transmitter during the receiving interval of the operating cycle. These advantages are accompanied by three new drawbacks which may rule out this system in certain applications.

The frequency difference in returns from a single pulse of rf energy transmitted in two opposite directions provides sufficient information for measuring horizontal velocity in the plane of the two beams. However, one cannot distinguish which of the two return signals is of higher frequency. This information cannot be extracted because a coherent reference is not present. Additionally, the system cannot sense when both frequencies change by the same amount (as would be the case for vertical motion) since velocity is sensed as the difference between forward and rearward frequency shifts.

The antenna must be vertically stabilized to assure "simultaneity" (similar Doppler spectra) of returns which are to be compared.

Self-coherent pulse Dopplers employ conventional pulse radar receiver techniques, reaching typical system noise figures as low as 12 to 15 db above thermal noise. The duration and high peak power of the transmitted pulse, in addition to finite receiver recovery time, cause a low-altitude hole extending to at least 300 ft. Below this altitude, the return signal is obscured by the main bang.

Fm/cw Doppler avoids the noise and leakage problems of the cw system and the velocity sense and vertical sense problems of the self-coherent pulse technique but introduces serious "altitude hole" problems.

The transmitted and local oscillator signals are identically frequency-modulated. When the received signal is mixed with the local oscillator, no output is obtained from the mixer unless the signal is delayed by the round trip time. If the signal is delayed, the Doppler shift frequency is derived by combining the mixer output with the modulation frequency and measuring the resulting difference. Leakage signals, not being delayed by a detectable amount, produce no output from the mixer.

Altitude holes occur when the round trip time is equal to the period of the modulation frequency, or some multiple of it. These are due to the inability of the mixer to distinguish between a 0 delay and a 360-deg delay. This problem is less critical at high altitudes because there is a spectrum of round trip times within the finite width of the an-

**Table 1. Characteristics of Doppler Modulation Systems**

Modulation System	Advantages	Disadvantages
<b>Cw</b>	<p>Simplicity  Modulator not required  Transmitter carrier frequency relatively easy to stabilize  Maximum utilization of all radiated power  Transmitter provides coherent reference for receiver</p>	<p>Maximum altitude performance limited by signal-to-leakage ratio rather than signal-to-receiver noise ratio. (Keeping this ratio high implies considerable art in antenna design and antenna installation).  Tracking of Doppler ground return may be inaccurate or impossible due to biasing or masking effects of direct signal leakage modulated by acoustical or engine-induced vibrations.  Must employ separate antennas for transmitting and receiving (more antenna bulk for given beamwidth than any of other types)  Requires self-contained radome.</p>
<b>Self-Coherent Pulse (Low-Duty-Cycle Pulse)</b>	<p>Simple Transmitter  Pulse-to-pulse frequency stability of transmitted pulse not required.  Local oscillator not required.  Doppler velocities (frequencies) are Janus-stabilized against aircraft pitch and roll thus reducing frequency tracking rate requirement.</p>	<p>Cannot detect velocity sense (direction)  Must stabilize antenna in pitch and roll (complex, heavy, slower)  Poor use of total radiated power.  Propagation losses degrade to <math>1/R^2</math> at high altitudes.  High transmitted peak power and receiver recovery time preclude elimination of low-altitude hole.</p>
<b>Fm/Cw</b>	<p>Relative simplicity  Leakage signals produce no output.  Local oscillator (LO) signal is a sample of transmitted power so problem of providing a strong coherent LO signal during receiver on time (requiring side-step LO, microwave amplification, etc.) is avoided.</p>	<p>No way to eliminate lowest altitude hole (from zero to say 300-500 ft.)  Low-altitude hole introduces serious tracking inaccuracies prior to complete loss of Doppler return.  High altitude holes exist (effect may be minimized but at the cost of wider beamwidths than necessary and degraded tracking accuracy).  Transmitted power utilization 10 db poorer than ideal cw system, 7 db poorer than icw.  Does not operate through 0 velocity.</p>
<b>Icw (High Duty Cycle)</b>	<p>Uses same antenna for transmitting and receiving.  Antenna may be hard mounted.  Self-contained radome not necessary.  Direct signal leakage impossible  Vibrating surfaces in near environment not important.  If prf is varied inversely with altitude, signal-to-noise ratio may be made constant with altitude (at any 1 prf).  Discriminates against precipitation and cloud return (constant signal-to-noise ratio with altitude means precipitation return can be considered as originating at ground level.</p>	<p>Maintaining transmitter coherence during receive interval requires side-step local oscillator technique and microwave amplification with attendant complexity.  Requires prf change as a function of altitude to prevent altitude holes.  Requires transmit-receive overlap operation at low altitudes to avoid zero-altitude hole.  3 db of radiated power lost in prf sidebands.</p>

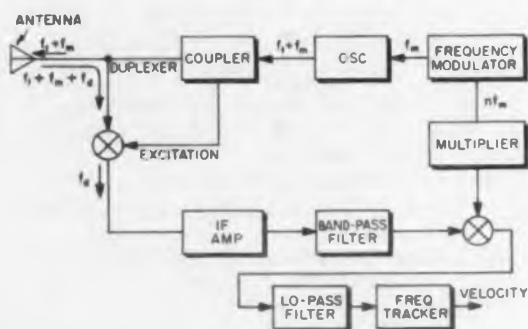

Fig. 3. Fm/cw Doppler transmits continuous, frequency-modulated signal. Internal reference signal is similarly modulated. Signal leakage problem is thus eliminated as the system cannot generate an output when the leakage signal is identical to the reference signal. Signals delayed by a round trip will, however, be shifted in frequency and will be detected by the system.

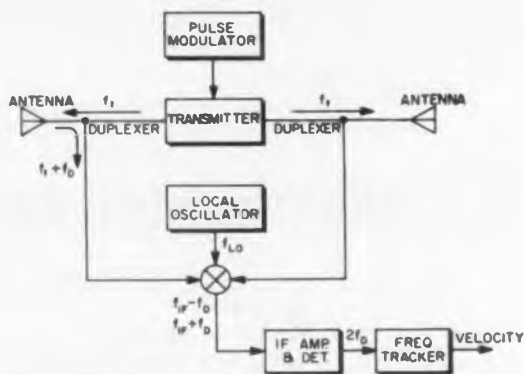

Fig. 2. Self-coherent pulse Doppler employs Janus antennas. (two antennas transmitting or receiving simultaneously). Since the antennas point in opposite directions, their Doppler shifts have opposite signs. The two received signals are combined so that the velocity is proportional to  $2f_d$ .

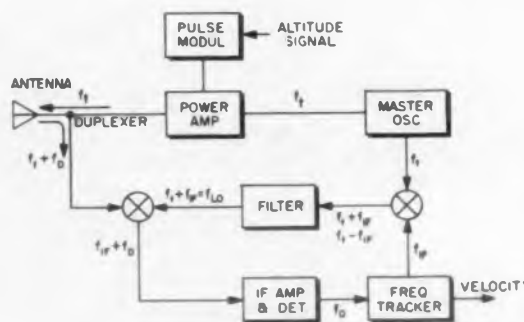

Fig. 4. lcw Doppler combines pulsed transmission with variable prf to eliminate altitude holes and signal leakage. For any given prf there exist round trip times that coincide with the intervals during which the receiver is off. These are avoided by decreasing the prf in discrete steps as the altitude increases. An intermediate frequency detection system is then employed to determine the Doppler shift.

Table 2. Doppler Modulation Technique Applicability

Class of Air or Space Vehicle	Medium Altitude, Low Maneuverability	High Altitude, Medium Maneuverability	Low-Medium Altitude, High Maneuverability	Extremely High Altitude, High Maneuverability
Examples	Commercial & Military Jet Transports	Fighters, Bombers Reconnaissance A/C	Helicopters V/STOL	Space Vehicles Space Probes
Applicable Criteria (See Text)	None	A, E, G, H	B, C, D, E, F, G, H	A, B, C, D, E, F, G, H
Doppler Modulation Technique				
Cw	X		X	
Self-Coherent Pulse	X	X		
Fm/Cw	X			
lcw	X	X	X	X

tenna beam which, though small, is enough to assure some output from the mixer at all times.

On the other hand, signal-to-noise ratio at some altitudes may be too small for reliable operation unless the antenna beam width is intentionally made quite large. Nevertheless, no reasonable amount of beam spreading will eliminate the lowest altitude hole extending from zero upward. Here, an advantage of the system, i.e., no interference from the near environment, works to its disadvantage. There is no recourse to such methods as transmit-receive overlap.

Interrupted cw ( $\approx 50$  per cent transmit-receive duty-cycle) modulation employs time duplexing to avoid the leakage problem of the space-duplexed cw and coherency to avoid the velocity sensing problems of the self-coherent pulse system. Altitude holes are also eliminated.

These advantages are accompanied by a moderate increase in complexity and some reduction of signal efficiency. A local oscillator signal coherent with the transmitted pulse is provided during the receiving interval.

The transmitter pulse-repetition-frequency is varied with altitude so that a signal return will not occur when the receiver is off. Altitude holes are thus avoided.

The prf may be halved each time the altitude doubles. Transition altitudes are selected so that at least half of the received signal occurs when the receiver is on.

lcw Dopplers provide constant receiver output level, from 0 altitude up to the altitude at which the selected prf is optimum. This characteristic significantly reduces errors caused by backscatter from nearby clouds and rain.

The low-altitude hole occurring when round-trip time is insufficient to delay the transmitted pulse into the receiver "on" time is circumvented by resorting to short term ( $\approx 5$  per cent of transmitted pulse duration) simultaneous transmission and reception. This is not as troublesome as in the cw case for, at low altitudes, the return signal strength is high and the signal leakage problem is more easily dealt with.

Working against narrow band receiver thermal noise levels, an lcw system achieves noise figures as low as 10 db, enabling use of peak transmitting power levels of 1 to 3 w at 70,000 ft.



In selecting a Doppler modulation system for a given application, one or more of the following criteria may apply:

- A. Must performance be optimum over a large range of altitudes?
- B. Is operation to 0 altitudes essential?
- C. Is 0 velocity demanded?
- D. Is a knowledge of velocity sense needed?
- E. Is vertical velocity required?
- F. Is high dynamic response necessary for hovering control?
- G. Must operation remain unimpaired under unusual pitch and/or roll?
- H. Are installation requirements extreme? (available space for antenna aperture, vibration levels, etc.)

Table II indicates how the several Doppler systems can best be combined with actual vehicles. The vehicle in which the Doppler equipment is to be used may belong to any of four classes as defined in the table.

For the first class, consisting of medium-altitude, low-maneuverability aircraft such as commercial or military jet transports, all four types of modulation systems will perform satisfactorily. In practice, self-coherent pulse and fm/cw Dopplers are preferred because of somewhat lower cost.

In the high-altitude, medium-maneuverability class, encompassing many fighters, bombers and reconnaissance aircraft, cw Doppler, while used in some instances, is apt to be ruled out at altitudes above, say, 50,000 ft. Self-coherent pulse and fm/cw Dopplers have been used here, though their performance at very low altitudes may disqualify them for airplanes that may also be called upon to fly sustained low-altitude missions. Total coverage of all possible operational altitudes is likely to be best met by an icw Doppler.

Helicopters and V/STOL (Vertical/Short Take-Off and Landing) vehicles commonly employ cw or icw Dopplers. Low-altitude holes limit the use of self-coherent pulsed and fm/cw systems. The icw system may offer some advantage over cw Dopplers in performance near 0 velocity and at negative velocities.

Space vehicles and probes will likely employ icw modulation because of its favorable signal-to-noise ratio and high altitude capability. For short range terminal guidance in planetary landings, however, cw Doppler may also prove satisfactory. ■ ■

# FOR THE FIRST TIME... AT WESCON!



**ALSO TO BE  
SEEN AT  
WESCON:**

Sierra Model 186B 50-ohm Coaxial Water Load, dc to 4000 mc, 1000 W av., 10,000 W peak  
Sierra Model 125B-CR Frequency Selective VM, with provision for carrier reinsertion  
Sierra Model 125B-Y with front-panel 20-pin connector, expanded input circuitry for carrier rack fast patch

*Don't miss the Sierra Instrumentation at Wescon! Booth 2006-8, Main Floor*

## Sierra introduces 3 versatile new instruments:

### Model 126A Two-Band Frequency Selective Voltmeter

Here's new broad frequency coverage, 5 to 1,620 kc in two bands, in a continuously tuneable frequency selective voltmeter that offers



- Dual selectivity, 250 or 2,500 cps
- Level ranges, -90 to +32 dbm
- Three bridging inputs, 75, 135 and 600 ohms
- Two-speed dial drive for extra convenience
- Crystal Controlled calibration oscillator
- Sierra reliability and rugged, modular construction

### Plus REAL convenience with the new Model 127A Solid State Frequency Selective VM!

You can see it at WESCON: The new solid state Model 127A Frequency Selective Voltmeter, 2 to 350 kc, — only 7 $\frac{3}{4}$ " x 7 $\frac{3}{4}$ " x 13"! It weighs less than 15 lbs.! It's completely portable with rechargeable battery pack! 250 cycle selectivity with audio monitoring capability, measures -80 to +22 dbm. You have to see it to believe it!

### Model 160-1200 Coaxial Load

There's remarkable versatility in this new three-way coaxial termination... Sierra Model 160-1200. Power capacity to 1200 watts in standard form, to 2000 watts with accessory air cooler, to 3000 watts with accessory water cooler. Both accessories are easily attached, can be delivered with the termination... or order the power capacity you need now, expand it later. 0 to 1000 mc, low VSWR, may be ordered with Type N, HN or LC connectors.

**sierra SIERRA ELECTRONIC CORPORATION**

A Division of Philco Corporation  
7306K BOHANNON DRIVE • DAVENPORT 6-2060 • AREA CODE 415 • MENLO PARK, CALIF., U. S. A.  
Sales representatives in all major areas  
Canada: Atlas Instrument Corporation, Ltd., Montreal, Ottawa, Toronto, Vancouver  
Export: Frazar & Hansen, Ltd., San Francisco

CIRCLE 158 ON READER-SERVICE CARD



**NEWS! API NOW HAS A CONTINUOUS READING METER-RELAY.** No signal-sampling interrupters necessary. The CRMR indicates continuously, controls continuously, resets automatically. Built around an unrestrained D'Arsonval movement, it will monitor and control any variable translatable to analogous voltage or current values. Sensitive enough to operate on inputs as small as 5 millivolts or 10 microamps full scale, it will accept low-level signals without amplification. Compact as a panel meter, it needs only a power supply and load relay (both of which API can furnish) to make a complete little control system. Or, you can build it into an equipment control network. Bulletin S-2-1 will give you details on operation, along with specifications and price information. A copy is yours for the asking.



**ASSEMBLY PRODUCTS, INC.**

CHESTERLAND 17, OHIO



SA 2976

CIRCLE 162 ON READER-SERVICE CARD



# Microwave Power Meter

## Accurate Within $\pm 0.5\%$



**D**IRECT-READING microwave power meter model 450 provides measurement accurate within  $\pm 0.5$  per cent of full scale on all scale ranges. Measurements may be made continuously over the range from  $0.5 \mu\text{W}$  to 10 mw. The high accuracy results from the use of a precision constant-current dc power source and a self-contained potentiometric system of measurements.

Made by General Microwave Corp., 47 Gazza Blvd., Farmingdale, N. Y., the meter exhibits a stability of better than 2 ppm per deg C over a wide

temperature range when used with the firm's 402 series of temperature-compensated coaxial and waveguide thermistor mounts. The coaxial series operates from 0.01 to 10 Gc, the waveguide mounts from 2.6 to 18.0 Gc. The meter may be used with any 100- or 200-ohm uncompensated detector, if some degradation in performance due to thermal drift can be tolerated.

Five scale ranges are provided with full-scale readings of 0.1, 0.3, 1.0, 3.0, and 10.0 mw. Corresponding scales are calibrated in decibels from  $-30$  to  $+10$  dbm. The 12-in. scale yields a resolution of  $0.1 \mu\text{W}$  on the lowest range. Instruments are calibrated against dc transfer standards with certification traceable to NBS, and may easily be recalibrated by the user.

The accuracy obtainable by use of dc replacement power is combined with the direct-reading feature as shown in the diagram. The rf bridge network is supplied with power from both a dc constant-current supply and an adjustable ac bias supply. With these two independent and noncoherent sources, dc power can initially be kept at a fixed value and the barretter brought to its proper operating resistance (100 or 200 ohms) with the adjustable ac power. Any change

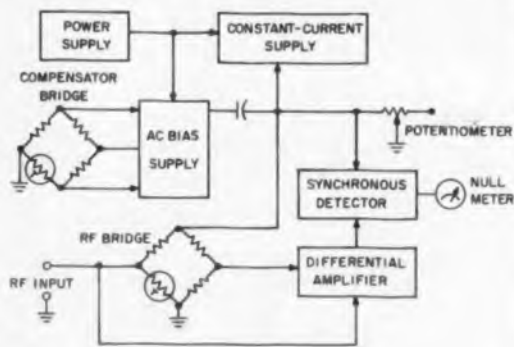

in dc power in the bridge which the operator may later effect with the potentiometer is then directly measurable.

In operation, the dc power level in the barretter is selected with the power range switch. The bridge is then applied and the dc power reduced to rebalance the bridge. The change in that dc power, which is equal to the rf power, is then read directly from the potentiometer dial.

To sense the bridge balance a sensitive differential amplifier and a synchronous detector circuit are used. This arrangement converts the low-level ac unbalance across the bridge to a dc current applied to the center-zero null meter.

Barretter sensitivity to ambient temperature changes is compensated by a dual-bridge system. The compensating bridge contains a thermistor whose characteristics parallel those of the rf thermistor. This thermistor is housed in close proximity to the rf thermistor so that it responds almost identically to environmental influences but is shielded from rf effects. A temperature variation in the compensating thermistor will produce a change in the ac bias power fed to the rf bridge, maintaining balance. When uncompensated detector mounts are used, a self-contained thermistor is switched into the compensating bridge network.

The model 450 is 7-1/2 in. wide, 11-1/2 in. high, and 14 in. deep. Weight is 18 lb. It is available off the shelf, price \$495.

For more information on this precision microwave power meter, turn to the Reader-Service Card and circle 259.

# ALFRED ELECTRONICS

*\* First in  
quality.  
broadband  
microwave  
instrumentation*



Testing insertion characteristics of X-band filter with Alfred Swept Generator which consists of Alfred Microwave Oscillator and Alfred Microwave Leveler. This combination electronically sweeps frequency linearly with respect to time while maintaining RF power virtually constant across the band.

#### MICROWAVE SWEEP GENERATORS

Still the industry's most advanced oscillators. Series 620 single band models and Model 605 use convenient plug-in generator heads covering 1-26.5 kmc. Models 6001B-6004C provide 1 watt output, electronically swept or stable single frequency, 1-12 kmc.

Features include built-in leveler and narrow band symmetrical sweep, adjustable frequency markers, and Quick Look readout. Drift, less than  $\pm 0.02\%$  per hour; residual FM, less than  $\pm 0.0025\%$  peak.

These units save valuable engineering time by providing constant RF power input to microwave tubes and other components under test. With constant input, variations in output indicate directly component transfer characteristics. Microwave properties are examined over continuous spectrum, assuring accuracy during broad or narrow band testing. Prices: Model 620 series, \$2,890-3,340; Model 605, \$1,750; Generator Heads, \$1,500-1,990; Model 6001B-6004C, \$7,250-8,690.

#### MICROWAVE LEVELERS

Ideal instruments for maintaining constant power output ( $\pm 1$  db) with long term stability. CW or square wave modulation. Fast response, very high gain assure flat RF output from BWO's. Also available: Model 700 leveler amplifier, which may be used with external RF components. Prices: Microwave Levelers, \$875-990; Model 700, \$575.

#### MICROWAVE AMPLIFIERS

Alfred manufactures microwave amplifiers for virtually every requirement — general purpose, medium power, high gain, and low to medium noise figure. All models feature low spurious modulation and stable operation. General purpose amplifiers provide 30 db gain and 10 mw power output with 25 db noise figure. Medium power models offer power up to 10 watts. High power amplifiers provide up to 1 Kw pulse power. Low noise amplifiers provide noise figure from 6 to 15 db at frequencies from .5 to 12 kmc.

In addition to standard amplifiers, Alfred offers periodic or permanent magnet focused amplifiers where light weight and low input power is required as well as amplifiers designed specifically for phase modulation. Prices: General purpose amplifiers, \$1,490-1,690; Medium power amplifiers, \$1,550-3,590; Low noise amplifiers, \$3,150-4,990.

#### POWER SUPPLIES

Alfred furnishes four basic types of power supplies. Model 250 Traveling Wave Tube Supply operates low and moderate power traveling wave ampli-

fier and oscillator tubes. This instrument provides all normal sources — helix, collector, four separate anodes, grid, heater, solenoid and blower — from one compact unit.

Microwave Power Supplies Model 252, with the unregulated and regulated solenoid supplies Model 253 and 254, operate all presently known low and medium noise figure TW tubes. Model 252 furnishes electrode and heater power for permanent magnet focused TW tubes. Electromagnet focused TW tubes require in addition either Model 253 or 254 solenoid supply. Alfred's Sweeping Power Supplies serve as general purpose sources for either electronically swept or fixed frequency operation of voltage tuned magnetrons, BWO's and similar microwave tubes. Alfred's floating high voltage supplies provide extremely stable and highly regulated DC voltages, featuring wide voltage and current ranges, very small ripple and accurate voltage adjustment. Prices: Model 250, \$1,990; Models 252, \$890; 253, \$300; 254, \$400; Sweeping Power Supplies, \$1,650-1,690; High Voltage Supplies, \$690-1,090.

Free catalog available. Write to:

## ALFRED ELECTRONICS

897 Commercial Street • Palo Alto, California

Phone: DAVenport 6-6496

\*SEE US AT  
WESCON  
BOOTH 1412

CIRCLE 163 ON READER-SERVICE CARD

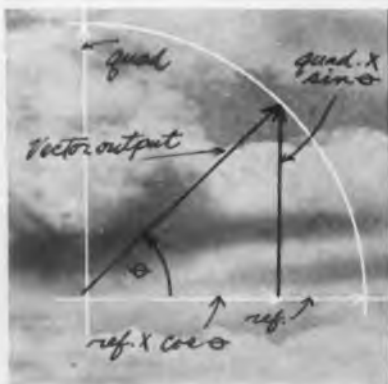

## GERTSCH VARIABLE PHASE STANDARD

--permits shifting of phase between  
2 self-generated voltages to any desired  
angle, with accuracy better than  $\pm .05^\circ$

**Precise generation of voltage vectors.** The Gertsch VPS-1 generates 2 signals differing in phase by any angle from  $0^\circ$  to  $360^\circ$ , as determined by front-panel controls. The reference signal has a fixed amplitude of 50V rms. The vector output, which may be displaced in phase, has a maximum amplitude of 50V rms, and can be attenuated in steps of 50 mv within a range of 0-50V rms.

**Operation at any 3 frequencies** within a range of 150-3000 cps is provided by a front panel selector switch. Fine adjust control permits varying the frequencies  $\pm 5\%$  max.

**Completely self-contained-unit** requires no accessories for operation. Case or rack mounted. Send for literature VPS-1.

# —Gertsch—

**GERTSCH PRODUCTS, Inc.,**

3211 South La Cienega Boulevard, Los Angeles 16, California / UPTon 0-2761 - VErmont 9-2201

See us at Wescon Show Booth No. 1602-04

CIRCLE 164 ON READER-SERVICE CARD



MICROWAVES

# MICROWAVE PRODUCTS

## Frequency Meter

510

Direct-reading frequency meter model S60-13, used from 7.5 to 9.6 Gc, offers continuous high resolution with 1 mc as the least dial division. Accuracy of  $\pm 1$  mc is maintained from +32 to +85 F. High-Q resonant cavity is tuned by a noncontacting choke plunger.

FXR, Inc., Dept. ED, 25-26 50th St., Woodside 77, N. Y.

*P&A: On request; 60 to 90 days.*

See at Show Booth 220-22.



## Backward-Wave Oscillators

511

Compact, lightweight backward-wave oscillators QKB890 (12.4 to 18 Gc) and QKB891 (18 to 26.5 Gc) are rated at 20 mw min output power, and have a control grid for low-voltage pulsed applications. Both feature permanent-magnet focusing, and may be mounted with a spacing of 2 in. between tubes. The metal-ceramic tubes are useful as swept local oscillators, and as pump tubes for parametric amplifiers. Military requirements are met.

Raytheon Co., Microwave and Power Tube Div., Dept. ED, Foundry Ave., Waltham 54, Mass.

See at Show Booth 3410-12.



### Broadband Ferrite Circulators 512

Rapid tuning over octave bandwidths is provided by this line of ferrite circulators. Models 2395-T through 2398-T cover 0.4 to 7 Gc in four units. Bandwidths range from 50 to 250 mc. Insertion loss is 0.5 db max, isolation 18 db min in all models. The vswr is 1.25:1 max. Average power rating is 100 w, peak 5 kw.

The Narda Microwave Corp., Dept. ED, 118-160 Herricks Doad, Mineola, N. Y.

**P&A:** \$370 to \$450; 120 days.

See at Show Booth 2407-09.



### Synchroscope/Spectrum Analyzer 514

Complete signal analysis, am, fm or pulse, as a function of time and as a function of frequency is provided by model TSA-S synchroscope and spectrum analyzer. Plug-in tuning units span 10 mc to 44 Gc in five models. Resolution is 5 kc to 5 mc.

Polarad Electronics Corp., Dept. ED, 43-20 34th St., Long Island City 1, N. Y.

**P&A:** DU-3A, \$2,685; tuning units \$1,590 to \$2,650; 30 days.

See at Show Booth 1911-13.

# New!

# SPERRY *Microline*®



## MULTIHOLE

# Couplers

- HIGH DIRECTIVITY
- MINIMUM COUPLING VARIATION
- CONVENIENT SECONDARY H-PLANE ARM

● Microline Multiholes are precision directional couplers characterized by flatness of coupling and high directivity over broad frequency ranges. These characteristics especially adapt them for broadband matching, reflection measurements and isolation of signal sources. Microline Multiholes may also be utilized as fixed attenuators.

Available in 3, 10 and 20 db coupling values, the Microline 45( )1 couplers cover the range of 2.6 to 40. Gc in eight waveguide sizes. The secondary arm of each coupler is an H-plane bend terminated in a standard flange.

#### SPECIFICATIONS

*Model	Frequency Gc	W/G Type & Flange	**Mean Coupling Accuracy (db)	Min Directivity (db)	***Input VSWR Max.	Price *
45S1	2.6 - 3.95	WR-284 UG-53/U	±0.4	40	1.05	\$375.00
45C1	3.95 - 5.85	WR-187 UG-149A/U	±0.4	40	1.05	250.00
45G1	5.85 - 8.2	WR-137 UG-344/U	±0.4	40	1.05	140.00
45H1	7.05 - 10.0	WR-112 UG-51/U	±0.4	40	1.05	120.00
45K1	8.2 - 12.4	WR-90 UG-39/U	±0.4	40	1.05	100.00
45U1	12.4 - 18.0	WR-62 UG-419/U	±0.4	40	1.05	115.00
45K1	18.0 - 26.5	WR-42 UG-425/U	±0.7	40	1.05	175.00
45V1	26.5 - 40.0	WR-28 UG-381/U	±0.7	40	1.05	200.00

\* When ordering, specify coupling by suffix number, eg 10 db X band unit is Model 45X1-10

\* The mean coupling is the average of the maximum and minimum coupling values over the frequency range. The variation in coupling over the frequency range is within ±0.5 db of the mean coupling.

\* Values given are for the 10 db and 20 db couplers. Input VSWR of the 3 db couplers is 1.10 max.

See it in operation at

**WESCON BOOTH**

Nos. 3111, 3113, 3115, 3117, 3119, 3121

# SPERRY

SPERRY MICROWAVE ELECTRONICS COMPANY, CLEARWATER, FLORIDA • DIVISION OF SPERRY RAND CORPORATION  
Microline Instruments • Radar Test Sets • Systems Instrumentation • Solid State Devices and Materials • Microwave Components and Antennas

CIRCLE 165 ON READER-SERVICE CARD



MICROWAVES  
PRODUCTS AT WESCON

### Sweep Generator 623



Plug-in oscillators on the model MS-2000 sweep generator cover frequency ranges from audio to 3 Gc. Microwave and vhf heads are tuned over a 2:1 range about center frequency, and are swept at a 50- to 60-cycle rate. Low-frequency heads are swept electronically at any rate from 0.01 to 100 cps. Ranges up to 1,250 mc may be attenuated in 1 db steps to 60 db.

Telonic Industries, Inc., Dept. ED, Beech Grove, Ind.  
See at Show Booth 2813-15.

### Receiver 625



Unmanned-aircraft receiver has 10 channels. Designated type BCR-47A, the instrument is crystal controlled for fm operation between 406 and 550 mc. Six channels can be used simultaneously with a  $\pm 20$  kc deviation per channel. Each channel operates a 2-amp spst relay. Made for missile-target aircraft, unit is all solid-state.

Babcock Electronics Corp., Dept. ED, 1640 Monrovia Ave., Costa Mesa, Calif.

See at Show Booth 312.

### FM Signal Generator 523



Continuously tunable fm signal generator model 1001 operates



ALL CERAMIC AND METAL X-BAND MAGNETRON provides 250 kW power at 8,500-9,600 Mc. Available in mechanically and hydraulically tuned models, QKH 1000 and QKH 1001.



EXTREMELY RUGGED K-BAND KLYSTRONS have very low microphonics, excellent thermal stability. QKK 923 for 23.5-24.5 and QKK 834 for 34.0-35.6 kMc.



PHASE STABILITY AND HIGH EFFICIENCY are features of Raytheon designed high-power amplifier chains for sophisticated search and track radar applications. Chain shown is one example of Raytheon's ability to supply microwave tubes, ferrite devices and magnetic components in a completely integrated package.



LIGHTWEIGHT X-BAND BWO is electrostatically focused, ideal for voltage tunable applications. QKB 830 covers 8.5 to 9.6 Mc range.



NEWEST ELECTRONICALLY TUNED BWO's have 40 mW minimum power output; are half the size and weight of their predecessors. QKB 890 for 12.4-18 and QKB 891 for 18-26.5 kMc.

### OTHER RAYTHEON MICROWAVE TUBES TO BE FEATURED AT WESCON

- 100 kw coaxial L-band Amplitron® for phased arrays, QKS 1012
- Miniature ten-watt cw S-band Amplitron for space telemetry, QKS 997
- 2.5 kW three-cavity power amplifier klystron for cw radar, QKK 809
- Experimental X-band high-ambient-temperature magnetron, QR 933
- Reflex klystron that extends millimeter band coverage to 120 kMc, QKK 971
- Rugged miniature magnetron for missile beacon transponders, QKH 821

®Raytheon Trademark



# RAYTHEON at WESCON puts emphasis on AEROSPACE MICROWAVE TUBES

Raytheon has been moving fast to break the bottleneck in the development and production of new microwave tubes for aerospace systems. WESCON engineers will see the evidence of this as a variety of new tubes for airborne, space and missile applications are introduced at WESCON.

Whether or not you plan to visit San Francisco, you'll want to skim the opposite page

*See us at WESCON — Booth 3410-3412*

for tubes that will answer your aerospace systems needs . . . then let us know where to send the appropriate information bulletins.

WRITE TODAY, SPECIFYING TUBES that interest you, or tell us about your particular microwave problem. Address Microwave and Power Tube Division, Raytheon Company, Waltham 54, Massachusetts. In Canada: Waterloo, Ontario.



RAYTHEON COMPANY

MICROWAVE AND POWER TUBE DIVISION

## MICROWAVES

from 400 to 550 mc. Modulation is controllable over 0 to 35 kc and 0 to 350 kc  $\pm 5\%$ . Output is 0.25  $\mu\text{v}$  to 0.1 v into 50 ohms, calibrated to  $\pm 1$  db. Frequency drift is 0.015% per hr; dial calibration accuracy is  $\pm 0.5\%$ . Three plug-in oscillators give frequency check.

R S Electronics Corp., Dept. ED, P. O. Box 11368, Station A, Palo Alto, Calif.

See at Show Booth 3322.

## Traveling Wave Tube 522



Made for relay links, type GKW-928 periodic-permanent magnet focused traveling wave tube operates from 5,925 to 7,125 mc. Minimum saturated power output is 12 w. Small signal gain is 36 db. Tube is said to have excellent vswr characteristics. It is of rugged metal-ceramic construction, and creates low external magnetic fields.

Microwave and Power Tube Div., Raytheon Co., Dept. ED, Foundry Ave., Waltham 54, Mass.

See at Show Booth 3410-12.

## RFI Equipment 624



The 1- to 10-Gc spectrum is covered by model NM-62A radio interference-field intensity measuring equipment. Device consists of a calibrated microvoltmeter and receiver. Impulse bandwidth is 0.5 and 5 mc, with minimum sensitivity of 12 and 5.5  $\mu\text{v}$  respectively.

Stoddart Aircraft Radio Co., Dept. ED, 6644 Santa Monica Blvd., Hollywood 38, Calif.

P&A: \$17,750 less antennas; from stock in April, 1962.

See at Show Booth 205.



MICROWAVES

PRODUCTS AT WESCON

### Transistor

516



Micro alloy diffused-base transistor has a typical power gain of 10 db at 1 Gc. Housed in a coaxial package, unit is designed to be used as a uhf amplifier.

Philco Corp., Lansdale Div., Dept. ED, Church Rd., Lansdale, Pa.

See at Show Booth 919-21.

### Waveguide Seals

520



Positive fluid sealing provided by Electr-O-Seals, prevents rf leakage, burning, and arcing. They fit standard EIA guides and are reusable.

Parker Seal Co., Dept. ED, 10567 W. Jefferson Blvd., Culver City, Calif.

See at Show Booth 4828.

### Coaxial Connectors

515



Weatherproof three-pin bayonet connectors are rated at 500 v rms, sea level. Characteristic impedance is 50 ohms to 10 Gc. Operating temperature range is -65 to +260 F. Metal parts are brass, with gold over silver plate. Series designation is TPS.

General RF Fittings, Inc., Dept. ED, 702 Beacon St., Boston 16, Mass.

P&A: \$2 to \$10; stock.

See at Show Booth 314.



A 4.0  
V



# ONLY POLARAD CAN 4,000 mc BANDWIDTH VISUAL MICROWAVE



Polarad takes another giant stride in advancing the state of the art for microwave research and development—you can now observe a complete 4,000 mc bandwidth on *one scope, at one time*, with the new Model WSA Wide Band Spectrum Analyzer.

**Here's the value to microwave engineers.** To see the *entire* tuning range of transmitters, generators and all other broadband devices, just push one appropriate band selection button—*no tracking, no further tuning.*

**Here's the value in RFI work.** Because you can view a wide band of frequencies at one time, you can see interfering signals instantly. And by switching over to narrow band analysis, the exact nature of the signal can be determined—an aid in compiling a "spectrum signature."

Model WSA joins the most comprehensive line of visual microwave analysis equipment available today.

## SPECIFICATIONS MODEL WSA

### Frequency Range

10 mc to 40,000 mc in 20 Bands

### Band Selection

Automatic; with illuminated pushbuttons

### Dispersion

Narrow Band: 1 mc to 25 mc.

Wide Band: 50 mc to 4,000 mc.

### Resolution.....

Narrow Band: 20 kc

Wide Band: 1.5 mc

### I-F Frequencies

8,200 mc, 3,600 mc, 1,000 mc, 160 mc, depending on band selection.

### High Intermediate Frequency

Assures image rejection and prevents video detection.

# DISPLAY FOR ANALYSIS

## Which of these Polarad Microwave Spectrum Analyzers solves your problem?

From 10 to 100,000 mc, Polarad offers spectrum analyzers for every aspect of microwave research and development. Thousands of the instruments shown here are in use today throughout the electronics industry—in laboratories, on the production line, in systems, out in the field and at research centers.

Ask your Polarad representative to work with you in selecting the equipment that will most efficiently accomplish your objectives.

### ALL POLARAD SPECTRUM ANALYZERS FEATURE:

- 1 to 30 cps adjustable sweep rate
- Direct-reading UNIDIAL® tuning control, with no klystron modes to set
- High accuracy, resolution and sensitivity
- Non-contacting klystron cavity chokes for noiseless tuning
- Provision for use with Multi-pulse Spectrum Decoder (Model SD-1)

### UNIVERSAL OPERATION?

#### Self-Contained Units Cover

10 to 40,880 mc

#### MODEL SA-84

- Dispersion: 10 to 35 mc: 500 kc to 5 mc, adjustable
- 35 to 40,880 mc: 500 kc to 25 mc, adjustable
- Resolution: 20 kc
- Internal Marker: variable

#### MODEL SA-84W

- Wide Dispersion: 10 mc to 240 mc: 10 mc to 240 mc to 40,880 mc: 80 mc
- Resolution: 2 kc to 80 kc variable
- Crystal controlled markers from 10 to 40,880 mc
- Log-linear display
- Accurately calibrated IF attenuator

### TRANSISTORIZED MOBILITY?

#### MODEL SA-84T

Single Unit Covers

10 to 40,880 mc

- Dispersion: 500 kc to 25 mc, adjustable
- Resolution: 20 kc at all frequencies
- Internal Marker:  $\pm 13$  mc
- Power Consumption: when battery operated, 110 watts, 12 vdc
- Sensitivity:  $-50$  to  $-105$  dbm, depending on frequency.
- Weight: 70 lbs. One half the weight of conventional vacuum-tube equivalent
- Meets MIL-1-26500 for r-f interference

### STANDARD OPERATION?

#### MODEL TSA

10 to 44,000 mc in 5 Plug-In Tuning Units

- Dispersion: 400 kc to 25 mc
- Resolution: 2 to 80 kc variable
- Attenuation: Continually variable
- Sensitivity:  $-50$  to  $-95$  dbm, depending on frequency
- Internal Marker:  $\pm 14$  mc

### TIME AND FREQUENCY DISPLAY?

#### MODEL TSA-S SYNCHROSCOPE ANALYZER

10 to 44,000 mc in 5 Plug-In Tuning Units

- Bandwidth: 5 kc, 50 kc, 500 kc, 5 mc
- Synchroscope sweep rate: 2, 10, 100, 1,000, 10,000, and 100,000  $\mu$  sec per screen diameter.
- Dispersion, Sensitivity and Internal Marker same as TSA.

### WIDE DISPERSION?

#### MODEL TSA-W

Narrow And Wide Pulse Analysis

10 to 44,000 mc in 5 Plug-In Tuning Units

- Dispersion: 200 kc to 80 mc (2 ranges)
- 80 mc dispersion displays pulses narrow as 0.1  $\mu$  sec. For wide pulses, dispersion may be adjusted down to 200 kc
- Resolution: 2 to 80 kc variable
- Internal Marker:  $\pm 40$  mc
- Screen Display: Linear or log

### ULTRA-BROAD BAND?

#### MODEL WSA

Self-Contained Unit Covers

10 to 40,000 mc in 20 Bands

- Dispersion: 1 mc to 25 mc in narrow band, 50 mc to 4000 mc in wide band
- Resolution: 20 kc in narrow band; 1.5 mc in wide band
- Rapid band selection by means of illuminated push-button switches
- Frequency difference marker up to 4000 mc.
- Sensitivity:  $-50$  to  $-80$  dbm, depending on frequency

### EXTENDED FREQUENCY?

#### MODEL DA-70

50,000 mc to 100,000 mc

in Three Bands

- Dispersion: Continuously adjustable from 50 mc to 1000 mc. Permits narrow pulse inspection.
- Resolution: 1 mc
- High intermediate frequency assures image rejection and prevents video detection.
- Dial Frequency Accuracy:  $\pm 1.0\%$
- Nominal Sensitivity:  $-50$  dbm for entire frequency range.

### SPECTRUM SELECTOR?

#### MODEL SD-1

MULTI-PULSE SPECTRUM SELECTOR

Permits spectrum analysis of individual microwave pulses in a pulse group when used with any Polarad Spectrum Analyzer. Any pulse in a complex coded signal may be isolated for examination.



## MICROWAVES

### Spectrum Tape Recorder

521



Video and audio channels can be recorded or played back simultaneously with the model TRS transistorized spectrum tape recorder. Machine handles 3,600 ft of 1/4 in. tape at 15 ips. Video output is 0 to 8 v; source impedance is less than 1 K; signal-noise ratio is 45 db.

Polarad Electronics Corp., Dept. ED, 43-20 34th St., Long Island City 1, N. Y.

See at Show Booth 1911-13.

### Klystron

400

This cw amplifier klystron, series VA-851, provides 2.5 kw min cw power from 10.00 to 10.55 Gc with low noise contributions. Each tube tunes over a 250-mc range. Device is water-cooled, ppm-focused, measures 6-3/4 x 10-1/4 x 11 in., and weighs 30 lb. Cathode, impregnated tungsten, is said to have long life.

Varian Associates, Dept. ED, 611 Hansen Way, Palo Alto, Calif.

See at Show Booth 2009-17.

### Bidirectional Coupler

517



Resistive loop coupler, model S61-2 is for use with L-band waveguide WR-650. Designed for power and vswr monitoring, it can be used in waveguides pressurized to 30 lb, carrying 15 kw average and 10 megawatts peak power. Coupling value is  $45 \pm 0.5$  db including frequency sensitivity over a 10% band.

FXR, Inc., Dept. ED, 25-26 50th St., Woodside 77, N. Y.

P&A: Approximately \$1,200; 60 to 90 days.

See at Show Booth 220-22.

# POLARAD

## ELECTRONICS CORPORATION

43-20 34th Street • Long Island City 1, New York

FREE LIFETIME  
SERVICE

DURING WESCON  
VISIT US AT BOOTH  
1911-1913

CIRCLE 167 ON READER-SERVICE CARD

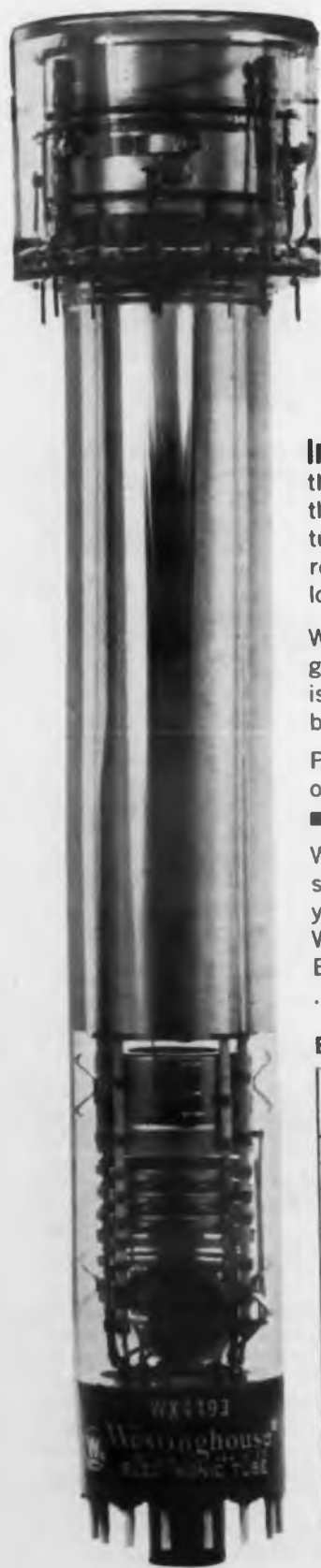

**In ruggedized and long-life image orthicons** Westinghouse leads the industry. Development contract work, continuous since 1953, resulted in the first truly ruggedized orthicon WL 7198. The latest version of this same tube, WX 4493, provides a special S-20 photo cathode that extends the red response, and a rugged thin film storage target that enhances sensitivity for low-light level applications.

Westinghouse also developed the WL 7611—the first image orthicon with a glass target that minimizes sticking and increases life expectancy. This tube is the first in the industry to be warranted for 1000 hours, and tubes have been recorded operating satisfactorily after 7000 hours in field applications.

Present development work includes: ■ image intensifier orthicons. ■ fiber optic inputs. ■ ultraviolet and infrared sensitive tubes. ■ field mesh tubes. ■ higher resolution capabilities.

Whether your application is standard or special, write on your Company letterhead to: Westinghouse Electric Corp., Elmira, N.Y. You can be sure . . . if it's Westinghouse.



#### Examples of Westinghouse image orthicon design capabilities

TUBE TYPE	MAXIMUM VOLTAGE RATINGS <sup>r</sup>		MAXIMUM ILLUMINATION FOR		SPECTRAL RESPONSE		SPECIAL FEATURES AND COMMENTS <sup>Δ</sup>
	ANODE VOLTS	PHOTOCATHODE VOLTS	200 TV LINES	400 TV LINES	PEAK A*	1% A*	
WL-5820	1350	-550	$7 \times 10^{-5}$	$5 \times 10^{-4}$	4500	7500	Standard I.O. used for TV broadcast.
WL-6849	1350	-550	$3 \times 10^{-5}$	$5 \times 10^{-4}$	4500	7500	Wide spaced 5820
WL-7198	1350	-550	$3 \times 10^{-5}$	$5 \times 10^{-4}$	4500	7500	Ruggedized 5820 (will meet environmental conditions per MIL-5272A)
WL-7611	1360	-550	$7 \times 10^{-5}$	$5 \times 10^{-4}$	4500	7500	Direct replacement for 5820 with long-life target essentially free of image retention and target burn throughout life.
WX-4299	2200	1st. —20,000 2nd. —800	$5 \times 10^{-6}$	$2.8 \times 10^{-7}$	4250	8250	Ruggedized image intensifier I.O. 6 Dynodes—factor of 700 more sensitive at low light level than 5820.
WX-4322	1350	-550	$2.5 \times 10^{-6}$	$1.3 \times 10^{-5}$	4500	7500	Thin film target—factor of 10-15 more sensitive than 5820 at low-light levels.
WX-4323	1350	-550	$7 \times 10^{-7}$	$4 \times 10^{-6}$	4250	8250	Thin film target—S-20 (tr. alkali) photosurface—factor of 50 more sensitive than 5820 at low-light levels.
WX-4476	1850	-650	$2.5 \times 10^{-6}$	$1.3 \times 10^{-5}$	4500	7500	Ruggedized (capable of meeting WL-7198 specs)—thin film target factor of 10-15 more sensitive than 5820 at low-light levels.
WX-4493	1850	-650	$7 \times 10^{-7}$	$4 \times 10^{-6}$	4250	8250	Ruggedized (capable of meeting WL-7198 specs)—thin film target factor of 50 more sensitive than 5820 at low-light levels.

\*Design objectives.  
<sup>r</sup>All cathodes 6.3 volts, 0.5 amps. <sup>Δ</sup>Max. usable image diagonal 1.8 inches except WX-4299, which is 1.6 inches. Max. over-all length 15 7/16 inches except WX-4299 which is 23 1/2 inches. Max. tube diameter 3 1/16 inches except WX-4299, which is 2 1/2 inches.

CIRCLE 168 ON READER-SERVICE CARD



MICROWAVES PRODUCTS AT WESCON

#### Crystal Mixers

518



Coaxial XR series. Single-ended mixers cover 225 to 6 Gc in 7 overlapping frequency ranges. They are fixed tuned and require no rf adjustment over the specified frequency bands. Standard ceramic type crystals are used.

Microlab, Dept. ED, 570 W. Mount Pleasant Ave., Livingston, N. J.

P&A: \$120.00; from stock.

See at Show Booth 4306.

#### Calorimetric Power Meter

399

Using plug-in calorimeters power meter model N680 measures rf power from dc to 10 Gc. Nine ranges from 0.1 to 1,000 mw are available, accurate to 2%. Noise is less than 0.2  $\mu$ v, with a sensitivity of 51 to 130  $\mu$ v per mw of rf. Device, in a portable cabinet measuring 7-3/4 x 10-1/2 x 15 in., weighs 20 lb.

PRD Electronics, Inc., Dept. ED, 202 Tillary St., Brooklyn 1, N. Y.

P&A: \$1495.00; 60 to 90 days.

See at Show Booth 2109-10.

#### Impulse Generator

519



For portable use. Transistorized model IC-120 impulse generator has a frequency range of 1 kc to 10 Gc flat within  $\pm 1/2$  db. Pulse polarity is automatically reversed every second. Pulse width is 0.02 nsec; pulse train width is 0.06 nsec; pulse repetition rate is 1 kc, fixed internally. Output level is 710 to 7,100  $\mu$ v, adjustable.

Polarad Electronics Corp., Dept. ED, 43-20 34th St., Long Island City 1, N. Y.

See at Show Booth 1911-13.

ELECTRONIC DESIGN • August 2, 1961

## MICROWAVES

### Attenuator

586



**Multihole-coupler fixed microwave attenuator.** Attenuation is adjusted by displacing the hole patterns relative to one another and fixing the waveguides in position.

ITT Federal Laboratories, Dept. ED, Fort Wayne, Ind.

**Availability:** Six weeks or less.

### Coaxial Isolator

387



**Ferrite coaxial isolator C993-100-910** provides isolation of 70 db min over 5.0 to 5.9 Gc. Insertion loss is 2.0 db max, vswr 1.20:1 max. Weight is 3 lb. Type N female coaxial connectors are standard.

General Precision, Inc., Kearfott Div., Microwave Products, Dept. ED, 14844 Oxnard St., Van Nuys, Calif.

### Portable Power Source

513



300 to 600 of cw or modulated rf microwave power from 350 mc to 10.5 kmc can be provided by this portable power source. Designated model L-3653, the equipment accepts modulation frequencies from 50 to 5,000 cycles, and requires about 300 w into 500 ohms for 100% modulation at full power. The source was designed for high-power testing of microwave components and for driving high-power amplifier tubes.

Litton Industries, Electron Tube Div., Dept. ED, 960 Industrial Road, San Carlos, Calif.

## Tunable-X Band Filters

**MAXIMUM REJECTION • LOW INSERTION LOSS  
• DELIVERY FROM STOCK**

Now, Frequency Standards, world leader in microwave filter technology, introduces a new series of precision tunable bandpass filters covering the range of 7 to 12.5 Gc — assembled and delivered from stock in two weeks or less!

These filters feature a bandwidth of 8 to 12 mc at 3 db and 30 mc at 30 db with 2 db insertion loss... VSWR of 1.5 max. at  $F_0$ ... temperature stability of 3 cps/Mcs/°C maximum drift over wide temperature range... two direct-coupled  $TE_{111}$  mode cylindrical cavities with single tuning control... counterdial and calibration chart or slotted shaft adjustment. Price: \$398.00 each (less quantity discount).

Frequency Standard's 14 years of experience in the development and production of high performance microwave filters is available to you without obligation. Look into our capabilities for special preselectors with balanced mixer as well as low bandpass and band rejection filters for both high and low power applications. Write for Bulletin P-26102 or send specific bandwidth and other requirements to Department KF.

## FREQUENCY STANDARDS

A DIVISION OF HARVARD INDUSTRIES, INC.  
BOX 504 • ASBURY PARK, N. J. • PROSPECT 4-0500

Center for new ideas in microwave technology — Discriminators, Antenna Couplers, Diplexers, Wavemeters, Reference Cavities, Signal Sources, Directional Couplers, Antennas, Cavities

# ACCURATE RF POWER MEASUREMENTS

$\frac{1}{1000}$  - 100,000 WATTS  
AVERAGE POWER

CW - PULSE or ANY OTHER WAVEFORM  
with the MOST COMPLETE LINE of  
**CALORIMETRIC POWER METERS**  
in the Frequency Range of 1/10 - 12000 MC

**DIRECT  
READING  
Calorimeter  
Bridge**

**MODEL CB-31**  
ILLUSTRATED



FOUR SCALES with the following FULL SCALE DEFLECTIONS:  
1 Milliwatt, 10 Milliwatts, 100 Milliwatts, 1000 Milliwatts

ACCURACY: 1%—except in the 1 milliwatt range.  
DC-10 KMC • Input Impedance: 51.5 ohms

In this Calorimeter the R.F. power to be measured is compared to an accurately known D.C. power, by means of a null indicator and 260 thermocouples in 2 differential thermopiles, which sense the very low temperature rise of .0015 degrees C per milliwatt of the circulating fluid. This fluid is flowing at the rate of  $\frac{2}{3}$  of an ounce per minute.

Since R.F. power is compared to D.C. power, both of which will depend to an equal extent on the ambient temperature, the effect of the ambient temperature on this power measurement is cancelled out. The R.F. power is then read directly on a  $\frac{1}{4}\%$  D.C. millimeter, calibrated in milliwatts. The null indicator pointer is deflected  $\frac{1}{4}$ " by a power difference of 100 microwatts.

WRITE TODAY for COMPLETE INFORMATION

**Electro IMPULSE LABORATORY**

208 RIVER STREET • RED BANK, NEW JERSEY  
Phone: SHadyside 1-0404

CIRCLE 170 ON READER-SERVICE CARD



MICROWAVES PRODUCTS

## Traveling-Wave Tube

383



X-band traveling-wave tube LY 10 is capable of supplying 20 kw power, 30 w avg. The grid-modulated tube has 15% min bandwidth to 3-db points. Gain is 13 db min from 9 to 10 Gc.

Ferranti Electric Inc., Electronics Div., Dept. ED, Industrial Park No. 1, Plainview, N. Y.

## Backward-Wave Oscillator

695



Is electrostatically focused. Type QKB830 operates over a frequency range of 8.5 to 9.6 Gc with no mechanical tuning. Minimum power output is 10 mw. A control electrode is provided for low-voltage pulse or amplitude modulation. The lightweight tube is 6 in. long.

Raytheon Co., Microwave & Power Tube Div., Dept. ED, Foundry Ave., Waltham 54, Mass.

## Reflex Klystron

368



Producing 250 mw at 70 Gc, type VA-99 reflex klystron oscillator is for radar and communications systems applications. It is factory preset to the customers desired frequency, between 68.0 and 72.0 Gc. Provision is made for subsequent fine trimming to exact operating frequency.

Varian Associates, Tube Div., Dept. ED, 611 Hansen Way, Palo Alto, Calif.

Send for

**FREE**

new  
1961  
**EICO**  
Electronics  
Catalog



EICO, 3300 N. Blvd., L.I.C. 1, N. Y. ED-8  
 Send free 32-page catalog & dealer's name  
 Send new 36-page Guidebook to MI-FI for which I enclose 25¢ for postage & handling.

Name \_\_\_\_\_  
Address \_\_\_\_\_  
City \_\_\_\_\_ Zone \_\_\_\_\_ State \_\_\_\_\_

**EICO**

3300 N. Blvd. L.I.C. 1, N.Y.

praised by the experts  
as Best Buys in Electronics

Export Dept. Return Agencies Inc., 431 Greenwich St., New York 13, N. Y.

SEE US AT WESCON SHOW, BOOTH 22413  
CIRCLE 171 ON READER-SERVICE CARD

**NEW** — Higher Temperatures  
— Wider Range Resistances  
— Miniaturization...  $\frac{1}{2}$  to 10 watts

**OMI**

**MINIATURE PRECISION POWER RESISTORS**  
To Meet or Exceed Applicable Paragraphs of MIL-R-26

Designed to withstand the high reliability requirements of sophisticated circuitry, O.M.I. engineers and chemists have developed TEMP-COTE, a new, silicone base coating material, permitting the series T miniature precision power resistors to operate up to 350° C.

Improved winding techniques, and careful matching of materials render the series T resistors as the outstanding choice where extremes of environmental conditions are found, such as thermal shock, low or high temperature exposure, high humidity, salt spray and vibration or mechanical shock.

Wattage Range... 10 basic sizes,  $\frac{1}{2}$  to 10 watts.  
Resistance Range... 0.05 ohms to 200K ohms depending on size.  
Standard Tolerances...  $\pm 0.05\%$  to  $\pm 5.0\%$ , depending on type and value.  
Operating Temperature... to +350° C.  
Temperature Coefficient... 0.00002/°C. MAX.  
Dielectric Strength... 1000 VAC — V block test.  
Fungus proof... all materials non-nutrient.

EXPEDITED DELIVERIES  
ON PRECISION TOLERANCE  
REQUIREMENTS

**OMI**  
OMRONICS MANUFACTURING, INC.  
P. O. BOX 1418 • PEORY PARK STATION • OMAHA 14, NEBRASKA • PHONE 345-5400

Manufacturers of "Temp-trol" Temperature Controllers

CIRCLE 172 ON READER-SERVICE CARD  
ELECTRONIC DESIGN • August 2, 1961

# LOUD AND CLEAR!

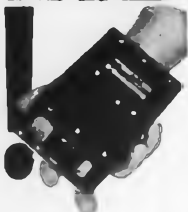

## RADIATION MODEL 3115 FM TELEMETRY TRANSMITTER PROVIDES...

- Carrier frequency stability to within  $\pm 0.01\%$
- Frequency response within 0.5 db from 100 to 100,000 cps
- 2 watts minimum output
- Virtual immunity to extreme environments
- Low microphonics
- Reliability proven in Tiros I, Redstone, Jupiter, Snark and other missile programs
- Off-the-shelf availability

For complete information on the Model 3115 ask for: Technical Bulletin RAD B-102. Write Dept. ED-8

All qualified applicants will receive consideration for employment without regard to race, creed, color, or national origin.



**RADIATION**  
INCORPORATED

Melbourne, Florida

CIRCLE 173 ON READER-SERVICE CARD



**YOU CAN OWN THIS VALUABLE AUTHORITY ON PERMANENT MAGNETS FOR ONLY \$10.** You'll find the answers to almost all of your questions about permanent magnets in this authoritative Crucible handbook — because its 346 pages cover everything from selecting magnet alloys for TV systems to interpreting molecular fields.

Just look at the chapter headings: Permanent Magnet Design • Permanent Magnet Measurements • Theory of Ferromagnetism • Electromagnetism • Permanent Magnet Steels • Cast Alnico • Permanent Magnet Alloys • Standard and Stock Magnets • Ferrimag • Magnetization and Demagnetization.

For your copy, send check or money order for \$10\* to Crucible Steel Company of America, Four Gateway Center, P.O. Box 88, Pittsburgh 30, Pa.

\*Add 40¢ for state sales tax if you are located in Pennsylvania.

**CRUCIBLE STEEL COMPANY OF AMERICA**

CIRCLE 174 ON READER-SERVICE CARD

ELECTRONIC DESIGN • August 2, 1961

## MICROWAVES

### Phase Shifter

701



Has wide range. Phase shifter BLP-123 provides a shift of 360 deg at 2.6 Gc, 450 deg at 2.86 Gc, and 770 deg at 3.95 Gc. Made in RG48/U waveguide, it is also a two-terminal component consisting of mitered elbows, a short-slot hybrid and ganged moving shorts for changing phase. Electrical length is manually varied. Power level is 1.0-megawatt peak, 2.7-megawatt peak pressurized. Insertion loss is 0.15 db max, input vswr 1.1:1 max. Weight is 22.5 lb.

Bomac Laboratories Inc., Dept. ED, Salem Road, Beverly, Mass.

### Coaxial Attenuators

363

Attenuations of 60, 70, and 80 db are now available in the model 50 line of coaxial attenuators. Insertion loss test data is supplied with each attenuator. Connectors, type N, are stainless steel. Units are identified by color coding.

Weinschel Engineering Co., Dept. ED, Kensington, Md.

Price: \$90.00.

### Bolometers

696



Accurate to 1%. A line of bolometers is made for absolute and relative power measurements up to 18 Gc. Ratings are 200 or 100 ohms at 8.75 or 4.5 ma. The hermetically sealed devices use gold-plated contacts. Square-law response error are less than 1% up to 0.2 mw.

Microwave Semiconductor & Instruments Inc., Dept. ED, 116-06 Myrtle Ave., Richmond Hill 18, N. Y.

P&A: \$10 ea; stock.

## NOW... S-BAND, NON-DEGENERATE AMPLIFIERS

with bandwidths up to 75 mc  
at 15 db gain!



### FOR MILITARY ENVIRONMENTS!

Broadband parametric amplifiers for applications at L, S, C, and X band are available now from Texas Instruments. The S-band model, designed with a TI XD-500 gallium arsenide diode, gives bandwidths up to 75 mc at 15 db gain. Gain variation is no greater than 3 db over temperatures ranging from  $-40^{\circ}\text{C}$  to  $+50^{\circ}\text{C}$ , and the unit meets the vibration requirements of MIL-E-5400D. Noise figure, including circulator loss is 3 db. The associated circulator is a miniaturized, three-port ferrite unit with 0.5 db insertion loss and 20 db isolation.

#### TYPICAL MODEL S-22 SERIES SPECIFICATIONS

frequency	2.8 to 2.96 Gc
bandwidth	40 mc
gain	15 db
noise figure	3 db
(includes circulator loss)	
pump frequency	X band
diode	Texas Instruments XD-500 $F_c \approx 70$ kmc at -2v bias
temperature	$-40^{\circ}\text{C}$ to $+50^{\circ}\text{C}$
range	
vibration	per MIL-E-5400D
pump power	50 mw

For details on TI's S-band amplifiers, write for Bulletin No. DLA-1217. For information on specific applications at all frequencies, contact **MARKETING DEPARTMENT.**

**TEXAS INSTRUMENTS**  
INCORPORATED  
APPARATUS DIVISION  
P. O. BOX 6015  
DALLAS 22, TEXAS

CIRCLE 175 ON READER-SERVICE CARD





K-BAND RECEIVER TEST SETUP shows Raytheon parametric amplifier in operation. Unit as supplied is shown at right.

# Raytheon parametric amplifier

has lowest noise figure  
yet reported at  $K_E$  band

New degenerate amplifier has noise figure of 3 db with double sideband signal

This parametric amplifier offers a greater signal-to-noise advantage than any yet announced for 13.5 kMc operation. The model described here is ideally suited for application as a pre-amplifier in MTI radar receivers. However, Raytheon can supply units with comparable performance at other frequencies to meet your particular requirement.

Write today for details on this or other Raytheon developments in microwave devices. Special Microwave Devices Operation, Raytheon Company, Waltham Industrial Park, Waltham, Massachusetts.

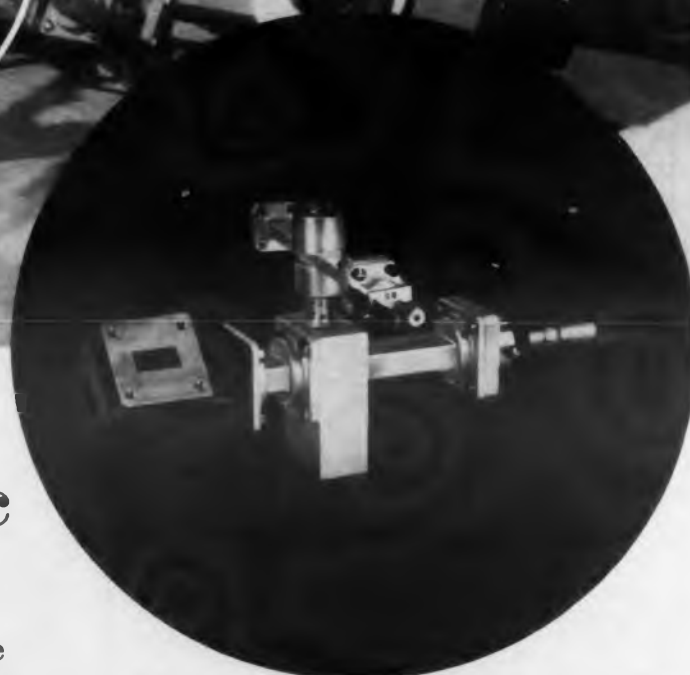

#### TYPICAL SPECIFICATIONS

Mode of Operation.....	Degenerate
Signal Frequency.....	13.5 kMc
Pump Frequency.....	27 kMc
Noise Figure (double sideband).....	3 db max.
Gain.....	17 db min.
Bandwidth.....	10 Mc min.
Tunability of Amplifier.....	10% min.
Typical Pump Power (Function of Diode).....	50 mw max.
Weight (includes 6 oz. circulator).....	2.0 lbs.

## RAYTHEON COMPANY

SPECIAL MICROWAVE DEVICES OPERATION

CIRCLE 176 ON READER-SERVICE CARD



MICROWAVES PRODUCTS

### X-Band Switch

388



High-speed switch has three cascaded cells, giving isolation of 30 db min with insertion loss of 5.0 db max. Rise and decay times are 10 nsec max each. Switch handles 100 mw, and requires 150 mw drive power. Length is 2 in. Operating range is 9.2 to 11.2 Gc. Similar characteristics may be obtained in C and Ku bands.

General Precision, Inc. Kearfott Div., Microwave Products, Dept. ED, 14844 Oxnard St., Van Nuys, Calif.

### L-Band Antennas

364

Flush-mounted L-band antennas, made for aircraft applications, pass 75,000-ft seal tests. The vswr is 1.6 from 1 to 1.1 Gc. Probe is coupled 16 to 20 db down. Power is 10 w average, 2,500 w peak at 75,000 ft. Antenna weighs 13 oz, operates from -65 to +260F.

Transco Products, Inc., Dept. ED, 12210 Nebraska Ave., Los Angeles 25, Calif.

### Microwave Amplifiers

473



Provide 2 and 5 w. Model 527 has an output of 2 w from 8 to 12.4 Gc; a similar 5-w unit operates from 7 to 11 Gc. Useful as stable power oscillators and broad- and narrow-band power amplifiers, each consists of a traveling-wave tube magnet, and a regulated power supply. Gain is 30 db; rated gain and power output are obtained over each range at 1 setting of controls.

Alfred Electronics, Dept. ED, 897 Commercial St., Palo Alto, Calif.

**RAYTHEON**

## Triode Cavity Oscillators

351



Frequencies of 2.5 to 3.9 Gc are covered by a line of triode cavity oscillators. Units have a single tuning control. Oscillators operate from a 200-v plate power supply, and are built for extreme environmental conditions.

Waveline, Inc., Dept. ED, Caldwell, N. J.

## Magnetron

360



Operating between 9 and 9.5 Gc, type VF11 pulsed magnetron can be tuned over  $\pm 15$  mc about the central frequency. Peak output power is 1.0 mw. The magnetron is designed for use with an electromagnet. Anode is liquid cooled.

Ferranti Electric, Inc., Dept. ED, Industrial Park No. 1, Plainview, L. I., N. Y.

## Backward-Wave Oscillator

362



Ten to 20 mw from 15 to 22 Gc is provided by the model OD 15-22 backward-wave oscillator. The tube is said to offer a wide-range electronic tunability, a smooth curve of power output over the frequency range, and uniform, reproducible characteristics.

Stewart Engineering Co., Dept. ED, Santa Cruz, Calif.

P&A: \$1,250; 30 days.

## Both Portable and Stationary FREQUENCY and TIME STANDARDS

### DECADE FREQUENCY SYSTEMS

Generate and Measure Frequencies from Zero to Kilomegacycles with Crystal Accuracy

#### FEATURES

- Frequency range from d.c. to 12.6 kilomegacycles.
- Accuracy and stability better than  $1 \times 10^{-9}$ /day, according to crystal oscillator used.
- Smallest crystal locked step 10 cps.
- Smallest frequency increment 5 millicycles.
- Crystal control steps rigidly locked to frequency standard.
- Continuous variable output voltage from less than 100 $\mu$ v to more than 1 volt.
- Simplicity of operation by small number of front panel controls.

The decade frequency measuring system is based on the principle of the frequency synthesizer, which generates a continuously variable frequency with the accuracy of the driving standard oscillator. Unknown frequencies are measured by heterodyning with this variable reference frequency, and the difference frequency is measured on a precision meter with magnifier. Facilities for recording also are available.

Type CAQ BN 7850

PORTABLE, FULLY TRANSISTORIZED  
FREQUENCY AND TIME STANDARD



### STANDARD TIME SYSTEMS

Permits Measurement of Drift in Frequency Standards by means of Comparison of Time Signals

#### FEATURES

- This system embodies more than 20 years' experience in the field of time and frequency standards.
- Simplicity of operation obtained by completely integrated system.
- Special time-comparison oscilloscope for photographic logging.
- Emergency power supply prevents loss of calibration due to line failure.
- Special accessories, such as sidereal time converters, are available.

The standard time system generates a time signal, derived from the frequency standard, for comparison with time signals from WWV, etc., on a special time-comparison oscilloscope. Daily log without calculation may be kept by a photographic recording. The system provides frequency divider, motor-driven phase shifter, and all-wave receiver for time signals from 14 kc to 28 mc. Frequency standard has built-in servo system for remote control from VLF standard frequency by means of a phase comparator.



## ROHDE & SCHWARZ

111 Lexington Ave., Passaic, N. J. • PRescott 3-8010

See us at the WESCON Show — Booths 2526-2528

CIRCLE 177 ON READER-SERVICE CARD

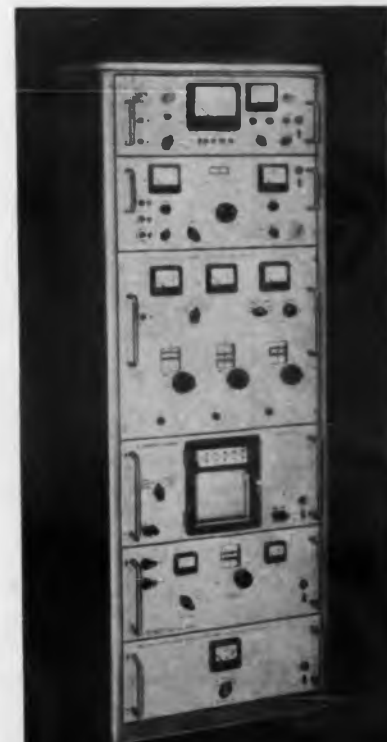

Type XZA BN 444044



Type CAA BN 78012

# MAKE NEW MICROWAVE IDEAS

## PAY OFF SOONER

*right through production!  
with Sanders' exclusive  
strip transmission line  
techniques and services!*

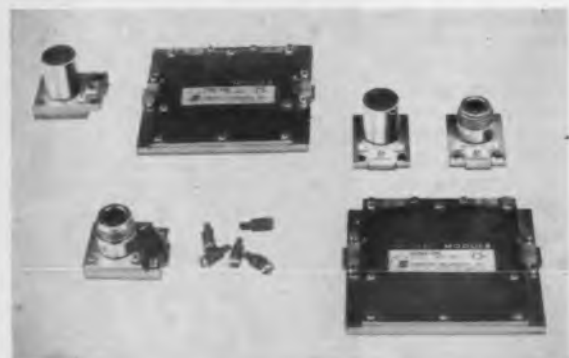
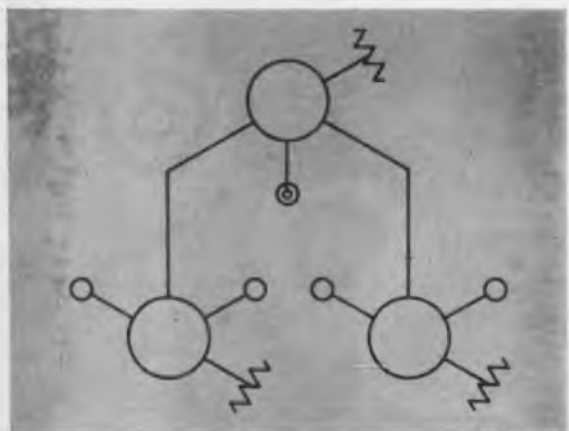

**BREADBOARDING MODULES!** These exclusive Sanders TRI-PLATE strip transmission line components . . . standard or custom-engineered . . . include hybrid rings, power dividers, bends, directional couplers, attenuator pads, coax transitions, mounts for transistors, tunnel diodes, varactors and switching diodes, etc. . . . all with integral connectors. You assemble them in minutes with thumbscrews.



**PRODUCTION PROTOTYPE** ready for quantity production! Unitized TRI-PLATE "packages" like this 4-way power divider for broad band operation at frequencies up through X band, feature low radiation and cross talk, precise reproducibility and mil-spec reliability. It weighs 1/10 as much, takes 1/10 the space of waveguide and at less cost.



**WORKING CIRCUIT** built with modules ready to test! This sub-assembly is a balanced, single-end mixer. It could just as well be an oscillator, pulse amplifier, down converter, harmonic generator, parametric amplifier . . . or a radically new microwave development of your own. Performance matches that of conventional plumbing as much as ten times larger and heavier.



**QUANTITY PRODUCTION** of customized TRI-PLATE "packages", employs automated photo-etching techniques. It reduces costs far below those of coaxial and waveguide units. Sanders' complete TRI-PLATE service . . . modules, engineering, production . . . is always on call. Write for your complete TRI-PLATE Data File with specifications and prices today to: Microwave Products Dept., Sanders Associates, Inc., Nashua, New Hampshire.



### SANDERS TRI-PLATE<sup>®</sup> STRIP TRANSMISSION LINE

Breadboarding Modules . . . Custom-Engineering . . . Quantity Production

Visit Booths #2523 & #2525, WESCON Show

©Sanders Associates, Inc.

34.1.34

184

CIRCLE 178 ON READER-SERVICE CARD



MICROWAVES PRODUCTS

#### Rejection Filter

389



**Tunable notch-band rejection filter** C994-181-302 provides a rejection bandwidth of 45 db,  $20 \pm 5$  mc over its range of 9,000 to 9,300 mc. Insertion loss is less than 0.5 db, vswr less than 1.2:1 at  $f_0 \pm 90$  mc; 3-db bandwidth is about 60 mc. Length is 4 in., weight about 11 oz.

General Precision, Inc., Kearfott Div., Microwave Products, Dept. ED, 14844 Oxnard St., Van Nuys, Calif.

#### Linear Actuator

593

**Heavy duty type.** Model C402 actuator has a positioning accuracy repeatable to within  $\pm 0.0025$  in. without feedback. Rated thrust is 500 lb, tension and compression. Maximum thrust is 1,000 lb. Unit also has a continuously adjustable stroke of from 0 to 6 in. with an optional potentiometer for position indication.

Lear Industrial Products, Lear, Inc., Electro-Mechanical Div. Dept. ED, 110 Ionia Ave., N.W., Grand Rapids 2, Mich.

#### Directional Couplers

460



**Handle 70 to 2,700 kw.** Waveguide couplers are offered in three general configurations: cross-guide coupling, sidewall coupling, and top-wall coupling to meet requirements of low cost, high power and high directivity respectively. Devices are available with customer specified coupling value.

Bomac Laboratories, Inc., Dept. ED, Salem Road, Beverly, Mass.

ELECTRONIC DESIGN • August 2, 1961

**Band-Pass Filter****697**

For L band. Coaxial band-pass filter model 1319 has 0.5 db or less insertion loss. Standard center frequencies are 1,270 and 1,320 mc; 3-db bandwidth is 40 mc, 20-db bandwidth about 90 mc. Other center frequencies are made on order.

Radar Design Corp., Dept. ED, Pickard Drive, Syracuse 11, N. Y.

**P&A:** \$300 to \$245; 4 weeks.

**Ferrite Attenuator****591**

For X-band use. Unit provides up to 50 db of attenuation. Attenuation is adjusted by passing a direct current through a magnetizing coil around a waveguide containing a length of ferrite. The ferrite is tapered at both ends and has a rectangular cross section coincident with the waveguide axis.

ITT Federal Laboratories, Dept. ED, Fort Wayne Ind.

**Availability:** 6 weeks or less.

**UHF Antenna****699**

Has dual pattern. Data-link antenna type 35500 has dual radiation pattern coverage controlled by a coaxial switch. One pattern is essentially omnidirectional in azimuth; the other is a cardioid pattern with front-to-back ratio of -17 db or more over 225 to 400 mc. The vswr is less than 2.5:1 in the omni pattern, 1.5:1 in the cardioid pattern. Antenna meets military specifications and environmental tests.

Transco Products, Inc., Dept. ED, 12210 Nebraska Ave., Los Angeles, Calif.

**NEW DVM CONCEPT!**

**FAST:** Two readings per second **ACCURATE:** 0.01% accuracy **LOW COST:** Only \$1,580

In the above test of a satellite's telemetry and solar cells, it was necessary to make 100 accurate measurements every minute. The job was done with the new Cubic V-70 digital voltmeter that reads out four times as fast as any instrument with stepping switches. The V-70 uses ultra-reliable reed relays hermetically sealed in glass for a life expectancy of at least 10 years. It has no moving parts, requires no maintenance, will operate in any position, and is resistant to thermal and physical shock. The V-70 is the only DVM offering 0.01% accuracy and less than 1 second balance time for less than \$2,000 (Model V-70, \$1,580; Model V-71 with automatic ranging and polarity, \$2,200). For details, write to Dept. ED-107.



**cubic**  
CORPORATION

INDUSTRIAL DIVISION  
SAN DIEGO 11, CALIFORNIA

OTHER OFFICES: LOS ANGELES, CALIFORNIA • ROME, ITALY (CUBIC EUROPA S.p.A.) • REPRESENTATIVES IN PRINCIPAL U.S. AND CANADIAN CITIES

Wescon Booths 3001 & 3003

CIRCLE 179 ON READER-SERVICE CARD

# ONE SOURCE FOR ALL YOUR METAL HOUSINGS

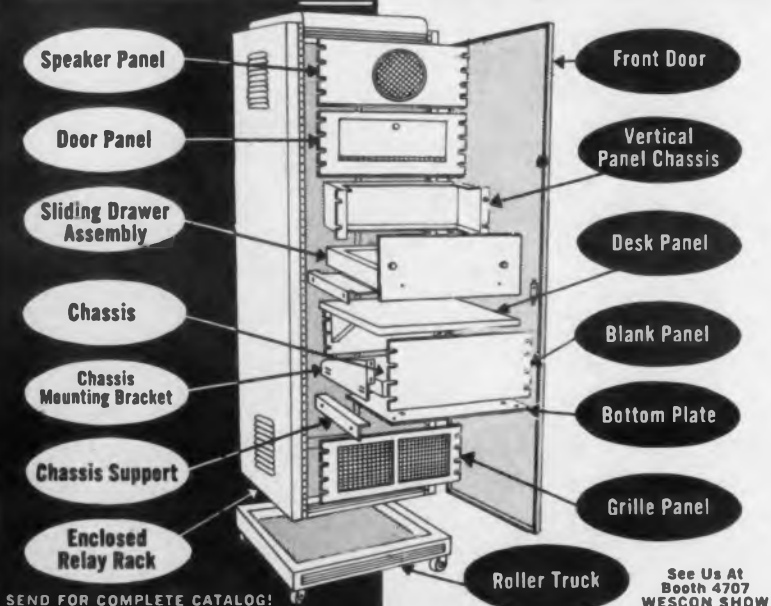

**PREMIER**

**METAL PRODUCTS CO.**

337 MANIDA STREET

NEW YORK 59, N. Y.



WESTERN SALES OFFICE  
EXPORT DEPARTMENT EMEC.  
MFD. IN CANADA by PREMIER METAL

1667 Laurel St., San Carlos, California  
127 Grace Street, Plainview, New York  
HOUSINGS, Ltd., 5810 Smart Ave., Montreal

CIRCLE 180 ON READER-SERVICE CARD

## Extra High Purity Gold Plate!



# TEMPEREX<sup>®</sup> HD<sup>\*</sup>

TEMPEREX HD electroplate meets or surpasses the most exacting specifications of the electronics industry. Its deposits of 99.99+ purity provide a uniformity of metallurgical characteristics never before attainable in gold electroplate.

Other advantages: 75 Knoop hardness; easy to solder or weld; and an exceptional ductility that permits *cork-screw twisting of electroformed strips without fracturing!*

Write for details.

\*Patent applied for

**SEL-REX CORPORATION**  
NUTLEY 10, NEW JERSEY

World's largest selling precious metal plating processes



CIRCLE 181 ON READER-SERVICE CARD



## Phase-Lock Receiver

354



Modular model SRA 506 is a fixed-tuned receiver with crystal control. Operating frequency, bandwidth, demodulation capabilities, phase-lock characteristics, and output can be adjusted by substituting modules. Frequency range is 38 to 2,500 mc, with phase-lock loop filter bandwidths from 20 cps up. Linear or logarithmic response is available.

Smyth Research Associates, Dept. ED, 3555 Aero Court, San Diego 11, Calif.

## Adjustable Attenuator

589

For X-band use. Insertion loss is less than 0.1 db. Maximum attenuation is up to 40 db and swr is less than 1.15 over the waveguide bandwidth. Calibrated dial plates (less index) can be supplied on the 270-deg units.

ITT Federal Laboratories, Dept. ED, Fort Wayne, Ind.

*Availability: 6 weeks or less.*

## Coaxial Rotary Joint

355



For antenna-receiver and servo-drive applications, model 320 rotary joint operates from 0.8 to 12 Gc. Maximum vswr is 1.1 at 0.8 Gc and 1.3 at 12 Gc. Maximum insertion loss is 0.3 db at 0.8 gc, 0.1 db at 12 gc. Torque is 1 oz-in. max. Continuous-duty rotational speed is 1,000 rpm. Models can be supplied with any connector for a 50-ohm line.

Sage Laboratories, Inc., Dept. ED, 3 Huron Drive, East Natick Industrial Park, Natick, Mass.

*P&A: \$125.00; from stock in small quantities.*

## Low noise TWTs... wide dynamic range

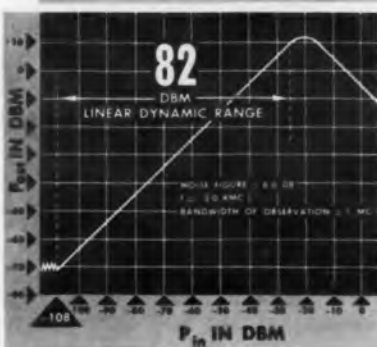

Huggins low-noise traveling wave tubes provide 7 DBM minimum saturation  $P_{out}$  over major portions of octave bandwidths—coincident with low-noise performance. An example is the HA-70 characteristics shown above. The low noise figure plus high  $P_{out}$  results in the maximum degree of linear operation consistent with the present state of the TWT manufacturing art.

S-band low-noise tubes perform at extremely low noise levels, in solenoids requiring 125 watts maximum power and weighing 25 pounds.



**Huggins low-noise tubes carry a 1500 hour warranty.**

Contact Huggins for further TWT information, including modification of standard tubes to your system specifications.

## HUGGINS LABORATORIES INC.

999 East Arques Ave.  
Sunnyvale, Calif.

Regent 6-9330

TWX Sunnyvale,  
California 116



CIRCLE 102 ON READER-SERVICE CARD

**NOW...the smallest  
microwave oscillators  
we've ever made!**



Microwave projects, impossible before, are now possible with these new sub-miniature Trak microwave oscillators. Limited quantities of developmental models now available. TRAK TYPE 9180 Size:  $\frac{3}{8}$ " long by  $\frac{3}{4}$ " diameter, excluding projections. Frequency: plate pulse, 4.5 KMc to 6 KMc; CW service, 4.0 to 5.5 KMc. Tuning range is limited to approximately 100 megacycles. TRAK TYPE 9181 Size:  $1\frac{1}{2}$ " long by  $\frac{9}{16}$ " diameter, excluding projections. Frequency: CW service, 5.0 KMc to 6.0 KMc with tentative tuning range of 400 megacycles.

TRAK MICROWAVE offers a complete line of microwave energy sources including oscillators, amplifiers and harmonic generators. Write for Catalog 61-A. See our WESCON display — Booth 2117; ISA display — Booth 501.

**TRAK**  
Microwave  
**TRAK MICROWAVE  
CORPORATION**

5006 N. Coolidge Avenue  
Tampa 3, Florida  
PHONE: REDwood 6-6422 or REDwood 6-6407

**Specialists In Miniature  
Microwave Energy Sources**

CIRCLE 183 ON READER-SERVICE CARD  
ELECTRONIC DESIGN • August 2, 1961

## MICROWAVES

### Directional Couplers 356



Miniature coaxial directional couplers operate from 200 to 4,000 mc in octave ranges, and couple from 3 to 20 db. Model CA has both ends of the auxiliary line available; the CB series has one end permanently terminated. Military environmental requirements are satisfied.

Microlab, Dept. ED, 570 W. Mount Pleasant Ave., Livingston, N. J.  
P&A: \$100 to \$150; from stock.

### Permanent Magnet Material 367

Ceramic material is used in periodic-focused traveling wave tubes. Called Incox VI-A, the material has an intrinsic coercive force of 3,000 oersteds at 20 C and 2,300 oersteds at -65 C. At 20 C, the maximum energy product is 2.55 million and residual induction is 3,300 gauss.

Indiana Steel Products Div., Indiana General Corp., Dept. ED, Valparaiso, Ind.

### Ferrite Switch 357



Ka-band switch operates on a 6% band, centered at 35.0 Gc. Designated type R-300LS, the device is 3.11 in. long and has four ports. Isolation is greater than 20 db, insertion loss less than 0.5 db, vswr less than 1.25, and switching time less than  $1\mu$ sec. A permanent magnet can convert the device to a four-port circulator.

Ferrotec, Inc., Dept. ED, 217 California St., Newton, Mass.  
Availability: 45 days.

## GAIN MORE GAIN

with Statham's new SA9-0  
DC to DC Signal Amplifier



Here's a major advance in DC signal amplifier design that gives you the HIGHEST GAIN available today — combined with a wider temperature range, a smaller sized package, and unequalled stability! The new versatile SA9-0 provides complete utilization of low-level DC signals from thermocouples, thermal sensing to bridges and DC excited transducers, etc. It gives you the utmost in dependability under extreme environmental conditions. Modular construction makes the compact transistorized SA9-0 ideal for airborne applications requiring multiple channel installation in limited space. Write for complete technical data!

GAIN: Continuously variable from 50 to 500. (Special models up to 1000)

#### TEMPERATURE RANGE

OPERATING: -65° F. to +165° F.

NON-OPERATING: -65° F. to +225° F.

#### THERMAL COEFFICIENT

OF SENSITIVITY: 0.02% / F.

THERMAL ZERO SHIFT: 0.01% / F. of full scale output.

OUTPUT: 0 to 5 V DC

INPUT REQUIREMENTS: 0 to 5 mv DC.

POWER REQUIREMENTS: 30 ma at 28 V DC  $\pm 10\%$ .

WEIGHT: 8 oz. (approx.)

SIZE: less than 8 cu. in.



ELECTRONICS  
**ED**  
DIVISION

Statham Instruments, Inc., 12401 W. Olympic Blvd.  
Los Angeles 64, Calif. / GRanite 8-0361 / TWX: West Los Angeles CAL 6602

CIRCLE 184 ON READER-SERVICE CARD

**NOW—ORDER YOUR  
PRINTED BOARDS AND  
EDGE CONNECTORS  
IN ONE READY-  
ASSEMBLED PACKAGE**



New convenience, new reliability, new speed in delivery! Graphik Circuits now manufactures edge connectors of all types in their City of Industry plant, and can supply assembled printed circuit boards with mating edge connectors. This means guaranteed Graphik Circuits compatibility, edge connectors custom-designed for your boards if you wish—and exactly half the number of purchase orders for you to process!

**Off-the-shelf deliveries** can be made on Graphik Circuits bifurcated connectors with conventional wiring tail, dip solder tail for .051 hole, and wire post tail. All types with 6 to 25 contact positions. All connectors meet MIL-C-21097A (ships) specifications.

See samples of these complete assemblies at our WESCON Booth, No. 405.



*Graphik Circuits*

Division of Cinch Manufacturing Company, 200 So. Turnbull Canyon Road, City of Industry (Los Angeles), Calif.  
Offices in 19 Principal Cities throughout United States listed under Cinch Mfg. Co. or United-Carr Fastener Corp.

CIRCLE 185 ON READER-SERVICE CARD



## NEW LITERATURE

### Dip Brazing

261

This eight-page illustrated brochure covers the basic advantages of using the dip braze method for joining numerous aluminum segments into a complex assembly. It provides data on material selection and factors to be considered when designing a unit that is to be assembled by this process. Precision Dipbraze, Inc., 12031 Vose St., North Hollywood, Calif.

### Commercial Glasses

"Properties of Selected Commercial Glasses," 16 pages, covers mechanical, electrical and optical properties, thermal stress, heat transmission and viscosity of 32 glasses. Also included is information on evaluating the hardness of glass. Write on company letterhead to Corning Glass Works, Dept. ED, Corning, N. Y.

### Ceramic Products

262

Industrial ceramics for electrical and electronic components, instrument and measuring apparatus and for laboratory testing and analysis applications are listed in a 20-page catalog. Electrical and mechanical properties and design recommendations are included. Saxonburg Ceramics, Inc., Saxonburg, Pa.

### RF Connectors

263

RF connectors are described in a 120-page catalog containing illustrations and complete technical data. Included are telephone jacks and plugs as well as special items for specific applications. A cross reference index is supplied that matches the company's numbers to MIL specification numbers. Kings Electronics Co., Inc., 40 Marbledale Road, Tuckahoe, N.Y.

## MOLDED CHOKE COILS



ACTUAL SIZE  
10,000 UH



Nicknamed the "Micro Mite", these reliable, rugged coils exhibit high Q, very low distributed capacity, all concentrated into an amazingly small package.

Miller's new "Micro Mite" coils are perfect for use where weight, space and high Q considerations are involved. Their volumetric reduction ranges up to 80%, with current ratings approximately 75-300 millamps and standard series values up to 10,000 uh.

The "Micro Mite" coil construction permits miniaturization without the use of ferrite materials, thus maintaining temperature stability to 125° C. These hermetically sealed molded coils conform to MIL-C-15305A.

ASK FOR OUR MICRO-MITE BULLETIN

J. W. MILLER COMPANY • 5917 So. Main St., Los Angeles 3, Calif.

CIRCLE 186 ON READER-SERVICE CARD

ELECTRONIC DESIGN • August 2, 1961

## Electron Guns 264

Electrons guns for all types of cathode ray tubes are described in this 34-page catalog. A cross reference chart specifying the correct gun mounts for all categories of cathode ray tubes of domestic and foreign manufacture is also included. Superior Electronics Corp., 208-212 Piaget Ave., Clifton, N.J.

## Silicon Transistors 265

Working principles of silicon field-effect transistors are described in a four-page booklet. It gives parameters and typical circuits. Crystalonics, Inc., 249 Fifth St., Cambridge, Mass.

## Semiconductor Testing 266

In-circuit testing of semiconductor diodes, rectifiers, and transistors is discussed in this 12-page booklet. The firm's in-circuit test set is described. Molecular Electronics, Inc., 87 Weyman Ave., New Rochelle, N. Y.

## Chopper Transistors 267

Bulletin No. 2107, 16 pages, describes transistor characteristics required in low level chopper applications. Included are circuit diagrams, performance charts and graphs, equations and general characteristics. Sperry Rand Corp., Sperry Semiconductor Div., Norwalk, Conn.

## Digital Modules 268

The firm's T-PAC series plug-in digital modules are described in this 12-page catalog. Block diagrams, specifications and prices are given. Computer Control Co., Inc., 983 Concord St., Framingham, Mass.

## Coaxial Relays, Switches 269

This 28-page catalog describes and illustrates the firm's series DX coaxial relays and switches. Characteristics and operating principles are included for the units. RF Products, 33 E. Franklin St., Danbury, Conn.

# PARAFORMED

SHARP  
SQUARE  
INSIDE  
CORNERS

FLAT  
SIDE  
WALLS

SMALL  
OUTSIDE  
CORNER  
RADIUS

SPIRAL WOUND  
*Not Die Formed*

# Spiral Wound PAPER TUBES

*Speed and Improve*  
**COIL WINDING**



**ANY SIZE—SQUARE OR RECTANGULAR**

PARAFORMED paper tubes simplify coil winding operations and speed production, *yet cost no more.* In the exclusive PARAFORM method of tube making, no artificial heat or pressure is used—*Paraforming* takes place at the time of spiral winding. Hi-Dielectric. Hi-Strength. Kraft, Fish Paper, Acetate, Red Rope or any combination wound on automatic machines. *Produced from stock arbors or special sizes engineered for you.* Can also be supplied in regular or with slight bow.

- No sharp outside edges to cut wire
- No need for wedges to tighten wire
- Permits winding coils to closer tolerances
- Has full rigidity and physical strength
- Allows faster stacking of wound coils

Write on company letterhead for  
**STOCK ARBOR LIST  
OF OVER 2000 SIZES**

## Paramount PAPER TUBE CORP.

608 LAFAYETTE STREET, FORT WAYNE 2, INDIANA  
*Manufacturers of Paper Tubing for the Electrical Industry Since 1931*



**WE'VE  
BEEN HIDING  
UNDER A BUSHEL BASKET**



**SERIES M-200  
I-F AMPLIFIERS**



**T-330 TRANSISTORIZED  
I-F AMPLIFIERS**



**LOG-LIN  
AMPLIFIERS**



**SERIES M-500  
WIDE BAND AMPLIFIERS**



**SERIES 300  
VIDEO AMPLIFIERS**



**SERIES P-205  
PRE-AMPLIFIERS**



**SERIES M-400 HIGH POWER  
DISTRIBUTED AMPLIFIERS**

Not by choice, but because we've been up to our ears in developing some of the nation's most sophisticated electronic counter-measures systems.

With the lid off, we applied our hard earned engineering and production experience and knowledge in developing a line of IFI amplifiers that meet some pretty tough specifications at lower cost than you'll find elsewhere. *Available for immediate delivery.*

Take a moment now to write for data sheets on IFI amplifiers, and judge for yourself.



**INSTRUMENTS FOR INDUSTRY, INC.**

101 NEW SOUTH ROAD  
HICKSVILLE, L. I., NEW YORK

CIRCLE 188 ON READER-SERVICE CARD

# HEART OF THE CIRCUIT

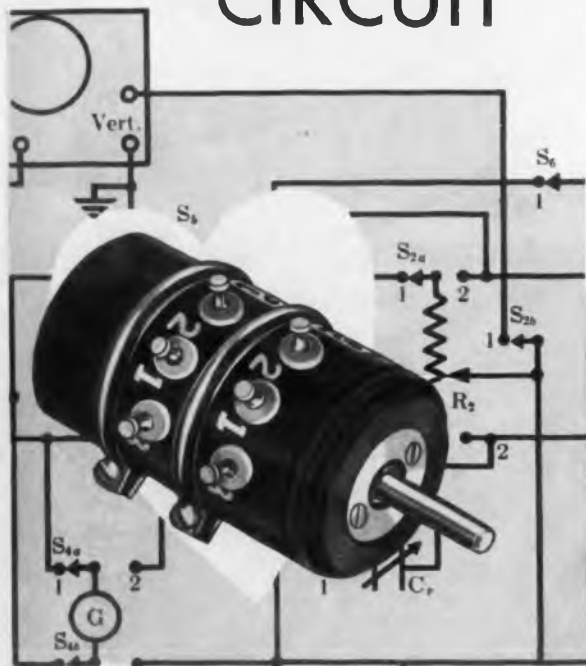

## PRECISION POTENTIOMETERS

by *New England Instrument*

### WIRE WOUND — CONDUCTIVE PLASTIC

Whatever your potentiometer requirement may be, N.E.I. has the answer. Since we produce both wire wound and conductive plastic types our engineers can impartially evaluate your problem and come up with the proper solution.

### CONDUCTIVE PLASTIC

- Infinite resolution
- Unsurpassed reliability
- Negligible noise level
- Standard resistance values 1K, 2K, 5K, 10K and 20K, 0.5 linearity.
- Specials from 500 ohms to 1 megohm — 0.1% linearity
- Single or multigang construction.

### WIRE WOUND

- Meet performance specs of MIL5272A, and NAS710 and applicable portions of JANB-19
- Maintain excellent characteristics from  $-55^{\circ}$  to  $150^{\circ}$ C
- Available from  $\frac{1}{2}$ " single and 10 turn types to 3"
- Standard resistances from 1K to 100K, special designs from 25 ohm to 250K
- Single or multigang construction.



SEND FOR COMPLETE CATALOG

*New England Instrument Company*  
39 Green Street, Waltham, Massachusetts

CIRCLE 189 ON READER-SERVICE CARD

## NEW LITERATURE

### Silver-Cadmium Batteries 270

The advantages of silver-cadmium batteries are presented in this paper. Physical characteristics and applications of the firm's batteries are described. Yardney Electric Corp., 40-52 Leonard St., New York 13, N.Y.

### Coaxial Cable 271

Flexible air-dielectric coaxial cable is described in 16-page Catalog H. Characteristics of the cable are given, and terminals and various accessories are described. Andrew Corp., P. O. Box 307, Chicago 42, Ill.

### Microwave Equipment 272

Klystrons, wave tubes, magnetrons, switching tubes, and other microwave and general electronic equipment are described in this catalog. Varian Associates, 611 Hansen Way, Palo Alto, Calif.

### Parabolic Antenna Calculator

Performance data on parabolic antennas can be determined with this parabolic antenna calculator. The calculator provides information on: wavelength in inches or centimeters; beam width relative to frequency and parabolic reflector diameter; gain at given efficiency; free space attenuation at required frequency and range; subtended angle at given frequency and diameter; return and mismatch loss vs vswr; and the force exerted on the mounting structure at winds up to 200 mph. Send \$2.50 to Technical Appliance Corp., Dept. ED, Sherburne, N. Y.

### Amplifiers 273

A line of pulse, rf, and if amplifiers are described in six-page brochure No. 1010A. Detailed specifications are included. RHG Electronics Laboratory, Inc., 94 Milbar Blvd., Farmingdale, L. I., N. Y.

### Relay Definitions 274

Terms commonly used in connection with relays are defined in this 13-page booklet, "Definitions of Relay Terms." The material has been approved as American Standard. National Association of Relay Manufacturers, c/o Dr. Charles F. Cameron, School of Electrical Engineering, Oklahoma State University, Stillwater, Okla.

# BEEDAC METER

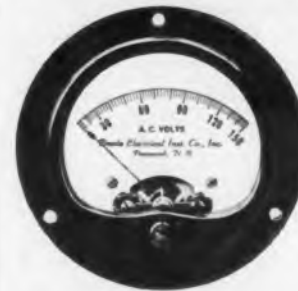

MODEL 610

ACCURATE  
DEPENDABLE  
LONG LIFE

THE BEEDE REPULSION TYPE AC METER IS AN EXCELLENT COMPANION TO THE DEPENDABLE LINE OF DC METERS AND IS AVAILABLE IN A WIDE SELECTION OF RANGES. WRITE FOR ADDITIONAL INFORMATION.



**BEEDE** ELECTRICAL INSTRUMENT CO., INC.  
PENACOOK, N. H.

CIRCLE 190 ON READER-SERVICE CARD

## JANCO MINIATURE Rotary Selector Switches



ACTUAL SIZE

SERIES 1900

All Janco switches are designed and built to exceed MIL-S-6807A. Possessing long-life with a high degree of reliability, they exceed the operational and environmental requirements of shock, vibration, altitude, and explosion. Because of their design and construction, all Janco switches are ideally suited for dry circuit and signal level switching applications.

### SPECIFICATIONS

- Electrical Rating: Make, break, and carry  
Up to 5 amps 115V AC and 28V DC resistive,  
and 2 amps 28V DC inductive
- Contact Positions: 2 to 12 positions
- Index: 30°, 36°, 45°, 60°, and 90° indexing
- Decks: 1 to 16 decks (single pole)

Write today for complete detailed specifications.

**JANCO CORPORATION**  
3111 Winona Avenue, Burbank, California

CIRCLE 193 ON READER-SERVICE CARD  
ELECTRONIC DESIGN • August 2, 1961

## WIDE RANGE

MODEL  
**105TA**



WITH



**ROBOTEC**  
overload and  
short protection  
and



**HEATRAN**  
electronic  
dissipation  
control

**\$239<sup>50</sup>**

FOB FACTORY  
**WESCON  
BOOTH  
2 7 0 5**

SEMICONDUCTORIZED  
**POWER SUPPLY**  
**1-100 VDC**  
**0-0.5 AMP**

High efficiency,  
stabilized solid state  
DC power supply with  
.05% regulation,  
1 millivolt ripple,  
.025 ohm source im-  
pedance, 50 micro-  
second response time,  
55-440 cycle input.

IMMEDIATE DELIVERY

**Power Designs inc.**

1700 SHAMES DRIVE, WESTBURY, NEW YORK  
EDgewood 3-6200 (LD Area Code 516)

CIRCLE 192 ON READER-SERVICE CARD

### PRECISION METERS

*Catalog Available*

If your operation demands accuracy to 1/10 of 1% you need this AMF Catalog, which includes specifications, sizes and weights of Frequency and Volt Meters for test, research, industrial, military and government use.

AMF Meters are rugged. They compensate for practically any temperature and environment. They can be tailored to your requirements - or are available immediately from stock. Send today for your Catalog! Address Department T.

**AMF American Machine & Foundry Company**  
1101 N. Royal Street, Alexandria, Virginia

CIRCLE 191 ON READER-SERVICE CARD

ELECTRONIC DESIGN • August 2, 1961

### Instrumentation Abstracts 275

Abstracts of technical journals, U. S. patents, and selected papers are distributed to subscribers weekly on 5 x 8 in. cards. The abstracts inform instrumentation engineers of developments in their field. Lowry-Preston Technical Abstracts Co., 914 Chicago Ave., Evanston, Ill.

### Wire Coatings 276

Electrical and physical properties of Tenite polypropylene formulas developed for solid and cellular wire coatings are described in Technical Report No. 7. The report describes extrusion conditions for the coatings and presents, with diagrams, techniques for applying the plastic material to wire. Eastman Chemical Products, Inc., Kingsport, Tenn.

### Telemetry Instruments 277

A line of airborne fm telemetry instruments is described in this four-page condensed catalog. Included are descriptions and condensed specifications of subcarrier oscillators, mixers and amplifiers, reference oscillators and calibration units, and vhf power amplifiers and transmitters. Electro-Mechanical Research, Inc., Sarasota, Fla.

### Push Buttons 278

Miniature industrial oil-tight push buttons are described in 12-page bulletin No. GEA-7127A. Four-color illustrations, dimensional drawings, and electrical specifications are included. General Electric Co., Schenectady 5, N. Y.

### Power Resistors 279

Fixed wirewound power resistors, including ceramic and enamel-coated, flexible, and stack-mounted types are described in 12-page catalog No. EEM-4600. Descriptions, specifications, dimensional drawings and photographs are included for eight different styles. Clarostat Manufacturing Co., Inc., Dover, N. H.

### Pressure Transducers 280

This data folder describes the firm's series SP-2 pressure transducers, giving physical and electrical specifications and application recommendations. It also contains a glossary defining standard terms related to pressure transducers. Standard Controls, 1130 Poplar Place, Seattle 44, Wash.

## EXPERT Help in Laminated Plastics From Specialists



### An Example of Synthane You-shaped Versatility

Do you have a materials problem? Perhaps laminated plastics is the answer: Why not discuss it with our field representative in your territory? He has behind him the entire Synthane organization with over 32 years of experience in the manufacture and fabrication of laminated plastics. Our engineers, technicians and field representatives are specialists in this field, and over two-thirds of our people have over 10 years' experience with Synthane. The solution to your materials problem can probably be found at Synthane.

*You-shaped Versatility makes Synthane a Better Buy in Laminates*

**SYNTHANE**  
CORPORATION **S** OAKS, PENNA.

Synthane Corporation, 42 River Rd., Oaks, Pa.

Gentlemen:

Please send me information relating to Synthane as a source for laminated plastics materials and parts.

Name \_\_\_\_\_

Address \_\_\_\_\_

City \_\_\_\_\_ Zone \_\_\_\_\_ State \_\_\_\_\_

CIRCLE 194 ON READER-SERVICE CARD

# For extreme environments!

## MICRO-PROCESSED BERYLLIUM COPPER Springs

— meet these tough MARKITE 'specs'!

### THE 'HEART' OF THE MARKITE POTENTIOMETER



1. A potentiometer element — embodying resistance track and take-off track of conductive plastic co-molded to an insulator base. 2. An I-S cantilever dual spring (with precious metal wipers); maintains contact with conductive tracks even under 70g vibration at 5-2000 cps, 100g shock and 100g acceleration!

Instrument Specialties' cantilever springs provide high reliability in potentiometers, servomechanisms, electro-mechanical controls and instruments for aircraft, missiles and similar continuous-duty applications.

Employed in Markite conductive plastic precision potentiometers, I-S beryllium copper cantilever springs maintain their high spring forces... thereby complying with Markite's standards for infinite resolution and minimal contact noise over an operational life span of more than 50 million revolutions.

If you have a spring problem—Ask I-S engineers for a recommendation on your specific application; or request catalog containing complete data on I-S Beryllium Copper Compression Springs, Flat Springs, Contact Strips, Strip Springs, Contact Rings and Screw Machine Parts.



TWX:LTFS,  
N. J.-1023



## INSTRUMENT SPECIALTIES COMPANY • INC.

270 Bergen Blvd., Little Falls, N. J.—Telephone: CLifford 6-3500  
CIRCLE 196 ON READER-SERVICE CARD

## NEW LITERATURE

### Switching Components

Information on electromechanical and electronic switching devices and components is given in this 100-page handbook. Relay and switch terminology and theory, unique switching, and control circuits, and reference, application, and technical data are included. Specifications for some of the firm's components are given. *Send \$1.00 to Component Products, Electronics Div., North Electric Co., Dept. ED, Galion, Ohio.*

### Vacuum Equipment 281

Vacuum pumps and related equipment are described in this 13-page condensed catalog. Pumps with capacities from 0.2 to 10,000 liters per sec, power supplies, valves, control units, systems and accessories are described and illustrated. Varian Associates, 611 Hansen Way, Palo Alto, Calif.

### Waveguide Chart 282

Electrical performance and mechanical dimensions of standard EIA waveguides between WR10 and WR2300 are tabled on this notebook-size waveguide chart. Standard JAN flange references and a cross reference between WR and RG numbers are given. Multiplication and scaling factors are also tabled. Microwave Development Laboratories, Inc., 15 Strathmore Road, Natick Industrial Centre, Natick, Mass.

### Data-Handling Systems 283

Product Digest No. 160, 18 pages, catalogs a line of data-handling instruments including oscillographs, telemetering equipment, instrumentation and audio tape systems, and servo devices. Illustrations, descriptions, and general specifications are given. Midwestern Instruments, P. O. Box 7509, Tulsa 18, Okla.

**Wassco**

**GLO-MELT**

**RESISTANCE SOLDERING**



... for Perfect  
lead-to-pin joints  
on All sizes of A/N  
and similar connections

**Wassco** GLO-MELT

... for Fast-Efficient  
Accurate-Permanent  
connections.

209-B

**POWER UNITS • HANDPIECES • ACCESSORIES**  
for all jobs from Micro-Miniature to Heavy-Current connectors

WRITE FOR DESCRIPTIVE LITERATURE, PRICES AND NEAREST DISTRIBUTOR

**Wassco** GLO-MELT DIVISION

AMERICAN ELECTRICAL HEATER COMPANY

DETROIT 2, MICHIGAN



CIRCLE 197 ON READER-SERVICE CARD

**Rare Earths 284**

Thorium, yttrium chemicals, and metals and alloys of rare earths are cataloged in this eight-page brochure. Properties and chemical analyses of over 50 products are listed. Vitro Chemical Co., 342 Madison Ave., New York 17, N. Y.

**High-Temperature Switches 285**

Precision switches for use at high temperatures are described in this four-page folder, No. 84-449. Illustrations and specifications are included. Micro Switch Div., Minneapolis-Honeywell Regulator Co., Freeport, Ill.

**Crossguide Couplers 286**

Data on a line of microwave cross-guide couplers are supplied by eight-page catalog No. XT-61. Electrical and mechanical data are included. Microwave Development Laboratories, Inc., 15 Strathmore Road, Natick Industrial Centre, Natick, Mass.

**Semiconductor Alloys 287**

Physical properties of aluminum-indium, gold-silicon, and lead-silver alloys are given on data sheets No. 6R, 9R, and 12. Phase diagrams are included. Available die sizes are listed. Alpha Metals, Inc., 56 Water St., Jersey City, N. J.

**Oscilloscopes 288**

This 15-page abridged catalog describes the firm's line of conventional, portable, and rack-mounted oscilloscopes. Auxiliary equipment is also covered. Illustrations, specifications, and prices are included. Tektronix, Inc., P. O. Box 500, Beaverton, Ore.

**Vacuum Components 289**

High-vacuum valves, baffles, traps, and adapters are covered by 27-page bulletin No. 10-1. Descriptions, cut-away drawings, and selection guides are included. Consolidated Vacuum Corp., 1775 Mount Read Blvd., Rochester 3, N. Y.

*deep drawn aluminum boxes and covers*

**11,600  
Standard  
Sizes  
and  
Shapes**

**WITH NO TOOLING COST!**



Choose from more than 11,600 sizes, shapes and heights of square, round, rectangular boxes and covers — pay no tooling charge! All can be trimmed and modified to your specification . . . brackets and fasteners can be installed, holes and louvers punched, etc. Complete facilities for welding and painting too! Send print or contact your Zero Representative for quote on custom deep drawn parts using the exclusive Zero-Method tooling.



**ZERO  
MANUFACTURING CO.**

1121 Chestnut Street, Burbank, California  
Telephone Victoria 9-5521 • TWX BRB 9862

*representatives in key cities covering the U.S.*

**WRITE FOR  
NEW ZERO STOCK  
BOX CATALOG**



**CIRCLE 198 ON READER-SERVICE CARD**

**ELECTRONIC DESIGN • August 2, 1961**



# I E R C

**COOLS  
POWER  
TRANSISTORS  
BEST-FOR LESS!\***



PATENT PENDING

**\* LESS WEIGHT! LESS SPACE! LESS COST!  
MORE VERSATILE! MORE EFFICIENT!**

The unique design of IERC's UP Series Transistor Heat Dissipators give amazing cooling performance in natural and forced-air installations. Technical data covering the unusual performance benefits of Universal Power Series Transistor Heat Dissipators is available now — *write TODAY!*

**I E R C**  **D I V I S I O N**

**International Electronic Research Corporation  
135 West Magnolia Boulevard, Burbank, California**

Foreign Manufacturers: Europelec, Paris, France. Gerrard Mfg. & Eng. Co., Ltd., Swindon, England

CIRCLE 199 ON READER-SERVICE CARD

tape to printer  
card to printer  
processor to printer  
adc to printer

# BUFFERS



It's almost sinfully easy to drive rotary-bar printers when you use DI/AN's RBP Series Buffer and Control Units. All the control functions, accessory features, and format flexibility a reasonable man could want — in a surprisingly compact package. We leave room for three extra cards—for unreasonable special requirements. All solid-state, magnetic-storage

circuitry with proven reliability. Price and delivery will discourage you from building your own.

We want to send you a handful of specification and applications literature on our complete line of sequential-access and special-purpose buffers. Fascinating reading. Write today.



## DI/AN CONTROLS, INC.

544 Berchester Ave., Boston 25, Mass. • Avenue 8-7700

magnetic digital/analog systems and components

CIRCLE 200 ON READER-SERVICE CARD

# new GEN-PRO

## REPICON<sup>®</sup> REMOVABLE CONTACT CONNECTOR

New from Gen-Pro: Repicon "C" high density removable contact connector offers unlimited application in wiring installations. Available in 34, 42, 50, 75 and 104 contacts. In accordance with requirements of MIL-C-22857, interchangeable with other connectors of MIL-C-8384 configuration and contact pattern

Repicon Removable Contacts in crimp or solder type give higher contact retention, closely controlled engagement and separation forces and low millivolt drop. Usable in other existing connector body sizes and configurations. Contacts are ordered separately for assembly by user.



TYPE C  
50 CONTACTS

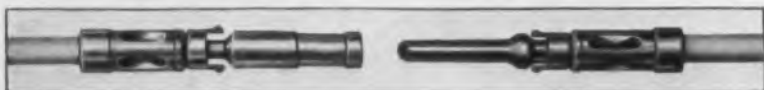

SOCKET CONTACT

PIN CONTACT

Write today for bulletin illustrating types in stock with specifications

### GENERAL PRODUCTS CORPORATION

Over 25 Years of Quality Molding

UNION SPRINGS, NEW YORK

TWX No. 169

CIRCLE 201 ON READER-SERVICE CARD

## NEW LITERATURE

### Electromechanical Parts 290

Catalog No. 65, 552 pages, lists the firm's line of electromechanical components, including speed reducers, magnetic clutches and brakes, differentials, and hardware. Specifications are included. Designatronics, Inc., Sterling Instrument Div., 5 Sintsink Drive, Port Washington, N. Y.

### Variable Capacitors 291

Military-type trimmer air-dielectric variable capacitors are described and illustrated in 16-page catalog No. 61. Physical and electrical specifications are given for over 20 different types. Hammarlund Manufacturing Co., 460 W. 34th St., New York 1, N. Y.

### Capacitance Calculator

Nomograph permits rapid estimation of cable capacitance or necessary

cable dimensions for required capacitance without using equations. Calculator is on laminated acetate, and contains information on cables and a chart on insulation and jacket combinations. Write on company letterhead to General Electric Co., Chemical and Metallurgical Div., Dept. ED, Bridgeport 2, Conn.

### High Voltage Equipment 292

Ten high voltage test sets and power supplies are described in this eight-page catalog. Included are a special cable hi-pot tester, insulating oil dielectric tester, ac-dc test set, industrial high voltage dc power unit and a corona pick-up network. Peschel Electronics, Inc., Patterson, N. Y.

### Magnetic Clutches

Miniature magnetic clutches, clutch-brakes and brakes are covered



Try this simple test. Tie a piece of Gudalace around a pencil in a half hitch and pull one end. Gudalace's flat, nonskid surface grips the pencil—no need for an extra finger to hold Gudalace in place while the knot is tied!

Gudalace makes lacing easier and faster, with no cut insulation, or fingers—no slips or rejects—and that's *real* economy. Gudalace is the original flat lacing tape. It's engineered to *stay* flat, distributing stress evenly over a wide area. The unique nonskid surface eliminates the too-tight pull that causes strangulation and cold flow. Gudalace is made of sturdy nylon mesh, combined with special microcrystalline wax, for outstanding strength, toughness, and stability.

Write for a free sample and test it yourself. See how Gudalace takes the slips—and the problems—out of lacing.

## GUDEBROD

Electronic Division  
225 West 34th Street  
New York 1, N.Y.

## BROS. SILK CO., INC.

Executive Offices  
12 South 12th Street  
Philadelphia 7, Pa.

Visit Gudabrod Booth 4718 at The Wexcon Show

CIRCLE 202 ON READER-SERVICE CARD

ELECTRONIC DESIGN • August 2, 1961

by this 12-page catalog. Schematics and operational descriptions of each model are included. *Write on company letterhead to Fae Instrument Corp., Dept. ED, 16 Norden Lane, Huntington Station, L. I., N. Y.*

alog, No. B-611. A nomograph of line voltage drop as a function of current and wire size is included. Kepeco, Inc., 131-38 Sanford Ave., Flushing 52, N. Y.

### Optical Comparators 293

Optical comparators and universal measuring machines are described in the 60-page catalog No. 6013. It contains complete specifications. Also included are an illustrated demonstration of how basic measuring is accomplished, details on accessories, and illustration of over 20 applications. Jones & Lamson Machine Co., Springfield, Vt.

### Power Supplies 294

Over 150 regulated dc power supplies, including semiconductor, vacuum tube, magnetic, and hybrid types, are listed with illustrations and specifications in this 32-page cat-

### Air Pumps 295

Catalog 660, 12 pages, describes rotary air motors, air compressors and vacuum pumps for original equipment manufacturers or plant use. Complete physical and electrical specifications are given for both oilless and lubricated models. Gast Manufacturing Corp., Box 117, Benton Harbor, Mich.

### Cryogenic Sensors 296

Platinum resistance temperature transducers for use with cryogenic fluids are described in eight-page bulletin No. 2000. Operating principles, calibration techniques, and applications are considered. Trans-Sonics, Inc., P. O. Box 328, Lexington 73, Mass.



## New Atohm catalog simplifies trimmer pot selection!

Atohm's new catalog has all the information you need to select the appropriate trimmer potentiometer for every application. Models and specifications, including terminal configurations, are clearly and simply presented to make selection easy. *Write for your copy today.*

**ATOHM ELECTRONICS INC.**  
7848 San Fernando Road, Sun Valley, California



## Automatic Battery Charger

**Q.** Why does the Hughes Electronics Company use General Electric Silicon Controlled Rectifiers in its automatic battery chargers?

**A.** "The General Electric SCR replaces the magnetic amplifier used as the main regulator in less advanced automatic chargers. It permits substantial savings in weight and size with no increase in cost, plus higher efficiency, unlimited life and absolute stability."



Modular construction of the "full-float" automatic battery charger developed by Hughes Electronics Co., Los Angeles, eliminates moving parts, relays, electronic tubes and transistors. Another example of advanced equipment design made possible by the use of the General Electric SCR.

Features of the Hughes Automatic Battery charger include:

- Improved voltage regulation (less than 1/2 of 1%)
- Current limiting to 110% load
- Constant voltage output
- Overload protection in AC and DC circuits
- Natural draft cooling

Now lower-priced than ever before, the SCR opens new areas for engineering development. *Can you afford to wait any longer?* Write today for application information. Rectifier Components Department, Section 23H23, General Electric Company, Auburn, New York.



# GENERAL ELECTRIC

## DC Motor Speed Control

**Q.** Why are the new DC motor Speed Controls from ACF Electronics Division designed around General Electric Silicon Controlled Rectifiers?

**A.** "General Electric Silicon Controlled Rectifiers and patented ACF magnetic triggers are largely responsible for making ACF DC motor speed controls smaller, and provide longer reliable life in any application or drive using a DC motor whose speed is regulated."



Control for 10 H.P. motor illustrates dramatic size reduction made possible for DC Motor Speed Controls from 1/20 to 15 H.P. from ACF Electronics Division, Paramus, N.J. Another example of advanced equipment design made possible by General Electric SCR's.

Features of the ACF Motor Speed Control include:

- Instant starting — no warm-up time
- Precise regulation over wide speed range
- More efficient over full speed range
- Less voltage drop
- Smaller, lighter weight
- Greater performance reliability

Now lower priced than ever before, the SCR opens new areas for engineering development. *Can you afford to wait any longer?* Write today for application information. Section 23H24 Rectifier Components Department, General Electric Company, Auburn, New York.



# GENERAL ELECTRIC

CIRCLE 204 ON READER-SERVICE CARD

CIRCLE 205 ON READER-SERVICE CARD

# IDEAS FOR DESIGN

## Vote for Ideas Valuable to You

Vote for the Ideas which are valuable to you. Other engineers will vote for the Ideas which are most valuable to them. The Idea which receives the most "Valuable" votes will be judged "Most Valuable of Issue." Its author will receive a \$50 award.

Choose the Ideas which suggest a solution to a problem of your own or stimulate your thinking or which you think are clever.

The Ideas chosen as the most valuable in each issue will be eligible for the \$1,000 Idea of the Year award.

So vote for the Ideas you find most valuable. And, after you've voted, why not send in an Idea of your own?

## Tuning Fork Oscillator Produces Square Waves Directly 746

Used in a square-wave generator, a tuning-fork oscillator usually provides about a 4-v sinusoid to be fed into a Schmitt trigger, or other squaring circuit. However, much higher voltage square waves can be obtained directly from the oscillator by introducing

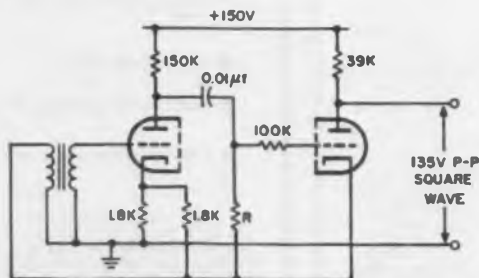

Fig. 1. Usual tuning fork oscillator produces low-voltage sinusoid which is fed to squaring circuit.

Table 1.

Tube	R	Output (pk-pk)
5814A	220 K	110 v
12AT7	62 K	110
5751	33 K	65

positive feedback, as shown in Fig. 2. And, the square-wave output has good rise and fall times.

Any of the three common twin triodes may be used by changing the value of  $R$ ,

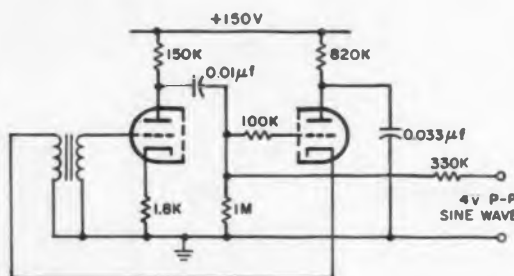

Fig. 2. With positive feedback applied, tuning fork oscillator produces higher voltage square waves, rather than sinusoids.

which is a function of the tube rather than of frequency. The table lists values of  $R$  for maintaining a 50 per cent duty cycle. Peak-to-peak output amplitudes are also indicated. The tuning fork used was a Philamon Laboratories model MJ.

William C. Whitworth, Design Engineer, Scottsdale, Ariz.

If this Idea is valuable to you, give it a vote by circling Reader-Service number 746.

## Sixth \$50 "Most Valuable of Issue" Award For Emitter-Follower Bias Method

Donald W. Bramer, engineer with the General Railway Signal Co., Rochester, N. Y., has won ELECTRONIC DESIGN's sixth \$50 Most Valuable of Issue Award.

Mr. Bramer receives the award for his Idea for Design. "Bypassed Bias Resistor Increases Emitter-Follower Input  $Z_i$ ," which appeared in the May 10 issue. The idea described a method for biasing an emitter follower so that its input impedance would be greater than could be obtained with a conventional connection.

## Voltage Comparator Uses Tunnel Diode Flip-Flop 747

A voltage comparator was needed to detect a 5-mv output change from the "off" to the "on" state at a frequency of 2 mc.

The voltage comparator designed for the job proved to be extremely sensitive. It used two silicon 4.7-ma peak current tunnel diodes connected as shown in the figure.

Essentially the tunnel diodes are biased as a flip-flop, one in the high conduction state, and the other in the low conduction state.

A positive pulse at the input switches the diodes to the opposite states.

The bias point is chosen so that 0.8 ma or more is required to make the diodes switch. Resistor  $R_i$  is used to adjust the amount of switching current. This circuit was able to detect a voltage of 1 mv resolution from the "off" state to the "on" state.

As an example, assume that an output is required when the input is above +1 v.

When the input is just below 1 v the diodes do not switch; they remain at their initial

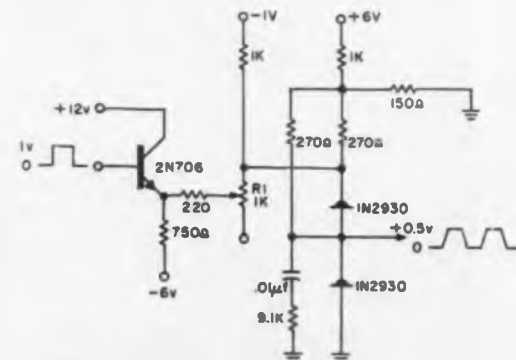

Tunnel diode voltage comparator uses diodes biased to form a flip-flop.

bias point. As the input voltage approaches +1 v, the additional current switches the diodes. ( $R_i$  is adjusted until the point is reached where the diodes switch.)

Nicholas Marchese, Assistant Electrical Engineer, Lockheed Electronics, Metuchen, N. J.

If this Idea is valuable to you, give it a vote by circling Reader-Service number 747.

## SEVENTH ANNIVERSARY AWARDS

# IDEAS-FOR-DESIGN

*Entry Blank*

### How You Can Participate

#### Rules For Awards

Here's how you can participate in Ideas for Design's Seventh Anniversary Awards: All engineer readers of **ELECTRONIC DESIGN** are eligible.

Entries must be accompanied by filled-out Official Entry Blank or facsimile. Ideas submitted must be original with the author, and must not have been previously published (publication in internal company magazines and literature excepted).

Ideas suitable for publication should deal with:

1. new circuits or circuit modifications
2. new design techniques
3. designs for new production methods
4. clever use of new materials or new components in design
5. design or drafting aids
6. new methods of packaging
7. design short cuts
8. cost saving tips

Awards:

1. Each Idea published will receive an honorarium of \$20.
2. The Idea selected as the most valuable in the issue in which it appears will receive \$50.
3. The Idea selected as the Idea of the Year will receive a Grand Prize of \$1,000 in cash.

The Idea of the Year will be selected from those entries chosen Most Valuable of the Issue.

Most Valuable of the Issue and Idea of the Year selections will be made by the readers of **ELECTRONIC DESIGN**. The readers will select the outstanding Ideas by circling keyed numbers on the Reader-Service cards. Payment will be made eight weeks after Ideas are published.

Exclusive publishing rights for all Ideas will remain with the Hayden Publishing Co.

Ideas-for-Design Editor  
**ELECTRONIC DESIGN**  
850 Third Ave.  
New York 22, N. Y.

**Idea** (State the problem and then give your solution. Include sketches or photos that will help get the idea across.)

*(Use separate sheet if necessary)*

I submit my Idea for Design for publication in **ELECTRONIC DESIGN**. I understand it will be eligible for the Seventh Anniversary Awards—\$20 if published, \$50 if chosen Most Valuable of Issue, \$1,000 if chosen Idea of the Year.

I have not submitted my Idea for Design for publication elsewhere. It is entirely original with me and does not violate or infringe any copyrights, patents or trademarks or the property rights of any other person, firm or corporation. Hayden Publishing Company, Inc. shall have the exclusive publication rights to these Ideas for Design selected for publication in **ELECTRONIC DESIGN**. This right extends to the subsequent use of the Idea for Design by Hayden in any of its other publications. Honorariums, if any, for subsequent publication shall be solely in the discretion of Hayden Publishing Company, Inc.

Name \_\_\_\_\_ Title \_\_\_\_\_

Company Name \_\_\_\_\_

Address \_\_\_\_\_

For Additional Entry Blanks, circle 750 on Reader-Service Card.

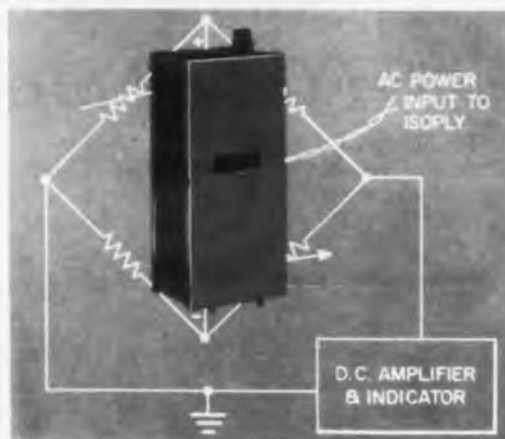
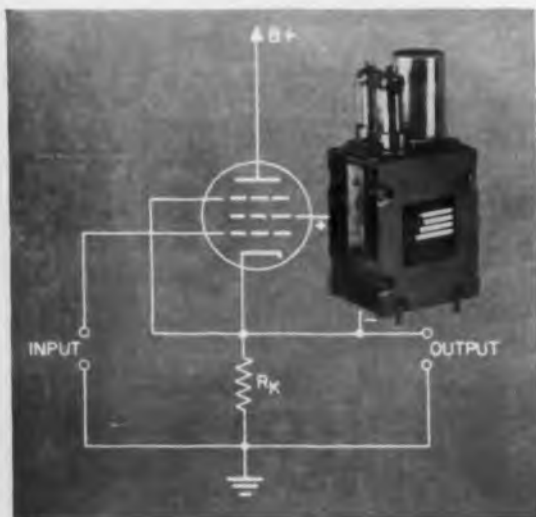
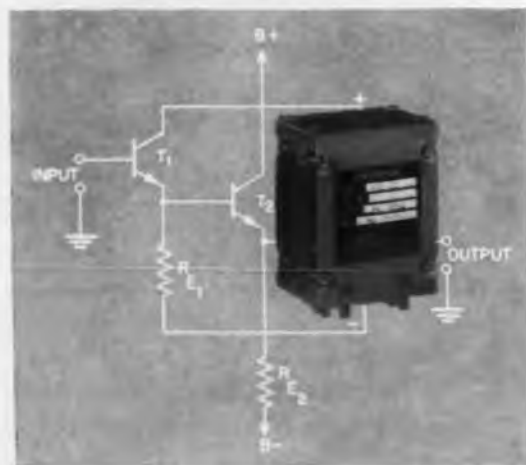
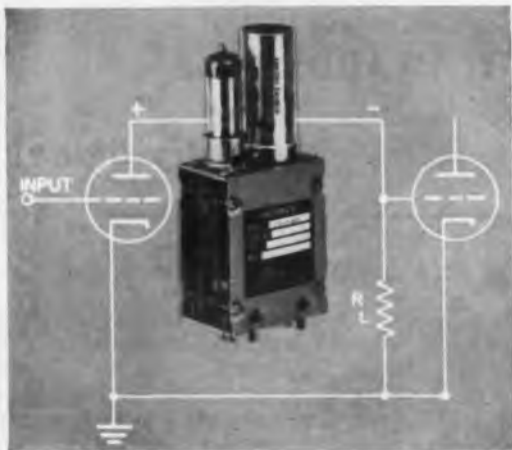

## Circuit designs made simpler and more economical with new Elcor ISOPLYS®

Isoplys (isolated power supplies) can be used ungrounded. Unlike conventional power supplies, Isoplys have low shunt capacitance to ground and low noise in ungrounded applications. They are relatively insensitive to power line fluctuations and give excellent frequency response.

Many components once thought essential in conventional circuits can be eliminated. Design and assembly time can be speeded. Troublesome interaction between circuits is substantially reduced. This also helps simplify maintenance as well as solve difficult circuit problems.

Let Isoplys help simplify a circuit design you are working on now. Be prepared for design problems in the future.

write for full information: **ELCOR Incorporated**

Subsidiary of Welx Electronics Corporation  
Sales / R & D Laboratory / Manufacturing  
1225 W. Broad Street / Falls Church, Virginia  
JEfferson 2-8850

CIRCLE 206 ON READER-SERVICE CARD

## IDEAS FOR DESIGN

### Sine-Cosine Pots Form 730 White-Noise Signal Generator

Advanced design procedures of networks, control loops and communication systems usually require the testing of their response to signals found in their normal, operating environment. Such testing procedures can be aided considerably by the almost white-noise generator shown in Fig. 1.

The generator was built to produce the low-frequency, nonpredictable forcing function required for a certain tracking problem. It consists of 1 per cent accuracy potentiometers driven from a single, constant-speed reversible ac motor at nonharmonic circular frequencies. Successive gear trains reduce the speed of rotation from one shaft to the next by the same ratio,  $r$ . The value selected was

$$r = \frac{23}{28} \quad (1)$$

When the potentiometers are biased symmetrically by the voltages  $\pm A$  and the outputs from the sine and cosine wipers are summed separately, they produce the signals:

$$f_s(t) = A \sum_0^{19} \sin(r^n \omega_0 t + \phi_n), \quad (2)$$

$$f_c(t) = A \sum_0^{19} \cos(r^n \omega_0 t + \phi_n), \quad (3)$$

where the phases  $\phi_n$  are random.

By a gear shift, either one of the following two basic frequencies may be selected:

$$f_o = f_{max} = \frac{\omega_0}{2\pi} = 1 \text{ or } 2 \text{ cps} \quad (4)$$

Consequently, for the first setting the twenty component frequencies cover the range 0.0228 to 1.0000 cps. By using one multiplier the following signal may be generated:

$$F(t) = f_c(t) [f_s(t) + f_c(t) + A] - 10A^2$$

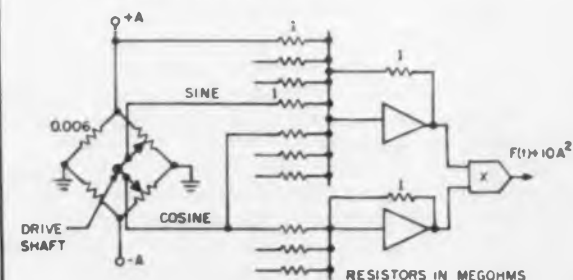

Fig. 1. Twenty wire wound sine-cosine potentiometers are driven on a single shaft in this repeatable, white-noise signal generator.



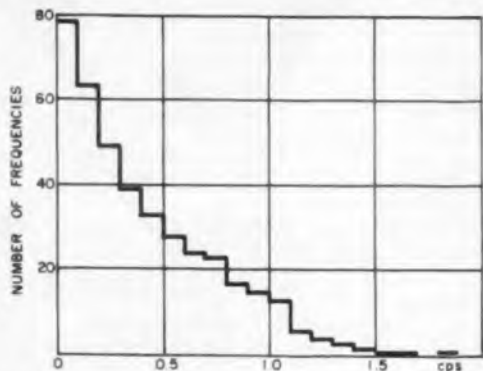
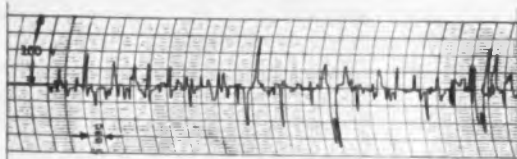

Fig. 2. (a) Sample of signal output,  $F(t)$  of the white noise generator with (b) Number of component frequencies within steps of 0.1 cps.

or

$$F(t) = A^2 \sum_0^{19} \cos(r^n \omega_n t + \phi_n) + A^2 \sum_0^{19} \sum_0^{19} \cos[(r^n + r^m) \omega_0 t + (\phi_n + \phi_m)] + \cos[(r^n - r^m) \omega_0 t + (\phi_n - \phi_m)] \quad (5)$$

This is a signal of an absolutely flat spectrum containing 400 frequencies between 1.8214 and 0.0050 cps none of which is an harmonic of another. A sample of the signal  $F(t)$  is shown in Fig. 2, while in Fig. 3 the number of component frequencies within steps of 0.1 cps is shown. The packing density of component frequencies was made intentionally higher at the lower end of the spectrum because the resolution of any linear system (the distinguishable frequency step) decreases as the signal frequency increases.

Because the numerator of the ratio  $r$  in Eq. 1 is a prime number, the ratio is irrational. Thus, the number of rotations of the fastest shaft necessary for all the terms of the geometric series:

$$1, \frac{23}{28}, \dots, \left(\frac{23}{28}\right)^{19}$$

to become integers is  $28^{19}$ . When this value is reached the signal will start repeating for the first time. Since each rotation requires one second, the repetition period is  $28^{19}$  sec or  $10^{23}$  yr.

If an rpm counter is coupled to the fastest shaft and the generator is run from a starting count  $M$  to a count  $N$ , it will generate a signal of total length  $(N-M)$  sec. If the motor

## PULSE POINTERS

Popular E-P 3450D pulse generator quickly converts to 6 standard pulse instruments\*

Modular flexibility, simplicity of operation expand versatility, cut pulse costs



Modular concept extends instrument versatility, guards against obsolescence, cuts costs. Standard modules, designed to accomplish specific instrument and system functions, quickly plug into both front and rear of rack frames. Simplicity of operation is highlighted throughout.

Can one general-purpose pulse generator handle such common laboratory and production applications as the design and test of radar, navigation and fire control systems, digital computers... then quickly convert to transistor and diode delay line testing, production line testing, quality control, high-voltage drive of strain gages, system transient testing, and other pulse applications? Yes, the *Electro-Pulse* Model 3450D. This popular general-purpose pulse generator is winning plaudits from both production and the lab.

The secret: modular plug-in construction and adjustable pulse-forming controls—standard with all *Electro-Pulse* instruments.

Interchangeable plug-in printed circuit modules quickly and economically extend instrument performance to meet changing requirements. Integral front panels and controls achieve both electrical and mechanical standardization.

Add the 3450D's fully regulated output amplitude; stable, jitter-free repetition rate and delay; reliable output

overload protection; and high resolution controls.

The result is a single versatile source of high power; very fast rise time; single or recurrent pulses...controllable in repetition rate, delay from trigger, duration, rise time, and top slope.

### Take these basic specifications:

- Positive and negative polarity
- 2 mc-2 cps rep. rate
- 0-10,000  $\mu$ s delays
- .05-10,000  $\mu$ s widths
- $\pm 50$  volts into 50 ohms
- 15 nanosec. continuous rise time

### Modify with these standard modules:

- Y Simultaneous complementary output.
- X Twin pulse and pulse train capability.
- T .05-5,000 cps rep. rate.
- I 1 volt input trigger sensitivity.
- G ON-OFF gated output.

In effect, you end up with 6 different instruments.

Model 3450D is just one of 33 cataloged instruments in the broad *Electro-Pulse* line, which includes as many as 200 standard pulse and digital circuit modules (both tube and transistor types). Advanced pulse techniques and circuitry, coupled with traditional Servo Corp. instrument quality and reliability, make E-P the wisest buy.

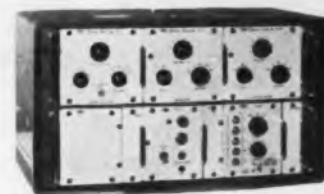

## 4500 Series 10-Megacycle Pulse Generators

7 standard models • solid state reliability and circuits • variable delay and width • optional output characteristics •

For reliable generation of variable parameter pulses at very high repetition rates. Wide application in development and testing of components, logic circuitry, and high clock rate digital systems.

Servo Corporation of America  
111 New South Road  
Hicksville, L. I., N. Y.

Gentlemen:

- Please send detailed catalog.
- Please contact me for demonstration.
- Please send me a free SERVO slide rule.

(name)

(title)

(organization)

(address)

(city, zone, state)



Electro-Pulse Products

# SERVO CORPORATION OF AMERICA

111 New South Road • Hicksville, L. I., N. Y. • WELLS 8-9700

Sales & service offices coast-to-coast • Representatives in major cities

single pulse generators • double pulse generators • word generators • pulse train and pulse code generators • time delay and gate generators • current generators and core testers • modules

CIRCLE 207 ON READER-SERVICE CARD



# DETUNE VIBRATION ISOLATE SHOCK

From Aeroflex Laboratories — a major development  
in the control of vibration and shock —  
the all new field proven Cable Isolation System.

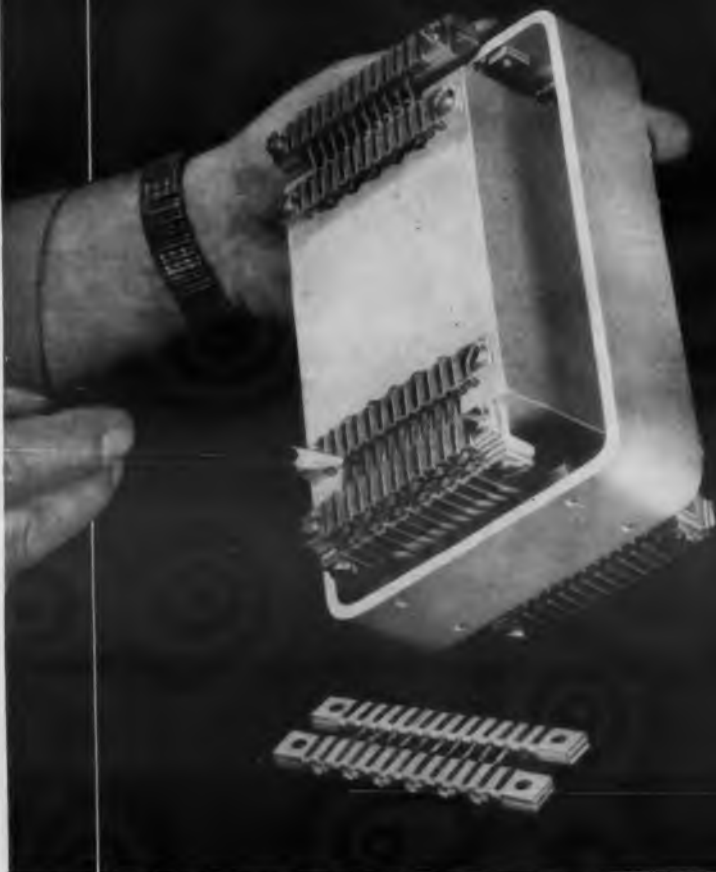

## NOW YOU CAN:

- Isolate your equipment against shock, vibration and noise, or any combination thereof — even in the presence of constant or long term "G" loading.
- Have three dimensional, all attitude isolation.
- Tune your isolation system in the field.
- Have a vibration control system that does not bottom out under heavy "G" loading and functions in a wide variety of environmental conditions including a temperature range of  $-100^{\circ}\text{F}$  to  $+1000^{\circ}\text{F}$ .

*For information on how an Aeroflex Cable Isolation System can be used to solve your vibration and shock problems, write today to Dept. BR-5.*

Licensed under Patents and Patent Application of Kerley Engineering Inc.

## AEROFLEX LABORATORIES INCORPORATED

48-25 36th STREET • LONG ISLAND CITY 1, N. Y.

CIRCLE 208 ON READER-SERVICE CARD



## IDEAS FOR DESIGN

is then reversed and the system returned to the original count  $M$ , it will be ready to generate the same signal with absolute repeatability. This is a great asset in cases where the forcing function must be repeated. It is also very valuable in comparing the performance of two or more systems, especially when these systems are nonlinear.

Various other combination possibilities exist. Thus, it is easy to find that the signal  $[F(t)]^2$  will contain approximately 80,000 frequencies in the range 0.00 to 4.0 cps. However, 400 will have twice the amplitude of the rest as well as being the first harmonics of others.

*N. D. Diamantides, Engineering Scientist, Goodyear Aircraft Corp., Akron, Ohio.*

If this idea is valuable to you, give it a vote by circling Reader-Service number 730.

### AF Tuned Amplifier Has Adjustable Bandwidth 742

Here's a circuit for a tuned af amplifier with adjustable bandwidth and an essentially constant gain-bandwidth product. If desired, it can be made voltage tunable by adding a single varactor diode.

The amplifier is basically of the regenerative type. Transistor  $Q_1$  is used as a common-base amplifier. The second transistor  $Q_2$ , together with the transformer  $T$ , form a negative-resistance generator that reflects approximately  $-R_e$  ohms into the collector circuit of  $Q_1$ . Transformer  $T$  can be either a center-tapped inductor or a small audio autotransformer.

Resistor  $R_e$  is the equivalent emitter-cir-

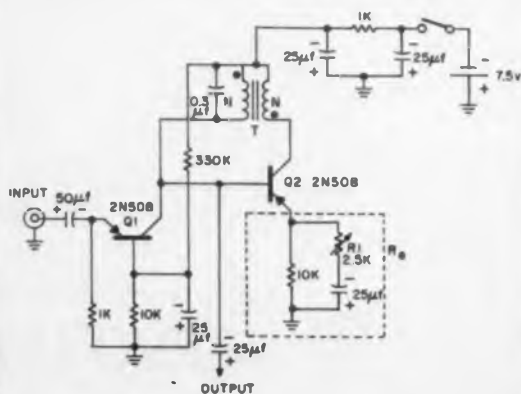

Tuned af amplifier has adjustable bandwidth and fairly constant gain-bandwidth product.

## THE Lavoie LA-303 ROBOTESTER



*speeds up*  
TEST PROCEDURES  
500%

FOR  
COMPONENTS,  
EQUIPMENTS,  
AND SYSTEMS  
IN  
PRODUCTION  
LINES,  
LABORATORIES,  
AND AT  
OPERATIONAL  
SITES

The basic Robotester measures:

- Voltages AC & DC
- Impedance
- Resistance
- Insulation Resistance

Robotester accessories extend test capabilities to meet complex problem configurations and provide a complete test system built around the Robotester.

For complete details write to:

*Lavoie Laboratories, Inc.*  
MORGANVILLE, NEW JERSEY

CIRCLE 209 ON READER-SERVICE CARD  
ELECTRONIC DESIGN • August 2, 1961

cuit resistance of  $Q_s$  at the signal frequency. Adjustment of the potentiometer  $R_1$ , which is part of  $R_s$ , controls both the gain and bandwidth of the amplifier.

The following measurements were obtained at a center frequency of 990 cps:

Voltage gain	500	100	20
Bandwidth cps	6	35	180
Input signal $\mu\text{V}$	0.02	0.1	0.5
Signal to noise voltage	12	30	50

These results correspond to a noise figure of approximately 7 db.

*Clement A. Skalski, Engineer, Norden Div., United Aircraft Corp., Norwalk, Conn.*

If this idea is valuable to you, give it a vote by circling Reader-Service number 742.

## "See-Saw" Multivibrator 735 Uses a Single Capacitor

By ignoring the conventional approach to multivibrator design, it is possible to use a circuit configuration with a number of characteristics, which make it superior, in most applications, to the conventional designs.

The circuit shown has the following advantages:

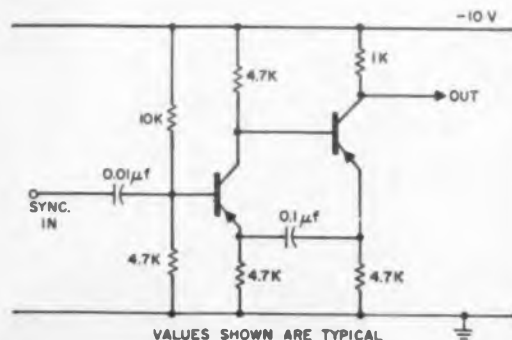

Multivibrator designed with only a single capacitor has several advantages over conventional circuits.

1. It is inherently self-starting.
2. It has an output isolated from the timing circuits.
3. It has an input isolated from the timing circuits.
4. It uses only one capacitor.

The only design requirement for reliable operation is that the resistors be proportioned so that the transistors are not saturated in a dc analysis. (Assume the capacitor is omitted).

*Roy P. Foerster, Group Engineer, The Martin Co., Baltimore, Md.*

If this idea is valuable to you, give it a vote by circling Reader-Service number 735.

ELECTRONIC DESIGN • August 2, 1961

# new

precision resolver developments by

FOR GUIDANCE • STABILIZATION • COMPUTER APPLICATIONS

Reeves



### 10-SECOND ACCURACY PANCAKE RESOLVER

Integral bearings permit direct mounting to gimbal structures of stable platforms. Beryllium housings provide highly stable operation in environments with extreme temperature variations.



### 20-SECOND ACCURACY SIZE 23 RESOLVERS

Double-ended design simplifies their incorporation into data transmission systems.



### HIGH IMPEDANCE PANCAKE RESOLVERS

Tuned impedance of 80,000 ohms makes these units ideally suited for use as control receivers. Rotor and stator assemblies may be independently attached to their mounting members. Standard units have an accuracy of 3 minutes of arc. One-minute accuracy can be supplied on special order.



### 0.005% FUNCTIONAL ACCURACY PANCAKE RESOLVER

100% compensated Resolver with integral Class III precision rotor gear. The ideal unit for high accuracy computer chains.

### 0.01% FUNCTIONAL ACCURACY SIZE 23 RESOLVER

100% compensated winding. Extreme accuracy in a standard resolver case size.

For complete information, write for Technical Data File 208

Qualified engineers seeking rewarding opportunities in these advanced fields are invited to get in touch with us.



• See our display at WESCON  
— Booths 3216 and 3218

REEVES INSTRUMENT CORPORATION

A Subsidiary of Dynamics Corporation of America, Roosevelt Field, Garden City, New York

Reeves

CIRCLE 210 ON READER-SERVICE CARD

7RV61

201

*New from Raytheon . . .*

---

## **QUALITY PULL HANDLES**

---

**in STAINLESS or ALUMINUM**

---

**from Factory Stock or  
Raytheon's 350 Distributors**

---

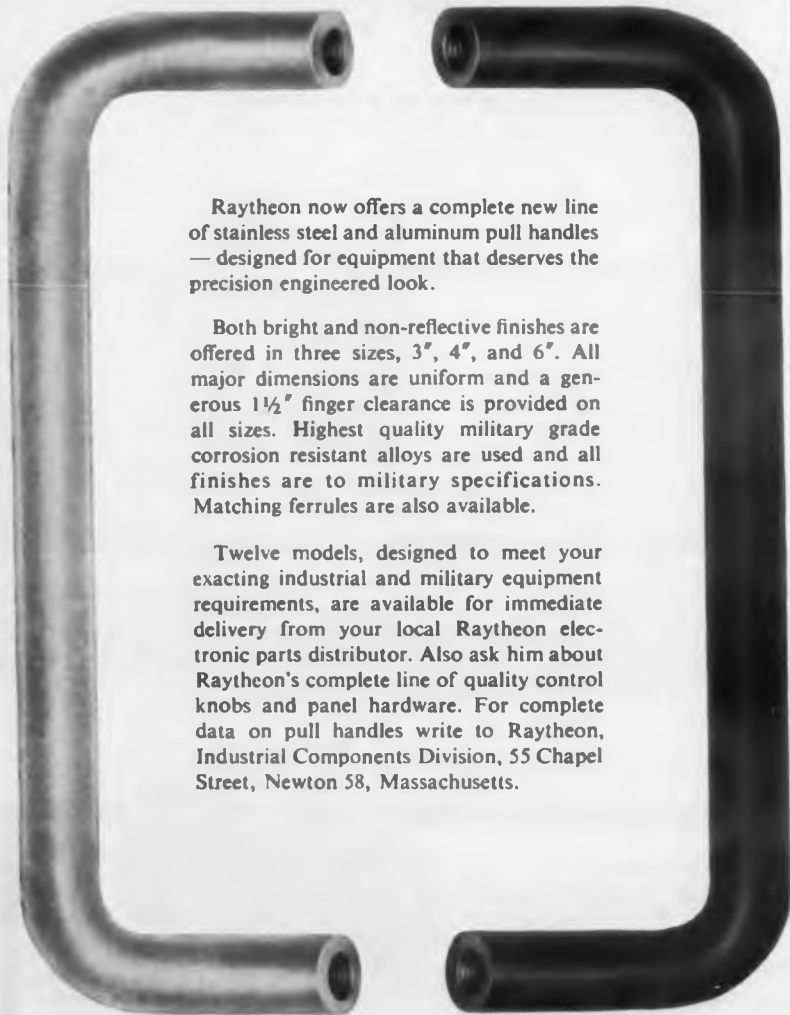

Raytheon now offers a complete new line of stainless steel and aluminum pull handles — designed for equipment that deserves the precision engineered look.

Both bright and non-reflective finishes are offered in three sizes, 3", 4", and 6". All major dimensions are uniform and a generous 1½" finger clearance is provided on all sizes. Highest quality military grade corrosion resistant alloys are used and all finishes are to military specifications. Matching ferrules are also available.

Twelve models, designed to meet your exacting industrial and military equipment requirements, are available for immediate delivery from your local Raytheon electronic parts distributor. Also ask him about Raytheon's complete line of quality control knobs and panel hardware. For complete data on pull handles write to Raytheon, Industrial Components Division, 55 Chapel Street, Newton 58, Massachusetts.

**RAYTHEON**

**RAYTHEON COMPANY**

**INDUSTRIAL COMPONENTS DIVISION**

**CIRCLE 211 ON READER-SERVICE CARD**

## IDEAS FOR DESIGN

### RC Pair Safely Sets Initial State of Relay Driver

744

Driving a relay by using the relay coil as a collector load of a flip-flop, as shown in Fig. 1, is not uncommon. However, when power is first applied to this circuit the relay will energize. This occurs because the coil inductance initially withholds current from the base  $Q_2$ . Thus  $Q_1$  conducts first, energizing the relay.

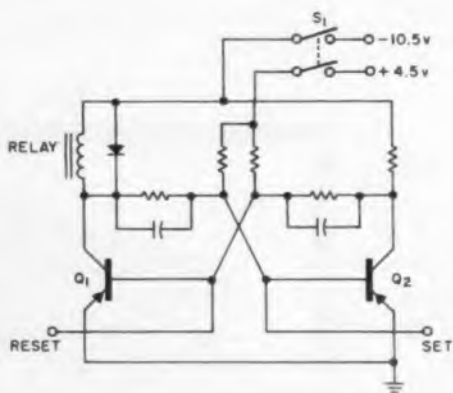

Fig. 1. Standard flip-flop with relay coil as collector load. Relay will energize when  $S_1$  is closed.

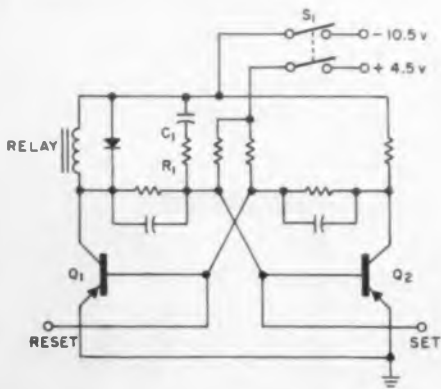

Fig. 2. Relay will not energize, in this modified flip-flop, when power is first applied.

It was necessary, in a particular application, that the relay not energize when power was first applied. This problem was solved by adding  $R_1C_1$ , as shown in Fig. 2.

When power is first applied to this circuit, a negative pulse is coupled by  $R_1C_1$  to the base of  $Q_2$  forcing it to conduct. This sets the flip-flop to the required initial state. After the power has been applied, the RC combination has no further effect on the operation of the circuit.

Using a  $-10.5$  v supply, as shown, values

# HOW ARE YOUR

# CON NEC

# ION S?

If they aren't what they should be, then you ought to be specifying Coaxial Connectors by

## Automatic

METAL PRODUCTS CORPORATION  
323 Berry St., B'klyn 11, N. Y. • EVERgreen 8-6057

CIRCLE 212 ON READER-SERVICE CARD

ELECTRONIC DESIGN • August 2, 1961

# GET LATEST DATA... ULTRASONIC DELAY LINES



Write today for **NEW CATALOG** . . . complete, timely specs on the industry's most complete line . . .

**ALSO** get your copy of "Definitions of terms used in Ultrasonic Delay Lines" a helpful guide to accurate specifying prepared by H. H. Lockhart, Manager, Delay Line Operations.



**LABORATORY FOR ELECTRONICS, INC.**

Computer Products Division  
1079 COMMONWEALTH AVENUE  
BOSTON, MASSACHUSETTS  
See a demonstration at WESCON  
August 22-25. Booths 2408-2410

CIRCLE 213 ON READER-SERVICE CARD

ELECTRONIC DESIGN • August 2, 1961

of  $R_1 = 5.1 \text{ K}$ , and  $C_1 = 0.68 \mu\text{f}$  gave reliable performance.

*Richard J. Bouchard, Electronics Engineer, Sanders Associates, Nashua, N. H.*

If this Idea is valuable to you, give it a vote by circling Reader-Service number 744.

## AC Amplifier Is Wide Band, Less Bulky

748

Because of their large number of bypass capacitors, multistage transistor amplifiers become bulky and expensive, especially if designed for low cut-off frequencies. Wide-band performance can, however, be obtained if the stages are ac coupled as shown in the figure. Bulk and expense are reduced because only one capacitor is used.

Any number of these amplifiers can be connected in cascade, since the dc potential at the amplifier output is equal to the potential at the input. The peak-to-peak output voltage is equal to the dc supply voltage. The dc collector voltage of  $V_3$  and the emitter voltage of  $V_1$  are maintained at the same potential. The voltage drop across  $R_2$  can be made negligible.

Gain stability is obtained by a proper choice of open loop gain and  $R_1$  and  $R_2$ . A small capacitor is usually required to prevent oscillations near the transistor cut-off frequency. Transistors  $V_2$  to  $V_5$  should have substantial current gain at  $V_{cb} = 0$ . Most silicon and some germanium units meet this requirement.

The amplifier can be designed for excellent

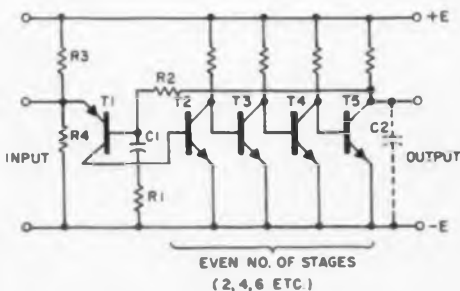

**Direct-coupled amplifier** has wide band and high gain, and operates without bulky and expensive bypass capacitors.

temperature stability (1 db for a 100 C change in temperature) and wide-band performance (0.1 cps to 2 mc) at high gain.

*Peter Laakmann, Project Engineer, American District Telegraph Co., New York, N. Y.*

If this Idea is valuable to you, give it a vote by circling Reader-Service number 748.

# New \*QC-SERIES



## TERMALINE COAXIAL LOAD RESISTORS

### A new series of Loads with QUICK-CHANGE CONNECTORS

This new series of TERMALINE Load Resistors are portable, general purpose, 50-ohm coaxial terminations. Their low VSWR, freedom from radiation and ruggedized construction, make them ideally suited as loads during the adjustment and testing of transmitters. All models in this series utilize the Bird Quick-Change Connectors (QC), which are available to accommodate any standard series of coaxial line fittings. VSWR specifications are 1.1 max. to 1000 mc, and less than 1.25 to 4000 mc.

Higher power loads with QC feature are available.

### \*QUICK CHANGE CONNECTORS

Eliminate connector-adapter problems. Any connector may be readily changed. QC connectors of the most popular types are illustrated below. For complete specifications request Bulletin R-QC-1.



Male "HN" Female "HN" Male "C" Female "C" Male "N" Female "N" Female UHF (SO-239)



# BIRD

## ELECTRONIC CORPORATION

30303 Aurora Rd., Cleveland 39 (Solon), Ohio  
Churchill 8-1200 TWX CGN FS 679

Western Representative:  
VAN GROOS COMPANY, Woodland Hills, Calif.

See us at Wescon Show Booth Nos. 1922-1924

CIRCLE 214 ON READER-SERVICE CARD



From Blueprint  
To Plastics Product  
**CONSOLIDATED**

gets it  
done!

At Consolidated, we take the designer's concept and turn it into exciting, satisfying reality.

Consolidated has always handled the tough jobs—the special jobs that "couldn't be made from plastics." And today at Consolidated we're still pioneering—still finding new, better ways to work with newer, better materials.

Most of America's live chip companies owe the honor roll of Consolidated customers. How About You?

FOR THESE QUARTERS  
OF A CENTURY  
YOUR SUSPENSE  
IS PLASTIC

CM  
IP

**CONSOLIDATED**

WORLD PRODUCTS CORPORATION  
442 CHERRY STREET, BRANSON, MO., 65616

Send for your free copy of our new 111 page Technical Report

## IDEAS FOR DESIGN

### Trigger Pulse Generates Two Separate Outputs 740

A circuit was required which, after receiving an input trigger, would produce two separate pulses in sequence. These pulses were to be used to drive a cold cathode counter tube. The circuit we designed is shown in the figure.

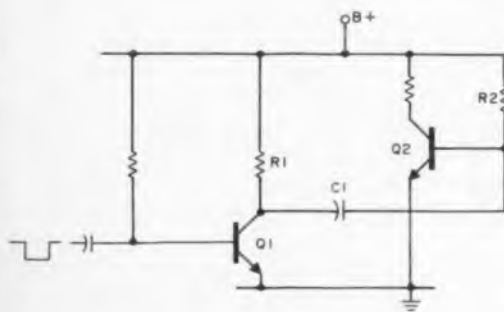

Negative trigger generates separate pulses of the transistor collectors. Variable delay between these pulses can be obtained by inserting RC elements at base of  $Q1$ .

Initially  $Q1$  and  $Q2$  are biased "on". A negative input pulse turns  $Q1$  "off". Capacitor  $C1$  then charges to  $B^+$  through  $R1$  and the base of  $Q2$  with a time constant  $R1C1$ . This positive going signal is transmitted to the base of  $Q2$ . Since  $Q2$  is already conducting no change takes place at the collector of  $Q2$ .

When the input pulse passes,  $Q1$  is again turned on. The negative signal at the collector of  $Q1$  is transmitted to the base of  $Q2$ . This turns  $Q2$  off. Capacitor  $C1$  now starts to charge to  $B^+$  through  $R2$  and the saturation resistance of  $Q1$ . It does so with a time constant of approximately  $R2C1$ . When it reaches  $1/2$  v it turns  $Q2$  on again and the circuit returns to its quiescent state.

Thus, an output pulse is generated at the collector of  $Q1$  as the input pulse begins, and a second pulse is generated at the collector of  $Q2$  as the input pulse terminates.

The pulse at  $Q2$  can be delayed from the input pulse by adding a time constant element, such as an RC combination, at the base of  $Q1$ .

Gordon Silverman, Senior Electrical Engineer, Loral Electronics Corp., Bronx, N. Y.

If this Idea is valuable to you, give it a vote by circling Reader-Service number 740.



at the WESCON SHOW

## MACHINES TALK!

over commercial telephone  
circuits equipped with  
Rixon's sebit 24  
data Transmitter-Receiver



Binary information is processed at 2400/1200/600 bits/sec in a nominal 3-KC voiceband such as a long distance toll circuit. Used for passing high speed data of: 3000 w m teleprinters; machines and computers; slow scan TV; facsimile, time division multiplexers; and sequential telemetering equipment.

- Built-in signal and test monitor • Fully transistorized • Fast acting AGC and self-contained, variable amplitude and delay equalization • Contains highly stable clock for synchronous detection and regeneration of received data signals • Low error rate • highly reliable over non-engineered circuits • Standard rack mounting.

SEE IT AT THE WESCON SHOW  
COW PALACE, SAN FRANCISCO  
AUGUST 22nd THROUGH 25th  
WEST COAST REPRESENTATIVE  
COSTELLO & CO.

SPECIFICATIONS AVAILABLE ON REQUEST

**RIXON**

ELECTRONICS, INC.

2121 INDUSTRIAL PARKWAY  
MONTGOMERY INDUSTRIAL PARK  
Silver Spring, Md., MAyfair 2-2121

CIRCLE 237 ON READER-SERVICE CARD

ELECTRONIC DESIGN • August 2, 1961

# hi-var\*

## CAPACITORS

... OFFER 75%  
REDUCTION IN  
WEIGHT VOLUME

Hi-Var capacitors have prime application in lightweight airborne equipments. Ideal for potted and oil immersed circuitry from sea level to 100,000 feet. High voltage radial terminals are space saving with long, heavy horizontal creepage path minimizing corona — yet permitting highest voltage in miniature circuitry.

(Bulletin 10-TB-60)

### CLEAR-PASS\* CAPACITORS

A new subminiature feed-thru RF interference suppressor, Dearborn Clear-Pass capacitors combine maximum insertion loss over a broad band of radio frequencies with minimum size/weight. Uniquely designed thread neck effectively eliminates inductance between noise source and output terminals and minimizes contact resistance to chassis — thus obtaining optimum insertion loss.

(Bulletin 11-TB-60)

### PULSE FORMING NETWORKS

Using Deltaply\* laminated dielectrics, Dearborn's PFN provide reductions in volume/weight as well as extended life and superior retrace characteristics. Units have application which require the use of "E" type high voltage networks and produce rectangular shaped pulses to near perfection.

(Bulletin 9-TB-60)

WRITE FOR  
THE ABOVE BULLETINS

**Dearborn**  
ELECTRONIC  
LABORATORIES, INC.

P.O. Box 3431 • Terrace B-5408  
Orlando, Florida

CIRCLE 238 ON READER-SERVICE CARD  
ELECTRONIC DESIGN • August 2, 1961

## Regenerative Switch Demodulates Sinusoid 743

By using what is basically a direct-coupled, regenerative switch, the carrier of a pulse-modulated sinusoid can be easily removed, leaving only the pulse modulation.

In fm-fm telemetry systems this function is usually performed by discriminator circuits. The output pulse can then be directly applied to digital circuitry.

The circuit shown is designed for a system where the digital transfer rate is at 2.5 kc, with a 20-kc carrier. Its hysteresis is less than 50  $\mu$ sec. Bandpass filtering of the carrier was not necessary for the application in which the circuit was originally used.

Hysteresis is kept low by placing the filter in the feedback circuit. There, its time constant is effectively amplified by the gain of  $Q_1$  and  $Q_2$ . This allows a smaller capacitor to be used at the input.

Positive feedback is adjusted by potentiometer  $R_5$  to eliminate all ac from the output. The adjustment from this point, to the point where the switch is locked on, is quite broad.

Transistor  $Q_1$  is held off by the drop across  $CR_3$  caused by the leakage current. Its base is held at ground potential by the return through  $R_1$  and  $RT_2$  in parallel. The  $I_{CBO}$  of  $Q_1$ , flowing through this combination does not produce a drop sufficient to overcome the threshold voltage of  $Q_1$  plus the drop across  $CR_3$ .

Transistor  $Q_2$  is similarly held off by  $CR_4$  and  $R_3$ . An incoming signal is half-wave rectified by  $CR_1$  and clamped to ground by  $CR_2$ . No filtering is used here since the discharge time constant of a filter of sufficient size would materially increase the circuit hysteresis.

The positive peaks of the rectified signal

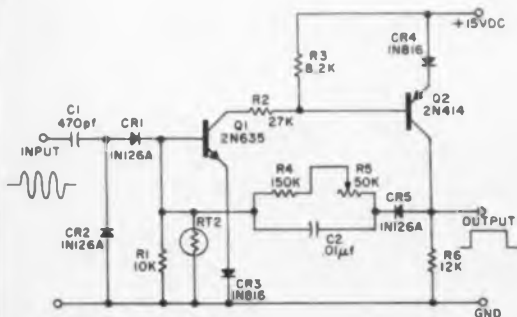

Simple demodulator removes carrier of pulse-modulated sinusoid, leaving only the modulating waveform.

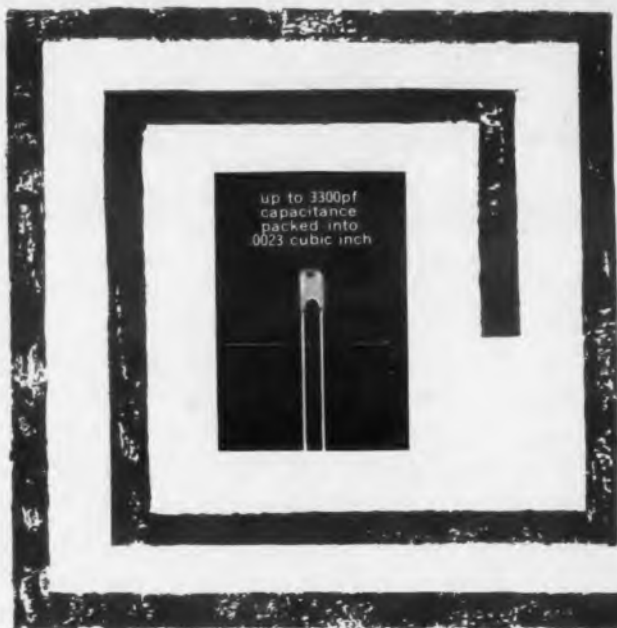

# NEW ERIE WEECON

## sub-miniature ceramic plate capacitors conserve valuable printed board space

High capacitance in limited board space is made possible by WEECON Ceramicons<sup>®</sup>, designed by Erie to offer the ultimate in miniaturization of ceramic capacitors.

Sub-miniature size and rectangular design permit a higher component density on printed circuit boards and in applications where space is a critical factor. Available in MIL lead spacing for printed wiring boards or conventional spacing for point-to-point wiring.

WEECON Ceramicons are conservatively rated at the following specifications:

- Temperature Range: -55°C to +85°C. Also available for 125°C at lower working voltages
- Working Voltage: 200 VDC
- Life Test Voltage: 2xVDCW 1000 hours 85°C
- Flash Test Voltage: 3xVDCW
- Coating: Dipped, resin coated

Style	4815	4825	4835	4845	4855	4865
Max. Size	.150x .150	.200x .200	.300x .300	.400x .400	.500x .500	.600x .500
Thickness	.100"	.100"	.100"	.100"	.150"	.150"
Capacitance	6pf to 3300pf	11pf to 6200pf	25pf to .0135mf	48pf to .025mf	76pf to .040mf	90pf to .05mf

For more information on WEECON Ceramicons, write for New Product Bulletin NP-128-1.



## ELECTRONICS DIVISION

ERIE RESISTOR CORPORATION

645 West 12th Street • Erie 6, Pennsylvania

Sales offices in principal cities of USA, Canada, Europe

CIRCLE 239 ON READER-SERVICE CARD

# WHEN HIGH QUALITY, *is the Criterion* *in Airborne Telemetry...*

Vitro Electronics Nems-Clarke airborne telemetry equipment should be the unquestioned choice in applications where proven performance and the utmost dependability outweigh considerations of size and weight. A thoroughly equipped system of this nature might, for instance, have Vitro Electronics Nems-Clarke Type 1403 Airborne Telemetry Receivers. Effective supporting auxiliary equipment in such an installation would include:

**Preamplifiers for amplification and improvement of received signals**  **Multicouplers for distribution of received signals to as many as 8 receivers**  **Phase-lock telemetry receivers—key units of a system**  **Diversity-combiners combining reception of up to 4 receivers into one output as good as best single receiver output—or better than equal outputs from all associated receivers**  **Spectrum display unit to each 4 receivers—for visual monitoring of received signals to determine character and modulation**



Type PR-202 Preamplifier



Type MC-202 Multicoupler



Type TR-100 Telemetry Receiver



Type DCA-2000 Diversity Combiner



Type SDU-200 Spectrum Display Unit

**WHERE THE UTMOST IN HIGH  
QUALITY AIRBORNE TELEMETRY  
IS DEMANDED—VITRO  
ELECTRONICS IS AT WORK.**

**Vitro ELECTRONICS** A DIVISION OF VITRO CORPORATION OF AMERICA  
PRODUCERS OF **NEMS-CLARKE** EQUIPMENT  
819 JESUP-BLAIR DRIVE, SILVER SPRING, MARYLAND / 2301 PONTIUS AVENUE, LOS ANGELES 64, CALIFORNIA  
CIRCLE 240 ON READER-SERVICE CARD

## IDEAS FOR DESIGN

turn  $Q_1$  on, supplying  $Q_2$  with a base current path. The output of  $Q_2$  is rectified by  $CR5$  and filtered by the combination of  $C2$ ,  $R4$ ,  $R5$  and the base return of  $Q_1$ . This signal constitutes positive feedback on the base of  $Q_1$ , switching it into saturation. This in turn causes  $Q_2$  to saturate, producing a pure digital output.

The feedback is actuated so that the dc from the collector of  $Q_2$  through  $R4$  and  $R5$  in series is, by itself, insufficient to keep  $Q_1$  on. Therefore, when the input signal is removed  $Q_1$  starts to turn off, causing a regenerative action in the reverse direction. Because the time constant associated with  $C2$  is short, no appreciable hysteresis results.

As the temperature increases the circuit becomes much more sensitive. This occurs because as temperature goes up (a) the threshold potential of  $Q_1$  and forward drop of  $CR3$  decrease approximately 0.2 mv/C and (b)  $I_{CRO}$  of  $Q_1$  increases causing a greater drop across  $R1$  and thermistor  $RT2$  in parallel.

However, the resistance of  $RT2$  decreases with increasing temperature, reducing the positive feedback. The circuit operated satisfactorily from 0 C to 40 C.

*William C. Silbert, Design Engineer, The Martin Co., Baltimore, Md.*

**If this Idea is valuable to you, give it a vote by circling Reader-Service number 743.**

## Pulse Circuit Provides 731 Sharp, Variable Pulse Delays

Here is a circuit we designed which yields a sharp, unattenuated and accurate pulse delay on either the leading or trailing edges of the pulse. The delay times of the circuit, Fig. 1, depend upon the time constant  $RC$  and the voltage factor  $K$ .

Assuming zero source impedance and a

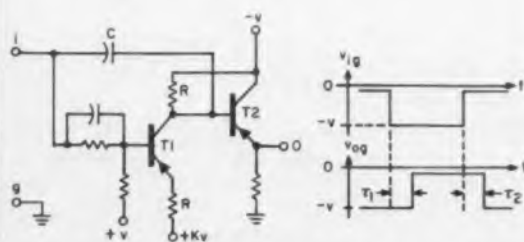

**Fig. 1.** Delay circuit can be adjusted for variable delays of pulse edges. With  $\tau_1 = \tau_2$ , factor  $K$  equals 1.83 and the input pulse is not distorted.

## How to make more money on payday without getting a raise



**You save more than money. You make sure of enjoying the things you're saving for. Every U.S. Savings Bond helps your Government keep the Peace.**

Why wait for a raise when you can do something now about increasing your income? More than 8 million Americans are doing it every payday by buying U.S. Savings Bonds on the Payroll Savings Plan. It works like this: each payday your payroll clerk sets aside whatever amount you wish, buys your Bonds, and delivers them. You receive \$4 for every \$3 you put in, guaranteed. Why not start planning a bigger payday this easy way today?

*Why U.S. Savings Bonds are good to buy and hold*

**You can save automatically on the Payroll Savings Plan • You now earn 3½% to maturity • You invest without risk • Your Bonds are replaced free if lost or stolen • You can get your money with interest anytime you want it • You buy shares in a stronger America.**

**You save more than money with U.S. Savings Bonds**



*This advertising is donated by The Advertising Council and this magazine.*

**NOW**  
FROM ROME CABLE



**COMPLETE CABLE  
ASSEMBLIES TO YOUR  
SPECIFICATIONS**

The next time your requirements call for a complete harness or cable assembly, take a look at what Rome's Special Products Facility has to offer.

Rome Cable can supply complete assemblies as well as bulk cable—in prototype or production quantities.

Save time and costs. Order custom cable assemblies ready for installation. To your exact specification we can supply: miniature or heavy-duty assemblies with cable bundles up to 4 inches in diameter, underwater cable and waterproof assemblies, umbilical cable assemblies for missiles, molded and potted connector terminations, molded breakout, special jacket materials, special connectors and hardware for unusual applications.

Build extra reliability into your electrical system. Call a Rome Cable specialist during the design stage.

For your files, ask for a copy of a 4-page brochure on our Special Products Facility. Write to Rome Cable Division of ALCOA Special Products Facility, 2937 South Tanager Street, Los Angeles 22, California.



CIRCLE 241 ON READER-SERVICE CARD  
ELECTRONIC DESIGN • August 2, 1961

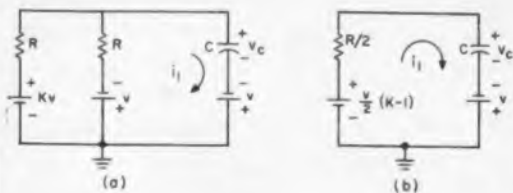

**Fig. 2.** (a) Equivalent charging circuit for capacitor  $C$  is used to derive expression for  $\tau_2$ . (b) Circuit of (a) can be further reduced by combining voltage sources  $KV$  and  $V$ .

very high input impedance for the emitter-follower, a circuit analysis shows that the delay times,  $\tau_1$ , and  $\tau_2$ , of the edges of the pulse are given by:

$$\tau_1 \cong \frac{RC}{2} \ln \frac{K + 3}{K - 1} \quad (1)$$

$$\tau_2 \cong RC \ln \frac{K + 3}{2} \quad (2)$$

These equations are derived from the following considerations:

When  $v_i$  goes to  $-V$ , transistor  $T_1$  saturates with low  $V_{ce}$ , and the equivalent charging circuit for capacitor  $C$  is as shown in Fig. 2. From Fig. 2b it is seen that:

$$i_1 = C \frac{dv_c}{dt} = \frac{V(K - 1) - v_c}{\frac{R}{2}} \quad (3)$$

Integrating Eq. 3 and solving for  $t_1$ , yields:

$$t_1 = \frac{RC}{2} \ln \left[ \frac{-\frac{V}{2}(K + 3)}{v_c - \frac{V}{2}(K - 1)} \right] \quad (4)$$

since at  $t_1 = 0$ ,  $v_c = -V$ .

When  $t_1 = \tau_1$ , the capacitor voltage has reached the value  $V$  and  $T_1$  is cut off. Thus Eq. 3 reduces to Eq. 1.

Eq. 2 is derived from the equivalent discharge circuit of capacitor,  $C$ , taken as  $v_c$ , goes to ground at the end of the input pulse.

For equal edge-delays, that is, for an undistorted pulse, Eqs. 1 and 2 are set equal. This yields:

$$\tau_1 = \tau_2 = 0.88 RC \text{ and } K = 1.83$$

The constant  $K$  may be adjusted to compensate for the asymmetrical effects of storage time and stray capacitance. A similar analysis will yield the relationships for a nonzero source impedance.

*David Borkum, Engineer, Lehigh Design Co., Newark, N. J.*

If this idea is valuable to you, give it a vote by circling Reader-Service number 731.

See the New...

# ADC BLUE CHIP

## TRANSISTOR TRANSFORMERS

At WESCON booth #4218

### Wide Choice of Power Ratings

Tiny plastic encapsulated ADC transformers are now available for printed circuit applications in a wide choice of power ratings. Five sizes vary from .08 to 1.2 cubic inches.

### Sixty-Four New Types

Sixty-four new ratings listed below show the available power levels for voice and extended frequency operation. They take into account not only power handling capacities at minimum frequencies

but also total harmonic distortion under stated conditions. Variations in both power and distortion levels are possible, within the limits shown, depending upon the minimum operating frequency.

### Designed to meet MIL Specs.

These new transformers were designed to meet MIL-T-27A Grade 5, Class S requirements.

Order from stock after September 1st



PIN LAYOUT:

Pin Diameter: .020"  
Pin Length: 1/4"  
Weight: 0.15 oz.

RESPONSE:  $\pm$  3 DB 60 to 100,000 CPS.  
DISTORTION: 10% at 1 MW, 60 to 100,000 CPS, or 10% at 30 MW, 300 to 100,000 CPS, except as noted.



PIN LAYOUT:

Pin Diameter: .030"  
Pin Length: 1/2"  
Weight: 0.4 oz.

RESPONSE:  $\pm$  1 DB 60 to 50,000 CPS.  
DISTORTION: 10% at 10 MW, 60 to 50,000 CPS, or 10% at 150 MW, 200 to 50,000 CPS.



PIN LAYOUT:

Pin Diameter: .030"  
Pin Length: 1/2"  
Weight: 0.9 oz.

RESPONSE:  $\pm$  1 DB 60 to 30,000 CPS.  
DISTORTION: 1.5% at 20 MW, 60 to 30,000 CPS, or 10% at 500 MW, 200 to 30,000 CPS, except as noted.

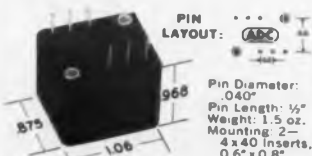

PIN LAYOUT:

Pin Diameter: .040"  
Pin Length: 1/2"  
Weight: 1.5 oz.  
Mounting: 2-4 x 40 Inserts, 0.6" x 0.8"

RESPONSE:  $\pm$  1 DB 50 to 10,000 CPS.  
DISTORTION: 1.5% at 60 MW, 60 to 10,000 CPS, or 10% at 3.5 W, 200 to 10,000 CPS, except as noted.

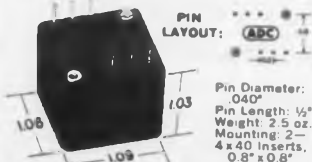

PIN LAYOUT:

Pin Diameter: .040"  
Pin Length: 1/2"  
Weight: 2.5 oz.  
Mounting: 2-4 x 40 Inserts, 0.8" x 0.8"

RESPONSE:  $\pm$  1 DB 30 to 10,000 CPS.  
DISTORTION: 1% at 250 MW, 60 to 10,000 CPS, or 10% at 10 W, 200 to 10,000 CPS, except as noted.

CATALOG NUMBER	PRIMARY IMPED.—OHMS	SECONDARY IMPED.—OHMS	PRIMARY-SECONDARY DC RESISTANCE-OHMS	MAX. DC IN PRIM. MA.	
324-6A	* 100K-CT	1000-CT	3000	70	0
324-6B	25K-CT	1000-CT	2800	120	0
124-6C	10K-CT	10K-CT	1100	1200	1
324-6D	10K-CT	1500-CT	1100	180	1
324-6E	10K-CT	600-CT	1100	75	1
224-6F	4000-CT	10K-CT	440	1200	1.5
324-6G	1000-CT	600-CT	110	75	3
324-6H	1000-CT	4	110	0.5	3
224-6J	600-CT	25K-CT	65	3000	4
124-6K	600-CT	600-CT	65	75	4
324-6L	600-CT	60	65	7	4
324-6M	600-CT	4	65	0.5	4
*Max. power level: 0.35 mw at 60 cps; 10 mw at 300 cps					
324-5A	100K-CT	1000-CT	11,000	120	0
324-5B	25K-CT	1000-CT	2800	120	0
124-5C	10K-CT	10K-CT	1100	1200	1
324-5D	10K-CT	1500-CT	1100	180	1
324-5E	10K-CT	600-CT	1100	75	1
224-5F	4000-CT	10K-CT	440	1200	1.5
324-5G	1000-CT	600-CT	110	75	3
324-5H	1000-CT	4	110	0.5	3
224-5J	600-CT	25K-CT	65	3000	4
124-5K	600-CT	600-CT	65	75	4
324-5L	600-CT	60	65	7	4
324-5M	600-CT	4	65	0.5	4
324-4A	* 100K-CT	1000-CT	11,000	120	0
324-4B	25K-CT	1000-CT	2800	120	0
124-4C	10K-CT	10K-CT	1100	1200	1
324-4D	10K-CT	1500-CT	1100	180	1
324-4E	10K-CT	600-CT	1100	75	1
324-4F	10K-CT	4	1100	0.5	1
224-4G	4000-CT	10K-CT	440	1200	1.5
324-4H	1500-CT	15	165	2	2.5
324-4J	1000-CT	600-CT	110	75	3
324-4K	1000-CT	4	110	0.5	3
224-4L	600-CT	25K-CT	65	3000	4
124-4M	600-CT	600-CT	65	75	4
324-4N	600-CT	60	65	7	4
324-4P	600-CT	15	65	2	4
324-4Q	600-CT	4	65	0.5	4
224-4R	250	600-CT	30	75	7
*Max. power level: 750 mw.					
324-3A	10K-CT	10K-CT	800	1100	1
324-3B	10K-CT	600-CT	800	65	1
324-3C	10K-CT	4	800	0.5	1
324-3D	1500-CT	15	120	2	2.5
324-3E	1000-CT	600-CT	80	65	3
324-3F	1000-CT	4	80	0.5	3
224-3G	* 600-CT	25K-CT	50	2800	4
124-3H	600-CT	600-CT	50	65	4
324-3I	600-CT	60	50	7	4
324-3J	600-CT	15	50	2	4
324-3L	600-CT	4	50	0.5	4
224-3M	250	600-CT	20	65	7
*Max. power level: 2.5 w.					
124-2A	* 10K-CT	10K-CT	700	900	1
324-2B	10K-CT	600-CT	700	55	1
324-2C	10K-CT	4	700	0.5	1
324-2D	1500-CT	15	105	1.5	2.5
324-2E	1000-CT	600-CT	70	55	3
324-2F	1000-CT	4	70	0.5	3
224-2G	** 600-CT	25K-CT	45	2400	4
124-2H	600-CT	600-CT	45	55	4
324-2I	600-CT	60	45	6	4
324-2K	600-CT	15	45	1.5	4
324-2L	600-CT	4	45	0.5	4
224-2M	250	600-CT	20	55	7

ALL RATINGS BASED UPON MAXIMUM UNBALANCED DC IN PRIMARY AS LISTED

WRITE FOR COMPLETE INFORMATION



### ADC PRODUCTS

A Division of Magnetic Controls Company

2835-13th Ave. S. • Minneapolis 7, Minn. • PA 1-5551  
PACIFIC BRANCH: North Hollywood, Calif.

CIRCLE 242 ON READER-SERVICE CARD





## Milestones in Engineering

The Romans were great road builders. They recognized that merely laying a road from one point to another did not provide adequate access and travel to and from any but "in line" points. Thus, they evolved the "network" principle of road building, with crossings or interchanges, affording the traveler alternate routing to enable him to select the "path" that most adequately satisfied his need.

The network principle has been engineered, over the centuries, into countless applications where there is a requirement for routing flexibility and traffic handling capacity.



The principle of many crossing points for routing flexibility, for multiple path selection, for traffic handling capacity, is basic to the North Electric Crossbar Switch which provides 1200 switching points in a minimum of space—how many uses can you find for such flexibility and capacity?

For detailed specifications on the North Electric Crossbar Switch, write

VISIT OUR BOOTHS 2502-4  
AT THE WESCON SHOW

**NORTH ELECTRIC COMPANY**

158 S. MARKET ST., GALION, OHIO

CIRCLE 215 ON READER-SERVICE CARD

ELECTRONETICS DIVISION



## REPORT BRIEFS

### Reliability

Laboratory tests are described for determining the reliability of ground electronic equipment including radar, communications, and navigational aids. The tests are designed to determine the mean life of equipments prior to their use in the field through the measurement of equipment characteristics. The test procedure followed for an AN/GRC-27 is presented as an illustrative example. *Establishment of Methods and Procedures of Testing for Reliability in Ground Electronic Equipment*, R. A. Miles, RCA Service Co., Camden, N. J., Dec. 1, 1957. 56 pp. Microfilm \$3.60, Photocopy \$9.30. Order PB 155152 from Library of Congress, Washington 25, D.C.

### Acoustic Sources

Bibliography on acoustic sources and related fields is arranged in outline form under four major topics: single sources and receivers, arrays of sources and receivers, transducer properties, and acoustic fields. References listed are from 1935 through 1958. The subject outline is repeated by author, date, and topic title. Some entries are cross-referenced. *A Bibliography on Acoustic Sources and Their Related Fields*, G. B. Thurston and R. Stern, Willow Run Laboratories, University of Michigan, Ann Arbor, Mich., Feb. 1959, 68 pp, \$1.75. Order PB 161330 from OTS, Washington 25, D. C.

### Machining Methods

As an aid to defense contractors in planning manufacturing operations, the principles and applications of four novel electrical machining techniques are described, and information on chemical and ultrasonic methods is given. The techniques can be used as alternatives to conventional machining methods for removing material. They have their widest application for processing materials such as carbides or ceramics and high-strength and temperature-resistant alloys that are difficult to cut. *Review of Some Unconventional Methods of Machining*, Defense Metals Information Center, Battelle Memorial Institute, Nov. 1960, 20 pp, \$0.50. Order PB 161225 from OTS Washington 25, D.C.

ELECTRONIC DESIGN • August 2, 1961



## Organic Semiconductors

The specific resistivity as a function of temperature for a variety of organic compounds was determined. The resistivities were obtained of materials in various stages of purification, over a wide range of applied voltages, in nitrogen and in air, and in the solid, and, where feasible, in the liquid state. A zone refiner developed and used in the purification of several materials is described. A model for conductivity in organic compounds is advanced postulating that the primary process responsible for conductivity consists in the formation of biradicals. *Investigation of Organic Semiconductors*, G. P. Brown and S. Afterbut, General Electric Co. for Wright Air Development Division, U.S. Air Force, Sept. 1960, 76 pp, \$2.25. Order PB 171340 from OTS, Washington 25, D.C.

## Micro Flip-Flops

The feasibility of applying thin-film techniques to microminiature circuit plates or functional circuit blocks was demonstrated. The approach consisted of both active and passive elements fabricated by solid-state techniques on a silicon substrate. The active component, or transistor, which was unilaterally constructed, was found fully compatible with the one-sided approach to microminiaturization. Excellent switching characteristics were achieved with this active device. *Research in Micro Flip-Flops*, T. V. Sikina, Philco Corp., Aug. 1960, 91 pp, \$2.25. Order PB 171566 from OTS, Washington 25, D.C.

## Microwave Frequency Translator

Microwave circuitry was developed for a frequency translator which used a highly stable ammonia beam Maser output of 23.-870 mc to stabilize a 300-mc signal. This was achieved through the use of harmonic conversion and dual mixing techniques. Detailed design information of a harmonic generator, TE<sub>011</sub> mode filters, and polarization converters is included. *Microwave Circuitry for a Frequency Translator*, by Robert D. Standley, Charles P. Heinzman, and Nathan Lipetz, Cornell Aeronautical Laboratory, Inc., Buffalo, N. Y., Oct. 6, 1958, USASRD Technical Report 1944, 22 pp, 10 refs, Microfilm \$2.70. Photostat \$4.80. Order PB 148112 from Library of Congress, Photoduplication Service. Publications Board Project, Washington 25, D. C.

ELECTRONIC DESIGN • August 2, 1961

# NEW MINIATURIZED LONG-LIFE COMMUTATION SWITCH



ACTUAL SIZE  
Plate dia. only 1 3/4"



See us at Booth 902-904  
WESCON Show  
August 22-25, 1961

... but 1 3/4" plate diameter and 50% space savings\* in a 180-channel switch are only the start of the story. This new electromechanical switch also gives the other advantages that have made MYCALEX® units the industry standard. Noise level of less than 1 millivolt when switching 5 volts into a 150-ohm load. Up-to-a 1000 megohm resistance between rectangular contacts. Speeds as high as 1800 RPM. Metal-to-metal wiping action that prevents graphite build-up. Super-hard, gold-plated contacts. SUPRAMICA® 555 ceramoplastic plate that withstands operating temperatures to 650° F., has total dimensional stability, locks contacts in place. Plus nylon-brush mountings of new design that eliminate bounce and deliver sharp, clean signal edges.

Whether you're looking for commutation plates or complete switches, it'll pay you to investigate both of these compact, new components which give you an additional degree of design latitude. (For example, other MYCALEX switches offer up to 540 contacts on a 3"-diameter plate.) Write today for our new, comprehensive technical bulletin.

\*When compared with conventional Inter-Range Instrumentation Group Telemetering Switches.

General Offices and Plant: 124 Clifton Boulevard, Clifton, N. J.  
Executive Offices: 30 Rockefeller Plaza, New York 20, N. Y.

EXCLUSIVE LICENSEE OF MYCALEX CORPORATION OF AMERICA  
CIRCLE 216 ON READER-SERVICE CARD



### Wide Range PULSE and SQUARE WAVE GENERATOR PSG-1

Broad Range of Frequencies  
and Pulse Widths

- Frequency—1 cycle to 1 mc
- Pulse Width—1  $\mu$ sec. to 3 seconds
- Rise and Fall Time—.02  $\mu$ sec. for 10 v, 100 ohm output
- Rise and Fall Time—.1  $\mu$ sec. for 50 v, 500 ohm output

DOUBLE PULSE ADAPTER • PSG-1/DG Price \$135.00

Pulse and Square Wave Generator—Rack Mounted  
PSG-1/RM Price \$740.00

Double Pulse Adapter—Rack Mounted  
PSG-1/DG/RM Price \$145.00



### Variable Width PULSE GENERATOR PG-10

The Pulse Generator, PG-10, generates variable width pulses in the frequency range 1 megacycle per second to 20 megacycles per second. It is especially useful where high repetition rates and narrow pulses are required.

- Frequency range: 1-20 mcps (3 overlapping ranges)
- Rise and fall time less than .006  $\mu$ sec.
- Minimum pulse width approximately .02  $\mu$ sec. at 50% amplitude
- Can be externally synchronized

### Very Low Frequency SPECTRUM ANALYZER SA-11

This analyzer system is designed for use wherever real time, accurate, high-resolution analysis of the very low frequencies is required. Some typical fields of application are:

- Seismology
- Underwater acoustics
- Heartbeat analysis
- Speech analysis
- Shock and vibration analysis

Frequency range—

0.0025-1000 cps  
(real time basis)  
seven scales

Analysis time—

1.6 seconds for maximum  
selectivity

3DB Selectivity

1 cycle scale: 0.0037 cps  
1000 cycle scale: 3.75 cps

Transistorized models  
SA-12 and SA-14 will pro-  
vide frequency ranges up  
to 5000 cps and, with  
GASL auxiliary equipment,  
offer power density and  
normal density capability



Visit us at our plant for a demonstration, or call  
our Marketing Department at EDgewood 3-6960  
to arrange for analysis of one of your sample tapes.

All prices subject to change without notice.



### Transistorized LOGIC MODULES

For systems containing dynamic and static type digi-  
tal logic as well as analog computation devices.

FMS-1	High Speed Flip Flop (2)	\$82	MG-1	Multiplexer Gate (6 gates)	\$59
FMS-1	Dual Medium Speed Flip Flop (2)	69	OA-1	Summing Amplifier	71
DG-1	Digital Gate (4)	51	SA-1	Servo Amplifier	87
DM-1	Delay Multivibrators (3)	62	CDX-1	Card Extender	30
ND-1	Nixie Driver	58	BCP-1	Bucket—27 card capa- bility—wired for power	357
BO-1	Blocking Oscillator (3)	85	BC-1	Bucket—27 card capa- bility—not wired for power	241
OS-1	Clock Oscillator	77	TLG-1	2 Leg Gate (8 gates)	69
CPA-1	Clock Pulse Amplifier (4)	105	LD-1	Light Driver (4)	42
AE-1	Active Element	61	ST-1	Schmidt Trigger (2)	68
DL-1	Delay Line Card	89	MSC-1	Special Circuit Card	25
CC-1	Computer Gate Card	49			
MDL-1	Magnetostrictive Delay Line	522			

CIRCLE 217 ON READER-SERVICE CARD

RUGGED • LOW COST • FAST RESPONSE • AVAILABLE MATCHED

## HUGHES' THERMOCOUPLE VACUUM GAUGE TUBE



For precise and dependable measurement of pres-  
sures ranging from atmospheric to 1 micron,  
Hughes offers the Type HV-2000 Thermocouple  
Gauge Tube.

#### FEATURES:

**Resistance to shock and vibration**—heater  
and precision thermocouple designed for rugged  
operation.

**Fast Response Time**—approximately one  
second.

**Unharmful by operation at atmospheric pres-  
sure.**

**Stable response over wide ambient temper-  
ature range.**

**Available matched (Type HV-2000M)**

See the complete line of HUGHES vacuum equipment at WESCON—Booth 3108

Hughes' new Thermocouple Gauge Controls, developed  
specifically for use with the Type HV-2000 Gauge Tube,  
feature easy-to-read scales for single or multiple station  
operation. Available in modern, self-contained portable  
cabinets—or for panel mounting.

For complete information on Hughes'  
Thermocouple Gauge Tubes and Con-  
trols, write or wire today: HUGHES,  
Vacuum Tube Products Division;  
2020 Short St., Oceanside, California.  
For Export information, write: Hughes  
International, Culver City, California

CREATING A NEW WORLD WITH ELECTRONICS

HUGHES

HUGHES AIRCRAFT COMPANY  
VACUUM TUBE PRODUCTS DIVISION

CIRCLE 218 ON READER-SERVICE CARD

## REPORT BRIEFS

### Semiconductor Diodes

Study and investigation are reported of  
the use of semiconductors as low-noise am-  
plifiers, harmonic generators, and fast-act-  
ing TR switches. The use of the nonlinear  
reactance of a reverse-biased pn junction  
diode as a low-noise sum-frequency ampli-  
fier is analyzed in detail. The problem of  
using semiconductor devices as fast-acting  
TR switches is outlined, and an analysis of  
pertinent TR system parameters in terms of  
the series resistance of the semiconductor  
diode is presented. The power-handling ca-  
pability of presently available semiconductor  
devices most suited to this application is  
also discussed. *Application of Semiconductor  
Diodes to Low-Noise Amplifiers, Harmonic  
Generators and Fast-Acting TR Switches*,  
R. Gardner, J. C. Greene and others, Airborne  
Instruments Laboratory, Mineola, N. Y.,  
Sept. 1958, 83 pp, Microfilm \$4.80, Photocopy  
\$13.80. Order PB 155258 from Library of  
Congress, Washington 25, D.C.

### Magnetic Recording

The effect of direct current in a magnetic  
recording head was measured. The point of  
occurrence (with respect to the signal) of  
maximum noise can be controlled; unidirec-  
tional signal-handling capability can be in-  
creased. The direct current does not increase  
dynamic range or the average signal-to-noise  
ratio, and the low-frequency response is re-  
duced. *Effect of DC in a Magnetic Record-  
ing Head*, J. C. Hoadley, Diamond Ordnance  
Fuze Laboratories, Washington, D.C., May  
1960, 16 pp, Microfilm \$2.40, Photocopy  
\$3.30. Order PB 155618 from Library of  
Congress, Washington 25, D.C.

### Interference Studies

Research results are presented on the  
theory of interference prediction and inter-  
ference measurement techniques. Eight sep-  
arate sections are devoted to permissible in-  
terference levels or susceptibilities, data  
presentation, methods and devices for meas-  
uring spurious and harmonic radiation, out  
of band pulsed and cw interference in a  
microwave receiver, loss of radar informa-  
tion due to blanking, bandwidth conserva-  
tion in pulsed radars, graphical techniques

for great circle calculations, comments on military interference specifications, and prevention of moding in magnetrons. *Interference Studies*, O. M. Slati, R. A. Rosien and others. Moore School of Electrical Engineering, University of Pennsylvania, Philadelphia, Pa., April 1958, 210 pp, Microfilm \$9.30, Photostat \$31.80. Order PB 146366 from Library of Congress, Photoduplication Service, Publication Board Project, Washington 25, D. C.

### Pulse Modulators

Presented here is a compendium of current "hard tube" modulator circuits, together with a detailed analysis of their circuit characteristics—rise and fall times, droop, charge storage, and power-handling capacity. The following circuits are considered: transformer-coupled, common cathode RC-coupled, common cathode direct-coupled, and gated modulators. From the detailed mathematical analysis presented, virtually all circuit design parameters can be computed for any desired modulator. *Vacuum Tube Pulse Modulator Analysis*, Henry Nettlesheim, Electronic Defense Laboratory, Sylvania Electric Products, Inc., Mountain View, Calif., Jan., 1960. Nov., 1960, 109 pp, Microfilm \$5.70, Photocopy \$16.80. Order PB 154213 from Library of Congress, Washington 25, D.C.

### RFI

An investigation was made to determine a practical method for suppressing radio interference generated by a 25-lb wringer-type laundry washer. Measurements indicated that approximately every 20 sec (the time point at which the motor was reversed), narrow high-intensity pulses were radiated from the laundry washer. The magnitude of the pulses was of the order of  $10^4 \mu\text{V}$  per meter at frequency of 200 kc to 20 mc, measured 5 ft from the machine. Interference of a higher repetition rate and a lower level was observed continually throughout the above frequency range. *Radio Interference Suppression of a Prosperity No. 2C-jr. Laundry Washer*, A. M. Intrator and E. D. Pettler, Naval Civil Engineering Laboratory, Port Hueneme, Calif., Feb. 20, 1953, 14 pp, Microfilm \$2.40, Photocopy \$3.30. Order PB 154651 from Library of Congress, Washington 25, D.C.

## With Eastman 910 Adhesive...

### Vinyl bonds to melamine-coated aluminum in seconds

In the assembly of its top-line "Galaxy" portable, Smith-Corona Typewriter division of Smith-Corona Marchant, Inc., has found four places to save time and materials with Eastman 910 Adhesive. Here's one:

In seconds, the adhesive securely bonds six vinyl retainers to the melamine-coated aluminum paper bail. Just one



#### Here are some of the bonds that can be made with Eastman 910 Adhesive

Among the stronger: vinyls, phenolics, cellulose, polyesters, polyurethanes, nylon; natural rubber, SBR, Buna N, most types of neoprene; most woods; steel, aluminum, brass, copper. Among the weaker: polystyrene, polyethylene, and fluoro-hydrocarbon plastics (shear strengths up to 150 lbs./sq. in.).

CIRCLE 219 ON READER-SERVICE CARD

drop of adhesive per retainer is needed—no heat, no solvent, and only momentary pressure to position the parts is required. Further assembly proceeds without delay.

Eastman 910 Adhesive will form bonds between almost any plastics or other materials. Like to see for yourself? Just send \$5 for a trial kit to use on your toughest job. Kits and more information are available from Armstrong Cork Company, Industrial Adhesives Division, 9105 Indian Road, Lancaster, Pa.; or from Eastman Chemical Products, Inc., subsidiary of Eastman Kodak Company, Dept. PW-7, Chemicals Division, Kingsport, Tennessee.



There is no adhesive like Eastman 910 Adhesive

- SETS FAST**—Makes firm bonds in seconds to minutes.
  - VERSATILE**—Joins virtually any combination of materials.
  - HIGH STRENGTH**—Up to 5,000 lbs./sq. in. depending on the materials.
  - READY TO USE**—No catalyst or mixing necessary.
  - CURES AT ROOM TEMPERATURE**—No heat required to initiate or accelerate setting.
  - CONTACT PRESSURE SUFFICIENT.**
  - LOW SHRINKAGE**—Virtually no shrinkage on setting as neither solvent nor heat is used.
  - GOES FAR**—One-pound package contains about 14,000 one-drop applications.
- The use of Eastman 910 Adhesive is not suggested at temperatures above 175°F., or in the presence of extreme moisture for prolonged periods.

See Sweet's 1961 Product Design File 10d/Ea.

# PRIMARY VOLTAGE REFERENCE (Solid State)

**New**

MODEL PVR-6  
Price ..... \$3850\*

Guaranteed STABILITY > 2PPM/3 months.  
> 3PPM/year.

Calibration Accuracy .0015%

PLUG IN REFERENCE with  
.001% month Stability,  
(.001%/year, typical)  
.001% .10% line change  
±2PPM °C Temp. Coefficient.

MODEL 456-005, 456-023  
Price ..... \$200\*

## from CALIBRATION > STANDARDS

At CSC, a major breakthrough in the "state of the art" of precision Zener References has enabled Calibration Standards to design and manufacture a limited number of Primary Voltage References. Tests prove the stability of the Model PVR-6 Reference may be equal to or better than the stability of the Saturated Cell (temperature controlled). Each CSC Model PVR-6 Primary Voltage Reference is accompanied with readings, showing its stability for 3 months, referenced against a bank of temperature controlled saturated cells. Models 456-005 and 456-023 Plug In Zener References operate on 115 VAC or 40 VDC with Outputs of 6.5 or 13.5 VDC. These references are used in CSC's 200 and 110 Series Voltage Measuring Instruments. Write for detailed specifications or contact your local CSC representative.

LOS ANGELES, SMITH-DIEBTRICH SALES COMPANY • SEATTLE-PALO ALTO, STANLEY ENTERPRISES • DENVER-SALT LAKE CITY, EMF ASSOCIATES • CHICAGO, LOREN F. GREEN & ASSOCIATES • WICHITA, LAWRENCE L. HILL • WALTHAM, MASSACHUSETTS, GEO. GOSTENHOFER & ASSOCIATES • SCHENECTADY, CHARLES A. WINICK COMPANY • NEW YORK CITY (MT. VERNON), QED ELECTRONIC SALES, INCORPORATED • PHILADELPHIA (LANSDOWNE), HOLDSWORTH & COMPANY • ARLINGTON, VIRGINIA, THE JAY COMPANY • ATLANTA-COCOA BEACH, SPECIALIZED EQUIPMENT COMPANY • CLEVELAND-BAYTON-DETROIT, ELECTRO SALES ASSOCIATES • EXPORT, FRAZAR & HANSEN, LTD. VANCOUVER-TORONTO-MONTREAL, AVIATION ELECTRIC LTD.

**CALIBRATION**

a subsidiary of ROYAL > INDUSTRIES INC.  
1025 Westminster Ave., Alhambra, Calif.  
\* P. O. BOX ALHAMBRA, CALIF. PRICES SUBJECT TO CHANGE WITHOUT NOTICE

**STANDARDS CORPORATION**

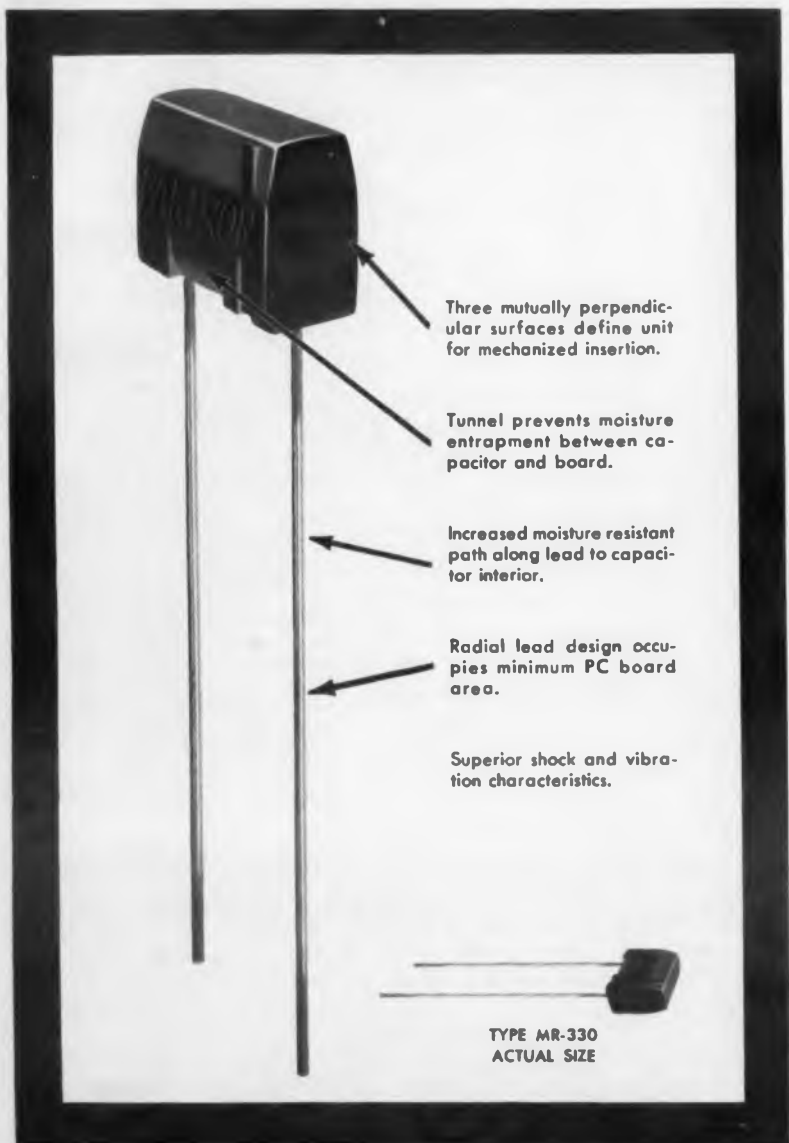

## GET MICRO-MOLDED MINIATURE MYLAR\* CAPACITORS FROM . . .

\*\*DUPONT

# PAKTRON

PACKAGED ELECTRONICS



DIVISION OF ILLINOIS TOOL WORKS  
1321 LESLIE AVENUE ALEXANDRIA, VA.

CIRCLE 221 ON READER-SERVICE CARD

## REPORT BRIEFS

### Organic Semiconductors

Results of experiments are presented for the temperature dependence of the resistivity of 13 organic compounds. Data are given on the rectification properties of copper phthalocyanine and other metal derivatives of space charge due to the presence of an oxidizing agent in the system. Preparations for a forthcoming study of the effects of high electric fields on anthracene and phenanthrene are discussed, and some qualitative results are presented. *Organic Semiconductor Study, J. B. Rust and others, Hughes Aircraft Co., for Wright Air Development Division, U.S. Air Force, June 1960, 58 pp. \$1.75. Order PB 171177 from OTS, Washington 25, D.C.*

### Digital Computers

Written for those who do not have specialized knowledge of electronics or digital computing, this report is an introduction to electronic digital computers. It reviews current applications of digital computers, and cites some of the varied uses of computers in science, engineering, and business, as well as uses psychologists have found for computers. Mathematical aspects of digital computing are discussed, and practical factors of computer programming are reviewed. *An Introduction To Digital Computers, B. F. Green, Jr., Lincoln Laboratory, Massachusetts Institute of Technology for Computers Committee, American Psychological Association, and U. S. Armed Forces under contract to the Air Force, Aug. 1960, 46 pp. \$1.25. Order PB 171100 from OTS, Washington 25, D. C.*

### Carrier Frequency Networks

A unified theory is presented for the analysis and synthesis of linear carrier frequency networks, based on the work of various authors in the field. The response of the network to the modulation envelope is characterized by an envelope response function. This is a double complex expression, that depends on two independent parameters, the carrier frequency and the carrier phase resolution angle. The poles and zeros of the envelope transfer function are derived from the poles and zeros of the conventional network response function. A simple, practical method is described for the design of ac lead

# ELECTRONIC ENGINEERS MAKE GOOD EDITORS



*James A. Lippke, Managing Editor*

All of ELECTRONIC DESIGN's editors have "converted" from engineering to editorial duties.

If you get satisfaction out of communicating with others, if you enjoy organizing written material, if you enjoy using words to convey ideas, you will like editorial work.

*Several openings are now available for Assistant Editors.*

EE's with 2-3 years electronic design experience have the ideal background.

Write: JAMES A. LIPPKE  
*Managing Editor*

**ELECTRONIC DESIGN**  
850 Third Avenue, New York 22, N.Y.



## HAWK-PROVEN CONNECTORS

# LIONEL

Series S-20

### Extra Reliability With—

- Shell-Enclosed, Die-Cast Housings
- Diallyl Phthalate Moldings
- Positive Alignment & Polarization
- Minimum Depth in Mated Position
- Beryllium Copper Contacts for Extended Insertion/Withdrawal Life



4 sizes: 13 to 41 high voltage contacts, 2 and 4 coaxial contacts; Meet applicable MIL specs; Materials & specifications modified to meet your special needs.

- Write Dept. 18-HW for Series S-20 Dimensional Data Sheets



## Lionel Electronic Laboratories

(Formerly Anton Electronic Laboratories)

1226 Flushing Ave.  
Brooklyn 37, N.Y.

CIRCLE 222 ON READER-SERVICE CARD

ELECTRONIC DESIGN • August 2, 1961

networks, particularly bridged-T's and parallel-T's, directly from the pole-zero specifications. *Carrier Frequency Networks*, Gerald Weiss, *Microwave Research Institute, Polytechnic Institute of Brooklyn, N. Y., Jan. 12, 1959, 192 pp, Microfilm \$8.70, Photocopy \$30.30. Order PB 155160 from Library of Congress, Washington 25, D.C.*

### Broadband Components

An engineering study is presented of possible methods of fabricating single-ridged waveguide and for determining the most suitable method of fabricating the two sizes of waveguide designed for the 3.75-to-15-kmc and 10-to-40-kmc frequency ranges. The fabrication of lengths of 3 to 5 ft and lengths over 5 ft were considered. *Research and Development of Extremely Broadband Waveguide Components*, E. Lampner, *Polytechnic Research and Development Co., Inc., Brooklyn, N. Y., Sept. 1957, 75 pp, Microfilm \$4.50, Photocopy \$12.30. Order PB 155159 from Library of Congress, Washington 25, D.C.*

### Endfire Antennas

The development of a new type of endfire antenna called the "Saucisson" antenna is described. It consists essentially of a two-wire line surrounded by a wire helix. The principle of operation is explained by the transformation of the excited antisymmetrical mode into the symmetrical radiation mode. The influence of different geometrical parameters is investigated and a scale model of a 350-600-mc range antenna working in the S band was built. A gain of about 20 db was achieved in the whole band with secondary lobes lower than 16 db. *Feasibility and Research on a new Type of Endfire Antenna "Saucisson Antenna"*, Erich Spitz, *Compagnie Generale de Telegraphic Sans Fil, France, Jan. 1-Sept. 1960, 62 pp, Microfilm \$3.90, Photocopy \$10.80. Order PB 153719 from Library of Congress, Washington 25, D.C.*

### Accuracy Is Our Policy . . .

The New Product description of high-temperature resistors appearing on p 115 of the June 21 issue listed an incorrect tolerance range. Made by Omtronics Manufacturing, Inc., P. O. Box 1419, Peony Park Station, Omaha 14, Nebr., the series T units cover a tolerance range of  $\pm 0.05\%$  to  $\pm 5\%$ .



PHOTOGRAPH COURTESY OF WESTERN ELECTRIC COMPANY

## Angelica Uniforms and Victor Gloves Help Prevent Clean-Room Contamination



*Angelica*  
**UNIFORM COMPANY**

1427 Olive St., St. Louis 3, Mo.  
107 W. 48th St., New York 36, N. Y.  
177 N. Michigan Ave., Chicago 1, Illinois  
1900 W. Pico Blvd., Los Angeles 6, Calif.  
317 Hayden St., N. W., Atlanta 13, Ga.

### Victor Monofilament Nylon Gloves

Angelica has been appointed the only distributor of Victor Gloves, the finest protective gloves made. Victor's non-contaminating gloves of monofilament nylon with plastic coated palms, have maximum touch sensitivity for precision operations. Victor Gloves Inc. collaborated with Bell Laboratories, Inc., in developing these gloves and Bell is currently using them in the assembly of select devices sensitive to physical and chemical contamination.

Other models include ambidextrous gloves and gloves for LOX parts.

### Static-Free Dacura\* Uniforms

Angelica's coveralls and frocks, of comfortable moisture absorbent Dacura (Dacron\*\* polyester and rayon), are non-linting, acid resistant and static-free. The tight weave of continuous filament yarns resists passage of contamination from the skin or undergarments.

There is a complete "engineer designed" line of Dacura, Dacron, or nylon uniforms and accessories by Angelica and Victor Gloves Inc.

Mail this coupon to the nearest Angelica office below.

\*Reg. T.M. H. P. Ogden Co.  
\*\*Reg. T.M. of Dupont

Send literature on White Room Uniforms  
and Gloves.

Name \_\_\_\_\_ Title \_\_\_\_\_

Company \_\_\_\_\_

Address \_\_\_\_\_

City \_\_\_\_\_ Zone \_\_\_\_\_ State \_\_\_\_\_

CIRCLE 223 ON READER-SERVICE CARD







Dr. Schuster using his card sort system. The needle has been stuck through the category hole in the index card and a circuit falls out.

Cards are coded on these seven categories. These 5 in.-by-8-in. cards are coded with a red pencil mark for all possible classifications of the circuit on the card. Then the marks are punched out with a V-shaped punch. The resulting circuit card is notched around its periphery according to the various classifications of the circuit. All circuit cards are piled together in random order.

#### Sorting Needles Used To Locate Circuits

To find a given circuit, the user inserts a sorting needle into the deck of cards at the spot (or hole) indicating the type of circuit desired. The deck is lifted and jiggled. Most of the cards remain on the sorting needle. Only those cards with that particular hole punched out will drop. And these, of course, contain the circuits of interest to the user.

If a circuit can be classified under several headings within one category, it should be. For instance, a hi-fi set with a tape recorder would be coded both for "Hi-Fi" and "Recorders." If its amplifier circuitry were of special interest, then "Amplifiers, Class A and 2B" would also be coded. This overclassification is a real help when looking for a specific circuit, as one may be searching under a different classification than the one that prompted saving of the circuit originally. (This can produce "inventions.")

Edge-notched cards can be obtained from at least two sources: the Royal-McBee Co. (Keysort cards) and the Todd Co., C. R. Hadley Div. (Unisort cards). These cards



## YOU'RE STILL TUNED IN, HERR PROFESSOR DOPPLER!

Back in 1930, your principle helped provide the first step in the development of radar. Since that time, radar has grown up . . . always depending on the Doppler shift to measure the velocity of a moving object. Now, we're about to put your principle to work again; this time as an integral part of the Bombing Navigation System for the B-52 weapons system.

If you would like to help us apply yesterday's principles, like Doppler's, to important projects like B-52 navigation, and if you have a BS, MS or PhD in EE, ME, Physics or Math, please contact Mr. G. F. Raasch, Director of Scientific and Professional Employment, Dept. G, 7929 S. Howell, Milwaukee 1, Wisconsin.

All qualified applicants will be considered without regard to race, creed, color or national origin.

**AC SPARK PLUG**  **THE ELECTRONICS DIVISION OF GENERAL MOTORS**

MILWAUKEE • LOS ANGELES • BOSTON

CIRCLE 901 ON CAREER INQUIRY FORM



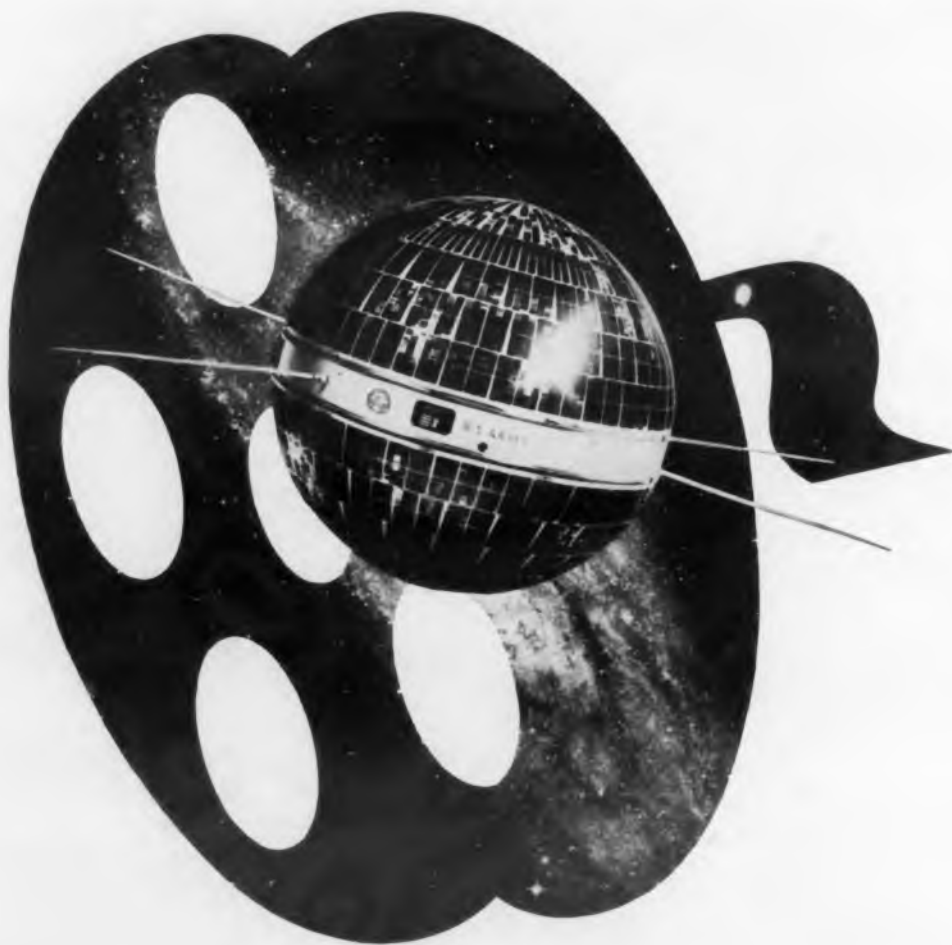

## LP Record—Stellar Style

The message from Courier is just one of the challenges offered to you at PHILCO Western Development Laboratories, whose long record in space communications achievement merely presages the adventure ahead.

From the earliest plans to invade space, PHILCO Western Development Laboratories has played a vital role in satellite vehicle instrumentation, still but *part* of its contribution to space communications. From this newest electronics center on the San Francisco Peninsula comes a continuing flow of advanced missile tracking, range and data processing instrumentation.

Added research projects and growing programs assure *you* a long and rewarding career as a member of the PHILCO Western Development Laboratories. What you think and what you do can be unhampered and uninhibited. Personal recognition and advancement promptly follow performance, with monetary rewards to match. Northern California provides an affluent climate for living, as PHILCO Western Development Laboratories provides a stimulating climate for working. For information on careers in electronic engineering, please write Mr. W. E. Daly, Dept. D-8.

All qualified applicants will receive consideration for employment without regard to race, creed, color or national origin; U. S. citizenship or current transferable Department of Defense clearance required.

**PHILCO**  
 Famous for Quality the World Over

**WESTERN DEVELOPMENT LABORATORIES**

3875 Fabian Way, Palo Alto, California

4317

CIRCLE 902 ON CAREER INQUIRY FORM

## DESIGNING YOUR FUTURE

are similar in appearance and use. When purchased in 100-1,000 quantities, the cost per card ranges from 1 to 5 cents. Sorting needles and special V-punches are also available from these companies.

A similar reference system for human-factors literature is described in an article by Carol S. Evans. This utilizes Keysort cards. My electronic-circuits filing system uses Uni-sort cards.

### IRE Classification Should Be Included

After four years of use, I am fairly satisfied with my present classification system. If I had to do it over again, however, I probably would use the IRE classification as one category, to facilitate the use of the cards by others. Also, I am contemplating changing the "primary transfer function" category to the PERCOS instrument classes (Keller, 1960). These classes are: converter, switch, transducer, amplifier, passive network, indicator, energy source, comparator and storage element.

If the reader wishes to form his own classification lists, an article by A. P. Vigliotta and K. D. Swartzel may help. In reviewing the basic data, their system notes frequent key words, called Kros-Terms. A list of Kros-Terms of interest can be used for classification of circuits.

This system works fine for a limited interest in circuits. The system is also size-limited: more than 500 cards are difficult to jiggle and sort at one time on the long sorting needle. When more than 500 cards accumulate, the deck is split into several smaller decks of major areas of interest. This system would not be feasible for library use, where more extensive classification and many more cards would be needed. For this, use an IBM card-sort. ■ ■

### References

Evans, Carol S. A Marginal Punched Card System for Human Factors Literature. *Human Factors*, Vol. 1, No. 4, Nov. 1959, pp 32-46.

Keller, E. A. PERCOS—Performance coding system of methods and devices used for measurement and control. *Proc. of the IRE*, 48, #2, Feb. 1960, pp 148-155.

Perry, J. W., Kent, A., & Berry, M. M. *Machine Literature Searching*, Interscience Pub., Western Reserve Univ. Press, 1956, 162 pp.

Vigliotta, A. P. & Swartzel, K. D. Use of Kros-Term System for Quick Retrieval of the Technical Detail From Large Pools of Information. IRE National Convention Record, 1958, Part 8, p 36.

After completing, mail career form to ELECTRONIC DESIGN, 850 Third Avenue, New York, N. Y. Our Reader Service Department will forward copies to the companies you select below.

(Please print with a soft pencil or type.)

Name \_\_\_\_\_ Telephone \_\_\_\_\_

Home Address \_\_\_\_\_ City \_\_\_\_\_ Zone \_\_\_\_\_ State \_\_\_\_\_

Date of Birth \_\_\_\_\_ Place of Birth \_\_\_\_\_ Citizenship \_\_\_\_\_

Position Desired \_\_\_\_\_

Educational History				
College	Dates	Degree	Major	Honors

Recent Special Training \_\_\_\_\_

Employment History				
Company	City and State	Dates	Title	Engineering Specialty

Outstanding Engineering and Administrative Experience \_\_\_\_\_

Professional Societies \_\_\_\_\_

Published Articles \_\_\_\_\_

Minimum Salary Requirements (Optional) \_\_\_\_\_

Use section below instead of Reader Service Card. Do not write personal data below this line. This section will be detached before processing.

Circle Career Inquiry numbers of companies that interest you

900 901 902 903 904 905 906 907 908 909 910 911 912 913 914 915 916 917 918 919 920 921 922 923 924  
925 926 927 928 929 930 931 932 933 934 935 936 937 938 939 940 941 942 943 944 945 946 947 948 949

## Advancement Your Goal? Use CONFIDENTIAL Action Form

ELECTRONIC DESIGN's Confidential Career Inquiry Service helps engineers "sell" themselves to employers—as confidentially and discreetly as they would do in person. The service is fast. It is the first of its kind in the electronics field and is receiving high praise from personnel managers.

To present your job qualifications immediately to companies, simply fill in the attached resume.

Study the employment opportunity ads in this section. Then circle the numbers at the bottom of the form that correspond to the numbers of the ads that interest you.

ELECTRONIC DESIGN will act as your secretary, type neat duplicates of your application and send them to all companies you select—the same day the resume is received.

The standardized form permits personnel managers to inspect your qualifications rapidly. If they are interested, they will get in touch with you.

Painstaking procedures have been set up to ensure that your application receives complete, confidential protection. We take the following precautions:

- All forms are delivered unopened to one reliable specialist at ELECTRONIC DESIGN.
- Your form is kept confidential and is processed only by this specialist.
- The "circle number" portion of the form is detached before the application is sent to an employer, so that no company will know how many numbers you have circled.
- All original applications are placed in confidential files at ELECTRONIC DESIGN, and after a reasonable lapse of time, they are destroyed.

If you are seeking a new job, act now!

# Major Systems Programs Pinpoint Opportunities In 26 Areas Of Specialization

Traditional boundaries of defense system definitions are giving way to new, vast-scale operational requirements that may extend from the ocean depths to deep space. ■ Right now, a number of new programs at Defense Systems Department call for backgrounds ranging from Oceanography to Space Physics. ■ Openings for graduate engineers at all levels of competence are immediately available on project groups undergoing expansion and new groups currently being organized.

*Specific experience is sought in these fields:*

Applied Mathematics / Astronomy / Auto Pilots / Classical Mathematics / Communications / Computers / Computer Application Engineering / Data Handling / Guidance Equations Inertial Guidance / Infra-Red / Nuclear Physics / Oceanography Operations Analysis / Optics / Propagation Engineering / Radar Radiation Physics / Sonar / Space Physics / Systems Analysis Systems Engineering / Systems Synthesis / Systems Test Engineering / Technical Writing / Weapons Systems Analysis

*All qualified applicants will receive consideration for employment without regard to race, creed, color or national origin.*

Write in confidence, briefly outlining your education and professional experience to  
Mr. P. W. Christos, Dept. 76-MH.



**DSD** DEFENSE SYSTEMS DEPARTMENT  
A Department of the Defense Electronics Division

**GENERAL  ELECTRIC**

Northern Lights Office Building — Syracuse, New York

CIRCLE 903 ON CAREER INQUIRY FORM

# look for the NEW

(TABLOID SIZE)

## Electronic Daily



Visitors to this year's WESCON in San Francisco will be greeted by an all new, tabloid, king-size *Electronic Daily*. Your familiar convention news magazine has been completely re-vamped—new layout, new, easy-to-read typography, new features and departments.

The 11" x 16½" size will enable the *Daily* to present more news in greater depth, jumbo photographs, more details about the show and its events.

Pick up your copy of the *Daily* in major hotels registering WESCON attendees—use it to plan your day at the convention. Other copies will be available in *Electronic Daily* booth P1, or at the entrances to the Cow Palace. The *Daily* is the *only* magazine published *exclusively* for the show.

## Electronic Daily

### WESCON Booth P1 and P2

ELECTRONIC DESIGN • August 2, 1961

# ACF ELECTRONICS

... where your status as an individual and your career in engineering grow

hand in hand —  
day by day!



You can bring new meaning to your career in engineering by investigating opportunities in state-of-the-art developments at ACF. Experienced engineers at all levels are cordially invited to inquire about challenging positions in the following fields:

**ANALOG & DIGITAL TECHNIQUES  
SIMULATOR ENGINEERING  
IONOSPHERIC PROPAGATION  
HF, RF COMMUNICATIONS  
MICROWAVE COMPONENTS & SYSTEMS  
OPTICS & INFRARED  
AIRBORNE RADAR SYSTEMS  
FIELD ENGINEERING**

These openings involve assignments at our laboratories located in SUBURBAN WASHINGTON, D. C. and the New York metropolitan area at Paramus, New Jersey. Pleasant residential neighborhoods provide readily available housing. Advanced study under tuition refund may be conducted at nearby universities. All qualified applicants will receive consideration for employment without regard to race, creed, color or national origin.

Send resume to:  
**A. C. SUGALSKI**  
Manager,  
Professional Employment  
at our Riverdale Facility  
Dept. 12

**ACF ELECTRONICS**  
DIVISION

**ACF INDUSTRIES**

**RIVERDALE, MARYLAND • HYATTSVILLE, MARYLAND • PARAMUS, NEW JERSEY**

CIRCLE 904 ON CAREER INQUIRY FORM

ELECTRONIC DESIGN • August 2, 1961

at MOTOROLA in PHOENIX:

# Leadership in action



Project leaders at Motorola are engineers and scientists who have won their right to leadership — with ideas, talent, and dedication — while working on challenging assignments in Project Groups. These teams are carefully selected — to get the optimum combination of experience and capabilities, and to utilize each man's talents to the fullest. Opportunities for individual advancement and career fulfillment are broadened and enhanced by Motorola's widely-diversified activities in advanced military electronics. Leadership in action is a vital force at Motorola. It provides the stimulus for challenging the state-of-the-art in Project Group assignments, assuring engineers and scientists of ever-broadening horizons for tomorrow. And Arizona's world-famed climate and beauty add to the whole family's year-round health and pleasure.

## Immediate Opportunities

- Systems Test Equipment Design
- Communications and Navigation
- Systems Analysis and Preliminary Design
- Missile and Space Guidance and Control
- Digital Circuitry Design
- Microwave and Radar
- Reliability and Components
- Solid State Devices

All qualified applicants will receive consideration for employment without regard for race, creed, color, or national origin.

Write Phil Nienstedt Dept. 802



# MOTOROLA

**MILITARY ELECTRONICS DIVISION, WESTERN CENTER**  
P. O. Box 1417, Scottsdale, Arizona

Motorola also offers opportunities at  
Chicago, Illinois, and at Culver City and Riverside, California

## Join Sanders Associates in Nashua, New Hampshire

"The company is interested in NEW ways of doing things"... "work is carried on above the average level"... "circuit design here goes all the way from DC through microwave"—

— so say Engineers who have joined Sanders Associates in the past few months.

Such progressive philosophy has led to this young company's growth from 11 engineers to 1800 employees in only 10 years, with a current contract backlog of over \$50 million.

Still further expansion is planned for pioneering programs in many advanced areas including phased array radar, pulse doppler radar systems, space radar and communications systems.

If you are interested in working on the threshold of the state-of-the-art, untethered by conventional techniques, send a resume now to R. W. McCarthy.

All qualified applicants will receive consideration for employment without regard to race, creed, color or national origin.



**SANDERS ASSOCIATES, INC.**

NASHUA, NEW HAMPSHIRE

(In the New Hampshire hill country about an hour from downtown Boston)

CIRCLE 906 ON CAREER INQUIRY FORM

**KEEP YOUR LEARNING CURVE UP!**

Opportunities  
are available  
now for:

### RECEIVER DESIGN ENGINEERS

3 to 8 years experience. For design and development of receivers for military applications. Experience should include design of low noise front ends, IF strips, AGC circuitry and application of image rejection techniques. All transistorized. BS in EE or Physics.

### TRANSISTOR CIRCUITRY CONSULTANT

To provide technical guidance at the Corporate level on a wide variety of transistor circuit design problems. Requires ability to design detailed circuits rapidly.

### CIRCUIT DESIGN ENGINEERS

To translate conventional wire circuits into flexible and/or rigid printed circuitry and to design circuitry layout and approaches for printed circuits. A prime requisite is a keen and imaginative mind and native ingenuity to provide unique solutions to new problems in the field. Requires EE, ME or ChE with printed circuit background.

### TRANSMITTER DESIGN ENGINEERS

For design and development of transmitters, VHF-UHF and microwave frequency range, tubes, pulse modulators, power in excess of 1 kilowatt for military and airborne applications.

Now The  
Time To  
Convert?

Electronic engineers make good editors. **ELECTRONIC DESIGN's** editors have all "converted" from engineering duties to editing duties. You may be interested.

We have new assistant editor openings. EE's with 2-3 years circuit design experience have the ideal background.

If you get satisfaction out of communicating with others, if you enjoy pulling out the important, if you enjoy using words to convey ideas, you will like editorial work.

Write

**Edward E. Grazda, Editor**

**ELECTRONIC DESIGN**  
850 Third Ave.  
New York 22, N.Y.



## ELECTRONICS DIVISION

of Space Technology Laboratories, Inc.

*Offers Immediate Assignments  
in Southern California*

The continuing growth and diversification of Space Technology Laboratories, Inc. creates immediate career openings in the Communication, Electromechanical, Guidance, and Space Physics Laboratories of STL's Electronics Division.

In supporting STL's expanding contributions to the Advent, OGO, Atlas, Titan, and Minuteman programs, this division's responsibilities include analysis, design, and development of advanced guidance, control, and communications systems—at every phase from applied research through electronic product and ground support equipment design.

Immediate career opportunities exist here for outstanding engineers and scientists in the fields of:

- Digital computers
- Logical design
- Communication systems analysis
- Parts application
- Electronic packaging
- Electromechanical systems development
- Ground support circuit design
- Systems design and integration
- Equipment systems—checkout and evaluation
- Support equipment systems design
- Control systems analysis
- Electromechanical design
- Space communications systems
- Telemetry systems design
- Antenna systems
- R-F transistor equipment design
- Transistor circuit design
- Guidance systems analysis
- Materials and processes
- Reliability
- Aerospace ground equipment design

All qualified applicants, regardless of race, creed, color or national origin, are invited to communicate with Dr. R. C. Potter, Manager of Professional Placement and Development.

**SPACE TECHNOLOGY LABORATORIES, INC.**

a subsidiary of Thompson Ramo Wooldridge Inc.

P. O. Box 95005K1, Los Angeles 45, California

Those attending WESCON are invited to visit STL at Booth Number 209

CIRCLE 907 ON CAREER INQUIRY FORM



## ADVERTISERS' INDEX

August 2, 1961

Advertiser	Page
ACF Industries .....	219
ADC Products, A Div of Magnetic Controls Company .....	207
AMP, Incorporated .....	14, 93
Aeroflex Laboratories .....	200
Air-Marine Motors, Inc. ....	102
*Alden Products Company .....	96
Alfred Electronics .....	171
*Allied Control Company, Inc. ....	104
Amco Engineering Co. ....	58
American Bosch Corporation .....	136
American Electrical Heater Company ..	192
American Machine & Foundry Co. ....	190
Ampex Instrumentation Products Co. ....	141, 225
Angelica Uniform Co. ....	213
*Arnold Engineering Company, The ..	41
*Assembly Products, Inc. ....	170
Atohm Electronics, Inc. ....	195
Automatic Metal Products Corp. ....	202
Babcock Relays, Inc. ....	60
*Baird-Atomic, Inc. ....	69
*Ballantine Laboratories, Inc. ....	120
Barber-Colman Co. ....	132
Beckman Instruments, Inc. ....	142
Beede Electrical Instrument Co. ....	190
Belden Mfg. Co. ....	103
Bendix Corporation, The. Montrose Div. ....	134
Bendix Corporation, The. Pacific Div. ....	45
Bendix Corporation, The. Scintilla Div. ....	140
Bird Electronic Corp. ....	203
Blue M Electric Co. ....	134
Boeing Company, The .....	147, 148
*Boonton Electronics Corp. ....	140
Borg Equipment Div., Amphenol-Borg Electronics Corp. ....	80
*Bourns, Inc. ....	76, 77
Brand Rex, Div. of American Enka Corp. ....	82, 83
Bulova Electronics .....	7
Burton-Rogers Co. ....	120
CBS Electronics .....	117
Cadillac Associates, Inc. ....	105
Calibration Standards Corp. ....	211
California Resistor Corporation .....	83
*Cannon Electric Company .....	111

\*Manufacturers' catalog appears in 1960-1961  
ELECTRONIC DESIGNERS' CATALOG

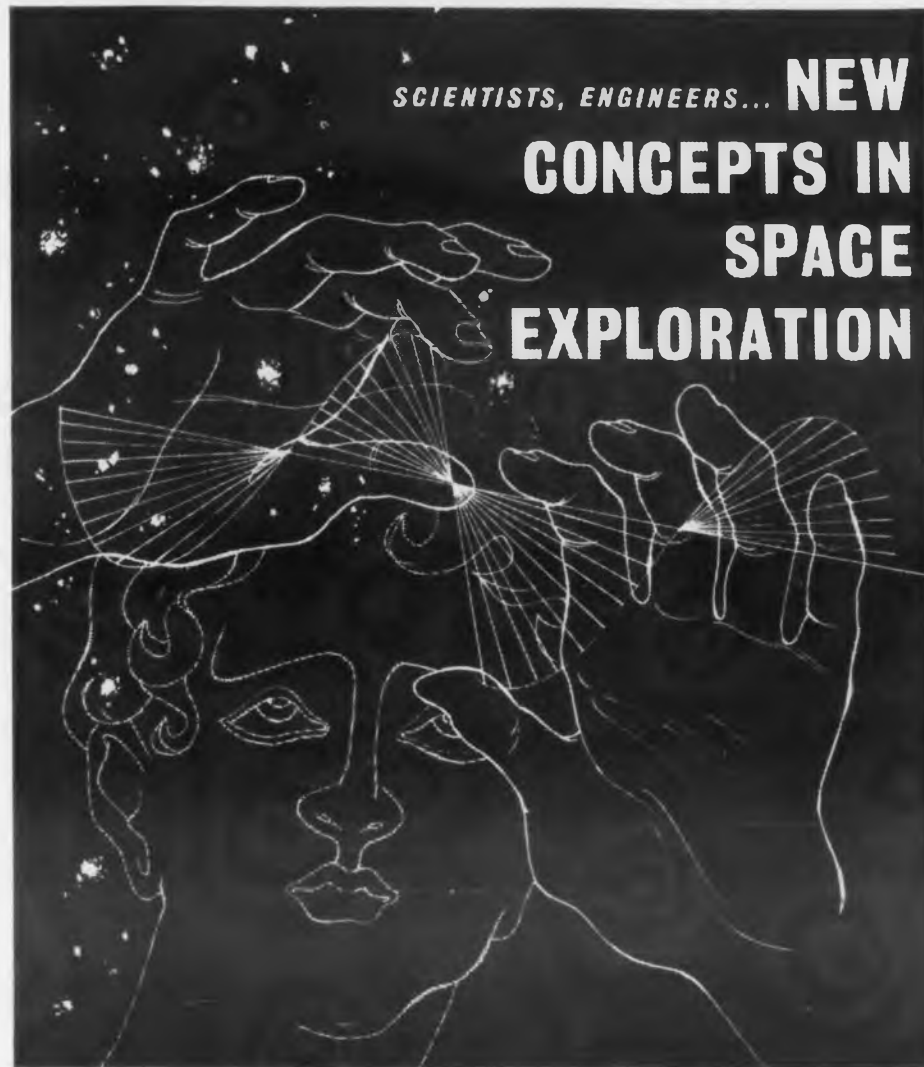

# SCIENTISTS, ENGINEERS... NEW CONCEPTS IN SPACE EXPLORATION

## at RCA'S Astro-Electronics Division Princeton, N.J. Creator of Tiros

Continued research and investigation into new areas of electronics and space technology has opened up a number of challenging opportunities for creative scientists and engineers at this rapidly growing division of RCA. Immediate openings are available in the following areas:

- **APPLIED PHYSICS RESEARCH** / Advanced space electrical power and propulsion
- **SPACE SYSTEM ANALYSIS** / Applied mathematics / Thermodynamics and mechanics
- **PROPULSION STUDY AND DESIGN** / For final stage space craft
- **ELECTRONIC SYSTEMS AND CIRCUIT DEVELOPMENT** / Communications / Video and digital data processing / TV camera and pickup tube design
- **INFORMATION PROCESSING** / Data systems analysis / Computer applications and programming research



To arrange a personal interview, call collect or write:

MR. D. D. BRODHEAD, Hightstown 8-0424  
Astro-Electronics Division, Princeton, New Jersey, Dept. PE -296

All qualified applicants considered regardless  
of race, creed, color or national origin.



The Most Trusted Name in Electronics

RADIO CORPORATION OF AMERICA

CIRCLE 908 ON CAREER INQUIRY FORM

# New

## CORNING CYFM CAPACITOR has reliability you can see

You get total protection against environment for less money than ever before

The new Corning CYFM capacitor gives you reliability at a markedly lower cost than that of any like capacitor.

The CYFM goes far beyond MIL-C-11272B specs. It has proved its performance through more than 3,000,000 hours of testing. It took a 50-day MIL moisture test and a 96-hour salt spray test with no measurable effects. We stopped testing only when it became evident that no more significant data could be developed. The CYFM went through other tests, with solvents, fluxes, boiling salt, and steam, to make sure it is the most completely sealed capacitor you can buy.

You'll see why the CYFM can take such torture when you check its design. We stack alternate layers of stable ribbon glass and aluminum foil. Then we weld the foils to the bead-terminal assembly, which has a glass bead sealed to the Dumet wire lead. With heat and pressure, the entire capacitive element is frozen in glass for complete protection against environment and for struc-

tured protection against physical shock.

True glass-to-metal seals at the weld area and along the leads bar moisture. The seal of the leads to the glass shifts stresses from the leads to the entire monolithic unit, guarding the capacitance area. Of course, you get electrical performance to match this environmental stability, since the CYFM has our glass-foil capacitor construction.

The CYFM is machine made... each capacitor is the same as every other, to give you uniformity which hand production cannot match.

You can get immediate delivery on the CYFM in four types. The CYFM-10 gives capacitance values from 0.5 to 300 pf; the CYFM-15, from 220 to 1200 pf; the CYFM-20, from 560 to 5100 pf, and the CYFM-30, from 3600 to 10000 pf.

For the rest of the story on this capacitor, send for our data sheet. Write to Corning Glass Works, 548 High St., Bradford, Pa.

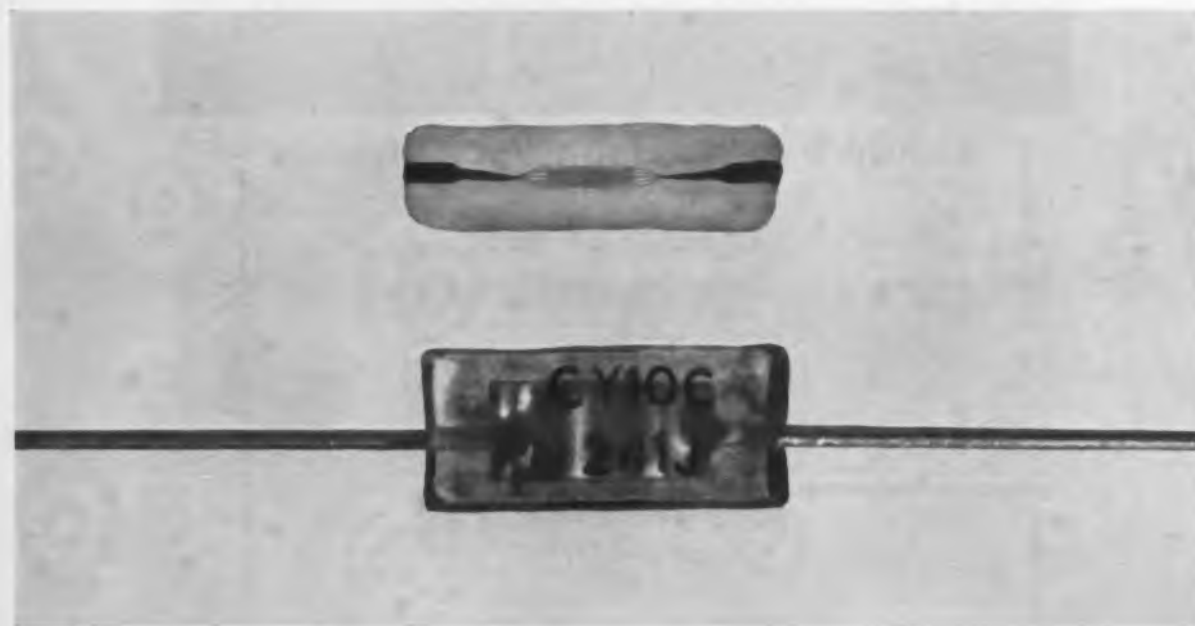

This is the CYFM capacitor. 6 times actual size. The dark areas between the ends of the glass and the capacitance element are your visual proof of the complete glass-to-metal seal.



### CORNING ELECTRONIC COMPONENTS

CORNING GLASS WORKS, BRADFORD, PA.

CIRCLE 231 ON READER-SERVICE CARD

Capitron Div., AMP, Incorporated	14
Carborundum Co., The	223
Celco Constantine Engineering Labs. Co.	124
Cetron Electronic Corporation	144
Clare & Co. C. P.	72-73
*Clarostat Mfg. Co.	15
*Clevite Electronic Components	87
*Clevite Transistor	24 A-B
*Clifton Precision Products Co., Inc. Cover II	
Communications Measurements Laboratory, Inc.	33
Computer Instruments Corporation	123
Consolidated Molded Products Corp.	204
Continental Connector Corporation	149
Controls Company of America	29
Corning Glass Works	222
Couch Ordnance, Inc.	34
Crucible Steel Company of America	181
Cubic Corporation	185

Dearborn Laboratories, Inc.	205
Delco Radio	
Div. of General Motors Corp.	32
De Mornay-Bonardi	158, 159
Diamond Tool & Horseshoe Company	121
Di/An Controls, Inc.	194
Dick Electronic Research Labs. A. B.	27
*Dow Corning Corporation	94-95
DuPont de Nemours & Co., E. I.	
Mylar Div.	129

EICO	180
Eagle Signal Company, The	124
Eastman Chemical Products, Inc.	211
*Elcor Incorporated	198
*Electro Impulse Laboratory	180
Electronic Design	218
Electronic Designers' Catalog	146
Electronic Measurements Co., Inc.	24
*Elgin Advance Relays	45
Equito Electronics Corporation	12
Erie Resistor Corp.	205

FXR, A Div. of Amphenol-Borg Electronics Corp.	157
*Fairchild Semiconductor Corporation	106, 107
*Fluke Mfg. Co., Inc., John	99
Frequency Standards	179

\*Manufacturers' catalog appears in 1960-1961 ELECTRONIC DESIGNERS' CATALOG

*C-V Controls, Inc.	21
Garlock, Inc.	28
Garner Company, T. H.	108
General Applied Science Labs.	210
General Electric Company, Defense Systems Dept.	218
General Electric Company, Instrument Dept.	145
General Electric Company, Magnetic Materials Section	49
General Electric Company, Rectifier Components Dept.	133, 195
General Electric Company, Silicone Products Dept.	112
General Electric Company, Tantalum Capacitors	65
General Instrument Corporation	61
General Motors Corporation, A. C. Spark Plug Div.	215
General Products Corporation	194
Gertsch Products, Inc.	172
Graphik Circuits	188
Grayhill, Inc.	150
Gurley, W. & L. E.	104
Gudebrod Bros. Silk Co., Inc.	194

Heinemann Electric Company	131
Hewlett-Packard Company	226, Cover III
Holt Instrument Laboratories	132
Hopkins Engineering Co.	30
Huggins Laboratories, Inc.	186
Hughes Aircraft Company	88, 210

Illinois Tool Works	212
Indiana Steel Products	71
*Industrial Electronic Engineers, Inc.	138
Industrial Instruments, Inc.	96
*Instrument Specialties Co., Inc.	192
Instruments for Industry, Inc.	189
International Electronic Research Corp.	193
International Resistance Co.	25
Invar Electronics Corp.	105
Itek Electro-Products Company	112

Janco Corp.	191
*Jerrold Electronics Corp.	78

*Kay Electric Company	22
Key Resistor Corporation	10
Kintel, Div. of Cohu Electronics, Inc.	5

\*Manufacturers' catalog appears in 1960-1961  
ELECTRONIC DESIGNERS' CATALOG

# Electronic Products **NEWS**

by **CARBORUNDUM**<sup>®</sup>



## New Dummy Antenna Load offered to ham operators

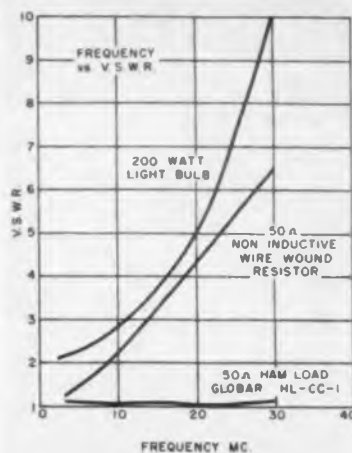

This new coaxial antenna impedance simulator HL-CC-1 was developed by Carborundum for use with ham radio equipment.

Specifications are: Short time power rating 250 watts (up to 5 min.); continuous rating 150 watts; V.S.W.R. 0-30 megacycles, 1.5 maximum.

With design changes, similar loads can be supplied for operation anywhere in the frequency range up to 1 kilo megacycle and for dissipating up to 1 Kw continuously.

Resistive component of the load is one of Carborundum's high temperature non-inductive resistors. It is furnished with coaxial terminations.

Available from electronic distributors, these ham antenna loads prevent radiation and interference while tuning, testing and making measurements.

For more information on Carborundum's dummy loads for other applications, write to Dept. EDL-81, Globar Plant, Refractories Div., Carborundum Co., Niagara Falls, N. Y.

Circle 804 on Reader-Service Card

## High Purity Crushable Ceramic Preforms meet Govt. Specs.



Crushable ceramic preforms for precision swaged thermocouples for atomic energy and turbine engine applications are available from Carborundum.

The following materials exceed the requirements of A.E.C. Specification SPC-SR-101-(ORO), Oak Ridge National Laboratories Specification ORNL Spec. 7444-1 and Knolls Atomic Power Laboratories ORPM 7-1.

1. High Purity Magnesium Oxide—Type 0333, certified purity 99.4% min. MgO  $Al_2O_3$ , and less than 2 ppm boron.

2. High Purity Fused Aluminum Oxide—Type 1513, certified purity 99.6% min.  $Al_2O_3$ , and less than 2 ppm boron.

3. Stabilized Zirconium Oxide—Type 0956, certified purity 91.9% min. and less than 10 ppm boron.

Standard sizes are from .022 O.D. with holes from .005. Standard preforms are offered for 1, 2 and 4 hole applications. Others are available on request.

For Technical Data Sheet and other information contact Dept. EDP-81, Latrobe Plant, Refractories Div., Carborundum Co., Latrobe, Pa.

Circle 805 on Reader-Service Card

## Carborundum insulators make possible 5-yr. guarantee for Electronic Air Cleaner



Key to the operation of an electronic air cleaner made by The Electro-Air Cleaner Co., McKees Rocks, Pa., is the ionizing collecting cell shown here.

Insulators supporting the electrically charged plates are exposed to extreme conditions of dirt and moisture, yet must prevent high voltage leakage. The search for a suitable material ended with Carborundum's steatite insulators. Operation

is so successful that The Electro-Air Cleaner Co. is able to guarantee its product for a full five years.

Ceramic insulating materials and parts, including metallized ceramics and ceramic-to-metal assemblies, are specialties of Carborundum's Latrobe Plant. For more information, write Dept. EDC-81, Refractories Division, Carborundum Company, Latrobe, Pa.

Circle 806 on Reader-Service Card

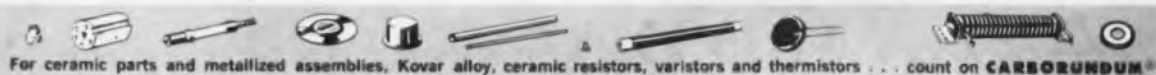

For ceramic parts and metallized assemblies, Kovar alloy, ceramic resistors, varistors and thermistors . . . count on **CARBORUNDUM**<sup>®</sup>

CIRCLE 804, 805, 806 ON READER-SERVICE CARD

# LAMBDA Convection Cooled Transistorized Regulated Power Supplies

VISIT  
LAMBDA  
AT WESCON SHOW  
BOOTHS 3602-3604



## LA SERIES

0- 34 VDC	5 AMP
0- 34 VDC	10 AMP
0- 34 VDC	20 AMP
20-105 VDC	2 AMP
20-105 VDC	4 AMP
20-105 VDC	8 AMP
75-330 VDC	0.8 AMP
75-330 VDC	1.5 AMP
75-330 VDC	3 AMP

## SPECIAL FEATURES

- Convection Cooled—No internal blowers or filters—maintenance free
- Ambient 50°C
- No Voltage Spikes or overshoot on "turn on, turn off," or power failure
- Short Circuit Proof
- Remote programming over Vernier band
- Hermetically-sealed transformer designed to MIL-T-27A
- Easy Service Access
- Constant Current Operation—Consult Factory
- Guaranteed 5 years

## CONDENSED DATA

### DC OUTPUT (Regulated for line and load)

Model	Voltage Range (1)	Vernier Band (2)	Current Range (3)	Price (4)
LA 50-03A	0- 34 VDC	4 V	0- 5 AMP	\$ 395
LA100-03A	0- 34 VDC	4 V	0-10 AMP	510
LA200-03A	0- 34 VDC	4 V	0-20 AMP	795
LA 20-05B	20-105 VDC	10 V	0- 2 AMP	350
LA 40-05B	20-105 VDC	10 V	0- 4 AMP	495
LA 80-05B	20-105 VDC	10 V	0- 8 AMP	780
LA 8-08B	75-330 VDC	30 V	0- 0.8 AMP	395
LA 15-08B	75-330 VDC	30 V	0- 1.5 AMP	560
LA 30-08B	75-330 VDC	30 V	0- 3 AMP	860

Regulation (line)..... Less than 0.05 per cent or 8 millivolts (whichever is greater). For input variations from 105-140(5) VAC.

Regulation (load)..... Less than 0.10 per cent or 15 millivolts (whichever is greater). For load variations from 0 to full load.

Ripple and Noise..... Less than 1 millivolt rms with either terminal grounded.

### Temperature

Coefficient..... Less than 0.025%/°C.

(1) The DC output voltage for each model is completely covered by four selector switches plus vernier range.

(2) Center of vernier band may be set at any of 16 points throughout voltage range.

(3) Current rating applies over entire voltage range.

(4) Prices are for unmeted models. For metered models add the suffix "M" and add \$30.00 to the price.

(5) Except for LA50-03A, LA100-03A, LA200-03A which have AC input voltage of 100-130 VAC. 105-110 VAC available upon request at moderate surcharge.

### AC INPUT

105-140 VAC, 60(5) ± 0.3 cycle(6)

(6) This frequency band amply covers standard commercial power line tolerances in the United States and Canada. For operation over wider frequency band, consult factory.

### Size

LA 50-03A, LA20-05B, LA 8-08B 3½" H x 19" W x 14¾" D  
LA100-03A, LA40-05B, LA15-08B 7" H x 19" W x 14¾" D  
LA200-03A, LA80-05B, LA30-08B 10½" H x 19" W x 16¾" D

Send for new Lambda Catalog 61

LA118A



LAMBDA ELECTRONICS CORP.

515 BROAD HOLLOW ROAD, HUNTINGTON, L. I., NEW YORK 516 MYRTLE 4-4200

Western Regional Office: 230 North Lake Avenue, Pasadena, California • Phone: Code 213, MUrray 1-2544

New England Regional Office: 275 Boston Post Road, Marlboro, Massachusetts • Phone: Code 617, HUNtley 5-7122

Advertiser

Page

Laboratory for Electronics, Inc. ....	203
*Lambda Electronics Corp. ....	224
*Lavoie Laboratories, Inc. ....	200
Ledex, Inc. ....	110
Linde Company ....	18, 144
Ling-Temco Electronics, Inc. ....	74, 130, 131
Lionel Electronic Laboratories ....	213
Lockheed California Div. ....	57

McLean Engineering Laboratories ....	116
*Magnetics, Inc. ....	67
Mallory & Co., Inc. P. R. ....	2, 118, 119
Metex Electronics Corp. ....	98
Melpar, Inc. ....	150
Metronix Inc. ....	102
Microwave Associates, Inc. ....	163
*Miller Co., J. W. ....	188
Minneapolis-Honeywell Regulator Co., Semiconductor Div. ....	151
*Minnesota Mining & Mfg. Co., Chemical Div. ....	143
*Motorola Military Electronics Div. ....	219
*Motorola Semiconductor Products, Inc. ....	19
*Mycalex Electronics Corp. ....	209

New England Instrument Co. ....	190
North Electric Company ....	208
Nytronics, Inc. ....	128

Omtronics Mfg. Inc. ....	180
--------------------------	-----

Paktron Packaged Electronics ....	212
Paramount Paper Tube Corp. ....	189
Penta Laboratories ....	113
Perkin Electronics Corporation ....	6
Phelps Dodge Copper Products Corporation ....	23
*Philco, Lansdale Division ....	9
Philco Corporation, Western Development Labs. ....	216
*Polarad Electronics Corporation ....	176, 177
Post Co., Frederick ....	70
Potter & Brumfield ....	90, 91
Potter Instrument Co., Inc. ....	108
Power Designs, Inc. ....	191
Premier Metal Products Co. ....	186

\*Manufacturers' catalog appears in 1960-1961  
ELECTRONIC DESIGNERS' CATALOG

◀ CIRCLE 233 ON READER-SERVICE CARD

Advertiser	Page
RCA Service Company	31
Radiation, Inc.	181
Radio Corporation of America	125, 221, Cover IV
Raytheon Co., Distributor Products Div.	37
*Raytheon Co., Industrial Components Div.	1, 202
Raytheon Co., Microwave and Power Tube, Magnetics Operation Div.	97
Raytheon Co., Microwave and Power Tube	174, 175
Raytheon Co., Semiconductor Div.	36
Raytheon Co., Special Microwave	182
Reeves Instrument Corp.	201
Rixon Electronics Inc.	204
Rohde & Schwarz	183
Rome Cable, Div. of Alcoa	207

Sanborn Company	86
Sanders Associates, Inc.	184, 220
*Sarkis Tarzian, Inc.	32 A-B-C-D
Scientific Atlanta, Inc.	165
*Seaelectro Corporation	75
Sel-Rex Corp.	186
*Servo Corporation of America	190
Shallcross Mfg. Co.	149
*Sierra Electronic Corporation	168
*Sigma Instruments, Inc.	39
Silicon Transistor Corporation	38
Space Technology Laboratories	220
Sperry Electronic Tube Div., Sperry Rand Corp.	152
*Sperry Microwave Electronics Co.	173
*Sperry Semiconductor Div. of Sperry Rand Corporation	137
Sprague Electric Company	11, 20
Standard Press Steel	43
*Statham Instruments Co.	187
Stoddart Aircraft Radio Co., Inc.	164
Switchcraft, Inc.	105
Sylvania Electric Products, Inc. Electron Tube Div.	80 A-B-C-D
*Sylvania Electric Products, Inc., Semiconductor Div.	126, 127
Synthane Corporation	191

Taurus Corporation	113
Tektronix, Inc.	63
Temperature Engineering Corporation	53
Texas Instruments Incorporated	109, 181
Thermalloy Company	146
Trak Microwave Corporation	187
*Transitron Electronic Corporation	89
Trio Laboratories, Inc.	128
Triplett Electrical Instrument Co.	114, 115
Tri Metal Works, Inc.	122
Tucor, Inc.	116
*Tung-Sol Electric, Inc.	13, 79

\*Manufacturers' catalog appears in 1960-1961  
ELECTRONIC DESIGNERS' CATALOG

CIRCLE 234 ON READER-SERVICE CARD ➤

FR-100C =  $\frac{P_{max} + S_{min}}{\$}$

## New Ampex FR-100C

Lightweight, single-rack recorder gives maximum performance  
in minimum space for your recorder dollar

**Brand New Modular Solid-State Plug-In Circuits** combined with the world's most proved instrumentation tape transport have enabled Ampex engineers to design an exceptionally high performance recorder with great reliability and economy of operation. The new FR-100C offers:

**Performance:** Frequency response is 300 kc at 60 ips direct record—20 kc with FM record. Fourteen-inch reels provide 24 minutes record time at 60 ips (with 1-mil tape). Tape handling is fully comparable to the Ampex FR-100B.

**Versatility:** Take your choice of direct, FM and PDM recording; six tape speeds; 1" and ½" tape; and up to 14 data channels and one auxiliary channel such as voice log or clocking generator.

**Economy:** Because the new FR-100C features modular plug-in circuits, you can tailor your recorder to your immediate needs. You can specify only the features you need now without sacrificing future flexibility.

**Operation:** Signal inputs and outputs are available both front and back. All connection, adjustment and calibration points are easily accessible from the front. Lightweight single-rack unit takes minimum floor space.

**Ampex Reliability Built In.** In addition to its greater versatility and economy, the fourth-generation FR-100C is designed to the same high standards that have made Ampex recorders the standard of excellence throughout the world. For complete specifications, write . . .

AMPEX INSTRUMENTATION PRODUCTS COMPANY • Box 5001 • Redwood City, California • EMerson 9-7111

AMPEX

*Ucinlte Company, The	136
Ultek Corporation	31
Union Switch & Signal, Div. Westinghouse Air Brake	134, 135
Utica Drop Forge & Tool Div.	3
United Aircraft Corporation	84, 85
Universal Manufacturing Co., Inc.	104

Varian Associates	154
Vickers, Inc.	52
Vitramon, Inc.	17
Vitro Electronics	206

Western Electric Company	92
*Westinghouse Electric Corporation	59, 100, 101, 178

Zero Mfg. Co.	193
---------------	-----

\*Manufacturers' catalog appears in 1960-1961  
ELECTRONIC DESIGNERS' CATALOG

### Advertising Representatives

**Adv. Sales Manager:** Robert W. Gascoigne

**Sales Service Supvr.:** Alvin D. Ross

**New York:** Richard Parker, Blair McClenachan, Berry Conner, Jr., James P. Quinn, Charles J. Stillman, Jr., Kenneth M. George, John M. Weber, Pierre J. Braudé, Thomas P. Barth, 850 Third Avenue, Plaza 1-5530

**Chicago:** Thomas P. Kavooras, Fred T. Bruce, 664 N. Michigan Avenue, Superior 7-8054

**Cleveland:** Douglas H. Boynton

**Los Angeles:** John V. Quillman, 3275 Wilshire Blvd., Dunkirk 2-7337

**San Francisco:** Stanley I. Ehrenclou, 292 Walter Hayes Drive, Palo Alto, Davenport 1-7646

**Southeastern:** Pirnie & Brown, Morgan Pirnie, Harold V. Brown, G. H. Krimmier, 1722 Rhodes-Haverty Bldg., Atlanta, Ga., Jackson 2-8113

**London EC4:** Brad Nichols, 151 Fleet Street

**Tokyo:** Karl H. Bachmeyer Associates, 27 Morimoto-cho, 1-chome, Azabu, Minato-ku

# NOW!

Measure phase  
angle directly  
in degrees  
with counter  
speed and accuracy!



This new 526D plug-in unit for  
*hp* 524C/D Electronic Counters  
allows fast, direct phase angle measurements—  
ideal for servo applications

## Other Plug-ins for 524C/D Counters

Order the measuring capability you need at present, later add other plug-ins  
to increase the usefulness of your 524 counter.



525A Frequency Converter, \$250.00,  
extends counter to 100 MC



525B Frequency Converter, \$300.00,  
extends counter to 220 MC



525C Frequency Converter, \$425.00,  
extends counter to 500 MC



526A Video Amplifier, \$200.00,  
increases sensitivity to 10 mv



526B Time Interval Unit, \$200.00,  
for measurement, 1  $\mu$ sec to  $10^7$  sec



526C Period Multiplier, \$225.00,  
allows measurement to 100 KC of  
100, 1,000, 10,000 period average

# ELECTRONIC DESIGN - ONE DAY SERVICE USE BEFORE SEPTEMBER 13th, 1961

Name \_\_\_\_\_ Title \_\_\_\_\_

Company \_\_\_\_\_

Company Address					City					Zone					State														
10	20	30	40	50	60	70	80	90	100	110	120	130	140	150	160	170	180	190	200	210	220	230	240	250	260	270	280	290	
1	11	21	31	41	51	61	71	81	91	101	111	121	131	141	151	161	171	181	191	201	211	221	231	241	251	261	271	281	291
2	12	22	32	42	52	62	72	82	92	102	112	122	132	142	152	162	172	182	192	202	212	222	232	242	252	262	272	282	292
3	13	23	33	43	53	63	73	83	93	103	113	123	133	143	153	163	173	183	193	203	213	223	233	243	253	263	273	283	293
4	14	24	34	44	54	64	74	84	94	104	114	124	134	144	154	164	174	184	194	204	214	224	234	244	254	264	274	284	294
5	15	25	35	45	55	65	75	85	95	105	115	125	135	145	155	165	175	185	195	205	215	225	235	245	255	265	275	285	295
6	16	26	36	46	56	66	76	86	96	106	116	126	136	146	156	166	176	186	196	206	216	226	236	246	256	266	276	286	296
7	17	27	37	47	57	67	77	87	97	107	117	127	137	147	157	167	177	187	197	207	217	227	237	247	257	267	277	287	297
8	18	28	38	48	58	68	78	88	98	108	118	128	138	148	158	168	178	188	198	208	218	228	238	248	258	268	278	288	298
9	19	29	39	49	59	69	79	89	99	109	119	129	139	149	159	169	179	189	199	209	219	229	239	249	259	269	279	289	299
300	310	320	330	340	350	360	370	380	390	400	410	420	430	440	450	460	470	480	490	500	510	520	530	540	550	560	570	580	590
301	311	321	331	341	351	361	371	381	391	401	411	421	431	441	451	461	471	481	491	501	511	521	531	541	551	561	571	581	591
302	312	322	332	342	352	362	372	382	392	402	412	422	432	442	452	462	472	482	492	502	512	522	532	542	552	562	572	582	592
303	313	323	333	343	353	363	373	383	393	403	413	423	433	443	453	463	473	483	493	503	513	523	533	543	553	563	573	583	593
304	314	324	334	344	354	364	374	384	394	404	414	424	434	444	454	464	474	484	494	504	514	524	534	544	554	564	574	584	594
305	315	325	335	345	355	365	375	385	395	405	415	425	435	445	455	465	475	485	495	505	515	525	535	545	555	565	575	585	595
306	316	326	336	346	356	366	376	386	396	406	416	426	436	446	456	466	476	486	496	506	516	526	536	546	556	566	576	586	596
307	317	327	337	347	357	367	377	387	397	407	417	427	437	447	457	467	477	487	497	507	517	527	537	547	557	567	577	587	597
308	318	328	338	348	358	368	378	388	398	408	418	428	438	448	458	468	478	488	498	508	518	528	538	548	558	568	578	588	598
309	319	329	339	349	359	369	379	389	399	409	419	429	439	449	459	469	479	489	499	509	519	529	539	549	559	569	579	589	599
600	610	620	630	640	650	660	670	680	690	700	710	720	730	740	750	760	770	780	790	800	810	820	830	840	850	860	870	880	890
601	611	621	631	641	651	661	671	681	691	701	711	721	731	741	751	761	771	781	791	801	811	821	831	841	851	861	871	881	891
602	612	622	632	642	652	662	672	682	692	702	712	722	732	742	752	762	772	782	792	802	812	822	832	842	852	862	872	882	892
603	613	623	633	643	653	663	673	683	693	703	713	723	733	743	753	763	773	783	793	803	813	823	833	843	853	863	873	883	893
604	614	624	634	644	654	664	674	684	694	704	714	724	734	744	754	764	774	784	794	804	814	824	834	844	854	864	874	884	894
605	615	625	635	645	655	665	675	685	695	705	715	725	735	745	755	765	775	785	795	805	815	825	835	845	855	865	875	885	895
606	616	626	636	646	656	666	676	686	696	706	716	726	736	746	756	766	776	786	796	806	816	826	836	846	856	866	876	886	896
607	617	627	637	647	657	667	677	687	697	707	717	727	737	747	757	767	777	787	797	807	817	827	837	847	857	867	877	887	897
608	618	628	638	648	658	668	678	688	698	708	718	728	738	748	758	768	778	788	798	808	818	828	838	848	858	868	878	888	898
609	619	629	639	649	659	669	679	689	699	709	719	729	739	749	759	769	779	789	799	809	819	829	839	849	859	869	879	889	899

For employment brochures give home address

Home Address \_\_\_\_\_

City \_\_\_\_\_

Zone \_\_\_\_\_

State \_\_\_\_\_

For Change of Address:

Old Company Name \_\_\_\_\_

- I Do Design Work  
 I Supervise Design Work  
 I Do No Design Work

Old Company Address \_\_\_\_\_

City \_\_\_\_\_

Zone \_\_\_\_\_

State \_\_\_\_\_

# ELECTRONIC DESIGN - ONE DAY SERVICE USE BEFORE SEPTEMBER 13th, 1961

Name \_\_\_\_\_ Title \_\_\_\_\_

Company \_\_\_\_\_

Company Address					City					Zone					State														
10	20	30	40	50	60	70	80	90	100	110	120	130	140	150	160	170	180	190	200	210	220	230	240	250	260	270	280	290	
1	11	21	31	41	51	61	71	81	91	101	111	121	131	141	151	161	171	181	191	201	211	221	231	241	251	261	271	281	291
2	12	22	32	42	52	62	72	82	92	102	112	122	132	142	152	162	172	182	192	202	212	222	232	242	252	262	272	282	292
3	13	23	33	43	53	63	73	83	93	103	113	123	133	143	153	163	173	183	193	203	213	223	233	243	253	263	273	283	293
4	14	24	34	44	54	64	74	84	94	104	114	124	134	144	154	164	174	184	194	204	214	224	234	244	254	264	274	284	294
5	15	25	35	45	55	65	75	85	95	105	115	125	135	145	155	165	175	185	195	205	215	225	235	245	255	265	275	285	295
6	16	26	36	46	56	66	76	86	96	106	116	126	136	146	156	166	176	186	196	206	216	226	236	246	256	266	276	286	296
7	17	27	37	47	57	67	77	87	97	107	117	127	137	147	157	167	177	187	197	207	217	227	237	247	257	267	277	287	297
8	18	28	38	48	58	68	78	88	98	108	118	128	138	148	158	168	178	188	198	208	218	228	238	248	258	268	278	288	298
9	19	29	39	49	59	69	79	89	99	109	119	129	139	149	159	169	179	189	199	209	219	229	239	249	259	269	279	289	299
300	310	320	330	340	350	360	370	380	390	400	410	420	430	440	450	460	470	480	490	500	510	520	530	540	550	560	570	580	590
301	311	321	331	341	351	361	371	381	391	401	411	421	431	441	451	461	471	481	491	501	511	521	531	541	551	561	571	581	591
302	312	322	332	342	352	362	372	382	392	402	412	422	432	442	452	462	472	482	492	502	512	522	532	542	552	562	572	582	592
303	313	323	333	343	353	363	373	383	393	403	413	423	433	443	453	463	473	483	493	503	513	523	533	543	553	563	573	583	593
304	314	324	334	344	354	364	374	384	394	404	414	424	434	444	454	464	474	484	494	504	514	524	534	544	554	564	574	584	594
305	315	325	335	345	355	365	375	385	395	405	415	425	435	445	455	465	475	485	495	505	515	525	535	545	555	565	575	585	595
306	316	326	336	346	356	366	376	386	396	406	416	426	436	446	456	466	476	486	496	506	516	526	536	546	556	566	576	586	596
307	317	327	337	347	357	367	377	387	397	407	417	427	437	447															

VIA  
AIR  
MAIL

FIRST CLASS  
Permit No. 725  
New York, N. Y.

B U S I N E S S R E P L Y M A I L

No Postage Stamp Necessary If Mailed In U. S.

POSTAGE WILL BE PAID BY

**ELECTRONIC DESIGN**

ONE DAY READERS INQUIRY SERVICE

830 Third Avenue

New York 22, New York

VIA  
AIR  
MAIL

FIRST CLASS  
Permit No. 725  
New York, N. Y.

B U S I N E S S R E P L Y M A I L

No Postage Stamp Necessary If Mailed In U. S.

POSTAGE WILL BE PAID BY

**ELECTRONIC DESIGN**

ONE DAY READERS INQUIRY SERVICE

830 Third Avenue

New York 22, New York



With the  $\Phi$  524 Counter and the new 526D Phase Unit, you can measure phase angle between two signals conveniently, accurately and at any frequency from 1 cps to 20 KC. At 400 cps, readings are direct in 10ths of degrees; at other frequencies readings are in time units with a resolution of 0.1 microsecond.

The new phase unit plug-in, whose specifications are given in detail below thus adds still greater versatility to the unique  $\Phi$  524C/D counters. Details of other 525/526 series plug-ins appear on opposite page.

**Brief details,  $\Phi$  524C/D Electronics Counters**  
Measure frequency 10 cps to 10.1 MC, period to 100 KC without plug-ins. With plug-ins measure frequency to 500 MC (with accessories to 18.0 GC), time interval 1  $\mu$ sec to 100 days. Measurements are automatic, direct reading, require no tedious calculation or interpolation. Big, bright Nixie readout (524C) or columnar neon readout (524D). Maximum resolution 0.1  $\mu$ sec, stability  $3/10^8$  short term,  $5/10^8$  per week. High sensitivity, high impedance. Can be standardized with WWV; available for printer operation. Readily used by non-technical personnel. Highest quality construction, military type design.  $\Phi$  524C, \$2,400.00.  $\Phi$  524D, \$2,150.00. Rack mount models available.

## SPECIFICATIONS $\Phi$ 526D Phase Unit

**Range:** Phase angle 0 to 360°, lead or lag

**Frequency Range:** 1 cps to 20 KC

**Reads In:** Time units with maximum resolution of 0.1  $\mu$ sec over full frequency range. For frequencies 396 to 404 cps, x 3,600 frequency multiplier provides readings direct in 10ths of degrees.

**Accuracy:**  $\pm 0.1^\circ \pm F_p/F_s \times 360^\circ$  (where  $F_p$  is frequency of phase-measured signal and  $F_s$  is counted frequency, assuming noise 65 db below signal).

**Input Voltage:** 5 to 120 v rms; usable to 240 v rms.

**Input Impedance:** Approx. 1 megohm, 80 pf shunt

**Price:** \$750.00



## 8 other widely used $\Phi$ Electronic Counters



### $\Phi$ 523C/CR Electronic Counter

10 cps to 1.2 MC with new 0.1 v sensitivity. Bright Nixie in-line readout. Measures time interval 1  $\mu$ sec to  $10^3$  sec. and period 0.00001 cps to 100 KC and phase angle. Stability  $2/10^8$  per week. Improved circuitry prevents triggering by unwanted signals, noise. Results appear in seconds, msec,  $\mu$ sec or KC with automatic decimal.  $\Phi$  523CR (rack mount) \$1,550.00;  $\Phi$  523C (cabinet) \$1,575.00.

### $\Phi$ 523D/DR Electronic Counter

Offers electronic features identical with those of  $\Phi$  523CR but has six-place neon columnar readout.  $\Phi$  523DR (rack mount) \$1,285.00;  $\Phi$  523D (cabinet) \$1,310.00.



### $\Phi$ 522B/BR Electronic Counter

Popular  $\Phi$  522B/BR measures frequency 10 cps to 120 KC, period 0.00001 cps to 10 KC, time interval 10  $\mu$ sec to  $10^3$  sec. Reads direct in cps, KC, seconds, milliseconds. Time base stability  $1/10^8$  per week; counts automatically, resets, action repetitive. Applications include measurement of production line quantities, nuclear radiation, power line frequencies, very low frequencies, and, with transducers, a wide array of physical quantities and phenomena.  $\Phi$  522B (cabinet) \$915.00;  $\Phi$  522BR (rack mount) \$900.00.



### $\Phi$ 521 Series Industrial Counter

$\Phi$  offers five Model 521 counters, all useful in measuring frequency, random events per unit of time, and, with transducers, speed, rps, rpm, weight, pressure, temperature, etc. Direct readings, display time variable or "hold"; four instruments cover frequency range 1 cps to 120 KC; the fifth measures to 1.2 MC. Two models with big, bright, in-line numeric readout, three with columnar neon display. Prices \$475.00 to \$955.00. Cabinet and rack mounts available.

## HEWLETT-PACKARD COMPANY

1089K Page Mill Road  
Cable "HEWPACK"

Palo Alto, California  
Davenport 6-7000

Sales representatives in all principal areas

## HEWLETT-PACKARD S.A.

Rue du Vieux Billard No. 1  
Cable "HEWPACKSA"

Geneva, Switzerland  
Tel. No. (022) 26. 43. 36

## ELECTRONIC DESIGN

**Publisher:** Robert E. Ahrens Dorf  
**Editor:** Edward E. Grazda  
**Managing Editor:** James A. Lippke  
**Technical Editors:** G. H. Rostky, H. Bierman, R. H. Cushman, M. W. Meisels, A. Rosenblatt  
**News Editors:** R. Haavind, Chief; A. Corneretto, R. N. Ross  
**New Products Editor:** A. W. Solda, Chief; C. H. Farley, E. G. Farrell  
**Washington Editor:** J. J. Christie  
**West Coast Editor:** T. E. Mount  
**Consulting Editor:** R. N. DeFloria  
**Contributing Editors:** J. G. Adashko, E. Brenner, B. Bernstein  
**Editorial Production:** D. S. Viebig, A. Abramoff  
**Art Director:** R. A. Schulze  
**Art Assistant:** J. Aruego  
**Production Manager:** T. V. Sedita  
**Asst. Prod. Mgr.:** H. De Polo  
**Production Assistants:** P. Bergang, M. Spector  
**Circulation Manager:** N. M. Elston  
**Asst. Circ. Mgr.:** H. A. Hunter  
**Reader-Service:** L. Blair

Hayden Publishing Company, Inc.

Chairman of the Board:

T. Richard Gascoigne

President: James S. Mulholland, Jr.

## Accuracy Policy

Recognizing the power of the printed word to influence, it is ELECTRONIC DESIGN's policy:

To make all reasonable efforts to insure accuracy of editorial matter.

To publish promptly corrections brought to our attention.

To not knowingly publish misleading advertisements.

To reserve the right to refuse any advertisement.

Readers noting errors or misstatements of facts are encouraged to write the editor.

## Subscription Policy

ELECTRONIC DESIGN is circulated only to qualified design engineers of U. S. manufacturing companies, industrial consultants and government agencies. If design for manufacturing is your responsibility, you qualify for subscription without charge provided you send us the following information on your company's letterhead: Your name and engineering title, your company's main products and description of your design duties. The letter must be signed by you personally.

ANY ADDRESS CHANGES FOR OLD SUBSCRIBERS NECESSITATE A RESTATEMENT OF THESE QUALIFICATIONS. Subscription rate for nonqualified subscribers—\$25.00 per year U. S. A., \$35.00 per year all other countries. Single copy \$1.50.

RCA PRESENTS A NEW MICROWAVE FAMILY

Integral-Cavity Pencil Tubes Shown Actual Size, Approximately

RCA Pencil Tubes provide the vital voice-communications link in the Satellite Communications System of Project Mercury

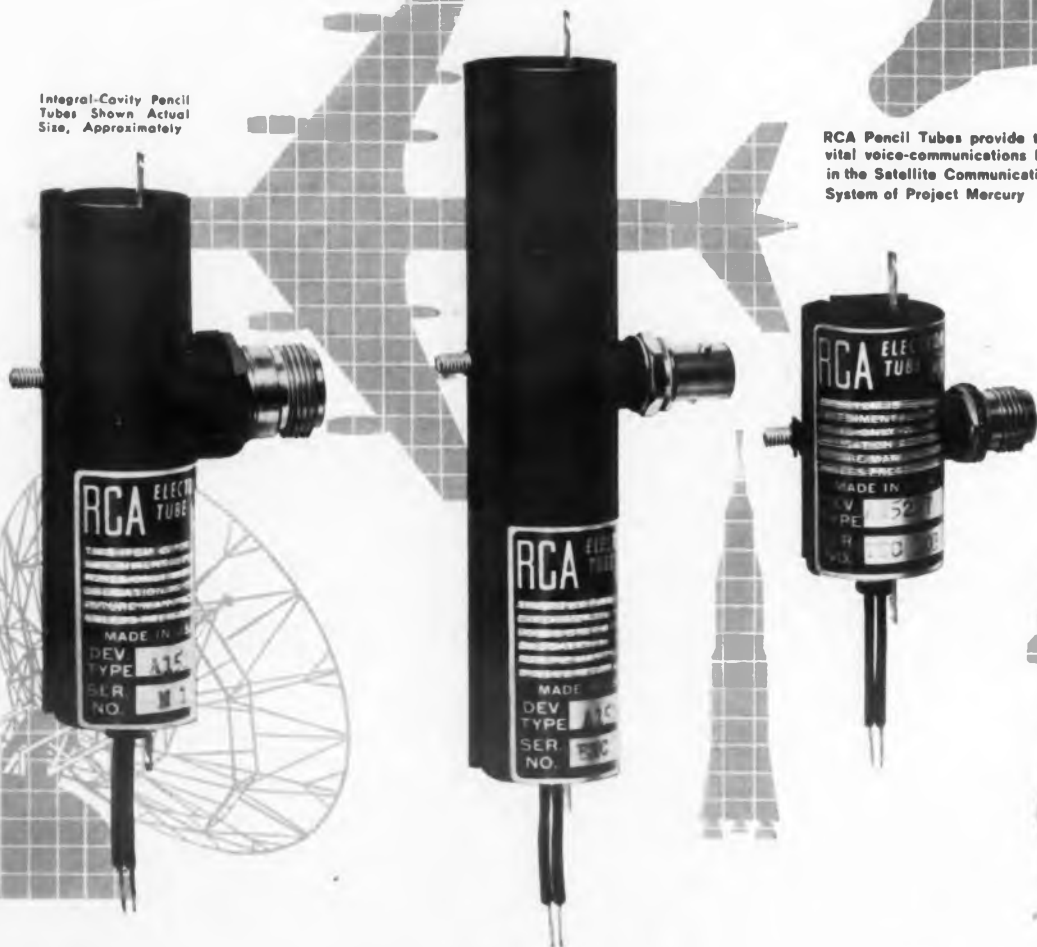

## Integral-Cavity PENCIL-TUBE OSCILLATORS

- From 900-3400 Mc
- Low-cost
- Includes RF Circuitry
- Compact

### OVERALL RF PERFORMANCE ASSURED

Now, RCA offers the recognized performance-advantages of the famous coaxial pencil tube . . . in a design which combines the pencil tube with a mechanically-tuned cavity—to produce a single-unit, compact, low-cost microwave oscillator.

Wherever circuit compactness and gross weight are major considerations in microwave designs, RCA Integral-Cavity Pencil Tubes hold intrinsic possibilities—for CW, plate-pulse, or cathode-pulse work. There's a choice

of over 20 types. And note this: RCA's Applications Engineering group is available to discuss special Integral-Cavity Pencil Tubes "tailored" to your specific requirements.

For information on RCA Integral-Cavity Pencil Tubes—and other integral cavity developments such as amplifiers, harmonic generators, voltage-tuned oscillators, get in touch with your RCA Field Representative. Or write: Microwave Marketing, Building 55, RCA Electron Tube Division, Harrison, N. J.



The Most Trusted Name in Electronics  
RADIO CORPORATION OF AMERICA

RCA ELECTRON TUBE DIVISION FIELD OFFICES . . . Industrial Product Sales: NEWARK 2, N. J., 744 Broad St., HU 5-3900 • CHICAGO 54, ILL., Suite 1154, Merchandise Mart Plaza, WH 4-2900 • LOS ANGELES 22, CALIF., 6801 E. Washington Blvd., RA 3-8361 • BURLINGAME, CALIF., 1838 El Camino Real, OX 7-1620 • Government Sales: HARRISON, N. J., 415 South Fifth St., HU 5-3900 • DAYTON 2, OHIO, 224 N. Wilkinson St., BA 6-2366 • WASHINGTON 7, D.C., 1725 "K" St., N.W., FE 7-8500

### TYPICAL PERFORMANCE OF REPRESENTATIVE OSCILLATORS

RCA-Dev. Type	Power Output (Watts)	Duty Cycle	Freq. (Mc)	Input Pulse Voltage
A-15132	500 (Peak)	0.001	1100	50
A-15228	300 (Peak)	0.001	2000	50
A-15234	100 (Peak)	0.001	3000	50
A-15221	1	CW	1100	—
A-15227	0.3	CW	2000	—
A-15233	0.1	CW	3000	—

### Important Technical Data for Microwave Designs

• RCA MICROWAVE TUBES and SOLID-STATE OSCILLATORS and AMPLIFIERS (ICE-180C). 16 pages of characteristics on nearly 100 RCA Microwave Devices. Please request in company letterhead.



• RCA PENCIL TUBES (ICE-219). 28-page book on Pencil Tube theory, application, characteristics curves, operating data. Price 50 cents. Please remit with order.

Send your order to—Section H-18-Q-1, Commercial Engineering, RCA Electron Tube Division, Harrison, N. J.

HAYDEN PUBLISHING COMPANY, INC.  
850 Third Avenue, New York 22, N. Y.

DESIGN