

# QST

november, 1938  
25 cents

devoted entirely to

# amateur radio

*In this Issue—*

**Amateurs Help  
in Emergency**

**DX Contest  
Results**

**Antennas and  
Feed Systems**

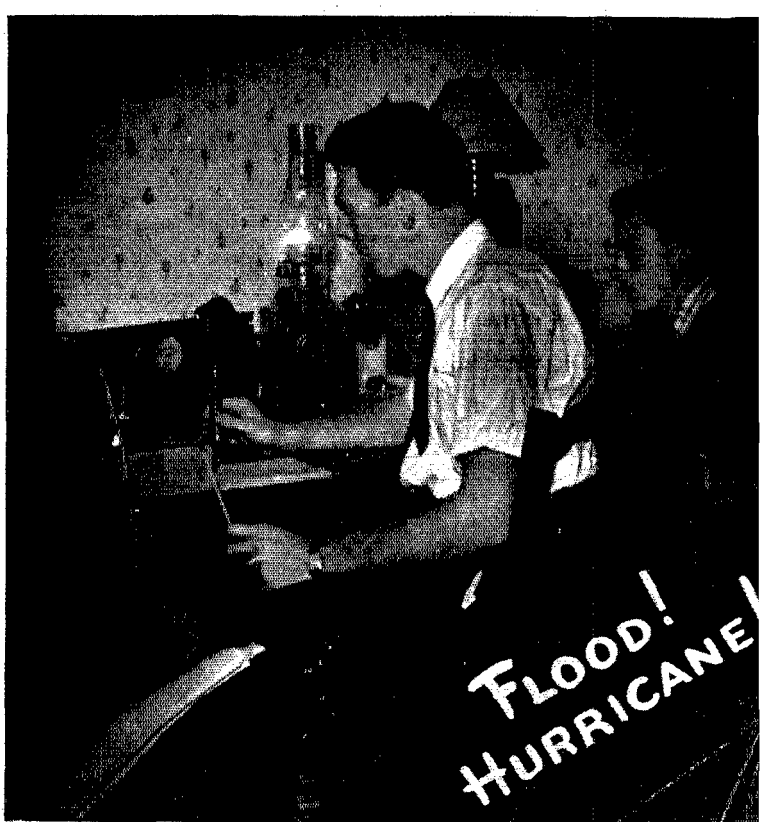

# COLLINS 26C



## LIMITING AMPLIFIER

A limiting amplifier or "compressor" can be used to even greater advantage in amateur and communications service than in broadcast service where these devices have already been adopted widely. In broadcast work the amount of compression must be restricted to about 3 db in order that the original "expression" or volume range will not be noticeably modified. But where voice only is transmitted and intelligibility is the primary consideration, a limiter may be used to control much greater changes in input level and the following advantages can be realized:

- 1 Substantially complete modulation can be maintained.
- 2 Adjacent channel interference due to accidental (or chronic) over-modulation is eliminated.
- 3 The need for frequent manual adjustment of gain controls is avoided.
- 4 Possibility of breakdown of transmitter circuits due to severe over-modulation peaks is prevented.

The bulletin describing the Collins 26C Limiting Amplifier contains a technical discussion of the special circuit developed to accomplish the rather difficult job of automatically adjusting gain in response to wide and rapid changes of signal input. A card will bring you a copy without obligation. You will find the bulletin of value if you are interested in the design considerations in limiting amplifiers for either broadcast or high frequency use.

We wish to announce, also, that the 30J and several other Collins Transmitters can now be supplied on special order with integral limiting circuits and that separate 76 Series Transmitter Speech Amplifiers are available with limiters.

# COLLINS RADIO COMPANY

CEDAR RAPIDS, IOWA

NEW YORK, N. Y. 41 WEST 42 STREET

### GREYMOUTH, N. Z.

ZL3BV writes: "Very pleased with set (A Super Skyrider)".

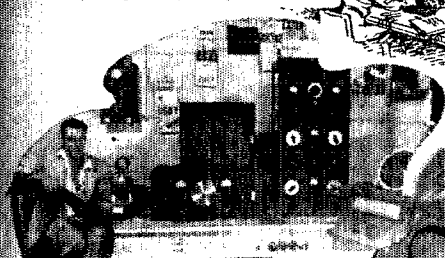

### BULAWAYA, SOUTH AFRICA

ZELJZ writes: "The set, (A Super Skyrider) has been a first class performer—the construction and workmanship have been admired by many people—ease of operation and stability with good tonal qualities have delighted me".

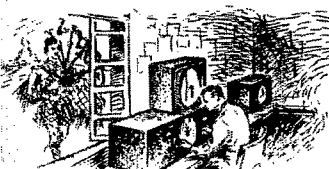

### DUMFERMLIN, SCOTLAND

GM3LO writes: "Very pleased with RX (A Sky Champion) one of the best I've handled. All the best from bonny Scotland".

### ON THE HIGH SEAS

A Hallicrafter Super Skyrider aboard the yacht "PARAGON" maintains communications on the high seas.



### HAVANA, CUBA

CO2WM writes: "During the last DX Phone Contest, I worked 691 stations in about 60 hours, under all weather conditions, and had perfect results with my new SX17, I consider the SX17 a wonderful receiver, one of, if not the best".

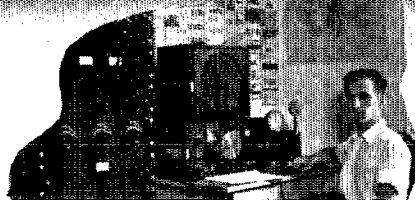

### GATUN, Canal Zone

From U. S. Naval Station, NAX regarding the SKY CHAMPION — "Extremely good selectivity and sensitivity"

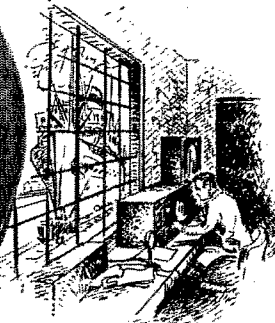

# Amateurs the World Over Acclaim HALLICRAFTERS RECEIVERS!

FROM BONNY SCOTLAND to the African Veldt, from "down under" in New Zealand to romantic Cuba, wherever Hallicrafters receivers are used by the great international amateur radio fraternity, we hear an enthusiastic "F B, —Hallicrafters".

It is encouraging to hear these generous commendations from far off lands, to feel that Hallicrafters receivers are duplicating their American popularity all over the globe. Such acclamation means more than material rewards, it is significant of real service to amateur radio, the first and foremost objective of the Hallicrafters.

## the hallicrafters inc.

2611 INDIANA AVENUE  
CHICAGO, U. S. A.

Cable Address: "HALLCRAFT," Chicago



All Hallicrafters Receivers  
are available on liberal  
Time Payments.

WORLD'S LARGEST BUILDERS OF AMATEUR COMMUNICATIONS EQUIPMENT

# " TRANSMITTER 1939 Design "

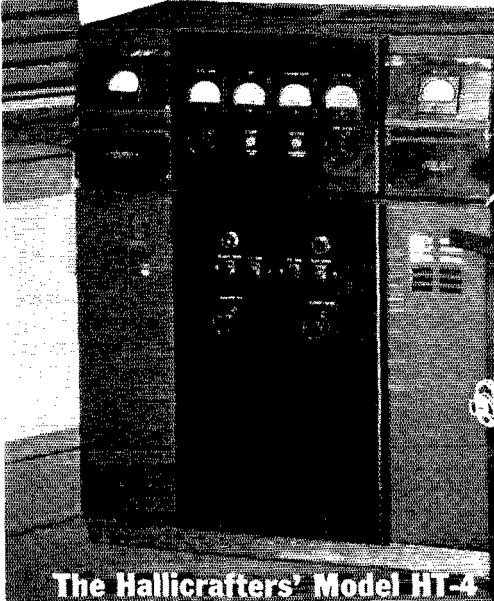

The Hallicrafters' Model HT-4

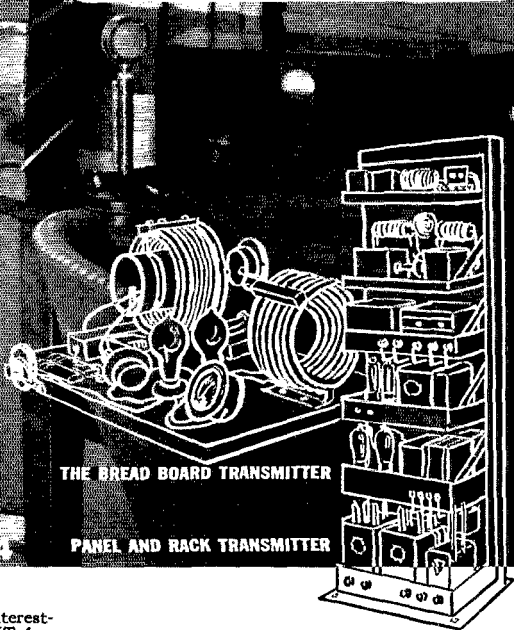

THE BREAD BOARD TRANSMITTER

PANEL AND RACK TRANSMITTER

THE swift pace of amateur radio provides an interesting study in evolution, and the Model HT-4 a striking example of the development in transmitter design.

Old Timers remember the "bread board" era, when getting a transmitter to operate at all was the first consideration, and convenience and appearance received little thought — with "hay-wired" parts spread over an entire table top.

The next step in the evolution of the amateur transmitter was borrowed from the telephone exchange. To provide standardized unit construction that would permit the easy assembly of a big city exchange or a smaller rural unit, telephone engineers created the "rack and panel." Amateur radio borrowed it, and transmitter parts left the "bread-board."

As transmitter circuits have developed in efficiency, the advantages offered by the rack and panel are being nullified. Built to impractical and "clumsy" heights, it leaves much to be desired from the standpoint of appearance, not to mention operating convenience. The

logical coordination of the transmitter components for the greatest efficiency is difficult if not impossible. Its open construction exposes many leads to accidental contact or short circuit.

The Model HT-4, offers a new conception of transmitter design, a distinct departure from the traditional to the functional. Here is a logical coordination of parts, with the entire R. F. section on a single plane, permitting shorter leads and a reduction of losses that greatly increase overall efficiency. The operating controls are brought within easy reach. All its parts are entirely enclosed and protected, but with ample provision for ventilation. The whole presents a finished "engineered" and planned appearance that leaves an impression of efficiency and dependability.

We present the Model HT-4 as the first of a new trend in Amateur Radio Transmitters.

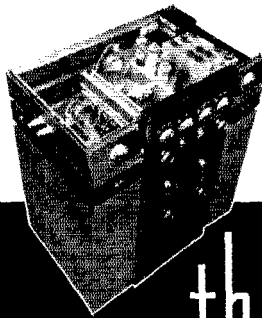

(left) Model HT-4 with cover removed showing complete Top View of R.F. Section.

(right) Rear View of Model HT-4 with back panel removed. Note orderly and logical placement of components.

ALL HALLICRAFTERS TRANSMITTERS  
SOLD ON LIBERAL TIME PAYMENTS

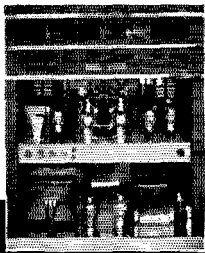

## the hallicrafters inc.

2611 Indiana Avenue, Chicago, U. S. A. • Cable Address: "HALLICRAFT," Chicago  
WORLD'S LARGEST BUILDERS OF AMATEUR COMMUNICATIONS EQUIPMENT

# QST

devoted entirely to

# AMATEUR RADIO

PUBLISHED, MONTHLY, AS ITS OFFICIAL ORGAN, BY THE AMERICAN RADIO RELAY LEAGUE, INC., AT WEST HARTFORD, CONN., U. S. A.; OFFICIAL ORGAN OF THE INTERNATIONAL AMATEUR RADIO UNION

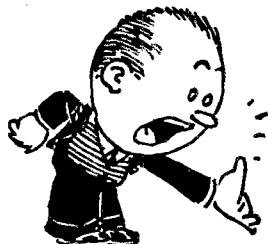

## NOVEMBER

## 1938

### Volume XXII

### Number 11



Kenneth B. Warner, *Editor and Business Manager*; Clark C. Rodimon, *Managing Editor*; James J. Lamb, *Technical Editor (on leave of absence)*; George Grammer, *Acting Technical Editor*; Donald H. Mix and Thomas M. Ferrill, *Technical Assistants*; Vernon C. Chambers, *Laboratorian*. . . . F. Cheyney Beekley, *Advertising Manager*; Charles Brunelle, *Assistant Advertising Manager*. . . . David H. Houghton, *Circulation Manager*; Ralph T. Beaudin, *Assistant Circulation Manager*.

*Editorial and Advertising Offices*

38 La Salle Road

West Hartford, Connecticut

Subscription rate in United States and Possessions and Canada, \$2.50 per year, postpaid; all other countries, \$3.00 per year, postpaid. Single copies, 25 cents. Foreign remittances should be by international postal or express money order or bank draft negotiable in the U. S. and for an equivalent amount in U. S. funds.

Entered as second-class matter May 29, 1919, at the post office at Hartford, Connecticut, under the Act of March 3, 1879. Acceptance for mailing at special rate of postage provided for in section 1103, Act of October 3, 1917, authorized September 9, 1922. Additional entry at Concord, N. H., authorized February 21, 1929, under the Act of February 28, 1925.

Additional second-class entries to cover sectional editions authorized March 20, 1935. Copyright 1938 by the American Radio Relay League, Inc. Title registered at United States Patent Office.

## The Contents

Editorial . . . . .	Ross A. Hull	7
Amateur Radio Bests Triple Catastrophe	Clinton B. DeSoto	11
A New Automatic Noise Limiter . . . . .	James E. Dickert	19
Our Cover . . . . .		22
Let's Settle Those Antenna Questions		
	T. M. Ferrill, Jr., W1LJI	23
Variable Frequency Control for Transmitters		
	Dana A. Griffin, W2AOE	28
Combined Beat Oscillator and I. F. Amplifier	F. W. Schor	31
A Transmitter of General Utility . . . . .	Don H. Mix, W1TS	32
Building Convenience into the Operating Table		
	Joseph Walker and Charles L. Cox, Jr., W3FPE	36
A 1.75- to 56-Mc. Crystal-Controlled Low-Power Transmitter . . . . .	Herbert W. Gordon, W1IBY	38
Silent Keys . . . . .		41
1938 DX Contest Results . . . . .	E. L. Battey, W1UE	42
A.A.R.S. Activities . . . . .		46
Naval Communication Reserve Notes . . . . .		47
Hams Over Chicago . . . . .		48
Announcing — Ninth A.R.R.L. Sweepstakes		
	F. E. Handy, W1BDI	52
Speaking of Rotary Beams — . . . . .		55
“Single-Ended” R. F. Receiving Tubes . . . . .		55
New Transmitting Tubes . . . . .	813, RK63, 56, 57, 58, 59, 60	57
Joint Pacific and Southwestern Division Convention . . . . .		58
Modern Radio Course Resumes Over W1XAL . . . . .		59
Hints and Kinks . . . . .		60
I.A.R.U. News . . . . .		63
Operating News . . . . .		65
Correspondence Department . . . . .		73
Standard Frequency Transmissions . . . . .		102
Book Reviews. . . . .		120
A.R.R.L. QSL Bureau . . . . .		122
Hamads . . . . .		123
QST's Index of Advertisers . . . . .		126

## Section Communications Managers of the A.R.R.L. Communications Department

All appointments in the League's field organization are made by the proper S.C.M., elected by members in each Section listed. Mail your S.C.M. (on the 16th of each month) a postal covering your radio activities for the previous 30 days. Tell him your DX, plans for experimenting, results in 'phone and traffic. He is interested, whether you are an A.R.R.L. member or get your QST at the newsstands; he wants a report from every active ham. If interested and qualified for O.R.S., O.P.S. or other appointments he can tell you about them, too.

Eastern Pennsylvania	W3QP	<b>ATLANTIC DIVISION</b>	
Maryland-Delaware-District of Columbia	W3BAK	John B. Morgan	Blue Bell
Southern New Jersey	W3BEI	Edgar L. Hudson	Laurel, Delaware
Western New York	W8CSE	W. W. Filson	Audubon
Western Pennsylvania	W8OFO	Ed Preston	Tully
		Kendall Speer, Jr.	Lowber
		<b>CENTRAL DIVISION</b>	
Illinois	W9RMN	Leslie M. Dickson	Edelwyn Farms
Indiana	W9OG	Noble Burkhart	R. 4, Box 1
Kentucky	W9ARU	Darrell A. Downard	116 N. Longworth Ave.
Michigan	W8DFE	Harold C. Bird	R.F.D. 2
Ohio	W8AQ	E. H. Gibbs	405 Broad St.
Wisconsin	W9UIT	Aldrich C. Kroenes	3127-A West Madison St.
		<b>DAKOTA DIVISION</b>	
North Dakota	W9RZA	Ernest Bloch	Box 202
South Dakota	W9VOD	Dr. A. L. Russell	
Northern Minnesota	W9IGZ	Edwin L. Wicklund	R.F.D. 3
Southern Minnesota	W9YNQ	Millard L. Bender	608 N. Huron Ave.
		<b>DELTA DIVISION</b>	
Arkansas	W5ABI	H. E. Velte	4415 West 12th St.
Louisiana	W5DKR	Eugene H. Treadaway	2749 Myrtle St.
Mississippi*	W5GHF	Robert E. Barr	
Tennessee	W4DEP	B. G. Lowrey Smith	673 Hillcrest St.
		<b>HUDSON DIVISION</b>	
Eastern New York	W2LU	Robert E. Haight	511 South Holmes St.
N. Y. C. & Long Island	W2AZV	E. J. Baunach	102 Central Ave.
Northern New Jersey	W2GMN	Fred C. Read	814 North Ave.
		<b>MIDWEST DIVISION</b>	
Iowa	W9ARE	Clyde C. Richelieu	1015 Dunham St.
Kansas	W9PB	Harry E. Legler	304 Miami St.
Missouri	W9OOD	Miss Letha Allendorf	1015 W. 3rd St.
Nebraska	W9FAM	Samuel C. Wallace	Green St.
		<b>NEW ENGLAND DIVISION</b>	
Connecticut	W1CTI	Frederick Ellis, Jr.	19 Merrill Rd.
Maine	W1FBJ	Winfield A. Ramsdell	1188 Washington Ave.
Eastern Massachusetts	W1IWC	Sam Gross	Pleasant St.
Western Massachusetts	W1JAJ	William J. Barrett	239 Columbia St.
New Hampshire	W1BFT	Carl B. Evans	21 No. State St.
Rhode Island	W1HRG	Clayton C. Gordon	192 Washington Ave.
Vermont	W1GNF	Alvin H. Battison	1 Central St.
		<b>NORTHWESTERN DIVISION</b>	
Alaska	K7ENA	Leo E. Osterman	Customhouse
Idaho	W7EMT	Carl Eichelberger	Route 2
Montana	W7FL	G. A. Woodhouse	Holter Dam
Oregon*	W7FNO	J. R. MacManiman	1545 N. E. 48th Ave.
Washington	W7FCG	W. Beale	R. 4, School Ave.
		<b>PACIFIC DIVISION</b>	
Hawaii*	K6OOE	Harold C. Smith	P. O. Box 150
Nevada	W6BIC	Edward W. Heim	509 Claremont St.
Santa Clara Valley	W6FBW	Elbert Amarantes	454 Washington St.
East Bay	W6JTV	Harold J. Burchfield	2140 106th Ave.
San Francisco	W6BPT	Alan D. Whitaker, Jr.	79 Filmer Ave.
Sacramento Valley	W6GZY	J. L. C. Buckenham	2720 22nd St.
Philippines	KA1GR	George L. Rickard	Box 849
San Joaquin Valley	W6LPE	Angelo V. Astone	729 Safford
		<b>ROANOKE DIVISION</b>	
North Carolina	W4OG	H. S. Carter	P. O. Box 111
South Carolina	W4RQE	Ted Ferguson	1213 College St.
Virginia	W3UVA	Charles M. Waff, Jr.	2607 Stuart Ave.
West Virginia	W8HD	C. S. Hoffmann, Jr.	47 Lynwood Ave.
		<b>ROCKY MOUNTAIN DIVISION</b>	
Colorado	W9FA	Glen Glasscock	2164 So. Corona St.
Utah-Wyoming	W7CLG	Ernest E. Parshall	Salt Creek Electric Plant
		<b>SOUTHEASTERN DIVISION</b>	
Alabama	W4DGS	James F. Thompson	1203 South Perry St.
Eastern Florida	W4DVO	L. A. Connolly	719 So. Willow Ave.
Western Florida*	W4AXP	Oscar Cederstrom	Second St. & Bruce Ave.
Georgia	W4PM	Charles W. Davis	2136 N. E. Boulevard Dr.
West Indies (Cuba-Isle-of-Pineas-Porto Rico-Virgin Islands)			Atlanta, Ga.
		<b>SOUTHWESTERN DIVISION</b>	
Los Angeles	W6MQM	Ralph S. Click	1038 Milwaukee Ave.
Arizona	W6KFC	Victor C. Clark	747 E. Polk St.
San Diego	W6JRM	Howard K. Breedlove	R. 2, Box 630
		<b>WEST GULF DIVISION</b>	
Northern Texas	W5DXA	Lee Hughes	125 N. Main St.
Oklahoma	W5CEZ	Carter L. Simpson	2010 So. 4th St.
Southern Texas	W5BHO	Dave H. Calk	6726 Ave. Q
New Mexico	W5CGJ	Joseph M. Eldodt	
		<b>MARITIME DIVISION</b>	
Maritime	VE1DQ	A. M. Crowell	69 Dublin St.
		<b>ONTARIO DIVISION</b>	
Ontario	VE3SG	Fred H. B. Saxon	302 Lee Ave.
		<b>QUEBEC DIVISION</b>	
Quebec	VE2EE	Stan Comach	780 Brault Ave.
		<b>VANALTA DIVISION</b>	
Alberta	VE4GE	C. S. Jamieson	581 W. Riverside Drive
British Columbia	VE5HP	J. Hepburn, Jr.	335 Foul Bay Road
		<b>PRAIRIE DIVISION</b>	
Manitoba	VE4BG	A. J. R. Simpson	635 Garfield St.
Saskatchewan	VE4SY	Arthur Chesworth	1071 4th Ave., N. W.

\* Officials appointed to act until the membership of the Section choose permanent S.C.M.'s by nomination and election.

### AUDIO TRANSFORMER SPECS.

#### 1. INPUT TRANSFORMERS.

(A) Line or microphone to single or P.P. Grids (Class A).

I. Impedance of primary.

II. Step-up ratio.

III. Secondary load.

(B) Line to P.P. Grids (Class AB or Class B).

I. Impedance of primary.

II. Level and true impedance of line.

III. Tubes to be driven with complete operating conditions.

#### 2. INTERSTAGE TRANSFORMERS.

(A) Type of tube working into primary.

(B) Type of tube into which secondary works.

(C) Single or Push-Pull type.

(D) Turns ratio.

#### 3. DRIVER TRANSFORMERS.

(A) Driver Tubes.

I. Operating conditions - Plate voltage - bias - plate current.

(B) Tubes to be driven.

I. Operating conditions - Plate voltage - bias - Power output required.

#### 4. OUTPUT TRANSFORMERS.

(A) Output Tubes.

I. Operating conditions - Plate voltage - bias - plate or plate to

plate load - power output.

(B) Secondary load.

I. If modulator - D.C. voltage and current

II. If two secondaries - will both be loaded simultaneously?

## Kandid Ken-O-Talk, No. 12

### • AUDIO TRANSFORMER SPECIFICATIONS •

AUDIO transformers are almost endless in their variety. It is therefore important that specifications covering them be complete in every detail.

Input transformers are used to couple a low impedance source to a single class A grid, or to push-pull class A grids. It is important that the primary impedance be specified as well as the tube or tubes into which the secondary works. The latter is important because the tube input capacity is a value which must be taken into consideration in the design. If the secondary is loaded with a resistor, or volume control, this should be stated.

For input transformers to be used with a single or double button microphone it is important that the button current be known as it may have a direct bearing on the low frequency response.

It must be remembered that step up ratio determines, to a large extent, the size and cost of an input transformer. A ratio of 1:12 from a 500 ohm line is an average value. Any value materially higher than this involves difficulty in maintaining good frequency response.

Line to grid driver transformer construction is controlled not only by the impedance of the line from which it works, but also by the impedance and power capabilities of the tube or tubes feeding the line. A line fed by pentodes will necessarily have a different loading characteristic from one fed by triodes. Under most conditions pentodes would not be used as driver tubes, therefore a line fed by pentodes would not be suitable for use with a line to grid driver transformer.

Interstage transformers are governed by much the same considerations as input transformers, inasmuch as the only difference is the primary impedance.

Driver and output transformers are quite uniform in design. It is important however to know exactly what tubes and operating conditions exist in order to design a transformer to give the best possible service. An example of this is an output transformer which may be ordered for P.P. 6L6's class AB. The engineer designing this transformer looks up his ratings on the 6L6 and finds that it may be operated class AB<sub>1</sub>, fixed bias, class AB<sub>1</sub>, self bias, class AB<sub>2</sub>, fixed bias, class AB<sub>2</sub>, self bias. The plate to plate load may be any value from 3800 to 8400 ohms, and the power output may be anything from 20 to 60 watts.

Complete specifications may take a little longer to make out, but they insure a satisfactory transformer with a minimum waste of time for all concerned.

*F. P. Fenyon*

# The American Radio Relay League



THE AMERICAN RADIO RELAY LEAGUE, INC., is a non-commercial association of radio amateurs, bonded for the promotion of interest in amateur radio communication and experimentation, for the relaying of messages by radio, for the advancement of the radio art and of the public welfare, for the representation of the radio amateur in legislative matters, and for the maintenance of fraternalism and a high standard of conduct.

It is an incorporated association without capital stock, chartered under the laws of Connecticut. Its affairs are governed by a Board of Directors, elected every two years by the general membership. The officers are elected or appointed by the Directors. The League is non-commercial and no one commercially engaged in the manufacture, sale or rental of radio apparatus is eligible to membership on its board.

"Of, by and for the amateur," it numbers within its ranks practically every worth-while amateur in the nation and has a history of glorious achievement as the standard-bearer in amateur affairs.

Inquiries regarding membership are solicited. A bona fide interest in amateur radio is the only essential qualification; ownership of a transmitting station and knowledge of the code are not prerequisite. Correspondence should be addressed to the Secretary.

HIRAM PERCY MAXIM, FIRST PRESIDENT

## OFFICERS

*President*.....EUGENE C. WOODRUFF, W8CMP  
State College, Pa.

*Vice-President*.....GEORGE W. BAILEY, W1KH  
Weston, Mass.

*Secretary*.....KENNETH B. WARNER, W1EH  
West Hartford, Connecticut

*Treasurer*.....ARTHUR A. HEBERT, W1ES  
West Hartford, Connecticut

*Communications Mgr.*...F. EDWARD HANDY, W1BDI  
West Hartford, Connecticut

*General Counsel*.....PAUL M. SEGAL  
1026 Woodward Building, Washington, D. C.

## DIRECTORS

*President*  
EUGENE C. WOODRUFF.....W8CMP  
234 W. Fairmount Ave., State College, Pa.

*Vice-President*  
GEORGE W. BAILEY.....W1KH  
74 Webster Road, Weston, Mass.

*Canadian General Manager*  
ALEX REID.....VE2BE  
169 Logan Ave., St. Lambert, P. Q.

*Atlantic Division*  
WALTER BRADLEY MARTIN.....W3QV  
Box 612, Roslyn, Pa.

*Central Division*  
R. H. G. MATHEWS.....ex-W9ZN  
100 East Ohio St., Chicago

*Dakota Division*  
FRED W. YOUNG.....W9MZN  
107 Hanover St., Mankato, Minn.

*Delta Division*  
E. RAY ARLEDGE.....W5SI  
P.O. Box 286, Pine Bluff, Ark.

*Hudson Division*  
KENNETH T. HILL.....W2AHC  
115 Willow St., Douglaston, L. I., N. Y.

*Midwest Division*  
FLOYD E. NORWINE, JR.....W9EFC  
120 South Fourth St., St. Louis, Mo.

*New England Division*  
PERCY C. NOBLE.....W1BVR  
37 Broad St., Westfield, Mass.

*Northwestern Division*  
RALPH J. GIBBONS.....W7KV  
c/o United Air Lines, Portland, Ore.

*Pacific Division*  
J. L. McCARGAR.....W6EY  
66 Hamilton Pl., Oakland, Calif.

*Roanoke Division*  
H. L. CAVENESS.....W4DW  
State College Station, Raleigh, N. C.

*Rocky Mountain Division*  
EDWARD C. STOCKMAN.....W9ESA  
618 So. Williams St., Denver

*Southeastern Division*  
BENNETT R. ADAMS, JR.....W4APU  
1512 Grove Place, Homewood, Ala.

*Southwestern Division*  
CHARLES E. BLALACK.....W6GG  
443 Main St., El Centro, Calif.

*West Gulf Division*  
WAYLAND M. GROVES.....WSNW  
c/o Humble Pipe Line, Mt. Pleasant, Texas

Address all general correspondence to the administrative headquarters at West Hartford, Connecticut



# "It Seems to Us — —"

THE brilliant career of Ross A. Hull, editor of *QST* and *The Radio Amateur's Handbook*, was ended on the evening of September 13th, when he was accidentally electrocuted in his home in Vernon, Connecticut, near Hartford, while engaged in experiments on a television receiver.

Thus was tragically closed the life of the man whom we consider the most brilliant and ingenious and indefatigable amateur we have ever known. Possessed of a restless, inquiring mind, a determination to out-do all others in everything he attempted, and never satisfied with the accomplishments either of himself or of others, Ross Hull poured an unbelievable number of hours and an astonishing enthusiasm into numberless projects, both in and out of amateur radio. He was interested in many technical fields, in which he habitually threw himself with the energy of ten men, always to emerge with remarkable results. A Simon-pure amateur, he had what we have always considered the perfect approach and attitude of the true amateur towards his hobbies. Where he found the time and energy to do all that he did was a constant marvel to his associates.

Most of our readers know him as a radio amateur who

left a deep impress upon our field but, although amateur radio was his greatest love, he was proficient in many fields. He was a brilliant pianist, with a great love of music, and played for hours every day. He was an artist of considerable ability in oils, water colors and crayon. He was an expert amateur photographer, both as a pictorialist and in scientific work, and many of *QST*'s cover illustrations have been his work. He was interested in astronomy and had built several reflecting telescopes. Model aircraft was one of his passions from childhood. The last several

years, he and W1ANA had been building model soaring planes of considerable span, large enough to carry radio apparatus for control in flight. Regular attendants at the Elmira soaring meet, they achieved encouraging success this summer with Hull's planes and were large with plans for a winter program. With it all, Hull found the time to read everything and the time to play: skiing in the winter, golf in the summer. With his radio gear, his piano, his cameras and his workshop he lived the life of the ideal amateur at his cottage in the Connecticut countryside. He was unmarried.

Ross Hull was born in Melbourne in 1902



ROSS A. HULL  
1902-1938

and was schooled to become an architect. But he was also a radio amateur and by 1922 one of Australia's outstanding ones, being the first VK to hear American signals. When Fred Schnell was in Sydney with NRRL on the Australian cruise of the United States fleet, Hull determined to see America. In 1926, as 3JU and secretary of the Wireless Institute of Australia, he visited us at headquarters on a study of American radio activity, particularly amateur radio. He was just in time to encounter a vacancy in the junior position in our editorial department, the technical information service. It was an admirable vantage point from which to see American amateur radio and he asked for and got the position. He extended his stay in America and was shortly an assistant technical editor. When, in 1928, our Board of Directors authorized a special technical development program at headquarters to devise new apparatus and methods to meet the trying conditions that would confront amateur radio in 1929 when the Washington convention took effect, Hull



AUSTRALIAN 3JU  
at his station in Melbourne, about 1924.

was the logical man to head the program and became its director. The brilliant success of that program is a matter well known to every old-time amateur. Much new gear of Hull's devising was introduced and it is not going too far to say that his studies over that period revolutionized our technique. He popularized "hand-spread" for amateur receivers and was responsible for the first serious use of the superheterodyne in amateur circles as the logical receiver for 'phone stations. He produced the first practical apparatus employing the high-C circuit for self-excited oscillators, made the first presentations in amateur radio of 100% modulation and the use of linear r.f. amplifiers, first introduced the signal monitor. This technical-development program was the beginning of real development work in the Headquarters laboratory and shop, thereafter carried on almost entirely under his direction. He himself had a flair for building unorthodox equipment. He popularized the practice of putting tubes upside down or at unusual angles to shorten leads and was largely responsible for the abandonment of bread-board construction in favor of bent metal chassis. The apparatus he built, although often put together under stress of time, was beautifully constructed, mechanically rigid, and with losses minimized to work at the greatest efficiency, whatever its purpose. He set the pace in apparatus design for many years back.

He returned to Australia in 1929 (see *QST* for May of that year, page 26) and became the technical editor of *Wireless Weekly*. But the American bug was in his veins and in a year and a half he was back on our staff, this time as associate editor. It is interesting to note that he was succeeded as technical editor of *Wireless Weekly* by his brother, A. Galbraith Hull, and that for the past year they were each the editors-in-chief of their respective publications. For Ross Hull became the mainspring of the *QST* editorial staff and has been the top man in our work for a year back. He had the ability to organize and direct; he could keep his eye on the ball and inspire others to do the same; and at the same time he worked like three ordinary men in the laboratory himself. This summer we celebrated his ten years of service to the League. Final papers in his application for American citizenship were pending in the courts at the time of his death.

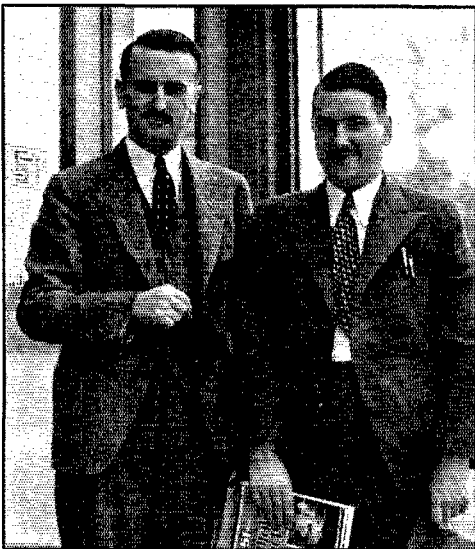

ROSS HULL AND HIS BROTHER  
A. Galbraith Hull, the latter editor of the Australian journal, "Wireless Weekly," during a visit to A.R.R.L. Headquarters in 1936.

Always possessed of an immense interest in the ultra-high-frequencies, he pioneered simple apparatus for this field and was directly responsible for most of the amateur accomplishments therein. One of his outstanding personal accomplishments was the popularizing of 56-Mc. work by showing amateurs the great enjoyment to be had with 5-meter local contacts; many well remember his article, "Fun on Five." He did a long-term piece of original research work of great value in recording received u.h.f. signals and correlating their transmission with weather observations, establishing for the first time the true cause for the bending of these waves in the lower atmosphere. For Hull, by means of high-gain antennas, was regularly communicating on five meters over distances in excess of a hundred miles, and there are yet to-day many five-meter amateurs who have never worked over fifteen miles except on the occasions when they talked to Hull. Over a period of several years he made regular recordings of distant u.h.f. signals, accumulating a vast quantity of data which required prodigious labor to correlate and analyze. He delivered several scientific papers on this work before technical societies. The Blue Hills Meteorological Observatory is now kindly arranging to carry his studies in this field to completion.

Hull was also the editor of the *Handbook*. He joined Communications Manager Handy in the rewriting of the fourth edition. Shortly, of course, it became a family affair, the product of the entire staff, and all the successive editions have been under his editorship. At the time of his death he was engaged in a laboratory program for the new *Handbook* and had just completed the development of some very interesting new u.h.f. transmitters and had a promising new receiver in process.

He had just returned from the national convention at Chicago, where many American amateurs met him for the first time. He appeared on the program on several occasions, speaking on ultra-high-frequency work and television, rendering a simplified report of his researches on u.h.f. bending, as well as speaking as the editor of *QST* during the "A.R.R.L. meeting."



ADDRESSING THE NATIONAL  
CONVENTION  
at Chicago on September 4th.  
(Photo by W9UZ.)

Hull was greatly interested in television, particularly in the ultimate opportunities for its employment in amateur radio. He had an elaborate experimental setup of his own devising at his home on a Connecticut hilltop, a thousand feet above sea level. With his remarkable ability to scoop up u.h.f. signals, he was succeeding, in his last few weeks, in receiving the N.B.C. experimental transmitters from New York, a hundred miles distant, about as well as they are received in New York City, much to the amazement of N.B.C. engineers. He had, in fact, built an experimental amateur television transmitter in our laboratory which was sufficiently promising to indicate that amateurs may soon expect low cost two-way television communication without occupying all of a band and without the need for precise standardization on number of lines and so on.

It was the power supply for his television receiver which caused his death. This receiver required a 6,000-volt plate supply for its large Kinescope. While only a few milliamperes were required, small transformers had caused trouble through surface leakage and he had replaced



ROSS HULL AND PETER RIEDEL  
the German soaring ace, at the 1938 Elmira meet.  
(Photo by W1ANA.)



**HULL (R.) AND HIS MODEL SOARING PLANE** at the Elmira soaring meet this past summer. The plane is a gull-wing of 16-foot span, and had been equipped with radio control by Hull and Bourne, W1ANA, the latter acting as control operator in flight.

them by a husky 1½-kw. 4,400-volt pole transformer. The power supply was on a shelf under the table, and the mains outlet was on the wall behind and immediately above this apparatus. It was a dangerous setup. While wearing 'phones connected to the converter and receiver, and grounded on one side, he reached over the power supply to plug into the 120. Upon withdrawing his hand he came in contact with the high-tension lead to the rectifier plate, pulled it off, and fell so that the 4,400-volt lead was contacting his body, the 'phones providing the ground. He had as a dinner guest that evening a doctor who is an X-ray expert and familiar with high voltages. Sensing trouble from the next room within thirty seconds after Hull plugged in the power supply, the doctor ran to his aid, dragged him clear and applied artificial respiration. Two other doctors arrived in a short time, adrenalin was administered, a pulmotor was quickly got, and every effort was promptly made by experts. But to no avail: death had been instantaneous.

There is an awful lesson for all amateurs in Ross Hull's tragic end. He did not need to die. If the small transformer had still been in use instead of the brute with a powerhouse behind it . . . if the power supply had been covered . . . if the plug had been some-

where else . . . if the line had been lightly fused . . . if he had not had on the headphones. . . . Hull was himself the author of the warning against high voltages which appears in the *Handbook*. You all might well stop right now and pull your *Handbook* down from the shelf and look at page 324. But skillful experimenters are too often contemptuous of the dangers in which they work. Far too many amateur transmitters are potential lethal machines. When death comes to as clever and versatile an experimenter as Ross Hull, it must be a painful object lesson to the rest of us.

Oh, the unending pity of it all! In his passing, amateur radio has lost one of its most valuable minds. For over ten years his name has been representative of the best and newest that radio offered the amateur. Our loss is the world's loss, because not every generation produces a Ross Hull, and a man of his genius and drive was certain to make even greater contributions to the world's progress had he been spared. His memory and example must be constant inspirations to the amateurs of the years to come.

Of the most endearing personal qualities, Ross Hull leaves aching hearts in all who knew him. He was a grand guy. He will live forever in the thoughts of his friends.

**R**OSS carried in his pocket at the time of his accident a memorandum to investigate the possibilities of a safety device wherein a beam of light, looked at by a photo-electric cell, would be reflected back and forth by mirrors to form an intangible barrier between the operator and the point of danger. On his desk was a recent exchange of correspondence with Mr. Howard A. Chinn of the engineering department of the Columbia Broadcasting System. It is so pertinent to this matter that, with the permission of Mr. Chinn, we reprint it:

*Dear Ross:*

The cover of your July 1938 issue of *QST* forcibly illustrates a matter which I have been wondering about for a long time. It is the question of safety of life in amateur transmitter installations.

As you are well aware, for the operation of commercial and experimental transmitting stations,  
(Continued on page 84)



**AN ENTHUSIASTIC SKIER**

of considerable ability, Hull made frequent week-end pilgrimages to the hills of upper New England. Snapped in New Hampshire last winter.

# Amateur Radio Bests Triple Catastrophe

## Long Island and New England Emergency Sees Hundreds of Stations Mobilized, Invaluable Service Performed

By Clinton B. DeSoto\*

**A**MATEUR radio in southern New England pulled a Joe Louis during the fourth week of September. Dazed by three staggering body blows in rapid succession: hurricane, tidal wave and flood—overconfident and undertrained—ham radio generally reeled in its tracks for one ghastly round of twenty-four hours before pulling itself together.

But the glorious comeback far overshadowed the initial faltering. Providing the sole communications for several severely stricken communities, draining off the pressure and affording priority service for official, business and personal traffic in places where vestiges of wire service remained, amateur radio again performed public service of an order that elicited the warm praise of official Washington, local and state leaders, the press, and the public as a whole.

### BAROMETRIC FREAK BRINGS CALAMITY

Each successive blow was unexpected, numbing. At first it was nothing more than a prolonged rain that had everyone grumbling. Up along the Connecticut a vague flood threat was still too remote for general suspense. But all unknown, offshore, there was a low-pressure center, moving north. Instead of moving eastward off into the North Atlantic, this "low"—so low that it induced lethargy like a climb to Pikes Peak—was blocked by an unusual high pressure area off Greenland, turned north-westward. Over Long Island swept the shrieking, churning vortex of high-speed air that accompanied it. Across the Sound to New London and up the middle of Connecticut the storm center sped, its cross-country velocity the swiftest ever

recorded—averaging 45 miles per hour. In the storm, gusts of 90, 100, even 200 miles an hour demolished flimsy structures, lifted roofs and steeples, uprooted and snapped hundreds of thousands of trees.

In the path of the wind came tidal waves, rising to heights of 30 and 40 feet—rushing floods of water that swept away summer cottages, hurled shipping far inland all along the coast. Traffic was halted, and the country was in darkness—thousands were without lights or food or shelter.

And still it rained. As the hurricane dumped countless tons of rain on the already saturated New England countryside, the threat of flood turned into a certainty and the Connecticut River rose to levels exceeded only by the disastrous flood of 1936. The triple catastrophe was complete. A known death list exceeding 600 had been written. An estimated damage exceeding half a billion dollars had been done.

### Long Island:

Long Island was sticking out like a sore thumb, and the hurricane stepped on it with all its fury. Sixty-two persons were known to be dead, sixty were missing, five million dollars property damage was done.

On September 21st when the disaster cut off all communication lines, only two stations are

known to have come on the air. One was W2DXO at Glen Head. The other was W2BME WLNO. Located near Southampton, where Mackay's giant 190-foot tower was blown down, this station was on its Army frequency by 7:00 P.M. with emergency power. From then on rush traffic was handled to all points.

Just six days before, W2JZX had been appointed

### THE AMERICAN RED CROSS

National Headquarters  
Washington, D. C.  
October 5, 1938

American Radio Relay League  
West Hartford  
Connecticut

Gentlemen:

On behalf of the National Headquarters of the American Red Cross, I should like to express to you our sincere appreciation of the splendid cooperation received from the amateur radio operators in connection with the flood and hurricane in New England and Long Island.

Never before in our disaster history have we relied so heavily on the amateur radio operators and never before has the work been carried on so effectively. We were able to get reports through members of your League on disaster conditions at many points when normal communication services were disrupted, and this information was invaluable to us during the first twenty-four to thirty-six hours in making our plans here.

There is no doubt but that the experience during the past two weeks will give a great impetus to further cooperation between amateur radio operators and disaster committees of our local Red Cross Chapters. The work of the members of your League has definitely shown all of us here that their service is an essential part of the disaster preparedness work of our Chapters.

Sincerely yours,  
Colin Herrie  
Assistant National Director,  
Disaster Relief

\* Assistant Secretary, A.R.R.L.

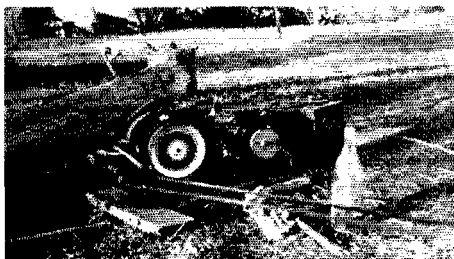

WHERE THE POWER POLE FELL DOWN, THIS GENERATOR TOOK OVER COMMANDEERED SUPPLY OF WIEBO

WIEBO—SOLE OUTLET FOR STRICKEN NORWICH, CONN.

WIDET, another of the crew, at right.

Emergency Coördinator for Nassau County at a meeting attended by various officials including State Police. Her baptism of fire began when Section E.C. W2DBQ telephoned that the Coast Guard wanted a link from Bay Shore to Fire Island. An expedition comprising W2JZX, W2AHG, W2AZV, W2HYJ, W2JTP, W2KXC, W2LAH, and W2LJJ set out from Brooklyn for Bay Shore, equipped with several mobile units. Both 75- and 5-meter stations were installed at police barracks using the calls W2JZX and W2LAH. W2HYJ and W2KXC, meanwhile, were taken by a C.G. boat to Fire Island, with 5-meter gear. They set up, using the call W2HYJ, and began work with a detailed report on the island's devastation.

Meanwhile W2DXO at Glen Head was operating his own station with a borrowed motor generator, aided by W2DUA. On Friday he, too,

THE 160-METER CONTROL POSITION AT W1NF, WITH W1JEQ MIKING

Just visible behind him is W1LJL



went to Bayshore, carrying a 3497.5-ke. crystal and authority to use the call WLNS. Thereafter W2JZX tied also into the A.A.R.S. Net. The next day S.C.M. W2AZV arrived and took over operation on 75. W2LR went to Fire Island as relief. Operators cooperating in various ways, included W2GGV, W2JDDJ, W2IRI, W2OT, W2IRC, W2FSK, W2HWR, W2DMM, W2KNA, W2TKU.

The base station for this work was W2JDG at East Rockaway. He was assisted by W2HSO, W2KB, W2BKZ, W2OQ and W2OT.

W2AZM, regional E.C., is located at Rockaway Beach. Hearing the storm warning on the Coast Guard's frequency just before the hurricane hit, he drove about frantically for



QRA NO. 1 FOR WIBDS  
L to r: WIKRF, WIBDS, WIKRQ.

W1FOF, MESSAGE CLEARING CENTER FOR SPRINGFIELD, MASS.

Besides owner-op. L. Eloise Cook, center, Sgt. C. L. Honiker, W1BCX and A. S. McLean, W1JQ, can be seen.

batteries, eventually got on the air with the aid of W2HLP and participated in organizational work.

Other stations got going as the hours passed—some when power was restored, others with battery supply. A 160-meter 'phone net sprang up, with W2JIO as net control. In various cities stations came on the air. W2HAP at Far Rockaway performed excellent work. W2IJU and W2JLQ were on there, too. W2AHG, Merrick; W2HSO, Baldwin; W2JUS, St. Albans; W2IXY, Springfield; W2OT, Ocean-side; W2EC, West Hempstead; W2OB, Jamaica; W2JLF, Ozone Park, and W2OQ and W2JDP in Manhasset have all been reported active.

The New York City and Brooklyn area, although buffeted by wind and storm and without power for an hour, did not experience a genuine communications emergency. A number of amateurs rendered emergency service, however. These included: New York City; N2COI, W2FYF, W1HJV, W1IUQ, W2JIO (portable), W2JXJ, W2KMS, W2KQV and W2SC/WLN and in Brooklyn; W2AOM, W2BJR, W2BO, W2CLC, W2DBQ (section E.C.), W2DCV, W2DW, W2ECL, W2HGO, W2KCX, W2LEN and W2PF/WLNA.

### Connecticut:

There is a new coastline for Connecticut, and a new skyline, too.

Its trees and some of its lesser buildings felled by hurricane, its coast eroded by tidal wave which dumped inland its load of millions of tons of sand, the "land of steady habits" stands shaken and bruised. Tree-lined avenues which set off stately colonial structures are now bare. Beaches and shore resorts where hundreds of thousands once lived carefree, casual summer lives are now tumbled, vacant fields strewn with matchwood.

But people live. And for all but one in a thousand life goes on in normal fashion, unremembering. Power lines are mended, telephone service restored, broken trees and wreckage hauled away. Amateur radio goes back to "CQ" and "73," to "that's the dope on that, old man" and "nil hr nw gid QSO cul 73."

There were four or five days when most of that was forgotten, though. First point along the Connecticut shore to receive serious damage from the blow was Bridgeport. Communications remained largely intact, the primary damage being from tidal wave rather than hurricane. Yet there was plenty of work for hams to do. W1APA, as E.C., assisted by W1IBH and W1JLN, manned the clubroom station of the Bridgeport Amateur Radio Association (W1JHT) and handled 171 messages. W1IM, released by station WICC from active duty for the purpose, operated 96 hours and built up a traffic total of 858. W1ANN, chief engineer of WICC, also put in shifts at his ham rig. W1KAB, on 160, handled traffic totalling 128. W1AMI, W1ASK, W1BGP and W1FYE were also reported active.

When New Haven lost power, all stations were out of commission except for 5-meter mobiles. On Thursday afternoon W1KFN got on the air, the first station to have power restored. His first contact was a QRR call from an isolated small village in Massachusetts; but after relaying this he went to work on his own emergency. Aided by W1KQY, over 250 messages were handled for all official agencies.

After trying vainly to reach New London with five-meter gear, W1JHM aided W1LHG in setting up an emergency station at a downtown radio

store where power and telephone became available. Assisted by W1HHJ, W1DDP, W1JQK and W1IQC, approximately 200 messages were handled. W1LHG and W1KQY later handled a quantity of traffic at their personal stations, as well. Two stations were set up at the New Haven Amateur Radio Club and about 100 messages were handled. W1GRF and W1JQO were heard on, too.

To all the other dangers at New London there was added that of fire, when a capsized boat started a conflagration that threatened the entire city. The Navy and Coast Guard sent boats and men to meet this threat, and through these channels streamed most communications. Much amateur traffic from outside went through the Navy's NOA. New London amateurs, living mostly near the water front, were largely without facilities. W1HXL was active on 80-meter c.w. in the outskirts of New London, although handicapped by QRM and other troubles. Other stations are said to have been using 56 Mc. for local work. W1JHK was reported on at a later stage.

In Meriden, W1GYT set up at the South Meriden airport, then operated on both amateur and N.C.R. frequencies. On the operating crew with N1EFW, N1AEY, N1FEF, N1LCF, N1HVX and W1HVF. Part of the work consisted of contacting airplane N18444 on its flight to Martha's Vineyard and return.

In Middletown W1AJB/WLGG held the fort alone at first, working into the A.A.R.S. as well as generally. Of 168 messages handled, 45 per cent were for the Red Cross. Later, W1BKO came on.

At Norwich, most severely hit inland town, amateur radio proved itself an indispensable adjunct to relief work. At 6 P.M., realizing that a major catastrophe was occurring, Norwich amateurs began to assemble equipment. To obtain emergency power it was necessary to commandeer a gas-driven 300-watt generator from its reluctant owner, with the combined aid of the mayor, National Guard and State Police.

With rare good sense, all Norwich amateurs cooperated in manning one station—W1EBO—high on its hilltop location. In the crew besides W1EBO were W1DET, W1ALW, W1LJX, W1KYV, W1CJN, W1LHF and John Dynon, all but the latter two and W1DET being N.C. Reservists. A 5-meter link using Army equipment relayed to City Hall. Without exception, all communications, official and otherwise, went through this station to W1BDI and W1AW for four days.

Hartford's dikes held this year, and the hurricane's greatest damage was in tossing thousands of uprooted trees on power and telephone lines. So the major communications need lay in coordinating state-wide emergency traffic in conjunction with state officialdom. There were three

major centers—at the State Police Barracks, Red Cross headquarters, and A.R.R.L. Hq. in West Hartford.

W1FOO was set up at the police barracks through personal cooperation by the State Police Commissioner, and served as their communications center to all isolated points. A comprehensive 160-meter network was set up. Traffic for other bands was routed through W1INF. W1DAV assisted as night operator in addition to handling 510 messages at his own station during the daytime. There he erected an emergency antenna during the height of the storm, lashing himself to the roof.

At Red Cross headquarters W1HJW set up his regular station. Assisted by W1KAW and W1DR, some 500 messages were originated and delivered. So valued was this station that Red Cross officials insisted on retaining the station for a two weeks' period for routine emergency work.

With W1AW's large transmitters without power for 36 hours, W1INF became the official headquarters station. Operation was on three bands simultaneously—160-meter 'phone, 80-meter c.w. and 5-meter 'phone. W1LJI, W1JEQ, W1DF, W1GS and W1JZB did the bulk of the operating. The Hq. office was, of course, besieged with telephone and personal callers seeking to file traffic; through Friday evening telephone calls averaged an estimated 75-80 per hour.

When W1AW resumed operation on Saturday, operators Bubbs and Hart, assisted by W1JKL, turned to with a vengeance and piled up a total of 644 messages.

Many other stations were active in the Hartford area, too many for a detailed account of their activities. W1AFB delivered to all New England points. W1AOK, assisted by W1KZA, was a key station on five, handled 400 messages. W1AOX was aided by W1DR and W1IHP. W1ASD used 160-meter 'phone. George Hart and W1JKL aided in operating W1BDI until power was restored at W1AW. W1DJC was active on 56 Mc. W1DLN tied into the A.A.R.S. W1EEV was on 75-meter 'phone. W1ES was active chiefly in N.C.R. work. W1FE occupied a strategic position at the State Armory; assisted by W1GUC and W1BEI the traffic total was 677.



W1HJW, TRANSPLANTED BODILY TO RED CROSS HEADQUARTERS IN HARTFORD

L. to r.: W1DR, Typist, W1KAW, W1HJW.

W1IAR operated at W1AW in addition to his own station. W1KDK was instrumental in organizing a valuable net for the New Haven railroad, in addition to keying a 160-meter 'phone net; W1KXM assisted. W1LLL was very active on five, notably in DX work along the Connecticut River and into Massachusetts. W1SZ, spelled chiefly by W1JPE, carried a heavy load on 75-meter 'phone, including all traffic coming out of stricken Westerly, R. I., during the initial emergency period. Other operators were W1FTR, W1EWD, W1TS and W1EAO—1000 messages were handled.

Across the river in East Hartford, W1JAM substituted for telephone service with the aid of W1CSC, W1BAH and Boy Scout messengers. At the same location W1CSC handled about 200 messages on 40 c.w.

W1KKS was on in Manchester. In Glastonbury W1KOY, assisted by W1GTF, had plenty to do in the hardest hit locality in the Hartford area. W1KPM, New Britain, participated in the 160-meter net; W1LED, W1LJA/1 and W1HNF were also on there. W1BGJ and W1BTU stood by in Southington. In Plainville it was W1BWL. Bristol's 5-meter outlet was W1FLS; W1DHT and W1DOW were on there, too. W1JSO linked Windsor with Hartford.

Located in the Engineering Building, Connecticut State College, at Storrs, W1CAS was for a time the sole outlet into northeastern Connecticut. Most of the operating was done by W1IOW.

When Stafford Springs was isolated and the State Police needed a contact, W1BDI, W1UE and W1JTD were escorted there with portable gear from Headquarters. W1AW/1 was established at the Barracks by lantern light. This station operated until W1HWG was restored power when he took over.

In the northwest corner of the state three stations were active—W1AFG, Goodyear, W1ITX, Brooklyn, and W1IED, Danielson. This section was last to be heard from and longest isolated; traffic handled included police, public utilities and personals.

Elsewhere in the state still other amateurs were operating. Among those reported are W1FWH and W1FVO, Greenwich; W1EER, Noroton Heights; W1ERX, Darien; W1CTI and W1BCG, Norwalk; W1KUN, Milford; W1CPL, Devon; W1LGZ, Danbury; W1KSH, Wallingford; W1KRC, Naugatuck; W1GME, Middlebury; W1JXP, Old Lyme; W1AIY, W1FTM, W1HLB and W1KSJ, Waterbury; W1KKG, Watertown; W1BIH and W1JLL, Torrington; W1KAK, No. Windham; W1DUC, Willimantic.

Cape Cod and Eastern Massachusetts:

The Cape is used to high winds, but



not to tidal waves. When surging waters rolled up along its coast to heights of 30 feet or more, the combination of wind and water obliterated wire communications throughout practically its entire extent.

At Provincetown, on the extreme tip of the Cape, W1KPW operated continuously for 60 hours on 160-meter 'phone and after four hours sleep returned for another stretch. W1KLC assisted. Traffic for the whole lower Cape went through this station via a telephone line to W1QJ at Hyannis. State Police used this circuit in preference to their own. Typical performance: A message delivered to Maine and reply returned, through two relays, in 3½ minutes elapsed time.

Little is known yet of the activities of W1EVJ on Nantucket Island except that his weak battery signals pushed through an AP dispatch to Boston and then were not heard again.

At Harwich W1BBM, together with W1DJK, cleared a quantity of personals. An entire emergency rig was assembled in three hours, including winding of coils. W1AOM was on a bit later in Harwich, with W1ARC in West Harwich.

In addition to W1QJ at Hyannis, W1ADM returned to the air with the return of power and rendered valuable service to the State Police and others, working into an N.C.R. circuit.

At Buzzards Bay, W1KKP, well known on 20-meter 'phone, cleared a variety of police and personal traffic with the aid of the Barnstable County police network—one message experiencing 13 separate relays in transit.

Down below, on Martha's Vineyard, W1JMJ did a job that had the residents heaping laurels on his head. The sole outlet for 32 hours, he handled the bulk of communications including Western Union files for seven days, totalling about 500 texts.

Other stations reported active on the Cape include W1JNB, Provincetown; W1RZ and W1KLC, Orleans; W1BMW, Osterville, and W1KJU and W1JQB, Fair Haven.

Fittingly enough, W1JJY, the local E.C., was the first station on in New Bedford. His principal job was Red Cross contact with Providence, having been detailed to that duty as a National Guard member. About 500 messages were handled, with the assistance of W1IKU, W1IZF and W1KHE. W1IZF handled personals on 75 over his own station. W1IKU and W1KHE also

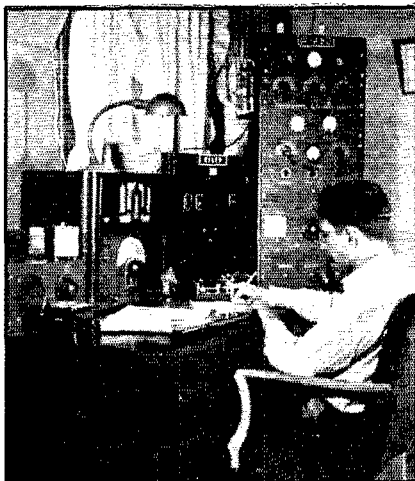

W1ASD, IMPORTANT HARTFORD 160-  
'PHONE LINK

operated their home rigs.

W1ZE's towers—170 and 130 feet high—miraculously withstood the storm, and that station was on when power resumed. Since W1ZE is manager of WNBH, the b.c. tie-up brought much traffic. He handled 556 messages single-handed.

W1ME went on in New Bedford when informed of the emergency by the mayor's secretary. He relayed from W1JMJ at Martha's Vineyard. W1DOP was also active for a 20-hour period. N1EHJ is reported to have been working, as well.

At Swansea, Mass., W1BOO assembled emergency gear with the aid of W1LIK and W1LIE. Police

had commandeered all storage batteries, let him have three. With these he stayed on for a week. He had resigned as E.C. of the Fall River area two weeks before, but it didn't seem to stick.

In Fall River, W1AWX and W1AHP were first on the air, with portable-mobile 5-meter rigs. They performed vital service in aid of the police, locating bodies, etc. Later W1AWZ set up an emergency 75-meter 'phone rig in his store and operated for two days. Others active in Fall River include W1CRN, W1DHX, W1IIC, W1JCD, W1LIE.

At Brockton W1HMM with W1HNY served the local police department as well as providing an outlet for W1KER and others. W1EZV and W1LJT were also on. W1CUY was reported on in Plymouth, as were W1EPE and W1EYY in North Easton.

When the hurricane struck Haverhill most power, telephone, fire and police wires were destroyed. To add cause for alarm, however, the Merrimack River was threatening to flood. The mayor suggested establishment of a police prowling net with two-way u.h.f. rigs, so E.C. W1KBQ secured three mobile units with the aid of W1IWR. W1KQU set up the base station at City Hall. W1IU1, W1IYT, and W1KUA manned the mobile units for 16 hours. A 32-mile area was patrolled and contact was 100 per cent at all times; about 200 contacts were made. The mayor and city council praised the performance.

In nearby Newburyport W1QW was a participant in the emergency work.

A great many stations were active in Boston and vicinity, far too many to allow of individual mention of their activities in the space available here. The following are on the active list.

Arlington: W1SS (456 messages), W1GZ,

W1HOM, W1JSM, W1LOC; Belmont: W1AR, W1JBZ; Beverly: W1EAQ, W1EKN, W1KMQ, W1NF; Boston: W1AR, W1AWX, W1BGW, W1DMG, W1DXR, W1FH, W1IIM (assisting ops); W1HPB, W1GUF, W1IXL, W1AIZ, W1JDE, W1IF 307, W1IXL, W1JRN, W1KRL, W1KZD, W1LDU, W1PI (2763!), W1QA, W1SC; Brighton: W1JWT (W1KZT assisting), W1KZD; Brookline: W1KZT; Cambridge: W1FHY, W1FQV, W1ILB, W1IZL, W1MX (W1LKV, W1IIN, W1SS, W2INQ, W2KVV, W3BXC, W5GMX, W9FRU, W9HRX, operating; 356 messages handled); Chelmsford: W1JLI (mobile); Danvers: W1HWE, W1JFS; Dedham: W1JLI, W1JCT, W1KCT; Dorchester: W1HLW, W1IDU, W1IGA, W1JQH; Everett: KGH; Framingham: W1CTR, W1DDM; Lawrence: W1HXE; Lowell: W1AR (mobile), W1JJV; Lynn: W1AJL, W1GOR, W1ITY, W1JNF, W1GY (250); Malden: W1EL, W1HKK; Marshfield Hills: W1IWC (170), W1LBY; Medford: W1KYJ (300); Melrose: W1EMN; Natick: W1DEI; Orange: W1JOG (150) Quincy: W1JMS; Randolph: W1JDO (mobile); Reading: W1AHK, W1EGO, W1JZR; Revere: W1AO; Roxbury: W1BGW (150), W1JDO; Salem: W1AKS/WLGO (259), W1AMT, W1KZO; Scituate: W1FIN; South Boston: W1JCK, W1KRN, W1LEM; South Peabody: W1AGX; South Weymouth: W1JKR; Waltham: W1BOD; Watertown: W1IY; West Medford: W1GKA, W1HRE; West Roxbury: W1KTE; Weston: W1KY; Weymouth: W1KRL; Winthrop: W1BB (150), W1BDU; Woburn: W1KNQ; Wollaston: W1GOU. Undoubtedly there are omissions in the above list, but it can be seen that Boston vicinity was well covered.

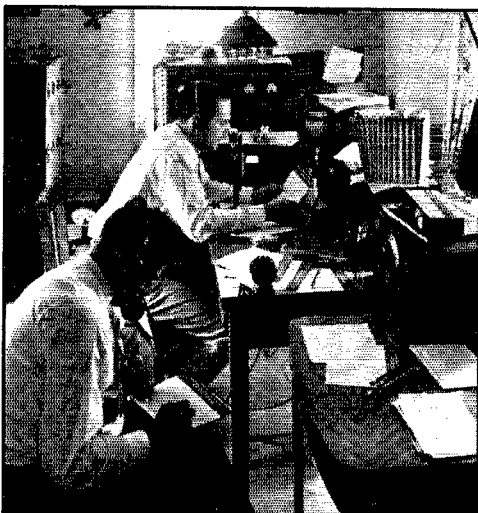

W1SZ ON THE LANDLINE, W1JPE PUSHING TRAFFIC VIA 75, AT SZ

## Rhode Island:

The greatest loss of life occurred in Rhode Island. Terrific though the wind was, it was the tidal wave that did most damage, sweeping up the beaches, reducing summer cottages and other shore property to a residue of scattered wreckage.

In Westerly, scene of the greatest havoc, amateur radio found its greatest opportunity for service. At the peak of the storm W1BDS, then downtown, foresaw the need for communications. Arriving home after several narrow escapes only to find his antennas and the garage that held them both gone, he set out with a coil of wire and a pair of pliers to erect a new antenna. As he rounded a corner of the house the wind whipped the pliers from his hand. Next morning they were found embedded in a tree, the handle driven deep into the trunk!

Nevertheless, the antenna went up. At 8 p.m. the first QRR went out, to be answered by W2CQD. But the latter had QRM trouble and other skeds so W1SZ took over and provided the outlet for W1BDS for the next four days. For 56 hours the station was Westerly's sole outlet; for a time it was the only signal emanating from Rhode Island. Early Saturday morning power was made available and the station transferred to the South County Power Company's office. But friction developed. The power company insisted that W1BDS handle only power traffic. So they moved to W1KRF's QRA, staying there through Sunday.

The crew that did the job included W1BDS, W1KRF, W1KRQ, W1KCG. They handled some 800 messages—every word that went in or out of the city for 56 hours, and most of it thereafter—and were lauded by such persons as Attorney-General Cummings, Harry Hopkins, Colin Herle of the Red Cross in Washington, etc. The little 42 crystal oscillator, fed by "B" batteries, bore a heavy load of responsibility and bore it well.

After power was restored in Westerly two other stations found room for sterling performance. W1KTH, brought in by the Providence Radio Club, was set up in the Town Hall within an hour after power resumed. The crew consisted of W1KTH, W1CBS, W1KOG, W1JXQ, W1KZN and W1DL. Of the 571 messages handled, about 250 were official—including 17 press dispatches.

W1AGJ, aided by W1KRQ, was the first Westerly station to work Providence. Red Cross workers erected an emergency antenna for him. Seven 45-volt "B's" powered the 42-6L6G exciter at 15 watts. The station provided valuable service to local officials, Red Cross, National Guard and the power company.

Near where Narragansett Bay opens into the sea, at Wakefield, W1CPI, A.R.R.L. E.C. for South County performed the Herculean task of manning his station 107 hours in six days. Over a thousand messages were handled for the 103rd

Field Artillery, Coast Guard, State Police, etc. Operating in the "Shore Limited Network," "Skipper" did a real coordinating job. W1IGB was also on in Wakefield.

W1KLR and W1BZX turned in an excellent performance at nearby Wickford, operating a joint station at the local fire house. The transmitter was on 160, but there was much cross-band work, especially in providing a Providence-Westerly relay link. W1IQF was also reported on in Wickford.

At Peace Dale W1ALJ, assisted for a time by W1IGB, succeeded in borrowing a gas-driven alternator to get on by 11:00 A.M., Thursday. He was useful to the New England Power Company, among others.

In the Providence area the A.R.R.L. Emergency Coördination plan was in successful operation. The annihilation of all means of transportation and communication led to a slow initial start, but when the Providence hams got going they turned in a job that commanded the respect of everyone.

W1JEZ, the E.C., started work at the governor's call on Wednesday evening. On Thursday afternoon the key station, W1INM (call of the Providence Radio Association), was set up at the State House next door to the governor's office. Perhaps 2000 messages were handled on behalf of various state agencies, largely in lieu of the state teletype system. The operators on duty included W1CPV, W1GOG, W1GTN, W1INT, W1INU, W1JCN, W1JEZ, W1JP, W1JRY, W1JUE, W1KCS, W1KYK, W1LAB, W1LCH, W1LDL, W1KWA, W1HCW.

For a period of six days W1INM maintained contact with W1KTH, the portable unit which was sent to Westerly. So successful was this station that an offer was made to provide another station and two operators to be flown to Block Island, reported devastated. When the Coast Guard reported conditions there not to be serious, this project was abandoned. Mobile units were sent into the Hope Valley region, and other points.

Another outstanding job was that of W1IPU. Active in Providence beginning 7:00 P.M., Thursday, when a special power line was installed, this station handled a total of a thousand messages, mostly on 75 'phone and 80 c.w. W1GVH, W1HEN, W1CAB, W1KUG, W1GYO, W1CLN and fifteen unlicensed persons provided efficient assistance. W1IPU had a tie-up with b.c. station WEAN.

W1BES got on 75-meter 'phone as soon after the emergency as power and antenna facilities could be restored. Traffic handled totalled 340. Before that he, along with W1GTN, had set up a group of Signal Corps transmitters at the Cavalry Armory, Central Station, State House and Dexter St. Armory, for local communication.

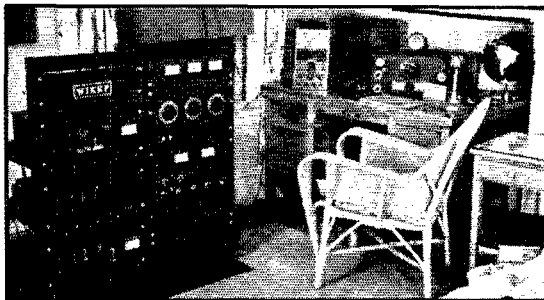

WIKKP AT BUZZARDS BAY, MASS., DELIVERED CAPE COD TRAFFIC THROUGH THE BARNSTABLE COUNTY POLICE NETWORK

W1BBA performed a useful purpose in clearing distant personals via 14 Mc., thus relieving the lower-frequency bands. He had a tie-up with WJAR, cleared for them as well as the other Providence stations. Over 500 messages were handled.

The club station of the Associated Radio Amateurs of Southern New England, W1AQ, was operated by W1CPV, W1BOY and W1JXL in downtown Pawtucket until 4 P.M., Friday, when the operators were called to relieve W1INM for an overnight trick.

Other Providence amateurs whose activity has been reported include W1ICE (commended for snappy c.w. break-in operating), W1IZO, W1JCR, W1KOG, W1KYK, W1LDL, W1LLC.

W1GPV, the A.R.R.L. E.C., got a station on the air at W1BGA's store in downtown Pawtucket and succeeded in handling 597 messages. W1BOY and W1KWA took operating shifts; W1JXL also took a watch. W1KSO was on for a time in Pawtucket, too, accepting R. I. traffic for delivery, as were W1BGO and W1JMT.

W1ISE and W1ITQ were on the job at Warren, first from the former's location and later, with an improvised a.c. line, from the latter's. For a time they were the sole outlet.

Newport stations displayed considerable activity after some degree of normalcy had been restored. The following were heard: W1AWG, W1DWO, W1HPE, W1JFF, W1JJM, W1JUC.

W1JUG of Howard still has a lot of people wondering. It seems he had a message to deliver to the Red Cross in New Bedford and no contact there. So he drove there, over roads that public works officials had declared impassable, handed the message to the doorman, and drove off before anyone could thank him.

Up at Woonsocket W1IHW, assisted for a time by W1JFK, operated during Wednesday evening. Answering a broadcast plea for amateur operators in Providence, he went there, only to be turned back by police. W1LCO was also on in Woonsocket, handling traffic, as did W1JFK later from his home station.

Elsewhere in the state activity has been re-

ported on the part of W1BLS, Middletown; W1KUF, Auburn; W1KXJ, Central Falls; and W1LJO, Jamestown.

#### Western Massachusetts:

Western Massachusetts amateurs, too, mindful of flood but unprepared for hurricane, were caught off guard briefly. But not for long.

Just above the Connecticut line, in Longmeadow, W1KER began watch on Wednesday, put in 80 hours continuously on 160. He was aided by W1KON and both XYL's. Chiefly, this station provided an outlet for W1IGS in isolated Ware and relayed Holyoke Dam water heights by land wire to State House, Boston.

In Springfield, W1AVK, A.R.R.L. E.C., established liaison with the mayor and operated a mobile unit on 10 at the North End dike and on 75 at City Hall. W1IOZ, W1KLN, W1DMZ, W1BPN and ex-W5ATK assisted. Much municipal business was transmitted.

The Springfield Radio Association, W1BWY, had a tie-up with WMAS, and served the Red Cross and telephone company. Some 60 messages were handled by W1BSJ, W1DLE and others.

Bulk of the Springfield traffic went through W1FOF, whose filaments were hot from 5:33 P.M., Wednesday, through 10:20 P.M., Monday. This station was the official mouthpiece of the National Guard, with a sergeant (W1BCX) and six men detailed to it. In addition to special telephone lines, 5-meter links were provided with City Hall through W1KFA (assisted by W1KDA) and the State Armory, W1CAI. W1JQ organized the system, plus manning a mobile unit. W1KOC and W1LKQ relieved at these stations, while W1JQ, W1KUE, ex-W8PI, W1BCX and ex-K5AG took shifts at W1FOF. A total of 571 messages was handled, mostly for the National Guard, Springfield Planning Board and Hartford Weather Bureau.

W1EOB/WLGD did yeoman service through the A.R.R.S., notably in handling orders for serum, etc. W1HDQ took mobile equipment atop Mt. Wilbraham on several assignments to contact distant mobile expeditions.

Other Springfield amateurs listed as active include W1ACJ, W1BEC, W1DYA, W1FPP, W1HZC, W1IGY, W1IPV, W1ISN, W1IWL, W1KEE, W1KPV, W1KLN, W1KQM. W1KUX was on Mt. Wachusett with 56-Mc. equipment. W1JWV was reported from Wilbraham.

Over in Westfield the A.R.R.L. Director, W1BVR/WLG, delivered a stellar performance in coordinating the A.A.R.S. networks throughout the section. At Chicopee, W1KWX was on deck, as was W1KUW.

A number of stations found work to do in Holyoke. W1GZL, using 160, had 228 Red Cross, power company, railroad and personal messages. Mr. and Mrs. W1EVZ/W1GQT, aided by W1AJD, had 176, many in connection with the

Holyoke dam. W1CON (with W1BPT), W1CJK, W1GZL, and W1LIW were also on in Holyoke. W1IMF served in the 56-Mc. net, aided by W1BPT. W1CGS provided the Holyoke terminus of the National Guard 56-Mc. hook-up. W1KOS was on in nearby Williamsett.

At Northampton W1DIF took 178 messages on 75-meter 'phone, mostly for the National Guard. W1CPG was on there, too. In Easthampton W1BVG was taking traffic.

One of the most severely hit communities in western Massachusetts, Ware, received a lot of amateur attention. W1JPI went to Ware from Cambridge with a mobile unit, accompanied by a Massachusetts State Police lieutenant. A number of relief messages were handled back through the base station, W1FHY. W1IPV had a portable set-up installed at the Ware Nipple Shop. W1DLY worked with a 10-meter rig, establishing cross-band QSO's with his receiver on 5. W1CJR, W1DJU and W1IGS were also active in Ware when power was restored. In Thorndike, W1CLX was on the air.

W1DLY in Gilbertville handled 145 messages for that isolated community, many for the health department relative to vaccine, etc.

Most Worcester hams were silenced by power failure, but W1ETC got a special line, handled 224 messages for all official agencies and the press. Later W1AMI, W1ASU, W1DJU, W1IOR and W1KUD were reported on.

W1ATK operated portable in the Southbridge Police station. Aided, by W1EFC, W1JQE and W1LLT, his traffic total was 140. W1HSK/W1KOJ handled some Southbridge traffic, working on 75-meter 'phone. W1KOJ supplied a transmitter for W1ATK before power failure. W1BPG was there, too.

Other points were covered, as well. Stations were reported on as follows: Ludlow, W1HJR, W1KNF, W1KOA; Pittsfield, W1AZW, W1BKG, W1FAU, W1HAZ, W1KVN; Dalton, W1HNE; Williamstown, W1EJV; Gardner, W1BIV; Fitchburg, W1BNO; Leominster, W1KOQ; Shrewsbury, W1LC; Whitinsville, W1JVA; Webster, W1LIB; Brookfield, W1CWH.

#### Northern New England:

The Connecticut River and other streams were in flood, and that was the emergency in Vermont and New Hampshire. The hurricane merely came along in the middle of it and complicated things.

In Vermont, Brattleboro's E.C., W1FPS, was on with emergency power the evening of the 21st and intermittently thereafter. He also assisted W1AZV, for at 5 A.M. the next morning the latter had, with the aid of a special detail of National Guardsmen, run a temporary 1500-foot power line to his station. They operated on behalf of all agencies until the crisis passed.

W1AD in isolated Springfield used "CQ pse"

*(Continued on page 78)*

# A New Automatic Noise Limiter

## Carrier-Controlled Squelch Circuit for Superhet Second Detectors

By James E. Dickert\*

SINCE James Lamb brought to our attention a method for silencing the effect of "shot type" noise,<sup>1</sup> several experimenters have attempted to improve the action either by changing the set-up of the original published Lamb circuit or by development through a different technique designed to accomplish similar results.

Significantly, all successful attempts, to the author's knowledge, have been approached by admitting the postulate of Mr. Lamb, that is, that bothersome "shot type" noise differs from the signal itself by exhibiting comparatively high instantaneous voltage level and extremely short duration, so that squelching the receiver sensitivity during the noise pulse will reduce the noise, and the period of reduced response will effect no practical discontinuity in the received signal.

Before description of the new automatic noise limiter, let it be said that in the author's opinion, if the Lamb silencer is properly installed, if the receiver is worthy of the name, if the operator intelligently and carefully adjusts the controls; then action is entirely satisfactory and results can be demonstrated to be of real value. The only excuse for a new type device is if a few additional requisites are satisfied:

First, the new device shall be as effective, or more so.<sup>2</sup>

Second, it shall cost less.

Third, the threshold control shall be automatic.<sup>3</sup>

Fourth, it shall be simple to construct and without manual adjustments.

\* 339 Cavell Ave., Highland Park, Ill.

<sup>1</sup> J. J. Lamb, "A Noise-Silencing I.F. Circuit," *QST*, February, 1936.

<sup>2</sup> The term "effective" here must be considered in a relative sense. The Lamb silencer has the advantage of functioning in the early receiver stages where the receiver's selective circuits have not had an opportunity to lengthen the duration of the noise pulses (see note 1); this is a particularly important advantage when a crystal filter is used, and is not possessed by the several noise-limiting arrangements operating on the second detector or audio circuits.—EDITOR.

<sup>3</sup> An essential feature of the Lamb silencing system is provision for automatic threshold control from the receiver's a.v.c. system. Further improvement in this respect has been made by Mr. Lamb, but completion of the work has been delayed for the present.—EDITOR.

Fifth, it shall be applied easily to any standard receiver without altering any of the existing functions such as pre-audio sensitivity, selectivity, or stability.

Sixth, it shall be incapable of causing serious distortion.

With these requisites in mind the following noise limiter description is submitted. At the risk

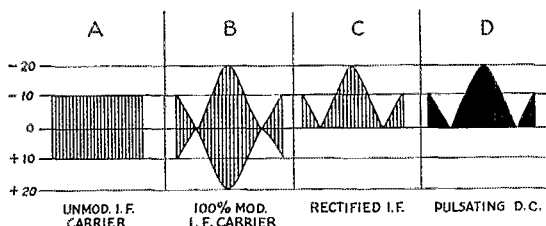

FIG. 1.—GRAPHICAL REPRESENTATION OF SUCCESSIVE STAGES OF MODULATION AND DETECTION

of boring the reader, brief reference is made to the mechanics of detection or demodulation. A review of Fig. 1 shows progressively an unmodulated carrier (A), a 100%-modulated carrier (B), a rectified 100%-modulated carrier (C), and lastly the same carrier converted by filtering to pulsating direct current (D) as appearing across the diode load resistance. The voltage values given on the scale are arbitrary and somewhat higher than normally experienced. However, all voltages referred to in Fig. 1 and hereafter, may be considered proportional to those actually occurring in practice.

Now in general, with properly-modulated carriers, the average value of rectified voltage appearing across the diode load resistor, or "stick" as we call it, is the same as the value caused by the same carrier when unmodulated. The carrier of Fig. 1-A would cause a ten-volt drop across the

stick, and the carrier of Fig. 1-B would cause a drop varying between twenty volts and zero, or an average value of ten volts. To put it another way, we can generally assume that the legal and desirable peak value of modulation is just double the average level of the rectified carrier. Also we can say truthfully, that if receiver response were defi-

Here is a newly-developed noise-suppressing system which can be applied without undue circuit or constructional complications to any superhet receiver using a diode second detector. Its noise-suppressing action is determined by the level of the carrier at the second detector, and thus is automatic on both 'phone and c.w. signals. Requires only one extra tube and a few small resistors and condensers.

—EDITOR

nately limited to a value twice as high as average, no harm could be done to the received signal, or to its modulation component.

Refer now to Fig. 2. Section "A" is a somewhat poetic representation of the rectified carrier of Fig. 1-D when accompanied by an objectionable

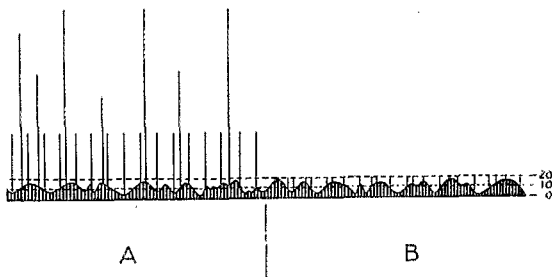

FIG. 2—MODULATED CARRIER WITH HIGH-AMPLITUDE NOISE PULSES (A), AND (B) MODULATED CARRIER WITH NOISE PULSES LIMITED TO THE PEAK MODULATION AMPLITUDE

amount of "Main Street QRN." The high vertical lines correspond to practically instantaneous voltages caused by ignition discharges and similar electrical "pops," including key clicks. Actually, instantaneous voltages as shown might not be terribly objectionable providing the highly-damped characteristic could be maintained. The sad part of it is that selective i.f. amplifiers, stray or unnecessary capacities, resonant audio systems, and above all reverberant room conditions—all add up to cause secondary effects and, what is more important, a psychological effect of aural masking. Our ears, however, are really quite rugged, and noise voltages several times signal intensity can be tolerated before interference becomes really objectionable.

If then, as in Section "B," Fig. 2, noise voltages could be reduced to a value not to exceed twice average carrier level, what little of the noise remains becomes psychologically absent. This conclusion is beyond the stage of theory. It is a demonstrated and accepted fact.

Now to figure out a way to do it! Fig. 3 shows six steps in the development of the submitted automatic noise silencer. Fig. 3-A represents a fundamental detector circuit utilizing a diode rectifier. If we assume the same order of carrier voltage as in the previous illustration, point *a* will vary from  $-20$  to  $0$  volts following the modulation. Proportions of this voltage can be taken off at the potentiometer arm of  $R_1$ . Point *c* remains at zero, or ground, which is used as reference.

Fig. 3-B is identical to (A) except that  $R_1$  is now split into two equal resistances,  $R_1$  and  $R_2$ . Point *a* still varies from  $-20$  to  $0$ . Point *b*, which is half-way toward ground, varies between the limits of  $-10$  and  $0$ .

Fig. 3-C has added a resistor and condenser combination identical to that used for storage of

voltage for a.v.c. The time constant of the combination should be slower than the lowest modulating frequency encountered, and the resistor should be of a high value relative to the value of  $R_1$  or  $R_2$ . Point *d* then will assume the relatively constant value of the carrier average whether modulated or not; that is,  $-10$  volts.

In (D) another diode has been added to the circuit between point *b* and ground, as shown. Given the conditions as before, the cathode of the second diode will always be negative with respect to the plate, which is at ground potential, since the cathode is connected to the point *b*, which varies from  $-10$  to  $0$  volts. This means that the diode is always conducting during signal reception, and as a conductor its low impedance practically shorts the audio potentiometer  $R_2$ , giving rise to much reduced voltage level at point *b* and hence at the potentiometer arm carrying audio voltage to the amplifier. We have in effect a permanent squelch circuit, active as soon as any signal is rectified, and obliterating both signal and any noise present.

So long as this diode can be such an effective squelch it would be desirable to adjust the action so it would take effect only on voltages exceeding double the average rectified carrier level. This level, incidentally, is the same voltage level being stored at the point *d* (twice the drop from *c* to *b*). Under such conditions, any voltage in excess of that produced by a fully-modulated carrier would be limited to the 100 per cent level.

Fig. 3-E shows one way of doing just that—at least approximately. The triode which supplants the diode is the "zero bias" type such as a 6A6, a 53, or a 6N7. This type is characterized by the fact that with reasonably-small positive plate potential, the grid must be positive with respect to the cathode before conduction occurs. This means that even on the highest modulation peaks—the most negative values not exceeding 100 per cent—the grid potential only equals the cathode potential and practically no current flows through the triode. However, assuming a noise voltage only slightly higher than the maximum value of modulation, the cathode has a tendency to become slightly negative with respect to the grid, thus allowing cathode-to-plate current to flow. As can be seen from the diagram, cathode-to-plate current is another way of saying "limited current in  $R_2$ ," since excess noise current which ordinarily flows to ground through  $R_2$  is now detoured via the noise triode cathode-to-plate route and therefore cannot appear at the volume control arm of  $R_2$ .

The circuit of (E) is not the final answer for several reasons which, although important are not particularly interesting. However, there is an additional condition we should like to observe. If, instead of the triode plate being maintained

at zero potential, we were to introduce on it a voltage in exactly the same form as that appearing on the cathode, but opposite in polarity, we would have, at the instant of necessity, the greatest potential difference between cathode and plate and thence the best action.<sup>4</sup> On the other hand, at the time of no signal or very slight signal, all voltages would automatically adjust themselves to values in proper mutual relation.

Such a condition obtains by using the set-up of Fig. 3-F. Note that  $R_3$  has been added in the cathode circuit of the signal diode. This resistance is rightfully part of the diode load, the only difference being that, because of the direction of current flow in the signal diode, positive voltage instead of negative is left at the ungrounded end of the resistor. If  $R_3$  and  $R_2$  are identical, then identical potentials built up by rectification of a given signal will be built up on each resistor except that one will have an opposing sign. Since plate current flows as soon as point  $b$  exceeds the negative potential of point  $d$ , all excess noise voltages across  $R_2$  are literally drained off and cause the condition originally anticipated—noise limiting.

For a slightly inaccurate but workable illustration of the noise-limiting action it may be convenient to visualize the operation illustrated in Fig. 4. During normal reception the grid is never positive with respect to the cathode so the high impedance presented by the triode plate-cathode circuit does not interfere with the standard circuit, shown by the heavy lines in (A). During

<sup>4</sup> Making the plate positive at the instant the grid tends to go positive with respect to the cathode is particularly helpful because the inherently poor voltage regulation of the rectifier system will not permit a very high positive grid voltage to develop, since it must be accompanied by grid-current flow.—EDMOR.

excessive noise pulses, however, the tendency is for the cathode to go negative with respect to the grid. At the same time the plate is quite positive, and the tube conducts. Such conduction can be considered as a change of current path to that shown by the heavy lines of (B), Fig. 4.

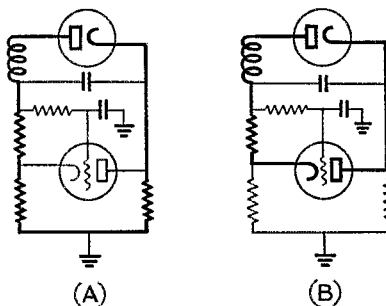

FIG. 4—EFFECTIVE CIRCUIT PATH FOR (A) THE DESIRED AUDIO SIGNAL, AND (B) NOISE OF AMPLITUDE GREATER THAN THE SIGNAL MODULATION PEAK

In other words, the lower section, of which the volume control is a part, is rather slighted for the duration of the noise peaks in excess of normal modulation. The conclusion again—noise limiting.

The fact should be understood by the analytical reader that the foregoing remarks are means toward a practical understanding of the operation in order that possible difficulties with special applications may be solved by common-sense reasoning. There are several circuit constants and functions not touched upon but which would alter somewhat the values given in the illustrations. A rigid circuit analysis not only is

laborious but in a sense futile because optimum operation is determined by the listener's comfort rather than by measured or calculated performance. An undeniable fact is that the device works, and by rule-of-thumb and cut-and-try methods the circuit can be modified to produce entirely satisfactory—and to those most experienced, surprising—results.

In the experience of the author, Fig. 5 represents optimum values for all circuit components when the noise limiter is built into a standard receiver setup. It is suggested that the schematic be followed quite closely, since components and values have been chosen with care and with due regard to their effect on associated circuits.

Keep the circuit parts huddled together as much as possible, steering clear of stray capacities and long inductive leads. Put the off-on switch on an extension shaft from the front

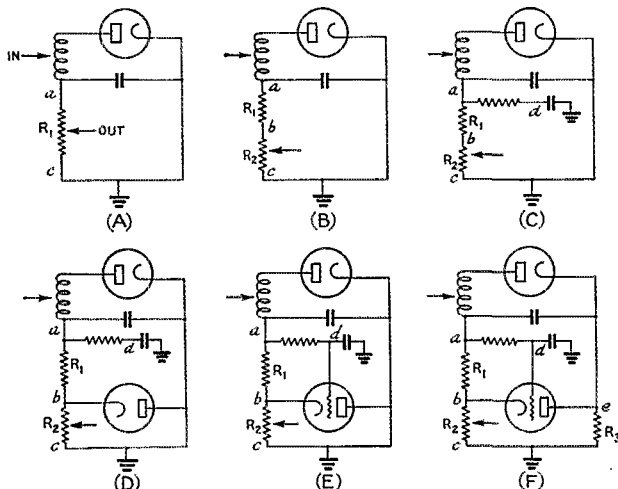

FIG. 3—DEVELOPMENT OF THE AUTOMATIC NOISE LIMITER FROM THE SIMPLE DIODE DETECTOR

panel so the switch can be located physically near the rest of the equipment; otherwise as shown.  $R_4$  is an "extension potentiometer" across  $R_8$ , which carries most of the direct current. Shielding of leads in general is undesirable because of

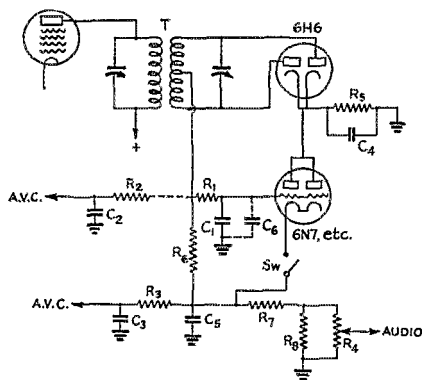

FIG. 5—PRACTICAL AUTOMATIC LIMITER CIRCUIT\*

The values are optimum for ordinary operation. Optional a.v.c. output connections are shown.

- T—Diode input transformer, center-tapped secondary.  
 $R_1, R_2, R_3$ —1-megohm,  $\frac{1}{2}$ -watt.  
 $R_4$ —1-megohm volume control.  
 $R_5$ —250,000-ohm,  $\frac{1}{2}$ -watt.  
 $R_6$ —100,000-ohm,  $\frac{1}{2}$ -watt.  
 $R_7$ —25,000-ohm,  $\frac{1}{2}$ -watt.  
 $R_8$ —100,000-ohm,  $\frac{1}{2}$ -watt.  
 $C_1$ —0.1- $\mu$ fd. paper.  
 $C_2, C_3$ —0.05- $\mu$ fd. paper.  
 $C_4, C_5$ —50- $\mu$ fd. mica.  
 $C_6$ —0.001- $\mu$ fd. mica (for additional i.f. filtering, if needed).  
 Sw—S.p.s.t. toggle switch.

the added capacity involved. It is more desirable to isolate the leads physically and to keep the circuit "clean." Diode biasing of the first audio tube may be used to advantage, providing a slight amount of cathode resistance (about one-fourth normal) also is used.

The resistors in Fig. 5 are proportioned so as to squelch voltage peaks in excess of about 80 per cent modulation. This threshold value gives slightly better silencing than the 100 per cent value previously discussed. At the same time some slight distortion may be noticed when receiving a signal of high modulation content. In general, however, the results will be quite satisfactory as a very small proportion of even a heavily modulated carrier will exceed 80 per cent, and when such peaks do occur there is good reason to assume other forms of distortion exist in the second detector. If the hook-up in Fig. 5 is followed, however, the common distortion ordinarily experienced is minimized. If, on the other hand, most complete silencing is desired, regardless of the amount of distortion, resistor  $R_8$  can be further reduced or even eliminated. Severe

\* Full-wave diode as shown is preferable for good r. f. filtering, but there should be no reason why the system cannot be used with existing receivers having half-way rectifiers.—EDITOR.

distortion will occur under all conditions of modulation but the intelligibility seems to be undisturbed. This latter condition, incidentally, is the ideal one for c.w. reception. Because of the automatic relation between noise threshold and carrier level, the condition of blocking or complete squelch never can occur.

The ratio of  $R_1$  to  $C_1$  is adjusted to allow fast automatic change of operational threshold during tuning or when receiving fading signals. Actually the listener is not conscious of any delay whatsoever even when receiving c.w. signals. The action is particularly desirable when hunting for weak carriers, as the ordinarily high noise level between carriers when using a.v.c. is cut down enormously by the automatic feature of the limiter. This is understandable when it is remembered that noises of double average carrier level and over are squelched. In the case of no carrier at all, double that carrier is still zero, so theoretically all voltage other than steady carrier is squelched.

Finally, rather than recite a lot of claims about how well the silencer operates in practice, let us issue just one thought. In your zest to put it in your receiver at lowest possible cost, do not omit the off-on switch. It's too much fun to play with it!

\* Probably some care must be used in adjusting the amplitude of the beat oscillator voltage at the second detector, since the limiting action will depend upon the rectified voltage, whether caused by the b.o. or signal. A weak b.o. voltage would seem best.—EDITOR.

## Our Cover

HELL and high water descended on New England and Long Island at 3 P.M. on September 21st. Typical of many a wrecked community was Westerly, R. I., with its surrounding towns of Stonington, Conn., Watch Hill and Misquamicut, R. I., all thrown into a complete shambles and with all lines of communication torn to shreds. Three hours after the storm started, with a gale still raging, WIBDS, with gear hastily thrown together, was on the air with an antenna that at last would stay up—wrapped around a house for support! An urgent QRR was addressed immediately to Washington on 3990 kc. From then on, Burgess and his crew of ham operators kept a circuit open into and out of Westerly for the handling of all forms of emergency traffic. Our cover photograph is of this station under actual emergency conditions—the last of three setups that were used at different times. Photo by WIBAW.

## Strays

W5FXO insists that an SWL of his acquaintance actually has oiled his speaker in an attempt to eliminate the "squeaks" (c.w.).



# Let's Settle Those Antenna Questions

## Beginning a Simplified Discussion of Antennas and Antenna Feed Systems

By T. M. Ferrill, Jr.,\* W1LJI

**W**HAT is an antenna, and what kinds of antennas are used in amateur stations? How critical are antenna dimensions? What determines the choice of an antenna? How high should it be, and should its position be horizontal, inclined or vertical? What is the most efficient method of feeding it? How should the feeders be coupled to the transmitter? Should one antenna be used on several bands, and if so, must efficiency be sacrificed? Of what importance are wire size, insulators, resistance of joints, and guy wires in the vicinity of the antenna?

These are questions which face the beginner, and undoubtedly cause a great deal of worry for the more advanced as well. Although the number of variables and unknowns makes simple and complete answers difficult, it is hoped that the following comments will remove some of the doubts which antenna questions so frequently cause.

### WHAT IS AN ANTENNA?

Entirely apart from the transmission line, insulators, poles and source of power, the antenna is the *part* of an antenna system which radiates power.

Until recently, nearly all amateur transmitting antennas were of the "resonant" type, and since this type still outnumbers the non-resonant antennas, it will be given the earlier part of the discussion. The resonant antenna is one whose length (and coils or condensers, if these are used in the antenna) determines its frequency. It is typified by "standing waves" (unequal current values at different points along its length) because of reflection at the open ends.

For operation on any single amateur band, the simplest antenna is the half-wave resonant antenna, several variations of which are shown in Fig. 1. This antenna may be horizontal, vertical, inclined, or part horizontal and part vertical. Where space and facilities permit, an effective antenna for any low-frequency band may be constructed by suspending a horizontal wire of the proper length between two reasonably high supports, and feeding it by any of the transmission lines shown in Fig. 1, (d) to (i), inclusive.

### HOW LONG?

If the half-wave antenna is to operate effectively, its length must be such as to make it resonant with the transmitter frequency. The

exactness with which this length must be adjusted has long been a source of worry for amateurs, probably because of the fact that antenna dimensions are often given to the nearest inch or half inch for lengths greater than 100 feet. Actually, removal or addition of a one-foot length of wire at the end of an 80-meter half-wave antenna which was originally exactly resonant with the transmitter will not affect its operation. The effect of such a change is much similar to the effect of a 23-kilocycle change in oscillator frequency on the driving power of a capacity-coupled amplifier—a much greater change of frequency is required to cause a noticeable reduction of efficiency.

Removal of a length of 8 feet from a resonant 80-meter half-wave antenna, on the other hand, has an effect similar to moving the oscillator frequency from one end of the 80-meter band to the middle (3500 kc. to 3750 kc.). This works backward, also, because moving the transmitter frequency across all or half of the 80-meter band without altering the tuning of the antenna will cause a noticeable reduction in output.

If operation of a resonant-type antenna on all frequencies in a broad amateur band is expected, then, it is desirable to have some means for readjustment of the tuning of the antenna system. This may consist of a method for decreasing or increasing the antenna length at will, or it may be some means for varying some tuning coil-and-condenser combination connected with the antenna.

In Fig. 1, nine antenna systems with 80-meter half-wave antennas, and with various ways of transferring power from transmitter to antenna, are shown. Since the length of each half-wave radiator is 133 feet, the frequency to which each is tuned (see Fig. 2-b) is approximately 3520 kc. If operation on 3900 kc. is desired, the correct length is approximately 120 feet. Thus any of the radiators shown may be retuned to the higher frequency by removal of 13 feet of wire. Any of the systems of (a), (b), (c), (f), and (g), however, may be made resonant by retuning the tank circuits connected to the antenna or feeders. In the first three, this effectively shortens the antenna itself, while in the latter two systems it has the effect of detuning the feeders, which in turn effectively shorten the antenna.

Although as was pointed out above, a difference of one foot has no noticeable effect on the operation of a half-wave 80-meter antenna, an excess or

\* Technical Department, QST.

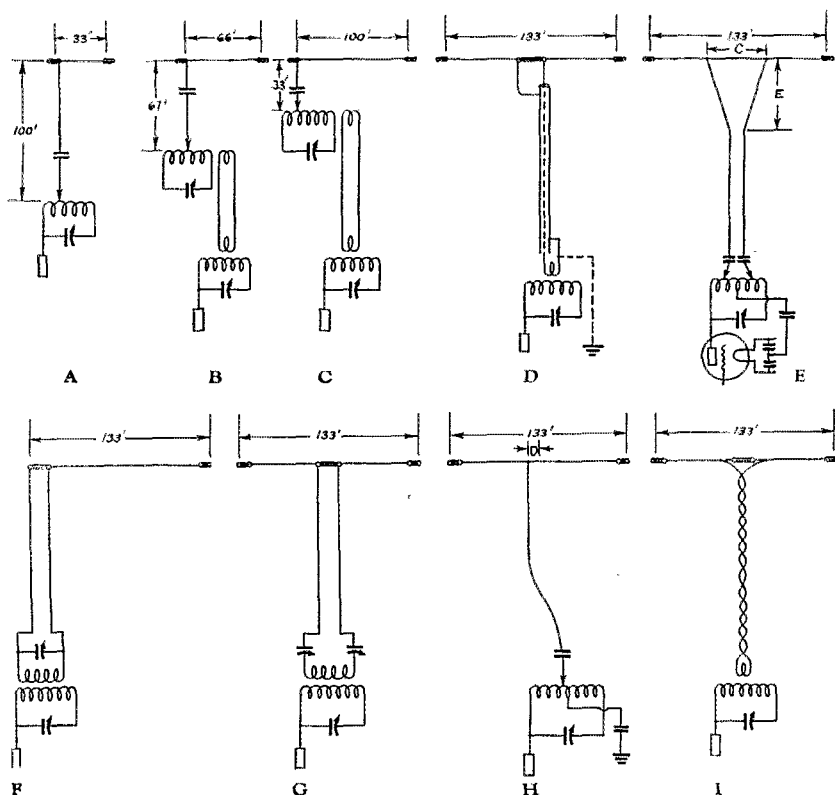

FIG. 1—ANTENNA SYSTEMS DISCUSSED IN THE TEXT

lack of as much as 13 feet causes the antenna to be noticeably off resonance, just as detuning the condenser of a plate tank circuit several dial divisions causes the circuit to be noticeably off resonance and somewhat less efficient. Hence if any of the four untuned-feeder antenna systems (Fig. 1-d, -e, -h, or -i) is to be operated at 3900 kc., a slight loss of efficiency will be experienced if no change is made in the antenna length. The antenna will still be effective, however, and the radiation pattern will be about the same. If operation throughout wide bands such as the 80-meter band is planned, the antenna—particularly one fed by an untuned line—should be cut to the length corresponding approximately to the middle of the band. If operation is to be largely confined to a frequency at one end of the band, on the other hand, the antenna should be cut for a frequency nearer this end of the band.

#### HOW HIGH?

Ordinarily, the general rule of "as high as you can get it" is a good one to follow for a decision about antenna height. The vertical radiation pattern is considerably changed by variation of the

height of the antenna.<sup>1</sup> The overall effect of increased antenna altitude, with consideration given not only to the gain in all directions but also to the fact that raising the antenna an additional distance of 15 or 20 feet usually puts it more "in the clear," usually is increased effectiveness. It should be noted, however, that an antenna an odd number of quarter-waves high has increased high-angle radiation (radiation in an upward direction), while one an *even* number of quarter-waves high has increased low-angle radiation. Therefore, since extensive use is made of high-angle radiation at the lower frequencies, while lower-angle radiation becomes increasingly important at the higher frequencies, a very suitable height for an antenna to be used on several bands is a quarter wavelength for the lowest frequency band (if this is to be 80 or 160 meters) and 2, 4, 6, and 8 quarter-waves, respectively for the frequency bands successively higher. Such a height as this, with high-angle radiation on the lowest-frequency band and low-angle radiation on the higher-frequency bands, is a very logical one if installation facilities are available.

<sup>1</sup> Grammer, "All-Around Radiation Characteristics of Horizontal Antennas," *QST*, Nov. 1938.

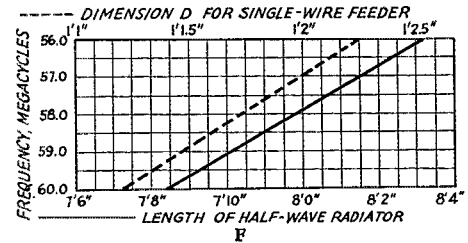
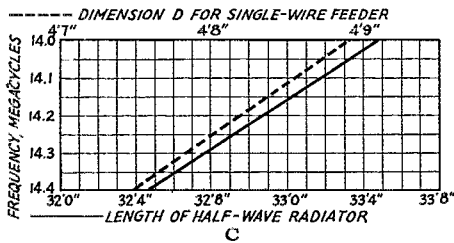
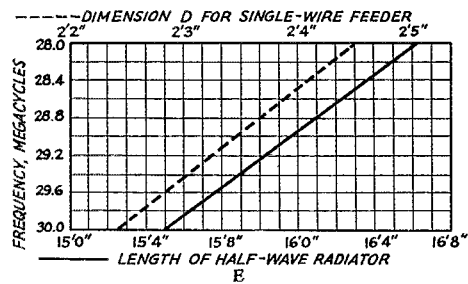
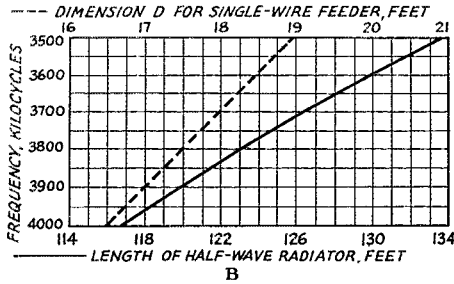
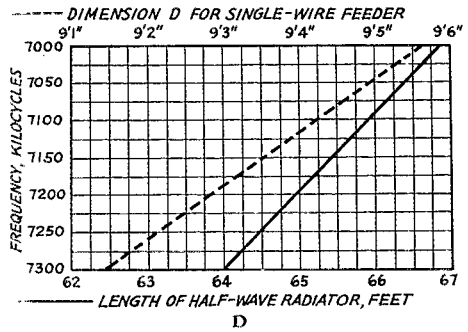
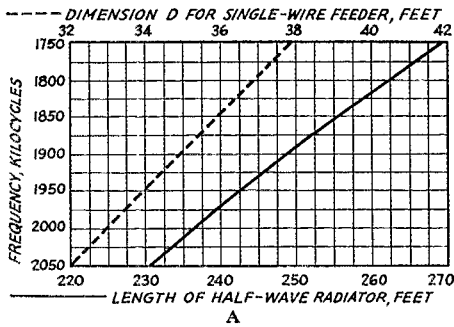

FIG. 2—CURVES FOR DETERMINING LENGTH OF HALF-WAVE RADIATOR  
Center-to-feeder distance for No. 14 single-wire feeder is also given.

#### WIRE, INSULATORS AND GUY WIRES

Selection of antenna wire and insulators is not at all difficult, but how is a beginner to know this? Actually, there is little difference, from the standpoint of electrical efficiency, in sizes 14, 12, 10, and 8 of solid copper wire. The larger wire has slightly lower resistance, but the difference between the operation of a half-wave antenna made of No. 14 wire and one made of No. 8 is certainly not noticeable. There is practically no difference between the operation of solid copper wire and steel-core wire of the sort made for antenna use. Thus, the prime factors in the determination of the kind of wire to be used for the antenna are the weight and mechanical strength.

In the selection of insulators also, weight and mechanical strength are important factors. At ordinary frequencies the electrical losses in a dime-store glass insulator four inches long are not much greater than in a higher-priced transmitting insulator. Two short insulators may be used in series at each insulated point to provide more

insurance against leakage loss along the surfaces.

The most important precaution in use of guy wires is that the wires be "broken" at the proper intervals to insure that there are no elements an even number of quarter-waves long between insulators, and that there be no elements a whole number of quarter-waves long between the ground and first insulators in the guys. A separation of 20 feet between strain insulators used to "break up" the guy wires is suitable for all bands from 160 to 10 meters, inclusive, and a separation of 10 feet is suitable for the 5-meter band in addition to the lower-frequency bands.

#### WHERE SPACE IS RESTRICTED

Lack of available space often makes the installation of a straight horizontal antenna for a low-frequency band impossible, unfortunately, hence it is sometimes necessary to resort to less commonly used variations.

Probably the best-known of these variations is the grounded antenna (sometimes called the

"Marconi"). If one end of an antenna is connected to ground, through a low-resistance contact such as may be had by use of several long rods or pipes driven deep into damp earth and connected together, the earth will behave as though it were an electrical mirror and the length of the wire will be doubled by reflection, the center of the antenna being at the ground connection. The resonant grounded antenna has serious disadvantages for amateur work, including the following:

1. It is difficult to obtain a low-resistance ground connection, and since the current is large at the point of connection to ground, the power loss at this point is usually much greater than that in the large-current part of a simple half-wave antenna.

2. The grounded antenna is confined to vertical or part-vertical installations, since obviously the wire cannot run along the surface of the earth from the point of connection.

3. The radiation from an antenna is normally greatest at the portions where greatest current flows, with the result that the part of the antenna at and near the ground connection radiates a large part of the power. The disadvantage of this feature can be compared to viewing distant objects from the level of a bird on the ground. If the ground is rough, or if there are bushes in the neighborhood, the bird will certainly have difficulty in seeing anything distant except the sky directly overhead. The large-current portion of a horizontal or vertical half-wave antenna suspended well above the ground, on the other hand, with the sort of view which confronts a bird sitting on a telegraph pole, will have an unobstructed view over great distances in many directions, low as well as high.

The advantage of the grounded antenna for amateurs, and almost the only reason for its use, is the fact that the total length of wire necessary for resonance is only half, approximately, the length necessary for the ungrounded half-wave antenna.

A more efficient method of making a tuned antenna for operation in cramped space on a low-frequency band is to bend the wire. If this is properly done, the compact antenna may be nearly as effective as the straight horizontal one. If operation is planned only for the band at which the antenna is a half-wave, it may have eighth-wave ends hanging vertically down so that the horizontal part is only a quarter-wave long. The radiation from the end portions of the antenna is quite small compared to that from the middle, and consequently, the radiation pattern of this compact system is little affected by the peculiar form taken by the ends. Thus, a length of approximately 75 feet may be made to accommodate a bent 133-foot antenna of which 33-foot lengths at each end drop down, leaving 67 feet in the horizontal portion. The poles for this type

of antenna should, unless placed some distance from the ends, preferably be made of wood. Two wood poles 40 to 60 feet long could very well be used, spaced at least 4 feet from the hanging portions. An undesirable antenna, however, would be a half-wave antenna bent sharply at its center (Fig. 1-b, for example), with legs horizontal, inclined, or vertical. This is true because radiation from one of the legs tends to cancel that from the other much in the same way as in tuned feeders, but to a less complete extent.

#### FEED SYSTEMS

Any of the methods of feeding a resonant antenna may be applied to almost any form of the resonant system—vertical or horizontal, grounded or ungrounded, bent or straight. However, some feed systems are better adapted to certain applications than others. If an antenna is to be operated on more bands than one, for instance, the feeders of (d), (e), and (i), are definitely unsuitable, while that of (h) is poor.

The simplest method of coupling a half-wave antenna to the output circuit of the transmitter is shown in (a). This system requires that the end of the antenna be brought into the station and to the transmitter, and thus some of the radiation from the antenna takes place within the room. However, this is not a serious disadvantage, since the current at this part of the antenna is quite small, and the part of the total antenna radiation taking place within the station is proportionately small.

The systems of (b) and (c) are variations of (a), with separate antenna coupling tanks coupled to the output tank by means of low-impedance cable, which may be either twisted lamp-cord or some such transmission line as EO1 or concentric line. An extreme case of the (b) or (c) system would allow use of an antenna tank circuit suspended at the end of a horizontal straight half-wave antenna, with the low-impedance line linking the antenna tank circuit to the transmitter. This would be difficult to adjust, however, since the antenna tank condenser usually would not be readily available for retuning.

With the exception of the antenna systems of (a), (b), and (c), all of the arrangements of Fig. 1 use transmission lines designed to eliminate radiation.<sup>2</sup> With proper adjustment, all except (h) have practical elimination of radiation. The tuned feeder systems, Fig. 1-f and -g, ordinarily require use of a coil and tuning condenser(s), whereas the systems of (d), (e), (h) and (i) are free from such apparatus. The use of the tuning arrangement with the tuned feeders is more often an advantage than not, however, because of the flexibility provided.

There is no appreciable difference in the efficiency of the systems of Fig. 1-d, -c, -f, -g, and

<sup>2</sup> Stuart W. Seeley, "Match and Mis-Match," *QST* Nov. 1937.

-i, properly adjusted, but the efficiency of any of them is usually slightly higher than that of any of the other four shown. If poor dielectric material is used in the transmission line of (d) or (i), the loss in a great length of the line may become large when it is used to carry power on one of the highest-frequency bands. This may be particularly true of the feeder of (i) in wet weather if a water-proof covering is not used and the dielectric material is at all water-absorbent. A commercially-made feeder of the type shown in Fig. 1-i is known as EO1, and is provided with a water-proof cover over twisted rubber-insulated wires of large conductors.

In addition to proper lengths of resonant half-wave antennas, the graphs of Fig. 2 show distance-from-center dimensions for placement of the feeder tap on systems of Fig. 1-h. This position is correct for a feeder of No. 14 wire.

The length  $C$  in Fig. 1-e is obtained by use of the following formulas:

For the 160-meter band,

$$C \text{ (feet)} = \frac{123,000}{\text{Frequency (kc.)}}$$

For the 80-, 40- and 20-meter bands,

$$C \text{ (feet)} = \frac{118,000}{\text{Frequency (kc.)}}$$

For the 10- and 5-meter bands,

$$C \text{ (feet)} = \frac{113}{\text{Frequency (Mc.)}}$$

The two taps should be equally spaced from the center of the radiator. The distance  $E$  in the same figure is obtained by use of the formula

$$E \text{ (feet)} = \frac{148,000}{\text{Frequency (kc.)}}$$

(Continued on page 59)

## New Amateur Regulations Effective December 1st

**J**UST as we close this issue of *QST*, word reaches us that the Federal Communications Commission has adopted a complete new set of regulations to govern amateur radio commencing December 1st. While patterned upon the present regulations without change in fundamentals, there are scores of alterations, some of considerable importance. Next month we shall present the complete new text of the regs and detailed explanations of the changes, but there has been insufficient time to do it in this issue. Don't miss December *QST*—it will be of vital importance to every amateur. Meanwhile here are the highlights of the most important changes:

1. New bands assigned, 112–118 and 224–230 Mc.
2. Requirement of stable signals and filtered plate supply extended to 60 Mc. No more modulated oscillators or raw a.c. on 5 meters; they may still be used on  $2\frac{1}{2}$  and  $1\frac{1}{4}$ , but 5 now takes the same rules as 10 and up.
3. All stations must employ means independent of the frequency control of the transmitter to insure operation within bands. Ownership of such means not actually required; reg says "shall provide for measurement of the transmitter frequency and establish procedure for checking it regularly." Use of receiver itself will suffice in middle of bands; stable calibrated receivers or monitors will do for frequencies approaching edges; frequency meters probably necessary for working close; those who wish to shave the edges must have precision measuring equipment.
4. Stations using over 900 watts must possess means to measure the power accurately.
5. New emergency rules. When F.C.C. declares communication emergency, only relief transmissions may occur in 1.7 and 3.5 bands. Segments of 25 kc. on these band edges reserved for emergency calls. First 5 minutes of each hour compulsory listening period for all participating stations. Provisions for amateur policing.
6. No more television in 1715 and 56,000 bands but OK on 112 Mc. and up.
7. Phones not to emit carrier unless modulated for communication—no more idling while receiving. Transmission of music forbidden. Class-A bands to be used only by stations licensed to Class-A operators.
8. Portable regulations clarified. Portable designator changed from double-break to fraction mark (DN).

There are dozens of small changes in licensing procedure and in prescribed operating practice and station conduct. Details next month. Also watch in your favorite supply store for a new edition of the "License Manual," being prepared in conformity with the new regs.

# Variable Frequency Control for Transmitters

An Easily-Built E.C.O. Which Fits any Crystal-Controlled Transmitter

By Dana A. Griffin,\* W2AOE

A CASUAL survey of modern transmitter design discloses a decided trend towards the use of self-excited oscillators that readily may be shifted in frequency. We now find a fairly large number of transmitters in operation that can be parked near a DX station's frequency in jig time, thereby increasing the chance of making a contact. Another use for such a unit is the possibility of sliding "out from under" heavy QRM in the crowded 'phone bands.

This article describes an oscillator—in fact two slightly different units—that provide this convenience. The novelty, if any, is the fact that they readily can be adapted to existing transmitters fitted with crystal switching means, without changes. Also, the units may be remotely located; that is, the oscillator can be placed on the operating table fifteen or twenty feet from the transmitter.

\*742 Central Street, Plainfield, N. J.

*A gadget of this sort is a most useful station accessory provided, as the author points out, a good job, both electrically and mechanically, is done. Convenient to use, and certainly not expensive.—EDITOR.*

The remote control feature was easily provided by using a link-coupling arrangement which also furnishes a "band-pass" action insofar as output is concerned. Referring to Fig. 1, it will be noted that the plate circuit of the oscillator is link-coupled to another tuned circuit. The latter circuit is mounted on a base that can be plugged into the transmitter in place of a crystal. By tuning these two circuits to different frequencies in the band, it is possible to get a reasonably "flat" output throughout the band. This eliminates several otherwise annoying adjustments.

In order to avoid any circuit changes in the transmitter, it is necessary to use the former crystal oscillator tube as a doubler. Obviously, if this is not done, and the output circuit of the e.c. unit is tuned to the same band as the crystal oscillator plate tank, uncontrollable oscillation will occur.<sup>1</sup> With the e.c. unit output at half the frequency of the crystal oscillator plate circuit, this difficulty is avoided. Since stability and a good note are obtained on the lower frequencies with ease, this cannot be considered a hardship.

## CONSTRUCTION

The photograph shows the construction of the unit whose circuit is exposed to public gaze in Fig. 1. It can easily be deduced that this unit preceded its more complicated companion shown schematically in Fig. 2. Not only is this an excellent example of evolution, but it also will enable groups with two different amounts of ambition and coin of the realm to make them work better and cheaper. The photograph enables one to tell at a glance that it is a lead-pipe cinch to build. An off-on switch, a keying jack, and a dial which

<sup>1</sup>Operation with the ex-crystal tube's grid circuit on the same band as the plate circuit is possible provided the grid circuit is sufficiently detuned to prevent self-oscillation. This usually requires tuning to some frequency outside the high-frequency end of the band in question. Doubling is more fool-proof, however.—EDITOR.

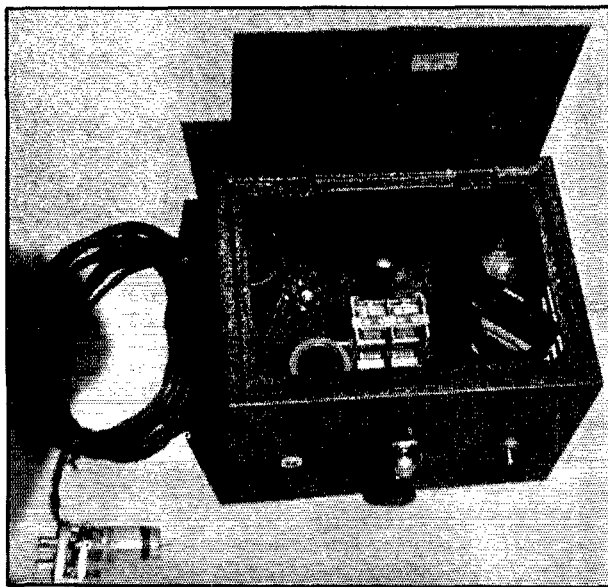

THE FREQUENCY CONTROL BOX WITH ITS OUTPUT COUPLING CIRCUIT AND CABLE

Note the coupling coil in the lower left corner, mounted with its trimmer on a 5-prong base which plugs in the crystal socket in the transmitter.

rotates a condenser that puts you just out of the band on one end, and in the same predicament at the other, are all that is necessary. There is an excuse for the internal appearance of the unit as it was built as an experiment that required a number of changes. Unfortunately, we ran out of film by the time beautiful unit number two was finished. The floor plan (Fig. 3) is one way that unit number two can be laid out.

To get back to Fig. 1 and the first unit again, all three tuned circuits resonate in the broadcast band, the oscillatory circuit covering a range from 860 to 1010 kc. with the padder appropriately set. When the output circuit is plugged into a transmitter in place of a 160-meter crystal, all frequencies between 1715 and 2020 kc. can be covered. This result will obtain with a 140- $\mu\text{f}.$  band-spread condenser and 400- $\mu\text{f}.$  padding condenser obtained from a two-section b.c.l. condenser, with a coil built to specifications. The high-C keeps the cir-

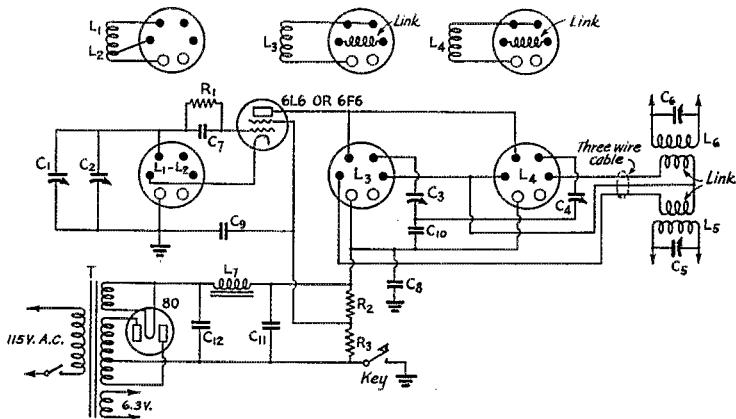

FIG. 2—THIS CIRCUIT WILL GIVE OUTPUT ON TWO BANDS

C<sub>1</sub>, C<sub>2</sub>, C<sub>3</sub>, C<sub>4</sub>—Same as in Fig. 1.  
 C<sub>5</sub>, C<sub>6</sub>—200- $\mu\text{f}.$  mica trimmers.  
 C<sub>7</sub>—100- $\mu\text{f}.$  mica.  
 C<sub>8</sub>, C<sub>9</sub>—0.01- $\mu\text{f}.$  mica.  
 C<sub>10</sub>—0.005- $\mu\text{f}.$  mica.  
 C<sub>11</sub>, C<sub>12</sub>—8- $\mu\text{f}.$  electrolytic, 450-volt.  
 R<sub>1</sub>, R<sub>2</sub>, R<sub>3</sub>—Same as in Fig. 1.  
 L<sub>1</sub>—Same as in Fig. 1.  
 L<sub>2</sub>—24 turns No. 20 s.c.c. on 1½-inch form; cathode tap at 6th turn from ground.

L<sub>3</sub>—90 turns No. 28 s.c.c. on 1½-inch form; link 15 turns.  
 L<sub>4</sub>—42 turns No. 20 s.c.c. on 1½-inch form; link 10 turns No. 28.  
 L<sub>5</sub>—B.C. coil; link 15 turns No. 28.  
 L<sub>6</sub>—50 turns No. 28 s.c.c. on 1-inch form; link 7 turns.  
 L<sub>7</sub>—30-henry filter choke.  
 T—Same as in Fig. 1.

cuit stable once the initial warm-up period is over. As was mentioned above, the plate circuit and the output circuits are tuned to different frequencies, giving a band-pass effect insofar as output is concerned.

The usual constructional "musts" that everyone hurriedly skips are now in order. First,

whether you like it or not, the oscillatory circuit components should be rigidly moored to the chassis. This takes time, but when the cat tramps out of the room your frequency won't take 10-kc. jumps with every foot-fall. After all, a cat is a quadruped. Short stiff wiring also is necessary if stability is to be obtained. A reasonable amount of hay-wire work is permissible elsewhere, for there are twenty million receivers working at these frequencies despite the best efforts of those intent on making it tough for the service man.

There is only one unusual feature in the circuit; namely, the method employed in keying or standing by. It is common practice to break some part of the oscillatory circuit for this purpose, but it was found that if this is done the position and length of keying leads affected the frequency even though the

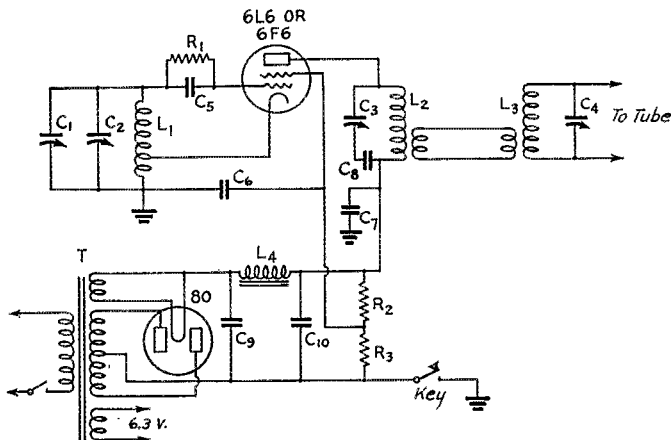

FIG. 1—CIRCUIT DIAGRAM OF THE FREQUENCY-CONTROL UNIT

C<sub>1</sub>—140- $\mu\text{f}.$  variable (band-spread).  
 C<sub>2</sub>—400- $\mu\text{f}.$  variable (band-set); two-gang b.c. type paralleled.  
 C<sub>3</sub>, C<sub>4</sub>—220- $\mu\text{f}.$  mica trimmers.  
 C<sub>5</sub>—100- $\mu\text{f}.$  mica.  
 C<sub>6</sub>, C<sub>7</sub>—0.01- $\mu\text{f}.$  mica.  
 C<sub>8</sub>—0.005- $\mu\text{f}.$  mica.  
 C<sub>9</sub>, C<sub>10</sub>—8- $\mu\text{f}.$  electrolytic, 450-volt.  
 R<sub>1</sub>—100,000 ohms, 1-watt.  
 R<sub>2</sub>, R<sub>3</sub>—5000 ohms, 10-watt.

L<sub>1</sub>—45 turns No. 28 s.c.c. on 1½-inch form; cathode tap at 15th turn from ground.  
 L<sub>2</sub>, L<sub>3</sub>—Broadcast-type coil (Meissner) with primary removed and 15-turn link wound on.  
 L<sub>4</sub>—30-henry choke.  
 T—Power transformer, 250 volts at 40 ma., with 6.3- and 5-volt filament windings.

keying leads are heavily by-passed. Accordingly, the oscillatory circuit was tied down permanently and the B-minus connection to the chassis opened and closed instead. It should be noted that the high-voltage winding center-tap, the bleeder, and the negative side of the high-voltage condensers connect together and to one side of the key. The other side connects to chassis, but when the key is up the bleeder load is still on the power supply.

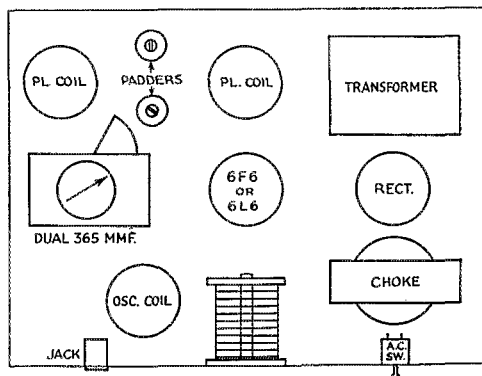

FIG. 3—SUGGESTED LAYOUT FOR THE CIRCUIT OF FIG. 2

With 250 volts on the plate and about 150 on the screen, both the 6F6 and the 6L6 function satisfactorily. The latter gives somewhat greater output, as would be expected. When pentode crystal oscillators are employed, the 6F6 will furnish sufficient output to drive such tubes as doublers. The photo shows the oscillator coil just peeping over the top at the left. Back of it in the shield can is the output plate coil. Between the coil and the tube is the tuning condenser for the plate circuit. It is mica-tuned with a screw-driver adjustment. The 0.005 condenser keeps the d.c. off the screw so that no short circuit to chassis will occur while this circuit is being resonated with the conventional uninsulated screw driver. The b.c.l. condenser is mounted directly in front of the tube, but the band-spread condenser is hidden by the front panel. The mica trimmers on the b.c.l. condenser should be removed as a precaution against drift. The cable and the output circuit with its tuning condenser mounted on a 5-prong base, also are shown. Ordinary receiving doublet wire is used for the transmission line. Both b.c.l. coils should have the primaries removed and a fifteen-turn winding wound over the secondary at the "cold" end. This size link winding seems to give sufficient overcoupling so that the band-pass feature is obtained.

#### OPERATION

The unit is placed into operation in a very simple manner. After the usual check of connections and circuit, the tubes should be inserted and the

power turned on. If a closed circuit jack is used it will not be necessary to plug in the key in order to have the unit operate, although the circuit must be broken if break-in operation is employed. Tune your b.c.l. set to a station around 860 kc., set the band-spread condenser at maximum capacity and turn the padder until a beat note is heard. With a dual condenser having 365  $\mu\text{mf}$ . per section this should occur with the plates about  $\frac{3}{4}$  in. By rotating the band-spread condenser to minimum capacity, it should be possible to tune in a station at 1010 kc. If this cannot be done the capacity of the band-spread condenser is incorrect, or the coil is not properly constructed. The plate circuit should next be tuned to resonance near one end of the band, and the output circuit near the other end. When this is done output is obtained throughout the band with two voltage peaks above average. A neon bulb can be used to determine the proper setting of the condensers. The output circuit must be retrimmed slightly when it is placed in the socket because of the added capacity across it.

#### A TWO-BAND ARRANGEMENT

This unit works in fine shape but it is limited in scope to transmitters employing 160-meter crystals. It was decided that a substitute for 80-meter crystals also would be a nice thing to have around, so unit No. 2 was constructed. The circuit is essentially the same as that of the first unit, but two sets of plug-in coils are used. The energy is transmitted by means of a three-wire cable to two output circuits permanently tuned and plugged into crystal sockets in the transmitter. As this arrangement provides broadcast and 160-meter output, both 160- and 80-meter crystals are eliminated.

The power supply and the oscillatory circuit are the same but the arrangement of the plate circuit, in order to provide the two-band outputs without retuning, is different. Coils  $L_1$ ,  $L_3$  and  $L_5$  provide broadcast output. The others furnish 160-meter output.  $L_1$  and  $L_2$  plug into the same socket, but  $L_3$  and  $L_4$  require separate sockets so that their tuning may be permanently set and the energy transferred to the proper output circuit. If the diagram is followed carefully no undue difficulties should be encountered.

The units have been tried at W3BJR and air tests check with those made against the extremely stable broadcast carriers. A clean signal with a T9 note and practically no chirp is obtained. After the initial warm-up period of fifteen minutes the drift is a matter of cycles between transmissions with the transmitter resuming operation on the original frequency in a matter of seconds. The ability to light on the frequency of the station with whom you desire to make contact, and conversely the ability to leave a heavily QRM'd channel at a moment's notice, make such a unit a worth-while addition to any station.



# Combined Beat Oscillator and I.F. Amplifier

## An Easily-Applied Circuit Which Does Not Affect Normal Operation of the Receiver

By F. W. Schor\*

WHERE additional socket space is at a premium or where for reasons of economy another tube is not available, it is desirable to combine the functions of beat-frequency oscillator with those of another tube. The usual result is some impairment in the performance of the other function of this tube, so that in the end another tube usually is added for the separate oscillator anyway.

It was found that the 6L7 makes a very good intermediate-frequency amplifier, running a close second to the familiar 6K7. In addition, the injector grid presents some interesting possibilities. It was at first thought that this injector grid could be coupled into the cathode using a conventional oscillator transformer. Any additional impedance in the cathode circuit immediately produced an unstable amplifier so the only thing left to do was to find some method of coupling between the plate circuit and the injector grid without appreciably affecting the i.f. amplification.

Referring to Fig. 1, it will be seen that the 6L7 is used as a conventional i.f. amplifier exactly as the 6K7 would be except that the injector-grid terminal (which is the suppressor grid terminal on the 6K7) is connected to one end of coil  $L_1$ .

The plate circuit of this tube is also conventional when the beat-frequency oscillator switch is closed. The b.f.o. is off when this occurs. Upon opening the switch, however, that portion of the plate circuit across  $R_1$  is connected to the lower end of coil  $L_1$  through condenser  $C_2$ . The oscillating circuit frequency is determined by  $L_1C_1$ . A small variable condenser  $C_3$  of about 50  $\mu\text{fd}$ . is used to control the pitch.

With the b.f.o. switch open, the 6L7 tube will oscillate efficiently while it amplifies at the intermediate frequency. We have heard fellows say that one tube cannot oscillate and amplify effi-

ciently at the same frequency but there it is. However, the catch is that the oscillation takes place at 155 kc. or the third sub-harmonic<sup>1</sup> of the i.f. frequency, 465 kc. The third harmonic is more than strong enough to give a good beat note and it will be found that the most powerful c.w. signals, including local broadcasters, will not block out the beat note. At the same time, there will be no difficulty in picking the weaker c.w. tweets out of the mush.

For proper operation of this circuit, it is essential that the oscillator circuit be not overcoupled but rather coupled just enough for oscillation to take place in the injector grid circuit. The coupling can be varied by changing the relative position of the tap on the coil  $L_1$  or easier still by varying  $R_1$ . The values given have worked with

(Continued on page 80)

<sup>1</sup> I. e., one-third the fundamental frequency.

An easy method of converting the all-wave b.c. receiver for c.w. reception. On sets using octal-based tubes, no socket changes are necessary, and the circuit additions are few.—  
EDITOR

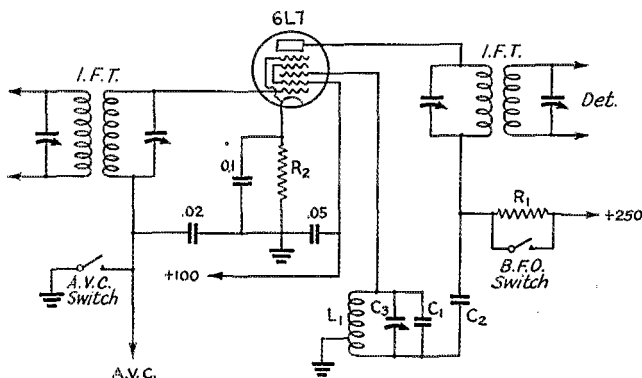

FIG. 1—COMBINED I.F. AMPLIFIER AND BEAT-FREQUENCY OSCILLATOR USING A 6L7

$C_1$ —0.0015  $\mu\text{fd}$ . (see text).

$C_2$ —0.01- $\mu\text{fd}$ . paper.

$C_3$ —50- $\mu\text{fd}$ . variable (pitch control).

$R_1$ —10,000 ohms, 1-watt.

$R_2$ —300 ohms, 1/2-watt.

$L_1$ —200 turns No. 36 pie-wound (i.f. coil fashion) with tap at 65 turns; larger coil section connected to grid.

(Note: The familiar 2.5-mh. sectional-wound r.f. choke also could be used, in which case the capacity required at  $C_1$  would be between 400 and 500  $\mu\text{fd}$ .; an appropriate trimmer should be substituted. The tap could be taken off one or two sections from the plate end.—EDITOR)

\* Engineering Staff, Hallcrafters, Inc., Chicago.

# A Transmitter of General Utility

Simple Three-Tube Exciter or Transmitter With Inexpensive Tubes

By Don H. Mix,\* WITS

**A**LTHOUGH the trend in amateur transmitter design these days seems to be in the direction of those features which provide a maximum of operating convenience, even though they may involve complexity, many of us are willing to get along with some sacrifice in convenience for the sake of simplicity in circuit and construction. This conviction is quite apt to be prevalent in the minds of those who hesitate to tackle the more complicated jobs because of limited previous experience and those whose occupations limit the amount of time available for constructional work.

## CIRCUIT DETAILS

In designing the transmitter shown in the accompanying photographs, effort was directed towards keeping the circuit as straightforward as possible while maintaining a broad field of utility. Thus, in the circuit, the diagram of which appears in Fig. 1, the grid-plate oscillator was chosen because it delivers satisfactory second-harmonic output although it requires tuning but one circuit. It has a reputation for being "easy" on the crystal, and keys well. The 6L6G in the buffer-doubler stage is connected as a triode principally to increase the plate-grid capacity, thus avoiding tricky neutralizing adjustments. The use of the tube in this manner also avoids critical adjustment of excitation often found necessary with beam-type tetrodes and pentodes. With the connection shown, greater power output is obtainable at low plate voltage than with the

\* Technical Department, QST.

high- $\mu$  connection, sometimes used, in which the screen forms part of the control grid.

Excitation for the final amplifier is taken from the "neutralizing" end of the buffer-doubler tank coil instead of the "plate" end to help maintain a better balance for neutralizing. The blocking condenser  $C_3$  insulates the rotors of the tank condenser from ground, permitting the use of a tank condenser with less spacing between plates. The tank condenser specified has sufficient range to permit the use of at least optimum capacity on all bands except the 1.75-Mc. band. Here a fixed air condenser  $C_{10}$  must be connected across the coil to maintain optimum capacity for the purpose of reducing harmonic output and maintaining linearity with plate modulation.

Output may be obtained on three bands with a single 1.75-, 3.5- or 7-Mc. crystal of properly selected frequency. A variety of tubes may be used in the final amplifier. With the 809, RK-11, RK-12 or HY57, an output power of approximately 50 watts is obtainable as a c.w. transmitter or exciter, or approximately 35 watts as a plate-modulated amplifier. With a plate voltage of 1000 such tubes as the T40, TZ40, or HY40 will deliver 70 watts or so for c.w. or driver work. A carrier output of 45 watts may be obtained for plate-modulated 'phone work.

## POWER-SUPPLY REQUIREMENTS

Since power-supply requirements depend upon the selection of the tube to be used in the final amplifier, some thought should be given in this direction. A single 6.3-volt filament transformer

will suffice if the Type 809, RK11-12 or HY57 is selected. It should have a current rating of five amperes. If any of the other tubes mentioned above is selected, a separate 7.5-volt filament transformer will be required.

A plate-voltage supply delivering 450 volts with a rating of about 150 ma. will be required for the oscillator and buffer-doubler. The 809, RK11-12 or HY57 will require a 750-volt supply rated at 150 ma. for c.w. operation or 600 volts at 125 ma. for 'phone operation. The larger tubes require 1000 volts at 150 ma.

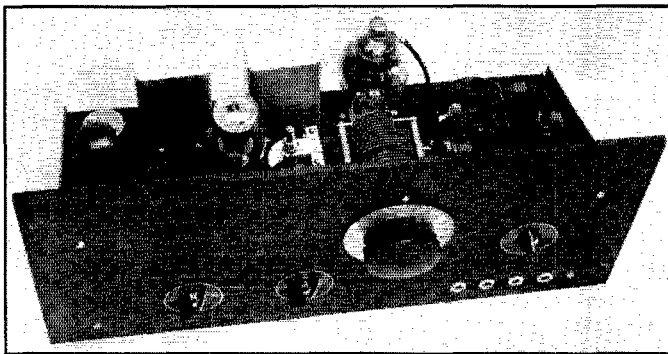

TOP VIEW — SHOWING PANEL AND CHASSIS ARRANGEMENT

6L6's or 6L6G's may be used in the driver stages and 809, RK11, RK12, HY57, T40, TZ40, HY40, or similar tubes may be used in the final amplifier. An insulated dial must be used on the final tank condenser.

for c.w. work or 800 volts at 125 ma. for 'phone work. Rated plate currents for the smaller tubes are 100 ma. for telegraphy and 83 ma. for plate-modulated 'phone operation, and for the larger tubes, 115 ma. for telegraphy and 90 ma. for telephony. Some additional allowance must be made for bleeder current. The tank condenser specified was selected with the above ratings in mind. A source of 90-volts is required for biasing purposes.

#### CONSTRUCTION

The unit is built up on a standard 7" by 17" by 2½" chassis with a 8¾" by 19" Masonite rack panel. The photographs require little explanation. A five-prong socket is required for the crystal located in the left rear corner for accessibility. The oscillator and buffer-doubler plate tank coils are mounted in National PB10 individually shielded plug-in units requiring five-prong sockets. The final-amplifier neutralizing condenser, the final tank condenser, immediately to the right, and the final tank coil plug-in strip are

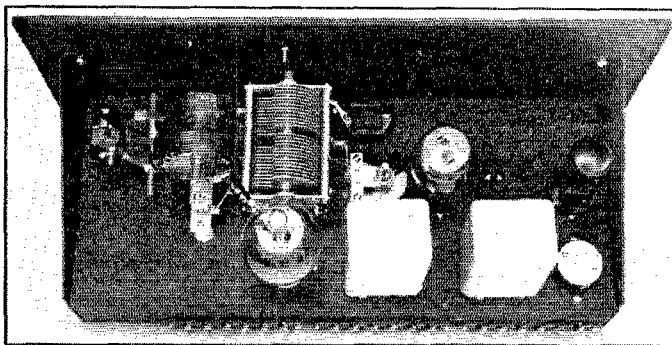

REAR VIEW SHOWING PLACEMENT OF PARTS

*Final amplifier neutralizing condenser is mounted next to the tank condenser on small stand-off insulators. The blocking condenser  $C_8$  may be seen close to the panel to the right of the tank condenser. Hole for the 6L5 neutralizing condenser may be cut in the space between the two coil shields. (See text.)*

Referring to the photograph showing the bottom view of the chassis, it will be noticed that all sockets and the tuning condensers for the oscillator and buffer-doubler plate circuits are mounted beneath the chassis. The socket for the final amplifier tube is lowered about one inch so that the panel height may be limited to 8¾ inches. This arrangement permits convenient wiring with short leads and provides shielding between grid and plate circuits of the final amplifier. It also

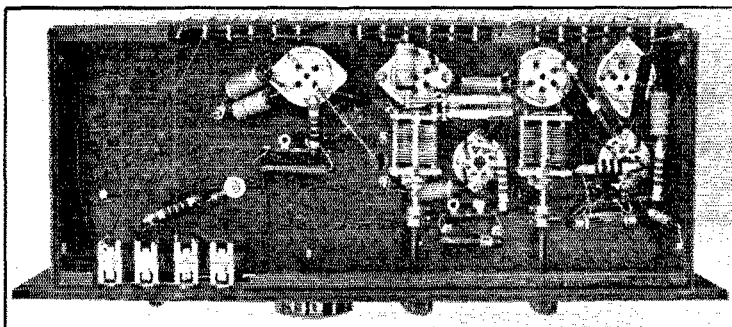

BOTTOM VIEW — SHOWING ARRANGEMENT OF WIRING AND COMPONENTS

*R.f. leads are short. By-pass condensers are grounded to the nearest mounting screw. Note clearance hole for wire between final neutralizing condenser and grid of tube.*

results in an exceptionally clean chassis top with a minimum of wiring showing. In the final form, a 12- $\mu$ fd. midget condenser was substituted for the two National NC600 neutralizing condensers shown in the photograph. It is mounted in approximately the same position with a clearance hole for the shaft between the two shielded coils so that it may be adjusted from the top of the chassis with an insulated screwdriver. The oscillator cathode-circuit inductance (r.f. choke) with its shunting 100- $\mu$ fd. fixed condenser may be seen mounted close to the oscillator-tube socket. The chassis is cut out at the rear and in front for the terminal strips and meter jacks. The jacks require no additional insulation since they are mounted on the Masonite panel rather than on the metal chassis. Series feed, placing both sides of the small tuning condensers at plate voltage, necessitates the use of small insulating flexible-shaft couplings. In mounting the panel, the lower edge is dropped one-half inch below the lower edge of the chassis to provide additional depth for the two variable condensers. The

mounted on five-eighths-inch Johnson stand-off insulators. If a plate voltage above 750 is used, a neutralizing condenser with greater spacing, such as the NC800, should be used. In fact, this type will do for any of the tubes mentioned. Sufficient space should be left at the right-hand end of the chassis to allow the variable link to be swung out to minimum coupling. If the arrangement of parts shown in the photographs is followed, space will be left in the rear right-hand corner for the fixed air padding condenser for 1.75-Mc. operation. The mica plate-circuit blocking condenser is mounted near the front end of the tank condenser to the left.

supporting side brackets are also dropped the same distance.

### WIRING

The location of the chief components is such that very little r.f. wiring is required. Short, rigid leads of an inch or so are sufficient to connect the low-power tank condensers to their respective coil sockets. Mica coupling condensers with pig-tail terminals are self-supporting and require no mountings. By-pass condensers are connected directly to the points to be by-passed and then grounded at the most convenient mounting screw. Care should be taken to make sure that these mounting screws make good contact with the chassis. In one or two places, it will be found convenient to use insulating anchor strips to support the junction between r.f. and resistor in series. Frequently, unused tube-socket or coil-socket terminals may be pressed into service for this purpose.

All power wiring is done with push-back wire. If plate voltages as high as 1000 are to be used, however, it would be wise to use wire with heavier insulation for circuits carrying this voltage. The meter jacks may be wired in before the panel is fastened to the chassis, leaving sufficient length to permit mounting when the panel and chassis are assembled. Care should be taken to connect the jacks so that the meter will read in the proper

direction when plugged into any of the four jacks. If the tip of the plug is connected to the positive side of the meter, the jack spring which makes contact with the plug tip should be connected to the positive high-voltage supply terminal in the case of the plate-circuit jacks and to the negative biasing terminal in the case of the grid-circuit jacks.

### COILS

Coils for the oscillator and buffer-doubler plate tank coils are all wound on XR2 one-inch-diameter coil forms and the forms mounted inside the PB10 shielded units. Winding data may be taken from Table I. Where the winding length permits, the turns specified should be spaced out to occupy the specified length. The tap on the buffer-doubler coil should be made as accurately at the center as possible so that it will not be necessary to reneutralize in changing bands. It may be necessary to shift the tap slightly to find the correct point. Dimensions given in the table should be followed as rigidly as possible. This applies particularly to the buffer-doubler coil since any appreciable deviation will make it impossible to tune to both of the bands for which the coil is designed.

In the final amplifier, Barker & Williamson type BVL coils are used. The 3.5- and 7-Mc. coils must be pruned as indicated in the Table I. The

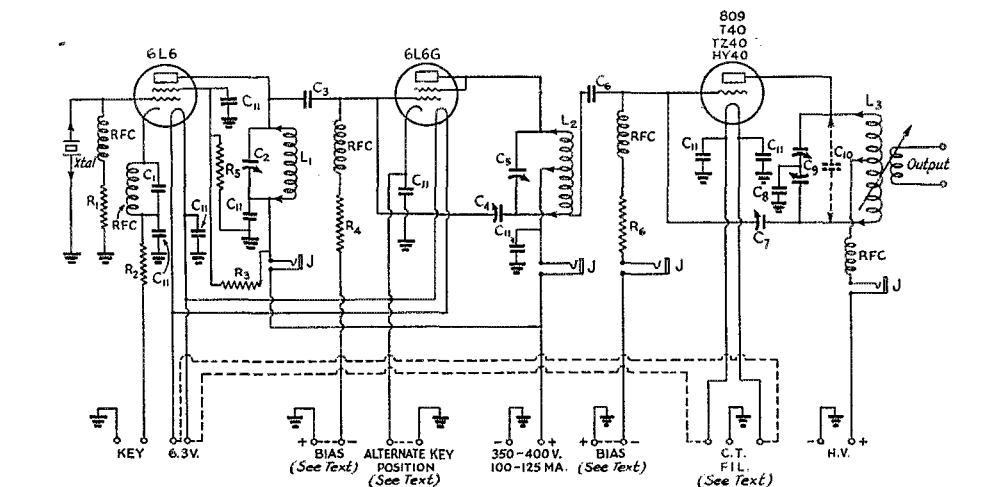

FIG. 1 — CIRCUIT DIAGRAM

- |  |  |   |
|--|--|---|
| <p>C<sub>1</sub>—100-<math>\mu</math>fd. mica.<br/>C<sub>2</sub>—140-<math>\mu</math>fd. midget (Cardwell ZU140AS) with mounting bracket.<br/>C<sub>3</sub>—100-<math>\mu</math>fd. mica.<br/>C<sub>4</sub>—12-<math>\mu</math>fd. (National UM-50) alternate plates removed.<br/>C<sub>5</sub>—140-<math>\mu</math>fd. midget (Cardwell ZU140AS) with mounting bracket.<br/>C<sub>6</sub>—100-<math>\mu</math>fd. mica.<br/>C<sub>7</sub>—25-<math>\mu</math>fd. (National ST-25) or NC 800 (see text).</p> | <p>C<sub>8</sub>—0.002-<math>\mu</math>fd. mica (Cornell-Dubilier 5000-volt).<br/>C<sub>9</sub>—260 <math>\mu</math>fd. per section (Cardwell MR260BD), spacing 0.03".<br/>C<sub>10</sub>—150-<math>\mu</math>fd. fixed air padding condenser for 1.75-Mc. band (Cardwell EO150FS), 0.05" spacing.<br/>C<sub>11</sub>—0.01-<math>\mu</math>fd., 600-volt paper (non-inductive).<br/>R<sub>1</sub>—100,000 ohms, 1 watt.<br/>R<sub>2</sub>—400 ohms, 2 watts.</p> | <p>R<sub>3</sub>—15,000 ohms, 10 watts.<br/>R<sub>4</sub>—10,000 ohms, 10 watts.<br/>R<sub>5</sub>—10,000 ohms, 10 watts.<br/>R<sub>6</sub>—50,000 ohms, 2 watts.<br/>R<sub>6</sub>—1500 ohms, 2 watts for 809, RK12, TZ40, HY57; 5000 ohms, 10 watts for RK11, T40, HY40.<br/>RFC—Radiofrequency choke—National R100.<br/>J—Single open-circuit jack. See Table I for coil dimensions.</p> |
|--|--|---|

COIL TABLE I

Coil	Turns	Wire	Diameter	Length
No. 1	62	No. 26 d.s.c.	1"	1 1/4"
No. 2	42	No. 22 d.s.c.	1"	1 1/4"
No. 3	22	No. 22 d.s.c.	1"	1"
No. 4	10	No. 18 d.c.c.	1"	1"
No. 1D	58	No. 28 d.s.c.	1"	1" *
No. 2D	32	No. 22 d.s.c.	1"	1 1/4" *
No. 3D	14	No. 18 d.c.c.	1"	1" *
No. 4D	7	No. 18 d.c.c.	1"	1" *

\* Tapped at center.

- Coil No. 1A—B & W BVL-80, no alteration  
Inductance—30 microhenrys  
Optional coil—15 turns, 5" diam., No. 14 double-spaced
- Coil No. 2A—B & W BVL-80, remove 4 turns from each end  
Inductance—17 microhenrys  
Optional coil—21 turns No. 14, 2 1/2" diam., 3" long
- Coil No. 3A—B & W BVL-40, remove 3 turns from each end  
Inductance—8.5 microhenrys  
Optional coil—13 turns No. 14, 2 1/2" diam., 1 7/8" long
- Coil No. 4A—B & W BVL-20, no alteration  
Inductance—3.1 microhenrys  
Optional coil—9 turns No. 14, 2 1/2" diam., 2 1/2" long
- Coil No. 5A—B & W BVL-10, no alteration  
Inductance—1 microhenry  
Optional coil—4 turns No. 14, 2 1/2" diam., 1 1/8" long

BVL-80 coil will do for the 1.75-Mc. band without alteration. Therefore, in purchasing the set, the 1.75-Mc. coil should be omitted, substituting a second BVL-80. Proper inductance values as well as typical dimensions are given in the table.

TUNING

After wiring has been checked carefully to make certain that no error has occurred, proper filament voltage should be applied. If a 6.3-volt tube is used in the final amplifier, the two sets of terminals may be connected in parallel as indicated by the dotted lines. The terminals for the alternate key position should be strapped together with a wire and the key connected in the oscillator circuit. The biasing voltage should be connected to the terminals indicated; a voltage of 90 is required for the 6L6G. If a pair of 45-volt batteries is used for this purpose, a tap may be taken off at 45 volts for the final amplifier. Care should be taken that the grid-leak resistance is proper for the tube used in the final amplifier as indicated under Fig. 1. A milliammeter should be connected temporarily in series with the negative biasing lead to the 6L6G with the positive terminal of the meter towards the battery. A second milliammeter with a scale of not less than 200 ma. should be plugged into the first meter jack to the left in the oscillator plate circuit and an open-circuit dummy plug inserted in the second jack in the plate circuit of the 6L6G. Suitable crystal and coils for the desired frequency band should be plugged into the proper sockets. (See Table II.) It will be noticed that each buffer-doubler coil is designed to cover two adjacent bands so that coil changing will not be necessary so frequently. Somewhat higher driving power for the final amplifier will be obtained at the higher frequencies with coils which resonate at the desired fre-

quency with a low value of capacity. Adequate power should be obtainable with either arrangement, however.

For this initial test, a coil combination which permits using the 6L6G as a straight amplifier should be chosen. With coils and crystal in place, the low-voltage plate supply may be connected and turned on. With the key closed, the oscillator plate current should rise to 60 or 70 ma. The oscillator tuning condenser should be rotated until a dip in plate current is obtained. At minimum dip, the oscillator plate current should be somewhere between 25 and 40 ma., the lower values being obtained at the low frequencies when not doubling frequency with the oscillator. Simultaneously a reading should be obtained on the meter connected temporarily in the grid circuit of the 6L6G; this grid current should run 15 to 20 ma. unless the plate circuit of the 6L6G happens to be tuned to resonance. The plate tank condenser of the buffer-doubler circuit should then be tuned, carefully watching the grid-current meter to detect any change in the reading. Starting with the 6L6G neutralizing condenser at minimum capacity, the capacity should be increased bit by bit, each time checking for change in grid current with tuning of the 6L6G plate tank circuit. A point should soon be reached where the tuning has no effect whatsoever upon the grid-current reading and the stage is neutralized. Increasing the capacity of the neutralizing condenser further should bring back the dip in grid current with plate-circuit tuning, indicating that the correct neutralizing point has been passed. Incidentally, the oscillator tank circuit should be adjusted occasionally to maintain maximum grid current.

The dummy plug may now be removed and the meter plug transferred to the second jack. Again, closing the key should cause a plate current in excess of 100 ma. if the 6L6G plate circuit is

(Continued on page 62)

COIL INDEX—TABLE II

Crystal Freq.	Output Freq.	L1	L2	L3	C5
1.75 Mc.	1.75 Mc.	No. 1	No. 1D	No. 1A	High
1.75 Mc.	3.5 Mc.	No. 2	No. 1D	No. 2A	Low
1.75 Mc.	3.5 Mc.	No. 2	No. 2D	No. 2A	High
1.75 Mc.	7 Mc.	No. 2	No. 2D	No. 3A	Low
1.75 Mc.	7 Mc.	No. 2	No. 3D	No. 3A	High
3.5 Mc.	3.5 Mc.	No. 2	No. 1D	No. 2A	Low
3.5 Mc.	3.5 Mc.	No. 2	No. 2D	No. 2A	High
3.5 Mc.	7 Mc.	No. 2	No. 2D	No. 3A	Low
3.5 Mc.	7 Mc.	No. 2	No. 3D	No. 3A	High
3.5 Mc.	7 Mc.	No. 3	No. 2D	No. 3A	Low
3.5 Mc.	7 Mc.	No. 3	No. 3D	No. 3A	High
3.5 Mc.	14 Mc.	No. 3	No. 3D	No. 4A	Low
3.5 Mc.	14 Mc.	No. 3	No. 4D	No. 4A	High
7 Mc.	7 Mc.	No. 3	No. 2D	No. 3A	Low
7 Mc.	7 Mc.	No. 3	No. 3D	No. 3A	High
7 Mc.	14 Mc.	No. 3	No. 3D	No. 4A	Low
7 Mc.	14 Mc.	No. 3	No. 4D	No. 4A	High
7 Mc.	14 Mc.	No. 4	No. 3D	No. 4A	Low
7 Mc.	14 Mc.	No. 4	No. 4D	No. 4A	High
7 Mc.	28 Mc.	No. 4	No. 4D	No. 5A	Low

# Building Convenience into the Operating Table

An Easily-Constructed and Inexpensive Cabinet Which Brings All Controls and Accessories Within Easy Reach

By Joseph Walker and Charles L. Cox, Jr., W3FPE\*

HOW often have you heard remarks such as these: "One of these days I intend to have a new layout here"; "Sorry, a wire just fell off and I had to put it on again before I could come back"; or, "Please allow me a few minutes to come back each time, as I have to jump up, throw three or four switches, change the antenna over to transmitter, etc., before I can settle down to enjoy our QSO."

Such conditions may be all right, if you care to put up with them. Take\*the following as an example: After a hard day's work, you hurry home to a quick dinner, then while the filaments are warming up for an evening of anticipated enjoyment, you must dust your feet in rosin and prepare to paddle five or ten miles per QSO, simply because you will not have operating switches at arms' length.

Is it not worth a little trouble to have your equipment so placed as to warrant a little comfort along with the pleasure of operating? We think so and, with this in mind, have designed a unit to meet this requirement. This project serves admirably as an example of the flexibility and utility of a few pieces of box lumber and plywood, which

are readily obtainable from wood piles or at local stores, which almost invariably have a few pieces to discard.

To begin with, we desired to have a central station, cabinet, or whatever we could obtain or build to house the receivers, monitors, controls, etc., having them so placed as to be out of the way and yet right at our fingertips for easy access when necessary. We also wanted to patch one unit into the other, should this be necessary for various reasons. The speakers should have their spot, being properly baffled to prevent hashy noises. These things seemed desirable, yet we knew that somehow everything would have to be compactly housed to be in a convenient position

and still present a fairly neat exterior that would please the OW, who hates the sight of a haywire assembly on the desk or, for that matter, anywhere. Her opinions are not to be contradicted, as open haywire equipment does present a source of danger to her as well as being a dust catcher *de luxe*.

The work required to complete this unit is straightforward and the time involved well spent. There are no really trick joints to bother one who, not being a cabinetmaker, might flinch at the idea; rather it can be easily constructed.

The materials to be used are the cheapest obtainable, and consist of box lumber cut to the desired lengths and sanded smooth. The paneling is  $\frac{1}{4}$ " fir plywood, finished on one side only.

While not entirely compact, this cabinet is 3 feet deep, 3 feet high, and 5 feet long. These dimensions can be altered to conform to individual needs.

A suggestion might be made here that should one have access to a power saw, a groove  $\frac{1}{4}$ " wide and  $\frac{1}{4}$ " deep could be made at each place where a panel is inserted and the plywood placed in these grooves. This method would doubtless improve both the strength and appearance, but it is not necessary, as sufficient strength is achieved in the other method of backing up the frame with the plywood.

At first we were doubtful about the possibility of covering up the grain in the plywood

Here's an unconventional arrangement which provides a lot of room in a small space. Even if you don't duplicate it you're bound to get some good ideas from reading this article.—EDITOR

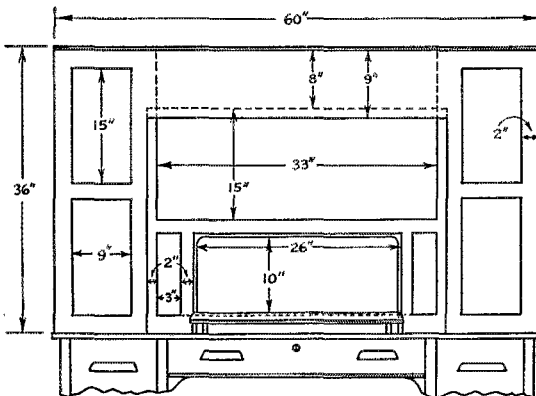

FIG. 1—FRONT-VIEW DRAWING, WITH DIMENSIONS OF THE DESK-TOP OPERATING CABINET SHOWN IN THE PHOTOGRAPH

Dimensions of the opening for the receiver will vary with the type of receiver used.

with paint, but this problem was overcome by the use of DuPont's flat black paint, a quart being more than sufficient to cover completely the entire cabinet with two coats, fully eliminating the grain and producing a smooth, glareless surface. Chrome stripping may or may not be added to this, depending upon the constructor's wishes.

A unique feature concerning the speaker installation results from the construction of the sides and back, a natural well for the speakers being formed, and for proper baffling a one-inch section of celotex is laid above the plywood. The speakers are mounted on this celotex after, of course, both the plywood and celotex have been pierced with a hole to the diameter of the opening of the cone. On the plywood, which is facing down towards the operator, a section of dark grill cloth is glued, completely covering these holes.

In all, there are five useful surfaces or sides, plus the speaker well, which can be used for varied purposes.

Our needs call for the two front diagonal panels to serve as the operating switch panels only. The

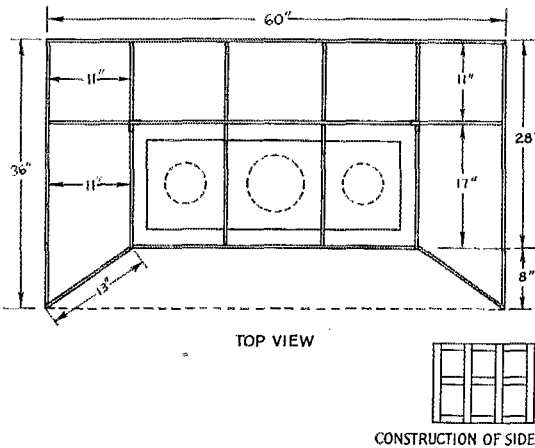
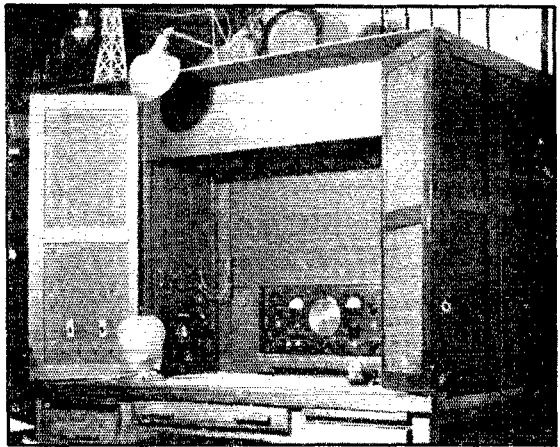

FIG. 2—TOP-VIEW DIMENSION DRAWING

The dotted circles indicate holes for speakers, in the horizontal member directly above the operating table. A space 8 inches deep is available for this purpose.

next two side panels (in our case) hold, left lower, 5-meter receiver; left upper, 5-meter monitor, audio oscillator; right lower, 2½-meter receiver; right upper, modulation monitor and frequency meter monitor. All input and output connections to these units terminate in pin jacks midway between upper and lower shelf (for patching purposes).

The back or main panel (lower section) holds a Skyriider receiver. The dimensions for this opening will vary with the type of receiver used. The



A DESK-TOP OPERATING CABINET WHICH PROVIDES A PLACE FOR ALL NECESSARY EQUIPMENT AND ASSURES CONVENIENT STATION CONTROL

receiver is in the lower center, resting on a sliding piece of plywood, the purpose being to slide the receiver out towards the operator (for comfort again!). On each side of the receiver are two tiny panels on which various pilot lights show up very effectively.

Now the question is up to the individual as to whether he would prefer to use the large panel or space above for other equipment or as a shelf for books, log, etc. It is there and can be utilized as one chooses. We put an oscilloscope there, this position being at eye level and therefore ideally suited for such a purpose. This space might also be used for a speech pre-amplifier unit.

The drawings illustrate the details of construction and general dimensions. Full information can be gained by a careful study of these drawings in conjunction with the photograph.

When this project is finished, you may be certain there is a place for all necessary gear, this being so placed as to be right at your fingertips, so that you can settle down with the feeling that your walking days per QSO are over.

## Strays

"Hardware cloth makes good side, top, and back panels for transmitters," suggests W9SDG. "Much cheaper than perforated metal, it also provides more ventilation and visibility. It is a good shield because all crossings of the wires are bonded. It resembles over-size window screen, and is available in ¼-, ⅜-, ½-, 5/8-, ¾-, and 1-inch mesh, with No. 23 or No. 14 iron wire.

# A 1.75- to 56-Mc. Crystal-Controlled Low-Power Transmitter

'Phone-C.W. Complete with Power Supply in One Cabinet

By Herbert W. Gordon,\* WIBY

**N**O doubt to a great many amateurs low power is a necessity, either for economic reasons or because of the b.c.l. interference problem. There is also the desire to operate in as much ham territory as possible. The construction of the outfit shown here was prompted by these factors, and this description is offered in the hope that it may benefit others similarly situated.

Several points had to be considered in the design of this transmitter. It had to be small physically, it had to cover all hands and be arranged so as to operate over a portion of each band; it had to have a minimum number of controls to facilitate rapid QSY.

Originally it was the intention to use a series of 6N7's in the r.f. end as well as in the audio, but while the set was in the paper stage and various 6N7 circuits were under consideration, the fundamental-reinforced harmonic-generator circuit was described in *QST*.<sup>1</sup> Since its

features seemed particularly suited to this outfit, the circuit was accordingly incorporated in the set.

As is often the case, the tube line-up depended to a considerable extent on the plate power available. The most suitable power transformer was deemed to be a Kenyon type T244, which delivers 425 volts each side of center at 165 milliamperes.

Using the 165 ma. as a base, a search through tube data showed that two 6F6's and a 6L6 could be used in the r.f. so that their drain, plus that of three 6N7's in the audio, would just equal 165 ma. under the expected operating conditions.

## THE CIRCUIT

The complete circuit diagram is given in Fig. 1. The 6F6 was

selected as a pentode crystal oscillator, not only because of plate-current economy, but also because of its relatively low crystal current. The second 6F6, the buffer-doubler, has its screen and control grids tied together for operation as a high- $\mu$  triode, so that it draws plate current only when excited by the oscillator.

The buffer-doubler's grid is connected to the oscillator plate by means of a mica condenser. This condenser is purposely small in capacity in order to reduce the possibility of too much oscillator loading.

The third and final r.f. tube, a 6L6G, is capacity-coupled through a small isolantite-insulated trimmer condenser to the plate of the 6F6 buffer-doubler.

The crystal-oscillator tube gets its grid bias from a resistor in the cathode circuit. This resistor serves two purposes; it reduces the non-oscillating plate current and it tends to make the crystal start more easily. Keying is accomplished in the cathode circuit of the 6L6G. Inserting the key in  $J_2$  also shorts the secondary of the modulation transformer; this was necessary because the surges resulting from keying are likely to break down the transformer. Then, too, it automatically makes available a slightly higher voltage for c.w. work by eliminating the drop in the

*This set has given a good account of itself on the air, despite the fact that the power output is only in the vicinity of ten watts. It is convenient to operate only two plug-in coils to change and one tuning adjustment to make when shifting bands. Can be used to drive a higher-power amplifier, of course.—EDITOR*

\* 69 Main St., Rocky Hill, Conn.

<sup>1</sup> J. L. Reinartz, "A Fundamental-Reinforced Harmonic-Generating Circuit," *QST*, July, 1937.

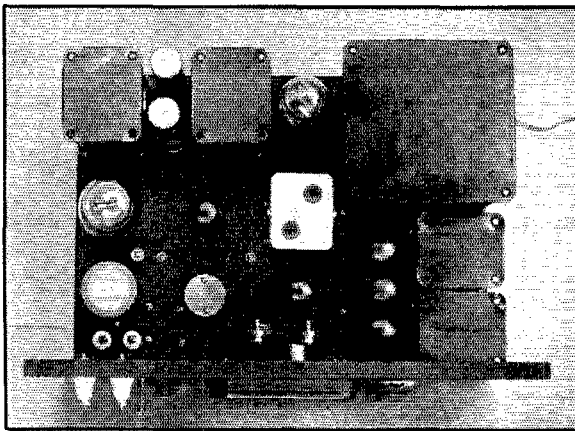

A TOP-OF-CHASSIS VIEW

Power supply components are along the back, speech amplifier at the right front. The 6L6G final tube and its tank coil are along the left-hand edge.



resistance of the secondary winding.

The meter reads the plate currents of all tubes simultaneously. When the a.c. switch is first turned on, all other switches should be off. After the filaments have warmed up, closing  $SW_2$  puts the oscillator in operation, and under these circumstances the oscillator plate and screen current can be read directly. With the oscillator tuned,  $SW_3$  may be closed, turning on the buffer stage. The meter will now read the sum of the plate currents of these two stages. When the buffer is tuned to resonance the current will rise to a peak.  $SW_4$  may now be turned on, and when the final tank circuit is adjusted to resonance there will be a pronounced dip in plate current. The meter will now read the total current of all three stages. To determine the Class-C current approximately, subtract the sum of the currents of the first two stages from the total reading. When the transmitter is to be modulated,  $SW_5$  is also closed, and with full modulation the current will swing upward about 20 ma. Because of the choke-input filter and the relatively heavy steady load on the plate supply filter, a 20-ma. plate-current increase results only in a 15-volt drop in plate voltage.

If the transmitter accidentally is turned on before the filaments are warm, no harm will be done because the heater of the 83-V takes as long to reach its operating temperature as do the other tube heaters. A check of the voltage drop across various rectifiers indicates that with the load imposed by this unit, the drop is as low with an 83-V as with an 83.

#### CONSTRUCTION

The complete transmitter is built on a black-crackle chassis measuring 13 by 10 by 3 inches, fitting a cabinet measuring 14 by 11 by 10.

The paper wrapper in which the chassis comes can be used as a template, the points where the holes are to be drilled being marked in pencil. These markings then are prick-punched into the metal pre-

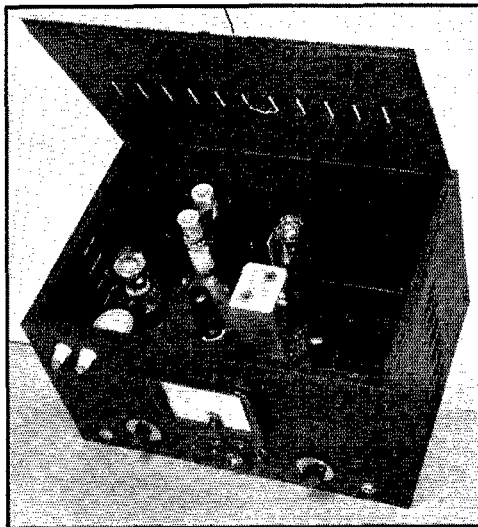

**TRANSMITTER, MODULATOR AND POWER SUPPLY COMPLETE IN ONE SMALL CABINET**  
*Power output averages 10 watts or better at normal input, on all bands from 1.75 to 56 Mc. Pre-tuned tank circuits are used in the exciter.*

audio and 83-V sockets Amphenol type.

After the chassis has been drilled and all rough edges have been cleaned smooth, a sketch of the panel layout should be made. Plenty of room should be allowed for the switches underneath the junction of chassis and panel.

When assembling parts on the panel, those that mount through both chassis and panel should first be fastened firmly to the chassis alone by means of a thin nut. Then, when the panel is fastened in place, the first nut anchors the part to

paratory to drilling. A hole should be cut in the back of the cabinet for connection to an external standby switch; the connections are made to a two-terminal strip which is fastened on the back wall of the chassis immediately to the rear of the power transformer.

A metal strip two inches wide by 7 or 8 inches long fastened under the chassis between the audio and r.f. wiring helps materially in reducing coupling between these two sections.

It is wise to use a liberal supply of tie-ins, soldering lugs, and conical insulators. These all help to provide rigid wiring. All the r.f. tube sockets are of steatite or isolantite, while the

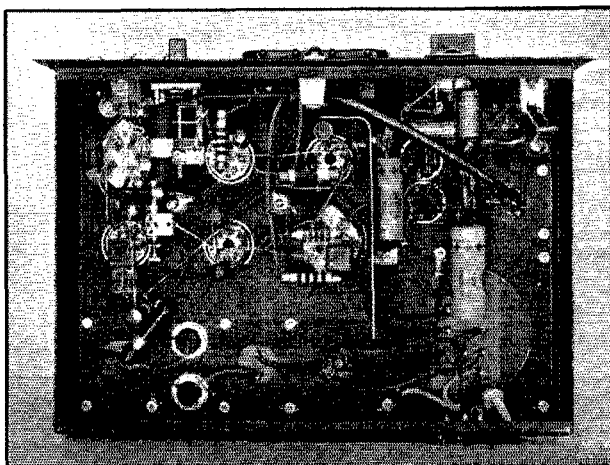

**BELOW-CHASSIS WIRING IS SHOWN IN THIS PHOTOGRAPH**

the chassis and the second nut, on the outside of the panel, holds the assembly firm. This provides a space between the chassis and the panel into which the front lip of the bottom of the cabinet will fit.

Another necessary precaution is to leave plenty of space between the coil-socket prong rivets and the edges of the socket holes in the chassis, to prevent possible short circuits.

Small lock washers biting into the paint are necessary to make good electrical grounds. Of course, it is wise to supplement the lock-washer contacts by scraping away the enamel. In wiring, a strip of bus or heavy tinned wire should be connected between the important r.f. grounds. Actually there are three connections of this type; one between the front baffle-shield bolt and the d.c. blocking condenser,  $C_{13}$ ; another from the ground side of  $C_9$  and  $C_{10}$  to the same blocking condenser; and the third connecting the cathode of the buffer to the ground side of  $C_9$ .

So far as possible, r.f. wiring is short and direct, while d.c. and a.f. wiring is kept separate from the r.f. and close to the chassis.

It is important that  $C_{17}$  and  $C_{21}$  be as specified, otherwise the high gain of the first 6N7 may cause motorboating.

#### MAKING THE COILS

The r.f. coils are not difficult to make if directions are followed closely. The specifications shown in Fig. 1 are the result of a great deal of cut-and-try, and because of the critical coupling between  $L_1$  and  $L_2$  as well as the small capacity of  $C_{12}$  it is suggested that they be followed closely.

The procedure in making  $L_1$ - $L_2$  for each band is as follows: First remove the base screws on the FXTB assemblies, then the hex nuts near the top. The shield may then be removed and the form itself may be clamped in a small vise just tight enough to hold it securely when drilling. Three pairs of  $\frac{1}{16}$ -inch holes are drilled, one pair at the completion of  $L_1$ , one pair at the start of  $L_2$  and one pair at the end of  $L_2$ . Because the small soldering lug forms an anchorage for the "hot" side of  $L_1$  no holes are necessary at this end. At the other coil ends, the wire should be drawn through one hole and out the other in order to

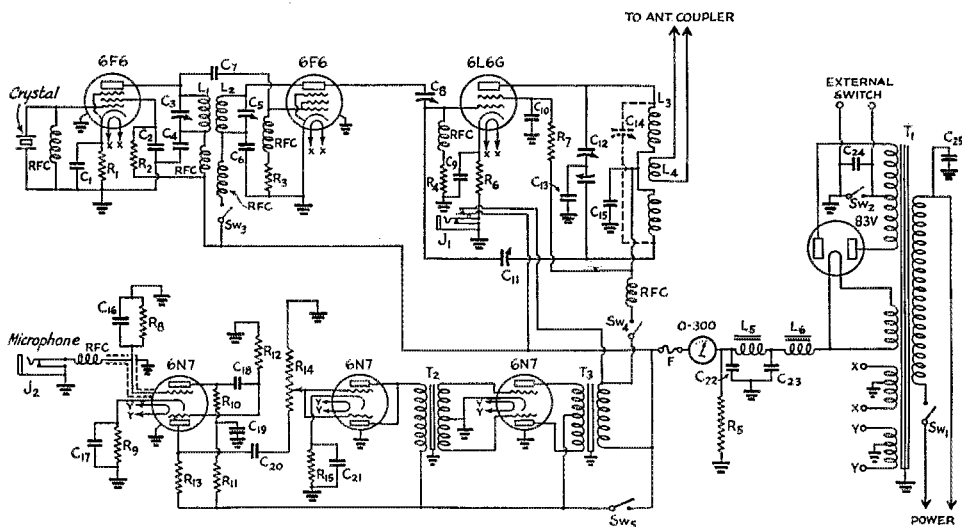

FIG. 1—CIRCUIT DIAGRAM OF THE COMPLETE TRANSMITTER

- |  |  |   |   |
|--|--|---|---|
| $C_1, C_{18}, C_{20}, C_{25}$ —0.01- $\mu$ d. paper, 600-volt.       | APC-100) for 1.75 and 3.5 Mc. only                     | $R_6$ —300-ohm, 5-watt.                             | 425 v. each side c.t., with 5-v. and two 6.3-v. filament windings (Kenyon T-244). |
| $C_2$ —250- $\mu$ d. mica.   | $C_{15}$ —0.006- $\mu$ d. paper, 600-volt.             | $R_7$ —15,000-ohm, 10-watt.                         | $T_2$ —Class-B input transformer, 6N7-6N7 (Kenyon T-251).                         |
| $C_3, C_4$ —75- $\mu$ d. midget (in National FXTB assembly).         | $C_{16}$ —200- $\mu$ d. mica.                          | $R_8$ —5-megohm, $\frac{1}{2}$ -watt.               | $T_3$ —Class-B output transformer, 6N7 to 3000 or 5000 ohms (Kenyon T-451).       |
| $C_4, C_6, C_9, C_{10}, C_{13}$ —0.001- $\mu$ d. mica.               | $C_{17}$ —50- $\mu$ d., 35-volt electrolytic.          | $R_9$ —2000-ohm, $\frac{1}{2}$ -watt.               | $L_5$ —Filter choke, 10 henrys, 200 ma. (Kenyon T-152).                           |
| $C_7$ —40- $\mu$ d. mica.  | $C_{19}$ —8- $\mu$ d., 450-volt electrolytic.          | $R_{10}, R_{13}$ —100,000-ohm, $\frac{1}{2}$ -watt. | $L_6$ —Swinging choke, 5–20 henrys, 200 ma. (Kenyon T-506).                       |
| $C_8$ —50- $\mu$ d. variable.  | $C_{21}$ —25- $\mu$ d., 35-volt electrolytic.          | $R_{11}$ —20,000-ohm, $\frac{1}{2}$ -watt.          | F—250-ma. Littlefuse.   |
| $C_{11}$ —Neutralizing condenser (National NC-600).                  | $C_{22}, C_{23}$ —16- $\mu$ d., 450-volt electrolytic. | $R_{12}$ —500,000-ohm, $\frac{1}{2}$ -watt.         |   |
| $C_{12}$ —Split-stator, 25 $\mu$ d. per section (Cardwell ER-25-AD). | $C_{24}$ —0.1- $\mu$ d. paper, 600-volt.               | $R_{14}$ —500,000-ohm potentiometer.                |   |
| $C_{14}$ —100- $\mu$ d. midget (Hammarlund                           | $R_1$ —500-ohm, 2-watt.                                | $R_{15}$ —1000-ohm, $\frac{1}{2}$ -watt.            |   |
|  | $R_2$ —50,000-ohm, 1-watt.                             | RFC—2.5-mh. r.f. choke (National R-100).            |   |
|  | $R_3$ —15,000-ohm, 1-watt.                             | $Sw_1$ - $Sw_5$ , inc.—S.p.s.t. toggle switch.      |   |
|  | $R_4$ —12,500-ohm, 2-watt.                             | $J_1$ —Circuit-closing jack (Yaxley 705).           |   |
|  | $R_5$ —35,000-ohm, 25-watt.                            | $J_2$ —Closed-circuit jack.                         |   |
|  |  | $T_1$ —Power transformer,                           |   |

COIL DATA

Freq.	Coil	Turns	Wire	Spacing	Coupling $L_1-L_2$
1.75 Mc...	$L_1$	60	28 d.s.c.	*	**
	$L_2$	60	"	"	"
	$L_3$	90	"	close-wound	"
3.5 Mc...	$L_1$	60	28 d.s.c.	*	$\frac{1}{8}$ "
	$L_2$	40	"	close-wound	"
	$L_3$	60	24 d.s.c.	"	"
7 Mc...	$L_1$	60	28 d.s.c.	*	$\frac{1}{8}$ "
	$L_2$	20	26 d.s.c.	close-wound	"
	$L_3$	46	24 d.s.c.	"	"
14 Mc...	$L_1$	18	"	"	$\frac{1}{8}$ "
	$L_2$	10	"	"	"
	$L_3$	20	18 enam.	length 2"	"
28 Mc...	$L_1$	18	24 d.s.c.	close-wound	$\frac{1}{16}$ "
	$L_2$	5	28 d.s.c.	length $\frac{1}{2}$ "	"
	$L_3$	12	18 enam.	length 2"	"
56 Mc...	$L_1$	4	18 enam.	length 2"	use 28-Mc. coil
	$L_2$				

\* See text.  
 \*\* As much separation as possible on form.  
 $L_4$ —Output link, 2 or more turns.

hold the windings tightly in place. The wire should then be brought through a hole in the isolantite mounting plate to the rotor lug of the condenser.  $L_1$  is wound at the base of the form, and  $L_2$  is wound in the same direction at the other end. The separation between coils determines the amount of coupling between the oscillator and doubler. To get the optimum 6L6 grid current, 4.5 milliamperes, the separation between coils must be carefully adjusted. In general, the larger the order of the harmonic in the frequency-multiplier stage the closer should be the coupling.

Because of the small space available on the FXTB forms, the 1.75-Mc. windings must be layer wound, with 40 turns on the bottom layer and the remaining 20 wound over the first 40 in the same direction.  $L_1$  and  $L_2$  are wound similarly.

After the windings are completed, five six-inch pieces of No. 18 tinned wire are soldered in the base pins of the form. One connects to a soldering lug which is bent over the side of the form under the screw holding the cover in place; this pin grounds the shield can. The remaining four wires are covered with spaghetti for a length of  $1\frac{1}{2}$  inches and are then fitted to their terminals, cut, and soldered in place. The can may then be re-assembled and rubber grommets inserted in the holes in the top. The grommets are to prevent short-circuits when using a metal screwdriver.

$L_3$  and  $L_4$  are relatively easy to make. The link, two or three turns in each case, is wound in the center of the coil form.  $L_3$  is split, with the two center wires going to the plus-B prong on the 3.5- and 1.75-Mc. forms. Hammarlund APC-100 midget condensers are assembled in the forms and wired as shown in Fig. 1 ( $C_{14}$ ).

TUNING

The transmitter employs only two crystals, one on the 1.75-Mc. band for output on 1.75, 3.5, and 7 Mc., and the other on 7 Mc. for output on

14, 28 and 56 Mc. With one exception the 6L6G is used as a straight amplifier on all bands, the second stage being either a doubler or quadrupler for the crystal harmonics. A coil set which octupled from 7 to 56 Mc. was tried, but even with the turns interwound, the 6L6G grid current was only 4 milliamperes—not quite enough for upward modulation. It is therefore advisable to run the 6L6G as a doubler from 28 to 56 Mc. when the latter band is to be used. The 10-meter excitation is ample for this purpose.

When everything is finished and the set is ready for tuning, the condensers in the respective coils are set between the frequencies to be used; for example, suppose two 7-Mc. crystals, one at 7118 kc. and the other at 7138 kc., are to be used. Set  $C_5$  midway between these frequencies, or at approximately 7128 kc., so that the transmitter will operate readily at either frequency without retuning. The oscillator tuning must be adjusted so that either crystal will "start" immediately; a suitable setting for  $C_3$  can be found experimentally. The neutralizing condenser,  $C_{11}$ , is adjusted in the normal fashion and once set properly need not be retouched for any band.  $C_8$  should be set for optimum excitation at the highest frequency to be used. A 20-ma. meter can be connected between the lower end of  $R_4$  and ground for checking grid current during the initial tune-up.

When everything has been wired, checked, and found working OK, assemble the unit in the cabinet and you are all set to operate efficiently and quickly on six amateur bands. With the unit described 17 watts was an average input though at times  $7\frac{1}{2}$  was used to work effectively over considerable distances.

**Strays**

The Low-Cost Single-Signal Receiver

Since publication of the description of the regenerative s.s. receiver in October *QST* (page 14) it has been found that the high-frequency oscillator may be operated at lower plate voltage without affecting the signal response, but with some reduction in plate dissipation and hence lesser warm-up drift. A 12,500-ohm 1-watt resistor in series with the plate-supply lead to the 6J5 will do.

Silent Keys

IT IS with deep regret that we record the passing of these amateurs:

- J. S. Elliott, VO1J, St. John's, Newfoundland
- Ross A. Hull, Editor *QST* and *The Radio Amateur's Handbook*
- Robert W. Maloney, W2BPY, Bradley Beach, N. J.

# 1938 DX Competition Results

By E. L. Battey,\* WIUE

**H**OW high is up?" . . . and "how high can a DX Contest score go?" You're wondering too? Each year we break loose with the exclamation points to give emphasis to the broken records, the new highs in results. Each year we say, "Boy, that must be the limit!" And each year we're wrong, for each A.R.R.L. DX Contest surpasses its predecessors.

The Tenth A.R.R.L. DX Competition, March

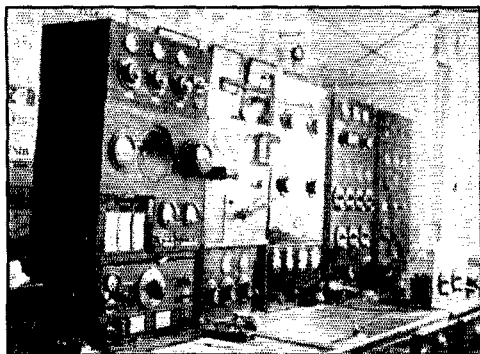

THE SHACK AT G6NF

A. D. Gay, G6NF, made a commendable score (91,696) in the c.w. period, winning the award for Great Britain for the second consecutive year. 704 contacts were made on 3.5, 7, 14 and 28 Mc. All apparatus, except receiver, is homemade. The first rack, at the top, contains two AT-cut 100 kc. bars, used for frequency measurement and cross-checking purposes. The frequency meter stands next to this rack on top of a variable-frequency exciter, consisting of an e.c.o. and buffer stages. Three separate transmitters are used for 3.5 and 7 Mc., 14 Mc. and 28 Mc., 'phone or c.w. being available on these bands with inputs up to 200 watts. In the contest P.P. RK-20's were used as final on 14 and 28 Mc., 211E single-ended on 3.5 and 7 Mc.

5th-13th (c.w.), and March 19th-27th ('phone), 1938 will long be remembered. It was an operating spree *de luxe*, crammed full of delights and disappointments alike and seething with as keen a spirit of competition as you could hope to find. And one must not overlook the fact that the contest afforded an unequalled opportunity to give the complete station and antennas a real break-down test. The operator who didn't discover something lacking in his equipment or operating technique is rare. Competitive operating certainly finds the weak spots in a fellow's layout. DX contests are unquestionably one of the greatest stimuli to station improvement. Bring on the next!!! . . . but wait, there are a few things to tell.

\* Assistant Communications Manager.

## WINNERS

Competition in the contest was confined to operators within a given League Section, or given country outside the W/VE area. That is, an operator within a given Section or country was competing only with operators within his own territory. This made for the best possible equalization of operating conditions among contestants. The official tally of scores lists 1352 c.w. operators (1013 W/VE, 339 in 66 outside localities) and 559 'phone operators (381 W/VE, 178 in 54 outside localities). Medallion awards are being made to c.w. operators in 67 A.R.R.L. Sections and 66 countries outside W/VE, and to 'phone operators in 64 Sections and 54 countries. The winners are the first-listed in each Section and country in the score list. To each victor—congratulations and well done!!

All logs submitted underwent a careful scrutiny by Tom York, W1BJJ, of the Communications Dept. In the matter of near-ties, all contacts made by stations in question have been cross-checked against the logs of stations worked. All special questions were decided by the entire contest committee.

## HIGH SCORES

In any competitive activity it is natural to endeavor to roll up as big a score as possible. And how some of the lads rolled 'em up! As a matter of information and general interest we'll list the results of some of the outstandingly high scorers.

## The C. W. Section

**F**OR the second consecutive year Ralph Thomas, W2UK, made the highest score among W's . . . 175,599! This represents 329

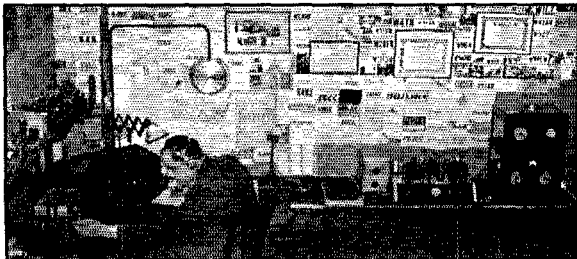

ALL EQUIPMENT AT PAØGN, EXCEPT RECEIVER, IS HOMEMADE

PAØGN placed second high among Netherlands c.w. participants. Type 800 tubes are used in the final stage of the transmitter; other apparatus includes a field strength meter (at left on left-hand table; and, L to r, on right-hand table, Class B '46's modulator and 75-meter 'phone rig.

contacts. Not satisfied with breaking his previous high score record, he also broke the "countries worked" record that he established last year (71) by making contacts in 76 different countries. Nice DX, Tommy! A score like that brings its own reward. Next year? Oh, let's wait; who can prophesy?

Second highest W was W3EMM, Norfolk, Va., with 157,905 points—321 contacts with 70 countries! Among other things, EMM worked all continents nine times, twice on 2S Mc. As signal-persuaders two V-beams and a rhombic took care of the output from P.P. 250TH's which ran at 1 kw. input on 3.5, 7, 14 and 28 Mc.

The Virginia Chamber of Commerce or somebody should work on the angle that ole Virginny is the place for DX-minded hams to live. Either that or tell the world what extra training Virginia hams get to enable them to top DX contest scores. W3EVT of East Falls Church, Va., was third high W scorer, and W3CHE of Norfolk was sixth high . . . and you've heard about W3EMM!! W3EVT with 325 contacts and a multiplier of 157 came through with 150,720 points. Plenty of good antennas and judicious use of the various bands "told" in EVT's case as they do in the case of all leading DX men.

Next in line we find W1SZ 137,000; W9ARL 133,648; W3CHE 128,250; W6CXW 120,888; W3PC 120,690. Each of these topped the 1937 high—119,000, and it's interesting to note that W2UK, W3EMM, W3EVT, W1SZ, W9ARL and W6CXW are all members of the A.R.R.L. W2DC 107,520; DX Century Club!

Other outstanding scores: W2JME 111,720; W1TS 108,110; W2DC; 107,520 W2BHW 103,806; W1TW 100,110; W4AH 90,024; W8LEC 86,198; W3HIL (5 oprs.) 85,644; W8BTI 84,444; W4AJX 83,500; W9AEH 82,560; W3BES 75,864; W2CBO 75,815; W8NJP 72,540; W6CUH 71,572; W2DSB 70,725; W2CJM 67,976; W1ME 65,670; W3FQP 63,630; W6QD 62,640; W3CHH 62,604; VE4RO 61,884; W4CBY 60,216.

Leaders in multipliers (total of countries worked on each band used) are: W2UK 179; W3EMM 165; W1SZ 163; W3EVT 157; W9ARL 156; W3CHE 150; W3PC 149; W2BHW 146; W1TS 143; W1TW 142; W2DC, W2JME 140; W4AH 132; W8LEC 131; W9AEH 128; W4AJX 125; W8BTI 124; W3HIL (5 oprs.) 122. High multipliers are mute evidence of use of several bands; these operators know how to land the DX!

#### FOREIGN HIGHS

The highest score among participants outside of the United States and Canada was made by XE1A, ex-XE2N, leader in the 1936 contest. XE1A's score of 236,322 represents 1419 QSO's on five bands (1.7 through 28 Mc.) in 75 hours, 40 minutes. Had he been able to put in the full 90 hours his score would have no doubt topped

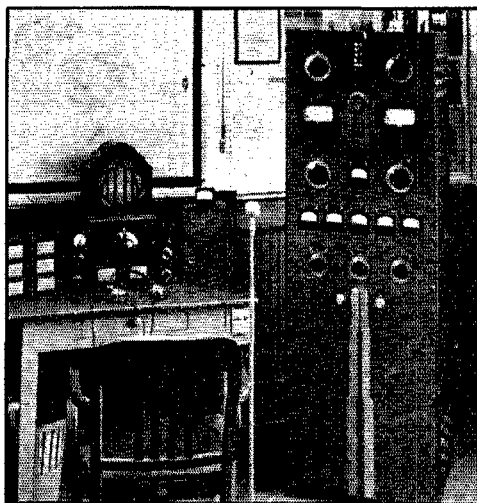

W8GLY, EDGEWOOD, PENNA.

The well-known station of W. S. Potter, W8GLY, led the field in Western Pennsylvania during the 'phone period, 197 contacts on 14 and 28 Mc., and a multiplier of 52 comprised the winning score of 30,524. Tube line-up: 47-807-35T-250TH; 838's in Class B modulator.

the '37 high. As it is, his QSO-average of 18.7 per hour is somewhat better than K5AY's average last year and he set a new record for multiplier—57! It is refreshing to note that XE1A's input was moderate—only 150 watts. This, in fact, is true of the majority of participants outside W/VE . . . they don't seem to need a "California KW" to put out decent signals. It may be due to the QRM situation on this side, or could it be that the W gang lacks confidence in low medium power? Anyhow, a row of VY FB's for XE1A!!

Second high non-W/VE is K6CGK, who placed third last year. His score is 145,909 . . . 931 contacts, multiplier of 53, on five bands (1.7-28). He made 5-band contacts with W6's, 4-band with W1, 5, 2, 7, 6 and 9. Input was only 85 watts, but of course that "diamond" antenna didn't have anything to do with his results (says who?)!

Other highs are K7PQ 134,872; K4KD 131,895; K4DTH 109,466; OK1BC 106,977; and GI6TK (who was not competing for award) 103,244. K7PQ made 993 contacts on five bands; K4KD 977 contacts, four bands, with all W districts worked on 3.5, 7, 14 and 28 Mc.; K4DTH 591 contacts, four bands; OK1BC 951 contacts, four bands.

Following these with scores of particular merit are LU7AZ 99,575; K5AN 94,392; G6NF 91,696; OZ2M 91,035; F8TQ 86,598; CM2AD 79,480; G6WY 78,210; OE3AH 76,239; FM8AD 73,390.

The highest scorer on each continent: Africa—ZS1AH 36,797; Asia—J3FJ 31,408; Europe—OK1BC 106,977; North America—XE1A 236,322; Oceania—K6CGK 145,909; South America—LU7AZ 99,575.

Those having the highest multipliers: XE1A 57; K6CGK 53; F8TQ 51; K4DTH 49; ON4AU 47; K7PQ 46; G6WY K4KD 45; F8ZF G6NF 44; OE3AH 43; PA0QQ 42; FM8AD 41; CM2AD G6RB PA0GN 40.

#### DISQUALIFICATIONS

The following are deemed ineligible for DX-score listings, or awards, in the March 1938 DX competition. Unless otherwise indicated disqualification is for off-frequency operation. For the information of those not familiar with the policy of disqualifications and the reasons for same, the subject was fully covered on pages 22 and 23, May 1937 QST.

C.w.: W6GRL W6MHH W7BTH W7BVI W8LEA W8LXA W8SI W9CCI W9EZW W9FS W9VAV VE1EA VE1ET VE2EE VE3AHK.

CT2BE CX1CG D3GPF D4CJF F3LE F8MW F8NJ HB9X HR7WC LU5AN LU6DG OH5OD OK2RM ON4CD ON4HC SP1BC SP1EB SU1CH VK2ADE\* VK2QL VO3X YM4AA YR5AA YR5CF YR5ML ZS1AN ZS2AL ZS5BH.

\* Evidence submitted to us makes it necessary to disqualify this station for two-operator status reported as one— included use of two transmitters on different frequencies calling/working two stations simultaneously.



W9ZBX, CLUB STATION OF THE LAKE MICHIGAN AMATEUR RADIO RESERVE, BELMONT HARBOR, CHICAGO, ILLINOIS

Eight operators were on the job at W9ZBX in both the c.w. and 'phone contest periods. The three rigs, l to r., were used on 7, 14 and 28 Mc. respectively, at inputs of 600, 375 and 120 watts. The first two rigs use T55's in the final. The bottom panel on the right-hand rack carries a heterodyne frequency meter-monitor. The high fidelity speech amplifier is just above the SX-17 receiver. Under this receiver and just behind the W.E. 600A mike are the red and green pilot lights for each rig; under the lights are the break-in switches; to the left of these are jacks for plugging in a key to each rig for c.w. operation.

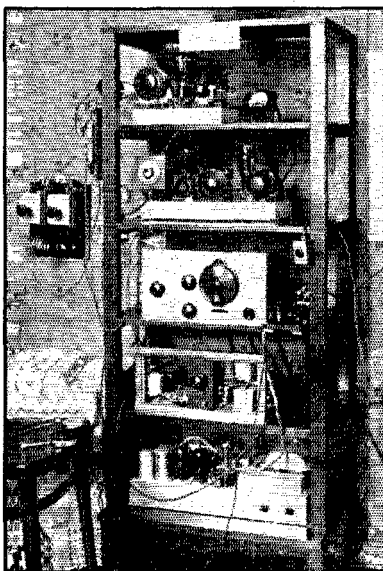

YL2CD'S TRANSMITTER

The transmitter used by YL2CD to win the Latvia award. Units sitting on the open wood rack include 2A5 c.c.o., '46 doubler and P.P. '46's amplifier. With 40 watts input on 14 and 28 Mc., 219 contacts were established with W's and VE's.

'Phone: W2JT W6LEE

In addition to the above, the following stations that did not submit contest entries were logged off frequency by observers during the period of the competition:

C.w.: W1AFR W1AJO W1DOV W2AGG W2EXM W2GDC W2GJH W2KZM W2KZQ W3ANS W3FMY W3GUB W4BUO W4CE W4CYC W4DVF W5DET W5DLZ W6AJN W6BIF W6GHU W6ITU W6LPC W6MJY W6NUD W6OTA W6WN W8ADZ W8DQV W8MEV W9CQB W9ELL W9GIL W9HER W9KCK W9KYI W9PXX W9UYK W9VDA W9VQZ W9WQB W9WWT W9ZIS W9ZUP VE2GA VE2MU VE4AEL VE4UT VE5EO.

CM2AF CM2PW CM7AD CM8AY CM8AZ CN8AX CT1PC D3GKR E2G F3AD F3MN F8JI FY8AA G5UG HH4AS HK4LC TI2LC UIAD U2NE U9AV U9AW U9ML XE2KG XE2Z ZL1HY.

'Phone:—W1KKJ W2ICT W9UYK YV1AQ.

## The 'Phone Section

RADIOPHONE participation was 48 per cent

greater than in the 1937 contest. Scores of many contestants doubled their previous efforts. Although conditions throughout the nine-day period were not the best (a magnetic storm raising havoc with 28 Mc.), the spirit of the gang was undaunted and a grand party was enjoyed by all.

Fenton J. Priest, Jr., W3EMM, second high W in the c.w. Section, made the highest 'phone score of any W or VE—97,092! And it's enlightening to note that the leading 'phone operators made more contacts than the leading c.w. operators!! W3EMM on 'phone made 374 QSO's against W2UK's 329 c.w. contacts. EMM used 3.9, 14 and 28 Mc. with Class B 805's modulating the 250TH kilowatt final. All the 'phone bands need are a few more countries to increase the multiplier and the c.w. boys will have to look to their laurels! Congratulations, W3EMM, on some snappy talking!!

W4CYU of Miami, Florida, is a good second with 94,320. He, too, kept the old tongue wagging, making 356 contacts on 14 and 28 Mc. Input was 700 and 500 watts to 100TH's.

In third position is Dave Evans, W4DHz, operating W6GRL, Ventura, California. Dave ran up 81,780 points—318 contacts, multiplier of 87—on 3.9, 14 and 28 Mc. P.P. 250TH's at 999 watts were modulated by HD-203A's.

Right up near the top also are W9ARA, 82,863; W2HNY operating W2UK, 69,264; and W9DKU, 63,525. Each of these considerably bettered his 1937 performance. Efficiently exercising their vocal chords also were W4BYY 57,174; W6CQI 57,072; W3CRG 54,599; W3PC 54,288; W61TH 51,240; W9ARL 51,170; W4AH 50,660; W4CDG 49,511; W9YGC 48,645; W3EOZ 46,860; W4YC 44,154; W1TW 43,608; W8NJP 42,296; and dozens of others . . . see the score list!

Leaders in multipliers: W3CRG 91; W4CYU 90; W3EMM W3PC W6GRL 87; W6CQI 82; W9ARA 81; W8NJP 79; W2UK W4BYY 78; W4CDG W9DKU 77; W3EOZ 71; W61TH 70; W1TW W9YGC 69; W4AH 68; W4YC 66; W2JME 65; W4AGB 61.

#### FOREIGN HIGHS

A well known DX-er, R. Bartholomew, K4SA, came through with the highest score among participants outside the mainland U. S. and Canada. "Dick" rolled off 674 QSO's, and with a multiplier of 35 made a total of 70,630. His operation was on 3.9, 14 and 28 Mc. for 60 of the 90 hours. On 3.9 Mc. input was 400 watts to a pair of '52's, Class B modulated; on 14 and 28 Mc. 100 watts to RK-20's suppressor grid modulated.

Congratulations to K4SA, and to CO2WM, who is second high scorer—67,982. With 120 watts input to a T-55 on 3.9, 14 and 28 Mc., WM made 601 contacts and a multiplier of 38. If you think such a showing represents "just a lot of talk," try it sometime.

Third high for the second consecutive year is G6LK with 50,544 points . . . 468 QSO's, a multiplier of 36, in 70 hours of operating. And next comes another Cuban, CO2JJ, 48,022, followed by TI2FG 34,713; ZS6DW 30,564; KA1ME 28,308; LU9BV 28,210; HC1JW 24,264; VK2IQ 22,858; VP9R 21,620; K4EZR 21,514; PAQUN 21,033; F8ZF 19,578; ON4PA 19,446; G6BW 18,475; YR5AA 18,020; PAQFB 17,776; VK2ADE 17,388; KA1ZL 17,190; ZE1JR 17,100; FSQD 16,752; LU5AN 16,330.

The highest scorer on each continent: Africa—ZS6DW 30,564; Asia—J2MI 5745; Europe—G6LK 50,544; North America—K4SA 70,630; Oceania—KA1ME 28,308; South America—LU9BV 28,210.

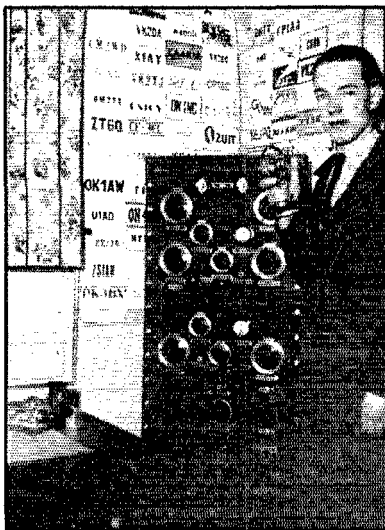

#### W9PGS—COLORADO C.W. WINNER

Warren M. Mallory, W9PGS, is standing beside his very business-like transmitter; line-up used during the contest was 53 oscillator, 801 doubler, P.P. 801's final, running at 130 watts input on the 7, 14- and 28-Mc. bands.

Credit for the highest multipliers is due CO2WM 38; G6LK 36; K4SA 35; TI2FG 29; KA1ME 28; PAQUN ZS6DW 27; CO2JJ F8ZF LU9BV 26; G6BW PY2AC 25.

#### CLUB SCORES

A genuine gavel, with engraved sterling silver band, was offered to the amateur radio club whose members, operating individual stations, submitted the greatest collective score in the contest (sum of both c.w. and 'phone scores). Winner of this beautiful trophy is the South Bay Amateurs Association, Los Angeles. Seven members of this organization made a total of 244,138 points. That shows what a group of W6's can do when they set out to win! FB!! Within the S.B.A.A., W6CUH wins the club certificate for c.w.,

while W4DHZ operating W6GRL wins the 'phone certificate.

A very close second is the Frankford Radio Club of Philadelphia—243,366—with W3BES, c.w., and W3HFP, 'phone, winners within the club. Last year's winning group, the Tri-County Radio Assn., Inc. (Plainfield, N. J.) placed a good third with 235,391; club winners W2JME, c.w., W3CRG, 'phone.

Other clubs made good showings also and they are here listed in order of the combined score of all participating members. The calls given in parenthesis with the club names are winners of the club certificates within their respective organizations; unless otherwise stated certificate was won in the c.w. Section. . . . Schenectady Amateur Radio Association (W2DC c.w.; W2AMM 'phone) 208,001; Oakland Radio Club (W6AM c.w.; W61TH, 'phone) 171,296; York Radio Club (Elmhurst, Ill.) (W9GY) 149,743; Trenton Radio Society (W3AIR c.w. and 'phone) 97,713; Central Illinois Radio Club (W9UQT) 70,518; Finger Lakes Transmitting Society (W8LDA) 67,296; Elmira Amateur Radio Association (W8DZC) 48,609; Birmingham Amateur Radio Club (W4ELQ c.w.; W4EHH 'phone) 48,121; Milwaukee Radio Amateurs Club (W9VDY) 46,379; Hamfesters Radio Club, Inc. (W9HFK) 34,594; Beaver Valley Radio Club (W8DWV) 33,639; Club ON4BC (ON4IF) 31,169; The Massillon Amateur Radio Club (W8KYY) 28,383; Tampa Radio Club (W4DCZ) 27,086; Winston-Salem Amateur Radio Club (W4OG) 25,656.

(Continued on page 82)

# ● ARMY-AMATEUR RADIO SYSTEM ACTIVITIES ●

THE Seventh Corps Area comprises eight Mid-Western States with headquarters centrally located in Omaha, Nebraska. A.A.R.S. activities began in 1927 and rocked along for three years with little military assistance. In 1931, First Lieutenant Haydn P. Roberts, Assistant Corps Area Signal Officer, reorganized the entire set-up, using active A.R.R.L. operators as net controls and other key men. Increased membership and more efficient net operation resulted. Each State operated a Local, District, State and Radiophone Net until 1936, after which time all State Army-Amateur activities, except radiophone, have been conducted on one frequency.

This arrangement is ideal in that any member may act as NCS. There are no special restrictions as to the use of these net frequencies except that the net control, when in the net, is in charge. Part of our drills are strictly business; but informal exchange of views is encouraged when time permits.

The nets, net control stations and frequencies are as follows:

Net	Net Control	Freq.
Arkansas.....	W5DHU	3692.5
Iowa.....	W9LCX	3652.5
Kansas.....	W9FLG	3662.5
Minnesota.....	W9UKB	3815.0
Missouri.....	W9TGN	3775.0
Nebraska.....	W9EDI	3745.0
North Dakota.....	W9YJL	3840.0
South Dakota.....	W9AZR	3717.5
Radiophone.....	W9JED	1912.5
Corps Area.....	W9BNT	3725.0

The record of the "Seventh" in emergency communication work is outstanding. In all such cases, the cooperation and assistance given by non-members was most important. Our danger zones for floods are the areas in east Arkansas, southeast Missouri and along the Nebraska-Kansas border. A close liaison exists between the Red Cross and the Army-Amateur Radio System. As a matter of fact, a large number of our members serve on local Red Cross Communications Committees.

Most of our drill activities are conducted on Monday nights. The State Nets operate 6:30 to 7:30 P.M. and 8:30 to 9:30 P.M., C.S.T. The Corps Area Net, which includes all State controls and the station in the office of the Corps Area Signal Officer, operates 7:30 to 8:30 and 9:30 until clear. Members should report into both of the State Net drills in order to clear "up" and "down" traffic, but are not required to keep a constant watch during these periods. On other days, excepting Saturdays and Sundays, one member of each State guards the net frequency at certain periods which are known to all other members.

All amateur radio operators are invited to copy

the Code Speed Tests which are transmitted the second Monday of each month, September through May, by W9BNT on 3725 kilocycles, beginning at 9:30 P.M., C.S.T. Eight plain language tests of three minutes each at speeds of 15 w.p.m. through 50 w.p.m. at 5 w.p.m. jumps will be broadcast by automatic equipment. One complete minute anywhere in a test will qualify for that speed. Mail your copies to the Signal Officer, Headquarters Seventh Corps Area, 1013 Federal Building, Omaha, Nebraska. Notifications of results will be sent to non-members.

Most any amateur radiogram may be handled in the Army-Amateur Nets. It is the policy, however, that important messages shall be given priority on a circuit before other traffic. Messages relating to the A.A.R.S. are sent before other routine business.

The present membership of the Corps Area includes 152 c.w. and 12 radiophone members. Appointments are open to all stations equipped to communicate in the 80-meter c.w. or 160-meter radiophone bands. Membership in other organizations has no bearing in the A.A.R.S. There are no age limitations and no physical examinations are required. After six weeks of satisfactory probationary activities, a new member is issued a regular two-year appointment. Membership may be cancelled at any time by writing the Corps Area Signal Officer. The only cost, in addition to the power and general maintenance of the station, is for a net frequency crystal which may be ground locally or purchased as desired. The necessary regulations and forms are furnished by the War Department. A monthly bulletin, "Army Amateur Time," is mailed each active member of the Corps Area. For application blanks or additional information, send a card or radiogram to W9BNT.

## Armistice Day Message

At 7 P.M. and 10 P.M. E.S.T. on Friday, November 11th, a message from the Chief Signal Officer to all Army Amateurs will be broadcast. As has been customary in the past, the broadcast will be made the subject of a competition among Corps Area Army Amateurs. The Corps Area having the largest number of members copying will be announced as the winner. Handicap factors based on quota membership applied.

ALL AMATEURS are invited to copy this message which will be broadcast by WLM on 3497.5 and 6990 kc.



# ● NAVAL COMMUNICATION RESERVE NOTES ●

PLANS are being perfected for considerable activity in the U. S. Naval Communication Reserve during the coming season. The annual competition between Naval Districts was begun on September 15th when the first national drill of the year was conducted. This radio drill includes Naval Radio Washington as the senior station, together with the master and alternate control radio stations in each Naval District, of which there are at the present time thirty-two. For this drill conducted by Naval Reservists from Radio Central Navy Department, Washington, frequencies of 4045 and 8090 kcs. are used, and the drills begin at 7:45 P.M. E.S.T. for the Eastern Network and NPG Radio Central, San Francisco, Calif., at 7:45 P.S.T.

The Naval Districts are also preparing to conduct their Naval Reserve District drills which are handled by their master and alternate control stations.

There has been a great increase in the past year in the Communication Reserve personnel which is now composed of 900 officers and 5000 radiomen. Many of these officers and men were trained at sea on naval vessels during the past summer.

One great step forward in handling these drills has been the assignment of Navy-Government frequencies to the various drills of the Naval Communication Reserve. Most of these frequencies lie in the band between 2 and 3 Mcs. This has made it possible for the individual amateur, who belongs to the Naval Reserve, to operate his station when engaged in official Naval Reserve drills, on government frequencies, and use a special Naval Reserve call sign. There has been a great advantage in this arrangement to both the amateurs at large and to the Navy, because it has eliminated from the amateur 80-meter band nearly all interference occasioned by Naval Reserve circuits, and at the same time has permitted the conduct of these drill circuits on cleared channels which has greatly improved the efficiency of the drills.

During the past year considerable strides have been made in the equipment of section and unit Reserve stations, most of which are now located in Federally owned or controlled buildings. Many of the local unit stations of the Communication Reserve have been installed in new post office buildings, where the quarters are very satisfactory.

Another stride forward has been the furnishing of a Naval Reserve outfit of uniforms to Naval Reserve radiomen who can attend these drills at their unit headquarters.

Navy Day will be celebrated again this year on

October 27th, and the schedules to be observed by Radio Washington (NAA) and Radio San Francisco (NPG) have already been published in *QST*. It is expected that every member of the Naval Reserve, and all other amateurs who can do so, will make a special effort to copy one or the other of these two broadcasts. As the transmitting speed this year will be raised to twenty-five words per minute, it will call for real operating ability to make a perfect copy.

For the first time, it is expected this fall to organize the U. S. Naval Reserve Aviation Bases into a point-to-point test and training circuit. There are thirteen of these Reserve Aviation Bases, of which ten are located in the Eastern Naval Districts. It is proposed to use a Navy frequency in the 6-Mc. band in the afternoons to run this test circuit between the Navy Department and the bases.

During the coming year the various Naval Districts will be afforded an opportunity to supply information for *QST* to appear under "Naval Communication Reserve Notes." Members of the Naval Communication Reserve who have any interesting news concerning general amateur activities should supply this to their section or unit commander, who can in turn transmit this information through official channel to the District Headquarters and in that way it can be included in future issues of *QST*.

The annual communication competition was won by the Twelfth Naval District for the year ending June 2, 1938. That District made a very fine record and succeeded in winning the competition by a fraction of 1 per cent, as the competition was very keen from the First and Fourth Naval Districts.

## Strays

It has been suggested by WILDC that probably the simplest way to work a station in Ireland is by calling "CQ California."

— . . . . —

### Correction

In the circuit diagram of Fig. 1, page 36, September *QST*,  $C_5$  and  $C_6$  are 100- $\mu$ mf. midget tuning condensers.

— . . . . —

"Barbed wire makes a good dissuader for those kids who have destructive designs for antennas suspended between trees," suggests W9SDG. "Tack it on the limbs like a clothes-dryer, and don't forget to add a warning sign."

# Hams Over Chicago!

1938 A.R.R.L. National Convention Greatest Ham Gathering of All Time

**T**HERE were hams all over Chicago. Most of the respectable citizens had left town, either because they had been warned of what was coming, or maybe because it was Labor Day week-end and the shores and hills were more appealing than hot city streets.

But the hams went to town! From thirty-five states, two provinces of Canada and five DX countries—from all districts and all divisions—by all modes of travel from jerking thumb to private plane—some two thousand hams made their way to the Hotel Sherman and its noisy corridors and intent meeting rooms.

Never did bedrooms see less sleep. There was a war on—a war against sleep! Even those who wanted to, couldn't. If loud voices and whistled CQ's didn't do the job of banishing mournful Morpheus, then jangling telephone bells and resounding door hammerings were resorted to. If these didn't work, then firecrackers exploding with thundering, echoing booms in the well of the inner court were certain to bring the most insensible noncombatant grabbing for his pants.

Not that it was a brawl. It was, in fact, the opposite. It was one of the cleanest, best organized, most orderly large ham conventions of recent times. There was nothing to be ashamed of. But there was such a surging of enthusiasm, such a pressure of high spirits, such a gala carnival air that normal rules and normal hours simply did not apply.

## SATURDAY

From the opening gun to the closing bell the program was timely and well-timed.

Although this reporter's personal information doesn't cover the opening sessions—the Hq. gang, held in Hartford Friday afternoon by the Maxim

Memorial dedicatory exercises, pulled in early Saturday afternoon—the dope is that they went off in good style.

Shortly after the address of welcome by Convention Committee Chairman G. L. Dosland, W9TSN, proceedings were enlivened by a "man in the street" broadcast over N.B.C. from the remote pick-up car which graced the mezzanine floor—that floor being the focal point for the convention and leading to all the meeting rooms. Hearing this broadcast on his car radio while en route to the National Air Races at Cleveland, pilot W9US, in the outskirts of Cleveland, torn between two loves, turned around and drove back to Chicago and the convention!

Meanwhile Marshall Wilder, W2JKL, and author of *QST*'s initial television series, went through his television demonstration of Monotron equipment in the Grand Ball Room. This demonstration, fast becoming a classic in engineering circles, introduced many a ham to that eerie world where the ghostly shades of television dwell.

Following a recess for the viewing of manufacturer's exhibits, John Reinartz packed the ball room with eager hams for his "harmonic generator" talk. Nor were they disappointed; "Kewpie" was in rare form and didn't miss a bet. Ted McElroy turned serious and lectured the boys like a true Bostonian in connection with his high-speed code demonstration. A rare entertainer, Ted Mac's sugarc coated pills of wisdom are famous and that Saturday afternoon the old doctor was passing out liberal doses of Grade AAA tonic. Then, as a fitting climax to a big afternoon, John Kraus divulged all the latest from Ann Arbor. The great W8JK turned the problem of close-spaced directive arrays inside out and showed just what made the wheels turn and why.

By that time no one was ready to dispute that dinner was in order. Empty stomachs and flagging spirits both got the proper treatment, the aisles of the manufacturer's exhibits got jammed with sight-seeing hams and stayed that way, and the elevator operators got a foretaste of what lay ahead of them that night. Despite Herculean efforts on the part of a corps of Chamber of Commerce ladies, the registration desk was a bedlam as hundreds of arriving hams collected tickets,

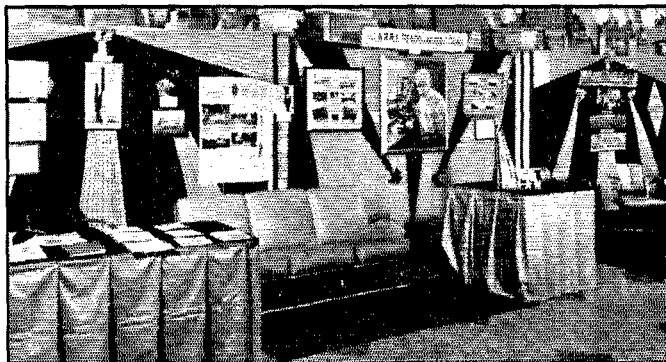

A.R.R.L. LOUNGE IN THE MANUFACTURERS' EXHIBIT HALL

badges and other convention paraphernalia.

After dinner the more serious-minded of those present went to work in the Louis XVI Room to discuss the work of the A.R.R.L. Planning Committee. With Fred Schnell, W9UZ, in charge, and Communications Manager Handy a speaker, the discussion rapidly reached the "open forum" stage.

The Saturday Night Party was actually two parties; a stage show, and dancing. Featured on the show were skits including "Broadcasting from Station B-U-L-L" with W9PNV as announcer, "Major Bow Wow," an "amateur" program staged by the Hamfesters Radio Club, "Professor Quizz," a question and answer contest conducted by W9AA, and a "goof" act by W9K GK and the Chicago Suburban Radio Association. This part of the evening concluded with the "Awarding of the Chisel" to W9KEH by ex-champ W9LIP.

Following the show Cy Read, W9AA, led an orchestra recruited among C.B.S. musicians to provide music for dancing. There was either too much standing around or too little dancing—it was hard to decide which. Anyway, the music was swell . . . a grand wind-up for a big opening day.

#### SUNDAY

It may have been Sunday morning to some people, but to the hams it represented (a) a helluva time to get up and (b) a bleary-eyed process of trying to locate N.C.R., A.A.R.S., u.h.f., c.w., 'phone, television, DX, and traffic and emergency meetings. At that, there was an astonishing number on hand for the sessions. It's really wonderful what a couple of hours sleep will do!

In order, the chairmen and featured speakers for the various meetings were N.C.R.: Lieut. Commander Fred H. Schnell, W9UZ, Lieut. John C. McManus and Lieut. R. W. Carter. A.A.R.S.: Major A. V. Eliot, Phillip Haller, W9HPG, Radio Aide. U.h.f.: Vic Reubhausen, W9QDA, Frank Lester, W2AMJ, and E. H. Conklin, W9FM. C.w.: Eugene A. Hubbell, W9ERU, George Grammer, W1DF. Radiotelephony: F. W. McDonnell, W9YUC, Wm. Bishop, W9UI, Douglas Fortune, W9UVC. Television: Ed Gibbons, W9TAK, Ross A. Hull. DX: Roy McCarty, W9KA, Clark C. Rodimon, W1SZ. Traffic and Emergency: John Huntoon, W9KJY, F. E. Handy, W1BDI.

Having passed the good word along to the blood brethren and with circulation once more restored by the combination of lunch, the effort to think and the exercise from another promenade around the exhibit hall, at 1:30 several hundred convalescents moved collectively upon the Grand



CAST OF THE R.O.W.H. INITIATION, COLORFULLY PRESENTED BY THE GENESSEE COUNTY RADIO CLUB, FLINT, MICH.

Ball Room for the A.R.R.L. meeting which featured Sunday afternoon.

Director Mathews, as chairman, led off. Re-counting his acquaintanceship with Hiram Percy Maxim, he introduced President Woodruff as a fitting successor. Dr. Woodruff then expounded his philosophy of amateur radio, dwelling on the social responsibility of the individual and pointing out the benefit to youth and the institutional good of amateur radio training. Then Vice-President Bailey discussed the future of the League, in terms of what we make of it ourselves.

By the time Secretary Warner reported on "The Cairo Conference and Its Significance," the hall was a mass of attentive hams. His emphasis on the loyal support of the U. S. Delegation to the conference brought a motion from W9TSN that a suitable resolution of appreciation be prepared. A committee was appointed and instructed to bring in a draft resolution at the "open forum" session following.

Following Warner's address, Communications Manager Handy outlined the League's position on "Our Responsibility for Emergency Preparedness." The concluding talk, by *QST*'s Editor Ross A. Hull, concerned "Present Problems in Amateur Radio." The meeting then adjourned upstairs to the Louis XVI room for the "open forum."

If the ghost of Louis XVI still haunts the room which Hotel Sherman saw fit to name for him, the dim mists of history must have opened to the memory of prefervid oratory echoing through the Halls of Versailles. The scene was an unforgettable, if not a memorable, one. Imagine 1500 sweating, shouting hams jammed into a room designed to seat perhaps 500. Visualize Chairman Bailey's sternly genial measures for forcing order, the clamoring competition for mike "time," the cheers and jeers, the handclapping and the booing. There was no answering of questions—no one bothered to wait for answers. It was "open forum"—the opportunity to speak was knocking—and everyone knew that opportunity knocks but once. Among the speakers were Sumner B. Young, W9HCC; Fred W. Young, W9MZN



Upper left: Doc Hard, XE1GE, shows the way it works. Upper center: Bob Henry, Fred Hager, Byron Hargrove. Upper right: Cy Reed, W9AA, blows a sweet one at the party. Left center: Fred Schnell, Ross Hull, Bob Wilson. Center: President Woodruff inspects an N.B.C. portable. Right center: Century Clubbers W8JMP, W1SZ, W8CRA. Lower left: W9EL and W1ES, hams for 27 and 35 years respectively. Lower right: W9NLP and W9ELL re-live the Ohio flood with W1EH.

Photos by Torkel Korling, courtesy LIFE Magazine

(Dakota Division director); R. H. G. Mathews, ex-W9ZN (Central Division director); Dr. W. S. Kelly, W9MDO; G. L. Dosland, W9TSN (Chairman, Chicago Area Radio Club Council); A. A. Emerson, W9ITQ; H. W. Hamilton, W9MRQ; Earl R. Linder, W9DZG; W. C. Heiber, Jr., W9PGB; Royal Fisler, W9NBA; Russell Bennett, W1GTN and Guy Wilson, W9EL. Despite perhaps 20,000 words of oratory let loose during the two-hour session the only tangible result was adoption of the Cairo resolution. It was ordered sent to the following: Hon. Wallace White, U. S. Senate; Rear Admiral S. C. Hooper, U. S. N.; Lieut. E. K. Jett, F.C.C.; Francis Colt deWolf Dept. of State; Gerald C. Gross, F.C.C.; Lieut. Comm. E. M. Webster, F.C.C.; and Lieut. Col. D. M. Crawford, U. S. A. It read:

WHEREAS: We, two thousand active Radio Amateurs assembled in National Convention at Chicago, being cognizant of the splendid support and recognition accorded the American Radio Amateur by the members of the United States delegation to the recent international radio conference at Cairo, Egypt, and

WHEREAS: We, as individual Amateurs, desire to express our individual appreciation for this support and encouragement, in addition to that expressed by our national organization, the American Radio Relay League.

NOW, THEREFORE, BE AND IT IS HEREBY RESOLVED: That we, as individual licensed Radio Amateurs, do hereby convey to each of the members of the United States delegation our sincere appreciation and gratitude for the effective support and protection given the institution of American Amateur Radio; and we pledge ourselves to so conduct our activities as individual Amateurs that we shall always merit the support and confidence of our Government.

#### THE BANQUET

At banquet time hams bulged the walls of the Sherman. The overflow occupied two large dining rooms in addition to the Grand Ball Room. It was the largest dinner the Hotel Sherman had ever served. With all appetites finally royally satisfied, ball room tables were removed, seats substituted, and the proceedings began.

These included a variety of events and speakers, now recalled only in kaleidoscopic fashion: Presentation of the C.A.R.C.C. Field Day cup to the York Radio Club by Chairman Dosland . . . . the dry style of SM-I-TH . . . . the bows taken by Woodruff, Bailey, Warner, Hebert, Handy, Hull, Dosland (and XYL), Eldred, Huntoon, Ashton (and XYL), Haller, Wiechmann, Kreis (and XYL), Cox, Horton, Mrs. Roberts, Schnell, Reinartz, Ransome Sherman, Directors Norwine and Young, and Paley Awardee W9MWC . . . . Feature event was, of course, the talk by Dick Stoddart, radio engineer on the Hughes 'round-the-world flight. Corollaries to this were the presentation of a recording of flight broadcasts made by W9JUG as a memento to Stoddart, and a brief word from his charming wife, who captivated the audience. Stoddart's talk, which followed a rising ovation from the crowd, summarized the trip and included anecdotes of radio details on flight and at

the stops en route. In closing he expressed appreciation for amateur cooperation, and brought 73 and a word of tribute from Howard Hughes, himself once a ham—ex-5CY at Houston—and still a member of A.R.R.L. . . . . The Wouff Hong center pieces on the tables—a clever touch . . . . The fastest QSL on record: A W9 worked ZL2JQ via "2-lung-power" whistle, discovered to his amazement that the Zedder was sitting by his elbow at the next table, traded QSL cards. Total elapsed time for call, QSO and QSL:



© LIFE Magazine

W8FIP EXPLAINS THE RAISED CIRCUIT DIAGRAMS DISPLAYED IN HIS BOOTH FOR "AMATEUR RADIO FOR THE BLIND"

The A.R.R.L. Handbook in Braille occupies the seven volumes shown in the foreground.

1½ minutes . . . . The heaviest ham at the convention was W9TLQ, at 322; the lightest Mrs. DeWageneire, W9ZTY, 111 . . . . W9NNE received the award for tallest at 6' 5", although W9WPF showed up later at 6' 7" . . . . ZL2JQ won the "ham who came from the longest distance" award, although had PK3AT arrived earlier there would have been some competition . . . . Shouted to the SWL who won the 250TH: "Tell him what it's for!" . . . . And was there a roar when Mrs. Eitel (Eimac) won the Taylor T-200! . . . . To top it off, the big transmitter—the grand prize—was won by an XYL—W9TLJ . . . .

The code speed championship award, a gold-plated key on a walnut pedestal, was also presented at the banquet. Again it went to John Huntoon, W9KJY. Of 33 entries, 10 qualified at 34 w.p.m. for the finals. The run-off went to 48.4 w.p.m., with W8LCW reaching 39.7 for second and W9YPO third at 37.1.

Climaxing one of the most hectic ham convention days in history, the midnight initiation into the Royal Order of the Wouff Hong, staged by

(Continued on page 116)

# Announcing—Ninth A.R.R.L. Sweepstakes

Nov. 12th-13th-19th-20th—Contest is for W, VE, K, KA, CM and VO Hams—  
'Phone or C.W. Any Ham Band(s)—Test Stations—Proves Operating Supremacy  
—Awards to the C.W. and 'Phone Leaders in Each Section<sup>1</sup> and Certificate  
in Each Club—Gavel Trophy to Winning Club

F. E. Handy\* WIBDI

**D**ON'T miss the annual "SS." Telegraphing operators will contact and compete with other telegraphing operators. 'Phone hams will compete with other 'phone hams.

New certificate awards will be made by the League to the winners in each group in each

edge of the way preambles to A.R.R.L. messages are sent and acknowledged, and fills requested, accuracy of 'phone communication assured, etc., if they take part and follow the standard practices set forth for these things in the new edition of *The Radio Amateur's Handbook*. Some emergencies of late years have found amateurs unfamiliar with good operating practices, resulting in delays, garbles, and inability to write or take a message in standard form. We hope that the "SS" will help both new and old timers to improve and perfect operating technique at the same time all make new station records.

Contest exchanges can be logged directly on the sheet that you send Hq. for a report. Paper work will be completed as you go along with nothing to do but total and summarize points and send it in. *Mimeographed contest forms will be sent gratis to anyone who sends a radiogram or drops a card for the same.* Use of our sheets is not required nor is advance entry necessary. The purpose is to help participants keep a uniform log. It is necessary that the arrangement or form shown with this announcement be followed. Draw your own columns on your own paper if you like . . . or ask us for the prepared sheet.

Thirty-three hours of "SS" operating in two week ends have been specified. You can work more than 20 hours on *one* of the two week ends, but in no case will any entry of more than 40 hours' total operating in the two contest periods be accepted. Use any amateur frequency bands you choose. This timing plan permits the average ham to plan for his time for meals, for 8 hours' daily sleep, etc. Cross examination of logs makes it possible to check operating time.

Effective choice of the different amateur bands, best use of available operating hours, and operating proficiency will take one a long way toward success. Single-signal selectivity and high sensitivity will win and bring in the stations at distant points calling you. However, results mainly depend on the man behind the station!

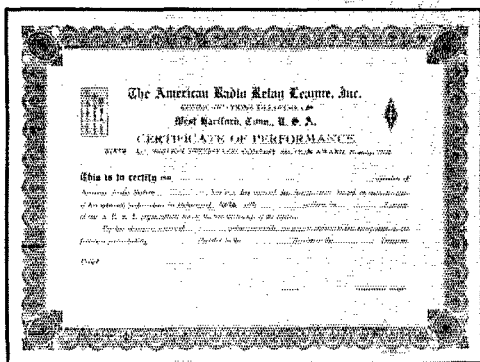

A.R.R.L. Section. The illustration will give you some idea of the certificate awards. They're beauties.

Many complete their QSL-card records and achieve "WAS" through each year's "SS." This is the best chance of the year to progress toward that objective.

The idea of the contest is to see how many stations *can* be worked in the given contest time. The points derived from this will be multiplied by the number of *different* A.R.R.L. Sections<sup>2</sup> worked with at least a complete one-way exchange in the contest. Message swaps are *not* required in proof of QSO this year. All essential contest information is sent in the form of a standard preamble. Exchanges are for the record sent to Hq. New hams may also add to their knowl-

\* Communications Manager, A.R.R.L.

<sup>1</sup> Including Cuba, Porto Rico, Hawaii, Alaska, P. I., etc. Amateurs in Newfoundland are included in the Maritime Section of the A.R.R.L. field organization.

<sup>2</sup> See the complete list of the 71 Sections in the A.R.R.L. organization, page 4 of this issue of *QST*.

## THE GENERAL CALL

"CQ SS CQ SS CQ SS de W . . . W . . .  
W . . ." is used by stations looking for contacts

**THE CONTEST PERIOD**

<i>Time</i>	<i>Starts</i>	<i>Ends</i>
A.S.T.	Nov. 12 & 19, 7:00 P.M.	Nov. 14 & 21, 4:01 A.M.
E.S.T.	Nov. 12 & 19, 6:00 P.M.	Nov. 14 & 21, 3:01 A.M.
C.S.T.	Nov. 12 & 19, 5:00 P.M.	Nov. 14 & 21, 2:01 A.M.
M.S.T.	Nov. 12 & 19, 4:00 P.M.	Nov. 14 & 21, 1:01 A.M.
P.S.T.	Nov. 12 & 19, 3:00 P.M.	Nov. 14 & 21, 12:01 A.M.

in the Sweepstakes. A single, snappy CQ SS will bring good results! You will test station performance, work new states and Sections, improve operating efficiency and ability, and meet old and new friends.

**PROOF OF QSO**

At least *one* way complete six part exchange must be completed and acknowledged between two stations as "proof of QSO"<sup>4</sup> before points or Sections can be claimed.

It is not essential that each station worked be taking part in the contest to make your points count. Any operator who needs information can be referred to this announcement. First, ask the operator to take your preamble and come through with like information in preamble form.

**POWER FACTOR AND SCORES**

If the power input to the final stage (plate current times plate voltage— $E \times I$ ) is:

(a) Up to and including 100 watts—multiply score by 1.25.

<sup>4</sup> There is no point in working the same station more than once in the contest period if two points have been earned by an exchange. If but one point is made the first time, you can add a point by working this station again for exchange in the opposite direction. Underline all such exchange entries in your "list," identify them by showing parenthetically the call of the correspondent station. Leave right or left report columns blank so that other pairs of exchanges completed in *one* contact are side by side.

(b) *Over* 100 watts—multiply score by 1.

Operating in both low- and high-power classes at different times is still permitted, but scoring rules do not permit Sections worked on high power to be used in the low-power classification. Points of some kind are credited for every QSO with a *bona fide* exchange, whether the station worked is a leading "SS" man or a ham outside the contest. If one breaks his power class, however, the Total Score is the *sum of scores separately computed* for each power class and added.

Scoring system in brief:

All contacts:

One point for each QSO when "receipt" is completed for an exchange one way.

Two points for each QSO when the required information is exchanged both ways.

For final score:

Multiply totaled points by the number of different A.R.R.L. Sections<sup>2</sup> worked, that is, the number in which at least one *bona fide* S.S. point or exchange has been made.

Multiply this<sup>6</sup> by 1.25 if you used 100 watts or less for transmitter input.

**ADDITIONAL RULES**

1. Information in contest exchanges (six parts) must be sent in the order indicated, that of the A.R.R.L. message pre-

<sup>6</sup> If the power was changed between (a) or (b) during the contest, separate scores must be kept for each power class, and the two added together for the total.

**EXPLAINING CONTEST EXCHANGES**

<i>Send Like Std. Msg. Preamble</i>	<i>NR</i>	<i>Call</i>	<i>CK</i>	<i>Place</i>	<i>Time</i>	<i>Date</i>
In the "SS" Exchanges	Number contest info. sent consecutively, 1, 2, 3, etc., a new nr. for each station worked	Send your own call	CK is RST report <sup>3</sup> of station worked	Your city and section <sup>3, 2</sup>	Send time of transmitting this "NR"	Send date of QSO
Purpose . . . . .	The QSO-nr tells how you are doing; aids Hq. checking	Identification	All stations exchange complete reports	The A.R.R.L. Section is vital contest data	Time and Date must check in both logs and fall within the contest period to prove each point claimed	

<sup>3</sup> Send the letters CK and just the three number RST report. In 'phone exchanges only two numerals need be used in the report, the first always "readability," the second "strength." Instead of just the state (which is the same as the Section in many cases), identify your A.R.R.L. Section as, for example, Salem, Eastern Mass.; Providence, R. I.; Buffalo, W. N. Y.; Omaha, Neb.; Oakland, E. Bay, etc.

amble. Incomplete exchanges or wrong order of sending justifies disqualification.

2. Entries should be (a) in the low-power class, or (b) high-power class, or submitted as the sum of separately computed work at one station falling in each class. Sections worked on high power do not count in the multiplier for low-power-score and vice versa. Logs must show the power used for each QSO or for groups of QSOs.

3. Reports must show operating time for each period spent on the air in the "SS," and the total of such operating time.

4. Logs must be marked for "Phone" or "C.W." entry grouping all work by either method together as one score.

5. All work must fall in the contest period.

6. Decisions of the award committee of C.D. staff members shall be accepted as final.

7. Reports must be received at A.R.R.L. Hdq. from all stations except those in Alaska, Hawaii, and P. I. on or before noon, Dec. 23, 1938, to be considered for certificate awards. From outlying points, reports must similarly be received on or before Jan. 20, 1939.

**CLUB PARTICIPATION**

Certificate awards (besides the 'phone and telegraph Section awards) will be made through each club where three or more individual club members, or new hams invited and

reported by such a club, in addition to sending a contest report have their club secretary write Hq. listing their individual calls and scores, and the total of such scores. Only the aggregate of scores confirmed by receipt here of Contest Logs shall count for the club. If there are both club 'phone and c.w. entries, A.R.R.L. will provide two certificate awards for the club to give its leading members. The sum of the scores of all club participants ('phone and c.w.) confirmed by logs will be added by the secretary, to count for the club!

A genuine gavel, with engraved sterling silver band, is offered as an award to that club whose officers or activities' manager submits the greatest collective score from "SS" logs. Club members must send in full reports either direct or through the secretary to substantiate the club's claim on the gavel award! A chance to win honors for your club and a valuable trophy for the club's presiding officer to use at meetings!

Competition comes only from operators in one's immediate Section. Awards are for the operator running up the best communication record for each Section (as indicated by the score). Operators thus have equal DX conditions and operating opportunity. Fullest operating enjoyment is assured. See May QST for full details on the last SS or ask any amateur who took part last year!

(Continued on page 116)

STATION W/VE! . . . SUMMARY OF EXCHANGES 9TH A.R.R.L. ALL-SECTION SWEEPSTAKES															
Freq. Band (mc.)	Time On or Off Air	NR	SENT (1 point)				RECEIVED (1 point)				Time	Date (Nov.)	Number of each Different New Section as Wkd	Points	
			Stn.	CK-RST	Place	Time	NR	Stn.	CK-RST	Place					
3.5	On 6:10 P.M.	1	W1AW	579	W. Hartford, Conn.	6:15 P.M.	12	3	W1GME	589	Middlebury, Conn.	6:18 P.M.	12	1	2
		2	"	439	W. Hartford, Conn.	6:25 P.M.	12	7	W1BHM	479	New Haven, Conn.	6:30 P.M.	12	..	2
"	"	3	"	587	W. Hartford, Conn.	6:40 P.M.	12	2	W3BKZ	389	Chevy Chase, M.D., D.C.	8:45 P.M.	12	2	2
7	"	4	"	498	W. Hartford, Conn.	10:18 P.M.	12	3	W8BEN	569	Rochester, W. N. Y.	10:24 P.M.	12	3	2
"	"	5	"	578	W. Hartford, Conn.	1:25 A.M.	12	7	W9TSV	589	Chicago, Ill.	1:15 A.M.	12	4	2
"	Off 3:00 A.M. 8 hours 50 min. On 1:00 P.M.	6	"	549	W. Hartford, Conn.	2:50 A.M.	12	15	W9VKF	479	Minneapolis, So. Minn.	2:55 A.M.	13		2
14	"	7	W1AW	479	W. Hartford, Conn.	2:15 P.M.	20	14	W5WG	339	Ruston, La.	1:05 P.M.	20	6	1
"	"					17	W5BDI	459	Houston, So. Tex.	2:20 P.M.	20	7	2		
7	"	9	"	578	W. Hartford, Conn.	3:00 P.M.	20	11	W1EWD	589	New Britain, Conn.	2:55 P.M.	20	..	2
"	"					(W5WG) <sup>4</sup>			4:06 P.M.						
"	"	10	W1AW	347	W. Hartford, Conn.	4:30 P.M.	20	16	W6MVK	439	Modesto, S. J. V.	4:31 P.M.	20	8	2
"	Off 5:20 P.M.	11	"	479	W. Hartford, Conn.	5:10 P.M.	20	9	W8IPT	579	Wheaton, Ill.	5:15 P.M.	20	..	2
4 h. 20 m. 13 h. 10 m.												8 Sec. 22 pts.			
3.5, 7 and 14 mc. used. 85 watts Input Power															

Number and name of operators having a share in above work . . . . .  
 Claimed score: 22 points x 8 Sections = 176 x 1.25 (85 watts input) = 220.  
 I hereby state that in this contest I have not operated my transmitter outside any of the frequency bands specified on my station license, and also that the score and points set forth in the above summary are correct and true.

Signature \_\_\_\_\_  
 Address \_\_\_\_\_  
 My Tube Line up \_\_\_\_\_  
 Number Different Stations Worked \_\_\_\_\_



# Speaking of Rotary Beams—

WE'VE seen—both “in the flesh” and in pictures—some pretty pretentious rotary antenna structures, but there's one that strikes us as being just about the final word in he-man mechanical construction. No doubt you'll be inclined to agree, after glancing at the accompanying photograph. And it has been instrumental in producing just about the outstanding 10-meter 'phone signal from Europe. Yes, we're talking about GM6RG.

GM6RG, known in non-ham circles as Bryan Groom of Galashiels, Scotland, had an idea that he wanted a rotary beam with some real gain and proceeded to carry it out. Aiming for a power increase of about 12 db with low-angle radiation, pencil and paper work produced a suitable antenna design (incidentally involving the use of 20 half-wave elements) and set the dimensions of the structure. Contractors and engineers were then called in and built up the rotating outfit shown. A 50-foot telephone pole, 16 inches in diameter, set 8 feet in the ground and firmly guyed at a height of 20 feet, supports the rotatable part.

The antenna supports are two “H”-shaped structures with lattice-work tapered members; the central beams of the “H”'s are capable of standing a steady weight of one ton when supported at the middle! At the top of the pole is the rotating mechanism, consisting of a worm gear giving a 1400:1 reduction and driven by a built-in  $\frac{1}{4}$ -hp. reversible motor. The antenna drive-shaft, to which the upper central beam is keyed, is a 3-foot length of 2-inch diameter steel, supported by ball bearings at the top and bottom of the gear box. The drive mechanism alone weighs 360 pounds. As a direction indicator, a 16-contact commutator is mounted on the drive-shaft, with a 16-conductor lead-covered cable running from it to the operating room. A wiping contact on the commutator controls lamps mounted on a great-circle map in the operating room, so that the part of the world at which the antenna is aimed is automatically illuminated.

The upper antenna section, on the top “H,” consists of two half-waves in phase, driven, and four sets of parasitic elements. Behind each driven element is a reflector and in front, three

directors, making five elements on each side or ten for the whole upper antenna section. An exactly similar arrangement is strung on the lower “H,” which is suspended from the upper structure by guy wires, broken up so that they are non-resonant. The pole passes through the central beam of the lower “H” with about 1-inch clearance.

The antenna was aligned by the aid of field strength measurements at a remote point. First the two driven elements were adjusted to the right length, then the reflectors were added and adjusted to give maximum gain, then the direc-

tors similarly pruned, one set at a time. When the top section was finished the bottom section was independently adjusted by the same method. Finally, the two pairs of driven elements were connected by a two-wire line, with a coaxial cable having an impedance of about 100 ohms tapped on at its center. The line spacing was then adjusted to obtain maximum antenna current, the line sections acting as “Q” bars for impedance

matching. A spacing of two inches was found optimum.

The upper and lower sections of the antenna are a half-wave apart, and the reflector-director spacing is a quarter-wave. Measurement shows that the gain over a half-wave antenna is in the neighborhood of 13 db. The rotary beam gives the same signal strength as a 28-Mc. rhombic with  $4\frac{1}{2}$ -wave legs, an antenna which previously had given a good account of itself. Measurements of course were made on the line along which the rhombic is pointed, alternate readings being taken over short periods with first one antenna and then the other.

All in all, an ambitious undertaking, but one which has proved its worth.

—G. G.

## “Single-Ended” R.F. Receiving Tubes

THE term “single-ended” as introduced in connection with tube construction hasn't anything to do with the circuits in which the tubes are used, but refers instead to the method of bringing out element terminals. A single-ended

(Continued on page 57)

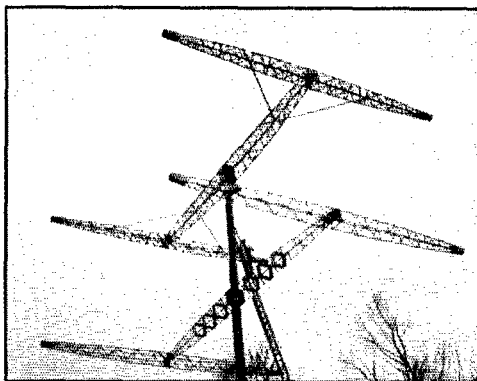

THE ROTATABLE ARRAY AT GM6RG

## BOOK REVIEW

*Radio Frequency Electrical Measurements*, by Hugh A. Brown, M.S., E.E. 384 pages, including index and bibliography. 177 illustrations. Published by McGraw-Hill Book Company, New York City. Price, \$4.00.

The average amateur, upon first glancing through this book, might think it much too technical and containing nothing of interest to him. If he had no curiosity about measuring methods he would be correct, but the more serious type of amateur will find much to interest him. Although primarily intended for use in a university radio engineering laboratory course, the book should prove to be a useful manual for the practicing engineer and advanced amateur. The amateur need not fear the mathematics; the book is so written that anyone should find no difficulty in following instructions and methods, even though he wishes to omit analyses and discussions of theory. Many nonmathematical explanations are given for those who wish to know why certain fundamentals are true, but the mathematical development is also given in practically every case.

As would be expected, the largest chapter is the one devoted to measurement of circuit constants, and it is quite complete. The chapter given to the measurement of frequency should prove quite interesting to many amateurs, since it contains excellent descriptions of all of the various frequency-measuring methods, including Lecher wires. A chapter on antenna measurements is of interest, especially the portion devoted to the determination of the characteristic impedance of a line. Other chapters include measurement of tube characteristics: voltage, current, and power; wave form, and receiver measurements.

The book is dedicated to "my fellow amateurs at W9YH."

—BG

## Strays

"A tip to the hams who might influence the purchaser of an electric shaver, or who contemplate one of their own: The best of the vibrator-type shavers cause excessive interference to radio reception. Electric shavers of a new type, making use of universal motors, do not cause any radio interference. With this latter type, you may shave while listening to the VK come back at you."

—W9GDB

W5E00 sent this explanation of the operation of a cathode ray oscillograph taken from the front page of a large college paper:

"Other features from the Department of Physics will consist of a demonstration of the registration of sound waves on a cathode ray oscillograph. According to the loudness or softness of sound, the line of the oscillography varies from regular to irregular, the louder the sound the more irregular the line."

No wonder that modulation seemed distorted!

"For the past three years I had been troubled at intervals with a terrific 'power line' noise. It was so loud that it blanketed a local b.c. station in our b.c.l. receiver. I could hear absolutely nothing on the ham bands during periods when the noise

was on. Usually the noise stayed on about half an hour at a time. There were some periods of several weeks during which it would not be heard, but at other times it was a source of annoyance every night. One night recently when this noise came on I turned off the switches and paid a visit to a friend who possessed a galena crystal receiver. The friend and I carried the crystal set and a small antenna out in search of the interference source. After carrying the set around the neighborhood for some time, we traced the interference to a spot about 150 feet down an alley from my location. We found an antenna with sparks jumping across the insulator. Further investigation revealed that the antenna had an old-time spark transmitter connected to it, and that the owner was operating it in an effort to make the neighbors turn off their b.c.l. sets so 'his baby could go to sleep!' In the conversation that followed this startling revelation, we learned that he was an old-time ham and used to be on the air before the government ban of the war. He had some old radio magazines, and among others, a copy of *QST* published when it was only a pamphlet. During the evening he told us his whole life-story. Although I missed three skeds while talking to him, the time was well spent, for there is no longer any spark-transmitter noise to interfere with operation!"

—W6KFC

## New Amplifier Tubes for Television Receiving

Two new television amplifier pentodes, the 1852 and the 1853, have just been announced by RCA. These tubes, intended primarily for use in experimental television receivers, both feature a special shielded-lead construction to permit bringing out the control-grid lead to a base pin rather than to a cap. With this construction, it has been possible to keep the grid-plate capacitance as low as that of this tube if it were constructed with a grid cap. From a circuit standpoint, the proximity of grid pin to cathode pin simplifies wiring and decreases the size of the inductance loop connecting the input circuit to the tube. These are features important at high frequencies because they provide decreased feedback and improved circuit stability.

The 1852 has extremely high grid-plate transconductance (9000 micromhos). It is recommended for use in the r.f. and i.f. stages of the picture amplifier, as well as in the first stages of the video amplifier when several video stages are used.

The 1853 is another high transconductance tube (5000 micromhos). The transconductance of the 1853 is not as high as that of the 1852, because the 1853 is designed with an extended cut-off characteristic so as to make it especially suitable for use in the r.f. and i.f. stages of the picture amplifier of television receivers employing automatic gain control.

(Continued from page 55)

tube is one in which all leads are brought out through a common base.

We've been so used to working with screen-grid receiving tubes having grids out the top that the thought of bringing both grid and plate through the base is utterly untenable. Of course it would be impossible to prevent self-oscillation with such tubes in tuned r.f. circuits—but it isn't! In fact, it is claimed that greater stability can be obtained with single-ended tubes, along with greater uniformity in performance, because open-air grid leads are not used. In other words, the effective

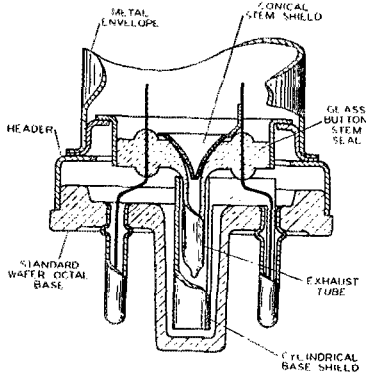

FIG. 1

grid-plate capacity is as low as with the conventional type of construction. At the same time, improved design has made possible reductions in input and output capacities, an obviously desirable feature.

Fig. 1 shows a cross-section of the base construction in the new-type single-ended tubes. The grid and plate leads are brought out to pins on opposite sides of the octal base to give them as much physical separation as possible, and shielding is inserted in the seal and in the locating pin further to reduce the capacity. A conical metal piece extends into the exhaust stem as shown, and a cylindrical shield is placed around the stem extending to the apex of the cone so that a substantially continuous shield is placed between the two leads. Both shields are connected to the metal shell of the tube. The shield in the locating pin also serves to reduce the capacity between the socket prongs as well as between the base pins. With the ordinary wafer socket the net grid-plate capacity, with the tube inserted, is practically the same as with the double-ended construction.

In using single-ended tubes in r.f. stages, arrangement of wiring can do much to prevent

capacitive coupling between grid and plate circuits. Hot r.f. leads should be kept separated and should be close to the chassis; the basing arrangement helps on this. Further reduction in feed-back can be obtained by mounting the screen by-pass condenser so that it lies across the socket between the grid and plate terminals, thus using the outside foil of the condenser as additional metallic shielding.

Besides the 1852 and 1853, tubes designed primarily for television receivers, four new types of single-ended tubes are to be made available in the near future. These are the 6SJ7, 6SK7, 6SF5 and 6SQ7. Complete characteristics are not available at this writing, but the types correspond approximately to the same metal tube numbers without the "S." The 6SJ7 and 6SK7 have higher transconductance, however, than the 6J7 and 6K7, and input and output capacities are 6 and 7  $\mu\text{fd.}$ , respectively, against 7 and 12  $\mu\text{fd.}$  for the older types. Pin connections on these types are as follows: 1, shield; 2, heater; 3, No. 3 grid; 4, No. 1 grid; 5, cathode; 6, No. 2 grid; 7, heater; 8, plate. The plate is pretty well surrounded by pins normally maintained at ground potential.

Receiver-manufacturing convenience and improved set-design possibilities primarily are responsible for development of single-ended construction. The nuisance of the flexible grid lead is eliminated. Possibly we can get better performance in our ham receivers by having all the r.f. circuits securely anchored.

—G. G.

## New Transmitting Tubes

### RCA 813

A NEW 260-watt output beam power transmitting tube is now available from RCA. This tube, with a new flared construction which makes possible reduced overall length, is a "big brother" to the 814 beam tube, and may be used in some applications where insufficient space in the vertical direction is available for the 814.

Typical operating conditions and ratings:

Filament voltage	10 volts
Filament current	5 amperes
Grid-plate capacity (with ext. shield)	0.2 $\mu\text{fd.}$
Input capacity	16.3 $\mu\text{fd.}$
Output capacity	14 $\mu\text{fd.}$
Plate dissipation	100 watts
Screen dissipation	22 watts

In Class-C telegraphy operation:

D.c. plate voltage	1500	2000 volts
D.c. screen voltage	300	400 volts
D.c. grid voltage	-70	-90 volts
Peak r.f. grid voltage	150	160 volts
Beam-forming plate voltage	0	0 volts
D.c. plate current	180	180 ma.
D.c. grid current (approximate)	6	3 ma.
Screen resistor	60,000	107,000 ohms
Grid resistor	11,700	30,000 ohms
Driving power	0.8	0.5 watt
Power output (approximate)	190	260 watts

SPACE limitations make it necessary to hold the results of Problem 21 until December *QST*.

The base of the 813 fits a special 7-contact transmitting socket. The overall dimensions are  $2\frac{3}{8}$  inches by  $7\frac{1}{2}$  inches, diameter and height.

### RK 63

A new high- $\mu$  tube in the high-power triode group is the Raytheon RK-63. This tube, with tantalum plate and grid, thoriated tungsten filament, and hard glass bulb, is designed for use as a power amplifier, oscillator, or frequency multiplier.

The following is manufacturer's data on the RK-63:

Amplification factor.....	37
Filament voltage.....	5 volts
Filament current.....	10 amperes
Grid-plate capacity.....	3.3 $\mu$ fd.
Input capacity.....	2.7 $\mu$ fd.
Output capacity.....	1.1 $\mu$ fd.

Data on operation as Class-C r.f. power amplifier.

#### Maximum ratings:

D.c. plate voltage.....	3000 volts
D.c. plate current.....	250 ma.
D.c. grid current.....	60 ma.
Plate dissipation.....	200 watts

#### Typical operation:

D.c. plate voltage.....	3000 volts
D.c. plate current.....	233 ma.
D.c. grid voltage.....	-200 volts
D.c. grid current.....	45 ma.
Peak r.f. input voltage.....	415 volts
R.f. driving power.....	17 watts
Power output.....	525 watts

Plate temperature: The plate of the RK-63 will show a yellowish red color (see temperature color chart in Raytheon Handbook of Amateur Tube Uses) when operated at the maximum rated plate dissipation. Dissipations above the rated value should be avoided.

### Ratings on RK-62

The gas-triode detector-thyratron tube mentioned earlier in *QST* as the Raytheon QY-4 experimental tube now has the published characteristics and ratings for this service given below. The tube is a combination high-sensitivity detector and relay tube for radio remote control purposes where low battery voltages are desirable. It is designed for use as a self-quenching super-regenerative detector with a high resistance relay in the anode circuit which is operated upon reception of a radio-frequency signal.

#### Direct interelectrode capacitances:

Grid to anode.....	2.5 $\mu$ fd.
Grid to filament.....	2.7 $\mu$ fd.
Anode to filament.....	2.8 $\mu$ fd.

#### Readings and nominal characteristics:

Filament voltage.....	1.4 volts
Filament current.....	0.05 ampere
Maximum d.c. anode voltage.....	45 volts
Maximum d.c. anode current.....	1.5 ma.
Anode voltage drop (approximately).....	15 volts
(at 0 d.c. grid voltage and 1.5 ma. d.c. plate current)	

#### Typical operation:

D.c. anode voltage.....	30 to 45 volts
No-signal anode current.....	1 to 1.5 ma.
With-signal anode current.....	0.1 to 0.5 ma.
Relay resistance.....	5000 to 10,000 ohms

### OPERATING NOTES

The tubes must always be operated with sufficient series resistance in the anode circuit to limit the anode current to the maximum rated value.

When operating properly the tube should be oscillating at audio-frequency except during reception of a radio-frequency signal whereupon the audio-frequency oscillation should disappear.

The useful life of the tube depends upon the anode current and is shorter than that of other Raytheon amateur types. The life may be prolonged by operating the tube with as low an anode current as possible.

### RK-56, 57, 58, 59, 60

THE following four new tube types have just been added to the Raytheon tube line:

The Type RK56 is a new beam type which is similar to the RK39 but has lower ratings. It is designed for use in portable equipment or in other applications where higher output is not required.

Types RK57 and RK58 are triodes which may both be used in zero bias Class B audio circuits as well as in general purpose applications. However, if used with a low negative bias two RK57 tubes in Class-B will supply 370 watts of audio power at 1500 volts on the plate. These two types are quite similar in construction, but the top cap plate connection of the RK57 permits higher ratings than those of the RK58.

The RK59 is another type suitable for use in portable high-frequency equipment, having been originally designed for police work. It is a double triode with a filamentary cathode which heats quickly enough to allow it to be turned off during standby periods. The two sections when operated in Class-C push-pull are rated at 32 watts r.f. output.

Type RK60 is a new rectifier capable of supplying 600 volts d.c. at 200 ma. This is a full-wave rectifier with ratings between those of receiving types and those of previous amateur types such as the 866.

## Joint Pacific and Southwestern Division Convention

Los Angeles, Calif., Nov. 11th, 12th, 13th

THE plans for the joint Pacific and Southwestern Divisions Convention to be held at the beautiful Elk's Temple, Los Angeles, Calif., November 11, 12, 13, 1938, under the auspices of the Federation of Radio Clubs of the Southwest,

are nearing completion, and the committee in charge has made up its mind that this convention will be something to remember. All amateurs and members of the A.R.R.L. are cordially invited to be present for three whole days of interesting events. Tell Your Friends Also. Write your director for information.

## Modern Radio Course Resumes Over W1XAL

**Q**ST has in the past plugged Dr. C. Davis Belcher's "Modern Radio Course" as presented over W1XAL. In consequence, many amateurs have been instructed and entertained by listening to the lectures and many more would-be amateurs have received a lucid, coherent background of technical radio education.

With four years of experience behind the present series, the course should supersede even its past successes. The broadcasts are on Mondays at 8:00 P.M. E.S.T. on 6.04 Mc. and on Fridays at 5:00 P.M. E.S.T. on 11.79 Mc. For detailed schedules write the station, W1XAL, World Wide Broadcasting Foundation, University Club, Boston, Mass.

The story behind the course is as unusual as it is interesting.

In the fall of 1934, Dr. Belcher lectured for the Division of University Extension of the Massachusetts Department of Education. In the course of his lectures, Dr. Belcher often conducted his classes at W1XAL's transmitting laboratories. Several times during his lectures, Dr. Belcher experimented with broadcasting the actual technical information which he was giving in his lectures. Thus, by pure chance, parts of Dr. Belcher's lectures seeped out over the short waves. To his surprise, he soon began to receive dozens of letters from short-wave listeners throughout the country, asking him more about his course and how they might enroll. From this unusual incident, the Radio Course took root and grew to its present proportions — with students enrolled in nearly the forty-eight states of the Union, the provinces of Canada, and in many foreign countries.

Dr. Belcher himself has had an interesting and colorful career. Shortly after leaving high school, he went to sea as a commercial operator. For several years he served on freighters, tankers, and passenger boats. Leaving the sea to take a position with General Electric, he worked for a time testing radio equipment. Later, Dr. Belcher attended Tufts Engineering School, receiving his B.S. degree in 1930. Following graduation, he was associated with the Department of Commerce Radio Division, as a radio inspector in the New York City area. Later he was transferred to field service for the Federal Communications Commission.

In 1933 Dr. Belcher left the government service to join the United States Coast and Geodetic Survey as a radio engineer, later leaving this service to teach in the extension division of the Massachusetts Department of Education. At the same time he began his graduate work at Tufts. Receiving his degree from their School of Medicine in June, Dr. Belcher has continued his work for the Massachusetts Department of Education.

In connection with his radio course, Dr. Belcher has prepared a series of four illustrated booklets, each designed to cover eight lectures of the course. These booklets, containing blueprints, circuit diagrams, and other material invaluable to the student, are available from the World Wide Broadcasting Foundation for the cost of the printing and mailing. This is in keeping with the station's non-profit non-commercial character, for it carries no advertising or commercial programs, and is designed solely for the benefit of the listener. The price of the course is moderate—\$1.00 for each set of diagrams, or \$3.50 for the complete course.

—C. B. D.

## Antenna Questions

(Continued from page 27)

This dimension is not critical. All of the above formulas are for use with a 600-ohm line, which may be made by use of No. 14 copper spaced approximately 5 inches, No. 12 spaced 6 inches, or No. 10 conductors spaced 8 inches apart.

Connections of the transmission lines of Fig. 1-d and -i may be made at or a few inches from the ends of a middle insulator. Usually, connection at each end of the center insulator (for the lower frequencies, two insulators in series may be used) results in a match sufficiently accurate to make unnecessary the use of a formula or table for finding an exact amount of "Y" or spread.

The feeders of Fig. 1-d and -h should be coupled to the output tank coil of the transmitter through a one- or two-turn coil. The degree of coupling between this pickup coil and the tank will control the load on the output stage.

The feeders of (e) should be equally spaced from the r.f. ground potential point on the output tank coil, and should be moved toward the ends of the coil until proper loading results. The single-wire feeder of Fig. 1-h should also be moved from the r.f. ground potential point on the output coil until the load rises to the proper value. If series plate feed is used in the stage, putting high d.c. voltage on the coil, 0.002- $\mu$ fd. or larger mica condensers should be used near the coil tap to isolate the antenna from the d.c.

Details on proper tuning procedure with the tuned-feeder and direct-coupled antenna systems, and a discussion of the systems for multi-band operation, will be given later.

# HINTS and KINKS for the Experimenter



## Economical Two-Stage Transmitter

**A**C.W. transmitter featuring break-in operation with keyed oscillator and externally-biased amplifier, ease of neutralization with only one stage, moderate output on three bands with one crystal, and excellent economy (only three tubes, all receiving-type, are used) is shown in Fig. 1.

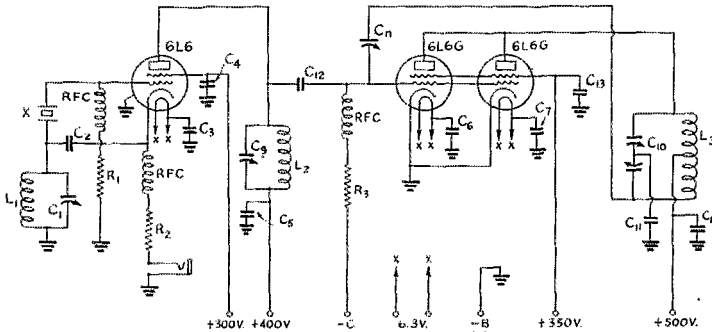

FIG. 1—MODERATE OUTPUT OBTAINED ECONOMICALLY WITH 6L6 TUBES

- C<sub>1</sub>—140- $\mu$ fd. midget variable.
- C<sub>2</sub>—0.01- $\mu$ fd. paper tubular.
- C<sub>3</sub> to C<sub>8</sub>—0.002- $\mu$ fd. mica, 600-volt working.
- C<sub>9</sub>—140- $\mu$ fd. midget variable.
- C<sub>10</sub>—265- $\mu$ fd. per section, split-stator (Hammarlund MTC D-250-C).
- C<sub>11</sub>—0.00055- $\mu$ fd. mica.
- C<sub>12</sub>—50- $\mu$ fd., 600-volt mica.
- C<sub>13</sub>—0.002- $\mu$ fd. mica, 600-volt working.
- R<sub>1</sub>—15,000-ohm, 1-watt.
- R<sub>2</sub>—400-ohm, 10-watt.
- R<sub>3</sub>—15,000-ohm, 5-watt.
- RFC—2.5-millihenry r.f. chokes (National R100).
- L<sub>1</sub>—See dimensions of L<sub>1</sub>, Fig. 813, The Radio Amateurs' Handbook.
- L<sub>2</sub>—See dimensions of L<sub>2</sub>, Fig. 813, The Radio Amateurs' Handbook.
- L<sub>3</sub>—See dimensions of L<sub>1</sub>, Fig. 828, The Radio Amateurs' Handbook.

With the final tuning condenser specified, the output can be tuned from 160 to 10 meters with reasonable L-C ratios for c.w. telegraph operation on all bands.

Typical operating currents and voltages are as follows:

Oscillator plate voltage . . . . .	400 volts
Oscillator plate current . . . . .	70 ma.
Oscillator screen voltage . . . . .	300 volts
Amplifier plate voltage . . . . .	500 volts
Amplifier plate current . . . . .	175 ma.
Amplifier screen voltage . . . . .	350 ma.
Amplifier grid current . . . . .	5 ma.

Using a 40-meter crystal, the transmitter operates satisfactorily on 20 meters, and the

amplifier may be used as a regenerative doubler for good 10-meter output.

—K. M. Reichenbach, W2KIF

## Inexpensive Flexible Shaft Coupling

**F**LEXIBLE shafts of any desired length may be made at home at a cost of five to ten cents each. Speedometer shafting is used as the basis of the couplers, and the ends are soldered into brass bushings of  $\frac{1}{4}$ -inch diameter, approximately  $\frac{3}{8}$  to  $\frac{1}{2}$  inch long. If it is impossible to obtain a broken speedometer cable from one of the neighborhood garages, a new cable approximately 6 feet long may be obtained from an auto supply store at a cost of 40 to 60 cents.

The construction of the flexible shaft coupling is shown in Fig. 2. The place in the shaft where the cut is to be made for an end of the coupling

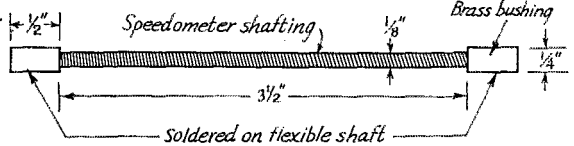

FIG. 2—HOME-BUILT FLEXIBLE SHAFT COUPLING

should be heavily tinned with solder before the cut is made. The inner surface of the bushing should also be tinned. After cutting through the soldered portions of the shaft, the ends should be sweated into the bushings with a hot soldering iron, and any excess solder on the outside of the bushing should be wiped off while warm.

—John Wilson, W2GUR

## Simple Noise-Limiter Addition to Receiver

**A**LTHOUGH much has been done to simplify noise silencers and reducers, there still are many who consider these devices too complicated or costly to be added to their receivers. Because of this fact, much operating enjoyment on the high-

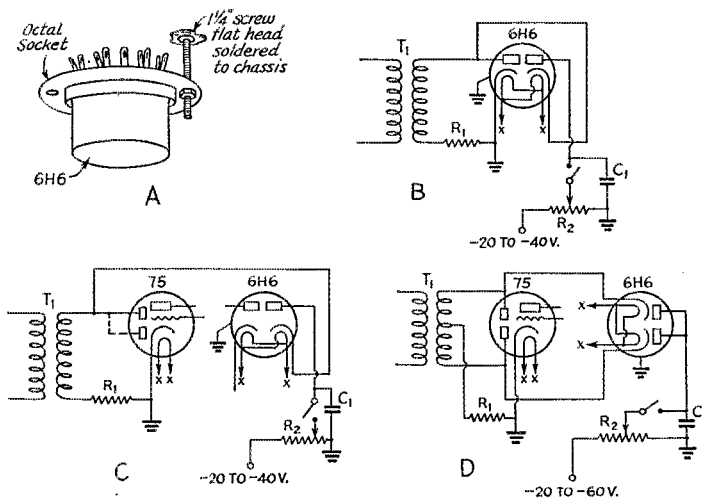

FIG. 3—SIMPLE RECEIVER CHANGE TO INCORPORATE A NOISE SILENCER

The 6H6 is mounted in an inverted position beneath the chassis by means of a single flathead screw.  $R_1$ —Diode-detector load resistor.  $R_2$ —25,000-ohm potentiometer.  $C_1$ —0.1- $\mu$ fd., paper tubular condenser.

frequency bands is sacrificed in regions of strong interference.

The circuit of a single-diode noise limiter is well known and extensively used with single- and parallel-diode second detectors. For receivers using full-wave diode detection, the two separate diodes of a 6H6 tube may be used in an equally simple circuit adapted from the one mentioned above. Typical circuit diagrams of the former type of noise limiter are shown in B and C of Fig. 3, while a diagram for use with a full-wave detector is shown in D. In any case, the total list of parts to be added to the receiver (assuming that a suitable source of negative bias voltage is available) includes only a 6H6 tube and socket, a bypass condenser, and a small potentiometer resistor.

Since the 6H6 tube and socket are light and compact, the assembly may be mounted beneath the chassis by means of a single long screw soldered in place. Alternatively, a longer screw may be substituted for one of the short screws or rivets

holding a tube socket in place, and the lower extension may thus be used.

The 0.1- $\mu$ fd. condenser should be mounted near the 6H6 socket. Many sets are equipped with fixed bias supply; and in these, the negative voltage applied to the suppression-control potentiometer may be set to a desirable value at the voltage-divider resistor. This should not noticeably affect the other voltages taken from the divider, as the current through the control is only a milliamper, approximately. The potentiometer resistor should be equipped with a switch and connected so

that beginning rotation in a clockwise direction places the noise limiter in action, and further rotation increases the noise suppression.

Addition of the 6H6 tube to the circuit of the second detector may detune this circuit slightly. In order to check on this point, the 6H6 should be taken from its socket while a steady signal is being received, to determine whether a noticeable increase in output accompanies the removal. If a

change is noticed, realignment of the i.f. transformer tuning condensers with the tube in operation should follow. It is important that the 6H6 tube be one in good condition; it might otherwise prove, because of leakage, to be a noise contributor rather than a noise limiter.

On very strong signals the noise limiter tube may cause noticeable audio distortion, although a limiter is seldom needed on signals of this sort. If such a distortion is objectionable, however, a higher value of negative voltage may be applied to resistor  $R_2$ .

The cost of the suppressor is probably less than two dollars and fifty cents. It can be used without seriously altering the receiver. The effectiveness has been checked many times on an oscilloscope and has been successfully demonstrated in practical use. Some experience in the use of this system is needed for best results in



VIEW OF THE DRIVE MECHANISM AND FEEDER CONNECTORS OF THE W8ECP ROTARY ANTENNA SYSTEM

Details of this simple but effective system were given in *Hints and Kinks*, QST, October, 1938. Note that wiping contacts on the tops of the large stand-off insulators have been substituted for the roller contacts described in the above article.



**SILHOUETTE PHOTOGRAPH QSL CARD**  
*This cut was made directly from the card.*

setting the control for the correct threshold setting for maximum noise suppression with minimum audio distortion.

Credit must be given to W6IOF for suggestion of the easy method of installation of the 6H6 suppressor system.

—Byron Trowbridge, W9TMP

### Novel QSL Cards

IT IS probable that the many radio amateurs who are interested also in photography will dust out their photoflood reflectors and load their cameras with fresh film when they see the QSL card used by W. H. Gillard, VE3AQS.

The call letters were made of broad black ribbon pinned on the wall. Two photofloods in reflectors were used between the subject and the wall. The exposure was  $\frac{1}{10}$  second with stop at  $f.11$ . The final negatives size of  $3\frac{1}{2}$  inches by  $4\frac{1}{4}$  inches was obtained, and the picture was contact printed on AXO postcards.

While mentioning unique QSL cards, credit must be given to Louis J. Gallo, W5GDU, for one requiring craftsmanship and painstaking work. This "card" is carved in a block of mahogany  $3\frac{1}{2}$  inches wide,  $5\frac{1}{2}$  inches long, and  $\frac{1}{4}$  inch thick. Although the finished block, properly treated, is a remarkably attractive article, it would probably require more than the customary 1-cent postal charge!

## A Transmitter of General Utility

*(Continued from page 35)*

tuned off-resonance. At resonance, the current should fall to somewhere between 60 and 90 ma. With the buffer-doubler tuned, the meter plug should be transferred to the third jack in the grid circuit of the final amplifier. When the key is again closed, the grid current should rise to 35 to 45 ma.

The next step is that of neutralizing the final

amplifier and it is carried out in exactly the same manner as described for the buffer-doubler. When neutralized, the grid current should remain constant with tuning of the plate tank circuit. In preliminary tuning of the final amplifier with voltage applied, voltage should be reduced, if possible. A 200-watt lamp may be inserted in series with the primary of the high-voltage transformer or a 100-watt, 10,000-ohm resistor connected in series with the positive high-voltage lead to protect the tube against possible damage during preliminary tuning. With plate-voltage applied, the tank condenser should be rotated rapidly until the plate-current dip is found. Care should be taken that the correct dip in plate current

is selected because some of the tank coils will tune to two bands. Approximately correct settings for the tank condenser with a 100-degree dial are: 1.75-Mc.—90, 3.5 Mc.—90, 7 Mc.—45, 14 Mc.—20, 28 Mc.—10. Full plate voltage may now be applied. The minimum plate current for any of the above mentioned tubes should be approximately 15 to 35 ma. depending upon the frequency. If desired, the power output may be checked roughly by coupling a 110-volt lamp to the final tank coil either by means of the link winding or by several turns of heavily insulated wire wrapped around the tank coil. The lamp should have a power rating approximately equal to the power output expected. Grid current to the final amplifier will decrease somewhat when plate voltage is applied and again when the load is coupled. It should not fall below 25 ma. for any of the tubes suggested.

The output link is provided for coupling by link line to a suitable antenna tuning unit. When the antenna has been tuned to resonance, coupling may be adjusted to load the amplifier to rated plate current by adjustment of the variable link. In a case where home-made coils are used without variable link, the number of turns to be used in the link winding to provide the correct loading must be determined experimentally.

In case the unit is used as a driver for a high-power amplifier, it will be found that the output amplifier doubles frequency quite efficiently. If desired, the transmitter may be keyed at the alternate position indicated in the cathode circuit of the buffer-doubler tube.

For 'phone work, a modulator capable of supplying 25 watts will be required for the 809, RK11-12 or HY57. The output transformer should be suitable for a load of 7000 ohms. If the larger tubes are used, the modulator must deliver about 40 watts and the output transformer suitable for 9500-ohm load.



# ● I. A. R. U. NEWS ●

Devoted to the interests and activities of the

## INTERNATIONAL AMATEUR RADIO UNION

Headquarters Society: THE AMERICAN RADIO RELAY LEAGUE, West Hartford, Conn.

### MEMBER SOCIETIES

American Radio Relay League  
Asociatia Amatorilor Romani de Unde  
Scurte  
Associazione Radiotelefonica Italiana  
Canadian Section A. H. R. L.  
Ceskoslovenski Amatéri Vysilaci  
Deutscher Amateur Sende-und-Empfangs  
Dienst  
Eesti Raadio Amatooride Ühing  
Experimental Radio Society of Egypt  
Experimenterende Danske Radioamatører  
Federation des Emetteurs Belges  
Irish Radio Transmitters Society

日本アマチュア無線聯盟 Japan  
Liga Colombiana de Radio Aficionados  
Liga Mexicana de Radio Experimentadores  
Magyar Rövidhullámú Amatőrök Országos  
Egyesülete  
Nederlandsche Vereeniging voor Interna-  
tionaal Radioamateurisme  
Nederlandsch-Indische Vereeniging Voor  
Internationaal Radioamateurisme  
Newfoundland Amateur Radio Association  
New Zealand Association of Radio Trans-  
mitters  
Norsk Radio Relæ Liga

Polski Związek Krotkofalowcow  
Radio Club de Cuba  
Radio Club Venezolano  
Radio Society of Great Britain  
Rede dos Emissores Portugueses  
Reseau des Emetteurs Français  
Reseau Luxembourgeois des Ama-  
teurs d'Ondes Courtes  
South African Radio Relay League  
Suomen Radioamatööriyhdistys r.y.  
Sveriges Sändareamatörer  
Unión de Radioemisores Españoles  
Union Schweiz Kurzwellen Amateure  
Wireless Institute of Australia

Conducted by Byron Goodman

### Emergency Work:

Out at the Chicago Convention ZL2JQ was telling the fellows about the emergency set-up in New Zealand. We had of course known of the "Radio Emergency Corps," how they are well-organized and have conducted several successful field tests, and how they have assigned special letters for various parts of the country so that "CQ M S" would mean that the caller wishes to contact both Taranaki and Palmerston. But we didn't know that they are recognized to the point where they are automatically released from work in the event of an emergency, such as is the National Guard in the U. S. So far, however, their work has been confined mainly to such matters as locating private planes whose pilots lose themselves in the interior.

The editorial of the August issue of *Break-In* continues the theme:

"In January, 1931, no one in Napier anticipated such a catastrophe as an earthquake. We are unable to visualize the shape or form of future visitations, but what we can do is to prepare ourselves to emulate that Napier amateur who was able to use his hobby as a means of keeping his stricken community in touch with the outside world.

"As an amateur, besides gaining enjoyment from your hobby, you have it in your power to be of great service to your community when normal communications systems are disrupted. How easily could your existing apparatus be converted for emergency operation in the event of power failure? If this difficulty be overcome, how well could you handle traffic—not the usual amateur

message—but messages with the necessary preamble so essential for filing and reference purposes? If you can reply favorably to both of these, you are pursuing your hobby not selfishly, and are considering its potential value to your community as a whole.

"When you are building your station, try to arrange it so that if necessary, parts essential to make it a self-contained communication link can readily be converted for use with batteries. This is the far-sighted attitude, and as an amateur it should be a source of pride for you to know that, with minor changes, your station could readily play its part as a link in a national emergency communication system.

"Your duty as a far-sighted citizen does not end here. The personal factor enters into it. Once contact has been established, the efficiency of an emergency link will depend upon the efficiency of the operators . . . make yourself familiar with correct operating procedure. . . .

"By preparing yourself in this way you will be an asset to your community. . . ."

That last paragraph is true not only in New Zealand but in every other country.

### Gleanings:

*Egypt:* Over 90 per cent of the licensed amateurs in Egypt are members of the E.R.S.E. . . . Much interest was shown on National Field Day, expeditions venturing forth to work under the hot sun of the desert near Alexandria and also the Cairo-Suez road. . . . *New Zealand:* P. A. Morrison of Wellington reports hearing W6ENC on 56-Mc. 'phone. . . . *Sweden:* Apparently

New Mexico is playing "hard-to-get" for the SM boys. A recent issue of *QTC* lists all the New Mexico amateurs. Like many other European countries, they take their WAS seriously. . . . *Netherlands*: Much interest in 56 Mc., with the N.V.I.R. 5-meter Relay a big success. Contacts made all over the country and with Belgian stations. . . . *England*: To complete the u.h.f. picture in Europe, the R.S.G.B. gives the ultra-highs a big spread in the latest *T & R Bulletin*,

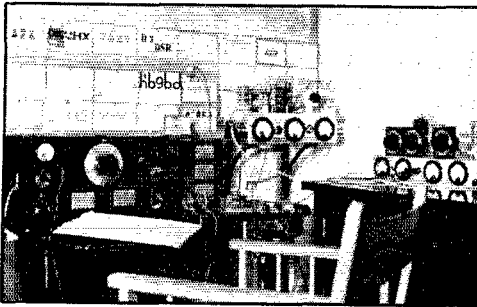

PY1AZ, RIO DE JANEIRO, BRAZIL

The straightforward arrangement has been responsible for over 80 countries worked with 150 watts input to the PP 800's final. PY1AZ is looking for Nevada, Utah and Arizona for his WAS.

detailing equipment, results of their Field Day and Relay Tests, and encouraging investigation of the wavelengths below 5. It would appear that there is a tremendous amount of interest over there right now. . . . Royal Air Force Wireless Reserve organized among British amateurs. Premium placed on code speed, with faster code men entitled to larger maintenance grants. . . . *Italy*: Transmitting licenses still not granted, although the A.R.I. hopes for a settlement of the question in the near future. . . . A.R.I. held their annual Convention on September 24th, in Milan. . . . *Roumania*: Roumanian amateurs officially licensed now. Applicant for license must be a member of the A.A.R.U.S.; the license examining commission has an A.A.R.U.S. delegate as one of its members. . . .

## Ross A. Hull

(Continued from page 10)

it is necessary to employ licensed personnel who, presumably, are especially trained for their profession. Furthermore, the men are employed for the specific work in hand.

In spite of these facts, it is necessary to provide elaborate protective devices on all commercial and experimental transmitting installations. Amateurs, on the other hand, who in many instances are unaware of the dangers involved, are not required to take any protective measures as regards high voltage cut-off switches and the like. And so, with his back to the wall, Mr. Bubbs puts his hand into the transmitter and isn't even afforded the opportunity of being thrown clear of the rig should he become involved with the high voltage.

The thought is left with you that perhaps amateur radio

should take steps to remedy this situation before an arbitrary set of rules is promulgated by a regulatory body.

Sincerely,

HOWARD A. CHINN

Dear Howard:

Of course you are quite right about the insane fashion in which amateurs operate high-voltage equipment and about the equally stupid fashion in which we even go to the trouble of providing photographic illustrations of just how to do it. I would explain (not that it helps any) that the WIAW transmitters were, when the photograph was taken, still in the laboratory undergoing final checking. Since then, the transmitters have been fitted with elaborate "dust covers" and elaborate illuminated signs. There will also be much more space between the back of the transmitters and the wall and I understand appropriate cushions are to be placed along the wall and behind each of the units!

Seriously, Howard, we should take some steps to keep amateurs impressed with the dangers involved and possibly insist on some protective devices, and I think we shall come to that. We have of course run quite a lot of material on the general subject—including a problem contest for ideas on the subject—but we should do more. Aren't you impressed, though, with the better performance in the amateur world than in the professional world, particularly when one thinks of the relationship between the high-voltage-hours involved in the ham game? The most important problem is that amateurs seem to insist on the right to tune their transmitters with a lead pencil. They will not use a complete enclosure with interlock. And any of the other "safety" devices are probably worse than nothing.

How about writing a story for *QST* on ways and means?

Sincerely yours,

ROSS A. HULL

Editor, *QST*

**M**ANY hundreds of radiograms, telegrams and letters of sympathy have been received at Headquarters from fellow experimenters and friends in the radio art and industry. *QST* gratefully acknowledges these expressions upon the passing of its editor.

Several of our advertisers expressed a desire to devote their space in this issue to his memory. It was the unanimous opinion of his associates that Ross would not want a cessation of any usual activity in the radio field—any more than he would want the magazine he edited to omit its usual editorial content and devote itself entirely to him. We have, therefore, asked our advertisers to pursue a regular course in their current copy. We thank them again here for their thoughtfulness, and for the kind inclination which led them to suggest such recognition of the passing of a friend.

We announce the reassumption of the editorship by the League's Secretary. K. B. W.

## Strays

The telephone number at W4NE sounds like an interesting sequence—73880!

— . . . —

W3BGD received his ham ticket on his 17th birthday, his first superhet on his 19th birthday, his W.A.S. certificate on his 21st birthday, and his commercial ticket on his 23rd birthday, points out W3QP.

Whaddayasuppose his 25th birthday will bring forth???



# OPERATING NEWS



Conducted by the Communications Department

F. E. Handy, Communications Manager

E. L. Battey, Asst. Communications Manager

**Communications emergencies** occur when wire communication circuits are overloaded, disrupted, or non-existent . . . when there is urgent information to transmit and no way to transmit it. If the *number* of wire circuits suddenly and definitely parted, and the *number* of communities and people isolated and concerned is the criterion, there is no doubt of the important part played by amateur radio in filling the breach following the recent wind storm. Amateurs may again "point with pride." At the same time, let us look over our message files introspectively to see what lessons and possible improvements in meeting future opportunities may come out of this hectic experience.

"It cannot happen here" is an expression frequently met where we have discussed amateur emergency communication organization in the last several months. This universal opinion about floods received a severe jolt a year or so back (at least in New England) and the popular skepticisms concerning hurricanes is now likewise something of the past. The first lesson for all people, and radio amateurs especially, is that **ANYTHING CAN HAPPEN . . .** and the only answer for the individual or organization is to **ATTAIN THE FULLEST STATE OF PREPAREDNESS POSSIBLE.**

All the recognized fundamentals were emphasized in this recent experience. Proper consideration for "priority" of official agency dispatches, coupled with some restraint (in general transmitting) and placing of responsibility for texts on officials signing messages (instead of unnecessary assumption by amateurs), was noteworthy throughout the week of heavy activity.

So many power circuits were interrupted that the shortage of emergency powered stations, representing communities, was at first very marked. Teamwork, universal cooperation and the coordination of community efforts of amateurs, showed progress over the past, attributable to a great extent we hope to the more general appointment and functioning of A.R.R.L. Emergency Coordinators in communities over 20,000 population. As one result of experience, we are now going to remove any "size" restriction, and extend the appointment and work of Coordinators, asking S.C.M.'s to make these appointments for all communities where qualified men to

represent the amateur service may be found, irrespective of the size of the city.

(1) There should be more "emergency powered" stations. Our Field Day campaigns for more individual stations must continue.

(2) Individual preparedness to serve a useful part, whether with self-powered sets or without must be extended. EVERY LICENSEE should be "registered" as to his station, in the League's Emergency Corps. He should be familiar not only with fundamentals of good operating, but aware of local plans, and the whole set up, and should be part of that set up! We want every licensed amateur to have an A.R.R.L. Emergency Corps identification card.

(3) The useful technique of certain stations equipped with e.c.o. (like W3BES and W8BQ) outside the main emergency zone, in quietly listening and hooking up stations with traffic for each other, "breaking" spot frequency nets if necessary to inform them briefly where to look, was noted . . . and we trust there will be lots more such helpful and intelligent operating in case of future need. Other stations out of the stricken area helped overcome "skip" by relaying, likewise operating with a very low ratio of transmitting time to that spent in learning full circumstances through listening.

(4) A commendable volume of traffic moved on 80-meter c.w. A great deal was handled by voice. Both methods were effective. There were a few gripes about the interference which grew to proportions at times on the low frequency 'phone bands. More telegraph circuits could have functioned to advantage. Operating included the 7-Mc. band usefully in some instances, and was in practically all cases in all the different bands, orderly. All our frequency bands that will cover distances involved (both telephone and telegraph) should be loaded as uniformly as possible with functioning circuits in communications emergencies, when the volume of traffic and number of stations so requires. The relatively low congestion of c.w. bands, of course, favored operation of low power isolated stations there. In this day of flexible transmitters and amateurs that use all bands, before a man asks for a general F.C.C. restriction or "hollers" about unbearable interference, he should look for the relatively unused channels and make use of them!

(5) The good operator who is experienced in handling recorded message traffic, knows the preamble from the address etc., is ever at a premium in communications emergencies. *Every* individual should strive to perfect his operating technique, and knowledge of "system" and forms. In some cases where operators were slow it was profitable to shift from code to voice to speed up matters.

(6) Numbered standard texts to save time and QRM, and aid in handling the secondary load of personal safety traffic, which wins so much approbation after the "official" traffic is off the hooks, may be of great help in the future. W2AQQ, W2KIU and W1PI come forward with this specific emergency-work suggestion, and we see nothing wrong with it. In fact we are proceeding to analyze some typical message files to note possible limitations and see what should be done right away. W3QP has likewise urged a similar standardization of message texts useful for routine work.

In conclusion let us say again that we may all swell with pride at the good job done. But we must not rest on our laurels. The amateur fraternity needs *every* licensee enrolled or registered in the A.E.C. It needs a representative of the amateur service, an A.R.R.L. Emergency Coördinator in *every* community, every city and town in the country. The League's program is a continuing one, and needs your full support. Are you, brother amateur, a member of the Emergency Corps? If you have a license, by all means ask your local coördinator, or your S.C.M. (address page 4) or your Headquarters, for the registration form today. Be ready for the "anything" that may come to pass. Get lined up now, today.

—F. E. II.

### Briefs

The McGill Radio Association at McGill University, Montreal, is attempting to organize a network of Canadian university stations for the purpose of exchanging news and is desirous of hearing from all universities in Canada where there are amateur radio stations. Communications should be addressed to E. H. de Grey, VE2IN, secretary-treasurer, The McGill Radio Assn., McGill Univ., Montreal, Quebec. Information is needed on frequencies, power and operating times.

Amateurs interested in aviation radio are invited to apply for enlistment in the 108th Observation Squadron, a unit of the Illinois National Guard. For information see Technical Sergeant E. M. Isaacson, W9MEQ, at the squadron hangars, Municipal Airport, 6048 So. Cicero Ave., Chicago, any Thursday after 7:45 p.m.

Each Sunday at 9:30 A.M., EST, three members of the Rag Chewers' Club get together on 7 Mc. Known as the "ABC Net" because of their "handles," they are W2LOQ (Al) 7190 kc.; W2HRN (Bill) 7104 kc.; and W3GGP (Curt) 7276 kc. W3GGP and W2HRN have been scheduling for 19 months, being joined by W8QPS (now W2LOQ) last March.

### PRIZES FOR BEST ARTICLE

The article by Mr. B. B. Greenleaf, W6VU,\* wins the C.D. article contest prize this month. Each month we print the most interesting and valuable article received marked "for the C.D. contest." Contributions may be on any phase of amateur operating or communication activity (DX, 'phone, traffic, rag-chewing, clubs, fraternalism, etc.) which adds constructively to amateur organization work. Prize winners may select a 1938 bound *Handbook*, QST Binder and League Emblem, six logs, eight pads radiogram blanks, DX Map and three pads or any other combination of A.R.R.L. supplies of equivalent value. Try your luck. Send your contribution to-day!

### "Mike" Impressions

Yours, to Determine—Good, Bad or Indifferent

PERHAPS the writer of this article has no reason to make comment regarding 'phone operation, having spent the better part of twenty years pounding brass, however, it cannot be denied that local rag chews bring a certain closer friendship that is impossible to obtain from brass pounding.

Sooooo—you Gentlemen of the phone bands, do you ever stop to realize just what your conversation sounds like to the fellow at the other end; *not to mention* any number of BCL's who may be "sitting" on your frequency.

It is not necessary or good practice to inject a lot of telegraph preamble into a phone conversation. Really, fellows, don't you think it would sound more intelligent to say, "Best Regards to you and good night," instead of "73's OM, Diddle de Bump de Bump."

Recently I listened to a very interesting discussion between a couple of phone stations and I pictured two very intelligent and educated fellows but when the sign off came it carried the usual line of silly sounding things—and I began to wonder.

Another thing that is so very noticeable is the constant repetition of certain words, especially the words "OK there." For instance, heard on the 160 meter band recently—"OK there OM fine business your YL there and OK there on your modulation there. Glad the weather there is better than here."

Dare we mention two more things?

One is the use of the CW signal "Hi." A laugh can be heard very nicely over a "Mike" so why not do a little of it when you are amused instead of shouting "Hi." And last—why not say "Go Ahead!" instead of "K." It sounds more like United States!

I am not writing all this in order to bring down the wrath of all our phone brothers upon my head but I am hoping it will cause some of our good friends on the phone bands to stop and think before they start talking into the old "Mike" so carelessly. Do you actually want people listening to think you are a small boy, or an older person who is just a trifle cracked—or would the public hold amateur radio more in esteem if we all operate with a certain reserve and dignity?

Gentlemen! Why not try this sometime when at a loss to know what to say. Instead of screwing up the gain to the limit on your "Mike" so that the fellow in the next town can hear your wife rattling dishes in the kitchen—try cutting it down so that you modulate nicely when talking directly into it, or at least only a few inches from it. If necessary gather the thing in your arms and picture your friend at the other end as sitting right there in the room with you, speak in a normal tone of voice and talk to him as a friend. I'll wager you will be able to say something really worth while into the thing.

\*2078 Belle Ave., San Bernardino, Calif.

## July O.R.S.-O.P.S. Parties

W3BES, an "old-familiar" of Sweepstakes contests, is now displaying his operating excellence in O.R.S. parties—he placed first in the July doings with 7,554,359 points; not bad for a summer party!! It was an FB party with many of the old crew and several of the newer members of the group going right to town. It looks like a big season in the O.R.S. ranks so watch out for some real competition!

W8MBW and W2HNA fought it out in great style for leading position in the O.P.S. Party, W8MBW finally ringing the bell with 5497, just 25 points ahead of HNA! A strong third (5208) was XYL W2JZX of the radio family of East Rockaway, L. I.—W2JZX Mother, W2JDG Father, W2LJJ Son. Official 'Phone Stations continue to set the standard for high voice operating ethics. Qualified 'phone operators should affiliate their stations with this group.

Get in touch with your S.C.M. (see list in front pages of each QST) for information on any appointment in which you are interested. Now is the time to get lined up. Radio activities are swinging into their peak season. Get in on some organized operating!

### Official Relay Station Scores

Station	Score	No. Dif. Stations	No. Dif. Sections	No. Heard	Power	Section
W3BES	7,554,359	156	41	7	150-250	E. Pa.
W1TS	5,011,776	132	45	12	350	Conn.
W4NC (4RA)	4,260,200	123	47	10	800	N. C.
W3FPQ	3,486,112	119	39	4	990	Md.-Del.-D. C.
W8ONK	3,383,030	115	40	26	250	Mich.
W9VES	3,317,017	111	40	37	—	Ill.
W8JTT	3,144,556	110	38	17	250	W. N. Y.
W1LJI	3,085,530	110	37	—	600	Conn.
W1JTD	3,026,896	110	38	32	75-100	Conn.
W8QAN	3,021,000	115	35	15	200-300	W. Pa.

## BRASS POUNDERS' LEAGUE

(August 16th-September 15th)

Call	Orig.	Del.	Rel.	Extra Del. Credit	Total
W4PL	26	108	1063	100	1297
W8IOX	32	57	740	55	874
W3EML	81	194	262	186	723
W7ERQ	16	39	588	26	669
W3CIZ	31	96	387	96	610
W9AWP	265	161	34	151	601
W6ITE*	69	148	312	96	625
K6NXXD	281	71	106	65	523
W7DUE	9	—	472	34	515

### MORE-THAN-ONE-OPERATOR STATIONS

Call	Orig.	Del.	Rel.	Extra Del. Credit	Total
W9NI	870	583	—	—	1453
KA1HR	694	404	204	—	1302
W5OW	137	103	488	91	819
W5DKR	236	84	176	176	672
K5AA	289	97	66	76	528

These stations "make" the B.P.L. with total of 500 or over. One hundred deliveries+ Ex. Del. Credits also rate B.P.L. standing. The following one-operator stations make the B.P.L. on deliveries. Deliveries count!

W9OZN, 258	W3QP, 164	W2JZX, 119
W6IML, 188	W7AP8, 162	W6EJA, 118
W5BN, 174	W1KH, 139	W9ICV, 117
W6JTV, 166	W9VQG, 128	More-than-one-opr.
W6NLL, 166	W3BES, 122	W1AW, 148

### A.A.R.S.

### MORE-THAN-ONE-OPERATOR STATIONS

Call	Orig.	Del.	Rel.	Extra Del. Credit	Total
WLM (W3CXL)	107	81	1631	37	1856

A total of 500 or more, or 100 deliveries Ex. D. Cr. will put you in line for a place in the B.P.L.

\* All traffic handled on radiophone.

## W1AW Operating Schedule

(Effective Oct. 30, 1938)

### OPERATING-VISITING HOURS:

3:00 P.M.—3:00 A.M. daily, except Sat. & Sun.

Saturday—8:30 P.M.—2:30 A.M.

Sunday—7:00 P.M.—1:00 A.M.

### GENERAL OPERATION:

W1AW will devote the following periods daily, except Saturday and Sunday, to *GENERAL work* with all amateurs in the following bands:

Band	Frequency	Time—Eastern Standard
1.8 Mc.	1808-1800.5-cc. 'phone/c.w.	3:00-3:30 P.M. 11:00-11:30 P.M.
3.5 Mc.	3800-cc. c.w.	3:30-4:00 P.M. 8:00-8:30 P.M.
3.9 Mc.	3950-cc. 'phone	4:00-5:00 P.M.
7 Mc.	7150-cc. c.w.	1:00-2:00 A.M.*
14 Mc.	14,254-cc. c.w.	6:00-7:00 P.M.
14 Mc.	14,240-cc. 'phone	10:00-11:00 P.M.

\* Daily except Sun. & Mon.

On Saturdays W1AW is operated from 8:30 P.M. to 2:30 A.M. E.S.T., and on Sundays from 7:00 P.M. to 1:00 A.M. E.S.T. On these days operation will be devoted to the most profitable use of bands for general contacts and to participation in special week-end operating activities and contests. The station is not operated on legal national holidays.

**OFFICIAL BROADCAST SCHEDULE** (for sending addressed information to all radio amateurs):

### Frequencies

C.W.: 1800.5-3800-7150-14,254 kes.

Starting Times (P.M.)	Speeds (W.P.M.)						
E.S.T. C.S.T. M.S.T. P.S.T.	M	T	W	Th	Fri	Sat	Sun
8:30 7:30	6:30	5:30	20	15	25	15	20 — 20
Midnight 11:00	10:00	9:00	15	25	15	20	15 15 —

### 'PHONE:

Each code transmission will be followed in turn by voice transmission on each of the following frequencies: 1808, 3950, 14,240 kes.

### Official 'Phone Station Scores

Station	Score	QSO's	Sections	No. Heard	Power	Sections
W8MBW	5497	39	23	22	600	W. N. Y.
W2HNA	5472	42	24	9	800/900	N. N. J.
W2JZX	5208	44	21	14	500	N. Y. C. & L. I.
W2HNP	4968	40	23	8	400-500	N. N. J.
W8VZ	4617	43	19	14	500/160	Ohio
W9VXL	4338	43	18	12	85-200	Ky.
W8PUN	3735	41	15	23	220	Ohio
W4GYB	3315	35	17	10	350	N. C.
W8KNP	3195	35	15	19	200	Ohio
W8BTP	3122	35	14	24	125	Mich.

Station	Score	QSO's	Sections	Station	Score	QSO's	Sections
W9NEF	3111	33	17	W8KKSJ	2340	30	13
W4EM/5	3043	35	17	W8PFM	2256	21	16
W8MOL	2940	34	14	W5ECE	2254	19	14
W8KIU	2890	34	17	W6ITH	2232	24	18
W9UNS	2660	34	14	W8NNJ	2112	26	12
W8GDR	2496	32	13	W9IAW	2080	24	13

## Brief

Floyd Hermanson, W4ASA, is proud to let the ham world know that he stole Elsie Reich, W4CQL, out from under the noses of other interested hams and married her! Making the wedding more interesting was the presence as witnesses of Mr. and Mrs. Atwood, W4CQJ and W4CQK. A ham wedding if ever there was one!

Because a hill intervenes between the start and finish lines of the Soap Box Derby course in Rapid City, So. Dakota, sponsors of the event depend on the Rapid City Radio Club for starting, timing and communication between officials. Having had some difficulty with 56-Mc. rigs on the two previous occasions of the derby, the club this year turned to 3.9- and 1.75-Mc. 'phone with W9ADJ, W9YKY, W9YJX and W9YOB building "junk-box" rigs for the event. W9ADJ worked 3.9 to W9YKY on 1.75, with W9YOB and W9YJX standing by for trouble (which did not develop). The rigs were mounted in panel trucks and powered by genemotors, with six volt broadcast receivers on the listening end.

—W9VOD, S.C.M., So. Dakota.

Jack Morgan, W3QP, announces the arrival on October 1st of "8¼ pounds of long-legged, brown-haired, blue-eyed boy—named David." Congratulations, Jack . . . may his vocal efforts never interfere with your trans-con schedules!

One of a series of radio rifle matches being undertaken by the Massachusetts Rifle Association was held with the Cleveland Shooting Association on September 11. At the range used by the Cleveland team near Bedford, Ohio, was W8AVH/8, working direct with W1IWC/1 at the range of the rival club at Woburn, Mass. The Westlake Amateur Radio Association handled the Ohio end; W1IWC and W1IHI manned W1IWC/1. The Cleveland team won the match, 4138 to 3916. Some excellent newspaper publicity for amateur radio followed the event.

As the young speedsters in the '38 Soap Box Derby at Gardner, Mass., flashed across the finish line members of the Chair City Radio Association radioed word back to the officials' stand so that results could be announced without delay. At the finish line were W1JXE and W1KIK; at the scorers' post, W1AUN and W1BIV. 56 Mc. was used.

The Dial Radio Club, W8ROT, handled communications for the Boy Scouts of America at the Old Trails Jamboree, a mobilization of Scouts at Marietta, Ohio, July 13-17, 1938. The Jamboree was held in conjunction with the celebration of the States of the Northwest Territory at Marietta. The Queen City Radio Club, of which the Dial Club is a chapter, sent W8FVW, trustee of W8ROT, and Edward Moore to make the radio installation and handle traffic from the encampment. Mr. Moore furnished transportation and handled all registrations and filing of messages. W8FVW operated W8ROT on 3.5-Mc. c.w. and 3.9-Mc. 'phone, aided by W8RET, W8ALG and W8KSJ as relief operators. A total of 226 messages were sent and 42 received. The station was in operation 54 hours. An extensive network was established to handle the traffic, principal stations being W8PUN (Chief Net Control), W8HYZ, AEF, ICQ, VZ, AQ, MOL, DK, KSJ, NQA, OZH, FSK, PAZ, NDV, BRE, W9SYJ, ARU, CLF, W4AZI and CAT. The National Chief of the Scouts, Mr. James E. West, spoke over W8ROT to W8VZ and other members of the network praising them for their efficient and whole-hearted service. In addition to regular traffic, some of the boys were enabled to talk direct with their parents back home. Several news dispatches were sent to various papers.

When a robbery occurred in Osaka, Va., W3FOU of that town transmitted a warning asking other amateurs to notify their local police. W8SES of Dunbar, W. Va., telephoned the message to West Virginia state police headquarters at Charleston and then retransmitted the information. He was logged by W4ESB at Goldsboro, N. C., who notified the police there—and the robbers were captured! Nice work, brother hams!!

And now comes the question—What is the DX record for contact between stations in the same call area? W9RSU, Cumberland, Ky., and W9WVL, Williston, N. Dak., think that their QSO may be something of a record—1300 to 1400 miles. Any competition?

The A.R.R.L. Southwestern Division Traffic Net operates nightly on 3550 kc. A controlled, one-spot net, it is open to all who care to join. The control is under a Southwestern Division member at all times. The principal net function is to get traffic in and out of Los Angeles, San Diego, and surrounding territory. If interested, get in touch with D. C. Strawn, W6AXN, R.M., 518 Seventh St., Calexico, Calif.

Amateur radio was represented at the Clay County Fair, Spencer, Iowa, September 12th-17th, by the operation of a station at the fair grounds. Actual demonstrations of two-way communication were given, some of the 139,770 people attending the affair participating in same. The following amateurs assisted in setting up and manning the amateur exhibit: W9KSS, W9TTO, W9REH (who handled the traffic via A.A.R.S. channels), W9WWK, W9GTO, W9SRR, W9ZYS, W9UOW, W9VDL and W9OC.

What started out as a three-way QSO between W9BMA, W9RSO and W9LLW in the early afternoon of September 18th sprouted into an eleven-station round table ragchew lasting until 5:30 p.m. The principals were W9BMA, RSO, LLW, NDB, ABE, NYD, SNO, HEL, JXT, ZVS and TQD, all in the vicinity of 7010-7060 kc. This gang plans to continue its get-togethers each Sunday. More good rag chews are invited!

. . . W9VPQ is on the Great Lakes aboard the S.S. *Theodore Roosevelt*; the receiver is a 1917 Marconi Wireless job with two stages of 201A amplification; the transmitter uses a pair of 211's with variable input up to three-quarters kilowatt. VPQ invites *Roosevelt* excursionists to visit the radio room. . . .

The Hawaiian Section of the A.R.R.L. celebrated the 4th of July by staging a bang-up convention-hamfest which was attended by over 150 amateurs. The usual contests, yarns and activities went over in grand style. Acting S.C.M. Smith, K6OQE, talked on the League and the final gun was the banquet in the evening.

The old saw "two can live as cheap as one" may have some merit, but there is little question but what "two can do more ham operating than one"! That's apparently how a certain well known New Hampshire couple figured it, for on June 23d Miss Dorothy Wilkins, W1FTJ, became Mrs. Carl Evans (W1BFT). Hearty congratulations, "Dot" and "Carl"!

W9ZAC will be operating 56-Mc. portable at various times while with the Cole Brothers-Clyde Beatty Circus this season. We don't know what ZAC does with the circus, but he may be the "man on the flying trapeze"! Watch for him.

A special A.R.R.L. program was broadcast over stations W2XAD and W2XAF, Schenectady, N. Y., on May 10th, from 5:00 to 5:15 p.m. EST. The announcer for this feature was Eugene Darlington, W2ALP, who introduced Lyle Peer, W2ACB, president of the Schenectady Amateur Radio Association. ACB interviewed A.R.R.L. President Woodruff, W8CMP, and Pacific Division Director McCargar, W6EY, who were visiting Schenectady en route to the League's Board Meeting.

As a time saver VK2TJ suggests an abbreviation to cover the usually drawn-out QSO ending, which goes something like this: "Tnx fer contact, will keep a lookout for u, cheerio, bext DX, BCNU". . . . VK2TJ suggests "92"

'or some other number or Q signal) to indicate all of our good wishes.

— . . . —

Speaking of alphabetical QSO's, W9YCR had such an experience when, after signing with W21JU, he called CQ and raised W21JV.

— . . . —

W8FOB points out that G8IY is in *Norwich, England*, while W8IY is in *Norwich, New York!*

— . . . —

W3AKT took a message from K5AC for delivery in his own town, Boonton, N. J. Delivering it in person, he did not go into great detail as to the exact manner in which he received it. Imagine his surprise—and amusement—when he read a newspaper headline shortly afterwards: "Mrs. ——— Receives Air Drop Letter from Grandson" . . . and the item went on, "The letter had evidently been dropped by a plane and someone picked it up and brought it to Mrs. ——— to read." Better explain our service when making deliveries, gang! Hi.

— . . . —

In the fall of 1937 W4APF asked W5FIY to make an effort in his contacts with VK4JU, Brisbane, to locate the mother of a friend. She had been heard of last in Brisbane many years ago. W5FIY put the matter up to VK4JU, who consented to do his best. Word received on subsequent QSO's indicated that he was having but little success in finding the woman. However, in late January, 1938, W5FIY received a letter from her, postmarked Sydney, N.S.W., with the advice that word had finally arrived through friends in Brisbane that he had word from her son. The letter was promptly forwarded to W4APF to deliver, thereby reuniting mother and son after many years.

— . . . —

Determined to find out whether his station was causing QRM to BCL's, W6IHH ran an item in his local paper reading as follows: "Anyone who can prove that my amateur station (W6IHH) is causing any interference to radio receivers of modern design in the City of Willits, in the broadcast band, any time between now and February 11th, will be presented with an all-wave nine-tube receiver." That's one way to find out!

— . . . —

### Let's Use Break-In

The use of break-in operation (keying the crystal oscillator, grid bias, etc.) is really a necessity for traffic operation and is used by 100% of the Army Amateur stations operating on the special 3497.5- and 6990-kcs. A.A.R.S. frequencies. If a letter or word is missed, the receiving operator just makes a few dots and sends the last word received and "AA." The transmitting operator breaks upon hearing this and repeats the words after "AA" (All After). Another great need for and use of break-in operation is when answering a "CQ" call. By just calling two or three times and signing once and then sending "BK IN" or "BK," it is possible to get a speedy answer to your call. This has been demonstrated time and time again in the operation of W2PF. And, during the ORS Party on July 25th, it seemed that almost every ORS calling "CQ ORS" also transmitted "BK IN" after his call. I worked more than ten stations, all ORS, in less than an hour who used break-in operation.

— W2PF.

— . . . —

While visiting her grandparents in Skowhegan, Maine, WIATK's daughter was taken ill with acute appendicitis. She was rushed to a hospital in Waterville where a successful operation was performed. Desiring to learn of her condition WIATK turned to amateur radio. A "CQ Maine" brought a reply from W1GOJ (Falmouth Foreside), whose mother (W1KOH) telephoned the hospital and secured a report. Following this QSO W1GOJ arranged contact with W1HSE in Waterville and kept a nightly schedule with WIATK, passing along a daily report on his daughter's condition. The circuit HSE-GOJ-ATK functioned until the

## A.R.R.L. DX Century Club

EIGHT new members swell the C.C. ranks this month: W1ZB, W8ADG, G6RV, W8BKP, W1JPE, W9TJ, W2CMY and W1WV. There are now 69 members and plenty of other chaps who aim to be among the "first one-hundred" to receive certificates. Go to it, gang!

### MEMBERS, DX CENTURY CLUB

G6WY (No. 5) . . . 138	W2BHW (No. 39) . . . 107
W1SZ (No. 7) . . . 129	W9GDH (No. 41) . . . 107
W1TW (No. 3) . . . 128	G6RH (No. 36) . . . 105
W6CXW (No. 4) . . . 127	W9EF (No. 44) . . . 105
W8CRA (No. 1) . . . 126	VK5WR (No. 49) . . . 105
W6GRL (No. 15) . . . 125	W6GAL (No. 50) . . . 105
ONAUU (No. 40) . . . 125	W9KA (No. 42) . . . 104
W8DFH (No. 14) . . . 124	W3EVT (No. 51) . . . 104
GZQO (No. 9) . . . 123	E1SF (No. 19) . . . 104
W1TS (No. 9) . . . 122	W5VV (No. 38) . . . 103
W2GW (No. 11) . . . 121	G6KP (No. 45) . . . 103
W2GTZ (No. 12) . . . 121	J5CC (No. 46) . . . 103
W1BUX (No. 2) . . . 118	W3EDP (No. 53) . . . 103
W2GT (No. 32) . . . 118	W3EMM (No. 58) . . . 103
W1LZ (No. 10) . . . 117	W8ADG (No. 63) . . . 103
H89J (No. 13) . . . 115	W4CBY (No. 20) . . . 102
W8DHC (No. 27) . . . 115	W6ZLV (No. 48) . . . 102
W6KIP (No. 28) . . . 115	W3EVL (No. 55) . . . 102
W8BTI (No. 56) . . . 114	W9TJ (No. 67) . . . 102
W9KG (No. 16) . . . 113	F8RJ (No. 8) . . . 101
W8ARL (No. 18) . . . 112	W2CJM (No. 47) . . . 101
W1DF (No. 29) . . . 112	W2CYS (No. 52) . . . 101
W8OSL (No. 23) . . . 111	W2HHF (No. 54) . . . 101
W7AMX (No. 26) . . . 111	VK3KX (No. 57) . . . 101
W8JMP (No. 22) . . . 110	ZL1HY (No. 59) . . . 101
W8OQF (No. 30) . . . 110	W4CEN (No. 60) . . . 101
W2UK (No. 33) . . . 110	W9ADN (No. 61) . . . 101
W6ADP (No. 34) . . . 109	W1ZB (No. 62) . . . 101
W5BB (No. 37) . . . 109	W1JPE (No. 66) . . . 101
W8DWV (No. 17) . . . 108	G6CL (No. 24) . . . 100
ONAUU (No. 31) . . . 108	PA9XF (No. 43) . . . 100
W6HX (No. 21) . . . 107	G8RV (No. 64) . . . 100
W8LEC (No. 25) . . . 107	W8BKP (No. 65) . . . 100
W9PST (No. 35) . . . 107	W2CMY (No. 68) . . . 100
	W1WV (No. 69) . . . 100

The following have submitted proof of contacts with 75-or-more countries.

W1DUK . . . 99	G6GH . . . 88	W3AGV . . . 81
W2GVZ . . . 99	W1GCX . . . 87	W5ASG . . . 81
W2QA . . . 99	W3ZX . . . 87	W8PKZ . . . 81
W3DDM . . . 99	W8AAJ . . . 87	W9PLH . . . 81
W2DC . . . 98	W8TWT . . . 87	W9RCQ . . . 81
W3AG . . . 98	W9AEH . . . 87	W1GTE . . . 80
W3EPV . . . 98	G2DZ . . . 87	W3BYN . . . 80
W4AJX . . . 98	PA0GGZ . . . 87	W3EPR . . . 80
W4BPD . . . 98	VE2EE . . . 87	W3GEH . . . 80
G2TR . . . 98	W1BGY . . . 86	W3OP . . . 80
W3GAU . . . 97	W4CCH . . . 86	W8DGP . . . 80
F8RR . . . 97	W6GHD . . . 86	W9YVU . . . 79
W1CC . . . 96	W6ITE . . . 86	G6ZQ . . . 79
VE2AX . . . 96	H89BG . . . 86	VK8SA . . . 79
W8EUF . . . 95	W4MR . . . 85	W1EWD . . . 78
PA0QE . . . 95	W4CFD . . . 84	W8AAT . . . 78
W2CBO . . . 94	W8AU . . . 84	W8FJN . . . 78
W3BX . . . 92	W8BSF . . . 84	W8MTY . . . 78
W1CDY . . . 91	W8DOD . . . 84	W9UTM . . . 78
W1ZI . . . 91	W8OXO . . . 84	G6YR . . . 78
W3BES . . . 91	G2MI . . . 84	VE2GA . . . 78
W1PTR . . . 90	G5BD . . . 84	W1CA . . . 77
W3FRY . . . 90	W1HX . . . 83	W2GBG . . . 77
W4DEB . . . 90	W2BYF . . . 83	W3EMA . . . 77
F8KAB . . . 90	W3ATU . . . 83	W3DSB . . . 76
SU1WM . . . 90	G8QY . . . 83	W3KT . . . 76
W1ADM . . . 89	H89X . . . 83	W6LDJ . . . 76
W5KC . . . 89	W6GPB . . . 82	W8LZK . . . 76
W8BAM . . . 89	W9CWW . . . 82	Z8ZX . . . 76
W8CJJ . . . 89	J2JJ . . . 82	W3CKT . . . 75
W8KSG . . . 89	W1AR . . . 82	PA0JMW . . . 75
W1RY . . . 88	W1BFT . . . 81	Radlotelephone
W3JM . . . 88	W2IOP . . . 81	W21XY . . . 77
W8NJP . . . 88		

girl was out of danger and about ready to leave the hospital. These are the kind of services that make one really appreciate amateur radio. FB, W1GOJ, HSE and KOH!

# How's DX?

## How:

We like to flatter ourselves into thinking that this pillar is read by some of the DX men in the country, but apparently not a soul glances at it. Or, if they do, they think we're always kidding. Sometimes we do wield the artificial chamois but this isn't one of those times.

During the past five or six months we have tried to present as accurate as possible information about some of the more questionable stations. Some of these have been tabbed as legitimate (in the country indicated by their call) but undercover, and it has been suggested that cards for such stations be sent undercover (in an envelope with no mention of radio) or else to us for forwarding. We have stressed this as particularly true in PJ, PZ, YU-YT, LZ, Ethiopia, YS and HR. In spite of this, we have on our desk right now letters telling that PJ3CO has been *jailed* and YT7KP, YU7GL and YU7VN have been confiscated. A few months back 17AA was caught and severely reprimanded. All, dear and gentle readers, because some of you were so eager (and selfish) to get cards that you had no consideration for Mr. Johnny Undercover DX and forgot that the government runs the post office in most countries. You didn't get a card, of course, and you may have helped to jug your DX friend. Right now PJ1BV has a hundred or more cards waiting for him at his post office. Do you think he's going to collect them? Don't be silly!

Whenever some new DX pops up that can be reached by open cards or letters we'll try and give you the address. But when we say we'll forward the card because the station is undercover, please send the cards here. It usually means that we already have the address and can deliver the card, and at the same time we'll not jeopardize the position of the DX operator. Unless you know the fellow's name and address, or can send it care of the national society, don't shoot the card to the country. If you're in doubt, drop us a

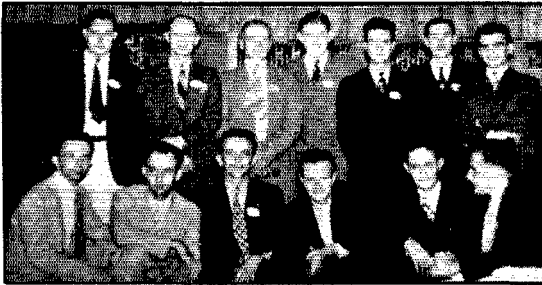

Photo by W8DWV—W3UVA

### THE DX CENTURY CLUB GANG AT CHICAGO

In the front row, in the usual order: W9ADN, W9KA, W8DWV, W8OSL, W8JMP and W1SZ. In the back: W1DF, W9EF, W8OQF, W9TJ, W9GDH, W9ARL and W8CRA.

card and ask about it. But please give the fellow at the other end a break! Talk it up at your club, pass the word around on the air, but get the idea across! If you don't, you may wonder fairly soon why there isn't so much DX to work.

## Where:

VS3OL is going to have to present quite a case for himself before a lot of the lads believe in him. They're working him from coast to coast, and the main reason for suspicion seems to be that he's nearly always too loud and lacks that characteristic sound of Asians. He gives his address as Cecil

Barrister, Cerabanga, Malaya, and says he's using a rhombic antenna. He's a good argument for QSL cards . . . . . That address we got for LX1AG from W8OXO last month didn't help at all—the cards bounced back . . . . . Speaking of LX's, LX1AI, the secretary of the *Reseau Luxembourgeois*, sends this bitter pill: "In this country there is not a single LX station working actually on c.w., and the so-called LX stations on c.w. which have been heard are simply foreign pirate stations having usurped LX calls." There have been legit LX stations on c.w., but apparently it isn't so now . . . . . YS2LR (7015 T7) got on the air and W1APA, W6POX, W6DIX and W1BFA were among the first to grab him. He's undercover! . . . . . QSL via A.R.R.L. . . . . W1FTR worked OY3X (14,350 T7) at 11 p.m. the other day. Can't say if he's good, although he sounded so . . . . . That unhappy pair, W5VV and W5BB, worked ZM1AA (14,415 T9) and got his address as c/o Radio ZMA, Apia, Samoa. He's supposed to be using a diamond antenna and 100 watts. We worked him at 6 p.m. the other day, an unusual time but possible . . . . . To further lower your spirits, we'll quote from a letter from F8DS, secretary of the *R.E.F.*: ". . . . . REF receives many cards for PX1A, PX1U and PX stations. To our knowledge, there are no amateur stations in Andorra, and undoubtedly there are no licensed stations there. So stations using "PX" are most certainly pirate ones." . . . . . A. C. Embrechts, ex ON4AC, writes to say that someone played him the practical joke of sending in his name to the Call Book people as EQ4AC, with the result that for the past two years he has been flooded with correspondence for alleged Iran amateurs. It is embarrassing, to say the least, because a lot of the correspondence is marked "to Amateur EQ4AC," and ham radio is prohibited there. Mr. Embrechts says the only genuine station he knows of was EP58O, who was on only a few days before he was caught and put off the air. EP1A and EP3RK he suspects of having been in the Balkans somewhere . . . . . ON4AU says that YA5XX (14,300) was really in Afghanistan—using 6 watts from automobile vibrator power supply . . . . . And W2GW adds dope on the ST gang. ST2WF was legit up to November, 1936, but phoney after that. Since November, 1936, the active stations have been ST2BN, ST2CM, ST2LR and ST6KR. 2BN and 2LR are now cancelled, and 2CM is leaving for SU, ZC6 or VQ4, which leaves only ST6KR (14,425-14,300 T9) . . . . . W2DSV heard ZK1AA (14,130 T9x) during a peculiar magnetic disturbance on Sept. 14, at noon . . . . . W9RBI says VK9XX (whom we were suspicious of) was VK2XX, who flew to New Guinea and is now back in Australia. So weren't so smart . . . . . W4BPD and W5VV report hearing F8AA on 14,330 and W2BHW worked him when he was on 14,410, T8c . . . . . W2AAL and W8ONG report working MX3A (14,300-14,330 T8). QSL care M.A.R.L., Box 30, Shinkyo, Manchukuo . . . . . W6ITH has some dope on the Pacific islanders, via K6BAZ. K6DSF (7190) is on Howland, K6NVJ (7185) is on Jarvis, K6HCO (7170) is on Enderbury, K6JEG (7015) is on Baker, and K6ODC (8100 'phone) and VR2FF (14,400) are on Canton . . . . . W1APA says that NY1AB is operating at Cape Mala, Panama, so if you work him now you might not need to put in a modulator for HP1A (14,280 'phone). The address is NY1AB, J. C. Blume, U. S. Naval Station, Cape Mala, Panama, but you should QSL to the Balboa Call Book address . . . . . From W9RBI, we have the address of TG9BA (14,000 'phone) as Walter Bay, Chalet Krolj, Guatemala City, Guatemala. We'd suggest you send the card undercover with no mention of radio (which means his call) on the envelope . . . . . W6EJA says that W6ACM-K7 (7100) is on the Geodetic Survey ship *Pioneer* and does



most of his operating anchored in Dutch Harbor . . . . . ZD4AB (14,340 T9) is still active, and has been blessing the lads with their first QSL from Gold Coast . . . . . VE2EE got a couple of nice ones in FO8AC (14,405 T9) and VQ3HJP (14,410 T9) . . . . . If you need Burma, look for XZ2KR (14,240 T8).

### When:

Wonder of wonders, we got a 3.9 'phone DX report this month! It's a good one and might spur you on a bit. W9VBQ worked ZL2BN (3965 'phone) the other day at 6:15 a.m., good DX for Kansas and 150 watts . . . . . With the winter season at the door, 80-meter DX should start to pick up, and any reports will be welcomed.

Ten looks mighty good about now. W2BHW worked VS7MB (28,185 T9), VQ3TOM (28,060 T7), and some LU, ZL, VK, ZE and ZS. This was on Sept. 10—Lindy could have had WAC in three hours but no Europeans came through . . . . . W6ITH has been working ZS's on 10 'phone and hearing CN8AV and a flock of Europeans.

W8AU came through with a nice letter this month, and mentions working VQ2PL (14,420 T9x) and OY1AA (14,380 T9) among others . . . . . Some of the better stuff worked at W4BPD includes VK4KC (14,375 T9), XU8NR (14,325 T7), CR7AF (14,260 T9), VQ3TOM (14,075 T7) and VQ2MI (14,345 T9). Heard were FM8AA (14,260 T8), VU2FC (14,285 T8) and VS7JW (14,145 T9) . . . . . On 'phone, W6ITH gives some good tips about CR7AK (14,080, 14,320), VK4HN (14,385) in Papua, VK7CL (14,070), FA3HC (14,120) and VP7NS (14,110). Reg says the KA 'phones come through from 11 p.m. to 10 a.m. out that way . . . . . From W9RBI, VU2LK (14,030 T9), CP1AA (14,420 T9), ZD2H (14,310 T9), VP4TK (14,060 'phone) and CX2AK (14,080 'phone) . . . . . W2GTZ has PK3EM (14,340 T9), VS8AO (14,335 T9), VS7RP (14,260 T9), PK6XX (14,010 'phone and c.w.), XU7CK (14,350 T9), PZ1AB (14,460 T5) and UX1CP (14,010 T9) . . . . . Texas' favored son, W5VV, keeps himself occupied and without an alibi by working VPSAD (14,300 T7) . . . . . W9EQG has XU6TL (14,395 T9), KA1AP (14,350 T9), KA1FG (14,385 T8) and XU6AW (14,430 T7) . . . . . W3A00 has some nice ones, what with VS7GJ (14,120), J8CD (14,410), XU7CY (14,365), J8CG (14,410), OX7OU (14,015), PK1BO (14,400) and HR1UZ (14,440) . . . . . W2CYS is always good for some juicy ones, and this month's include VR2FR (14,375 T8), G5UG-P (14,410 T9), portable on the Isle of Man, VR1AB (14,245 T9), PK3AA (14,350 T9), XU8ZX (14,325 T8) and XU6ST (14,420 T7) . . . . . W1KKS adds U5HD (14,310 T6), YMA4U (14,340 T8) and CT2BC (14,310 T9) . . . . . W6MX has PJ1BV (14,400 T7), LA6G (14,300 T9), HA3H (14,405 T9) and TG2AC (14,410 T9) . . . . . W2BHW takes his DX seriously and when he isn't burning himself out in the VK/ZL fracas, manages to grab VS2AL (14,385 T7), PK1TM (14,205 T9) and KA1RP (14,330 T9), and hear VS7RA (14,090 T9) at 1:30 p.m., VU2EU (14,335 T9) at 2 p.m., VU2FZ (14,300 T8) and XU6LN (14,080 T8) . . . . . W6JMR has been making a lot of apple cider lately, which may or may not account for FA8RY (14,380 T9) and FT4AG (14,415 T8) . . . . . W9WJD got XU8CM (14,280 T9), LY1KK (14,380 T8), J5CC (14,310 T7), and heard EP6SO (14,010 T6). He arches an eyebrow at that last one, however . . . . . W1BGY worked VS2AE (14,380 T9), ZB1R (14,320 T9), and heard CN1AA (14,350 T7) and KA1BC (14,300 T9) . . . . . To wind it up, W2CTO worked ZELJM (14,310 T8), and W2CHK worked CN1AF (14,280 'phone, also c.w.).

### What:

W6CUH was up this way a few weeks ago and, oddly enough, the talk turned to DX, for about three days. We were bemoaning the fact that the signal reports don't mean much these days because, although the system is quite sound, you give a DX station a good report even though he's weak because you don't want to hurt his feelings and jeopardize your chances of a card or something. It was decided that, as far as reports go, a DX man is interested in

how his signals compare with others coming from the same general area. This immediately brought forth the suggestion of a comparison or "C" report, to go along with RST. It would work quite simply: just tack on at the end of the report another number (from 1 to 9) showing how the signals stand in comparison with others from that part of the world. For example, now if you get a 339 report from somewhere you figure your antenna is down or something, but if you were to get RST 339 C9 it would mean that you were as loud as anyone from your part of the world. You'd feel better, and still know enough about the actual strength of your signal at the other end to operate accordingly.

Arriving at the value of the report would be fairly simple. Ordinarily you listen around a bit before making any calls, and thus you establish the general level of signals coming through at the time. Suppose the Asians are coming through, and the loudest one is S6 (honest, not a DX S6!). Then, when you work an Asian, if he's S6 you give him C9, if he's S5 you give him C8, if he's S4 you give him C7, etc. It immediately tells the Asian that the loudest Asian at that time is S6, and how he compares. On the other hand, VK's might be up to S9 at the same time, and an S6 VK would receive a report of C6.

We talked about it a lot, and it sounded like a good idea. It's easy to do, doesn't change any existing system, could be dropped in contests if desirable, and only entails the slight additional effort of listening around a bit to get a line on conditions. "QC?" was suggested as a signal to use in asking for the comparison.

Your suggestions and criticism would be appreciated.

### Who:

The straight dope on Y12BA (14,315) is contained in a letter to W4DSY from Eddie Behnan, who has taken over Y12BA from Mellon. Mellon, plenty busy with airport duties, just didn't have time to QSL everyone, and had to give it up. He then left on leave and Behnan took over. He's trying to catch up with the cards, and asks your patience. The address is still Y12BA, Port Directorate, Margil, Basrah, Iraq . . . . . If you're looking for Maine for your WAS, W1BFA (14,385, 14,256) will be glad to help you out . . . . . G2ZQ, who runs second only to G6WY in a DX way, bemoans the fact that all the DX seems to be using only the high-frequency end of 20, and would like to see the boys divide their activity a bit more. How about it? . . . . . From an unimpeachable source, we learn that HH4AS (c.w.) and HH2B ('phone) are the only Haiti stations that QSL these days . . . . . That was straight dope about ZC6NX being ex-G5KW. He'll be on again soon, in Egypt, signing SU5KW. W1GNE set us right on this one . . . . . W1BGY assures us that the QSL Bureau went safely through Helen Highwater, and to note that OE cards are coming through, via the D.A.S.D. bureau . . . . . W6KIP says that K6NVJ (7190) had only a few QSL's out there on Jarvis, but he'll QSL everyone when he returns to Hawaii in December . . . . . W8ACY-8 worked G2MI, signed, and called CQ three times. G3MI called him, making QSO's with 2MI and 3MI within two minutes apart. He thought he was copying wrong, or something! . . . . . W9BMM passes it along that ZB1R wants Iowa for WAS—OZ4H only needs a card from W6AJP in Nevada for his . . . . . VO3X has been working a nice lot of Asians lately, and wonders how many countries a fellow has to work to get 100 confirmations . . . . . VE3QB, VE3 QSL Manager, is taking a crack at DX, and opens with VP1BA (14,410) . . . . . W6ITH says Andrew Young at VR6AY said the other night, "The last ship brought 5000 letters from hams and SWL's. Will answer on I.R.C. but it helps much to have a self-addressed, stamped envelope stamped with a one penny New Zealand stamp. The envelope should not be smaller than 4 1/2" x 6". (Jeeves, cancel that order we had for a desert island.) . . . . . Maybe we make too much of this DX stuff. It's a pipe. For example, W1KGW worked a VK and started boobing W1KGH because KGH had never worked any DX. So KGH got an alarm clock and another crystal, and next five mornings had one QSO each morning: VK, VK, VK, ZL, VS2AE! W1KGW now has an alarm clock, another crystal, and an ear out for an Asian

... A swell letter from the XYL at W5FYZ tells how the whole family is radio-minded; OM, XYL and son at Texas Tech. They do all right too, what with AR8PK (14,425 T9) YSIBC (14,420 T9), CN8AJ (14,330 T7), ZD4AB, VR4AD (14,305 T9) and PK1MF (14,340 T9) ... D4BU, doing research at Brown U., thinks that call we suggested last month should have been "PH1Y" ... Nomination for finest amateur of 1938: VP7NT. The reason: his card put us right smack into the Century Club. Yippee!

### WAC and WAS:

W1KOM received his WAC the other day, which wouldn't be especially interesting if W1KOM wasn't Fred Elser and this is his second WAC. His first was from op3AA (KA3AA to you young squirts) in June, 1926, the ninth one issued ... The first Alaskan 'phone WAC goes to K7FBE at Unalaska ... W6LWS made his 'phone WAC with less than 45 watts input—24 countries have been worked on 'phone.

G5BJ got the first WAS in Great Britain recently, G6QS the second. The only other European WAS is OE3AH, received some time ago.

—W1JPE

## First Eastern DX Round-Up

Bridgeport, Conn., Nov. 5

THE Bridgeport Amateur Radio Association announces the first eastern "DX Round-Up," to be held Saturday evening, November 5th, at 8 P.M., in the B.A.R.A. club-rooms, Liberty Building, 945 Main Street, Bridgeport. The Round-Up is intended to give the eastern DX gang a chance to get acquainted and have a nice little chin-fling about everything pertaining to the latest Paris styles. Tommy Thomas, W2UK, will be present and may tell how to smash all DX Contest records. Lew Bellem, W1BES, will bring movies of Pitcairn and the story of VR6AY. If possible, Hugo Romander, W2NB, will attend to discuss antennas. A number of Century Club members have already signified their intention of coming.

DX men from Boston to New Jersey are making plans to get there. For out-of-towners with lean purses, the Bridgeport club members are arranging for gratis sleeping accommodations, in case anyone decides to go to bed. A nominal charge of 25 cents will be made, to cover the coffee and doughnuts to be served. All DX-minded hams are cordially invited—no others need apply.

### O.B.S.

The following is a supplement to the list of A.R.R.L. Official Broadcasting Stations in October QST (page 71): W1AQL, W1KON, W1WR, W3BIW, W3DNU, W3UVA, W4BJF, W4DHG, W4DSY, W4MS, W5CIQ, W5TO, W6BF, W6CFN, W6DHS, W6GTM, W6KNZ, W6ZM, W7FPN, W8IBR, W8NW, W9CWW, W9EDW, W9GY, W9YQN, VE3PL.

## Hams Afloat

The U.S.S. *Texas* lifted anchor at Philadelphia, Pa. on September 10 bound for Guantanamo Bay, Cuba, with the following Naval Communication Reservists aboard: W1HOU, W2AOS, W3FVD, GYA, QL, ESS, EYT, DLJ, GKP, CPM, ID, EZ, CMV, HAT, HIV, EGN, EHZ, SB, HIT, EO, FPA, W4DMV, W8BLL, GVT, OFO, MKQ, EPA, QBK, NZR, FQL, LBO, QFR, NQQ and CVS. After four days at sea the ship was anchored in Guantanamo Bay. Liberty was granted for the next two days and the men had the opportunity to visit Guantanamo City. Enroute home there were thrills for all when the ship rode through the hurricane which swept up the Atlantic seaboard causing much damage in New England. All types of drills were

simulated giving experience in case of an emergency. Watches and circuits were rotated among the radiomen thereby giving them much schooling in Naval operating procedure. The *Texas* docked at the Philadelphia Navy Yard on September 23, completing the training duty period for the Reservists for another year. ... The following amateurs are attending the radio school of the U. S. Coast Guard at New London, Conn.: W1GVN and W8NAZ, assigned to U.S.S. *Cayuga*; W3HCE, Floyd Bennett Field; W2LCK, U.S.S. *Algonquin*; W1IRZ, U.S.S. *Commanche*; W2HSB and W8QQQ, U.S.S. *Mohawk*. ... W5AGG is Sparks on the S.S. *Elwood*. ... W5ADZ pounds brass on the S.S. *Republic*, KUBS, coastwise to Baltimore, etc. ... W8CLL was operator for the fourth consecutive year on the Tug *Sulphite*, KENQ, on the Great Lakes. ... W9LNX signs KOGP on the S.S. *Hadnot*; the equipment consists of a 1 kw. spark transmitter and a 50 watt tube rig; the receiver is a new 4-tube metal tube t.r.f. long-wave job supplanted by LNX's March QST short-wave super. ... Radiomen on the U.S.S. *Ranger* with station at San Diego are W6OLU, W6NMZ, W8JAW, W6MRE, W6PPN, W1DDL, W6PKY, W6OLD and W6PJJ. ... Recent assignments of W4EBP have included ND U, N1RF, LEMZ, VPRJ and VQNS. ...

## Briefs

W4DSU, Concord, N. C., worked W1AFA, Norway, Maine, on Labor Day (4:53 P.M.—14 mc.) with no antenna on the rig (47 crystal, pair '46's amp., 15 watts input). Take down the antennae, fellows, we don't need 'em any more! Hi.

"Radio Amateurs Foil Drug Store Burglary," reads a headline in the *Milwaukee Sentinel*. W9EYH was QSO W9VZJ (both operators in Milwaukee) one morning about 3:00 A.M. The contact was interrupted by a neighbor coming to tell EYH that a burglary was being attempted in a nearby drug store. EYH promptly asked W9VZJ to notify the police, who were very shortly on the scene.

## Alaska

Alaska is one place where amateur radio is really appreciated. K7BOE recites a typical example of the extreme usefulness of ham radio there: "The out-going mail from here (Pilot Point) to Anchorage was nine days getting out this time, because at Egegik, 50 miles north of here, the pilot blew out a cylinder. Luckily there is an amateur radio station there—K7EZE, Mrs. Williams, the U. S. Government teacher's wife. Soon a plane with two mechanics was on the way there from Anchorage. (Our son Virgil, K7BND, is the operator of KTKV, Anchorage.) But the mechanics and the pilot couldn't repair the engine there, so the head pilot of the Star Air Service had to come with a new engine, and take part of the regular pilot's load of mail and passengers. When the head pilot landed about fifty miles further north at Koggiung he cracked off a ski. But luckily again, that is where K7EMV is postmaster and second winterman. I give weather reports every morning for the benefit of the planes to K7BND, my son, who has schedules three times daily with stations here in the village, K7BOE, K7EMU and K7FMM. The amateurs all up and down Bristol Bay as well as stations to the westward all give daily weather reports. K7FAD, the territorial teacher at Naknek, gives weather from there. So you see amateur radio does its part here in Alaska. If all the emergency work they have done, saving lives, etc., was written, it would make a good sized book alone." Here is one for city "cliff dwellers" to read (and then weep): Says K7FDV, "Am located one hundred miles N.E. of Fairbanks and my nearest neighbor is sixty miles. ... I built a little rig, 12 watts, and reach nearly around the globe. ... right now our daylight begins about 9:30 A.M. and ends at 2:30 P.M. so we get plenty of time to operate the rig." Yep, Alaska is some place for amateur radio!

Station Activities on page 100



# CORRESPONDENCE

The Publishers of *QST* assume no responsibility for statements made herein by correspondents

## Citizen Radio

Port Wing, Wis.

Editor, *QST*:

I am suggesting the A.R.R.L.'s interfering in something entirely out of its line of business because, as far as I know, no one else is capable and interested.

I believe that the Federal government should assume a much more open policy towards the private use of non-commercial non-amateur radio on the ultra-high frequencies, and permit non-licensed operators to use sealed, fixed-tuned transmitters, possibly with state jurisdiction, much as automobiles are licensed.

While this would not be an amateur activity, amateurs would be benefited because they are qualified as service men and technicians on small transmitters.

There is a need for low-power portable u.h.f. rigs which is not filled by commercial, experimental or amateur licenses, especially in radio-auto-horns, radio model control, intercommunication between salesmen and truck drivers and the home office, and between small-town fire and police departments that cannot afford an operator, plus many other uses.

—Herbert Brooks, W9SDG

## Something Wrong Somewhere

Providence, R. I.

Editor, *QST*:

I was on five-meter 'phone from 1929 to 1934, and then dropped out of the game. I have been back into it for three weeks now, operating mostly 80 c.w.

I was having a last QSO before pounding the pillow instead of the brass, with a new ham in northern New England. He asked me to QSP to Boston—so I kindly agreed. Since he started to spell the street number, and changed to figures, I asked, "Pse rpt street number." He obliged with the state. I tried again, at about 7 per, and got the message number. The next time it was the CK. I finally got the address OK, and sent "CQ CQ Boston" five times, signed, and listened. I repeated this for an hour, and was rewarded with an S7 sig—calling from Annapolis to tell me my

6L6 was 599x down there! So I tried for a half hour more, without result and decided on one last try before QRT, deciding there was skip on, and succeeded in raising a 347 call—from White Plains, this time. Thinking he might have a sked with Boston, I asked him "QSP Boston" and got the amazing answer that his rig was built so-and-so and how he was doing, and sorry, but his rig was not reliable enough to relay with!

I threw the switch and went to bed.

I can understand a youngster hating to say QRS, but what sort of periodic deafness afflicts those who answer directional calls without noticing the direction?

—Chester H. Page, W1CHP

## Movies and Hams

102 W. 3rd Ave., Lexington, N. C.

Editor, *QST*:

I recently attended the motion picture "Love Finds Andy Hardy" in which there is a scene showing an amateur radio station being used to get a message through to a point where there was no regular telegraph or other fast means of communication. I think scenes of this type are beneficial to amateur radio. However, I think that in such cases it would be well if a typical modern station were shown instead of the "rig" shown in this picture. I do not mean that one of the commercial looking jobs should be used but I do think that a neat job of some kind would be in order. Of more importance than the rig used is this: Correct A.R.R.L. procedure should be used in all cases. In the picture referred to the procedure was very badly bungled up. (However, I must admit that some members of our fraternity do more damage over the air than the picture will ever do!)

I should think it would be wise for the A.R.R.L. to discuss this matter with the moving picture producers in an effort to get them to show typical stations and operation procedure. It might be wise for the A.R.R.L. to furnish them with quite a bit of dope on the subject and to offer any assistance that the League may be able to give in order to produce true-to-life scenes on amateur radio.

—William C. Harris, W4WX-W4NC

## Convention BC

Cando, Sask., Canada

Editor, *QST*:

It has been with the greatest pleasure that I have listened to the first National convention of the A.R.R.L. for fifteen years, as brought to me via N.B.C. and KFYR. You have no idea what this fifteen-minute broadcast meant to the amateurs in Canada and other parts of the world who were unable to get to the convention. Had I known of the convention six months earlier I believe I could have made it.

This short note is to express my thanks for the broadcast, and to express the thanks of pal VE4OQ, whom I telephoned thirty miles long distance telephone that he could grab a radio and tune in the broadcast. Many thanks and success to the convention!

—Howard Walker, VE4BN

## Against Periodic Re-Exams

56 Pearl St., Gardner, Mass.

Editor, *QST*:

In regard to W3BYF's letter last month I would like to question the so-called "accomplishments" to be gained by re-examinations for every renewal. I'll take each "accomplishment" in order.

1. (Making the boys remember the code)

In the first place I doubt if there are any licensed operators to-day who haven't passed a code test. In the second place why is code proficiency so darned important? During most of the emergency operating in the last few years 'phone played as high if not a higher part than code. In case of emergency, 'phone has the decided advantage of being able to be copied by millions of S.W.L.'s throughout the country.

Let us admit that code proficiency is desirable. There are very few 'phone men who couldn't pass a code test to-morrow, and if given a week or so to brush up the percentage of failures would be practically nil.

2. (Thinning the ranks of "dabblers")

This is a rather absurd argument. After all if they are only slightly interested they certainly won't be on the air much and won't be bothering anyone. What harm is it doing anyone for a fellow to hold an operator's license and use it only occasionally?

3. (Getting rid of those guys who never took their exam)

Apparently W3BYF has heard from someone about the old class "C" mail order licenses that didn't require a personal exam, but he has failed to hear about the complete personal examination of all these old timers that took place several years ago. All the holders of those old licenses had to travel to examination points and take regular personal exams on both code and theory.

So, who are these mythical operators who never took an exam, unless W3BYF is referring to a small percentage of fellows who are physically unable to journey to examining points?

In many cases the only enjoyment these unfortunates have is in operating amateur sets and I see no point in persecuting them.

4. (Getting rid of the old timers)

Well, it looks as though another "purge" has started. All the old timers who have helped open up the new bands (I can remember when 20 meters was considered extremely high frequency) are to be thrown out on their respective ears, unless they study night and day to keep up to every latest development.

The privilege of holding a radio operator's license means a lot to most of these old timers and seems a small reward for their years of splendid work when their outfits were probably a lot more up-to-date at that time than yours may be now. So now, disregarding their years of experience you want to push them out in the cold if they happen to slip a little on modern theory, and take away their right to push a key occasionally.

5. (Making W3BYF darn unpopular)

Well you have me on this one. Here's one accomplishment that would undoubtedly take place.

The F.C.C. is doing a splendid job of handling the present flood of new applicants without dumping the whole lot on their shoulders for re-examination. I wonder if W3BYF realizes the tremendous amount of work involved? . . .

If the F.C.C. has any extra time to be devoted to charring up the amateur bands wouldn't it be much better to maintain additional monitoring stations on the amateur bands, and instead of sending out tickets, send out compulsory "invitations" to special exams to those amateurs whose operating ability appears questionable? . . .

—Gordon V. N. Wiley, W1AUN

## Order of the Boiled Owl

Whiting, Ind.

Editor, *QST*:

I wonder how many of the old timers can remember 'way back when we used to proudly display the letters "B.O." on our cards (no wise cracks). I don't remember just when that grand old order passed away, but for the benefit of these young squirts and a lot of the old heads I think it would be a noble idea to resurrect the "B.O." I suggest that A.R.R.L. issue a certificate to those that qualify, a small one the size of a QSL card.

"B.O." stands for Boiled Owl, and in order to become such a magnificent bird it is necessary to spend an entire night pounding brass—from dark until sun-up, chewing rag, working DX, traffic, 'phone or c.w. . . . A copy of the log sheet should be sent to *QST* as evidence whereupon the "B.O." card would be sent out. . . .

—Amos Utterback, W9FB

## Appreciation

Cleveland, Ohio

Editor, *QST*:

Will you kindly express through your columns the sincere thanks of the radio amateurs who operated at the National Air Races to the amateurs in Cleveland and vicinity for the perfect cooperation given in eliminating QRX to the low-powered portable 160-meter 'phones. This cooperation is deeply appreciated and we hope every amateur who cooperated will be able to receive our thanks through *QST*.

Joseph H. Pitzer, W8AXV

Chief of Pylon Communication

## Recommended Reading

4463 Melrose Ave., Montreal, P. Q., Canada

Editor, *QST*:

. . . Last winter, I bought a book that I found especially valuable. It is "Mathematics for the Million" by an Englishman, Lancelot Hogben, F.R.S., published by W. W. Norton & Co., Inc., of New York.

The book treats algebra, trigonometry, geometry, spherical trigonometry, graphs and calculus in a most elementary manner. As far as I am concerned, it was most useful. The treatment is more by reason than elaborate mathematical proof. Yet all the elements necessary for a reasonable understanding are contained therein.

The reason I am writing you about it is that I think it a very valuable book for any ham to possess. I used the calculations for spherical trigonometry to calculate the direction of an antenna. . . .

—W. Alan Lunan, VO6L/VE2NY

## No Phoney

W2CQB/Mobile aboard S.S. *Pan-Kraft*, Georgetown, S.C.

Editor, *QST*:

During the past several months my station has been operating portable-mobile aboard the S.S. *Pan-Kraft* on the 28-Mc. band with 9 watts, crystal controlled. However, when I sign that I am aboard ship, many of the operators answering seem to believe that the station and call are

(Continued on page 76)



Most of the men who design National's products are amateurs, which is one reason why they meet amateur problems so squarely. Nevertheless, when we present a new product there are usually a number of amateurs who are very surprised at the design. They tell us they would never have gone about it that way.

There is a very simple reason for this. When an amateur designs a piece of equipment, he wishes to have it work as soon as it is assembled and adjusted. After all, it is not much fun to have to go back to the beginning and do the job over. At National, on the other hand, we do not care very much how long we work on a design. We are quite willing to spend six extra months building six extra models (and often do) if we think we can find a way to give more performance for less of the customers money.

This makes a lot of difference in the result. And to show how it does, we are going to comment on a typical design — the NTX-30 transmitter. This is appearing on the market just about now, and we expect to see raised eyebrows any minute.

The story really goes back to the NTE Exciter, because in designing the NTE we planned to use the same exciter system for the NTX-30. This involved no compromise, and had the great advantage of spreading the cost of tools. This made it possible to build a special push switch of low-loss design, for instance, without having it add too much to the cost of either unit.

The NTX-30, then started with the NTE. The exciter and power supply were there, and there was room on the chassis for the output stage, and space on the panel for controls. We wanted 30 watts of harmonic-free output, and we wanted to get it the most economical way. After much experimenting, the choice limited itself to one of three things. We could use a single 807 operating at high plate voltage. Or we could use two 6L6G's in push-pull or in parallel.

Most amateurs would have chosen the 807, partly because it is comparatively sure-fire, and partly because high voltages are favored for efficiency. We decided against it, partly because the improvement in efficiency is apt to be in large part imaginary, much of the extra power being in the form of harmonics, due to the high L/C ratio required. Also, the low plate impedance of 6L6's made it possible to maintain full output down to 10 meters. As a matter of fact, the efficiency of the 6L6's was not at all bad, being over 60% even on 10 meters. In this particular case, the 6L6's are actually cheaper also, because the extra tube cost is more than offset by the elimination of a separate high voltage filter.

In the remaining choice — push-pull versus parallel — we also went counter to usual amateur practice. Amateurs avoid operating tubes in parallel because they are considered almost impossible to neutralize and because they are prone to parasitic oscillations. However, experiment showed that both difficulties could be avoided by careful layout and attention to details.

Such being the case, parallel seemed better than push-pull, for the latter required an additional tuned input circuit. This would have made band shifting less convenient, as well as adding to the cost.

The trouble with trying to tell a story like this on one page is that so much has to be left out. It does not give a true picture of the work involved. However, it does illustrate the point that we wanted to make — that with lots of time and good equipment, one can often hew a short cut through the woods instead of going the long way around by the highway.

JAMES MILLEN



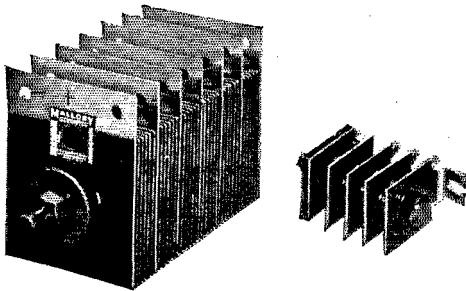

**From 1 to 1,000 Amperes!**

P. R. MALLORY & CO. INC.  
**MALLORY**

**Magnesium-Copper Sulphide  
 RECTIFIERS**

Because of their efficiency, long life, compactness and low cost, Mallory Magnesium-Copper Sulphide Rectifiers are widely used in a variety of devices ranging from battery chargers, "A" eliminators, motion picture exciter lamp and arc power supplies, to heavy-duty electroplating equipment requiring a thousand or more amperes.

Their increasing use opens up a new and profitable field for the serviceman. The same high quality and precision design has been built into a line of Mallory Replacement Rectifiers for this field.

See the Mallory-Yaxley Radio Service Encyclopedia, 2nd Edition, for complete list of recommended rectifier replacements.

Information on special or heavy-duty rectifiers will be supplied on request. Address Rectifier Application Division.

**P. R. MALLORY & CO., Inc.**  
 INDIANAPOLIS INDIANA  
 Cable Address—PELMALLO

Use

P. R. MALLORY & CO. INC.

**MALLORY**

APPROVED RADIO  
 PRECISION PRODUCTS

---

Use

**YAXLEY**

APPROVED RADIO  
 PRECISION PRODUCTS

## Correspondence Department

*(Continued from page 74)*

phoney, and possibly some stations don't call for the same reason. If space permits, I would appreciate a short note to the effect that this station is perfectly legal in every way and that I will QSL every card that is sent to my QRA as listed in the call book. . . .

—Robert Brandt, W2CQB

## Amateur Radio Bests Catastrophe

*(Continued from page 18)*

instead of "QRR" for his emergency call—an object lesson for those *outside* emergency zone who still persist in using "QRR" for incoming traffic. In addition to providing press, etc., he made personal check ups on road conditions for the information of officials.

W1GNF of Windsor, aided by W1AHN, W1ERJ and W1JHK, served the power company chiefly, but handled flood levels and WU traffic as well. Duplicating his performance in the 1936 flood, W1EMQ at White River Junction provided valuable river and weather reports.

Up in St. Johnsbury, W1CBW, aided by W1JLF and W1JMO, served the State Police in various ways. W1KIE was on there, too, as was W1JLF at his own station. W1KTB, Lyndon Center, and W1KOO, Orleans, were active, the latter handling traffic for Western Union and the telephone company.

In Morrisville, W1KJG (assisted by W1KUY), W1JRU and W1QG were given the assignment by United Farmers of locating routes for milk shipments to Boston. The milk went via Montreal and Sherbrooke, but it got there!

In Burlington, W1JVS found opportunity to be of service to the city as well as to students at the local university. W1BNS, Fair Haven, was called on by the airports, Western Union, railroad, etc.

Other stations reported active in Vermont include W1GQJ and W1KWB in East Barnet; W1KNC, North Bennington, W1BJP, Newport; W1JVT, Hardwicke; W1EZ, Pownal; and W1AAJ, W1APV, W1FSV, W1GAN and W1GAZ in Rutland.

Crossing over into New Hampshire, W1KIN, Hudson, was on the air within two hours after the storm hit, using a battery rig. Town officials and the American Legion used the station.

Over in Peterborough W1KPL telephoned flood warnings to various amateurs in the state early Wednesday morning, then continued the warnings by 56-Mc. mobile from Monadnock until the hurricane drove him down. W1GDE brought a portable into town, set up at W1KPL's location, and, aided by W1HXJ, handled much official traffic over a week's period.

W1CVF built up a traffic total of 452 in four days of continuous operation at Keene. The station was powered from a truck fitted with generating equipment. All agencies were served, notably the National Guard.

With two or three masts gone and power off, W1APK at Pembroke went on with the auxiliary battery rig. Aided by W1IJB, about 150 mes-



# IMAGINE!

## **75 WATTS UNDISTORTED PHONE**

### **WITH ONLY 1.2 WATTS MODULATING POWER!**

Since RAYTHEON developed the suppressor modulated tube thousands have been used by Air Lines, Commercials and "Hams." They have always meant high quality, high efficiency and low cost phone operation. Now—redesigned in the Raytheon Research Laboratories—they are **BETTER THAN EVER!**

**RK28A Phone Output 75 Mod. Power 1.2W Driving Power 2.0W \$34.50**

Now available with a husky graphite anode, permitting higher plate dissipation and a greater safety factor. Drives easily from only 2.0 watts, requires no neutralization, has a big thoriated filament for long life. Can be both plate and screen modulated. Ideal for a high quality phone job—at low cost—because it requires so little driving and modulating power that the cost of the rest of the parts is way down.

**RK20A Phone Output 21W Mod. Power 0.36W Driving Power 1.5W \$15.00**

An even better tube than the famous RK20. *Exceptionally long life* with fine quality output. Has a bigger thoriated filament (24.3 watts), a bigger moly plate with radiating fins, and a hard glass Nonex bottle! Can be used as a final amplifier, driver or crystal oscillator. Requires no neutralization.

**RK25B Phone Output 6W Mod. Power 0.3W Driving Power 0.5W \$3.50**

A new heater type pentode designed for use as a power amplifier, oscillator, frequency multiplier, or suppressor modulated amplifier. Ideal for the portable rig as one tube delivers 22 watts as a Class C final and as a suppressor modulated final puts out 6 watts of phone.



A copy of the "Handbook of Amateur Tube Uses" will help you get the maximum out of any rig. Get one from your Parts Jobber or write the factory. Price 50c.

# RAYTHEON RK

## TRANSMITTING TUBES

NEWTON, MASS. NEW YORK CHICAGO SAN FRANCISCO ATLANTA

RAYTHEON  
CORPORATION

### **"WORLD'S LARGEST EXCLUSIVE RADIO TUBE MANUFACTURERS"**

At Your  
Request



# A 40-METER VARIABLE

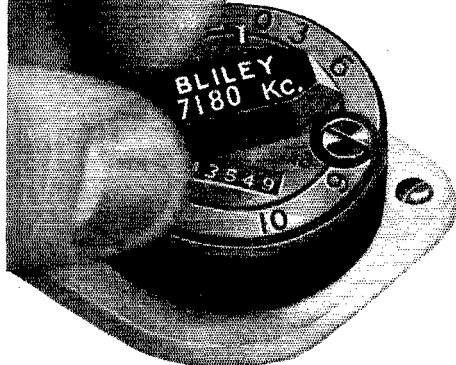

## CRYSTAL UNIT

Replies received from a questionnaire sent to representative amateurs were nearly unanimous on one point . . . "We need a 40-meter variable frequency crystal!" Development work, then in progress, was speeded to meet this demand. The result . . . the Bliley Type VFI Unit for the 40-meter band.

Now, with a minimum of equipment, you can enjoy variable frequency at the higher frequency bands and still retain the stability of crystal control. The crystal frequency is variable over a range of up to 12kc. at the 40-meter fundamental, 24kc. when doubling to 20 meters or 48kc. when quadrupling to 10 meters.

The specially ground crystal has a drift of less than 4 cycles/mc./°C. It has, because of the variable frequency feature, somewhat less activity than the fixed-frequency B5 40-meter unit. However, in practically all transmitters where adequate excitation exists to the following stage, the slightly decreased power output from the oscillator requires no consideration.

Make the most of your transmitter . . . use variable frequency crystal control and operate on clear channels.

Type VFI 40-meter unit, within  $\pm 15$ kc. of specified minimum frequency . . . at all Bliley distributors . . . \$7.50.

**BLILEY ELECTRIC COMPANY**

UNION STATION BUILDING

ERIE, PA.

sages were handled, among them United Press dispatches, WU telegrams, state highway road reports and all State Police messages—including the ones closing all liquor stores in the state!

W1DMD-W1BFT served as key station in the New Hampshire Emergency Net, from Concord, with W1LIN, W1JCA, W1AWU, W1HOV, W1JJD and W1FTJ as assisting operators. A total of 334 messages was handled, 163 of them being for twenty-three official and business agencies—government departments, etc.

W4FIR/1 was at the Alpine Hotel at Bethlehem, N. H., found opportunity to aid Western Union and the local citizenry, aided by W2DKM who was also at the hotel.

Amateur radio in New Hampshire did a bang-up job during this emergency—and a genuine emergency it was, too. Certainly their performance this year overshadowed that of 1936. Much of the credit for this goes to the N. H. Emergency Net. On its roster of active stations were W1JGI, North Conway; W1KLV, Littleton; W1GDE, Manchester; W1GHT, Nashua; W1AXL, Claremont (on with a 201-A and dry batteries); W1FFL, Manchester; W1AYH, Milford; W1BAC, Alexandria; W1DUK, Rochester; W1AEF, Hampton; W1CVF, Keene; W1EDN, Glencliff; W1FX, Laconia; W1HQE, Nashua; W1IJB, Suncook; W1APK, Pembroke; W1KKL, Franklin; W1CME, Manchester, and W1AAJ, Rutland.

W1KKL in Franklin turned in a traffic total of 109 in 67 hours, 30 per cent of which was official. W1CEH, Pittsburg, at the headwaters of the Connecticut, was on with a 6L6 and put 75-meter 'phone signals into Connecticut. Stations reported at other points include W1HUD, Sunapee; W1JNO/1 Laconia; W1BCP, Dover; W1CME, W1FFL, W1ICS, and W1KKS, Manchester; W1ANS and W1HGV, Milford; W1GHT and W1KIN, Hudson; W1GMD, Berlin; W1BAC, Claremont; W1LID and W1TA, Nashua; W1CCM, Center; and W1HRP, Hampton Beach.

Turning now to Maine, at North Berwick W1BFA operated on all bands during the emergency, found all useful but 10 and 20 less so than others. The hurricane demolished wire service in the region and all agencies were served. W1FBJ in Portland served Vermont stations well. W1GE and W1CPT were also reported on in Portland, as were W1HSE, and W1BNC, Waterville; W1BKN, Houlton; W1BWB, Kennebunk (battery-powered); W1KYT, Lisbon Falls; W1LEV, Bangor; W1IBR, Easton; W1FAP, Old Orchard Beach; W1INW, Lewiston; W1GOJ, Falmouth Foreside; W1IWA, Orono; W1IJJ, Augusta; W1LIC, Bar Harbor; W1ITU, Livermore Falls, and W1IST, Rumford.

— — — —

Throughout the eastern half of the country, amateurs generally cooperated during the emergency, if only by standing by to avoid causing QRM. Despite a few notable exceptions, the bands were exceptionally quiet and QRM



# New TRANSMITTING CONDENSER Type "TC"

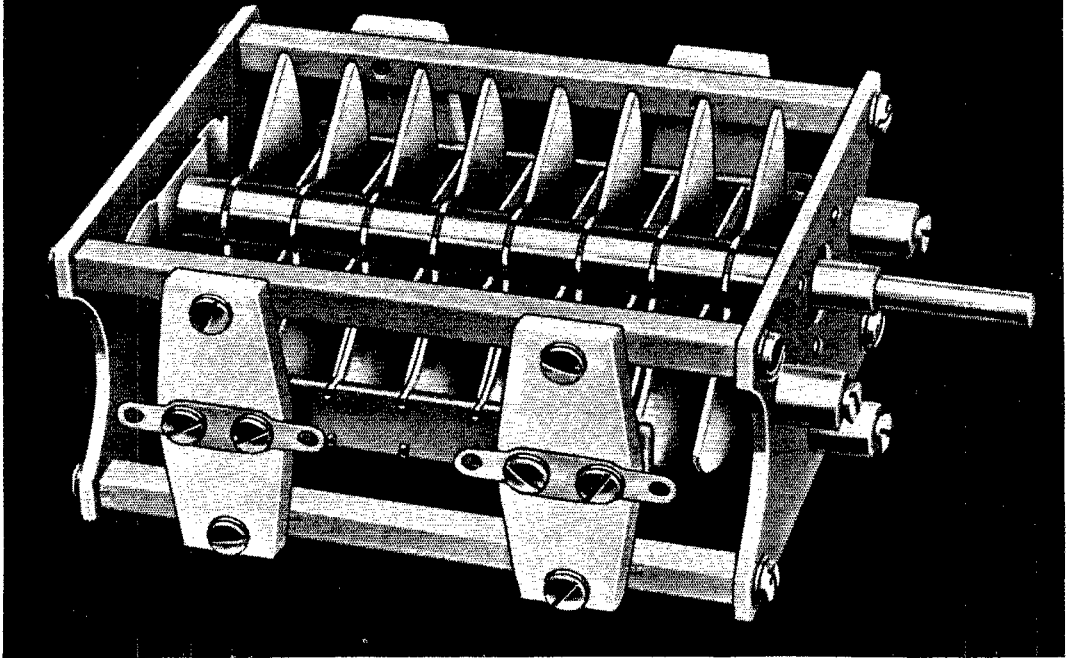

**H**AMMARLUND announces a new line of medium and high power transmitting condensers. There are 34 different types ranging in capacities from 20 to 465 mmf. and voltage ratings from 1000 to 7500. Many outstanding features incorporated in these new condensers are the result of years of careful research in both electrical and mechanical design of variable capacitors. Heavy metal end plates for maximum strength are tied together with four 5/16" duraluminum pillars. Both rotor and stator plates are polished and buffed aluminum with rounded edges, to minimize danger of flash-over. The rotor assembly embodies the exclusive Hammarlund non-magnetic principle. The stainless steel dial shaft does not pass through the rotor. All magnetic material is kept out of the field of the condenser — something absolutely necessary for maximum efficiency at high frequencies. Special full-floating bearings eliminate binding and twisting. The rotor contacts are heavy silver plated Beryllium wipers. This contact is direct to the rotor shaft and extends through the rear plate of the condenser for soldering.

Metal to metal contact in the frame of the condenser is not

depended upon to carry current. This shortens the electrical path and greatly increases efficiency. The more popular dual stator types have drilled and tapped tie pillars to accommodate brackets for mounting the neutralizing condensers and tank coil directly on the condenser. This greatly simplifies transmitter construction.

Our new 1939 catalog is just off the press. Including many new Hammarlund items, this catalog contains a wealth of technical information together with drawings, curves, etc. on the new "TC" condensers. Send for your free copy now. Mail coupon below.



HAMMARLUND MFG. CO., INC.  
424-438 W. 33 St., N. Y. City

( ) Please send 1939 catalog Q-11

Name.....  
Address.....  
City.....State.....

Canadian Office: 41 West Avenue, No., Hamilton, Ont.



# HAMMARLUND

Say You Saw It in QST — It Identifies You and Helps QST



## It's the newest

When you're shopping around for a new transmitter — what do you look for? Is it efficiency, dependability, convenience, appearance? Then you're looking for the Harvey UHX-25.

For efficiency and dependability the popular 6L6 is used as crystal oscillator followed by a second 6L6 as frequency multiplier which in turn drives an 807 final amplifier to 50 watts input on all bands (5-160 meters). Because both RF and audio sections are on one chassis,

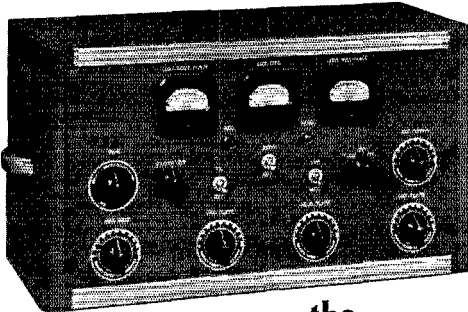

## the HARVEY UHX-25

has unlimited possibilities as an exciter for higher power. For convenience and appearance, all controls are placed right at your fingertips and the cabinet has a hinged cover, gray wrinkle finish and chrome trim. Why not write to Harvey Radio Laboratories, Inc., 25 Thorndike St., Cambridge, Mass., today for further information and also be sure to see our catalog in the 1939 ARRL Handbook.



was at a minimum. At no time did it seem necessary to seek special emergency quiet hours. The ham fraternity as a whole showed a sportsmanlike willingness to cooperate with the stations actually doing emergency work.

The following stations have been cited for active participation in emergency activities: W2ACB, AMX, BIG, BNU, BXC/WLNF, CBO, CDU, CGG, CMI, CQD, DSV, EOA-HXQ (700 messages), FK, GSB, GVZ, HB, HNP, HQL/WLNR, HZY, IIR, IJG, IKV, IM, IWU, JDJ, JIO, JMX, JUC, JZR, KFB, KHA, KNQ, KOI, KYH, LA, LBB, LDB, LFJ, LMC, LV, RW, SQ, UL, W3ADE, ADM, AFH, BDU, BEI, BES, BMC, BPD, BPT, BSO, CFK, CRO, CRW, CXL/WLM, DD, DNU, DUK, ECP, EDC, EML, EOG, EUD, EUG, EVA, EWF, FBM, FDY, FMF, FPU, FZ/WLMP, GIX, GKN, GNU, GPM, GXI, GXO, GZK, HCG, HDJ, HDQ, HLV, HLY, JC, LP, MX, NF/WLML, QV, SN/WLQ, UA, UX, ZI, ZD, W4AHH, AYA, BM, CEL/4, FFH, FKY, OC, W5AFS, AGZ, AHK, BTE, CDU, DLP, W7FAF, W8AOR, AU, AVK, AXV, BBW, BFR, BQ, CHR, CL, CO, CSE/WLNM, CTX, DAE, DHO, EA, GCD, GMI, GMY, GWY, HHO, HJP, HYZ, IQE, JBO, JQE, KYJ, KNF, KUK, K VX, KW, KYR, MPX, NQC, NUG, NZQ, OKK, OPB, PLA, PWI, QAN, QBU, QIS, QNW, QUL, QVJ, QZR, REN, RGA, RNW, RRS, RWC, WA, WV, W9BQW, DCV, EMS, ESJ, GM, HG, JPS, KAD, MEL, MGN, MN, NLP, NYH, PJY, QG, SYJ, TLB, TRN, VDX, VMI, VMZ, YCR, YXD, WPS, ZEF, ZMG, ZOO, ZYY.

### Combined Beat Oscillator

(Continued from page 81)

a large number of 6L7 tubes and no difficulty should be experienced. If, however, the tube refuses to oscillate, increase  $R_1$ . If the tube is microphonic, it is an indication that the oscillator is overcoupled and  $R_1$  should be reduced. The automatic volume control circuit should preferably be grounded when receiving c.w. and the r.f. gain control used to control sensitivity.

$C_1$  should consist of a 0.001- $\mu$ f. mica condenser in parallel with a 400-800  $\mu$ f. padder condenser. With the pitch control set half-way

### THE NEW HARVEY UHX-25 UNIT

DESCRIBED ON THIS PAGE

DOWN PAYMENT ONLY \$10.00

COMPARE THESE LOW TERMS

And Send Your Order Direct to W3DQ

Receiver and Model	Down Payment & 12 Mo. Pay'ts
New NC-44	\$4.04
New RME-70	11.30
New NC100XA	11.70
Super Skyrider	8.08
Sky Challenger II	6.28
NC101X	10.52

Also Super Pro, HRO, Patterson, Breting, Sargent and Others

Lowest Terms on Harvey — RCA — Temco — National — Thorndarson — Transmitters & Kits

**DELAWARE RADIO SALES COMPANY**

405 Del. Ave. — W3DQ — Wilmington, Del.

*Still* THE  
SHORTEST  
PATH TO  
*Good  
Control*

STILL — through the years Servicemen are staying superbly satisfied with the smooth performance of Centralab's Standard Replacement control.

STILL — the shortest path to good volume control is this wall type resistor strip which hugs the inner circumference of the bakelite housing.

- Maximum resistor length for case diameter
- Close uniformity between resistors
- Accurate tapers
- Lower specific resistance and attendant low noise level
- Better power dissipation
- Longer life

As usual always available in standard and special replacement types.

The new 1938-39 Volume Control Guide (available at your jobber) lists thousands of recommended replacements for all current and older receivers.

**Centralab**  
GRL

DIVISION OF GLOBE UNION, INC.  
MILWAUKEE, WISCONSIN

# NEW CARDWELL BAND-SPREAD TRIM-AIRS

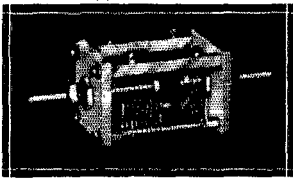

THE popularity of ECO's makes it imperative that some form of station frequency meter be on hand as a constant check against off frequency operation. Many satisfactory types of frequency meters and monitor combinations have been described but the nucleus almost invariably is a low capacity condenser for "band-spread" with a high capacity for "band-set."

Cardwell EU-25-100-AF and EU-50-100-AF Band-Spread condensers combine both units in one compact Trim-air midget frame.

The high capacity tank section may be locked at any desired capacity, allowing the tuning section to spread a narrow band of frequencies over the entire dial for any band or inductor used.

Sturdiest construction for these units made possible by four tie bar construction shown. Heavy isolantite plates fit regular Trim-air mounting brackets or panel mounting posts, in addition to single hole or base mounting normally supplied.

Heavy isolantite end plates, nickel brass construction in all metal parts except plates which are non-corrosive aluminum. Temperature coefficient of capacitance approximately 50 parts per million per degree C.

	Tank Capacity	Tuning Capacity	Depth Behind Panel	List	Dealers Price
EU-25-100-AF...	100 mmfd.	25 mmfd.	3 3/4"	\$3.00	\$1.80
EU-50-100-AF...	100 mmfd.	50 mmfd.	3 3/4"	3.25	1.95

## TYPE "J"

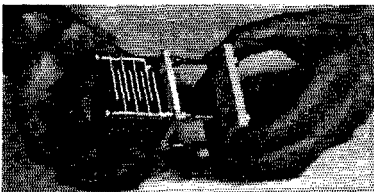

THE flexibility of the "J" type plug-in air condensers, due to the removable plates are creating more enthusiasm for these handy units than expected. Diathermy manufacturers find in them the answer to their low loss blocking and protective condenser problem. May be obtained with mounting studs insulated entirely from the condenser, if required.

If you don't have your reprint of W2KTC's "QRM DODGER" built around the JR-750-OS, write for it. Also get your handy Cardwell listing of latest quality additions to the line from your dealer or write for "UCP" sheet.

Type	Capacity mmfd.	Air-gap	Length	List	Dealers Price
JCO-50-OS...	50	.250"	5 3/4"	\$5.50	\$3.30
JCO-25-OS...	25	.250"	3 3/4"	4.00	2.40
JD-80-OS....	80	.125"	4"	5.50	3.30
JD-50-OS....	50	.125"	3 3/16"	4.00	2.40
JD-25-OS....	25	.125"	2 3/4"	2.80	1.68
JR-750-OS....	750	.030"	4"	8.80	5.28

All "J" types are 2 1/4 inches square. TYPE JB — Jack Base for "J" fixed units. Alsimag 196 — 2 3/8" x 2 3/8" x 1/4". Complete with mtg. posts, screws and nuts.  
List.....\$1.00 Dealers' Price.....\$6.60

**THE ALLEN D. CARDWELL  
MANUFACTURING CORPORATION**  
82 PROSPECT STREET, BROOKLYN, NEW YORK

in, the padder condenser is adjusted for zero beat with a signal tuned in. Be sure there is enough capacity to get to 155 kc. since the second sub-harmonic, 232 1/2 kc. will not give satisfactory operation. If upon operating the pitch control, the beats are of equal intensity on either side of the zero beat, the b.f.o. frequency has been properly adjusted.

## 1938 DX Competition Results

(Continued from page 45)

In addition to the above, club awards are being made to the following: W1BGY, Holyoke Amateur Radio Club; W2FSN, Raritan Valley Radio Club; W6FZL, 20-40 DX Club; W7LD, c.w., W7ESK, 'phone, Rho Epsilon Fraternity, Univ. of Wash.; W8IQS, c.w., W8QBO, 'phone, Genesee County Radio Club; W8LCO, Dayton Radio Amateur Association; VE2KS, c.w., VE2EE, 'phone, Montreal Amateur Radio Club. Awards are made only in clubs having three or more reporting participants.

### MISCELLANY

A special hand is due the Southern California gang. That section of the United States experienced a serious flood just prior to the start of the contest, necessitating much emergency communication work and getting the boys off to a bad start in the competition. As W6AM puts it, "After being up almost all night and day with the flood, I was pretty tired to start on a DX test. I, like many others, gauge the year, as from DX test to DX test. One year it was an earthquake emergency, started two hours after the DX tests started, lasted for weeks. Another year it was being snowbound in the East, delayed me five days. I thought the flood was just another one of those things to spoil the DX week." . . . OK2LO found conditions best on the last day of the test, when he made 115 QSO's; not bad for an old pair of '45's either. . . . W4CYU worked 55 different countries on 'phone. . . . W8OKC started the contest true to form by working G6RB just as specified in the sample log in February QST! . . . Out of 977 QSO's K4KD added but one new state, Utah, to his W.A.S. list; and he worked 43 states during the contest at that. . . . Similar experiences while in quest of W.A.S. are recounted by numerous other contestants. . . . 7 Mc. was found generally FB and it has won many new boosters in the DX ranks. . . . W4CDG on 'phone made 63 contacts with stations in England proper, 73 contacts on the British Isles; 26 of these contacts were on 14 Mc. the first night of the contest. . . . Two operating complaints— from the W's and VE's: Foreign stations should indicate in what part of the band they are going to tune following a CQ. . . from the foreign contestants: W's and VE's should not call so long, especially in reply to a QRZ? . . . Nominations for extinction: (1) The chaps who tested incessantly without rhyme or reason; (2) the stations with the prehistoric notes. . . . OA4J receives the Peru award for the seventh year.

# A NEW GAMMATRON SAVING

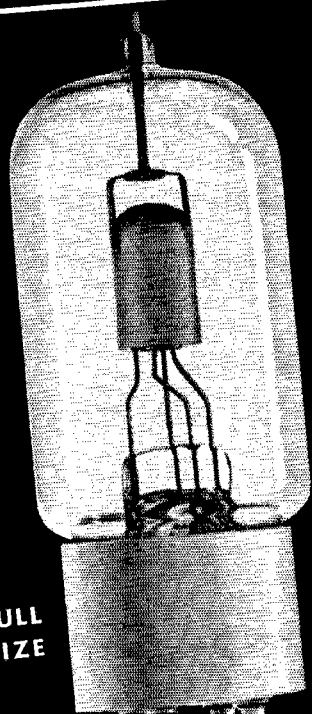

FULL  
SIZE

THE  
NEW TYPE 24

\$3<sup>50</sup>

For the first time a real low cost tantalum constructed tube is offered to the low power ham. Performance and quality is equivalent to the more expensive GAMMATRONS.

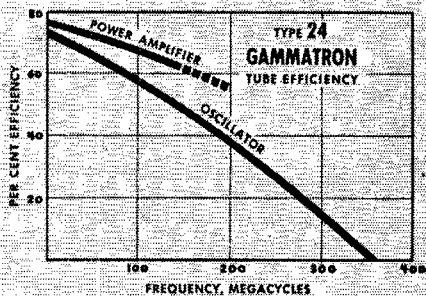

Careful attention to spacing and electron control has resulted in a superior design of extraordinary high frequency performance.

## RATINGS

Power Output, watts . . .	87.5
Plate Dissipation, watts . . .	25
Driving Power, watts . . .	3.8
Max. Plate Volts . . . . .	1500
Max. Plate M. A. . . . .	75
Amplification Factor . . . . .	25
Filament Volts . . . . .	6.3
Filament Amps. . . . .	3.0

WRITE FOR DATA

HEINTZ AND KAUFMAN  
SOUTH CALIFORNIA  
SAN FRANCISCO LTD. U.S.A.

# HOW TO

# LEARN CODE!

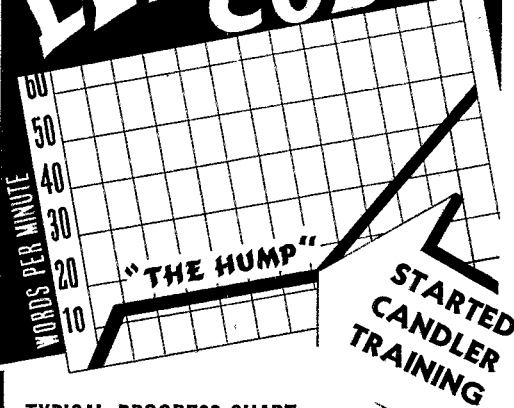

## TYPICAL PROGRESS CHART OF AN AMATEUR OPERATOR

# BEFORE AND AFTER CANDLER TRAINING

It's positively uncanny the way a typical amateur reacts to Candler Training! As an absolute beginner he makes progress—up to a certain point. There he sticks with little or no further progress for months or even years regardless of how much he practices—how desperately he works. And then, in despair, he comes to Candler!

Almost at once, under Candler's scientific guidance, he's over the "Hump" and progressing by leaps and bounds until he's taking and reading code with the same effortless ease that he reads print!

Hours of undirected practice won't help! It takes a thorough knowledge of fundamentals and the proper mental training and coordination that Candler gives you to make a skilled operator. Learn code the Candler way—with the same system that made Champions of men like T. R. McElroy and L. D. McDonald, W8CW. It's the quickest way, too—a real short cut to code skill as thousands of Candler-trained operators will testify. Ask any skilled operator about Candler training!

### SEND FOR THIS

## FREE "Book of Facts"

52 PAGES of vital information every radio telegrapher should know! Contains F. C. C. requirements, principal exam questions, etc. Whether you're trying for a license or just learning code, send for your Free copy now!

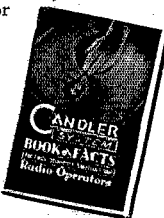

**CANDLER SYSTEM CO.**  
Dept. Q-11, Asheville, N. C., U. S. A.

... Hint for working Asia: Says VU2FV, "I should like to make a comment about the operating of W/VE's. The sending was very good but the W's should come to India and hear the 'tails' they develop. Unless the signal concerned is quite strong, it is impossible to read at more than about 10 w.p.m. Perhaps this will be a help to W's and VE's wishing to work Asia in the next contest." ... G6WY made 67 c.w. contacts with the States (one with VE1EA) on 3.5 Mc. ... GI6TK made a four-band (including 3.5!) contact with W6GRL. ... W6AM made W.A.C. daily for eight consecutive days. ... Have you noticed how some of the lads use the same serial number year after year? W6JMR is superstitious that way; he sticks to 373, which adds up to 13! ... Band-edge mania, the state of mind that causes everyone to crowd the edges of all bands, was as strong as ever. ... More frequent use of the QMH-QML series would help that situation. ...

## Scores

### Tenth International DX Competition

(Operator of the station first-listed in each Section and Country is winner for that territory, unless otherwise indicated. ... Asterisks denote stations not entered in contest, reporting to assure credit for stations worked. ... The multiplier used by each station in determining score is given with the score—in the case of W/VE entrants this is the total of the countries worked on each frequency band used; in the case of non-W/VE participants it is the total of the W/VE Districts worked on each frequency band. ... The number of bands on which successful contacts were made is next listed. ... The letters A, B and C approximate the power input to the final stage at each station; A indicates power up to and including 100 watts; B indicates over 100 watts, up to and including 500 watts; C indicates over 500 watts. ... In cases where power is varied, this is shown by the use of more than one letter. ... The total operating time to the nearest hour is given for each station and is the last figure following the score. ... Example of listings: W3BES 75,864-119-4-B-83, or, Final Score, 75,864 multiplier 119, 4 frequency bands used, power over 100 watts, total operating time 83 hours. ...)

#### ATLANTIC DIVISION

##### E. Pennsylvania

W3BES	75864-119-4	B-83
W3HLL	85644-122-4	B-90*
W3CHH	82604-111-4	C-70
W3OKC	32640-80-3	B-59
W3ENX	29848-81-4	B-46
W3AOJ	29108-77-3	BC-53
W3ASW	26988-78-4	B-71
W3KTT	26424-72-4	B-77
W3CWU	24840-72-3	B-56
W3DPU	21045-69-3	C-55
W3ATR	20412-63-3	B-73
W3FRY	17384-54-1	BC-65
W3GHO	13260-52-2	B-47
W3FKO	13144-53-4	B-46
W3DDM	11205-45-1	C-73
W3CBK	11088-48-3	A-75
W3EYY	10850-50-3	B-37
W3FLH	10512-48-2	-45
W3FQG	8323-41-2	B-37
W3BQP	7585-37-1	B-65
W3DGM	6300-36-4	A-33
W3BYE	4930-34-2	A-37
W8MEH	4312-28-1	B-27
W3HFF	4123-31-3	A-59
W3AGV	3870-30-4	BC-33
W3GTL	3036-22-2	- - -
W3GMS	3024-26-1	B-35
W3BGD	2496-26-2	B-13
W3ANZ	2280-20-1	C-15
W3GKH	2140-20-2	A-44
W3GTV	1953-21-1	B-17

W8CVX	1664-18-1	-15
W3OP	1620-18-1	B-15
W3GYV	1520-19-2	A- -
W3GDI	1350-18-2	B-16
W3CGT	1260-15-1	A-13
W3FPR	1200-15-1	B-25
W3DJI	872-14-1	B- -
W3CNP	462-11-1	C-7
W3LAP	420-10-2	B-34
W3EBP	360-10-1	B- -
W3GRF	360-9-2	A- -
W3DGC	297-9-2	A-9
W3EML	108-6-1	B-4
W3EJH	60-6-1	AB-9
W3AJZ	27-3-1	- - -
W8AZT	18-1	B-13
W3AOC	12-2	A-10

#### Md.-Del.-D. C.

W3BEN	44820-90-3	BC-85
W3GAU	30020-79-3	B-67
W3EPV	24276-68-3	B-61
W3APJ	20008-61-2	C-64
W3GKZ	15288-56-3	AB-62
W3GZH	13122-54-2	B-60
W3AYS	12600-50-3	B-40
W3GKN	10215-45-2	B-56
W3A00	9720-45-2	B-43
W3GHB	7560-35-1	C-7
W3CDG	7035-35-2	B-38
W3GXX	5594-29-2	A-39
W3DRD	5202-51-4	A-78
W3EEW	2514-21-2	A-52
W3GAD	2442-22-1	- - -

# THORDARSON AND NATIONAL

A  
COMBINATION  
HARD  
TO BEAT

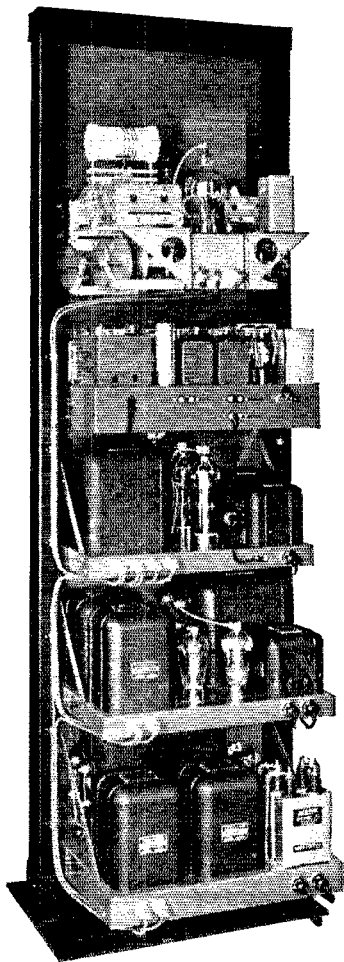

**C.H.T.  
TRANSFORMERS  
USED**

T-15D82  
T-11F51  
T-11M77  
T-15P19  
T-11F53  
T-15P15

**CHOKES  
T-15C46  
T-15C37**

Thordarson C.H.T. transformers and chokes are used in the National Company's new 600-watt transmitter. Once again the conservative ratings, high quality performance, ease of installation and attractive appearance of C.H.T. transformers give them the call for an important job. Notice how well these units harmonize in appearance regardless of size. They "dress up" a rig with that "commercial station" appearance.

**THORDARSON ELECTRIC MFG. CO.**  
**500 W. HURON ST., CHICAGO, ILL.**

*Demand "Power by Thordarson"*





# JOHNSON<sup>SM</sup> *Commercially Built* CONDENSERS

## 90 TYPES and SIZES

### for Every Amateur Transmitting Requirement

If you have seen or used Johnson Condensers, there's nothing more we can say — if you haven't, ask your jobber to show you one. You'll immediately recognize that quality, precision-built look and feel that is usually associated only with costly equipment built for commercial radio use.

Notice particularly the sturdy rigid construction, the husky tie-rods — look over the design, the long insulation paths, the laminated rotor brushes. You'll feel, as hundreds of amateurs have already discovered, that a Johnson Condenser in your rig is a guarantee of dependability and superior performance.

And then you'll be amazed at the tremendous values offered in each one of over 90 different types and sizes of fixed and variable condensers in the Johnson Amateur Line. In design, in performance, in value, Johnson Condensers are supreme. Ask to see a Johnson Condenser today or write direct for catalog 965J.

## E. F. JOHNSON CO.

WASECA, MINNESOTA

EXPORT: 25 WARREN ST., NEW YORK, N. Y.

"MANUFACTURERS OF RADIO TRANSMITTING EQUIPMENT"





# PARIS TO PODUNK

**U**NDERLYING all of the highly touted deals between Dictators and Diplomats are personal differences and mental reservations. Among them, a whole-hearted agreement on anything is as rare as five meter DX. About the only subject on which the World Powers seem to be in *real* accord is in their liking for our Insulated Resistors.

While we have been making about a hundred million in the U. S. A., other IRC factories and licensees in seven foreign countries have been taking care of the growing Worldwide demand. As a result, you will find these little Metallized units in popular favor wherever in the World radio is known and enjoyed — from Paris to Podunk and Timbuctoo.

Thus, due to their wide utility, a few notes on their design and application may be of interest.

In manufactured products as well as in diplomatic conferences there are always compromises. If the product is a popular one, you can be sure that the designer has struck a happy balance between the various qualities desired. This is true of automobiles, lipsticks, breakfast cereals and shot-guns — and even resistors.

The characteristics outlined below are made possible by their Metallized construction and offer some explanation for the widespread adoption of the Type BT.

1. **Life.** There is no known limit.
2. **Stability.** Under normal weather and humidity conditions they will remain within 1% of their original value at no load and within 2 to 5% when run continuously at rated load.
3. **Overload Capacity.** Will remain within 5 to 15% of original value (depending on the size and range of the resistor) when run under a 100% overload for 1000 hours.
4. **Temperature Coefficient.** (Change in resistance with temperature.) From minus .02% to minus .05% per degree Centigrade change in temperature — the lower value for the lower ranges.
5. **Voltage Coefficient.** (Change in resistance with changes in applied voltage.) From 0% to .01% per volt applied.
6. **Noise Level.** From 0.1 to 1.5 microvolts noise per volt applied to the resistor. Noise level is a function of voltage per unit length; therefore for extremely low noise level applications the longer units should be used.
7. **Voltage Rating.**  
 Type BT-1/2 (1/2 Watt) 350 Volts Maximum  
 Type BT-1 (1 Watt) 500 Volts Maximum  
 Type BT-2 (2 Watt) 500 Volts Maximum
8. **Insulation.** Better than 1000 volts breakdown to ground through bakelite covering.
9. **Mechanical Strength.** Lead wires withstand better than 20 pounds pull.
10. **Humidity Protection.** Molded bakelite insulation insures against moisture penetration; will withstand salt water immersion.
11. **Small Size.**  
 Type BT-1/2 3/16" Dia. x 5/8" Long  
 Type BT-1 1/4" Dia. x 1 1/4" Long  
 Type BT-2 5/16" Dia. x 1 3/4" Long

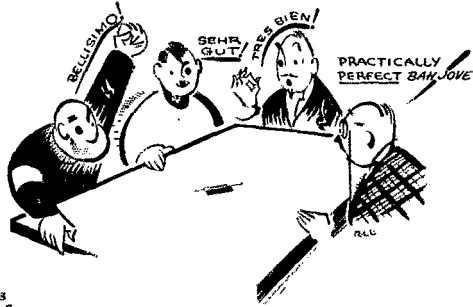

12. **Tolerance.** Standard tolerance plus or minus 10% (or plus or minus 5% on Special order).

13. **Frequency Characteristic.** Suitable for general use from DC up to 5 or 10 megacycles. Low resistance ranges, up to 25,000 ohms, have constant impedance at frequencies up to 10 megacycles. High range units (0.5, 1.0 megohm, etc.) drop off in impedance at frequencies above 1 megacycle. For high frequency operation, where the resistance value is 100,000 ohms or above, our Type F resistor is recommended.

#### 14. Temperature Rise.

At rated load. . . . .	BT-1/2	35°C.
	BT-1	40°C.
	BT-2	50°C.

#### 15. Ranges Available.

BT-1/2	50 ohms to 20 megohms
BT-1	150 ohms to 20 megohms
BT-2	200 ohms to 20 megohms

The application of these resistors in receivers, low power transmitters, oscilloscopes, etc. is common knowledge. The above noted figures may suggest their use in voltmeters, ohmmeters, etc. They are entirely suitable for such use and, in fact, we count several of the well known meter companies among our customers. They should not be substituted for Precision Wire Wound Resistors where 1 or 2% accuracy is necessary.

In this service we would recommend operating them at a low load — say, not more than a fourth their rating. This reduces the temperature rise and drift due to temperature changes. For higher voltages than rating, series operation is feasible. Series operation will increase the wattage rating in proportion (providing the resistors are all the same value) and still further reduce the noise level, due to the increased length. Parallel operation of the same value resistors will also increase the wattage rating in proportion (if the resistors have air circulation around them) but won't increase the voltage rating or lower the noise level. The noise level, however, is low enough to be completely neglected.

In summary: We make many special types of resistors excelling in certain characteristics for particular uses but for general purpose low wattage applications where cost is important the Type BT is our recommendation.

**INTERNATIONAL RESISTANCE COMPANY • 401 NORTH BROAD STREET, PHILADELPHIA, PA.**



# Is Radio . . .

## Just A Job to You?

Here's how you can get a better job and make more money

E. H. Rietake  
Pres. CREI

If you can equip yourself with the necessary training . . . Radio can offer you an excellent future. Continuous new developments have created a need for technically trained men, who have kept their knowledge up with Radio's fast pace.

### You can't bluff your way

CREI courses are planned only for serious-minded men who know that it takes Training to qualify for and to hold the big jobs and salaries that go with them. Let us suggest the course best suited for you and the easy ways of paying for it.

### TEAR OUT COUPON AND MAIL FOR FREE BOOK

**FREE!** *New illustrated book, "A Tested Plan for a Future in Radio"*

Name.....

Address.....

City.....



**Capitol Radio Engineering Institute**  
Dept. Q11, 3224 16th St., N.W., Washington, D. C.

# PERFORMANCE

. . . at a popular price

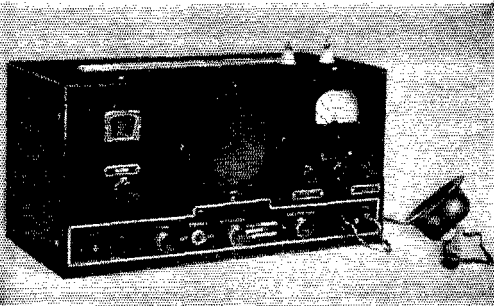

### ★ TR-8 Transmitter — Receiver

Our Engineering Department has developed the successor to the popular dependable TR-7, to conform to imminent rulings on quality and stability of signals on 60 Megacycles.

You need this CRYSTAL — M.O.P.A. station of the future . . . today . . . Net to Amateurs . . . **\$62.70**

Write for literature on approved portable equipment

### Radio Transceiver Laboratories

8627 115 STREET, RICHMOND HILL, NEW YORK CITY  
Cable address: "RATRALAB" NEW YORK

W2HUB	975-15-1	B-14	W2DJT	1224-17-2	A-13
W2JRH	910-14-1	B-33	W2EAE	1534-18-1	B-27
W2JBQ	210-7-1	B-11	W2EWM	1008-14-1	B-16
W2KFB	60-4-2	A-17	W2GFF	1008-14-1	B-30
W2SZ	36-3-1	A-17	W2BFF*	960-16-1	B-17
W2HVR	27-3-2	A-4	W2JFF	944-10-2	A-30
W2ISJ	12-2-2	A-4	W2GGW	864-16-1	C-15
			W2GGW	756-14-2	A-1
			W2BLY	624-13-2	B-7
			W2CAY	480-10-1	B-7
			W2GCV*	432-13-1	C-17
			W2CGU	306-9-1	A-9
			W2DSV	306-9-1	A-11
			W2HVY*	297-1-1	A-1
			W2IYQ	252-9-1	A-10
			W2BNU	240-8-1	B-7
			W2VJD	210-4-2	A-4
			W2JJE	144-6-1	B-3
			W2HZN	108-6-2	B-8
			W2JSS	75-5-1	A-1
			W2JKH	72-4-2	A-1
			W2OBT	48-4-2	A-1
			W2JLK	48-4-1	B-1
			W2KNN	27-3-1	B-20
			W2JOG	12-2-1	A-3
			W2KSM	6-1-1	A-1
			W2ASY*	3-1-1	A-1
			W2KEG	3-1-1	A-1

### N. Y. C. & Long Island

W2UK	175509-179-4	C-88
W2BEF*	53550-102-3	C-90
W2BJ	37944-102-4	B-51
W2AHC	34161-83-4	AC-59
W2IRV	25528-73-3	A-69
W2IOP*	16800-56-2	AB-35
W2GTZ	14193-57-2	B-45
W2BHD	11421-47-2	A-42
W2ALB	11340-45-1	B-56
W2DVA	7752-38-3	B-47
W2FSK	7616-34-3	C-53
W2CTO	7215-37-1	B-1
W2AIS	6615-35-4	A-54
W2HYA	6336-33-2	A-46
W2BAK	5236-34-2	A-38
W2HDT	4896-34-2	A-66
W2DXL	4278-58-3	B-58
W2OQ	4081-28-3	A-31
W2WY*	3892-28-2	A-1
W2GKO	3888-27-1	B-14
W2DYJ	3510-26-1	B-24
W2BO	3276-26-1	B-21
W2GRA	2508-22-2	B-1
W2DKF	2346-23-1	B-16
W2FFV	2200-22-2	B-32
W2HAY	2037-21-2	A-23
W2JIN	1826-17-1	B-16
W2HXT	1104-16-2	B-7
W2DAG	1085-15-2	A-20
W2KIB	924-14-1	B-21
W2BJQ	570-13-1	B-8
W2EQG	504-12-2	A-1
W2FJH	486-9-1	B-7
W2DVT	462-11-2	B-4
W2KZQ	429-11-2	A-7
W2AJL	270-9-1	B-19
W2EW	248-8-1	B-9
W2EVA	168-7-1	A-1
W2HQX	165-5-1	A-6
W2A0Y	108-6-1	B-5
W2HSL	90-5-2	B-16
W2GP	60-4-1	A-12
W2IGA*	60-4-1	A-1
W2APZ	45-3-1	A-1
W2HCN	45-3-1	B-4
W2HUG	40-4-1	A-7
W2LAY*	27-3-1	A-1
W2KKR	12-2-1	B-2
W2APO*	3-1-1	A-1
W6CFT-2*	3-1-1	A-1
W2HBO*	3-1-1	A-1
W2KAM*	3-1-1	A-1

### MIDWEST DIVISION

Iowa		
W9AJA	7641-43-3	B-50
W9HAQ	4470-30-1	-68
W9FDL	3360-29-2	B-24
W9GKS	1680-20-1	B-71
W9VRD	840-14-3	B-12
W9LDH	486-9-2	B-19
W9JSO*	405-9-2	A-31
W9ARE	378-9-1	B-1
W9AZZ	189-7-2	B-10
W9DIB	144-6-2	B-17
W9FQA	144-6-1	B-19
W9TJ*	60-4-1	A-1
W9YXK	24-2-1	A-9

### Kansas

W9ARL	133618-150-4	C-89
W9CWW	17748-58-3	ABC-55
W9AQP	8253-37-2	C-29
W9AWF	162-6-1	B-9
W9YAH	84-4-1	A-1
W9JFP*	12-2-1	A-1
W9VBQ*	3-1-1	A-1

### Missouri

W9NNZ	47880-95-4	B-87
W9TJ	40176-93-2	C-49
W9AVS	18300-60-3	B-84
W9BMM	17388-54-2	BC-60
W9GBJ	12051-22-3	B-33
W9DAE	5565-35-2	C-19
W9MYX	2391-21-1	B-44
W9WCM	1824-19-2	B-32
W9TPH	1782-18-2	B-21
W9LBB*	1162-16-2	A-1
W9EYM	792-12-1	A-21
W9PFR	684-12-1	B-27
W9ARH	147-7-2	A-10
W9WBT*	126-6-1	A-1
W9CTR	77-12-1	B-16
W9ZFF*	48-4-1	A-1

### Nebraska

W9BBS	4650-31-2	B-50
W9DMY	3570-10-3	A-1
W9ZNA	1120-14-1	B-23
W9POB*	960-16-1	A-1
W9DGL*	108-7-1	A-1
W9RQS	27-3-1	A-5

### NEW ENGLAND DIVISION

### Connecticut

W1EWD	41205-93-4	B-90
W1EPT	40950-91-2	-71
W1N1	31509-81-3	B-62
W1IED	31388-76-3	C-64
W1GXC	20670-65-3	B-87
W1DIO	11680-53-4	B-57
W1VVF	9900-44-2	B-54
W1KOK	9504-44-2	C-44
W1APA	8658-39-3	BC-49
W1EJT	7236-36-3	B-45
W1AFG	5359-29-1	A-59
W1CSC	3741-29-2	B-28
W1CUH	3528-28-2	B-50
W1DGG	2943-27-3	B-32

101

Say You Saw It in QST — It Identifies You and Helps QST

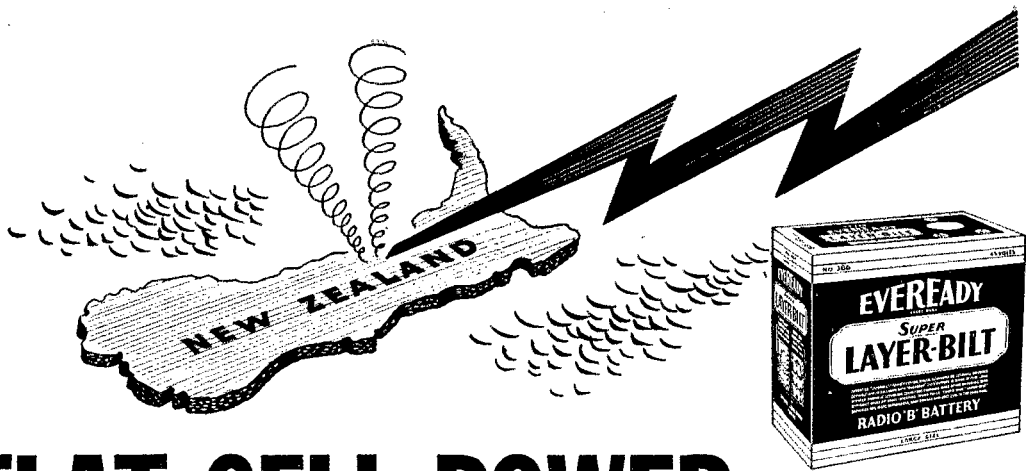

# FLAT-CELL POWER CONTACTS NEW ZEALAND AT ARRL FIELD DAY

T. E. Powers, W9CNM, a member of the Hamfesters Radio Club, Inc., of Chicago, reports on the A.R.R.L. Field Day:

"Your heavy-duty 'Eveready' 'Super Layer-Bilt' 'B' batteries were used to power a single 6L6 CW transmitter with an input of 20 watts, and saw *continuous* service for 26 hours. During this period communication was established with every U. S. district, three Canadian districts and one 100% QSO with New Zealand!

"Our battery powered equipment actually saved the day for the field group because our three A.C. operated transmitters failed us for various reasons. The combined total of

the four transmitters was 1294 points; and of this 1072 points were made with the tiny QSL 40 transmitter with battery power. Unquestionably the success and ability of this 'rig' to get out as it did was due to the steady constant supply of D.C. power that cannot be obtained from rectified sources."

And *now*, all "Eveready" "B" batteries (except those for special purposes) are "Layer-Bilt" batteries, and priced competitively with shorter-lived, old-fashioned round-cell "B" batteries. Today, more than ever, it's wise to insist on reliable, longer-lived, flat-cell construction. You get *more power per dollar* when you buy "Layer-Bilt" "B" batteries.

## NATIONAL CARBON COMPANY, INC.

General Offices: New York, N. Y. Branches: Chicago and San Francisco  
Unit of Union Carbide  and Carbon Corporation

The words "Eveready," "Layer-Bilt" and "Super Layer-Bilt" are trade-marks of National Carbon Co., Inc.



# Taylor HEAVY CUSTOM BUILT DUTY Tubes

*New Low Price Gives You Increased Value!*

**T-55 NOW REDUCED TO \$6.00**

Amateurs everywhere acclaim the TAYLOR T-55 the finest in its class. A better T-55 can't be built. Today over 9,000 of these most popular tubes are serving amateurs throughout the world. These tubes were sold first at \$8.00 — then at \$7.00. Now, keeping pace with the TAYLOR slogan, "More Watts Per Dollar," we give you radio's outstanding tube value —

the TAYLOR T-55 for only \$6.00.

**TAYLOR T-55  
NOW ONLY  
\$6.00**



## ALL PUNCHED CHASSIS GIVEN

### TO PURCHASERS OF NECESSARY TAYLOR TUBES

*Used in the Famous-Popular 275-Watt Dual RF Unit*  
**DE LUXE ALL BAND TRANSMITTER**

New — Different — Better. Full input on all bands 5 to 160 meters. Instant operation on any two bands. TZ-40's Push-Pull modulated by TZ-40's Class B. Peak compression built-in. Complete parts cost but \$275.00. To establish quickly the popularity of this most modern transmitter, **TAYLOR TUBES AND THEIR PARTS DISTRIBUTORS**, are giving you *free of all charges* the four 13" x 17" x 3" sturdy metal chassis used in this "Rig." All socket and other large holes are ready punched for your convenience, ( $\frac{1}{4}$ " holes and smaller are not drilled). **GET THE COMPLETE STORY IN THE \*\*\*\***

**NEW 1938-1939 TAYLOR TUBES MANUAL  
AND CATALOG NOW READY**

All new circuits — New Technical Data — including complete building information on the De Luxe Dual Unit Rig and on other brand new transmitter circuits. You liked the last Taylor Manual — **THIS IS BETTER THAN EVER — AND IT'S YOURS FOR THE ASKING** — at your distributor's or write direct to us.

*"More Watts Per Dollar"*

**TAYLOR TUBES, INC., 2341 WABANSIA AVE., CHICAGO, ILLINOIS**





GET TUBES THAT STAY

*Gas-free*

**SPEER Graphite Anodes  
help keep tubes gas-free  
— help in two ways:**

*first* Tubes can be degassed at temperatures far above any encountered in operation—and thereafter no further gas will be given off.

*second* Gas given off by other tube elements will be absorbed by the graphite—as carbon does in a gas mask.

Add this advantage to the fact that you can not warp or blow holes in a SPEER Graphite Anode, no matter how you slap on the voltage—plus at least twelve other advantages—and you will buy tubes with SPEER Graphite Anodes. Leading tube manufacturers use them. Write for list and Anode Booklet No. 80 which tells the whole story.

**SPEER CARBON CO.  
ST. MARYS, PA.**

Chicago  
Cleveland  
Detroit

Milwaukee  
New York  
Pittsburgh



**SPEER GRAPHITE ANODES**

# Be Right with OHMITE in Your Rig!

You get the extra-value of Ohmite time-proven dependability, when you use Ohmite all-porcelain vitreous-enamelled Rheostats\*, Fixed and Adjustable Resistors, Band-Change-Switches, R.F. Plate and Power Line Chokes. They're the same sturdy, trouble-free units which today are standard equipment with prominent manufacturers of amateur, commercial and broadcast transmitters and receivers.

\* Underwriters Laboratories Listed

See the new Ohmite Model D-100 Vacuum-Type Dummy Antenna Resistor at your Jobber, or send for D-100 data.

**OHMITE MANUFACTURING CO.**  
4831 Flounoy St., Chicago, Illinois, U. S. A.

# OHMITE

## DO YOU WANT TO LEARN WIRELESS and TELEGRAPHY?

A BOOK EVERY AMATEUR  
SHOULD HAVE —

*Send Now!*

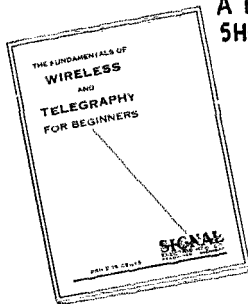

Hundreds of amateurs have learned from this book, so can you.

**15¢**  
POSTPAID  
COIN, OR  
STAMPS

This book gives you the fundamentals of wireless and telegraphy. It contains the codes and how to learn them. Mail your order now to:

**SIGNAL ELECTRIC MFG. CO., Menominee, Michigan**

ESTABLISHED  
1892

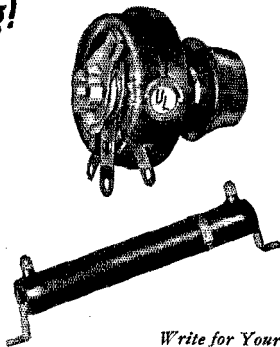

Write for Your  
Copy of the New  
Catalog 17

W5DXA	2652-26-3	B-19
W5GBC	192-88-1	A-6
W5FBQ	105-5-1	A-4
<b>Oklahoma</b>		
W5YJ	46035-93-4	C-90
W5FFW	1292-17-2	B-13
W5CVA	390-9-2	A-10
<b>So. Texas</b>		
W5VY	19305-65-3	--45
W5FI	18081-63-3	BC-48
W5BB	10486-49-3	C-41
W5EJW	4092-33-2	--27
W5FNA	3810-30-2	B-38
W5ARO	827-11-2	A-25
W5GLK	594-11-2	A-11
W5BDI	217-7-3	---
W5MNI	3-1-1	A- --
<b>New Mexico</b>		
W5HAG	1104-16-2	A-37
W5GGX*	54-3-1	---
<b>CANADA</b>		
<b>Maritime</b>		
VE1CO	1649-17-2	---
VE1FB	1512-13-2	A-15
VE1KJ	510-10-1	A-8
VE1AP	96-8-3	---
VE1MK	3-1-1	---
<b>Ontario</b>		
VE3QD	25456-74-3	B-79
VE3QL	9306-47-2	B-48
VE3HP	6364-37-2	AB-41
VE3ES	5587-37-3	A-45
VE3GH	3690-30-3	A-88
VE3YU*	1716-22-1	AB-20
VE3GT	1680-20-4	A-24
VE3AGX	460-10-2	A-47
VE3ADV	108-6-1	B-9
VE3AJE	68-4-1	---
VE3IR	48-4-2	A-6
VE3QT*	12-2-1	A-10
VE3DU*	3-1-1	---
VE3XY*	3-1-1	---
<b>Quebec</b>		
VE2EW	10032-44-3	B-77
VE2KA	9198-42-2	B-75
VE2EP	4176-29-2	A-21
VE2KS	3744-26-2	B-26
VE2HG*	1653-19-1	---
VE2GZ	910-14-1	B-21
VE2DQ	450-10-1	B-19
VE2AA*	18-2-1	B- --
<b>Alberta</b>		
VE4GD	4089-29-3	A-50
VE4GE	1035-23-1	A-12
<b>British Columbia</b>		
VE5QP	11891-47-4	AB-73
VE5FG	4941-27-3	AB-72
VE5AAD	3528-28-2	B-30
VE5MZ	3432-26-2	AB-47
VE5HR	1794-23-2	A-16
VE5VO*	336-8-1	---
VE5VP	196-7-2	B-13
VE5ADD	3-1-1	A-1
<b>Manitoba</b>		
VE4RO	61884-108-3	C-86
VE4DU	4080-20-2	B-26
VE4BO	1200-16-2	A-31
VE4SH*	513-9-1	---
VE4AJP	231-7-1	A-29
VE4NMF	192-8-1	---
VE4AEO	168-7-1	A-10
VE4MJ	162-6-1	A-2
<b>Saskatchewan</b>		
VE4JV	2725-25-2	B-43
VE4BD	1159-19-2	B- --
VE4ZC	360-9-2	A-78
VE4AT	126-6-1	A-11
<b>AFRICA</b>		
<b>Egypt-SU</b>		
SU2TW	162-6-2	A-2
SU1WM*	90-2-1	---
<b>Madagascar-FB</b>		
FB8AB	3820-10-1	A- --
<b>Madeira-CT3</b>		
CT3AB	22064-28-3	A-47
CT3AN	11438-19-2	A-45
<b>Mauritius-VQ8</b>		
VQ8AB	135-5-1	A-2
<b>Morocco-CN8</b>		
CN8AV	21663-20-3	---
<b>Mozambique-CR7</b>		
CR7AK	126-2-1	A- --
<b>Southern Rhodesia-ZE</b>		
ZE1JR	6171-17-2	A-27
ZE1JI	880-5-1	A-15
<b>Southwest Africa-ZS3</b>		
ZS3F	12-2-1	A- --
<b>U. of So. Africa-ZS/ZT/ZU</b>		
ZS1AH	38797-31-3	A-65
ZS5AB	8866-13-1	A-45
ZS5BB	1400-8-1	A-11
ZS1B	1134-8-1	---
ZS4U	114-6-1	A-3
<b>ASIA</b>		
<b>China-XU</b>		
XU6MK	2286-9-1	A-25
XU8LS	432-4-1	A-16
<b>Hong Kong-VS6</b>		
VS6AG	6380-12-1	A-23
<b>India-VU</b>		
VU2FV	1390-10-1	A-27
VU2FH	544-8-1	A-6
VU2FX	504-8-1	A-9
VU2EO	315-7-1	A- --
<b>Japan-J</b>		
J3FJ	31408-26-3	--68
J2LL	20300-25-3	B-76
J2MH	10626-23-3	A-47
J2NG	905-5-2	A-17
<b>Chosen (Korea)-J8</b>		
J8CH	318-2-1	A-20
<b>EUROPE</b>		
<b>Austria-OE</b>		
OE3AH	76230-43-4	A-90
<b>Azores-CT3</b>		
CT2CB	7245-15-2	A-32
CT2BO	3627-9-1	---
<b>Belgium-ON</b>		
ON4AU	48974-47-4	B-78
ON4FE	47056-34-3	B-76
ON4LX	32637-33-4	AB-77
ON4NO	32508-28-2	A-53
ON4BR	22128-24-2	B-61
ON4NW	20804-28-3	B-72
ON4IP	20496-28-3	B-70
ON4ZC	6083-11-1	--41
ON4SG	4590-15-2	B-27
ON4AW	1710-10-1	B-12
<b>Czechoslovakia-OK</b>		
OK1BC	106977-39-4	A-88
OK2LO	50782-34-4	A-66
OK2MV	20385-27-3	A-58
OK1CX	15525-27-3	A-52
OK2HM	13795-28-3	A-82
OK1AW	8001-21-2	A-31
OK3VA	3896-21-2	A-17
OK2KJ	1716-12-2	A-26
OK1ZB	1170-9-1	A-9
OK2PN	840-10-2	A- --
OK1BM	51-3-1	A-4
OK1XA	24-2-1	A- --
<b>Denmark-OZ</b>		
OZ2M	91035-35-3	---
OZ9Q	62907-39-4	A-82
OZ7CC	7714-19-2	---
OZ4H	7344-17-3	--39
OZ7UU	432-8-1	---
OZ8B	390-5-1	A-10
OZ2PX	174-6-2	A-2
OZ4S	3-1-1	A- --
<b>Fire-EI</b>		
E18M	31938-29-3	A-62
E15F	18018-26-3	A-40
E15G	13024-22-2	A-35

# Not how many but...

# HOW GOOD

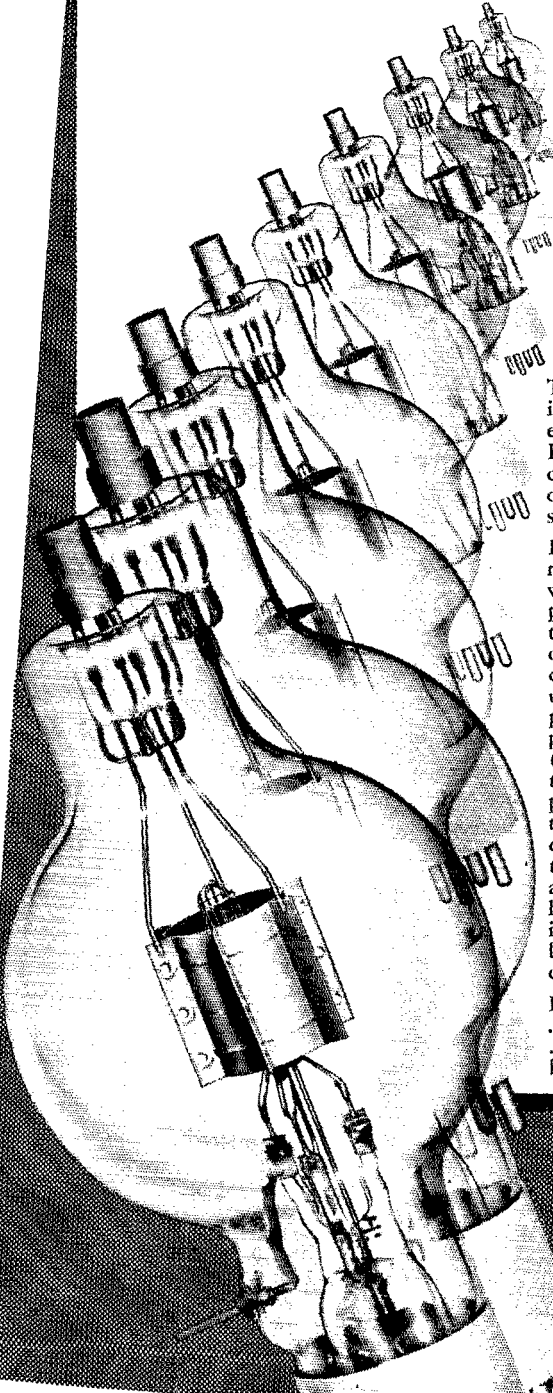

The results you get from Eimac tubes is our guiding star . . . NOT the large sales volume we've enjoyed. Because of this policy you'll find that Eimac tubes are a radical departure from the conventional . . . and because of the radical design you'll find that Eimac tubes give vastly superior performance.

Ease with which high plate efficiencies can be realized; low amount of grid power consumed when excited for maximum results; ability to place more watts in the antenna than most other tubes operating under similar conditions; ease of operation, even at the highest radio frequencies; ability to produce enormous amounts of undistorted class "B" audio power. Such unusual performance, found only in Eimac tubes, is made possible by (1) unique grid and filament design; (2) use of cylindrical grid and plate which allows the symmetrical construction so essential to peak performance; (3) lower interelectrode capacities than any tube of equal power ratings or capabilities; (4) new type, low temperature, thoriated tungsten filament; (5) removal of voltage limitations from grid and plate; (6) heavy, low loss grid and plate leads; (7) extremely high interelectrode insulation without internal insulators; (8) positive guarantee against tube failure caused by gas released internally.

Eimac tubes warrant your immediate attention . . . NOT because we sell thousands of them . . . NOT because you like their looks . . . BUT because Eimac tubes give better performance.

## Eimac

### TUBES

TEL-McCULLOUGH, INC.  
SAN BRUNO, CALIFORNIA

Say You Saw It in QST — It Identifies You and Helps QST



# NATIONAL UNION *brings you* TELEVISION TUBES *at prices to fit* *your pocketbook!*

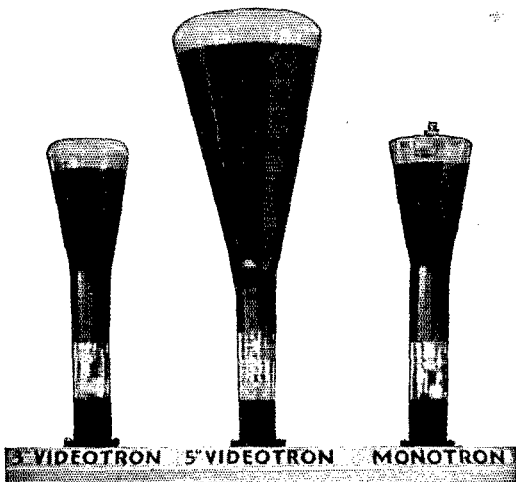

Maintaining a steady pace in the development and production of cathode ray tubes and television type tubes, National Union has made some noteworthy contributions to this field.

All National Union effort, insofar as television is concerned, tends toward the practical angle with an aim to bring these tube types within a price range which will make it possible for amateur and experimenter to work with them.

THESE TUBES DESIGNED BY M. P. WILDER, W2KJL  
FOR NATIONAL UNION RADIO CORP.

## TYPE 2303—MONOTRON PICTURE SIGNAL GENERATOR TUBE

**\$16<sup>50</sup>**  
NET

- 1—First satisfactory picture signal source.
- 2—Spot small enough for 441 line definition.
- 3—Pattern designed for complete test of transmitter quality.

- 4—Electro-static focus and deflection.
- 5—Non-magnetic deflection plates.
- 6—Constant signal output.
- 7—Ceramic mounted gun.

## TYPE 2003—3" VIDEOTRON TELEVISION PICTURE TUBE

**\$12<sup>00</sup>**  
NET

- 1—High brilliance.
- 2—Non-magnetic deflection plates.
- 3—Ceramic mounted gun.
- 4—No defocus along trace.

- 5—Good modulation characteristics.
- 6—Constant sensitivity.
- 7—Interchangeable with Type 906.

## TYPE 2005—5" VIDEOTRON TELEVISION PICTURE TUBE

**\$22<sup>50</sup>**  
NET

- 1—Designed for television reception.
- 2—Super quality as an Oscillograph.
- 3—Non-magnetic deflection plates.
- 4—Perfect trapezium correction.
- 5—Employs screen grid.
- 6—No defocusing at extremes of sweep.

- 7—Sensitivity to .56 mm/volt.
- 8—High brilliance.
- 9—Extra long life.
- 10—Clean sharp focus.
- 11—Ceramic mounted gun.

## TYPE 2109—9" VIDEOTRON TELEVISION PICTURE TUBE

**\$50<sup>00</sup>**  
NET

- 1—High brilliance.
- 2—For magnetic deflection.
- 3—Ceramic mounted gun.
- 4—Gun is mica spring supported to obviate possibility of knocking it off center.
- 5—Double getter flashed for highest vacuum, longest life.

- 6—Fine trace for 441 line definition.
- 7—Screen material produces black and white pictures.
- 8—No defocusing at extremes of sweep.
- 9—Forty degrees of light contrast due to special processing of fluorescent screen.
- 10—Interchangeable with Type 903.

For Technical Details  
and Nearest Dealer write:

**National Union Radio Corp., Newark, New Jersey**

Say You Saw It in QST — It Identifies You and Helps QST

## Station Activities

### HUDSON DIVISION

**E**ASTERN NEW YORK—SCM, Robert E. Haight, W2LU—2KFB schedules SC daily with FB results on traffic. LLU hails from Feura Bush. KWG is ready for any West Point traffic on 3.5 or 3.7 Mc. KXF starts traffic season with FB line-up of schedules. HCM attended S.A.R.A. Hamfest with YF. HTU sports new center fed Zepp, 130 ft. long. FQG is sticking to 3.9-Mc. 'phone. BLU's new rig: '47-10-211, about 150 watts input. KXF reports 2LOR new ham in Port Jervis. HOA is pounding out on 3.9- and 1.75-Mc. 'phone with 35T final. GTG increased power on 3.9 Mc. to 500 watts. JHO is building for 23 Mc. while JJO is perking on that band. HLJ, brother to JHO, is blasting out on 14-Mc. 'phone. CLV was on Long Island Labor Day with portable 3.9-Mc. 'phone. BTY is chief opr. at 2GGP. HOA, GTG, CLJ and FQG attended S.A.R.A. Hamfest. ACB, popular E.C. of Schenectady area, did a fine job assisting in handling emergency traffic during recent hurricane in New England. E.N.Y. welcomes back our old friend BSH. DC, E.N.Y.'s P.A.M., was active assisting during emergency work. The Naval Communication Reserve Nets are in full swing. Let every amateur get behind the U. S. and offer his services by signing with the N.C.R. Information may be obtained from any "N" station or from your S.C.M. ISQ, back to school, has 6L6 crystal-6L6-6L6-35T buffer-250TH final. LLH from Brooklyn joined E.N.Y. Section and promises support while at R.P.I.

Traffic: W2KFB 106 LU 62 LLU 36 KWG 17 KXF 10 HCM 8 HTU 7 FQG 3 BLU 3.

**N**EW YORK CITY & LONG ISLAND—SCM, Ed. L. Baunach, W2AZV—LOQ is now O.R.S.; he is former 8QPS. IBT is back in N. Y. C. from the west coast. LAP is now located at 1799 Popham Ave., N. Y. C. For the next few years KVV's QTH will be the Georgia School of Tech. PF has been doing active duty at Fort Bragg, N. C. from Oct 2nd to the 15th. This report is being written during one of the worst hurricanes that L. I. has ever experienced and it is proving that emergency power supply is a very great necessity as the power has been off for over three days on the island. HYJ and LAH rushed to Fire Island and maintained contact with the mainland on 56 Mc. JZX and DXO operated a 3.5-Mc. rig from the State Police Barracks at Bay Shore and acted as a link for Fire Island. We want all operators in Suffolk County who have portable equipment capable of operating on their own power supplies to get in touch with us for enlistment in the A.E.C. net of this Section. KJY is looking for a 70 foot mast for his portable QTH at Mt. Siani. DVU completed his rig and it works FB on all bands. Two seven pound twin girls arrived at BRB's shack. Congrats, Ed. EVA has plenty of QSL's waiting for their owners. HAK had a surprise one day when he was in W.U. office; VE1BEI whom he worked several years ago was there visiting N.Y. KCV returned from Pittsburgh where he was visiting 8KVR. LED is operating from Michigan on all bands. KSI at 954 St. Nicholas Ave., N. Y. C. says he has never operated on 56 Mc. and his call is being bootlegged. HMJ completed rebuilding his transmitter. KYO made W.A.C. when he worked Y12BA. JBL has new receiver that works FB on 14 Mc. IHT just works DX. KTF is putting up a 3.5-Mc. Zepp and 56-Mc. "Q" for the winter season. IXZ built a 14-Mc. rig with a 25L6 in the final. BNW had an FB time at the National Convention. HBO is back after a summer lay-off. JEQ is back from vacation. EC reports that A.P. trunk line on nightly at ten p.m. on 3630 kc. LXQ swapped a 1000 volt power supply with KTA for a portable typewriter. Bill, the opr. at SC, is busy with A.A.R.S. and C.A.N.C.S. duties. JVK in first report advises he is using a 10 final on 7 Mc. GMS and KIF got a kick out of handling Maxim Memorial Relay messages. DOG is busy grinding a number of crystals. KVV is looking for traffic on 3.5 Mc. CHK is working his 8JK beam to perfection. After three years on 7 Mc. HGO is going on 3.5. JWE is QRL R.C.A. institute. BVE resigned as president of Tuboro R.C. APM is now president. LEA reports a new club in Ridgewood known as the Queens Radio Amateurs; the officers are: Pres. LPJ; vice pres. CWE; sec. LEA; treas. CHT. LJC schedules 81WV on 7133 kc. LFN moved from Amity Harbour, L. I. LR is getting portable gear working. We are pained to hear of the death of Ross Hull; he was the Marconi of the 56-Mc. band and his loss will be deeply felt by the gang.

Traffic: W2SC 260 (WLN 354) AZV 120 JZX 151 KYO 36 PF-KCV 17 HMJ-LR 16 LOQ 15 LFN 14 LED-CIT 11

AA-DLR 10 HYL-FJE 9 DBQ-CHK 8 KYV-FLD 7 IHT-KIF-HGO 6 EC-ADW 5 GMS-GUV 4 DVU-HSO-IRC 3 KJY-AHG-BYL-GRJ 2 LJC-CET-AGC 1.

**N**EW JERSEY—SCM, Fred C. Read, W2GMN—N.N.J. Traffic Net 1 resumed operation Sept. 6. Members are GVZ, HOZ, CMC, HCO and KTR. KTR is new member of A.A.R.S. GFW rebuilt his transmitter for the higher frequencies. KSW is studying at Stevens Tech. IOZ visited all the New England States in one week-end. HRN is member of the "ABC" Net, a 7-Mc. net which operates every Sunday morning. KTR has Class A license. LMN worked 31 countries during his first 3 weeks on the air. KHA improved his transmitter. JKG at Yale University intends to spend some of his spare time in traffic work. JYK has new "expander" unit. FB has been designing new 28-Mc. antenna. HZY with 175 watts input gets fine reports on 7 Mc. HXI is attending Northeastern Univ.

Traffic: W2CGG 184 HSI 55 HZY 30 JKG 30 KTR 29 HQL 17 (WLN 2R) 23 GVZ 12 IZV 6 KHA-LMN-CIZ-JUC 5 HRN 3

### ATLANTIC DIVISION

**E**ASTERN PENNA.—SCM, John B. Morgan, W3QP —Asst. S.C.M. in charge of Emergency Coordination: W3AKB, R.M.'s: 3AKB, 3AQN, 8ASW. Reports indicate intensive preparation for fall-winter schedules throughout this Section. The Eastern Penna. Traffic Net has swung into operation on 3595 kc. with about seven members. All stations are O.R.S., report regularly, and operate in the best standard procedure. Membership in this group will indicate outstanding ability, and may be had only after careful investigation by Route Manager Stumpf, W3AQN, who is the Net Control. Any O.R.S. interested in joining should communicate with W3AQN, Pam L Stumpf, 1330 West King Street, York, Penna., and give full information about his experience and length of service, class of license, equipment, etc. Application for membership, however, is not an assurance of acceptance. Those interested in joining the A.R.R.L. Emergency Corps for this Section should communicate direct with W3AKB, Miss Frances V. Rice, 202 E. Gorgas Lane, Mount Airy, Philadelphia.

Traffic: W3ADE 26 3AKB 10 3AOC 5 3AQN 11 3BES 147 3BRZ 4 3DGC 61 3DGM 1 3DXC 9 3ECP 7 3EDC 49 3EML 723 3GAG 10 3GDI 15 3GMK 21 3GUB 23 3GY 1 3HCT 2 3QP 267 8ASW 109 8EKG 11 8EU 9 8FLA 16 8OML 9.

**M**ARYLAND-DELAWARE-DISTRICT OF COLUMBIA—SCM, E. L. Hudson, W3BAK—3CQS, 3CXL, R.M.'s: 3BWT, Chief R.M.—8JA-3 is going to Indianapolis for several weeks. WU and ME are working plenty of DX. Traffic: W3CIZ 610 BWT 151 GKN 43 GZK 17 FPQ 12 8JA-3 13 ME 11 EZN 4 BAK 1 CXL 137 (WLM 1856).

**S**OUTHERN NEW JERSEY—SCM, W. Walter Filson, W3BEI—BZX in Cape May Court House, N. J. sent his first report; he was 3ARC back in '28. AEJ keeps a couple of schedules. The Delaware Valley Radio Ass'n held a very successful Hamfest and Outing at Sullivan's Grove, Washington Crossing Park, N. J. on Aug. 14th with over 350 present from as far as Delaware to Conn. The S.J.R.A. ran into another rainy day like last year for its 56 Mc. hunt and outing on Sept. 18 at Berlin Park. DNU turned in a nice traffic report, most of it the result of the N.J.N.G. Camp at Indiantown Gap, Pa. The Atlantic City unit of the N.C.R. is now housed in the A. C. Coast Guard building. FFE is going to U. of P. this fall. FPA, QL and GIA left on a cruise on the U. S. S. Texas on Sept. 10 for two weeks. The South Jersey 3700 kc. net is again getting into shape.

Traffic: W3DNU 106 BZX 38 AEJ 16 ZI 7 BEI 4.  
**W**ESTERN NEW YORK—SCM, H. E. Preston, W8CSE —R.M.'s: 8BJO, 8DSS, 8JTT. P.A.M.: 8CGU. Activity in all phases of ham radio is on the upgrade. The S.C.M. would appreciate receiving news and reports from any and all active amateurs in this Section. All stations with a "W8" call in New York are in the Western New York Section. Your report should be mailed so that it reaches the S.C.M. by the twentieth day of each month. The Binghamton Hamfest was well attended. Motion pictures taken on Pitcairn Island were shown by Lew Bellam, W1BES, who installed VR6AY. It was very fitting that the first showing of these pictures should be made in the home town of W8CNA, who was the first contact ever made from VR6AY. BDV went on a Naval Reserve cruise. PCW is back at the Univ. of Cincinnati. MKA "hopes" to become O.R.S. RKA is putting up a new antenna. CTX reports that the Utica

radio club started off with a feed on Sept. 22 and has plans for a big season. AU works lots of stations from 7000.0001 kc. AON sold the one kw. final and is on with fifty watts to a 6L6. FEJ takes exception to the statement in August QST that he has a 500 watt 'phone; he wants a little credit given to the other 300 watts that go to make up the 800 watts that he is using on 1.75-Mc. 'phone. DHU is getting ready to resume schedules. NA is still working for 56-Mc. contacts. (Shh! So am I). The low power DX man ACY has been W.A.C. twice since returning to Rochester. RXG is now member of R.C.C. and is preparing for O.R.S. RNF is leaving for R.P.I. DEQ has an FB7XA and keeps a few schedules! RFX is returning to Endicott from his summer home in Vestal. BJO has been working nice DX with his "Bi-Push" on 7 Mc. JTT has a 100-ke. crystal and a 10-ke. multivibrator for accurate QSY. QILX reports a fine time at the Binghamton Hamfest. ROI is all settled in new QTH at Aurora; with a whole 75 watts input to the final he needs only Asia for W.A.C. RTX is doing a nice job of traffic handling on 1.75-Mc. 'phone. QXS is doing great work with that three watt 'phone on 1.75 Mc. also. AVD gets out with only six watts on 3.9-Mc. 'phone. KEK has been on 3.5 Mc. QQM plans to use 6L6G's in oscillator and buffer stages. ABV is located in Oswego. MJV and JFW are planning on a school station at Oswego Normal. MVQ does a little operating now and then. KDY is very active on 1.75-Mc. 'phone. LYJ, SED and RDJ in Syracuse are on 1.75 Mc. also. RZX is going to St. Lawrence Univ. SHC in Syracuse is busy on 3740 kc. CSE visited RKM on Sept. tenth and a tour was made of the ham shacks in Cortland. (Bet they aren't shined up like that all the time. Hi.) QLT has separate "Hammarlund" type finals for 14 and 7 Mc. REI wanders from band to band. QXB also visited RKM and the Cortland gang on Sept. 10th. SHO is the ham call of WANC, the emergency unit of the Jamestown American Legion Post; they operate on 3520 kc. and would like to gather reports from anyone who hears them in order to determine the effectiveness of their equipment. CSE and PLA and their families spent the most enjoyable Labor Day week end of their lives as guests of VE3EF and VE3SG. On Sunday, Sept. 4th about a dozen local hams and their families gathered at VE3EF's summer home at King, Ontario, and a grand and glorious time was had by all. Western New York Hams are reminded that one of the section's finest hamfests will be held in Auburn early in November. Don't miss it.

Traffic: W8CQU 12 RTX 14 JTT 24 DHU 9 CTX 15 MVQ 8 RXG 12 RKM 7 CSE 17.

WESTERN PENNSYLVANIA—SCM, Kendall Speer, Jr., W8OFO—R.M.'s: 8KUN, 8KWA, 8MOT, 8GBC. A.A.R.S. Liaison R.M.: 8UK. N.C.R. Liaison R.M.: 8KOB. P.A.M.: 8RBL. Emergency Coordinators: McKeesport; SDNF: Pittsburgh, QAN; Erie, AQJ; St. Marys, NDE; Butler, DDC; New Castle, NQO. New appointments: O.R.S.; QEM, IZS. O.P.S.: PJJ, QEM. The Altoona Horse-shoe Radio Club reports new meeting room with larger facilities; September meeting included interesting speaker and movies of amateur radio's part in the Cleveland Air Races. Although the N.C.R. is going on a pay basis next year there are still a few openings for good amateur operators. For details contact the Section Commanding Officers, Lt. Williams, N8ZD-ZAE, and Ensign Hiner, N8FUW. PFW says that each member of the A.A.R.S. state net originated messages in the Maxim Memorial Relay. FOW maintains daily schedule on 3610 kc. from 6:30 to 8:00 p.m. for N.C.R. traffic. KUN says 9YXD-8 is ready for another rush traffic season. RQA divides his time between 3610 kc. and 14 Mc. VE3SF visited NCJ for a few days. The XYL op. at NCJ is busy with DX on 14 Mc. IOH attended the Toronto Fair. NDE went away for several weeks. OEM is building new rig with 211 or '03A final. KXP is rebuilding his exciter. QEM operates 1.75-Mc. 'phone. PER lost his wife after brief illness. Our sympathies, OM. OSI rebuilt rig into metal rack with P.P. 809's final. ROA has been doing nice work with new doublet antenna on 1.75-Mc. 'phone with 20 watts input. RTU worked 30 states and 5 countries in a short time on 7 Mc. with only 30 watts. JZZ will be active as O.R.S. on 3.5 Mc. FER completed emergency rig using 6F6-807 with 6N7-6A6 Class B modulator for 3.9 and 1.75-Mc. 'phone with emergency power equipment. OUT works 14-Mc. 'phone. IZS uses 89 e.o.o.-6L6G modulated by 76-6L6G on all bands. RYD has had 19 contacts with 1.5 watts input, one contact lasting 3½ hours. KBJ says "believe it or not"—QAN is on 14-Mc. 'phone. RBD's 89-89 rig works fine under very poor operating con-

ditions. KQX is on 1.75-Mc. 'phone. ASE is rebuilding using seven foot rack layout with '03A final, 325 watts. BOZ changed from 211 modulators to TZ40. KYW is rebuilding. NTJ is building new radio shack. APQ heard three Asians—almost went W.A.C. DGL is getting his shack in shape since his honeymoon. MIM, RTV runs 300 watts to 802-6L6-P.P. T20's-P.P. T55's modulated Class B with '03A and '45's drivers. MQT, QEA and SHL made the N.C.R. cruise on the U. S. S. *Arkansas* to Portland, Maine. QFM is rebuilding for more power. RYD operates low power 1.75-Mc. 'phone. HAJ is experimenting with portable equipment. RIT operates 1.75-Mc. 'phone during summer and 3.5-Mc. c.w. in the winter. AYH is active on 7 Mc. ATTENTION—The O.R.S. Net resumed operation October 3. Arrange to route your traffic through this channel for rapid and dependable service. FGI is now Lt. (JG) in the N.C.R. Congrats. Western Penna. boys making the N.C.R. Cruise on the U.S.S. *Texas* to Guantanamo Bay, Cuba, included LBO, NQQ, FQL, BLL, OFO, EFA, QBK, NZR and QFR.

Traffic: W8PFW 74 FUW 81 KUN 56 RQA 55 ZD 46 NCJ 34 OFO 32 IOH 13 NDE 12 OEM 9 KXP 7 QEM 5 RAU 4 CMP 3 OSI 2 ROA 4 RTU 3 MJK 1

#### NEW ENGLAND DIVISION

CONNECTICUT—SCM, Frederick Ells, Jr., WICTI—All Connecticut amateurs mourn the unjustly passing of Ross Hull. AW is on the air and leads the Section in traffic. Welcome to George Hart, 3AMR, second operator at AW. JXP reports A.A.R.S. nets in full operation. KQY is rebuilding power supplies and reports on the local gang. AGT, HSX and JHM are building new 28-14-Mc. transmitters. GC has new ACR111. JAK has nearly finished kw. P.P.—HF 200's and beam antenna. JHN moved to West Haven. KUK is DXing on 28 Mc. GRF is doing the same on 14 Mc. BYW is trying a new ACR111. FMV is back from the West Coast. N.H.A.R.A. resumed activities with election of officers October 7. EAO handled his traffic on 3.9-Mc. 'phone. ITI has new HRO and is building an addition on home to serve as sunparlor and radio room. AMQ is back on 3.5 Mc. and all set for traffic. The Manchester Radio Club held its first meeting Sept. 13. DJG has portable-mobile 56 Mc. crystal rig. DUD is on 7 Mc. with 6L6G. DJC, CSC, BUE and JAM enjoyed the Chicago Convention. DVO has a Meissner "Traffic Master." LMK uses ACR136 and 6L6G crystal with 30 watts input. September 21, 1938 is a date that will always remain in the memory of the Conn. amateur . . . —hurricane and flood, power lines down, telephone and telegraph communications generally wrecked! If you have not already done so, please advise A.R.L.L.L. Headquarters at once of your radio activities pertaining to emergency work.

Traffic: W1AW 232 JXP 103 KQY 98 KFN 97 EAO 71 ITI 40 B1H 36 AMQ 23 TD 21 KKS 20 JLL 18 UE 17.

MAINE—SCM, Winfield A. Ramsdell, W1FBJ—The Pine Tree Net starts the traffic season with following members: GOJ Net Control, IS1, INW, KCO, JLF, CEM, HSD, IBB and FBJ. This net will operate on 3597 kc. (spot frequency), five nights weekly at 7:30 p.m. JJP is now teaching school in Massachusetts. KKT is working into Mass. FB with 1.6 watts on 1.75-Mc. 'phone. LMQ is new ham in Farmington. LHI moved to Dover-Foxcroft. LHD added pair of 6L6's to the rig and now has 90 watts input, also new sky Buddy. GOJ has regular schedules with NY1AB, Canal Zone. E1Y is rebuilding for 1.75-Mc. 'phone. CPT is new O.R.S. HZI is building new rig for 1.75 Mc. with 211 final, class AB modulation. EJS is going on 28 Mc. to finish working the DX he couldn't get on 56 Mc. DVP obtained First Class Commercial ticket. CFO reports the Army Net swinging into action with FAP, GVS, KOU, GE and HMS already on the active list. IEB is still plenty interested in Radio Rifle Matches and reports that a recent issue of "Rifleman" devoted a whole page to this branch of our operating. They also ran pictures of ham stations that have run matches. It certainly is very fascinating work and it is hoped that more stations will become interested. If you have a Rifle Club in your vicinity, why not offer your station for a trial? How many of us felt the need for an emergency power supply during the recent hurricane which hit most of New England? How did you feel when the power service went off, while you were standing by to be of some assistance to the people in the stricken area? We have always felt safe from anything like this but it should look different now. Let's get going on the emergency line of thought and be

(Continued on page 104)

quality above all

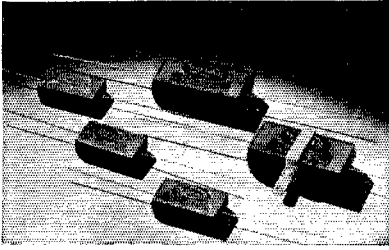

**TYPE XB**  
**Mica Transmitting Capacitor**  
**WITH LEADS . . .**



NOW, for the first time, high voltage mica condensers with convenient wire leads! Low-loss Bakelite; excellent r.f. characteristics; individually packaged.

Order through your jobber

**SOLAR MFG. CORP.**  
**599-601 Broadway New York, N. Y.**

## WINNERS

of

### TRIMM FEATHERWEIGHT HEADSETS

at A.R.R.L. Convention in Chicago

Mr. E. H. GIBBS — W8AQ

Mr. R. EWERT — W9RDN

Mr. E. LINDQUIST — W9ORL

The Featherweight, used by many amateurs is light in weight for comfort . . . rugged in construction for years of service . . . and extremely sensitive for clearer reception. Write Dept. R-411 for folder

**TRIMM RADIO MFG. CO.**

1770 West Berneau Ave. Chicago, Illinois

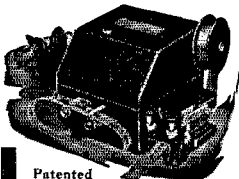

Patented  
Save your fist. Let the Automatic Sender raise your stations for you. Repeats calls or messages indefinitely. Length of messages practically unlimited. Sends from 2 to 70 words a minute. Motor driven. Entirely automatic. Built-in tape perforator. Absolute uniformity in spacing of characters. Used with buzzer or oscillator, makes excellent code teacher for novice and speed-builder for the advanced amateur. Complete with 6 rolls of tape and full instructions. No extra equipment needed. If your dealer can't supply you, write us.  
**FULLY GUARANTEED**

At Last!  
A Perfected  
**AUTOMATIC**  
**SENDER**

**\$12.50**

\$13.50  
West of  
Denver

Postpaid  
in U. S. A.

**Gardiner-Levering Co.** Haddon Heights, New Jersey, U. S. A.

## Standard Frequency Transmissions

Date	Schedule	Station	Date	Schedule	Station
Nov. 4	A	W9XAN	Dec. 2	A	W9XAN
	A	W6XX		A	W6XX
Nov. 11	BB	W6XX	Dec. 9	BB	W6XX
	A	W9XAN		A	W9XAN
Nov. 12	BX	W6XX	Dec. 10	BX	W6XX
Nov. 13	C	W6XX	Dec. 11	C	W6XX
Nov. 18	A	W6XX	Dec. 16	A	W6XX
Nov. 25	A	W9XAN	Dec. 23	A	W9XAN
	B	W6XX		B	W6XX
			Dec. 30	A	W9XAN
				A	W6XX

### STANDARD FREQUENCY SCHEDULES

Time (p.m.)	Sched. and Freq. (kc.)		Time (p.m.)	Sched. and Freq. (kc.)	
	A	B		BB	C
8:00	3500	7100	4:00	7000	14,000
8:08	3600	7100	4:08	7100	14,100
8:16	3700	7200	4:16	7200	14,200
8:24	3800	7300	4:24	7300	14,300
8:32	3900		4:32		14,400
8:40	4000				

Time (a.m.) Sched. and Freq. (kc.)

Time (a.m.)	Sched. and Freq. (kc.)
6:00	7000
6:08	7100
6:16	7200
6:24	7300

The time specified in the schedules is local standard time at the transmitting station. W9XAN uses Central Standard Time, and W6XX, Pacific Standard Time.

### TRANSMITTING PROCEDURE

The time allotted to each transmission is 3 minutes divided as follows:

2 minutes—QST QST QST de (station call letters).

3 minutes—Characteristic letter of station followed by call letters and statement of frequency. The characteristic letter of W9XAN is "O"; and that of W6XX is "M."

1 minute—Statement of frequency in kilocycles and announcement of next frequency.

2 minutes—Time allowed to change to next frequency.

W9XAN: Elgin Observatory, Elgin National Watch Company, Elgin, Ill., Frank D. Urie in charge.

W6XX: Don Lee Broadcasting System, Los Angeles, Calif., Frank M. Kennedy in charge.

## WWV Schedules -

EACH Tuesday, Wednesday and Friday (except legal holidays), the National Bureau of Standards station, WWV, transmits with a power of 20 kw. on three carrier frequencies as follows: 10:00 to 11:30 A.M., E.S.T., on 5000 kc.; noon to 1:30 P.M., E.S.T., on 10,000 kc.; 2:00 to 3:30 P.M., E.S.T., on 20,000 kc. The Tuesday and Friday transmissions are unmodulated c.w. except for 1-second standard-time intervals consisting of short pulses with 1000-cycle modulation. On the Wednesday transmissions, the carrier is modulated 30% with a standard audio frequency of 1000 c.p.s. The standard musical pitch A = M440 c.p.s. is also transmitted from 4:00 P.M. to 2:00 A.M., E.S.T., daily except Saturdays and Sundays, on a carrier frequency of 5000 kc., power 1 kw., 100% modulation. The accuracy of the frequencies of the WWV transmissions is better than 1 part in 5,000,000.



# AGAIN . . .

## NEWARK is OUT IN FRONT WITH THE LATEST IN AMATEUR RADIO RECEIVERS

# The RME-70

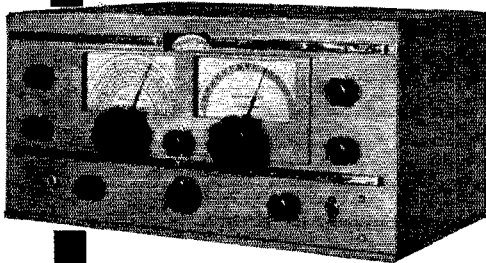

**Buy Now on Easy Terms!**

### Check These Features

- ★ New illuminated DB-R meter
- ★ Three new iron-core IF transformers
- ★ Improved automatic Noise Suppressor
- ★ Variable phasing crystal control circuit
- ★ Break-in relay control
- ★ Frequency range from 550 to 32,000 KC
- ★ Extreme selectivity
- ★ Streamlined cabinet design
- ★ Controls designated with lettering
- ★ Total complement of ten tubes
- ★ One stage of amplification
- ★ Sturdy construction, detailed engineering and exceptional quality throughout.

**NET CASH PRICE . . . WITH TUBES AND NEW SPEAKER . . . \$138.60**  
**ONLY \$28.60 DOWN and \$9.91 Per Month . . . 12 Months to Pay or \$19.42 Per Month**  
**for 6 Months; or \$13.07 Per Month for 9 Months**

#### THE DB-20-70

The two stage R.F. amplifier and pre-selector may be ordered to match the outward appearance of the RME-70. Frequency Range from 550 to 32,000 KC. Net price, with tubes and change-over switch, black or gray finish . . . . . **\$42.60**

#### THE COMBINATION

The RME-70 and DB-20-70 are also built into one cabinet, either black or gray finish. This combination makes one of the finest and most up-to-date units for any amateur radio station. Net price, complete with the newly designed speaker and tubes **\$181.80**

Time Payments Available on any Combination. Write for Details

#### THE 510X-70

This frequency expander is available in the front trim to match the RME-70 receiver at no additional cost. Frequency coverage 28 to 70 megacycles. Very effective in image suppression. Net price, with tubes and change-over switch, black or gray finish **\$45.10**

### Oil Filled, Oil Impregnated FILTER CONDENSERS

Only **\$1.00**

1500 V. DC. 1 1/2 mfd.



2" Diameter Round Can. 2 3/4" high. Weight 1/2 lb. Well Known Makes. Bought at a lucky price! Quantities limited. First come, first served. Guaranteed at rated voltages.

2 mfd., 2000 V. DC 4 3/4 x 5 3/4 x 1 3/4, 1 1/4 lbs. . . . .	\$1.50
3 mfd., 1000 V. DC 5 x 3 3/4 x 1 3/4, 1 1/4 lbs. . . . .	1.10
3 mfd., 1250 V. DC 3 3/4 x 3 3/4 x 1 1/4, 1 1/4 lbs. . . . .	1.25
3 mfd., 1500 V. DC 5 x 3 3/4 x 1 3/4, 1 1/4 lbs. . . . .	1.50
4.4 mfd., 1500 V. DC 5 x 3 3/4 x 1 3/4, 1 1/4 lbs. . . . .	1.75
8 mfd., 2000 V. DC 5 x 3 3/4 x 3 3/4, 2 3/4 lbs. . . . .	2.75
14 mfd., 750 V. DC 4 3/4 x 4 3/4 x 1 3/4, 2 lbs. . . . .	2.00

#### NEW "FOREIGN ORDER" DEPARTMENT

Special Attention given to FOREIGN ORDERS in this new Export Department. Hams outside the U. S. be sure to WRITE TODAY for Big New Catalog and full details of Newark's New Foreign Order Dept.

### Plate and Filament Transformers

600 VOLTS—200 MILS

Another Scoop by Newark. Famous plate and filament transformer made for us only. Thousands used in Ham rigs. 600-0-600 at 200 M.A.; 2.5 v. at 10 amps; 5 v. at 3 amps; 7.5 v. at 3 amps. Weight 10 lbs. Use this transformer for your buffer and final amp. stages. Just the thing for 46's, T-20's, 807's, etc. N. 1000 . . . . . **\$2.95**

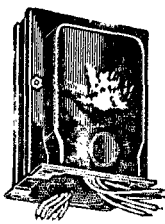

### YOUR CALL LETTERS IN GOLD

Hams look at this! Your Call letters in impressive three dimensional style. Big shadowed decalomania letters nearly TWO INCHES high. Put them on your HAM SHACK door, auto window, etc. Send dime for yours today. Be sure to give your call letters.

### FREE! Get This Big New 1939 Ham Bargain Catalog

Illustrations, prices and full details on thousands of separate items, sets, tubes, parts and supplies! MAKE UP A \$60 ORDER and Buy All the supplies you need at present low prices. AND PAY ON EASY TERMS.

Write for This Big 76-page Catalog Today

# NEWARK

## Electric Company

323 W. MADISON ST.  
Dept. Q CHICAGO, ILL.

(Continued from page 101)

prepared. The boys in the thick of the fray certainly did a wonderful job. Congratulations to those who were able to get on the air and help do this job and we sympathize with those who were unable to salvage enough of their equipment to do so. W7GCO, Wallace H. Leland, 3017 O'Neil Ave., Cheyenne, Wyo., would be glad to schedule any Maine amateur who is looking for a Wyoming QSO for W.A.S.

Traffic: W1FBJ 31 IIE 11 LHD 4 LDC 3 CPT 10.

**EASTERN MASSACHUSETTS**—SCM, Sam Gross, W1IWC—KH attended National and New Hampshire Conventions. KMJ is running 100 watts on 56 Mc. to pair of HY25's. JNF is using RK-20 crystal osc. JYJ added pair of 809's to rig. KZT is new net control station for E. Mass. Net. KPW got news of conditions on Cape through to papers when storm isolated Cape Cod. AGX is putting HY25's in final. Hope you're able to be up and around soon. HWE. HRE is active in A.A.R.S. and E.M.N. LLX finds time to work VQ3EJP on 14 Mc. IWC is back to handling traffic again. BDU applied for O.R.S. GAG is planning new rig with RK-38's in final. JKT is trying to get rig perking on 28 Mc. WY worked ZD2H for 108th country and made his 984th "G" QSO. KKO is attending Northeastern Univ. JXU is running pair of T20's at 90 watts input. IHI is spending his time on 28-Mc. 'phone. LOC (ex-3GRX) applied for O.R.S. LBY, IWC and IHI went to Woburn Sept. 11 and handled the Massachusetts end of a rifle match with Cleveland, Ohio. The Westlake Amateur Radio Ass'n with Sec'y 8LVH and 8AVH did the job at the Cleveland range. The Massachusetts shooters were licked again although their high man made a new record for this type of target. A return match is tentatively set for Oct. 2. This report is being made up with the aid of a flashlight and the old kerosene lantern and not so easy for me with my hunt and peck system! Maybe we won't have another storm like this one but we might—why not enroll in the A.R.R.L. Emergency Corps and be ready when another one hits. The S.C.M. had several real old fashioned rag chews when LOC and LLX dropped in to see him last month. RE also stopped in to say hello and pay his respects to the chickens. The Eastern Massachusetts Net opened for business September 19. KZT is the N.C.S. and the net now meets at 7:30 p.m. every evening except Sunday. Active stations so far are KZT, BMW, BEF, IHI, IWC, LBY, HRE, LLX, LOC, JYJ and EPE. The South Shore Amateur Radio Club held its first meeting of the year Sept. 23.

Traffic: W1KH 183 EPE 177 AKS 118 KMJ 103 KCT 98 EMG 97 JNF 75 JYJ 71 KZT 63 KPW 36 AGX 32 HWE 26 HRE 20 LLX 13 IWC-JSM 12 LBY 8 BDU-GAG 5 JKT 3 BMW 2 WY 4. (July-Sept.): W1JSM 35).

**WESTERN MASSACHUSETTS**—SCM, William J. Barrett, W1JAH—AJ reports plenty cards from European DX. IOR is looking for new men for A.A.R.S. BIV's 6L6G tri-tet portable worked swell on Delco system while Pres was vacationing in Barnet, Vt. How about a few more stations getting equipped for emergency-powered operation? Let's get started, gang, on something for 3.5- or 1.75-Mc. c.w. or 'phone. JAH is rebuilding but as of yore the ole input will stay about ten watts. VOID visited JXE recently en route to A.R.R.L. Hdqs. COI is still working on his speech amplifier. KXR, our newest O.R.S., was visited by BJP of Newport, Vt. LHJ had swell time handling Maxim Memorial Relay traffic. KJK/9 again reports from Wisconsin. Romander's extended double Zepp is perking fine for BNO on 14 Mc.; he also has new SX-16. And that, brethren, winds up the smallest mailbag ye S.C.M. ever got—How's about some action? The Section extends its sincerest sympathy to those bereaved by the passing of Ross A. Hull.

Traffic: W1AJ 15 IOR 14 (WLGJ 12) BIV 9 JAH 8.

**NEW HAMPSHIRE**—SCM, Carl B. Evans, W1BFT-DMD—As this is being written, we are just recovering from the worst emergency in which amateur radio has ever been called upon to render assistance in this Section. The N. H. Amateurs were "Johnny-on-the-spot" giving excellent service to the public utilities and state departments. The two state nets on 3735 and 3840 functioned exceedingly well despite the loss of power in practically all sections of the state. It was our first opportunity to use our recently organized emergency net in a case of actual necessity. Results were favorable, but left plenty of room for improvement. Various "bugs" will be ironed out of our system in the following months in an attempt to give even better service the next time that we are called upon. Please accept my personal thanks to every one who helped in the crisis. We certainly

will appreciate further cooperation in an attempt to smooth out rough angles in our emergency networks in the future. The Fifth Annual N. H. Hamfest and A.R.R.L. N. H. Section Convention was held at the Hotel Carpenter in Manchester, on September 17. From all reports a good time was had by all. 250 hams from all of the New England states were present. JNO is experimenting with an automatic limiting amplifier. KIN is now using an RME-69. APK and IJB have been handling traffic from VE1IN, Kents Island Expedition on 3.9-Mc. 'phone. KBR is rebuilding with an 809 final. IMB is active on 28 Mc. 'phone. EDN is rebuilding his oscillator using a 53. LKK is a new ham in Manchester. HJI is on 3.9-Mc. 'phone with a T-40 final and class B modulator. DMD, the new station of your S.C.M. in Concord, was kept on the air continuously for 109 hours by a staff of operators belonging to the N.V.A.R.A. and the N.C.R. during the recent emergency; 161 messages were handled for various state departments and public service companies plus many messages of a personal nature. The New Hampshire Net (NHN) is now functioning regularly on 3840 daily except Sundays at 6:30 p.m. All N. H. amateurs are welcome to either join the net, or break in occasionally. 3900 to 3700 kc. is covered regularly by QRZ's so that it is not necessary for all to be on the spot frequency.

Traffic: W1KIN 132 APK 14 BFT 1.

**RHODE ISLAND**—SCM, Clayton C. Gordon, W1HRC—All R. I. Amateurs join in the feeling of great loss which the League and radio as a whole have sustained in losing Ross Hull, our Editor of QST. Very few of us are so gifted with talent that we may be leaders in science and point the way for others to follow. The loss is bound to be felt more and more as time goes on and the many contributions which he made to our hobby are realized. May his sacrifice serve as a real warning to the rest of us, no matter how familiar we become with our apparatus, that high voltage is no respecter of persons, and that carelessness may bring about a loss which can never be replaced. LAB moved to new QTH: 12 Baldwin St., Pawtucket. KWA has 35-T final on 14 Mc. and has worked all but 7 states for W.A.S. KLR has 3752-ke. crystal for A.A.R.S., 802 tri-tet linked to pair of '10's with 60 watts and new Sky Challenger. FB, OM, and certainly glad to see A.A.R.S. spreading out over the state instead of keeping bunched up here in Providence and Pawtucket. KTU of Fort Adams and LAL of Providence are signed up with A.A.R.S. and GTN is gunning for more members. INU and INT have moved to California Ave., Prov. JUE is still the e.c.o. expert. HRC has e.c.o. job now, along with the usual set of crystals. The P.R.A. is holding a membership drive and the present membership will now, under new rules recently adopted, be given membership in A.R.R.L. after they have kept their membership dues in the P.R.A. in force for a three months' period. This will make P.R.A. 100 per cent A.R.R.L. inside of a year.

Traffic: W1GTN 29 LAB 26 INU 15 HRC-CPV 13 KCW 10 INT 9 JDX 7 KWA 2.

**VERMONT**—SCM, Alvin H. Battison, W1GNF—GAZ is operating at WSVB. KVB hopes to contact the Vermont fellows during Christmas vacation. EZ is turning to traffic. JRU-IQG have a photo-radio laboratory. KXL is attending Mass. Radio Club. DPO is still in Burlington. KWC moved to North Springfield. KIE, KWB, KVB, LFM and 2BAQ kept St. Albans on the map. GNF and brother have an ignition eliminator, one hundred per cent proof—a Stanley Steam Car—Vintage of 1913. KJG visited KIE, 2BAQ and KBW. 2AZK is attending Casleton Normal School. The following attended the Manchester Hamfest: AAJ, AVP, ELR, FSV and JLF. AVP won an RME-69 there. FSV is anxious to hear from all who are interested in a 1.9-Mc. 'phone A.A.R.S. net. Don't forget. . . . We were all going to be active this year!

Traffic: W1EZ 50 KVB 21 GNF 10 FSV 7 AHN 1.

#### ROANOKE DIVISION

**NORTH CAROLINA**—SCM, H. S. Carter, W4OG—The entire North Carolina gang enjoyed having our Communications Manager Mr. Handy as a visitor to the various clubs throughout the State. CYB is a member of the A. A. R. S. 'Phone Net meeting every Monday night; he now has a pair of T-125's final. ETE is attending school at Wake Forest. FT and BRK are on 28-Mc. 'phone. BJU is working 14-Mc. 'phone. EDY handled some traffic as portable, as well as working some good DX on 7 Mc. The Charlotte Club will entertain the Carolina Floating Club the first Sunday in November. Be there. DLX is making some

good schedules for the winter. AEN's "Q" blew down while he was out of town, but BX saved the "Q" bars for him. BIP is putting the final touches on his rig for Fall and Winter work; he attended the Chicago Convention, along with BVD and BHR. FJS returned from C.C.C. camp where he has been working WUNB this summer; he is going on 1.75-Mc. 'phone soon. ECW and FIX went 'afloat' with N.C.R. on the Arkansas. TO is building a 3.9-Mc. rig with pair of 849's final. HX is putting his rig back in cabinets. DPF vacationed in Ohio with portable rig. GW is running a kw. on 14-Mc. 'phone. BC is back on 14-Mc. 'phone. EJ and EFX left for Wake Forest to attend school. The Raleigh Club is gathering parts to build an emergency portable transmitter. EBA handles N.C.R. drills every Thursday night. The N.C.R. will be on soon from the Post Office building with call FNG. FIB, a new ham, has Thorarson 100-watt transmitter and is working 7 and 28 Mc. JB sticks to 14-Mc. 'phone. DW and ESO took part in the Maxim Memorial Relay. ESO is attending school in Raleigh. AE is on 3.5. Mc. FLG and FFX are keeping the 7-Mc. band hot in Raleigh. BNL, CGL and BRT attended the Convention in Chicago. BRT is keeping a daily schedule with CDD in New Holland. OQSAE is on furlough in Rockingham until 1939. AHF is keeping the air hot working DX; he has boosted his total to 63 countries since March. FB, DWB left for Chapel Hill where he will attend school. DGV says his new RAE is the berries. 4NC with a new pair of 806's has been DXing on 14 Mc. OG attended the National Convention. CYY is wondering about F1881, worked while his feeders were shorth!

Traffic: W4CDD 65 DLX 21 BRT 21 EDY 19 ETE 11 EBA 10 CYB 8 ESO 4 ANU 3 DWB-DW 2.

SOUTH CAROLINA—SCM, Ted Ferguson, W4BQE—CZN, has his A.A.R.S. Net going Mon., Wed. and Fri. nights. Moultrieville has a new ham, FNT. Welcome, OM. OW is now located in Asheville, N. C. CUS and DGD are working 1.75-Mc. 'phone. BWA is on active duty at Charleston Navy Yard. FDN and BDT are active on 3.5-Mc. EUX is going to Ga. Tech. DXF is back on with new remote controlled rig. CZA will soon have another rig on the air. DRF is working 7 Mc. and has applied for O.R.S. BAY is on the air again. EXJ has new antenna, four half waves in phase. CQU is active in A.A.R.S. FFO returned to Clemson and will be on 3946 kc. EPJ acquired some new equipment and will be on 3.9-Mc. 'phone. CQG glassed in the back porch for a new shack. CPX is building new exciter. MN entertained the Palmetto Club at his country place known as "Egypt." DTU sticks to 28 Mc. DQY is working on his portable rig. DNR has been appointed Emergency Co-ordinator. ECG is revamping his rig. ETF has a new beam for working west. EJK completed a new steel vertical for working 1.75-Mc. 'phone. CE is active in C.C.C. Nets as well as Naval Reserve. The North Carolina Floating Club will meet in Charlotte, N. C. Sunday, November 6th. Will see you there. 7GCO, W. H. Leland, 3017 O'Neil Ave., Cheyenne, Wyoming, would be glad to schedule any S.C. ham who needs Wyo. for W.A.S.

Traffic: W4CZN 80 CQU 16 CZA 12 DGD-CPX 4.

VIRGINIA—SCM, Charles M. Waff, Jr., W3UVA—P.A.M.'s: AIJ, GWQ—R.M.'s: DJC, GTS—Thanks, fellows, for a good response this month. Are you in on all the fall activities? FQO is W.A.C. with 40 countries verified. AHC is on 1908 kc. DZW has new NC-101X receiver. FHO wants O.P.S. EXW worked VS7MB. HAE wants O.R.S. after rebuilding finishes. 4BAB moved back into Tenn. BSW went to Chicago for National Convention. EQQ likes 7 Mc. CGR looks forward to hamming, after nice fishing this summer. GKL is moving shack back to Richmond from summer location; new shack is being built in back yard. WS, UVA, EQQ and BZE drove to A.R.R.L. National Convention at Chicago stopping by WLW on way back. HAO is ex-4AYX of Clearwater, Fla., with new QTH in Richmond. HRC is new ham in Norfolk. GWQ is new O.P.S. and P.A.M. for 1.75 Mc. All interested in a Net for 1.75 Mc. write GWQ who will act as Net Control. BZE is rebuilding. AHK will consolidate with GKL; new vertical antenna in prospect. HKG is preparing for action. NT, along with EMM, BEK, GCH, II, FGJ and FQP were on at request of Red Cross at Norfolk preparing for hurricane with a 1.8-Mc. 'phone net covering that area. GCO is planning 125-ft tower with rotating beam for 7, 3.5 and 28 Mc. 5FUM and YF spent vacation at Virginia Beach. BRA is back ashore after a spell of operating on S.S. *Malchace*, KULC. BRY is putting up vertical antenna. SE is located at Chicoteague Island on

the Eastern Shore. GBC moved to Hancock, Md. AOT is on 1900-ke. 'phone. EVT was first W3 to make DX Century Club; congrats; some of his latest DX: K6NVJ, PZ1AB, VP9X, LZ1ID, VQ8AS, OY4C. ENO has new QTH. FQQ is now 4FFO at Clemson College, S. C. FHF will be on 'phone and c.w. with new rig. GFX is trying for W.A.S. with a single '45 with 4 watts input. Looks like FKQ is leaving for San Francisco soon. CA is back on 3580 Kc. AIJ is building new speech amplifier. GTS wants Virginia schedules. HQ has new NC-81X receiver. FFC is building new six-band rig with 35T final. GJP has been working some DX. AAI is experimenting with 28-Mc. portable-mobile unit. DJC had his mast blown down. GSG passed Class A exam. EBK is at V.P.I. FMY is preparing for the SS Contest. HEZ is on 14 Mc. GBA is practising on a bug. GTS would like to hear from hams interested in A.A.R.S. FBL gives code class on 1929 kc. Mon., Wed. and Fri. from 5 to 6 p.m. ZU was Richmond contact station for Va. National Guard when they were at Virginia Beach. UVA is back at old QTH; P.O. Box No. 1212, University, Charlottesville. Actual location is 7 miles south of Charlottesville. Richmond Amateur Radio Club had a banquet Sept. 23rd with twenty-three present. New officers were installed and the National Convention was described. Watch this live-wire club. Send club news to the S.C.M. as well as your own activity regularly on the 16th; all persons reporting will receive "QRX" monthly.

Traffic: W3FBL 5 FMY 6 GTS 5 (WLMG 49) AIJ 3 GFX 2 GKL 3 GWQ 2 GSG 1.

WEST VIRGINIA—SCM, C. S. Hoffman, Jr., W8HD/W8NS—Several of the clubs want a Club Radio Net sponsored. A frequency of 1810, 3620, 7240 kc. has been suggested, giving fellows in all three bands a chance to QSO W. Va. Those interested, drop the S.C.M. a line. It is hoped those State DXers on 7 Mc. will be interested too. Wheeling Radio Club selected delegates to represent them at the Pittsburgh Radio Council as follows: Delegates: 8AZD, 8BWK, 8HD; Alternates: 8CDV, 8KSS, ex-8E00, 4DW, our Director, asks all W. Va. radio clubs to consider if they can handle a Division Convention during 1939. This should be considered seriously, if your club is interested. The S.C.M. would be glad to act as a clearing house for your ideas, and exchange them between clubs. It will be FB to have a Convention in W. Va. in 1939! RDH is new O.R.S. and R.C.C. Congratulations, OM. PHY says the 7040 Kc. Round-Table schedule in W. Va. will begin soon. SDK is new Crystal, W. Va., ham. MLW is on 1.75 Mc. with new 'phone rig. JKN put up an 8JK two Section 14-Mc. beam, getting lots of DX on single 6L6 osc. LCN is DXing on 28 Mc. FQQ has worked 72 countries; five times W.A.C. and once W.B.E. QFN completed tests on his new 'phone job. JM is active again and wants O.P.S. Lots of 'phone activity at MOL and AHF. KIU/DSJ has new YL opr. born July 16th! 2CTT, 8RFP and PQQ are attending W.V.U. JJA has worked 33 countries and is now W.A.C. JKN, writing for Buckhannon hams, wants to sponsor a movement for hams to write their State Senators, asking that suitable legislation be passed to retard ignition QRK to high frequency radio. If you are interested, write your State Senator and send JKN a copy of the letter. BTV hopes to be on A.R.R.L. Trunk Line this fall.

Traffic: W8RDH 9 KSJ 3 MOL 4.

#### SOUTHEASTERN DIVISION

ALABAMA—SCM, James F. Thompson, W4DGS—R.M.'s: 4DS, 4APU; P.A.M.'s: 4DHG, 4BMM; E.C.'s: 40A, 4ECI; O.O.: 4EBZ. The B'ham Club reports via APU: ERW has new 35T on 3.5 and 7 Mc. DUK is still messin' with 56 Mc. We believe that DUK has the two crystal freqs. with the greatest separation: 1803 and 57,508 kc. EDR will be APU's alternate on Trunk Line "J". EYY is still on 14,314 kc. FIG breaks into the traffic column. EBZ has new rig for all bands built up with metal chassis and 6L6-TZ20-P.P. 801's; he remote controls it so he can use the family Breting receiver. BLL has new Jr. Opr. Congrats, Tom. FAT works 7 Mc. only. EHH added T55 buffer and now has excitation to spare; he still holds down 28-Mc. EDR renewed O.P.S. and O.R.S. ECP is working the Academy Club station at West Point. DQW had a letter from ex/BOU who is a W8 lid as 8SBQ. BCU changed to P.P. 50T's. BHY is 14 Mc. AIY is heard once in a while. CRG left for the U. of Ala. all ready for DX and calculus. BAQ has new rig. DQW has new e.c.o. for future contests.

**HIGH POWER . . .  
HIGH EFFICIENCY  
. . . at LOW COST!**

The Type HDVL SWINGING LINK ASSEMBLY is a heavy duty unit conservatively rated at 1 KW. It is absolutely accurate and dependable.

HDVL Coils are equipped with heavy Alkings 136 plus bars and jumbo type banana plugs. To assure perfectly uniform air-spacing, they are wound by precision machines operated by highly skilled craftsmen. B & W's "Lock-Strip" construction provides ample mechanical rigidity. This air-spaced winding — found in all B & W AIR INDUCTORS — eliminates the mass losses experienced in even the best ceramic forms.

The HDVL Independent Link and base assembly permits front-of-panel coupling control. The variable link may be coupled direct to untuned lines with impedances of 600 ohms or less.

In short, the HDVL ASSEMBLY is the most practical, accurate and efficient Swinging Link unit ever developed for high power jobs. And at the prices listed here — it no longer pays to make your own!

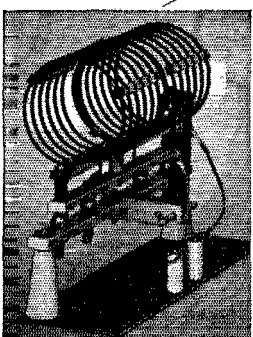

**TYPE HDVL**

160HDVL .....	\$5.25
80HDVL .....	4.50
40HDVL .....	4.00
20HDVL .....	3.75
10HDVL .....	3.25
HDV Base Assembly .....	5.00
HDA Antenna Matching Coil 4.00	

See them at your jobber's — or write for details

**BARKER & WILLIAMSON**  
Radio Manufacturing Engineers • ARDMORE, PENNSYLVANIA

# RADIO

**ENGINEERING,** broadcasting, aviation and police radio, servicing, marine radio telegraphy and telephony, Morse telegraphy and railway accounting taught thoroughly. Engineering course of nine months' duration, equivalent to three years of college radio work. School established 1874. All expenses low. Catalog free. DODGE'S INSTITUTE, Day Street, Valparaiso, Indiana

**READ CODE LIKE AN!  
SEND EXPERT.**  
Learn Quickly at Home, Get Real Speed

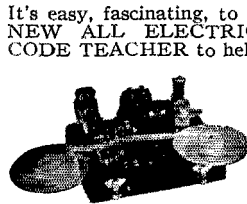

It's easy, fascinating, to become a good up with the NEW ALL ELECTRIC MASTER TELEPLEX CODE TEACHER to help you. Only instrument ever produced which records your sending in visible dots and dashes — then sends back to you at any speed you desire. Also sends practice work, recorded by an expert. That is why so many schools teaching code prefer Master Teleplex.

That is why thousands agree this method is surest, quickest. We furnish Complete Course, lend you Master Teleplex, give you personal instruction with a MONEY-BACK GUARANTEE. Low cost. Send today for booklet Q-11; no obligation.

**THE "HAM" SPECIAL**  
Standard Teleplex — a highly efficient code teacher using heavy specially prepared waxed paper tape, having two rows of perforations. Write for Free folder QT-11.

We are the originators of this type instrument

**TELEPLEX CO.** 67-69 PARK PLACE  
NEW YORK, N. Y.  
TELEPLEX — "The choice of those who know"

## DX Scores

(Continued from page 98)

SM5ZF	8169- 21-2-AB-31	VK2VA'	3280- 10-1- --19
SM7YE	5015- 17-4- A-38	VK3JA	2034- 18-2- A- 8
SM6UJ	2410- 16-3- B-22	VK3BV'	1790- 10-2- A- 8
SM5WJ	2115- 15-2- A-14	VK2AFJ	1560- 13-2- A- --
SM5OI	1540- 11-1- A-13	VK3CX	1503- 9-1- A-13
SM7MF	630- 9-1- A-11	VK5GR	1485- 15-2- A-11
SM5ON	399- 7-1- A-17	VK3HG	1235- 13-2- A- 6
SM5XW	399- 7-1- A- 6	VK3BG	864- 9-2- A-10
SM5RH	144- 6-1- A- 5	VK3VQ	616- 8-1- A- 7
SM5OJ	64- 4-1- A- 4	VK5QR*	396- 6-1- A-15
SM5SI	24- 2-1- B- 1	VK4CG	344- 8-2- A- 6
SM2VP	5- 1-1- -- --	VK2PV*	336- 7-1- -- --
		VK3RX	296- 8-1- A- 5
		VK5RX	288- 6-1- -- --
		VK5HM	80- 8-1- -- --
		VK3MV	36- 3-1- -- 3
		VK2AS	26- 3-1- -- --
		VK4RC	18- 3-2- A- --

<i>Switzerland—HB</i>			
HB9BN	5040- 18-3- A-36		
HB9J*	90- 5-1- -- --		
<i>Wales—GW</i>			
GW2GV	3262- 14-2- A-21		
<i>North America</i>			
<i>Alaska—K7</i>			
K7PQ	134872- 46-5-AB-79		
K7FNE	46527- 39-4- A-60		
K7CHP	41610- 30-3- A-61		
K7GOM	30800- 30-3- A-36		
K7EVM	4288- 16-3- A-12		
K7FBN*	2832- 14-3- A- --		
K7FSX	324- 9-3- A- 7		
K7QI	24- 2-1- -- --		
<i>Canada Zone—K6</i>			
K6AN	94392- 38-3- A-82		
K6AY	41412- 34-4- B-20		
K6AU	1305- 9-2- A-11*		
<i>Costa Rica—TI</i>			
TI2FG	27027- 33-3- B-23		
<i>Cuba—CM</i>			
CM2AD	79480- 40-4- A-83		
CM2OP	18760- 28-3- B-15		
CM2AO	4608- 12-1- B-31		
<i>Haiti—HH</i>			
HE1P	16097- 13-1- A-40		
<i>Honduras—HR</i>			
HR4AF	2964- 19-2-AB-10*		
<i>Martinique—FM8</i>			
FM8AD	73390- 41-4- A-65		
<i>Mexico—XE</i>			
XE1A	336322- 57-5- --76		
XE1AM	41679- 33-3- B-52		
XE1AX	23270- 26-3- B-31		
<i>Newfoundland &amp; Labrador—VO</i>			
VO1N	9170- 14-2- A-20		
VO4Y	3145- 15-3- A-23		
VO3Z	245- 7-1- A- --		
<i>Nicaragua—YN</i>			
YN1AA	5247- 11-1- B-13		
<i>Puerto Rico—K4</i>			
K4KD	131895- 45-4- A-88		
K4DTH	109466- 49-4- B-87		
<i>Virgin Islands—K4</i>			
K4AAN	672- 7-2- -- 5		
<i>Windward Islands—VP#</i>			
VP2LA	19360- 22-2- A-54		
VP2LB	10890- 18-2- A-34		

<i>Hawaii—K6</i>			
K6CGK	145909- 53-5- A-87		
K6HZI	47600- 23-3- B-50		
K6PAH	13133- 23-2- A-53		
<i>Holland Island—K6</i>			
K6BAZ	18- 2-1- -- --		
<i>New Zealand—ZL</i>			
ZL1MR	46655- 35-3- A-64		
ZL1CK	28352- 32-3- A-40		
ZL1AC	27900- 25-3- A-44		
ZL1BR	25425- 25-2- A-60		
ZL1GX	20160- 32-3- A- --		
ZL4AP	8700- 20-2- A-28		
ZL1BT	4620- 22-3- A-26		
ZL4AC	4532- 11-1- -- --		
ZL3GR	4032- 12-1- A-19		
ZL1FT	276- 6-2- A- --		
<i>Philippine Islands—KA</i>			
KA1SL	10676- 17-2- A-37		
KA1YL	6888- 12-2- B-27		
KA1AX	4368- 13-2- B-28		
KA4LH	244- 5-1- -- --		
KA1AA	180- 6-2- B- 5		
<i>Tasmania—VK7</i>			
VK7CM	3904- 16-2- -- --		
VK7LZ*	1071- 9-1- -- --		
VK7AL	284- 4-1- A- 7		
<i>South America</i>			
<i>Argentina—LU</i>			
LU7AZ	99575- 35-3- A-90		
LU9BV	48137- 38-3- A-90		
LU3DH	11088- 22-2- A-16		
LU3EV	6852- 12-1- A-37		
LU7BK	1053- 9-1- -- --		
LU2CW	3- 1-1- -- --		
<i>Brazil—PY</i>			
PY2AC	27297- 27-2- B-57		
PY1AX	25375- 25-2- B-45		
PY5AG	2002- 14-2- A-25		
PY2BJ	60- 4-1- -- --		
<i>Chile—CE</i>			
CE4AD	3894- 11-2- A-13		
CE1AU	468- 6-1- A-17		
<i>Colombia—HK</i>			
HK1PA	5764- 11-1- -- --		
HK1JB	4047- 19-2- A- 6		
<i>Ecuador—HC</i>			
HC2HP	1740- 10-1- A-17		
<i>Peru—OA</i>			
OA4J	60004- 34-3- B-61		
<i>Uruguay—CX</i>			
CX1FB	184- 8-3- -- --		

## Phone Scores

<i>ATLANTIC DIVISION</i>			
<i>E. Pennsylvania</i>			
W3EOZ	46880- 71-3- C-51		
W3LN	7700- 50-1- B-46		
W3DHM	6697- 37-2- B-20		
W3FXC	2300- 23-1- C- --		
W3ANZ	840- 10-1- C- --		



## Announcing the *NEW* **UTAH PORTABLE TRANSMITTER and RECEIVER KITS!**

**E**NTHUSIASTIC crowds of amateurs greeted the new Utah Portable Transmitter-Receiver Kit at the recent A. R. R. L. Convention, hailing it as a real engineering achievement in amateur radio. Consisting of 5 Units, to be used in various combinations, a 13 Watt, 3.5 to 60 MC, 5 Band Transmitter; — a 1.7 to 14 MC Superhet receiver; — a 27 to 60 MC (includes 7 meter police band) receiver; a twin vibrator power supply unit for 6 volt operation and a 110 Volt A.C. supply unit, the Utah Portables will answer practically every requirement for a complete portable or emergency station at a sensationally low cost. Each unit kit may be purchased separately.

The highly efficient transmitter, receiver and power supply units can be used separately or locked together with sturdy clasps to make a convenient easily carried unit, as illustrated, with a total weight of only 36 lbs.

Here's a portable you'll be proud to own — get complete description and specifications from your Utah Jobber or write Utah today!

**UTAH RADIO PRODUCTS CO.**  
 CABLE: UTARADIO, CHICAGO  
**"DEPENDABLE SINCE 1922"**

# TERMINAL'S NEW 5-BAND PRESELECTOR

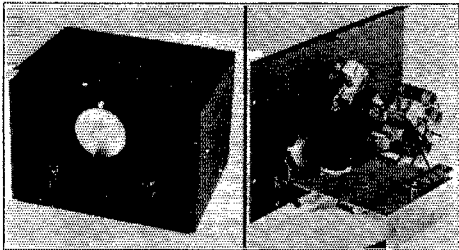

You'll hear stations you were never able to hear before, with the new Terminal Preselector!

### THE TERMINAL PRESELECTOR —

Provides plenty of r.f. gain to bring up weak signals \* Improves selectivity to substantially reduce the blocking effect of strong local stations \* Covers five amateur bands with efficient band-switch \* Makes possible 10 meter reception on receivers covering 20 meters \* Small power requirements easily obtained from receiver.

You NEED the Terminal Preselector for present day amateur radio reception!

Terminal Preselector, wired and in cabinet, less tube.....\$14.95  
Type 1851 tube..... 2.10  
Type 6K7 (can be used in place of 1851)..... .31

Browning BL-5H r.f. unit, as used in above. \$7.85  
Cabinet, chassis and panel only..... 2.25

Our new enlarged facilities enable us to demonstrate ALL the latest amateur receivers — National, Hallicrafters, RCA, Hammarlund, RME — besides complete sound systems and amateur speech equipment.

All Browning tuners in stock. 5P — \$6.65,  
5G — \$8.80.

Free chassis with tubes — see us for Taylor's special amateur tube deal!

New line of Parmetal racks and cabinets, in deluxe grey and black finishes, in stock!

We have all Premax antennas — at lowest prices!

We carry complete stocks of everything in radio. Mail orders are promptly and accurately filled. We ship to all parts of the world.

Cable Address: TERMRADIO

**TERMINAL**  
*Radio Corporation*  
80 CORTLAND STREET, NEW YORK, N. Y.

W3GTL	288-	8-1	---	W8JFC	1921-	17-1	A-22
W3HFP	100-	5-2	A-6	W8KZD	1248-	16-1	B-54
W3EED*	95-	5-1	---	W8QUM	108-	6-1	B-11
W3FNF*	27-	3-1	---	W8LCO*	27-	3-1	---
W3GYH	24-	2-1	B-2	<i>Wisconsin</i>			
W3CHH	6-	1-1	B-1	W9BCV	20007-	57-2	B-41
<i>Md.-Del.-D.C.</i>				W9RBI	6300-	29-2	A-57
W3BNC	4929-	31-2	B-44	W9FAA	5664-	32-2	B-55
W3GWL	1530-	17-1	---207	W9CCI	4425-	25-2	B-55
<i>So. New Jersey</i>				W9ZTO	2024-	23-2	BC-30
W3CRG	54599-	91-2	B-87	W9SPV	1394-	17-1	B-39
W3PC	54288-	87-2	C-70	W9OFL	1326-	17-1	---12
W3AIR	24534-	58-2	---44	W9CGO	884-	13-1	A-30
W3BVE	3864-	24-1	B-33	W9YKH	12-	2-1	A-1
W3BMA	2880-	16-1	B-1	<i>DAKOTA DIVISION</i>			
W3CRY	1638-	18-1	B-26	<i>South Dakota</i>			
W3BBO*	780-	10-2	---	W9USI	5018-	26-1	B-39
W3ZX	611-	13-2	C-15	<i>So. Minnesota</i>			
W3EDP	420-	10-1	B-3	W9VXZ	15327-	39-2	C-8928
W3ENZ	36-	3-1	B-2	<i>No. Minnesota</i>			
W3AXU	27-	3-1	A-3	W9JLE	342-	6-1	---
W3AWH	3-	1-1	A-1	W9LQT	270-	9-1	A-18
<i>W. New York</i>				W9RLL	189-	6-2	B-7
W8LUQ	9065-	35-2	B-37	<i>DELTA DIVISION</i>			
W8DST	4239-	27-2	---37	<i>Arkansas</i>			
W8NXQ	1926-	18-1	B-25	W5ASG	16899-	43-2	B-72
W8JLW*	429-	11-1	---	W5AKZ	12528-	36-2	B-34
W8FOB*	6-	1-1	---	W5GKK	11400-	38-1	B-56
<i>W. Pennsylvania</i>				W5AYH	192-	8-1	A-14
W8GLY	30524-	52-2	B-90	<i>Louisiana</i>			
W8RED	10395-	33-1	B-65	W5BMM	10080-	30-2	B-47
W8KBJ	1116-	12-1	C-12	W4BGO-5	3762-	22-2	B-42
W8RHK	374-	9-1	---9	W5CXH	2508-	19-2	B-21
W8OJM	312-	8-1	---	<i>Mississippi</i>			
W8OCR*	99-	3-1	---	W5DNV	32804-	52-2	C-51
W8BOZ*	3-	1-1	B-1	<i>Tennessee</i>			
<i>CENTRAL DIVISION</i>				W4DYP	10076-	35-1	AC-22
<i>Illinois</i>				W4EHG	621-	9-1	B-1226
W9DKU	63525-	77-2	C-54	W4DLK	72-	3-1	A-6
W9QI	12267-	47-2	B-64	W4NL*	3-	1-1	---
W9NDA-9	3054-	29-2	A-30	<i>HUDSON DIVISION</i>			
W9SJE	1986-	16-1	B-19	<i>E. New York</i>			
W9ZBX-9	567-	9-1	B-322	W2EOA	20043-	51-3	BC-38
W9UQT*	507-	13-2	B-8	W2AMM	11700-	45-2	B-44
W9WC	351-	9-2	B-9	W2HVI	9870-	30-2	---8927
W9RRX	312-	6-1	---	W2CHF	9720-	40-2	C-27
W9OF	204-	6-1	---	W2HHU	8880-	37-2	B-79
W9BG	168-	7-1	B-1	W2IKV	4488-	24-1	BC-25
W9WXT	168-	7-1	---6	W2AN	648-	9-1	C-13
W9LXX*	105-	5-1	---	W2DSB*	363-	11-2	---
W9TDD*	36-	3-1	B-3	<i>N. Y. C. &amp; Long Island</i>			
W9TB	27-	3-1	B-1	W2UK	69264-	78-2	C-8028
<i>Indiana</i>				W2KHR	2584-	19-1	B-1
W9YGC	48645-	69-2	C-80	W2GHK	528-	11-1	B-13
W9LQ	9870-	47-2	B-32	W2GRA	495-	11-2	B-1
W9MM	9630-	30-1	---	W2CLA	378-	9-1	---
W9AXH	4442-	22-1	C-30	W2CHK	198-	6-1	B-1
W9TMP	4294-	28-2	B-26	W2FHJ	45-	3-1	B-1
W9LZP	486-	9-2	B-20	W2KOT	27-	3-1	B-10
W9USU	48-	4-1	---	W2HID*	6-	1-1	---
W9UTL*	36-	3-1	---	<i>No. New Jersey</i>			
W9QEI	27-	3-1	A-1	W2IUV	39324-	45-2	B-60
<i>Kentucky</i>				W2JME	34125-	65-2	---68
W9ELL	24450-	50-3	C-79	W2HEM	14850-	45-2	B-55
W9NGZ*	1428-	14-1	---	W2HNA	13680-	38-2	---39
W9YHQ*	972-	18-1	---	W2JV	5200-	28-2	BC-32
W9EYW	60-	4-1	---	W2GNQ	5048-	29-2	B-19
<i>Michigan</i>				W2AER	2001-	23-2	B-24
W8NJP	42296-	79-3	C-71	W2IDQ	1782-	23-1	B-13
W8KML	15650-	30-2	C-5628	W2IDI	1589-	18-2	A-22
W8QDU	5676-	33-2	BC-19	W2GRG*	637-	13-2	C-11
W8MSK	5022-	31-2	B-33	W2HSC	550-	11-2	A-17
W8GQ	3075-	25-1	B-75	W2HYV	402-	5-1	---20
W8QBO	1275-	17-1	B-26	W2JUJ	279-	9-2	---11
W8PAA	390-	8-1	---	W2CAY	105-	15-1	B-11
W9EMB	350-	10-1	B-11	W2COT	12-	2-1	---
W8MCC	312-	8-1	A-16	<i>MIDWEST DIVISION</i>			
W8KSL	140-	8-1	---	<i>Iowa</i>			
W8BTP	105-	5-1	B-8	W9MCD	22758-	49-2	C-87
W8IQS	76-	4-1	A-15	W9JOL	10140-	39-2	B-42
W8PTD*	48-	3-1	---	W9GFO	1920-	16-1	---
W8QAG*	3-	1-1	---	W9AZZ	378-	9-2	B-10
<i>Ohio</i>				W9VRD	90-	5-1	B-4
W8AAJ	14256-	36-1	---48				
W8NKK	7986-	34-1	B-37				
W8NV	7344-	34-2	C-28				
W8NXF	3744-	34-1	B-32				
W8YX	3300-	25-2	BC-5424				
W8KYY	3168-	22-1	A-59				

"I Have Been Using a Meissner Signal Shifter In Lieu of a Crystal with My Transmitter and Have Found It to be the Exact Answer to Dodging Around QRM That Every Ham Should Have."

K. A. K. - Chicago

*"I haven't missed a single QSO since I put in my Meissner Signal Shifter...!"*

# THE SIGNAL SHIFTER THAT REALLY WORKS!

*"-there are lots of empty spots on all the bands with your signal shifter"*  
R. M. B.  
Ludington, Mich

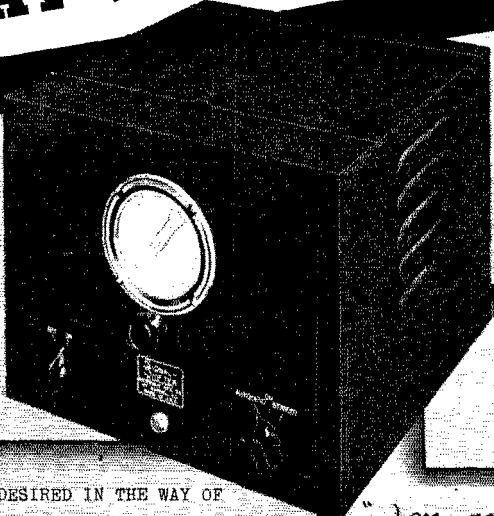

*"...I have one of your signal shifters and it is performing beautifully."*

Elgin, Ill

"giving me results far beyond my expectations especially in the 20 meter phone band"

H. S. L. - Honolulu

"LEAVES NOTHING TO BE DESIRED IN THE WAY OF OPERATION"

O. B. G. - Tulsa

*"I see no reason for putting out money for crystals when such an instrument can be had..."*

W. E. G. - Hot Springs

"I WOULD NOT EXCHANGE MY SIGNAL SHIFTER FOR A BOX FULL OF MOUNTED XTALS."=

E F K STLOUIS.

"A few hours operation with this instrument on any QRM crowded band will convince the most skeptical Ham."

E. S. - Louisville, Ky.

*and for the first time I can get away from QRM instantly..."* - N.Y.

**SEE YOUR JOBBER OR SEND THIS COUPON!**



**Meissner**

MT. CARMEL, ILL.

Meissner Mfg. Co. Dept. Q-11  
Mt. Carmel, Ill.

Please RUSH full detail:  
SIGNAL SHIFTER      RECEIVER KITS

Name .....  
Address .....  
City ..... State .....

**"A FAMOUS NAME FOR TWO DECADES"**

# ASTATIC

PIONEER  
MANUFACTURERS  
OF QUALITY  
CRYSTAL DEVICES

\*\*\*\*\*

## New DUAL DIAPHRAGM MULTI-UNIT CRYSTAL MICROPHONE

An instrument of the highest type for P.A., broadcast and amateur use. Cannot be acoustically overloaded.

Guaranteed maximum amplification without feedback. Made in two models. Black and chrome or all chrome finishes. Complete with interchangeable locking connector and 25-ft. cable. LIST PRICES: MU-2, \$29.50; MU-4, \$39.50. See your Astatic jobber or write for literature.

\*\*\*\*\*

# ASTATIC

Microphone Laboratory, Inc.  
Youngstown, Ohio

Licensed Under Brush Development Co. Patents



## for the SUDDEN LOAD

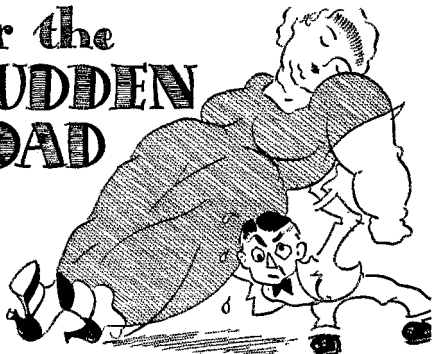

Ward Leonard Midget Overload Relays provide protection to the tubes while tuning or through loss of excitation. The underload Relays protect class "B" tubes and transformers. Send for Free Bulletin 507B. Learn about Ward Leonard Protective Relays and how to use them.

## WARD LEONARD PROTECTIVE MAGNETIC RELAYS

### WARD LEONARD ELECTRIC COMPANY

41 South St., Mount Vernon, N. Y.

Please send FREE Bulletin 507B.

Name.....  
Street.....  
City and State.....  
Call Signal.....

W9JRY*	84-	4-1-	---	W7GHT	1410-	15-2-	B-20
W9REG	27-	3-1-	B---	W7GKJ*	18-	3-1-	---
<i>Kansas</i>							
W9ARL	51170-	59-2-	C-71 <sup>20</sup>	Washington			
W9BEZ	6336-	32-2-	B-34	W7DVY	8777-	34-2-	C-64
W9SJV	3588-	26-1-	B---	W7BSK	8160-	34-2-	--83
W9TTS	1800-	18-2-	B-32	W7AXS	420-	10-2-	B-30
W9BPL	824-	13-2-	B-36	W7FVL*	72-	4-1-	A---
W9TVU	504-	12-1-	A-23	W7ADU	12-	2-1-	---
W9VZL	252-	7-1-	A-12	<b>PACIFIC DIVISION</b>			
W9VBQ*	12-	2-1-	---	<i>Nevada</i>			
<i>Missouri</i>							
W9ARA	82863-	81-3-	C-88	W6LCJ	3-	1-1-	---
W9EYM	540-	12-1-	A-20	<i>Santa Clara</i>			
W9VAV	216-	8-2-	B-7	W6MPS	4032-	24-1-	B-58
W9LBB	147-	7-1-	---	W6GUJ*	105-	5-1-	A---
W9ZFF	12-	2-1-	---	<i>East Bay</i>			
W9KEE*	3-	1-1-	---	W6LTH	51240-	70-4-	C-90
<i>Nebraska</i>							
W9ZNA	6156-	27-1-	B-57	W6COH	37758-	58-2-	BC-61
W9BBS	1368-	19-2-	B-31	W6CQS	16170-	35-2-	C-61
W9AGS*	1068-	14-2-	---	W6AMG*	7344-	24-1-	--36
W9WOA	192-	9-1-	B-8	W6IDY	7172-	22-1-	C-42
<b>NEW ENGLAND DIVISION</b>							
<i>Connecticut</i>							
W1LED	10803-	39-2-	B-30	W6LCT	1600-	16-2-	A-61
W1COJ	7384-	32-2-	A-43	W6MVQ	1488-	12-2-	B-12
W1FMP	1995-	15-1-	--19	W6JSS-6	147-	7-2-	B-10
W1WR	440-	11-1-	B-10	W6CUG*	36-	3-1-	---
W1JWX*	162-	6-1-	---	<i>San Francisco</i>			
W1JXV	120-	4-1-	B-8	W6SG	155-	11-1-	B-11
W1DIO	75-	5-1-	A-6	<i>Sacramento Valley</i>			
W1APA	45-	3-1-	B-6	W6EJC	12180-	35-2-	--62
<i>Maine</i>							
W1ASQ	156-	4-1-	B-6	W6AK	108-	6-1-	B-6
W1GKJ	40-	4-1-	A---	<i>San Joaquin Valley</i>			
<i>E. Massachusetts</i>							
W1TW	43608-	69-3-	B-67	W6CQI	57072-	82-3-	C-74
W1AXA	37017-	57-2-	C---	W6GCA	1575-	12-2-	A-16
W1ADM	24013-	59-3-	C-67	W6IWU	1027-	13-3-	AB-73
W1BLO	9424-	38-2-	--23	<b>ROANOKE DIVISION</b>			
W1JGX	7802-	38-2-	B-42	<i>North Carolina</i>			
W1BTL	4784-	26-2-	B-18	W4AH	50660-	68-2-	C-70
W1QM	3168-	24-1-	B-25	W4CDG	49511-	77-3-	B-75
W1GYZ	2056-	22-2-	B-16	W4FT	13200-	40-1-	C-51
W1BBX-1	1638-	12-1-	B-10	W4OC	8190-	39-2-	BC-29
W1DJK	891-	11-1-	A-25	W4GW	1818-	18-1-	--21
W1JLL	405-	9-1-	B---	W4EC	264-	8-2-	B---
W1GDY*	390-	10-1-	---	<i>South Carolina</i>			
W1GEX	351-	9-1-	C-9	W4EDQ	2508-	19-1-	B-12
W1HRS	231-	7-1-	A-13	W4FEH	2205-	21-1-	B-10
W1JTG	210-	7-1-	A---	<i>Virginia</i>			
W1KTG*	180-	6-1-	---	W3EMM	97092-	87-3-	C-89
W1WV	150-	5-1-	B-16	W3FGJ	6528-	32-2-	B-15
W1AGW	144-	6-1-	A-7	W3FPQ	363-	11-2-	B-5
W1IGO	60-	5-1-	A-14	<i>West Virginia</i>			
W1JCI*	36-	3-1-	--14	W3MOL	1027-	13-1-	B-15
W1KIM	36-	3-1-	B---	W3RJ	27-	3-1-	---
<i>W. Massachusetts</i>							
W1GOL	9918-	29-2-	B-27	<b>ROCKY MTN. DIVISION</b>			
W1GGY	6528-	25-1-	B-37	<i>Colorado</i>			
W1DSK	5040-	28-1-	B-30	W6FUH	5580-	31-2-	AB-41
W1AEP	4992-	32-2-	B-42	W6WJJ	3700-	21-1-	C-45
W1DIC*	1092-	14-1-	---	W6PGS	47-	3-1-	---
W1AQM	600-	12-1-	B---	W6IYT*	3-	1-1-	C---
W1ZD*	144-	6-1-	---	<i>Utah-Wyoming</i>			
W1DVA	48-	4-1-	---	W6DTB	10680-	40-2-	B-44
W1CQR	38-	3-1-	---	<b>SOUTHEASTERN DIVISION</b>			
<i>New Hampshire</i>							
W1WVU	54-	3-2-	B-4	<i>Alabama</i>			
<i>Rhode Island</i>							
W1JFG	15920-	40-1-	C-54	W4EQJ	576-	12-1-	C-14
W1CJH	10560-	40-2-	--67	W4EHH	240-	6-1-	B-21
W1BDS	3381-	23-2-	B-13	W4BOE	133-	7-1-	C-6
W1BBN	12-	2-1-	---	<i>E. Florida</i>			
W1DQ	3-	1-1-	---	W4CYU	94320-	90-2-	BC-90
<i>Vermont</i>							
W1DQK	7960-	40-1-	B-30	W4AGB	31454-	61-3-	B-62
<b>NORTHWESTERN DIVISION</b>							
<i>Idaho</i>							
W7AGD	540-	10-1-	B-10	W4AQK	3744-	32-1-	C-29
W7EZS*	12-	2-1-	---	W4DDB	328-	8-1-	A-37
<i>Montana</i>							
W7EOI	115-	5-1-	B---	<i>W. Florida</i>			
<i>Oregon</i>							
W7AMQ	1536-	16-2-	C-30	W4MS	1683-	17-1-	B---
<i>Georgia</i>							
				W4BYV	57174-	78-2-	B-72
				W4YC	44154-	66-2-	A-82
				W4DAA	6600-	22-1-	--34
				W4EGT	2220-	20-1-	B-24
				W4FBH*	660-	11-1-	A---
				W4EFO*	86-	6-1-	---
				W4EGJ*	86-	6-1-	---



**LISTEN  
to the  
HAMS RAVE...**

**YOU CAN QSO THE WEAKEST SIGNAL ON A HOWARD**



**NEW MODEL 450-A**

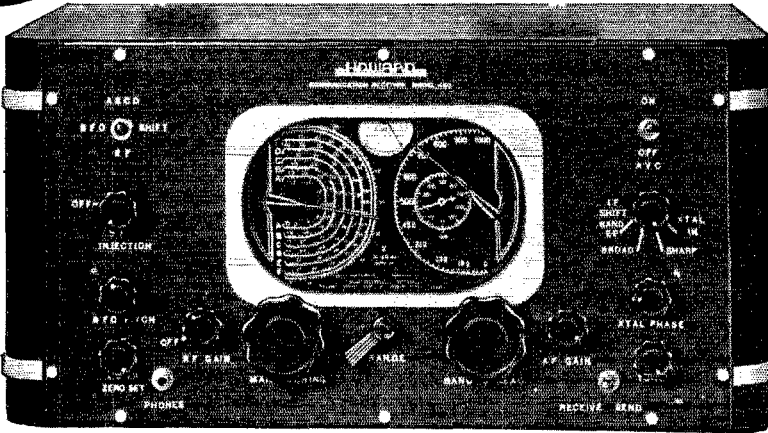

**Here are some of the comments:**

"The weakest fone or CW sig can be pulled thru qrm and qrn on a Howard 450-A."

"The Howard 450-A certainly makes a 100% Sunday afternoon 'qso-ing' on 20 meters."

"I didn't know there were so many on 10 meters till I got a 450-A."

"I can now give an accurate QRG on my 450-A."

"An RAC will soon be mine."

● Frequency Coverage 65 MC to 540 KC in Six Bands: (a) .55 to 1.2 MC, (b) 1.2 to 2.8 MC, (c) 2.8 to 6.5 MC, (d) 6.5 to 16 MC, (e) 16 to 40 MC, (f) 32 to 65 MC... Twelve Tubes, eight metal, four glass: 6K7—Signal Freq. Amplifier; 6L7—First Detector (Mixer); 6J5-G—Oscillator; 6K7—I.F. Amplifier; 6K7—I.F. Amplifier; 6Q7G—Second Detector—1st AF Amp.; 6J5G—Phase Inverter; 6V6G—Push-pull Output; 6V6G—Push-pull Output; 80—Rectifier; 6J7G—R Meter Voltage Amplifier; 6J7G—Beat Frequency Oscillator... Electrical Band Spread... Illuminated Dual-Dial accurately calibrated, with new S.L.F. calibrations... Band spread RE-SET or LOGGING scale finely divided for accurate repeat readings... CERAMIC coil forms of special Howard design... 2 three-gang S.L.F. STRAIGHT LINE FREQUENCY CERAMIC insulated tuning condensers... MICROMETER BAND SPREAD. Band Spread scale has a total length of 47 inches divided into 1,000 divisions... B.F.O. Shift Switch providing beat oscillator on each of the I.F. circuits (1560 KC

and 465 KC)... Flywheel tuning on both tuning controls... Calibrated R Meter... Band-In-Use Indicator... R.F. Stage on all bands except five-meter band... R.F. Coil system coaxially designed with band switch, eliminating coil secondary leads... AIR-TUNED R.F. and oscillator circuits... Iron Core I.F. Coils... Dual channel, variable selectivity I.F. circuits, providing crystal switching, 1560 KC I.F. for the five-to-ten meter bands, broad and sharp for other bands all accomplished with one control knob... High Gain antenna coils... High translocation mixer circuit... Push-pull Beam Power Output, 9½ Watts... B.F.O. with amplitude and pitch controls... Output terminals for 5 and 500 ohms... Headphone Jack... Terminals for standard and doublet aerials. Separate five-meter antenna connection. Relay connection for break-in work... Send-Receive switch... Heavy copper-plated chassis. Headphone Jack on front of panel... Modern cabinet design, finished in brushed silver and telephone black... Speaker in cabinet to match design of receiver.

**PRICES**

Model 450-A, including tubes, less speaker, less crystal... \$87.50 Net  
 Model 450-A, speaker only... 7.95 Net  
 Model 450-A, equipped with tubes, crystal filter and speaker... 105.45 Net  
 Pacific Coast and Export Prices slightly higher.  
 Available for long wave operation, 25 cycle, or special line voltages.

**HOWARD RADIO COMPANY**

1731-35 West Belmont Ave., Chicago, Ill.

Please send me more information on your Model 450-A;  Other Communication Receivers.

Name .....

Address .....

City .....

Cable Address—"Howardco"

**HOWARD RADIO COMPANY**

*America's Oldest Radio Manufacturer*



# PROBLEMS

This Problem Quickly and Easily Solved with Type A Calculator

**PROBLEM:** HOW MANY TURNS ON A  $1\frac{1}{2}$ " DIAMETER FORM  $\frac{1}{2}$ " LONG MUST I USE WITH A 25 MMFL CONDENSER TO TUNE TO 4000 KC.?

$L = \frac{10^8}{(2\pi f)^2 C}$  MICROHENRYS

$f = 4 \times 10^6$   
 $C = 25 \times 10^{-12}$

$L = \frac{10^8}{(2\pi(4 \times 10^6))^2 (25 \times 10^{-12})}$

$= \frac{10^6}{15776}$

$= 63.4$  MICROHENRYS

$N = \sqrt{\frac{3A + 9B}{0.2A^2} \times L}$

$A = 1.5$   
 $B = 0.5$   
 $L = 63.4$

$N = \sqrt{\frac{(3)(1.5) + (9)(0.5)}{(0.2)(1.5)^2} \times 63.4}$

$= \sqrt{\frac{36 \times 63.4}{0.45}}$

$= \sqrt{1268}$

$= 35$  TURNS  
**ANS.**

## EASY

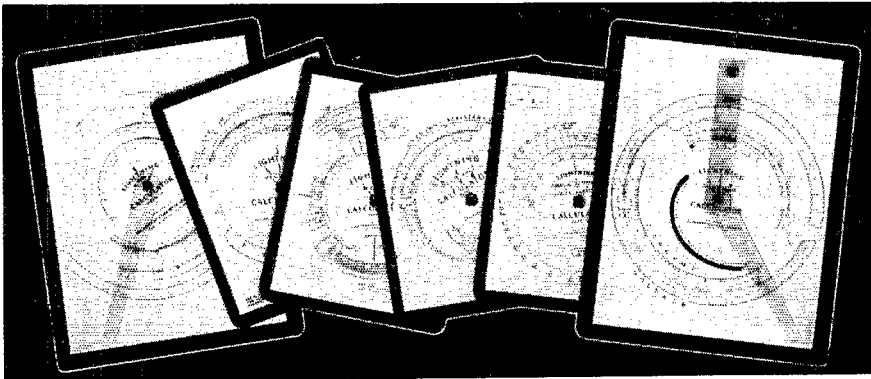

## LIGHTNING CALCULATORS

Six Types Solve ALL Problems

**TYPE A** — For problems involving frequency, inductance and capacity, in design of radio frequency circuits. Direct reading answers for size of coils and condensers for any range between 400 kc. and 150 mc. Price, \$1, postpaid.

**TYPE C** — More information on electrical conductors than you could find in a book full of tables. Price, 50c, postpaid.

**TYPE E** — Direct reading total resistance of resistors connected in parallel, and total capacity of condensers connected in series. Price, 50c, postpaid

**TYPE B** — Gives direct reading answers to calculations involving current, resistance, voltage and power with scale for resistance of copper wire and scale for calculating decibel gain or loss. Price, \$1, postpaid.

**TYPE D** — Gives decibel gain or loss when input and output voltages, currents or power are known. Price, 50c, postpaid.

**TYPE F** — Permits measurement of resistance, from 1 ohm to 1 megohm by use of a voltmeter. Makes an ohm-meter of your voltmeter. Price, 50c, postpaid.

AMERICAN RADIO RELAY LEAGUE, INC., West Hartford, Conn.

Say You Saw It in QST — It Identifies You and Helps QST



# COMPACT CRYSTAL SOCKET

THE NEW "XS-2" Isolantite crystal socket, recently developed in the Hammarlund laboratories, fills a long felt need for a small size crystal mounting. This socket is equipped with heavy contacts treated against corrosion and mechanically arranged so that they can not shift or loosen. The Isolantite base is  $\frac{3}{16}$ " thick and  $1\frac{3}{8}$ " in diameter. The top and sides are glazed and the bottom is treated to eliminate moisture absorption. Fits all standard crystal holders and has  $1\frac{5}{16}$ " mounting centers. This new unit also fits into the top of XP-53 coil forms for changing coil and crystal together, as in our "OD-10" foundation unit; see illustration. Exciter units employing a number of crystals can be made more compact through the use of these new sockets. They can be mounted flush or with stand-off bushings. Packed complete with screws, nuts, and mounting bushings.

SEND FOR "39" CATALOG JUST OFF THE PRESS!

**HAMMARLUND MANUFACTURING CO., INC.**

424-438 West 33rd Street, New York City

Canadian Office: 41 West Ave. No., Hamilton, Ont.

XS-2 CRYSTAL  
SOCKET

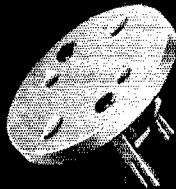

PLUG-IN  
CRYSTAL AND  
COIL ASSEMBLY

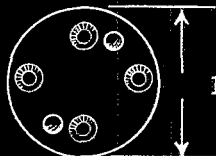
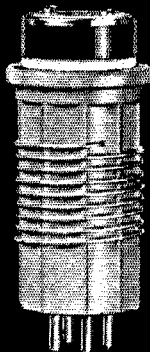

$1\frac{3}{8}$ " DIAMETER



## Print Your Own

**QSL**

Cards, Stationery, Advertising, Labels, paper, circulars, tags, etc. Save money and time. Sold direct from factory only. Junior outfit \$8.25, Senior outfits \$17 and up. Do popular raised printing like engraving with any of our presses. Print for Others, Big Profits Pays for itself in a short time. Easy rules sent. Write for free catalog of outfits and all details. Kelsey Presses N-95, Meriden, Conn.

EXCELSIOR

## Piezo-Electric Crystals Exclusively

- Quality crystals of all practical frequencies supplied SINCE 1925. Prices quoted upon receipt of your specifications.

Our Pledge: **QUALITY FIRST**

**SCIENTIFIC RADIO SERVICE**

"The Crystal Specialists Since 1925" University Park, Hyattsville, Md.

## • RADIO OPERATOR'S COURSE •

TELEGRAPHY  
TELEPHONY  
AVIATION  
TELETYPE  
TELEVISION  
TRANS RADIO  
PRESS



PRACTICAL  
EXPERIENCE  
STUDIO —  
TRANSMITTER —  
ANNOUNCING  
TYPEWRITING

Port Arthur College advertises primarily to Radio Amateurs and the training is too technical for the average student who has not selected Radio as his life's work. The opportunities for positions and advancement are unlimited for men who are interested in Radio and who plan to make this their career and are willing to make the sacrifice and effort necessary to master the training. P. A. C. maintains strict collegiate rank — only high school or college graduates are eligible for enrollment.

*If interested in details about Radio Course, write for bulletin R*

**PORT ARTHUR COLLEGE** ■ **PORT ARTHUR (World-known port) TEXAS**



**DID YOU KNOW . . .**

- ★ That HARVEY'S is open till 8:00 p. m. for your shopping convenience.
- ★ That HARVEY'S is located only one block from Times Square . . . convenient to everywhere.
- ★ That HARVEY'S will custom build any kit described in QST or any other publication.
- ★ That HARVEY'S maintains a complete camera department for the "photo-minded" amateur.
- ★ That HARVEY'S will arrange liberal "trade-in" deals on camera for radio or radio for camera.

**SIGMA RELAYS**

for Radio Control of powered models. . . See the October issue of QST . . . article by W1CBD, Clinton B. DeSoto. . . . \$4.08

- RK-62 . . . . . \$3.50**
- NEW TAYLOR T-21 . . . . . \$1.95**
- BLILEY 40 METER VARIABLE FREQUENCY CRYSTALS . . . . . IN STOCK**

- RCA-1851 . . . . . \$2.10**
- RCA-1852 . . . . . 1.85**
- RCA-1853 . . . . . 1.85**

**IN STOCK  
PREMAX BEAM ANTENNAS  
CARDWELL MULTI-BAND  
CONDENSERS**

**TAYLOR—T-55**

Now Only . . . . . **\$6.00**

Only recognized brands of merchandise from reputable manufacturers are sold at HARVEY'S

OUR *Best* VALUE IS OUR RECORD OF LOYAL SERVICE

**HARVEY**

*Radio Company of New York*

103 WEST 43rd STREET • NEW YORK, N. Y.

CABLE ADDRESS: "HARADIO"

Ecuador—HC	CX2AK	936- 8-1- B- 7
HC1JW	24261- 24-2- B-37	
Uruguay—CX	Venezuela—YV	
CX1FB	1280- 8-2- - - -	YV6AL 212- 5-1- - - -

<sup>1</sup> Station score, Schuylkill Valley Radio Club; oprs. scores—W3CRW 9285; W3FCB 9102; W3JHS 3093; W3GCT 1740; W3ERM 22. <sup>2</sup> Station score; opr. W3FA X 7708; W3JED 5108. <sup>3</sup> Two oprs., W9IML, W9RHK. <sup>4</sup> Station score, Lake Mich. Amateur Radio Reserve; oprs.—W9QNS ZRJ SSU MK PFG NLL V8Z WDM. <sup>5</sup> Station score, four oprs.—W8PQQ ODV PMA W95QC. <sup>6</sup> Station score, two oprs.—W9KHG, W2DIJ. <sup>7</sup> Station score, two oprs.—W2KIB JVF. <sup>8</sup> W3CGU opr. <sup>9</sup> Station score, two oprs.—W1ILA, GKM. <sup>10</sup> Member A.R.R.L. HQ's staff; ineligible for contest awards. <sup>11</sup> Score of 1st opr.; 2nd opr., 2028. <sup>12</sup> Station score, two oprs.—W1IGR, Charles Wilde. <sup>13</sup> W7JC opr. <sup>14</sup> Station score; oprs. scores—W7DRF 720; ENW 135; DSY 126; AEA 90; CSF 80; BDW 60; ETN 60; EAW 18; ETE 12; LD 8; EXP 3; Rho Estion Frat., Univ. of Wash. <sup>15</sup> Station score, four oprs.; W4DAR 370; DXI 270; ERD 756; AJJ 32. <sup>16</sup> W6BBR opr. <sup>17</sup> Halifax Amateur Radio Club; VE1KG opr. <sup>18</sup> Score of opr. J. Zeleznik; opr. Tailleir 1120; opr. Scott 1089. <sup>19</sup> Score of opr. E. Aymar; opr. Shay 2739. <sup>20</sup> Score of opr. C.L.L.; opr. L.I. 2654; station score 3180. <sup>21</sup> W3GAD opr. <sup>22</sup> Station score, oprs. W9QNS AJ NTH, ZC9N ZBJ SKQ MK WDM. <sup>23</sup> Score of opr. W8KML; opr. W8LUP 100; station score 16900. <sup>24</sup> Station score, oprs. W8ODV ORN ORL PMA PQQ W85QC. <sup>25</sup> Three oprs., Weber, Overby, Lamm. <sup>26</sup> W4EYB opr. <sup>27</sup> Station score, five oprs., W2HVI W3CIV W6PZR W7AOF W6DXU. <sup>28</sup> WENY opr. <sup>29</sup> Station score; opr. "M" W9ARL 42185; "D" W9GDE 1872. <sup>30</sup> W4DEZ opr. <sup>31</sup> Station score, two oprs., W6PNX NGD. <sup>32</sup> Station score, three oprs., W6LUB ITY BBR. <sup>33</sup> W9PEV opr. <sup>34</sup> Station score, two oprs., W5CCU GWL. <sup>35</sup> Score of opr. Mrs. T. A. Archer; opr. T.A.A. 4368.

**Sweepstakes Contest**

(Continued from page 54)

**REPORTING RESULTS**

Report <sup>7</sup> to A.R.R.L., West Hartford, Conn., as soon as the contest is over. Use the log form shown in the example. List all operators <sup>8</sup> whose work at your station is responsible for any part of the score.

All active ham operators are invited to take part and report. You will work a new bunch of stations, make new records for your station, get QSL cards (be sure to send one for each QSO), have a lot of fun, meet new friends, and perhaps rate an A.R.R.L. award at the conclusion. Do your best operating. Send A.R.R.L. the results for QST mention. MAIL YOUR REPORT IMMEDIATELY AT THE END OF THE CONTEST TO AVOID DELAY AND INSURE THAT YOUR RESULTS ARE CREDITED AND KNOWN THROUGH QST.

<sup>5</sup> The highest individually-attained score of any one of the operators of amateur stations having more than one operator is the official score for such a station. The summary of score must show all stations worked by all operators however, circling the entries of stations and/or Sections that cannot count in the official total. Awards will be based on the official total and will be made to the individual operator accredited with this total. To show the possible scores that can be built up by several operators at one station, such scores (all Sections listed by all points listed) may be shown parenthetically after the "official" score that counts toward a possible award.

<sup>7</sup> All hams are requested to submit lists, even if they only show a small score, on a postal. By doing this they help support claims made in logs from other stations and receive credit in QST.

**Hams Over Chicago!**

(Continued from page 51)

the Genesee County Radio Club of Flint, Mich., thrilled some 400 or more novices and old members—the largest group ever to attend such a ceremony. Although the eerie, impressive ceremony was born in Flint in 1921, it was an altogether new crop of hams, led by W8JYP, that put on the 1938 version.

**MONDAY**

The Monday morning diet was heavy, but highly worthwhile. Prof. F. E. Hartig of the

"Put Your Signal Where You Want It When  
You Want It There"

## FEATURES OF THE 1939 SIGNAL SQUIRTER



- ★ New coupling system permits efficient *open wire feed*, instead of inefficient twisted pair.
- ★ Continuous rotation in either direction.
- ★ Sturdy, simple, ingenious rotating mechanism.
- ★ "Inductostub" — the marvelous, new coupling device.
- ★ Self-supporting radiating elements.
- ★ Greater transmission gain.
- ★ Easy tuning.
- ★ Direction indicator.

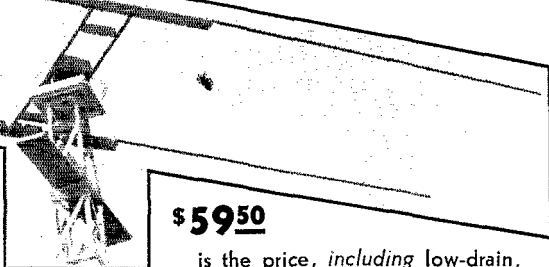

**\$59<sup>50</sup>**

is the price, including low-drain, non-interference producing motors. Illustration above from unretouched photo. • Ten meter kit for \$49.50. • Separate components also available. At these low prices, must be factory-direct proposition. Write now for full dope.

**WRITE  
RIGHT  
AWAY!**

**MIMS RADIO COMPANY**

M. P. MIMS—WSBDB, P. O. Box 504, Texarkana, Ark.

## LEARN RADIO — TELEVISION —

500 Licensed graduates placed in past 7 years in shipping, broadcasting, aviation, police, etc.; we also teach radio servicing and repairing; new term Sept. 12th, Nov. 7th day or eve.; 52-page catalog free; oldest, largest and best equipped.

**MASS. RADIO SCHOOL**  
18 Boylston Street, Boston

G. R. Entwistle, Pres.  
Established 1899

R. F. Trop, Treas.  
Hancock 8184



**NEW HOLDER DESIGN**  
15 SECONDS TO  
INSTALL CRYSTAL

For All Bands  
GREATER STABILITY  
Plugs in 5 prong tube socket

Beautiful Appearance

**MODEL AH HOLDER \$1.00** At your dealer or direct

**HIPOWER LOW DRIFT CRYSTALS:**  
within 10 kc. or Choice of stock

AH-10, 1700-3500 Kc. bands \$2.35

AH-10, 7000-7300 " bands 3.90

WRITE FOR NEW LITERATURE

Hipower "Low Drift" Broadcast and Commercial  
Crystals Are Approved by F.C.C.

Hipower Crystal Co., 2035 Charleston St., Chicago

## A GOOD NAME ASSURES DEPENDABILITY

You can depend upon Ken-Rad Radio Tubes to give you the ultimate in good reception. Ask anyone who has tried them. Then you will try them yourself.



# Ken-Rad Radio Tubes

**KEN-RAD TUBE & LAMP CORPORATION - OWENSBORO, KY.**  
Manufacturers of all types of radio tubes and Ken-Rad Electric Lamp Bulbs

Say You Saw It in QST — It Identifies You and Helps QST

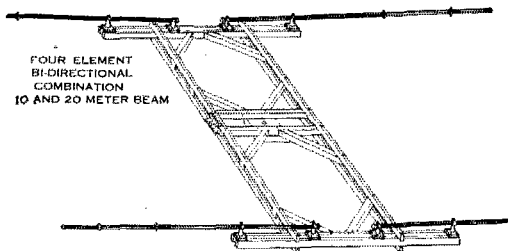

## CORULITE ROTARY BEAM ANTENNA

- For 10 and 20 meters
- Substantial gain in power transmitted in given direction
- Marked increase in received signal
- Great reduction in unwanted signal
- Simplest construction — universal utility — better efficiency
- A rotary beam kit for every amateur at a price he can afford

Now giving outstanding performance at W2AZ, W2GYL, W3CHO, W2DKJ, W8JK, this telescoping and adjustable Rotary Beam Antenna meets all amateur requirements! Complete Kit includes 4 1 1/2 foot telescoping Corulite Elements, 8 combination mounting brackets and soldering lugs; complete drawings and instructions for erecting, and a comprehensive bibliography of directional arrays, matching sections, transmission lines, etc. Ask your jobber or write direct.

# Premax Products

Division of Chisholm-Ryder Co., Inc.

3919 HIGHLAND — NIAGARA FALLS, N. Y.

SEND  
FOR  
SPECIAL  
ANTENNA  
BULLETIN

## RADIO ENGINEERING



RCA Institutes offer an intensive course of high standard embracing all phases of Radio and Television. Practical training with modern equipment at New York and Chicago schools. Also specialized courses and Home Study Courses under "No obligation" plan.

Illustrated Catalog on request

**RCA INSTITUTES, INC.** Dept. ST-38

A Radio Corporation of America Service

75 Varick St., New York 1154 Merchandise Mart, Chicago

## SAVE TIME AND HEADACHES

You get performance plus rugged individuality when

**We Build It for You**

Professional equipment at real Ham Prices.

Send sketch of your requirements.

We will send photo samples of Measurement and monitoring our work. Specialized receiver equipment; RF and AF units; and instrument servicing. limiters, packs, relays, etc.

**FEIGHNER TECHNICAL ASSOCIATES**

525 Woodward Avenue Detroit, Michigan

22 years in radio

## LEARN CODE RIGHT

Always ready — no weather interference — beats having someone send to you. Speed range 5 to 40 W.P.M. Radio or Morse.

**STANDARD** with 10 tapes and book of instructions ..... \$20.25

**JUNIOR** with 5 tapes and book of instructions (not rented) ..... \$12.00

**RENTAL** Standard with 10 tapes and books of instructions \$3.00 first month, \$2.25 each additional month.

Complete oscillator equipment less battery, \$6.50

Write for details today.

## INSTRUCTOGRAPH COMPANY

Dept. Q-11, 912 Lakeside Place, Chicago, Illinois

Representatives for Canada:

Radio College of Canada, 863 Bay Street, Toronto

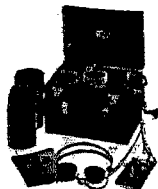

University of Minnesota provided an illuminating demonstration of the behavior of resonant lines by the use of mechanical analogies. Fritz Franke of Bendix reported recent developments in aircraft radio in terms of amateur applications. Ross A. Hull, editor of *QST*, discussed recent experimental work with u.h.f. gear, especially in receiving. Boyd Phelps, W9BP, ended the technical sessions with his discourse on "ultra-ultra" high-frequency antennas. The closing address was by Chairman Dosland, expressing the good wishes of the Chicago Area Radio Club Council.

This account would not be complete without mention of the manufacturers' exhibit. About forty of the leading suppliers of amateur equipment were represented, many with colorful and elaborate booths that showed the expenditure of time and thought. It was not their fault that the convention committee ended with a deficit (written off by contributions from Chicago dealers and manufacturers). It was estimated by some one that \$100,000 worth of gear was on display at the various exhibits.

First place in the exhibition hall was occupied by the Hamfesters amateur station, operated under the call W9YQH. Two transmitters were used—100 watts to a pair of T-20's and 175 watts to an RK-47—and three receivers. A 250-foot single-wire feeder ran to the 66-foot Hertz on the roof. Break-in was used at all times, and skeds were kept with W8QHJ, W9POG, W8BBH and W4PL. The traffic total reads: Originated, 258. Relayed, 3. Hours of operation: 19. A feature of the display was the old rig used by W9HRM of the Milwaukee Radio Club under the call 9EJ in 1915.

The ladies committee, under the chairmanship of XYL-W9YMF, arranged a program for the non-radio XYL's and YL's in attendance, including a tour of Marshall Field & Co., a bridge tea, Sunday church attendance, trips to the Flower Show, Garfield Park, and the Chicago Historical Society, and, on Monday morning, viewing the N.B.C. "National Farm and Home Hour" broadcast. Adding these to the Saturday night party and the banquet provided a full round of things to do for the ladies.

### IN GENERAL

The registered attendance by divisions and countries was as follows: Atlantic, 63; Central, 1555; Dakota, 38; Delta, 13; Hudson, 21; Midwest, 133; New England, 30; Northwestern, 1; Pacific, 4; Roanoke, 24; Rocky Mountain, 10; Southeastern, 7; Southwestern, 11; West Gulf, 14; Ontario, 32; Manitoba, 4; Mexico, 3; Philippines, 1; New Zealand, 1; Java, 1; France (S.W.L.), 1. Total: 1966—the biggest A.R.R.L. convention ever held. Of course, this figure does not include several hundred interested members of the public who wandered in and out meetings and the exhibition hall and pestered attendants with inquiries concerning the "free television demonstration"!

All credit to N.B.C. and C.B.S. for splendid cooperation in the way of spot broadcasts, use of exhibit space, etc., in support of the convention



# Where to buy it

A directory of suppliers who carry in stock the products of these dependable manufacturers.



**ALBANY, N. Y.** Uncle Dave's Radio Shack 356 Broadway  
**ATLANTA, GEORGIA** 265 Peachtree Street  
 Wholesale Radio Service Co., Inc.  
**BOSTON, MASS.** Radio Shack 46 Brattle Street  
**BOSTON, MASS.** 110 Federal Street  
 Wholesale Radio Service Company, Inc.  
**BRONX, N. Y.** 542 East Fordham Rd.  
 Wholesale Radio Service Company, Inc.  
**BUTLER, MISSOURI** 211-215 N. Main Street  
 Henry Radio Shop  
**CHICAGO, ILL.** 833 W. Jackson Blvd.  
 Allied Radio Corp.  
**CHICAGO, ILL.** 901-911 W. Jackson Blvd.  
 Wholesale Radio Service Company, Inc.  
**COLUMBUS, OHIO** 203 N. Fourth St.  
 Bell Radio Parts Co.  
**DETROIT, MICH.** 171 E. Jefferson Ave.  
 Radio Specialties Co.  
**DETROIT, MICHIGAN** 11845 Woodward Ave.  
 Radio Specialties Co.  
**HARTFORD, CONNECTICUT** 227 Asylum Street  
 Radio Inspection Service Company  
**HOUSTON, TEXAS** 625 East 14th Street  
 R. C. Hall & L. F. Hall  
**JAMAICA, L. I.** 90-08 166th Street  
 Wholesale Radio Service Company, Inc.  
**KANSAS CITY, MO.** 1012 McGee Street  
 Burstein-Applebee Company  
**NEW ORLEANS, LA.** 902 Poydras Street  
 Shuler Supply Company  
**NEW YORK, N. Y.** 51 Vesey St.  
 Gross Radio, Inc.  
**NEW YORK, N. Y.** 12 West Broadway  
 Harrison Radio Co.  
**NEW YORK, N. Y.** 100 Sixth Ave.  
 Wholesale Radio Service Co., Inc.  
**NEWARK, N. J.** 219 Central Ave.  
 Wholesale Radio Service Co., Inc.  
**OAKLAND, CAL.** 2085 Broadway  
 Offenbach Electric Co.  
**POTTSVILLE, PENN.** E. Norwegian & George Sts.  
 Jones Radio Company  
**READING, PENN.** 404 Walnut St.  
 George D. Barbey Company  
**READING, PENN.** 104 North Ninth Street  
 Jones Radio Company  
**SAN FRANCISCO, CAL.** 1452 Market Street  
 Offenbach Electric Company  
**SPRINGFIELD, MASS.** 349 Worthington St.  
 T. F. Cushing  
**WASHINGTON, D. C.** 938 F Street, N. W.  
 Sun Radio & Service Supply Co.

**ALBANY, N. Y.** Uncle Dave's Radio Shack 356 Broadway  
**ATLANTA, GEORGIA** 69 Forsyth Street, N. W.  
 Garvin Electric Company  
**ATLANTA, GEORGIA** 265 Peachtree Street  
 Wholesale Radio Service Company  
**BOSTON, MASS.** 46 Brattle Street  
 Radio Shack  
**BOSTON, MASS.** 110 Federal Street  
 Wholesale Radio Service Company, Inc.  
**BRONX, N. Y.** 542 East Fordham Rd.  
 Wholesale Radio Service Company, Inc.  
**BUTLER, MISSOURI** 211-215 N. Main Street  
 Henry Radio Shop  
**CHICAGO, ILLINOIS** 833 W. Jackson Blvd.  
 Allied Radio Corp.  
**CHICAGO, ILLINOIS** 25 North Franklin Street  
 Electric & Radio Supply Co., Inc.  
**CHICAGO, ILL.** 901-911 W. Jackson Blvd.  
 Wholesale Radio Service Company, Inc.  
**DALLAS, TEXAS** 1905 Commerce Street  
 Southwest Radio Supply  
**JAMAICA, L. I.** 90-08 166th Street  
 Wholesale Radio Service Company, Inc.  
**LITTLE ROCK, ARKANSAS** 409 W. 3rd St.  
 Beem Radio Company  
**MIAMI, FLORIDA** 123 Second Street, N. E.  
 Tropical Camera Stores, Inc.  
**MINNEAPOLIS, MINNESOTA** 1124-26 Harmon Place  
 Lew Bonn Company  
**MONTREAL, CANADA** 285 Craig Street, West  
 Canadian Electrical Supply Co., Ltd.  
**MUSKOGEE, OKLAHOMA** 204 North 12th Street  
 Home Radio Mart  
**NEW ORLEANS, LA.** 902 Poydras Street  
 Shuler Supply Company  
**NEW YORK, N. Y.** 100 Sixth Avenue  
 Wholesale Radio Service Company  
**NEWARK, N. J.** 219 Central Ave.  
 Wholesale Radio Service Company  
**OAKLAND, CAL.** 2085 Broadway  
 Offenbach Electric Co.  
**POTTSVILLE, PENN.** E. Norwegian & George Sts.  
 Jones Radio Company  
**READING, PENN.** 404 Walnut Street  
 George D. Barbey Co.  
**READING, PENN.** 104 North Ninth St.  
 Jones Radio Company  
**SAN FRANCISCO, CAL.** 1452 Market Street  
 Offenbach Electric Company  
**WASHINGTON, D. C.** 938 F Street, N. W.  
 Sun Radio & Service Supply Co.

# PLEASE PASS THE MICROVOLTS

We can't sell microvolts by the package to "pour into" ailing communications receivers and thus improve their sensitivity. Nevertheless, as sensitivity slowly but surely "pours out" of any communications receiver in a year's time, something must be done to restore the set to its original condition.

Our laboratory screen room, equipped with Ferris Signal Generators, enables us to measure accurately the loss in gain and then put the receiver back to the factory-standard of peak performance. Start the season right with a receiver "chock-full of microvolts". A complete alignment job on any super-het with one R. F. stage is only \$5.00; SX-17, \$7.50; HRO and Super-Pro, \$10.00, DB-20, \$2.50.

**NOISE SILENCERS.** To add a silencer to a receiver not regularly equipped with this useful device, presents some problems. First of course, the silencer should be effective. Secondly, no changes in the circuit of the set should be made. Thirdly, no extra holes should be drilled in the panel or chassis thus reducing the resale value. We meet these requirements on the National HRO and the Hallicrafter SX-16, employing the popular reverse diode circuit with a manual control, at a cost of only \$10.00.

**SERVICE.** We do service work on all types of communications receivers and transmitters. This includes "Official Factory Service" in the New York Area for the following manufacturers: The Radio Manufacturing Engineers, The Hallicrafters, and E. M. Sargent. Your inquiries are invited and a prompt reply is assured.

## COMMUNICATION MEASUREMENTS LABORATORY

136 LIBERTY ST., NEW YORK CITY  
TELEPHONE: WHITEHALL 4-7275

... Both put on network shows ... The convention committee did a total of 1042 man-hours of actual work, according to Chairman Dosland; this doesn't include the time of Al Cox, business manager, who was going full-time for a solid six months ... National conventions are some job!

And for that reason, plus a lot of others, the Chicago Area Radio Council and Director Mathews deserve an undying vote of gratitude on the part of the ham fraternity in general for the tremendously successful job they did. The Chicago *Daily News* truly set the spirit of the committee and of the occasion when it editorialized:

"Welcome, hams, to Chicago. Here you will find a degree of public understanding and sympathy with your activities exceeded by no other city."

Thanks, Chicago! We had a wonderful time.

—C. B. D.

### Book Review

*Engineering Electronics*, by Donald G. Fink; 358 pages, 217 illustrations. McGraw-Hill Book Company, New York. \$3.50.

Primarily a volume for engineers who wish to acquaint themselves with the ramifications of the electronic art, *Engineering Electronics* nevertheless is a readable book for the active-minded amateur who likes to keep abreast of progress in radio and allied fields. The book fills a need not quite met by the several texts on vacuum tubes, in that it discusses the various types of gas-filled tubes and lamps, as well as the familiar radio vacuum tubes, photo-cells and cathode-ray tubes.

The subject matter is divided into three sections, the first on the physical principles underlying the operation of electron tubes, the second on various practical tube structures, and the third on applications. Chapters in the first section discuss the electron, electron emission, control of electrons, and current flow in gases, on the basis of present-day theoretical physics. The treatment of practical tubes includes design considerations and performance characteristics of vacuum, gas-filled, photo-sensitive, and cathode-ray tubes, as well as electronic sources of light. In the section on applications, circuit theory, power transformation, communication circuits and industrial control are covered. A useful feature of the book is an appendix containing definitions of terms used in connection with electron tubes.

Although no treatment of a subject of this nature can be non-mathematical, *Engineering Electronics* achieves a high degree of intelligibility for the layman. Equations are given in a form easily handled with high-school mathematics. Examples are worked out and problems given in each chapter. The general reader will find the meanings of the equations satisfactorily explained in words, so that there is no difficulty in forming a mental picture of the processes discussed.

—G. G.

### Strays

When W8OFO experienced trouble with "hash" in b.c.l. and amateur receivers caused by the 866 rectifier tubes, he tried the simple expedient of exchanging the two plate leads to the 866 tubes before attempting use of r.f. chokes at this point. Strange to say, the exchange of the plate wires completely cured the trouble.

# RADIO SHACK *All Stars*

5-10 Hallicrafters

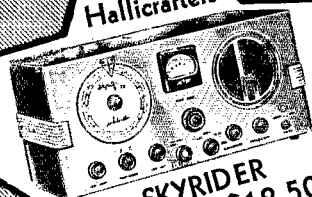

**SKYRIDER**  
Cash Price or \$12.50 down  
\$69.50 or \$5.23 for 12 months

WRITE for NEW CATALOG

S-17 Hallicrafters



**SUPER SKYRIDER**  
Cash Price or \$25.50 down  
\$125.50 or \$9 for 12 months

S-20 Hallicrafters



**SKY CHAMPION**  
Cash Price or \$9.50 down  
\$49.50 or \$7.33 for 6 months

S-22 Hallicrafters

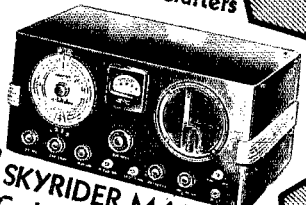

**SKYRIDER MARINE**  
Cash Price or \$11.50 down  
\$64.50 or \$4.88 for 12 mo

S-19 Hallicrafters



**SKY BUDDY**  
Cash Price or \$5.50 down  
\$29.50 or \$4.83 for 6 months

2 MFD. 2000 VOLT CONDENSER



All the characteristics of the finest.  
Spec. net price  
\$1.49

2-band operation

**NEW JOHNSON "Q" Beam Antenna**

Bands	Net Price
5 and 10	\$9.25
10 and 20	14.40

Chassis Crackle Finished and Electro Zinc Plated

*5 1/2 x 9 x 1 1/2	35c	10 x 14 x 3	69c
x 10 x 3	49c	10 x 23 x 3	89c
x 14 x 3	49c	7 x 17 x 2	63c
x 7 x 2	39c	10 x 17 x 3	66c
*7 1/2 x 9 x 2	42c	10 x 17 x 3	69c
x 7 x 2	45c	12 x 17 x 3	79c
x 11 x 2	49c	12 x 17 x 3	85c
x 13 x 2	59c	13 x 17 x 3	89c
x 15 x 3	65c		
x 12 x 3			

\*Available in Zinc Plated only

**NEW TAYLOR BEAM TUBE**

T-21.....	\$1.95
Triodes	
T20 and TZ20....	\$2.25
T40 and TZ40....	\$3.50
866.....	\$1.50
866 Jr.....	1.00
T55.....	6.00

**PLAY WHILE YOU PAY**

A small down payment and a year to pay the balance.

*Mail Orders Promptly Filled*

# The RADIO SHACK

46 BRATTLE ST. - BOSTON, MASS.

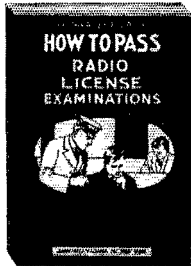

**Answers  
YOUR  
Questions**

**HOW TO PASS  
Radio License  
Examinations**

By CHARLES E. DREW, I.R.E., A.I.E.E.

This book is more than just a new edition of a famous work. It has been completely rewritten, and will serve as an excellent guide to all radiomen. Important phases of the subject are given thorough treatment, so that the man who understands the content of this book will be well qualified to pass the examination for his commercial license. **\$2.00**

**ON APPROVAL COUPON**

John Wiley & Sons, Inc.  
440 Fourth Avenue, New York, N.Y.

Kindly send me a copy of Drew's HOW TO PASS, on ten days' approval. If I decide to keep it, I will remit \$2.00; otherwise I will return the book postpaid.

Name .....

Address .....

City and State .....

Employed by .....

QST 11-38

**Academic Standards ENGINEERING Accredited Curricula**

*Newton Accredited Engineering* (parallels college curricula) designed for high school graduates seeking professional engineering (Radio, Elec., Civil, Mech.) careers. College recognition — credit transfer. University faculty; formal instruction based on college texts. Special Students admitted conditionally. Graduate Division; higher mathematics, advanced engineering. Bulletin available. *Newton Institute of Applied Science, 2021-G Raymond-Commerce Bldg., Newark, N. J.*

**HOME STUDY ON THE COLLEGE LEVEL**

**PRECISION CRYSTALS**

Highest quality crystals carefully prepared for frequency stability and maximum output. Rigidly tested to assure you of dependable operation. Be sure of your transmitter frequency — use PRECISION CRYSTALS.

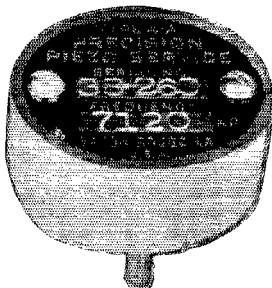

Type 4-A low drift unit plugs into a tube socket. Supplied within 5 kc. of your specified frequency in the 40, 80 or 160 meter bands. Calibration accurate to within 0.03%. Price, \$4.50.

'X' cut crystals supplied in type 4 holder for tube socket within 5 kc. of your specified frequency in the 40, 80 or 160 meter bands. Price, \$4.00.

Either the low drift crystals or the 'X' cut type can be supplied in square holders to plug into G.R. type jacks at the above prices.

Crystals for commercial requirements quoted on at your request. Now in our ninth year of business.

**PRECISION PIEZO SERVICE**  
**427 Asia Street Baton Rouge, La.**

**A.R.R.L. QSL Bureau**

FOR the convenience of its members, the League maintains a QSL-card forwarding system which operates through volunteer "District QSL Managers" in each of the nine United States and five Canadian districts. In order to secure such foreign cards as may be received for you, send your district manager a standard No. 10 stamped envelope. If you have reason to expect a considerable number of cards, put on an extra stamp so that it has a total of six-cents postage. Your own name and address go in the customary place on the face, and your station call should be printed prominently in the upper left-hand corner.

- W1—J. T. Steiger, W1BGY, 35 Call Street, Willimansett, Mass.
- W2—H. W. Yahnel, W2SN, Lake Ave., Helmetta, N. J.
- W3—Barron P. Freeburger, W3DK, 435 5th St., N. E., Washington, D.C.
- W4—G. W. Hoke, W4DYB, 328 Mell Ave., N. E., Atlanta, Ga.
- W5—E. H. Treadaway, W5DKR, 2749 Myrtle St., New Orleans, La.
- W6—Horace Greer, W6TI, 414 Fairmount Ave., Oakland, Calif.
- W7—Frank E. Pratt, W7DXZ, 5023 So. Ferry St., Tacoma, Wash.
- W8—F. W. Allen, W8GER, 324 Richmond Ave., Dayton, Ohio.
- W9—Roy W. McCarty, W9KA, 11 South Michigan Ave., Villa Park, Ill.
- VE1—J. E. Roue, VE1FB, 84 Spring Garden Rd., Halifax, N. S.
- VE2—C. W. Skarstedt, VE2DR, 236 Elm Ave., Westmont, P. Q.
- VE3—Bert Knowles, VE3QB, Lanark, Ont.
- VE4—George Behrends, VE4RO, 186 Oakdean Blvd., St. James, Winnipeg, Manitoba.
- VE5—H. R. Hough, VE5HR, 1785 First St., Victoria, B. C.
- K4—F. McCown, K4RJ, Family Court 7, Santurce, Puerto Rico.
- K5—Norman F. Miller, K5AF, 15th Air Base Squadron, Albrook Field, Canal Zone.
- K6—James F. Pa, K6LBH, 1416D Lunalilo St., Honolulu, T. H.
- K7—Dean Williams, K7ELM, Box 2373, Juneau, Alaska.
- KA—George L. Rickard, KA1GR, P. O. Box 849, Manila, P. I.

**Strays**

W3FXG, M. O. Marple, Jr., was called for jury duty recently, and found in the group chosen W3CAF, another ham bearing the Marple family name. W3QP wonders whether all the Smith hams may be collected together on some such memorable occasion.

Upon noticing some wild barley lodged between the feeders of W9XJL's transmitting antenna, an amateur, observing from some distance, exclaimed, "Look at the nice brush discharge."

—W9ONI

# HAM-ADS

(1) Advertising shall pertain to radio and shall be of nature of interest to radio amateurs or experimenters in their pursuit of the art.

(2) No display of any character will be accepted, nor can any special typographical arrangement, such as all or part capital letters be used which would tend to make one advertisement stand out from the others.

(3) The Ham-Ad rate is 15c per word, except as noted in paragraph (6) below.

(4) Remittance in full must accompany copy. No cash or contract discount or agency commission will be allowed.

(5) Closing date for Ham-Ads is the 25th of the second month preceding publication date.  
 (6) A special rate of 7c per word will apply to advertising which, in our judgment, is obviously non-commercial in nature and is placed and signed by a member of the American Radio Relay League. Thus, advertising of bona fide surplus equipment owned, used and for sale by an individual or apparatus offered for exchange or advertising inquiring for special equipment, if by a member of the American Radio Relay League takes the 7c rate. An attempt to deal in apparatus in quantity for profit, even if by an individual, is commercial and all advertising by him takes the 15c rate. Provisions of paragraphs (1), (2), (4) and (5) apply to all advertising in this column regardless of which rate may apply.

Having made no investigation of the advertisers in the classified columns, the publishers of *QST* are unable to vouch for their integrity or for the grade or character of the products advertised.

**QUARTZ**—direct importers from Brazil of best quality pure quartz suitable for making piezo-electric crystals.  
 Diamond Drill Carbon Co., 719 World Bldg., New York City.

**RADIO** engineering, broadcasting, aviation and police radio, servicing, marine and Morse telegraphy taught thoroughly. All expenses low. Catalog free. Dodge's Institute, Byrd St., Valparaiso, Ind.

**USED** receivers. Bargains. Cash only. No trades. Price list 3p. W3DQ, Wilmington, Del.

**QSL'S**, all colors, cartoons, snappy service. Write for free samples today. W1BEF, 16 Stockbridge Ave., Lowell, Mass.

**CALLBOOKS**—Fall edition now on sale containing complete up-to-date list of radio hams throughout entire world. Also world prefix map, press schedules and new time conversion chart. Single copies \$1.25. Canada and foreign \$1.35. Radio Amateur Call Book, 610 S. Dearborn, Chicago.

**QSL'S**, Cuts, Cartoons. Free samples. Theodore Forcher, 7708 Navahoe, Philadelphia, Penn.

**CRYSTALS**, mounted, 80-160 \$1.25, V-cut 40 \$2.25. R9 Crystals, 358 Murray Ave., Arnold, Pa.

**QSL'S**, Free samples. Printer, Corwith, Iowa.

**GENERAL** Electric 24/750 volt 200 mill dynamotors with filter, \$20. Westinghouse 500 watt 6-15 volt, \$8. 500 watt 500 cycle, \$8. 900 cycle 200 watts, \$15. Henry Kienzle, 215 Hart Blvd., Staten Island, N. Y.

**QSL'S**, finest quality, lowest prices, 500—\$2. postpaid. Free samples to hams. Howe Brothers, Wisner, Neb.

**RADIO** amateur course, 50¢ postpaid. W9KJF, Indianapolis.

**AMATEUR** Tube Engineering Handbook and Transmitter Circuits Hamanual and log book all for 50¢ postpaid. W9KJF, Indianapolis.

**NATIONAL**, Biley, Hammarlund, Hallicrafter, RME, RCA, Taylor, Thordarson, etc. Van Sickle, W9KJF, Indianapolis.

**QSL'S**, SWL's: one color 45¢, two color 60¢ hundred, postpaid. Samples. W1FTM, 268 Piedmont, Waterbury, Conn.

**BASSETT** buys for cash Collins, Harvey, Temco transmitters; National, Hammarlund, RME receivers; etc. Send data and desired price to W9ZDO.

**CRYSTALS**: X-cut, 1750-2000, 3500-4000, ± five kilocycles, \$1.50; spot frequency, \$2.50. Three small, 80 meter blanks, including carbondum, \$1.20. William Threm, W8FN, 3071 Moosewood St., Cincinnati, Ohio.

**TELEPLEXES**, instructographs, omnigraphs bought, sold. Ryan's, Hannibal, Mo.

**QSL'S**, SWL's. 100—3 color—75¢. Lapco, 344 W. 39th, Indianapolis, Ind.

**METER** repair: d.c. milliammeters, springs repaired, \$1.75. Thermocouples 1 to 5 amperes, \$2.50. Factory parts used, repairs absolutely guaranteed. Prices quoted on all meters. Braden Engineering Co., 1809 Fifth Ave., Dept. B, Dayton, Ohio.

**QSL'S**—print your own. W8HRL, 749 E. Moore St., Flint, Mich.

**METER** bargains: Weston Model 506 d.c. amperes 0-5, \$2.50. GE Type AO, a.c. amperes 0-30, \$2.50. W.E. galvanometers, \$2.50. Set of 12 new Ward Leonard vitreous enamel resistors 3/4" x 5/16" long, 600-1000-2000 ohms, \$1. Miller Surplus, 2553 Madison, Chicago, Ill.

**SELL** crystal microphones non-directional eight-ball model. Brand new latest factory product, \$8. each. White Sound Studio, 151 W. 63 St., New York, N. Y.

**TRANSMITTER** complete: 200 watts phone, 300 watts c.w., 10-20 meter coils, rack and panel, 9 Weston meters, Hammarlund, Cardwell, UTC, etc., parts. 53-807-p.p. 801's-T-125, 10 watt speech, 800's p.p. Class B, mod. Make offer. W3ASQ.

**NAT. FB7A** complete—best cash offer or trade for candid camera, F-2 lens. W9ZJZ.

**QST'S**—What is oldtime amateur offered for complete 15-year file of *QST*, 1923-1937 inclusive, in standard *QST* binders? Box 8, *QST*.

**QSL'S** of quality. W2AEY, 338 Elmora, Elizabeth, N. J.

**MUST** sacrifice surplus equipment. Send for list. E. Hatch, Box 691, Hyannis, Mass.

**NEW** standard W.E. relay racks, \$12.50 f.o.b. W6OZZ, 2603 Grande Vista, Oakland, Calif.

**HAVE** no time for radio; practically giving away hundred-watt transmitter, \$25.; super-gainer receiver, \$10. W5EUP, Box 692, Sweetwater, Texas.

**SELL** *QST* 1929-1934. Best offer. W9VBO.

**HF300's**, one nearly new, \$14.; two good, \$11.50 each. W7DES, c/o KDFN, Casper, Wyo.

**SELL** super-gainer complete kit, chassis, coils 10-200 tubes, less 6F6, \$16. VE4WF.

**WEBSTER** X71A2 Pickup. Used two hours. Guaranteed, \$5.50. W9CTF

**QSL'S**, Finest cards—lowest prices. Maleco, 1805 St. Johns Place, Brooklyn, N. Y.

**CRYSTALS**: Eidson's T9, 40-80 m., \$1.60. Holders, \$1.10. C.O.D.'s accepted. Espy's, W5CXH, 2223 State, New Orleans.

**BOOKS**—my entire library of radio and electrical engineering books at a fraction of their original cost. Write for list. Francis C. Kramer, W9DEI, St. Charles, Minn.

**SELL**: One 110 v. a.c. 60 cycle generator and gas engine rated 500 watts self-excited, 700 watts externally excited, one 32 v. d.c. to 110 v. a.c. at 2.2 amps. converter. Cash or trade or both. W3BBV, 859 E. Market St., York, Penn.

**CRYSTALS? BLILEY**. Patronize W8DED.

**QSL'S? Samples? Stamp**. W8DED, Holland, Mich.

**MEISSNER** signal shifters, \$39.95. W8DED.

**COMPLETE** 40 meter rig, \$15.; transceiver, \$12.50; 5 meter transmitter, \$7.50; new RCA 801's, \$5. pair. W1HLL, Melrose, Mass.

**SELL**: complete three-stage transmitter, \$19.50. Stimpson, 615 Alabama Ave., S.E., Washington, D. C.

**HALLICRAFTER** 1937 Sky Challenger, \$40. Complete all-band 200 watt phone. W1FZX, 37 Oakland St., Natick, Mass.

**WANTED**: cheap good National 80X or 81X receiver complete. W2IOP.

**TELECHART'S** copyrighted method will help you learn code. Easy and fast. Only 50¢ complete. Telechart, Box 25-Q, Knoxville, Tenn.

**SELL** *QST's* 1923 through 1937 complete—fine condition. W8KJ.

**SELL** PR-16 complete, \$50. Also noise silencer, \$4. F. M. Fiole, W5DPE, Canadian, Texas.

**CRYSTALS**: see Eidson's Hamad for complete dope. Van's very fine 160 meter crystals, \$1.25. Van Radio, 464 E. 117th, No. 7, Cleveland, Ohio.

**NATIONAL** NC81X—new condition—complete. Best offer. W2DCO.

**WHY** spray or squirt your signals? Shoot 'em straight down the bore with a tilting head rotary. Our variable speed worm drive starts, accelerates, reverses, stops, instantly. Drives any beam. Steer it with a Selsyn type synchronous direction indicator. Ball-bearing beam heads, \$5. Telescoping aluminum tubing. Save half on your beam. W8ML.

**WANTED**: FBX. W2KCK.

**ARTISTIC** QSL's. T. Vachovetz, Elmsford, N. Y.

**ROTARY** beams—complete arrays or special heat treated tubing only—very reasonable—write International Arrays, 1577 Olivewood Ave., Lakewood, Ohio.

**OLD** *QST's*. Will buy, sell, or trade. W9VKF.

**BIG** profits for radio hams selling shortwave diathermy apparatus and other electro-medical equipment to physicians. Old established firm. Exclusive territory. Intensive instruction course. McIntosh Electrical Corp., 225 N. California Ave., Chicago.

**LISTEN** for high frequency broadcast station W9XA, 26,450 kilocycles, Kansas City.

QSL'S, samples. Meador, Box 1534, Savannah, Ga.

1 mfd. 8000 v. mica. \$1.50; 203A Class B transformers, \$5., for 46's, \$3.50 (pairs); Western Electric 387W, \$3.50; misc. Thoradson transformers. Write for list of used bargains. Police Radio WMO, Highland Park, Mich.

ANTENNA wire, 42-strand phosphor bronze, rope center, 1 3/4 cents per foot prepaid. Minimum order 150 feet. Wanted: Dumont or NU 5-inch oscilloscope. John T. Duty, 30 Murray, Augusta, Me.

BOOK matches imprinted with your call letters—50 for \$1.00. Marine Crafts, 1360 Hicks St., Bronx, N. Y.

CUSTOM-built oscillograph, 3-inch tube, 13 tubes, relay rack mounted, used 30 hours. Thomas F. Marker, 1523 S. Emerson, Denver, Colo.

GENUINE EO1 cable, antenna wires. W8DT.

SELLING out—rig using RK20 final. Complete 1500 v. power supply. Write for details. W9TAY.

TRADE pair UTC 250W Class B, power equipment, VT73 Turner mike, pair T20's, all new, for Superhet. W6CZO, 1314 Hacienda, Bellflower, Calif.

T9 crystals: thousands of amateur and commercial users know from experience that Edson crystals are tops in high power output and dependability. You, too, will like these features together with our prompt service and reasonable prices. X-cut 40 and 80 meter bands, \$1.60; 7301-7500 kc. range, \$2. postpaid. C.O.D.'s accepted. Commercial folder on request. Announcing: improved T9 ceramic holder only \$1. You can't afford to pay less, why pay more. Fully guaranteed. These and other reputable dealers sell and vouch for T9 crystals: Espy's, 2223 State St., New Orleans, La.; Pembleton Laboratories, Ft. Wayne, Ind.; Frank Anzalone, 375 W. 46th St., N. Y. C.; Henry Radio Shop, Butler, Mo.; The Hargis Company, Austin, Texas; Casa Edison, Havana, Cuba; Van Radio, 464 117th St., No. 7, Cleveland, Ohio; or Edson's, Temple, Texas.

TRANSMITTER 6' metal rack and panels. 5 mtr. receiver complete. Write for particulars. Stanley Peirce, Topsfield, Mass.

WANTED: a 1938 Hallcrafters SX16 or SX18—will pay cash. Write to Edward Frazier, 46 E. Albion St., Somerville, Mass.

BRILLIANT 6' neon R.F. indicators, 50¢; super-sensitive, 75¢. W9LWB.

WANTED: Peak preselector. Ewing, 1057 Pratt, Chicago.

OHIO only: high power transmitter, receiver for sale. W8IPF TAYLOR and RCA transmitting tubes. Distributor. W8DT

TRANSCIEVER for 5, 30 w. phone trans. wanted. Ken Merian, Healdsburg, Calif.

SEND three cent stamp for list of tubes, amplifiers, meters, microphones, cables, condensers, test equipment, etc. Closing out former station W8EKK and public address systems. All apparatus hi quality. No junk. Charles Taylor, 235 Baker St., Corning, N. Y.

ESCO MG, 110 volt d.c. to 220 three phase a.c., 3.5 k.v.a., GE transformer 1300/2250 secondary, primary 220 three phase, tapped, 3 k.v.a. Both slightly used. Best offer takes them. W2AN.

WHEN buying amateur equipment whether you pay cash, trade equipment, or buy on terms, it's to your advantage to write me. Write me for quickest delivery of the latest equipment. Bob Henry, W9ARA, Butler, Mo.

BRAND new in factory cartons: S-10 Ultra-Skyriders, \$69.; ACR-175's, \$79.; PR-15's, \$99.; ACR-111 demonstrator, \$89. W9ARA.

BARGAINS: reconditioned guaranteed communications receivers shipped on ten-day trial. Practically all models at big savings. Buy these as well as all new models on my economical 6% terms. List free. W9ARA.

CODE machines rented. W9ARA.

OUR phonograph records of ur sigs, phone, CQ, etc., are F.B. Write for sked. 75c. Brown's Radio Lab., Dolgeville, N. Y.

CRYSTALS: spot frequency 80M crystals for AARS, NCR, etc. Mounted AT cuts, \$2.75. Ham Crystals, 1104 Lincoln Place, Brooklyn, New York.

TRANSMITTERS—power supplies—complete portable station. Write for complete list, now. Glassford, W2EQK, 12 Beekman Place, N. Y.

JENSEN A-12 hi-fidelity speaker, a.c., output transformer, baffle, hardly used, \$6. W2EXR.

BEST QSL's—SWL's made. Fritz, 455 Mason, Joliet, Ill.

CRYSTALS: free air mail service. Guaranteed crystals 160-80M AT and 40M X, \$1.95; 40M AT, \$2.75; loloss mounting, \$1. State frequency desired. Commercial crystals quoted. C.O.D.'s accepted. C-W Mfg. Co., 1170 Esperanza St., Los Angeles.

SELL cheap or swap—short wave receivers, double button mikes, motor generator, speech amplifiers, Class B mod. P.A. system, other parts. Want 852 and 845 tubes or what? Riley Parsons, Old Forge, N. Y., W8BXV.

RECEIVER headquarters. W8ANT.

BEAM antennas. W8ANT.

TRANSMITTER headquarters. W8ANT.

ALL lines of new and used transmitting and receiving equipment. Everything for the amateur. Equipment bought, sold, exchanged. Write to Southern Ohio's only amateur owned amateur business. Jos. N. Davies, W8ANT, 2767 N. Bend Rd., Sta. A., Cincinnati, Ohio.

## RADIO COURSES

RADIO OPERATING: Prepare for Gov't License Exam. ●  
RADIO SERVICING: Including Short Wave ● AMATEUR  
CODE ● ELECTRONICS ● TELEVISION

Day and Evening classes—Booklet upon request

NEW YORK YMCA SCHOOLS

4 West 63rd Street, New York City

## UNIDIRECTIONAL DYNAMIC D9T

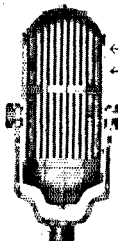

← BACK—No Pickup  
← FRONT—Full Coverage

VOLUME INCREASED  
by Reducing Feedback

D9T, List \$37.50, High Imp., 25' Cable

D9, List \$35.00, Low Imp., 25' Cable

Write for Catalogue No. 29

Manufacturers full line Dynamic, Crystal, and Carbon Microphones and Stands

AMERICAN MICROPHONE CO., INC.

1915 So. Western Ave.

Los Angeles, California

## RIVALS CRYSTAL FILTER!

A unique, single-unit, noise- and static-reducing, electro-acoustical device called Selectosphere. Universally adaptable to old and new ham receivers, from trios to supers. No alterations. Three years proven performance with amateurs, commercials and expeditions. See page 16, Feb. '38, QST. Selectosphere sold direct at \$3.95. Write for "dope."

SELECTOSPHERE CO., BOX 3, NEWTONVILLE, MASS.

Greater

5-METER DX



Concentrate your power on a single frequency with a Bliley HF-2 10-meter crystal. Ask your Bliley dealer for complete details.

BLILEY HF2 CRYSTALS

## SICKLES COMPONENTS FOR THE KINN EXCITER

Exact duplicates of the specially designed coils and other Sickles components used in the exciter described by T. P. Kinn, W1CC, in September QST, are available to amateurs at moderate cost.

For full particulars, write

THE F. W. SICKLES COMPANY

300 Main Street

Springfield, Mass.

# Your Nearest Dealer Is Your Best Friend

Your nearest dealer is entitled to your patronage. You can trust him. He is equipped with a knowledge and understanding of amateur radio. He is your logical and safe source of advice and counsel on what equipment you should buy. His stock is complete. He can supply your needs without delay. His prices are fair and consistent with the high quality of the goods he carries. He is responsible to you and interested in you.

Patronize the dealer nearest you—You can have confidence in him

## ATLANTA, GEORGIA

Wholesale Radio Service Company, Inc.  
265 Peachtree Street  
"The World's Largest Radio Supply House"

## MONTREAL, CANADA

Canadian Elec. Supply Co., Ltd.  
285 Craig St., W.  
Quality parts and equipment for discriminating buyers

## BALTIMORE, MARYLAND

Radio Electric Service Co.  
3 N. Howard St.  
Everything for the amateur

## NEWARK, N. J.

Wholesale Radio Service Company, Inc.  
219 Central Avenue  
"The World's Largest Radio Supply House"

## BOSTON, MASS.

Wholesale Radio Service Company, Inc.  
110 Federal Street  
"The World's Largest Radio Supply House"

## NEW YORK, N. Y.

Gross Radio, Inc.  
51 Vesey Street  
Fair dealings plus fair prices. Anything in radio

## BRONX, NEW YORK

Wholesale Radio Service Company, Inc.  
542 East Fordham Road  
"The World's Largest Radio Supply House"

## NEW YORK, N. Y.

Wholesale Radio Service Company, Inc.  
100 Sixth Avenue  
"The World's Largest Radio Supply House"

## BUFFALO, NEW YORK

Dymac Radio  
216 E. Genesee Street  
Ham and BCL Equipment W8RRL, W8OLB, W8GJ Cl. 2080

## NEW YORK, N. Y.

Harrison Radio Company  
12 West Broadway  
Harrison Has It! Phone WOrth 2-6276 for information or rush service

## BUFFALO, NEW YORK

Radio Equipment Corp.  
326 Elm Street  
W80BK — Ham, service and sound equipment

## PHILADELPHIA, PENNSYLVANIA

Eugene G. Wile  
10 S. Tenth Street  
Complete Stock of Quality Merchandise

## ELMIRA, NEW YORK

Miller's Radio Shack  
205 Railroad Avenue  
Fine equipment for amateurs

## RICHMOND, VIRGINIA

The Arnold Company  
Broad at Harrison St.  
W3EQQ — "The Virginia Ham Headquarters" — W3FBL

## JAMAICA, L. I.

Wholesale Radio Service Company, Inc.  
90-08 166th Street (Merrick Road)  
"The World's Largest Radio Supply House"

## ROCHESTER, NEW YORK

Radio Parts & Equipment Co.  
244 Clinton Avenue, North  
Complete stock amateur-BCL parts. Standard discounts

# You Are Protected When You Buy From QST Advertisers

“Advertising from QST is accepted only from firms who, in the publisher’s opinion, are of established integrity and whose products secure the approval of the technical staff of the American Radio Relay League.”

Quoted from QST’s advertising rate card.

Every conceivable need of a radio amateur can be supplied by the advertisers in QST. And you will know the product has the approval of the League’s technical staff.

## Index to Advertisers

American Microphone Company, Inc.	124
Astatic Microphone Laboratory, Inc.	110
Barker & Williamson	106
Billy Electric Company	78, 124
Browning Laboratories, Inc.	94
Candler System Company	84
Capitol Radio Engineering Institute	90
Cardwell Manufacturing Corp., Allen D.	82
Centralab	81
Collins Radio Company	Cov. 2
Communication Measurements Laboratory	120
Cornell-Dubilier Electric Corp.	92
Delaware Radio Sales Company	80
Dodge’s Institute	106
Dumont Electric Company, Inc.	98
Eitel-McCullough, Inc.	97
Feighner Technical Associates	118
Gardiner Levering Company	102
Hallcrafters, Inc., The	1, 2
Hammarlund Manufacturing Co. Inc.	79, 115
Harvey Radio Company	116
Harvey Radio Laboratories	80
Heintz & Kaufman, Ltd.	83
Henry Radio Shop	94
Hipower Crystal Company	117
Howard Radio Company	111
Instructograph Company	118
International Resistance Company	89
Johnson Company, E. F.	87
Kelsey Presses	115
Ken-Rad Tube & Lamp Corp.	117
Kenyon Transformer Company, Inc.	5
Mallory & Company, Inc., P. R.	76
Massachusetts Radio School	117
Meissner Manufacturing Company	109
Midland Television, Inc.	86
Mims Radio Company	117
National Company, Inc.	Insert, 75, Cov. 3
National Carbon Company, Inc.	91
National Union Radio Corp.	99
New York V. M. C. A. Schools	124
Newark Electric Company	103
Newton Institute of Applied Science	122
Ohmite Manufacturing Company	96
Port Arthur College	115
Precision Apparatus Corp.	88
Precision Piezo Service	122
Premax Products	118
RCA Institutes, Inc.	118
RCA Manufacturing Company, Inc.	Cov. 4
Radio Mfg. Engineers, Inc.	127
Radio Shack, The	121
Radio Supply Company	108
Radio Transceiver Laboratories	90
Ralston Record Company	114
Raytheon Production Corp.	77
Scientific Radio Service	115
Selectosphere Company	124
Shure Brothers	98
Sickles Company, F. W., The	124
Signal Electric Manufacturing Company	96
Solar Manufacturing Corp.	102
Speer Carbon Company	95
Sun Radio Company	112
Taylor Tubes, Inc.	93
Teleplex Company	106
Terminal Radio Corp.	108
Thordarson Electric Mfg. Company	85
Trimm Radio Manufacturing Company	102
Triplet Elec. Instrument Co., Inc.	92
United Transformer Corp.	128
Utah Radio Products Company	107
Ward Leonard Electric Company	110
Wiley & Sons, Inc., John	122
Wilson, Willard S.	80
Wincharger Corporation	114
Yaxley	76



# The RME-70

now on display at your dealers, and awaiting your approval . . . a REAL Communication Receiver at a very moderate cost

## CHECK THESE FEATURES

- ✓ Frequency coverage from 550 to 32000 KC
- ✓ Designated controls lettered on front panel
- ✓ Variable phasing crystal filter circuit, complete with crystal
- ✓ 3 iron core IF Transformers with extreme selective tuning
- ✓ 1-stage radio frequency amplification
- ✓ New automatic noise suppressor
- ✓ Break-in relay control circuit
- ✓ Monitor circuit incorporated
- ✓ Either black or gray crinkle finish—optional

**NEW  
LITERATURE  
NOW READY**

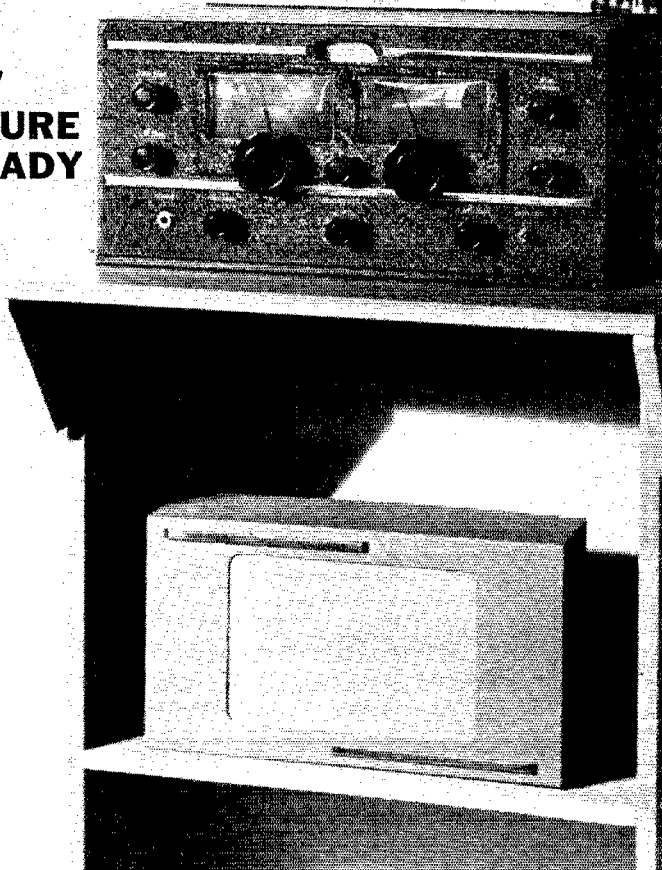

**RADIO MANUFACTURING ENGINEERS, INC.**  
**ONE ELEVEN HARRISON STREET PEORIA, ILLINOIS, U. S. A.**

# NEW COMMERCIAL TYPE POWER SUPPLY COMPONENTS

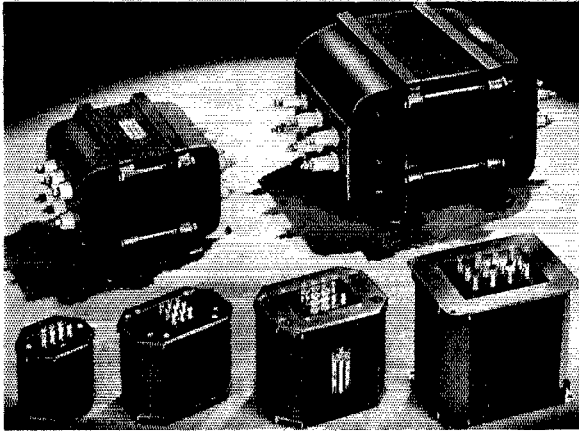

## LOW POWER FILTER CHOKES

Type No.	Inductance Henrys	D.C. MA.	D.C. res. Ohms	Case No.	List Price
PA-40	10	200	110	PA-2	\$4.50
PA-41	5-25	200	100	PA-2	4.50
PA-44	30	100 max.	375	PA-2	4.00
PA-45	250	15 max.	4500	PA-1	4.50
PA-48C	100	50 ma.	2500	PA-1	4.50

## SMOOTHING CHOKES

Tapped for humpbacking circuit. Commercial safety factors. Inductance rating at max. DC.

Type No.	Inductance Henrys	D.C. M.A.	D.C. res. Ohms	Case No.	List Price
PA-100	12	150	115	PA-2	\$5.00
PA-102	12	200	105	PA-3	8.00
PA-104	12	300	90	PA-4	12.00
PA-108	10	500	60	CA-1	20.00
PA-15	10	1000	50	CA-1	36.00

## HIGH POWER PLATE TRANSFORMERS

Primaries for 105, 115, 220, 230 volts, 50/60 cycles. For reduced power secondary voltages can be reduced to half by using 220V. Pri. on 110 volts. These transformers may be used on 25 to 43 cycles if 220V. Pri. is used on 110 volts.

Type No.	High Voltage	D.C. Voltage	D.C. MA.	Case No.	List Price
PA-300	825-515-0-515-625	500/400	200	PA-3	\$10.00
PA-301	580-530-300-0-300-530-580	475/425/250	500	PA-4	14.00
PA-302	950-750-0-750-950	780/610	325	PA-4	17.00

Type No.	High Voltage	D.C. Voltage	D.C. MA.	L	W	H	Wt. lbs.	List Price
PA-303	1500-1235-400-0-400-1235-1500	1250/1000/300	300/175	8	7 3/4	5 3/4	32	\$26.00
PA-304	1500-1235-0-1235-1500	1250/1000	800	14	11	9 3/4	118	65.00
PA-305	2400-1750-0-1750-2400	2000/1500	300	10	7 3/4	5 3/4	50	35.00
PA-306	2400-1750-0-1750-2400	2000/1500	500	14	11	9 3/4	120	65.00
PA-307	3500-3000-2400-0-2400-3000-3500	3000/2500/2000	300	13	11	9 3/4	110	60.00
PA-308	3500-3000-2400-0-2400-3000-3500	3000/2500/2000	500	15	11	9 3/4	140	85.00
PA-309	3500-3000-2400-0-2400-3000-3500	3000/2500/2000	1000	17	14	11 3/4	210	135.00
PA-310	4600-4050-3500-0-3500-4050-4600	4000/3500/3000	800	15	14	11 3/4	168	105.00
PA-311	1500-1235-0-1235-1500	1250/1000	500	10	7 3/4	5 3/4	50	35.00

THE new UTC PA power transformers and Chokes have been designed to commercial standards. Temperature rise and insulation requirements are in accordance with the conservative specifications of the A.I.E.E. and Fire Underwriters. Temperature rise is less than 55 degrees C., and units are tested for breakdown on all windings at twice working voltage plus 1,000 volts. In addition, plate transformers are given a surge test at 2 1/2 times normal applied voltage using a 500 cycle supply. In view of the conservative ratings and manufacturing procedure, these units are suitable for use on most types of government and standard commercial communication equipment in addition to amateur service.

## COMBINED PLATE AND FILAMENT TRANSFORMERS

Primary 115 volts 50/60 cycles. \*Tapped for either voltage. † Replaces former transformer types PA-22, PA-425 and PA-426

Type No.	High Voltage	DC. MA.	FIL. 1	FIL. 2	FIL. 3	FIL. 4	Case No.	List Price
PA-422	435-365-0-365-435 125-0-125	125	5V-3A	5V-2A	6.3 VCT-3A	2.5 VCT-5A	PA-3	\$10.00
PA-428	500-0-500 80-0-80	250	5V-3A	5V-2A	6.3 VCT-4A	*6.3 VCT-3A †3.0 VCT-3A	PA-4	14.00
PA-429	600-525-0-525-600	250	5V-3A	6.3 VCT-3A	*7.5 VCT-3A †6.3 VCT-3A		PA-4	15.00
PA-431	500-400-0-400-500 80-0-80	500	5V-6A	5V-2A	6.3 VCT-5A	6.3 VCT-2A	CA-1	22.50

## UNIVERSAL BIAS TRANSFORMERS

Primary 115 V 50/60 cycles. No filament windings.

Type No.	D.C. Voltage	D.C. M.A.	Case No.	List Price
PA-315	Tapped for any voltage from 15 to 100 V within 6 %	250	PA-2	\$6.50
PA-316	Tapped for any voltage from 75 to 400 V within 6 %	250	PA-4	15.00

## SWINGING INPUT CHOKES

Type No.	Inductance Henrys	D.C. M.A.	D.C. res. Ohms	Case No.	List Price
PA-101	5-25	150	115	PA-2	\$5.00
PA-103	5-25	200	105	PA-3	8.00
PA-105	5-25	300	90	PA-4	12.00
PA-109	5-25	500	60	CA-1	20.00
PA-1C	5-25	1000	50	CA-1	36.00

## FILAMENT TRANSFORMERS

Primary for 105, 115, 220, 230 volts, 50/60 cycles. These transformers may be used on 25 to 43 cycles if 220 volt primary is used on 110 volts. Secondary voltage is simultaneously reduced to half.

\*Two Windings.

Type No.	Sec. Volts C. T	Sec. Amps.	Working Voltage	Test Voltage	Case No.	List Price
PA-34	2 1/2	10	2500	6000	PA-2	\$7.50
PA-120	2 1/2	10	5000	11000	PA-3	9.00
PA-121	5	22	5000	11000	PA-3	14.00
PA-122	7.5/6.3	3	1500	4000	PA-2	11.00
PA-124	10	10	1.00	4000	PA-3	12.00
PA-125	14/12/11	10	1500	4000	PA-3	14.00
PA-126	*14/11/10 14/11/10	10 10	1500	4000	PA-4	20.00

ALL PRICES SHOWN ARE SUBJECT TO AMATEUR DISCOUNT.  
YOUR COPY OF THE NEW PS-403 Bulletin is waiting at your local UTC JOBBER

# UNITED TRANSFORMER CORP.

72 SPRING STREET NEW YORK, N. Y.

EXPORT DIVISION 100 VARICK STREET NEW YORK, N. Y. CABLES "ARLAB"

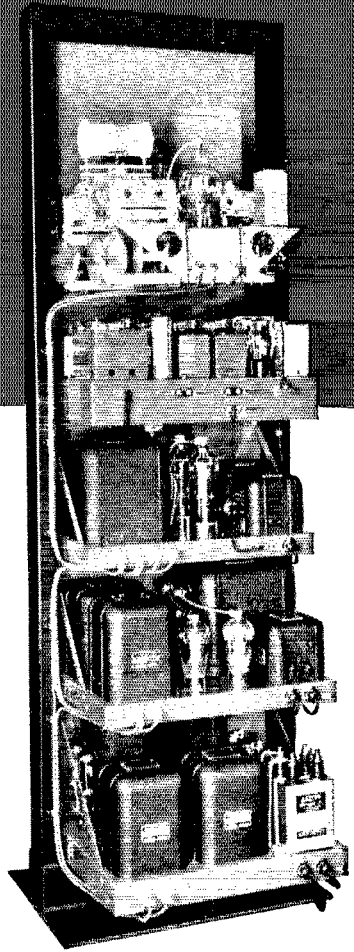
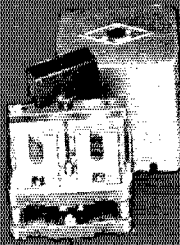
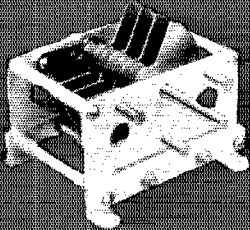
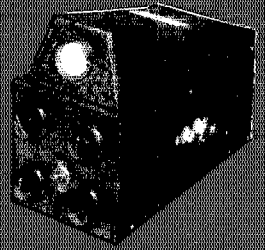
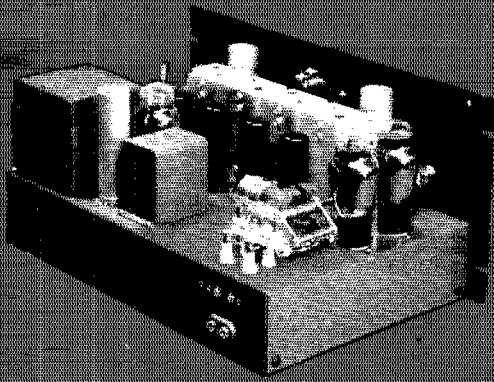

**LOW IN COST**  
**LONG LIVED**  
**VERSATILE**  
**HIGH IN PERFORMANCE**  
**NATIONAL QUALITY**

NATIONAL makes a complete line of Transmitting Equipment, ranging from acorn tube sockets to complete transmitters. Right down the line, every item is designed to meet amateurs' needs dependably, conveniently and at low cost. And most important, National products have versatility as well as long life so that gear bought for today's needs will find its place in next year's rig.

*Tomorrow's  
Tube TODAY!*

# NEW RCA 813

**gives 260 watts output  
with less than 1 watt  
Driving Power!**

**IT'S A FACT!** This sensational new RCA Beam Power Transmitting Tube actually requires less than one watt driving power to give 260 watts output in Class "C" Telegraph service. Needing no neutralization, a pair of 813 makes a bang-up final for that quick-bang change, high-power transmitter.

The new 813, is among the finest transmitting tubes RCA has ever developed, employs a new stem structure which makes practical a compact tube—only 7½" long—having very short heavy leads and low lead inductance. Because of its design, this new high-power beam tube can be operated at full ratings up to 30 megacycles without neutralization.

Other noteworthy features of this new tube are: Heavy-duty thoriated-tungsten filament, oversized graphite plate, dome-top bulb with cushion mounting supports, low screen current, and a new Giant 7-pin base having short shell and wide pin spacings.

### *Typical Operation (Class "C" Telegraphy)*

- Filament Voltage  
10 volts (a. c. or d. c.)
- Filament Current  
5 amperes
- D-C Plate Voltage  
2000 volts
- D-C Screen Voltage  
400 volts
- D-C Grid Voltage  
-90 volts
- D-C Plate Current  
180 milliamperes
- D-C Screen Current  
15 milliamperes
- Driving Power  
0.5 watt
- Power Output  
260 watts
- Price, \$28.50 Amateur Net.

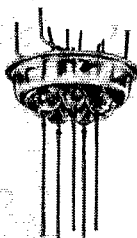

View of moulded glass stem assembly showing individual lead seals.

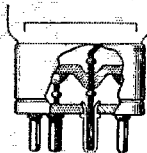

Cut-away view showing short, heavy leads to terminal pins.



## Radio Tubes

RCA MANUFACTURING COMPANY, INC., CAMDEN, N. J.  
A Service of the Radio Corporation of America

# NATIONAL

# RECEIVERS





## NATIONAL HRO

*A professional receiver, designed for maximum performance. Two preselector stages give remarkable weak signal response, signal-to-noise ratio, and image suppression to the HRO. Two high gain IF stages employ Litz-wound coils and air condensers. The usable sensitivity and selectivity are exceptional. Circuit details include AVC, MVC, S-meter, crystal filter, CW oscillator, phone jack and*

Send-Receive switch. When standard HRO coils are used for general coverage, each of the four coils includes two amateur bands and the spectrum between. A simple switching device is provided which makes these same coils bandspread their respective amateur bands over a span of 400 divisions on the dial.

A simplified model having the same constructional and design features, but omitting the crystal filter, the S-meter, and the bandspread feature on the coils, is known as the HRO Junior. It is considerably lower in price.

The net price of the standard HRO table model, including coils (1.7-30 MC), tubes, speaker in cabinet and power supply is \$210.18. Refer to the general catalogue for a complete listing.

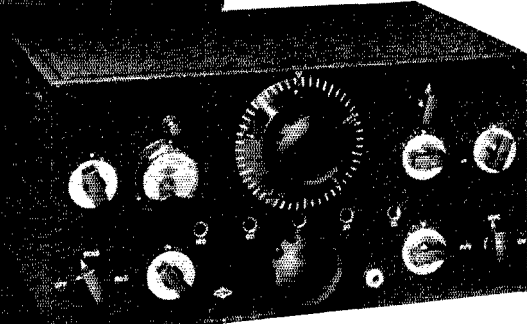

## NATIONAL NC-100A NC-101X

*Fine Communication Receivers with splendid tone. These 11 tube superheterodynes are self-contained (except for the speaker) in table model cabinets that can be readily adapted to relay rack mounting. One stage of RF and two stages of IF amplification are used. High quality construction throughout gives a performance approaching that of the HRO. Automatic plug-in coils are selected from the panel by rotating a knob. Circuit details include AVC, MVC, S-meter, crystal filter, CW oscillator, phone jack and Send-Receive switch.*

The NC-101X, illustrated above, is built strictly for the amateur bands. It covers only the ranges: 1.7-2.05 MC, 3.5-4.0 MC, 7.0-7.3 MC, 14-14.4 MC and 28-30 MC.

The NC-100XA, illustrated below, gives continuous coverage from 540 KC to 30 MC. The NC-100A is similar, but without the crystal filter.

The net prices of the AC operated models, complete with tubes and 10-inch speaker in cabinet are as follows: NC-101X, \$129.00; NC-100XA, \$142.50; NC-100A, \$120.00.



# NATIONAL

## NATIONAL NC-81X

*An excellent Communication Receiver at a moderate price. This inexpensive ten tube superheterodyne uses a 1560 KC IF Amplifier, giving excellent image suppression (better than in many receivers having elaborate preselectors). The crystal filter is of advanced design, with continuously variable selectivity from 400 cycles to 5 KC, and with phasing range similarly extended. The range changing system is similar to the NC-100. The NC-81X is an amateur model, covering the following bands only: 1.7-2.05 MC, 3.5-4.0 MC, 7.0-7.3 MC, 14.0-14.4 MC, and 28-30 MC. The NC-80X is a similar receiver with continuous coverage from 550 KC to 30 MC, except for a small gap at 1560 KC. The net price of either receiver, complete with tubes, crystal filter, 8-inch speaker in cabinet, etc., for 115 V., AC or DC, is \$99.00.*

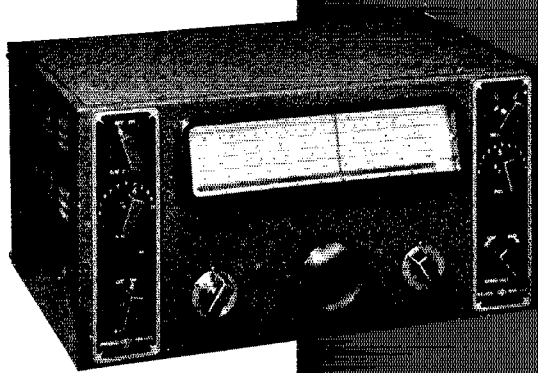

## NATIONAL NC-44

*For capable performance at very low price. A seven tube superheterodyne with continuous coverage from 550 KC to 30 MC in four ranges, with coil switch. A straight-line-frequency main condenser is used in conjunction with a separate bandspread condenser; both have inertia-type tuning. A CW oscillator is provided. The net price of the NC-44 Table Model, complete with tubes, coils and speaker chassis, for 105-130 V. AC or DC, is \$49.50.*



## NATIONAL SW-3

*An old favorite — the dependable regenerative receiver. When the SW-3 was first introduced its performance was considered phenomenal. Today, after seven years, its performance is still rated so high that it is preferred for many classes of work. It uses three tubes in a highly developed circuit that provides maximum sensitivity and flexibility. The net price of the SW-3, without tubes, coils, power supply or phones, is \$21.00. Coils are available for coverage from 9 to 3000 meters. Coils are \$3.00 net per pair for all amateur frequencies.*

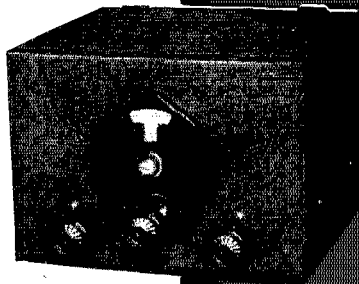

# NATIONAL



## NATIONAL NC-510

*A specialized superheterodyne covering 28 to 64 MC. The NC-510 is strictly a communication receiver, embodying all the features commonly needed in such work, but is specialized to give maximum performance in the range from 28 to 64 MC. The RF circuit and tubes are built completely inside the frame of*

*the three gang tuning condenser. The coils are mounted in a revolving turret shield directly below the condenser assembly. This compact assembly provides the shortest possible leads from coils to condensers to tubes. A 956 acorn is used in the RF, a 954 in the first detector, and a 955 in the HF oscillator. Circuit details include a wide range crystal filter (300 cycles to 7 KC), CW oscillator, AVC, S-meter, stabilized HF oscillator and phone jack. Output is two watts for speaker. Inter-channel noise suppression for quiet standby operation can be supplied on special order. The net price of the NC-510, complete with tubes, coils, speaker and power supply is \$150.00.*

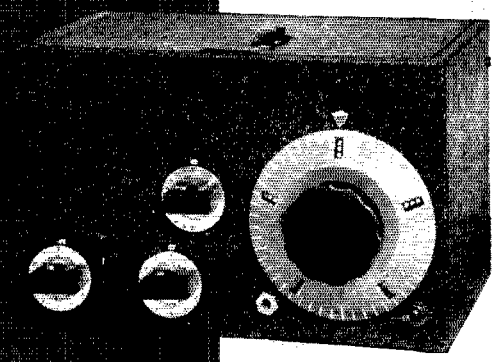

## NATIONAL ONE-TEN

*A specialized receiver for the range from 1 to 10 meters. The One-Ten Receiver is intended primarily for the experimenter. It is a thoroughly satisfactory receiver for the ultra-high frequencies, but cannot equal the NC-510 or the HRO on the frequencies which they cover. A four tube circuit is used, composed of one tuned RF stage, a self-quenching super-regenerative*

*detector, first audio, and power output. Acorn tubes (954 and 955) are used in high frequency circuits. The net price of the One-Ten, with 6 sets of coils, but without tubes, power supply or speaker, is \$51.00.*

# NATIONAL