

QST

DEVOTED ENTIRELY TO

AMATEUR RADIO

Published by the American Radio Relay League

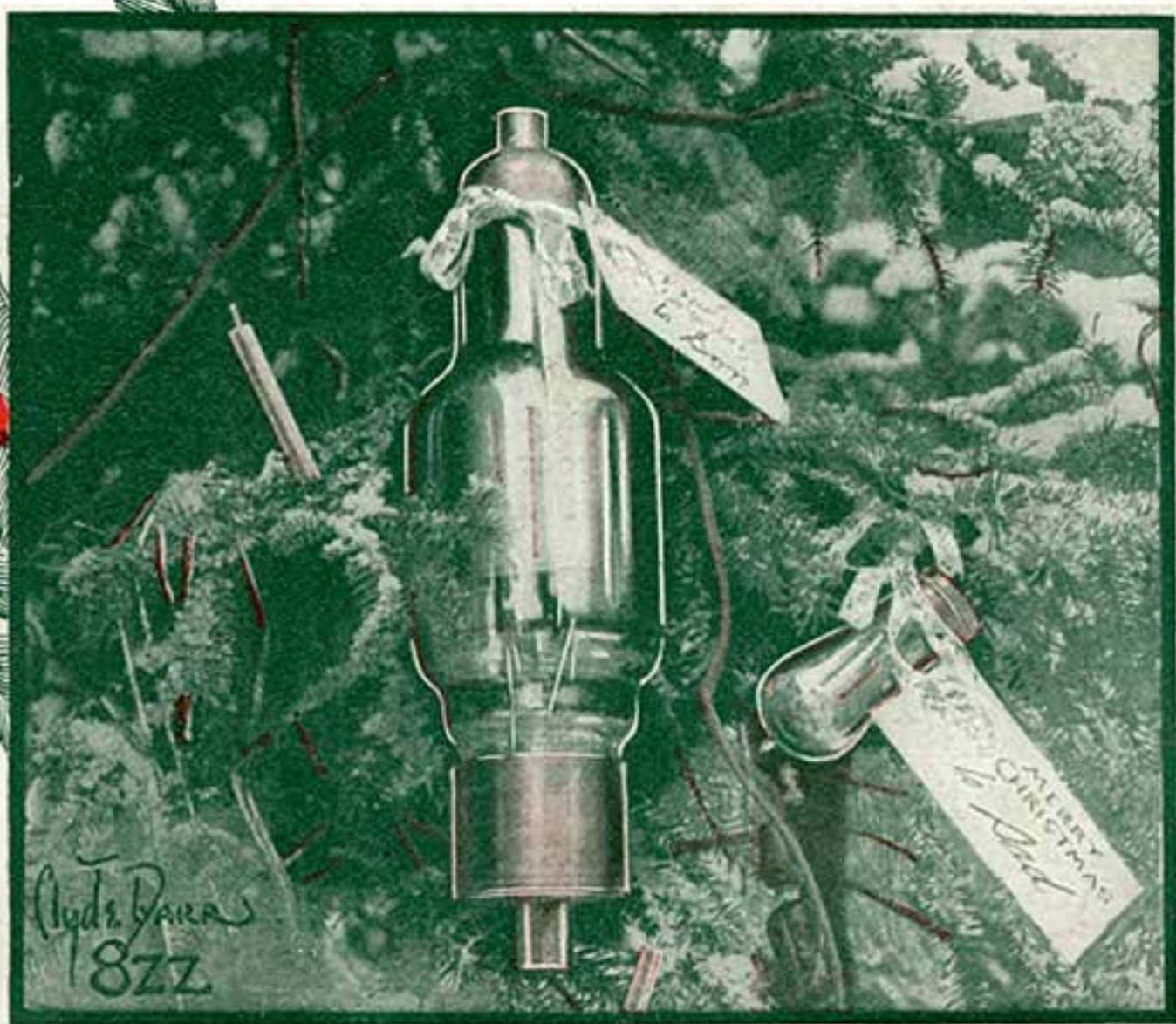

DECEMBER
1925

25¢

Cunningham RADIO TUBES



*Ever Alert—
Always on Duty—*

CUNNINGHAM RADIO TUBES are the sentinels which guard radio reception from distortion and discord. Enlist them for long faithful service in every socket of your broadcast receiver---place them on the firing line---and when the strain grows terrific---then you will learn why these radio tubes have a ten year record of success behind them.

Since 1915 --- Standard for All Sets

\$2.50
each

E. J. Cunningham, Inc.

CHICAGO

Home Office: 182 Second Street
SAN FRANCISCO

NEW YORK

You Fellows Invented "Low-Loss" Do We Measure Up?

Long ago Q S T coined the term "Low-Loss." The radio industry welcomed it so eagerly that Brother Kruse complained of the way this "brain-child" was abused. Seems that manufacturers "hain't done right by our Nell." *Everything* became Low-Loss.

It's time to speak up. We make the well-known Thorola "Low-Loss" Doughnut Coil. We know that it really is "Low-Loss." Its construction as well as its toroidal principle will stand the most searching scientific analysis. And its behavior in the Thorola Islodyne receiver fully justifies your attention and scrutiny.

For several months Q S T readers have been invited to make their own test of the Thorola Islodyne. Events have proved that our confidence has not been misplaced. Here we are again deliberately waving that invitation before the most confirmed and habitual sceptics. See for yourself. And decide whether we have kept faith with Q S T

Thorola Doughnut Coils are supplied separately and as part of the Thorola Islodyne. The Thorola dealer is fully equipped to serve you.

REICHMANN COMPANY, 1725-39 West 74th Street, CHICAGO

Thorola
I S L O D Y N E

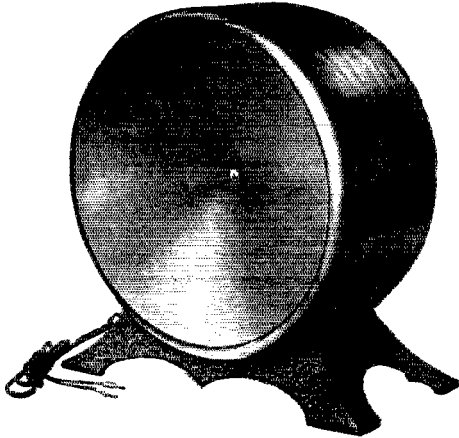

The Acme "double free-edge cone" loud speaker. Puts back into the so-called "Radio voice" the living, recognizable, individualistic tones of each speaker. Round model (shown) \$25.00. Cabinet model \$35.00

To our old friends of Q S T a little "tip"!

YOU have probably seen a dozen loud speaker advertisements in the last month. Horns, cones, what not. You've read all sorts of claims.

Now just between us—as old timers, here's a tip.

Frankly, it relates to Acme, but you don't care do you, as long as you get what you're looking for?

Well to make it quick. Acme has a new "double free-edge cone" loud speaker. We have no reputation as slow pokes, but it's taken us exactly 5 years, thousands on thousands of dollars and 256 experimental models to make it right—to give exact reproduction of the human voice and all musical instruments.

Perhaps we need scarcely tell you real amateurs what you can expect from speakers hastily conceived and hastily

manufactured. If it has taken us 5 years with all our experience specializing on "amplification without distortion" what must be the answer?

So hear the new Acme—we know you'll know.

Meanwhile, if you haven't already a copy, be sure to send for the new 10th Edition of "Amplification without Distortion"—ask also for Bulletin T of Acme Transmitting Apparatus.

Claude Hains

President Acme Apparatus Co.

Send for
your copy!

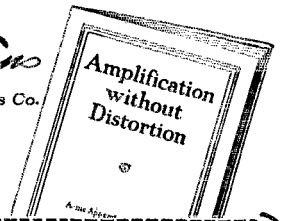

ACME APPARATUS COMPANY
Dept. E, 11 Cambridge, Mass.

Enclosed find ten cents stamps or coin for my copy of the new 10th edition of "Amplification without Distortion". Please also send bulletin T on Acme Transmitting Apparatus.

Name.....
Street.....
City..... State.....
Station Call.....

ACME

~for amplification

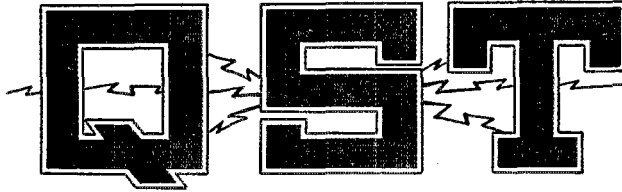

The Official Organ of the A.R.R.L

VOLUME IX

DECEMBER, 1925

NUMBER 12

Editorials	7
The Second Pacific Division A.R.R.L. Convention	8
Toroids	<i>F. J. Marco</i> 9
Practical Picture Transmission	<i>Thornton P. Dewhirst</i> 12
Financial Statement	17
Receiver and Wavemeter Calibration	<i>J. A. Baker</i> 18
New Coils and Condensers	19
Low Power Station <i>2BBX</i>	<i>Burton Synnot</i> 20
The Mast at 9KC	23
Amateur Filter Problems	<i>F. S. Dellenbaugh</i> 24
Experimenters' Section Report	27
A Correction—"Reviewing the Receiver"	28
In Memoriam	28
Frequency Doubling in Vacuum Tubes	<i>T. T. Greenwood</i> 29
A New Porcelain Socket	30
A New Vernier Dial	30
Obituary—C. T. Caswell	30
The New Carborundum Detector	<i>M. L. Hartmann and J. R. Mcagher</i> 31
What is the Radio Club of Argentina?	<i>Enrique L. Repetto</i> 33
An Inexpensive Low Power Transmitter from Receiving Parts	<i>Rufus P. Turner</i> 35
Small Panel-Mounting Meters	36
Book Reviews	<i>R. S. Kruse</i> 37
Proper Graduations for Dials	<i>C. A. Briggs</i> 39
A Three-Tube Neutrodyne for Short Waves	<i>Dave Ablowich, jr.</i> 41
Rating Circuit Resistance	<i>G. H. Browning</i> 42
Speaking of Low Power Work	<i>John M. Clayton</i> 44
Variometer Tuning for C. W. Reception	<i>Raymond C. Schlorf</i> 46
Opening Out the Tuning Scale	<i>R.S.K. and Albert W. Sonn</i> 48
How to Eliminate Body Capacity Effects	<i>Dale G. Buffington</i> 50
Amateur Radio Stations	<i>2WC, 5ZAI, 9UQ</i> 51
I. A. R. U. News	54
Errata	57
Calls Heard	58
Communications	62

Official Organ of the International Amateur Radio Union

QST is published monthly by The American Radio Relay League, Inc., at Hartford, Conn., U. S. A.

Robert S. Kruse,
Technical Editor

Kenneth B. Warner (Secretary, A.R.R.L.)
Editor-in-Chief and Business Manager

Edwin Adams,
Advertising Manager

John M. Clayton,
Asst. Technical Editor

F. C. Beekley,
Managing Editor

David H. Houghton,
Circulation Manager

Subscription rate in United States and Possessions, Canada, and all countries in the American Postal Union, \$2.00 per year, postpaid. Single copies, 25 cents. Foreign countries not in American Postal Union, \$2.50 per year, postpaid. Remittances should be by international postal or express money order or bank draft negotiable in the U. S. and for an equivalent amount in U. S. funds.

Entered as second-class matter May 29, 1919, at the post office at Hartford, Connecticut, under the act of March 3, 1879. Acceptance for mailing at special rate of postage provided for in section 1103, Act of October 3, 1917, authorized September 8, 1922. Additional entry as second-class matter, acceptable at special rate of postage provided for above, at Springfield, Mass., authorized September 17, 1924.

Copyright 1925 by the American Radio Relay League, Inc., Title registered at United States Patent Office.

Member of the Radio Magazine Publishers' Association.

Real Progress in Radio

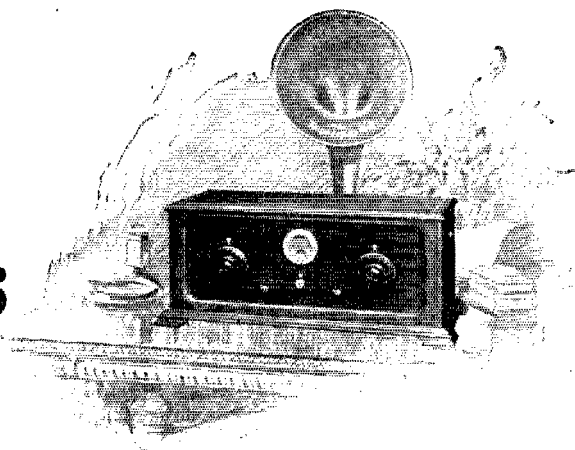

Emphatically Yes!

Radio IS marching forward, this season as before. But it is marching in a new direction.

Quality of Reception.

That is the big, new theme. And the new Jewett Receiver is its inspiration.

At last Radio commands a Receiver that is truly a Musical Instrument, by a manufacturer of experience in the musical instrument field.

Mere words cannot describe this new Jewett Quality of Reception. You must hear and understand.

So just visit an authorized Jewett Dealer and let him prove to you that here is a new kind of Radio—so different from the old as to create new standards and ideals.

For the first time, B-Battery current and resulting distortion have been completely barred from the speaker circuit.

You should know the story of this epoch-marking Receiver and its birth in the brains of our straight-thinking young engineers who refused to admit that it couldn't be done. Ask us for it.

"There Is No Substitute For The Best"

JEWETT RADIO & PHONOGRAPH CO.
5674 TELEGRAPH RD. PONTIAC, MICH.

Factories: Allegan, Mich.—Pontiac, Mich.

In Canada: Jewett Radio-Phonographs, Ltd., Walkerville, Ont.
Export Sales Offices: 116 Broad Street, New York City

Special Wednesday WJR feature
—The Burroughs Hour, 9 to 10 p. m.



The Jewett Receiver

The Jewett Superspeaker

The Jewett Superspeaker Console

The Jewett Cone

The Jewett Vemco Unit

The Jewett Parkway Cabinet

The Jewett Micro-Dial

The Jewett Superspeaker Highboy

"Quality Broadcasting to Match Quality Products—Station WJR"

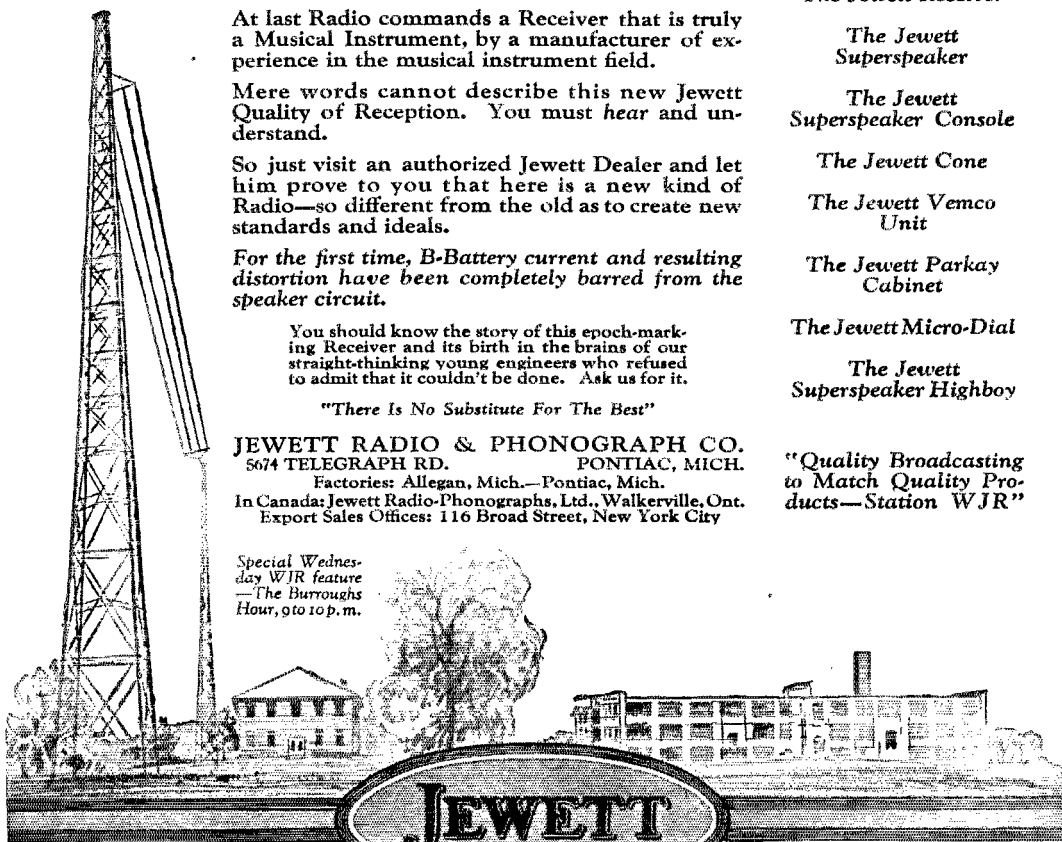

© 1925 Jewett Radio & Phonograph Co.

THE TRAFFIC DEPARTMENT, A. R. R. L.

Manager
A.D.M. D. of C.
A.D.M. Maryland
A.D.M. No. N. J.
A.D.M. West. N. Y.
A.D.M. East. Pa.
A.D.M. West. Pa.
A.D.M. Delaware

3DW
3AB
3HG
3EH
3PJ
3FM
3ZD
3A1S

Manager
A.D.M. Michigan
A.D.M. Ohio
A.D.M. Illinois
A.D.M. Wisconsin
A.D.M. Indiana
A.D.M. Kentucky

3ZN
3ZZ
3AA
3CA
3VD
3CYQ
3EI

Manager
A.D.M. Minnesota
A.D.M. So. Dak.
A.D.M. No. Dak.

3ZT-3XAX
3GGU
3GJS
3CSI

Manager
A.D.M. Mississippi
A.D.M. Arkansas
A.D.M. Tennessee
A.D.M. Louisiana

3MB
3AKP
3XAB
3CN
3TK

Manager
A.D.M. No. N. J.
A.D.M. N. Y. C.
A.D.M. East. N. Y.

3RRB
3WR
3WR
3GK-2XAB

Manager
Asst. Secy to DM.
A.D.M. Iowa
A.D.M. Mo.
A.D.M. Kansas
A.D.M. Nebraska

3DXY
3BYG
3ARZ
3RR
3CNS
3CT

Manager
A.D.M. R. I.
A.D.M. N. H.
A.D.M. Vt.
A.D.M. E. Mass.
A.D.M. Conn.
A.D.M. Maine

1AWW
1BYB
1GL
1AJG
1KY
1BM
1EF

Manager
A.D.M. Montana
A.D.M. Wash.
A.D.M. Oregon
A.D.M. Idaho
A.D.M. Alaska

7ABB
7NT
7GE
7IV
7OB
7DE

Mgr. Southern Section
A.D.M. Dist. 1, 2, 3
A.D.M. Ariz.
Mgr. Northern Section
A.D.M. Dist. 4
A.D.M. Dist. 5
A.D.M. Dist. 6
A.D.M. Nevada
Mgr. Hawaiian Section

3ANT-3LJ
3CTO
3ZZ
3ZX
3NX
3AWT
3HAF
3GO
3TO

Manager
A.D.M. West Va.
A.D.M. Virginia
A.D.M. No. Carolina

3HZ
3BSU-AKZ
3CA
3JR

Manager
A.D.M. Colo.
A.D.M. Utah

7ZO
9CAA
6ZT

Manager
A.D.M. S. U.
A.D.M. Ala.
A.D.M. Fla.
A.D.M. Ga.
A.D.M. Porto Rico

4KT
4RR
5ABP
4EZ
4IO
4OI

Manager
A.D.M. Oklahoma
A.D.M. So. Texas
A.D.M. No. Texas

5ZU
5APG
5YK
5AJT

Manager
A.D.M. P. E. I.
A.D.M. N. E.

1DD
1BZ
1EI

Manager
A.D.M. Can. Ont.
A.D.M. West. Ont.
A.D.M. East. Ont.

3NI
3BJ
3X1
3APP

Manager

3CG

Manager
A.D.M. Sask.
A.D.M. Manitoba

3AO
4CB-9BX
1DE

ATLANTIC DIVISION

E. R. Duval
B. Goodall
G. L. Deichmann, Jr.
H. W. Denstau
C. S. Taylor
J. E. Rau
P. E. Wiggin
H. H. Layton

Box 317
1324 Inglewood Ter.
Chapel Gate Lane
149 Washington St.
598 Masten St.
1551 So. 58th St.
6044 Hoeveler St., E. E.
305 Washington St.

Edmonston, Md.
Washington
Ten Hills, Baltimore
Collingswood
Buffalo
Philadelphia
Pittsburg
Wilmington

CENTRAL DIVISION

R. H. G. Mathews
C. E. Darr
C. E. Nichols
G. W. Bergman
C. N. Crapo
D. J. Angus
J. C. Anderson

2747 Hampden Court
137 Hill Ave., Highland Pk.
739 Westlock Ave.
443 Newton Ave.
310 N. Illinois St.
Glensary Farm

Chicago, Ill.
Detroit
Lima
Ft. Worth
Milwaukee
Indianapolis
Lexington

DAKOTA DIVISION

D. C. Wallace
C. L. Barker
M. J. Jenkins
M. L. Monson

54 N. Penn Ave.
E. 12th St.

Minneapolis, Minn.
Hennepin
Brvant
Grafton

DELTA DIVISION

B. E. Pinter
J. W. Gullett
Dr. L. M. Hunter
L. K. Rush
C. A. Feitag

124 Hamilton Nat. Bank Bldg.
819-29th Ave.
207 1/2 Main St.
4 Second St.
8520 Forshey St.

Chattanooga, Tenn.
Meridian
Little Rock
Bemis, Tenn.
New Orleans

HUDSON DIVISION

E. M. Glaser
A. G. Wester, Jr.
F. H. Alarion
G. Kastenmeyer

845 E. 13th St.
1075 Chancellor St.
1409 W. Farms Rd.
417 Paige St.

Brooklyn, N. Y.
Irvington
Bronx
Schenectady

MIDWEST DIVISION

P. H. Quinby
B. Diehl
D. E. Watts
L. B. Lazure
C. M. Lewis
H. A. Nielsen

Box 134A, Rt. 6
3006 So. Ave.,
116 Hyland Ave.
3020 Mercer St., E. F. D. 1
312 E. Rutledge St.
4708 N. 39th St.

Omaha, Nebr.
Omaha, Nebr.
Ames
Kansas City
Yates Center
Omaha

NEW ENGLAND DIVISION

E. F. Cushing
D. B. Fancher
C. P. Sawyer
Charles T. Kerr
Miss Gladys Hannan
H. E. Nichols
A. F. Wheeldon

78 College St.
86 Franklin St.
11 State St.
3 Sumner Rd.
60 Benham Ave.
165 State St.

Springfield, Mass.
Westerly
Manchester
Foultney, Vt.
Cambridge
Bridgeport
Ellsworth

NORTHWESTERN DIVISION

Everett Kiek
A. R. Willson
L. C. Maybee
Paul R. Hoppe
K. S. Norquest
Leo H. Machin

3302 Hoyt Ave.
1321 W. Platinum St.
110 S. 7th Ave.
College Hill,
Weather Bureau

Everett, Wash.
Butte
Pasco
Eugene
Boise
Cordova, Alaska

PACIFIC DIVISION

M. E. McCreery
E. H. Burdman
H. L. Gooding
P. W. Dann
E. J. Guement
B. Molinari
St. Clair Adams
C. B. Newcomb
K. A. Cantin

317 Central Ave.
1200 Tamarind Ave.
Box 175
562-25th St.
51 Pleasant St.
653 Union St.
1503 Pihoiki St.

Los Angeles, Calif.
Hollywood
Douglas
Oakland
San Jose
San Francisco, Cal.
Bureka
Yerlington
Honolulu, T. H.

ROANOKE DIVISION

W. T. Grady
C. S. Hoffman, Jr.
J. F. Wohlford
R. S. Morris

124 Main St., Box 245
126 Chantal Court
118 Cambridge Ave.
413 S. Broad St.

Danville, Va.
Wheeling
Roanoke
Gastonia

ROCKY MOUNTAIN DIVISION

N. R. Hood
C. R. Steilman
Art Johnson

1022 S. Ash St.
1641 Albion St.
247 E. 7th South St.

Casper, Wyo.
Denver
Salt Lake City

SOUTHEASTERN DIVISION

H. L. Reid
A. Dupre
P. P. Traub
C. F. Clark
J. Morris
Luis Rexach

11 Snadow Lawn Ave.
300 Wofford Campus
217 Catoma St.
576 Western Union Tel. Co.
678 Frederica St.

Atlanta, Ga.
Spartanburg
Montgomery
Jacksonville
Atlanta
San Juan

WEST GULF DIVISION

F. M. Corlett
K. M. Ehret
E. A. Sahn
W. B. Forrest, Jr.

2515 Catherine St.
2904 N. Robinson St.
Box 569
592 Royal St.

Dallas, Texas
Oklahoma City
New Braunfels
Waxahatche

MARITIME DIVISION

W. C. Borrett
W. Hyndman
T. D. Lacey

14 Sinclair St.
C/o N. B. Power Co.

Dartmouth, N. S.
Charlottetown
St. John

ONTARIO DIVISION

Wm. H. Sutton
W. Y. Sloan
J. E. Hayne
F. A. C. Harrison

373 Dufferin St.
167 Close Ave.
303 N. Brock St.
181 Hopewell Ave.

Port Arthur, Ont.
Toronto
Sarnia
Ottawa

QUEBEC DIVISION

J. V. Arkyle

393 Decarie Blvd.

Montreal, Que.

VANCOUVER DIVISION

Wm. J. Rowan

1928 Pender St., E.

Vancouver, B. C.

WINNIPEG DIVISION

W. R. Pottle
E. L. Maynard
F. E. Rutland, Jr.

1164 Willow Ave.
452 St. John Ave.

Moose Jaw, Sask.
Morse
Winnipeg

THE AMERICAN RADIO RELAY LEAGUE

The American Radio Relay League, Inc., is a non-commercial association of radio amateurs, bonded for the promotion of interest in amateur radio communication and experimentation, for the relaying of messages by radio, for the advancement of the radio art and of the public welfare, for the representation of the radio amateur in legislative matters, and for the maintenance of fraternalism and a high standard of conduct.

It is an incorporated association without capital stock, chartered under the laws of Connecticut. Its affairs are governed by a Board of Directors, elected every two years by the general membership. The officers are elected or appointed by the Directors. The League is non-commercial and no one commercially engaged in the manufacture, sale or rental of radio apparatus is eligible to membership on its Board.

"Of, by and for the amateur", it numbers within its ranks practically every worth-while amateur in the world and has a history of glorious achievement as the standard-bearer in amateur affairs.

Inquiries regarding membership are solicited. A bona fide interest in amateur radio is the only essential qualification; ownership of a transmitting station and knowledge of the code are not prerequisites. Correspondence should be addressed to the Secretary.

OFFICERS

President
HIRAM PERCY MAXIM
Hartford, Conn.

Vice-President
CHAS. H. STEWART
St. David's, Pa.

Traffic Manager
F. H. SCHNELL
Hartford, Conn.

Canadian Gen. Manager
A. H. K. RUSSELL
6 Mail Bldg.,
Toronto, Ont.

Treasurer
A. A. HEBERT
Hartford, Conn.

Secretary
K. B. WARNER
Hartford, Conn.

DIRECTORS

President
HIRAM PERCY MAXIM
Drawer 4,
Hartford, Conn.

Vice-President
CHAS. H. STEWART
St. David's Pa.

Canada
A. H. K. RUSSELL
6 Mail Bldg.,
Toronto, Ont.

Atlantic Division
GEO. L. BIDWELL
1245 Everts St., N. E.,
Washington, D. C.

Central Division
CLYDE E. DARR
187 Hill Ave., Highland Park,
Detroit, Mich.

Dakota Division
C. M. JANSKY, JR.
Dept. of Elec. Eng., U. of M.,
Minneapolis, Minn.

Delta Division
BENJ. F. PAINTER
424 Hamilton Nat'l Bank Bldg.,
Chattanooga, Tenn.

Hudson Division
DR. LAWRENCE J. DUNN
480 East 19th St.,
Brooklyn, N. Y.

Midwest Division
L. BOYD LAIZURE
80th & Mercier Sts., R. F. D. 1,
Kansas City, Mo.

New England Division
DR. ELLIOT A. WHITE
Apt. K, The Parker, N. Park St.,
Hanover, N. H.

Northwestern Division
K. W. WEINGARTEN
3219 No. 24th St.,
Tacoma, Wash.

Pacific Division
ALLEN H. BABCOCK
65 Market St.,
San Francisco

Roanoke Division
W. TREDWAY GRAVELY
503 Main St.,
Danville, Va.

Rocky Mountain Division
PAUL M. SEGAL
c/o District Attorney,
West Side Court Bldg.,
Denver, Colo.

Southeastern Division
HARRY F. DOBBS
c/o Dobbs & Wey Co.,
Atlanta, Ga.

West Gulf Division
FRANK M. CORLETT
2515 Catherine St.,
Dallas, Tex.

Address General Correspondence to Executive Headquarters, Hartford, Conn.

EDITORIALS

The Army A.R.R.L. Affiliation

A PLAN of affiliation between the Signal Corps of the U. S. Army and the transmitting amateurs of the country was described in October *QST*. The plan was approved by the War Department and went into effect on November 1st, the American Radio Relay League being named by the General Staff as the representative of the amateur thereunder. Captain Tom C. Rives, of 2CXL, Fort Monmouth, has been named as the Army liaison agent and is busily at work with the various Corps Area Signal Officers to put the plan in motion.

It seems to us that this affiliation is about the most important thing that ever happened to amateur radio in this country. It constitutes a very signal recognition of the importance of the amateur. We now have bonds with both the Army and the Navy and are assured of their assistance when we need it. The independence of our existence is not disturbed in the slightest; quite the contrary. We are going to do some things for the Army and they are going to do some things for us in return. The attention of all hands is requested to the plan as published in our October issue. Numerous of our stations are to be named as Army Amateur Stations, handling Army traffic on one night a week, and working in networks which eventually will embrace all the National Guard and Reserve units in the country, the office of the governor of every State, and the important military command posts throughout the nation. Under such a plan we amateurs will be able to be of immense assistance in time of national or local emergency and we will be provided with a new and interesting source of important message traffic that will put new vim in the gentle art of brasspounding. The Signal Corps in turn is assured of the existence of a large body of skilled operators trained in Army radio methods. It is in fact a huge plan for organized emergency communication service of the type we amateurs are always anxious to embrace. The position of the amateur is tremendously strengthened by this alliance.

At this writing the League is appointing contact representatives in each of the nine Corps Areas, to act as advisors to the Signal Officers of each Area and to look after the appointments in each territory. The work will be decentralized by the League,

the same as it is in the Army. Every amateur able to accept an appointment under this plan is urged to read the October article carefully and file his application at A.R.R.L. Headquarters.

The Why of It

SOMEHOW or other it seems desirable to the Editor to recount in this column every so often the story of how we amateurs have a League and why, so that all of us may carry around with us a bird's-eye view of the picture.

We amateurs have this American Radio Relay League of ours because it is capable of giving us, as individuals, a greater measure of enjoyment out of our pursuit of amateur radio than we would have as independent individuals. The activities of the League exist for that very purpose. Through our organization we have a participation in the framing of radio laws and regulations which gives each one of us more privileges than we would have if we were not bonded in a League. We own, co-operatively, our magazine *QST*, which undertakes to give us the most authoritative and up-to-the-minute radio information, as well as acting as monthly bulletin of our organized activities. We have a large staff of people at Headquarters to render service of various kinds to our membership.

All of these things exist in order that we may derive the maximum profit from our activities as individual amateurs. That is to say, we amateurs have organized and maintained our A.R.R.L. so that, in our actual work with radio apparatus, we are able to enjoy benefits that otherwise would not be ours. This business of working with apparatus is what all of us want to do—it is our ultimate aim as amateurs. Our work with apparatus is of two sorts—either it is communication or it is experimentation. To direct and co-ordinate our communication enterprises we have our Traffic Department—which, since it deals with many other forms of communication than message traffic, we admit could be much more happily named. The other side of our practical work with apparatus—experimentation—at present is not at all well taken care of. Experimental work has become so important a part of amateur activity with the gradual change of conditions that it de-

serves much better facilities than our Headquarters at present is able to give it; and, just in passing, let us say that we hope to be able to arrange things soon to take proper care of this phase of amateur activity.

We support this League by our membership dues and by advertising in our magazine. The number of things our League can undertake is limited by their cost—limited by our income. For the last couple of years our year-around expenses have just about equalled our year-around income. We govern our League by electing directors, one from each United States division and one from Canada, who then form our Board and are in control of our policies. Each director represents the members who elected him. Thus we maintain ourselves

as a democratic self-governing organization of amateurs.

In its eleven years of existence the League has demonstrated times without number that it is worthy of the support of every amateur. It is by no means perfect, and nobody knows that better than those of us carrying on at Headquarters. But it can never be better than all of us amateurs make it, by our united efforts. All we need to do is to keep plugging along, in mutual confidence and co-operation. Let us do it!

And by the way, if you're not an actual member, there's a nice convenient application blank somewhere in the aft section of the magazine. Sorry we don't know the page number now, but Beek is on his honeymoon this month and we don't know what page Ed's going to put it on.

Kenneth Bryant Warner

The Second Pacific Division

A.R.R.L. Convention

THE Pacific Division Convention was held this year at Santa Ana under the auspices of the Orange County Radio Association. Santa Barbara was to have the convention, but on account of the disastrous earthquake there, someone else had to step in and fill up the gap. The Orange County boys were right there on the job and gave us a convention that all will remember.

The list of notables included Commander Hooper, Chief of Communications, U. S. N.; Lt. Fred Schnell; Col. Dillon (6th dist. Radio Supervisor) and Mr. A. H. Babcock, the Pacific Division Director. The convention opened Friday afternoon, Oct. 2nd, with a traffic meeting. Friday evening the main meeting was called to order and, after a very helpful talk by Col. Dillon, Fred Schnell opened the valves and spilled his U. S. A. Australia-Tahiti trip. Fred carried the convention by storm, so much so that the gang were all ready to pull up their masts and move to Tahiti *pronto!* As a fitting climax to his tale the gang chipped together and presented him with a toy battleship, an elephant, (see elsewhere in this magazine for dope on the elephant, or address communications to F. H. Schnell, % A.R.R.L.) and a red hot Tahiti girl.

Saturday, Oct. 3rd was spent in a technical meeting in the afternoon, at which two very important subjects were presented; one—a paper by Dr. Hoyt Taylor, on the Heavyside Skip Theories—presented by 6BUR, and the other, an illustrated talk on Radio Television, by Prof. C. Strem of Whittier College.

Saturday night came the big chow, awarding of all prizes, and the drawing of the

raffle. The gang from San Francisco were more than lucky on the raffle as they got two five-watters (6AWT got one of 'em. Hi!) two condensers, and a vibroplex. At this time 6CJJ, in behalf of the Modesto Radio Club, awarded the M.R.C. Wouff Hong Trophy. (see Jan., 1925, *QST*.) The award was based on four main points, using the percentage basis of computation. The four points were: D.X. in miles-per-watt, maximum, 35%; Traffic handled, Maximum 25%; Operating ability maximum 20%; Percentage of apparatus homemade, maximum 20%.

The contest was a rather close one as some of the fellows on the Pacific Coast have sure been kicking out with D.X. L. Elden Smith, 6BUR, won with a total of 86% over 6VC who had a total of 84%. And while we're on the subject, gang, NOW is the time to sign up for the 1926 Wouff Hong award. All you California D.X. hounds give us your "John Henry" now, so that we can be keeping tab on you during the year. Send in your name to the Modesto Radio Club, P. O. Box 883, Modesto, Cal. And do it NOW, don't wait until next September.

Before the banquet was over it was decided to hold the next convention at San Jose, a live little town with a live bunch of hams living there, and so we're all set now for another big time, like we have just had, next year at San Jose, California.

R.L.B. 6CJJ.

Strays

9DIB reports hearing a station on 29 meters on Sept. 28 calling "CQA" and signing 1CM with "P" as intermediate signal. Anyone know the QRA?

Toroids

By F. J. Marco*

TRULY of the revolutionizers of radio there is no end! First we had the honeycomb coil, then the banked winding, and now comes the toroid; to dazzle the poor experimenter and broadcast listener. The dazed attitude of the radio public towards the toroidal inductance certainly needs some clearing up, for the general answer to the question—"Are toroids worth while?"—seems to be rather vague.

In the first place, the necessity for an inductance possessing a minimum of external field effects was a natural conse-

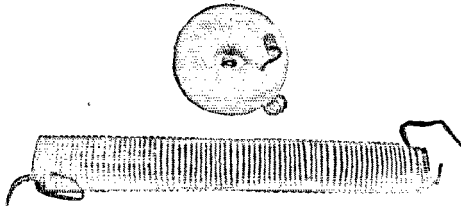

FIG. 1. AN EXPERIMENTAL TOROIDAL COIL IN WORKING CONDITION AND UNROLLED.

In the lower view we have simply a long, narrow coil whose magnetic field leaves at one end, sprays out into the air and returns finally to the other end of the coil. In the upper view the magnetic field from one end of the coil is fed directly back to the other and the spraying avoided. In both cases there is, in addition, a magnetic field which travels along the outside of the coil, hugging it closely.

quence of the development of tuned radio-frequency amplifiers. The continued use of radio-frequency amplification has served to stimulate activity in the design of such an inductance for use in broadcast receivers.

The ordinary form of solenoid inductance has various disadvantages, among which are three of considerable importance. First, it is a miniature loop antenna within itself and as such is affected to a considerable extent by local disturbances. This characteristic has the effect, in a multi-stage R.F. amplifier, of making the receiver broad in tuning when located near powerful transmitting stations. The reason for this is, of course, the fact that we cannot take full advantage of increased selectivity due to a multiplicity of tuned stages. Second, it is difficult to prevent the electromagnetic coupling of successive tuned stages, which makes the prevention of self generated oscillations, always a very serious problem, almost impossible. This is only partially overcome by placing the inductance at the

so-called "sacred angle". Third, but only of importance in poorly designed layouts, the resistance of the tuned circuit is almost always increased when metallic bodies or poor dielectrics are placed *too* near the inductances.

The theory of the torus is that it has practically zero external field and therefore should automatically correct all of these evils. This has so often been discussed and graphically demonstrated by contemporary writers that it is not necessary to go into great detail here. Suffice it to say, then, that because the high and low potential ends of the inductance are bent around to form a complete circle, (see Fig. 1), the electromagnetic field theoretically becomes continuous and closed upon itself, resulting in no external effects. Correspondingly, any external electromagnetic field linking the coil produces an equal and opposite voltage in each half of the coil resulting in no voltage across the terminals of the inductance. (See Fig. 2).

With this theoretical background, and armed with a slide rule, an imposing array of technical literature on the subject and the average analytical laboratory equipment, the writer spent several months dur-

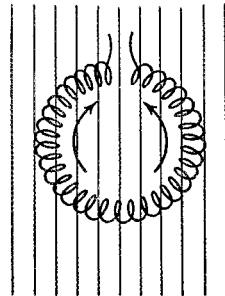

FIG. 2. Light vertical lines represent a magnetic field cutting the toroid. Arrows show the resulting (and opposing) voltages in the two halves of the coil.

ing the spring of 1925 trying to find out "the truth about toroids".

It was reasonable to suppose that in order to design an effective inductance of this type the ordinary requirements of solenoid design should be observed, in addition to several others peculiar to the torus. The Bureau of Standards Circular No. 74, which is, by the way, a valuable paper which should be in the hands of every radio enthusiast, gave a good starting place with the standard toroid formula:

* Consulting Radio Engineer, Member Experimenters' Section A.R.R.L., and 9ZA.

$$L_0 = .004606 N^2 H \log \frac{r_2}{r_1}$$

Where: L_0 = inductance
 N = number of turns
 H = thickness
 r_2 = outside radius
 r_1 = inside radius

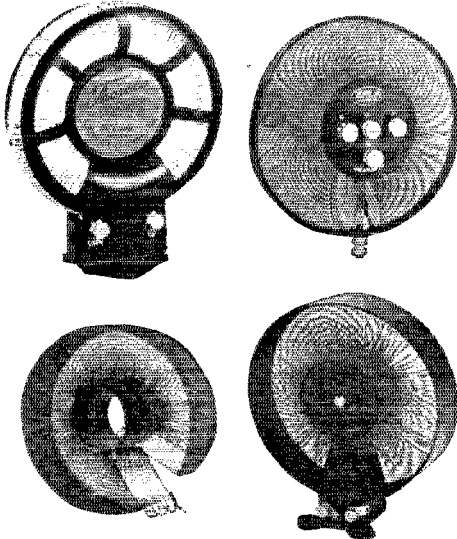

COMMERCIAL INTERSTAGE TOROIDAL TRANSFORMERS

Upper left: Thorola (Reichmann) Transformer using approximate Lorenz type mounted in celluloid frame. Upper right: Erla Transformer using a spaced-turn coil of torus form. Lower left: Un-mounted Bremer-Tully Toroid with spaced square turns. Lower right: All-American Transformer using spaced square turns.

Having decided upon the value and maximum permissible dimensions of the inductance, together with the size of wires, which, for a compact coil, should be small, (See "What Size Wire"—June 1925, *QST*) we can easily substitute in the formula and find our other quantities. It may be seen that with a given size of wire, say No. 24 D.S.C., and a known outside diameter, four inches, the number of turns is determined by the perimeter and therefore the radius of the inside circle. Juggling figures we obtain:

$$L_0 \text{ is proportional to } r_1^2 \log \frac{r_2}{r_1}$$

which simply says that the inductance is proportional to the square of the inside radius times the logarithm of the ratio of the two radii. This gives data for the curve, Fig. 3, which, for a maximum inductance in a given space results in:

$$\frac{r_2}{r_1} = 1.68 \text{ (about)}$$

In other words, if the outside diameter is four inches, the inside diameter for a maximum inductance should be about two and three-eighths inches. However it can easily be seen that the most compact coil is not necessarily the most efficient. Therefore both factors must be considered in our analysis. By comparing the maximum point of this curve with that of another plotted against various values of the ratio of the two radii (from measured resistances of experimental coils), the best compromise between size and efficiency can easily be obtained. The curves in Fig. 3 make this clear.

Thus having all our relations fixed and substituting for the required inductance, (about 245 microhenries to tune to 550 meters with 350 picofarads¹), the torus inductance is designed!

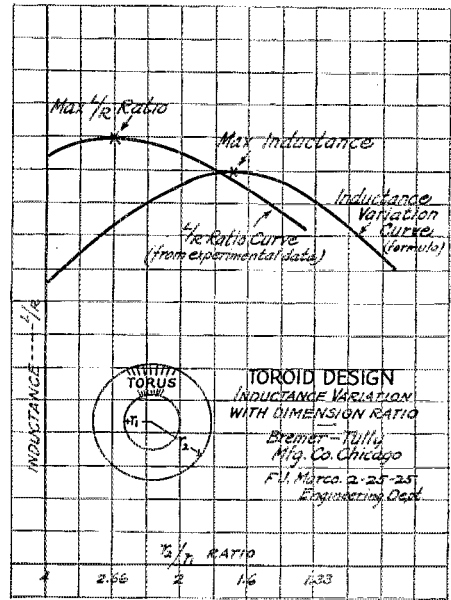
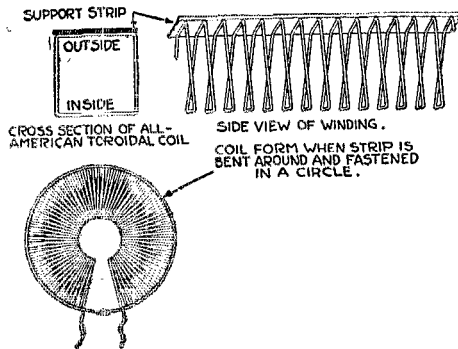

FIG 3

Because of its general characteristics and physical shape, the Torus style of coil requires special consideration when it is used as a coupling link between two tubes, that is, in a radio frequency amplifier. It would seem that the best radio frequency transformer is one whose primary is as tightly electro-magnetically coupled (to the secondary) as is possible, with just sufficient primary inductance to give the peak of voltage amplification without going too far, resulting in broadness and lowered amplification. Unfortunately, this peak is not

1. See Experimenters' Section in this issue.

the same for all frequencies. Measurements made on many commercial R.F. transformers indicate that they could be greatly improved by the addition of more primary inductance. (See recent *QST* articles.) The third requirement for the ideal k.F. transformer is that it have a reasonably low capacity coupling between primary and secondary, not necessarily because such coupling lowers the amplification per stage as has been claimed, but because it tends to upset the balance in "bridge" neu-



COMMERCIAL TOROID CONSTRUCTION
(Courtesy All-American Radio Corp., Chicago)

tralized systems, making oscillation prevention needlessly difficult.

With these considerations in mind, it is desirable to wind a primary coil for a torus coil on a second form either inside or outside of the main inductance, and concentric with it for about one-third its circumference, near the filament end. Although the primary itself is thus not a complete torus, its pick-up is negligible due to its small inductance, and the broadness usually resulting from a complete concentric torus primary is avoided. A compromise in the best number of primary turns must be made, for to gain maximum amplification at 550 meters, so much inductance must be used that the sharpness and amplification below 300 meters are considerably impaired. The inductance should be so chosen that the greatest effectiveness is manifested about the center of the broadcast band with a correspondingly small lowering of efficiency at the edges of this band.

The completed transformers when compared with all others of the torus style then available proved considerably superior on laboratory test (microhenries per ohm at various frequencies) and also in actual operation within the completed receiver. This last feature, shown by somewhat better selectivity and greater sensitivity to distant signals, the writer believes to be due more to proper coupling between stages than to superiority of actual torus design.

Unfortunately, however, toroids have disadvantages as well as advantages. It is true that the signal picked up from a local station without antenna or ground is noticeably less than on a set employing open solenoids. The effect is not eliminated completely however.

Some reduction of electromagnetic inter-stage coupling manifested itself. This was partly over-balanced by the increased capacity coupling between stages caused by the fact that the toroids occupied more space than the solenoid. Placing the toroids with their nearest edges several inches apart produced this effect.

An investigation into further intimacies of the torus led to some interesting conclusions. First the torus does not possess a zero external field at radio frequencies. In addition to the field due to the axial loop (that is the field generated by the entire torus acting as one large single turn) the leakage field of the air core solenoid comprising the toroid is considerable as indicated in Figure 3. This effect is of major importance at radio frequencies although not a disadvantage at low frequencies where it can largely be prevented by use of a good iron core. (Such iron core toroids have been in use for telephone use for many years).

Electrostatic Pick-Up

It was found that a part of the pickup in the receiver itself (antenna and ground disconnected) is electrostatic and not electromagnetic. This sort of pickup cannot be greatly reduced by any scheme of inductance design. Even if our toroid were electrically perfect and completely rejected all influence of electromagnetic waves the set would still respond to strong local signals because of the electrostatic pickup of the other part of the set. To prevent such effect it is necessary to shield the entire set completely both electrostatically and electromagnetically. (See "The Shielding of Electric and Magnetic Fields" by J. H. Morecroft and Alva Turner, Proceedings I.R.E., Aug. 1925).

Shielding Toroids

It was found somewhat easier to shield a set employing toroids than one using open solenoids or rather it was found easier to shield toroids without increasing their resistance. However, the subject of shielding receiving inductances has been investigated by W. W. Harper and as his results are soon to be published the question will not be discussed in detail here.

Conclusion

In conclusion let it be said that the Torus coil absolutely cannot eliminate or in any

way nullify interstage oscillation in a radio frequency amplifier system (except of course to lessen magnetic coupling, which is only part of the story). In other words, systems of capacity balances or resistance

"lossers" are still necessary when the torus is used. Whether the toroid coil is or is not to be made a reliable step toward the ideal receiver will depend on three things: Design, Application, and Workmanship.

Practical Picture Transmission

By Thornton P Dewhirst*

THE two most popular picture transmitters now available for amateur use are the Midget and Junior, both made by the Jenkins Laboratories.

General Basis

Both types of machines transmit pictures in exactly the same manner. It must be understood, however, that a Midget and a Junior will not work together.

A continuous line is made to cover the entire surface of the picture to be transmitted, and at the receiving station a continuous line is drawn on the receiving medium. As a matter of fact the line is not continuous, in one sense, since the pictures which these machines transmit are silhouette, and, therefore, the part of the picture being transmitted is either black or white. During the time black is being transmitted, the circuit is closed, during white the circuit is open. A keying effect is the net result.

Let us say this in another manner. These machines transmit sketches, writings, line drawings, etc., in black and white by dividing them into parallel lines and then sending these lines. By wrapping the picture around the cylinder of the sending machine we gain the advantage of being able to send continuously, going from the bottom of one line right into the top of the next line and so on. We are then able to send a picture by simply sending a line and modulating the color of this line 100%. That is, the line is either black or white. The line is continuous since the cylinder rotates steadily and at the same time the sending contact is moved steadily along the cylinder.

The cylinders of both the Midget and the Junior are designed to turn at approximately 30 revolutions per minute. A message or drawing with 25 breaks per revolution

single-pointed one. The circuit at this end passes through the contact, to the zinc etching and then to the cylinder.

The left (receiving) cylinder is equipped with a blunt iron recording point. The paper on the receiving cylinder is maybe of the electrolytic variety and the record is made by current flowing from the iron point to the cylinder through the electrolytic paper.

Lower picture—The machine equipped for regular transmission. The right cylinder now carries a double contact as shown in Fig. 3. The picture is drawn in graphite ink. The left cylinder now carries a pen-and-ink recorder although the electrolytic device shown in the upper photo can be used.

A—32 volt D.C. motor.
B—Sending cylinder.
C—Sending contact.
D—Receiving cylinder.
E—Recording point.
F—12-volt tungsten lamp which glows evenly when motor speed is correct.
G—60-cycle tuning fork used to provide speed control.

H—Contact-maker used in connection with F and G to control motor speed.

I—Chopper which breaks transmitted signal up into a buzz and transmits this buzz as a speed-control or synchronizing signal.

J—Pierced disc through which receiving operator observes his neon lamp K.

K—Neon lamp operating at a flicker-frequency determined by the breaks-per-second of the chopper I at the sending end. When the receiving operator views his disc J by the light of this lamp it appears to stand still if his motor speed is correct.

L—Threaded shaft or lead screw which moves the sending and receiving points endwise as the cylinders B and D rotate.

M—Insulating strip connecting the points C and E.

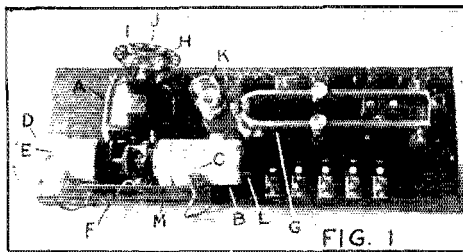
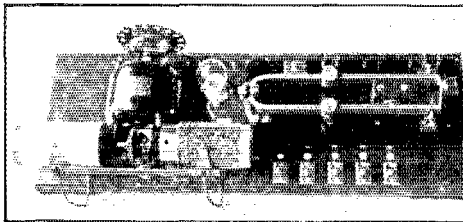

FIG. 1. THE JUNIOR PICTURE TRANSMISSION AND RECEPTION MACHINE.

Top picture—The machine equipped for practice transmission. The right (sending) cylinder carries a reversed zinc-etching and the traveling contact is a

*Jenkins Laboratories, 1516 Connecticut Ave., Washington, D. C.

would give the equivalent of a keying speed of 30 words per minute.

The Junior Machine

The Junior machine (Fig. 1) consists of two cylinders mounted on a common shaft and rotated by a 32-volt direct-current motor. One cylinder (B) is used for sending and the other (D) for receiving. A threaded shaft (L) is geared to the same motor which drives the cylinders. As the cylinders turn the threaded shaft moves the sending and receiving contacts (C and E) along their respective cylinders.

The rear end of the motor shaft carries a chopper (I) which is connected in the sending circuit and sends regular timing pulses. It is necessary to operate the sending motor at a fixed speed. To accomplish this the 32-volt motor is operated from a 42-volt source through a resistance which is cut in and out by a special 60-cycle tuning fork (G). It is not necessary to explain the operation of this speed control except to say that a small tungsten lamp (F) glows evenly whenever the proper adjustment has been made.

As soon as the speed of the sending motor is fully adjusted the receiving station is so informed and starts its motor in operation. At the same time the receiving operator connects the output of his receiving set to the neon lamp (K) which is mounted on the base of his receiving machine. The pulses sent by the chopper on the sending machine now cause the neon lamp to flash rapidly. The receiving operator looks at this neon lamp through the row of circular holes punched in the edge of a metal disk (J) mounted on the rear end of the motor of his receiving machine. If the disc appears to stand still he knows that the machine is in synchronism with the sending machine. In case the disc does not seem to stand still, he adjusts the speed of his motor.

All that has been accomplished so far is to get the two machines to running at the same speed. No picture is being sent as yet.

When the contact (C) of the sending machine reaches the picture on its cylinder the steady buzz is broken up into dashes and dots of odd lengths, to correspond with the lights and darks of the picture. During the time black is being transmitted the sending circuit is closed and the buzz is being transmitted; during the time that light is being transmitted the sending circuit is open and nothing happens except that the cylinders of both sending and receiving machines keep on turning.

Since the signal is chopped at the sending end the transmission is "I.C.W." and no heterodyne detector is needed at the receiving end, although louder signals may be gotten under some circumstances if it is used.

The Midget Machine

The Midget machine (Fig. 2) differs from the Junior in two respects.

(1) The motor used (A) is of the 60-cycle single-phase 110V. synchronous type, and, therefore, no synchronizing signal is transmitted.

(2) No chopper is used on the machine itself, and, therefore, the received picture

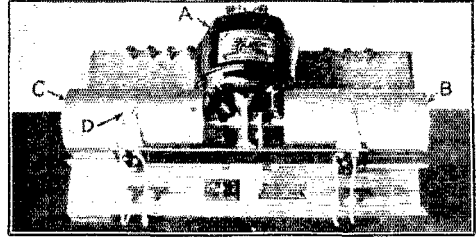

FIG. 2. THE MIDGET MACHINE.

- A—110-volt, 60-cycle synchronous motor.
- B—Sending cylinder.
- C—Single-contact for sending. The double contact can, of course, be used for graphite-ink pictures.
- D—Receiving cylinder.

note must be heterodyned at an audible frequency by the receiving station or the wave must be modulated by a chopper at the transmitter.

The Transmitter Contacts

The machines pick the picture off the sending cylinder by means of a double or single contact. When the double contact is to be used the picture is drawn in graphite ink on ordinary paper and this paper is wrapped around the sending cylinder. The double contact is shown in Fig. 3. Whenever a graphite-ink mark passes under the two points they are connected together, current flows through them and the sending set operates. Such a double contact can be seen at C in the lower view of the Junior machine, although it does not show very distinctly.

It is also possible to use a single contact. A stencil cutout may be wrapped around the sending cylinder and the single contact will make contact with the sending cylinder whenever an opening passes under the sending point. The control circuit of the radio transmitter must include the point and the sending cylinder. It is also possible to make up a picture in the shape of a zinc etching, to insulate the low parts of the etching with shellac and then to bend this etching around the sending cylinder. Whenever a raised part of the etching touches the sending point the circuit is completed to the sending cylinder and the sending set operates.

Either one of these sending points may

be used with either of the recording systems to be described later.

The contacts of the picture transmitter should not be expected to handle the power-supply of the sending set, but only the current for a relay. This relay can handle the

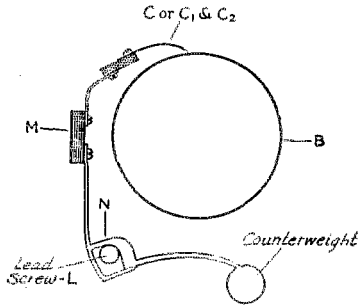

END VIEW

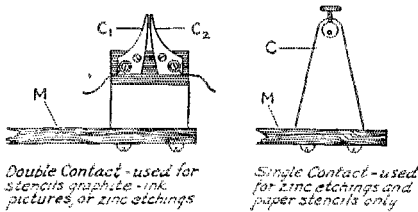

Double Contact - used for stencils, graphite-ink, pictures, or zinc etchings

Single Contact - used for zinc etchings and paper stencils only

TOP VIEW

FIG. 3

The Sending Contacts used with the Midget and Junior machines. The lettering corresponds with that on the photographs.

M—Insulating strip connecting sending and receiving contacts and forming a traveling carriage.

N—Half-nut riding on the lead screw. By lifting this nut from the lead screw the carriage can be moved endwise freely.

L—Lead screw or threaded shaft which moves the carriage endwise.

B—Sending cylinder.

C—Single contact.

C1 and C2—Halves of the double contact.

When using single contact the circuit is completed through the sending cylinder B.

power supply and must be able to follow the frequency of the picture to be sent. (Any relay able to follow a fast "bug" will answer.)

The Radio Transmitter

The Junior machine requires a straight C.W. transmitter which can send the synchronizing (chopper) frequency during each of the odd-length dashes which make up the picture. We may also say that the sending set transmits the synchronizing frequency, broken up into picture-frequency groups.

The Midget machine does not transmit its own synchronizing impulses, but depends on

the correctness of the commercial 60-cycle lines at the sending and receiving points.

The Midget machine does not transmit a synchronizing signal, therefore C.W. or I.C.W. may be used and crude results may even be obtained with spark.

The machine is equipped with a motor which rotates both the sending and receiving cylinders. The right hand cylinder is generally used for sending and the left hand cylinder is for receiving. For practice work the sending cylinder is equipped with a reverse zinc etching, having everything but the raised characters insulated with shellac. Either a double or single contact attachment may be placed on the carriage, which rides on the threaded shaft. In case of the single contact attachment a connection to the ground on the machine is used to complete the circuit.

Recording With Carbon Paper

Two methods of reproduction are used at the receiving end. One method employs a stylus attached to the armature of a single phone unit. The incoming signal moves the stylus up or down. On the receiving cylinder is placed a piece of bond paper and over this a piece of carbon paper. The stylus is now moved to the left and adjusted so it just barely touches the paper as the cylinder rotates. Synchronizing adjustments are now made and the transmitting station informed that you are now ready to receive a picture. The radio set is now tuned so as to operate the stylus best and the stylus attachment is placed on the threaded shaft which gradually moves it to the right and the cylinders rotating distribute the picture parts in their proper places as the stylus pounds them out. This method of placing the carbon paper over the bond paper does not give the operator a chance to see the picture as it comes through. This may be accomplished by placing the carbon paper on first (carbon side out) and then placing a piece of heavy tissue paper or onion skin over it. Care must be taken that the stylus does not tear the tissue paper in this method.

Recording With Ink

An ink pen arrangement may also be used, although it is a bit messy. If the pen attachment is used a piece of white paper 5½ inches by 8½ inches is secured to the cylinder with sticky paper or tape, and over this a piece of ordinary paper is placed. As the cylinders revolve the circuit is closed by contact made at the sending end and the pen attachment pounds out a reproduction of the sketch.

Electrolytic Recording

The other method employs electrolytic paper. A blunt stylus made of iron maintains contact with a sheet of electrolytic paper wrapped around the receiving cylin-

der. The passage of current through the paper from the stylus to the cylinder below discolors the paper and the picture is built up in this manner. A relay may be used to control the electrolytic stylus circuit or it may be operated directly from the plate of the control tube as explained farther on. Now that the general idea has been given, we will proceed to discuss the matter in a little more detail. A piece of 6" x 10" bond paper is allowed to soak thoroughly in an electrolytic solution in a small tray. The surplus solution is blotted off and the paper wrapped around the receiving cylinder so that the contact needle pulls with the overlapped end. The motor moves the carriage slowly to the right, and in so doing makes a reproduction of the etching, line by line, on the moist paper. Quite a number of details may be learned in this manner, such as how wet to use the paper, etc. An excellent solution can be made up of the following:—½ lb. Potassium Iodide; 2 lbs. Potassium Bromide; 1 oz. of Dextrine or Starch; 1 gallon Distilled Water. Another electrolytic solution, which is possibly more messy, but is not nearly so expensive, is made up of Nitrate of Ammonia 3 oz.; 1½ oz. Muriate of Ammonia; ¼ oz. Ferrocyanide of Potassium, and 16 oz. Distilled Water. Ferrocyanide of Potassium is poison and should be handled with care. The second solution is also more sensitive, responding to less current.

The next step in practice work is to send some handwriting, sketches, etc., written with graphite ink. The ink is conductive and to use it the sending cylinder is equipped with the two-fingered contact.

After the machine has been mastered by direct wire practice, proceed to try it in a radio hook-up.

The Receiving Set

The receiving equipment found in most amateur stations is meant for C.W. reception and therefore is suitable if that sort of signal is being used for picture work.

Picture work must be done with fairly strong signals because the receiving machine cannot (like the ear) decide to ignore strong interference. In case the ordinary audio frequency amplification is not sufficient, one of the circuits in Fig. 4 may be used to advantage. At A we have a low power tube (a receiving tube, 5-watt or 7½-watt tube) connected with a sufficient C battery to block the grid. The incoming wave kicks it off or reduces the grid bias as is shown in Fig. 5, A, and current flows in the plate circuit. An ordinary audio frequency amplifying transformer is used as an input transformer and is connected direct to the output of the ordinary audio frequency amplifier.

For a 5-watt "E" tube, the C battery varies from 22½ to 45 v., while the B battery varied from 150 to 405 v.

Fig. 4, B, shows an arrangement which is excellently suited for the electrolytic method of reproduction. The relay controls the circuit in which the electrolytic pen and battery are placed. Of course the electrolytic pen

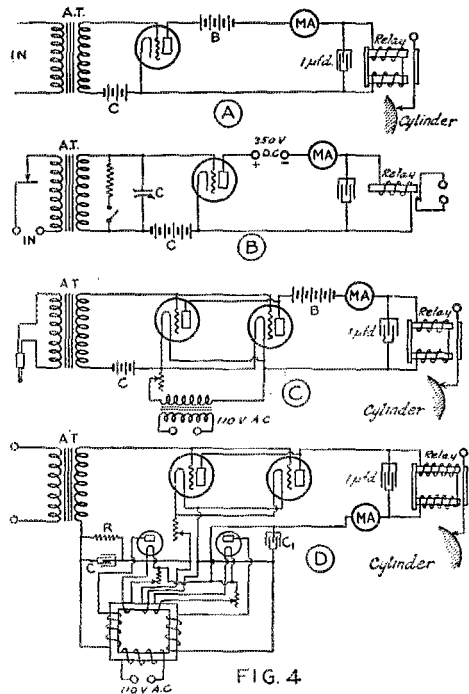

FIG. 4

Circuits used to operate the recording end of the machines from the output of an ordinary radio receiver.

may be substituted for the relay and operated directly. The plate supply here is taken from D.C. generator. A suitable relay winding for this circuit would consist of about 12,000 turns of No. 30 Cotton-Enamel wire. A resistance and condenser are shown in shunt with the secondary of the transformer. The resistance may vary from 1 to 3 megohms. A 500-micromicrofarad condenser will answer the requirements here. By tuning this condenser, it is possible to select any one of several stations transmitting on the same wave, but having a different audio frequency note. In the case of the heterodyne method the note is adjusted to a different frequency from those being transmitted, which are undesirable. Two control tubes can be connected in series across the same receiving set and by means of two receiving cylinders, two pictures with different audio frequency notes received simultaneously.

Fig. 4, C and D (with a few minor changes) are steals from circuits employed by F. W. Dunmore, of the Radio Laboratory, Bureau of Standards, in his Relay Recorder. Two tubes are used in parallel in both cases any be ordinary receiving tubes.

Receiving tubes can also be used as rectifier tubes in D, the grids and plates being tied together.

A condenser of about 4-microfarad capacity is connected across the output of the rectifier tubes. Chokes are apparently unnecessary.

R is a resistance (about 40,000 ohms) which is necessary to provide a path for the grid current to the filament of the tubes. The return would otherwise be insulated from the filament by the rectifier tube.

The one-microfarad condenser is used in all cases to prevent the pen attachment or relay armature from tending to respond to the rectified audio-frequency current in the plate circuit.

Speed

The speed to which the pen attachment will respond is, of course, regulated by the amount of current flowing in the plate circuit and the degree of sensitivity of the pen attachment. The speed controls the degree of refinement of the picture to be sent. With current of one milliampere pictures with approximately 20 breaks per second are possible, with 10 milliamperes approximately 50 breaks per second are possible. With certain adjustments the pen attachment requires a large plate current to trigger it off. In cases of this sort, the bias is so adjusted as to allow just enough current *not* to trigger it off pass through the attachment and the incoming picture wave reduces the bias still farther and the attachment responds.

Static

In general, static will effect the sketch or writing very little, since it does not occur at any definite interval or have a pre-determined form. Even if it were extremely bad the worst it could do would be to sprinkle the picture over with black dots, but which in case of writing does not prevent easy reading of the message, though it does not look so pretty. It is possible to eliminate a large amount of static and other disturbances by increasing the bias beyond the point where no plate current flows. See Fig. 5, B, for example. Here the tube is completely biased at 30 volts, C, but 35 volts are used. It, therefore, requires a change of at least 6 volts to cause any current to flow. Consider the static to give a grid voltage of 5 volts the plate current would not be changed. The 10 volts decrease caused by the picture wave, how-

ever, is sufficient to cause plate current to flow and the picture is carried through minus the static.

The outside disturbances here are considered to be less than the strength of the

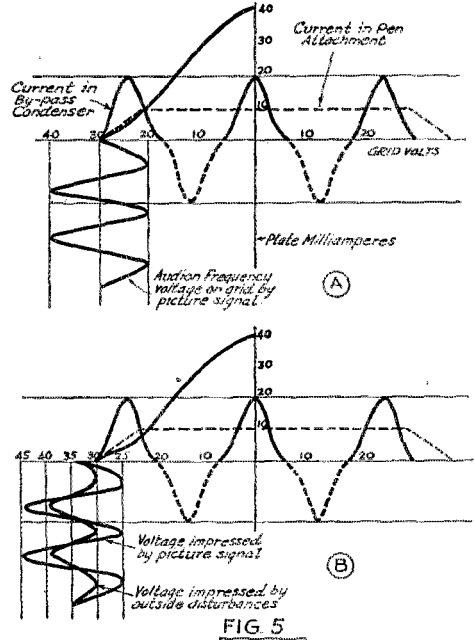

FIG. 5
The method of eliminating interference by means of grid bias adjustments.

picture signal. In cases where the disturbance voltage is equal to or greater than the signal voltage, the method falls down and there is no method at present which will eliminate it.

C.W. or I.C.W.

In order to reproduce the picture at the receiving end considerable amplification must be used. C.W. may be used and heterodyned at the receiving end or the wave may be broken up at the sending end. (See Note by Tech. Ed.) Fig. 6, A and B, show keying methods where C.W. is to be transmitted and the heterodyne method used for receiving, the beat note to which the transformers respond best, of course, being used. C must be such as to give with the grid circuit resistance, R and C2, a suitable time constant. Fig. 6, C, D and E, show connections for superimposing the picture wave and breaking the main wave into audio frequency units. E shows a double buzzer arrangement. At F is shown a method which may be used in case a microphone transformer is employed. The additional

battery may or may not be used, depending upon how the buzzer is connected.

A very unique method which may be employed to give an audio frequency note to the carrier wave is to utilize the electron tube as a generator of audio frequencies. A coil consisting of 6000 turns of No. 30 copper wire wound in pies on an iron core, 6 x 5", with a cross-section of about 1 square inch and tapped every 500 turns would answer quite well, if used in a Hartley circuit, with a condenser of approximately .005-

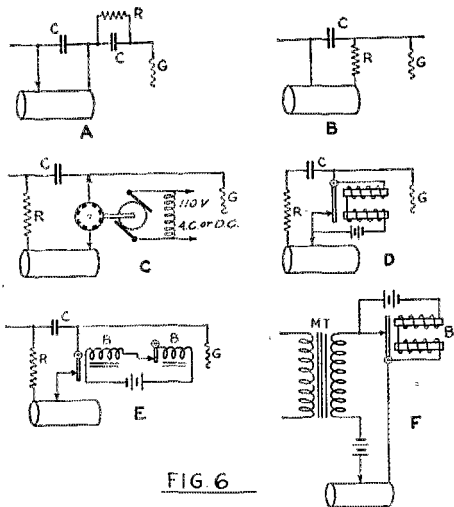

FIG 6

CIRCUITS USED AT THE SENDING SET

A and B—Methods of operating a transmitting tube by putting the sending contacts into the grid circuit.

C, D, E, F—Methods of putting an ICW modulation on the transmitted wave so as to permit easier audio amplification at the receiving end.

C—Chopper connected in series with the sending cylinder. This is the normal connection for the Junior machine.

D—Simple Buzzer method.

E—Buzzer method which prevents the "kick" of the buzzer magnets from disturbing operation.

F—The simple buzzer method with the output fed to the tube through a modulation transformer.

Possibly a still better method would be to use the scheme of diagram E with a modulation transformer.

microfarad capacity. A transformer having 300 turns of No. 26 copper wire in the primary with about three taps and a secondary with approximately 500 turns of the same size wire, with about five taps would also fulfill the requirements. Suitable condensers, of course, being used.

In the case of the Junior the chopper which is mounted directly on the motor shaft serves a double purpose. (1) It furnishes a frequency which is used in keeping the motors in synchronism, as explained before. (2) It furnishes an audio chopper for the transmitter and the signals may be received without heterodyning.

Financial Statement

IN accordance with instructions of the Board of Directors, the following statement of revenue and expenses of the American Radio Relay League for the three months ended September 30, 1925, is published for the information of the membership.

K. B. WARNER, Secretary.

Statement of Revenue and Expenses
QUARTER ENDED SEPTEMBER 30, 1925

REVENUE	
Advertising sales	\$19,571.11
Newspaper sales	14,611.94
Newspaper syndicate sales	2,401.50
Dues and subscriptions	6,840.57
Back numbers, etc.	313.30
Emblems	87.88
Interest on bank deposits	62.40
Cash discounts earned	287.88
	\$44,135.53
Deduct:	
Returns and allowances...\$7,407.03	
Less transfer from reserve	
for newsdealer returns... 734.44	6,672.59
Exchange and collection charges....	70.12
Discount 2% for cash.....	258.16
	7,000.87
	\$37,134.66

EXPENSES	
Publication expense	14,418.21
Salaries	14,329.43
Newspaper syndicate expense.....	538.50
Forwarding expenses	596.12
Telgraph, telephone and postage..	1,401.17
Office supplies and general expenses	1,604.42
Rent, light and heat.....	852.82
Traveling expenses, regular.....	472.92
Traveling expenses, Chicago Con....	779.72
Depreciation—furniture and equip- ment	145.34
Bad debts written off.....	524.67
Traffic Dept. field expenses.....	538.74
News Bureau field expenses.....	86.27
	36,288.33
Net Gain from Operations.....	\$846.33

Strays

7ZZ suggests if the metal cap in a 10,000-ohm Bradleyohm is removed from the porcelain the two piles of resistance material may be connected in multiple by removing the insulating disc and using the metal cap as one connection and the two former connections, connected together, as the other terminal. This will give a resistance having a range of 2,500 to 25,000 ohms.

Note

The Midget machine with a C.W. sending set may be used at any amateur wavelength under any general amateur sending license. The Junior machine may be used *only* on those wavelengths assigned to I.C.W. work. If the Midget machine is used with an I.C.W. sending set, or if it is provided with a chopper attachment, the same rule applies.

Receiver and Wavemeter Calibration

By J. A. Baker*

THIS is a method of calibrating a short wave receiver or wavemeter by a standard wavemeter of much higher wavelength range by making use of the harmonics present in an oscillating vacuum tube circuit.

Theory

An oscillating vacuum tube circuit has, in addition to its fundamental frequency, a number of harmonic frequencies; these frequencies being exact even multiples of the fundamental frequency. If these harmonics are used to form audible beats with the fundamental frequency of a shorter-wave receiver or oscillator the longer wavelength will then be an even multiple of the shorter wave. If the shorter wave is maintained unchanged, while the longer wave oscillator is varied until another beat note is obtained, this longer wave will be another even multiple of the shorter wave. If a series of such beats be obtained, we will have the longer wave oscillator tuned to a series of wavelengths, each of which is a multiple of the shorter wave. Since these waves are all multiples of a certain lower wave, the difference between any two consecutive wavelengths of the series will be the value of the shorter wavelength. It is then possible, by finding the average difference between the members of the series of wavelengths, to obtain a fairly accurate estimate of the shorter wavelength. Also, by dividing each member of the series by a whole number representing the ratio of the beat forming harmonic to its fundamental, and averaging the results, a more accurate value is obtained. If the longer wavelengths are so chosen as to come within the range of a standard wavemeter, we can then calibrate a receiver or wavemeter designed for wavelengths much lower than those covered by the standard wavemeter.

Apparatus Needed

1. A standard wavemeter of known accuracy. The writer uses a General Radio Type 247-W, with a range of 75 to 250 meters, which has been checked against WWV.

2. A driver or oscillator which can be made to oscillate over the range of the standard wavemeter. This may be a simple Hartley or tickler feedback circuit. It should be provided with a pair of phones in the plate circuit.

3. A short-wave oscillator, which will usually be the short-wave receiver to be cali-

brated. This will hereafter be referred to as the receiver.

4. A short-wave wave meter to be calibrated.

Operation

The driver and receiver are preferably operated from the same set of batteries. This provides sufficient coupling for the purpose desired, and permits the two circuits to be placed far enough apart to reduce the mutual inductance between their coils to a negligible value. This also permits the receiver to be calibrated as fast as the measurements are made. If the driver has a separate set of batteries it must be inductively coupled to the receiver. It will then be necessary to first calibrate the new wavemeter, remove the driver from the vicinity of the receiver, and then calibrate the receiver from the new wavemeter.

The receiver is set in oscillation at any desired point in its range, *and left there*. Start with the driver tuning condenser at maximum and slowly lower the driver wavelength until a beat note is heard in the phones of the driver circuit.

Measure the driver wavelength with the standard wavemeter. Set this wavelength down on paper. Lower the driver wavelength again until another beat is heard, measure the driver wavelength and set this value down underneath the first. The difference between these two wavelengths will give an approximation of the wavelength at which the receiver is set. Continue lowering the driver wavelength, measure its wavelength when beats are heard, and set these measurements down under the first two in a column. Continue until the lower limit of the driver or wavemeter is reached. A sample series is given below under the heading "Driver W. L."

Driver W. L.	Diff.	Factor	Quotient
177.5	19.5	9	19.72
158.0	19.5	8	19.66
138.5	10.0	7	19.78
(128.5)		6½	19.77
118.0	10.5	6	19.75
(109.0)	9.0	5½	19.82
99.5	9.5	5	19.90
(89.0)	10.5	4½	19.78
79.0	10.0	4	19.75
	Average		19.77

The first two readings have a difference of 19.5 meters. This indicates that the receiver is tuned to approximately that wave. Also it indicates that the first reading is nine times the receiver wavelength. Dividing this reading by nine gives the value of

* 1BIS, 120 Myrtle St., Claremont, N. H.

19.72 shown in the last column. Similarly the next reading is eight times the receiver wave and the third seven times. Now we come to the fourth reading. This is only ten meters lower than the third, instead of 19 or 20 as would be expected. Also we find the remaining readings differing by about ten meters. Further we note that only alternate readings are even multiples of the receiver wave, and that the other readings, those in parentheses, are $6\frac{1}{2}$, $5\frac{1}{2}$, etc. times the receiver wave. In making the readings, it was noted that these odd wave lengths gave much fainter beat notes than those produced when the driver wave was an even multiple of the receiver wave. This leads to the conclusion that these are not beats between the driver harmonics and the receiver fundamental, but are beats between the driver harmonics and the *second harmonic* of the receiver. Now that we know what they are, we can make use of them in figuring the final value of the receiver wavelength.

This is done by averaging the quotients found on dividing the readings by their appropriate factors. This average is 19.77 meters. If we now average the difference between the even multiple readings, and also those between the second harmonic readings, we get an average difference of 19.71 meters, which checks with our first value. We can then state fairly accurately that the receiver is tuned to 19.7 meters. The next thing is to tune the new wavemeter to the receiver, thus locating this particular wave on the wavemeter scale. The receiver is then set at other points, the wavelengths of these points determined, and transferred to the new wavemeter, by a repetition of the process outlined above. The entire range of the receiver and wavemeter can thus be covered and calibrated.

Precautions

Use low plate voltage on the driver, not over $22\frac{1}{2}$ volts. This helps to prevent the appearance of confusing beats with the second and sometimes the third harmonic of the receiver. The receiver regeneration control should also be kept just over the point of oscillation, for the same reason.

Don't take readings less than four or five times the receiver fundamental. Harmonics and off readings are almost sure to appear when the driver gets below five times the receiver wave.

Make your readings carefully and note the strength of the beat note beside them, so as to be able to tell a second harmonic beat from one with the fundamental.

If your driver has a fixed value of feed back, it will probably howl steadily over its lower range. This can be prevented by not using a grid condenser and grid leak in the driver circuit.

Remember your results will be no more accurate than your standard wavemeter. Be sure it is right.

New Coils and Condensers

THE very excellent plug-in-coil forms shown in the illustration come from Silver-Marshall in Chicago. The coil forms are fitted with six contact buttons which make contact with six springs in the moulded "socket" into which the coil is

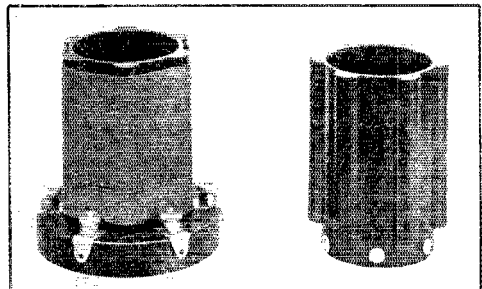

plugged. The form itself is moulded of Bakelite and has six large half-round ribs on which the wire is wound. The actual contact between the wire and the ribs is very small and as the ribs are quite high the wire is kept well away from the tube itself. Inside the form, supported on two long brass springs, is a second coil form

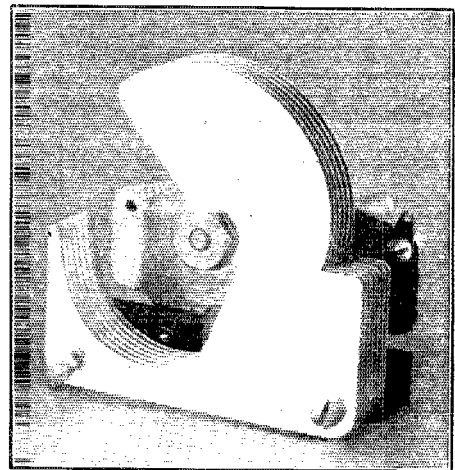

normally for use as a pick-up coil in a superheterodyne oscillator. The smaller coil can be rotated inside of the larger one to vary the coupling between them. This pick-up coil terminates on two of the contact buttons at the bottom of the larger coil. These coils are supplied for use in

(Continued on Page 28)

Low Power Station 2BBX

By Burton Synnott*

HAVING no desire to become the greatest consumer of electricity in the Bronx, and at the same time a target for neighboring B.C.L.s I decided that the best way to avoid trouble and get worth-while transmission results was to build a station designed for forty-meter work, using a low D. C. input and very loose coupling.

With these views in mind, I built the station shown in the photograph. Using power inputs varying from ten to thirty watts, I succeeded in communicating with the Antipodes during nocturnal hours and with our sixth district in the daytime.

My antenna system has a fundamental wavelength of 125 meters. It consists of an inverted L aerial made of a single No. 12 enameled wire, the horizontal part being thirty feet long and the vertical lead-in forty-five feet long, kept at a distance of ten feet from the house. The aerial is suspended between two wooden masts fifty feet from the ground. The masts are made of two by four inch white pine and are in twenty-foot sections. Creosote paint was used to protect them against dry rot. Each mast is guyed with three No. 8 galvanized wires, broken up every ten feet with insulators. I could not get a suitable place outside the house for my counterpoise so I built it in a hallway, thirty-five feet under the aerial and in the same plane. It consists of two No. 12 enameled wires spaced three feet apart. The dielectric between aerial and counterpoise is made of wood and stone. I managed to keep the counterpoise wires eighteen inches from highly absorptive material, such as bell wires, chandeliers and the like. On the whole, the entire antenna system is rigid and strong; has well soldered joints; is "Pyrex" insulated and presents, in its entirety, one of the real reasons for my successful work on low power. Most amateurs could build a system like this in six hours.

The Receiver

A "three-circuit" tuner was made. It is quite a good oscillator and, due to its loose coupling of primary to secondary and a good variable grid leak, it is easily controlled. Signals glide in and it is a poor night when stations five thousand miles or so distant fail to be intercepted. All parts used are of well known brands, except the coils, which are homemade. These coils are wound with No. 18 D. C. wire, and are three inches in diameter. The primary consists of two turns, the secondary

eleven turns and the tickler four turns. The primary is fixed three inches from the secondary and the tickler coupling is varied from the front of the panel by a shaft made of one quarter inch dowel stick attached to a dial. The Bremer-Tully secondary condenser has four rotary plates and three fixed plates. A dial with a long handle attached controls the tuning of the secondary circuit. With the leverage afforded by the long handle it is pos-

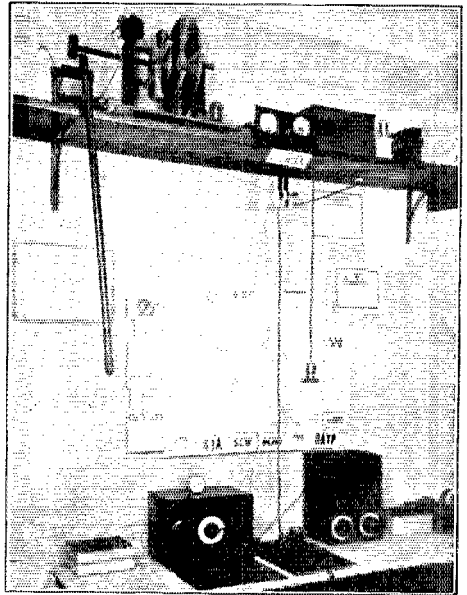

THE STATION AS A WHOLE

Only one comment is needed—the wavymeter is within easy reach.

sible to tune extremely finely and that is what is needed to help find a weak "DX" signal. The variable condenser mentioned gives a range of from eighteen to sixty-six meters nicely in conjunction with the coils described. Bradleystat carbon-pile filament control is used in the set and all parts are mounted on hard rubber. Connections are taken from binding posts on the back of the supporting shelf. Two DV5's or UV201A's and from twenty to forty-five volts of "B" battery, plus a good "A" battery, give me the most satisfactory results with this receiver.

The Transmitter

The short wave transmitter shown employs the conventional inductively coupled

*2BBX, 1237 Castle Hill Ave., Bronx, N. Y.

Hartley circuit. This circuit was selected because of its ease in tuning, minimum of apparatus required and general adaptability for low wave transmission.

Power for the transmitter is obtained from the 110 V. A.C. mains. This power is fed into the Primary of an Acme 200-watt plate transformer and a G.E. 75-watt filament hearing transformer. The separate filament transformer is used, in order to prevent the filament voltage on the single UV210 tube from fluctuating when the key is down. *The maximum voltage*

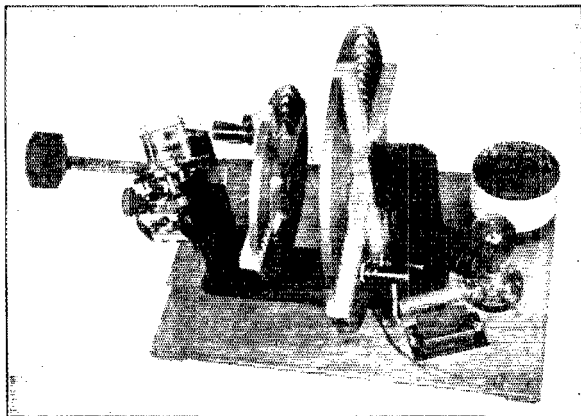

THE TRANSMITTER

The left upright carries the secondary spiral, also the two variable series condensers in the radiating system.

The large spiral is the primary. In front of the tube socket is the grid-leak-and-condenser combination, just behind the socket is the pair of filament bypass condensers and at the rear corner of the base is the R. F. plate choke.

available is 500 volts, less the drop across the "S" tube rectifiers and the filter system. Two "S" tubes are used in a full wave rectification circuit and I have no trouble getting a pure D. C. tone. The filter which "irons out" the ripples and "kinks" in the R.A.C. from these tubes, consists of a twelve henry toroidal choke, which is homemade, and a bank of Mershon electrolytic condensers, amounting to 36 microfarads. A milliammeter in the positive lead of plate supply and a voltmeter across the filament comprise the measuring instruments of the power system. A straight key in the filament centre lead, shunted by two microfarads of condenser in series with a thirty ohm rheostat, eliminates any back wash and keying thump. Once I used a "bug" key, but the only one who could copy it was ZFF, so I gave him the key as a reward.

The closed oscillatory or primary circuit of the transmitter consists of a twelve turn pancake inductance, a 200 μ fd mica grid condenser shunted by a 5000 ohm resistor, a 1000 μ fd filament by-pass condenser, a 2000 μ fd plate-blocking

condenser, an R. F. choke, the socket and the UV210 "tube of eternal life." This pancake inductance has twelve turns of 1/32" x 3/8" hard drawn ribbon wound in hacksaw slots cut in the maple supporting frame. The spacing between turns is 3/8". The cruciform frame is solidly constructed and is *not* painted. The wooden form (which supports the primary coil also) is made to permit mounting the movable antenna coupling coil. The inside turn of the primary is connected to one side of the grid-leak and condenser combination

by a short flexible lead. The other end of the leak-and-condenser is soldered directly to the grid terminal of the socket. This way of shortening the grid circuit lead, plainly seen in the photograph, is an important factor in the set's efficiency. The filament clip is placed at a point on the inductance approximately one third from the grid clip and two thirds from the plate clip. Its lead is four inches long, being soldered to the filament by-pass condensers, which are mounted on the bottom of the base board, directly under the tube socket, thus insuring short connections between the filament terminals on the socket and the by-pass condensers. The 4 inch plate lead is clipped to one of the outer turns of the inductance and goes directly to one end of the plate blocking condenser, the other end of which,

is soldered directly to the plate terminal of the socket. From here, a rigid connection is made to one side of the radio frequency choke coil. No condenser is used in the primary circuit, capacity of tube, socket, etc., being sufficient.

The secondary inductance is similar to the primary except that only six turns are used. Separate variable condensers are used in the aerial and counterpoise leads. These condensers are of good low-loss construction. A hot wire ammeter was used in the turning process, and then taken out of the circuit and placed in my curiosity chest, i. e. "junk pile." Why use the energy, grudgingly bestowed by a hard working tube, to heat a piece of resistance wire, when it may be better employed to heat the magnet windings on a New Zealander's phones?

Tight coupling has never been used at this station, as the best results were obtained when a four to six inch coupling was used. This loose coupling eliminated all prominent harmonics and aids greatly in securing a steady, sharp wave. The entire transmitter is mounted on a shelf 5

feet above the operating table. All oscillating equipment is mounted on rubber sponges, in order to absorb any vibrations caused by trains or heavy motor trucks, which pass this station. The antenna "change over" switch is operated by means of a long, wooden rod, which is easily reached from the operator's chair. The main reasons why the transmitting set was put up near the ceiling are as follows:—No chance of receiving shocks and burns, absence of body capacity effects, dry air with a minimum of dust, and less liability of displacing connections.

Operation

With one tube, rated at 7.5 watts output, a pure D.C. note, 4-1/2 inch coupling and from ten to twenty-five watts input, this transmitter has worked all of the United States, Porto Rico, Mexico, Canada,

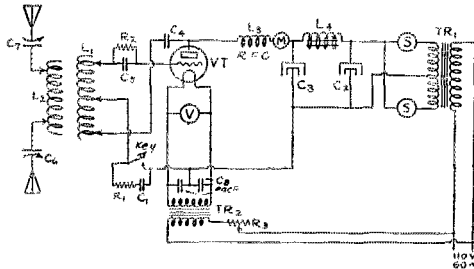

THE SHUNT-FEED HARTLEY TRANSMITTING CIRCUIT

- VT UV210 vacuum tube.
 L Primary spiral.
 L2 Secondary spiral
 L3 R. F. Plate choke, 120 turns No. 28 D.C.C. on 4" tube.
 L4 Filter choke, 12 Henrys.
 S Amrad "S" gaseous rectifier tubes.
 C1 Keying condensers, 2 microfarads.
 C2 First filter condenser, 2mfd.—paper.
 C3 Second filter condenser, Mersehou electrolytic, total capacity 34 mfd.
 C4 Plate bypass, 2000 mmfd mica.
 C5 Grid condenser, 2000 mmfd.
 C6 Counterpoise series condenser, duplex engine governor 500 unfd receiving condenser.
 C7 Antenna series condenser, Remler 500 mmfd receiving condenser.
 C8, C9 Filament bypass condensers.
 R1 Keying resistance, 30 ohms.
 R2 Grid leak, Lavite 5000 ohms.
 R3 400 ohm lamp resistance.
 V 0-15 Alternating voltmeter.
 M 0-250 direct current milliammeter.

Cuba, England, Netherlands, France, Italy, Hawaii, New Zealand and Australia. Also NVE, NITC, DI-1 and WAP. Signals from this set were logged in Brazil, Belgium, Germany, Poland, Azores, and by ships in the Arctic Atlantic and Pacific Oceans, not to mention all the "near" hams who sent me cards from all over the world. I consider my best daylight "DX" work as being 6CHS, who was worked for 21 minutes in broad daylight on 40 meters, July 5th,

1925, with only 22 watt input. a2BC and z4AR were worked for over twenty minutes on different nights, with the same power. I have three cards from sixth district stations, who heard me in daylight. 9EK, the Burgess Co. station, was worked recently at night, from here, with a power of from eight to twelve watts input. My cards total over two thousand and they are still coming in.

In spite of all distance work, I have always managed to keep well up in the Hudson Division's traffic report of the A. R. R. L. and, in conclusion, would say that with a good antenna system, an efficient receiver, a transmitter operating with a cool tube, pure steady D. C. supply and loose coupling, I am sure any station in a fair locality can duplicate, or even surpass, the results obtained here.

And the Proof

Just as illustration of the work that can be done at the worst time of the year if the note is steady and clear, here's the log of stations worked from July 1st to August 9th of 1925. Stations in districts 1, 2 and 3 not listed.

Daylight

4MF, 4RR, 4SH, 5UK, 5AGN, 6CHS, c1AM and also WAP at Hopedale, Labrador.

Night

American 4CU, 4FJ, 4JS, 4MF, 4RM 4RR, 4SH, 4TV, 4UX, 4XE, 5ED, 5IN, 5LS, 5QS, 5UK, 5VL, 5AGN, 5ATV, 6EB, 6FA, 6ZQ, 6AHP, 6AJM, 6AKH, 6AMM, 6ASV, 6BDE, 6BHZ, 6BTU, 6CAI, 6CBB, 6CGW, 6CHS, 6CNC, 6CSS, 6CSW, 6CTO, 6CUB, 6DAH, 6DAI, 6DAJ, 7WU, DI1, NAJ, NVE, WAP.

Porto Rican 4JA, 4OI, 4SA.

Canadian 1AA, 1AC, 1AF, 1AM, 3EN.

Cuban 2BY, Mexican 1K, English 5BV, French 8BF, New Zealand 4AR and Australian 2BC.

(How does that look to you fellows who are using 50- and 250-watt tubes with an input of 250-2500 watts?—Tech. Ed.)

Strays

New Zealand Wireless and Broadcasting News is always welcome around this shop if for no other reason than the genial humor of our friend MacClurcan of New Zealand 2CM. His latest bright remark was made after the visit of the Pacific Fleet. After having been lost in the maze of gangways and ladders below the deck of one of the American battleships, MacClurcan says that he positively will not buy a battleship because he might lose the book of instructions.

The Mast at 9KC*

THE Westmont Radio Club's station location is on high ground adjacent to the C. B. & Q. tracks at Westmont, Illinois. Because the place can be seen from a considerable distance it was necessary to adopt some type of antenna mast that would have fairly good appearance. It was also necessary to keep the cost down. As a result there was built a lattice mast that based on descriptions in past issues of *QST* but differed in some details.

The mast is four-sided, has a height of 70 feet and is topped by a 7-foot flagpole. The corner pieces are 2" x 2" spruce and the lattice work is of plaster lath. The base is cross-braced but there is no other internal bracing unless one includes a block on which the flagpole stands after being slipped down inside the mast. A piece of 4" x 4" material protrudes from the side of the mast near the top to afford a point at which the pulley can be fastened.

These lattice masts are always unconvincing to anyone that has never seen one but the writer of this squib (and several others of the *QST* gang) knows that they are amazingly stiff. The 80 footer at 1XAQ-1AEL-1ASN-1OA-11D could be lifted by two people although the separate sides (before nailing together) were so limber that waves could be sent along them as they lay on the ground, just as one would cause a rope to "flop" at the far end by snapping the near end. The Westmont mast "was so light that it could be lifted with ease by two men;



can be lifted by four men now that it is up, even though the guys are pulling on it."

Before the mast went up the guy anchorages were prepared by digging 8" holes 6' deep and slanting away from the mast-base. Lengths of 1" pipe were put into these holes and concrete poured around them. The upper ends of the pipes were equipped with eye bolts to receive the guy wires. There are three guy anchorages and each one receives three No. 8 iron guy wires which

* Written from information in a letter of Louis A. Pease, President Westmont Radio Club, P. O. Box 165, Westmont, Ill.

1 See Page 17, Sept. 1923 and page 39, June 1924 issues of *QST*.

start at the mast-top, 22 feet down and 44 feet down.

The mast-base is of concrete, 6 feet square and 2 feet thick.

The method of putting up the mast can be seen from the photographs. The base of the mast was first secured against slipping while still permitting the mast to rise. A tackle was secured at the middle guy point, that is to say 22 feet down from the top. With the aid of this tackle, two large "horses" and the extension ladder the mast went on up. Men at the side guys prevented side-sway. The whole thing was done in two hours by 8 men.

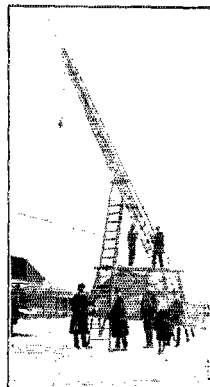

The writer helped put up the 80-footer mentioned above and will never again try anything of the sort with three guy anchorages. Four have the very great advantage that one can at the very start fasten all of the side guys and the back guys and then can use all available man-power to do the lifting. This is a big advantage when the gang is limited and a still bigger advantage when a cross wind starts up.

The lifting system at 9KC was excellent, however. The use of the extension ladder is especially ingenious because it enables the gang to rest. By the way—if the ladder is put too near the top or too far down the mast will be strained badly. 1/3 of the way down is about right.

Strays

Do Tell

"Many folks think an antenna having four wires improves the reception of signals. This type of antenna causes very broad tuning, due to the large amount of capacity and effective antenna resistance. A great many of the present day transmitters desire a lot of capacity, due to the high power. In the transmitter the resistance is overcome by the high voltage output, but in the receiver there is no output; it is all coming in and nothing to counteract the resistance." —[Page 11, *Radio World*, August 22, 1925.

Amateur Filter Problems

By F. S. Dellenbaugh*

OCCASIONALLY an amateur radio station has use for a band filter or for a high-pass filter, but the low-pass filter fills most needs. The commonest problem of all is that of removing a commutator ripple from the direct current supplied by a generator or that of removing the alternating currents from the output of a rectifier operating on commercial 25- or 60-cycle line supply.

Smoothing out a rectified wave may be considered from two angles. First we can say that the gaps in the pulsating output of the rectifier must be filled in by stored energy from the filter. From this viewpoint the exact arrangement of the apparatus is not important and it is desirable to connect large lumps of inductance in series with the line to store energy in magnetic form and also large condensers in parallel to store more energy in electro-static form. The action is then like that of a flywheel. Secondly, we can say that the rectifier output is D.C. plus a lot of frequencies of alternating current and by means of filter circuits carefully designed we can take out each of these frequencies and leave the D.C.

These two methods might be called the "brute force method" and the "intelligence method."

Testing Filters

Adjusting the Air Gap of the Chokes

In the "Brute Force" type of filter the choke does not have to be adjusted to any particular value of inductance; in fact we do not care what the inductance is, as long as it is more than about 30 henries.

Design of Iron-core Choke Coils

The dimensions for choke coils which are given in the full page chart will fit most amateur needs. When a choke with less inductance is needed, turns may be removed from the winding, remembering that the inductance varies as the square of the number of turns, so that taking off half of the turns will reduce the inductance to one-fourth of the value it had before. The reverse change of adding more turns must not be attempted as the core will become saturated. The dimensions b and c may be understood by referring to Fig. 19.

The choke coil designs given in this article are based on calculations that cannot be repeated here on account of lack of space. The design of both the windings and the

core is quite conservative and overloads can be carried.

In all of the chokes the arrangement of the core and the winding is assumed to be that shown in Fig. 19. The dimensions b and c refer to the measurements of the coil and are to be used in connection with the design tables.

Cores—The most convenient material is of course electrical (silicon) sheet steel, .014" or thinner being satisfactory. The thinner steels give lower losses. Fine iron wire is excellent. In all cases painting each piece of the core with shellac or japan is advisable to reduce losses. The corners should be made with butt joints instead of the usual interleaved corners. An air gap is needed in any case and the losses are lower with butt joints. After the adjustment of the air gap the core should be clamped firmly, since the magnetic pull is considerable, and if the yoke is loose the air gap will change the value of inductance, besides being noisy. (In the Acme chokes small pads of cloth are placed in the air gaps.)

Wire and Winding—Wire with the thinnest insulation should be used to make an economical design. As a comparison, a coil of No. 28 enameled wire 1 $\frac{3}{4}$ " long and 2" outside diameter with a core $\frac{1}{2}$ " square

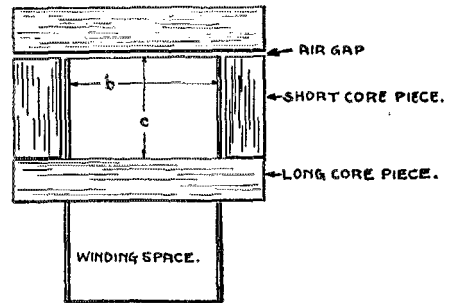

ARRANGEMENT OF INDUCTANCE COILS.

FIG. 19

gave the same inductance as a coil wound with No. 25 cotton-covered wire 2 $\frac{3}{4}$ " long and 4" in diameter with a core 1" square.

Heavy flexible leads should be soldered to the ends of the coil and firmly taped down to prevent breaking off. For minimum amount of winding the core should be covered with a layer of tape and the winding run directly on that. For voltages above 500 extra insulation must be used, but this should be no thicker than is absolutely necessary. Accordingly, the very

* Acme Apparatus Co., Cambridge, Mass., also Massachusetts Institute of Technology. This article is printed in response to a general demand for an abstract of the original article which appeared in the July and August, 1924, issues.

DESIGN DATA FOR INDUCTANCE COILS WITH IRON CORES. Weight of Steel taken as 480 lbs. cu. ft. = 0.28 pounds cubic inches

Table with columns: CORE SIZE, INDUCTANCE, EQUIV GAP, ACTUAL GAP, NO TURNS, FLUX DENS, WINDING FORM, MEAN TURN, FEET OF WIRE, RESISTANCE, WEIGHT OF COPPER, CORE DIMENSIONS, POUNDS. Includes sub-headers for Cross Section, Henrys, G, Decimals, Nearest Fraction, (N), (B), Lines/Inch, b, c, inches, WIRE, (D C), COPPER, Long Piece, Short Piece, STEEL.

All wound with No 33 enamel coated wire, 20.6 ohms per 1000 ft. (650 ft. per lb. Carrying Capacity 0.65 amperes.

All wound with No 30 enamel coated wire, 20.6 ohms per 1000 ft. (327 ft. per lb. Carrying Capacity 0.65 amperes.

All wound with No 26 enamel coated wire, 20.6 ohms per 1000 ft. (330 ft. per lb. Carrying Capacity 0.25 amperes.

All wound with No 23 enamel coated wire, 20.32 ohms per 1000 ft. (434 ft. per lb. Carrying Capacity 0.50 amperes.

* The actual gap can only be an approximation owing to the many factors which may affect Fringing of Flux, permeability of core etc. It must be adjusted by trial until the proper value of inductance is obtained or better yet, until the set up operates at the best point.
** The values of (B), the flux density, are those obtained with all D.C. & 60 A.C., or the effective B if all A.C. The maximum value in the latter case will be 1.41 X B as given in the case of rectified A.C. applied to coil with no previous smoothing. The maximum B may be 1.57 times the values given.

best insulating material should be used under the winding. Before the winding is begun, strips of cotton tape are laid along the coil and the fiber end flanges, and temporarily secured in place. For coils up to 2" in diameter 1/16" flanges will do and above that 1/8" should be used. After the coil is wound the cotton tapes are brought up and tied tightly over the coil to keep it from spreading.

The dimensions given here are for all of the winding on one side of the core. The winding may be split into two coils, one on each long core piece, which takes less wire per turn but does not use the copper so effectively (due to the leakage between coils) and hence requires more turns. If the winding is not any deeper than the thickness of the core it is probably not worth while to split the coils. If the winding is very deep the coil should be split and about 10% extra turns used on each of the two resulting coils.

The wire sizes given in the tables are conservative. 10% larger currents can be carried continuously and 25% greater for

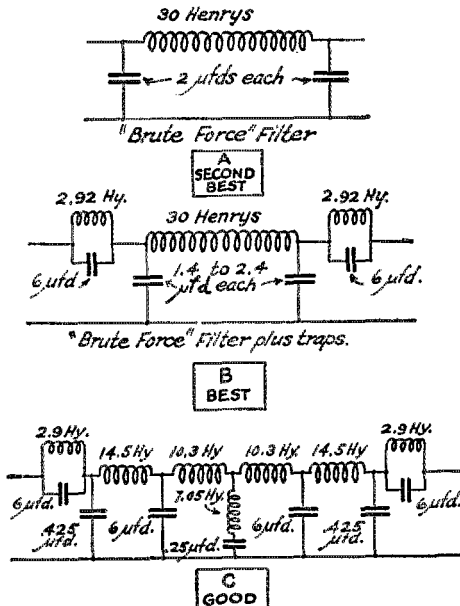

FIG. 21 THREE GOOD FILTERS FOR RECTIFIED 60~A.C.

a short time. If the coils are heavily taped over the outside they will not cool well.

Air Gaps

Air Gap—A large air gap will reduce the inductance and require a very large choke, making wasteful use of the material. A small air gap increases the harmonics and defeats the purpose of the filter. A good value is one that uses up about 90% of the ampere turns of the coil, the rest be-

ing used up in magnetizing the core. As the permeability of sheet steel is 1000 to 5000, a core 10 inches long will require an air gap only about .05 inches long to meet the requirement of using up 90% of the ampere turns. The exact value must be found by trial.

The simplest way of adjusting the air gap is to connect the filter to the load with

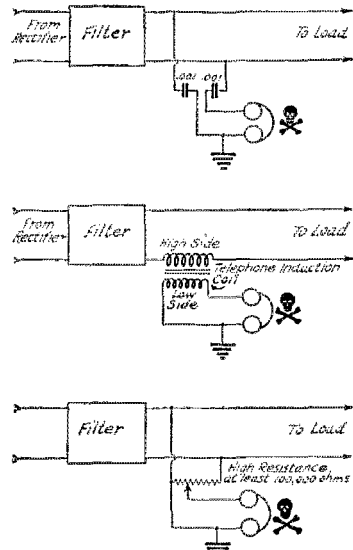

FIG. 23 TESTS OF FILTER ACTION

which it is to work (tests with a different load mean very little) and then change the air gap till the best filter action is gotten. One of the circuits shown in Fig. 23 may be used for this adjusting but DO NOT LEAVE OFF THE GROUND CONNECTION OR TOUCH ANY PART OF THE SET WHILE THE CURRENT IS ON. UNDER NO CIRCUMSTANCES WEAR THE HEADSET, AS THERE IS AN EXCELLENT CHANCE OF BEING KILLED OR SEVERELY BURNED.

After a test has shown how the output of the filter sounds, turn off the power, unclamp the core of the choke and set the air gap to a different value. Then clamp the core tight and try again. When things are properly adjusted the sound in the phones should be very weak. If nothing is heard at the start of the test the setting may accidentally be correct but the chances are that the apparatus connecting the headset to the line is wrong.

Finally—Don't forget to ground one side of the phones and then keep the headset on the table; a well-filtered plate supply is of no use to a dead operator.

Experimenters' Section Report

THE November issue of *QST* has not been gone long enough so that we have obtained from the membership of this Section any opinion on the proposed plan for the Section's future. It will be greatly appreciated if every man who has not written before this time will communicate with this Section at once on reading this notice. The nature of these responses will largely determine whether the Experimenters' Section will continue. The discontinuation of the Section would, quite frankly, be a rather severe blow to the Editorial Department of this magazine.

WGY Experiments

A corps of observers has been appointed from the membership of this Section to work with the Research station of the General Electric Company at South Schenectady, New York. This is not the same transmitter as the one popularly known under the call of WGY but is a group of transmitters located at a different point and operating under various conditions. The wavelengths used have at various times ranged from 1500 meters down to 10 meters. At this time a number of transmissions are being effective synchronous with the usual operation of WGY. Other members of the Section interested in making observations on this are urged to get into immediate communication with this Section or else to get into direct touch with Mr. C. J. Young at the Radio Laboratory, South Schenectady, sending carbon copies of the correspondence to this Section in order that everything may be kept co-ordinated.

Grid Leaks

There has been a wide divergence of opinion for some time as to the goodness of the ordinary receiving grid leak. Work on this subject has been done by a number of members of this Section and results have been received from Mr. Beverly Dudley of Chicago and Mr. Austin Lidbury of Niagara Falls. Mr. Lidbury especially has made a great number of measurements. These results will be published in *QST* soon and this is a request for any additional information on the same subject. Tests should be made under conditions which will show what the usual customer receives and should not be unfair to either the manufacturer or the consumer.

Polarized Waves

The theories of Heaviside, Larmor and Eccles have now to be reconsidered in view of the suggestion that the irregularities of short wave transmission may be due to polarization at fairly low levels and not (or

at least not always) to reflection or refraction in the upper atmosphere.

The general idea is not new and indeed many measurements on wavefront distortion have been made by a long series of investigators through many years. Interesting new lights on the matter is due to the investigation of R. L. Smith Rose and R. H. Barfield in England and of Dr. Greenleaf W. Pickard in America. A practical application of Dr. Pickard's conclusions has been made by B. H. Taylor of Haverhill, Mass., who has been able to obtain some surprising results in the reception of short waves.

The technical editor is very anxious to hear of all possible investigations along this line as they seem to suggest entirely new possibilities in reception which are not at all possible with our present system of receiving.

"Picofarad"?

For some time the editors of this magazine have been thoroughly dissatisfied with the clumsy units "microfarad" and "micromicrofarad". The first of them is enormously too large for ordinary radio use and the second one is of the right size but has a lubberly and inconvenient name incapable of easy pronunciation or type-setting.

It has been suggested that we substitute "picofarad" for "micromicrofarad". The justification for this suggestion is that the term is used by some English writers. The term has been discussed in correspondence with a number of leading men in the industry and was also talked over at a dinner of the Radio Engineers Club in Chicago. The general opinion appears to be that the word "picofarad" is an improvement over micromicrofarad but is too much like "microfarad" and can easily be mistaken for it.

Mr. Melville Eastham is inclined to think that it would be well to manufacture a new name outright. The technical editor is inclined to favor this and as a tentative suggestion proposes that the "micromicrofarad" be given the name of some man prominent in the industry or the art. His name should of course be one that can be easily pronounced and spelled in several languages. Suggestions are very welcome.

Has the Small Antenna Advantages?

Several members of this Section have objected vigorously to the much repeated statement that the ratio of signal to static is better when one is using a small antenna.

Is anyone able to produce measurements or to undertake making measurements which will definitely establish the correctness or incorrectness of this supposed improved ratio?

"Fundamental"

Several months ago we suggested tentatively that it might be good practice to make a distinction between the fundamental of an unloaded antenna and the fundamental of a loaded antenna. It was suggested at that time that "natural" be used to indicate the fundamental of an unloaded antenna. Several members have pointed out the necessity for an improvement on that terminology, giving reasons that are good but too long to be detailed here. What does the membership think of modifying the suggestion to the use of the terms "natural fundamental" and "loaded fundamental" or else "unloaded fundamental" and "loaded fundamental"? It is understood of course that the loading may be of a nature which will bring the wavelength up or of a nature which will bring it down, that is to say it may be a series inductance, a shunt condenser or a series condenser.

—R. S. K.

A Correction

On page 9 of the September issue, in connection with the article "Reviewing the Receiver", by Adams, we published this

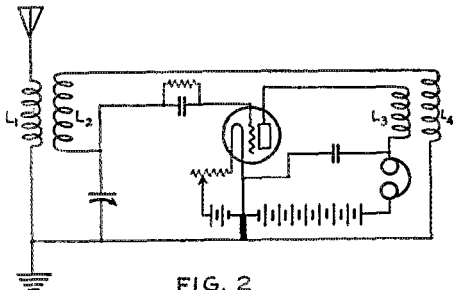

FIG. 2

circuit without the filament-ground connection shown by the heavy black line. This connection is essential to satisfactory operation of the set.

Strays

Traffic Manager Schnell, FS of NRRL, returned home to Hartford on October 31st, loaded down with trophies, interesting stories, photographs, and the praises of the Navy Department for his successful demonstration of high-frequency communication from his set aboard the "Seattle" in the recent cruise of the Battle Fleet. At this writing he is engaged in preparing an account of his adventures for *QST* readers, which we shall have pleasure in presenting very soon, perhaps in our next issue.

In Memoriam

F. C. Beekley

L. W. Hatry

Francis C. Beekley, the managing editor of *QST*, and Miss Aline Fisher, of Willimantic, Conn., were married on October 31st and are honeymooning through the month of November somewhere in the Virginias.

Louis W. Hatry, manager of the A.R.R.L. Information Service and radio editor of "The Hartford Times," was married in New York City on October 24th to Miss Dorothy M. Bates, also formerly of A.R.R.L. headquarters.

To these good men and true, almost the last of the bachelors at headquarters, these lines are indited to the memory of days that were, by the benedicts of the Staff.

New Coils and Condensers

(Continued from Page 19)

superheterodynes or can be obtained unwound. They should make excellent forms for short wave tuners. Their plug-in feature allows one to use them as short wave tuners in which the complete unit can be removed and another one for a different wave band substituted quickly. The tickler can be wound on the small rotating coil inside the form. The contacts on the socket are of spring material. The springs are long enough to give good tension and should last a long time. The coil cannot be inserted in the socket incorrectly as one of the ribs extends the full length of the form and fits in a notched place in the socket.

The condensers are also Silver-Marshalls. They are made from silver-plated brass. The plates are rigidly bolted together with long machine screws supported by small rubber angles. There is but one bearing. It is cone shaped and is provided with a spring and machine screw to adjust the tension of the rotary plates. As the plates, both rotary and stationary, can be readily removed, almost any maximum capacity can be obtained. The condensers are supplied in either straight wavelength or straight frequency line types and come in various maximum capacities from 175 μfd . to 500 μfd .

—J. M. C.

Frequency Doubling in Vacuum Tubes

By T. T. Greenwood*

THE present interest in short wave transmission directs attention to a novel and recently patented scheme of a German engineer for doubling the frequency of electrical oscillations by means of a vacuum tube. The usual 3-element type of tube is employed and the tube is operated on that part of the grid-current plate-potential curve at which the grid-current shows a decrease for either positive or negative potential applied to the plate, whereby means of a suitable transformer the frequency of the plate voltage is doubled in the secondary of the transformer.

Fig. 1 illustrates the essentials of the circuit while Fig. 2 illustrates the variations of grid-current with variations of plate potential and Fig. 3 illustrates a typical grid-current plate potential curve.

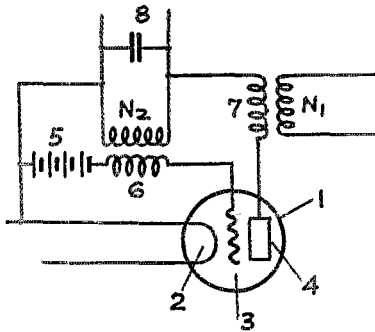

FIG. 1

The tube 1 contains the usual filament 2, a grid 3, which preferably is wide meshed, and the plate 4. The grid is connected to the filament by the battery 5 and the primary winding 6 of an output transformer. The plate is connected to the filament by the secondary winding 7 of a transformer. An auxiliary potential can be applied to the plate circuit; and the filament battery or the battery 5 can be used for this purpose. The increased frequency n_2 is obtained from the secondary winding of the transformer 6. The operation is as follows:

Due to the battery 5, a continuous current flows in the grid-filament circuit. This continuous current is not independent of the plate potential. Either a positive or a negative plate potential causes a fall of current in the grid-filament circuit as may be seen from Fig. 3. Therefore, the alternating positive and negative voltage waves of the

current n_1 , both cause a decrease in the current in the transformer 6. The curve of Fig. 2 represents this action. The dotted line J_0 represents the continuous current in the grid-filament circuit. If the potential n_1 now begins to act on the plate, both the positive and negative half-wave of this potential will cause a fall in the current J_0 . The result is the occurrence of a wave current of doubled frequency in the grid-fila-

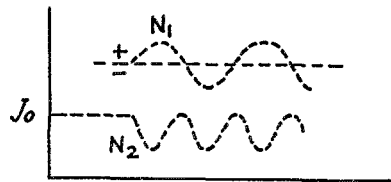

FIG. 2

ment circuit and this wave current can be obtained as pure alternating current of double frequency by transformation in the secondary winding n_2 . The presence of the battery 5 in the grid circuit is essential to the efficiency and energetic action of the apparatus. The action of the apparatus is better in proportion to the strength with which the potential variations of plate 4 affect the current in the grid-filament circuit. Therefore for the present purpose it is advisable to use tubes having a large amplification.

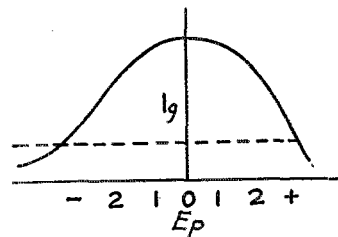

FIG. 3

The curve of Fig. 3 is an approximate characteristic curve of the tube 1 and shows the change of grid current with change of plate voltage. Values of grid current are represented by ordinates, and plate voltages by abscissae. The portion of this curve above the dotted line represents the part upon which the system is preferably designed to operate.

* Patents and Trademarks, 40 Court St., Boston.

The stepping up of the frequency can be repeated many times: the frequency n_2 of the potential variations of the plate can be superposed on another tube or even on the tube which has already been used. In the latter case the frequency is repeatedly doubled in the same tube. It is advisable to have the system n_1 and n_2 in resonance. Circuit n_1 will be in resonance with the waves applied to the input circuit while n_2 will be in resonance with the output waves by tuning it by means of a variable condenser S or other suitable means. The great advantage of the arrangement lies in the fact that it is possible not only to increase the frequency, but also to amplify the energy simultaneously. It is evident from Fig. 2 that battery B produces additional energy when the frequency is increased.

A New Porcelain Socket

THE Hart & Hegeman Company of Hartford have developed a porcelain socket to which the attention of the gang should be drawn: There are several novel features embodied in this socket—features which are not found in any other tube socket. One of them is the new spring contact method. The springs make contact with the side of the tube pins. These springs are flared

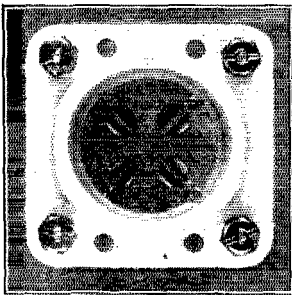

over at the edges so that the tube pins will not catch on the edge of the spring. It is not necessary to turn the tube at all after it has been pushed into the socket. Other sockets have this side-contact feature but they require that the tube be turned a quarter of the way around after the tube has been placed in the socket. After a while the springs become weak and when the tube is turned it catches on the back side of a spring and either breaks the spring off or causes a short circuit.

The porcelain is very well glazed and should be entirely impervious to moisture. Small soft rubber mounting feet are attached to the spring supporting screws, and the wood screws which hold the socket in

place on a baseboard have rubber washers under their heads. This mounting takes up a lot of the vibration which would normally reach the tube and cause microphonic noises.

J. M. C.

A New Vernier Dial

THE Marco vernier dial is exceptionally neat. The rotating scale is housed in a mottled bakelite case and is visible at three places through the case. At the top of the dial there is a celluloid window with a vertical hair-line indicator mark. This window is used to read the scale degrees. The windows at the right and left are used to spot call letters that may be written on the rotating scale. The vernier action

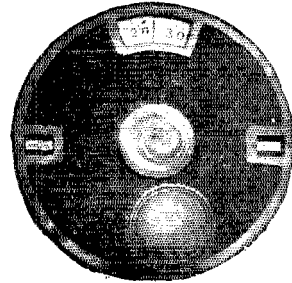

is very good. As there is no backlash or lost motion the 6 to 1 ratio of the vernier is ample for broadcast as well as amateur condenser control. The vernier control has a small brass pulley on it, inside the bakelite case. This pulley turns in a cut-out and grooved portion of the brass scale. As there is a continual tension on the vernier shaft the dial and vernier make good contact and any wear is automatically taken up. The dial is made by the Martin-Copeland Company of Providence, R. I.

Obituary

We regret to record the death of Carlton Taft Caswell of Framingham, Mass. He was owner of the call 1BT; and one of the pioneer amateurs of that vicinity for he had operated pre-war 1MD. He was an enthusiastic amateur, and a hearty worker in behalf of "ham" radio.

The New Carborundum Detector

A Description of the Modern Development of a Historic Rectifier

By M. L. Hartmann* and John R. Meagher†

THE name Carborundum has been closely interlinked with radio since 1906 when General Dunwoody of the United States Army discovered that the rectifying property of this crystal permitted its use as a detector in receiving sets.

For many years before Dunwoody's invention, physicists knew that the resistance of some crystalline substances varies with the amount and direction of an impressed electrical force: the resistance being practically infinitely high for low values of voltage applied in one direction and decreasing for increasing values of voltage applied oppositely. Current, of course, passes through the crystal only when the resistance has some finite value, a condition which exists only when the voltage is applied in a certain direction. So if a source of voltage varying alternately in one direction then in the other is connected to such a crystal, current will flow in one direction only: it will be direct instead of alternating.

Dunwoody was the first to realize that as the crystal resistance varies simultaneously with variation of the impressed electrical force, rectification is possible even with extremely high or radio frequency alternation of voltage. He chose Carborundum as the detector element because of its stability and current carrying capacity.

Many scientists following in the footsteps of Dunwoody discovered and re-discovered innumerable rectifying substances and countless combinations of crystals and mountings were developed. But as yet no crystal has been found that possesses the electrical stability and permanence of Carborundum.

Realizing that this feature of stability and permanence would be of great importance in detectors of broadcast receivers, the Research Laboratory of the Carborundum Company undertook the development of a fixed Carborundum detector. Many months of investigation were required to determine the variety of Carborundum having the most efficient rectifying qualities, the best type of mounting, the correct pressure between crystal and contact, the kind of metal for contacts and all the other small but important details that were

necessary to perfect the Carborundum Detector.

For example, with a particular variety of Carborundum which has hitherto never been used for rectifiers, it was found desirable to press the crystal against the hardened metal plate with a pressure greater than five pounds. It is evident that in comparison with the usual "catwhisker" touch of other crystal detectors this heavy contact pressure places the Carborundum Detector in a class by itself so far as ruggedness and stability are concerned. The detectors as they are now manufactured represent a decided improvement over the type used so successfully on the Marconi receivers.

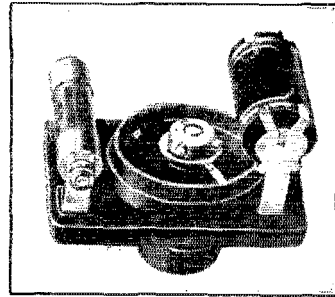

The Carborundum Detectors have a comparatively high resistance so they exert a smaller damping effect upon the tuning circuit and thus afford greater selectivity than low resistance crystals, such as galena. However, this higher resistance militates against sensitivity because it prevents full current flow with the small voltages available in reception of distant stations.

To obviate this disadvantage, we have developed a Carborundum Stabilizing Detector Unit which provides electrical control of the detector so that the value of resistance may be selected which best suits the circuit impedance and operating conditions.

The unit, which is completely self-contained with detector and dry cell and requires only two leads for connection in any detector circuit, consists of a high-resistance center-tapped potentiometer, a Carborundum Detector and a by-pass condenser to nullify the inductive reactance of that portion of the potentiometer winding

* Research Director, The Carborundum Co., Niagara Falls, N. Y.

† Research Department, The Carborundum Co., Niagara Falls, N. Y.

included in the detector circuit. The center-tapped potentiometer gives a "biasing" voltage over the range of negative $\frac{1}{2}$ to positive $\frac{1}{2}$ volts. Owing to the large number of contact turns, the adjustment is in fine steps of about .0025 volts. The effect of this biasing voltage upon the resistance of a typical Carborundum Detector may be seen in the accompanying graph.

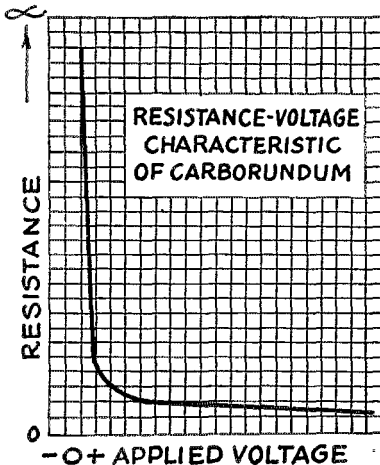

The advantages resulting from regulation of the detector resistance in a plain circuit are twofold:—

1. The resistance may be made high so the detector will have but slight damping effect on the tuning circuit, resulting in greater selectivity. In actual practice increase of the detector resistance affords better control of selectivity than does a very loosely coupled antenna circuit. This

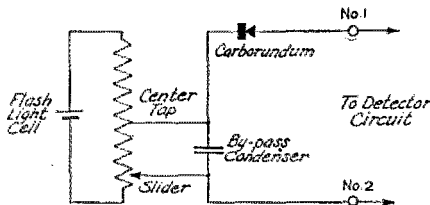

is owing to the fact that the damping effect of the average crystal is considerably greater than that of the antenna; loosening of the antenna coupling decreases the power input, but does not appreciably reduce the detector circuit damping. On the other hand, increase of the detector resistance does not decrease the power input, but it does very materially reduce the

detector circuit damping, resulting in increased selectivity and, of course, sharper tuning.

2. The detector may be adjusted to the point of most rapid resistance change, resulting in most efficient rectification with correspondingly increased sensitivity and volume.

In reflex circuits one other very important advantage is gained:—

The degree of damping of the detector circuit governs to a considerable extent the damping of the radio frequency amplifying tube circuits. In turn the damping of the radio frequency circuits determines the amount of effective regeneration. And, of course, upon the value of regeneration depends the degree of selectivity and sensitivity. When the radio frequency amplifier is operating on the peak of regeneration, the set is most sensitive and most selective. By controlling the detector resistance and thus indirectly the radio frequency tube circuit damping, it is possible to work on the peak of regeneration through the entire wavelength range of the receiver. The result is plainly evident in sharper tuning and increased volume and range.

The inherent stability and current capacity of Carborundum plus the additional features of controlled sensitivity and selectivity makes this unit particularly well suited for use in modern receivers. It is especially adaptable to sets employing 'A' and 'B' battery substitutes to minimize the 'hum' encountered with a vacuum tube detector.

Strays

Some foreign amateurs are taking the liberty of sending bundles of QSL cards to Headquarters for forwarding when there are at present obtainable call books giving the addresses needed. For their information the following list of call books and prices is given:

Amateur Radio Stations of the U. S.—25c plus 6c postage, Superintendent of Documents, Government Printing Office, Washington, D. C.

Citizens Radio Call Book (Amateur Edition), 75c plus 10c post, Citizens Radio Service Bureau, 508 So. Dearborn St., Chicago, Ill.

The Conrad Company, 233 Fulton street, N. Y., has gotten up a "Radio Listeners Guide and Call Book" that is a combination of a series of good B.C.L. constructional articles plus a good list of B.C. stations and a good list of ham stations.

Remittance should be made by international money order or New York draft as stamps and personal checks are not accepted.

What Is the Radio Club of Argentina?*

By Enrique L. Repetto.†

ONE of the greatest desires of the amateurs of the whole world was realized after the congress of International Amateurs in Paris. The International Amateur Radio Union is a fact.

The relations between all the amateur societies will be greatly enhanced, and it is desirable that our great society, the Radio Club of Argentina, should be known.

This society was founded in 1921, when the number of amateurs in Argentine was very small. We began with something like 100 members. When radio began to develop in the Republic of Argentina, all transmitting amateur stations installed in Buenos Aires and the cities of the interior carried on voice transmission and a small number pursued telegraphic transmission. In a very short time the number of stations increased considerably, and now is over 700. These stations constitute an interesting medium of pleasure, and they are also a national asset because many farmers have the use of these stations for communicating with their friends in Buenos Aires or in the interior. When they cannot have direct communication (when their power is insufficient or atmospheric conditions are unfavorable) they have their messages relayed and a reply is obtained and returned in the same manner until it reaches the station of origin. In the United States such relaying is done through the medium of the telegraphic code, whereas in Argentine it is done by radiophone.

With the development of communication on short waves and with the encouraging example of our "Pioneer" operator, Mr. Braggio, owner of station CB-8, interest in long distance communication has been awakened in our Argentine amateurs who are disposed to perfect themselves and perform the best of work.

It is, then, conceivable that the Radio Club of Argentina will unite all of the Argentine amateurs; that is to say, all who are interested in the development of radio communication in whatever field they represent.

Organization

The present number of members in the club is well over 1000, and its organization, it must be understood, is complicated since it offers advantages to various kinds of amateurs.

The management is in the hands of an Executive Committee composed of 10 persons. With this committee is working a great number of sub-committees who are studying projects to be presented to its members or to associated organizations. These sub-committees report to the Executive Committee recommending approval, modification or rejection.

The first committee is for Publicity. Its duty is to study all questions that would make for the progress of the Club or be an incentive for the amateurs who are not members. This committee has more than 60 members and meets once a week. When the urgency of business demands, it can have a session with only two members.

Second is the Technical committee: composed of a great number of amateurs, generally the most advanced, to give technical advice to the Executive Committee. Its members submit for the consideration of the committee projects of technical nature. Articles to be presented are referred to this committee for its opinion.

There is a legal committee, in which is included all of the lawyers who are members of the club. Fortunately this committee never had to meet, as the normal expansion of the Radio Club of Argentina has not been inconvenienced by its constitution.

Legal Authority

The Radio Club of Argentina is the only society of its kind in Argentina which has personal jurisdiction. That is, it has the authority of the government to act in the name of its members and fulfil all operations permitted by law.

There is, also, a Committee of the Interior acting as a vigilance committee, and it has charge of all the property owned by the Club; it instigates local modifications for the benefit of the members.

The Brasspounders

Lastly, there is the Committee of Transmitting Amateurs, which is possibly the most important of all and which has the most arduous work. All members of the Club who receive a license to operate a transmitter automatically become members of this committee, as do all new members who possess a license. As this committee has a considerable number of members, it elects annually its own executive committee who has charge of the organization of all the work with reference to communications between amateurs, whether by telephone or telegraph. Its work is closely connected with that of the Publicity or Technical Com-

*Written for *QST*. Translated from the Spanish by A. A. Hebert.

†Chairman Publicity Committee, Radio Club Argentine, Buenos Aires, Argentine Republic, South America.

mittee. Actually this committee, at this time, is devoted exclusively to the organization of a most important test in radio; that is, a "relay" around the world in the Southern Hemisphere. This relay will be radiotelegraphic and has been organized jointly by the Radio Club of Argentina and one of the most important newspapers in Buenos Aires, "La Nacion".

The interest awakened by this test is very great, and the Radio Club of Argentina has made arrangements to teach the code to those amateurs who do not know the telegraphic signals. The number of students is large, and it has been necessary to divide them into three groups and to begin a night course for those who cannot attend the day sessions.

In consequence of this experiment it is hoped that the number of telegraph transmitting stations, on short waves, will be more than 100. When the Executive Committee holds its meetings, which generally are twice a week, all the presidents (chairmen) of the sub-committees are present and submit the projects that are presented in the name of the sub-committees, but do not have a vote.

The Magazine

The Radio Club of Argentina owns a magazine which is its official organ and is published by the club itself; the direction being entirely in the hands of the amateurs. Its name is "R.C.A." There is a manager who is the Secretary of the Executive Committee and counts on the assistance of the editorial committee which are the presidents of the sub-committees. The magazine is published monthly, and though it makes no profit for the club it is hoped that as the number of copies sold increases some profit will result. If so it will be used for the club's improvement. All the articles appearing in "R.C.A." are written by the members of the club and are edited by the editorial committee before being given publicity.

The library, which is one of the principal attractions of the club, is managed by a director with a number of assistants. It has more than 400 volumes on radio, electricity and physics, and in the lecture room the members have for their use more than 50 magazines or reviews from all parts of the world.

The Club is situated in one of the most central buildings in Buenos Aires and occupies a floor divided as follows:

Secretary, Broadcasting studio connected with all the broadcasting stations in the city (also with the Board Room of the Executive Committee); Library and lecture room; work-shop where the members may find all the tools for the construction of receiving or transmitting sets; laboratory where various receivers are at the disposi-

tion of all members; and small radiophone and telegraph transmitters for communication with the city. One thing we have encountered on the second floor of this reinforced concrete building, which is in the center of the city, is difficulty in good transmission and the reception of long distance stations. In the laboratory there is at the disposal of the members a variety of measuring apparatus for the calibration of condensers, coils, resistances, etc. Special apparatus permits of immediate testing of any class of vacuum tubes, also the plotting of their characteristic curves. Dealers or manufacturers of radio material may use the laboratory apparatus to verify their own apparatus, a small charge being made for the use of the apparatus, which sum is used to acquire new apparatus for the laboratory.

Finally, we have a meeting hall with a capacity of more than 300 people. In this are held periodic conferences where one may encounter a large number of members and visitors.



THEY TELL US THAT QZZZ OVER IN BLARRH, MO. CALLS HIS CQ'S SO LONG AND SO STEADY THAT-



An Inexpensive Low Power Transmitter from Receiving Parts

By Rufus P. Turner*

WHEN the average broadcast receiving amateur becomes interested in transmission, he worries over the high cost of transmitting apparatus. While he is pondering over a catalogue of transmitting tubes and motor generators he little dreams that a low power, yet effective, C.W. and phone transmitter can be built from receiving parts. A C-301A or UV-201A tube is used as the oscillator in this simple transmitter. The inductances are wound with

in the diagram. As may be seen the inductively coupled Hartley circuit is employed. There is but one control in the closed (primary) circuit. This control is a 500-micromicrofarad variable condenser of the ordinary receiving variety. A rather good condenser, particularly one making reliable contact to the rotor, should be used here. The antenna or open circuit is adjusted by the clip "C" and the 1000 micromicrofarad variable condenser. (A smaller condenser will usually serve—Tech. Ed.)

Antenna current is indicated by the low reading RF ammeter which has a scale graduated from zero to $\frac{1}{2}$ ampere. The key is inserted between the mid-tap of the inductance No. 1 and the negative filament lead. A switch S short circuits the microphone when the latter is not in use.

Both coil No. 1 and No. 2 are wound in the same direction on a 3-inch cardboard or Bakelite tube. No. 18 double cotton-covered wire is used for both inductances and a space of $\frac{1}{8}$ inch separates one coil from the other. Use no shellac on the coils. Wind them as tightly as possible.² Coil No. 2 consists of 30 turns of No. 18 D.C.C. wire tapped at every 5th turn while coil No. 1 is of 36 turns of the same wire, tapped at only one point, that is at the 18th or center turn.

Make all the leads as short and direct as possible, using either No. 14 bare copper wire or the usual "bus" used in receiving sets.

The whole thing may be mounted on a 7 inch by 10 inch Bakelite panel and slipped into a cabinet—or left on a plain base.

Now you have a station but no permit to send. Write to your Supervisor of Radio for application blanks for both operator's and station license. Fill out these blanks as instructed and return them to the Su-

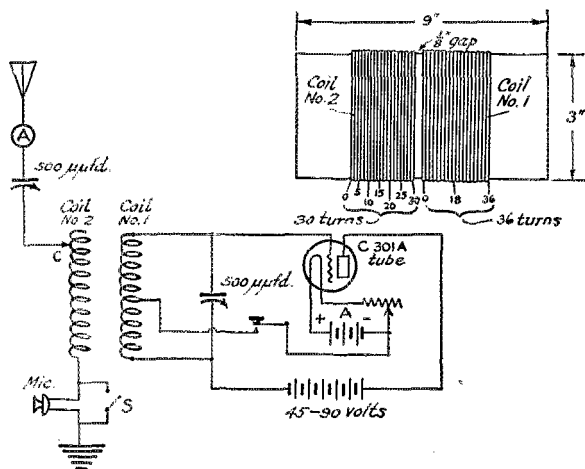

No. 18 D.C.C. wire on a 3-inch cardboard tube. A 90-volt (or higher) "B" battery is used as the source of high potential plate supply and an ordinary telephone microphone is used if phone transmission is desired.

Some may look on such a transmitter as a worthless toy but it is really an effective low-power device. The author used the transmitter described in this article for a period of three months and in addition to working many locals on phone he worked several "2s" on pure C.W. All this was while the sun was high in the heavens. The signals were reported very QSA.

The hook-up of the transmitter is shown

*SLE, 427 Franklin St., N W., Washington, D. C.

¹As a rule the Technical Editor is absolutely opposed to the use of the microphone in amateur transmission. For the same power, phone stations create enormously more interference than telegraphic stations. However, it is all right when using only a receiving tube and a 90-volt battery.

²This is for mechanical reasons. Electrically the coil will be as good if wound with smaller wire spaced with string so as to get the same number of turns on about the same length of tubing. Another good way of winding the coil is to make a close winding of No. 20 annunciator wire, preferably avoiding the green covering which has a habit of corroding the wire. White is best of all.—Tech. Ed.

pervisor.³ The operator's license will be issued to you first and subsequently you will be given a written or verbal examination (depending on where you live) and will receive your station license. You must, of course, be able to read the code before the operator's license is issued. When your license arrives call up (by land telephone) one of the local transmitting amateurs and ask him to listen for you and to check your wavelength. Hold down your key and speak into the microphone, using his station call and "signing" your own. When he hears you, adjust the clips and the aerial condenser until he reports that your wave is around 170 meters.⁴ It is of course necessary to follow these adjustments with adjustments of the primary condenser until the signals at the receiving end are louder and the antenna ammeter shows the greatest antenna current.

You are now all set for operation in this particular wave band. Since the range of the C.W. is so much better than that of the microphone, short circuit the microphone with the switch S and call (with the key) some station that you hear operating near your wave-length. Since you have a "real C.W." station the wave is exceedingly sharp and you will probably not succeed in "raising" anyone who is not listening in the same wave band in which you are working. It may even be necessary to call "CQ" to get into communication with someone.⁵

When phone is to be used, open the switch, hold down the key and talk.

³The addresses of the Supervisors of Radio can be obtained from this office by writing the Traffic Department or the Information Service.

⁴Radiophones may operate only between 170 and 180 meters. By avoiding use of the microphone one can also operate in all the other amateur bands. The transmitter shown in this article will get down to 80 meters by cutting down the primary turns somewhat and using the secondary clip and condenser in the obvious manner. For still lower waves slight reconstruction will be necessary.—Tech. Ed.

⁵The calling of "CQ" should be done in strict accordance with the rules of the Traffic Department. There is no way for an amateur station to become more despised in short order than by unlimited "CQ" calling.—Tech. Ed.

Small Panel-Mounting Meters

BOTH Jewell and Weston have come out with small model voltmeters, ammeters and milliammeters for use on receiving panels. The Jewell instruments are known as the No. 135. The meters have an outside diameter of only 2 inches. They are mounted simply by drilling a 2 1/16 inch hole in the panel, slipping the meter through the hole and then placing a metal cover over the back of the meter. The cover is fitted with flanges that are pushed against the back of the panel. The metal cover is held against the meter by

means of a knurled nut, which holds the meter securely in place. The voltmeter is available in ranges of 5, 8, 10, 100 and 150 volts. It is also available in double readings with a common negative terminal for voltage combinations of 5 and 100, 10 and 100, and 7.5 and 150 volts so that both the A and B battery voltages can be measured.

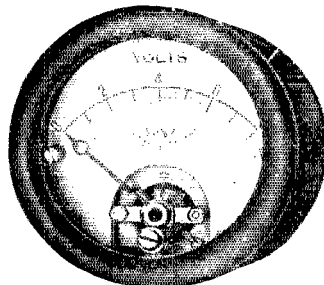

The Jewell No. 135 Meter

Milliammeters in ranges of 10, 15, 25 and 50 milliamperes and ammeters in 3 and 5 ampere ranges can also be had. The Jewell people also sell a simple hole-cutting device which will quickly bore out a hole in which the No. 135 meter will fit.

The Weston meter is known as Model 506. It is of the permanent magnet movable coil type. The body of the instrument is also 2 inches in diameter. It is normally supplied with a narrow flange and arranged for flush mounting, to be fastened to the panel by means of a simple clamp fitting over the meter case, behind

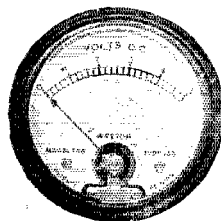

The Weston Model 506

the panel. The voltmeters are made in three forms; two terminals with a single range, three terminals with a double range and a self-contained push button in the flange of the case, which when depressed indicates the B battery voltage; and four terminals with a double range scale. One pair of terminals is for the low range scale and the other pair are connected to the self-contained resistance for the high range. The latter terminals are insulated from the low range terminals. The voltmeter can be used in connection with a

simple multiple point switch for many receiving circuits. If the meter is used with the Weston Universal Bipolar Switch it can be used to measure the voltage in any part of any kind of receiving set, regardless of the set connections. The usual double ranges for 5 volt tubes are 7 and 140 volts, or $7\frac{1}{2}$ and 150 volts. For 3 volt tubes the most suitable ranges are 5 and 125 volts, in the double range meter. This same type of instrument is also made as an ammeter and milliammeter in a variety of ranges.

BOOK REVIEWS

By R. S. Kruse, Technical Editor

Guide to The Radio Art (Wegweiser durch die Radio Technik.) Dr. P. Lertes and staff for the S. W. German Radio Club. Published by H. Bechhold Verlagsbuchhandlung, Frankfurt A. M., Germany. Price not known. 196 pages, 143 illustrations.

It is not pretended that the title of this book has been translated verbatim. The attempt has rather been to reproduce the spirit of the original.

As a "Guide to the Radio Art" we do not expect a book to contain "how to build it" information, but rather to discuss radio phenomena and principles. It is seldom, however, that these principles are so carefully, or so competently, discussed as in the book here presented. This is not surprising inasmuch as the authors are almost without exception teachers, most of whom bear the title of Doctor. Perhaps the highest praise of all is found in the statement that the discussions are so able that it has been quite unnecessary to introduce mathematics.

Manual of Radiotelephony (Manual de Radiotelefonii), by Jorge A. Duclout, Buenos Aires, Price not known but about 3 pesos. 358 pages, 313 illustrations.

This is one of the most amazing books that has ever reached my desk. The author has compressed the entire sending and receiving game below 1000 meters into a book with hardly 360 pages, and those of pocket size. The information is strictly practical, it is based mainly on the "how to build it" idea.

Both sending and receiving sets are described for telegraphy and telephony at all waves below 1000 meters, yet enough theory has been crowded in to permit a proper understanding of the sets.

The illustrations are good, dimensioned drawings appear by the score and the instructions are very much to the point. Much radio experience went into the making of this book.

Our Spanish-American fellow-amateurs are lucky in the possession of this book, and also in being so situated that the author has been able to find in their market tubes of American, Dutch, French and British makes, all of which he describes in detail. This makes the artificially limited market of the United States all the more galling.

Radio Simplified, by Kendall & Koehler, Revised by John M. Clayton, The John C. Winston Co. Philadelphia, Price \$1.

It is hard to praise a colleague's work convincingly. Yet—what is a reviewer to do in the case of such a wholly admirable piece of work as the "Clayton Edition" of "Radio Simplified?"

The first edition was very good in many ways. The

Both the Jewell and Weston instruments are exceptionally neat, and in addition they are high class meters. No effort has been made to "skimp" either in material or workmanship. Before long almost all set manufacturers will see the wisdom of supplying complete sets with meters of these types built into the panels and measuring both filament and plate voltage.

—J. M. C.

second edition is better in all these regards and has in addition the concise lucidity that characterizes "J. M. C.'s" articles in *QST*. Why the original author's names were left on the cover is a mystery—there is virtually no trace of them in the book. It would have been better justice to label the cover "Completely re-written by John M. Clayton."

But enough of that. The book has done the thing so many authors aim at, but do not hit. It has tied theory to practice in every page. No sooner is a theoretical statement made than there is a practical application of it. In this process the theory does not become obtrusive for the book aims steadily at the practical. "The ultimate purpose of radio communicating systems is to communicate." Their theory may be interesting but it is not the final aim. Therefore the apparatus descriptions are exact, the instructions intensely practical. The statements as to the goodness and badness of practices and apparatus are blunt and fearless.

If one desires to build radio receivers stupidly this is not the proper guidebook. The man who reads "Radio Simplified" with any decent care at all will emerge with sets that operate (even though they be superheterodynes) and with an understanding of the thing that he is doing—and there will have been nothing painful about his education.

Volume 2, the electrical section of the Illustrated Technical Dictionary (6 languages) By Alfred Schloman and C. Kinzbrunner, Published by R. Oldenburg, Munchen and Berlin, Germany. 2100 pages, 3773 ills. Price not stated in copy received for review.

This book is of a sort that we never seem able to produce in America. Some idea of its completeness may be gained from the fact that it has 2100 pages and 3773 good illustrations. In spite of this mass of material the book is of pocket size, clearly printed and wholly readable.

There are two sections. In the first part there appear thousands of electrical terms with their translations into German, English, French, Spanish, Russian and Italian. The illustrations are beautiful little line drawings, obviously the results of a great deal of careful thought. Incidentally these pictures are a liberal education in European electrical practices.

The second section is a "finding section." In this part of the book all the terms used (regardless of language) are arranged in one alphabetical series, each term having opposite it the page on which it may be found in section 1.

With the aid of this book a "one language man" may make good headway in the reading of electrical and radio literature in the other languages. The only regret is that there are in America so many of us pitiful "one language" folks who need such a book—and need it very much indeed.

The 5-language Dictionary for Radioamateurs. By "Hanns Guenther" (W. DeHaas) Published by the Franckh'sche Verlagsbuchhandlung, Stuttgart, Germany. 320 pages, price not stated in copy received.

The 5-language dictionary does not attempt to cover

the entire electrical industry as does the "Illustrated technical dictionary," but confines itself to the radio field alone. In this perhaps it falls behind the larger book, but at the same time its specific usefulness to the radio man is increased.

The book is in a single section, alphabetically arranged from start to finish, regardless of the language of the word being handled. Thus a single term will appear 5 times in the book, once with the English term at the top of the group and again with the German, French, Spanish and Italian word at the head. With this arrangement no finding list is needed.

It is hard to judge a dictionary off-hand. My impression is that this one covers the radio field very well indeed. That is to be expected for it is the work of the Editor-publisher of that genial radio magazine "Rafa," whose full name is Radio fur Alle.

Radio Theory and Operating. By Mary Texanna Loomis. Published by Loomis Publishing Co., Washington, D. C. Price not mentioned in copy received for review. 850 Pages, 635 Illustrations.

This book is hard to review, being a strange mixture of the very good and the decidedly ordinary.

The material of the book is good. A tremendous mass of detailed radio information has been gathered from good sources and these sources have been mentioned frankly. An index has been supplied that is better than is customary in radio books—which is really not very high praise, for the average American radio book has a miserable index. The order in which the material has been arranged is good and logical.

The book is worth while and useful. Likewise it is unique on the American market in treating all the breeds of radio within the same covers.

Perhaps that is enough to expect from any first edition, for first editions are always made in haste.

Let us hope that in the later editions (for there certainly will be such) there will be time enough to replace the present heavily "patterned" copy-halftones with others made from the original photographs, also to have the line-drawings done over in a single style. There might also be considerable advantage in the way of smoothness and readability if the author were to re-write the text, rather than to use outright quotations so freely. That last, obviously, is a matter of opinion.

Radio Interference, Serial Report of the National Electric Light Association. Publication No. 25-63. National Electric Light Ass'n., 29 W. 39th Street, New York City.

An intensely interesting 48 page report that gives actual information (instead of noisy opinions) on the causes, locating methods and cures for such power line disturbances as cause radio interference. Information from a number of generating and distributing firms is combined to make a 48 page book worth several times the modest 60c asked for it. No radio dealer, radio repairman or generating company should overlook this report.

Measurements of Electrical Resistance and Mechanical Strength of Storage-Battery Separators. C. L. Snyder, Bureau of Standards technological paper No. 271. 10c, Superintendent of Documents, Government Printing Office, Washington, D. C.

I do not remember having seen any other publication which in so few words showed me so many things that I had not thought of before. Any user, maker or repairer (if there is such a word) of batteries will appreciate paper 271, in spite of the tremendous title with which the Bureau has labeled it. That, by the way, is a distinctly bad habit on the part of the Bureau.

A Modern Super-Heterodyne Type Receiver. Elmer H. Lewis and staff. Norman W.

Henley Publishing Co., 2 West 45th Street, New York City.

The writing of book reviews becomes a bit discouraging at times, for book reviews have a habit of standing in the galleys until the books themselves are either universally known or altogether forgotten. However—one does not have to worry when writing about such a book as this latest member of the Henley Family. With characteristic practicality and brevity it tells its story in 30 of the Henley pocket-size pages. This type of book does not pass out of print in a hurry.

Robinson's Manual of Radio Telegraphy and Telephony, 6th Edition. Press of the U. S. Naval Institute, Annapolis, Maryland.

The famous "manual" has, in its 6th edition, risen to entirely new heights. This last edition comes with the very best of all published radio matter and adds to its usefulness the excellent printing and binding that has marked the earlier issues.

Never have we seen a book that so well followed out the plan of starting with simple theory but always keeping in mind that the reader was interested in the application of the theory, and cared nothing about the theory itself. Therefore the text progresses rapidly to the actual apparatus and discusses the modern types clearly, rapidly and usefully.

This book is so universal that it deserves unusual treatment and shall have it—here are the chapter headings in full.

- 1—General Theory
- 2—Elementary theory of electricity
- 3—A.C. Theory
- 4—A.C. Theory applied to radio
- 5—Damped oscillations
- 6—Wave propagation
- 7—Radio Instruments
- 8—Radio Transmission
- 9—Radio Reception
- 10—Theory of vacuum tubes
- 11—Vacuum-tube transmitters
- Part 2—Practical application of apparatus and measurements.
 - 1—Practical application of apparatus
 - 2—Radio measurements
- Part 3—Useful Information
 - 1—Tables and formulas
 - 2—Mathematics (Arithmetic, Algebra, Geometry, trigonometry)
 - 3—Radio Laws
 - 4—Miscellaneous
- Part 4—Index

That is a tremendous territory to cover in a single volume, and it takes almost 400 pages to do the job. However the job is done and the result is a book that is not only worth \$8 which it costs but is perhaps the best radio book that ever came to this desk.

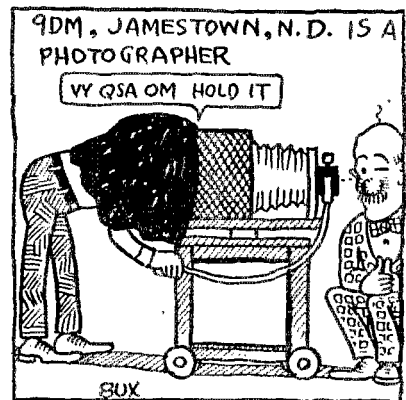

Proper Graduations For Dials

By C. A. Briggs*

THE decimal method of ruling used on most dials now manufactured, is the best arrangement, and when proportioned properly is far superior to the method of progressive binary subdivision common on most measuring rules. In nicely designed graduations with a suitable indicator it is easy to read or estimate to the nearest tenth of a division, without eye strain, and this can be done quickly. The naked eye in small graduations and without strain is sensitive to differences as small as two-one-thousandths of an inch.

However the graduations on most dials are too long. See Fig. 1. They delay and confuse the eye which is required to run up and down the marks to study and iden-

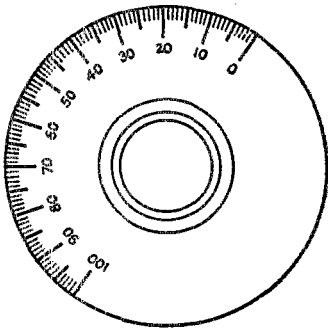

"The graduations on most dials are too long and the lines are too broad"

FIG. 1

tify the particular space; and the lines are mostly too broad, which unnecessarily interferes with fractional estimates. All this puts an unconscious burden on reading and makes persons tend to avoid it.

In addition to these undesirable things the index used for reading the setting is often a complicated or complicating scheme that appeals through its novelty, but is of questionable merit. The best kind of an index is a simple straight line of substantially the same character as the dial graduations; Fig. 2—this should come as near to the graduations as possible, preferably being in the same plane with them. Parallax, that is conditions where the reading changes with the position of the eye, should be avoided.

Cross rulings are highly objectionable. See Fig. 3. They are hard on the eyes. All

eyes are astigmatic to some extent, and suitable tests show that it is not possible to focus at the same time on the vertical

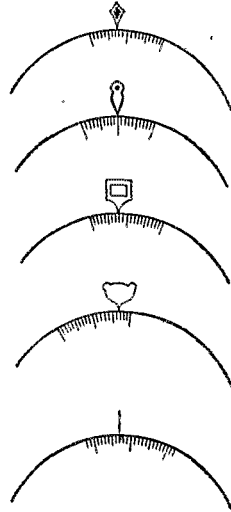

The best index is a straight line

FIG. 2

and horizontal rulings of two intersecting lines. There is a struggle of the eye to focus on both which produces eye strain. Strange as it may seem, the most "finished-looking" ruling is often one in which grad-

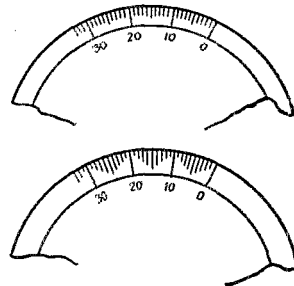

Finished looking—but bad for the eyes

FIG. 3

uations are boxed in by cross boundary rulings.

For the same reasons it is not desirable to have a sharp contrast between the dial edge and the background beyond.

*3CAB, 1311 Spring Road, N. W., Washington, D. C.

It seems that so often the people with poor eyes pick out the poorest kind of graduation, and are attracted by some complicated scheme that is novel, at least to them, and therefore is assumed to have merit or indicate progress, when the contrary is true. The writer's eyes are unusually good but he has seen persons with defective vision strain at something he would not tolerate.

A word about looking may be in order here. The readings should be looked at easily. Do not squint at the lines in an effort to resolve them into microscopic detail.

It has been found by tests that more ac-

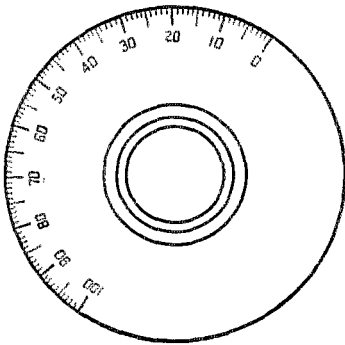

The writer's idea of proper graduations

FIG. 4

curate results are obtained when the readings are made promptly and without straining, than where the observer is over-anxious and studies and worries in making his decision. In practicing reading allow yourself just one second for determining the tenth of a subdivision, and finally get so you make the complete reading in this time easily, casually as it were, but accurately.

Specifications for Graduations

The following represent the ideas of the writer for proper graduations:

1. The decimal system of graduating should be used.
2. The length of the ordinary lines should be from $1\frac{1}{2}$ to 2 times the distance between the centers of adjacent lines.
3. The fifth, fifteenth, twenty-fifth, etc., lines should be longer than the ordinary line, a good value being longer by the space between the ordinary marks.
4. Every tenth line representing 0, 10, 20, etc., should be marked with the number of the graduation, "0," "10," "20," etc. They may be longer than the other lines, but the marking if suitably placed will often distinguish this line adequately.

5. The thickness of the rulings ordinarily should be about $1/10$ of the graduated space between. In closely spaced graduations it may be necessary to accept a slightly greater line width and where the spaces are fairly large a line thinner than $1/10$ the space can be used.

6. The mark should be clean cut and as white or black as possible, as the case may be.

7. The pointer or index should be a straight line in the same plane as the graduations.

8. No cross rulings should be used.

9. The plane of the graduations should be at right angles to the line of sight.

10. The color of the background beyond the dial at the index should be the same as the dial.

Strays

Another adventurous sea-going experimenter returned to terra firma when the "Bowdoin," WNP of the MacMillan Arctic Expedition, docked at Wiscasset, Maine, on



The Reinartz Smile, as WNP Returned

Oct. 12th. Reinartz enjoyed himself hugely, had a wonderful experience, and has made a number of interesting radio observations which we expect to present in these columns soon — watch for them.

GEU offers to check your wavelength on a wavemeter that has just been calibrated against the Mare Island Navy Yard's standard meter. Call him on the air or arrange a schedule by mail. Address H. E. Williams, 1319 Napa Street, Vallejo, Calif.

A Three-Tube Neutrodyne for Short Waves

By Dave Ablowich, Jr., 5DW

A NEUTRODYNE receiver which operates successfully over a wavelength range of 80 to 235 meters has been used for a number of months at 5DW. This is the dope on it, be it of benefit or not to those who read it.

The circuit is the standard neutrodyne circuit used in broadcast receivers of that type and was described in *QST* for April, 1923. The amplifier is neutralized to prevent oscillation but the detector made to oscillate by means of a tickler, to provide autodyne reception of C.W. signals.

The inside coils of the neutroformers are wound on pieces of calendar mailing tube $1\frac{1}{4}$ " diameter and have 8 turns of No. 22 D.C.C. on the lower end. The outside coils have 40 turns of the same wire wound on a cardboard tube $2\frac{1}{8}$ " in diameter. The coil is tapped at 8 turns for connection to the neutralizing condensers, which may be of any of the numerous brands on the market. There is a $\frac{1}{2}$ "-piece of wire soldered to the 25th turn of each secondary. Each set of coils is secured to the back of the condenser for that set. The condensers used are .00025 U.S. Tool Company variables.

Wires from the grid of each tube are about three inches long and terminate in a very small Fahnestock clip for connecting to the outside coil at 25 or 40 turns. The former connection gives a wavelength range of 80 to 170 meters. The latter a range of 145 to 235. The dial covers only 90 meters with either connection, thereby making tuning comparatively easy. The tap arrangement is not as efficient as one coil with no taps. If the tap is used, *in no case run the leads to the panel for a switch.* Use a small clip, one for each coil.

A feedback coil of 25 to 35 turns in the plate circuit of the detector for regeneration is slipped inside of the detector grid coil. A variometer or a coil of suitable size wound in the right direction on either end of the same tube as the grid coil will give good results but if a coil is used a little experimenting may be necessary to determine the correct number of turns for best results. The correct number is that which will produce continuous oscillation over the entire band of waves.

Regarding tubes: those in use at 5DW are 201's for R.F. amplifiers and a pre-

war tubular Audiotron for detector. 200's or VT-1's may be used for the detector and 201-A's for amplifiers if desired, but the set must be neutralized for whatever tube is used.

Tuning a neutrodyne is a bit harder but the excellent results warrant a little trouble. The best policy to follow in getting QSO seems to be that of watchful waiting. Find a station in the direction in which communication is desired and then pounce on him. If the transmitter is any good it seldom fails and the working distance depends entirely on the transmitter.

The condensers across the grid coils of the second R.F. amplifier and the detector tune sharply and at approximately the same dial settings, but the one across the first

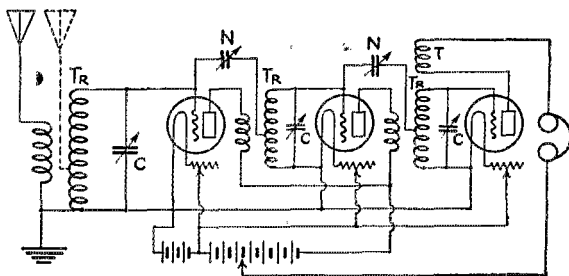

CIRCUIT DIAGRAM

N—Neutralizing Condensers
T—Tickler inside of last r.f. transformer
Tr—Short-wave r.f. transformers ("Neutroformers")
C—Tuning Condensers
90 volts on amplifier
22 volts on detector

R.F. transformers set at angle with horizontal. This angle depends on distance between transformers and must be found by trial. It is 60° at 5DW.

R.F. amplifier is best set about half open and the other two adjusted after the manner of the old three-circuit regenerative, until signals are heard. The other condenser may then be adjusted to improve signal strength or to eliminate interference. Once adjusted the receiver stays put and does not have to be retuned after transmitting.

RESULTS

As for results: The receiver, being extremely sensitive, brings in every U.S. and most Canadian districts on any decent night. Signals from the gang in Mexico and Cuba roar in very QSA and f8BF and g2OD have been copied easily readable barring local and nearby interference. (For some reason have never been able to

(Continued on Page 43)

Rating Circuit Resistance

By G. H. Browning*

IN reading Mr. F. J. Marco's excellent article "What Size of Wire" in the June issue of *QST*, page 30, I was struck particularly by the sentence, "Why not rate circuit resistance in average over the broadcast spectrum rather than at some arbitrary point". It occurred to me that it might be of interest to some of the readers to take the data presented by Mr. Marco and formulate it in another way, which is believed to give an easy way of rating the worth of a circuit used in the reception of radio signals.

The sharpness of tuning of a circuit depends upon three quantities: the resistance, the frequency at which the resistance was

be the capacity (in farads) of the tuning condenser, "R" the resistance, of the coil and condenser combined, (the oscillatory circuit resistance), and "i" the current flowing in the oscillatory circuit "LC".

To a very close approximation:

$$C_g = Xi$$

If we tune the circuit to resonance

$$i = \frac{E}{R} \quad (\text{Equation 2})$$

where E is the voltage set up in coil L due to a signal through L_o . (This assumes that the coupling between L_o and L is loose.)

Placing the value of "i" given by 2 in equation 1 we obtain

$$C_g = \frac{XE}{R} \quad (\text{Equation 3})$$

If in equation 3 we substitute the quantity "n" defined as

$$n = \frac{R}{X} \quad \text{we have } C_g = \frac{E}{n} \quad (\text{Equation 4})$$

This readily shows that "n" is the important quantity in a circuit, for the smaller its value the greater the signal strength and the sharper the resonance curve.

Of course we have made the assumption that L_o was coupled loosely to L, but had we determined the general solution of the circuit shown, using coupled circuit equations, we should still have found, after reducing several long equations, that the voltage impressed on the vacuum tube depended upon "n".

Fig. 2 shows the quantity "n" plotted

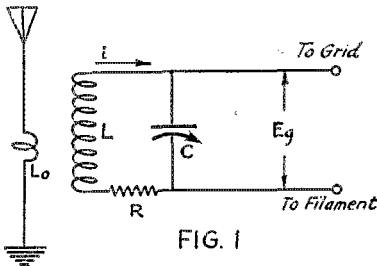

FIG. 1

measured, and the inductance of the coil used. It so happens that these three quantities may be combined into a fourth quantity which varies little over the broadcast spectrum. This fourth quantity we shall

call "n" and define it as $\frac{R}{2\pi fL}$ where R is

the resistance of the circuit at a frequency f; L is the inductance of the coil used, and 2π is the ratio of the circumference of a circle to its radius. Now $2\pi fL$ is the inductive reactance of the coil. Usually reactance is represented by the letter X. Substituting this our equation simplifies to

$$n = \frac{R}{X} \quad (\text{Equation 1})$$

To show the usefulness of "n" let us take a specific problem. Consider the circuit shown in Fig. 1. We desire to calculate the voltage e_g impressed on the grid of the first vacuum tube due to an incoming signal picked up by the antenna-ground system. Let "L" be the inductance of the coil, "C"

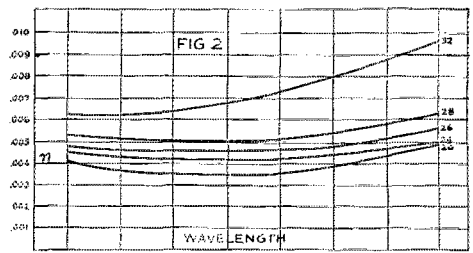

against wavelength for a number of Mr. Marco's coils with the spaced windings. The curves were calculated from the data given in Fig. 2, Page 31, June *QST*. The numbers at the ends of the curves refer to the size wire used. Fig. 3 also shows "n" plotted against wavelength for a number of the coils which were not space wound. The data for calculating these were obtained from Fig. 1, Page 32, June *QST*.

*Engineering Dept., The National Co., Cambridge, Mass.

More exactly C_g is exactly $= i \sqrt{R^2 + (L2\pi f)^2}$ where R1 is the resistance of the coil itself. As R^2 is about 225 ohms and $(L2\pi f)^2$ is about 5,100,000, ohms at 300 meters, in computing the value of the radical R^2 may be neglected.

We can now readily see that the quantity "n" gives a very convenient way of rating circuit resistance for "n" almost constant when plotted against wavelength, and at the same time is the quantity which determines the amount of signal that will be obtained from a given transmitting station. However, if we were to take a very wide spectrum and chart "n" against wavelength a curve such as shown in Fig. 4 would result. In other words, a given coil is best used over a particular wave band, and that

20 wire not spaced has an "n" of .0058, while the No. 26 spaced winding has an "n" of .00045, so that there appears to be a definite gain in using the latter.

Radio development of the past has been little better than a "cut and try" process, but this is fast giving way to scientific development. Mr. Marco's excellent work on circuit resistance, the data from which I have taken the liberty to use in this article, agrees very closely to our recent work on the same problem, as well as Mr. Richardson's thesis written for research course at The Massachusetts Institute of Technology.

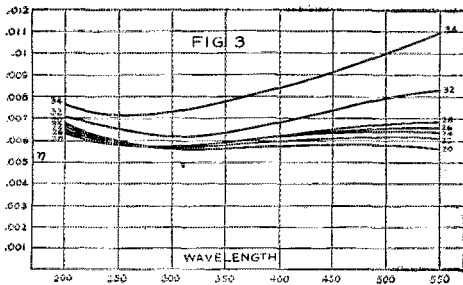

particular band should be a region such as B-C, where "n" is a minimum and almost constant. When the natural period of the coil is approached "n" increases at a very rapid rate as is shown, the dotted line A indicating the coil's natural period.

Now let us consider which coil we might choose in working from 200 to 550 meters, keeping in mind that its size must be small enough for practical use. The spaced coils generally have a lower value for "n" and therefore would be more efficient, and No. 20 D.S.C. spaced one diameter, which would be first choice, however this is out of the question, for a coil three inches in diameter

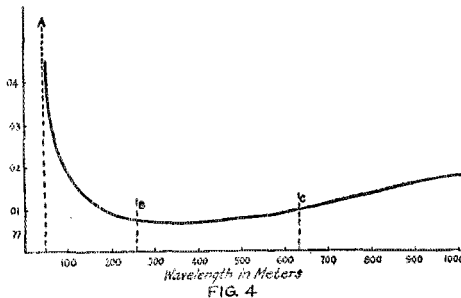

with an inductance of .360 millihenries would be about six inches long. The same argument applies to lesser extent to No. 22 and No. 24 wire and brings us down to a choice between No. 26 wire spaced one diameter and No. 20 not spaced. Each of these coils on a three inch form having the inductance before mentioned would be approximately three inches long, which is a reasonable size to use in a radio receiver. The number

A Three-Tube Neutrodyne for Short Waves

(Concluded from Page 11)

hear f8AB.) Signals from ten- and fifteen-watters 50 miles away "knock" the detector as do the best 5's, 6's, 8's and 9's. 1XAM, 1KC, 2AGB, 6XAD, 6XBC, 7BJ and several others have "knocked" the detector at times.

Almost as good results may be obtained without the antenna as with it and tuning is sharpened greatly. 5GN, two blocks away with 3 amperes from a 15-watter and a bad key click, may be put entirely aside for stations from districts 4, 5, 6, 8, 9, and an occasional Canadian 3 or 4 may be worked with ease while he is transmitting. This cannot even be attempted with the Reinartz used here. He does not knock signals unless they happen to be within about five meters of his wave on either side. When a local opens up the antenna is disconnected and the first R.F. condenser dial is moved until the station being worked "booms in".

It is my belief that the use of coils with 5 and 22 turns wound on the same size tubes as those described and .0005 condensers will eliminate the tap arrangement and include the entire 80-235 meter band in the range of the dial. This will make the tuning more critical, however.

The writer will be glad to hear from any one who builds a set of this kind and will gladly furnish any additional information upon request.



Speaking of Low Power Work

By John M. Clayton, Asst. Technical Editor

A COUPLE of hundred miles north of Seattle, Washington, there lies a wild and partly unexplored tract of land called Vancouver Island, a part of Canada. About 125 miles up the island from the main city there is a small settlement called Alberni, and about 12 miles further north there is a lake known as Sprout Lake. On the shores of this lake, hewn out of the forest, one finds a logging camp. In this camp lies a tale, and it's a radio tale, too.

Colonel Clair Foster, u6HM, of Carmel, California, goes to this camp in the summer and pushes the key behind the coal-burning 6HM in the winter. Last summer Colonel Foster decided to bring radio into this camp. It was obviously out of the question to transport the 250-watt tube-set of 6HM miles into the wilderness—there was no power available for a tube of this size—so Colonel Foster set out from Carmel with his regular 20-to-40-meter receiver and a simple breadboard transmitter designed for one 5-watt tube. Two hundred and seventy-five volts of Eveready B battery was taken along for plate supply. Previous to his arrival in Canada Colonel Foster secured a special license from the

tenna. The first signal heard was a3YX, in Sydney, Australia. Colonel Foster took a long chance and called him and experienced the usual thrill when a3YX answered him. Five watts—Canada to Australia—"pretty good work," thought Colonel Foster. After chewing the rag with him for a while, the Colonel took the 5-watter out of the transmitter and substituted a 201-A. With 6 volts on the fila-



FIG. 2. QRM RIGHT AROUND THE CORNER FROM 9CK. THIS BIRD WAS RECEIVED QSY VY. QSB ROUGH.

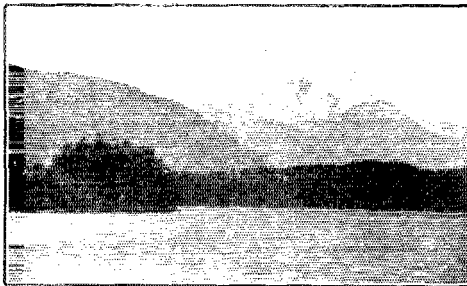

FIG. 1. SPROUT LAKE, VANCOUVER ISLAND, B. C., THE QRA of c9CK.

Canadian Government and the station-to-be was assigned the call 9CK.

Arriving at the camp, after a shack had been erected from timber cut out of the surrounding woods, two poles were set for antenna supports. The poles were cut from the native timber and two antennas were hung from them. One was a 120-meter affair, suspended between one pole and the shack, and the other a 20-meter one hung between the other pole and the shack. By this time it was the 11th of August. The receiver was connected to one antenna and the transmitter was tuned to the third harmonic of the 120-meter an-

ment, 235 on the plate and with a plate current of 4.3 milliamperes (representing an input of a little over 10 watts) c9CK called a3YX and got him! The next half hour was taken up in trying to get over the idea to a3YX that a 201-A tube was pumping the signal he was hearing in Australia. After that a lot of time was consumed in explaining the QRA of c9CK. Soon daylight came and 3YX faded out and was lost. On August 13th c9CK heard and called 2TM in Australia, this time with the 5-watt tube in the transmitter. After getting him 9CK switched to the 201-A again and, with an input of 14.3 watts, successfully carried on with him for about a half an hour. All this time the 201-A was cold—not cool, but cold. It should be mentioned right here that this was no ordinary 201-A. It has served time (one and a half years) as an oscillator in a B.C.L. superheterodyne and then it graduated to short waves where it was used as a detector on 20 meters. When put in as a transmitting tube it had, of course, learned to do its stuff both as an oscillator and a short wave oscillator at that.

In the next two weeks that followed c9CK worked no less than six different

Australian stations, all of the time using the 201-A operated with an input never greater than 14 watts and most of the time around 11 watts, and putting from 235 to 275 milliamperes into the antenna. Then one night c9CK hooked a5BG, Henry A. Kauper, of Dulwich, Adelaide, South Australia. Kauper is a ham who has the typical British bull-dog grip once he gets on to something and he gripped 9CK and there followed a series of tests in which Colonel Foster tried all sorts of tests. All credit to Kauper. Not being satisfied with an hour and a twenty-seven minutes contact on only one occasion he suggested a schedule every night for the following week. The schedule was kept to a dot and contacts were had each night over periods varying between 25 minutes and an hour and a half. Then a5BG asked for another week of schedules. The next week all schedules but two were kept. One of them was missed because a5BG's transmitter was out of commission and the other because c9CK was lost in heavy QRM right on top of him. As a crowning feat one night when Foster was working a5BG he used the 201-A in the transmitter both as a transmitting and receiving tube. When he finished working a5BG he took the 201-A out of the transmitter and

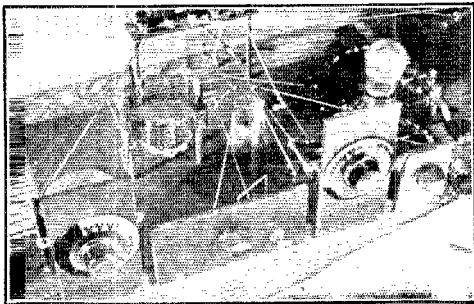

FIG. 3. THE 20 TO 40-METER RECEIVER.

slapped it into the receiver to copy 5BG's reply! Even Henry Ford would approve of such economy! Two way communication between Canada and Australia on one \$3 tube!! Time and time again c9CK has worked "A's" and "Z's" on the 201-A—his two week schedule with 5BG shows that all of the communications are not due to freak conditions.

In addition to the Australians and New Zedders 9CK has been QSO 6's all up and down the coast and has worked KFUH, NRRL, NEDJ and other ships in Australian waters. His best work East occurred on October 6th when he established contact with u2AHM in Schenectady, N. Y.

Various explanations have been of-

fered by member of the party up there in British Columbia for the extreme ease in which c9CK has worked Australia time and time again. Colonel Foster himself suggests the simplest solution—a casual glance at a globe will show that the sgs travel downhill all the way. The best theory though is the one offered by Bill Sholl, said to be the best cook that ever invaded a Canadian logging camp. The Sholl theory is that there is a hole in the Heavy-

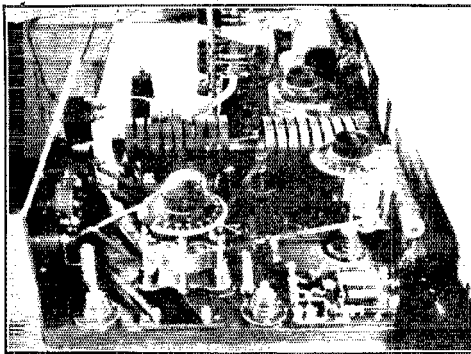

FIG. 4. THE TRANSMITTER. NOTE THE VERY LOW-LOSS CONSTRUCTION AND THE HEAVY LEADS.

side layer right over 9CK and another hole over Australia. The signals from 9CK go through the first hole and slide along *above* the layer, only to fall out in the vicinity of the "Z's" and "A's"!

The transmitter at c9CK is a series feed coupled Hartley. Plate and grid coils are shunted by ordinary receiving condensers. The inductances are wound of heavy copper strip supported only at their ends by porcelain wall insulators. The strip is heavy enough to be self-supporting without vibration. Part of the turns of the coils are short-circuited for 20-meter operation by means of porcelain base knife switches. The R. F. chokes are wound on ordinary electric wall tube insulators of porcelain. Previous to being wound the tubes were boiled in paraffine for two hours. A Leach relay is used as a combination break-in and keying relay. Keying is done either in the grid circuit or the plate circuit. Before going to Canada Colonel Foster had the meters checked in a laboratory and they are all accurately calibrated.

The receiver is a breadboard affair using space wound Lorenz or basket weave coils. These coils are self supporting and are spaced by means of knotted cord holding the turns together. A detector and one stage of audio frequency amplification is all that is ever needed.

(Concluded from Page 4)

Variometer Tuning for E. W. Reception

By Raymond C. Schlorf*

IN a radio receiving set using a three-element audion as a detector, the strength of the signals in the headphones is dependent upon the electro-motive force applied to the grid of the tube. The formula for electro-motive force in a tuned circuit reads:

$$E = I \sqrt{R^2 + X^2}$$

In a well designed regenerative receiver the resistance of the secondary is so small that for the purpose of argument we may let $R = 0$. In this case the equation becomes:

$$E = I \sqrt{X^2} = I \sqrt{\omega L^2}$$

Also if $R = 0$, $I = \frac{W}{E}$ then by substituting $\frac{W}{E}$ for I we may prove that:

$$E = \sqrt{V \omega L W}$$

Then for all ordinary purposes we may state that the efficiency of a regenerative receiver is roughly proportional to the square root of the secondary inductance.

As a practical example of this theory let us suppose that we have two broadcast tuners, built exactly alike, except that one

users always gave better results on distant stations than sets using twenty-three plate condensers.¹ In order to verify this theory further an inductively tuned short wave set was built and it was found to give much louder C.W. signals than any condenser tuned set it was compared with. It has also been observed that while the beat notes from broadcasting station harmonics were louder than those received on a condenser tuned set, there was only a slight increase in the volume of the voice and the music. This may be due to the fact that the resistance of an inductive tuned set in a non-oscillating state is very high compared to a condenser tuned set (See first equation) but when the set begins to oscillate the resistance drops to a minimum, thereby causing the inductive tuned set to give louder signals than a condenser tuned receiver.

The secondary of the inductively tuned set referred to in the above paragraph was composed of two spiderweb coils, the smaller of which is lashed to a wooden shaft and rotates within the larger. The rotor is wound with 13 turns of No. 20 double cotton covered wire and has an inside diameter of $2\frac{1}{4}$ inches and an outside diameter of $3\frac{3}{4}$ inches. The stator has an inside diameter of $3\frac{1}{2}$ inches, an outside diameter of 5", is wound with 22 turns of wire, and is tapped at the twelfth and seventeenth turns. The tuner has a two-turn primary 4 inches in diameter, and a three turn tickler with a diameter of 6 inches. The primary and tickler coils are mounted in planes parallel to and on opposite sides of the stator coil. In the table of characteristics given below, the value of capacity is the sum of capacities in the secondary circuit.

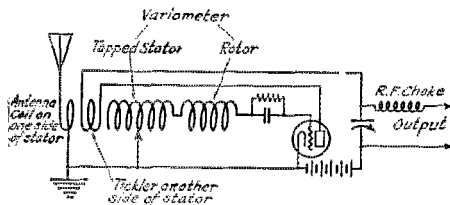

uses a secondary inductance of 180 microhenries and a tuning condenser with a capacity of 500 micromicrofarads, and the other uses an inductance of 360 microhenries and a capacity of 250 micromicrofarads. Since the secondary inductance of the latter set is twice that of the former, it will have an efficiency equal to the square root of two or one and four-tenths times that of the former set.

The author has used several condenser-tuned regenerative sets for broadcast reception and the sets using eleven plate conden-

	Max.	Min.
First Tap		
Wavelength	83 M.	65 M.
Inductance	148 μ h.	76 μ h.
Capacity	13 μ f.	15 μ f.
Second Tap		
Wavelength	75 M.	55 M.
Inductance	124 μ h.	55 μ h.
Capacity	13 μ f.	15.5 μ f.
Third Tap		
Wavelength	52 M.	38 M. ?
Inductance	67 μ h.	—
Capacity	11.5 μ f.	—

(Wavemeter not calibrated below 50 meters).

It will be noticed from the above table that the capacity of the grid circuit is slightly higher when the variometer is set

* 2025 W. 23rd St., Chicago, Ill.

1 — The corresponding capacities are approximately 250 and 500 micro-microfarads respectively.

at a minimum inductance. Due to an oversight in building the variometer the rotor is one-half inch further away from the stator when set at maximum inductance than when set at minimum inductance. This effect can be reversed by reversing the position of the rotor. If this is done the inductance and distributed capacity of the

201-A furnishes ample power provided it is built into a really low-loss transmitter.

Strays

The S.S. *Yorba Linda* makes occasional trips to Europe and at such times Richard E. Cark, the operator, carries a short wave receiver. He is interested in arranging receiving tests with DX amateurs on 20 and 40 meters. An accurate log is kept and reports, in detail, will be given to interested parties. Address him care General Petroleum Corpn. (S. S. *Yorba Linda*), Terminal Island, Calif.

BD of 9EBV says that automatic bells on railroad crossings are wonderful QRM factories. If you live near a railroad crossing better have the trains stopped.

DeForest hasn't anything on 8CCN. DeForest put the grid in the vacuum tube and 8CCN takes the filament out.

A number of the West coast fellows use a large copper ball as a "terminal" on the end of their transmitting aerials. Who has any dope on it?

British for a long-distance hound: "DX Merchant."

90G: Well, I'm coming back on the air again.

9BBJ: Howcum?

90G: My girl just gave it to me.

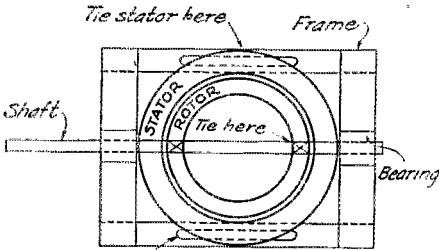

NOTE: Connect inside of rotor to grid, outside of stator to filament

SHORT-WAVE VARIOMETER

variometer will be at a maximum at the same time, and the set will have a wider tuning range.

In a set of this kind it is better to have a secondary with a low distributed capacity than to have one with a low direct current resistance. If the distributed capacity of the variometer is reduced to a very low value it might be a good idea to connect a small condenser in the circuit. This can be done best by connecting one strip of metal to the filament binding post of the tube socket and another to the coil side of the grid condenser. A "Figure 8" or "D coil" variometer should give excellent results if it is space wound on a skeleton frame. The type of variometer with spherical coils which was so popular a few years ago should not be used, as they have a high distributed capacity.

An attempt was made to lower the tuning range of the set described by shunting an external inductance around the secondary variometer, but it was found that although the inductance of the secondary was reduced, the capacity of the coil was added to that of the variometer, leaving the wavelength slightly greater than before.

Speaking of Lower Power Work

(Concluded from Page 45)

Colonel Foster returned to 6HM in the latter part of October. We would not be surprised if 6HM junks the 204-A set and substitutes a simple 201-A tube transmitter since the Colonel has thoroughly convinced himself that for excellent DX a



Opening Out the Tuning Scale

FOR some unknown reason most transmitting amateurs insist on using tuners that cover a wide wavelength range with the same coil and condensers. Naturally, if a tuner goes all the way from 18 to 45 meters, or even from 20 to 100, the tuning is going to be terribly crowded in the 20 and 40 meter bands. One can't hope to cover two or three bands and still have open tuning on each one.

Interchangeable Coils

The best way out is to use a very small tuning capacity and to use interchangeable secondary coils, one for each waveband. Then it is possible to make each band spread over the entire tuning scale. That isn't all; one can make a tuning chart for each waveband and know that the chart will "stay put." The finishing touch then consists of a good vernier knob with which the tuning condenser can be moved slowly enough.

The same primary can usually be used for all wavelength below 100 meters but two are a shade better. The tickler coil will probably need changing for each waveband if nice control is to be had.

The design of such a tuner takes some time. The job has been done for various wavelengths by the Assistant Technical Editor and the tuner will be shown in *QST* in this, or a later issue. If one does not wish to go to quite so much trouble there is an easier way out—although one has to give up a few things. This method is to shunt a small variable condenser across a larger one. Then one can set the larger condenser for the right waveband and do the tuning inside this band with the small condenser. Of course the set cannot be calibrated accurately because both settings must be known and it is hard to read the setting of the large condenser accurately enough—a small movement here has such large effect.

However, only one set of coils is necessary and that is certainly an advantage. One cannot hope to go from 5 to 500 meters though, and that is easily possible with plug-in coils of good design.

Ten Degrees Per Meter

By Albert W. Sonn*

THE purpose of this article is not to advertise any particular make of tuner or condenser. It just happens that the writer made his tuner from a short-wave Bremer-Tully tuner and one of their "7 plate" (150 micromicrofarad) variable condensers. This is the combination which

normally tunes from 50 to 110 meters with a half-turn of the tuning condenser. Therefore it is possible to cover the 80 meter band, also the Canadian amateur waves but the tuning scale in these regions is very close.

To cover these same regions, together with the 150-200 meter band while keep-

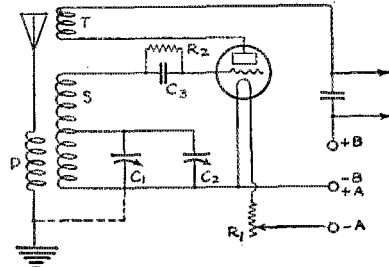
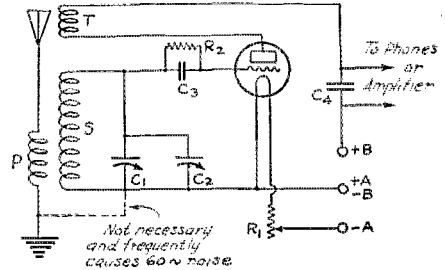

TWO WAYS OF USING THE IDEA ON THE FAMILIAR TICKLER REGENERATOR

The circuit with the tap will probably tune a bit lower while the other one avoids the need for a tap on the secondary coil. Sometimes it is convenient to connect the larger condenser across the whole coil and the vernier condenser to the tap.

R2—Grid leak. For C.W. reception a value from 5 to 10 megohms is usually best.

P—Fixed primary. This has 7 turns in the "BT" tuner.

S—Secondary, 17 turns tapped at 7th. Turns spaced widely.

T—Tickler, adjust turns for tubes, etc.

C1—Vernier tuning condenser, capacity about 100 micromicrofarads is sufficient.

C2—Main tuning condenser. When using tap this should have a capacity of 1000 micromicrofarads. When using entire secondary 350-500 micromicrofarads is ample.

C3—The usual mica grid condenser, 250 micromicrofarads.

C4—The usual plate-bypass condenser, a convenient size has a capacity of 2000 micromicrofarads.

R1—Rheostat.

ing open tuning, several changes were made.

The circuit was left as always.

The secondary of these tuners has 17 spaced turns. The upper turn was left connected to the grid-condenser as usual.

*2CG, Radio Editor Newark Sunday Call, Newark, N. J.

but the tuning condenser connection was moved down to the 7th turn. A quarter of an inch of insulation was carefully removed from this turn and a piece of No. 22 bare wire soldered on. This tap was connected to the tuning condensers.

The Small Tuning Condenser

The lower 7 turns of the secondary were, as we have just said, shunted by the tuning condensers. There were two of these, a large condenser for setting to the right wave-band and a small vernier condenser for tuning within the band.

The small condenser was the "7 plate" Bremer-Tully condenser with two of the outer rotor plates removed by bending back and forth until they broke off. It was then a "5 plate" condenser with 2 rotor plates and 3 stator plates. This condenser should be given a 4 inch or 5 inch dial (or pointer) in the center of the panel.

Directly across the five-plate condenser is shunted another condenser having a capacity of 500 or 1000 micromicrofarads. The writer happened to have a very small book-type of condenser made by the Wallace & Tiernan Co., of Belleville, N. J. It has a maximum capacity of 1000 micromicrofarads and a minimum of 15 micromicrofarads. Of course this particular condenser need not be used and the writer does not think that they are available now, so one might as well seek some other make.¹

The two condensers are connected in parallel across the lower 7 turns of the secondary. The rest of the coil connects to the grid condenser as usual. The 7 turns across the secondary condenser and the total 17 turns connected to the grid-condenser and leak can thus be thought of as acting in the way of a Oudin Resonator or Tesla Coil, raising the grid voltage and thereby giving louder signals.²

The extra turns do not affect the wavelength of the secondary circuit greatly but are convenient when working in the 150-200 meter range of wavelengths. The condenser connections are simply shifted as shown in the diagram and the entire 17 turns used across the condenser, thereby making it possible to tune to 200 meters.

1. "Book" condensers are sometimes good and sometimes bad, it depends on the insulation, design and mica. All I have seen had another weakness—the same setting of the shaft never gives the same capacity.—[Tech. Ed.]

2. The Technical Editor is thoroughly unconvinced of this. Many tests failed to show the slightest gain over a normal secondary system. In the present case a "normal system" would be the 7 turns without the extra 10. Distinctly better signals can be obtained by a third combination, that of using the entire 17 turns with a correspondingly smaller variable condenser.

3. Without attempting to discount an excellent little tuner one must admit that this hardly fulfills present needs—and that we are back again at the conclusion that the present-day amateur tuner needs interchangeable coils.—[Tech. Ed.]

Tuning

Set the small condenser at zero and tune the secondary circuit to 75 meters by moving the large-capacity condenser. When you have in this way reached the lower edge of the 75 meter band stop the large condenser and tune in the band by using the "5 plate" condenser with the large dial. You will find that its entire scale will cover only about 10 meters, a meter to a degree. You will find some station at almost every division on the dial however and will pick up many more than with the usual cramped-scale tuners.

In the same way you can go into the region of 100 meters with the large condenser and then hunt through that region with the small condenser. Finally the condenser connections can be moved to B (see the diagram) and the 150-200 meter band explored.

Suggestions

A single-plate condenser will still further open out the scale and a half-turn of such a condenser may be made to cover but 5 meters in a hundred.

The tuner described will go down to 45 meters but still lower wavelengths require special coils.³

Of course the idea may be applied to other receiving circuits and to other couplers with the standard circuit. It is simply a vernier condenser arrangement which permits open-scale tuning.

Strays

The ever active Washington Radio Club has inaugurated a new thing—an A.R.R.L. Orchestra. This aggregation of good musicians was gotten together by Wadsworth, 3BE-3ZW and is ready to liven up any radio convention anywhere at anytime! The ensemble is composed of:

Director (with baton) 3ZW
Banjo, 3JJ
Saxophone, 3IR
Saxophone, 3ND
Banjo, 3BCW
Drum, Mr. Clough
Piano, 3KM
Saxophone, 3AFU

And they sure do do their stuff.

ch9TC asks the gang to QRX for him every Wednesday, Friday and Saturday night starting at midnite. E. S. T.

E. H. Hobbs, 2ADM, offers an 8 x 10 photo of his transmitter to anyone hooking up with him on 5 meters more than 50 miles distant.

How To Eliminate Body Capacity Effects

By Dale G. Buffington*

SHIELDING the back of the panel of a radio set with tinfoil or sheet copper to eliminate body capacity is not sufficient. There are other things that must be done if the shielding is to be effective.

In the first place the shafts of many variable condensers, variometers, etc., are "alive". See Fig. 1. If these instruments are mounted directly on the panel, the shafts stick out in front of the shield, thus making the shield ineffective.

All these instruments can be mounted a considerable distance back of the panel and

which is provided with holes for screwing to the main baseboard of the set.

The portion of the shaft which connects with the dial on the panel is about 2 inches long and is provided with two bearings as

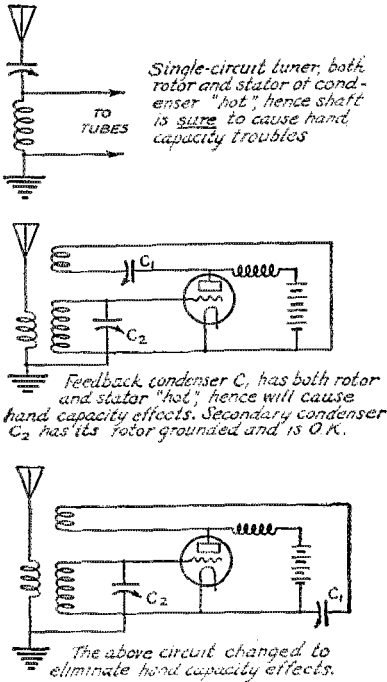

FIG. 1

connected to the dials by shafts which are insulated from the shafts of the instruments. Such a construction avoids the whole difficulty.

For each instrument a small Bakelite panel is obtained, about 3½ inches wide and high enough to mount the instruments at the proper distance above the baseboard of the set as in Fig. 2.

Each of these little panels is mounted upright on a small wood base of its own

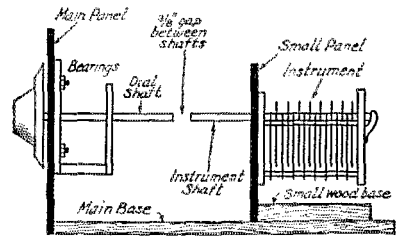

FIG. 2

shown in Fig. 2, so that the dial will run perfectly true on the panel. These bearings can even be made of wood and be attached to the panel as shown.

The little panel with the instrument mounted on it at the correct height is now brought up and the ends of the two shafts brought about ½ inch apart and centered perfectly as in Fig. 2. The little panel is then screwed tight to the main baseboard.

The ends of the shafts are now coupled together by a short piece of a very small

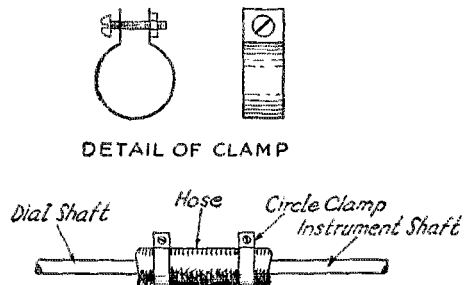

FIG. 3

and very stiff rubber hose which fits tightly over the shafts. This hose is fastened tightly to the shafts by means of two small circle clamps made of sheet brass and small screws, as shown in Fig. 3. This provides a flexible coupling which takes up all the little misalignments between the shafts and also insulates the instrument shaft from the dial shaft.

The dial shaft may be connected to the

(Concluded on Page 57)

*Lost Springs, Wyoming.

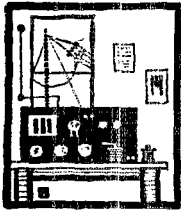

Amateur Radio Stations

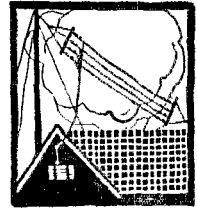

2WC, Brooklyn, N. Y.

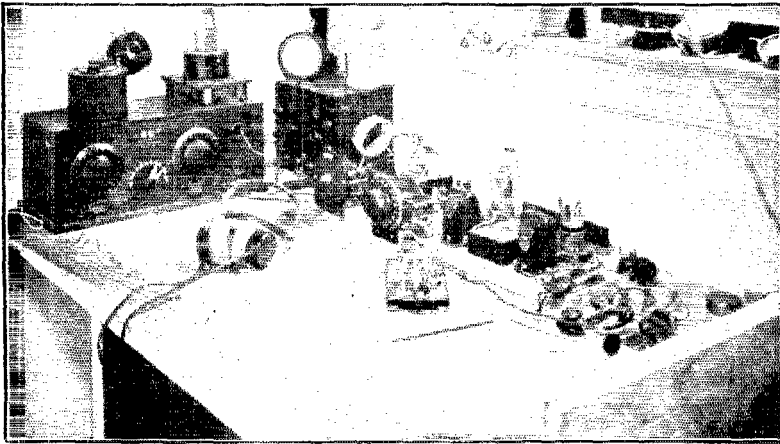

RADIO station 2WC, which is owned and operated by Stanley P. McMinn, 1332 East 5th street, Brooklyn, N. Y., started out by being a spark coil in the aerial rig more than twenty-three years ago. From this you judge that at this late date the operator is an OM in truth. Skipping the intervening years the station today consists of a single 203A tube in a shunt feed very loosely coupled Hartley circuit fed by a 400-watt, 1000-volt Esco M.G. With an input of only 95 watts, which is never exceeded, the antenna current is 1.3 amperes. Previously the station went through the throes of a 5-watter, a couple of them, a 50-watter and a couple of those and finally settled down as a 250-watter with 300 watts input, rectified A.C. through "S" tubes and a brute force filter. Despite this comparatively high power, though, DX results, as gauged by the ratio of answers to CQ's and calls was remarkably low.

Up to this time the station had been operated on the theory that if you put enough power into the sky-wire you were sure to get somewhere. But it doesn't work out that way. For a period of a year now all time and effort has been devoted to improving the efficiency and the added results from this have been well worth while. The sta-

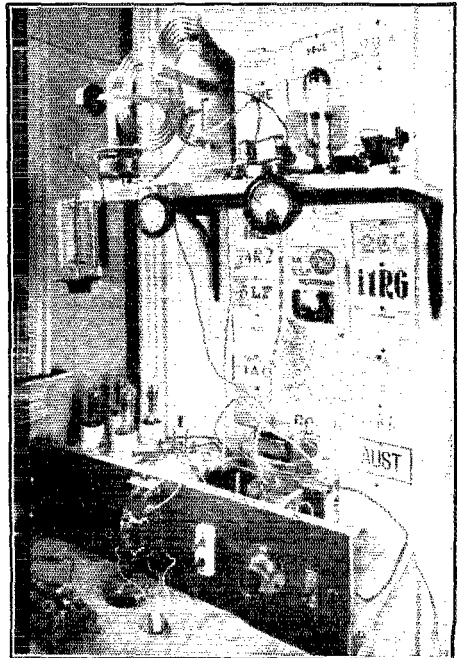

tion is not by any means a rule of thumb outfit. Its constants were mathematically figured. Then the transmitter was built to fit the figures. Today, 2WC can, literally, work anyone he can hear and has heard amateurs in every civilized country, and some that are not civilized.

Both the antenna and counterpoise are single wires of No. 10 enamelled copper. The antenna rises vertically to the top of a 40 foot Hercules steel mast set about twelve feet from the house. The transmitter is on the ground floor in what used to be a breakfast nook. The counterpoise stretches horizontally 7 feet above the earth. Both are very carefully insulated with three Pyrex insulators in a string. It is believed that the physical arrangement of the station quite as much as anything else is responsible for its consistent results. The transmitter is mounted on wall brackets three feet above and to the right of the operating table. Power supply, when using R.A.C., is directly under the transmitter on the end

of the table. The motor generator for D.C. supply is in the cellar. This arrangement gets the transmitter out of the way and keeps the operator out of the field of the inductances, and brings the transmitter over close to the antenna-counterpoise leads.

As for DX—the West Coast is worked nightly, starting as early as 9:30 E.S.T.; the station has been QSO WAP when she was within 12 degrees of the North Pole; NRRL was worked when Schnell was in Papeete and a number of Australian stations have been worked. South America, England, Africa, France, Germany, Belgium, Holland, Spain and other European countries conclude the DX list of 2WC.

The receiver is a Reinartz type with 2 stages of audio frequency amplification, and uses removable coils. A Grebe is used for long wave reception. At present a lot of experimental work is being done on crystal control for the transmitter. More about that later.

5ZAI, Beeville, Texas

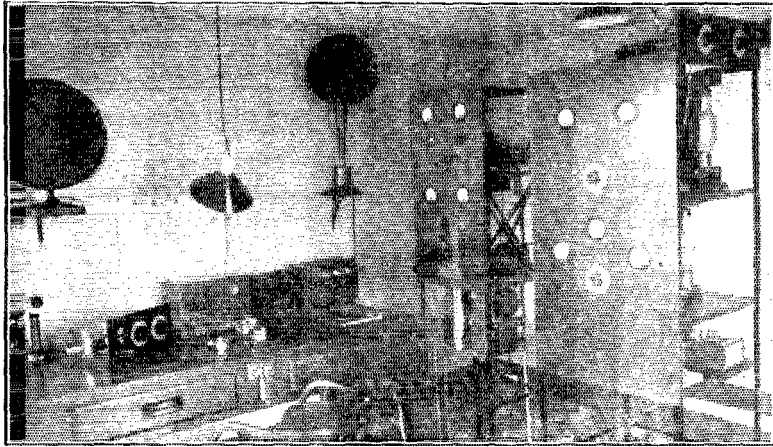

BEFORE the war Henry W. Hall operated station 5AY at Beeville, Texas. For a time, after the war, he was out of the game but reentered in the summer of 1924. He and Jim Hunt of Victoria, Texas, got together and the present 5ZAI-5TG at Beeville is the result.

This station is located in a specially constructed shack on top of the Rialto Theatre. Power lines come into the shack through BX cable. Plate supply to all of the transmitters is obtained from a one and one-half kilowatt 2,000 volt Esco motor-generator. The transmitters are assembled behind two

panels. One panel contains the choke coils and filter condensers used to smooth out the generator supply, the field rheostat which controls the plate voltage, an automatic circuit breaker set to "throw" if the plates are overloaded, a filament transformer and filament rheostat in the primary of the filament transformer circuit. The two separate transmitters are mounted on the other panel. The upper shelf contains a 20 and 40 meter transmitter using two UV 204-A tubes in a special form of coupled Hartley circuit. Large double spaced variable transmitting condensers are used in the grid and plate

circuits of this transmitter. The lower shelf contains the 80 meter set which also uses two 204-A's operated in the familiar inductively coupled Hartley circuit. The transmitting panel was completed in the

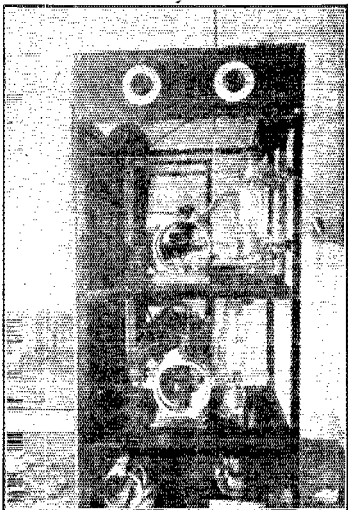

latter part of July. Since then 5ZAI has worked Australian, Brazilian, Chilean, British, Swedish, Hawaiian, Italian, Japanese, Mexican, South African, Spanish and New Zealand stations.

Previous to July 5ZAI consisted of a 250 watt set on 80 meters. This set was heard in every continent on the globe.

The antenna and counterpoise are strung between poles on top of the Rialto Theatre. Both antenna and counterpoise are two foot six wire cages, 60 feet long of the inverted L type. When operating on 80 meters the first harmonic of the antenna is used. On 40 meters the third harmonic is made use of while on 20 the fifth harmonic effects transmission.

The receivers at 5ZAI consist of a "1BGF" type and a "Schnell" type with one stage of audio amplification. Either receiver can be plugged into a power amplifier-loud speaker combination for painfully loud reception.

A number of years ago Hall sustained a broken leg in a fall in a Curtiss Jenny airplane. He has been having trouble with the leg ever since and each year goes to Rochester, Minn., to a hospital. He carries along a portable 50 watt transmitter working from the a.c. supply at the hospital. The transmitter is assembled bread-board fashion and is so compact that a typewriter cover is used as a carrying case. In the hospital Hall continues to bat out DX. With a steam radiator or pipe as a ground and a bedspring as an antenna he has worked U, C, M, PR and Q stations time and time again!

9UQ, Ames, Iowa

THIS station is located at the Iowa State College and is assembled from parts that are the property of the Electrical Engineering Department of the College. The station was assembled and is operated by Woolfries and Fritschel, who are also the operators of the Iowa State College broadcasting station WOI.

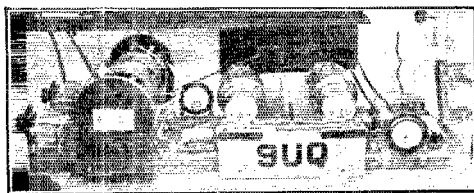

The transmitter uses a standard loosely coupled Hartley circuit. Two UV-204-A's are ordinarily in the circuit, although at times only one of the tubes is used. A small double spaced receiving condenser is connected across three turns of the plate

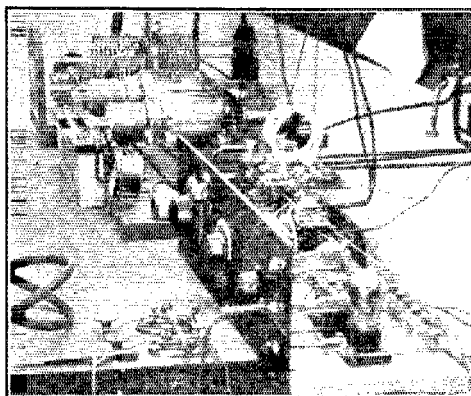

coil and is used for accurate wavelength adjustment. Plate supply is obtained from a 2,000-volt motor-generator set. The input on 40 meters is 1,000 watts and on 20 meters 750 watts. This transmitter is the
(Continued on Page 57)



Sr. Moya Elected Spanish President

Notice to all Spanish Members:

The ballots recently sent out from this office to elect a President of the Spanish Section of the International Amateur Radio Union were counted on November 1, 1925, at the conclusion of the voting period, with the following result:

Sr. Miguel Moya 13 votes

Sr. Fernando Castano 3 votes

Sr. Miguel Moya, eAR1, of Madrid, accordingly is declared elected as the Spanish President for a term of two years commencing November 1, 1925.

K. B. WARNER, International Sec'y-Treas.

M. Audureau, f8CA, Secretary of the French Section writes the following account of French activities: SRM is now in Guyanne and is making tests on QRH 2 meters and 5 meters at 1015 and 1400 G.M.T. and on 15 meters at 1930 G.M.T. f8WAG has been qso z2AE lately with a power input of 28 watts on 38 meters. z2AE reports an audibility of 4 to 5 on two tubes. f8EE recently carried on an interesting test with z2AE. First with an input of 80 watts fed to an antenna tuned to 42 meters (outdoor antenna) 2AE reported his signals as r8. Then on a one wire indoor antenna about 9 feet long with an input of 20 watts on a wavelength of 45 meters 2AE reported his signals as r5. f8HU succeeded in connecting with z4AG the morning after his transmitter was assembled. M. Robert Larcher reports the signals of NW4X whose QRA is Berven Stavanger, Norway. f8MB at 6 a. m. on September 19th established two way work with z2AC and on September 20th with z2AE and z2AC when using three repaired receiving tubes with 800 volts of raw A.C. on their plates and a single wire antenna 50 meters long with a four wire counterpoise 15 meters long.

Journal des 8

In January 1924 f8BP, Monsieur Georges Veuclic, a printer by trade and a radio amateur by preference, addressed a letter to all French amateur transmitting stations asking them whether they would welcome a real ham publication, a sort of amateur

house organ where they could exchange their views, calls, apparatus and anything else French amateurs have to exchange. The response was favorable, and the result is the very excellent French ham magazine *Journal des 8*, so-called because all French calls begin with an "8". The "Journal" contains all sorts of interesting things; each Saturday it goes forth to practically all French amateurs as well as others in many other countries where there are amateurs. It contains information on circuits and apparatus used by prominent DX men, schedules of French stations, strays about stations in other countries; it maintains a QSL card forwarding bureau as many French amateurs are not listed in Call Books; its purpose is to maintain contact with the amateurs of all countries and to bring them together wherever possible. M. Veuclic started the magazine at his own expense and has carried it on largely by the same process. As he is the owner of a printing establishment he could afford to print the "Journal" for much less than would have been possible elsewhere and as he does it for the love of the game the profits all go into the publishing of the sheet. To all intents and purposes it is a young QST except there is no League back of it. We believe it represents the spirit and thought of the French transmitting amateurs better than any other French publication and in support of this it has been named the official organ of the French Section of the International Amateur Radio Union. To those who are interested in learning more about the *Journal des 8* we suggest writing its editor whose address is Georges Veuclic, Rugles (Eure), France.

In a letter from Mr. R. Tappenbeck, President of the Netherlands Section of the I. A. R. U. we learn the following concerning the I. A. R. U. and amateurs in Holland. On October 1st we had fifty-six members in Holland. Although the license fee for an amateur transmitter is only two dollars a month, very few amateurs try to get licenses because they are full of restrictions that are totally impossible. As soon as Mr. Tappenbeck was elected President of the Section he

immediately took steps which are hoped will result in the solution of the license problem. The newest and brightest Netherland star is OSV who started to twinkle a few months ago. This station was the second N station to be QSO the Zedders and Aussies and after some time of working he got the anti-pode reputation of being the strongest station heard in the antipodes, with the exception of g2NM. It was impossible for OSV to sleep after this so he kept at it. By the latter part of September almost every Zedder told him his signals were the strongest ever heard in New Zealand, so OSV sleeps again! OBA, who was the first Holland station to work the "a's" and the "z's", and OBQ are working the antipodes regularly. Listen on Saturday nights for them. OBQ wonders why he only gets answers from U and Z stations when CQing with his 150 watt set, and no reply from Europe, when a CQ with his Ford coil-emergency-set with only an old five watt tube never fails to raise a G, F or I station. WAP has been worked by OSV, OBA and PC7. PC7 is now using an input of 450 watts. His usual wavelength is 37 meters. He has been qso bz1AF and bz2SP often. PB3 has just finished a 200 pound 50 foot steel pipe mast with an 8 wire conical cage. He is QSO Brazilian stations but is on very little because he is busy building a super-transmitter, with which he threatens to dent the diaphragms of every headset in the world. OGN is QSO the U. S. and OPM, OZA and 2PZ are handling bushels of European traffic using from 10 to 40 watts power. PC9 reports hearing music from WAP. The accompaniment seemed to be due to the crew on WAP who evidently were beating on tin pans.

The Australian Bulletin sent via radio from a 2YI to u9ZT to A.R.R.L. Headquarters contains the following news:

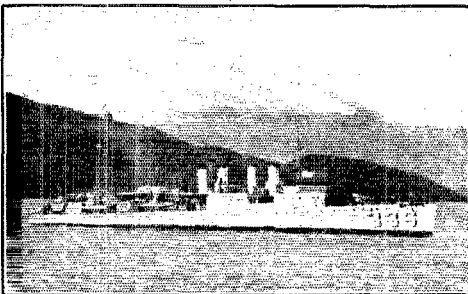

THE HOME OF NUMM, U. S. S. LITCHFIELD, IN NEW ZEALAND.

Several Australian stations have been heard in both south and north Africa and it is hoped that two way communication between these countries will soon be established. Africa is the only continent that has

not been worked by Australia. Numerous East coast stations have been heard on 40 meters in the morning between 8 and 9, Sydney time. Close to 50 Australian stations have been successful in working the United States, many of them with five watt tubes. Excellent results are still being obtained in two-way working with England during late afternoons from 4:30 p. m. on. Tasmanian station 7JB using an input of only 30 watts has successfully worked g6RM. a3BD reports working several French stations and has spent the last few mornings composing cards for them. He has worked many Americans recently using an indoor antenna. WNP and WAP have not been heard since their first and only contact with a2YI and a2DS. Hams missing a3JU please note he is now in Sydney and will soon be an active a2 station.

On the 3rd of October at 3:38 P. M. E.S.T. u1CMX at Fall River, Mass. and a3BD were in communication! Several days later 1CMX and a3BQ connected at about the same time of day. The distance was either approximately 9,000 miles through daylight or 16,000 miles through darkness. F.B. OM's and congrats.

South Africa and U. S. A. Now QSO

Although there has been much activity in South Africa and a number of stations there have been doing very good DX work no amateur in this country has been QSO the States until, on the morning of September 20th at 0100 G. M. T. (S. African time), oA4Z and u1CMX connected. oA4Z is the station of J. S. Streeter of Observatory, Capetown and u1CMX is the internationally known station of Jefferson Borden, 4th at Fall River, Mass. 1CMX answered a CQ of A4Z and they were QSO for some time. We have been looking forward to contact of this type for a long time and it is with a great deal of pleasure we chronicle this communication. May there be lots more of them. Again, congrats!

A few weeks later oA4Z and g2LZ hooked up. At the time g2LZ was on 44 meters and oA4Z was operating on 34 meters. We believe this to be the first contact between England and South Africa. also. g2LZ advises that he has a special permit from the British P.O. authorities to use any wavelength between 23 and 45 meters and any power up to 1 k. w. 2LZ is anxious to arrange schedules with American amateurs for the purpose of conducting tests to explore the wavelengths between these limits.

Contact with Germany improves nightly. kY8 and u2AKB have been QSO, ky5 and u1AXA connected on October 5th and k4LV with an input of only 9 watts hooked u410 on October 7th. There is a great deal of activity in Germany. Before long the German stations will be QSO all countries. F. B.

NCG1 (one) is the U. S. Coast Guard Radio Repair Base, Navy Yard Philadelphia. He has been doing some nice work in the 40 meter band.

HER announces the following schedule of transmissions during which various types of transmitting equipment will be used: Every morning at 0400 G.M.T. on 35.5 meters and every Sunday morning at 1800 G.M.T. on 5.8 meters. HER will appreciate reports of reception of either of these transmissions.

z2AC reports QSO with cs OKI, the latter of 44 meters with 500 cycle note.

Another Canal Zone station is in operation. Call, NOSN. The QRA is U. S. Submarine Base, Coco Solo, Panama. The station is owned and operated by F. A. Emrick, ex 1ALC, and was first QSO the States when working 9ADO, Savannah, Missouri.

The British regulations have been modified to allow amateur transmission for ten minutes in any hour on 23 meters or 44 to 46 meters and also 90 to 200 meters. It is to be hoped that before long the "ten minutes in any hour" part will be increased to sixty minutes in every hour.

WIK is a new RCA call of the New Brunswick, N. J. station, licensed for operation on 22 meters, point-to-point service.

u9ZT reports hearing h9AD for several hours on the morning of October 18th. Audibility of r4 and QRH 45 meters.

1JW giving his QRA as Wolff, Luxembourg and u1CH of Brockton, Mass. connected on November 1st for probably the first communication between these countries. 1JW was operating on a wavelength of 44 meters at the time.

A new station is in operation in Brazil. The call is bz7AA and the QRA A. A. Santos, Maranhao, Brazil. He will appreciate QSL cards reporting reception of his signals. QRH is around 35 meters and power one 50 watt tube.

NWQ, the short wave station of the U. S. S. Wyoming is in operation in Guantanamo Bay, Cuba. The transmitter con-

sists of a UV-202 master oscillator feeding a UX 210 power amplifier. Ensign Hammond, the operator and ex 1UV, is anxious to connect with as many amateurs as possible.

g6LJ reports reception of the 40 meter signals of j1AA recently.



j1AA, NEAR TOKIO, JAPAN

u6AJI, with a 5 watt tube worked at an input of 18 watts recently was QSO g5XY, z2AC and f8TOK. The antenna at 6AJI is a single wire 25 feet long and the counterpoise a single wire 10 feet long. The set was operated slightly above the fundamental of the antenna system. F. B. O. M.

d7EC reports that his signals have been heard by oA4M at Johannesburg, South Africa. He has been QSO bz 1AB and received a report from Siberia on his "QSA signals" there.

L. O. Doran, the operator on the SS West Jester, who has been doing such splendid dx reception in Japan and China hopes to have a short wave transmitter on KUDG. The set may be a 30 watt Japanese affair. If licensed, Doran hopes to be QSO the gang soon.

Syd Strong, z3AE, writes that the most outstanding New Zealand interest for the month has been the thrill of the wicked fone signal g2NM has been pumping into New Zealand. He adds that z2XA has been QSO Philippine Islands. VMG the

high power New Zealand Governmental station in Samoa has dropped down to about 33 meters with a tube set replacing the murderous high power 600 meter spark set.

Strays

ERRATUM: The line just above the cut in the November advertisement of R. C. Ballard, page 109, should have read: "Sent C.O.D. or on receipt of \$2.50 in M.O. or check."

It is at Tacoma.

We are advised that the title "Curing Seattle's Radio Interference" should not have been used on page 14 of our November issue. The interference originated at the Tacoma Smelter as stated in the article; therefore the interference was most severe at that locality.

The error was occasioned by a misinterpretation of a sentence in Mr. Smelser's letter.

Fortunately the cure seems to have been effective. We assume that Tacoma no longer has the "QRM" but still has the smelter.

SLO says WAP should be named "Bubble and Squeak".

".....condemned to hard labor—sucking the vacuum out of V.T.'s."—L. O. D. Initiation.

SCVK suggests a good primary rheostat can be made from Cutler-Hammer 25 ohm resistance units (costing 25 cts), connected in series. Three or four units in the primary of a transformer whose secondary voltage is 12 will pull the voltage down to 10. The units do not get hot enough to bother, even with a 50-watt tube.

Fundamental or Harmonic?

Many readers of *QST* send in claims that one way or another of working the antenna is the best when they have only tried one way at a time.

As our good friend Charles MacLurcan says in the New Zealand Wireless and Broadcasting News: "There is only one reliable way to decide this question. Have both aeriels up and fire at the same man on the same night."

Furthermore, it doesn't settle anything to try such a thing at one station on one or two nights. The only way to get real evidence is to have both antennas up and run them for a long time, using the same transmitter alternately on the two antennas. The more stations that make the experiment, the better.

Now go to it fellows, and let us have the results in complete detail: meter readings, times, dates, everything.

How to Eliminate Body Capacity Effects

(Concluded from Page 50)

shields by a flexible wire though this is not always necessary. The shield should be connected to the ground binding post.

All switch levers should be mounted in the same way.

This is obviously necessary as a switch lever mounted on the panel will, of course, defeat the purpose of the shielding.

If these details are carefully followed a very neat job can be done and all traces of body capacity effect can be eliminated.

9UQ, Ames, Iowa

(Concluded from Page 53)

fourth high powered short wave transmitter built in one month. Each one of them was an effort to overcome difficulties found in the previous model. Keying difficulties were finally solved by keying in the negative lead, using a one- μ f. condenser and iron core choke in series across the relay.

The transmitting aerial is a 12-wire fan 120 feet across the top and 140 feet high. It has a fundamental of 240 meters. An extensive ground consisting of buried wires, steel framework of three buildings, water system, etc., is used. The receiving set is of the low-loss style, and uses celluloid supported coils. Capacity controlled regeneration is used. Best results on short waves have been found when a UV-199 tube was used at a detector and a 201-A as an amplifier. Although the receiver has two stages of audio frequency amplification only one stage is used for amateur work. A separate detector B battery, having short leads, has been found to improve both the selectivity and volume of the receiver. The receiving aerial is a single wire strung at right angles to the transmitting aerial and is 50 feet long and 40 feet high.

The set with its present power was put in operation about the 1st of July. Since then its signals have been reported in Australia, New Zealand, Philippine Islands, Samoa and many nearer places. Most of these countries have been worked. Australia and New Zealand have been worked on an average of 5 nights a week.

Calls Heard



IAB. Alvaro S. Freire, 46, Rua Oswaldo Cruz, Icarahy, Nitcheroy, E, do Rio, Brazil
40 and 20 Meters Only

1aao, 1abp, 1aci, 1ahg, 1ahl, 1air, 1ajz, 1aiw, 1are, 1awl, 1bhd, 1bes, 1biz, 1bgi 1gqi, 1bzp, 1bvx, 1el, 1eak, 1ecx, 1ek, 1ekp, 1emp, 1cmx, 1li, 1ka, 1mk, 1my, 1pl, 1te, 1uc, 1uv, 1uw, 1wi, 1ve, 1xu, 1za, 1zs, 2afn, 2afp, 2agb, 2ain, 2amj, 2anq, 2api, 2apm, 2apv, 2bpx, 2bee, 2buu, 2buy, 2egj, 2ct, 2eth, 2ety, 2eub, 2eul, 2exw, 2ds, 2dx, 2gk, 2gv, 2gy, 2ha, 2iu, 2mu, 2nf, 2xaf, 2xbb, 2xi, 2xu, 2za, 3ab, 3aew, 3ajd, 3aha, 3ask, 3auv, 3bva, 3bwj, 3cdk, 3ckg, 3jw, 3kg, 3ot, 3qw, 4cu, 4fy, 4kt, 4jr, 4oi, 4rr, 4tv, 5akn, 6uk, 5zai, 6bur, 6cgv, 6caw, 8apw, 8apo, 8brc, 8bf, 8byn, 8ccq, 8cdt, 8chq, 8cuk, 8cyl, 8eq, 8er, 8jq, 8pl, 8rx, 8ry, 8sf, 8zm, 8acf, 9ek, 9bj, 9bht, 9bf, 9cap, 9cxx, 9dvw, 9ff, 9uc, 9xn, 9zt, m1aa, m1b, m1k, e1am, e1ar, e3aa, e4gt, p4ras, q2by, z1ao, z1ax, z2ac, z2ae, z2xa, z4aa, z4ak, z4ar, a2cm, g2cc, g2dx, g2kf, g2lz, g2mm, g2od, g2sz, g2wy, g2xy, g5dh, g2if, g6kk, g6rn, f8bv, f8dp, f8ec, f8ec, f8fg, f8tk, f8sm, f8wag, f8yor, fyz, 1laf, 1ier, 1iirt, 1irg, 1ilt, 1d7ec, hsmyy, np7, nosv, bb7, b8alg, ra8, raal, raf1, raf2, rff9, rfg4, rga2, chleg, chlgw, ch2ld, ch2re, ch2rm, yek4, yfwx, yjcp, yrj, Misc, fgh, in, fx1, nkf, nrll, numm, nve, nisv, nerkl, pemm, pcuu, octu, pof, pow, ppx, rdw, wap, wir, wvz, wnp, wb, Zt, 8cmp, 9ch, sgc.

hz7AA. A. A. Santos, P. O. Box 53, Maranhao, Brazil
1aac, 1aag, 1aao, 1aay, 1aci, 1afl, 1aiu, 1aju, 1ajo, 1ald, 1are, 1arh, 1bie, 1bvx, 1bpz, 1cb, 1ccj, 1ci, 1ciu, 1emp, 1cmx, 1li, 1ka, 1mu, 1pl, 1rr, 1si, 1xu, 1yb, 1zi, 1sz, 2adb, 2afn, 2ahm, 2au, 2amj, 2apv, 2bpx, 2bee, 2buy, 2eth, 2eul, 2gk, 2ha, 2kf, 2kr, 2iu, 2mc, 2nf, 2sz, 2vc, 2vr, 2xbb, 3aoa, 3ajd, 3ar, 3ask, 3hg, 3jw, 3vg, 4js, 4rm, 4tv, 6qw, 8adg, 8bhm, 8bpl, 8bu, 8cca, 8ccr, 8djp, 8eq, 8es, 8jg, 8tk, 8bbh, 8bht, 8bn, 8brg, 8bvt, 9ff, 9rk, 9xn, bz1a, 1ab, 1ac, 1af, 1am, 1ap, 1as, 2ap, 7ab, rgt, rc8, af4, g2cc, 2sz, f8jb, 8tk, e7e, 1rti.

IIWG. Rome, Italy
30 to 45 meters

1aae, 1aao, 1aay, 1abp, 1acc, 1aci, 1adb, 1af, 1ahg, 1ajz, 1akb, 1aki, 1alw, 1ana, 1ang, 1aou, 1ap, 1ar, 1arc, 1arh, 1atv, 1aw, 1ayn, 1baq, 1bes, 1bg, 1axa, 1aaz, 1aya, 1ayu, 1ah, 1bom, 1bat, 1bov, 1bvl, 1bvx, 1bzg, 1bzp, 1bhm, 1bke, 1bdx, 1box, 1cab, 1caw, 1ect, 1ci, 1cee, 1cj, 1ck, 1ckp, 1eln, 1mf, 1emp, 1cmz, 1ebz, 1ccz, 1cki, 1cmx, 1er, 1hj, 1ka, 1km, 1my, 1pl, 1py, 1qb, 1qm, 1rr, 1te, 1tie, 1ve, 1wr, 1uc, 1uw, 1xg, 1xm, 1yb, 1zs, 2af, 2ag, 2ai, 2aim, 2amj, 2api, 2apr, 2avo, 2ax, 2aif, 2agw, 2agz, 2bbx, 2bee, 2bum, 2bur, 2bxj, 2ct, 2rb, 2bnz, 2bq, 2bwa, 2beo, 2cga, 2egj, 2ehu, 2ekr, 2epa, 2eth, 2eva, 2evj, 2evu, 2chj, 2cxl, 2elg, 2eur, 2cyw, 2ds, 2dx, 2fo, 2gk, 2gy, 2ha, 2kes, 2ks, 2tr, 2jg, 2iu, 2kur, 2mu, 2mkb, 2mt, 2nf, 2ngh, 2np, 2pd, 2sz, 2wc, 2vr, 2xaf, 2xbb, 3aa, 3aao, 3afg, 3ag, 3ais, 3au, 3awh, 3aha, 3ai, 3bce, 2bn, 3bv, 3bva, 3ebi, 3hco, 3bet, 3bnt, 3ael, 3ehz, 3gkg, 3cm, 3ekt, 3en, 3edv, 3jw, 3ju, 3ma, 3mv, 3ot, 3uy, 3wb, 4am, 4aso, 4ao, 4ig, 4fn, 4fl, 4fm, 4fj, 4it, 4js, 4mm, 4ll, 4nj, 4rl, 4rm, 4oy, 4tv, 4nk, 4sl, 4vl, 4oa, 4wr, 4xe, 5acy, 5ag, 5ax, 5ac, 5aut, 5ai, 5ame, 5ev, 5gm, 5jd, 5he, 5la, 5nj, 5nq, 5oq, 5uk, 5va, 5vr, 5za, 5zai, 5z1, 6cgv, 8ac, 8udk, 8adm, 8alf, 8aq, 8avi, 8ay, 8bel, 8hen, 8hf, 8hft, 8hgn, 8bhm, 8bkm, 8bq, 8bwb, 8by, 8byn, 8byo, 8buk, 8brc, 8br, 8bpl, 8ada, 8aud, 8aul, 8agq, 8ccq, 8ccr, 8cj, 8ckm, 8ccr, 8cvi, 8ec, 8cau, 8cjp, 8ebi, 8erz, 8eud, 8daa, 8dm, 8de, 8don, 8dsh, 8dea, 8dpl, 8dgl, 8dkr, 8dal, 8dfr, 8gc, 8er, 8es, 8gl, 8gl, 8gz, 8jg, 8jma, 8ja, 8fl, 8ka, 8ki, 8mw, 8lca, pl, 8pka, 8rj, 8rh, 8tt, 8mw, 8af, 8tx, 8uk, 8xy, 8zm, 8z, 9aaw, 9adk, 9al, 9at, 9aim, 9bbj, 9bbo, 9bcs, 9bht, 9bn, 9br, 9bpb, 9bdr.

9bwb, 9boj, 9bz, 9bnd, 9cap, 9dhr, 9dnz, 9dpx, 9dw, 9ek, 9esa, 9ekk, 9eky, 9ef, 9ejl, 9dww, 9cvb, 9ff, 9hat, 9gv, 9hp, 9og, 9mm, 9se, 9ut, 9uk, 9xn, 9wu, 9za, e1ar, e1el, e2ax, e2bg, e2fo, e3aa, e9al, e9ch, a2cm, a3bd, a3bu, z1ao, z2ac, z2ae, z2xa, z4ag, z4al, z4av, z4ak, z4ar, m1aa, m1af, m1b, m1dh, m1k, bz1ac, bz1af, bz9z, q2mk.

H. C. C. McCable, 71 Holloway Road, Wellington, New Zealand

1aep, 1axa, 1arh, 1aep, 1are, 1anq, 1aoo, 1amf, 1aao, 1azd, 1bqi, 1bvl, 1bpz, 1bg, 1cmx, 1ka, 1uw, 1er, 1te, 1pl, 2acs, 2agw, 2ahm, 2bee, 2bbx, 2egi, 2czq, 2cvf, 2cxl, 2gy, 2iu, 2zb, 3cdk, 3afq, 3aha, 3auv, 3cg, 3ld, 3lw, 4sb, 4fg, 4rm, 4fl, 4tv, 4cu, 4oa, 5ade, 5aci, 5aid, 5ail, 5akz, 5amw, 5ado, 5atv, 5auq, 5afd, 5aj, 5agu, 5akl, 5ame, 5aau, 5akn, 5ew, 5se, 5ls, 5ms, 5uk, 5oq, 5wi, 5tj, 5nq, 5va, 5j, 5ox, 5j, 5zai, bl5 6ab, 6cig, 6nx, 6ct, 6hm, 6avj, 6das, 6amf, 6akz, 6uf, 6bv, 6vr, 6dah, 6cto, 6dai, 6csc, 6xad, 6est, 6hu, 6cgv, 6av, 6hvs, 6rj, 6bqu, 6asv, 6eah, 6cmq, 6zh, 6dab, 6vc, 6xg, 6csw, 6jp, 6ur, 6aj, 6dam, 6bqv, 6zd, 6ae, 6ake, 6bkv, 6bjd, 6akm, 6dh, 6aj, 6adt, 6asr, 6abg, 6sk, 6clp, 6beb, 6bjv, 6rw, 6fh, 6cgy, 6ai, 6zac, 6csc, 6akx, 6aon, 6daa, 6bmw, 6bas, 6ak, 6bvy, 6bjd, 6cix, 6enc, 6ckm, 6kb, 6ev, 6chl, 6ap, 6ckz, 6cls, 6abt, 6awt, 6sz, 6apj, 6bzg, 6bbv, 6aea, 6ect, 6ahp, 6cep, 6agk, 6dan, 6bb, 6bep, 6ut, 6ac, 6bdn, 6ds, 6wr, 6bip, 6zbn, 6bc, 6eb, 6aqp, 6euk, 6che, 6afg, 6hc, 6hwr, 6bse, 6oa, 6fn, 6nv, 6bon, 6bay, 6cgu, 6bhq, 6ml, 6dag, 7ay, 7it, 7de, 7au, 7uv, 7ly, 7uz, 7dx, 7av, 7uq, 7uj, 7abf, 7na, 7oe, 7df, 7aek, 7adq, 7d1, 7gb, 7fb, 7wu, 7hi, 7vp, 7nl, 8tx, 8eg, 8ay, 8bpl, 8bce, 8aly, 8cyl, 8jg, 8pk, 8bnh, 8nt, 8ay, 8sf, 8ced, 8gz, 8cau, 8bf, 8pl, 8buc, 8ebi, 8byn, 8se, 8ada, 8caz, 8gk, 9ek, 9uc, 9cx, 9ebo, 9dtk, 9hqq, 9dng, 9amd, 9n, 9ado, 9czw, 9eft, 9aad, 9bpy, 9eky, 9ael, 9dvr, 9bvh, 9ff, 9dwn, 9ent, 9cld, 9avr, 9ale, 9dax, 9tj, 9mn, 9dry, 9akf, 9ebx, 9dpx, 9ecc, 9aot, 9dfl, 9bht, 9bbh, 9cjm, 9dac, 9zt, 9bez, 9dkv, 9aul, 9dr, 9efa, 9ua, 9wa, 9bwo, 9aim, 9dwo, 9bpb, 9bwb, 9ded, 9cxx, 9cjs, 9egu, 9hp, 9dqr, 9yav, 9eel, Alaskan: 7de, wvd, e3aa, e4gt, e4bv, e4aa, e5hp, e5ef, e5ct, e5go, e5ba, e5gt, m1aa, m1b, m1k, m2ei, m4na, m1da, m1fa, hu6buc, hu6aff, hu6ajl, hu6tz, hu6cst, hu6dcf, hu6asr, pr4r, pr5a, chleg, ch2rm, ch9tc, rpz, raf1, rc8, bz1ab, bz2sp.

R. W. Mintorch, 62 Barton St., Woolston, Christchurch, New Zealand

1agh, 1anq, 1axa, 1bgw, 1eln, 1emp, 1cmx, 1er, 1ka, 1my, 1pl, 1te, 1wv, 2agw, 2ahm, 2aim, 2awa, 2bee, 2bur, 2ebg, 2egi, 2elz, 2ety, 2evf, 2evu, 2lu, 2mm, 2nf, 2xaf, 2xi, 3aao, 3afq, 3awh, 3bva, 3bv, 3cdk, 3ekg, 3kg, 3ot, 3vx, 3wn, 4ask, 4au, 4fl, 4ju, 4rm, 5afd, 5agn, 5agu, 5aid, 5aj, 5atv, 5co, 5ew, 5jd, 5kc, 5nj, 5nq, 5nr, 5oq, 5ox, 5ps, 5se, 5uk, 5va, 5yd, 5zai, 6aff, 6azk, 6aj, 6ajm, 6ake, 6akx, 6akz, 6alv, 6apw, 6aum, 6bau, 6bv, 6bde, 6bqz, 6hgk, 6bjj, 6bmw, 6hdt, 6btu, 6cvc, 6edy, 6ocj, 6cfl, 6cgv, 6cix, 6cls, 6cmq, 6csw, 6dad, 6dan, 6ex, 6jp, 6js, 6ml, 6nw, 6uf, 6ls, 6uo, 6ur, 6vc, 6xad, 6zh, 7aek, 7aly, 7ay, 7de, 7dm, 7ls, 7nl, 7oz, 7uj, 7z, 7xt, 8alf, 8aly, 8avl, 8ay, 8bce, 8bch, 8cjp, 8cyl, 8dgl, 8dip, 8er, 8jg, 8pl, 8sf, 8xk, 9akf, 9apm, 9bez, 9bht, 9bpb, 9bpy, 9bwo, 9ccb, 9edv, 9civ, 9evn, 9cxx, 9dac, 9ded, 9dex, 9dfl, 9dpx, 9dwn, 9dzw, 9efs, 9fj, 9hp, 9mn, 9se, 9uc, 9xn, 9yav, 9zt, g2cc, g2lc, g2mm, g2od, g2xy, g5bv, g5dh, g5if, g6kk, g6lj, g6mp, g6rm, g6tm, f8az, f8bf, f8bv, f8co, f8ct, f8eu, f8ec, f8fg, f8gp, f8jv, f8qq, f8sz, f8tok, f8wag, f8was, f1au, f1ay, 1ier, 1irt, 1irt, ssmzy, ssmzs, noba, nobq, nosv, npcuu, b4ra, b4yz, h9ad, e4gt, e4io, e5af, e5go, e5ct, e5gf, m1aa, m1af, m1ax, m1b, m1k, m1x, m9a, mada, bz1ab, bz1ap, bz2sp, chleg, ch2ld, ch2rm, ch9tc, rafi, raf4, rbai, ra8, reb8.

**KUDG. S.S. West Jester, Struthers & Barry,
San Francisco, California
Homeward Voyage: Philippines, China, Japan and
Western Pacific**

Alaska: 7de, rbal, rdh5, rdm9, avjz, a2bb, a2bk, a2cm, a2ds, a2jw, a2io, a2rj, a2sw, a2ws, a2yh, a2yi, a3ad, a3ak, a3ap, a3bd, a3bq, a3ef, a3kb, a3lm, a3yx, a4gd, a5ah, a5bg, a5im, a5ag, a7jb, a9dr, c4gt, f8go, f8ui, hu6xl, hu6ajl, hu6buc, hu6cmh, hu6est, hu6dcf, hlaa, mlaa, m3ym, m9a, z1ao, z1ax, z2ac, z2ae, z2bl, z2br, z2bx, z2he, z3am, z3ao, z4ag, z4as.
Russia: Nrl. Samoa: vmg. 6zac. Tunis: octu.
Turkey: gh. U. S. A.: kfuh, naj, nirj, nkf, nqg, nve, wap, wiz, wqo. 4kn, 4tv, 5atv, 5ft, 5zai, 6ahp, 6ajm, 6ake, 6awt, 6bav, 6bbv, 6bgv, 6bid, 6bjx, 6bq, 6btm, 6bur, 6cgo, 6cgv, 6cms, 6cto, 6ea, 6ec, 6ji, 6nx, 6of, 6rw, 6vc, 6vr, 6wt, 6zh, 6ben, 6eq, 6pl, 6se, 6bvh, 6dmj, 6dng, 6dxr, 6eae, 6eky, 6xn, 6zt.

**p1HR, Lieut. H. P. Roberts, Ft. Wm. McKinley,
Rizal, Philippine Islands**

40 meter band
5atv, 5zai, 5zl, 6aff, 6alv, 6awo, 6aww, 6bcl, 6bhz, 6bil, 6bjx, 6bu, 6bv, 6bv, 6ca, 6cgo, 6cgp, 6cgv, 6chs, 6cmv, 6cnc, 6co, 6cto, 6fca, 6fe, 6bn, 6rx, 6rw, 6ta, 6vc, 6vr, 6xg, 6zac, 7ay, 7it, 7ld, 7zai, a2bb, a2bk, a2cm, a2ds, a2tm, a2xa, a2yi, a3bd, a3bm, a3ef, a3tm, a4ak, a4at, a5ah, a5bg, z1ao, z1ax, z2ae, mlaa, f8tok, fign, chleg, npecm, npr, j1aa, jja, j1ym, jycb, jab, jbn, hu6xl, hu6aff, hu6dcf. Samoan: 6zac. Tahiti: kfuh. Misc: kfvm, kudg and all Pacific Naval Stations.

p3AA, F. Johnson Elser, Baguio, P. I.

a2bb, a2bk, a2sc, a2ds, a2dy, a2ij, a2jw, a2tm, a2ua, a2yh, a2yi, a3aa, a3bd, a3bm, a3bq, a3ef, a3im, a3tm, a3xo, a3yz, a5ah, a5bg, a5da, a5uk, a7dx, z1ao, z1ax, z2ac, z2aq, z2xa, z4ak. Army: 1hr, fx1, vvy, g2lz, f8ak, f8mb, hu6aff, hu6aji, hu6buc, j1aa, jk, ks, ws, ba, (kily). Navy: a6w, a7l, f8z, najd, namg, nedj, nir, nisl, nisl, nsv, npm, npn, npo, app, npu, nrll, numm, nuqg, leur, 2ij, 5agn, 5atv, 5ew, 5nq, 5oz, 5zai, 6afv, 6ajm, 6ake, 6awt, 6bjx, 6bor, 6bg, 6bur, 6cgv, 6chs, 6cj, 6mq, 6cto, 6dai, 6dcf, 6fa, 6vc, 6ws, 6xg, 6zac, 6dng, 6uq. Misc: ane, bx, ghz, hvj, hym, kel, kudg, stb, vis, vjz, vmg, wap, wzd.

**u8ACT at Paris, France
40 meters**

1ab, 1ac, 1ay, 1aao, 1aap, 1aar, 1aay, 1abp, 1ach, 1aci, 1aep, 1ahg, 1ahi, 1air, 1amf, 1ams, 1amu, 1anq, 1apc, 1are, 1arh, 1atv, 1auk, 1axa, 1ayg, 1bbr, 1bfw, 1bhm, 1biz, 1bqi, 1bqk, 1bqz, 1byx, 1bzp, 1ch, 1ck, 1co, 1ckp, 1cmf, 1cmp, 1cmx, 1cre, 1ef, 1ka, 1mk, 1oy, 1pl, 1qm, 1qs, 1rf, 1uw, 1xf, 1zs, 2afn, 2agb, 2agi, 2agq, 2bm, 2bbx, 2bec, 2bkr, 2buc, 2bui, 2bur, 2buy, 2bxj, 2ci, 2cs, 2cpa, 2ctb, 2ctq, 2cty, 2cvj, 2cvu, 2cyw, 2fj, 2ha, 2hv, 2kw, 2mu, 2nf, 2sa, 2wm, 2xb, 2xb, 2afn, 2afq, 2aha, 2apv, 2axq, 3bc, 3bnf, 3bta, 3bwt, 3bz, 3cg, 3ege, 3ckg, 3ju, 3iw, 3li, 3lw, 3oq, 3pa, 3qt, 3rf, 3sa, 4ask, 4cu, 4du, 4er, 4kt, 4oa, 4of, 4rm, 4sh, 4tv, 4ua, 4vr, 4vl, 4xe, 5nj, 5wi, 5ac, 5alf, 5apo, 5aul, 5avl, 5bbp, 5bgn, 5bq, 5caz, 5ccq, 5ccr, 5cic, 5dh, 5dme, 5don, 5dqv, 5eb, 5pl, 5sf, 5uk, 5up, 5aup, 5cdv, 5cax, 5dfq, 5kda, 5kf, 5wp, 5wr, 5wz, 5wp, 5wq, 5wn, 5wg.

**g6LJ, S. K. Lewer, 32 Gascony Ave., London,
N. W. 6, England**

4ask, 4bu, 4cu, 4gw, 4rm, 5ac, 5oq, 6bpg, 6cmd, 6css, 6ji, 7nx, 7uj, 8aa, 8ada, 8afd, 8aly, 8aun, 8aul, 8awa, 8bnn, 8bc, 8caz, 8eb, 8gz, 8jq, 8ll, 8tw, 8tx, 9cwx, 9dmj, 9dr, 9eky, 9xn, nisl, nisp, nism, nsf, nsn, nve, ntt, nkf, elar, c2bg, a2bb, a2bk, a2cs, a2cm, a2ds, a2ij, a2jw, a2io, a2me, a2tm, a2yl, a3ad, a3bd, a3bm, a3bq, a3ef, a3ju, a3kb, a3ld, a3lm, a5ah, a5bg, a5bm, a5ag, a7jb, z1ac, z1ao, z1ax, z2ac, z2ae, z2ap, z2xa, z3al, z3am, z3ao, z4aa, z4ag, z4ak, z4al, z4Ar, z4As, z4Au, z4Av, hzlab, bzlab, bzlau, bz2ap, raf1, rbal, rdm9, beber, ch2id.

**g2BGU, Glasgow, Scotland
35 to 45 meters**

1af, 1ah, 1ay, 1bs, 1ck, 1ef, 1er, 1fh, 1ii, 1my, 1or, 1pl, 1qm, 1uw, 1zs, 1aap, 1abn, 1abp, 1aci, 1aep, 1af1, 1agb, 1agg, 1agp, 1ahl, 1ais, 1aiu, 1ar, 1apu, 1apz, 1are, 1arh, 1arr, 1atg, 1atj, 1atv, 1axa, 1ayg, 1bad, 1bgc, 1bhm, 1bke, 1bqp, 1bqi, 1bus, 1bzp, 1cex, 1cki, 1ekk, 1ckp, 1cmf, 1cmx, 2bw, 2ch, 2cq, 2cs, 2ff, 2fo, 2gk, 2ha, 2ku, 2ld, 2lu, 2mm, 2nj, 2qs, 2ud, 2vc, 2sk, 2zb, 2ac, 2acs, 2adm, 2afn, 2agt, 2agw, 2ahg, 2ahw, 2akb, 2aok, 2apv, 2bee, 2bgi, 2bpb, 2brb, 2brc, 2bse, 2bur, 2buy, 2bxj, 2cgl, 2cnk, 2erc, 2evj, 2cl, 2cyw, 2czf, 2czr, 2xbb, 3jm, 3ju, 3iw, 3ko, 3ot, 3qs, 3qw, 3rf, 3wj, 3zi, 3zm, 3abj, 3afq, 3aha, 3az, 3bhv, 3bva, 3bwj, 3cex, 3ckg, 3cmz, 4cu, 4fm, 4io, 4ki, 4kt, 4mm, 4oj, 4iv, 4rl, 4rz, 4sa, 4tx, 5aqi, 5ac, 5do, 5jd, 5mk, 5ry, 5sf, 5uf, 5zz, 5aul, 5awa, 5ben, 5bgn, 5bhm, 5bhn, 5boy, 5bzu, 5cau, 5djf, 5dip, 5dme, 5don, 5dsm, 5ec, 5za, 9bbj, 9ejy, clam, cled, c9ch, ra8, rbal, q2bv, mlka, chieg, bzlab, nve, wir, wiz, wnp, nkf, nerkl. Cards waiting.

**F. Walker, Crowmarsh, Wallingford, Berks. England
40 meter band**

1ag, 1ad, 1ac, 1au, 1axa, 1ajt, 1alk, 1avw, 1ajp, 1aae, 1azd, 1acx, 1abp, 1air, 1avz, 1aag, 1azr, 1ajg, 1af1, 1aep, 1ahm, 1awe, 1aao, 1abzm, 1bgp, 1bzq, 1bly, 1bv, 1bg, 1bz, 1ch, 1cx, 1ca, 1cmf, 1caw, 1chj, 1ckp, 1cak, 1ere, 1da, 1er, 1ir, 1ii, 1ka, 1kh, 1kn, 1nt, 1pe, 1rr, 1st, 1ie, 1sw, 1uw, 1yb, 2aw, 2ax, 2akb, 2axk, 2acs, 2ahm, 2adm, 2ahw, 2awm, 2arj, 2aga, 2ahe, 2be, 2bo, 2bm, 2buy, 2buc, 2bkr, 2bbl, 2bum, 2brc, 2bir, 2erp, 2cyw, 2chk, 2czk, 2cvj, 2cpa, 2cxl, 2cqi, 2em, 2eg, 2gy, 2ir, 2kr, 2hu, 2mm, 2as, 2u, 3aco, 3anb, 3af, 3bit, 3bc, 3bz, 3br, 3py, 4as, 4ar, 4ask, 4eo, 4fl, 4gt, 4io, 4kc, 4lk, 4mf, 4oa, 4rl, 4sa, 4ur, 5hh, 5uk, 6xg, 7jb, 8awa, 8aoo, 8ayy, 8afk, 8aly, 8aub, 8afr, 8amr, 8bgn, 8bgk, 8bin, 8bop, 8ben, 8bha, 8boy, 8bfe, 8cer, 8caz, 8dvw, 8dg, 8dme, 8dpa, 8dip, 8djq, 8du, 8er, 8eq, 8ev, 8gm, 8jl, 8vl, 8zu, 8zz, 9aot, 9dqu, 9ff, 9ky, 9hk, 9xn, 9zt, wnp, wap, ntt, nsf, nve, nkf, nisl, bzlab, bzlab, bzrgt, ciar, c2fo, c4gt, z1ax, z2ac, z3am, zac, z4ag, z4ar, z4as, z4av, a3bq, a5ah.

**William G. Rose, 46 Trewence Road, Wimbledon,
S. W. 20, London, England**

1aep, 1aci, 1ajg, 1amf, 1ana, 1auc, 1axa, 1bke, 1bvl, 1bzp, 1ch, 1ckj, 1cln, 1cmf, 1dm, 1ef, 1er, 1ev, 1fd, 1hn, 1my, 1qb, 1rq, 1yb, 2ahk, 2ahm, 2akb, 2bec, 2bkr, 2bui, 2bum, 2buy, 2ebr, 2egj, 2eth, 2erb, 2cvj, 2cxl, 2kg, 2mm, 2qs, 2zb, 3aha, 3as, 3bta, 3cel, 3chg, 4io, 4jr, 4kt, 4mf, 4oa, 4rl, 4rs, 4tv, 4ur, 4us, 7jb, 8ada, 8alc, 8ben, 8boy, 8caz, 8dip, 8mc, 8sf, 8zu, 9adt, 9xn, c2ax, c2be, c2fo, bzlab, bzlab, bz2sp, bzrgt, raf1, a2bb, a2bk, a2cm, a2yi, a2tm, a3ak, a3bd, a3bq, a3ef, a3im, a5bg, a2ac, z4ag, z4ar, z4as. Misc: csokl, nve, ntt, ane, wap, wir, wqd, wqn, wqo.

**Leslie H. Fitzgibbon, 38 Trewence Road,
Wimbledon, England**

1aac, 1aal, 1abf, 1abs, 1aea, 1ael, 1afe, 1agh, 1aid, 1aja, 1ajg, 1ajw, 1akk, 1alk, 1alw, 1amf, 1ana, 1anr, 1aos, 1aqa, 1aqm, 1ary, 1atj, 1atq, 1axi, 1axz, 1ayl, 1bal, 1ban, 1bds, 1bdt, 1bdx, 1bes, 1bqq, 1bhm, 1bjo, 1blb, 1bnt, 1bpb, 1brm, 1br, 1bvl, 1caf, 1cak, 1chc, 1cit, 1ck, 1ckp, 1eme, 1erc, 1eru, 1da, 1ef, 1ez, 1fd, 1fg, 1ga, 1hn, 1ii, 1je, 1kc, 1kx, 1lw, 1mc, 1my, 1ow, 1pc, 1qh, 1qv, 1rp, 1se, 1sf, 1sz, 1vj, 1wi, 1xam, 1xq, 1xar, 1xav, 1xax, 1xj, 1xu, 1xw, 1zad, 1za, 2abd, 2abt, 2ady, 2afp, 2agb, 2agd, 2agw, 2aho, 2awf, 2axf, 2azy, 2bnn, 2bbx, 2bkg, 2blb, 2blm, 2bm, 2bqu, 2br, 2brb, 2bc, 2bsl, 2by, 2byw, 2cbg, 2ccg, 2cdg, 2ce, 2cee, 2cel, 2cfa, 2cgl, 2chg, 2cjb, 2cpa, 2pk, 2erp, 2ety, 2evf, 2evj, 2cyw, 2cxl, 2cxw, 2dx, 2em, 2fk, 2gk, 2ku, 2kx, 2le, 2me, 2mo, 2pd, 2rk, 2ud, 2wr, 2xla, 2zb, 3adb, 3adg, 3adv, 3aic, 3aik, 3ajd, 3anj, 3bco, 3bhv, 3bng, 3bqp, 3bss, 3bwj, 3bwt, 3ca, 3chl, 3cfn, 3cdp, 3cf, 3che, 3chg, 3chh, 3cjin, 3hg, 3hh, 3jo, 3lg, 3mb, 3me, 3mf, 3og, 3oq, 3ot, 3qv, 3sf, 3vw, 3wb, 3we, 3xc, 3yo, 4do, 4eg, 4eq, 4gw, 4io, 4js, 4kt, 4mb, 4my, 4oa, 4om, 4pk, 4tl, 4td, 4tw, 4uk, 4ve, 5ajg, 5cn, 5dw, 5hl, 5lh, 5os, 5uk, 5ad, 5adg, 5aly, 5ame, 5bhd, 5ebp, 5cca, 5ci, 5cie, 5cse, 5csj, 5dgl, 5dgo, 5dnf, 5do, 5fm, 5gz, 5kl, 5pl, 5tr, 5uf, 5up, 5vq, 5wo, 5wp, 5bcj, 5cap, 5cjc, 5dmj, 5dqu,

Communications

The Publishers of QST assume no responsibility for statements made herein by correspondents



Crystal Control

"Bellevue", Anacostia, D. C.

Editor, QST:—

Referring to the article "Crystal Control for Amateur Transmitters" in the November issue of QST, kindly accept the following explanation of the way by which a crystal controls the crystal oscillating circuit.

With the tuned plate circuit which you describe wherein the crystal is connected between filament and grid, the crystal circuit will only oscillate when the reactance of the plate circuit is of an inductive nature; in other words, the radio frequency current in

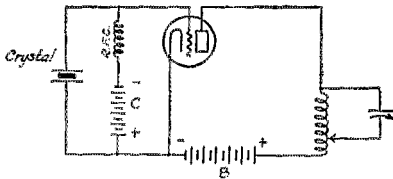

the closed circuit will gradually increase in value until the point is reached which is slightly below the wavelength of the crystal. As soon as the closed circuit is tuned to exact resonance to that of the crystal, the circuit stops oscillating by virtue of the fact that the plate circuit is now a resistance of a very high value. On tuning the circuit further by increasing the capacity, the plate circuit assumes a capacitive reactance value which does not permit the generation of oscillations in the circuit. In other words, the plate circuit is a parallel circuit which can assume an inductive or capacitive reactance value and in addition when tuned to resonance with the crystal it becomes a resistance. It may be stated that the crystal itself, when functioning as an oscillator acts like a very large inductance with a small capacity in series with it. In other words, the characteristics of the circuit are similar to the well-known self-oscillating circuits which require the proper phase relationship between grid and plate circuits to produce oscillations.

—A. Hoyt Taylor, Superintendent,
Radio Division, Naval Laboratory.

Shunted Thermo-Couple Meters

Chicago, Ill.

Editor, QST:—

In a number of recent technical papers the writer has noted a tendency in the use of

instruments which not only seems entirely unwarranted, but definitely wrong. I refer to the use of a shunted thermo couple galvanometer. Most of these authors state quite specifically that they do not care about absolute values of current, hence the fact that the shunting effect may vary with frequency does not bother them. Neither does it bother me. But there are other factors coming in which perhaps have never been brought to the attention of our scientific friends.

A thermo couple galvanometer is built essentially for high current-sensitivity. One popular instrument has a full scale deflection of 115 milliamperes and an internal resistance of 4.5 ohms. This gives a drop across the instrument itself of 517.5 millivolts full scale. Now, regardless of the shunt that is soldered across the studs of the meter it still takes 517.5 millivolts to give full scale deflection, so that if we shunt the thing way down, we may have a case where we are drawing 5 amperes in the circuit and there is a drop across the meter of 517.5 millivolts to move the pointer to full scale. For comparison take a standard 5 ampere meter of the thermo couple type, which, as in the previous case takes 5 amperes for full scale deflection. On testing several of these meters, I find that the average millivolts drop across their terminals will only run 194 millivolts, or some 37% of the previous case.

From the above it can be seen that using the galvanometer has introduced considerably more resistance into the circuit than in the case of the standard 5 ampere instrument, and resistance, of course, is what we wish to remove, or at least, keep as low as possible in order that resonance points be kept sharp. Many of these tests are also to determine resistance in other parts of the circuit, and an increased resistance in the indicator simply reduces the accuracy of our measurements. Therefore, instead of taking a relatively high resistance instrument which is sensitive to current and then shunting it down until the current sensitivity is reduced, why not use an ordinary 3 or 5 ampere thermo couple meter for the job? The latter is considerably cheaper, a lot more rugged, more accurate as to following a perfect square law and will introduce considerably lower losses into the circuit for a given amount of current.

It might also be mentioned that if such a relatively heavy current as 5 amperes is

used in a measuring circuit, a special instrument could readily be constructed which would have even a lower resistance than those mentioned above, whereas in the case of the galvanometer, the resistance cannot be reduced very greatly.

Perhaps this practice of shunting down a thermo couple galvanometer has persisted merely because such laboratories have this type of instrument on their shelves in quantity. But we really cannot see why there is not something definitely lost in shunting such an instrument as opposed to using a standard instrument built for heavier current.

—John H. Miller,
Jewell Electrical Instrument Co.

Receiver Dead Spots

Miami, Florida.

Editor, *QST*:—

When changing my transmitter and receiver to the shorter waves I have encountered some problems and phenomena which may help some of the gang who are stumped. First, when I changed my receiver to 40 meters I was confronted with several bad dead spots which I immediately laid to the antenna. I took off the antenna and two of the dead spots disappeared, but one persisted in spite of everything. After considering every possible source I lit upon the choke coil and found that a harmonic of its natural frequency caused the dead spot. I had about 150 turns as per many instructions on the subject and I took off 100 and the dead spot departed. Next I wanted to go to 20 meters and there again I found a regiment of dead spots. I eliminated some by detuning the antenna again but there was one spot that simply would not move away. I laid it to the choke again and took off some more turns. The result—the dead spot just shifted around a bit. Finally I took out a metal base 201-A tube and put in a bakelite base tube in place as a detector and the dead spot quietly died.

—E. G. Watts, Jr., *AFM*

More Harmonic Operation

Devon, England.

Editor, *QST*:—

In a letter in the September issue of *QST* SZE states that he considers that satisfactory operation on a harmonic of the antenna is governed by the position of the voltage node. I should like to say that his theory as to leaks at insulation points is rather strikingly borne out by my own experimental results. Using an artificial antenna I found that in all cases the 1st and 3rd harmonics gave better results than the 2nd and 4th. Beyond this the difference was not so marked and on harmonics above the 7th and 8th no difference could be de-

tected. This was probably due to the unavoidable presence of a large amount of solid dielectric in the artificial antenna, resulting in leaks at one or more of the increased number of voltage nodes.

I hope to shortly continue these experiments using an open antenna, the distance of probable leak points being known, thus making possible the expansion of the above results. I shall be very glad to communicate with other experimenters interested in this type of investigation.

—John W. Barrett, *g2BBM*

Counterpoise vs Ground Reception

Santa Ana, Calif.

Editor, *QST*:

I would like to call your attention to certain conditions prevailing at my station. At present I am on the forty meter band with a straight three circuit tuner and one stage of audio frequency amplification. It seems to work as well as the majority of receivers so well enough for that. Now the point I want to raise is this: When using a counterpoise at night my reception is improved fully 100 per cent over what it is with a ground. By changing to ground in daylight the results are again brought up to par. NRRL, NVE, NKF and many others come in excellently with the counterpoise although while I use a ground I cannot possibly hear them. While in broad daylight reception is perfect with a ground connection. I have heard 9's and 7's here at 12:30 and 1 P. M. P. S. T. The ground seems to work OK until the sun has set and then the counterpoise seems to be much better. The question probably arises that my ground is poorly constructed or such but I have found that my ground is as good as they make them. Have any of you fellows ever tried to test your ground by substituting it for the ground side of your 110 volt lighting power? This works beyond any doubt. The 110 line is supposed to be the best of course. After substituting your own ground for that of the power lines, you can tell by the brilliancy of the lamp in the line whether or not the ground is effective. If a line voltmeter is handy it can be used to tell whether the voltage has dropped or not when the various grounds are tried.

If any of the hams have met with a similar condition I would be glad to carry on correspondence and exchange results on further tests. The counterpoise used in making these tests is entirely out of the field of the receiving antenna. In fact, it proves that it does not make very much difference whether it is directly under the antenna or not. I have never tried this experiment on any other wave lengths except the forty meter band.

—George D. Sackman, *6LA*

Filters and the Motor-Generator

By Melvin J. Cramer, 2BGI

THE smoothing out of the ripples and commutator hum of a Motor-Generator or M.G. is not such a difficult proposition if one has a few parts that go to make up a filter. In the past we have had some very excellent articles on filters. I will not attempt to go into the theory and more technical side of filters but rather give some practical uses of them. To obtain the proper results, these filters must be arranged intelligently. I wish to impress upon the readers and users the importance of isolating the R.F. currents from the plate supply, especially the commutator of a M.G. A perfectly good filter can do more harm, and cause more trouble, than no filter at all, if it is not properly used.

In the course of a few experiments I found some of the following methods effective, and real good pure D.C. was obtained.

In Fig. 1, a familiar hook-up is given with series feed. This arrangement produced fine I.C.W. from a D.C. generator and aroused the wrath of the neighborhood. No semblance of a C.W. note could be found. The arrangement shown at figure 1_b was then tried. A C.W. note was obtained but a very bad hum carried with it, making it possible to get C.W. or I.C.W. according to the way the signal was tuned in. A choke smaller than 15 henries had little or no effect. Fig. 1_c was next in order. The Brute-Force Filter is used in this hook-up. An excellent D.C. note was obtained but a very bad hum still existed. At Fig. 1_d I made a radical departure. The results obtained were most gratifying. A 200-turn R.F. choke was placed in the positive side, and another in the negative side, close to the by-pass condenser. The action of this arrangement is what prompted me to write this article. I believe this to be the most simple and effective filter that anyone could use with a generator. It shows the importance of isolating the R.F. currents from the commutators. Look again at Fig. 1. Most of us are familiar with the use of an absorption loop for modulation by fone. A similar action takes place in the M.G. Regardless of the fact that a by-pass condenser is used, a certain amount of R.F. current reaches the commutator, and modulation develops enough to break up the pure C.W. There are a number of paths for leakage and absorption. The most evident is the capacity between counterpoise and ground via the usually 110-V. A.C. power supply, also through the plate-filament capacity via the filament transformer, etc. Any interruption in these leakage paths will cause undesirable results for a pure

C.W. wave with D.C. plate supply. At figure 1_b, a small amount of current could find its way into the commutator, the same as it did at figure 1_a, but due to the presence

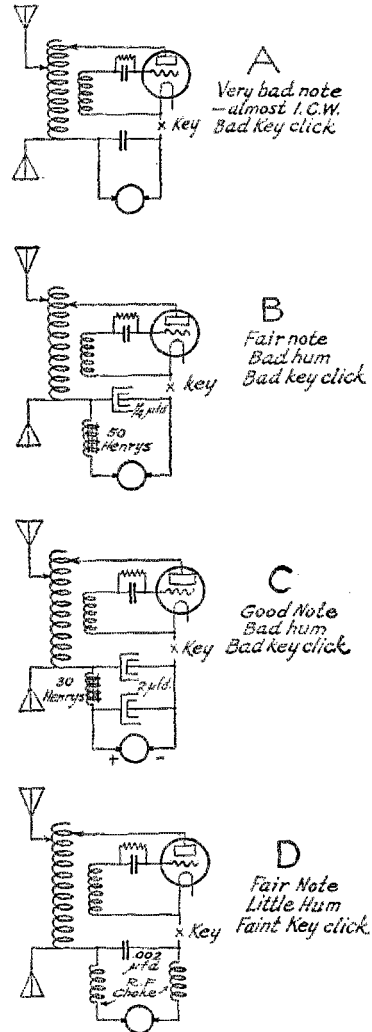

FIG. 1 THE SERIES FEED TEST CIRCUIT

of the 50 henry choke, the major part will follow the counterpoise-to-ground-via-the-110 route. To prove this fact, after figure 1_b had been tried, I placed R.F. chokes in the 110-V. A.C. line to the M.G. and the

major portion of the hum was cut out, leaving a small hum which I assumed followed the plate-filament capacity, via the filament transformer. The action at 1_c was much the same as at 1_b. At figure 1_d the major troubles were corrected to such an extent that one need not have to worry about getting the proper results. The use of an R.F. Choke was applied to various types of filters, making all of them more or less successful.

It was found that an iron core choke impeded the flow of R.F. current somewhat but not enough. This is due to the fact that the winding is concentrated and, hence,

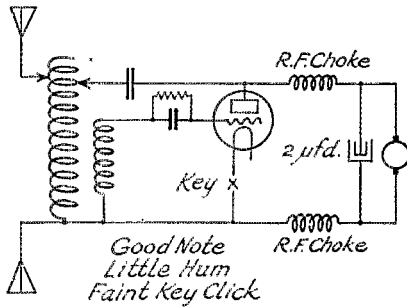

FIG. 2 THE FIRST SHUNT-FEED CIRCUIT

will by-pass an appreciable amount of R.F. The use of R.F. chokes prevented this trouble. The series feed circuit was changed to shunt, and more experiments were made.

In Fig. 2 a two microfarad condenser was connected across the plate supply. This proved advantageous for telephone work, altho not absolutely necessary for C.W. signaling. Two to twenty microfarads were tried but no better results were obtained. Attention was then turned to key clicks. As I consider it is a part of the job for filters to take care of I will say a few words about it. It will be noted the keying has been done in the center tap of the filament transformer, which is considered very bad practice these days. Using the hook-up at figure 1_a the keying click was negligible. However, the addition of an iron core choke or a condenser multiplied this click many times, making it a nuisance. So a method of keying, given in QST, was put into use and most excellent results are obtained, in fact the neighbors hardly know that I am on the air when using C.W.

It has been found bad practice to use an iron core choke any larger than 6 Henrys with a M.G. In the first place it makes keying more difficult and dangerous, and in the second place it has a habit of cutting down the voltage. The transients set up in the circuit were much more pronounced and sometimes caused arcs in the

stem of the tube, which is detrimental to their life. With the choke out it was possible to use every bit of energy generated on the plates of the tubes. Inasmuch as the M.G. used in most of these tests was rated at 250 watts and 2 50-watt tubes were used, it was desirous to obtain every bit of energy on the plate.

The hook-up at Fig. 3 is now in use at this station, and the purity of the note can be testified to by the excellent reports received.

The R. F. Coils

A few words on R.F. choke coil will not be amiss. Those in use at the present time consist of 200 turns of No. 26 D.C.C. wire on a 3 inch tube. They answered the purpose admirably well for all work below 200 meters. I would advise staggering the tube with as many holes as possible to reduce the dielectric losses, or wind those coils on an octagon shaped frame with narrow strips of wood or hard rubber. This sort of coil proves its worth more on the lower wave lengths. I would not recommend tuning choke coils with a variable condenser because the dielectric losses are sufficient to by-pass R.F. currents, and defeat the original purpose. *By no means use a honey-comb coil or any other concentrated inductances for this purpose.* Many unknown troubles have been traced to their use. The number of turns has a little effect on the steadiness of the wave. The best results, however, seem to be with a coil having a greater choking action on the working wave.

The Commutator and Brushes

Another source of trouble in filtering lies in the commutation. On a good M.G. there should not be any great amount of sparking, even at full load. At the least no arcing should be allowed. Bad sparking is usually due to improper seating of

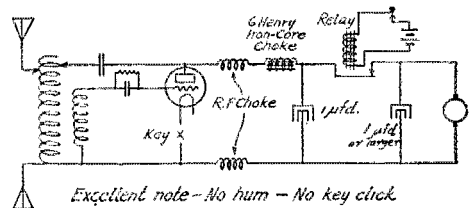

FIG 3 THE FINAL CIRCUIT

NOTE See p 39-41 July QST for relay arrangement.

the brushes. A good way to properly seat these brushes is to take them out and then bend a strip of the finest of sandpaper around the commutator, holding it there with the fingers or put a little glue on the ends and let it stick. Place the brushes back into their proper positions, then rock the armature back and forth until the brush is ground down. *Warning—do not*

run the M.G. but turn it by hand. The brushes are not seated exactly but are so near the desired shape that a few minutes of operation will put them in the right condition. Arcing is usually due to a rough surface on the commutator. If the M.G. has been used for some time and this trouble occurs, take it out and go to a good machinist and have him turn down the commutator on a lathe. Loose particles of carbon coming off the edge of a brush also cause arcs. This can be fixed up by running a nail file along the edge of the brush until it becomes straight again. A good clean cut commutator takes the little bumps out of an otherwise good pure note. The trouble of keeping the brush and commutators in good shape is well worth while.

Another thing noted was the frequency of commutation. The M.G. in use at this station consisted of 68 bars in the commutator, driven at 3450 R.P.M. The frequency of commutation is 400 cycles at a normal load. The frequency changes with the speed and number of bars in the commutator. Generally a machine with a higher frequency of commutation required less filter than one of a lower frequency. Especial note can be taken of the Dynamotors used by the U.S. Navy and the U.S. Army Signal Corps. All of the machines of this type are very high speed with a goodly number of commutator bars. Some of these machines attain a speed of 6000 R.P.M. They are quite easy to filter.

It is not considered advisable to push the machine over its limit as an overload causes too great a drop in voltage, putting a lilt on the note. This is more noticeable in Dynamotors. However, it is not bad with a good induction motor driving the generator, if it is working within its rated horsepower.

I most earnestly recommend the use of the thump filter described by 2XQ on page 41 of July, 1924, QST. A similar arrangement is shown in figure 3. With a little good judgment, they can be arranged to work properly in any form of circuit.

RADIO OPERATORS WANTED

Radio Operators are needed on board ships sailing for Europe, The Orient, Africa, South America, etc. THE EASTERN RADIO INSTITUTE can train you quickly and thoroughly because:

MODERN and EFFICIENT METHODS
THOROUGH yet Simple INSTRUCTION
New and UP-TO-DATE APPARATUS
THIRTEEN Years a RADIO SCHOOL

The OLDEST, LARGEST, and MOST SUCCESSFUL school in New England. RECOMMENDED BY THE A. R. R. L.

Day or Evening Classes Start Every Monday.

Write for Illustrated Prospectus

EASTERN RADIO INSTITUTE

899 BOYLSTON STREET
BOSTON, MASS.

AMERICA DEMANDS MILLIONS

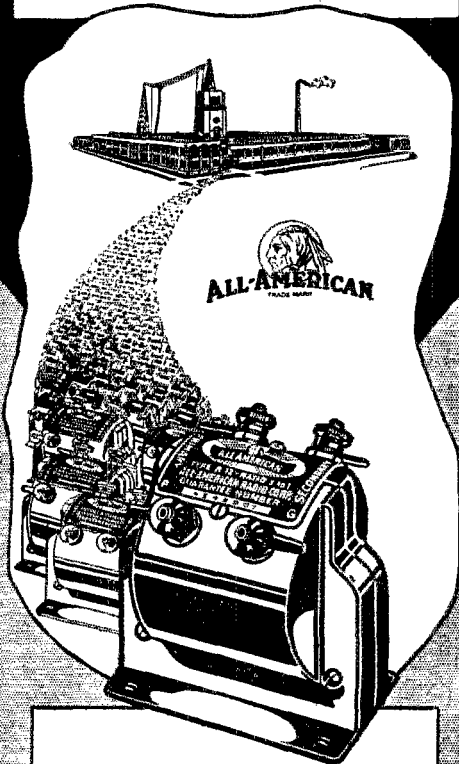

Year after year the supreme high precision quality of ALL-AMERICANS is demonstrated by their continued leadership —

Largest Selling Transformers in the World

ALL-AMERICAN RADIC CORP.

E. N. RAULAND, President

4205 Belmont Ave. Chicago

OWNING AND OPERATING
STATION WENR — 266 METERS

ALL-AMERICAN
Pioneers in the Radio Industry

ASK ANY RADIO ENGINEER

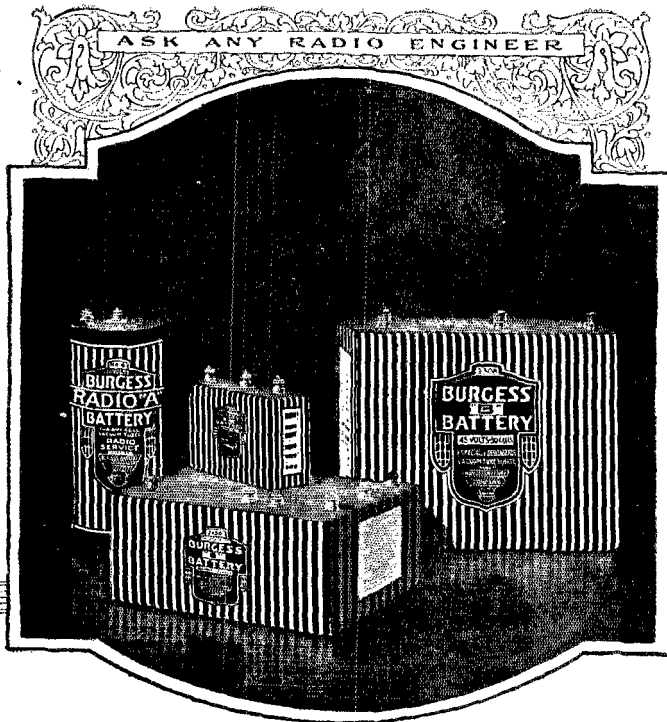

Contributors to your radio entertainment

VERY probably hidden away in the cabinet of your receiving set, the batteries you use are nevertheless surrendering their power unseen and unheard.

And to be able to contribute their energy and to add to the complete efficiency of your receiving equipment, those batteries must combine every desirable factor and formula known in the electro-chemical field.

Such Batteries are Burgess—products of the Burgess Laboratories—products which have been used by practically every famous explorer, the majority of amateurs and the leading radio engineers.

That's why when you use Burgess Radio 'A,' 'B' and 'C' Batteries you are using batteries which assure the utmost dependability, longer life and complete satisfaction.

BURGESS BATTERY COMPANY

GENERAL SALES OFFICE: CHICAGO

Canadian Factories and Offices: Niagara Falls and Winnipeg

BURGESS RADIO BATTERIES

SAY YOU SAW IT IN QST—IT IDENTIFIES YOU AND HELPS QST

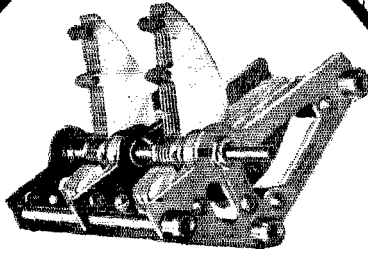

Made under Hogan Patent No. 1,014,002, Jan. 9, 1912

U. S. Tool Straight Line Frequency Condensers

Combine the utmost in Selectivity with simplicity and ease in tuning.

For sharp tuning and dependable accuracy ask your dealer for the U. S. Tool Straight Line Frequency Condenser—and accept no other.

Made by the largest makers of quality condensers with whom the manufacture of fine condensers is an art.

Write for Booklet

U. S. TOOL COMPANY
AMPERE
New Jersey

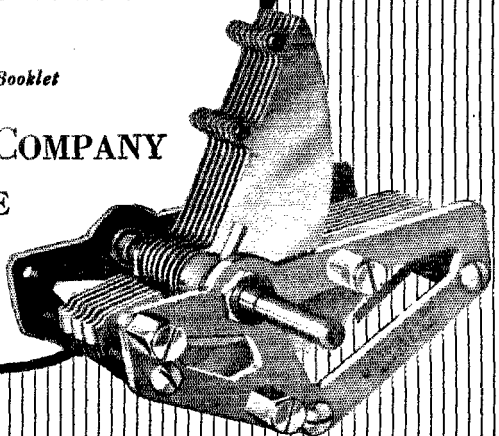

AMERTRAN
TRADE MARK REG. U.S. PAT. OFF.
DE LUXE

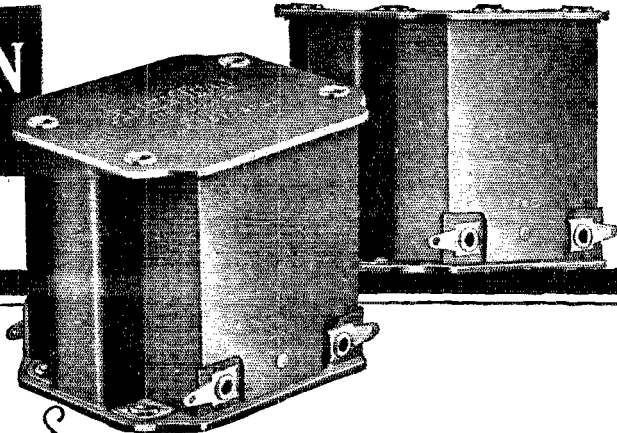

AMERTRAN
Types AF-7 and AF-6

AmerTran audio transformers Types AF-7 and AF-6 have been considered for years among the leaders in audio amplification. These popular and efficient models may now be purchased at a considerable saving in cost. Types AF-7 (ratio 3 $\frac{1}{2}$:1)—AF-6 (ratio 5:1) \$3.00 each

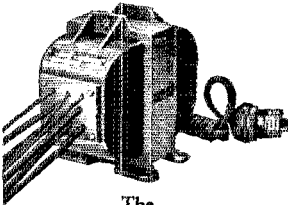

The
AMERTRAN Power Transformer

Type PF-45, 55 *Va-out* cycles 110 volts
primary, 450-480-510 secondary

Type PF-45 is intended for use on the standard 110 volt, 60 cycle house lighting circuit. It has three separate well-insulated secondary windings. These are enclosed in a strong metal case provided with mounting feet. The secondary leads are standard code flexible wires left long enough to reach the terminals in the average set without splicing. This transformer is well suited for supplying AC power for filter circuits, and is designed with the usual margin of safety. \$15.00 each

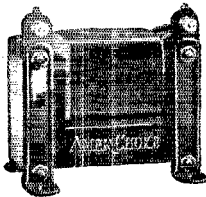

The New **AMERCHOK**
Type 854

Type 854 is a scientifically designed impedance or choke coil of general utility, designed primarily for use in filter circuits. As an output impedance for by-passing direct current from the loudspeaker it is just as efficient and more economical than an output transformer. When used with a 1 mfd. (or greater) fixed condenser, the tone quality equals that of the best output transformer. DC saturation is prevented by two adjustable butt joints in the core. \$6.00 each

A New Standard of Excellence in Audio Amplification

THIS new audio transformer has been developed for those who are satisfied only with the utmost in quality. It possesses an unusually straight line frequency characteristic extending the range below the lowest note now being broadcast, and actually shows a gain of about three octaves below that previously obtained.

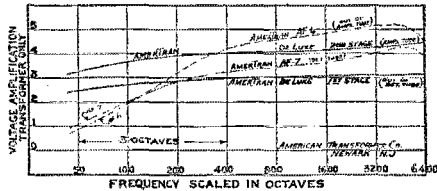

The AmerTran De Luxe is a transformer of moderate size and weight, enclosed in a strong metal case with mounting holes at both top and bottom so that it may be inverted, affording simplified connections. While the AmerTran De Luxe will improve any set, appreciation of its uniform amplifying qualities can best be realized when operated in conjunction with straight line frequency loudspeakers, such as the best cone and disc types, and with a tube in the last stage capable of handling the output.

The AmerTran De Luxe is made in two types, one for the first stage and one for the second stage, and plainly marked as such. The chief difference between these two types is that the first stage transformer has approximately 50% greater primary inductance than the second stage transformer, thus more nearly corresponding to the operating impedances of the tubes out of which they work. For this reason it is advisable to purchase and operate these transformers by the pair!

PRICE, EITHER TYPE, \$10.00

Write for descriptive booklet on AMERTRAN Radio Products

American Transformer Company

178 Emmet Street, Newark, N. J.

"Transformer builders for over twenty-four years"

**SOLD ONLY AT
AUTHORIZED AMERTRAN DEALERS**

Send for this RADIO 1926 Catalog of RADIO BARGAINS Save 1/3 to 1/2

The World's Largest Exclusive Radio Mail Order House Will Send You This Wonderful Book FREE



AMERICAN RADYNOLA 5 TUBE SET

\$29.50

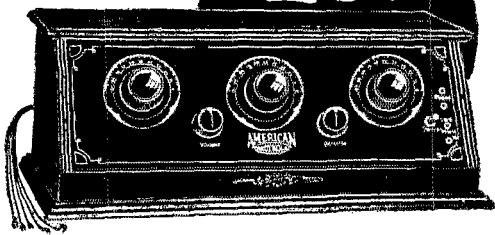

64 illustrated pages containing thousands of bargains in radio sets, semi-finished sets and radio kits of all styles, sizes and approved circuits. **5-tube sets as low as \$29.50.** Beautiful models of the very latest designs and types. Elaborate console models with loud speakers built right in cabinets of genuine mahogany and walnut. **All sets guaranteed.** Coast to coast receiving range. Also contains everything in radio supplies, including batteries, chargers, loud speakers, transformers, condensers, rheostats and any other parts you may want for improving your set or building a new one. **Guaranteed saving to you of 1/3 to 1/2.**

The Biggest 5-Tube Value on the Market

Positively the world's greatest 5-tube radio bargains. **Regular \$75.00 value.** Our large quantity production enables us to sell this set for **only \$29.50**, fully built and wired in beautiful mahogany cabinet of latest design with sloping Bakelite panel of Satin finish, handsomely etched and engraved as illustrated. Constructed of the finest low-loss condensers, coils and sockets. Bakelite baseboard panel and dials. **Price for set only \$29.50** Transportation charges extra, shipping weight 25 lbs.

This set with all accessories, including the famous American Bell loud speaker with adjustable unit, 2-45 volt "B" batteries, one guaranteed 100 Ampers Hour storage "A" battery, cable for battery connection, 8-201A tubes, Aerial and ground equipment, and everything complete ready to set up and operate. Nothing else to buy. Price \$59.75 Transportation charges extra. Shipping weight 100 lbs.

Order Direct from This Page! Save About One-Half!

Order direct from this page. Save 1/4 to 1/2. Our guarantee protects you. Money cheerfully refunded if you are not satisfied. Write your order and prices plainly. Send post office money order or bank draft for full amount to insure safety. Refer to any bank or commercial agency regarding our reliability.

SEMI-FINISHED 5-TUBE RADIO FREQUENCY SET

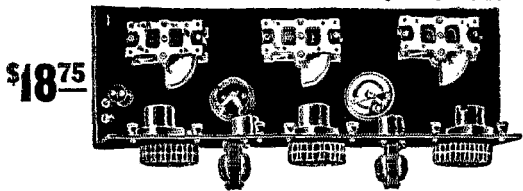

\$18.75

This special offer is astounding the radio world. **Coast to coast reception on loud speaker.** Low loss condensers and sockets. Highest quality transformers. Bakelite rheostats. All wiring concealed under Bakelite baseboard. 7x13 panel—fits into any standard 7 x 13 cabinet. Complete instructions for wiring. **Guaranteed saving to you of \$50.00. Price of set all mounted, \$18.75.** Cabinet of same model as American Radynola pictured above \$5.65 extra.

You must have our catalog no matter what set or kit you want. Our line is complete and includes all popular sets, such as Super-heterodyne, Neutrodyne, Ultradyne, Reinartz, Regenerative, Radio Frequency, Browning-Drake, Super-Heterodyne Reflex and all other latest circuits. Kits, sets and parts manufactured by all well known manufacturers such as Frost, Howard, Baldwin, Brandes, Western Electric, Columbia and others.

Our semi-finished sets come with all parts mounted on panel and baseboard ready for wiring. Do not fail to send for our catalog. Remember—we are the largest exclusive radio mail order dealers in the world and carry the best of everything in radio. We save you 1/3 to 1/2 on the following kits. Detailed descriptions appear in our catalog.

SEMI-FINISHED 8-TUBE SUPER-HETERODYNE

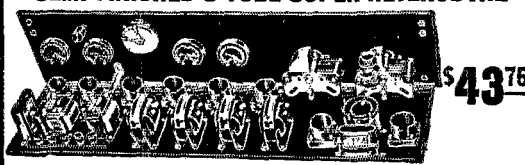

\$43.75

World's Famous 8-tube superheterodyne. Fully mounted on panel and baseboard. Comes **completely assembled** ready to wire and operate. We have testimonials from thousands of builders of this set. Some have received foreign stations on loop aerial. Unsurpassed in volume and tone quality. Low-loss straight line frequency condensers, vernier dials, finest quality rheostats. Matched Columbia long waved transformers. Requires only three screws for attaching panel and baseboard and set is ready to operate. 7x30 panel. **Price of set only \$43.75.** Requires following accessories to complete this set: 7x30 cabinet, 8-201A tubes for storage battery operation or No. 190 tubes for dry cell operation. 100 Ampere hour storage battery, 2-45 V "B" batteries, loud speaker, center tapped loop aerial. All these items are listed in our catalog at a tremendous saving.

Complete Parts for Best 45 Kilocycle Super-Heterodyne Genuine Remler Parts \$49.50

Catalog includes list of broadcasting stations, general radio information and facts about our free service division. Write for it today.

NEUTRODYNE
Genuine licensed Neutrodyne kit of parts, come fully assembled on the panel and baseboard with complete instructions, **\$29.75** ready to wire. Price.

COCKADAY
3-tube Cockaday kit of parts, fully assembled on panel and baseboard, ready to wire **\$15.85** Price.

LOW LOSS SHORT WAVE
8-tube set—25 to 100 meters. Fully assembled on panel and baseboard, ready to wire. **\$19.80** Price.

Browning-Drake 4-Tube Kit Complete \$32.40

RANDOLPH RADIO CORPORATION

159 N. Union Ave. Dept. 186 Chicago, Illinois

Pacent

Engineering Achievements

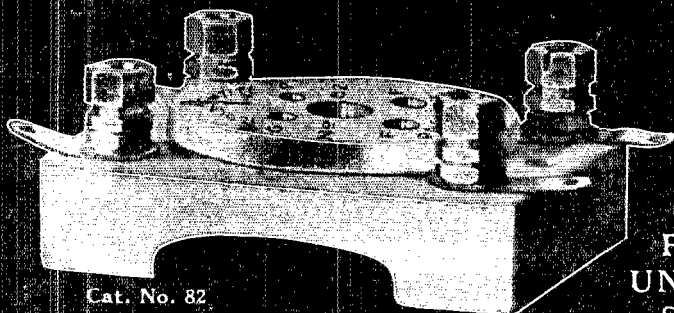

Cat. No. 82
Price, 60c

PACENT
UNIVERSAL
SOCKET

Dependable!

No need to worry over types of tubes now. Try this ISOLANTITE Universal in your hook-up and use them all—the new X as well as the old standard 201A and 301A. It will put pep in your short wave work too.

A real 3½ to 1 transformer with an exceptionally high degree of amplification over the entire band of sound frequencies.

No high peaks. Small and unique in appearance. Binding posts at the bottom for easy soldering.

Get them from your dealer.

Our latest catalog will be mailed on request.



PACENT
IMPROVED AUDIOFORMER
Cat. No. 26 Price, \$5.00



PACENT ELECTRIC COMPANY, Inc.
91 Seventh Avenue, New York City

Washington
Birmingham
Detroit
Buffalo
Chicago
Jacksonville

Pacent

RADIO ESSENTIALS

San Francisco
St. Louis
Philadelphia
Minneapolis
Pittsburgh
Boston

Canadian Licensed Manufacturers: White Radio Limited, Hamilton, Ont.

DONT IMPROVISE - PACENTIZE

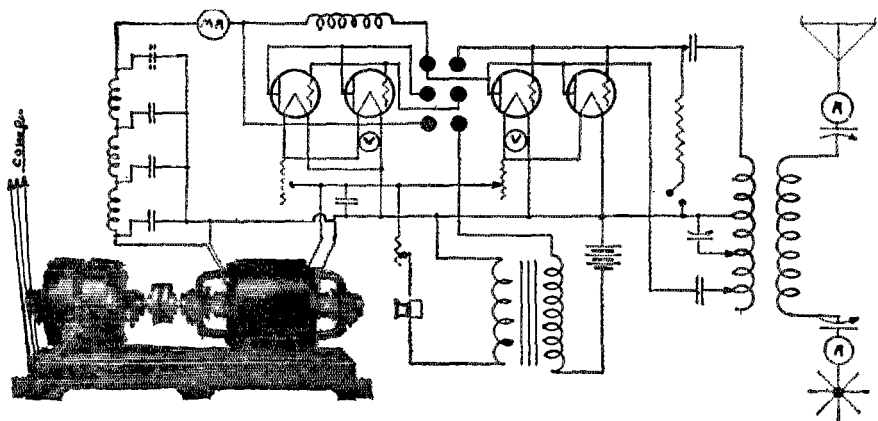

Item No. 37—Supplying 4-50 watt tubes in a telegraph and telephone circuit makes a good reliable “DX” set. Generator is 1000 volts, 600 watts —12 volts, 300 watts. Motor single phase, polyphase or direct current supplied to suit customers requirements.

“Esco” is the pioneer in designing, developing and producing Generators, Motor-Generators, Dynamotors and Rotary Converters for all Radio Purposes

HOW CAN “ESCO” SERVE YOU?

ELECTRIC SPECIALTY COMPANY

225 South St.

TRADE “ESCO” MARK

Stamford, Conn.

JOYCE BROS.

wonder cell!

Replaces Dry Cells

Marvelous, new, patented storage battery. A marked advance in the radio field. Storage efficiency at dry cell cost. Rechargeable from lighting circuit for a few cents. Suitable for different tube voltages 2-4-6 volts, and for transmission as well as reception.

Insist on Wonder Cells at your dealers. For further information write direct to

HELIOS BATTERY CO.
71 Chestnut Street
Boston, Massachusetts

RAJAH SOLDERLESS SNAP TERMINALS

Instantaneous in Operation — Positive Contact. For Panel, Ground and Battery Connections.

Patented—Sept. 23rd, 1924.

The Base Stud is tapped and furnished with 8-32 screws and washer. This fits all “B” Batteries with screw posts.

RAJAH Ground Connection

Used on TUNGAR, RECTIGON, PHILCO and EXIDE.

Terminal, complete, either style15c
Extra Base Studs5c

RAJAH AUTO SUPPLY COMPANY
Bloomfield, New Jersey

The AMSCO ALLOCATING CONDENSER

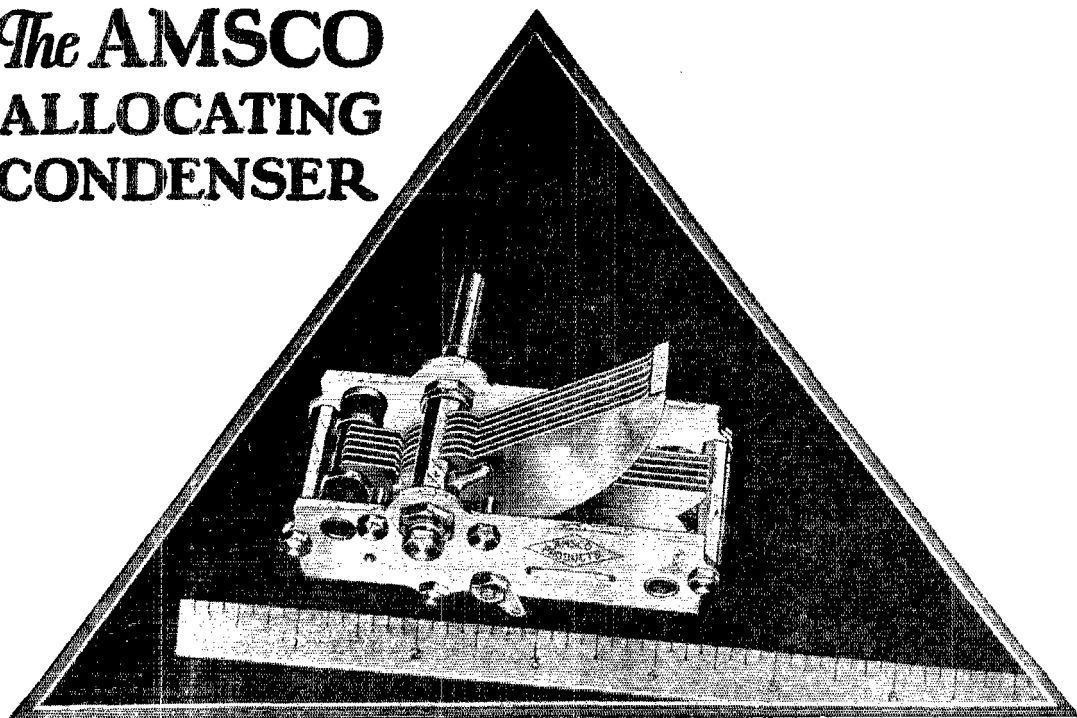

IT SAVES SPACE!

This straight line frequency condenser is a space-saver in the radio cabinet It can usually be substituted for the old type condensers in existing sets Once installed, it revolutionizes your ideas about tuning Those Amsco half-a-heart-shaped plates add Kilocycles at the rate of ten to each dial division—giving “a station for every degree” All wavelengths—high or low on the scale—tune in with equal ease Amsco allocation of the stations is uniform and correct to within a fraction of 1% *Insist on Amsco Allocating Condensers Made in six space-saving models, three Single and three Siamese, at reasonable prices*

Amsco Products, Inc., Dept. C
Broome & Lafayette Sts., N. Y.

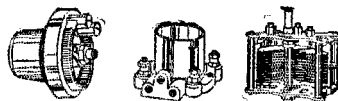

OTHER AMSCO PARTS

Write for our booklet, “The Heart of the Hook-up” for full details and prices of the entire Amsco line. Amsco for Excellence.



Accuracy guaranteed within 10 per cent of marked capacity.

Corrects salt-air troubles

RADIO sets located anywhere near the sea are particularly subject to condenser trouble. Salt air creeps in and causes corrosion. Then comes distortion—if your set will work at all. Don't assume that your condensers are right! Put in Sangamo Mica Condensers—solidly molded in bakelite—and no service can ever change their accuracy.

Sangamo Mica Condensers

Every Sangamo Mica Condenser is separately tested at the factory. If it does not come within very fine limits, it is rejected. You can solder it, boil it, freeze it, or subject it to heavy electrical surges—but the capacity stays exactly the same. The bakelite jacket is impervious, and nothing gets through to the delicate parts inside.

All wide-awake dealers carry Sangamo Mica Condensers or know where to get them for you quickly. Put them in when you build your set and you will never have fixed condenser trouble.



ALSO AVAILABLE
SANGAMO
By-pass Condensers
1 Mfd.—\$1.25
½ Mfd.—.90

Sangamo Electric Company
1421-3 Springfield, Illinois

RADIO DIVISION, 50 Church Street, New York

SALES OFFICES—PRINCIPAL CITIES

For Canada—Sangamo Electric Co. of Canada, Ltd., Toronto.
or Europe—British Sangamo Co., Ponders End, Middlesex, Eng
For Far East—Ashida Engineering Co., Osaka, Japan

SM
SUPER-
PARTS

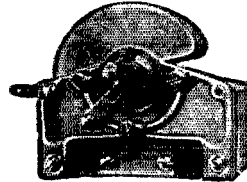

S-M condensers are particularly adapted for short wave operation because of their extremely low dielectric, surface and eddy-current losses. They are available in 250, 350 and 500 M.M.F. sizes, either S.L.F. or S.L.W. types.

The new interchangeable inductances for all waves and purposes—their unwound forms and six-contact sockets—are a real boon to the discriminating amateur.

See them at your dealer's or send stamp for circulars.

Silver-Marshall, Inc.,

105 Q. So. Wabash Ave.,

Chicago

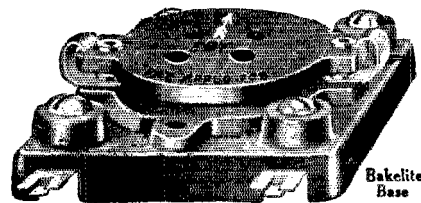

A Positive Contact On A Shock-Absorbing Base

The new EB Y Cushion Sockets make it possible to maintain a positive wiping contact at all times, regardless of the size of the tube prongs or the amount of solder on the prong tips.

By an ingenious shock-absorbing feature these sockets eliminate microphonic noises and are a guarantee against tube damage. EB Y Cushion Sockets give the advantages of interchangeability of the new U. X. Tubes.

Don't take a chance on twenty loose connections in a five tube set. Ask your dealer about EB Y Sockets or write us for complete information.

H. H. EB Y MFG. COMPANY
4710 Stenton Ave., Philadelphia, Pa.
Made by the Makers of EB Y Quality Binding Posts

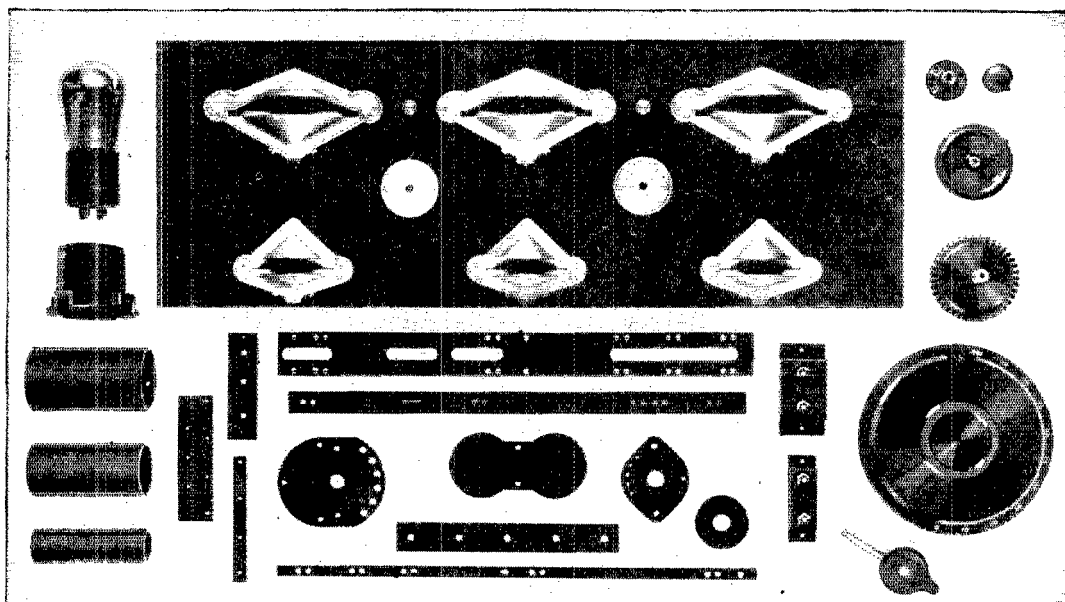

Imagine a Radio Set stripped of these parts

What a useless collection of wood, wire and metal it would be. Realizing that the parts and accessories shown here are wholly or partly of Bakelite, gives you a vivid picture of its importance to Radio.

Today Bakelite is used in a greater variety of radio parts than ever before—and the number grows constantly. This dominance of Bakelite in

radio reflects the experience and the opinions of radio manufacturers, great and small.

Radio set and parts manufacturers have every facility for testing all insulation materials and over 95% have standardized on Bakelite. This indicates how really important it is for you to make sure that the set or parts that you buy are Bakelite insulated.

Write for Booklet 27

BAKELITE CORPORATION

247 Park Avenue, New York, N. Y.
Chicago Office: 636 West 22d Street

Bakelite is an exclusive trade mark and can be used only on products made from materials manufactured by the Bakelite Corporation. It is the only material which may bear this famous mark of excellence.

BAKELITE

REG. U.S. PAT. OFF.

BAKELITE
is the registered trade mark for the phenol resin product manufactured under patents owned by the Bakelite Corporation.

THE MATERIAL OF A THOUSAND USES
SAY YOU SAW IT IN QST—IT IDENTIFIES YOU AND HELPS QST

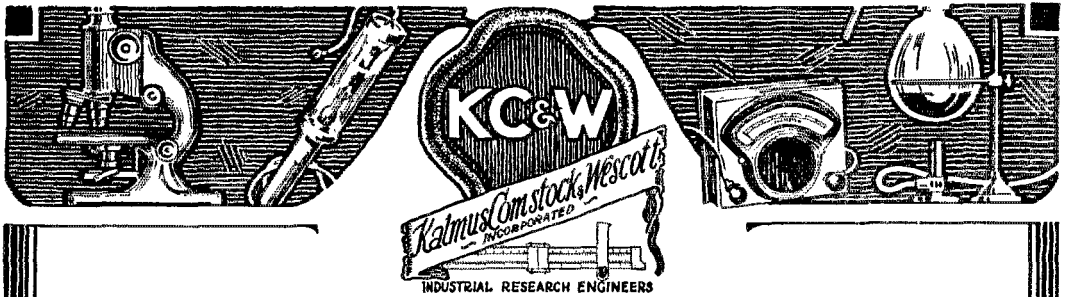

“RESEARCH IS THE KEY TO THE FUTURE OF RADIO”—
says R. E. Renaud in “Popular Radio”.

Radio manufacturers, radio investors and the buying public are beginning to realize the tremendous importance of research work based on science and method.

Large manufacturers maintaining research departments of their own find our services of great value for the solution of problems which arise from time to time outside the more specialized field of their own research departments.

Smaller manufacturers may now have their necessary research work done without the financial burden of maintaining research departments of their own.

A descriptive booklet will be furnished on request.

KALMUS, COMSTOCK & WESCOTT Inc.

110/114 BROOKLINE AVE. *Industrial Research Engineers* BOSTON, MASSACHUSETTS

IT'S A WINNER!

Radio Theory and Operating

By
MARY TEXANNA LOOMIS

The new radio text book. Off the press only a few weeks and already approved and used by the United States Government, leading Radio Colleges, Technical Colleges and Universities. 850 pages, 670 illustrations, flexible red kraft leather binding. Up to the minute and contains much valuable matter never before published in a text book.

Price \$3.50

Postage paid to all parts Canada and United States. If your dealer cannot supply it, send check or money order to

LOOMIS PUBLISHING CO.

Dept. T
 405 9th St. N. W. - Washington, D. C.

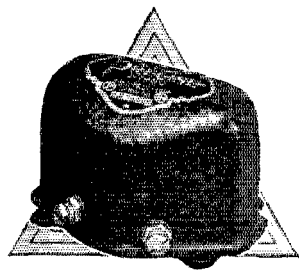

For

**Volume without
Distortion!**

MOST radio receivers have ample volume but few have volume without distortion.

The new Precise Supersize No. 480 Audio Transformer was designed to bring forth with magnificent volume a remarkable range of pure tones.

Mr. James L. McLaughlin, the noted super-heterodyne authority specifies the Precise No. 480 for his new One Control Receiver. Ratio $2\frac{1}{2}$ to 1 and 5 to 1.

List Price \$7.50

**PRECISE MANUFACTURING
CORPORATION**

ROCHESTER

NEW YORK

Perfect Precision!

Radio technicians and engineers as well as seasoned amateurs know that "General Instrument" is satisfied with nothing short of **perfect precision**.

For example: The General Instrument laboratories developed the eccentric type straight line frequency condenser at great expense—Only TO ABANDON IT!

Try to rotate an eccentric type straight line frequency condenser and note the effect on the bearing and then you will realize why "General Instrument" discontinued the eccentric type and created the CONCENTRIC straight line frequency condenser.

CONCENTRIC straight line variable condensers represent the latest development in condenser engineering. Observe the even distribution of weight of the rotor plate.

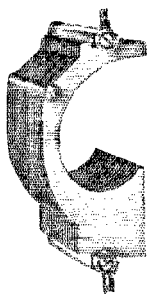

TYPE 80
Stator

"General Instrument" thinks more of its reputation than the cost involved in creating a perfect instrument. Hence—the CONCENTRIC straight line frequency condenser.

CONCENTRIC
Straight Line Frequency
Condenser.

(Pyrex Insulated)

The perfect instrument
created by General Instrument. Type 80

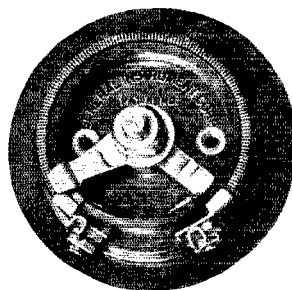

TYPE 40

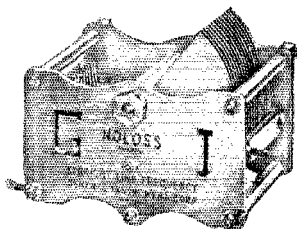

TYPE 80
Patented

THE INIMITABLE RHEOSTAT

Built only by General Instrument, this rheostat can NOT be imitated. To get it, you must make sure of the name "General Instrument."

Obtainable at Better Class Radio Departments

General Instrument Corporation

Manufacturers of Laboratory Equipment

423 Broome Street

New York City



Carol

Far out over hill and valley—into the homes of rich and poor alike—come the waves that carry the glad tidings of the Savior's birth. Little does it matter whether the set is of new mahogany and gold or of humble cardboard coils. *Tonal beauty* in the amplifier is the one indispensable need for the real joy of radio. Happy indeed is the owner of Rauland-Lyric!

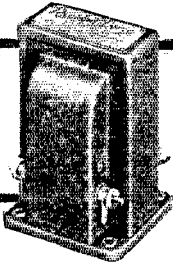

A New Gift for Every Radio Listener

Two Rauland-Lyrics in this beautiful holiday box (fully sufficient for any radio set). See it at your dealer's!

ALL-AMERICAN RADIO
CORP., Chicago

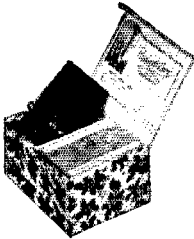

Rauland-Lyric
AN

ALL-AMERICAN
TRADE MARK
TRANSFORMER

The Choice of Noted Music Critics

*To-day
-in every
good set!*

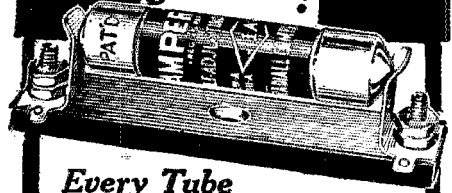

Every Tube Full of Life!

What a wonderful difference AMPERITE makes! Every tube is so brimful of snap, so eager to deliver 100% value. Individual tube regulation to meet each tube's individual needs is the answer. And only AMPERITE can fill that requirement. Permits the use of any type or combination of tubes. Specified in all popular construction sets. Price \$1.10. *There is an AMPERITE for every tube*

Write for free hook-ups

Radiall Company

Dept. QST-12 50 Franklin St., N. Y. City

AMPERITE
REG. U.S. PAT. OFF.

The "SELF-ADJUSTING" Rheostat

**Better Results with
Less Space — Using**

DUPLEX

*Straight Line
Frequency*

CONDENSERS

Their specially shaped-out stators afford separation on all wave-lengths, increasing selectivity and eliminating interference. Their carefully-planned design retains all low-loss advantages and keeps DUPLEX S. L. F. Condensers as small as the previous models.

Learn the secret of DUPLEX superior construction. Sample plate and literature sent on request.

DUPLEX CONDENSER & RADIO CORP.

32 Flatbush Avenue Extension
BROOKLYN, N. Y.

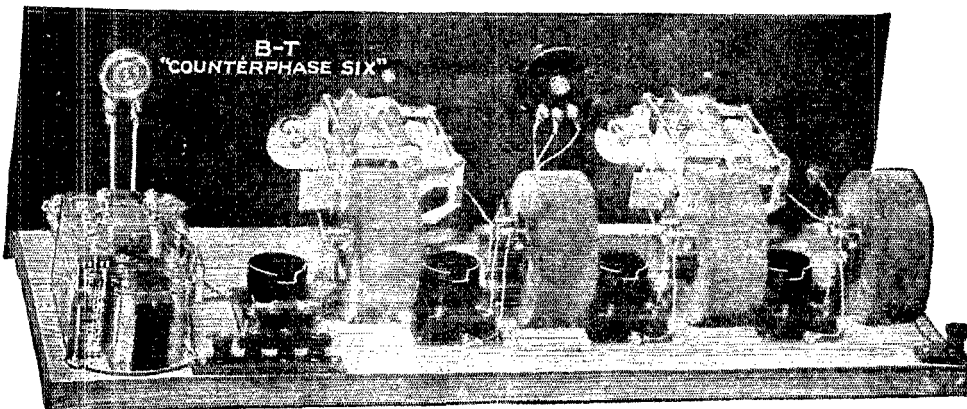

B-T "COUNTERPHASE" (as built from kit)

(The Counterphase is also furnished as a complete six-tube receiver)

It is not necessary to explain to Q S T readers the necessity for a means of providing maximum sensitivity over the full broadcast range. The "Counterphase" has it, thru the patented B-T method of variable oscillation control.

Neither is it necessary to argue about tuning controls. The "Counterphase" uses *two*,—more are unnecessary,—less would be unwise, (in our opinion.)

Combine the "Counterphase" with the efficiency of the B-T parts designed for it and you have another product of the kind that has put the B-T name where it stands to-day.

The "Counterphase-Six" with three stages of R. F. gives distant reception on a short indoor antenna. If you're interested in four-tube circuits, try out the B-T "Four," using the "Counterphase" method on a stage of R. F. added to the old B-T No. 2. We believe you'll agree it'll beat any other four-tube hook-up and give a greater "kick." Note also that it has only two tuning dials.

The B-T Torostyle,—the Toroid that's Different

There's a lot of research and inductance experience back of B-T "Torostyles." It took over two years for B-T engineers to design a toroid that was "right." "Torostyles" are more than just a primary and secondary. They are designed for a specific circuit,—the B-T "Counterphase", and the circuit was in turn designed for them. The result is oscillation control without loss of efficiency over the entire broadcast wave band.

B-T "Counterphase" diagrams are printed in progressive charts using nine colors (the same as the wires furnished with 5 and 6 tube kits.) There's no excuse for errors. Price 75c.

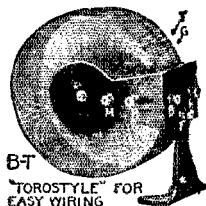

BETTER TUNING GROWN TO 80 PAGES

"Better Tuning" is different, that's why readers like it. 80 pages of hints, hook-ups and comment in the 8th edition. Postpaid for 10c.

BREMER-TULLY MFG. CO.

532 S. CANAL ST.

CHICAGO, ILL.

The 1926 Model Tuning Control

On the new set you build, or on the favorite set you own now—put 1926 model dials! Today's conditions demand more accurate tuning control than old-type dials can give. Replace them with MAR-CO dials—handsome, responsive, supremely accurate—and keep a record of the settings in the two slots, right on the dial itself!

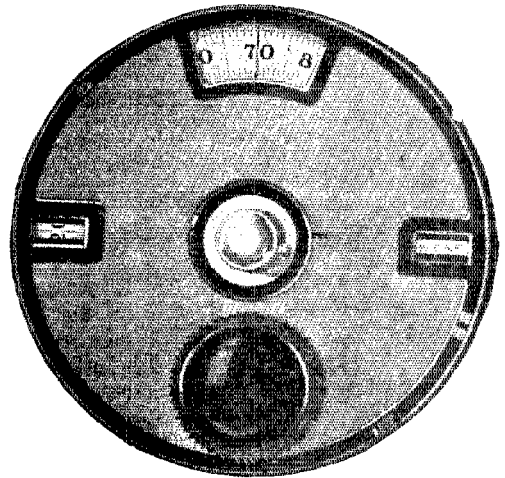

Martin-Copeland Company
Providence, Rhode Island

Nickel
Plated
\$2.50

Gold
Plated
\$3.00

Provided with scales
reading 0 to 100, or
100 to 0, as preferred

MAR-CO

RADIO
PRODUCTS

Vernier Dial

You Need This ADVANCE "SYNC" RECTIFIER

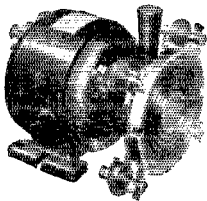

for Farther
and Smoother
Transmission!

(Ask other A. R. R. L. Men)

Thousands in the American Radio Relay League have improved their transmission with the new Advance "Sync" Rectifier. Gives clearer tone and better volume. Rectifies alternating current at 500 to 3000 volts to direct current for the plates of your transmitting tubes. Puts more energy into the antenna and counterpoise on account of actual copper-to-copper contact in rectification. Very efficient on short waves. Requires no attention—always ready. More in use than any other rectifier made.

Revolving disk is moulded bakelite six inches in diameter. Nickel plated brush holders with adjustable gauze copper brush support and brush holders perfectly insulated.

Price For rectifying wheel with complete brush assembly and mounting ring to fit your own synchronous motor. (Note: Motor must be 1/2 H.P., with 1/2 in. shaft and 1800 R.P.M.) Rectifier with Westinghouse 1/4 h. p. Synchronous Motor — \$40.

We Pay All Transportation Charges in U. S. A.
ADVANCE ELECTRIC COMPANY
1260-1262 West Second St., Los Angeles, Calif.

get one now!

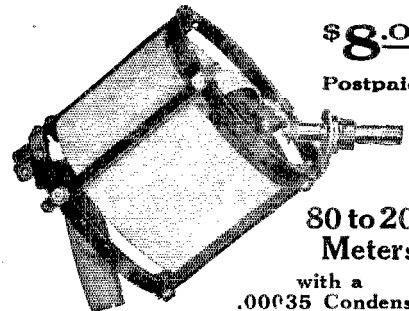

\$8.00
Postpaid

80 to 205
Meters
with a
.00035 Condenser

AERO COIL SHORT WAVE TUNER

The 95% Air dielectric, the dopeless, uniformly air-spaced windings of this new short wave tuner permit it to accomplish far more in short wave work than any other tuner yet devised. The Aero Coil Short Wave Tuner is not sold by retailers. Order direct. \$8.00 postpaid. Satisfaction guaranteed.

Henninger Radio Mfg. Co.,
1772 Wilson Ave., Chicago

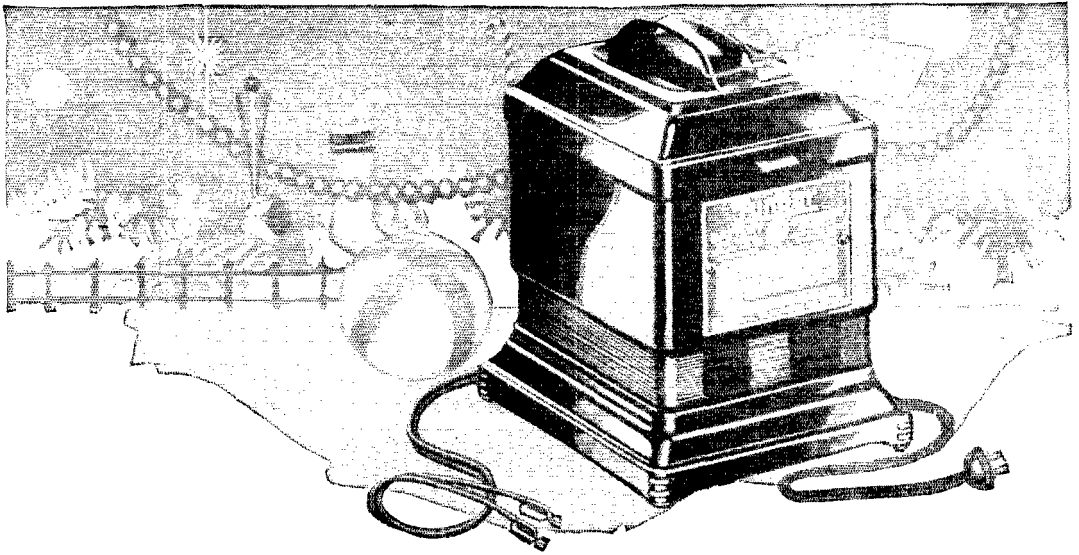

What to give the radio fan

Give him a two-ampere Tungar if he has a storage battery of any kind. It will charge all his radio batteries and his auto battery, too.

Or, for bigger jobs, give him a five-ampere Tungar—built to do the same work but to do it more than twice as fast.

Every man who has a storage battery wants a charger. And every man who wants a charger wants the original General Electric bulb charger—the Tungar.



The Tungar is a G-E product, developed in the Research Laboratories of General Electric.

The new Tungar charges any make and size of storage battery: radio "A" and auto batteries, and "B" batteries as high as 96 volts in series.

Prices

Two ampere size \$18.00
Five ampere size \$28.00
60 cycles . . . 110 volts

Tungar

REG. U.S. PAT. OFF.

BATTERY CHARGER

Tungar—a registered trademark—is found only on the genuine. Look for it on the name plate.

Merchandise Division

General Electric Company, Bridgeport, Conn.

GENERAL ELECTRIC

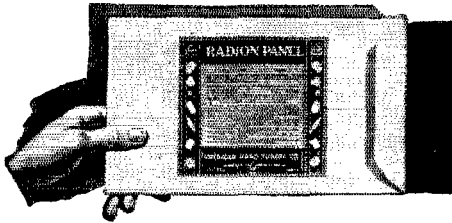

Radion Panels in black and Mahogany come cut in standard sizes for all sets.

Be sure of lowest losses

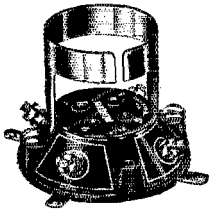

No. 2 Socket for new UX tubes with collar adapter for old type tubes. No. 4 same as No. 2, without collars, for new UX tubes exclusively.

Send 10 cents for Booklet, "Building Your Own Set"

RADION Panels are most effective in reducing surface leakage and leakage noises because they are moulded from the insulating material made to order for radio purposes exclusively.

Tests after tests have proved that Radion insures lowest losses and highest efficiency. Radion Sockets, Dials Insulators and Tubing have the same high-resistant characteristics as Radion Panels. They embody the latest developments in radio. Ask your dealer to show you the complete line of Radion low-loss parts

AMERICAN HARD RUBBER COMPANY
Dept. L9, 11 Mercer Street, New York City

Chicago Office: Conway Building
Pacific Coast Agent: Goodyear Rubber Co.
San Francisco Portland

New No. 10 4-inch Radion Dial. Nine other styles in several sizes to meet all requirements.

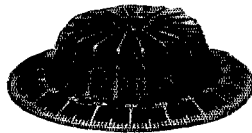

RADION

The Supreme Insulation

Made to order for radio purposes exclusively

AMERICAN HARD RUBBER CO.
Dept. L9, 11 Mercer St., New York City
Please send me your booklet for which I enclose 10 cents in stamps.

Name

Address

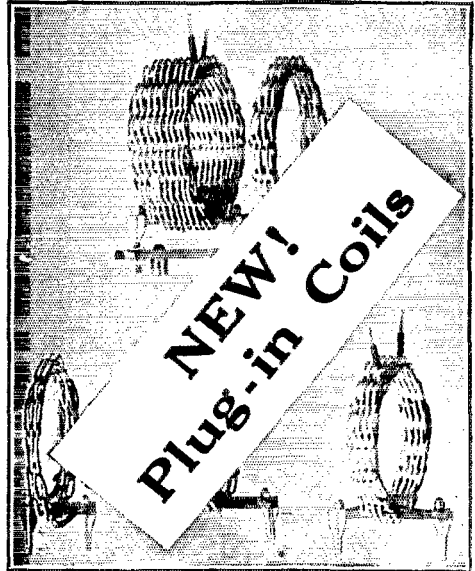

**NEW!
Plug-in Coils**

LOW **REL** LOSS LOW WAVE COILS

Build with "REL" Basket Weave Coils for efficiency—For any Low Loss Low Wave circuit—Wound with chocolate color, triple cotton-covered paraffined wire—Five interchangeable units with each outfit—Tunes from 10 to 110 meter range efficiently—New Models equipped with plug-in mountings—Inexpensive—Rugged.
Price \$4.50 including mounting—at your dealers or order direct.

Send for Coil Chart which tells you how to use "Rel" coils in any circuit—Up to 1000 meters—It is free.

Radio Engineering Laboratories
27 Thames St. New York, N. Y.
"THE LOW LOSS COIL PIONEERS"



"a new 5-Tube Set with all the power and none of the grief of the Supers" — so wrote Henry M. Neely, Editor of Radio in the Home, Philadelphia.

Get This Book

Write today for this big fascinating 32-page booklet which tells how you can build the truly amazing new QUADRAFORMER receiver. Based on a new radio principle, five tubes give remarkable results.

Enclose 10c and you'll have it by return mail

Gearhart-Schlueter Radio Corp'n
713 Voorman Avenue, Fresno, California

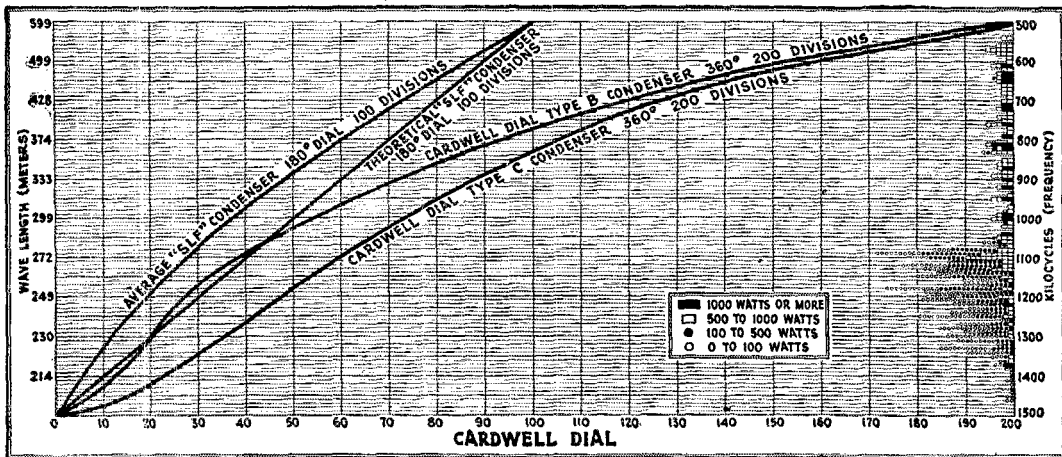

FROM SLC TO SLF



A CONDENSER to possess real efficiency, must have negligible losses and retain its calibration at all times. These are the cardinal virtues of Cardwells. That they were the original "low loss" type, suggests that they must be so excellent in all other respects that they are the final perfection in condenser art.

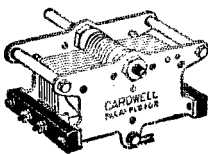
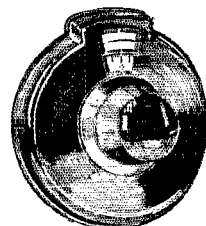

TYPE B

Because of their inherent efficiency, they are readily adaptable to straight-line design which affords conveniences at the dial in logging. Thus, without resorting to peculiar looking construction, the Cardwell can be made in SLW, or SLF without sacrificing its basic advantages: extreme rigidity and constant calibration.

S E R I E S B

Type	Cap*	Price
154B	150	\$4.00
141B	250	4.25
153B	300	4.50
152B	350	4.75
123B	500	5.00
137B	1000	6.00

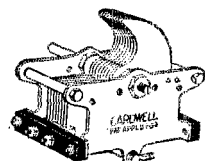

TYPE C

S E R I E S C

Type	Cap*	Price
168C†	130	\$4.00
170C†	250	4.25
192C†	300	4.25
171C†	340	4.50
173C†	500	5.00
175C†	1000	7.75

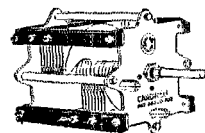

TYPE D

Note that Type B (SLC) is converted into SLW by using the Cardwell Equitrol dial. This is shown in terms of frequency above and in terms of wave-lengths in the small graph. Type B is more "selective" than most SLF types. With the Equitrol, you have more dial visibility than with any 180° SLF condenser. Type C gives semi-SLW tuning. Type D is for SLF service, 217 being a dual, balanced type recommended for all TRF circuits.

S E R I E S D

Type	Cap*	Price
217D††	330	\$8.00
173C†	240	5.00
174D†	320	5.50
193D†	340	6.00
194D†	400	7.00
175D†	440	8.00

Write for booklet 77

*MMF. †Specify "R" for clockwise, "L" for counter-clockwise. (Add "V" to any type number for built-in vernier, adding \$1.50 to list price of plain type.) ††Dual. ††Singles. Over 100 other types not listed.

ALLEN D. CARDWELL MFG. CORP., 81 PROSPECT ST., BROOKLYN, N. Y.

CARDWELL

SAY YOU SAW IT IN QST—IT IDENTIFIES YOU AND HELPS QST

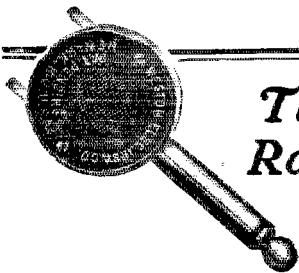

Two Radio Essentials

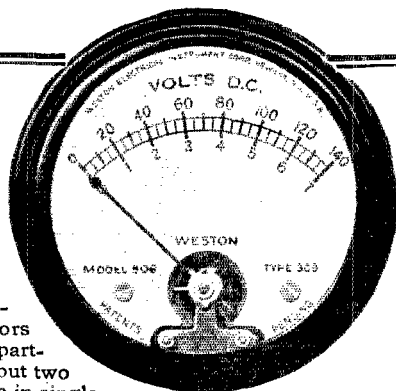

THE Weston Instant Change Radio Plug still leads the field of over 50 other various types and makes.

Price only 60c.

THE new Model 506 meter designed especially for radio enthusiasts, embodies a distinct forward step in small instrument design and construction. It is a credit to the endeavors of the Weston Engineering Department. This panel Voltmeter is but two inches in diameter and is made in single and double ranges to meet the need of your individual case. It has a remarkable high resistance of 125 ohms per volt which is an especially noteworthy feature when receiving sets are operated by dry cell tubes.

For complete technical information write for "Weston Radio Instruments"

WESTON ELECTRICAL INSTRUMENT CORPORATION
158 Weston Avenue, Newark, N. J.

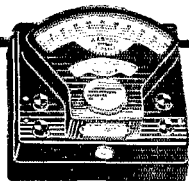

STANDARD THE WORLD OVER WESTON

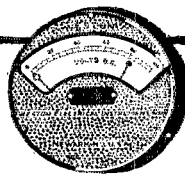

Pioneers since 1888



UC 1015-\$1

each condenser. These condensers may be used as plate and grid blocking, closed circuit, antenna and counterpoise series and filament bypass condensers.

What's Xmas without one of our UC 1015 condensers? Nil!

The Utility Radio Co.,

58 North 6th St., Newark, N. J.

HANG 'EM ON YOUR CHRISTMAS TREE!

Santa never handed out anything like this!

A UC 1015 CONDENSER FOR \$1.00

This condenser is rated at 7500 volts and is a three-section series connected unit with taps giving, normally, three capacities, .0003, .0004 and .0005 mfd. However, by connecting the four leads in series, parallel and in other ways, capacities ranging from .0002 to .001 mfd. may be obtained as shown in the instruction sheet accompanying

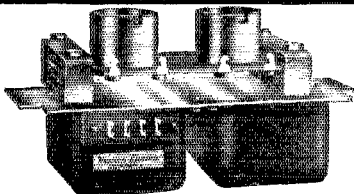

1000 CYCLE AUDIO AMPLIFIERS (2 Stage)

Mfd. by **WESTERN ELECTRIC CO.**

These transformers will enable you to Heterodyne all C. W. signals to one frequency and amplify them. Ratio 7.7-1 and 23-1. Equipped with standard base tube sockets, mounted on bakelite shelf suspended in sponge rubber.

PRICE ONLY \$3.25 Ea.

AMERICAN SALES CO., 21 Warren St., N. Y. C.

Laboratory Product



CRESCENT LAVITE RESISTANCES

for Distortionless Amplification.

As transmitting Grid leaks, they are made in special sizes and are not afraid of power. Designate 10 watts. Four standard sizes \$1.50 each. Special resistances \$2.50 each.

Crescent Radio Supply Co., 1 Liberty St., Jamaica, N. Y.

Copy the Foreign Arcs on 1000-13500 Meter



NAVY RECEIVERS

Cost \$500 Slightly Used \$45
Express Paid

Other Government Apparatus

Geo. W. Eaton Electric Company
1915 S. 12 Street Philadelphia, Pa.

Daven Tubes

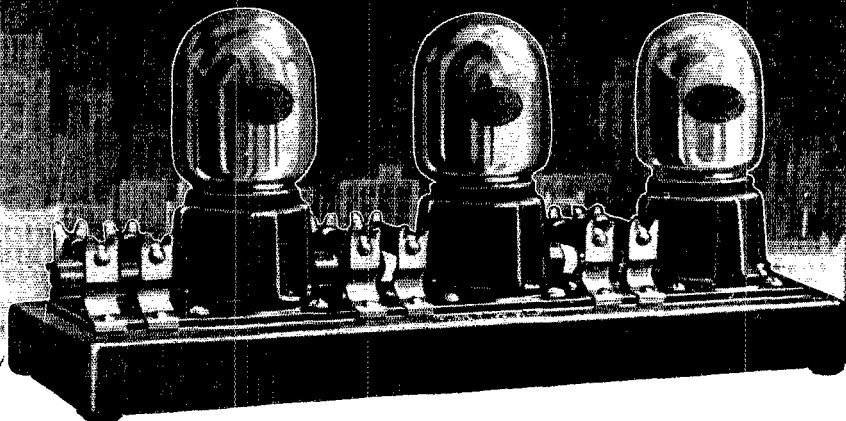

Resistance Coupled Amplification For All

THE Daven Super-Amplifier is for set owners who want more volume or for set builders or manufacturers who want resistance coupled amplification without the labor of assembly.

All the plate resistors, grid leaks and fixed condensers of the proper value, as well as all necessary binding posts, are supplied. There is nothing to do but connect with the tuner and the batteries.

Thousands have changed over their amplifiers to the resistance coupled system and testify to the wonderful improvement in richness and sweetness of tone and hearty, generous volume. The Daven Super-Amplifier makes even the best set a little better.

A ONE-PURPOSE TUBE

The new Daven Tube MU-20, 6 volt, $\frac{1}{4}$ ampere, increases the amplification of The Daven Super fifty percent, without distortion. The tone remains sweet and true. Daven Power Tube Type MU-6 is recommended for the last or output stage in any set.

Any Daven dealer will show you how to hook up the Daven Super-Amplifier.

DAVEN PRODUCTS ARE SOLD ONLY BY GOOD DEALERS

"The Sine of Merit"

DAVEN RADIO CORPORATION

Resistor Specialists

Newark

Reg. U. Pat. Off.

New Jersey

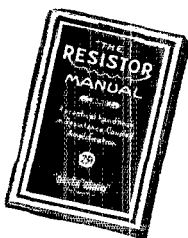

Resistor Manual

The Handbook of Resistance Coupled Amplification at best radio dealers 25c. Direct by mail, postpaid 30c.

CLIP THIS COUPON

DAVEN RADIO CORPORATION
158-160 Summit Street
Newark, New Jersey

Please send me the following on Resistance Coupled Amplification:

Check one.

- Resistor Manual. 39c is enclosed.
 Complete catalogue (free)

Name.....

Address.....

For dealers: Send your letter-head or card, or this coupon and we will have our nearest distributor communicate with you.

THE BIG LITTLE THINGS OF RADIO

PYREX Sockets

For the New "UX" Tubes

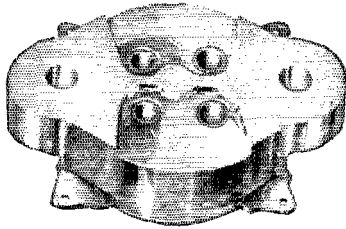

PYREX Sockets will improve Your Short Wave Receiver

Perfect Insulation

Maximum Contact Spacing

Base or Sub-Panel Mounting

THE PYREX LINE FOR AMATEURS
Includes Stain, Counterpoise, Guy,
Lead-in and Support Insulators.

*The Best Dealers Stock
PYREX*

CORNING GLASS WORKS

Industrial Division

Corning - New York



**"B" ELIMINATOR
SIMPLICITY
PERMANENT
ALKALINE STORAGE
BATTERY RECEPTION**

KIC-O MULTI-POWER UNITS operate from your lighting line and eliminate the replacing of dry cell "B" batteries... usually saving their cost in the first six to twelve months of service on Neutrodyne and Super Heterodyne sets.

Guaranteed
Two Years
Prices
MULTI-POWER UNITS
(Complete)
90 Volt MX....\$28.50

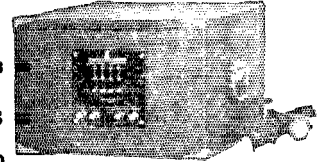

PERMANENT ECONOMICAL POWER
Shipped charged and ready to use.
No costly bulbs! No acid fumes!
Units for 110 volt A. C., D. C. or farm Plants.
Write for special offer! Distributors! Everybody!
Kimley Electric Company, Inc.
2665 Main Street - Buffalo, N. Y.

FILTER CONDENSER

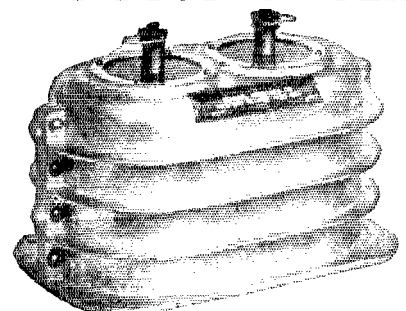

Size:—7¼" x 4½" x 5" High.

3000 Volts ——— 2 MFD.

Cast Aluminum Case, 10,000 volt Insulators around each terminal. Triple laminated by our special nascent impregnation process, Not a WAX-PAPER product.

GUARANTEED AS RATED

5.50 Postpaid

Order from your dealer or direct from
GENERAL INDUSTRIES CO.
MEDFORD HILLSIDE, MASS.

The wonderful performance of these CROSLLEY Radios will be duplicated this year—and with these New Prices they should be Radio's best values!

Crosley 2-Tube 51 Regular

This efficient little set uses any make of tubes. Nearby stations on loud speaker, long range on headphones.

Now \$14⁷⁵ was \$18⁵⁰

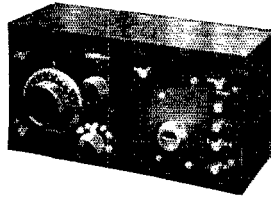

Hot Weather did not Keep this Crosley Trirdyn Owner Home

"During hot weather I bring in New York, Schenectady, Detroit, Omaha, Cincinnati, Cleveland, New Orleans, Denver, St. Louis, and Atlanta on any night. No matter how many stations are broadcasting in Chicago I can always pick up 10 to 20 outside stations on my set."
Orville G. Daily, Chicago, Illinois.

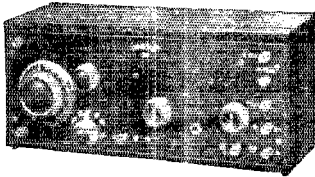

Crosley 3-Tube 52 Regular

For a less expensive 3-tube set the Crosley 52 Regular cannot be surpassed at the new low price.

Now \$25³⁰ was \$30

Vermont Man Appreciates Selectivity of Crosley 2-Tube 51

"KOA, Denver, Colorado, as you know is very close to WGB of New York City. Come in on my dial only one point from each other, yet I get no interference."
Alton D. Farrington, Putney, Vermont.

Crosley Super-Trirdyn Regular

In the Super-Trirdyn, 3 tubes do the work of 5. Matchless performance. Beautifully finished solid mahogany cabinet.

Now \$45⁵⁰ was \$50

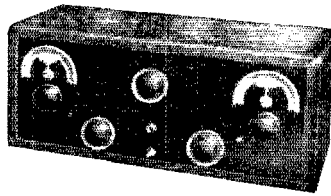

Lives in the Heart of Chicago —Gets the Country's Best in Radio with a Crosley 2-Tube 51

E. W. Plauk of 5130 Sheridan Road, Chicago, sends a list of 46 stations he hears regularly outside of Chicago from New York City to Los Angeles, California, to which he adds "all praise and credit to Crosley Radio."

Vancouver, in Torrington, Connecticut, is a Short Distance for the Crosley 2-Tube 51

"Following are only a few of the stations I have received:
WBAP—Port Worth, Texas.
6 KW, Cuba.
KOA — Denver, Colorado.
WTG, Manhattan, Kansas.
KPO—San Francisco, Manchester, England, and Vancouver, for which I can furnish sworn statement if desired."
Harris C. Rodsetfellow, Torrington, Conn.

These prices do not include accessories. Add 10% to all prices west of the Rockies.

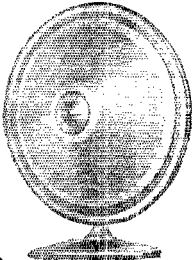

The Famous MUSICONE

This marvelous loud speaker—well on its way to REPLACE HALF A MILLION HORN TYPE SPEAKERS by January 1st—is substantially reduced because of assembly improvements developed by Crosley engineers. Reproduces all tones—without distortion. Crosley patented unit, not cone, secret of its amazing perfection.

Now \$14⁷⁵ was \$17⁵⁰

CROSLLEY RADIO

B E T T E R · C O S T S L E S S

THE CROSLLEY RADIO CORPORATION Department 18 Cincinnati
SAY YOU SAW IT IN QST—IT IDENTIFIES YOU AND HELPS QST

Now Is the Time to Prepare !

for Your Winter DX. Work
THESE TROY SPECIALTIES WILL HELP YOU

Low Loss Treated Wood Short Wave coupled Inductances for 40 or 80 meters **\$8.00**



UX 210 R. C. A. 7 1/2 Watt Tubes **\$8.00**

Double spaced Variable Transmitting Condenser 41 plate .00048 MFD **\$9.00**

Low Loss Radio Frequency Choke wound on glass forms **\$3.00**

Bruno Short Wave Tuner 40-150 meters wound on glass forms **\$6.50**



Amrad "S" Tubes 4000-1 **\$8.00**

" " 5000-1 **\$6.00**

Change Over Switch **\$6.00**

R.C.A. 40 Henry 150 Mil. Chokes **\$13.00**

All prices F. O. B. N. Y. *See us for your transmitting accessories or any other needs. Inquiries solicited and promptly answered.



Troy Radio Company

1254 St. Johns Place

Brooklyn, New York



Specialists in Amateur, Experimental and Commercial Radio Apparatus.

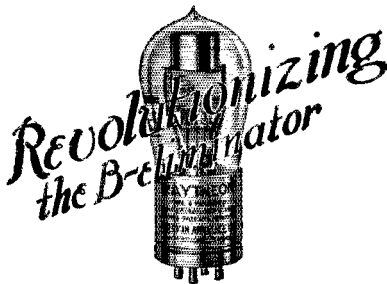

Revolutionizing because of the application of new and fundamentally sound principles to the rectifier. B-eliminators or parts, specially designed for use with RAYTHEON tubes are made by these and other well-known manufacturers, and are now on sale at your dealer's:

- Acme Apparatus Co., Cambridge, Mass.
- All-American Radio Corp., Chicago, Ill.
- Dongan Electric Mfg. Co., Detroit, Mich.
- General Radio Co., Cambridge, Mass.
- Jefferson Electric Mfg. Co., Chicago, Ill.
- Mavolian Radio Mfg. Co., New York, N. Y.
- Thordarson Electric Mfg. Co., Chicago, Ill.
- Tope Deutschmann Co., Boston, Mass.

RAYTHEON

Long Life **\$6** Economy

No Filament **6** Reserve Power

RAYTHEON MANUFACTURING CO.

CAMBRIDGE, MASSACHUSETTS

FORMERLY AMERICAN APPLIANCE CO.

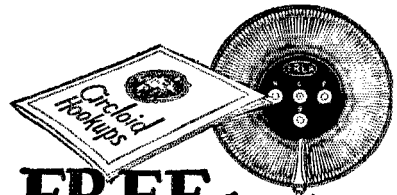

FREE book

Shows how to get—greater distance, more volume, amazing selectivity, finer tone

Science has discovered a new principle in radio amplification . . . a striking new development that is bringing unheard of results. This principle is founded upon a new kind of coil—the Erla Balloon Circloid. It brings 4 distinct improvements. These are explained in a fascinating book just published and being mailed free.

Edition limited—Write today

Get this book and read about this newest scientific radio principle. See the many different circuits in which it may be used. Find out how you can turn your present set into the latest example of radio engineering—and at a remarkably small cost. There are only a limited number of these books, so you must write immediately.

Address

Electrical Research Laboratories

2500 Cottage Grove Ave., Dept. 2C Chicago, Ill.

Build a Practical "B" Eliminator

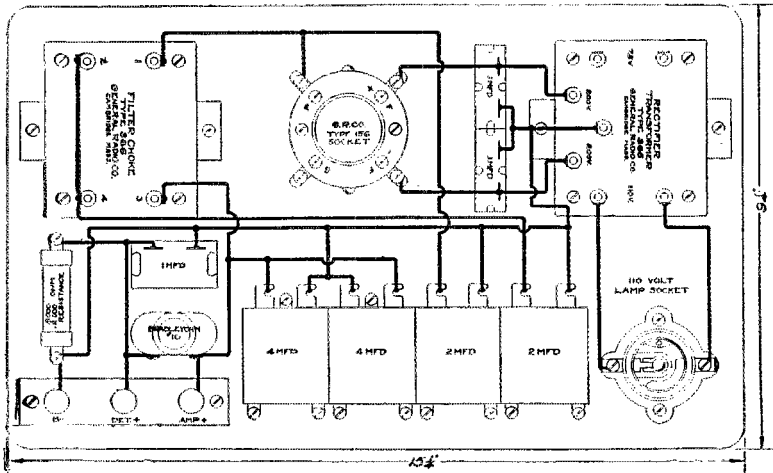

Wiring Diagram for "B" Eliminator

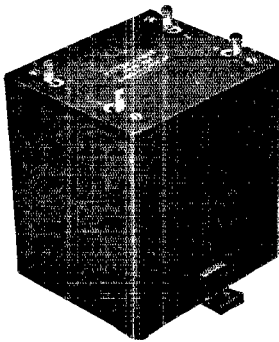

Type 366
FILTER
CHOKE

Price \$10.00

THE above diagram shows the arrangement of parts and connections for an efficient "B" battery eliminator using the new General Radio Type 365 Rectifier Transformer and Type 366 Filter Choke. These Transformers give very satisfactory results in a plate voltage supply unit when used with the new Raytheon rectifier tube or other tubes of similar characteristics.

For further description refer to page 9158 of our new Bulletin 923-Q or write for our circular, "Instructions for Building a "B" Eliminator."

GENERAL RADIO CO.
CAMBRIDGE 39, MASSACHUSETTS

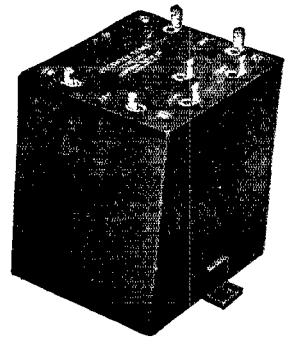

Type 365
Rectifier
Transformer

Price \$10.00

GENERAL RADIO

The Loud Speaker Sensation..!



The KODEL MICROPHONE LOUD SPEAKER

You can't tell the KODEL MICROPHONE LOUD SPEAKER from the microphone the broadcasting stations use—they are exactly alike in size and appearance.

The efficient Kodel Sound Unit, with a ingenious new snail-shell horn, mounted inside the microphone case, produces a remarkably clear, full-toned volume. Non-vibrating tone chamber absolutely eliminates distortion.

\$15 model incorporates Kodel, Jr. unit; equipped with large Kodel unit \$20

\$15⁰⁰

Radio dealers everywhere have them.

THE KODEL RADIO CORP.
508 E. Pearl St. Cincinnati, O.

RECEIVERS :: SPEAKERS
HOMCHARGERS



The Wilson "B" Radiopower Unit

Pats.
Pend.



In Walnut Case

The ideal plate current supply. Operates from light socket without setting up the slightest hum in the receiver. Furnishes constant voltage. No acid to spill. No moving parts to get out of order. Requires no attention except to switch it on and off. The least expensive type of unit when service is considered. Pats all sets.

Write for details. If your dealer does not have this unit in stock.

Pats. Pend.

Paddlewheel Coil

Has highest ratio of inductance to resistance with minimum distributed capacity. Losses are negligible. Gives maximum volume without distortion. Used in De-casadyne and Buckingham receivers. Blueprints of standard circuits employing this coil from your dealer.

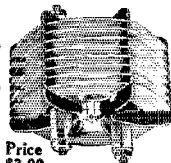

Price
\$3.00

We also manufacture the famous DUO-SPIRAL Folding Loop. Our Technical Dept. will be pleased to answer any inquiries regarding any of these standard products.

Radio Units Inc.

1304 First Ave. Maywood, Ill.
Perkins Electric, Ltd., Montreal, Toronto, Winnipeg

Faradon



THE EXPERT AMATEUR NEEDS NO FURTHER ASSUR- ANCE REGARDING FARADON CONDENSERS

The importance of their dependable operating efficiency in his own transmitting set and in the operating equipment of the outstanding broadcasting stations is well known to him.

The competent staff of the same progressive pioneer organization now produces an equally superior compact all-metal-mica condenser for receiving sets.

FARADON QUALITY at the receiving end is secured by utilizing the MODEL T

If your dealer has not the Model T on hand advise us. An informative circular will be sent if you also mention QST.

Wireless Specialty Apparatus Co.
JAMAICA PLAIN, BOSTON, MASS., U. S. A.

ELECTROSTATIC CONDENSERS FOR ALL PURPOSES

Instruments that Accelerate Successful Broadcasting

WESTINGHOUSE Electric manufactures a most complete line of radio instruments for both transmission and reception. These instruments are made of the highest quality materials and are assembled and tested by specialists in the science of designing and the art of building radio instruments.

The most satisfactory results are obtained when Westinghouse instruments are used in connection with radio communication. Station KDKA is proving this, day after day, by unexcelled radio communication to the most remote corners of the world.

Our nearest district office gladly will furnish detailed information on radio instruments for every and all applications.

Westinghouse Electric & Manufacturing Company
Newark Works Newark, N. J.
Sales Offices in All Principal Cities of
the United States and Foreign Countries

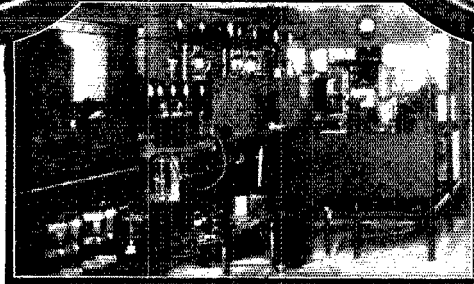
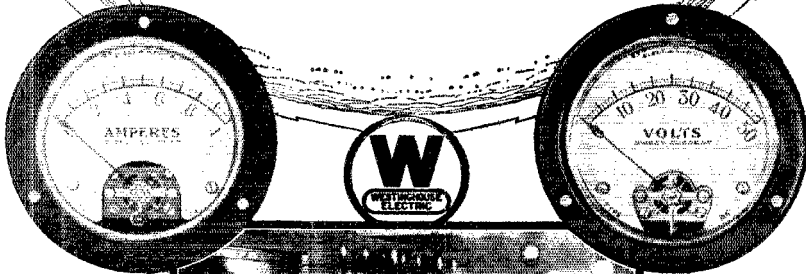

Westinghouse

X 85573

SAY YOU SAW IT IN QST—IT IDENTIFIES YOU AND HELPS QST

Antenna

Series

Condensers

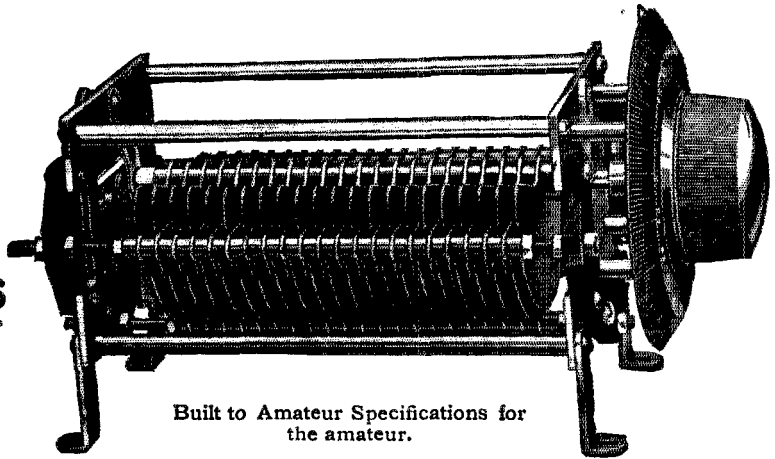

Built to Amateur Specifications for the amateur.

- Type 150 — 3000 150 MMFd. (.00015 MF).
 3/16" spacing (ordinarily known as double spacing), 3000 volt flashover. Fine
 for 5W and normal 50W sets. Proper size for primary circuits. Price \$7.50
- Type 450 — 3000 450 MMF (.00045MF)
 3/16" spacing, like those NATIONAL supplied to N.R.R.L. Price \$16.50
- Type 100 — 6000 100 MMF (.0001MF)
 3/8" spacing, 6000 volt flashover, for the overloaded "50" and the "250" W.
 Plenty big enough for the primary, too. All prices include 4" Velvet Vernier Dial. Price \$12.50
 "NATIONAL" can furnish you with 5 or 3 plate Receiving Variables for that short wave receiver.
 Send for Bulletin 106 Q S T

NATIONAL COMPANY, INC., ENGINEERS AND MANUFACTURERS
 110 Brookline Street, Cambridge, Mass.

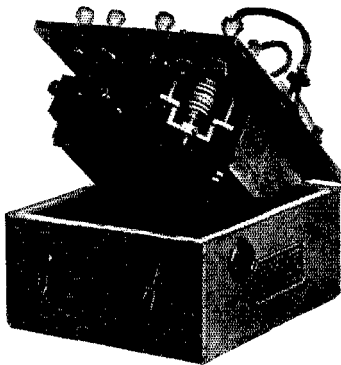

RADIO SPARK TRANSMITTERS (75 WATT PORTABLE)

Made for U. S. Army Aeroplanes

This is a tuned spark coil transmitter, with a wave length of 100-300 meters. The set is made of the finest of materials and the essential parts are the spiral tuning inductance, the induction coil, sending condenser and spark gap. Average range about 25 miles more or less.

Brand new, in original cartons.

ORIGINAL GOVERNMENT COST, \$47 EACH

OUR PRICE \$5.75 EACH

AMERICAN SALES COMPANY

21 Warren Street

New York City

QST! Oscillating Crystals

No need of asking "HW MI QSB?" any more. He will just rave, telling you how steady, clear and bell-like you pound in. This is possible with crystal controlled transmitters.

We can furnish crystals guaranteed to vibrate at some frequency in the amateur bands at the following prices:

- 150-200 meter band \$21.00
- 75-85 meter band \$36.00
- 37-42 meter band \$66.00

Every crystal is calibrated and its frequency accurate to 1/10 of 1%.

We also grind crystals to your specified frequency. Frequency guaranteed accurate to 1/10 of 1%. Prices for this special work upon application.

Listen for 3CKP on 1698.5 Kcs and 3628.0 Kcs for that clear, bell-like signal.

SCIENTIFIC RADIO SERVICE COMPANY
 BOX 55 MOUNT RAINIER, MARYLAND

Our Type A Wave Meter Is Ready

Send for Literature

Other Real Ham Apparatus Under Way

We are specialists in apparatus for the amateur and want every real ham's name on our permanent mailing list.

THE WIRELESS MFG. CO.

Canton

Ohio

No matter what circuit— Far, Far Better Results with

KARAS

Orthometric Condensers and Harmonik Transformers

Karas instruments have been tested and recommended by leading technical editors for use in all types of sets from the most elaborate super to the simplest low loss 3-tube receivers. The most exacting home set builders, the country over, demand Karas Transformers and Condensers—and will use nothing else. Nothing can take the place of these

scientifically designed, precision instruments. Use them in your next set—or improve your present set by installing them. It's easy to do—the results will be worth many times the cost.

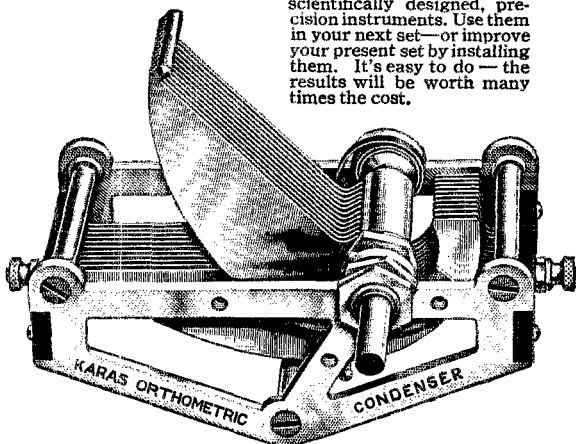

Spreads Stations Evenly Over the Dial —No Crowding Whatever

The Karas Orthometric Condenser positively separates all adjoining wavelengths by EQUAL distances on the dial—giving you full benefit of the 10 Kilocycle frequency separation fixed by the government. Ordinary condensers jam 70 of the 100 Government allotted wavelengths into the first 30 points on the dial—even straight-line-wavelength condensers crowd 57 of them below 30. But with Karas Orthometrics, each point on the dial corresponds to one of the 100 allotted wavelengths. The result is marvelous simplicity in tuning—and better, clearer reception—all side bands without interference.

Brings in KDKA at 53

Not at 17—or 28, but at 53 where it belongs, leaving lots of room for the 82 wavelengths that must come in below it. The Karas Orthometric is a "precision job"—entirely of brass. Every joint soldered. Plates patent-levelled and securely bridged.

If your dealer is out of Karas Instruments Order Direct on This Coupon

Most good dealers everywhere sell Karas parts. If your dealer happens to be one who doesn't, we will supply you direct at no trouble on your part—on our 30-day money back guarantee. Just fill in and mail this coupon at once. Send no money. You can pay the post-man on delivery.

**KARAS ELECTRIC CO., 4056 N. Rockwell Street
CHICAGO, ILLINOIS**
For more than 30 years makers of PRECISION Electrical Apparatus

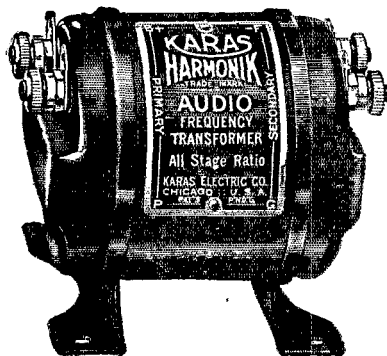

For Long Distance with Big Volume and Keen Musical Quality

Karas Harmoniks deliver perfect music with loads of volume from stations one to two thousand miles distant. DX broadcasting becomes really enjoyable. "Fishing" for distant stations is only a matter of finding programs you want to hear—not straining to catch only the bare announcement and making up a list of call letters.

Even from far away points, Karas Harmoniks bring out full, round musical tones. All the vital harmonics and rich overtones are fully retained. Low bass notes pour forth, rich, sweet, sonorous.

If you want music like this, you must have Karas Harmoniks in your set. Get a pair TODAY! The best transformer money can buy.

Karas Electric Co.
4056 N. Rockwell St., Chicago

Please ship me the instruments checked below. I will pay the postman prices listed; plus postage upon delivery. It is understood that I have the privilege of returning these goods, for full refund, within 30 days, if they do not prove entirely satisfactory.

....Karas Harmonik Audio Transformers. (\$7.00 each)
....Karas Orthometric Condensers: Size.....
(23 plate \$7 ea.; 17 plate \$6.75 ea.; 11 plate \$6.50)

Name

Address

If you send cash with order, we'll send package postpaid

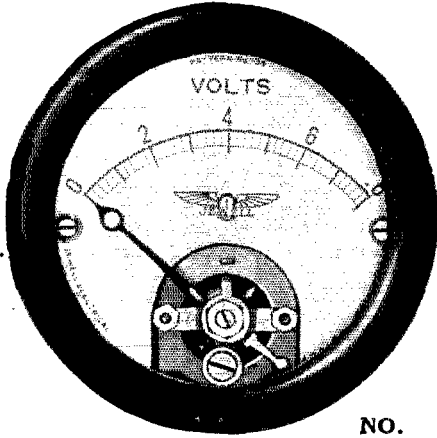

NO. 135

WE FIND—

That many amateurs build receiving sets for themselves and their friends, requiring the use of instruments on the panel.

Let us send you our circular No. 776 showing our two new two inch diameter panel instruments Nos. 135 and No. 140.

CONTEST

Did you receive one of our circulars announcing our radio contest for amateurs, "More Miles Per Watt"?

JEWELL ELECTRICAL INSTRUMENT COMPANY

1650 WALNUT STREET - CHICAGO



**Everybody is helped—
everybody should help!**

TUBERCULOSIS in this country is a threat against your health and that of your family. There are more than a million cases in this country today.

The germs from a single case of tuberculosis can infect whole families. No one is immune. The only sure escape is to stamp out the dread disease entirely. It can be stamped out. The organized work of the tuberculosis crusade has already cut the tuberculosis death rate in half. This work is financed by the sale of Christmas Seals.

Everybody is helped by this great work—and everybody should help in it. Let every member of your family stamp all Christmas parcels, letters and greeting cards with these able little warriors against disease. Everybody, everywhere, buy Christmas Seals—and buy as many as you can.



*Stamp Out
Tuberculosis
with this
Christmas Seal*

**THE NATIONAL, STATE, AND LOCAL TUBERCULOSIS
ASSOCIATIONS OF THE UNITED STATES**

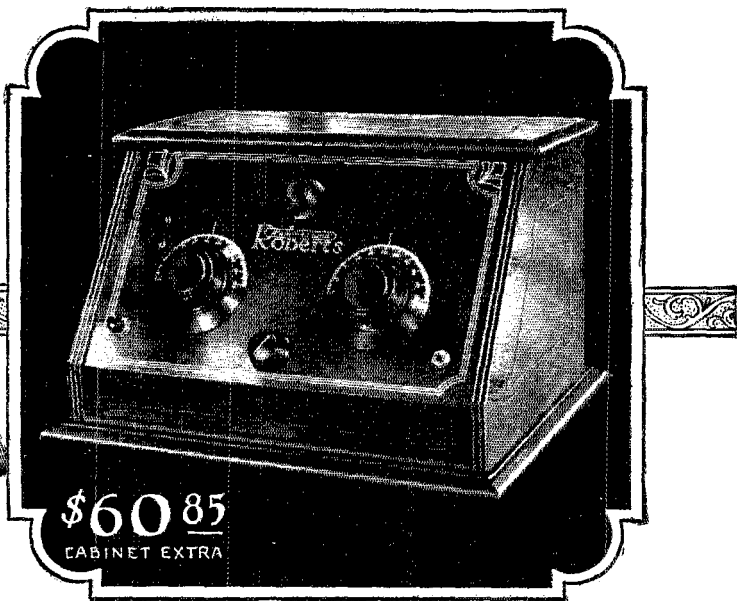
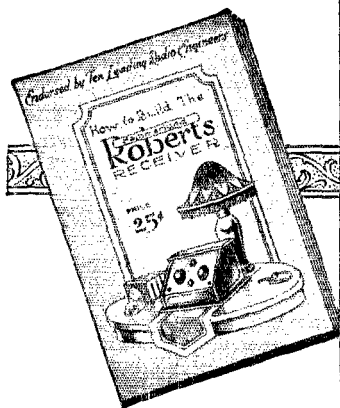

**Write for
This Book**

You will find it surprisingly easy to build the Hammarlund-Roberts Receiver from this instruction book. Full illustrated throughout.

25c

*Every Part Designed
by a Specialist*

**Associate
Manufacturers**

- All-American Radio Corp.
- Alden Manufacturing Co.
- Radiall Company ("Amperites")
- Carter Radio Co.
- Union Radio Corp.
- International Resistance Co. Inc. ("Durham Resistors")
- Westinghouse Micarta
- Hammarlund Mfg. Company Inc.

EVERY single unit that goes to make up this remarkable receiver was chosen by a specialist after months of research. The transformers were selected by an engineer familiar with every reliable make; the condensers by a man who had made a special study of condenser constructions and functions. So it was even with the smallest, usually neglected units.

From the work of these engineer-designers, backed by the endorsements of ten famous radio parts manufacturers, comes the Hammarlund-Roberts, a receiver that is truly the ultimate in five-tube possibilities. The equal of a standard eight tube set in selectivity and volume—so simple in design and operation that anyone might construct it. Without a doubt, the Hammarlund-Roberts offers the greatest value possible in the radio field today.



This Famous Instrument and the other parts shown here are some of the units used in the Hammarlund-Roberts.

**Hammarlund
Roberts**

Hammarlund-Roberts 1182-P Broadway New York, N. Y.

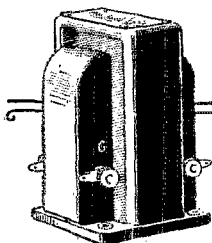

Dials and Sockets



Switches and Rheostats



Phone Tip Jack



DURHAM Resistor

THE SUPER-SYNC

The Only Synchronous Rectifier That Can Be Filtered

The Super-Sync is the only synchronous rectifier that delivers a pure D. C. when filtered. Heretofore it has been impossible to filter a synchronous rectifier therefore one would naturally think that it would require a complicated filter circuit. This however is not true as the common type "Brute Force" filter will give just as good results as the more complex types of filter circuits.

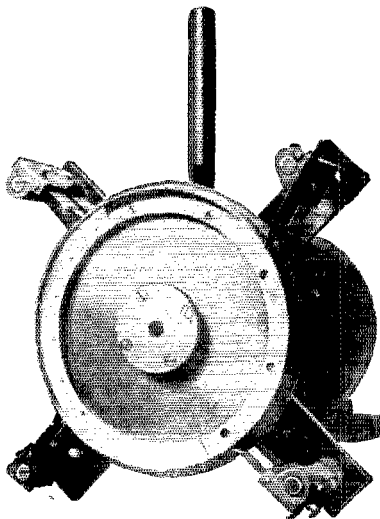

The Super will handle 4000 volts at 250 M.A. without giving the least bit of trouble. This is usually sufficient to supply the average amateur transmitter.

The commutator is turned at a Synchronous speed by a 1/4 H. P. Synchronous motor made by the General Electric Co. This motor can be supplied for either 110 or 220 volts 60 or 50 Cy. Motors with special ratings can be supplied but will require a slight delay in shipment.

PAT. PENDING

PRICE \$75.00 F. O. B. ST. LOUIS

MARLO ELECTRIC CO., 5241 Botanical Ave., St. Louis, Mo.

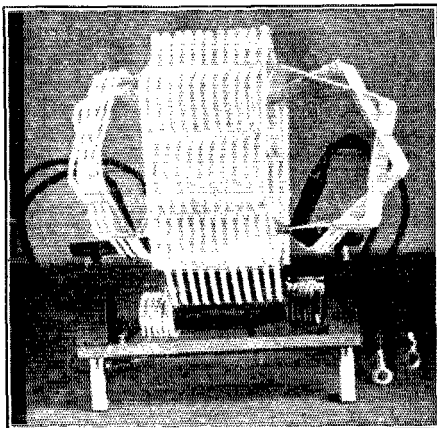

Lowloss Tuners & Coils FOR ALL CIRCUITS

Broadcast, Amateur and Special Amateur 3-Circuit Tuners, \$7.00 each. R. F. Coils, \$2.00 each.

Coils to Order Write for Literature

Davenport Radio Laboratories
DAVENPORT, IOWA

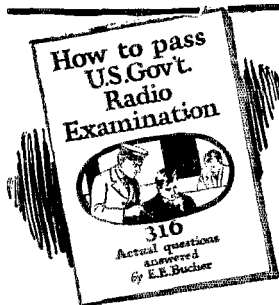

60c

For a Short Time Only

PASS the U.S. Government Commercial or Amateur Radio License examination! This book will help you do it! Send sixty cents in stamps or coin for your copy — postage prepaid to any point in the U. S., Canada or Mexico.

RADIO INSTITUTE OF AMERICA
326A Broadway New York City

Filters

(TYPE 2A). Mfd. by WESTERN ELECTRIC CO. consists of 1 mfd. 1000 volt condenser, 1 mfd. 500 volt condenser, 1 Iron core choke coil and 2 resistances, enclosed in a wooden box. Complete with 7 foot extension cord.

Parts can be used for a "B" Battery Eliminator
BRAND NEW IN ORIGINAL CASES Price Only \$2.50 Ea.
AMERICAN SALES CO., 21 Warren St., N. Y. C.

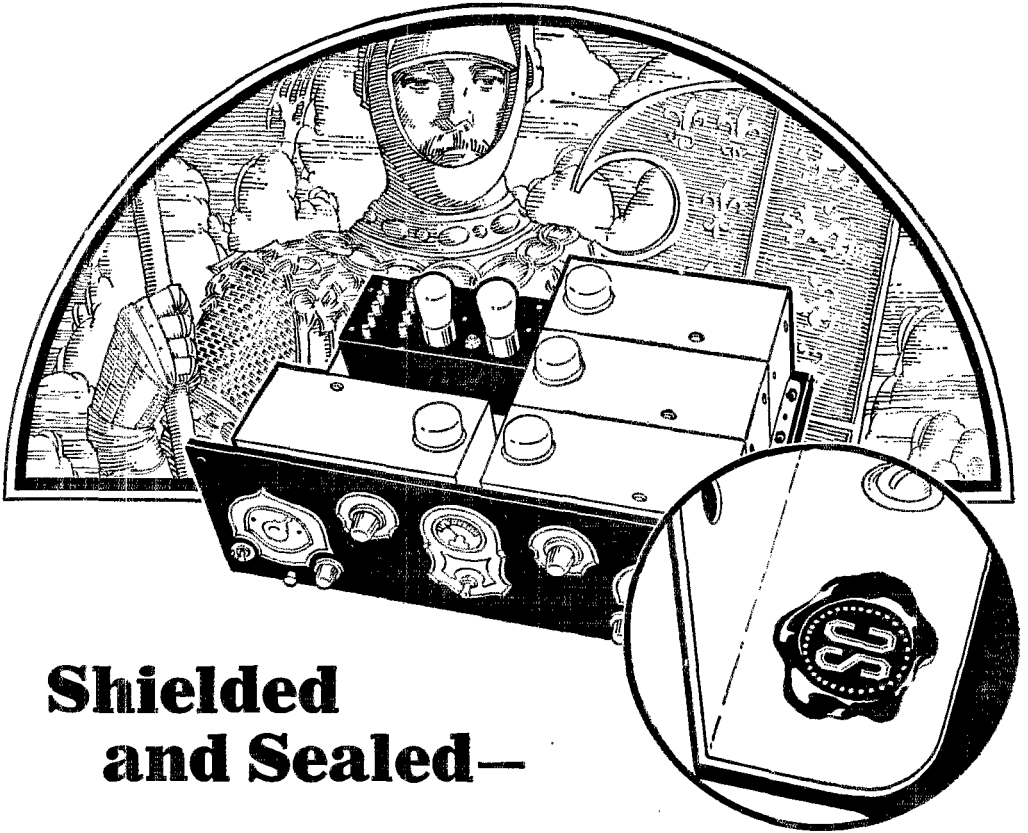

Shielded and Sealed—

Stromberg-Carlson Receivers are shielded against interference.

In the No. 601 and No. 602 Receivers, heavy copper shields guard all four tuned radio frequency circuits from every extraneous sound except that to which the antenna is tuned.

Stromberg-Carlson Receivers are shielded against thoughtless handling.

This ensures that the distance ability, the marvelous tone quality and the selectivity which the shielding makes possible, shall remain unchanged.

Stromberg-Carlson Receivers are sealed.

And with each instrument goes the manufacturers' guarantee of its faithful performance as long as the seals remain unbroken.

Stromberg-Carlson Telephone Mfg. Company
Rochester, N. Y.

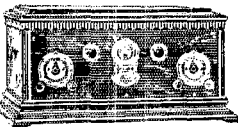

No. 601 RECEIVER, Table Model. 6-tube; totally shielded; dual control; with volt meter; operates horn or cone type Loud Speaker; Solid Mahogany.



Stromberg-Carlson

Makers of voice transmission and voice reception apparatus for more than thirty years.

At Last! A Practical and Sensitive Photo-Electric Tube

THE

PHOTOTRON

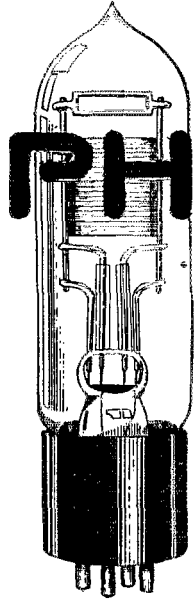

An alkali-metal tube for use in radio pictures, picture telegraphy, talking movies, and other light actuated devices.

Just the thing for the HAM experimenter in picture broadcasting and reception. A strong, permanent tube fitting the ordinary radio socket.

PRICE

\$20 each

PHOTON ELECTRIC CORPORATION

1269 Cochran Ave.,
Los Angeles

247 Park Ave.
New York City

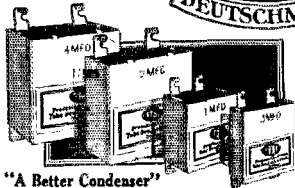

"A Better Condenser"

Used by Miles Pennybacker in his article "The Raytheson Rectifier" in November Q S T.

Made in the following capacities:—

Type	Price
1. MFD 705	\$.70
25. MFD 706	\$.75
15. MFD 707	\$.90
1. MFD 708	\$ 1.25
1. MFD 709	\$ 1.75
3. MFD 710	\$ 2.75
4. MFD 711	\$ 3.75
5. MFD 712	\$ 4.50

TOBE condensers were specified in "How to build" articles in the November issues of Radio News, Popular Radio, Radio Broadcast, and Radio. Such unanimous approval has seldom, if ever, been awarded to any radio apparatus.

TOBE condensers received this tremendous endorsement—

First:—Because of their uniformity (less than 5% variation from rated capacities).

Second:—Because of their permanence (their rigid construction assures permanence of rated capacities through variations of temperature).

Third:—Because of their high megohm resistance (indicating extreme low-loss and high insulation).

Fourth:—Because of their capacity to withstand overload (can operate at voltages up to 700 D. C. without breakdown.)

Ask for TOBE Condensers

[DTW (COLLAPSIBLE) The one \$25.00]
[LOOP selected in all America by McLaughlin. Price

TOBE DEUTSCHMANN CO.
CORN HILL BOSTON, MASS.

Another TOAZ Development FUSOCKETS

PATENT APP. FOR

Individually Fused Sockets
Insure your Tubes
199 or 200

Single or any multiple

At Your Dealers or

\$1.00 per Socket, P. P.

TOAZ TERMINALUGS BEST FOR RADIO BUGS

At your Dealers or send \$1.00 for Special Package, including Gripfast Terminalugs. (Pat. App. For.)

TOAZ Engineering & Sales Co.
11703 ROBERTSON AVE., CLEVELAND, O.



SAVE on all the latest Standard

Radio Merchandise.

Our 1926 Beautifully Illustrated Catalog JUST OFF THE PRESS.

Rush your name and address and get our wonderful Catalog. Also a LOG BOOK FREE.

ECONOMY RADIO SALES COMPANY
288—8th Ave., Dept. D, New York, N. Y.

The Easy Way to Send

With The Improved Martin

VIBROPLEX

SEMI-AUTOMATIC TRANSMITTER

The Genuine
Martin In-
strument Bears
the Nameplate
of the Vibro-
plex Co., Inc.



Reg. Trade Marks
Vibrop'lex
Bug
Lightning Bug

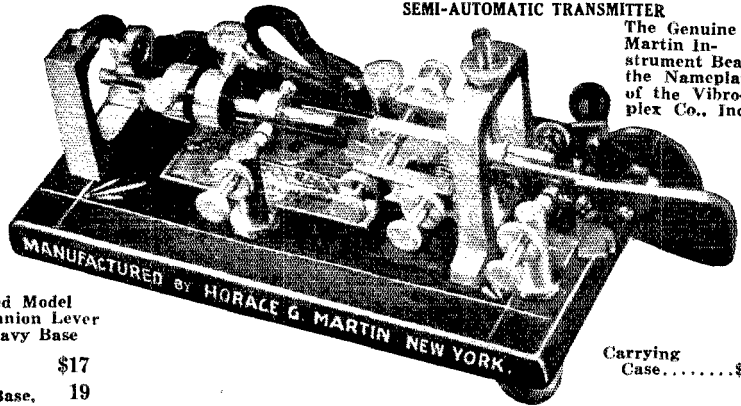

Carrying
Case.....\$3

Latest Improved Model
Simplified Trunnion Lever
Mounted on Heavy Base

Japaned Base \$17
Nickel-Plated Base. 19

Simply Press the Lever—The Vibroplex Does the Rest

Any experienced radio operator will tell you the **easiest** way to send **GOOD, CLEAR** signals is with a Vibroplex.

No human fingers can form signals on an ordinary key with the ease and perfection of the Vibroplex.

Dots are automatically made—five being made as easily as one and with no more effort on the part of the operator.

Signals that will be easily read by the operator thousands of miles away can be sent at any desired speed simply by pressing the lever—the **Vibroplex does the rest.**

From Station 4UA Dundee, Fla.

"I am a constant user of the Vibroplex, and my signals are always clear and readable at audibility R5 in England, France, Italy, Argentina and Alaska according to reports received on Q.S.L. cards. Have had many a compliment on my sending 'good first' but I attribute it to my faithful Vibroplex."

From Station u2EV New York City

"I wouldn't be without a Vibroplex. I use it continuously at my station and on ships at sea and results have been more than I anticipated. It's speed and accuracy is marvelous, and makes one's sending far more readable than when using the ordinary key. What a blessing it would be if all amateurs used the Vibroplex thereby improving those 'bum lists' you hear so much."

Thousands of radio operators on land and sea now use the Vibroplex instead of the key, because the sending is more uniform, the signals stronger and easier to read, and the effort of sending is reduced to the minimum.

No radio station is complete without a Vibroplex. Every amateur should know how to use it. A little practice enables you to send with the skill of an expert. Sent anywhere on receipt of price. Money order or registered mail.

Special Model Vibroplex for use without relay. Equipped with Specially Constructed Contact Points 3/16" in diameter to break high current. Fills a long standing need. Sent anywhere on receipt of price \$25

Wide Awake
Agents
Wanted

THE VIBROPLEX CO., Inc., 825 Broadway, NEW YORK

J. E. Albright, President

Telephones: Stuyvesant 6094, 4828, 4829

SAY YOU SAW IT IN QST—IT IDENTIFIES YOU AND HELPS QST

A CHRISTMAS GIFT FOR EVERY AMATEUR!



What better Christmas present could you give to a Brother A.R.R.L. Member, or receive yourself from someone of "the folks" (if the suggestion is properly planted!) than your A.R.R.L. Emblem.

The A.R.R.L. Diamond comes in four popular and useful forms, at least one of which will be acceptable to your friend or yourself.

THE PERSONAL EMBLEM. A handsome creation in extra-heavy rolled gold and black enamel, $\frac{3}{4}$ " high, furnished in lapel button or pin-back style. Either kind, \$1.00 postpaid.

THE "JUMBO" EMBLEM. A wonderfully decorative and appropriate embellishment to the League member's shack wall. A big gold and black enameled sheet steel emblem, 19 x 8 $\frac{1}{4}$ ", holes top and bottom for easy attachment, the same style as the auto-

mobile emblem. \$1.25 each, postpaid.

THE EMBLEM CUT. A mounted printing electrotype, the same size as the lapel button, for use by Members in any type of printed matter. \$1.00 each, postpaid.

AUTOMOBILE EMBLEM. Nearly 1,000 cars have so far been decorated with the A.R.R.L. Diamond. As distinctive on your car as the Rolls-Royce figurehead, and it stamps you as one of the radio aristocracy wherever you drive. Sheet metal base, heavily enameled in gold and black, holes top and bottom; only 50c postpaid.

Do Your Christmas A. R. R. L. Emblem Buying Early! There'll be a Rush!

THE AMERICAN RADIO RELAY LEAGUE
HARTFORD, CONNECTICUT

EAGLE



All That's Best in Radio

Eagle Performance is based on Quality Parts, Expert Workmanship, and Thorough Inspection.

Ask Your Dealer



EAGLE RADIO COMPANY

23 Boyden Place Newark, N. J.



BLUEBIRD RADIO TUBES

are powerful—sensitive for distance, give clear volume and long service.

GUARANTEED

to work in Radio Frequency, Neutrodyne, Super Heterodyne and Reflex.

WITH BAKELITE BASE

Type 200
Type 201A
Type 212
Type 244
Type 299A with standard base
Type 202 5 watt Transmitter \$3.00

\$2⁰⁰

When ordering Mention Types Shipped Parcel Post C. O. D.

BLUEBIRD TUBE CO.

200 Broadway Dept. S, New York

ELECTRASOTE

TRADE MARK
(NEW TYPE)

Radio Panels

have a High Volume and Surface Resistivity, excellent Tensile and Transverse Strength and a very Fine Appearance.

M. M. FLERON & SON, Inc.

Exclusive Sales Agents

113 N. Broad St.,

Trenton, N. J.

Never before
used in **DIALS**

The Mechanical Principle
in **GEE-HAW**

Ratio 100 to 1
No Backlash—

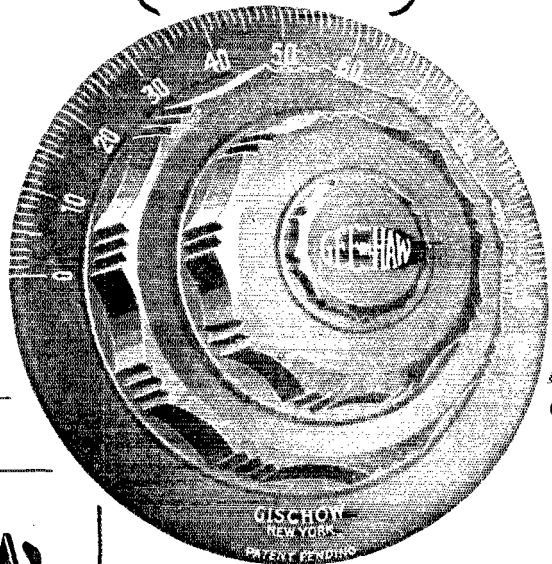

GEE-HAW Micrometer Tuning **DIAL**

Proven by Test
Supreme Master
for Sharp Tuning

*The true value
of these DIALS
to any set is
"indescribable"*
**GEE-HAW
- DIALS -**
*are the "THAT" which
makes any set
function*
100%

To Appreciate
it's full worth
See Demonstration

Guaranteed

If the use of the GEE HAW DIAL does not materially improve the selectivity of any radio set on which it is installed, it may be returned to us (accompanied by bill of sale from dealer) and purchase price refunded without question or argument. Does any other manufacturer of dials dare duplicate this offer? Price \$3.00.

OTTO R. GISCHOW Co. INC. 125 West 51st St
NEW YORK CITY.

Yours-free!

RADIO



WRS 90 PAGE RADIO GUIDE BOOK

Profusely illustrated "hook-up" of data for the radio fan:
 Trouble Shooting Chart
 Complete New List of Broadcasting Stations.
 Log Chart—and details of newest apparatus and hundreds of Exceptional Radio Values on our **MONEY BACK GUARANTEE**

From bus bar to the finest multi-tube set, we carry one quality—**THE FINEST!** EVERY article represents 100 cents worth of value for every dollar you invest! **EVERYTHING** purchased from WRS is guaranteed! Your Money is still YOUR Money until you are thoroughly satisfied in every way.

WRS IS HEADQUARTERS FOR KITS
 Cockaday Super
 Cockaday D. X.
 Ultra-dyne
 Roberts' Knock-Out
FREE A postal brings you this radio guide, costs you nothing. Write for it TODAY. Room 108

EVERY STANDARD RECEIVER

Neurodyne
 Superdyne
 Pressley Super
 Rasia

WHOLESALE RADIO SERVICE CO.

ROOM 108 6 CHURCH ST. NEW YORK CITY

5 TUBE GUARANTEED RADIO

BIG POWERFUL MIRACO ultra 3

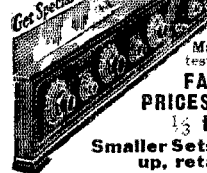

Users everywhere report it gets programs coast to coast, Canada to Gulf, loud and clear on speaker! outperforms \$100 to \$200 sets. Many near Europe. Marvelous value. Let users' testimony convince you.

FACTORY PRICES—SAVE 13 to 15

Smaller Sets \$13.75 up, retail

FREE! Literature on latest 1 to 5 tube models, new low prices and SPECIAL OFFERS! (Agents, Dealers, Write)

MIRACO RADIO GETS 'EM COAST & COAST

Midwest Radio Corporation

Pioneer Builders of Sets

526 B-E 8th St.

Cincinnati, Ohio

RARE GAS AND HIGH VACUUM LABORATORIES

Neon, Helium, Argon, etc.

We specialize in construction and development of all types of special thermionic valves, Neon glow lamps, Neon arc lamps, Mercury arc lamps, hot cathode and gas filled rectifiers, tubes utilizing the alkali and alkaline earth metals, and photo sensitive apparatus.

We supply testing apparatus for capacity and resistance measurements using neon lamps. Safest and quickest method.

Also, high vacuum pumps, manifolds, etc., made of lead, lime, pyrex or quartz glass. Special high frequency apparatus for electronic bombardment.

Photo electric cells \$20.00 each. Three electrode potassium sodium tubes \$10.00 each. Complete equipment for high vacuum work installed.

RADIO ELECTRICAL WORKS

Research Division, 23 Union Sq., New York, N. Y.

PATENTS

TRADE MARKS · DESIGNS
 FOREIGN PATENTS

MUNN & Co.

PATENT ATTORNEYS

Associated since 1846 with the Scientific American

640 Woolworth Building, New York City

521 Scientific American Bldg., Washington, D.C.

1310 Tower Building, Chicago, Ill.

633 Hobart Building, San Francisco, Cal.

518 Van Nuys Building, Los Angeles, Cal.

Books and Information on Patents and Trade Marks by Request.

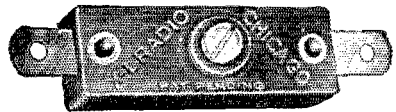

FOR ACCURATE CONDENSER VALUES USE X-L VARIO DENSTERS

The Best Semi-Fixed Condenser Made. Endorsed by All the Leading Radio Authorities.

MODEL N—Capacity range 1.5 to 20 micro-micro-farads, for balance in Roberts two tube, Browning-Drake, McMurdo Silver's Knockout, Neurodyne and tuned radio frequency circuits.

MODEL G—Two capacity ranges, .0016 to .0055 and .0003 to .0015 Microfarads, for the Cockaday circuit, filter and intermediate frequency tuning in super-heterodyne and positive grid bias in all sets.

X-L RADIO LABORATORIES, 2428 Lincoln Ave. N. Chicago



"Windham" Wire Former

(Pat. Pending)

A complete and handy tool for electricians, radio set builders and mechanics. It will accurately form loops or eyes for No. 4, 6, 8 and 10 screws, make easy radius and sharp right angle bends, has flat jaws and wire cutters. This tool is made of the best quality steel, dropped forged and carefully tempered in oil.

We guarantee every tool against defects in workmanship and materials and will promptly replace or refund money on any found defective by purchaser.

Price \$1.25 Each

Ask your dealer
MANUFACTURED BY

THE GOYER COMPANY

Willimantic, Connecticut

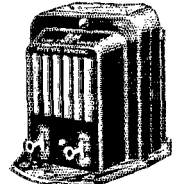

FAMOUS "BH" TRANSFORMERS

BH Vivaphonic (Registered)

A Straight-Line-Frequency Distortionless Transformer. Test curve made at McGill University shown in catalog. A full line of Transmuting Transformers. Ask your dealer for our literature or write us.

BENJAMIN HUGHES ELECTRIC CO.
 298 Lagachetiers St., W. Montreal, Canada
 Transformer Builders Since 1910

SAY YOU SAW IT IN QST—IT IDENTIFIES YOU AND HELPS QST

RADIO AGENTS WANTED

5 Tube Demonstrator FREE!

Earn \$25 to \$100 a week, part or full time. Everyone a prospect. Complete line standard sets and accessories, \$5 to \$90. Write today for illustrated catalog and exclusive selling plan for live dealers and community agents.

20TH CENTURY RADIO CO., 1141 Coca Cola Bldg., Kansas City, Mo

20 QSTs FOR ONLY \$4.00

June, July, 1917; June 1919; May, August, October, November, 1923; May, September, October, November, December, 1924; January to August 1925.

ORDER NOW.

QST CIRCULATION DEPARTMENT
 1711 Park Street
 Hartford, Conn.

**6-VOLT "A"
BATTERY**

Here is the rugged, good-looking Exide 6-volt "A" Battery. One-piece case.

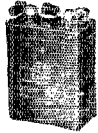

**2-VOLT "A"
BATTERY**

Compact Exide for low voltage tubes. Also made in 4-volt size.

**24-VOLT "B"
BATTERY**

In glass cells, 6000 milliampere hour capacity. Also in 48-volt size.



RECTIFIER



Exide Rectifier for recharging of "B" Battery from your house current.

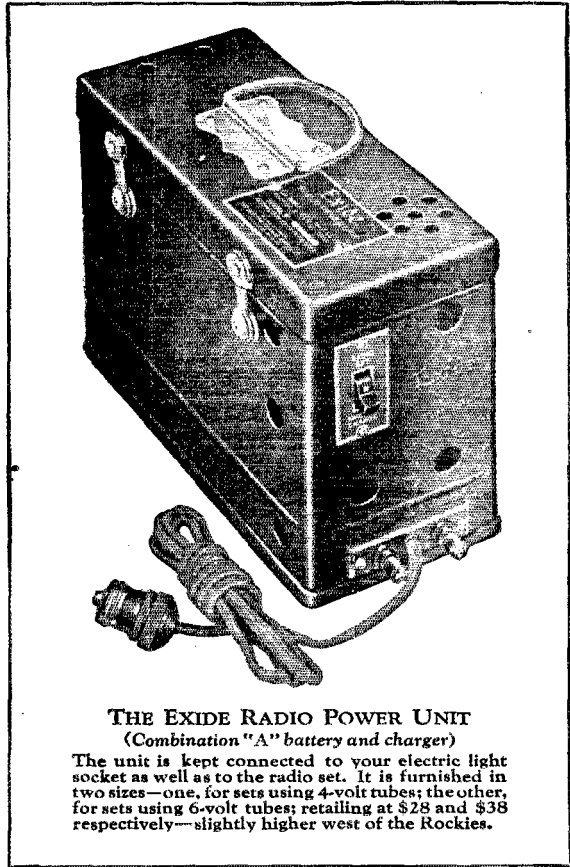

THE EXIDE RADIO POWER UNIT
(Combination "A" battery and charger)

The unit is kept connected to your electric light socket as well as to the radio set. It is furnished in two sizes—one, for sets using 4-volt tubes; the other, for sets using 6-volt tubes; retailing at \$28 and \$38 respectively—slightly higher west of the Rockies.

Range far and near with your radio set

BRINGING in the distant stations, selecting the choice numbers from local programs—in short, getting the most enjoyment from your radio set—is largely a matter of proper current supply.

All the distance, volume, and clearness that an ample, uniform supply of current gives to radio reception are yours when current is supplied by Exide Radio Batteries. There are Exide "A" and "B" storage batteries for every requirement, and a rectifier for recharging "B" storage batteries.

See the complete line at any Exide Dealer's or at your favorite radio store.

Exide

**RADIO
BATTERIES**

THE ELECTRIC STORAGE BATTERY COMPANY
Philadelphia

Exide Batteries of Canada, Limited, 153 Dufferin Street, Toronto

FOR BETTER RADIO RECEPTION, USE STORAGE BATTERIES
SAY YOU SAW IT IN QST—IT IDENTIFIES YOU AND HELPS QST

To Our Readers Who Are Not A. R. R. L. Members

Wouldn't you like to become a member of the American Radio Relay League? We need you in this big organization of radio amateurs, the only amateur association that does things. From your reading of *QST* you have gained a knowledge of the nature of the League and what it does, and you have read its purposes as set forth on page 6 of every issue. We would like to have you become a full-fledged member and add your strength to ours in the things we are undertaking for Amateur Radio, and incidentally you will have the membership edition of *QST* delivered at your door each month. A convenient application form is printed below—clip it out and mail it today.

.....1925

American Radio Relay League,
Hartford, Conn.

Being genuinely interested in Amateur Radio, I hereby apply for membership in the American Radio Relay League, and enclose \$2 (\$2.50 in foreign countries) in payment of one year's dues. This entitles me to receive *QST* for the same period. Please begin my subscription with theissue. Mail my Certificate of Membership and send *QST* to the following name and address.

.....
.....
.....

Station call, if any
Grade Operator's license, if any
Radio Clubs of which a member
Do you know a friend who is also interested in Amateur Radio, whose name you might give us so we may write him about the League?
..... Thanks!

20, 40, 80 METER

Low Loss Coupled Inductances
 PYREX PILLAR MOUNTING } \$3.00
 } EXTRA \$6.75 POSTAGE
 } EXTRA EXTRA
PRICE WILL BE INCREASED SOON!
 Wound with Heavy Brass Ribbon'
 Coupling Easily Varied.
 Panel Mounted Transmitters in
 Stock 5 Watts Up
 QUARTZ CRYSTALS, \$4.00 EACH, FOR YOUR
 CRYSTAL CONTROL TRANSMITTER

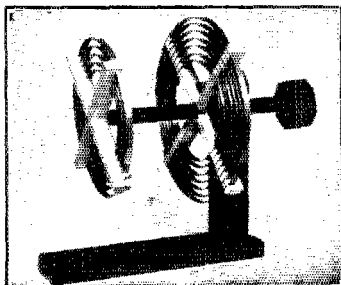

For Personal Calls
Laboratory at 74 Dey St.

FULL LINE PARTS AND TUBES
 ON HAND. WRITE FOR LIST

WAVE METERS 20 TO 200 METERS

\$18.75 POSTAGE
 EXTRA
 Enclosed in High Grade Case
 Lamp with Indicator. Finest
 Material Used Throughout.
 Calibration Accurate within
 1%. Meissner Inductances
 for High Power Phones. \$50
 and \$75 to order.

Address Mail
J. GROSS & CO.
 907 Fox St., Bronx, N. Y. City

HAM-ADS

IMPORTANT NOTICE! NEW RATES ADVANCED CLOSING DATE

Effective with May QST, the HAM-AD Advertising Rates are TEN CENTS A WORD. Name and address to be counted, each initial counting as one word. These rates are shown on QST Rate Card No. 6, in force with the May issue.

The closing date for HAM-ADS is now THE TWENTY-FIFTH OF THE SECOND MONTH PRECEDING DATE OF ISSUE. For example, all HAM-ADS for the June issue must be in this office not later than April 25.

Hereafter no HAM-AD will be accorded any particular or special position.

Rates for the QRA Section remain the same; 50c straight. See heading of that section for details.

MOTORS—New G.E. $\frac{1}{4}$ HP \$12.50, $\frac{1}{2}$ HP \$28.50, 1HP \$45. GENERATORS—Radio Transmission 500 V \$28.50, Battery Chargers—Farm Lighting generators all sizes Lathes, Drill Presses, Air Pumps other Garage and Shop equipment. Wholesale Prices. New Catalog. MOTOR SPECIALTIES CO., Crafton, Penna.

TELEGRAPHY—Morse and Wireless—taught at home in half usual time and at trifling cost. Omnigraph Automatic Transmitter will send on Sounder or Buzzer unlimited messages, any speed, just as expert operator would. Adopted by U. S. Govt. and used by leading Universities, Colleges, Technical and Telegraph Schools throughout U. S. Catalog free. Omnigraph Mfg. Co., 13M Hudson St., New York.

\$2.95 ——— OUT AT LAST!
"The Hawley." An alkali un-acid rechargeable "B" storage Battery of 22½ volts. Not an un-assembled battery but ready to use—no extra parts to buy. Uses the largest sized tested Alkaline elements (Edison). Heavy closed top glass cells. Chemical electrolyte included and shipped separate. Any detector or amplifying voltage easily had. Special offer. 4-22½ volts (80 volts) \$10.00; 12½ volts \$12.50; 135 volts \$14.75; 157½ volts \$16.80. For those wishing to put their own together buy the knock-down kits. Put up in all voltages at still greater savings in price. The only battery of its kind sold on a 30 days trial with complete guaranteed satisfaction or your money returned in full without any ifs, ands, or buts. Further guaranteed 2 years. Order direct—send no money. Simply pay expressman its cost plus the small carrying charges. Patent pending. Same day shipments. Write for my guarantee testimonials and literature. It's free and it's interesting. Complete sample cell 35c prepaid. B. Q. Smith, 31 Washington Ave., Danbury, Conn.

G. E. MOTORS, 110v. 60 cyc. 7000 RPM. 1/32 HP. List at \$10.50 Special price \$3.50 ea. Twin-R Circuit Breaker, Trip and Re-set buttons, adjustable around 10 amps. \$2.50 ea. AMRAD No. 2834 Send Receive Switch \$5.00 ea. No. 2796 Lightning Switch mounted on porcelain posts, \$1.50 ea. No. 3650 Basket-Ball Variometer \$1.50 ea. No. 4000-1 "S" Tubes. Lowest Prices. UP-414 Microphone Transformer \$3.75 ea. UC-1831 Variable Trans-

mitting Condenser \$1.50 ea. Roller-Smith 0-5 amps. Radiation Meter, \$3.75 ea. ALL POSTPAID. Write for AMATEUR'S DISCOUNT SHEET and keep in touch with real Bargains. STATE RADIO COMPANY, 276 Columbia Rd., Dorchester, Mass.

WANTED—Young men learn Radio Operating. Save \$1,000 a year at sea. Free catalog. Sample code lessons free. Write Mass. Radio School, 18 Boylston St., Boston, Mass.

MAKE \$120 WEEKLY IN SPARE TIME. SELL what the public wants—long distance radio receiving sets. Two sales weekly pays \$120 profit. No big investment no canvassing. Sharpe of Colorado made \$955 in one month. Representatives wanted at once. This plan is sweeping the country—write today before your city is gone. OZARKA, 853 Washington B'vd., Chicago.

One Western Electric Power Amplifier, No. 14A enclosed Cabinet Speaker, with three No. 216A tubes. Practically new. List price \$175.00, will sell for \$37.50. M. M. Fleron & Son, Inc. Trenton, N. J.

EDISON ELEMENTS LARGE SIZE WITH CLAMPED ON CONNECTOR 5c PER PAIR. ALL OTHER PARTS CARRIED IN STOCK. 300 AMPERE EDISON A BATTERIES, PERFECT CONDITION \$35.00 GET PRICE LIST. ROMCO STORAGE BATTERY CO., 146 W. 68TH ST., NEW YORK CITY.

COMPLETE PRINTING OUTFITS, presses, type, ink, paper, supplies. Write for catalog. Press Co., C-95, Meriden, Conn.

SELL Jewell Trio, Jewell 1000 Voltmeter, General Radio Laboratory Condenser, Audibility Meter, Wave meter, 550 volt Emerson Motor-generator, 9AAL, 4602a Delmar. St. Louis, Mo. Telephone, Main 326.

SUPERSENSITIVE GALENA CRYSTALS pound \$1.00 prepaid. ALKEMITE, Allsensitive Crystals 50c. Buskett, Chemist, Joplin, Mo.

—Radio Nut's Headquarters—Parts only, no sets. \$20.000 stock. Most comprehensive. If you can't find it, ask us. Weekly latest "dope"—10 wks. 50c. "Change Your Nut" Kit—\$5 prepaid. Particulars—10c. 48 page parts catalog—10c. Kladag Radio Laboratories, Kent, Ohio.

HELIX clips, best imported, no danger, can adjust with 1500 volts on hard rubber insulation 35c. 3 for \$1.00 postpaid. Geo. Schulz, Calumet, Michigan.

WHEN SANTA CLAUS COMES: No. 4000-A "S" TUBES \$10.00. JEWELL 0-15 AC VOLTMETERS \$6.95. 0-500 MILLIAMMETERS \$6.95. THORDARSON POWER TRANSFORMERS 550 each side \$0.95. SPECIAL POWER-FILAMENT 250 WATT 550 each side \$10.50. Pure ALUMINUM square foot 85c; LEAD square foot 85c. NEW UX-210 7.5-WATTER \$8.95. APEX 5-WATTERS \$3.00. "HAM-LIST" 3c. CURTIS-GRIFFITH. 5AQC-51F-5RV, 1109 EIGHTH AVENUE, FORT WORTH, TEXAS.

COMMERCIAL RADIO TRAFFIC MANUAL—The only publication covering all details of modern radio traffic handling. Improve your ham operation and prepare yourself for a commercial berth. One dollar from Howard S. Pyle, 1922 Transportation Building, Chicago.

200-20000 METER RECEIVER including Radiotron \$25.00. Two step amplifier \$15.00. Smith, 1416 Market St., Philadelphia, Penn.

General Electric 24/1500 volt .233 ampere 6000 RPM ball bearing dynamo new \$45. slightly used guaranteed perfect \$25. IDEAL FOR BATTERY PLANTS. \$28. with shaft extension for belt drive equally as satisfactory. Crocker Wheeler 24/1500 volt 450 watt 6500 RPM 100 segments \$45. used \$35. GE 12/350 volt .143 ampere with filter \$18. Holtzer-Cabot 12/500 volt .07 ampere \$18. 10 volt 20 ampere new storage batteries in case \$7.50 Navy keys with blinker \$2.00 prepaid. 500 cycle motor generators etc. Henry Kienzle 501 East 84th Street New York.

FOR SALE: Weston meters, Brandes & Western Electric Phones, Radiola II; Western Electric Amplifier, Audio Frequency Transformers, Phonograph attachment; R.C.A. Tubes, transmitting and receiving, other goods. Send for list. Robert T. Searing, 1213 Gray Ave., Utica, N. Y.

BALLAST TUBES MADE BY W E, AND G E BRAND NEW IN CARTONS. WONDERFUL RESISTANCE TO CONTROL "A" CURRENTS. WILL PASS 1 1/2 AMPS. ON SIX VOLTS. 50c EACH OR THREE FOR \$1.00. MODERN RADIO, 1903 NORTH 18TH ST., PHILADELPHIA PENNSYLVANIA.

MOTOR GENERATORS, Emerson 1000 volts, 400 watts, motor 110 volts AC, A1 condition, \$75. Abe Lincoln, 5400 Gaston Ave., Dallas, Texas.

WANTED light manufacturing and experimental work. Prices guaranteed to be cheapest in America. Send models or drawing for quotations. Mele's Mfg. Co. Station A, New Haven, Conn.

For Sale: One 550 volt 150 watt Robbins & Myers motor-generator, uses 110 volt 60 cycle, \$28.00. Also one Acme CW 550-750 volt 200 watt transformer, uses same power, \$10.00. C. Lundblad, Clarion, Iowa. 9CME

EDGEWISE wound copper ribbon, the only really satisfactory antenna inductance. 350" wide; 3 1/4" outside diameter 10c turn; 4 1/4" 13c turn; 5 1/4" 15c turn; 6 1/4" 17c turn; 7 1/4" 20c turn, prepaid any number turns in one piece; Geo. Schulz, Calumet, Michigan.

SIMPLIFIED 8 TUBE SUPERHETERODYNE, semi-assembled, can be completed in one hour. Very powerful, compact, no rheostats, foolproof, write for proposition. Barnes & Worden, Islip, N. Y.

OMNIGRAPHS, Bought, Sold and Traded. Ryan Radio Company, Hannibal, Missouri.

FOR SALE. One Acme 2000 watt transformer, Kenotron winding burnt out. Cheap, \$10.00. SACW, West High School, Akron, Ohio.

FOR SALE—Navy Holtzer Cabot dynamotors 10/500 output \$25. General Electric Navy 24/500 volt dynamotors \$45. All generators guaranteed new. Western Electric Navy Submarine Chaser CW936 outfits complete with tubes wired for CW-ICW. Phone brand new first \$200 takes it. Navy long wave receivers type CN240 range 1000-10000 meters \$70. United States Army Signal Corps receivers 50-200 meters, original cases \$75. 8 tube Superhetrodyne receiver 100-600 meters beautiful outfit \$125. Esco motor generator outfit 60 cycle drive—100 volts 1 kilowatt output \$200. Western Electric tubes from 1/2 kW to 5 watt tubes. RCA 204 tube brand new \$92.00. All kinds of Navy precision wave meters at \$75. Weston meters 20% off list. Grebe CR13 brand new \$50. Also CR6—150-1000 meters. List price \$200—original case \$85. All types Navy receivers—All kinds of transmitting supplies. Advise your requirements. Save money. 2AGD, 1515 Eastern Parkway, Brooklyn, New York.

DEALERS — WE CAN SUPPLY YOU IMMEDIATELY with AMRAD 8 tubes, MERSHON condensers, THOR-DARSON CW apparatus, ESCO, & Etc. at standard discounts. Locust Radio Company, 117-19 168th Street, Locust Manor, L. I.

ROICE 5-WATT DX BABIES \$3.00. CURTIS-GRIF-FITH, FORT WORTH.

TUNGAR CHARGERS. New models \$15.50. Fox, 887 Longwood Ave., New York City.

EDISON ELEMENTS for Absolutely Quiet, Clear, Dependable, and ECONOMICAL Reception. Large size type A ELEMENTS ELECTRICALLY WELDED to Pure strip NICKEL CONNECTORS. Beautiful Cabinet ENGRAVED PANEL with CHARGE-RECEIVE switch binding post for taps, etc. Glass Cells. Hard Rubber Separators. CHEMICALS, SEALING OIL, Everything for that 100 VOLT EDISON "B" 1500 MILLI-AMPERE \$10.75. EDISON ELEMENTS type A Per Pair 4 cents, Drilled 5 cents. ELECTRICALLY WELDED to Pure strip NICKEL CONNECTORS 6 cents, Separators Included. 2 positive 1 Negative Welded, Including Separators, 7 cents; 3 positive 2 Negative Welded, Including Separators, 10 cents; PURE NICKEL WIRE No. 20 B.S. per foot one cent; CHEMICALS for 5 lbs. ELECTROLYTE 70 cents; Complete Sample Cell postpaid 35 cents. FREE HOOK UP. MARTIN COMPANY, 1843 West Van Buren Street, Chicago, Ill.

TEST TUBES 3c. COMMON CHEMICALS FOR MAKING SOLUTION. 65c. PEPP0 \$1.25. PEPP0, 1695 TAYLOR AVENUE, DETROIT, MICHIGAN.

RADIO SPARK TRANSMITTERS 75 WATT PORTABLE MADE FOR U. S. ARMY AIRPLANES. WAVE-LENGTH 100-300 METERS. CAN EASILY BE CONVERTED INTO SPARK COIL CW TYPE. PRICE \$3.00 EACH. MODERN RADIO, 1903 NORTH 18th ST., PHILADELPHIA, PENNSYLVANIA.

ISOLANTITE SOCKETS THAT FIT 5 WATERS, 201As AND THE NEW X TUBES ONLY 60c; 5 WATT AND 201A GLASS SOCKETS 40c; Wabner straight line frequency glass enclosed condensers .000356 mid only \$2.95 here. Thordarson 5 watt power and filament transformer \$6.75; Bremer-Tully new short wave tuner with four interchangeable coils; tines from 12 to 200 meters, \$8.00. Schnell used National Transmitting Condensers on NRRL. We have 'em—National .00015 mid, for use on powers up to 50 watts complete with vernier dial \$7.00. Some buy! AND SAY OH, OUR ILLUSTRATED CATALOG CONTAINS DOPE ON BUILDING POWER, FILAMENT AND MODULATION TRANSFORMERS, CONDENSERS, REACTORS, ETC. BETTER SEND FOR IT. THE HAM SHOP, 501 RUSTON, LOUISIANA.

WANTED SYNCHRONOUS RECTIFIERS. 9BOK.

THE NEW HAMALOG IS OUT, THE FINEST ASSORTMENT OF AMATEUR TRANSMITTING AND RECEIVING PARTS TO BE HAD, BESIDES VALUABLE DOPE ON CONSTRUCTION, OPERATION, AND CARE OF AMATEUR APPARATUS. DISCOUNTS TO BONA FIDE RADIO DEALERS. Lots of new listings, such as Pyrex 7" insulators \$1.50, 12" \$3.50, Pyrex lead-in bowls \$1.50; Findlay 6 3/4" stand off insulators 50c; The old standby, 20" Sure Fire porcelains \$1.00; No. 12 enameled wire \$6.90 per 1000', 75c per 100'; No. 14 enameled \$5.00 per 1000', 55c per 100'; Edgewise wound copper strip, excellent quality, 4" inside diameter 10c per turn, 6", 12c per turn; Best clips made for flat strip, 20c; Complete inductances, like RCA, only \$7.50; RENT AN OMNIGRAPH, EITHER 15 OR 5 DIAL, AT VERY LITTLE COST. SEND FOR THE TERMS: Plenty 8 tubes in stock \$10.00, sockets 90c; Bremer-Tully short wave plug-in Ham tuner \$8.00, B-T condenser, 7 plate \$4.25; Eria 1000 cycle Ham audio transformers \$6.50; 1/16" rectifier aluminum 75c per square foot, lead 90c; UC-490 1 mfd. 1750 volt filter condensers \$2.50; UC-1014 3000 volt .002 mfd. grid and plate condensers \$2.50; UP-1719 5 watt grid leaks \$1.10, Ward-Leonard 5,000 ohm grid leaks for big tubes, \$2.45; STILL A GOOD SUPPLY OF UC-1831 4000 VOLT MERCURY VARIABLE TRANSMITTING CONDENSER ONLY \$1.80, formerly \$9.00; Cardwell transmitting condenser, 8000 volt .00045 mfd. \$15.00; National variable transmitting condenser .00025 mid., with 4" National vernier dial, \$11.50, a real buy; SPECIAL, Signal key and sounder sets, can be used to make a high voltage break relay, at less than a key alone, only \$1.50; NEW UX-210 7 1/2 watt RADIOTRON, \$9.00, UX-216-B RECTRON (KENOTRON), \$7.50, UV-208 RADIOTRON \$30.00, UV-203-A RADIOTRON \$38.00, UV-217 KENOTRON \$26.50; 50 watt sockets \$2.50, Garod pry sockets \$1.50; General Radio 247-W wavemeters, 150-500 or 200-600 meters \$10.00, 1/2 and 1/4 wave coils \$3.00 extra; Thordarson filament transformers, 80 watt \$7.00, 150 watt \$10.00, 300 watt \$15.00, plate transformers, 100 watt \$13.00, 450 watt \$18.00, 900 watt \$30.00, special plate and filament transformer for one 5 watter, \$7.50; All popular sizes of Acme chokes; Hallantines Radio Telephony for Amateurs, \$2.00; Jewell meters, thermo-ammeters \$12.00, milliammeters and AC voltmeters \$7.50; 284-W microphones \$3.75; magnet wire from No. 10 to 30 DCC; R-48 Signal keys \$2.80, R-62 keys, 1/2" contacts \$3.50; General Radio No. 260 supporting insulators 25c, get a box of 10; Transformer iron 1lb per pound plus cutting charge, any size straight pieces, include money for postage, please, or we'll ship C O D if you wish. Order from a real Ham store for service, and get the HAMALOG, the only real Ham catalog. FREE. E. F. JOHNSON, 9ALD, Waseca, Minn.

FOR SALE—Ten watt transmitter complete mostly RCA parts. Forty dollars. 9AD, Plymouth, Illinois.

Input and Intermediate Transformers for Superhet, \$1.00 per set of four. Charles Kaps, 306 Engineers Bldg., Cleveland, O.

LOT new receiving parts for sale at bargain prices. Send for list. Amrad tuner and two step \$20, one tube Honeycomb \$8, McKenna, 30 W. 65th St., New York City.

WHY USE A LOOP AND THEN RUN THE LIGHT LINES RIGHT INTO YOUR SKT? ELIMINATE THE RACKET WITH AN ISOLATED POWER PLANT

PLATE SUPPLY—AN 8ML. LIFETIME NICKEL—ALKALINE EDISON B. ELECTRICALLY WELDED SOLID NICKEL CONNECTORS (NOT SHREDDED TIN CANS). 54 VOLT \$8.25. 100 VOLT \$15.00. OTHER SIZES. OAK CABINET. LARGEST ELEMENTS. REAL EDISON SOLUTION. A BIG 2000 MILLIAMP HOUR B FOR THE MULTITUBE SET, 105 VOLTS \$24.00. CELL PARIS 17c. DRILLED 19c. ASSEMBLED CELLS 24c. QUANTITY DISCOUNTS. EDISON A ELEMENTS 5c. WELDED PAIRS 7½c. A NEW SUPERCELL 4000 MILLIAMP HOUR 40c. SAMPLE 50c. ANNEALED TEST TUBES ¼"-3c, 1"-4c. SHOCKPROOF JARS 1 x 6-4c; 1½ x 6½-5c. PUREST SOFT .032 NICKEL 1c ft., .034 (HEAVY) 1¼c ft. RUBBER SEPARATORS ½c. REAL EDISON ELECTROLYTE (THAT'S NO LYE) LITHIUM COMPOUND \$1.25 MAKES 5 LBS. WILLARD COLLOID—A REAL B CHARGER, 50 VOLTS \$2.00. JUMBO \$3.00. 100 VOLT FULLWAVE \$4.00. JUMBO FULLWAVE \$6.00. BRING YOUR AERIAL UP TO QST SPECIFICATIONS WITH NO. 12 SOLID COPPER ENAMELED AERIAL WIRE, 75c 100 FT. PYREX INSULATORS. A NEW QST LEAD-IN. BOWL TYPE PYREX, NOW \$1.50. ANYTHING YOU NEED, NOT PRICED TO SELL BUT TO SERVE. FRANK M. J. MURPHY, 4837 ROCKWOOD ROAD, CLEVELAND OHIO.

Motor generator 500 volts \$50.00. Acme 200 Watt Transformer \$12.50. 2 PR535 Rheostats \$2.00 each. 2 power rheostats \$1.50 each. UC1831 Condenser \$4.00. 2 sockets 50 cents each. 2 gridleaks 5000 Ohms 75 cents each all above practically new. Box 602, Abilene, Texas.

SELL—Fifty watter station, fifty watter meters, receiver and all necessities, fifty dollars. Write Allen Pennybacker, Coshocton, Ohio.

ALSO have \$5 ASSORTMENTS. R. P. BARROWS, 4-6 Columbia Rd., Portland, Maine.

HAM MAILORDER COMPANY and STOCK FOR SALE. INVOICE. PRICE. ETC. 25c (Nothing Free). Box CG, CARE "QST."

A REAL RECEIVER. A REAL TRANSMITTER AND A GOOD ANTENNA. WHAT MORE WOULD YOU WANT? WE CAN SUPPLY THE STUFF. FROM ANTENNA TO GROUND. OUR EQUIPMENT IS NOW USED BY SOME OF THE LEADING AMATEUR RADIO STATIONS ALL OVER THE COUNTRY. IF IT'S HAM RADIO WE CAN HANDLE IT. WE BUILD TO ORDER ANY EQUIPMENT. RECEIVERS, TRANSMITTERS, WAVEMETERS, STANDARD OSCILLATORS, Etc., JUST MENTION THE STUFF. OUR QUOTATIONS WILL FOLLOW. SPECIAL EQUIPMENT TO ORDER. LET US HAVE YOUR EXPERIMENTAL WORK. ANY WAVELENGTH. WE SUPPLY PYREX INSULATORS, ESCO MOTOR GENERATORS, THORDARSON, ACME POWER TRANSFORMERS, POWER TUBES, CHOKES, INDUCTANCES FOR ANYTHING, RECEIVER OR TRANSMITTER. OUR POWER CONTROL PANELS MAKE A REAL STATION. EVERYTHING ON ONE PANEL TO CONTROL ENTIRE STATION. RECTIFYING UNITS. FOR THE HAM CATERING TO THE BROADCAST GAME WE SUPPLY THE HIGHEST GRADE BROADCAST RECEIVERS. DISCOUNT TO THE GANG. IF THE SUPER-HETERODYNE WON'T PERK. DON'T FORGET THE EXPRESS COMPANY IS STILL IN BUSINESS! WE BUILT ONE OF THE FIRST SUPER-HETERODYNES TO WORK BELOW 50 METERS. OUR SHORT WAVE RECEIVER WILL COPY DX THAT IS SATISFACTORY. PRICES ON REQUEST. RANGE FROM 5 TO 150 METERS OR HIGHER. WE WIRE INTO ANY SET. YOUR PARTS IF YOU WISH. IF IT'S HAM LET'S HAVE THE DOPE. ANYTHING TO ORDER OR FROM STOCK. FOR THE BEST IN THE GAME DROP US A LINE. ESTIMATES GLADLY FURNISHED. GET QSO. THOS., ENSALL (ENSALL RADIO LAB.,) 1208 GRANDVIEW AVE., WARREN, OHIO. (Designers of High Grade Amateur and Broadcast Equipment.)

TUBES BRITISH OSRAM TYPE C MANUFACTURED BY BRITISH GE COMPANY BRAND NEW IN CARTRONS. THESE TUBES ARE THE FINEST FOR RESISTANCE, COMPLED. ALSO FOR INTERMEDIATE AND AUDIO FREQUENCY. CONSUMES SIX VOLTS ½ AMPERE. VERY GOOD AND CLEAR. 75c each. MODERN RADIO 1903 NORTH 18TH ST., PHILADELPHIA, PENNSYLVANIA.

"9DIP selling out, ten watt apparatus cheap." SAY YOU SAW IT IN QST—IT IDENTIFIES YOU

For Sale: One new Western Electric 14A Loud Speaking Outfit with tubes; forty-five dollars. Kenneth Downs 815 North Lombard Avenue, Oak Park, Illinois.

GALVANOMETERS—Tangent type. For the particular amateur. Used wherever there is an electric current. \$1.65 cash. Particulars if desired. Delta Instrument Company, 1021 South 24th Street, Fort Smith, Arkansas.

DON'T READ THIS—Government QSLs printed like YOU want 'em—Black \$1.90—Two color—\$2.40. In lots of 100—9DOA.

GREBE "13" \$39.50; Grebe "3" and Rord \$39.50; W. E. Power Amplifier and Loud Speaker \$35.00; Key \$1.00; UV202 (used) \$2.00; CW936 FILTER AND METER \$15.50; 220 volt DC ¼hp motor \$5.00. Ernest Roy, Finderne, New Jersey.

ICIC HAS IT. A BETTER CHEMICAL RECTIFIER SOLUTION MATERIAL—NO BORAX. MORE EFFICIENT, CLEANER, LESS ATTENTION. TRIAL PACKAGE FOUR BITS. 123 BLUE HILLS PARKWAY, MILTON, MASS.

BARGAINS: Loudspeakers for Christmas, all standard makes at greatly reduced prices, also have very attractive prices on all late model Crosley sets—UX210 tubes \$7.85. Naald sockets for same 30c. Write J. Nold, 27 Chestnut Street, Schenectady, N. Y.

DODGE RADIO SHORTKUT KILLS HESITATION

In Reading Transmitted Code HAS PRODUCED RESULTS Unequaled by Any Other Method BEGINNERS HAVE REPORTED Mastered Code in 15 to 45 Minutes and Qualified for License by 3 to 10 Hours Total Practice in Short Sessions. FAILURES HAVE REPORTED After Few Days with our Method Passed Examination and Obtained License HAMS HAVE REPORTED Increased and in Some Cases Doubled Receiving Speed by Few Hours Attention REPORTS from 200 Licensed Students on request. U. S. and Canada \$2.50 Elsewhere \$3.00 DODGE RADIO SHORTKUT, Mamaroneck, New York.

FREE—One year subscription to a "HAM" MAGAZINE or a RADIO CALL BOOK with each order. AMRAD No. 4000-1 S tubes, receptacles FREE; \$10.00 prepaid. Five tube tuned radio frequency sets; \$32.50. Write. AGENTS WANTED. Locust Radio Company, 117-19 168th Street, Locust Manor, L. I.

SILICON Transformer Steel cut to order, .014", 10 lbs. 25 cents, 5 lbs. 30 cents, less than 5 lbs. 35 cents, 4 cubic inches to lb. .007" for radio frequency transformers. 50c cubic inch, postage extra. Geo. Schulz, Calumet, Michigan.

CLEVELAND HAMS: Complete 50 watt transmitter \$60. 8AVT.

EDISON 6 VOLT STORAGE "A" BATTERIES. PERFECT CONDITION. NEW ELECTROLYTE AND SHIPPED TO YOU FULLY CHARGED READY TO USE. TYPE B-2, 37½ AMPERE \$8.00. TYPE J-3, 48 AMPERE \$10.00. TYPE J-4, 67½ AMPERE, \$14.00. TYPE A-5, 187 AMPERE \$24.00. TYPE A-6, 225 AMPERE \$29.00. ONLY A FEW OF EACH TYPE SO ACT QUICK. SHIPMENT BY EXPRESS ONLY. PRICES ARE F. O. B. PHILA. J. ZIED 530 CALLOWHILL ST., PHILA., PA.

WESTERN ELECTRIC TRANSFORMERS. Same as used in 7A amplifier. Tapped first stage and two push-pull. \$18 set. Acme 200 Watt transformer New. Mounted, \$14. Two Mershon condensers Used \$5 each. 10D Loud speaker like new \$30. 10D Used \$20. Dr. P. L. Small, 738 Lexington Ave., New York.

BUILD your own "B" battery. Lasts a life-time. Use my large size Edison Elements with welded connections. 07½ cents a pair postpaid. Separators ½ cent each. I select good live elements and WELD two pure nickel wires on each negative element and one weld on each positive. This connection never becomes noisy. Can also furnish complete batteries, sample cell 10c. Paul Mills, Woodburn, Oregon.

U. S. NAVY RECEIVING SETS. C. N. 239-1000-10, 000 M. (Tuner only) C. N. 208-250-3100. M. (Tuner only) S. E. 350. 300-3000 M. complete. Priced for quick sale at \$51.50. Sets are in perfect operating shape. Send stamp for our new list of U. S. Government Radio Apparatus, Bargains, WELLS' CURIOSITY SHOP, 20 South 2nd St., Philadelphia, Pa.

THORDARSON 650-VOLT POWER-FILAMENT TRANSFORMERS for 5-WATERS \$6.90 Postage 25c. CURTIS-GRIFFITH, FORT WORTH.

"EVERYTHING FOR THE HAM." No. 12 "DYNEX" SOLID COPPER ENAMELED WIRE. (NOT THE CHEAPEST BUT THE BEST), 1c ft., 500' \$4.75., 1000', \$9.25. No. 10 FOR HEAVY DUTY) 1 1/2c FT., PYREX GLASS TRANSMITTING INSULATORS \$1.50. RECEIVING SIZE, 45c. 1 1/2" LEAD AND ALUMINUM. 90c SQ. FT. "DYNEX" KEM RECTIFIER ELEMENTS, 1" x 1/2", 6c, 1" x 6" 7c, 1 1/2" x 6" 8c. PYREX GLASS SOCKETS \$1.50. FLERON LEAD-IN INSULATORS, \$1.10. ALLEN-BRADLEY RADIOSTATS \$6.50. TYPE E-210, \$4.00. "S" TUBES, WITH BASES \$10.00. No. 16 COPENAMEL LARGER STOCKS MEAN BETTER SERVICE. SUCH LINES AS AGMC, CARDWELL, GENERAL RADIO, JEWELL, NATIONAL CO., RCA, ETC., CARRIED IN STOCK. SEND YOUR ORDERS TO THE "EIGHT THAT PAYS THE FREIGHT." AND DON'T FORGET "DYNEX FOR DX." MBIN, E. J. NICHOLSON, 1407 FIRST NORTH ST., SYRACUSE, N. Y.

"LISTEN HAMS I HAVE ONE THOUSAND DUBILIER FILTER MICA TRANSMITTING CONDENSERS WHICH I HAVE JUST BOUGHT FROM THE GOVERNMENT. .002 CAPACITY YOU CAN PASS 5-AMPS UP TO 5000 VOLTS. COST YOU ONE BUCK. ALSO 500 SPARK TRANSMITTERS 100-300 METERS MADE FOR SIGNAL CORPS CONTAINS ABOVE CONDENSER CONNECTICUT SPARK COIL SPECIAL SPIRAL INDUCTANCE WITH CLIPS AND SPARK GAPS CAN BE USED ON A C.W. SET IN FIVE MINUTES. FORMERLY ADVERTISED IN QST AT \$5.25 MY PRICE TO EVERY FULL BLOODED HAM \$2.75 YOUR MONEY REFUNDED IF DISSATISFED. HAVE ONE KENETRON 50-WATT 3 BUCKS TO THE FIRST BUYER. STILL HAVE SOME W.E. 1-10 MIKE FILTER CONDENSERS 28 AND SOME MORE GENERAL RADIO .00025 27K CONDENSERS ONE BUCK. FEDERAL DESK MICROPHONE \$3.95 50-WATT RHEOSTATS \$2.25. A LOT OF PARAGON NEW STYLE LOW LOSS VARIOMETERS .95 EACH SOME .00025 LOW LOSS CONDENSERS .37. D.K. SUPERHET INPUT AND INTERMEDIATE TRANSFORMERS \$3.50. A LOT OF U.S. TOOL .0005 LOW LOSS CONDENSERS .95 ORIGINAL BOXES. HAVE GREBE CLARIFIERS ORIGINAL CASES REGULAR 30 BUCKS - \$9.95. ONE BUCK TAKES A G.E. MAGNETIC POWER AMPLIFIER INCLUDING 3 TUBES 216-A NEVER USED \$49.95 COMPLETE ORIGINAL CASES. ROLLER SMITH 0-5 D.C. AMMETERS AND 0-10 D.C. VOLTMETERS \$4.80 EACH. HAVE OMNIGRAPH LARGE MODEL WITH TEN PLATES 15 BUCKS. 450-WATT ESCO GENERATOR 1000-15000 VOLTS 110-220 MOTOR 10 VOLT FILAMENT LIGHTING COMBINED YOURS FOR 100 BUCKS BRAND NEW. PYREX LARGE TRANSMITTING INSULATORS \$1.50 SIZE \$1.05. SIGNAL CORPS PORTABLE TELEPHONES TWO OF THEM RIGGED UP TALK OVER FIVE MILES WITH HAND MAGNETO \$3.75 ONLY 700-FT. FEDERAL 100-AMP STORAGE BATTERIES RUBBER CASES BRAND NEW ORIGINAL BOXES \$11.95. PORCELAIN V.T. SOCKETS .16 FOR STANDARD BASE TUBES. HAVE COMPLETE STOCK OF RADIO APPARATUS. IF YOU DO NOT SEE WHAT YOU WANT LISTED WRITE TO ME. BLUEPRINTS ON RADIO BROADCASTING STATIONS SPEECH AMPLIFIERS PROPER CONSTANTS ANY CIRCUIT UP TO 5000 WATTS." 2CAL, 89 LEHIGH AVE., NEWARK, N. J.

COMPLETE Transmitter for sale. Phone or code. Four new tubes furnished. Compact. Portable. Panel Mounted All Radio Corporation parts. First-class throughout Cost \$175.00. Price \$60.00. Gerst, 2674 W. 25th Street Cleveland, Ohio.

SELL—50 wattor \$12.00. Rig and disc off Stahl Sync \$9.50. 6000 volt 1K.W. Transformer \$18.00. Relay-\$2.00. Jewell 0-10, 0-15 T.C.A. meters \$7.00. 0-25 \$15.00. Advance Sync. burnt out motor, \$13.00. American Radio Wave Meter Rheostat for 204, \$4.00. Valley Charger, New, \$13.50. Want U.C. 490 Filters—9CVO.

EDISON ELEMENTS ABSOLUTELY PERFECT LARGE TYPE A 3c PAIR TYPE G 2c PAIR. MODERN RADIO, 1903 NORTH 18TH STREET, PHILADELPHIA.

HAMS: Get our Samples and Prices on Printed Call Cards made to order as YOU want them. BAPY, HINDS & EDGARTON, 19 S. Wells St., Chicago, Ill.

FLINT GLASS INSULATORS, stand over seven hundred pounds strain. The long skinny types. Twelve inches long, one dollar; sixteen inch, one twenty-five; two and one half footers, two dollars; five footers, two fifty. all half inch diameter. D. L. Lusk, Lansdowne, Pennsylvania.

BEST CASH OFFER takes Paragon RA-10 and DA-2. C. E. Seabold, 841 W. DeWald St., Fort Wayne, Ind.

"HAMS" SEND FOR OUR NEWLY PREPARED "HAM LIST." LOCUST RADIO COMPANY, 117-19 168th STREET, LOCUST MANOR, L. I.

Transformers and chokes all sizes new low prices. We carry ham stuff. Write for prices. 9DAL & Company, Arkansas City, Kansas.

BARGAIN—\$35 Vocarola speaker, Baldwin "C." Sacrifice \$15. B. Weiss, 96 Watkins, Brooklyn, N. Y.

EVERYTHING FOR THE RADIO EXPERIMENTER. All standard advertised parts and supplies 20% discount from list price, cash with order. Neon no filament rectifier tubes work on 250 to 400 volts, fifty mil \$4.25, 150 mil \$6.00, 300 volt 100 mil transformer no center tap, primary for 110 AC \$2.95. Fifty henry 100 mil choke \$2.95. Two mid salvaged condensers tested on 220 AC 75c. Blue print for building eliminator from above free. Guaranteed high test type 201A tubes 95c. 5000 ohm non inductive resistance 25c. General Electric 10,000 ohm resistance 50c. Three stage resistance coupled kit without sockets and rheostat \$3.35. Desk microphone \$4.00. Radio frequency kit three low loss coils and three straight line frequency condensers \$7.85. Order anything from us at 20% discount. The Radio Club, Inc., LaPorte, Ind.

For Sale—Transmitter Westinghouse TF, 20 watt, excellent phone and cw, complete outfit including generator etc. Worked coast to coast; fine condition. 8-OM, 915 Sybil Ave., Ann Arbor, Michigan.

PURE ALUMINUM and lead rectifier elements, holes drilled, brass screws and nuts, pair 1/16", 1" x 1/4", 13c, 1 x 6, 15c, 1 1/2 x 6, 17c, 1 1/2 x 6, 19c, single elements half price. Sheet aluminum 1/16", \$1.00. 1/8", \$1.90. Lead \$1.00 square foot all prepaid. GEO. SCHULZ, Calumet, Michigan.

DOLLAR ASSORTMENTS — SPINTITES RHEOSTATS LUGS WIRE SCREWS CLIPS GRIDLEAKS CONDENSERS and other small parts included in our DOLLAR ASSORTMENTS. The biggest value we have ever offered. Send postage two pounds. R. P. BARROWS, 4-6 COLUMBIA RD., PORTLAND, MAINE.

Be sure and see our Ham-Ad in September issue, Jewell Meters, Fleron Stand-off Insulators and Lead-in Bushings, 2500 volt A.C. test filter condensers, high voltage filament and plate transformers, tubes, No. 12 enameled Celoron Bakelite tubing, sizes from one to four inch, Bakelite panels in stock. Bulb type Battery chargers, etc. Write us when you need anything in any quantity and don't forget Parcel Post charges. Discounts to Amateurs. A. R. R. L. and dealers only. Roy C. Stage, wholesale Radio, Burt & Montgomery Sts., Syracuse, N. Y.

FOR SALE—Self excited inductor alternators, 500 to 900 cycles, for plate excitation. Also all kinds of Signal Corps and Air Service radio equipment. Write for price list. Radio Service Shop, 2412 Main Ave., San Antonio, Texas.

ZIED BUILT EDISON ELEMENT STORAGE Ba ARE NOT MAKE-SHIFT AFFAIRS. THEY ARE BUILT FOR SERVICE, ENDURANCE AND CONVENIENCE. NO HUM OR NOISES AND THAT MEANS DISTANCE AND CLARITY. FULLY ASSEMBLED AND WIRED. OAK RACK, ENGRAVED HARD RUBBER PANEL. CHARGE-RECEIVE SWITCH, ELECTRICALLY WELDED ELEMENTS, LID, SEALING OIL, AND REAL CAUSTIC POTASH (NO LYE). 100 VOLT TYPE "A",

\$11.00. 140 VOLT 2000 MILLIAMPER TYPE 3-G. \$18.00. 100 VOLT HEAVY DUTY TYPE 5-G. \$19.50. WELDED TYPE "A" ELEMENTS 5c PER SET. TYPE 3-G WELDED, 6c. TYPE 5-G WELDED, 9c PER SET. DOUBLE SEPARATORS FOR SAME, 1c. $\frac{3}{4}$ x 6" FLAT BOTTOM CONTAINERS, 3c. 1 x 6", 4c. NO. 20 PURE NICKEL WIRE, 1c PER FT. NO. 18, 1 $\frac{1}{2}$ c. CAUSTIC POTASH (NO LYE) FOR MAKING 5 LBS. ELECTROLYTE, 55c. SEPARATORS 1/3c. J. ZIED, 530 CALLOWHILL ST., PHILA., PA.

GENUINE ISOLANTITE SOCKETS FOR 5 WATERS, THE NEW X TUBES, AND 201-A's, SIDE WIPING CONTACTS, AT LOW PRICES, \$0.60 Glass Sockets for all types, \$0.40. Roice 5 Watters for DX, \$3.00. Acme Power Rheostat for 5 Watter, \$1.25. THE NATIONAL TRANSMITTING CONDENSER FOR 50 WATERS AND UNDER SELLS HERE COMPLETE WITH VELVET VERNIER DIAL FOR ONLY \$7.00. SCHELL USED NATIONALS ON NRRL, NUF SAID. Towers Scientific Navy Phones can't be beat at \$2.95. Thordarson Plate and Filament supply for 5 Watters only \$6.75 here. UNIVERNIER STRAIGHT LINE LOW LOSS CONDENSER, .000356 MFD. GLASS ENCLOSED, SPECIAL AT \$2.35. IT'S THE BERRIES ON THE LOW WAVES. Pyrex Glass Transmitting Insulators put that last milliamp into your antenna, \$1.40 each. Receiving Size, .45 each. AND SAY OM OUR CATALOG CONTAINS DOPE ON TRANSFORMER, CHOKE COIL, CONDENSER CONSTRUCTION ETC. IT'S FREE AND BELONGS IN YOUR SHACK ALONG WITH QST. Equipment shipped collect, postage extra. THE HAM SHOP, 501, RUSTON, LOUISIANA.

TRADE G.E. CAT. 40525 MERCURY ARCS. USED, FOR FIFTY WATTER OR 0-200 MILLIAMMETER, ETC. USED. QSL. TEC ASTORIA, OREGON.

IDEAL XMAS GIFTS—A.R.R.L. SWEATER EMBLEMS ARE MADE OF YELLOW AND BLACK HI-GRADE FELT, 5" x 3" DIAMOND @ \$1.00 PP. ERIC ROBSON. 135 JEFFERSON RD., WEBSTER GROVES, MISSOURI.

RADIO PURCHASING BUREAU In game since 1909. Send me your order for prompt service. All standard lines General Radio a specialty. 2JL, 126 Woolsey St., Astoria, L. I.

FOR SALE. New Brandes phones. In original cartons. \$3.50 a pair. All shipments C. O. D. unless money order included with order. ECONOMIC APPLIANCE COMPANY, IRWIN, PENNA.

FORTY-THREE only. THREE CIRCUITS BROADCAST RECEIVERS COMPLETE WITH TUBES AND BATTERIES TEN BUCKS EACH. MATERIAL to rebuild into short wave tuner two bits extra. EARL C. GREEN, HOLYOKE, MASS.

WAVEMETERS, 10 to 100 meters, two coils, individually calibrated. Accuracy guaranteed within one percent. Excellent construction and handy size, with flash lamp, \$12.50 Postpaid. SHORT WAVE COILS, set of four celluloid supported space-wound plug-in coils with mounting for that new receiver, 18 to 250 meters, \$4.00. We build real amateur equipment and carry the supplies you need. Send for list. Seattle Radio Laboratory, 3335 33d Ave., South, Seattle, Washington.

Q R A SECTION

50c straight, with copy in following form only: CALL—NAME—ADDRESS. Any other form takes regular HAM-AD rates.

1AAO—H. H. Cooley, 460 Ward St., Newton Center, Mass.

2MK—E. F. Reynolds, Central Valley, New York.

4PF—Henry I. Middleton, Box 370, Hendersonville, North Carolina.

3PY, Francis Richardson, 507 So. Orange St., Meats.

4PF—Henry I. Middleton, Box 370, Hendersonville, No. Car.

4VD, (ex 8DLZ)—Paul Curtis, Clermont, Fla.

8AL—Frank E. Pelton, Jr., 414 Church St., Herkimer, N. Y.

8AJX—Ray C. Spence, 104 North 3rd St., Columbus, Ohio.

8ARN—Julius C. McCoy, 112 South Main Street, Wayland, N. Y.

8AXA—C. Bruce Hoag, 123 E. Matson Ave., Syracuse, N. Y.

8GK—Cari E. Mielke, 3619 Grenada St., N. S. Pittsburgh, Pennsylvania.

9ATE—Harold W. Armstrong, 7327 Phillips Ave., Chicago, Illinois.

65HS, C.O.L. Sawyer, 3723 Burns Street, Vancouver, British Columbia, Canada.

The following stations belong to members of the A.R.R.L. Headquarters gang. Mail for them should be addressed care A.R.R.L., Hartford, Conn.

1XAQ R. S. Kruse	1KP F. C. Beckley
1BAO R. S. Kruse	1OA R. S. Kruse
1BHW K. B. Warner	1OX L. W. Hatry
1DQ John M. Clayton	1ES A. A. Herbert

NO MORE LOOSE CONNECTIONS

X-L PUSH POST

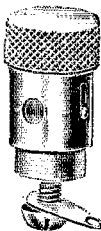

A Binding Post that really does excel, looks, action, service and convenience. Push it down—insert wire—cannot jar loose from vibration. No screwing or danger of shearing off wires. Furnished attractively plated with soldering lug and necessary markings.

Price Each, 15 Cents

X-L RADIO LABORATORIES
2428 Lincoln Ave., N. CHICAGO

HERCULES

AERIAL MAST

We pay freight
Mail the Coupon

20 Ft. \$10. 40 Ft. \$25. 60 Ft. \$45.
All Steel Construction
Complete with
guy-wires
etc.

S.W. HULL CO. Dept. D 2048 East 79th St. Cleveland, Ohio.
Please send free the full details about the "HERCULES" Aerial Mast.

NAME _____ STREET _____



CONNECTICUT TELEPHONE & ELECTRIC CO.

FIXED CONDENSERS

8 Mfd. 350 volts. D. C. Breakdown

These filter Condensers are just what you want for your "B" Battery Eliminator or Experimental Work. The Condensers are made of the best quality of paper and tin foil and each Condenser is sealed in a metal container. They are compact, accurate and mounting brackets are conveniently located for placing anywhere in the circuit.

PRICE ONLY \$1.85 ea.

AMERICAN SALES CO.,
21 WARREN ST., NEW YORK CITY

**EVEREADY HOUR
EVERY TUESDAY AT 9 P. M.**

Eastern Standard Time

For real radio enjoyment, tune in the "Eveready Group," broadcast through stations—

WEAF New York	KSD St. Louis
WJAR Providence	WCAE Pittsburgh
WEEI Boston	WSAI Cincinnati
WTAG Worcester	WWJ Detroit
WFI Philadelphia	WCCO { Minneapolis
WGR Buffalo	WOC { St. Paul Davenport

For radio economy

EVEREADY Radio Batteries are noted for their long service and economical operation. They are made in different sizes and types so that every radio user can enjoy the economy and convenience to be had by fitting exactly the right Eveready to his receiver. Five of the dry-cell types of Eveready Radio Batteries are here illustrated and described to make it easy for you to decide just which will give the longest and most economical service on your set. A dealer near you sells Evereadys.

Manufactured and guaranteed by
NATIONAL CARBON CO., Inc.
New York San Francisco
Canadian National Carbon Co., Limited
Toronto, Ontario

EVEREADY Radio Batteries

—they last longer

No. 764
Portable
22½-volt
Vertical
Price
\$1.75



Eveready
Columbia
Ignitor
"A"
Battery,
the
proven
dry cell
for all
radio
dry-cell
tubes
1½ volts

No. 779
22½-volt
Large
Vertical
Price
\$2.00



No. 486
45-volt
Layerbilt
Extra-
large
Vertical
Price
\$5.50

No. 771
4½-volt
"C"
Battery
Price
60 cents



—FOR YOUR CONVENIENCE—

QST'S INDEX OF ADVERTISERS IN THIS ISSUE

Acme Apparatus Co., The	2	Jewell Elec. Inst. Co.	94
Advance Electric Co.	89	Jewett Radio and Phonograph Co., The	4
All American Radio Corp.	66-78	Kalmus, Comstock & Wescott, Inc.	76
Allen-Bradley Co., The	3rd Cover	Karas Electric Co.	93
American Hard Rubber Co.	82	Kimley Electric Co.	86
American Transformer Co.	69	Kodel Radio Corp., The	90
Amsco Products, Inc.	77	Loomis Publishing Co.	76
American Sales Co.	84-92-96-109	Mario Electric Co.	96
A.R.R.L. Application Blank	104	Martin-Copeland Co.	80
A.R.R.L. Emblem	100	Midwest Radio Corp.	102
Bakelite Corp.	75	Munn & Co.	102
Bluebird Tube Co.	100	National Carbon Co., Inc.	110
Bremer-Tully Mfg. Co.	79	National Company	92
Burgess Battery Co.	67	Pacent Electric Co., Inc.	71
Cardwell Corp., Allen D.	83	Photion Electric Corp.	98
Corning Glass Works	86	Precise Mfg. Co.	76
Crescent Radio Supply Co.	84	QST Back Copies	102
Crosley Mfg. Co.	87	Radiall Co.	78
Cunningham, E. T., Inc.	2nd Cover	Radio Corp. of America	4th Cover
Daven Radio Corp.	85	Radio Electrical Works	102
Davenport Radio Labs.	96	Radio Engineering Labs.	82
Deutschmann, Tobe G.	98	Radio Institute of America	96
Duplex Cond. and Radio Corp.	78	Radio Units, Inc.	90
Eaton, Geo. W.	84	Rajah Auto Supply Co.	72
H. H. Eby Co.	74	Randolph Radio Corp.	70
Economy Radio Sales Co.	98	Raytheon Mfg. Co.	88
Electric Storage Battery Co.	103	Reichmann Co.	1
Electric Research Lab.	88	Sangamo Elec. Co.	74
Eagle Radio Co.	100	Silver Marshall, Inc.	74
Eastern Radio Institute	66	Scientific Radio Service Co.	92
Electric Specialty Co.	72	Stromberg-Carlson Telephone Mfg. Co.	97
Fleron & Son, M. M.	100	Toaz Engineering & Sales Co.	98
Gearhart Schlueter Radio Corp.	82	Troy Radio Co.	88
General Electric Co.	81	Twentieth Century Radio Co.	102
General Industries Co.	86	U. S. Tool Co.	68
General Instrument Corp.	77	Utility Radio Co.	84
General Radio Co.	89	Vibroplex Co.	99
Gischow Co., Otto	101	Westinghouse Elec. Mfg. Co.	91
Goyer Company, The	102	Weston Elec. Inst. Corp.	84
Grebe & Co., Inc., A. H.	112	Wholesale Radio Service Co.	102
Gross & Co., J.	104	Wireless Mfg. Co., The	92
HAM ADS	105-109	Wireless Specialty Apparatus Co.	90
Hammarlund-Roberts, Inc.	95	X-L Radio Labs.	102-109
Helios Battery Co.	72		
Henninger Radio Mfg. Co.	80		
Benjamin Hughes Elec. Co.	102		
Hull Co., S. W.	109		

ALWAYS MENTION QST WHEN WRITING TO ADVERTISERS



A The high-wave reception range of the Grebe dial (B) - from 550 down to 240 meters - equals the practical tuning range of the usual receiver. The low-wave range of the Grebe dial (A) provides additional reception down to 150 meters.

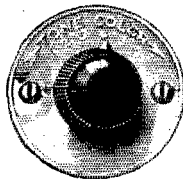

Grebe "Colortone"



Flexible Unit Control
One dial operates two or all three; or dials may be adjusted separately, at will.

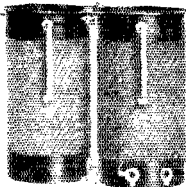

Grebe Binocular Coils
Reg. U. S. Pat. Off.
and
Low-Wave Extension
Circuits

The Three Outstanding Radio Advances of 1925

YOU could not give or receive a finer Christmas gift than the Grebe Synchronphase.

Last year Grebe developed the fieldless *Binocular Coils* and *S-L-F Condenser*. This year even greater strides have been made in radio reception.

With the Grebe "Colortone" the quality of sound can be kept absolutely true and clear and is always under the listener's control, independent of the loud speaker's influence. This tone control also makes it possible to reduce, to a great degree, disturbances due to static and to suppress considerably the high-pitch frequencies caused by heterodyne interference of one station with another.

The *Low-Wave Extension Circuits* have widened the reception range so that over 100 low-wave stations not reached by other receivers can be tuned.

Flexible Unit Control gives one, two or three-dial control.

Both in range and quality of reception, the Grebe Synchronphase is far in advance.

Ask your dealer to demonstrate, then compare Grebe reception with that of other receivers

A. H. Grebe & Co., Inc., 109 West 57th Street, New York
Factory: Richmond Hill, N. Y.
Western Branch: 443 So. San Pedro St., Los Angeles, Cal.



"Take the lead and set an example of diligent toil."

-Confucius

Much toil and great diligence have made the Synchronphase worthy of first rank in radio receivers.

Doctor Mhu

The GREBE SYNCHROPHASE

TRADE MARK - REG. U. S. PAT. OFF.

This company owns and operates stations WAHG and WBOQ; also low-wave re-broadcasting stations, mobile WGMU and marine WRMU

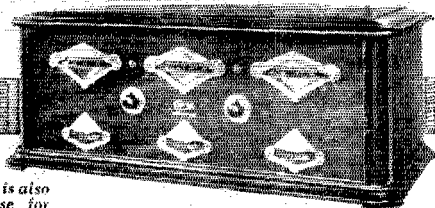

The Synchronphase is also supplied with base for batteries and in a de luxe Console model.



TRADE MARK
All Grebe apparatus is covered by patents granted and pending.

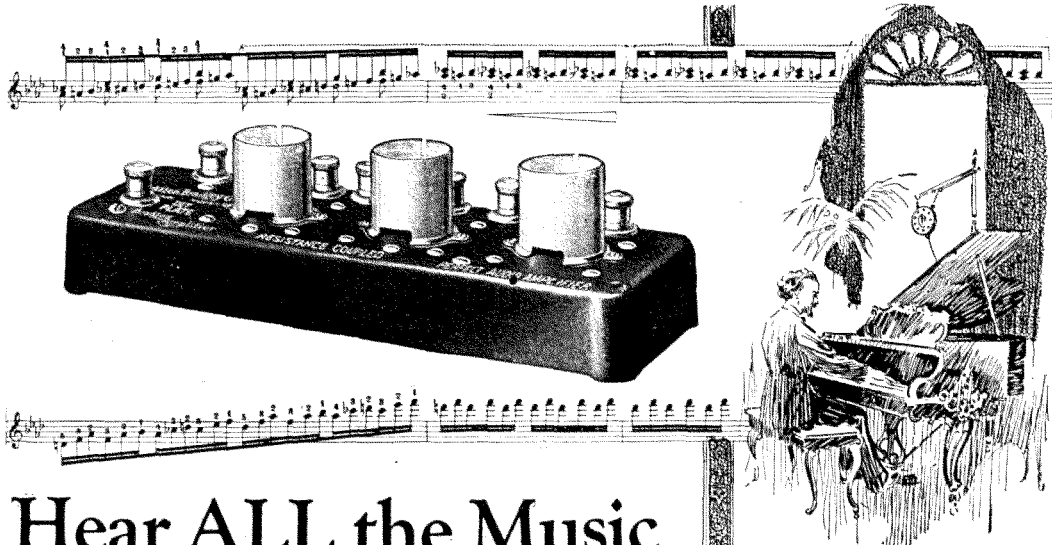

Hear ALL the Music with the Bradley-Amplifier

THE delicate variations and shadings of instrumental music and the exquisite strains of the vocalist are amplified with faithfulness and clarity by the Bradley-Amplifier. It matters not whether you own a factory-built set or a home-built receiver, either will be improved by using the Bradley-Amplifier.

Bradleyunit resistors, that are impervious to moisture and unaffected by atmospheric changes, take the place of the audio-frequency transformers of ordinary amplifiers. There is no distortion and no loss of low or high frequencies. All tones are reproduced with equal facility.

Ask your dealer for the Bradley-Amplifier today and substitute it for your present audio-frequency amplifying transformers. Resistance coupled amplifiers are acknowledged by radio experts to be the most perfect type of amplifier. You can make your set perfect with a Bradley-Amplifier.

Retail Prices—In U. S. A. \$15

—In Canada \$21

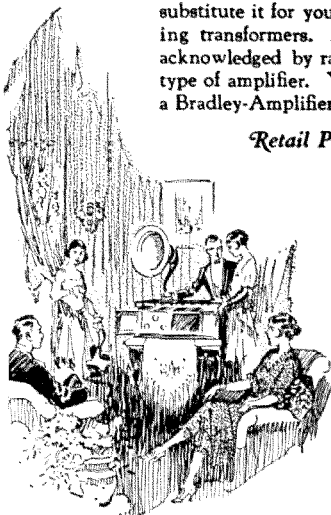

Allen-Bradley Co.
Electric Controlling Apparatus



MILWAUKEE,
WISCONSIN

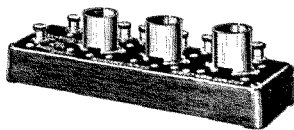

Can be installed within radio cabinet.
UX as well as old tubes can be used.



All resistors, condensers, and wiring,
are concealed within Bakelite base.



Bradleyunit resistor is made of solid
molded material which does not
change with age. All units are soldered.

ALLEN-BRADLEY CO.
277 Greenfield Ave., Milwaukee, Wisconsin

Please send me your latest literature on the
Bradley-Amplifier, explaining how it will im-
prove my receiver.

Name

Address

Mail
the Coupon



No matter what set you buy, be sure the dealer puts in *genuine Radiotrons*:

UV-199	\$2.50
UX-199	\$2.50
UX-120	\$2.50
UV-201-A	\$2.50
UX-201-A	\$2.50
UV-200	\$2.50
UX-200	\$2.50
WD-11	\$2.50
WD-12	\$2.50
WX-12	\$2.50
UX-112	\$6.50
UX-210	\$9.00

Rectrons:

UX-213	\$7.00
UX-216-B	\$7.50

A "UX" or "WX" tube is the same as the corresponding "UV" or "WD" tube, except in the design of the base.

For every Christmas Radio Set use only genuine RCA Radiotrons

READE all the claims of all the makers of radio sets—and then remember this when you buy—that getting what is claimed for a set depends upon the quality of the *vacuum tube* put into it. You cannot get clearness—you cannot get distance—you cannot get volume—unless the *tubes* get it. That is why it is so important to look at the base of every tube, to be sure it is a *genuine* RCA Radiotron.

**A great gift
for any fan — at \$2.50**

A radio fan will appreciate a "spare" Radiotron, just as an autoist appreciates a spare tire. But the Radiotron—a genuine RCA Radiotron—costs only \$2.50. If you note what make of set a man owns, any dealer can tell you which *type* of Radiotron he uses, and you can give him exactly what he would choose for himself.

**for owners of Super-Heterodynes
— the new power tube**

Every owner of a Radiola Super-Heterodyne can bring his set right up-to-date with the latest improvement, if you give him the new dry battery power Radiotron UX-120, and the adapter. The adapter costs but \$1.50. And this new tube means great volume with better tone than ever!

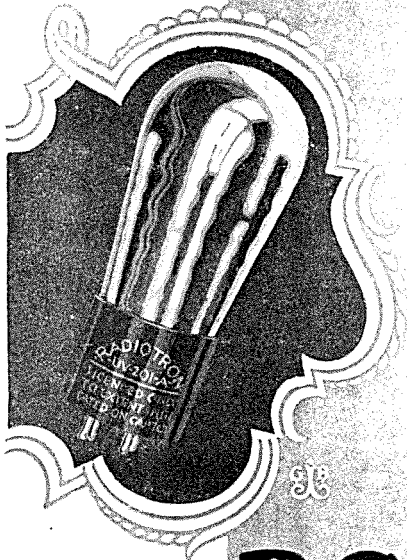

Radiotron
UV-201-A,
standard high-vacuum tube for storage battery sets.

RADIO CORPORATION OF AMERICA
CHICAGO NEW YORK SAN FRANCISCO

RCA-Radiotron

MADE BY THE MAKERS OF RADIOLAS

The Traffic Department

F. E. Handy, Acting Traffic Manager
1711 Park St., Hartford, Conn.

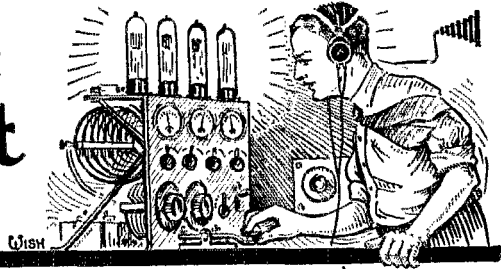

Numbering Messages

Every transmitted message should bear a "number". Beginning on the first day of each calendar year, each transmitting station shall establish a new series of numbers, beginning at "nr 1."

9DTK and 1MK have been using a "number sheet" that is very convenient and useful in keeping the records straight and in avoiding duplication of numbers on messages. Take a blank sheet of paper and put a consecutive list of numbers on it, starting with the current message number. Run the numbers in columns, ten numbers to each column, and leave sufficient space between columns to allow calls to be entered. File your messages without numbers and when you have a station ready to take a message, consult the number sheet (9DTK keeps his attached to the log sheet), assign the next available number to the message, and when the station acknowledges the message, cross off the number, putting the station call after this number and writing the number on the message blank.

This system enables one to always tell what number is next and eliminates guess work and confusion in a station of either one or several operators.

A new number sheet can be made as often as necessary. A sheet that is in use looks something like this:

110*	40A	120	6CGO
111	5AGN	121	11B
112	8GZ	122	1B1D
113	2WG	123	9CAA
114	6RUR	124	4MM
115	4EZ	125	5ZC
116	7NT	126	
117	3BZ	127	
118	9DXY	128	
119	1IT	129	

Number 126 will be the next number originated at the station using this number sheet. A glance at the sheet shows to whom you have given messages. The number of messages originated in a given "message" month may be easily checked at any time directly from the number sheet. Just try a *number sheet* at your station today. Don't forget to start the New Year right by making a new number sheet with a whole new series of numbers, too.

* Bold face numbers indicate those which have been crossed off.

Working "DX"

"As done by some—and too many—hams."
As seen by 4FM.

WE will now sit in with INUT, who is about to do his Saturday night's DX.

Enter INUT. Says, "Ho hum, wonder how the ol' set's perkin' t'night." Sits down, and without even a glance at the receiver, turns on transmitter and calls CQ, sprinkling in plenty of long dashes and V's, ending after twenty CQ's and two signs.

Slams switches right and left and reaches for cans. Loud bangs from receiver. Twists dials frantically. Receiver settled down to work after a couple more minutes of jiggling connections. Starts tuning. "Tweets" past every weak station, stopping occasionally on the louder ones, but taking care not to hear more than one dash or so. Comes to end of range. Remarks: "Huh, funny nobody on tonight." Has taken about ten seconds to go from top of band to bottom.

He says, "Wonder if transmitter is on the blink?" Slams down cans. Turns on transmitter. Lays book on key. Goes outside and pulls out ground switch. Loud exclamations. Finds switch has been on grounded side. Pushes it to antenna side and gets

spark. Plays with spark for minute. Comes back in and remarks: "Now we'll do something." Lights coffin nail and turns off transmitter. Takes book off key. Remarks: "Give 'em another CQ." Slams switches. Pushes key, which stays down. Loud oaths. "Who the devil adjusted this key like this?" Tightens spring until it takes a strong arm to budge it. Explains that "Gotta do that on account of the spark." Pushes key again. Loud P-Z-Z-ZZZT after each push. Spark sounds like it is having a good meal off the contacts. Starts CQ again. CQ's thirty times and repeats for about five minutes. Shuts down and remarks, "If they don't hear that they're crazy."

Grabs cans. Receiver still paralyzed. Thumps tubes. Receiver groans and gets to work. Tunes over a dozen weak stations. Runs across loud CQ. Stops to listen. Remarks: "Try this guy." Loud CQ finishes. Slams switches.

Turns on transmitter. Lays on the key for a minute while looking at the meters. Calls a couple of times and starts to sign. Signs a dozen times and calls some more.

Slams switches, turns to receiver. Not a sound. Thumps tubes. Loud bangs. Tightens loose wire. Signals come in. Loud station now signing. Says, "GE, etc." (mostly etc.). Finishes and signs without calling.

INUT remarks, "Huh, don't know whether he got me or not." Slams switches. Lays on key while generator is starting. Calls and hands back the same line. Slams switches.

Receiver works right off this time. Loud station not heard. Comes on in a minute calling some "9". Loud oaths from INUT. Tunes off. Turns on transmitter. Calls CQ for five minutes. Remarks, "Sure bum night."

Nurses receiver into activity. Hears weak station calling INUT. Remarks, "Huh!" Tunes off without logging dial settings. Hears another weak one calling. Tunes off again. Doesn't hear any more, so returns to where he heard second weak one. Not a sound. Looks for first weak one. Still calling. Signs and quits.

Slams switches. Calls twenty times, signs, and spills, "Ge OM U R7 HR, QRK?" K sending double.

Listens to weak station. Finds he has wrong one. Looks around dial. Finds that large flopping tickler has moved and changed wave. Can't find weak station. Loud oaths. Exclaims: "Why don't somebody invent a receiver that the wave will stay in the same place?"

Turns on transmitter. Calls CQ five minutes. Shuts down and tunes over range in few seconds. Remarks, "Nothing doing tonight, guess I'll hit the hay."

Takes down "Log" for the first time in the evening and scribbles "CQ" and "bum night". Remarks, "Good thing to keep a log." Turns out lights and beats it.

What is wrong with this picture? How many points of operating or set design are in bad taste? Perhaps the question occurs to each of us, "How do I appear to those who sit in at my station?" or "How do my signals and operating get across to those who have to listen and take my traffic?"

Today we are living in the 20th century. We put on all steam and hurry through our daily duties at the highest possible speed. Perhaps if we would "see ourselves as others see us" we might behave differently. All of which is beside the point we want to make.

In following our hobby why not get a more lasting satisfaction by being a bit more leisurely in our labors of construction and operation? Let us try to see *not* how *quickly* we can build our station *but* how *well* we can build it. A little patience and judgment in operating will often do more than many kilowatts.

Report on the June Questionnaire!

JUST before June 1, 1925, each Official Relay Station was sent a long questionnaire. Many requests for information on the results have been made since that date. Because of the pressure of routine work it was impossible for us to spend much time digging out the data comparing a lot of individual stations, even though our file is fairly complete on the subject.

The general interest shown makes it desirable to prepare a table of certain results in condensed form from which everyone can gather such useful facts as may be wanted. We cannot cover here the answers to all the questions that were asked on the questionnaire. However, we can print a table of percentage results that will show our national characteristics with respect to age and education. We can see how we stand as Divisions on matters of schedule keeping, wavelengths in use last June, wavemeters available, and general technical knowledge.

The national return of completely filled out questionnaires was 64%, exceeding our fondest hopes of what might be expected from the Official Relay Stations. The table gives percentage returns so that it is easy to compare the Divisions on the subjects listed at the left of the table.

The average age of our operators is 22.4 years. The majority of our station-owners have a High School education or still attend high school. A very large number are students.

We have gone to the questionnaires for information on a number of subjects. When Signal Corps Officers became interested in us the questionnaires available showed that 17.6% of the fellows were NOT interested in the work. However, 82.4% of the Official Relay Stations signified their enthusiastic approval in answer to the question, "Would you like to handle some OFFICIAL traffic regularly for the U. S. Signal Corps," and so the plan was undertaken.

The questionnaire brought out the disconcerting fact that 16.2% of our Official Relay Stations did not have a wavemeter of any kind available at their station. One of the first instruments any station should have is a wavemeter and it was surprising to us that so many of our picked crack stations were trying to get along without a wavemeter.

From the standpoint of interference alone we should have stations on our different wavelength bands in accordance with the width of the respective bands. 12.5% of our stations should be on the 150-200 meter band, 12.5% should work on the 80 meter band, 25% can easily work together on the 40 meter wavelength. There is room for 50% of our stations on our 20 meter band. The table shows how we were using our different wavelengths in June. You will note that in June we had more than the necessary 12.5% of our stations on the 150-200 meter band, which proportion of stations seems necessary to justify our use of that wavelength. Since June probably a few more stations have decided to use the forty meter wavelength. Possibly the figures shown for the 40 and 80 meter bands have changed places by now.

Perhaps some data on just what the average U. S. amateur uses for transmitting tubes will be interesting.

- 2.8% of the amateurs use a UV201-A.
- 56.3% use the UV202 or some other so-called "aver."
- 34.7% use the UV203A.
- 5.7% use a UV204A.
- .5% use tubes larger than a UV204A.

The answers to the general questions were graded in per cent and Divisional and National averages worked out. Such figures show along what lines technical information is most needed and on what subjects there is best understanding at the present time. We will give a few of the questions with their correct answers.

How can plate input power be measured? Average 63.7%.

Plate input power can be measured with a plate ammeter and voltmeter (D.C. instruments). A wattmeter may also be used if the proper voltage multiplier is available. If an electro-dynamometer type wattmeter is used to measure power in the low voltage side of the plate transformer, the transformer, rectifier, and filter losses must be subtracted from the reading to give the plate dissipation.

Age, (years)	Atl.	Can.	Dak.	Del.	Hud.	M.W.	N.H.	N.W.	Pac.	Roa.	R.Mt.	S.E.	W.G.	Mar.	Ont.	Que.	Vnt.	Wh.	Nat. Ave.
% Grammar School	7.2	4.7	22.7	19.8	32.8	5.6	23.8	20.6	21.2	26.1	24	23.4	22.8	25.6	22.7	27.3	22.4	24	22.4
% High School	55.9	71.8	65.2	75	71.4	50.6	59.3	82.5	76.0	68.3	9.1	72	17.5	28.6	22.2	33.3	21.2	33.3	7.7%
% College	39.9	24.0	27.5	20.3	32.9	32.9	35.3	12.5	23.0	26.8	22.6	33	38.5	50.4	25.9	57	66.5	33.3	64%
Are schedules impractical? % YES	17.4	12.8	20.3	28.5	19.4	10.0	30.0	12.5	15	9.4	21.5	21.9	20.6	25	15.4	14.3	19.2	33.3	17.6%
Are schedules impractical? % NO	82.6	87.2	79.7	71.5	80.6	90.0	70.0	87.5	85	90.6	78.5	78.1	79.4	75	84.6	85.7	100	100	83%
Can you keep schedules? % YES	80.0	73.9	80.5	100	72.0	83.8	77.0	69.7	79	83.3	82.5	91.5	82.70	80.3	77	50	77	50	73.5%
Can you keep schedules? % NO	20.0	23.1	19.5	0	22.3	16.2	23.0	31	21	16.7	17.5	8.5	18	30	10.7	0	23	0	20.5%
% O.R.S. using 20 meter band	3.5	1.9	7.3	0	1.2	4.2	4.8	0	2.2	2.9	3.2	2.1	5.4	30	5.9	0	0	0	8.1%
% O.R.S. using 40 meter band	26.75	39.6	29.3	57	38.7	27.4	39.6	26.1	43.2	28.8	45.2	25	24.2	50	32.8	40	0	0	32.5%
% O.R.S. using 60 meter band	53.4	43.1	43.9	43	46.5	49.3	47.0	67.3	48.5	51.8	28.3	62.5	59.4	37.5	58.0	30	100	25	49.7%
% O.R.S. using 175 meter band	16.8	13.4	4.8	14	18.6	19.1	8.6	6.6	5.9	17.3	23.8	5.4	11.0	12.3	8.3	30	0	78	14.6%
% O.R.S. having no wavemeter	9.6	20.3	4.8	14	2.7	26.2	13.4	38.6	21.5	65	76	60	28.5	72.5	20.7	12.5	7.7	25	16.5%
% O.R.S. having a home-made wavemeter	57.5	50	60.2	57.3	70.0	50.0	47.3	54.5	63.5	33	16	48	28.3	27.5	62.1	75	77.0	25	56.8%
% O.R.S. Having a man fact'd wavemeter	32.8	30	33.5	23.7	33.8	33.3	39.3	6.9	16.0	16	16	28	27.5	17.2	12.5	15.3	15.3	10	19.3%
What is "reactance"?	23.8	11.2	38.3	8.2	15.8	33.1	22.7	6.4	30	31.8	23.2	10	17.4	15.9	6.86	21.8	22.7	10	19.3%
How can plate input power be measured?	61.5	78	64.0	35.6	64.5	71.3	66.0	77	74.5	47.1	52	45.1	65	72.7	52.75	37.5	46.2	62.5	63.7%
What is d.t. bet. ind. & cap. coup.?	33.4	38.7	29.5	37.5	42.5	35.95	36.4	24.1	49.7	42.1	29	44.5	37.6	22.7	33.48	31.2	42.8	12.5	37.7%
How can power in ant. circ. be calc.?	23.7	40.3	21.9	15	23.2	34.1	26.1	17.3	29.8	24.2	16	14.5	14.1	40.9	20.2	37.5	23.1	12.5	27.3%
How many ways of changing coupling	40.3	40.9	47.3	53.1	45.9	42.42	45	52.6	47	41.2	50	29.5	38.6	54.5	89.7	25	53.9	37.5	42.8%
% Average of above five questions	36.64	40.66	39.13	29.83	38.58	37.37	33.04	35.43	44.4	33.12	45.04	41.34	30.38	30.6	37.64	27	37.54	27	37.8%
% Questionnaire Return	75	65.2	66.3	66.6	63.5	65.0	63.7	73.2	53.6	58.7	73.5	57.2	47.4	61.2	80.5	66.6	65.0	67	64.0%

In how many ways may the coupling between two tapped coils be changed? Average 42.8%.

The coupling in such an arrangement may be changed by changing the number of active turns in either coil or by changing the relative position of the coils (distance or angle between them).

What is the difference between inductive and capacitive coupling? Average 85.7%.

Whether the coupling is inductive or capacitive is determined by whether the two circuits are linked by a magnetic or an electro-static field, in short, by whether the link common to both parts of the system is a coil or a condenser.

How can the power in the antenna be calculated? Average 27.8%.

Antenna power may be considered as the input to the set minus the losses in the set. If a resistance curve of the antenna is available, antenna power is (RI^2) where R is the resistance at the wavelength under consideration and I is the current at the center of the radiating system. Some of the fellows answering this question said the antenna power could not be found unless the wavelength was known, which is not strictly true.

What does "reactance" mean? Average 19.2%.

Reactance is the property of a coil or condenser. It is that property depending on the frequency and inductance (or capacity) which determines the behavior of the coil (or condenser) in limiting the current that flows when an alternating current voltage is applied. Reactance is one component of the "impedance". Resistance, the other component is always present in coils and condensers and must also be taken into consideration.

In addition to the questions just mentioned, there were several dealing with operating problems and with the other subjects, all listed on page 51 of July QST. We cannot mention all the peculiar answers that were received to certain questions, amusing though some of them are, as space prohibits.

Over half the stations answered, "Yes, I know what a service message is." Many examples of such messages were given. General conditions were much worse than indicated by the figures, however. A lot of fellows thought a service message was something relating to P.R.R. work. Others answering "yes" thought a death message, or a message of any kind that really performed a service to the public, was a service message. The "service" message was explained for everyone on page I of the Traffic Department section of September QST.

About half the answers received to, "What is an antenna ammeter?" were correct. An antenna ammeter measures the current in the antenna at the point where it is located. The other replies were that an antenna ammeter directly measured "set efficiency", "radiation" and "energy".

Over one-fourth the Official Relay Station owners in the country did the problem on antenna resistance correctly, which was much more than we expected. The efficiency of a transmitter was given as 50%, the plate voltage 1,000 volts D.C., the plate current 200 milliamperes, and the antenna current (at the node) 2 amperes. Again some one thought that the antenna resistance could not be found unless the wavelength was stated. The plate voltage times the plate current gives the plate power. This input power times the efficiency gives the output power from the transmitter or the power in the antenna circuit (this is still another way to calculate antenna power). Substituting the antenna current and this value of antenna power just found in the $(P=RI^2)$ formula the value of 25 ohms is found as the antenna resistance wanted.

The average amateur station uses one "fifty" or two "five" watters.

10% of our Official Relay Station personnel belongs to the U.S.N.R.F.

Many constructive suggestions and criticisms came in with the questionnaire and these have been very valuable in making some changes in Traffic Department procedure. The intense loyalty and interest shown in the Department by those who sent back the questionnaires with the information we wanted helped us all in planning bigger and better things for the A.R.R.L. For your support and activity we thank you.

F. E. HANDY.

Use a Break-In

2PF, 2WC, 2BO, 2BW and 8SF use a "break-in" system. They work together very nicely, but report that other stations are ignorant of "break-in" work and its advantages.

Suppose 8SF has a message for New York City. He calls, "CQ NY u 8SF ar," repeating the call three times. 2PF hears him, answering "8SF u 2PF bk me bk me." When 8SF hears 2PF, 8SF immediately holds his key down and makes some long dashes. 2PF, who is, of course, receiving "break-in" while he calls, stops sending when he hears the dash. 8SF then starts to call in the regular manner saying, "2PF u 8SF ge hr msg QRV?" Then 2PF gives him a "ga OM" and the message is sent without further preliminaries. Since both stations are using "break-in," they can interrupt each other at any time when something goes wrong or a letter is dropped, and traffic can be handled in half the usual time. There is a real "kick" that comes from working a "break-in" arrangement. After the fun is over, there is a wholesome satisfaction in the knowledge of a job well done. Swift, clean-cut operation brings its own reward. What can you say from experience with "break-in" operation? If you haven't had the experience that qualifies you to answer, there's no time like right now to get that experience!

Code Practice Schedules

50I transmits practice code signals from the station at the Ham Shop, Ruston, La. 50I uses one UV203A and an 80 meter wavelength. Every night except Sunday night at 10.00 p. m. Central Time the transmission starts at a rate of five words per minute. Ten minutes later, the speed is changed to eight words per minute. At 10.20 the speed is increased to ten words per minute, which speed is maintained until 10.35, when an increase to a 15 word per minute speed is made. The last part of the sending is done at twenty words per minute, and this begins at 10.40. A short series of numbers and punctuation will be included with disconnected words at the slower speeds. Reception may be checked by sending a self-addressed, stamped envelope to the Ham Shop, who will forward a copy of the transmission used on any specified nights free. Preliminary CQ signals are repeated twice at 9.55 CST.

Traffic Department Information

The Seventh Edition of the Rules and Regulations of the A. R. R. L. Traffic Department is just off the press. An up-to-date list of all the Official Relay Stations is also just in print. It has been corrected to November 1, and gives the call and location of the most dependable of our stations for the help of the traffic-handlers. If you want a list to help in routing your traffic; if you are a bit uncertain concerning the correct message form to use; if you don't understand how to make up a "service" message or to ask for "fills" in a message; if you want to know a little something about A. R. R. L. standard practices or about our Traffic organization, just drop a postal card to Headquarters and ask for a copy of the rules or for the list that we have mentioned. They will be sent you without cost.

Some time ago, g2NB gave 2CPD a message for 410. After acknowledging the message, 2CPD forwarded it by Western Union Telegram. Baguley writes us from England to say that this very conscientious act of a true and sincere ARRL member was much appreciated, and that we are to be complimented on having members like 2CPD. We are sending g2NB our up-to-date list of Official Relay Stations so that he can pick other Official Relay Stations with operators who will do a good job of handling traffic also. We are glad to report that message delivery conditions are showing a steady improvement. Every holder of an ORS certificate is doing his part. If each of us assumes personal responsibility for the accuracy and speed of each message handled we will have just cause for pride in our League as a whole. Do your part, OM.

Our English friends point out that many of our stations fail to work England because our operators use poor judgment. They want us to listen on 45 meters or 23 meters and to reply within our 37.5-42.5 or 18.7-21.4 meter band where they always listen for us. They report U. S. signals good as early as 2.00 p. m. EST, and ask our help so that they can work more stations.

The Traffic Trophy

9DTK gets in the starred rectangle this month. He is out after the Trophy in earnest and he is working hard to handle a bunch of good messages every day to keep him there for two more months. We hear that he has already handled more messages than this for next month.

Fred W. Catel—9DTK
 711 Kenwood Blvd.,
 Milwaukee, Wis.
 Central Division
 Messages:

Orig: 85 Del'd: 45 Relayed: 122 Total: 252

BRASS POUNDERS' LEAGUE Messages

Call	Orig.	Del'd	Relayed	Total
9DTK	85	45	122	252
8EU	8	2	80	167
9BFG	95	8	49	152
9DWH	52	30	60	142
9ATO	74	9	54	137
9CAA	46	15	62	123
9ELT	17	8	76	101

8EU is out after the Trophy, too, and he took second place this month. We think that the competition is going to be interesting about two months from now. All the fellows listed above tried hard for their laurels, and we hope to see them in a prominent place each month. 6BJX sent a bundle of messages through, but they did not arrive at Hartford in time for inclusion in this month's Brass Pounders' League. 1BUO sent us three books of messages handled during August and September. We wish they had come through earlier so we could have counted them for last month. Both 6BJX and 1BUO get honorable mention.

The rules for the Traffic Trophy contest mean exactly what they say. All messages are checked carefully. We threw out some messages received Oct. 12, 4:02 p.m. and relayed Oct. 14 4:44 p.m. (time 42 minutes over 48 hours). 41 messages were thrown out of 9DTK'S total for lack of both city and station of origin.

9CAA got a bunch of his messages by leaving special mimeographed message blanks at the local "dime" store for the use of the customers. We are glad to be able to report that all the traffic sent in for checking was "good" traffic.

We expect that the Brass Pounders' League is back to stay. Can we list your call among those above next month? Read the next paragraph. Then send your messages in to give us a chance.

BACK numbers of QST contain complete information about the Traffic Department Trophy. When you handle over 100 messages in a month be sure to turn them in to your local Traffic Officials who will forward them along to the Division Manager. Division Managers will send bundles of messages to Headquarters each month and one man at Headquarters will count the messages and make up a Brass Pounders' League each month, after which the message file will be returned promptly direct to you. Only messages containing the CITY and STATION of origin, a SUFFICIENT ADDRESS to insure delivery, the TEXT, and the SIGNATURE shall be counted. The date and number are important as the inclusion of a date speeds up the message and the number makes it possible to easily trace the message. The fundamental parts of a message shall determine whether or not it is counted. All messages must be handled in 48 hours or less. If there is any doubt about your messages, send them in and get the credit that is due you.

9APY and 2AKV have a schedule every night at midnight EST. Usually they handle about ten messages each way.

Official Broadcasting Stations

THE attention of the membership is again called to the League's broadcasting system.

The latest news and schedules are made into a broadcast which is sent each operator of an Official Broadcasting Station weekly. The broadcast has a release date slightly later than the mailing date so that the material to be sent can be in the hands of each operator at the beginning of the week of release no matter in what part of the country he is located.

Each station listed is putting the broadcast on the air on scheduled time and wavelength to the best of its ability. The operators of the various stations are willingly giving their time to this work. They will appreciate it if you will drop them a postal card saying that you copied the Official Broadcast Message from them on schedule, and we will be pleased to have any suggestions from you regarding ways of making this service through the Official Broadcasting Stations of more value to you.

Call	Wavelength			Days of Transmission
	(Local Standard Time)	12.30 p.m.	7.00 p.m.	
1ADP	28	Mon. Wed. Fri.
1BEP	42	Tues. Fri.
1CKP	39	Sat. Wed.
1EF	40	Mon. Fri.
1GA	21.3	Sun.
1GA	40.1	Tues.
1GA	80	Thurs.
1SE	39	Mon. Wed. Fri.
2ADM	84	Wed. Sat.
2ADM	41.58	Thurs. Sat. Sun.
2AFI-ZA***	39.4	Thurs. Tues.
2AGQ	40	Wed. Sat.
2AGQ	40	Tues. Thurs.
2APV	40	40	Thurs. Sun.
2BEE	40	Monday
2C7H	38	Tues. Fri. Sun.
2C7H	38	Fri. Sat.
2CQZ (Special schedules on 40, 80, and 185 meters)				
2WR	20	Sat. Sun.
2WR	80	Wed. Fri.
2XBF	80	Daily but Sun.
3ALE	160	160	160	Mon. Thurs.
3ALE	75	75	Tues.
3ALE	80	Wed. Sat.
3APV	19.3	Wed. Sat.
3BWJ	40	Mon.
3BWJ	80	Thurs.
3BWT	82	82	Fri. Sat.
3LL	39.6	Tues.
3WQX	240	Daily except Sun.
4FM	42.5	42.5	Tues. Sat. Sun.
4JE	39	39	Sat. Sun.
4TR	79.4	79.4	Mon.
4TR	39.7	39.7	Wed.
5AUL	40	Tues. Thurs. Sat.
5ACZ	38	38	Tues. Thurs. Sun.
5ADA	85.7	Sat.
5AGN	38	Daily
5AJT	82	Wed.
5AJT-WBF	80	80	Wed. Sun.
6GI	83	Mon. Thurs.
6UO	80	40	Mon. Fri. Sun.
6YB	80	Tues. Sat.
6AKO	40	Sun. Mon. Wed. Sat
6AQA	80	Tues. Thurs. Sat.
6AON	80-40	Sun. Wed.
6RUR	20	20	Tues. Thurs.
6CCT	40-80-175	Mon. Wed. Fri.
6CHE	40	Tues. Thurs.
6CLP	41	Tues. Fri.
6HT	40	Mon. Wed. Fri.
6NX	180	(voice) Mon. Wed & Fri.
6TO	80	Wed. Fri.
6VC	38	Thurs. Tues. Sat.
7BJ	76	76	Sun. Mon. Fri.
7DF	38	76	Sat. Thurs.
7NT	21	Sun.
7NT	39	80	Sat.
7OY	79	Wed. Sat.
8ATP	39	Mon. Fri. Sun.
8AUL	39	59	Wed. Sat.
8AUL	39	Sun.
8BHM	40	Wed. Sun.
8CPO	80	Mon. Wed. Fri.
8DME	41.5	81	Tues.
8DME	21.5	Sat.
8DOO	40-80	Mon. Wed. Fri.
8EQ	40.3	40.3	Tues. Thurs. Sat.
8GX	20.7	Thurs.

8ZE	415	Tues. Fri.
8ZE	41.5	Wed.
8ZH	76	Mon. Fri.
8AGL	80	40	Mon. Thurs.
9ATO	80	80	Mon. Wed. Fri.
9AIM	40	Mon. Wed. Sat.
9BKE	40	Daily except Thurs.
9BNC	76	76	Wed. Sat.
9BXG	80	Tues. Thurs. Sat.
9CAA	160	40*	Fri.
9CAA	80	Sun.
9CPT	30	40	Wed.
9CPT	40	40	Sat. Sun.
9DZI	80	Wed. Sat.
9DZR	80	Thurs. Fri.
9DZR	206.7	Tues.
9DXY 20 (noon.)	12.8	75	Sun. Wed. Sat.
9EGU	37.5	Mon. Wed. Fri.
9HIC	40	40	Wed. Fri. Sat.
9MN	40-80	40-80	Mon. Wed. Fri.
9TJ	40	Mon. Wed.
9TJ	80	Wed. Sun.
9BER	36	Sat. Sun.
9BFE	40	Fri. Sat.
9CUG	21	Wed.
9CAFP	120	Thurs.
9CAFP	85	Thurs. Sat. Sun.
9CAZ	39	Sun. Tues. Fri.
9CXI	41	Tues. Thurs.
9CCR	36	Wed. Sat.
9CDO	50	80	80	Mon. Wed.
9CER	75	Fri.
9CCT	120	Mon. Wed. Fri.
9CCT	81.5	Tues. Thurs. Sat. and Sun.

*Midnight
 **40 M Sat. and Sun. 4 P. M. EST
 ***Sun. Wed. Fri. 1.15 A. M. EST
 †6.30 and 10.00 P. M.
 ††Sun. 4 P. M. 40 meters
 †††P. M.
 ††††Noon 41.5, 12.45, 180 meters

Navy Day Honor Roll

OCTOBER 27 was Navy Day. An even dozen stations sent telegraphic broadcasts to amateurs on scheduled time and on different short wavelengths on the evening of Navy Day. Our President, Hiram Percy Maxim, was at the key of 1AW with his message, "PS", just returned from the cruise with the Fleet, was at NKF with a message of his own. NRRL, NPL, NFG, NAJ, 4NKF, NEL, NDF, NEDJ, NUMM, and NPV were the other stations participating that sent messages from local Naval Officers and from Curtis D. Wilbur, Secretary of the Navy.

The Navy Day Honor Roll has been made up from copies of messages forwarded to Headquarters by Official Relay Stations. The first ten names on the list are those of the men sending in the most accurate copies of the messages that they were able to receive. There is no particular significance to the order in which the calls appear. The ten amateurs listed first have received a letter from Admiral Eberle, Chief of Naval Operations, in recognition of their good work.

Call	Name	Address
8ADA-PQ	Norman Gimmy	E. Cleveland, Ohio
9BNU	D. G. Anderson	Fremont, Nebraska
6BJX	E. O. Knoen	Los Angeles, Calif.
1BCN	E. Gosselin	New Bedford, Mass.
6ZH	L. Picker	San Presidio, Calif.
6BNU	David Atkins	Piedmont, Calif.
9CVL	Milton L. Johnson	Atchison, Kansas
5AC	N. S. Hurley	Mobile, Ala.
5KW	LeRoy Moffett	Norman, Okla.
6HJ	D. D. Phalen	San Francisco, Calif.
8DME	Chas. J. Heiser	Auburn, N. Y.
6UO	C. B. Newcombe	Yerington, Nevada
2BBX	Burton Synott	Unionport, Bronx, N. Y.
3RTQ	A. E. Glans, Jr.	Pennington, N. J.
3APV	B. J. Kroker	Chevy Chase, Md.
8AKP	J. D. Bohannan	Columbus, Ohio
3SZ	C. E. Stewart	St. David's, Pa.
8RHM	C. R. Phillips	Canandaigua, N. Y.
9DOA	L. R. Huber	Tipton, Iowa
8AGO	Biddle Arthur, Jr.	Pittsburgh, Pa.
8CEO	A. W. McAuly	Oakmont, Pa.
8BKM	W. G. Gross	Conneaut, Ohio
8ATZ-8SI	G. M. Murphy	Salem, Ohio
9BDA	L. M. Matthews	McCure, Ill.
4JR	R. S. Morris	Elizabeth, N. J.
2KR	Morton B. Kahn	New York City
8ZU	Don Exner	Ithaca, N. Y.
9EFS	C. R. Miller	Cedar Rapids, Iowa
4WJ	M. G. White	Macon, Georgia

9RIB	H. J. Pansch	Racine, Wisconsin
2CLL	Eugene Bussey	Yonkers, N. Y.
1BET	Carl B. Evans	Concord, N. H.
3CKL	E. D. Gray	Blacksburg, Va.
3AAI	John S. Arnold	Alexandria, Va.
4AAE	Raphael Painter	Atlanta, Ga.
2CDH	J. B. Evans, Jr.	Castleton - on - Hudson, N. Y.
2KU-2LU	O. Oehman	Brooklyn, N. Y.
3MQ	Wm. Foley	Allentown, Pa.
3BO	Gordon Kressel	Camden, N. J.
6BUW	E. De K. Leffingwell	Whittier, Calif.

Club Activities

ILLINOIS—The second Annual Radio Show of Joliet, Ill., October 27, 28, 29, and 30, was a great success, due to the activities of the Joliet Amateur Radio Club. The ARRL booth had the beautiful 40 meter transmitter of 9AJM and the receiver of 9ALF. A clumsy old half-K. W. spark set was on exhibition for comparison. Over 200 real messages were accepted from the public during the four nights of the show, and all the gang stayed up nights clearing the hook in all directions. After the first night, the management advertised the two-way radiophonic communication stunt put on by the club as a feature attraction.

INDIANA—The Radio Traffic Association of Fort Wayne is getting under way with a bang. There was a large attendance at a banquet held at the Chamber of Commerce Bldg., Friday, October 9th. Any ham passing through Fort Wayne is cordially invited to visit the gang and come to the club meetings.

9CUR reports the chief activity of the club operating a set in a booth at the Broadcast Listener's Exposition. At the invitation of the Association, the Radio Club of Indianapolis installed a tuner and transmitter to handle traffic. 85 messages were filed and transmitted. Old style spark sets as well as the latest CW equipment was exhibited.

MAINE—The Queen City Radio Club of Bangor is going in great shape with enthusiasm at a high pitch. A good crowd turns out every Friday night for meetings. A membership drive is now on. The club station handled nine messages.

MASSACHUSETTS—The Springfield Radio Association has been having some good meetings. A party of Holyoke fellows attended a meeting the other evening and a very enjoyable meeting was held. They came to get some ideas on forming a club in Holyoke.

Mr. Ralph Pierce, 1AXA, of Plymouth, Mass., recently gave a talk before the Thomson Radio Club. The program was so instructive and interesting that we are listing the subjects treated here, hoping that some of them may be useful subjects for discussion by our affiliated clubs. Incidents in Amateur Radio History. The MacMillan Expedition and the work of Amateur Stations, Experiments with the Pacific Fleet. Amateur Interference with Broadcasting Before the Use of Short Wavelengths, Amateur Short Wave Transmission Today, A Combination Broadcast and Short Wave Receiver. A Complete Short Wave Receiver. Types of Aerials for Reception and Transmission, A Comparison of Transmitters of Yesterday and Today, Transmitter Efficiency, Communication Accomplishments and the Short Wavelengths, and Theory Accounting for Short Wave Behavior are the subjects.

MINNESOTA—At the recent Northwest Radio Trades Association Show held in the St. Paul Auditorium, the Twin Cities Radio Club in conjunction with the ARRL had a booth equipped with a modern Radio transmitter. Messages were accepted from the visiting public for transmission via amateur radio. In the six days the show was held 854 messages were accepted and distributed to several amateur stations in the Twin Cities for transmission. 9DEA and 9BTZ also handled some of this traffic. Messages to all parts of the U. S. A. and to eighteen foreign countries were handled. 9SE handled most messages and 9ZT certainly did his part. 9BOL loaned the transmitter and receiver which had a dry cell battery plate supply donated by the National Carbon Co. 9ALP was the station at the Auditorium.

NEW YORK—2SZ at Rensselaer Polytechnic Institute, Troy, N. Y., has been rebuilt and may be found on 40 meters for traffic from 4.30 to 6.00 p. m. EST week days and also every Friday and Saturday night. Operators at 2SZ are anxious to get in touch

with other colleges having radio stations in order to arrange special schedules for inter-collegiate work.

The White Plains High School Radio Club has re-organized and elected officers. 2AQV is President and 2AZZ is Vice-President. The school station, 2CTB, is being rebuilt.

8FT was built by 8RT, 8CTK, 8DPL, 8NT and 8BSE. It was installed in the Broadway Auditorium, Buffalo, for the week of Oct. 18-24 by the Radio Association of Western N. Y. All Buffalo amateurs had a whack at the 468 messages that were collected from the people who attended. Many exhibitors used the ARRL message service exclusively during the show. Several press dispatches were also sent. Stations handling traffic besides operating the show set were 8NT, 8DPL, 8BSM, 8AWA, 8RV, 8BOF, 8QB, 8AYB, and 8AY.

The Yonkers Radio Club is making a drive for better operating and is having classes for code and operating instruction regularly. Several new "ops" will be sent down for tickets soon.

During the week of the Radio Exposition at the Grand Central Palace in New York, the Radio Club of Brooklyn had a large booth there known as the official A. R. R. L. Hudson Division Booth. 2PF, 2BRB, 2UD, and 2CLA took care of the operation of some of the work in connection with the Exposition. There was always a crowd around the booth inspecting the portable transmitter and receiver which were on exhibition.

8ZU, Cornell University at Ithaca, N. Y., is on the air again. 8ZU is a traffic-handling station and has two schedules a week with pr 4KT and pr 4RL. Some messages were handled for the Navy, NAW being the ship worked the most.

OHIO—The Union Central Radio Ass'n. of Cincinnati had an efficiency contest with a silver loving cup as a prize. The club station, 8ARS, is on the air every night for traffic.

The Cleveland Radio Amateur Ass'n. have elected the following officers: N. H. Gimmy, Pres.; Orrie Baumgardner, V. Pres.; and W. K. Sauber, Sec'y. They are trying to bring all Cleveland amateurs into the organization.

The Columbus Radio Club and the Dayton Radio Relay Club have disbanded.

The Norwalk Amateur Radio Ass'n. made some new DX with their station 8DDQ, worked Lincoln, Nebr.

The Van Wert Radio Club has elected new officers and planned a big banquet soon.

The Mahoning Valley Amateur Radio Club of Warren report only local activities.

Traffic Briefs

1MY and 1CKP both made the trip to Wiscasset to Wascaset Reinartz. They installed a set at Wiscasset October 8, and connecting with WNP at 4 p.m., he was worked for two hours. A schedule was made for October 9, and from 7 a. m. until noon the operators were kept busy handling traffic between the expedition and friends on shore. Over 50 messages were handled using a UV203A on a 42.5 meter wavelength. Comstock says that signals were good both ways and that communication with their hastily installed set was absolutely reliable.

Don Mix just stopped in at Headquarters on his way from Madison, Wisconsin, to Burgess Island, Florida. This means that there will be something doing at 4DM this fall. The 9EK-4DM combination will probably show the rest of us a few pointers in handling real traffic during the winter season to come.

6RJB and pi 1GW have arranged a schedule for handling traffic for the Philippine Islands. Lots of Manila traffic has been handled and two way communication every single morning easily keeps the hook clear.

A lot is said about "good" operating these days. The old timers who listen in certainly do get an awful. z1AO has been working 9ZT and he certainly sets a good example which is in marked contrast to the usual stories of operating that we hear. z1AO sends slowly enough so his stuff can be copied "words once." Don Wallace suggests that the standing of American amateur operators would be much higher if they would forget this sending "double" business

unless absolutely necessary because of bad reception or a "lid" receiving operator. Let's SEND SINGLE.

For the benefit of those who are just starting in this amateur game of ours, we want to call attention to the article on "Operating Your Station" that appears on page 48 of July, 1925, QST. Follow the suggestions made in that article and you will never be called a "lid."

"BER" says that he tries to "break in" on practically every station that calls him, but without much success. He points out that usually about five other stations are standing by or being interfered with while the idiot keeps calling and calling, while he himself goes through "the agonies of an enforced wait before communication is established. Page III of the Traffic Department for September QST tells about using a break-in. It is very useful and easy to arrange. Why not try it, OM?

41O handled over 67 real messages this month. Most of his messages were taken from U. S. battle-ships having short wave apparatus. ALL the work was done on schedule. 8JQ worked NISM. 2CTY keeps a 1.15 a. m. schedule daily with the U. S. S. Milwaukee, NISM. Both stations handled a bunch of messages which were relayed to friends and relatives of those on board the Milwaukee. The operators of NISM sent a message of appreciation to ARRL Headquarters. 8GZ has not been idle. He has been taking traffic from the U. S. S. Utah now at Cuba. 8GZ has schedules with NVE (also with 8CT), and he can be depended on to keep traffic moving swiftly to its destination.

8CNH of Herkimer, N. Y., recently gave 2AEV a message for a party in New York City. While 8CNH stood by, the message was telephoned. A reply was taken and sent. The whole transaction took about five minutes. Lots of other examples of our good service might be cited.

An Armistice Day message to President Maxim brought greetings to American amateurs from South African brass pounders, expressing the hope that our League might be of great value in cementing a lasting bond of Friendship between two great nations. The message was started from Coombs at the South African Radio Relay League Headquarters, Johannesburg, South Africa, on November 10. It travelled over the following route, arriving at A.R.R.L. Headquarters Station 1MK at 12.45 p.m. November 11: 0-A6A, 0-A6N, 0-A4Z, u2AGQ, u1MK. How was this for good relaying?

g2SZ and 6VC-BAN made more history when they were in communication for an hour and a half exchanging compliments and traffic. 'Twas dawn Sunday morning in England, but only 10.50 Saturday night, October 17, at 6VC. Arrangements were made by both stations to keep a nightly schedule.

The Rensselaer Polytechnic Institute Radio Club, 2SZ, received reports of the R. P. L-Springfield College football game played at Springfield Oct. 10, by radio through 1AWW. Everyone at Troy was grateful to 1AWW, as the only reports and prompt ones at that came through 1AWW. 2SZ is on every Friday and Saturday nights especially for traffic handling.

Three months ago we mentioned something about future communication possibilities with South Africa. Today, we are glad to chronicle the realization of our earlier hopes. In the past month four different U. S. stations have actually communicated with South Africa direct!! 1CMX started the ball rolling September 18, working 0-A4Z for about one hour and a half. 8JW, 8GZ, and 1GA have also worked him recently, handling traffic reliably. Streeter is on 35.6 meters and he pounds in like a local 200 meter station. The best time to work South African stations is between 4.00 and 8.00 p. m. CST.

1AWW and 1KY have a regular schedule. Sometimes 1AWW orders goods shipped, using an amateur radiogram to do the ordering, saving time and postage. Do you remember the old days when it was thought that Springfield and Boston were separated by an impenetrable barrier as far as radio waves were concerned? How times do change!!

Traffic Summary by States

IT IS interesting to compare the traffic figures from the different Divisions for the month that has just ended with the corresponding figures for the preceding months. In almost every Division a general improvement is evident. A few A.D.M.s need to get around among their men and see that the right competition between the Districts in their territory is started, so that a further general improvement will be noticed and so that their Division will lead other Divisions in traffic-handling work.

Over three times as many messages were originated this month as last month, probably due to the large number of conventions and shows held at this season of the year in all parts of the country.

Over twice as many messages were delivered this month as last month. This is an increase in the number of deliveries but not in the percentage delivery. In fact we must call attention to the fact that only 50% of the messages originated during the "message month" got delivered during the same period, which is a serious condition to observe in a communication system and one which must be given attention if our service is to be one to which we can point with just pride. Messages received should always be delivered immediately by telephone, in person or by mail if no other means are available. Unless it is going to be delivered, there is little use in accepting a message, anyway. All that we need is a little more individual responsibility regarding deliveries. Repeating what we said last month, "if every station owner who reads these words will see that every one of his messages is delivered and handled promptly we will be 100%." DO YOUR PART IN IMPROVING RELAYING, OM.

There is now little excuse for the complaining that we hear that no traffic is available for relaying. More messages are being originated each month and our immediate attention should go to improving the "efficiency" of our work so that every message will reach its destination. There was 67% increase in the total number of messages reported that shows we have plenty of material to work with. The "score board" for each Traffic Official follows. The Acting T.M. is going to watch the figures from month to month to see which A.D.M.s show the biggest improvement.

ATLANTIC DIVISION

State	A. D. M.	Orig.	Del.	Rel.	Total
Md.	G. L. Deichmann	19	7	55	82
Del.	H. Lavton	4	7	14	25
D. of C.	A. B. Goodall	22	28	43	93
So. N. J.	W. W. Densham	578	54	259	965
W. N. Y.	C. S. Taylor	144	32	198	318
E. Pa.	J. F. Rau	44	20	43	93
W. Pa.	P. E. Wiggin				
		811	168	712	1576

CENTRAL DIVISION

Ohio	C. E. Nichols	98	36	341	595
Ind.	D. J. Angus	24	39	72	652
Mich.	C. E. Darr	—	—	54	54
Ill.	G. W. Bersman	—	—	—	475
Kv.	J. C. Anderson	16	11	33	60
Wis.	C. M. Crapo	511	153	487	951
		449	239	987	2387

DAKOTA DIVISION

So. Dak.	M. J. Junkins	18	19	104	141
No. Dak.	M. L. Monson	3	—	3	27
Minn.	C. L. Barker	107	80	394	590
		128	99	501	758

DELTA DIVISION

Miss.	J. W. Gullett	26	2	93	121
Ark.	Dr. L. M. Hunter	—	—	28	28
Tenn.	L. K. Rush	—	—	68	68
La.	C. A. Freitag	6	2	74	82
		32	4	261	297

HUDSON DIVISION

N. Y. City	F. H. Marston	390	148	432	694
E. N. Y.	G. Kastenmeyer	68	62	140	270
No. N. J.	E. G. Wester, Jr.	12	20	209	241
		470	230	781	1295

MIDWEST DIVISION

Kans.	C. M. Lewis	26	319	72	714
Iowa	D. B. Watts	—	—	—	418
Mo.	L. B. Lazrus	68	18	170	374
Nebr.	H. A. Nielson	96	39	8	163
		190	296	250	1869

NEW ENGLAND DIVISION

Conn.	H. B. Nichols	—	—	—	238
Maine	A. F. Wheeldeen	31	16	12	119
W. Mass.	T. F. Cushing	81	69	122	272
E. Mass.	Gladye Hannah	43	74	236	354
Vermont	Chas. T. Kerr	23	2	32	49
N. H.	C. P. Sawyer	—	—	—	135
R. I.	D. B. Fancher	—	—	—	103
		188	141	492	1250

NORTHWESTERN DIVISION

Wash.	L. O. Maybee	43	20	163	231
Oregon	Paul R. Hoppe	2	6	18	26
Idaho	K. S. Norquest	—	—	59	59
Mont.	A. R. Willson	23	1	34	58
Alaska	No report	—	—	—	—
		78	27	274	374

PACIFIC DIVISION

So. Seo.	M. E. McCreery	306	124	694	1024
No. Seo.	P. W. Damm	55	55	96	536
Nevada	C. B. Newcombe	—	—	—	7
Hawaiian	K. A. Cantin	29	83	—	106
		394	262	790	1673

ROANOKE DIVISION

W. Va.	C. S. Hoffman, Jr.	4	1	70	85
Va.	J. F. Wohlford	37	11	51	99
No. Car.	R. S. Morris	39	20	120	187
		80	32	241	371

ROCKY MOUNTAIN DIVISION

Utah	Art. Johnson	34	50	60	168
Colo.	C. R. Stedman	130	31	196	357
Wyo.	N. R. Hood	19	4	59	74
		164	85	286	509

SOUTHEASTERN DIVISION

Fla.	C. F. Clark	107	51	67	235
So. Car.	A. Dure	13	9	4	35
Ala.	A. D. Trum	20	115	29	316
Porto Rico	No report	—	—	—	—
Georgia	J. M. Keith	—	—	—	121
		140	175	100	707

WEST GULF DIVISION

No. Tex.	W. B. Forrest, Jr.	28	13	103	144
So. Tex.	E. A. Suhm	25	13	30	68
Oklia.	K. M. Ehret	361	18	125	542
		414	44	258	754

MARITIME DIVISION

Maritime	W. C. Borrett	14	4	17	35
		14	4	17	35

ONTARIO DIVISION

Can. Ont.	W. Y. Sloan	45	12	32	89
W. Ont.	J. E. Hayne	No report	—	—	—
E. Ont.	F. A. C. Harrison	—	—	—	48
		45	12	32	137

QUEBEC DIVISION

Quebec	J. V. Ansley	No report	—	—	—
--------	--------------	-----------	---	---	---

VANGOUVER DIVISION

Vancouver	Wm. J. Rowan	60	24	26	110
		60	24	26	110

WINNIPEG DIVISION

Winnipeg	W. R. Pottle	76	7	7	90
		76	7	7	90

Total for country

Originated	Delivered	Relayed	Total
3618	1829	5925	14,502

ATLANTIC DIVISION
E. B. Duvall, Mgr.

THE DM has moved to a place where there is no carrier mail service. Unless reports are mailed in time to reach the P. O. on the 25th, the closing date for traffic reports at this office, they stand an excellent chance of never appearing in QST. The new QRA is Box 317, Edmonston, Maryland. The DM has been a month getting settled and in shape for a hard winter's work on reports, appointments, and general correspondence, with a new office and shack completed. Now everything is in order and Division business is handled with the usual promptness. 3DW-3EM has been out of commission, but will be operating on 82 meters. Later, consistent schedules with Division stations for traffic handling will be arranged.

In Philadelphia, 3FS has been appointed as City Manager for the whole city in place of the four sectional City Managers. Philadelphia amateurs are requested to co-operate in every possible way with their new CM. Rumor has it that 3OE has quit the game and if this is true we lose not only a good station and official, but a real old timer in the Division. 3BO will succeed 3OE as CM as soon as 3OE officially resigns.

The Monthly Service Bulletin has been temporarily discontinued for lack of funds. The situation has been explained in a circular and those interested in the continuance of the Bulletin, who have not received the circular, kindly advise by postal and one will be mailed promptly.

The DM has asked Division Officials to send photographs (cabinet size—not snap shots) for publication in QST or in the Service Bulletin. None have been received, few promised. Remember, the photographers cannot live without your support, fellows. The gang wants to see the officers back of the Division. Let's have these photographs! All will be returned when the job is complete.

Time is short until the convention city for next year is selected. You have been asked to vote, giving the preferred city, the best time, and if you can attend. Let's have more fellows. Hams visiting Washington and south are cordially invited to stop at Edmonston and at The Washington Radio Club. Drop a postal before your arrival and arrangements will be made to guide you. Phone the DM, at Main 4870 on arriving in Washington.

MARYLAND—ADM, 3HG; 3CGC is operating on both 40 and 80 meters. 3AHA on the 40 meter band worked WAP and WNP often. 3ZD-3APT has a great kick, on 80 meters. 3OU is a little late opening up this year, but Bailey, chief "Op" at the Tome School station, will have the usual good traffic reports as soon as sufficient apparatus can be collected. 3HG is operating on 39 and 82 meters. Club Secretaries are requested to report to the ADM of Maryland. 3APV will try a one-wire Hertz antenna soon. 3HU is on regularly.

Traffic: 3AEA, 11; 3HU, 16; 3LG, 25; 3GT, 4; 3WA, 6; 3HG, 15; 3RUR, 2; 3APV, 3.

DISTRICT OF COLUMBIA—ADM, 3AB; 3HS operates on 40 meters. 3CEJ has gone up the river boating for the home life. 3LR is on again for good. 3AB gave the Club an interesting illustrated lecture on Mercury arcs. The TM just back from NRRL attended the meeting and gave the gang an outline of his wonderful experience.

Traffic: 3BWT, 14; 3JO, 9; 3AB, 2.

DELAWARE—ADM, 3AIS; 3BSS and 3AIS are the only active relay stations. 3BSS lost a brand new 70 foot iron mast. 3WJ reports from Christobal, C. Z., that he is quitting his ship as soon as she docks in Philadelphia. 3AEB is still waiting for filter condensers. 3SL was visited and found working on BCL receiver with a new sixty foot stick waiting to be hoisted.

SOUTHERN NEW JERSEY—ADM, 3EH. 3BFH shows real activity. 3BBX says his brother's Dahlia patch under the counterpoise decreased his range. 3ZI has been heard in England again on his miniature antenna. 3BTQ handled a few good messages. 3SK has a new UX210 tube. He will have plenty of messages when college opens. 3RE is having receiver trouble. 3XAN sends code Tuesdays, Fridays and Saturdays, while WOAX (the same crew) transmits the Official A.R.R.L. Broadcast on 240 meters voice on Tuesdays and Fridays with a short educational talk on League activities. A number of BCLs have written WOAX for further information regarding the League and QST. The work is done through the whole-hearted co-operation of Mr. F. J. Wold, the owner of the station.

Dist. No. 7: 3OQ is doing good work lining up his stations. 3KU met with a painful auto accident. Best of luck, OM.

Dist. No. 8: 3AIH is star traffic man. He delivered 20 messages, 19 having come from WAP. 3BWJ sprung a surprise by working OKL in Czechoslovakia for an hour and a half. 3JW worked O-A4Z in Capetown, South Africa. FB, OM! 3BAY and 3ALX are busy with school. 3CO and 3WB also let school interfere with traffic schedules. 3BO keeps an early morning schedule, while 3BEI is loaded with traffic in esperanto for all the ports of the world.

Traffic: 3BEL, 6; 3CO, 3; 3BWJ, 13; 3AIH, 26; 3BO, 3; 3JW, 9; 3WB, 6; 3OQ, 3; 3XAN, 6; 3ZI, 2; 3BTQ, 3; 3SK, 3; 3CBX, 6.

EASTERN PENNSYLVANIA—ADM, 3FM. Dist. No. 2: 3BNU is building a special shack to house his transmitter, 3LK is erecting a 60 foot mast. 3CTZ had rectifier trouble (better write 3AB and 3CKG for dope on a mercury arc, DM). 3AVL was on the job with a good traffic report this month. 3AVM has a new motor generator. 3BUV has now worked 20 countries.

Dist. No. 6: 3BQ is working a few stations on schedule. 8 EU has joined the Army-Amateur crowd and is out to bust records in the Brass Pounders' League. A woodpecker is threatening his pole. (Page the OM, something rotten!) 8WH is installing a new receiver. 8CCQ is at 8XE pounding brass. 3FS, 2425 South 12th St., Philadelphia, is City Manager of the entire city. 3FS has in the past reported for Dist. No 4 and has been a faithful and earnest worker. All ORS will kindly note and report in the future to Mr. Benzing and they can be assured their reports will receive prompt attention. 3HX and 3BPM are automatically relieved of their duties as section City Managers by this change. 3KO is one of the new ORS. Clubs are invited to report their activities through the ADM.

Traffic: 3ZM, 10; 3PY, 6; 3BQ, 32; 3EU, 167; 8WH, 14; 3BFE, 8; 3BR, 1; 8CFT, 14; 3AUV, 38; 3KO, 2; 3AVL, 18; 3BLC, 12; 3MD, 13; 3AHR, 1; 3FS, 6; 3AWT, 12; 3LW, 14; 3AIY, 10; 3BVZ, 16.

WESTERN PENNA.—ADM, 3ZD: Traffic in Western Pennsylvania for the past month has dropped to practically nothing. The best hams are making money in the BCL line and are, therefore, not giving as much time to amateur radio as in the past. The number of districts is being reduced to help in bringing in reports promptly. McAuly has started the ball rolling by combining Dist. No. 9 and Dist. No. 14. Form 1 reporting cards are now available to take care of those stations who do not receive Form 1 from Headquarters. Write the ADM for them. He is looking for new ORS, too, and has application forms and reporting cards for those who will use them.

Dist. No. 8: A radio show is being held in Altoona, where Bill Aughenbaugh, 3AKI, will demonstrate the workings of amateur radio, push QST and demonstrate the Jenkins Radio Picture Machine. A ham station will be in operation during the entire week, accepting messages for relay throughout the country. 3DOQ is working on 80 meters with generator DC CW. With only 15 watts, he is getting all over the country. He has tried 20 and 40 meters but finds 80 meters the best for all around work.

Dist. No. 9: 3DPE, "The Pioneer Radio Station of Jeanette, Pa." sends in the best report and has an ambition to get into the "Brass Pounders' League." 3DNF sent in a good report by telephone. 3DGL lost his power supply but is remodeling his station. 3CGF is a new ORS. He has ten watts working on the 80 meter band. 3CKM has rebuilt for the lower waves. 3JW is at Swarthmore College and operating 3AJ. 3CES is making a master oscillator set for forty meter use. 3GEO is converted to the Hertz antenna, broadcasting on 80 meters as per schedule in QST. A great deal of interest is being shown by the students at 3AGQ.

PITTSBURGH—Sec. No. 1: The Alexander brothers, 3JQ, continue to be the stars of this locality. About 35 long press reports were handled from the MacMillan expedition. 3BIT has a new cage antenna. MacHesney of 8VQ and 8EW fame is now operating with Jamison at 3BIT. We know great things are about to break forth! 8CLV has a new antenna system and chemical rectifier. 8VE has temporarily had his call and ORS appointment assigned to 8AGO's address. 8VE will be the portable call of 8AGO. 8AGO is doing good work on 38.5 meters. He worked A6BG 45 minutes recently and the Aussie reported

that it was "sun up" when he signed off. Within the next month 8AGO will have 1000 watts "Sync R. A. C." and 400 watts of "D. C." The high power is to be used when the station he is working requests "QRO." Westervelt of 8VE still does half the operating.

PITTSBURGH—Sec. No. 2. SCTF is on 40 meters nightly. An enjoyable hamfest was held here Oct. 2nd and 74 present. 8AJU just moved and his station is under construction. 8AEY, on 40 meters, has been heard in three foreign countries. 8BQP handled six messages with a five watter. 8DIZ has gone South and is at 4KJ.

ERIE—Bibley, 8XC, reports conditions improving considerably in this city. 8VH, known to all of us in "spark" days, is coming back with a "fiver" and will probably use the call 8QJ.
Traffic: 8DQ, 2.

WESTERN NEW YORK—ADM, 8PJ: Dist. No. 6 reports this month are strong in every section. 8AVR, recently appointed DS, wants co-operation from the gang. Send him your report. 8DRJ has a new shack. 8CNH, with a new UX210, wants schedules with stations who want to handle real traffic. 8DHX has transmitters going about two weeks each month working on schedule with 2KE and doing good work. 8BQK does fine work on schedule with 9MP and 9EZ. 8BQK is a newly appointed ORS. 8AVJ is building a new shack. 8APU is at college. 8BXP is rebuilding. 8AVJ, 8BQK, 8CNH, 8DRJ and 8DHX are handling the bulk of the traffic in great style.

Dist. No. 10: 8AXA on 40 meters, uses some UX210 tubes. 8AIQ died of injuries received while racing at Boonville, Fair Ground Track. This is a sad loss to our District. 8AOZ is in line for ORS appointment. 8BCW has two "fivers" on 80 meters. 8KXF, Miss Helen Gilbert, and 8BCW visited 8RV, 8GV and the ADM while in Buffalo. 8BER now operates Utica's lone RC station, WIBX. 8ADG works the globe in every direction with his 208A. The gang in Syracuse will have to wake up if they want to put the city on the map.

Dist. No. 11: 8CTH handled messages in great style on 80 meters. 8PF got him through heavy QRM.

Dist. No. 12: 8DME handles traffic and wants to work more 80 meter stations. 20 meter broadcasting does not seem to bring him results. 8AHG is doing fine work on 154 meters. 8BRC is on regularly now. 8CVK is a new station using 10 watts on 80 meters. 8CCT is going strong on 80 meters. 8EU handles quite a bit of traffic. 8ADM is on the job. All stations in this territory please communicate with Rust, Ds., Dist. No. 12, to help put the District on the map.

Dist. No. 15: 8AY is working everyone on 40 meters with one "fiver." 8AWA, on 40 meters, worked N. Z. 8NT has a 208A. 8BSM handled considerable 40 meter traffic. 8CTK still mourns the loss of his 80 foot stick. 8BCL is at Cornell. 8RV, on 40 meters, worked Samoa, South America and the South Seas. Does his new antenna explain it? 8QB works the DS often, handling traffic for the ADM.

Dist. No. 16: 8ARG and 8AFQ are combined now and use the call 8AFQ. 40 and 80 meters is used mostly and schedules with Buffalo are wanted for traffic handling. Traffic throughout Western New York has increased greatly. Stations desiring 150 meter traffic should get in touch with 6BUM, E. Hanson, Box 1701, R. No. 7, Sacramento, Cal., for transcontinental work.

Proposed routes—No. 1: Seattle, Butte, St. Paul, Buffalo, New York. No. 2: San Francisco, Denver, St. Louis, Chicago, Boston. No. 3: San Diego, Dallas, New Orleans, Atlanta. These routes are to be worked on 150 meters and all traffic to Europe can be worked on lower bands. All stations interested in having a part in keeping these routes open should write Mr. Hanson so credit can be given in QST.

Traffic: 8PSF, 23; 8OR, 1; 8AYB, 7; 8AFQ, 14; 8APO, 1; 8QB, 12; 8AWA, 12; 8RV, 15; 8BOF, 35; 8BSM, 21; 8DPL, 40; 8NT, 13; 8AY, 12; 8DME, 39; 8ZU, 29; 8ADM, 68; 8CTH, 23; 8BZU, 5; 8DSM, 6; 8DDV, 9; 8DF, 5; 8DRJ, 25; 8DNH, 2; 8BQK, 18; 8DHX, 22; 8AVJ, 6; 8ET, 468.

CENTRAL DIVISION R. H. G. Mathews, Mgr.

THE Chicago Radio Traffic Association has started to organize the stations in Chicago and vicinity in a "traffic pool." Several stations will work East with two or three stations on each wavelength band. Other stations will do the same with respect to other directions. The "pool" is used to get messages for a

given direction to the stations working in that direction. Every station is responsible for handling messages in the direction in which he can work best and will arrange schedules or make whatever arrangements seem necessary to get the traffic handled reliably. The whole scheme is really nothing more or less than a "Five Point System" arranged on a city-wide scale with the responsibility for establishing schedules left to the individual stations to be worked out as the plan progresses. Each station has a list of the stations who handle traffic in certain directions so that the messages may be phoned or transmitted by radio to the proper stations working in the pool without delay. Anyone who wishes may join in the "pool". The time for the work is from 7.00 to 8.00 p. m. CST daily. A 175 meter wavelength is used for general communication. Many of the members of the CRTA have two sets in use or use sets with interchangeable coils so that 40, 80 or 175 meters may be used at will for carrying out the work under the plan. 9APY, 9GE and 9QD use the interchangeable coil scheme in their transmitters.

A new plan of message collection is being considered. The local Boy Scout organization may help and probably "message boxes" will be used as in Milwaukee. Further plans on message origination will be announced later.

INDIANA—ADM, 9CYQ. The ADM is pleased at finding a better distribution of stations on the various amateur bands. A few cities in the state still have stations on but one band which (if the band is 40 meters) makes it difficult to handle in-state traffic evenings. Your ADM asks that in every city in the state some stations operate on 40 meters and others on 80 meters, so that traffic between cities can be handled at any time of the day.

Dist. No. 1: "When Winter Comes" there will be more stations on the air. The DS urges each station owner to see that his station is represented in this section of QST. This can be done by sending your reports to him not later than the 15th. 9AAI increased his output to 20 watts. 9AVB is back at his new location with 10 watts. 9AFY and 9AFI are going again. 9DLW has sold his outfit to 9EGZ.

Dist. No. 2: 9DHJ has a new pole. 9BYL is off. 9BK is still busy getting going. 9DWM is senior and chief "op" at 9VB. 9ABI is doing good work. 9OA is getting out. 9ABP has a vertical antenna. 9CEM tore loose from the "yis" and is on again. 9DVE worked 1000 miles with a 201A and 75 watts plate input. 9AEB got a card from NZ.

Dist. No. 3: 9NG is a live wire station. 9NI, operating 9ABI, hopes to work all Southern Indiana hams. 9EBW is handling good traffic. 9EBP reports tube trouble. 9AHM is splitting the air with a "fiver." 9BSC had trouble getting apparatus. 9BUB says they are putting in a new generator so he can run his transmitter. 9CKH is doing fine on "DX." 9BRK will work on 40 and 80 meters as soon as receiving conditions improve.

Traffic: 9JP, 85; 9DVE, 58; 9EJI, 51; 9BYL, 49; 9CYG, 44; 9NG, 41; 9ABI, 36; 9MM, 40; 9DPI, 30; 9AUU, 27; 9OG, 24; 9DHI, 20; 9BRK, 17; 9CXG, 15; 9BKJ, 14; 9AMI, 13; 9CKH, 12; 9EGZ, 9; 9CP, 8; 9EBW, 7; 9ADK, 7; 9FB, 7; 9ASX, 6; 9AAL, 4; 9BKQ, 3; 9DXI, 3; 9ABP, 2; 9BBJ, 2; 9AIL, 2; 9CGL, 2; 9DWM, 2; 9DMC, 2; 9QR, 2; 9DRS, 2; 9BVZ, 2; 9DUC, 1; 9EBG, 1; 9BHH, 1; 9CSC, 1

Dist. No. 4: 9UR is on again after a year's vacation. 9UT has gone to Florida. 9ASJ auctioned off his old junk to get coin for a fresh start this winter.

OHIO—ADM, 8AA. Dist. No. 1: 8BSA is on every morning from 9.30 to 11.30 E.S.T. 8AVX operates on an 80 meter wavelength. 8DND had trouble getting his set going on 40 meters. 8EQ handled traffic from U.S.S. battleships (also NISR). More power to you, OM! 8CHY moved to Cleveland. 8LO uses both 40 and 80 meter wavelengths. 8AS does too and finds more traffic on 80 meters.

Dist. No. 2: Traffic moves better this month and more stations report. 8RY leads with a total of 103 messages. 8ZE is on the air after his summer recess. 8 "ops" keep his set on the air most of the time. 8BKQ used third harmonic transmission and worked lots of "Aussies" and "Zedders." 8BCE works Australia and New Zealand every morning. 8AJZ and 8AGS are busy at school. 8CTE and 8AGS are building a portable transmitter. 8DDQ has been remodeled.

Dist. No. 3: 8BWB is the only ORS in this district handling over 50 messages. With 150 watts plate input he worked a bunch of foreigners. 8DREX did just as well. 8CLZ is attending Case University.

Dist. No. 4: 8CPQ has installed a "50" watter. 8CAU was heard in New Zealand, S. Africa and Argentina on 20 meters. 8CGR steps out with two "fivers." 8CWR reported. 8APR expects to use a motor generator soon. 8BON is a busy road engineer for the state. 8ALW is not on school.

Dist. No. 6 needs more ORS.

Traffic. 8RY, 103; 8BWB, 56; 8DBM, 53; 8BKM, 35; 8ZE, 31; 8CAU, 30; 8GZ, 26; 8BYN, 22; 8DMX, 20; 8EQ, 19; 8BSA, 19; 8APR, 17; 8BOP, 17; 8DAE, 15; 8BPL, 13; 8BN, 10; 8ANB, 10; 8CWR, 9; 8CPQ, 9; 8DHS, 9; 8BON, 9; 8CGR, 8; 8PL, 8; 8BQL, 7; 8AA, 7; 8DRX, 5; 8ALW, 4; 8BAU, 4; 8BNH, 4; 8BKQ, 4; 8DRL, 3; 8AGS, 3; 8EI, 2; 8LO, 2; 8DEM, 1; 8BCE, 1.

KENTUCKY—ADM. 9EI. Dist. No. 1: 9MN has worked several foreigners. 9HP worked a7JB. 9CVR worked England. We have found 9ARU! He was on 200 meters but is moving to forty. 9DIT is working a "one lugger," the other "S" tube having exploded. 9WU deplores his inability to stay on permanently.

Dist. No. 2: 9AMJ applied for ORS appointment. He uses one "fifty" with 650 volts "B" plate supply. 9EP is expected on the air soon. 9EI is on again. 9BMH spends the winter in Florida. 9ALM is having his license changed. There will be several stations in Danville soon.

WISCONSIN—ADM. 9VD. Dist. No. 1: 9DTK moves all his traffic by having several schedules and sticking to them. The station is going full blast now, with no rest for the wicked. 9ATO finds the only one way to run up the message totals is to make schedules. 9BER is busy at school.

Dist. No. 2: 9EK wants more schedules on 20, 40 and 80 meters. They are experimenting with low power transmission, using a C299 with a total input of 14 watts. They worked districts No. 1, 2, 5, 9 and Mexico. 9EK and 9DUJ are the star traffic handling stations for the District this month, each handling 101 messages.

Dist. No. 3: 9DKA has 50 watts keeping schedules moving traffic. 9ALI operates on 20, 39 and 82 meters. 9AEU, attending the University of Madison, handles traffic when off duty. 9CIU visited 9EGF, 9ADS, 9KV, MNE, 9DXT and 9CUI. He will be on in a month. 9BVA is busy at school.

Dist. No. 4: 9AZN handled most traffic in this district. He has a schedule at 12.40 p. m. with 9DTK on 75 meters. LaCrosse and Milwaukee therefore consistently handle some important messages. 9DCX is on consistently. 9AB has started and has a good kick. 9AKY is back with two "fivers." 9BKC has finished fall house cleaning and will bring in a few next month. 9BSO says he is getting lazy. Old Brass Pounder 9BLF is waking up since his YL left for Florida. We expect a big total from him. 9BKU and 9CPX are inactive.

Dist. No. 5: 9DPR has a noon schedule on 39 meters. 9ELI is a taxi driver.

Traffic: 9MN, 14; 9OX, 31; 9DIT, 6; 9DVR, 6; 9HP, 2; 9ARU, 1; 9DTK, 293; 9ATO, 13; 9DUJ, 101; 9EK, 101; 9DKA, 65; 9AZN, 47; 9BIB, 30; 9EBV, 30; 9BKR, 26; 9EAN, 24; 9DLD, 17; 9OM, 13; 9BTK, 12; 9DCX, 11; 9ALI, 11; 9CUI, 8; 9DPR, 8; 9BWD, 6; 9EAR, 4; 9AEU, 4; 9AKY, 3.

ILLINOIS—ADM. 9CA. Dist. No. 7. Stations in this district are organizing to handle traffic efficiently. Traffic pools are being worked out and stations working best in any given direction or having schedules in various directions are given the traffic for that direction. The leaders in this movement are 9APY, 9GE, 9QD. 9EJX, 9CYD and 9AAR are quiet temporarily. 9JN, 9KV and 9ALK are busy at school. 9AOL accidentally burned up his transformer. 9APY is using the old "fifty" again. 9BFF is still off. 9RNA has a new latticed tower. 9DGF and 9CBP attend the University of Illinois. 9CIA is busy moving. 9COW has a "fifty" immersed in oil. 9US, 9DAV and 9CRP are rebuilding. 9CVF uses a new UX210 on 80 meters. 9CVS has a ham phone, also pounds a key on 40 meters. 9EAS divides his attention between wave bands of YL's and 40 meters.

Traffic: 9DWH, 144; 9QD, 65; 9APY, 37; 9GE, 35; 9AOL, 27; 9RNA, 26; 9AAW, 26; 9AZK, 20; 9IX, 14; 9BE, 12; 9EAS, 12; 9DOX, 10; 9COW, 10; 9FP, 8; 9CVF, 7; 9DXG, 7; 9AIO, 6.

MICHIGAN—ADM. 8ZZ. Dist. No. 3: 8AUB is the big station this month. 8JG "ops" on a ship on the Great Lakes. 8AQA works at a commercial station, too.

8BOK will soon have a new "50." 8DSE is on

regularly now. 8AKF is looking for a chance to have a station in Kalamazoo. 8AOR uses 10 watts now. Please send all Western Michigan reports to Jas. A. Wilson, 911 Lay Blvd., Kalamazoo, Mich., 8CPY-8DKC. 8CPY is on daily from 5.30 p. m. to 7.00 p. m. on 80 meters.

Traffic. 8AUB, 40; 8AKE, 5; 8DKC, 6; 8JG, 3; 8DSE, 1.

DAKOTA DIVISION D. C. Wallace, Mgr.

NORTH DAKOTA—ADM. 9CSI. Dist. No. 1: 9IK-9DFS is going to the State School of Science. 9CRB worked 4FR on 200 meters. He is on every night after midnight and has arranged schedules with different hams. 9DKQ is busy. 9AMP is working on 80 meters. 9DLF expects to be working on short waves soon. 9CZG has been busy with school work. 9EFN is rebuilding.

Dist. No. 2: 9DMV operates on 77 meters. 9CNI is waiting for new bottles. 9AFM has resumed operation. 9BZF is rebuilding.

Traffic: 9CZG, 15; 9CCT, 5; 9CSG, 1.

SOUTH DAKOTA—ADM. 9CJS. 9DAJ will soon have a fifty. 9DBZ reported by radio. 9DZI ran down his batteries listening to the World's Series. 9DXR has his set running smoothly on all bands. He has a very new YL at his place too. 9CBF has a new plug-in coil receiver. 9DWN lost his 85 foot mast. 9AGL is attending college at Vermillion. Other new "Ops" there are 9AAO, 9RNH, and 9BOW. 9EH built a broadcast transmitter for the high school. 9BBF is using some new 75 watters. 9DID is without power. 9CKD and 9CIS are installing a fifty and 15000 volt generator. 9CVH is a new Watertown station. 9ASP and 9ALN are reopening. 9BBF, 9CVH, 9DXR, 9DID, 9BDW, 9CJS and 9CBF dropped in on 9CKD and had a house-warming at the new station. 9TI is still gathering storage Ba.

Traffic: 9BBF, 1; 9BDW, 12; 9DZI, 20; 9DBZ, 41; 9NM, 2; 9KB, 5; 9EH, 7; 9CKD, 22; 9DKT, 10.

MINNESOTA—ADM. 9EGU. The fellows all are active here. Lack of co-operation has been evident among some State officials, hence the brevity of some reports. On the whole, things are developing nicely and soon we will claim that Minnesota is the most active state in the League. We need your co-operation, which is the foundation of success.

Dist. No. 1: 9AGU worked a bunch of foreigners. His overloaded UV203A is over a year old and still working nicely. 9AYQ is busy. 9CWN has a new "fifty" and is knocking them cold. 9AOG is leaving us. 9EGN worked all districts with a 201A. 9EGF now uses "RAC." "WZ" left for the U. of Minnesota, leaving "AL" on the job at 9CDV, which is open to "ops" attending the U. of North Dakota. 9ADS is on "40." 9BVA says he can't get out of town. 9EEP is on again. 9BMR moved his shack from the store to his home. 9ADW is a new and consistent ORS. 9CMS uses the 80 meter band. 9AND of Duluth wrote from Atlanta saying his new call was 4KU. He has been operating 4RM and 4IO.

Dist. No. 2: 9BFU, 9CYX, 9DMA, 9DSW and 9SW have been honorably cancelled as their stations are inactive due to school. New appointments will be issued without application when they resume operations. 9AWM sports a three-phase full-wave chemical rectifier. 9DMA uses 40 meters. 9ACT is busy. 9EFD had no success on 40 meters. 9CAJ is on 40 and 80 meters. 9BBV has a 60 foot mast.

Dist. No. 3: Minneapolis will soon have a new CM. 3ZT-XAX says a receiving antenna 400 feet long, average height 70 feet. 9APE lost his mast. 9BMX worked Australia and England with 50 watts input to his UX210. 9BVH rebuilt. 9BPY worked Australia, N.R.R.L. and NISR. 9ABK was heard in Holland on 24 watts input. 9ABK handled much radio show traffic. 9BKN is a good traffic handler on "40."

Traffic: 9EGU, 16; 9CDV, 92; 9EEP, 5; 9AOG, 10; 9EGN, 5; 9AWM, 12; 9BTZ, 6; 9CAJ, 23; 9COF, 2; 9CPO, 10; 9EBC, 15; 9MF, 14; 9BBV, 1; 9DDB, 5; 9DBW, 17; 9EHO, 7; 9AIR, 2; 9BMX, 11; 9CVC, 9; 9PH, 18; 9BVH, 10; 9BPY, 119; 9DYZ, 5; 9APE, 14; 9ZT, 68; 9ABK, 52; 9GH, 5; 9BKN, 37.

DELTA DIVISION
B. F. Painter, Mgr.

FOR the first time we have a good report from all the states. In an attempt to create interest in traffic we are starting what we will call the Delta Division Honor Roll. Detailed information will soon be sent the different members and if you have not received yours, write the DM.

MISSISSIPPI — ADM, 5AKP: 5AEV reports his usual traffic. 6AQU is a football man. 5ANP says the Gulf gang is waking. 5AFV is on 80 meters. 5AUC has ordered a new dynamometer. 5FQ has a new MG. 5QZ handles traffic on 40 and 80 meters. 5ARB did his usual good 40 meter work. 5AGS is hunting a new location. 5AKP has rebuilt. The Meridian Club announces a traffic contest with prizes starting November 1. The 1st prize is a one year subscription to QST.

Traffic: 5ACY, 8; 5AEV, 10; 5AFV, 14; 5AGS, 4; 5AKP, 14; 5ANP, 3; 5ARB, 16; 5AUC, 20; 5QZ, 32.

LOUISIANA — ADM, 5UK: 5ML of Shreveport does not get out well on 40 meters. 5ANC is torn up. 5BB now has 20 watts. 5AGJ worked a few. 5WY has been busy holding down two jobs but found time to work a few.

Traffic: 5EN, 5; 5UK, 23.

ARKANSAS — ADM, 5XAB: 5WK has been off since fall but is back. 5ANN is selling BC sets. 5QH won first prize with his transmitter at the fair. 5ABD took second prize with his transmitter and first with his receiver. 5ABI uses both 40 and 80 meters. He has started a lot of interest in Arkansas. 5AIP is the most enthusiastic ham in the state. 5AW has a new Junior "op." Sure, it's a boy! 6HN was heard in Europe. 5AQN is on 40 and 80 meters.

Traffic: 5ABI, 9; 5AIP, 8; 5ANN, 20; 5AQN, 9; 5WK, 20.

TENNESSEE — ADM, 5CN: 4HE at the University and Dubose of Jackson are trying to get a station going at Knoxville. 4CU handled lots of traffic and worked a bunch of foreign stations. He is using a 250 watter. 4KN had to shunt his ammeter with No. 14 wire and then it fused. 4EO took traffic from across the pond. He also worked NISP. 4IV has a 208A on 40 and 80 meters. He worked NZ and Australia eleven times in eleven days. 6CMU was in Memphis for a few days. 4DR lost both station and operator's license for failure to report for examination. 4BU is raising the plate voltage 1000 volts a day.

4KM can't raise anything but the wrath of his neighbors. Chattanooga hams had a nice visit from Service from HQ, who caught the Florida fever and resigned. He tuned 4MM. 4FP is tired of living in an apartment house, having clothes hung on his counterpoise. 4IB, ex 5HL, is back with 250 watts. 4AJ has returned from Columbia.

Traffic: 4CU, 49; 4EE, 4; 4EO, 2; 4FP, 7; 4IV, 16; 4KM, 4.

HUDSON DIVISION
E. M. Glaser, Mgr.

THE Hudson Division meeting proved a great success. About 300 members were present. Interesting talks and demonstrations were given by Mr. Dunn, 2CLA, who presided, F. E. Handy, our Acting T. M., two Army officials, Capt. Tom Rives and Capt. Autrey, Vice-President of the I. R. E., Donald McNicol, and Mr. Droste, and ye DM. A second meeting is scheduled for Nov. 9th and a third for Dec. 14th. Be sure to come if possible. Mr. McNicol delivered a timely talk on "Good Sending and Good Copy for Radio Operators."

Mr. James L. Murray, 2KS, has been appointed City Manager of Newark, N. J., in place of Kenneth McGrath, 2CMK, who resigned. Many new ORS appointments went through this month. Officials must cancel ORS not reporting as explained in the circular from the DM. Notify your superior official the same as for appointment. **PLEASE CO-OPERATE WITH YOUR DM AND SEND IN A LIST OF STATIONS NOT REPORTING WITH YOUR REPORT!** The DM is overloaded with work and unless he gets 100% co-operation from EVERY official, he cannot continue as Division Manager. Please get information from the ADM when possible.

NEW YORK CITY — ADM, 2CWR: 2BEE leads the

division in traffic. 162 messages were collected at the Radio World's Fair for foreign countries. French 8NY and 8OK visited his station. 2CVL is re-building. All N. Y. stations requested to report to Harold Sachs, 2CHK, CM Manhattan, 161 West 75th St. 2HJ, ex 2XNA, Radio Club of the College of the City of New York, is working on schedule on 39 meters. FXI was worked the first night of operation. 2AUY is closing down. 2BNL is using a "fiver" on 40 meters. 2TT is selling BCL sets. 2CZR is on 40 and 80 meters regularly. 2LD says the quality of messages has improved. 2KR does the usual fine work. 2CHK is using a tank-coupled Hertz antenna. 2CHY is on a vacation. 2BRB has three transmitters on 20-40, 80 and 170 meters. When the DM gets through answering correspondence (not often) he works some foreign stations and after a kick from that, he can again tackle another heap of mail or reports. 2PF has a new shack. The tower at 2UD came down. 2CLA is on 40 again. 2AEP has a schedule with pr. 4KT. 2KK is using two "fivers." 2CEP has finished his transmitter. 2CEV has a "fifty." 2AFV has been recommended as ORS.

Traffic: 2BEE 316, 2BBX, 56; 2CYX, 68; 2CRB, 41; 2BRB, 21; 2ADC, 8; 2ADD, 4; 2BNL, 4; 2LD, 11; 2KR, 65; 2CZR, 27; 2CSL, 6; 2AMJ, 21; 2AEP, 12; 2AHZ, 2; 2BSL, 12; 2ACZ, 1; 2AKK, 6; 2AKR, 6; 2CEV, 12.

EASTERN NEW YORK — ADM, 2GK. Dist. No. 1: 2AV has rebuilt. 2BPB is working on 40 meters. 2AIZ, a new ORS, is on 150 meters and leads the bunch this month. 2KK has a new call for his Radio Store (2LS) but does not have much time to be on now. Although forced to cancel 4 schedules 2CLG has done good work, handling important traffic for a Porto Rican Senator and also working A2DS.

Dist. No. 2: Several new stations are expected to open. 2AAN is on 89 with a DC note. 2CTF has a new control panel on everything. 2DD has a "fiver" on 40 and a bunch the OW is going to give him a "fifty" for Christmas. 2AG has a receiver in the making that positively eliminates QRM. 2CIL has a German bottle. 2AJQ has a new "fifty." 2AAZ blew a "fiver" and a 201A but keeps after traffic. He has been recommended for an ORS appointment. 2COV forgot the new schedule for reports. The DS wants to hear from 2NW. 2APT reported via W. U. He has been recommended for an ORS appointment. 2AMN threatens to open up near Yonkers. 2LA has moved but will be going soon.

Dist. No. 3: 2SZ is now on the air and has a fine supply of "ops." 2CTH hears any number of A and Z stations. 2AGM is reconstructing. 2CYH is a new ORS working on the 80 meter band. 2CDH is minus a couple of "fivers." 2EM has gone back to 30 meters to boost traffic. 2CUL has lost his counterpoise, due to an auto truck trying to pass through his back yard. HII

Dist. No. 4: 2AKH did some fine low power work. 2CYM is on some. 2AUG is doing good 40 meter work. He lost his mast recently. 2CXG and 2AQR have left for college. 2AOK is on again with five watts. 2COV moved from Poughkeepsie to Newburgh. 2AGQ is on both 80 and 40 meters. 2AII is sick but reports every month. 2CXG and 2AQR have been active but are at college now.

Dist. No. 5: 2AWF has put up a new antenna and counterpoise. 2BSB expects to use a "fifty." 2PV doesn't get out well on 40 meters.

Traffic: 2AJZ, 53; 2AV, 29; 2BPB, 4; 2LS, 3; 2CLG, 11; 2AAN, 5; 2AAZ, 20; 2APT, 35; 2EM, 8; 2SZ, 3; 2CDH, 5; 2CYH, 21; 2CTH, 20; 2ANM, 6; 2AKH, 52; 2CYM, 5; 2AGQ, 10; 2AUG, 16.

NORTHERN NEW JERSEY — ADM, 2WR. Dist. No. 1 is in charge of 2CJX. The ADM requests all ORS to extend full co-operation to Mr. Mallory. 2AT has a fine report. 2CMK devotes his time to operating 2WR. 2AHR uses a UX210 with a good traffic total. 2BXD-ZB worked most everywhere. Traffic collects daytimes at 2XBF on 170 meters and is relayed at night at 2ZB. FB1, 2BBH and 2EG are rebuilding. 2JC and 2BIR worked Europe. 2BY sticks to the high waves. 2BW reports 40 meters tricky. 2CRP with 22 watts input puts Bayonne on the map. 2CDR says traffic is poor. 2BGi is building a transmitter for all waves. 2AUH steps out fine with his "fifty" watter. 2FC wants to locate a few Radiostats and S Tubes. 2CGK is off. 2DX is a new ORS.

Traffic: 2WR, 2; 2DX, 16; 2ADU, 4; 2ARB, 4; 2AT, 34; 2ATE, 2; 2BLM, 8; 2AHR, 33; 2BXD, 25; 2BW, 4; 2BY, 2; 2JC, 6; 2CRP, 19; 2CDR, 12; 2AUH, 5; 2FC, 2; 2CQZ, 6; 2QS, 7.

MIDWEST DIVISION
P. H. Quinby, Mgr.

WINTER is here and traffic on the top-grade. Some of us have totals which qualify for the BRASS POUNDERS' LEAGUE. Don't forget, fellows, it takes 100 real messages, handled in perfect ARRL form, and checked by the DM and TM to enter. When your total runs over 100, be sure the messages are in correct form and complete. Send them to your DM, Quinby, who will check and forward them to "HQ" to enter your station in the BPL contest. Mail them the same day you mail your report to the DS or CM. This will allow for checking, and unless you do, we cannot enter you.

At this time of year we bury dead ORS, so those not reporting regularly had better make a will. There are still a few desirable openings of appointment as Official Broadcasting Stations, especially for the 12.30 p. m. (mid-day) schedules and for the 20 meter band. Apply to your DM without delay. Have you noticed how the "OLE MIDWEST" stands out in the list of OBS published elsewhere in this issue? Let us keep her at the top.

Now is the time to oil up your schedules for railway emergency work. Those who have participated feel well repaid for their trouble. Get in the swim. OM.

IOWA—ADM, 9ARZ: Des Moines hams are doing fine work. 9BXR and 9AZU are new. 9DME is temporarily off. 6ATE, ex 9AYO, is in Des Moines. 9LA has a new 65 ft. tower. 9BMN has 5 watts. The Capitol City Radio Club has been re-organized. 9ACH was recommended for City Manager. 9CLG is head traffic man for Des Moines this month.

9EKX got to Australia and France on two "fivers." 9BPF and 9DIP are at Ames. 9AED worked Australia. 9BOS and 9AED have commercial licenses. 9DMS was heard in Chile and France. 9DSL is teaching and coaching at HS. 9DJA works on 80 and 160 meters. 9CGY has difficulties on 80 meters.

Traffic: 9AXD, 7; 9BCX, 11; 9CXX, 10; 9BZE, 2; 9DAU, 47; 9HK, 42; 9BCD, 16; 9DOA, 16; 9BPF, 371; 9DMS, 11; 9DXR, 3; 9DME, 30; 9CLG, 32; 9AZU, 3; 9EKX, 8.

NEBRASKA—ADM 9CJT, Dist. No. 1: 9BFG is the most consistent and active ORS. He is keeping five schedules every night, and as a result is doing most of the traffic handling. He is on 80 meters at present, saying that it is much easier to get traffic there. 9BVG is rebuilding. 9DUO's Hertz antenna didn't work very well. 9CIM lost more tubes. 9CGS is on. 9CJT is on with a "50." 9BNU reports little traffic and the sad fact that his aerial came down. 9BKG with his 7 1/2 wattter certainly gets out well. 9DUH has a new pole. 9AJJ is a regular. The Omaha Vigilance Committee reports no complaints registered during the past month.

Dist. No. 2: Things are quiet, due to school work. 9BOQ tops the list for traffic. His schedule with 9DI is helping. 9EHW was on a few nights. 9PN is off for transformer repairs. 9EAK is getting ready for 500 watts. 9EEO actually takes traffic from Omaha with an amplifier tube. 9DAC has a good push and a better note. 9AKS is busy and has little time for operating. Take a look at 9BFG's traffic report, notice the reason for it—then make those schedules and let's have more reports in three figures.

Traffic: 9BFG, 157; 9BNU, 2; 9CJT, 4; 9BOQ, 10; 9PN, 2; 9EEO, 9; 9AKS, 2.

MISSOURI—ADM, 9RR: Many schedules are being put into operation here.

Dist. No. 1: 9DXN DS. 9DMJ is using only an antenna (no CP). 9BEQ has two transmitters on 40 and 80 meters. 9ZK has his old call, 9AAU, and has discarded 9DS. 9BHI is on 80 meters. 9DLB and 9DXN are busy.

Dist. No. 2: 9DAE DS. 9CDF is on 40 meters. 9ARA has one set at Butler and one in Warrensburg. Ex-9DZO went to Butler to operate WNAR. 9BVK is attending school at Columbia. 9DAD works on 180, 40, and 80 and 20 meters. 9ADC has a 10 wattter in spite of QRM from the OW. 9DAD has a 10 p. m. schedule with 9BMM. 9DIX is going to KSTC at Kirksville. 9DNJ has moved. 9BRU and 9LK combined stations. 9CMI is a new station. 9DVF apologizes for taking second place in traffic.

Dist. No. 3: 9BSH DS—9BDS is building a new house. 9DVK is on occasionally. 9BSH is operating at 9DVK week ends. There are a number of stations not ORS who have never reported. Any such please communicate with 9BSH.

Dist. No. 4: 9ZD, DS—9ELT takes traffic honors in Kansas City. 9TJ is second. 9ADR has been ap-

pointed CM. The K. C. ham club has reorganized for the season and much interest is shown. Publicity is being obtained through the Sunday papers. 9EEZ and 9BRD worked a bunch of foreign stations; each used a 5 wattter. 9BND is CM of Independence. 9BND led the message report. 9CZW and 9EEZ ran close for second and third. 9ETJ and his huge bottle are temporary inmates of the Finnegan Club. Yep, off again, Finnegan.

Traffic: 9BHI, 9; 9ZK, 20; 9BEQ, 20; 9DMJ, 33; 9CYM, 9; 9AOE, 67; 9DIX, 4; 9DNJ, 2; 9BRU, 1; 9DVT, 27; 9RT, 4; 9EAO, 3; 9AYK, 8; 9CYK, 14; 9DAE, 3; 9CRM, 19; 9ELT, 181; 9TJ, 30; 9BKK, 1; 9ADR, 10; 9BRD, 10; 9BVU, 6; 9ACX, 4; 9ZD, 1; 9BND, 46; 9DZW, 28; 9EEZ, 24.

KANSAS—ADM, 9CCS: The Kansas City gang are going strong. 9KM is a new station. 9DBH has a new set, and will be heard regularly now. 9DMZ hopes to have a set going with a "YL op" soon. 9KM is on 180 meters. 9BXG is proud owner of a new fifty. 9BVN and 9KM want schedules west. 9DNG worked dozens of foreign amateurs (we haven't space to list them). 9EHT is at college. 9CVL is on 88.4 meters. He received a message from pi IHR via 6BQ and delivered it 48 hours after it left Manila. 9ACQ is open for schedules, before 6 in the a. m. on 89 and 78 meters.

Traffic: 9CEA, 25; 9BVN, 23; 9BXG, 7; 9AEY, 6; 9CVL, 19; 9CFI, 10; 9DNG, 40; 9ACQ, 1; 9KM, 56; 9AIM, 45; 9AFP, 4; 9BRD, 6; 9CVN, 61; 9CCS, 2; 9BHA, 9; 9VAC, 400.

NEW ENGLAND DIVISION
T. F. Cushing, Mgr.

GREETINGS! I wish to take this opportunity to thank my many friends who made my election as New England Division Manager possible. Your friendship and good will are things I value very highly, and for that reason, if no other, I will endeavor to do my work in such a manner that you will not regret my election. IAWW will continue to be on as much as possible, and will keep a continuous watch from 6.15 to 7.00 p. m. on the 75 meter band every Monday and Thursday, especially for New England ADM's and ORS. I appreciate your wonderful co-operation in the past and trust it will continue and improve this Division.

PRIZE TEST MESSAGES—Hurrah! This month, deliver. You fellows in New England are doing well now. Prizes are distributed regularly and the time made is much faster and more interest in making and keeping schedules, and in relaying all messages promptly. IUE won the Brandes phones donated by the Wetmore Savage Company of Springfield.

Prize Winning Message No. 75: 1ARE-1CLN-IUE-1KY-addressee. Time 3 hrs. 35 mins. Number 74 traveled 1ARE-1CLN-1AYJ-1VF-1EF-addressee. Time 96 hrs., but never held more than 48 hrs. Number 76 traveled 1KY-1BUL-1AID-1AWW-addressee. Time about 72 hours. Number 73 traveled 1KY-1UE-1QB-1ANE-1BM-addressee. Time 10 days. This message was held by 1-QB from Sept. 25 until Oct. 2nd. Why? It should have been mailed after 48 hours.

Additional messages will be released during the next three months. If each of you make and keep schedules and forward messages promptly, you may be a prize winner. You cannot tell which messages are "Prize Test Messages," so follow good operating procedure and get your messages off promptly. It will pay.

MAINE—ADM, 1EF: With winter at hand most Maine hams are thinking of big traffic totals to come. WNP and WAP have returned. 1EF was the only Maine station to work them. He kept a nightly schedule with WNP. One message went WNP-ARRL-HQ-WU-1EF-WAP. Some Relay! 1EF was high traffic man this month and so wins the first gold Brass Pounders' Certificate. It looks good on the wall. Three blue ones get a gold one and with the next gold one goes a year's subscription to QST or a copy of Ballantine. Let's go! 1ATV worked 7AY with 60 watts plate input. 1AAV just finished rebuilding. 1BDB is using a duplex system and advises others to try it to speed up traffic and shorten calling. 1BNL is patiently waiting for an overdue C303-A. 1BTT is working for the W.U. at Hanover, N. H. 1BNL does the same at Rochester, N. H. 1VF has a new mast. 1KX will have a station in the 9th District this winter. 1CKQ has a new MG. 1ED is at the U. of M. 1ALK has annexed an OW.

1KL uses a "fiver" for traffic work. IIT's report got in by the skin of its teeth. IAYJ has applied for an ORS.

Traffic: 1VF, 10; 1AAV, 1; 1ATV, 36; 1BDB, 11; 1BNL, 1; 1BIG, 1; 1EF, 16; 1IT, 54.

NEW HAMPSHIRE—ADM, 1GL: 1AYL is trying to get a set going at the Univ. of N. H. 1ATJ worked 88YOR. 1YB has six old "ops" and 10 new ones. Schedules are being arranged and a big year is promised.

Traffic: 1ATJ, 4; 1YB, 131.

EASTERN MASS.—ADM, 1KY: Dist. No. 1: 1LM is under construction. 1BZQ has been busy during the summer. 1NV is using an indoor Hertz antenna. 1BX1 is a new station using a UX-210. 1TU is home again. 1YC keeps a continuous watch on 40 meters from 9 a. m. to 5 p. m. Many students have volunteered their services after school hours. 1CJR expects to operate at 1XM this winter. 1CJT is back again on 40 meters. 1AGS has his troubles getting down to 40 meters.

Dist. No. 2: 1GA has the best traffic report this month. He has two sets, one for 20 and 40 meters and another for 20, 40 and 80 meters. 1BBG hopes to be on soon with 50 watts. 1BBM has finished the new receiver. 1RR's wave is always 39.5 meters. 1BVL still works A's and Z's with his "fiver."

Traffic: 1AGJ, 3; 1BFQ, 6; 1BZQ, 17; 1CJR, 14; 1KY, 48; 1YC, 31; 1ZW, 17; 1ACL, 10; 1AHL, 3; 1AIR, 3; 1AVY, 2; 1AXA, 16; 1BUO, 2; 1BVL, 17; 1GA, 55; 1NT, 10; 1RF, 34; 1RR, 8; 1SE, 3; 1UE, 4; 1ZG, 11; 1BRF, 8.

RHODE ISLAND—ADM, 1BVB: This month's report was made out with the help of a new Mrs. ADM. Hearty congrats from all the gang, OM. Everything is running smoothly in Rhode Island now and we will make a fine showing this winter. Mr. Huddy resigned as D.S. of the Providence County District. All ORS report direct to the ADM at present.

PROVIDENCE—Dist. No. 1: 1ABP lost his big steel stick. He works Europe nearly every night. 1AWV is at the State College. He has a beauty of a new mast. 1BCC is rebuilding, using a 201A to work 9's for the present. 1BIE is banging away on 40 meters with plenty of pep. 1BCR will have another big tube soon. 1BHI is also at college but on week-ends. 1AEI is building a master oscillator outfit. 1AAU is experimenting. 1GV is off temporarily. 1AWE is back from the country.

WESTERLY—Dist. No. 2: 1AAP has been "experimenting" and blew his "fivers." He has been using a ten foot antenna on 40 meters but is going to try a 33 footer and work on harmonics. 1BVB has a 50 watter on 80 meters where there is some traffic. Doc Helfrich is about ready to "knock 'em dead" but is busy at Westerly's new hospital "bringing 'em back to life."

NEWPORT—Dist. No. 3: 1BQD is back; just watch him next month. He is using two "fivers" on 80 meters. 1AOA and 1AFN will get straightened out after a while. 1BQD keeps a daily schedule with 1BVB for traffic and quite a bit is moved this way.

Traffic: 1AWE, 22; 1BVB, 31.

VERMONT—ADM, 1AJG. Dist. No. 1: 1BDX says the traffic totals will not jump. 1BEB originated one message. 1AVZ with two fivers gets out well. 1BBJ is still talking of a quarter KW tube. Will the ham in Waitsfield that has a station pse qsl 1BDX? 1ARY was heard but no report from 'em yet. 1YD is also quiet. 1BQ is somewhere on the briny deep.

Dist. No. 2: 1APU worked Mexican 9A. 1AC has WNP to his credit. 1CQM is at RPI operating at 2SZ. 1HA has left for Florida. 1AJG (88 meters) is on the air as usual. He has a new antenna system that is FB.

Traffic: 1REB, 1; 1APU, 18; 1AC, 18; 1AJG, 20.

CONNECTICUT—ADM, 1BM: A few of our best men are at College, consequently reducing our traffic totals. Some new stations have come forward to "help span the gap," for which your ADM expresses hearty thanks. More stations are needed. This winter will be a banner season! The ADM will appreciate it if more new stations will help with their report.

The college men we miss but who report regularly are 1AOS, Clark Univ.; 1IV, Trinity; 1ZL, Wesleyan; 1AH, Columbia; 1AYT and 1AWY, all good loyal relay men located at various places. Luck, boys, and may success attend you. 1XG reports that big chief Randall is on a deer hunt. The other "ops" were on the job. Milton Mix, brother of "our famous Don," is one of them and signs MW. 1AOX is rebuilding. 1QV is working fourth and ninth district stations

on schedule. 1BEM is using a Hertz oscillator system. 1AYR has been on the sick list. 1CTI had a hard time getting power to make his tube "perk."

Traffic: 1QV, 41; 1ADW, 32; 1AFI, 14; 1BGG, 12; 1IV, 4; 1BHM, 11; 1AOX, 4; 1MY, 61; 1CKP, 26; 1HJ, 6; 1AJO, 16; 1AXN, 11.

WESTERN MASSACHUSETTS—ADM, 1AWW: Dist. No. 3: 1AMZ reports that messages are coming along fine and that North Adams receives its share of traffic. He has a "fiver" in place of his UV-201-A and reports better DX. He originated a bunch of messages during the month. 1AAE blew his new 50-watter after only a week's use. 1VC has a new 50-watter and a new pole. 1CLN is going strong. No messages stop at his station more than four hours. Fine work! 1ARE worked the MacMillan Expedition 48 times and handled 103 messages, many of which ran close to a thousand words.

Dist. No. 5: 1KC is all for studies and no radio. 1CI is at Dartmouth. 1AKL may invest in a Grebe CR-17. He keeps a constant watch for 1ARY and wants their wave and hours. 1BIZ is using a 750 watt R.C.A. transformer now.

Dist. No. 6: Will 1BOM or other good "Ham" send in a report on or before the 15th each month to the ADM?

Dist. No. 7: 1XU has found that by connecting the minus high voltage to the plate and the plus high voltage to the filament of his three-quarter meter transmitter, that he can burn out flashlight bulbs every six inches along his lecher wires! Page Mr. Kruse, please.

Dist. No. 4: 1VU is trying out a new UX-210. 1AWW is keeping schedules with Can. 1BO, 1KY and 2WC. 1BSJ has been busy too mucking Rolls Royce motors, and most of his evenings are spent at the factory. 1APL has a dynamotor. 1PY worked 5VC with his 5-watter. 1DB moved and lost a few days. 1COH is a newcomer at Worcester. He's an old timer and we welcome him. 1GR is doing good work. 1ASK has a new antenna and counterpoise. School has opened at 1XZ and 1YK. Both stations are on the air. 1XZ is on 40 meters and 1YK is on 80.

Traffic: 1CLN, 12; 1VC, 4; 1AAE, 33; 1AMZ, 44; 1BIZ, 22; 1ORZ, 5; 1ARE, 84; 1PY, 5; 1AWW, 18; 1ASU, 9; 1AAL, 7; 1DB, 2; 1BQK, 4; 1AKZ, 8; 1XZ, 1; 1BVR, 6; 1AAC, 8.

NORTHWESTERN DIVISION

Everett Kick, Mgr.

THE Holiday season is near. Get your transmitter ready and solicit Xmas greeting messages from your friends. If you're real industrious, make a cigar box with an end knocked out dressed up in a coat of paint; hang it up in a conspicuous place in some downtown building; affix a note explaining our service and watch results.

WASHINGTON—ADM, 7GE: This month marks the last report of ADM Maybee, who states that he can no longer keep up the pace, for business prevents his doing so. 7FD, 4340 30th Ave., West, Seattle, has accepted the responsibilities in 7GE's place. Give him your heartiest co-operation gang, for I'm sure you will find him willing to do his share for you. 7EK (ex7ABB) led the Division in traffic handling. 7UQ celebrates his debut as an ORS coming second. 7GB, 7IJ and 7AIM have good reports. 7NH is moving. 7DC is completing his station. 7AHA is at school. 7WQ kept a schedule with NITF and NRA in the Bering Sea. 7GY reports lots of "DX." 7EN is on week-ends. Ex-7AFH is touring California. 7MN will have a "six" also. Pullman is overstocked with hams. 7GI, 7ADP, 7JP, 7SH, 7CT, 7NW, 7JR, 7BG, 7RL, 7SZ and 7AO are all attending W. S. C. with high hopes of getting the Rho Epsilon station 7UL on the air. 7RL and 7AO are on week-ends. 7JP is coming back with 100 watts. 7DM is going strong. 7MZ has a "50." 7NE works out well, using 201's. Spokane is represented by 7AF, 7NS, 7VL, 7WA is at school. 7AF wants a 50. 7AKO, 7VL and 7NS are doing good work. 7EQ's alarm clock broke.

Traffic: 7UQ, 36; 7OY, 16; 7ATA, 1; 1WQ, 13; 7NH, 4; 7DM, 14; 7AO, 18; 7WA, 3; 7AF, 2; 7VL, 6; 1EK, 40; 7BO, 2; 7DF, 12; 7LJ, 5; 7GB, 8; 7AFO, 35; 7AIM, 15.

OREGON—ADM, 7IW: 7LS has a portable call, 7HU. 7MF reports good reception. 7LR has returned from Alaska. 7AY and 7UN are working out well. 7AAJ is pounding brass for the W. U. 7SY and 7AKH are heard week ends. 7AIX will be home Thanksgiving. 7ALD had trouble with his "fiver." 7EO is working on 40 meters. 7AV has new

fixings. 7EC moved to Seattle to attend the U. of W. 7AJB is back from California and is on 80 meters.

Traffic: 7EO, 7; 7ALD, 4; 7SY, 2; 7AV, 3; 7MP, 10.

IDAHO—ADM, 7OB: 7GW is active. 7GX lost a tube. 7JF has a schedule with 6BNV (7SI) for 7ZN. 7QC is busy. 7SI wants schedules with Boise. 7IU has installed his set at the Technical School. 7RQ and 7VI have their sets installed at the College of Idaho. 7PS is on 40 meters. 7OB's call expired.

Traffic: 7QC, 12; 7JF, 24; 7GW, 23.

MONTANA—ADM, 7NT: This month's reports were not as good as we expected. 7GS wins the prize this month because of steady key work. 7GS wants schedules with Seattle. 7MX led the state on traffic. 7DD established Montana's record for blowing tubes. 7NT isn't quite settled. 7ACI is too QRW with his Radio institution. 7PU maintains a schedule with his brother at Northfield, Minn. 7FL was on some. 7AGF is back home. 7KZ is at the State University. 7ZI is using 40 and 75 meters now. 7ZJ and 7MG are due back on the air soon.

Traffic: 7MX, 24; 7GS, 15; 7DD, 15; 7NT, 3; 7FL, 1.

PACIFIC DIVISION

M. E. McCreery, Mgr., Southern Section

DISTRICT 1A has been obliterated, as no active amateur station could be found. 6XAD has gone into broadcasting. He offers his station KFWO as a broadcasting station for the League. All ORS not reporting will be cancelled. New appointments are 6BEV and 6JI.

Burk has resigned as District Supt. District No. 3. Vern Stockholm, 6JJ, of Dinuba is appointed his successor.

ARIZONA—H. L. Gooding, 6ZZ, has resigned as ADM. Radio Inspector Lovejoy is making a tour of Arizona and has accepted the assignment of getting a man to fill 6ZZ's shoes. 6ZZ's loss will be mourned. The DM and gang wish him luck and hope we may hear him on occasionally. We know that Arizona fellows will support the new man when he is appointed with their full co-operation.

Activity is concentrated in Dist. No. 2 with plenty of messages moving in speedy fashion. More good schedules are needed. Write 6UTO to arrange schedules, giving time and other necessary details.

Dist. No. 1: 6ZH continues trying to make the big jug work like a real 250. 6CHS and 6CGO showed the visiting convention bunch what super-dx sets look like. 6ALK made the convention a success. 6HU sends the ARRL broadcast Mon., Wed. and Fri. at 7 p. m.

Dist. No. 2. 6CGW has been off. 6CAE claims he will be on the air this winter. 6AJI is the only active station in Redlands. 6AKW hears fives at noon on 40 meters. 6COU worked Argentina with a "five." 6AHP is keeping the ether buster on the air pretty steady. 6BUR was awarded the M.R.C. Wouff Hong trophy. 6CDY had a set working at the Ventura Fair. Pasadena is the leading radio town now. 6RH has his "five" on 40 meters. 6RN is on the air again. 6BBQ has a "five" on 20 and 40 meters. 6RLS has his station up again. 6CMQ claims he has a super low loss receiver. 6OF is on the air. 6CSW is one of the most consistent sixes. 6AE can't learn to Charleston and handle traffic at the same time. 6BJD is perhaps the first West Coast amateur to work South Africa. 6BJX maintains a schedule with p1HR.

Dist. No. 3: Superintendent Burk has been compelled to give up his job. 6JJ is taking his place. Dellbert Hall will handle the CM's job. 6ASV and 6AJJ have been the only stations showing reliability.

Traffic: 6SB, 11; 6BWY, 9; 6CGO, 1; 6ZH, 2; 6CMQ, 64; 6BH, 14; 6RN, 4; 6BBQ, 25; 6RLS, 11; 6BJX, 94; 6BGC, 2; 6APG, 36; 6DAH, 52; 6CSW, 29; 6BEV, 14; 6BBV, 23; 6CAH, 3; 6VC, 60; 6RF, 1; 6AE, 13; 6CTO, 68; 6BJD, 34; 6CDY, 132; 6AHP, 27; 6BUR, 47; 6COU, 89; 6AKW, 2; 6AJI, 14; 6CGW, 25; 6CAE, 2.

P. W. Dann, Mgr. Northern Section.

CALIFORNIA, Dist. 4; 6CJJ is moving to Oakland. 6CUL is a new ORS. 6CJD is starting school. 6BLT operates on 40 and 80 meters. 6AME is too busy for radio. 6ADB handles his usual amount of traffic. 6CIS moved his shack. 6BCL keeps a steady schedule with 6CK. 6BMW is on the air every day. 6NX handles many messages. 6BON started up with a bang this month. 6AMM worked

bziAB and rBAL. 6HC began to handle traffic this month. 6CKV's set is working fine. ASM wants to see you fellows handling more traffic.

Dist. No. 5: There were only a couple of stations on the air during September. ASM B. Molinari, 653 Union St., San Francisco, D. S. Gee Becker, Jr., 2375 Fruitvale Ave., Oakland, Calif., C. M. Oakland, H. J. Irthum, 1090-55th St., Oakland California. C. M. Berkeley. E. Deell, 1045 Peralta, Berkeley, Calif. C. M. Richmond, J. Geritz, 460 South 40th St., Richmond, Calif. C. M. San Francisco, R. Hart, 741-47th Ave., San Francisco, Calif. 6BIP is on again. 6IM lost his mast. Ex SAHU hasn't his 6 call yet. 6CLZ has just moved. 6AOA is back on the air again. 6ANW's rectifier went on the bum. 6CTX is building a new receiver.

Dist. No. 6: The A. S. M. while putting forth every effort to get this district going does not meet with much success. 6CC and 6BAF are the only active stations on the air in this section so far.

Traffic: 6BIP, 6; 6CCT, 276; 6CUL, 11; 6CJD, 1; 6BLT, 4; 6CCY, 2; 6ADB, 8; 6BMW, 37; 6BON, 9; 6NX, 11; 6AMM, 37; 6HC, 4; 6CFI, 2; 6BCL, 23; 6ANW, 43; 6CTX, 12; 6AOA, 104.

NEVADA—Dist. No. 7: 6AAR has most of his equipment ready. 6AJR is now operating at KDEK. 6BEH is down on the Coast. 6CCA will be on with "10" warts soon. Dann and Newcomb have a schedule every Sunday morning at 9:30.

Traffic: 6UO, 7.

K. A. Cantin, Mgr. Hawaiian Section.

6BUC uses a 250 watt and would like to hook up with CB3 and P1-1HR. He regularly works the U.S.A. 6AJL is making up for lost time. Power Leakage has caused 6AFF considerable trouble. 6BCG has hit the air with a 50 watt bottle. 6DBL has been on the air for a short time. 6ASR has no difficulty in handling traffic. 6TQ has had trouble in getting QSO with coast stations.

Traffic: 6TQ, 1; 6AFF, 6; 6AJL, 19; 6BUC, 80.

ROANOKE DIVISION

W. T. Gravely, Mgr.

WEST VIRGINIA—ADM, 8BSU: The new ADM wishes to thank the gang in this state for their co-operation. SAUL worked NISR, U.S.S. Trenton at Panama. 8CDV is building a new filter. 8BJG is overhauling too. 8BLI moved to Dayton, Ohio. 8ATC and 8DJN get out well. We hope 8ATC, 8CAY and 8CQH get ORS appointments soon. Traffic: 8CDV, 14; 8AUL, 56; 8AMD, 5.

NORTH CAROLINA—ADM, 4JR: Again ORS must have their attention called to the counting of messages relayed. If a message is received and sent on to another station it has been relayed and each such message counted TWO, one received and one sent, in the relayed space on the report card. Don't send in a report saying relayed nine or another odd number, for it is not possible to get 9 or 11, etc!

Dist. No. 2: This is again the star district. 4NJ lacked tubes. Porto Rico and Mexico are easy for 4TS. 4GW has a 250 watt on 40 meters. 4MI is in winter quarters now and is on often. 4SX is on 40 meters.

Dist. No. 3: 4BX is busy at the store but manages to get on some. 4JR is on daily on 40 meters. 4TJ and 4JR have commercial tickets.

Dist. No. 4: 4NT has things going fine. DX and traffic are good at 4RW. 4NT has been waiting for transmitter parts. 4MA is at State College.

Traffic: 4NJ, 5; 4TS, 13; 4GW, 2; 4MI, 40; 4BX, 21; 4JR, 85; 4RW, 20; 4NT, 1.

VIRGINIA—ADM, 2CA: A new station is now open for traffic at W.M.I. R. L. Downey is in charge. 8BBM, (ex-3ASS) 3RX, and 4TG are operators at this station. Give them your traffic.

Dist. No. 1: 3CKA is now operator of station WTAR. 3MK says there is no traffic on 80 meters. 3CEL worked U. C. F. M. O. P. in one night. 3QF punches out with a "five." 3BS still works on 80 meters. 3SB plans to combine with 3JF for the winter. 3BNE handled two messages for Port Au Prince. He wants your traffic. 3TI still works on 150 meters.

Dist. No. 2: 3BMN is rebuilding and running a radio shop.

Dist. No. 3: All operators at 3IW have either been flat on their backs or got married. We expect a big report from the gang at this station soon. 3BFE has also been sick. 3BGS, while doing some work with his radio masta, injured his hand.

Dist. No. 4: 3CKL worked a2YL. 3RZ spends most

of his time experimenting with the junk. He worked some Europeans. 3CA uses four coil Meissner circuit 40 meters. 3BDZ is ready to go on the air.

Traffic: 3CKA, 1; 3MK, 21; 3CEL, 10; 3SB, 4; 3BNE, 13; 3TI, 7; 3CKL, 40; 3BZ, 3.

ROCKY MOUNTAIN DIVISION N. R. Hood, Mgr.

UTAH—ADM, 6ZT. 6FM is now on 78 meters but moving down to 40. City Manager Haight reports 6SI on 40 meters. 6CQJ and 6BUV will be on the job soon. We hope to see some real activity in Ogden now.

SALT LAKE CITY—6ZT will be called away in a few days and is forced to give up League work for three or four months. 6CRS hears many British and Australian stations between ten p. m. and midnight M. S. T. 6RV is building a new antenna and erecting new masts. 6BUH has been sick. 6RM is in operation again, using a link coupling system. ADM Johnson left October 30 for San Francisco. He spent several days in the Bay District. He hopes to find time to call on several of the hams in that neighborhood. During his absence Mr. D. C. McKae, City Manager for Salt Lake City, will act as ADM.

Traffic: 6FM, 23; 6CRS, 19; 6RM, 2; 6CRR, 5.

COLORADO—ADM, 9CAA: The Denver gang had a booth at the Denver radio show and many messages were obtained. 9BJN, 9AJQ and the YL 9BD F deserve special mention for the good work they did at the show. 9ABC is using a new 7½ watt tube, on 20, 40 and 80 meters. 9DED is now going to college. 9WO worked WNP on a single wire strung up in his attic. 9QL is trying to make 40 meters work satisfactorily. 9EAM is doing business in regular style. 9OO gets out well. 9CAA put in a lot of time at the radio show. He works at a BC station to get a living. He collected quite a few messages from a 10c store. 9DKM has been sick.

Traffic: 9CAA, 134; 9ABC, 57; 9EAM, 17; 9WO, 11; 9DKM, 10; 9OO, 8; 9QL, 6; 9CJY, 4.

Dist. No. 1: 9AOI is going to college. 9DVL managed to keep 'em moving.

Traffic: 9DVL, 100.

Dist. No. 2: 9CDE is the new DS. Give him your support, fellows. 9CDE delivered his report in person. Get behind 9CDE, fellows, and let's see what Dist. No. 2 can do. Several new stations are on the air lately who are not ORS. We need you, fellows. Let's hear from you.

Traffic: 9CDE, 10.

WYOMING—7HX is back with several regular schedules. 7ZO has not so far been able to get a good set on the air. He has had 500 watt tubes down to fifty watt tubes in three different sets. A new set will be on the air possibly by the time this reaches the readers. 7LU is waiting for his transformer. A new station will open up soon in Rawlins.

Traffic: 7HX, 44.

SOUTHEASTERN DIVISION H. L. Peid, Mgr.

WITH this report the DM takes the opportunity of thanking every single member of the division for his support during the last three years, in which time the writer has tried to make this section of the ARRL worth while to the membership. It is with deep regret that I have found it necessary to resign from the position of Division Manager. Business duties have become pressing, so that I do not have time to devote to League work as it should be done. I feel that the work should be given to the man who is in a position to devote some time to it. Although I leave the traffic game, my support is always with the League in any way that I can be of use.

ALABAMA—ADM, 5AJP. Dist. No. 1: Snow of 5ARJ handled a bunch of worthwhile messages at Tuscaloosa.

Dist. No. 3: 5ADA does bigger things every month. He is at it every week-end. 5AJP is on most every night on 80 meters. He installed WIBZ at Montgomery and his First Class Commercial hangs over the set. 5ASU has a second "op" in the person of Captain W. H. Amerine, veteran of the early spark days. 5ATP has his set on 40 meters. Howell is doing his part and if we had more 5ATPs we surely would shine. Howell succeeds Powell of 5ASU as D. S. Coe, 5ASR, promises great things.

Dist. No. 4: 5YB came from behind the curtain this month by handling 115 messages.

Traffic: 5ADA, 48; 5AJP, 34; 5ARJ, 32; 5ASU, 8; 5ATP, 21; 5YB, 115.

SOUTH CAROLINA—ADM, 4RR: Good weather is with us again, with opportunities for better DX and increased traffic handling. 4VQ, a portable set at P. C. College worked WAP and took a long message from him. The Radio Inspector held examinations in Spartanburg a short while ago. 4IT and 4OY got first grade licenses, 4HW and 4RR extra first grade ones.

Traffic: 4VQ, 33; 4RR-4VL, 2.

PORTO RICO—ADM, 4OI: The distinguishing intermedate assigned Porto Rico,—"PR"—has been a godsend to our amateurs. It is now easier to obtain communication with the mainland than before. Most of our gang is on regularly. 4KT at Carolina is doing a good bit of work handling messages for the United States and Europe. 4BJ is again back taking care of Cantano's district. 4RL is most dependable for traffic handling. Regular schedules are kept. 4OI is on regularly. 4JA with a single "fiver" is doing as good work as others with a "fifty." 4SA is moving to new quarters.

Traffic: 4KT, 16; 4BJ, 7; 4RL, 20; 4JA, 11; 4OI, 13.

FLORIDA—ADM, 4EZ: In writing this, his last report, the A.D.M. wishes to thank all of his men for their splendid co-operation, and he hopes the new A.D.M. will receive the same co-operation. The outstanding need right now is for more 80 meter stations. So many stations are on 40 meters that short distance traffic handling is in jeopardy. 4VS is the live-wire traffic pusher of Miami. He claims service there is as good as the telegraph companies are giving. 4FM allowed a trip to New York to interfere with radio—shame! 4QY has a brand new outfit and reports from all over the world. 4ZE keeps his own station and 4NKF on the air. 4TR had the unluckiest kind of hard luck, and 4UA almost ditto, but both are going strong again now. 4TV keeps the world reminded of St. Pete., the Sunshine City. 4ASK is most active in central Florida. Northern Florida is taking on more pep.

Traffic: 4VS, 76; 4ASK, 54; 4XE-4IU, 32; 4KK, 21; 4TV, 14; 4QY, 12; 4PL, 7; 4UA, 6; 4UK, 4; 4FS, 4; 4FM, 2; 4BL, 2; 4TR, 1.

GEORGIA—ADM, 4IO: Dist. No. 1: 4BQ is back doing well as usual. Atlanta 4AAD and 4AAE are getting out well and becoming well known. 4RM has been appointed as new C.M.

Dist. No. 2: As D.S. 4FJ supplants 4FZ, who has gone away to school. 4AAH has moved. 4HS is efficiency expert of the BCL department of a large department store. 4IO is back on the air with a bang. 4KU-4AU, Reid & McMillan, are in the sordid but remunerative BCL business. 4KU, which made such enviable records has been sold. 4KW has moved but is on the air with a mean wallop. We all sympathize with 4ME in the recent loss of his father. "Transformer-4QE" is trying valiantly to get the old 250 perking on 40 meters. 4RM modestly admits being on the air. 4SI worked some new ones. 4TX is heard occasionally. The National Guard has a new station, EV8.

Traffic: 4FJ, 17; 4BW, 4; 4RM, 12; 4SI, 21; 4IO, 67.

4NKF is operated by the Communication Division of the Seventh Naval District, U. S. N. R. F., for the purpose of training, drilling, and maintaining the efficiency of Naval Reserve communication officers and men. This station is on the air every Tuesday evening from 7.45 to 9.15 p. m. EST, and operates exclusively on the 80 meter wavelength band (usually on 83.5 meters).

The station has a standard short wave tuner with one step of audio amplification. A mercury arc rectifier capable of delivering several kilowatts is used for the plate supply. A fifty watt tube supplies the high frequency for the antenna circuit.

At present the organization consists of seven officers and forty-five men. About thirty of the officers and men own amateur transmitting and receiving equipment. The "shack" is a special building assigned to the use of the outfit by Rollins College of Winter Park, Florida. Letters have been received from the Director of Naval Communications complimenting the organization on the fact that it is leading all Naval Districts in activity. Wm. Justice Lee, Lieutenant, U. S. N. R. (4XE), is Division Commander.

WEST GULF DIVISION
Frank M. Corlett, Mgr.

HATS off to the Oklahoma Section! 15 stations report 542 messages handled. 5ADE, Swan of Oklahoma City and 5TW, Harris of Hugo, Okla., handled 188 and 146 respectively. 5HY, Haling of Dallas, leads the Northern Texas Section. In Southern Texas, 5ZAI made the best traffic record. The average per station reporting was 27 messages.

OKLAHOMA — ADM, 5APG: Even the slight improvement due to the advent of October resulted in a traffic increase three fold. 5ZM is getting ready with a new 250 watter. As soon as the express company delivers 5CE a 50 watt bottle all in one piece he will be going. 5ABO made a successful rally on the 40 and 80 meter bands. 5PU is itching to get his repaired plate transformer back. 5ANL kept several schedules on 176 meters. He has been elected CM by the Cushing gang. 5ADO is lining up two new relay stations, 5DQ and 5AEQ.

5ATU has been chosen CM of Tulsa. 5ATA worked all districts on 80 meters. 5GS will be ready for 80 meter traffic regularly. 5ADM uses self-rectification with keen results. 5ATA, 5ATU, 5GS, 5FS and 5ADM are each ready for 80 meter traffic between ten and eleven p. m. 5AGK has pulled his set down to 80 meters after heroic efforts. 5GJ does consistent work. 5TW handled a "gob" of "World Series Applause" to the BC station at Dallas. 5JU has his set operating at Sulphur now. 5AHD rebuilt his set.
Traffic: 5ANL, 7; 5ADO, 9; 5ADE, 188; 5AAV, 24; 5ATV, 43; 5ATK, 24; 5YY, 52; 5CE, 2; 5SW, 2; 5TW, 146; 5JU, 7; 5ABO, 3; 5GB, 15; 5AGK, 1; 5ATA, 19.

NORTHERN TEXAS — ADM, 5AJT: 5AFU has returned from Houston. 5JF worked NVE, U.S.S. Utah, on schedule for a week, while she was off Cuba. 5ATZ is getting out well with a "five-er." 5NW and 5ADD are keeping traffic open through Denton. 5NW is working some nice DX. 5DW is now married. 5ACL, 5HY, 5RG are keeping their DX records polished and renewed. 5AKL is a new station at Waco. Reports were received from 5SD, 5QL, 5AFU, 5AMB, 5ADH, 5VD, 5DW, 5ADZ, 5AJT, showing no traffic handled.

Traffic: 5JF, 42; 5ATZ, 22; 5NW, 15; 5ADD, 4; 5ACL, 9; 5RG, 16; 5HY, 30; 5AKL, 6.

SOUTHERN TEXAS — ADM, 5YK: The month has been uneventful. San Antonio has been represented by 5HS, 5HC and 5ACZ. 5HS has been rebuilding. 5MS has been rebuilding too, and we are glad to have a reliable station at Corpus Christi. 5HC and 5ACZ handled considerable traffic for San Antonio on forty meters. 5AMP of San Marcos is back on forty in the early evening hours but reports a scarcity of traffic. 5ZAI has a splendid station.

Traffic: 5HC, 16; 5ACZ, 10; 5EW, 11; 5ZAI, 27; 5AMP, 4.

CANADA

WITH the return of fall weather, interest in amateur radio is picking up again in Canada. The big item in November was the Eastern Canada Radio convention held at Montreal, November 26-28 to which all amateurs were cordially invited. A good program was carried out and there was a representative gathering of all Eastern amateurs. The CGS Arctic, VDM, returned safely home October first. Radio communication during the later part of her voyage was considerably improved, being all accomplished on 40 meters. The trip was not as successful as last year due to numerous difficulties with the apparatus.

MARITIME DIVISION
W. C. Borrett, Mgr.

TRAFFIC honors this month go to Palmer of IAM, Fredricton, N. B. who worked 2ZAC. 1AR, 1DQ, 1DD, 1AF and IAM have now attained the honor. Hurrah for the ten thousand miles! 1BO is our latest New Brunswick ORS. Welcome, OM. 1AF is spending the winter at St. John studying law. 1AN is on a visit to the U.S.A. 5AR is on the low waves. The gang are asked to look for him on 85 meters. 1CO is perking again. With 1BZ he will put PEJ on the map. 1ED has returned from the West. 1AW reports several new hams, plugging for their amateur tickets in his district. 1DM has been appointed a Radio Inspector. 1AE is on 150 meters. 1CX, 1AE and 1DM promise to show some activity. If any CB stations want to become ORS, 1AW will

look after them. 1AR worked Czecho-Slovakia OK. He keeps a nightly schedule with 2NM. 1DJ has been appointed Division NEWS Manager. All the gang are asked to write him when they have news worth publishing. Strange calls heard and worked are interesting news. Let 1DJ have them. 1DD works England on 42 meters often. Many Maritime Stations are heard on 40 meters at noon.

ONTARIO DIVISION
W. M. Sutton, Mgr.

EASTERN ONTARIO: Again, for the third month, we hand the traffic laurels to 3AEL. On top of handling 41 message, he worked several sixes and was heard in England, all on one "five-er." FR! More stations should participate at the Wednesday night meetings. 3AF and 3AFP are regular attendants. The latter opens proceedings with the official broadcast message at 12.30 am sharp.

Traffic: 3AEL, 41; 3AF, 2; 3AFP, 5.

CENTRAL ONTARIO: Great activity is going on. Last minute changes are being made to antennas, before colder weather sets in. 9AL, 3CK and 3AZ are all using the Hertz antenna. 9AL did some great 40 meter traffic handling with VDM. 3VH handles traffic with HER in the early evg. He sent 4 QRX'ed and recd answers. FBI 9BJ will be on with new bottle when this appears. The gang had a real hamfest at Montreal.

Traffic: 9AL, 21; 3VH, 13; 3AZ, 19; 3KQ, 7; 3ACH, 5; 3FL, 3; 3PH, 21.

SOUTHERN ONTARIO: 8AQ and 3ZD will be on the air soon. 3KA and 3KB are on 40 meters. 3KP worked Europe often with a fifty. 3DH is getting on "40" with a "five-er." 3ZB is getting new apparatus! 3FU will give 40 meters a try. Galt: 3AEC is on a harvester excursion out west.

Sarnia: 3AD has a new fifty. 3XI is on the air regularly. He has been QSO Z-1AO and P. R.

VANCOUVER DIVISION
W. J. Rowan, Mgr.

FOR SOME reason, the gang don't seem to be getting on the job very quickly for the winter session. The active list of ORS is being pruned down to the RELIABLE stations so watch out gang.

GREATER VANCOUVER:—We had a peep from our old "standby," 5AH the other day. 5AN, our experimenter, is getting a great kick in receiving. 5AS is changing from 80 to 40 meters.

5CT is stuck for power. The main generator in the town plant broke a shaft and is out of repair indefinitely. 9CK is at 6HM. He worked a-5BG regularly on schedule for nearly a month with less than 12 watts input. 5AM is a new station in Duncan.

CALGARY:—Hurray! 4GT has the stirrups donated by Major Raven-Hart ch9TC for being the first Canadian to work him. (FB, OM, we are proud of you, DM). 4IO is getting some newcomers lined up who will be a credit to the ARRL.

PRINCE RUPERT:—5GT worked Australia and nearly all U. S. districts. He is arranging schedules for traffic handling. Write him.

EDMONTON:—4HF is back at the farm. We hear he is a poet. Let's have the report that way.
Traffic: 5AS, 1; 5BM, 8; 5HS, 3; 5GO, 9; 5HB, 37; 4AL, 21; 4GT, 15; 4IO, 7; 5CT, 9.

WINNIPEG DIVISION
W. R. Pottle, Mgr.

OUR report shows that the regular stations are active. There is still some difficulty in moving traffic in the Division. How about a SPECIAL WATCH for Canuck Hams 10.30 pm MST on 40 meters and 11.00 on 80 meters? Let's try it fellows. 4IX is splitting the air with a "fifty." 4GH is going strong on 85 meters. 4EZ has not opened up yet. Annual Manitoba Convention, held in connection with the Western Canada Radio Show. The ARRL booth was much in evidence. A complete Ham Transmitter in working order held large crowds. Considerable traffic was handled. A real Ham feast was staged at the Marlborough Hotel. 4DE is reaching out with his new transmitter. 4DF is on 40 meters with 10 watts. 4DY's 50 watter is perking. 4CR still works 'em all from the South Seas to Britain. 4EA and 4EZ get out good. 4CJ has installed S tubes.

Traffic: 4DE, 27; 4DY, 21; 4AW, 6; 4FZ, 22; 4AO, 18.