

# 73 Amateur Radio Today

MARCH 1994

ISSUE #402

USA \$2.95

CAN \$3.95

A WGI Publication  
International Edition

## Picture This!

Satellite Imagery in Your Shack

## The FOXBOX

Build This  
Voice Controller  
For Your  
Next Hunt

## 73 Reviews

Ten-Tec Scout

## Connect Systems

Repeater Controller

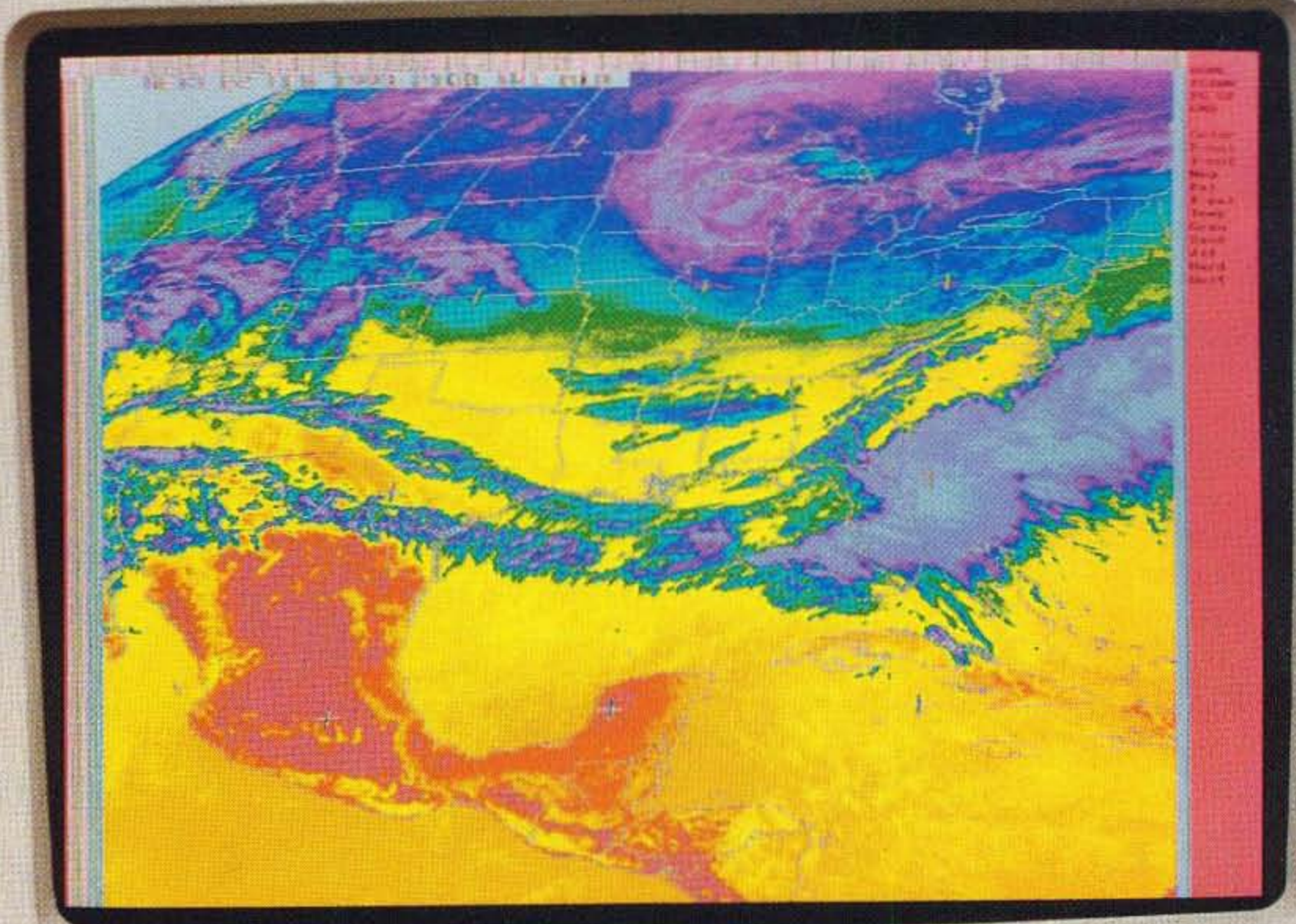



# The IC-Δ100H Takes The Magic Beyond 3 Wishes!

## Exclusive Triple Band Capability

- ▲ Three independent band units for 2 M, 440 MHz and 1.2 GHz operation (simultaneous receive).
- ▲ Three independent displays can freely select the desired band unit.
- ▲ Each display indicates S/RF, volume and squelch levels.
- ▲ Each display is controlled by a separate volume and tuning knob.
- ▲ Select from 3 external speaker jacks.

### 8 POSSIBLE COMBINATIONS!

#1	#2	#3
2M	440MHz	1.2GHz
2M	440MHz	440MHz
2M	2M	1.2GHz
2M	2M	440MHz
440MHz	440MHz	1.2GHz
440MHz	440MHz	440MHz
440MHz	2M	1.2GHz
440MHz	2M	440MHz

More than a tri-band radio, the IC-Δ100H gives you true freedom of choice!

- ▲ No removal or installation of additional band units required.
- ▲ Each operating band has a separate antenna connector to enable duplexer/triplexer use without any mismatching antenna loss (not one common antenna for multi-signal, one band operation like you see in competitive models).

- ▲ Cross band double duplex (transmit on one band while receiving on two others) and full crossband duplex (transmit on one band and receive on another) is possible. The one-touch PTT enables telephone-like conversations without having to continually press PTT.

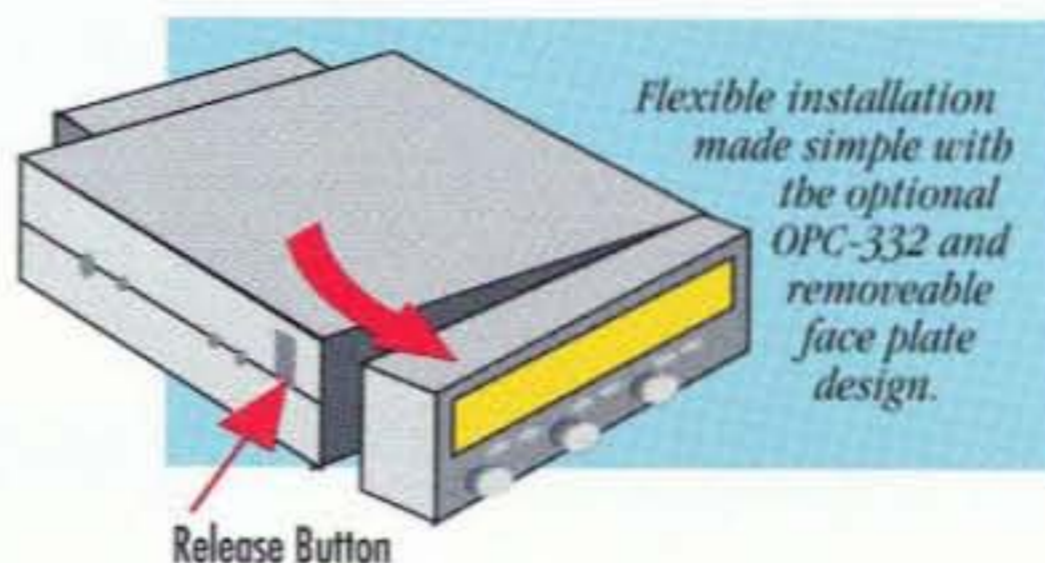

## Remote Installation Options

- ▲ **One Body** – install as a complete unit.
- ▲ **Separate** – detach the front panel and mount each separately (see illustration).
- ▲ **Remote** – Mount the main body in the trunk (OPC-333 and OPC-335 req.).

## Incredible Performance

- ▲ AFC-RIT, AFC-VXO, manual RIT and manual VXO modes to compensate for "off frequency" of the Tx station (1.2 GHz).
- ▲ High Sensitivity – less than .16μV.
- ▲ Double-conversion superhetro-dyne receiver system.
- ▲ More than 2.4 W audio output power.

## Memory Bank System

- ▲ 642 memory channels organized in two separate banks\* (very convenient for two ham families).

MEMORY BANK SYSTEM							
Options	Bank/User #1			Bank/User #2			TOTAL
Bank	#1	#2	#3	#1	#2	#3	
Normal*	100	100	100	100	100	100	600
Scan Edge	6	6	6	6	6	6	36
Call	1	1	1	1	1	1	6
<b>Total IC-Δ100H Memory Channels:</b>							<b>642</b>

The memory bank system can even be customized for "bis" and "bers" operation!

- ▲ Priority Watch – Scans one (or more) memory channels per band while operating on a VFO frequency.
- ▲ Transfer call or memory channel contents to VFO. Particularly useful when searching for signals around a memory channel frequency and for recalling the offset frequency, tone frequency, etc.
- ▲ 14 DTMF autodial memories for autopatching, accessing repeaters and controlling other equipment, etc.

\* Stores operating frequency, duplex direction, offset frequency, subaudible tone frequency, encode on/off, tone squelch on/off and skip information.

## Microphone Remote Controls

### You Can Control All Of These Functions From The Microphone Keyboard!

<input checked="" type="checkbox"/> Power On/Off	<input checked="" type="checkbox"/> Code Squelch
<input checked="" type="checkbox"/> Select Main Band	<input checked="" type="checkbox"/> Tone, Tone Squelch
<input checked="" type="checkbox"/> Change Operating Band	<input checked="" type="checkbox"/> Pocket Beep On/Off
<input checked="" type="checkbox"/> Volume Adjust	<input checked="" type="checkbox"/> AFC On/Off
<input checked="" type="checkbox"/> Squelch Adjust	<input checked="" type="checkbox"/> Attenuator On/Off
<input checked="" type="checkbox"/> Mode Select	<input checked="" type="checkbox"/> Set Mode
<input checked="" type="checkbox"/> Duplex Select	<input checked="" type="checkbox"/> DTMF Auto or Manual
<input checked="" type="checkbox"/> Frequency Select	<input checked="" type="checkbox"/> Operating Freq. Annce. (with opt. UT-66 synth.)
<input checked="" type="checkbox"/> Memory Channel Select	<input checked="" type="checkbox"/> Write VFO Contents to Memory or Call Channel
<input checked="" type="checkbox"/> Mute Bands	<input checked="" type="checkbox"/> Lock All Mic Keys or Keyboard Only
<input checked="" type="checkbox"/> Scan or Priority Watch	
<input checked="" type="checkbox"/> Pager On/Off	

- ▲ A multi-function keyboard with complete control over the IC-Δ100H.

- ▲ The beep tones for each band are different and distinguishable so you can keep your eyes on the road.

- ▲ Over 22 functions are at

your fingertips with the IC-Δ100's unique microphone keyboard (see chart above)!

## Other Great Features

- External remote control via another transceiver (UT-55 required)
- Tri, dual or mono band operation
- Sub band access/mute/busy beep functions
- Optional pocket beep and tone squelch
- Opt. pager/code squelch
- Tone encoder built in
- Multiple scans

IC-Δ100H Triple Band Mobile Transceiver (shown with the optional OPC-332)



ICOM America, Inc. Corporate Headquarters: 2380-116th Ave. N.E., Bellevue, WA 98004  
All stated specifications subject to change without notice or obligations. All ICOM radios significantly exceed FCC regulations limiting spurious emissions. The ICOM logo is a registered trademark of ICOM, Inc. Δ1001193T

For more information call our brochure hotline: (206) 450-6088

# ICOM®

CIRCLE 179 ON READER SERVICE CARD





# STARTEK INTERNATIONAL INC. FREQUENCY COUNTERS

Made  
in  
USA

## New ATH™ Series

Say goodbye to random counting & false readings with the ATH™ Series

### WARRANTY

5 YEARS all parts  
1 YEAR labor  
ALL MODELS

### FIND FREQUENCIES FAST

With the new, high sensitivity, ultra-fast, Auto Trigger & Hold STARTEK frequency counters. Increase readability distance with the new Band Pass Filters. All products made in USA.

### AUTO TRIGGER & HOLD

Now, for the first time, available on inexpensive, portable counters with our new ATH™ Series. This feature is the most significant improvement ever made to the pocket sized counters! It allows "Hands Free" operation to automatically read & hold a signal as quick as 80ms or 8% of a second.



ATH-15  
1-1500 MHZ

HP-400  
Band Pass Filter



ATH-30  
1-2800 MHZ  
One-Shot Feature



TA-90 Antenna  
(priced separately)

ATH-50  
5 Hz to 2800 MHZ  
One-Shot Feature



Ultra Bright  
Display

Signal  
Strength  
Bar Graph  
Works  
on Every  
Range

Low  
Battery  
Indicator

Size 4" h x  
3.5" w x 1" d  
Aluminum  
Cabinets  
(No Self Tap  
Screws)



### ATH™ SERIES FEATURES INCLUDE:

- Easy to use - simple controls
- Ultra fast response time
- Extra BRIGHT LED digits
- 3-5 hour battery operation
- Automatic clean dropout
- Maximized sensitivity, <1mV typical
- Signal strength Bar Graph
- 2 ranges - 6 fast gate times
- 9-12V auto-polarity power jack
- StarCab™ aluminum cabinet

Ni-Cads  
and A/C Charger  
INCLUDED  
with ALL Models



### In Stock... Same Day Shipment!

ATH, Ultra High Sensitivity Frequency Counters		
ATH-15	1-1500 MHZ, High speed	\$199. <del>\$255</del>
ATH-30	1-2800 MHZ, High speed, one shot	259. <del>299</del>
ATH-50	5 Hz to 2800 MHZ, one shot	289. <del>389</del>
HST-15	Optional 0.2 PPM TCXD High Accuracy Timebase (installed)	100. <del>125</del>

Economy Frequency Counter		
1350	1-1300 MHZ, 10 HZ Res. 3 gate times, Hold switch	\$119. <del>129</del>

Band Pass Filters		
Increase range or distance from a transmitter with a Band Pass Filter. <1 dB pass band insertion loss.		
LP-60	DC-60 MHZ Usage	\$69.
HP-400	400-1500 MHZ Usage	69.
HP-800	800-2000 MHZ Usage	69.
BP-3	Above 3 filters (SAVE \$30)	\$177. <del>207</del>

Accessories		
A	CC-90 Case for all models	12.
B	TA-90 Telescope BNC antenna	12.
C	TA-90-L Telescope elbow antenna	16.
D	RD-150 150 MHZ rubber duck	16.
E	RD-2750 27-50 MHZ rubber duck	28.
F	RD-800 800 MHZ rubber duck	29.
G	M-207-IC Interface cable for MFJ-207	10.
H	P-110 200 MHZ, 1x, 10x probe	39.
J	LP-22 Lo-Pass, audio usage probe	25.
K	DC-10 Direct, 50 OHM probe	20.



Factory Direct Order Lines  
SAME DAY SHIPMENT

Orders Only 800-638-8050  
Orders & Information 305-561-2211  
FAX 305-561-9133



STARTEK INTERNATIONAL INC.  
398 NE 38th St., Ft. Lauderdale, FL 33334

Terms: Ship/Hand charges for US & Can \$10, others add 15%. FL residents add tax. C.O.D. \$5. VISA, MC, Discover accepted. Prices and specifications subject to change without notice or obligation.



# SIMPLE, AFFORDABLE & FUN

DESIGNED FOR ONE REASON... TO HAVE FUN!  
AND BOY DOES IT DELIVER!!!

**\$495**



- Change bands in a second. Just plug in desired module!

### It's SMALL

Makes mobile or portable fun for more hams than ever before. Fits almost any car, even compacts. Measuring only 2.5" X 7.25" X 9.75", this five lb. travel companion tucks in a briefcase with plenty of room to spare.

### It's HOT

Receiver runs circles around rigs at twice the price. 90 dB dynamic range, low phase noise design lets you hear the weak ones even on crowded bands. It's no fun if you can't hear em!

### It's SIMPLE

Just sit down and operate. Master every feature in minutes - no modern rig is as easy to use. Change band modules in a flash to work 160-10 meters including WARC.

### It's AFFORDABLE

At \$495, it's half the price of the close competition. No other rig packs so much performance at so low a price. Have fun on HF without spending a fortune.

**MADE IN USA**

- Patented "Jones" Filter provides variable bandwidth 9 pole crystal filter - 500 Hz to 2.5 kHz. The right filter for every condition at the touch of a knob.
- "SYNCHRO-LOCK" software keeps VFO virtually drift free regardless of temperature variations.
- Optional Noise Blanker
- SSB and CW 50 Watts Output Adjustable To 5 Watts
- Runs Off 12-14 VDC TX -10 Amps, RX -.6 Amps
- Receive Offset Tuning
- Built-in Iambic Keyer with Legendary QSK. Speed adjustable on front and shown in display.

**\$495\*** Includes one band module of your choice

**\$25\*** Each additional band module

#### SCOUT ACCESSORIES:

MODEL		PRICE*
296	Mobile Bracket	\$15.00
297	Noise Blanker	\$19.50
937	11 Amp Power Supply	\$79.00
938	Tiny Switching Supply (Only 3 lbs.!)	\$95.00
700C	Hand Mike	\$39.95
607	Weighted Key Paddle	\$39.00
291	Antenna Tuner	\$89.00

#### VISA, MC, DISCOVER

\*Plus shipping and handling; call toll-free for charges.

### It's NOT A TOY

Crystal mixing (no synthesizer) coupled with meticulous circuit design yields sparkling clean receive audio. And you'll marvel at the unsolicited compliments on transmit audio.

**CALL 1-800-833-7373**

Telephone Hours:  
9:00 AM - 5:30 PM Eastern

...America's Best!  
**TEN-TEC**

1185 Dolly Parton Parkway  
Sevierville, TN 37862 USA  
Office: (615) 453-7172  
Fax: (615) 428-4483  
Repair Dept.: (615) 428-0364

**KITS ARE BACK!**  
Introducing TK Kits  
A new division of Ten-Tec  
Call 615-453-7172  
to request your  
kit catalog



## THE TEAM

**PUBLISHER/EDITOR**  
Wayne Green W2NSD/1

**ASSOCIATE PUBLISHER/EDITOR**  
David Cassidy N1GPH

**MANAGING EDITOR**  
Hope Currier

**SENIOR/TECHNICAL EDITOR**  
Charles Warrington WA1RZW

**EDITORIAL ASSOCIATES**  
Sue Jewell  
Joyce Sawtelle

**CONTRIBUTING EDITORS**  
Bill Brown WB8ELK  
Mike Bryce WB8VGE  
Joseph E. Carr K4IPV  
David Cowhig WA1LBP  
Michael Geier KB1UM  
Jim Gray W1XU/7  
Chuck Houghton WB6IGP  
Arnie Johnson N1BAC  
Dr. Marc Leavey WA3AJR  
Andy MacAllister WA5ZIB  
Joe Moell KOOV  
Carole Perry WB2MGP  
Jeffrey Sloman N1EWO

**ADVERTISING SALES MANAGER**  
Dan Harper  
**ADVERTISING COORDINATOR**  
Judy Walker  
1-603-924-0058  
1-800-274-7373  
FAX: 1-603-924-9327

**GRAPHIC DESIGN**  
Suzanne Self

**GRAPHIC SERVICES**  
FilmWorks, Inc.  
Hancock NH

**TYPESETTING**  
Linda Drew

**CIRCULATION MANAGER**  
Harvey Chandler  
To subscribe: 1-800-289-0388

### WAYNE GREEN, INC.

**Editorial Offices**  
70 Route 202N  
Peterborough NH 03458  
1-603-924-0058;  
FAX: 1-603-924-9327

**Subscription Services**  
1-800-289-0388

**Foreign Subscribers**  
1-609-461-8432



Audit Bureau  
of Circulations  
Member

Reprints: \$3.00 per article.  
Back issues: \$4.00 each.  
Write to 73 Amateur Radio Today, Reprints,  
70 Route 202N, Peterborough, NH 03458.

Printed in the U.S.A. by Quad  
Graphics, Thomaston, Georgia.

# 73 Amateur Radio Today

March 1994  
Issue #402

## TABLE OF CONTENTS

### FEATURES

- 10 Getting Started With Satellite Imagery**  
Enjoy a bird's-eye view using your PC and VHF rig. ....KO4BD
- 18 Using the World's Most Accurate Frequency Standard, Part 3**  
Building a good secondary frequency standard. ....K9EUI
- 26 The TW-1 Cheap Digital Front Panel**  
Easy thumbwheel tuning for the Techno-Whizzy 1. ....N9JZW
- 42 The FOXBOX**  
A voice ID T-hunt controller. ....KI5GH
- 52 The Commercial General Radio-telephone Operator License**  
Pass that test!  
.....WB6NOA

### REVIEWS

- 34 The CS-800**  
Connect System Inc.'s Full Duplex Interconnect. ....N3KHM
- 36 The Ten-Tec Scout**  
Easy, affordable and, best of all, fun!  
.....WB8VGE

### DEPARTMENTS

- 74 Above and Beyond  
81 Ad Index  
78 Ask Kaboom  
70 ATV  
89 Barter 'n' Buy  
58 Carr's Corner  
87 Dealer Directory  
17 Feedback Index  
83 Ham Help  
64 Hams with Class  
60 Homing In  
6 Letters  
4 Never Say Die  
88 New Products  
68 Packet & Computers  
96 Propagation  
65 QRP  
8 QRX  
96 Random Output  
57 RTTY Loop  
82 73 International  
86 Special Events  
94 Uncle Wayne's Bookshelf  
83 Updates

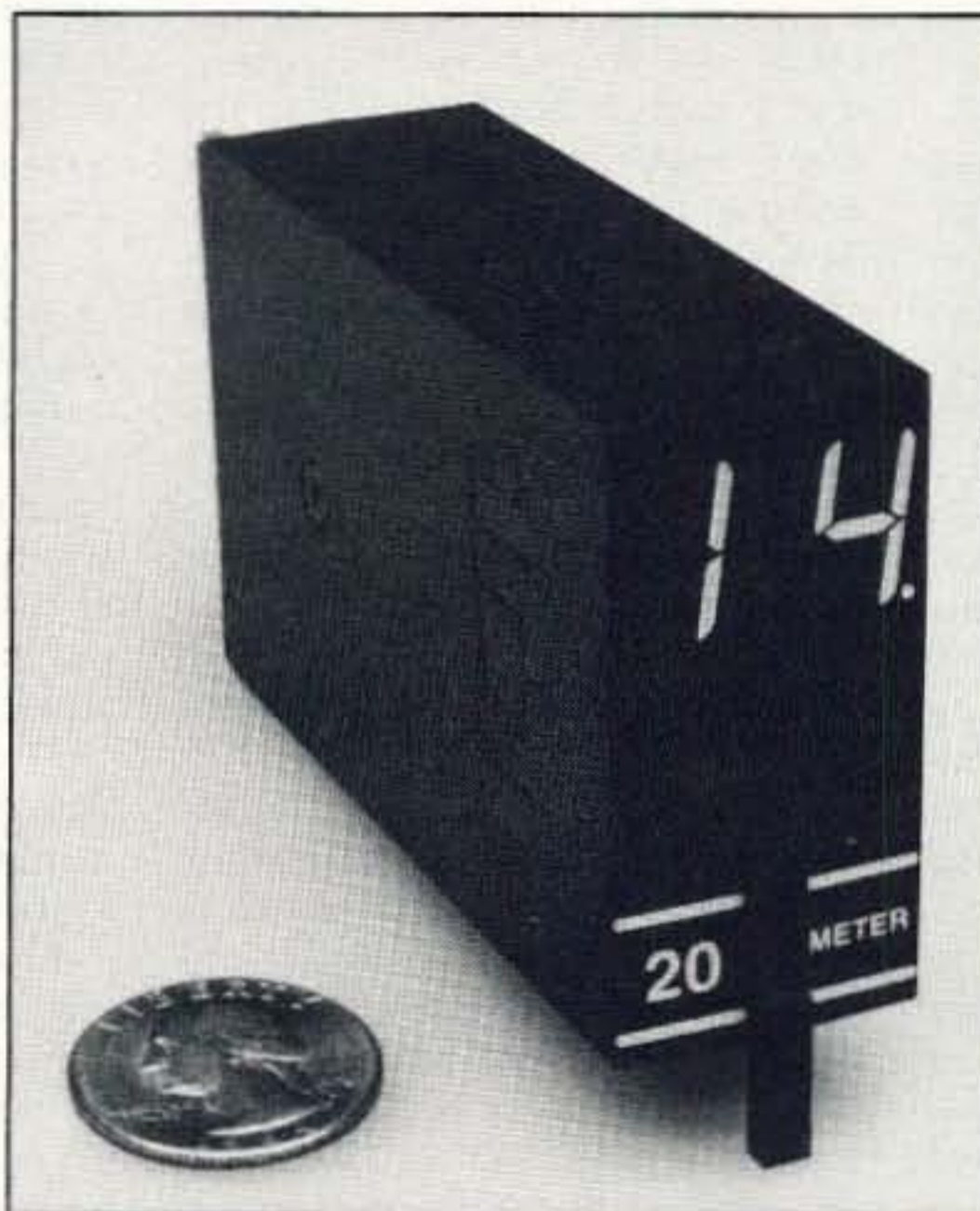

Want to plug in a new band? . . . See page 36.

### FEEDBACK... FEEDBACK!

It's like being there—right here in our offices! How? Just take advantage of our FEEDBACK card on page 17. You'll notice a feedback number at the beginning of each article and column. We'd like you to rate what you read so that we can print what types of things you like best. And then we will draw one Feedback card each month for a free subscription to 73.

On the cover: Bring pictures from space right into your home. See "Getting Started With Satellite Imagery" on page 10. Receiver Model R7100 courtesy of ICOM. Satellite image courtesy of MultiFAX. Photo by David Cassidy N1GPH.

## FB

**Editorial Offices**  
70 Route 202N  
Peterborough NH 03458  
phone: 603-924-0058

**Advertising Offices**  
70 Route 202N  
Peterborough NH 03458  
phone: 800-274-7373

**Circulation Offices**  
70 Route 202N  
Peterborough NH 03458  
phone: 603-924-0058

**Manuscripts** Contributions in the form of manuscripts with drawings and/or photographs are welcome and will be considered for possible publication. We can assume no responsibility for loss or damage to any material. Please enclose a stamped, self-addressed envelope with each submission. Payment for the use of any unsolicited material will be made upon publication. A premium will be paid for accepted articles that have been submitted electronically (CompuServe ppn 70310.775 or MCI Mail "WGEPUB" or GENie address "MAG73") or on disk as an IBM-compatible ASCII file. You can also contact us at the 73 BBS at (603) 924-9343, 300—2400 baud, 8 data bits, no parity, one stop bit. All contributions should be directed to the 73 editorial offices. "How to Write for 73" guidelines are available upon request. US citizens must include their Social Security number with submitted manuscripts.

**73 Amateur Radio Today** (ISSN 1052-2522) is published monthly by Wayne Green Inc., 70 Route 202 North, Peterborough NH 03458. Entire contents ©1993 by Wayne Green Inc. No part of this publication may be reproduced without written permission of the publisher. For Subscription Services, write to 73 Amateur Radio Today, P.O. Box 7693, Riverton NJ 08077-7693, or call 1-800-289-0388. The subscription rate is: one year \$24.97, two years \$39.97; Canada: \$34.21 for one year, \$57.75 for two years, including postage and 7% GST. Foreign postage: \$19.00 surface or \$42.00 airmail additional per year. All foreign orders must be accompanied by payment in US funds. Second class postage paid at Peterborough, NH, and at additional mailing offices. Canadian second class mail registration #178101. Canadian GST registration #125393314. Microfilm Edition—University Microfilm, Ann Arbor MI 48106. POSTMASTER: Send address changes to 73 Amateur Radio Today, P.O. Box 7693, Riverton NJ 08077-7693.

**Contract:** You are hereby required to apply your knowledge and goodwill as a licensed amateur radio operator to help those in need. Get involved with an emergency net, public service initiative, or volunteer project. Build on ham radio's proud tradition.



# NEVER SAY DIE

Wayne Green W2NSD/1



## Dayton or Not?

The weekend at Dayton is exciting, with hundreds of indoor and seemingly thousands of flea market exhibits, plus an endless array of special interest sessions. Dayton provides the only practical meeting place for the whole group of hobbies we call amateur radio. It's a place for the pioneers in packet to get together and talk, and to see the latest hardware, software and information products for their niche in the hobby. Ditto those interested in DXing, RTTY, SSTV, ATV, and the almost endless other ham sub-hobbies.

So why would anyone bother to take an hour and a half out of the few hours of the Dayton weekend to sit in a hot room and listen to Wayne Green talk about whatever happens to be on his mind—which usually isn't even about amateur radio?

Last year we stopped having a 73 booth. We looked over the sales vs. costs of having a booth over the last few years and found it just wasn't cost effective anymore. After so many years at Dayton, that was a difficult decision. Lordy, I set up my first booth at Dayton in 1955 and haven't missed many years since then.

But even without a booth I made the HamVention trek, mainly to go around and say hello to my many friends in the industry and to give my Saturday afternoon talk. But I found that my industry friends were so busy dealing with the hams at their booths that they didn't even notice me trying to say hello. They were too busy selling to schmooze.

Since my talks are usually just rehashes of the things I've been writing about in my editorials, I can understand why only about 1% of the attendees bother to sit and sweat while I repeat what they've probably already read.

When I was gung-ho on OSCAR, or helping to pioneer RTTY, repeaters, 50 MHz, SSTV, and so on, I had a good reason to go to Dayton to meet my fellow pioneers. But these days my pioneering interests are in new technologies, in politics, and stuff like that. Stuff you probably don't care about—even though you should.

From my viewpoint there are so many exciting things happening that I

don't know where to start and what to do next. There's this cure for AIDS which an ex-ham physicist friend of mine has developed. There's the incredible progress in cold fusion, which looks like it'll be one of the fastest growing new industries in the world. One that will present endless opportunities for entrepreneurs to make fortunes. There's the growing understanding of how bioelectrical systems work, both in plants and animals. There are those pesky problems we're all ignoring, like the deficit, our crooked Congress, crime, guns, drugs, lousy schools, street gangs, taxes, health care, the Morse code, Somalia, government waste, the IRS, FDA, FBI, and an endless other bunch of government acronyms which are screwing us.

You may have plenty of time to sit and look for pileups to jump on, ball games to watch, golf to play, but I'm up to here in books I want to read, stuff I want to write, and new businesses I think are needed.

So what do you think? Is there anything I could talk about at Dayton that would make you want to come and listen? For most of us it's a long and expensive trip to get there, so we want to make every minute count. We want to see all the inside exhibits. We want to haggle the dealers for the best new gear prices. We want to check out the humongous flea market. We want to get together with hams who share our special interests, and Dayton's the only place we can do that.

Please drop me a note or a QSL card and let me know.

## Is Artificial Light Making You Sick?

The odds, oddly enough, are that your home, hamshack, and office are helping to make you sick, and not any way you'd probably guess. No, I'm not talking about the electro-magnetic field from your electric blanket, or your linear amplifier, though they're certainly bad enough.

One of the books I came across at the recent Tesla Society science conference in Colorado Springs is a corker. I'll try to have it available for you through Uncle Wayne's Bookshelf. It's *Light, Medicine of the Future*, by Jacob Liberman. Light? Good grief, what's Wayne found now?

OK, before I get into a review of the book, follow me on this. Unless you've been intellectually stunted by religious fundamentalism or watching too many stupid sitcoms, you're aware that evolution, over millions of years, has resulted in we humans. And that means that we've been designed to operate within the parameters of our world. Thus we find, when we send people into space, that their bodies don't do well at all. We're designed to operate with one G of gravity. Further, we've evolved in a world with a strong permanent magnetic field—one which changes continuously as a result of varying radiation from the sun and the influence of the moon. We're also being impacted by solar radiation, including light, as well as a wide range of other frequencies from the infrared up through the ultraviolet and cosmic rays. The light from the sun has a spectrum that we've evolved in which is important to us. You take that away, or even change it a little, and there's hell to pay. Indeed, we're paying for it with sickness and bad dispositions.

There's even strong evidence that one of the factors contributing to the demise of the dinosaurs was the reversal of the Earth's magnetic field.

Now, scientists have been experimenting with light and their findings are scary. Maybe Edison didn't do us as much of a favor as we thought. It's turning out that we are a lot more dependent on sunlight that we've suspected. One of the more damaging things we've done to our health is invent glass and, in particular, sunglasses. Another is to invent artificial lighting which doesn't give us nearly the same light spectrum as the sun.

So here we are living and working in fluorescent and incandescent light, and it looks as if we're suffering a wide variety of illnesses as a result. The human immune system, given a decent break, is able to beat almost any germ, virus or even carcinogen. But we've been crippling our immune system in a number of ways—and a big one is via cutting off the light spectrum our eyes and bodies need—the light our eyes and bodies have been designed to use and are dependent upon through thousands of generations of evolution.

A small group of researchers has been testing different colors of lights

on plants, animals, and lately on humans. You can set up your own experiments at home and see for yourself what happens to growing things when they are deprived of sunlight. It's simple. All it takes are some beans or other seeds and patience. Grow some in the sun—and I don't mean behind a glass window. Grow others with the sun they get through a glass window. Try some under different colors of fluorescent lamps. Try some with the full-spectrum fluorescent lamps. And don't forget to find out what happens when you use incandescent lamps.

This whole business got started when a chap named Ott got involved with the stop-motion photography of plants. He had to light them properly and keep them in a closed box so they wouldn't be disturbed by the wind. Well, he sure ran into all kinds of problems. The darned things refused to grow right. He eventually discovered it had to do with the light he was using. Hmm, if light makes that much difference for plants, what about animals? He went on to test different light colors with mice and rats, and then larger animals. It turned out to make an incredible difference in their growth and dispositions. I can't give you all the details here, but you'll find his story most fascinating. It's all in the book, *Health and Light* by John Ott (1973-\$10).

Ott's pioneering work has been carried on by Liberman. In his book you'll read about some amazing cancer cures just with sunlight, the curing of a wide variety of illnesses, of hyperactivity in kids, and so on. You'll read about how introducing the sunlight spectrum of fluorescent light bulbs can completely change the way people work in offices and factories, and even the way classrooms work. You'll also read about the efforts of a small group of scientists who have been fighting our scientific system for years, trying to get their work published and recognized.

Scientific research is a big business, with a third of the research funds coming from the government. The fund allotments lie mainly in the hands of a few businessmen who are very careful not to upset any established businesses. But the problems we have with our scientific research system is a real shame. I've been reading some excellent books on this. The bottom line is that there are a whole bunch of fields that science should explore, but which those controlling the money refuse to acknowledge. I'll review the exposé book, *Impure Science* by Robert Bell, a 1992 book, for you on this topic. What's happening is a disgrace.

So start growing some beans and see for yourself what an amazing influence the sun's light spectrum has on life. And don't try to tell me that, well, those are plants and we humans are different. The hell we are. When you graduate to growing mice under different colors of light, you'll see that

Continued on page 84



Modern, high-performance stations use COMET Antennas, Duplexers, Triplexers and Accessories! COMET products are designed to provide an exceptional level of signal quality and coverage area. Whether operating mobile or from your base station, COMET products make you sound good. No other product line has the selection, convenience, quality and performance!

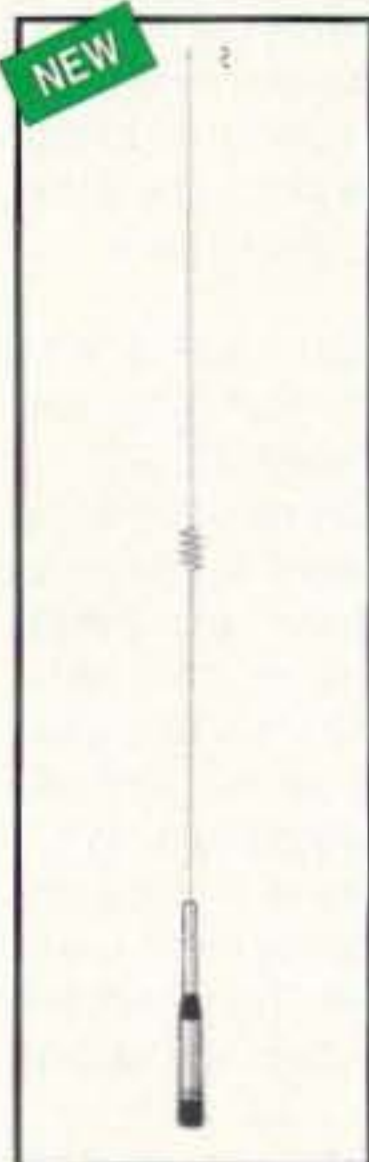

**NEW**  
**SB-5/SB-5NMO**  
Dual-Band 146/446MHz  
**Gain & Wave:**  
146MHz 3.0dB 1/2 wave  
446MHz 5.5dB 5/8 wave x 2  
**VSWR:** 1.5:1 or less  
**Max Power:** 120W FM  
**Length:** 38"  
**Connector:** PL-259 or NMO style

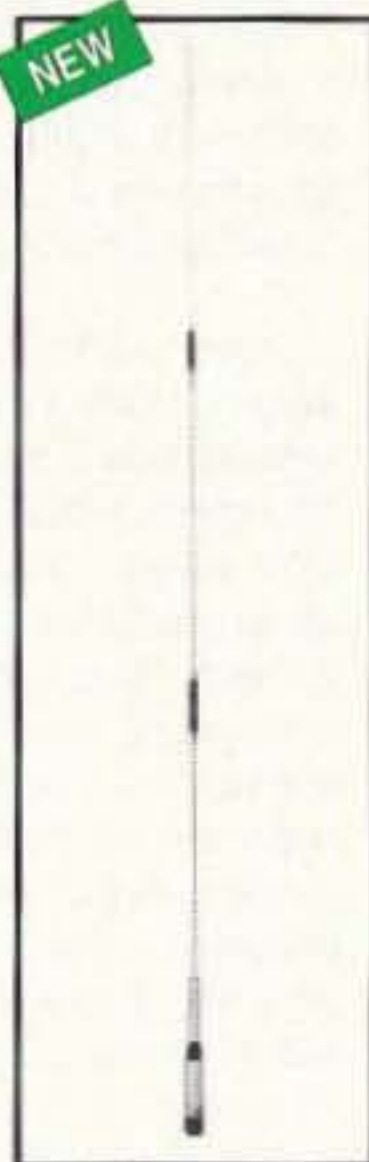

**NEW**  
**SB-7/SB-7NMO**  
Dual-Band 146/446MHz  
**Gain & Wave:**  
146MHz 4.5dB 6/8 wave center load  
446MHz 7.2dB 5/8 wave x 3  
**VSWR:** 1.5:1 or less  
**Max Power:** 70W FM  
**Length:** 4' 7"  
**Connector:** PL-259 or NMO style

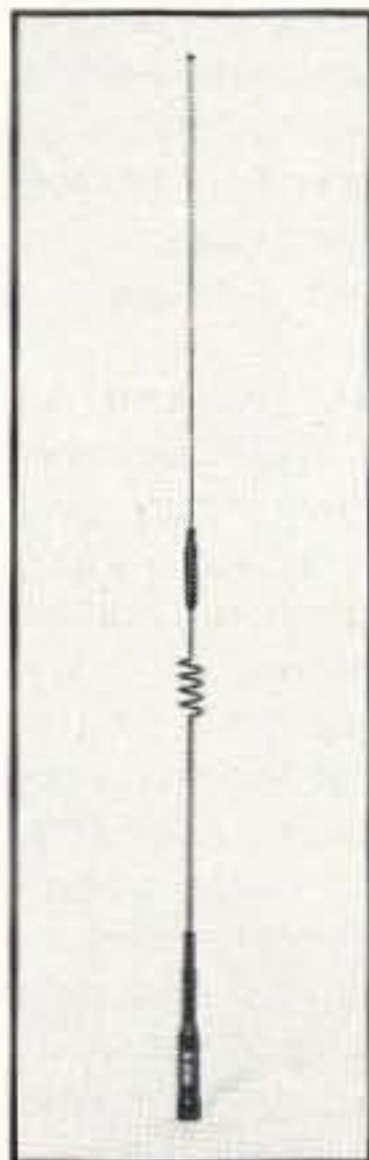

**B-20/B-20NMO**  
Dual-Band 146/446 MHz  
**Gain & Wave:**  
146MHz 2.15dB 1/2 wave  
446MHz 5.0dB 5/8 wave x 2  
**VSWR:** Less than 1.5:1, 144-148MHz, 440-450MHz  
**Max Power:** 50 watts  
**Length:** 30"  
**Connector:** PL-259 or NMO style  
**Construction:** Black, w/fold-over w/fold-Over

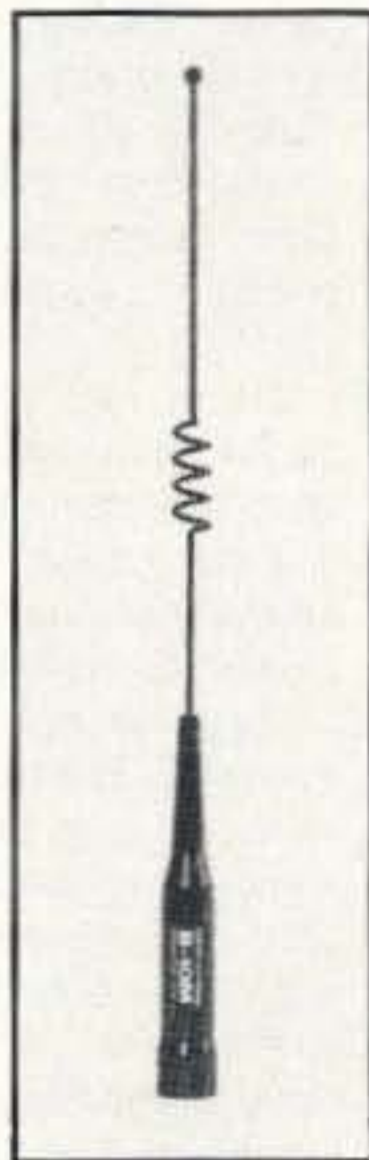

**B-10/B-10NMO**  
Dual-Band 146/446 MHz  
**Gain & Wave:**  
146MHz -dB 1/4 wave  
446MHz 2.15dB 1/2 wave  
**VSWR:** Less than 1.5:1, 144-148MHz, 440-450MHz  
**Max Power:** 50 watts  
**Length:** 12"  
**Connector:** PL-259 or NMO style  
**Construction:** Black, cellular look-a-like w/fold-Over

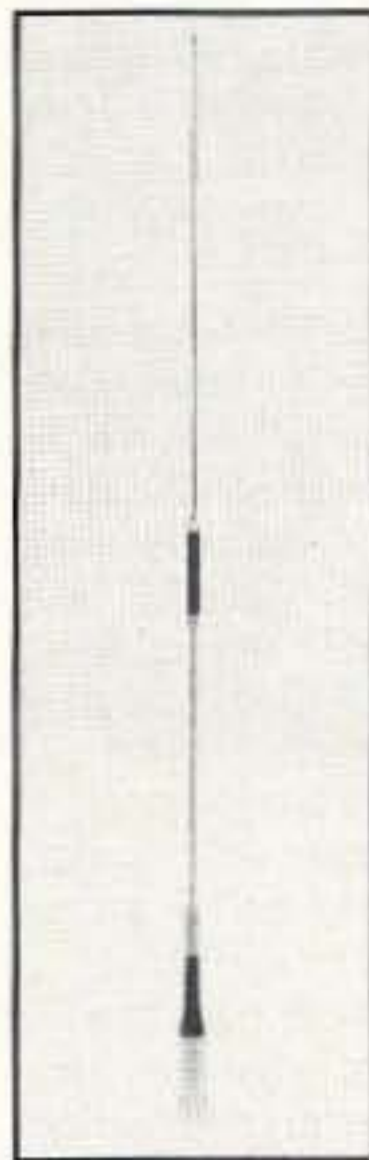

**CX-224/CX224NMO**  
Tri-Band 146/220/446MHz  
**Gain & Wave:**  
146MHz 2.15dB 1/2 wave  
220MHz 3.6dB 5/8 wave  
446MHz 6.0dB 5/8 wave x 2  
**VSWR:** 1.5:1 or less  
**Max Power:** 100 watts  
**Length:** 3'  
**Connector:** CX-224 PL-259 CX-224NMO NMO Style



**NEW**  
**HA4S**  
Quad-Band HF Mobile  
7, 14, 21, 24, 28MHz  
**Wave:** 1/4 wave  
**VSWR:** Less than 2:1  
**Weight:** 1 lb. 14 ozs.  
**Length:** 4' 4"  
**Connector:** PL-259  
**Construction:** Heavy Duty, w/fold-Over  
**L-14HS:** Optional 14MHz Coil

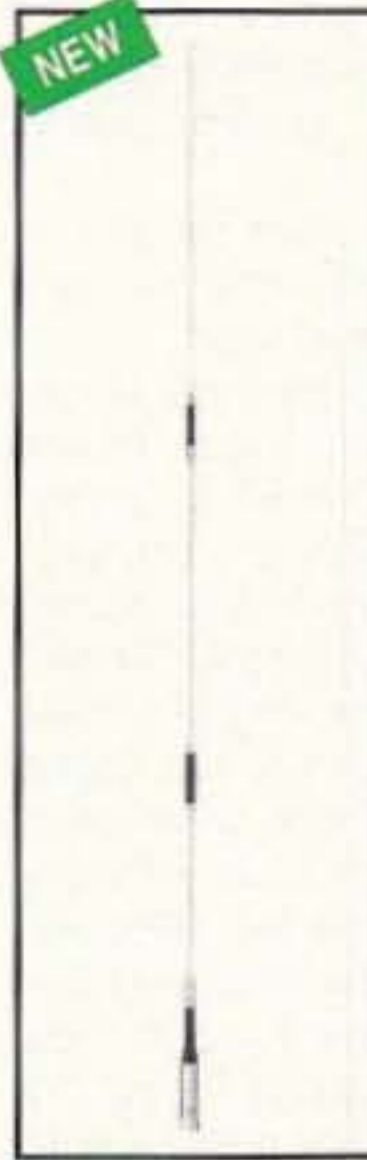

**NEW**  
**FJ-15S**  
Tri-Band Mobile  
50/146/446MHz  
**Gain & Wave:**  
50MHz 2.15dB 1/4 wave  
146MHz 4.5dB 5/8 wave center-loaded  
446MHz 7.2dB 5/8 wave x 3  
**VSWR:** 1.5:1 or less  
**Max Power:** 120 watts FM  
**Length:** 4' 10"  
**Connector:** PL-259

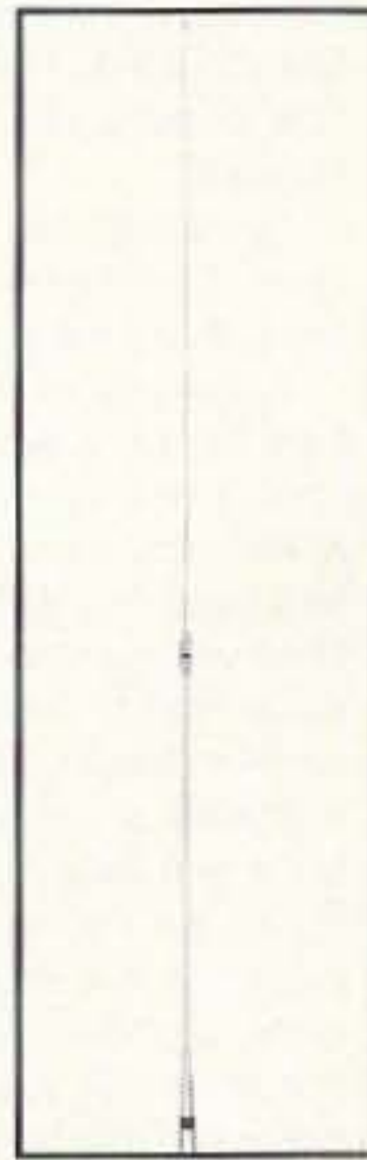

**CHL-185**  
146MHz  
**Gain & Wave:**  
4.1dB 5/8 wave  
**VSWR:** 1.5:1 or less  
**Max Power:** 200 watts  
**Length:** 4' 8"  
**Connector:** PL-259

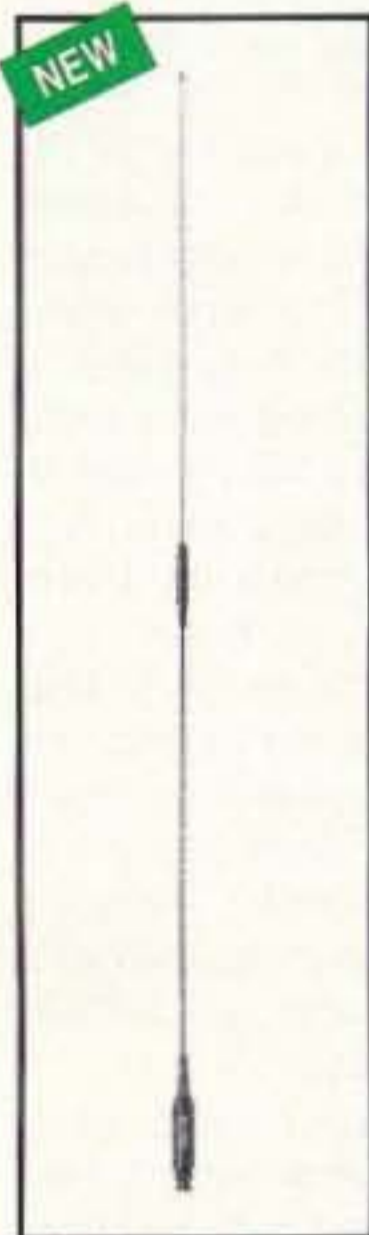

**NEW**  
**CH-722SA**  
146/446MHz HT Antenna  
**Gain & Wave:**  
146MHz 3.0dB 1/2 wave  
446MHz 5.5dB 5/8 wave x 2  
**Max Power:** 50 watts  
**Length:** 36"  
**Weight:** 3.9 ozs.  
**Connector:** BNC

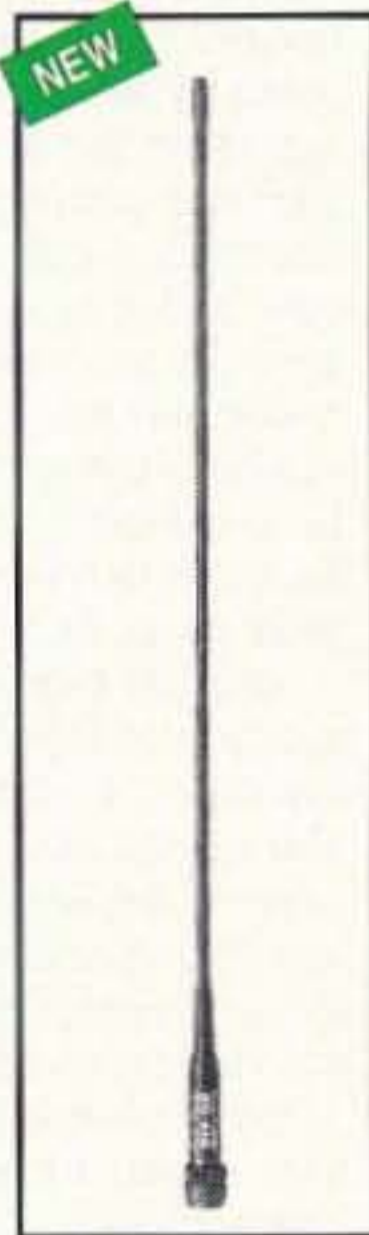

**NEW**  
**SH-55**  
146/446MHz HT Antenna  
**Gain & Wave:**  
146MHz 1.5dB 1/4 wave  
446MHz 3.2dB 5/8 wave  
**Max Power:** 10 watts  
**Length:** 15.5"  
**Connector:** BNC



**CH-32**  
Miracle Baby 146/446MHz HT Antenna. Compact design, the smallest HT antenna available!  
**Gain & Wave:** 0dB  
**VSWR:** 1.5:1 or less  
**Max Power:** 10 watts  
**Length:** 1.75"  
**Connector:** BNC



**RS-21**  
Trunk, hatchback, rear door (van, blazer, etc.) mount. Adjustable to virtually ANY angle. Rubber-coated base protects vehicle paint.



**RS-820**  
Heavy-duty low profile trunk lip or hatch back mount. Rubber coated base protects vehicle paint.

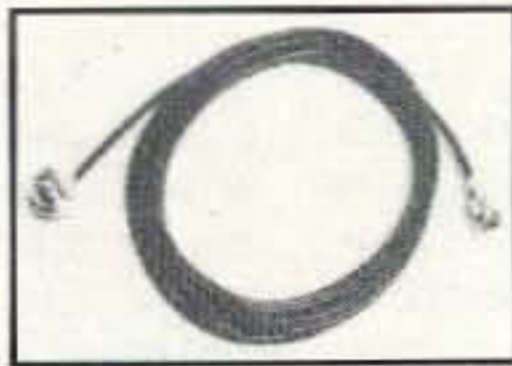

**3D4M** Standard Cable Assembly  
13.5 feet of low loss coax. Gold plated UHF (PL-259/SO-239) connectors.

**3D5M** Standard Cable Assembly  
Same as 3D4M, but 17 feet of coax.



**CK-5M** Deluxe Cable Assembly  
13 feet double shielded very low loss coax. + 12" RG-188 teflon coax. Gold-plated UHF (PL-259/SO-239) connectors. Allows easy entry from a lip-mount w/o causing coax or weather strip damage.

**CK-5M5** Deluxe Cable Assembly  
Same as CK-5M, but 17 feet of coax.



**CF-4160K, CF-4160I, CF-4160J**  
146/446 MHz  
**Band Pass, Ins. Loss, Max Power:**  
1.3-150MHz, 0.1dB, 800w PEP  
400-540MHz, 0.2dB, 500w PEP  
**Isolation:** 60dB  
**CONNECTORS:**  

<b>CF-4160K</b>	<b>CF-4160I</b>	<b>CF-4160J</b>
<b>Output:</b> SO-239	SO-239	SO-239
<b>Low In:</b> PL-259	PL-259	SO-239
<b>High In:</b> PL-259	N-Male	SO-239

**CROSS NEEDLE METERS**

- Separate Meter and RF Sensor allows for convenient placement of the meter.
- Cross Needle Meter provides FWD, REF, and VSWR simultaneously.
- The RF-Sensor is a compact design, and has an extremely low-loss circuit.
- Beautifully illuminated when connected to power supply.
- 6 foot cable standard.
- Optional "EKS-3" 10 foot extension cable for a total of 16 feet between the sensor and meter.

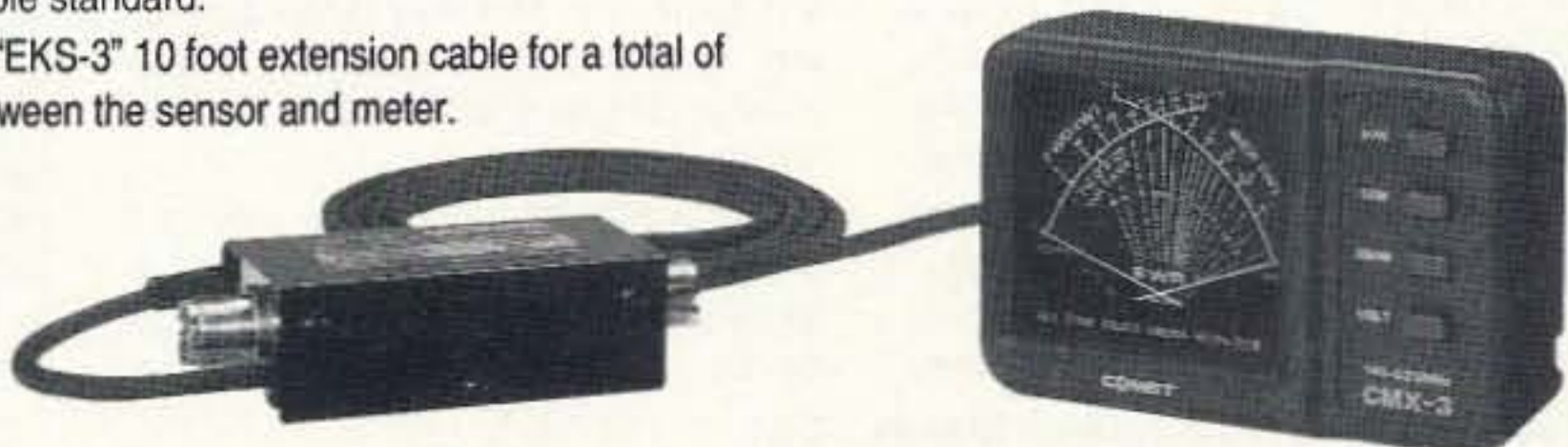

COMET products are available from most major dealers. For customer service, or a complete catalog, please call us at 800/962-2611. We're confident COMET products and accessories will enable you to enjoy Amateur Radio to its fullest!



## From The Hamshack

**Bruce E. Parkes KA2ZGW, San Antonio TX** How is life in the snow belt? Once I finish the next four years in the Air Force I may be joining you in the cold, only a few states to the west. It's too early for me to get the cheap air fares, but then I do enough flying right now to last a lifetime, at least riding in the back.

You asked for product reviews in your December 1993 column, so I thought I'd send you a couple.

Since I travel a lot and still like to participate in amateur radio on the road, I like to try both HF and VHF while in my motel room at night. VHF has been the easiest mode to use. Have you ever tried to hang a 40 meter dipole from the second story of a motel without attracting attention? I've used a few window frames with an antenna tuner with fair results, but 2 meters seems the easiest. Use the *ARRL Repeater Book* to find the locals and kerchunk all the repeaters listed until you find some that you can hit. Calling CQ doesn't do much, so wait until you hear an XYL (or YL) come on frequency. Jump in, and soon you will have all the folks you would like to talk to. I have found that the Radio Shack 2 meter HT is the best rig for the road. I carry it in my helmet bag, which takes a lot of knocks, and it has always done well for me. Having two battery packs increases its utility on the road. The only problem I have with it is the inability to modify it to cover the MARS frequencies. It is a great rig for on-the-road packet and, with an external power supply, it produces an honest 5 watts out.

However, I am not so fond of the ARRL's book *Low Profile Amateur Radio* by Jim Kearman KR1S. I have been operating low profile for years while away from home. The most impressive was during my tour in Panama, which coincided with the problems there that culminated in Operation Just Cause. Since I had a station that wasn't really legal with the local government, I kept it low key. This was an advantage during the war, since I was able to slip away from my duties for a few minutes to keep a schedule with a ham near my home, and relay that I and others from the same area had weathered the initial assault and were well, to my wife, who then passed it on to other families. Unfortunately, I was unable to find any new ideas in the 124 pages. Maybe this book will be of interest to new hams. It didn't do a thing for me.

I liked your certificate from Lambda. After talking with large numbers of hams over the years, I have noticed that what they do in bed has never been a major item of discussion. In fact, I've never discussed it with anyone. Strange that one group wants to throw it up in everyone's face. As a nurse, I have noticed that folks are most defensive about that which they are most un-

comfortable with. Are gays that worried about themselves that they must throw their styles in everyone else's face? I hope they get a life.

**John Doe** I have just started reading your magazine and your "Never Say Die" column hits the nail on the head each month. I just recently passed the No-Code Technician exam and I eagerly await my license.

I have tried on several occasions to learn the code but, for whatever reason, I've not been successful. I joined a local club and one of the first things they did was try to pressure me into learning the code. They just don't understand how someone could be happy with just local communication capability. Let me explain.

My main interests are model railroading and photography. I often go into remote areas to photograph trains, then I use the photos to assist with building models. It finally dawned on me (I'm 36) that some means of communication would be good to have in case I get into trouble. The no-code license fills that need for me. Anyhow, I'm stubborn enough that I'll remain a club member and I'll resist their efforts to get me to learn code, especially when that archaic means of communication seems to be in direct conflict with one of the purposes of the amateur radio service, which is to "advance the radio art."

If you want to incorporate any of this into your column feel free, just change the name and location. I don't need to be ostracized any more than I already am by the local hams.

P.S. The ARRL will never see me as a member until they take a more up-to-date approach.

*John—As long as you are able to get your interest piqued by the many other aspects of amateur radio, and are content to use just one very small piece of our hobby, you have no real problem with the code. But if you have no interest in talking with people in other countries, in using the hobby as anything more than an alternate to CB, I wonder why you've bothered to join a ham club.*

*I've been fighting the ARRL for over 30 years to get rid of the stupid code as a barrier to getting a license. The no-code ticket is a good start. However, I do admit that if a person goes about learning it the best way, it's a small problem. You can learn the code characters in less than an hour. And that's all you need to know to pass the 5 wpm test, as we pointed out in 73 several years ago, much to the consternation of the ARRL. You just write down the dots and dashes and then, at your leisure (their is no time limit for the exam), you decipher them.*

*But, using my code tapes you can learn the code at 20 wpm within a few days, and it doesn't take any brains to do it . . . just tune our bands to prove*

*that. Total idiots can learn the code. Five-year-old kids learn the code. We've any number of seven-year-old Extra Class hams. Yes, the code test is dumb. But then, one would be hard put to find any area where the government has messed with things that their rules aren't dumb.*

*I learned the code over 50 years ago and haven't used it more than two or three times. But one of those times did save my life and those of 83 of my shipmates. Another enabled me to make aurora contacts on 2m, which was exciting. The trouble I went to learning the code did pay off for me. But I promote the learning of the code as voluntary, so one can have fun with it . . . Wayne*

**Jim Gray W1XU, Payson AZ** Wayne, your column in the December issue is a corker! My wife, Peggy, and I had many good laughs, and we also enjoyed several items particularly: psynce and subtle energies.

John Nelson, as you well know, pioneered the PSYNCE of planetary alignments in radio propagation. I've followed in his footsteps, but have never been able to find his book on the subject. Consequently, my forecasts (in 73's "Propagation" column) are not as elaborate—or as accurate—as I'd like them to be. Perhaps you have his book in your library; if so, I'd like to borrow it from you. When John died, a lot of good information went with him . . . and I'm very interested in learning more. None of the sources I've checked seem to have his book, and most don't even know what I'm talking about. Of course, as we both know, "scientists" are great pooh-poohers of anything that's not dogma and "accepted" knowledge. However, here's a field that ought to attract scientists, but to them it's "astrology" and therefore untouchable. Needless to say, "astrology" uses a geocentric system, whereas Nelson and I used/use a heliocentric system, and the *Astronomical Almanac* as our prime data source.

The well-known "weak forces" of gravity and atomic binding forces are being studied everywhere among REAL scientists, and it's now considered by some that the Heisenberg Principle is factual, and that even looking at an electron or an atom can actually "create" it, and most certainly move it. We can know where an electron is, or when it is, but not both at the same time . . . and many consider an electron field as a "smear" rather than discrete orbital mechanics of individual electrons in "shells" . . . quite different from the Bohr atomic model that you and I learned. It is my view that the weak forces/subtle energies of gravity, electromagnetism, and atomic/nuclear binding forces are all part of PSYNCE. So, what holds our universe together on the micro as well as macro levels is worthy of study. Once, I built an Hieronymous machine according to the diagram and discussion by John W. Campbell in *Astounding Science Fiction* back in 1946. The darned thing worked . . . at least it did for me! Dowsing also works for me, as it does for the street and water depart-

ments of many towns and cities. I guess what I'm saying is that the so-called "esoteric sciences or pseudo-sciences" deal with portions of the whole. Just as medicine is now acknowledging a "holistic" approach to human health, it is necessary to adopt a holistic approach to the unified field that may include remote viewing, psychokinesis, dowsing, and other "valid" portions of psy phenomena.

**Tom Linde KZØT, Knoxville IA** Wayne, thank you for your most marvelous piece in the December 1993 73. You speak with a glorious vision about the frontiers that we need to explore as an essential part of our good hobby. Some of those frontiers are in the classroom, some are in the stars, and a few are in resources that we use, and perhaps take too much for granted, daily. I suspect part of the survival of our endangered hobby is making better use of what we already have. The example I submit is the Extra Class subband on 75 meters.

Before I got my Extra I was motivated by the goal of having a classy 2 x 1 callsign, and working people who were more enlightened than those who inhabit other parts of the band. I have a disability with a speech defect, and there were predictable responses whenever I went on the air.

One day a couple of years ago I discovered a very special net in that very hallowed subband of 75. The net accepted me as one of theirs. But far beyond that, it launched me on an adventure that to me was the very essence of ham radio at its best. The net let me explore my limits on 75. Even better, it helped me begin exploring new ways to expand and stretch the limits of that often goofy band. It's a band which challenges us to find ways to make it work better for us. As a net, we do that.

What net is this? It's the Geritol Net, and as a member let me say right off that Geritol is not the greatest acronym. The net operates to help properly licensed hams win their WAS. There is a fine, strong sense of collaboration, a sense of collegiality which is too often missing from our hobby.

Our next newsletter (we publish three a year) will focus on ways to help people who live in the city be more active on our net since we noticed that most of our members have rural or up-beat suburban addresses. But there are lots of cliff dwellers out there. How can we help them expand their horizons?

I think it would be great if you could use some of this information in your column because I think you do wish to push the many horizons which give shape to our hobby.

If by chance you ever tune in to our net—it meets every night on 3.768 MHz at 01:00Z until 50, 6 or 7Z—you might hear me. I do get on a lot because I love adventure and adventure is the essence of this net. My voice stands out because it is the voice of one who has severe cerebral palsy. I have worked all states several times over and I'm also the editor of our newsletter.



## Low Cost GaAsFET PREAMPS

### LNG-(\*)

ONLY \$59  
wired & tested



#### FEATURES:

- Very low noise: 0.7dB vhf, 0.8dB uhf
  - High gain: 13-20dB, depends on freq
  - Wide dynamic range - resist overload
  - Stable: low-feedback dual-gate FET
- \*Specify tuning range: 26-30, 46-56, 137-152, 152-172, 210-230, 400-470, 800-960 MHz.



### LNW-(\*) MINIATURE PREAMP

ONLY \$29 kit, \$44 wired & tested

- GaAs FET Preamp similar to LNG, except designed for low cost & small size. Only 5/8"W x 1-5/8"L x 3/4"H. Easily mounts in many radios.
- \*Specify tuning range: 25-35, 35-55, 55-90, 90-120, 120-150, 150-200, 200-270, 400-500 MHz.

### LNS-(\*) IN-LINE PREAMP



ONLY \$89 kit, \$119 wired & tested

- GaAs FET Preamp with features similar to LNG series, except automatically switches out of line during transmit. Use with base or mobile transceivers up to 25W. Tower mounting brackets incl.
- \*Tuning range: 120-175, 200-240, or 400-500.

### HELICAL RESONATOR PREAMPS

- GaAs FET preamps with 3 or 4 section helical resonators reduce intermod & cross-band interference in critical applications. MODEL HRG-(\*), \$80 vhf, \$110 uhf. \*Specify tuning range: 142-150, 150-162, 162-174, 213-233, 420-470.

## RECEIVING CONVERTERS

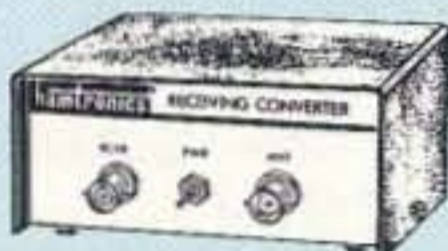

Low noise converters to receive vhf and uhf bands on a 10M receiver.

- Kit less case \$49, kit w/case & BNC jacks \$74, w&t in case \$99.
- Input ranges avail: 50-52, 136-138, 144-146, 145-147, 146-148, 220-222, 222-224 MHz, 432-434, 435-437, 435.5-437.5, and 439.25 (to chan 3).

## TRANSMITTING CONVERTERS

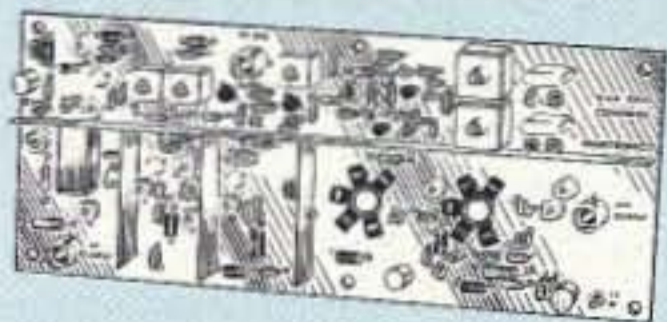

XV2 for vhf and XV4 for uhf. Models to convert 10M ssb, cw, fm, etc. to 2M, 220, 222, 432, 435, and atv. 1W output. Kit only \$89. PA's up to 45W available.

- Buy at low, factory-direct net prices and save!
- For complete info, call or write for free catalog. Send \$2 for overseas air mail.
- Order by mail, fax, or phone (9-12 AM, 1-5 PM eastern time.)
- Min. \$5 S&H charge for first pound plus add'l weight & insurance.
- Use VISA, Mastercard, check, or UPS C.O.D.



A SPRING SALE TO ENCOURAGE EVERY HAM TO BUILD AT LEAST SOME OF HIS EQUIPMENT, NOT ONLY BECAUSE IT IS EDUCATIONAL, BUT FOR THE SATISFACTION AND FUN! AND IT IS EASY WITH OUR THOROUGH MANUALS AND GREAT TECHNICAL SUPPORT.

#### VHF & UHF EXCITERS:

TA51 2W Exciter Kit for 6M, 2M, or 220 ..... \$109 \$79  
TA451 2W FM Exciter Kit for 440 MHz ..... \$109 \$79

#### VHF & UHF RECEIVERS:

R144 2M FM Receiver Kit or R220 Receiver Kit ..... \$149 \$139  
R451 UHF FM Receiver Kit ..... \$149 \$99  
R901 900 MHz Receiver Kit ..... \$169 \$119  
R76 FM Receiver Kit for 10M, 6M, 73 MHz, 2M, 220 MHz ..... \$129 \$89  
R137 Weather Satellite Receiver Kit for Weather Fax ..... \$129 \$89

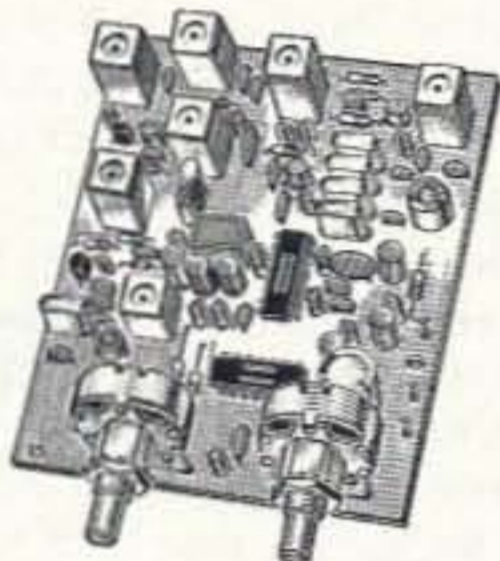

**NEW** R76-M Monitor Receiver Kit for 10M, 6M, 73 MHz, 2M, hi-band, 220 MHz. Great for monitoring repeaters, amateur calling frequencies, or packet radio frequencies, and for listening to commercial two-way radio or police/fire frequencies. It makes a good starting kit to build, too, because it is easy to assemble and align.... only \$59!

VHF & UHF PREAMPS:  
LNW Preamp Kit for various ranges up to 500 MHz (see ad at left) ..... \$29 \$19  
LNW-WB Broadband Preamp Kit for 20-600 MHz ..... \$29 \$19

#### DATA:

MO-202 FSK Data Modulator & DE-202 FSK Demodulator ..... \$49 \$39  
MO-96 9600-Baud Modem ..... \$49 \$39

#### REPEATER ACCESSORIES:

COR-3 Repeater Controller ... \$49 \$39  
CWID Kit ..... \$59 \$44  
COR-4 Controller/ID'er ..... \$99 \$79  
TD-3 CTCSS (Subaudible Tone) Decoder/Encoder ..... \$29 \$24  
DVR-1 Digital Voice Recorder \$89 \$59  
TD-2 DTMF Controller ..... \$89 \$79  
AP-3 Autopatch ..... \$89 \$59

**NEW** COR-6 COR & Real-Voice ID on one board. Records up to 20 seconds of your voice. .... only \$99

TD-4 Selective Calling Module & Economy DTMF Controller ..... only \$49  
Simplex Autopatch System with AP-2 Timing Board, AP-3 Autopatch, & TD-2 DTMF Controller ..... \$247 \$177

## REP-200 REPEATER

A fully microprocessor-controlled repeater with autopatch and many versatile dtmf control features at less than you might pay for a bare-bones repeater or controller alone!

We don't skimp on rf modules, either! Check the features on R144 Receiver below, for instance: GaAs FET front-end, helical resonators, sharp crystal filters, hysteresis squelch.

Kit \$1095; w&t only \$1295!  
(900MHz units slightly higher)

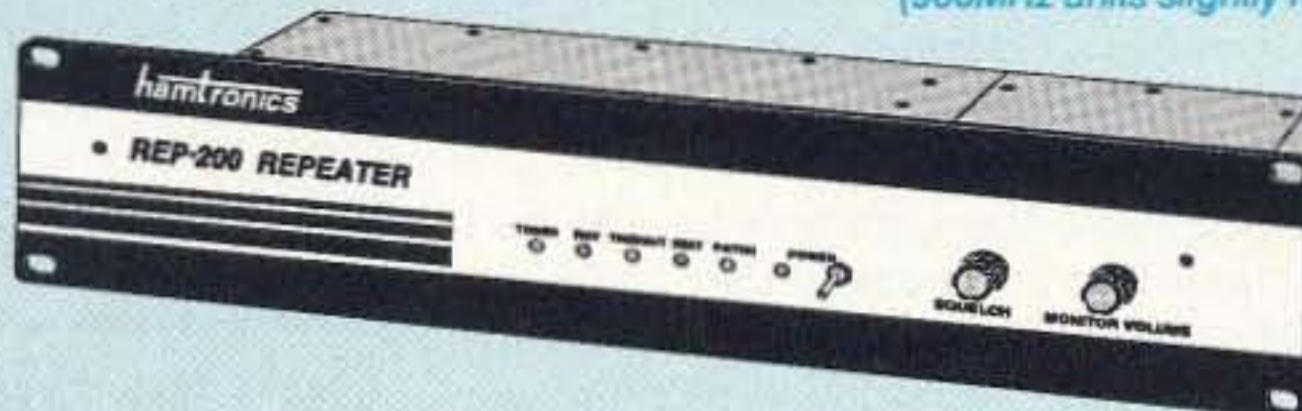

- Available for the 50-54, 143-174, 213-233, 420-475, 902-928 MHz bands.
- FCC type accepted for commercial service (150 & 450).
- Power out 20W 50-54MHz; 25W 143-174MHz; 15W 213-233 MHz; 10W uhf; 10W 902-928MHz.
- Available add-on PA's up to 100W.
- Six courtesy beep types, including two pleasant multi-tone bursts.
- Open or closed access autopatch, toll-call restrict, auto-disconnect.
- Reverse Autopatch, two types.
- DTMF CONTROL: over 45 functions can be controlled by 4-digit dtmf command, via radio or telephone.

- Owner can inhibit autopatch or repeater, enable either open or closed access for repeater or autopatch, and enable toll calls, reverse patch, kerchunk filter, site alarm, aux rcvr.
- Cw speed and tone, beep delay, tail timer, and courtesy beep type can be changed at any time by owner password protected dtmf commands.
- Auxiliary receiver input for control or cross linking repeaters.
- Color coded LED's indicate status of all major functions.
- 3 1/2 inch aluminum rack panel, finished in eggshell white and black.

**NEW** REP-200T Voice Message Repeater. As above, except includes Digital Voice Recorder. Allows message up to 20 sec. to be remotely recorded off the air and played back at user request by DTMF command, or as a periodical voice id, or both. .... kit \$1145, w&t only \$1395

**NEW** REP-200C Economy Repeater. Like REP-200, except uses COR-6 Controller (no DTMF control or autopatch). Features real-voice id recorded with built-in microphone. .... Kit only \$795, w&t \$1095

REP-200N Repeater. Want to use your ACC controller, etc.? No problem! We'll make you a repeater with rf modules only. .... Kit only \$695, w&t \$995

## XMTRS & RCVRS FOR REPEATERS, AUDIO & DIGITAL LINKS, TELEMETRY, ETC.

Also available in rf-tight enclosures, and with data modems.

**FM EXCITERS:** 2W continuous duty. TCXO & xtal oven options. FCC type accepted for com'l high band & uhf.

- TA51: 50-54, 143-174, 213-233 MHz ...kit \$109, w&t \$189.
- TA451: 420-475 MHz ...kit \$109, w&t \$189.
- TA901: 902-928 MHz, (0.5W out); w&t \$219.

#### VHF & UHF AMPLIFIERS.

- For fm, ssb, atv. Output levels from 10W to 100W. Several models starting at \$99.

#### FM RECEIVERS:

- R144/R220 FM RECEIVERS for 143-174 or 213-233 MHz. GaAs FET front end, 0.15uV sensitivity! Both crystal & ceramic if filters plus helical resonator front end for exceptional selectivity: >100dB at ±12kHz (best available anywhere!) Flutter-proof hysteresis squelch; afc tracks drift. ....kit \$149, w&t \$219.
- R451 FM RCVR, for 420-475 MHz. Similar to above. ....kit \$149, w&t \$219.
- R901 FM RCVR, for 902-928MHz. Triple-conversion, GaAs FET front end. .... \$169, w&t \$249.
- R76 ECONOMY FM RCVR for 28-30, 50-54, 73-76, 143-174, 213-233 MHz, w/o helical res or afc. ....Kits \$129, w&t \$219.
- R137 WEATHER SATELLITE RCVR for 137 MHz. Kit \$129, w&t \$219.

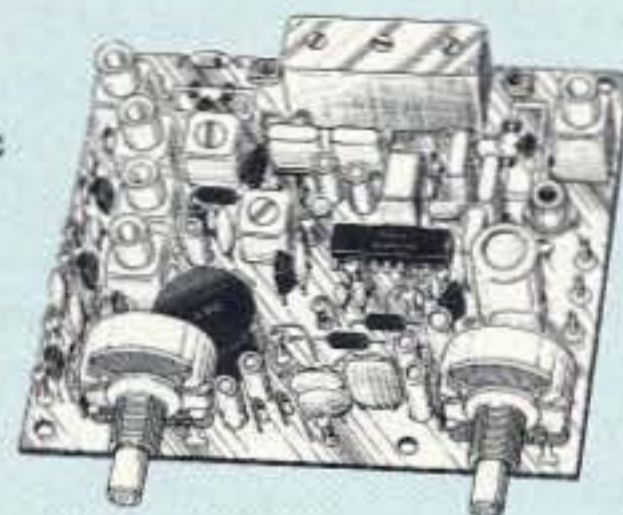
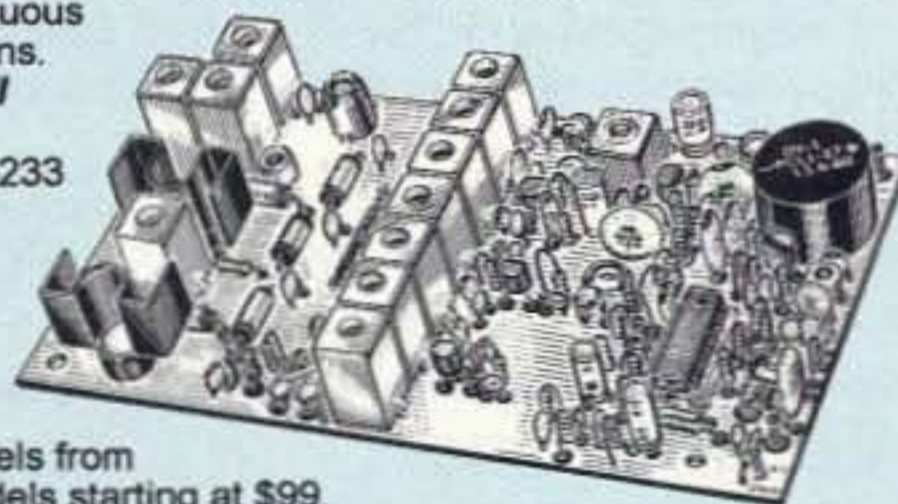

Our 32nd Year!

# hamtronics, inc.

65-D MOUL RD. — HILTON NY 14468-9535

Phone 716-392-9430 — FAX 716-392-9420



## Novice Operators Gain Privileges

The Federal Communications Commission in late November decided to grant full 1.25 meter band access to Novices. The FCC declined, however, to adopt proposed rules that would have allowed Novice Class operators to own and operate repeaters in the 1.25 meter and 23 centimeter bands.

In other action, the commission adopted rules to create a small subband from 222.00 to 222.15 MHz for experimental work where repeaters are prohibited. Many experimenters feel weak signal work and repeaters are incompatible because of the lengthy operating time of repeaters. Under the new rules, all other types of communication can continue in this subband. This should allow for more weak signal experimentation.

Effective February 1, 1994, the following replaced the old amateur service rules:

### Section 97.201 Auxiliary Station

(b) An auxiliary station may transmit only on the 1.25m and shorter wavelength frequency bands, except the 222-222.15 MHz, 431-433 MHz, and 435-438 MHz segments.

### Section 97.205 Repeater Station

(b) A repeater may receive and transmit only on the 10m and shorter wavelength bands except the 28.0-29.5 MHz, 50-51 MHz, 144-144.5 MHz, 145.5-146 MHz, 222-222.15 MHz, 431-433 MHz, and 435-438 MHz segments.

The entry under VHF in Section 97.301 (f) is amended by revising the frequencies authorized for use by Novice Class Operators in ITU Region 2 to read as follows:

### Section 97.301 Authorized Frequency Bands

(f) For a station having a control operator holding a Novice Class operator license: VHF 1.25 m wavelength band: 222-225 MHz. Sharing requirements; see Section 97.303 paragraph (a).

More than 100,000 amateurs now hold the Novice Class license. *TNX W5YI Report, Issue #24, December 15, 1993.*

## College Bound

The Foundation for Amateur Radio, Inc., a non-profit organization headquartered in Washington, DC, plans to administer 49 scholarships for the 1994-95 academic year to assist radio amateurs. To qualify you must be a licensed ham and you must be enrolled in or accepted for enrollment in a full-time course of studies at an accredited university, college, or technical school.

The awards range from \$500 to \$2,000, with preference given, in some cases, to residents of certain geographical areas. Additional information and an application form can be requested by letter or QSL card, postmarked prior to April 30, 1994, from: *FAR Scholarships, 6903 Rhode Island Avenue, College Park MD 20740.*



## Go the Distance

Fred Doob AA8FQ is no couch potato. In fact, the 47-year-old ex-smoker likes to mix ham radio with another favorite pastime: running marathons. Fred recently participated in the New York City marathon (see QSL card above) and will attempt to finish the grueling 26.2 mile Los Angeles Marathon on March 6th to help raise money for Children's Cancer Research Fund of Los Angeles.

Fred says he'll be operating his ICOM IC-W21AT HT transceiver equipped with a headset/boom mike while he is running the race. With the HT strapped to his waist, Fred carries a special PTT switch in his hand in order to complete plenty of QSOs on the four-hour run. In New York, Fred raised \$2,500 for the Sloan-Kettering Cancer Center and logged more than 300 contacts. As with the NY event, ICOM will contribute \$5 to cancer research for every QSO.

You can help Fred go the distance in helping kids with cancer by sending a contribution to CCRF, c/o Fred Doob, P.O. Box 20100, Shaker Heights OH 44120.

## Custom Callsigns

In December, the FCC proposed giving amateurs the ability to choose their own callsigns, once a new automated processing system has been implemented at the Commission's Private Radio Bureau. Under the so-called "vanity callsign" proposal, hams would be required to file a form and pay a fee to apply for an available callsign.

The FCC said that callsign selection by new hams was not yet feasible, but left that issue open for possible future discussion. The new automated system may eventually allow for individuals to check on the availability of callsigns and for electronic filing of license applications.

Trustees of club and military recreation stations would also be eligible for the new program. An earlier rule establishing a callsign administrator program for club and military stations was canceled after never being implemented. The action took place during the first meeting under new FCC Chairman Reed Hundt. *TNX San Gabriel Valley Radio Club's "The Loudspeaker," January 1994.*

## Examiners Busted

The FCC has suspended the accreditation of several Southern California Volunteer Examiners following a three-month investigation. The Commission also invalidated the amateur licenses and license upgrades of 21 people. The testing sessions in question took place in the Los Angeles area in June and August of 1993. Both involved the ARRL and W5YI VECs.

Details are still sketchy as this goes to press, but there are indications the investigation could be turned over to the Department of Justice for further inquiry. Should the Justice Department seek prosecution on fraud charges, a lot of people could face heavy fines or jail time as a result.

FCC Personal Radio Branch Chief John B. Johnston W3BE commended both the ARRL and the W5YI group for their joint cooperation in uncovering the irregularities in the L.A. testing sessions. He also praised them for their quick action in suspending the Volunteer Examiners believed to be involved. *TNX Westlink Report, No. 664, December 31, 1993; ARRL; and Newline.*

## Cheap Chips

Less expensive integrated circuits are on the way because Sumitomo Chemical recently resumed production of epoxy resin. This special resin is necessary to produce memory chips. Experts believe this may lead to a quick end of the worldwide shortage of memory ICs.

Sumitomo Chemical has dominated worldwide production of epoxy resin. Production was interrupted last summer, however, by an explosion at the manufacturing plant. Another Japan-based chemical firm, Nippon Kayaku, says its new resin production facility will soon be constructed. It will produce resin for a 16-megabit DRAM chip. *TNX Westlink Report, No. 664, December 31, 1993.*

## 3-D Moving Forward

Following a series of meetings in both the United States and Germany, AMSAT's Phase 3-D Project Development Team has stepped up construction speed on amateur radio's newest satellite. Organizers say the project is "on track" for the launch of Phase 3-D slated for 1996.

According to Engineering V.P. Dick Jansson WD4FAB, "Each country's team is performing their assigned tasks very well." Dr. Tom Clark W3IWI, AMSAT North America's President Emeritus, added that the team is "... really pulling together as an international group. Thanks to the work of our European, South African, and Japanese friends, it now looks like we will have some superb cameras, some really 'hot' receivers, and some very powerful transmitters on Phase 3-D." Clark is now a key member of the team's Global Positioning System experiment group. *TNX Keith Baker KB1SF.*





# We Do Windows™

Tired of being controlled by your data controller software? Take control with PC-Pakratt for Windows. PC-Pakratt for Windows lets you do all the things you wanted to do in DOS but were afraid to try—or couldn't remember the command for.

With full Windows™ functionality (like background operation, cut & paste, etc.) and extensive on-line context-sensitive help, PC-Pakratt for Windows is the easiest way to use a data controller. You don't have to remember cryptic commands, either—just click a button and you're on your way.

Not only is PC-Pakratt for Windows the easiest way to communicate, it's the friendliest. Change the colors,

display font, or operating window layout—you are in control here!

PC-Pakratt for Windows cleans up with top-notch features, too. Control two data controllers *simultaneously* for dual-, tri-, or even quad-port operation. Pick your favorite mode—PACTOR, Packet, AMTOR/SITOR, Morse, RTTY (Baudot/ASCII), NAVTEX, or TDM. PC-Pakratt for Windows supports all current AEA Data Controllers.

Call AEA's literature request line at (800) 432-8873 for more information, or call us direct at (206) 774-5554. Contact your favorite ham radio equipment dealer for a demonstration and best pricing.



*Connect with us*



# Getting Started With Satellite Imagery

*Enjoy a bird's-eye view using your PC and VHF rig.*

by Tom Glembocki KO4BD

Now that the amateur ranks are growing again with large numbers of no-code licensees in the VHF bands, it may be time to look at what else can be done with some of this VHF radio equipment coupled to a personal computer. With very little effort, a VHF receiver, 2 meter antenna and personal computer can be pulling in signals from the orbiting weather satellites and displaying these images on the screen. Receiving weather imagery from one of these satellites operating in the VHF frequencies is no harder than listening to the local repeater. Here's a guide to what it takes to get going in this captivating hobby.

The driving force in making the reception of imagery easier than ever is, of course, the march of technology. The National Oceanic and Atmospheric Administration, NOAA, recently celebrated the 30th anniversary of the first polar orbiting weather satellite, *TIROS-1*, launched April 1, 1960. Three years after that historic launch, on December 21, 1963, the launch of *TIROS VIII* made imagery col-

lected by satellite directly available to hundreds of ground stations. Many of these early stations were amateur radio operators because they had the VHF radio equipment in the shack and the technical know-how to track and tune into the weather imagery, nicknamed "Direct

---

*"The driving force in making the reception of imagery easier than ever is, of course, the march of technology."*

---

Readout" by NOAA. In the 1970s, *73 Magazine* published the *Weather Satellite Handbook* by Ralph Taggart WB8DQT, a book which has become the bible for weather satellite do-it-yourselfers. The latest edition of this handbook, now published by the ARRL, was printed in 1990.

Of course, advancing technology has already made some of the hardware projects in this edition out of date! (The book is still very useful and is a "must have" for the satellite information content.)

The primary change that has taken place in the last few years is the influence of the personal computer. A good way to stay in touch with the technology changes for satellite imagery, besides reading *73 Magazine*, is to subscribe to the "labor of love" journal, *WeatherSat Ink*, 4821 Jessie Drive, Apex NC 27502; Fax: (919) 362-5822; published quarterly for \$18 US, \$23 foreign per year. Over the past 30 years radio amateurs have been building data demodulators for the satellite signals and have concentrated on converting old Western Union fax machines or slow-scan TV equipment for display devices. With the prevalence of personal computers equipped with displays capable of faithful rendering of imagery at affordable prices, radio amateurs no longer have to "roll their own" to display good imagery. Demodulator hardware has also become incredibly inexpensive. Many companies, some of them advertising in the pages of this magazine, now offer plug-in cards that do all the work. One of the cards, the WEFAX Explorer from Quorum Communications, Inc., even includes the radio on the computer card! This is an instant weather satellite ground station—just add an antenna.

## What's Up There?

Every day, a half dozen satellites circling the earth continuously take pictures of the planet below in an orbit that completes every hundred minutes. The picture information scanned from the terrain below is broadcast a line at a time as the bird moves forward in orbit. This information can be received by any radio listening below as the signal passes over. No complex antenna tracking or tuning is required. The NOAA polar orbiters use a 5 watt transmitter broadcasting an FM signal on one of two frequencies, 137.5 MHz or 137.62 MHz, and are flying at an altitude of about 400 miles up. The signal is loud enough that I have been able to hear it on my

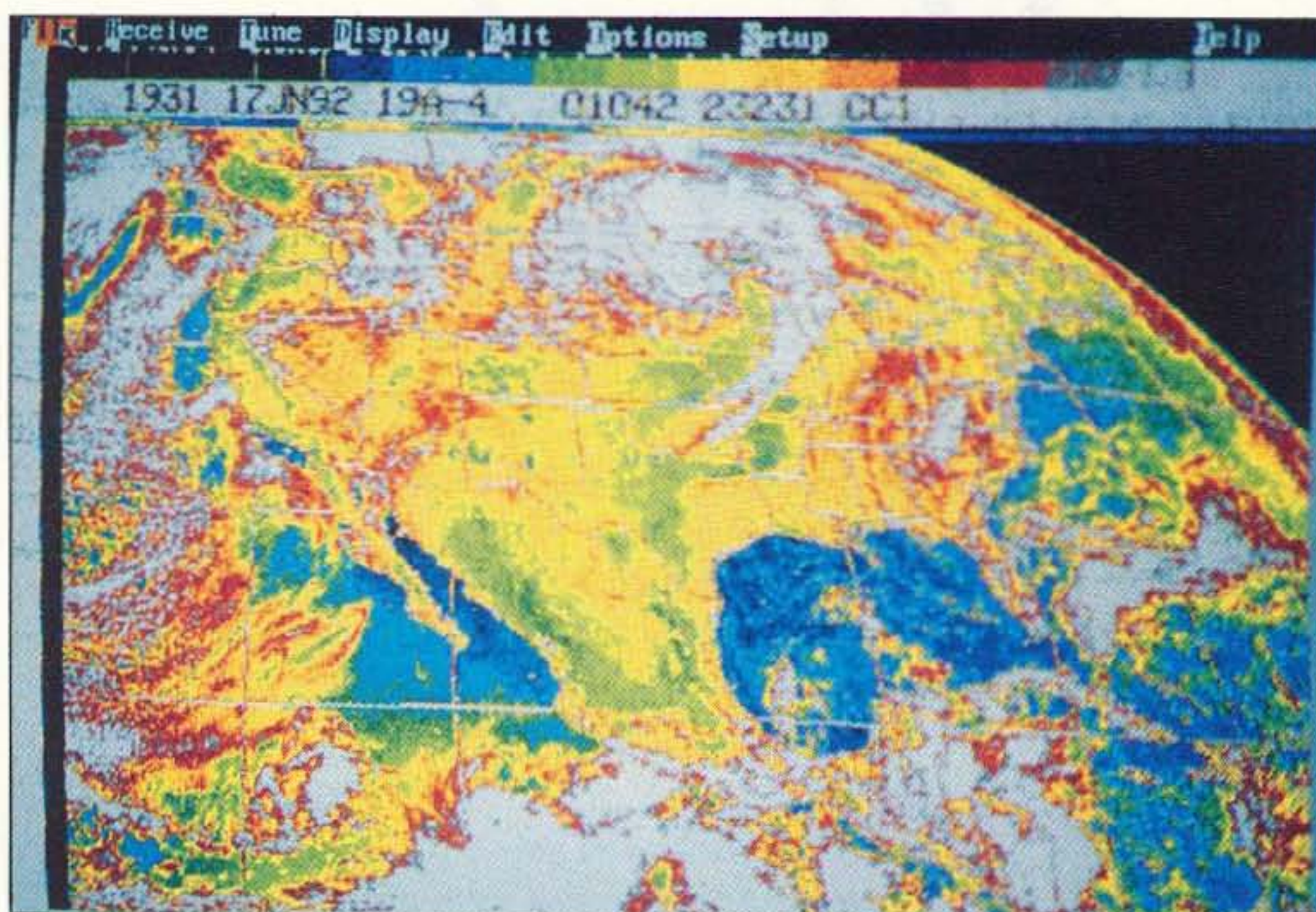

Photo A. A false color visible light picture of the United States received over shortwave radio. (Photo courtesy of Software Systems Consulting.)



# MFJ HF/VHF SWR Analyzer™

... Read your antenna SWR from 1.8 to 170 MHz continuously ... built-in 10 digit LCD frequency counter ... smooth vernier tuning ...



**MFJ-249** handheld **Universal SWR Analyzer™** lets you read your antenna SWR from 1.8 to 170 MHz quickly and easily without any other equipment!  
**Has built-in 10 digit LCD frequency counter and smooth vernier tuning.**  
**You get three instruments in one ...**

high accuracy frequency counter ... RF signal generator ... **SWR Analyzer™**.

**Measure** antenna resonant frequencies and 2:1 SWR bandwidths. Adjust mobile antennas, antenna tuners and matching networks in seconds.

**Measure** feedpoint resistance, inductance, capacitance, resonant frequency of tuned circuits,

transmission line velocity factor/impedance/loss. Test RF chokes, transformers, baluns.

Use 8 AA cells or 110 VAC with MFJ-1312B, \$12.95. 4x2 1/2x6 1/8 inches.

**MFJ-209**, \$109.95, same as MFJ-249 less frequency counter.

See free MFJ catalog for complete line of MFJ SWR Analyzers™.

## MFJ-949E 300 W Tuner



**World's most popular antenna tuner covers 1.8-30 MHz, has lighted peak/average Cross-Needle SWR/Wattmeter, 4:1 balun for balanced lines and full size 300 watt dummy load.**

**Versatile 8 position antenna switch lets you pre-tune MFJ-949E into dummy load to minimize QRM.**

**Custom inductor switch was carefully engineered to withstand extreme voltages and currents.**

**Cabinet is chemically etched to MFJ's bond tough baked-on paint.**

## VHF/HF Packet TNCs



**MFJ-1270B super TAPR TNC** one has a world wide reputation as **the most reliable packet TNC in the world** -- many work 24 hours a day for years without a single failure!

**Fully TAPR TNC-2 compatible, HF and HF operation, free AC power supply, new enhanced mailbox expandable to 512K with auto/reverse mail forwarding, WeFAX mode lets you print weather maps, optional plug-in 2400/9600 baud modems, RS-232C interface, MFJ Host mode.**

## MFJ TNC/Mic Switch



**Switch between your TNC or microphone by pushing a button!**

**Just plug pre-wired cables into your rig's mic connector and TNC.**

**Plug-in jumpers let you use nearly any rig with 8 pin mic connector.**

**MFJ-1272B, \$34.95 /MFJ/TAPR TNC2 clones; MFJ-1272BX/PK-232;**

**MFJ-1272BYV/KAM VHF/KPC3;**

**MFJ-1272BYH/KAM HF Port;**

**MFJ-1272BZ/PK-88, \$39.95 each. Replace 8 pin RJ45 modular phone jack receptacle B with M in model number above.**

## Regenerative RCVR Kit



**Build this regenerative shortwave receiver kit and listen to shortwave signals from all over the world with just a 10 foot wire antenna. Has RF stage, vernier reduction, auto tune, smooth regeneration, five bands.**

## MFJ-1278B Multi-Mode Data Controller

Use this **MFJ-1278B**, your transceiver and

**MFJ-1278B** \$299.95



computer to transmit and receive digital communications! You'll discover a whole new world of ham radio and communicate in ways you never knew existed on our ham bands.

**The world class MFJ-1278B Multi-Mode and MultiCom™ software is packed with features no other multi-mode gives you.**

**You get 10 digital modes ... Packet, AMTOR, PACTOR (at no extra cost), RTTY, ASCII, Navtex, Color SSTV, 16 Gray Level FAX, CW and Memory Keyer plus an enhanced 32K Mailbox.**

**You'll have fun joining worldwide packet networks and exchanging color SSTV pictures with your buddies around the world. You'll marvel at full color FAX news photos as they come to life on your screen.**

**You'll see weather changes on highly detailed weather maps in all 16 gray levels. You'll eavesdrop on late breaking news as it happens on RTTY. You'll enjoy error free HF QSOs on PACTOR and AMTOR and receiving packet mail in an enhanced 32K mailbox. Want to copy some CW? Just watch your screen.**

**MFJ-1289, \$59.95, MultiCom™ software and cables.**

## MFJ halfwave vertical Antenna

**6 bands: 40, 20, 15, 10, 6, 2 Meters ... No radials or ground needed!**

**Operate 6 bands -- 40, 20, 15, 10, 6 and 2 Meters --with this MFJ-1796**

**ground independent halfwave vertical antenna! No radials or ground ever needed!**

**It's only 12 feet high and has a tiny 24 inch footprint! You can mount it anywhere from ground level to the top of a tower -- on apartments, condos, small lots, even on motorhomes. Perfect for vacations, field day, DX-pedition, camping.**

**Frequency selection is fully automatic -- all you do is transmit. Its low angle of radiation really reaches out and brings in DX. Omni-directional. 1500 watts PEP.**

**Efficient end loading, no lossy traps. Entire length is always radiating. Full size halfwave on 2 and 6 Meters. High power air-wound choke balun eliminates feedline radiation. Adjusting one band has minimum effect on other bands. Add \$20 s/h.**

**Easy to assemble -- you'll have it on the air in an afternoon.**



## MFJ's world famous 3 KW Versa Tuner V

**Here's why the MFJ-989C is the finest 3 KW antenna tuner money can buy ...**

**Two massive 250 pf transmitting variable capacitors can handle amps of RF current and 6000 RF volts. Logging scales.**

**Precision ball bearing roller inductor, three digit turns counter and spinner knob give you exact inductance control for minimum SWR.**

**Lighted peak/average Cross-Needle SWR/Wattmeter has 200/2000 watt ranges. Super heavy duty current balun has two giant 2 1/2 inch powder iron toroid cores wound with Teflon® wire.**

**Six position ceramic antenna switch has extra large contacts. Flip stand, dummy load, one year unconditional guarantee, aluminum cabinet, tough baked-on paint, locking compound on nuts/bolts, handles 3 KW PEP, 10 1/8x4 1/2x15 in. Meter lamp needs 12 volts. Add \$13 s/h.**



## MFJ No Matter What™ Guarantee

**MFJ's famous one year No Matter What™ unconditional guarantee means we will repair or replace (at our option) your MFJ product sold in this ad no matter what for a full year.**

## Super Hi-Q Loop Antenna

**MFJ-1786** \$299.95

**Tiny 36 inch diameter high efficiency loop antenna covers 10-30 MHz continuously with low SWR. Handles 150 watts.**

**Ideal for home installations where space is limited-- apartments, condos, small lots. Take on trips.**

**All welded construction.**

**Remote control has Automatic Band Selection™, Cross-Needle SWR/Wattmeter. No control cable needed. Use batteries or 110 VAC. Add \$20 s/h.**

**No ground or tuner needed.**

**MFJ-1782, \$269.95, like MFJ-1786 but remote control has only slow/fast tune buttons.**

## Dual Band Mobile Ant.

**Mobile Antenna for 144/440 MHz**

**MFJ dual band magnet mount mobile antenna for 144/440 MHz**

**has 19 inch stainless steel radiator, low SWR. For mobile rigs with SO-239 UHF connector and handie-talkies with included BNC adapter.**

## 5/8 Wave Mobile Ant.

**Maximum Gain™ 5/8 Wave 2 Meter magnet mount mobile antenna has stainless steel radiator, 12 ft coax, low SWR. UHF mobile (MFJ-1728) or BNC handie-talkie (MFJ-1728B) connector.**

**MFJ-1724B \$14.95**

## 5/8 Wave Ground Plane

**\$19.95 gets you a 2 Meter 5/8 wave ground plane home station antenna! You get the highest gain of any single element antenna, shunt fed matching, ceramic insulators.**

**MFJ-1750 \$19.95**  
**MFJ-1752, \$19.95, for 220 MHz.**

## Free MFJ Catalog

**Write or call ... 800-647-1800**

**Nearest Dealer/Orders: 800-647-1800**  
**Technical Help: 800-647-TECH (8324)**  
 • 1 year unconditional guarantee • 30 day money back guarantee (less s/h) on orders from MFJ • Free catalog

**MFJ ENTERPRISES, INC.**  
 Box 494, Miss. State, MS 39762  
 (601) 323-5869; 8-4:30 CST, Mon-Fri.  
 FAX: (601)323-6551; Add \$6 s/h  
**MFJ... making quality affordable**  
 Prices and specifications subject to change © 1993 MFJ Enterprises, Inc.



# A NEW CONCEPT IN HF TRANSCEIVER DESIGN FROM A NEW COMPANY

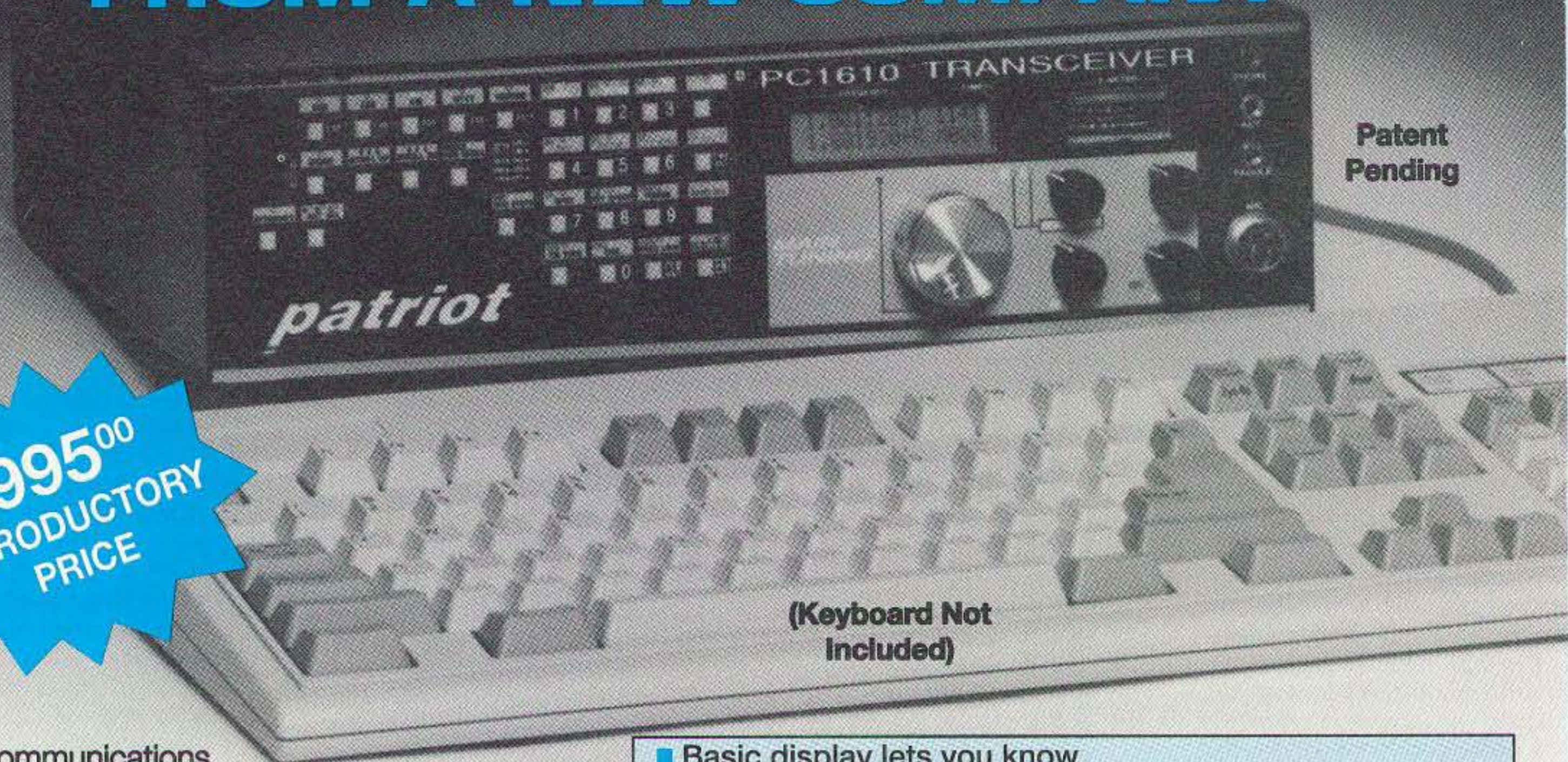

Patent Pending

**\$995<sup>00</sup>**  
**INTRODUCTORY PRICE**

(Keyboard Not Included)

Patriot Communications Technology introduces the PC-1610™, a full featured HF transceiver with built-in keyboard interface. Plug a standard IBM XT\* compatible keyboard into a PC-1610 and instantly enjoy keyboard CW, RTTY (BAUDOT and ASCII) data communications. Incoming morse & RTTY data is decoded and displayed on the built-in LCD display. The PC-1610 offers the following features:

- Built-in XT keyboard interface (keyboard optional)
- 160-10M ham band coverage
- USB/LSB/CW/FSK modes
- 75W output power
- Built in digital power/SWR meter
- DDS VFO with 1Hz step size
- Selectable variable speed/fixed 10Hz step VFO tuning
- Built-in 24hr clock
- 90 tunable memories
- 1 scratchpad memory
- 9 (256 character) keyboard data buffers
- Built-in 5-75 wpm IAMBIC keyer
- Built-in 2.4KHz, 1.8KHz, 500Hz, 200 Hz & RTTY filters
- Notch filter
- Select 1 of 3 antennas from front panel

Specifications are subject to change without notice.  
\* IBM XT is a registered trademark of the IBM Corporation.

<ul style="list-style-type: none"> <li>■ Basic display lets you know exactly where you are.</li> </ul>	<ul style="list-style-type: none"> <li>■ Standard Display shows RX/TX VFO freq's, time and current memory</li> </ul>
<ul style="list-style-type: none"> <li>■ Send &amp; Receive in: CW / RTTY(BAUDOT) / ASCII</li> </ul>	
<ul style="list-style-type: none"> <li>■ Store up to nine 256 character messages.</li> </ul>	<ul style="list-style-type: none"> <li>■ Messages can be: edited, sent &amp; appended to outgoing message</li> </ul>
	<ul style="list-style-type: none"> <li>← Format &amp; Edit stored MSG's here</li> </ul>
<p><b>PC-1610 =</b> <span style="border: 1px solid black; padding: 2px;">HF XCVR</span> + <span style="border: 1px solid black; padding: 2px;">PC</span></p> <p style="text-align: center;">+</p> <p style="text-align: center;"><span style="border: 1px solid black; padding: 2px;">DATA CNTLR</span></p> <p style="text-align: center;">+</p> <p style="text-align: center;"></p>	
<ul style="list-style-type: none"> <li>■ The PC-1610 Performs the functions of an HF Transceiver, Computer, Data Controller and Control Software all in one package.</li> </ul>	

**The PC-1610 has too many features to adequately describe in one ad... call or write for a detailed brochure—Major Credit Cards Accepted.**

**patriot**  
Patriot Communications Technology, Inc.

Designed and manufactured in the U.S.A.  
Phone: (516) 862-6512 ■ Fax: (516) 862-6529  
7 Flowerfield M100, St. James NY 11780



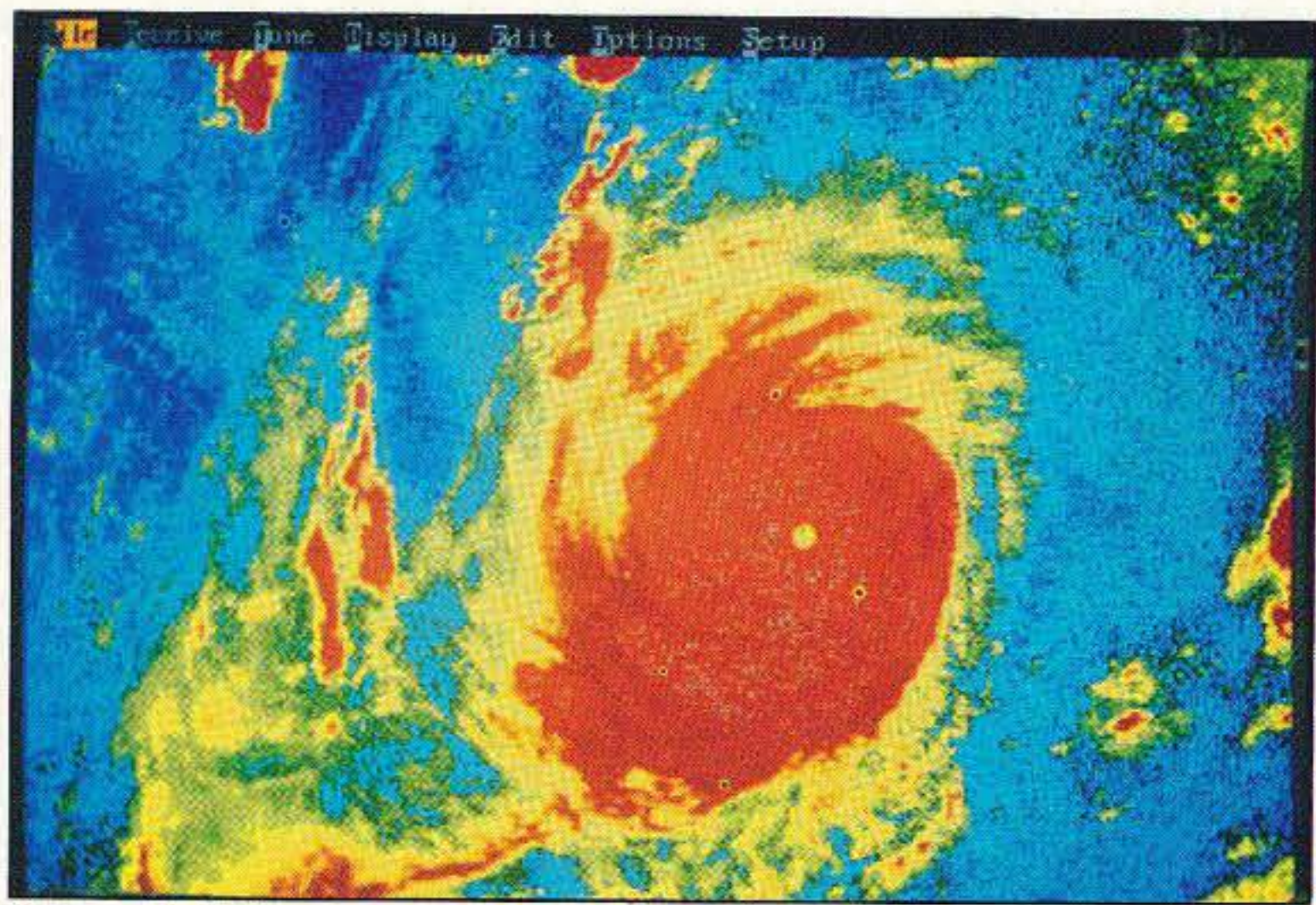

Photo B. This picture was received from a NOAA polar orbiting satellite on 137 MHz. It shows Hurricane Andrew as it approached landfall near Florida. (Photo courtesy of Software Systems Consulting.)

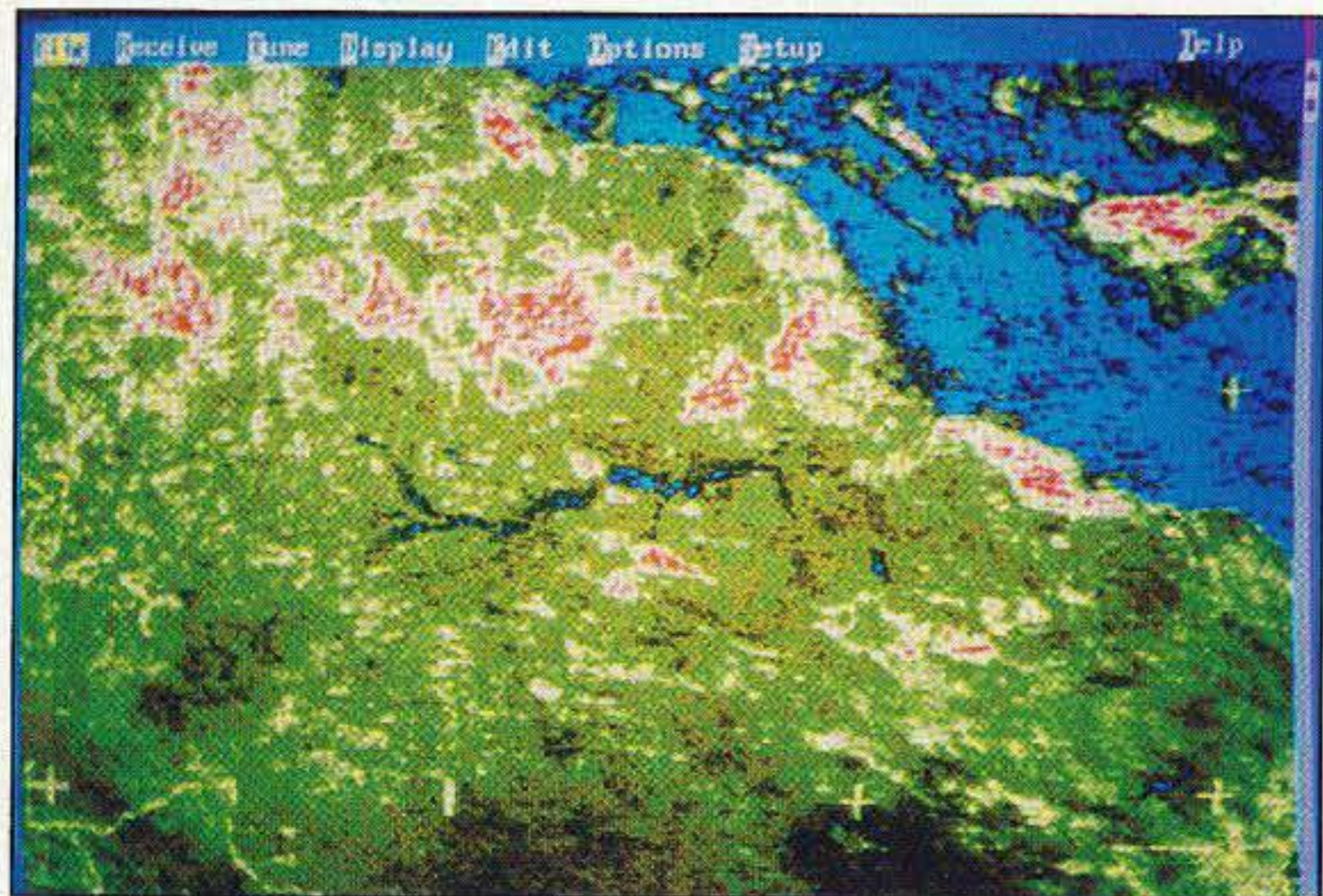

Photo C. A false color picture of the Amazon River Basin. The blue Amazon River can be seen against the green background of the jungle. The white areas with red highlights indicate thunder cells that form over the Amazon Rain Forest daily, contributing to the lush growth there. (Photo courtesy of Software Systems Consulting.)

Bearcat 100XL hand-held scanner with a rubber duckie antenna. Of course, for best results a good omnidirectional VHF antenna is helpful. You don't need a special 137 MHz antenna—any 2 meter omnidirectional antenna will do because we are not interested in transmitting and thus are not too concerned with VSWR. A 2 meter beam will also do well, but because the beam is directional, you will have to constantly aim the antenna at the satellite as the satellite travels overhead.

The Russians also have a series of weather satellites in the same 137 MHz frequency band as NOAA and these are

***“Knowing when to listen is the key to any capture of satellite imagery.”***

even easier to hear because they use a 7 watt VHF transmitter for their signal.

Knowing when to listen is the key to any capture of satellite imagery. In the old days before computers (1980s), to determine if a satellite was passing overhead I used to leave my Bearcat scanner running with the squelch on and the volume slightly turned up. When a satellite passed over, the radio would unsquelch and the loud 2400 Hz beeping of the passing satellite would ring throughout the house—usually just as the family was sitting down for dinner. Technology has fixed this problem—there are now over a dozen brands of tracking programs available that graphically display on the screen where all the weather satellites are located at any point in time and, more important, when the next one will be passing over your QTH. Some of these programs are available as shareware and others are programs for sale. I use InstaTrak sold by

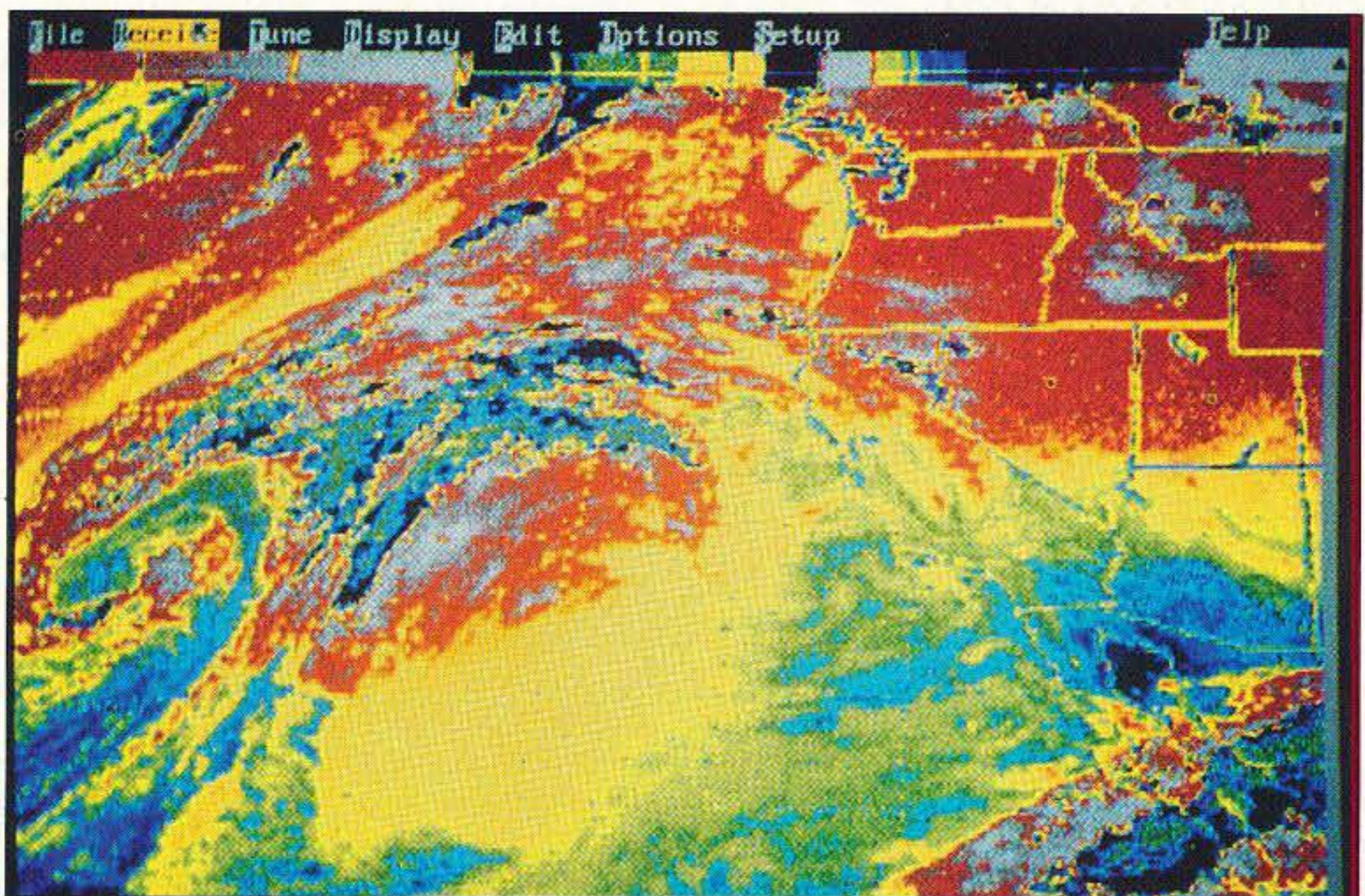

Photo D. A colorized picture of the western United States showing atmospheric moisture as a function of color. A legend is visible across the top of the display, but essentially the order of colors is: black, blue, green, yellow, red, and white. This order of colors shows progressively greater moisture content in the atmosphere. (Photo courtesy of Software Systems Consulting.)

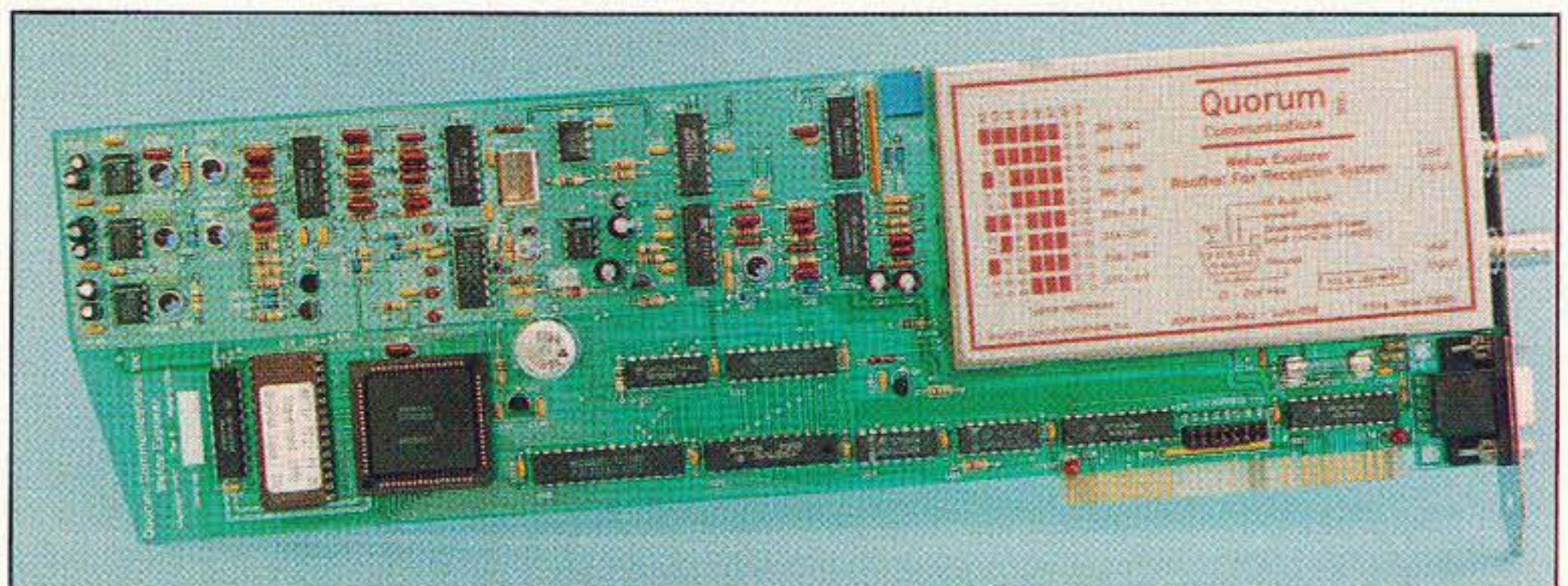

Photo E. One of many systems available for easy weather fax reception. (Photo courtesy of Quorum Communications, Inc.)

AMSAT for \$80; however, as with any program, all the tracking programs achieve the same goal—satellite orbit prediction. The differences are in user inter-

face, presentation of the data, and bells and whistles. One of the shareware programs, TRAKSAT, is available from the following BBSs: Celestial at (513) 427-





Photo F. Three-dimensional image of Hurricane Andrew taken from NOAA-II. (Photo courtesy of Quorum Communications, Inc.)

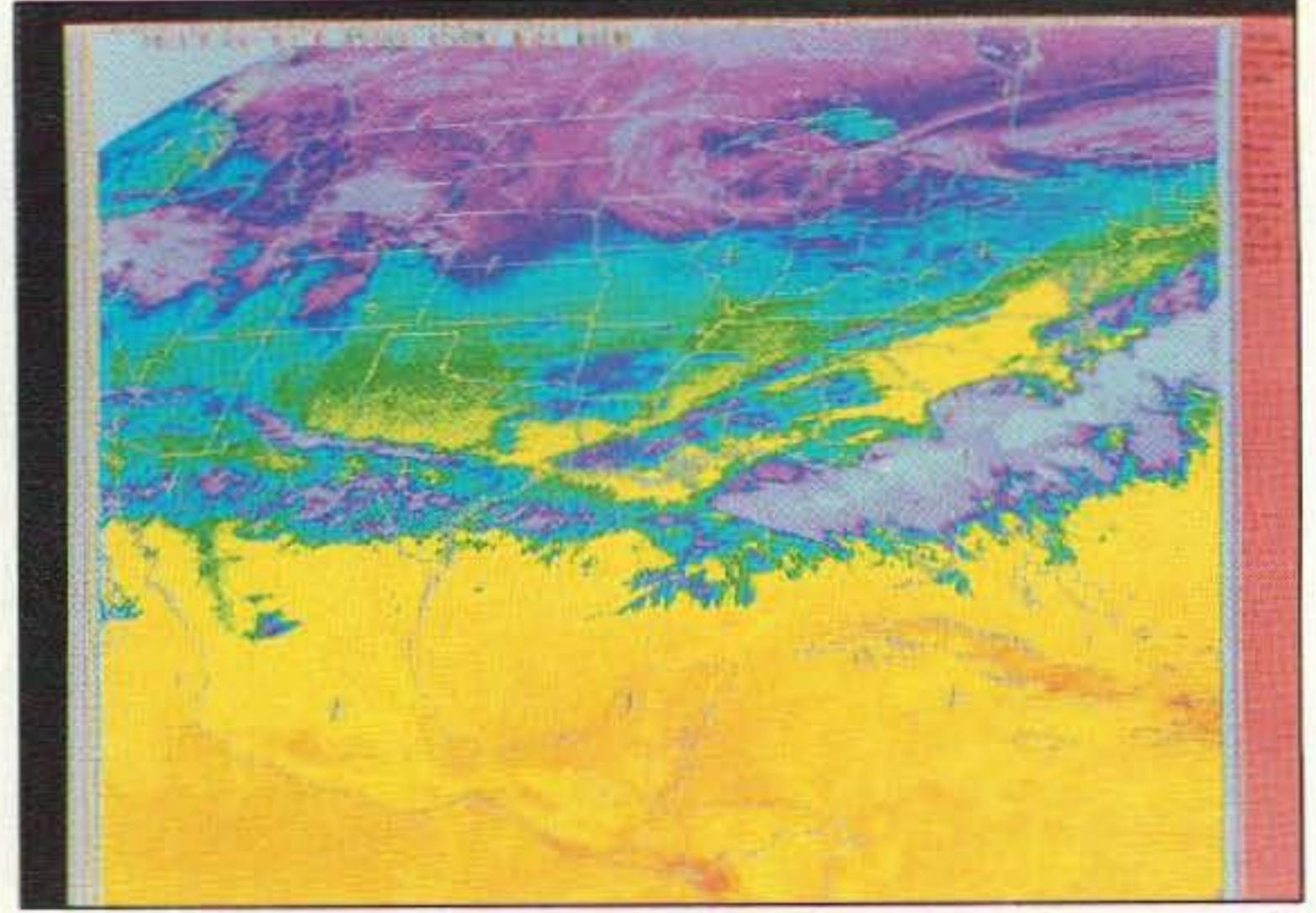

Photo G. A morning IR Meteosat shot taken when things were still cool. Note the false color from software. (Photo courtesy of Multi-FAX.)

0674, SatTrakers at (714) 590-4382 or Quorum Communications, Inc. at (214) 915-0346.

The following table lists the currently operating Russian and US weather satellites:

#### POLAR Orbiters

NOAA-9:	137.62 MHz
NOAA-10:	137.50 MHz
NOAA-11:	137.62 MHz
NOAA-12:	137.50 MHz
METEOR 2-20:	137.85 MHz
METEOR 3-3:	137.40 MHz
METEOR 3-4:	137.30 MHz

Once you know when to listen, wait for the familiar beeping sound to be faintly heard in the static as the satellite rises above the horizon. When the signal gets loud and strong enough to be noise-free, start up the image capture program and watch in awe. Line after line that the satellite passes over will appear on the computer screen. Each line represents a swath about 2,800 km wide from east to west. If it's winter, you may see snow on the ground in the imagery, or possibly ice flows in rivers and large bodies of water.

Summer reception will show the development of thunderstorms, or differences in vegetation cover and farm crop development. I usually sit in endless fascination at the pictures that appear before me on the computer screen.

#### VHF Radios for Weather Satellites

Many popular "police" scanner radios are available from Uniden Bearcat, Radio Shack and others. These cover the 136 to 137 MHz satellite band. If you use a scanner receiver, the regular communications IF bandwidth of the scanner is probably not optimum. The ideal IF bandwidth of your receiver needs to be about 42 kHz. A wide bandwidth will mean the signal will be weak and there may be too much background noise to see the picture. If the bandwidth is too narrow, the white areas of the picture may come out gray or noisy.

The March 1991 issue of *73 Magazine* has an article by John Hoots on page 12 with a description of modifications that can be made to some scanners to improve the IF bandwidth.

Another approach would be to use a high quality VHF/UHF receiver, such as the ICOM R7100 shown in the cover pho-

to. This rig works well and will even correct for doppler shift as the satellite approaches and retreats.

Ready-made satellite receivers with the correct IF bandwidth are available from several sources. These sources are:

Vanguard Labs, 196-23 Jamaica, Hollis NY 11423; tel. (718) 468-2720.

Hamtronics, Inc., 65-D Moul Road, Hilton NY 14468-9535; tel. (716) 392-9430.

Quorum Communications, Inc., 8304 Esters Blvd., Suite 850, Irving TX 75063; tel. (214) 915-0256, fax (214) 915-0270.

Spectrum International, PO Box 1084, Concord MA 01742; tel. (508) 263-2145.

#### PC Satellite Image Capture Cards

The audio from the earphone jack of your scanner needs to go to a weather satellite facsimile card in your PC. The software that comes with the PC card does the rest. For best results you need a VGA or SuperVGA monitor on the PC. That's all there is to it!

Here are a few prices for various weather facsimile PC cards:

#### Vendor Addresses:

A & A Engineering  
2521 W. LaPalma, Unit K  
Anaheim CA 92801  
Te. (714) 952-2114  
Fax (714) 952-3280

MultiFAX  
143 Rollin Irish Road  
Milton VT 05468  
Tel. (802) 293-7006  
Fax (802) 893-6859

OFS WeatherFAX  
6404 Lakerest Ct.  
Raleigh NC 27612  
Tel. (919) 847-4545

Quorum Communications, Inc.  
8304 Esters Blvd., Suite 850  
Irving TX 75063  
Tel. (214) 915-0256  
Fax (214) 915-0270

Satellite Data Systems  
P.O. Box 219  
Cleveland MN 56017  
Tel. (507) 931-4849

SSC/Software Systems Consulting  
150 Avenida Cabrillo, Suite C  
San Clemente CA 92672  
Tel. (714) 498-5784

Timestep (dist. by Spectrum International)  
Spectrum International  
P.O. Box 1084  
Concord MA 01742  
Tel. (508) 263-2145

Vanguard Electronics  
196-23 Jamaica  
Hollis NY 11423  
Tel. (718) 468-2720

WeatherSat Ink  
4821 Jessie Dr.  
Apex NC 27502  
Fax (919) 362-5822



# ORDER NOW 1-800 4 HOBBY KITS

- 2 Meters
- 223 MHz
- 440 MHz
- 6 Meters

## FANTASTIC FM TRANSCEIVERS

Ramsey breaks the price barrier on FM rigs! The FX is ideal for shack, portable or mobile. The wide frequency coverage and programmable repeater splits makes the FX the perfect rig for Amateur, CAP or MARS applications. Packeteers really appreciate the dedicated packet port, "TRUE-FM" signal and almost instant T/R switching. High speed packet? ...No problem. Twelve diode programmed channels, 5W RF output, sensitive dual conversion receiver and proven EASY assembly. Why pay more for a used foreign rig when you can have one AMERICAN MADE (by you) for less. Comes complete less case and speaker mike. Order our matching case and knob set for that pro look.

FX-50 kit (6 Meters) .....	\$149.95	FX-146 kit (2 Meters).....	\$149.95
FX-223 kit (1 1/4 Meters) .....	\$149.95	FX-440 kit (3/4 Meters).....	\$169.96
CFX matching case set.....	\$24.95	FXM-1, ICOM/Yaesu style speaker mike .....	\$24.95

## 2 MTR & 220 BOOSTER AMPS

Here's a great booster for any 2 meter or 220 MHz hand-held unit. These power boosters deliver over 30 watts of output, allowing you to hit the repeater's full quieting while the low noise preamp remarkably improves reception. Ramsey Electronics has sold thousands of 2 meter amp kits, but now we offer completely wired and tested 2 meter, as well as 220 MHz units. Both have all the features of the high-priced boosters at a fraction of the cost.

PA-10 2 MTR POWER BOOSTER (10 X power gain) Fully wired & tested .....	\$89.95
PA-20 220 MHz POWER BOOSTER (8 X power gain) Fully wired & tested.....	\$89.95

## QRP TRANSMITTERS/HAM RECEIVERS

### 20, 30, 40, 80M CW TRANSMITTERS

Join the fun on QRP! Thousands of these mini-rigs have been sold and tons of DX contacts have been made. Imagine working Eastern Europe with a \$30 transmitter—that's ham radio at its best! These CW rigs are ideal mates to the receivers at right. They have two-position variable crystal control (one popular QRP XTAL included), one watt output and built-in antenna switch. Runs on 12VDC. Add our matching case and knob set for a handsome finished look.

Your choice of bands (Specify band: QRP-20, 30, 40, or 80).....	\$29.95
Matching case knob set.CQRP .....	\$12.95

### 20, 30, 40, 80M All Mode RECEIVERS

Build your own mini ham station Sensitive all-mode AM, CW, SSB receivers use direct conversion design with NE602, IC as featured in QST and ARRL handbooks. Very sensitive varactor tuned over entire band. Plenty of speaker volume. Runs on 9V battery. Very EASY to build, lots of fun and educational—ideal for beginner or old pro. New 30-page manual. Add the case set for well-fitted professional look.

(Specify band: HR-20, HR-30, HR-40, HR-80) .....	\$29.95
CHR, Matching case .....	\$12.95

## Miniature SPEAKER-MIKE



Fits Icom, Yaesu, Alinco, Ramsey and Radio Shack rigs! Looking for a handy little speaker-mike to complement your FX transceiver or other ICOM style handie-talkie? The Ramsey

SM-1 speaker-mike is a beauty. It's only 1 1/2" wide by 2 1/2 inches high and has a handy clip on the back so you can easily clip it to your lapel or shirt. Its small, internal speaker isn't going to break any eardrums but is very clear and has plenty of pop to be heard when worn. There's even a jack on the mike so when you plug it in, you still have the use of the speaker jack from your radio. Fits all Radio Shack, ICOM, Yaesu, Alinco and Ramsey rigs.

SM-1 Mini-Speaker mike, Fully assembled.....	\$24.95
---	---------

## CW KEYS

Send perfect CW. Microprocessor keyer features 4 programmable memories of up to 26 words each, lmbic keying, dot-dash memory, variable speed from 3-60 WPM, adjustable sidetone, keying to any rig and fully RFI proof. EAROM memory keeps messages up to 100 years - you'll go silent before the key! Includes built-in touch paddles or use your own. Easy assembly and matching case set available for a nice station look.

CW-700 Micro keyer kit.....	\$69.95	MK Matching case set.....	\$12.95
CW-700WT Assembled CW-700and case .....	\$99.95		

## ACTIVE ANTENNA

Cramped for space? Get longwire performance with this desktop antenna. Properly designed unit has dual HF and VHF circuitry and built-in whip antenna, as well as external jack. RF gain control and 9V operation makes unit ideal for SWLs, traveling hams or scanner buffs who need hotter reception. The matching case and knob set gives the unit a hundred dollar look!

AA-7Kit.....	\$24.95	Matching case & knobset, CAA .....	\$12.95
--------------	---------	------------------------------------	---------

## AIRCRAFT RECEIVER



Hear exciting aircraft communications—pick up planes up to 100 miles away! Receives 110-136 MHz AM air band, smooth varactor tuning superhet

with AGC, ceramic filter, adjustable squelch, excellent sensitivity and lots of speaker volume. Runs on 9V battery. Great for air shows or just hanging around the airport! New 30-page manual details pilot talk, too. Add case set for "pro" look.

AR-1 kit .....	\$24.95
Matching case set, CAR .....	\$12.95

## 2M POWER AMP

Easy to build power amp has 8 times power gain, 1W in, 8W out, 2W in, 16W out, 5W is for 40W out. Same amp as featured in many ham magazine articles. Complete with all parts, less case and T-R relay.

PA-1, 40W pwr amp kit.....	\$34.95
TR-1, RF sensed T-R relay kit.....	\$11.95

## MORE KITS NEXT MONTH'S ISSUE

## MINI KITS

Ramsey carries a complete line of low cost, easy to build, easy to use functional kits that can be used alone or as building blocks in larger more complex designs. Mini-kits include audio amps, tone decoders, VOX switches, timers, audio alarms, noise-makers and even shocking kits! Call for our free catalogue!

## QRP AMPLIFIER

For a slick little QRP boost, use one of the 20 Watt amplifiers. Needs only 1/2-2 watts of drive for full output, linear for SSB, AM or CW operation, power MOSFETs for high efficiency and multistage low pass filter for a clean signal. Built-in T/R relay for automatic switching, runs on 12-15 VDC at 2-4 amps. Add our matching case set for a complete station look.

Your choice of bands .....	\$49.95
Specify band: (QAMP-20, 30, 40, 80)	
CQAMP Matching case set.....	\$12.95

## 2WAY RADIO SERVICE MONITOR

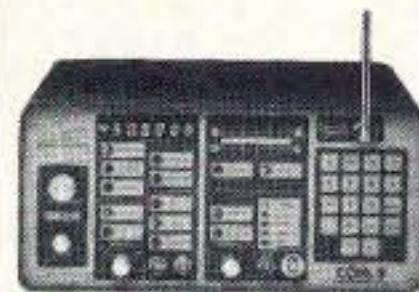

COM-3, the world's most popular low-cost service monitor. For shops big or small, the COM-3 delivers advanced capabilities for a fantastic price—and our

new lease program allows you to own a COM-3 for less than \$3.00 a day. Features • Direct entry keyboard with programmable memory • Audio & transmitter frequency counter • LED bar graph frequency/error deviation display • 0.1-10.000  $\mu$ V output levels • High receive sensitivity, less than 5  $\mu$ V • 100 kHz to 999.9995 MHz • Continuous frequency coverage • Transmit protection, up to 100 watts • CTS tone encoder • 1 KHz and external modulation. COM-3 2 Way Radio Service Monitor .....

\$2995.00

## FOXHUNT HEADQUARTERS



Locate hidden or unknown transmitters fast. The Foxhound direction finder connects to the antenna and speaker jack on any radio receiver, AM or FM from 1 MHz to 1 GHz. The antenna (a pair of dipole telescopic whips) is rotated until the Null meter shows a minimum. A pair of LEDs indicate to turn Left or Right. The Foxhound is ideal to use with a walkie-talkie. If you wish to transmit, go ahead, a built-in T/R switch senses any transmitted RF and switches itself out of circuit while you talk. It doesn't get any easier than this! We provide all parts except for a few feet of 1/2 inch PVC pipe available at any hardware store for a dollar or two. Add our matching case set for a complete finished unit. Be the one with the answers, win those transmitter hunts and track down those jammers, you'll do it all with your Foxhound.

Add some fun to your club events by having a transmitter hunt! Foxhunting is a craze sweeping the nation, but many clubs are missing out on the action because they lack the expertise or time to develop their own foxhunt transmitter. We set one of our most devious and sneaky engineers to the task of designing an easy to build and use, yet highly capable Foxhound transmitter. A snazzy microprocessor controller has both preset and programmable transmission characteristics allowing you to easily set the difficulty level from "beginner" to "know-it-all!" The SlyFox, FHT-1, is crystal controlled in the 2 meter band (crystal for 146.52 included) with a power output of 5 watts that is adjustable by the controller. The transmitter is programmed to ID in CW or add our voice option if you really want to aggravate the troops - "Ha ha, you can't find me!" Join the fun, get rid of those stuffy old meetings and picnics, have a foxhunt!

DF-1 Foxhound direction finder kit.....	\$59.95	CDF Matching case set for DF-1 .....	\$12.95
FHT-1 SlyFox Foxhound transmitter kit .....	\$129.95	FHT-1 Voice ID option.....	\$29.95
CFHT Heavy duty metal matching case set for FH T-1 .....	\$29.95		

## PACKET RADIO

Two new versions are available for the Commodore 64 (P-64A, P-64B) and PC (P-IBM). Easy assembly NO TUNING". Includes FREE disk software, PC Board and Full Documentation. Kit form.

P-64A.....	\$59.95	P-IBM .....	\$59.95	CASE CPK .....	\$12.95
------------	---------	-------------	---------	----------------	---------

## STEREO FM TRANSMITTER

Run your own Stereo FM radio station! Transmits a stable signal in the 88-108 MHz FM broadcast band up to 1 mile. Detailed manual provides helpful info on FCC regs, antenna ideas and range to expect. Latest design features adjustable line level inputs, pre-emphasis and crystal controlled subcarrier. Connects to any CD or tape player, mike mixer or radio. Includes free tuning tool too! For a pro look add our matching case set with on-board whip antenna

FM-10A Stereo transmitter kit .....	\$34.95
CFM Case, whip ant set.....	\$12.95

## SPEECH SCRAMBLER

Descramble most scramble systems heard on your scanner radio or set up your own scrambled communication system over the phone or radio. Latest 3rd generation IC is used for fantastic audio quality - equivalent to over 30 op-amps and mixers! Crystal controlled for crystal clear sound with a built-in 2 watt audio amp for direct radio hook-up. For scramble systems, each user has a unit for full duplex operation. Communicate in privacy with the SS-70. Add our case set for a fine professional finish.

SS-70 Scrambler /descramblerkit .....	\$29.95
CSSD matching case set.....	\$12.95
SS-70WT Assembled	
SS-70 and case set .....	\$69.95

## MICRO-MIKE

World's smallest FM wireless mike. Smaller than a sugar cube - including battery and mike. Two sets of SMT parts supplied in case you are clumsy! Terrific audio pick-up (pin drop at 5 ft) and transmit range of 300 ft. We include the battery (watch style), electret mike and even a tuning tool! Be a James Bond and learn SMT too!

FM-5 Micro mike kit.....	\$19.95
--------------------------	---------

## CRYSTAL RADIO

Relive the radio past with a crystal set like your grandfather built. Uses genuine Galena crystal and catwhisker. Several different types of radios are built, including standard AM broadcast, shortwave and even WW II foxhole style. To compare modern semiconductor detectors, we include a diode for comparison. No soldering required and we even give antenna ideas. Radio for free, get it now before Clinton taxes it!

CS-1 Crystal set kit .....	\$19.95
----------------------------	---------

## DR. NI-CAD CONDITIONER/FAST CHARGER

Quit spending big bucks for replacement battery packs, rejuvenate and condition your batteries for peak capacity. Advanced circuitry has optimized discharge before charge to eliminate memory effect and to condition batteries that have been poorly cared for in the past. Quick charge rapidly brings battery to full charge in less than an hour—just 15 minutes for some types! And "top-off" charge mode squeezes every last bit of energy into each cell for the absolute most capacity. Switch-mode regulator controls constant current charge while being monitored by a negative delta-V system that cuts off the fast charge at the exact point of full charge—batteries are charged, not cooked! Charges NiCads or NiMH packs from 2 to 10 cells (easily expanded) and current capacities up to 10 Amp-hours. Runs on 12 to 15 VDC. Quit cooking your batteries, buying new packs, waiting hours for recharge, get a Dr. Ni-Cad today! Available in money saving kit form or wired and tested with case at a special price. Kit builders: add our matching case set for a snazzy finish.

DN-1 Dr. Ni-Cad conditioner/fast charger kit .....	\$49.95
CDN Matching case set.....	\$12.95
DN-1WT Fully assembled Dr. Ni-Cad with case.....	\$89.95

ORDERS CALL 1-800-4 HOBBY KITS (446-2295) ORDERS ONLY  
TECH/ORDER/INFO (716)924-4560 FAX (716)924-4555

TERMS: Satisfaction guaranteed. Examine for 10 days. If not pleased return in original form for refund. Add \$3.95 for shipping, handling and insurance. For foreign orders add 20% for surface mail. COD (U.S. only) add \$5.00. Orders under \$20 add \$3.00 NY residents add 7% sales tax. 90-day parts warranty on kit parts. 1-year parts & labor warranty on wired units.



RAMSEY ELECTRONICS, INC 793 CANNING PARKWAY VICTOR NY 14564



- Multifax \$250
- OFS WeatherFAX \$445  
assembled  
and tested;  
\$395 kit form
- Timestep ProSat \$399
- Satellite Data Systems \$799
- Quorum Communications, Inc. \$695

Check the ads in 73 Magazine or WeatherSat Ink for features and other available equipment. An example of a package deal is the one from Quorum Communications, Inc. For \$495 they have a combination receiver and demodulator

card that plugs into your PC. The addition of an omnidirectional VHF antenna is the only other piece of equipment you need (in addition to your computer).

Once you start pulling in satellite imagery on your computer screen you'll be hopelessly addicted. The imagery changes every day with the weather and seasons. You may find yourself looking forward to that next big snowstorm or hurricane so you can have a bird's-eye view from the comfort of your shack. As with all hobbies, once you get hooked you start looking for ways to do more and more.

Well, satellite imagery doesn't disap-

point. After the initial thrill of pulling in images live from space wears off, a whole new world remains open for exploration. Temperature calibration of the infrared imagery from these birds allows you to measure water temperatures. Color enhancement of the temperature differences on the PC screen will reveal the Gulf Stream or Labradorian current or where the best fishing is. Several individuals have launched successful businesses marketing sea surface temperature maps to marinas and commercial fisherman. In the months ahead we hope to present many facets to this fascinating hobby. Stay tuned!

73

**COMTELCO INDUSTRIES**

Take Your H.T. Mobile!

**MAGNET MOUNT** **19.95**

**Dual Band Mobile**  
140 mhz, 440 mhz

or

**Multi-Whip Mobile**  
140 mhz, 220 mhz, 440 mhz

150 Watt Power Rating  
Supplied with 12ft of RG58 Coax  
Choice of BNC or PL259 Connector

**1-800-634-4622**  
Quality products Made in the U.S.A.  
**COMTELCO INDUSTRIES INC.**  
501 Mitchell Rd., Glendale Hts., IL 60139

**CIRCLE 15 ON READER SERVICE CARD**

**VHF UHF MICROWAVE**

**Transverters:**  
6 M, 2 M, 222 MHz, 70 cm, 902, 1296, 2304,  
3456, 5760 MHz, 10 GHz

**Receiving Converters:**  
1691 MHz, 2400 MHz

**Antennas:**  
Loop Yagis 902 - 3456 MHz  
Rutland Arrays Yagis: 6M - 70 cm

**Low Noise Preamps and Kits:**  
144 MHz - 10 GHz

**Linear Power Amps:**  
70 cm - 2304 MHz

Components, Cable, Antenna Relays  
*FREE Catalog Available*

**DOWN EAST MICROWAVE**  
Bill Olson W3HOT  
RR 1, Box 2310  
Troy, ME 04987-9721 USA  
Phone (207)948-3741  
Fax (207)948-5157

MasterCard VISA

**Handheld Power Amplifier Kits**

**Ultra compact 2 meter linear amplifier kits. 12-14 volt operation, high gain with TR switching**

**15 watt (14.5 dB gain) \$60**  
**30 watt (10 dB gain) \$70**

**(510) 644-3779**  
FRB, 1442 Walnut St. #406  
Berkeley, CA 94710

**CIRCLE 253 ON READER SERVICE CARD**

**ZD ENGINEERING**

Specialists in CATV Hardline Matching Transformers, Power Dividers and Related R.F. Devices.



Built to fit 1/2, 3/4, and 7/8 inch hardline, or can be custom built for other sizes of hardline and any frequency between 50 MHz and 1.3 GHz. When ordering, please include a 4 inch section of your hardline and specify the design frequency you need.

144 MHz units are \$34.95 per pair. 222 MHz, 440 MHz, 903 MHz and 1296 MHz units are \$32.95 per pair.

Add \$5.50 per pair UPS shipping (U.S. only).  
Ohio residents add 5.5% sales tax.  
Custom built prices on request.

**ZD ENGINEERING**  
Paul H. Darwactor, W8ZD,  
605 Balsley Avenue, Findlay, OH 45840  
PHONE: 419-424-8765

**NEW**

**AR1500**  
**500KHZ TO 1300**  
**MHZ. WITH BFO**

AR1500. A 1000 Channel Scanner with 500KHz to 1300 MHz coverage, & no cutouts. 10 search, 10 scan banks lockout on search & search&store. VFO tuning with AM/FM/WFM modes. With Ni-Cad batteries, Chgr, VHF Ant., and long wire antenna, case & belt clip. Limited time offer, not valid with any other specials. Only 5.95 shipping & handling anywhere in the 48 states. Call toll free and order this new unit!

**\$449**

**ACE COMMUNICATIONS**

Call **1-800-445-7717**

6975 Hillsdale Ct, Indianapolis IN 46250  
317-842-7115 Fax 1-800-448-1084

MasterCard VISA

**CIRCLE 164 ON READER SERVICE CARD**

**"FIBERWHIPS"**  
Mobile HF Antennas

**ASA**

MODEL	MTR	MHZ
HFA 6		50.0-54.0
HFA10		28.0-29.7
HFA12		24.89-24.99
HFA15		21.0-21.45
HFA17		18.1-18.8
HFA20		14.0-14.35
HFA30		10.1-10.15
HFA40		7.0-7.3
HFA75		3.5-4.0

**MADE IN U.S.A.**

**\$17.75 EACH**

+ \$5.00 S&H (SC Residents Add 5% Sales Tax)  
Check in Advance or C.O.D.

**HEAVY-GAUGE NICKEL-CHROME BRASS FITTINGS 250 WATTS POWER APPROX. 8' LENGTH AVAIL. IN BLACK**

75 40 30 20 17 15 12 10 6

**ASA**  
PO Box 3461  
Myrtle Beach, SC 29578  
**1-800-722-2681**

**100% Guaranteed**

**CIRCLE 18 ON READER SERVICE CARD**



# FEEDBACK

In our continuing effort to present the best in amateur radio features and columns, we recognize the need to go directly to the source—you, the reader. Articles and columns are assigned feedback numbers, which appear on each article/column and are also listed here. These numbers correspond to those on the feedback card opposite this page. On the card, please check the box which honestly represents your opinion of each article or column.

Do we really read the feedback cards? You bet! The results are tabulated each month, and the editors take a good, hard look at what you do and don't like. To show our appreciation, we draw one feedback card each month and award the lucky winner a free one-year subscription (or extension) to 73.

To save on postage, why not fill out the Product Report card and the Feedback card and put them in an envelope? Toss in a damning or praising letter to the editor while you're at it. You can also enter your QSL in our QSL of the Month contest. All for the low, low price of 29 cents!

- 1 Never Say Die
- 2 Letters
- 3 QRX
- 4 Getting Started With Satellite Imagery
- 5 Using the World's Most Accurate Frequency Standard, Part 3
- 6 The TW-1 Cheap Digital Front Panel
- 7 Review: The CS-800
- 8 Review: The Ten-Tec Scout
- 9 The FOXBOX
- 10 The Commercial Radiotelephone Operator License
- 11 RTTY Loop
- 12 Carr's Corner
- 13 Homing In
- 14 Hams with Class
- 15 QRP
- 16 Packet & Computers
- 17 ATV
- 18 Above and Beyond
- 19 Ask Kaboom
- 20 73 International
- 21 Ham Help
- 22 Updates
- 23 Special Events
- 24 Dealer Directory
- 25 New Products
- 26 Barter 'n' Buy
- 27 Random Output
- 28 Propagation

CIRCLE 137 ON READER SERVICE CARD

## Slow Scan Television

doesn't have to be expensive anymore

Quality Color SSTV  
is easy and affordable with Pasokon TV.

**Pasokon TV \$229.95**

Send and receive all popular modes.  
Hardware interface fits inside computer

**New - SSTV Explorer \$94.95**

Small receive-only interface plugs into serial port.

Both require IBM PC/AT or compatible, '286 or better CPU, color VGA display, MS-DOS. Prices include free shipping to U.S.A. Write or call for complete details.

Absolute Value Systems  
115 Stedman St. #7  
Chelmsford, MA 01824-1823  
(508) 256-6907

CIRCLE 351 ON READER SERVICE CARD

## Packet Rat?

**DON'T LET THE RATS NEST GET YOU!** Does your Packet Network site look like a rat's nest of wires and cables? If the answer is YES, or you just like the good looks, easy maintainability and reliability of a neat, orderly installation, then you should send for our FREE catalog today!

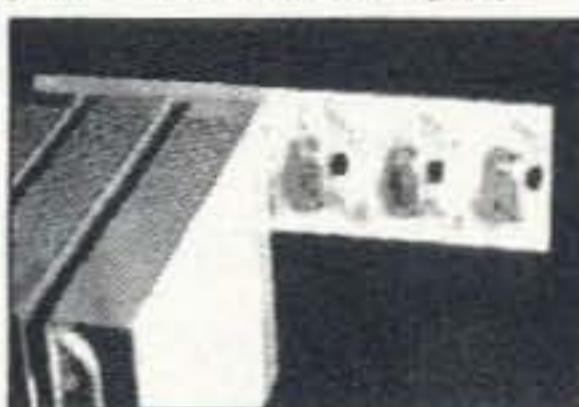

The NETRIX Diode Matrix Board uses no cables to interconnect up to six network TNCs, creating a multi-port network switching node. Set up a network node, or link a few sites together and make your own network! The NETRIX uses DB-9F connectors and is compatible with both TheNET and ROSE networking software! \$24.95 as a kit, \$39.95 assembled.

Adapters for DRSI or MFJ TNCs are only \$2.49 each - specify.

Our Power Distribution Board lets you further reduce the rat's nest by organizing your power connections. Eight TNC-type power jacks, fused, rev. polarity protected, and more. \$24.95 assembled. 24" power cord, \$2.49 each.

The WireModem Adapter Set connects up to 6 TNCs together via their modem disconnect headers at high speed. Connect servers (BBS, DX, etc.) directly to the network. Useful & reliable. Complete kit, \$12.95.

TNC to Radio Cables - Kits from \$1.99, assembled from \$7.99 to \$12.99.

TekK KS-900 Power Supply w/TNC cable, assembled, only \$29.95.

EPROMs and Sysop Manuals for TheNET & ROSE - Write for order form.

Please write for our free catalog. To order, send check or MO, add \$3 S/H, NJ address add 6% tax. All US orders shipped 2-Day air! Your Satisfaction is Fully Guaranteed.

**Amateur Networking Supply**

Post Office Box 219, Montvale New Jersey 07645-

CIRCLE 76 ON READER SERVICE CARD

## VOX CONTROLLER SECOND GENERATION

next generation VOX controller with adj vox sensitivity, timers and CWID. Operate VOX with no internal connections to your radios or COR for more demanding systems.

**BC-2I w / CWID & enclosure.....\$89.95**

Add DTMF rmt control, patch and outputs to control other equipment to the BC-2I.

**BC-2R adds rmt ctrl and patch....\$79.95**

**DTMF decoder Boards for every need**

BTD-8C has 8 latched, rmt toll-restriction,

LiTZ, IC sockets & more .....\$99.95

BTD-8M momentary outputs.....\$79.95

BTD-8A....\$69.95      Orig BC-1....\$34.95

**Box Products, Inc    Orders 800-854-2426**

P.O. Box 57                      Info 901-968-5416

Lexington, TN 38351            add \$4.00 S & H

CIRCLE 137 ON READER SERVICE CARD

## X-BAND TRANSMITTER

Miniature (2 1/4 x 3 3/4 x 1") GaAs microstrip transmitter provides 10 dBm centered at 10.525 GHz.

Integrated microstrip patch antenna eliminates the need for an external antenna. Advanced matching techniques secured good temperature stability with low frequency pulling. Great for long-range testing of radar detectors, calibration of radar receiving equipment, and point-to-point communication links.

Complete Assembled System ..... \$39.00  
Parts & Instruction Kit ..... \$29.00

Plus \$2.00 Shipping and Handling

**INNOTEK Inc.**

P.O. Box 80096, Fort Wayne, IN 46898

(219) 489-1711

Visa • MasterCard • Check • Money Order • COD  
Money-Back Guarantee

CIRCLE 283 ON READER SERVICE CARD

## CABLE X-PERTS, INC.

	100 ft/UP	500 ft
FLEXIBLE 9913 DIRECT BURIAL JACKET .....	.52/ft	.57/ft
9913 EQUAL UV RESISTANT JACKET.....	.44/ft	.40/ft
RG 213/U MIL-SPEC/DIRECT BURIAL JACKET....	.34/ft	.32/ft
RG 8/U FOAM 95%.....	.30/ft	.28/ft
RG MINI 8X BLK or CLR UV JACKET.....	.16/ft	.14/ft
RG 11U FOAM MIL-SPEC.....	.42/ft	.40/ft
RG 214/U-MIL SPEC.....	1.50/ft	1.30/ft
RG 142B/U-MIL SPEC.....	1.30/ft	1.10/ft

ROTOR CABLE		
C4080 STD DUTY 2/18-6/22 UV JACKET.....	.20/ft	.18/ft
C4090 HVY DUTY 2/16-6/20 UV JACKET.....	.34/ft	.32/ft
18GA 4/C GRAY JACKET.....	.15/ft	.13/ft
18GA 7/C GRAY JACKET.....	.18/ft	.16/ft

ANTENNA WIRE		
14GA 168 STR SUPER-FLEX UNINSULATED.....	.12/ft	.10/ft
14GA 7/22 H.D B.C UNINSULATED.....	.08/ft	.07/ft
14 GA SOLID "COPPERWELD" UNINSULATED..	.07/ft	.06/ft
RG 11U STR FLEXIBLE BC UNINSULATED.....	.11/ft	.10/ft

BALUNS		
W2AU 1:1 or 4:1 BLN 1.8-40MHz TRNSFRM.....	\$22.50/ea	
W2DU 1:1 BLN 1.8-30MHz CRRNT.....	\$25.95/ea	
40/80 METER ANTENNA KIT.....	\$79.95/ea	
TRAPS 10-40 MTR.....	\$42.95/pr	
CENTER INSULATOR.....	\$9.95/ea	
DAC ROPE DBL BRD 3/16" 77# TEST.....	\$12.00/100ft	

WIRE		
10 GA 2/C RED/BLK 25ft - \$9.00/ea.....	12 GA RED/BLK 25ft - \$6.00/ea	
1/2" BRAID 25ft - \$10.00/ea.....	1" BRAID 25ft - \$17.50/ea	
450 OHM LADDER LINE 18GA SOLID CW.....	\$12.00/100ft	

MORE ITEMS STOCKED INCLUDING CONNECTORS & ANTENNAS  
CABLE & WIRE CUT TO YOUR SPECIFIC LENGTH!

**ORDERS ONLY: 800-828-3340**

TECH INFO: 708-506-1886



113 McHenry Rd., Suite 240  
Buffalo Grove, IL 60089-1797



For Complete Literature Mail SASE

## The FLYTECRAFT™ SFX Line of Monoband Vertical HF Antennas

For those who demand a high-efficiency antenna where height and space are critical factors, the FLYTECRAFT™ SFX line is ideal.

- 8 unique models for 80, 40, 30, 20, 17, 15, 12 & 10 meters. Each only 9 ft. tall (10 meter is slightly shorter.)
- Precision-wound full length helix gives incredible DX performance.
- Unobtrusive - Perfect for antenna restricted areas.
- Instant set-up and tear down, or leave up permanently.
- Top whip adjusts for low SWR point.
- Uses 2 shortened tuned radials with FLYTECRAFT™ RADIALCOILS™ (10 meter uses 3).



FLYTECRAFT™ SFX Monobanders are in daily use around the world.

Built with pride & sold worldwide ~ FLYTECRAFT™ USA

SFX 80 ~ \$79.95    40, 30, 20, 17, 15, 12 ~ \$69.95 ea.  
10 ~ \$59.95      Add \$6.50 s/h, Cont. U.S.

Satisfaction Guaranteed  
**VISA/MC PHONE ORDERS**  
**800-456-1273**  
M-F 9A-5P (PT) 805-583-8173

Send Check/ \$ Order to:  
**FLYTECRAFT™**  
P.O. Box 3141  
Simi Valley  
CA 93093

CIRCLE 118 ON READER SERVICE CARD

## Is Your Shack Grounded?

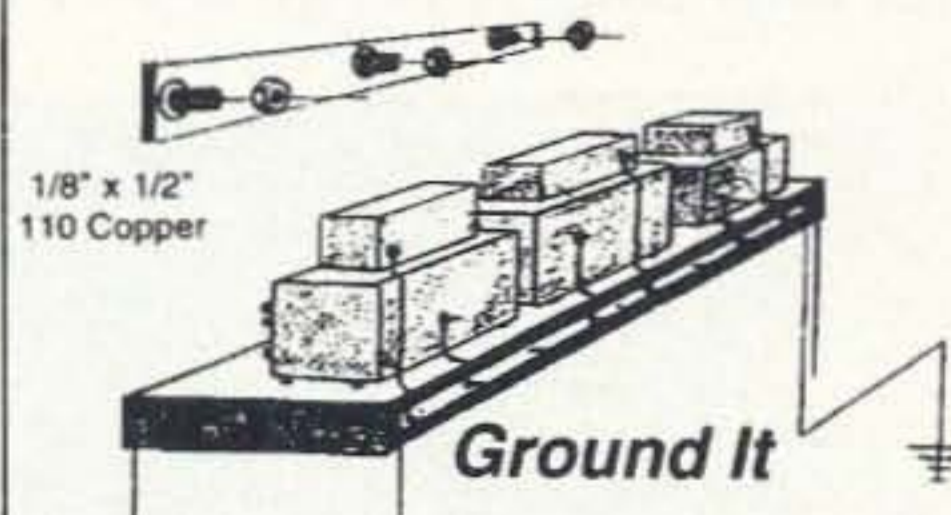

**Solid Copper Buss Stainless Steel Hardware**  
Grounding Stud Every 6 Inches  
Top or Back Installation

Ground all of your equipment chassis's to a single earth ground in one easy installation.  
Money back guarantee, if not satisfied!

+ \$5.00 S & H                      2 ft.....\$11.95      Custom Lengths Available  
Mail check/money order to:    3 ft.....\$16.95  
**J.M.S.**                                      4 ft.....\$21.95

35 Hilltop Ave., Dept. R  
Stamford, CT 06907                      **J. Martin Systems**

CIRCLE 26 ON READER SERVICE CARD



# Using the World's Most Accurate Frequency Standard, Part 3

*Building a good secondary frequency standard.*

by Bob Roehrig K9EUI

A good frequency standard is an important piece of test equipment for any shack. With a little effort, you can build a unit that is 10 or 100 times more accurate than the oscillators found in most frequency counters.

Crystals are variable devices. They must be used with care to operate correctly. The main problem with an oscillator is drift, which is caused by many things:

1. Crystal aging
2. Temperature change
3. Varying drive levels
4. Oscillator component variations
5. Circuit loading changes
6. Power supply variation

All these variables must be kept to a minimum to end up with a stable oscillator. Most of these items have been discussed in detail in other articles and I recommend that you read as many as you can of the references at the end of this article. The frequency standard described here has been designed to keep these variations to a minimum.

There are two ways to minimize the temperature drift problem. You can use a circuit with temperature compensating components that have the opposite temperature coefficient of the crystal (a TXCO); or you can

use a standard circuit and just keep the crystal and the oscillator at a constant temperature, which is far easier. Just holding a crystal at a constant temperature is not quite good enough either. The temperature must be set at the upper turning point to be the most stable.

As a crystal is heated up above room tem-

---

*“Crystals always age, meaning that the frequency will naturally change with use even though everything else remains constant.”*

---

perature, its frequency decreases. The rate it decreases depends on how the crystal was cut. As the temperature increases the frequency eventually stops decreasing, then begins to go up. This leveling out area is called the *turning point* and this is where the crystal should be operated.

Crystals always age, meaning that the frequency will naturally change with use even though everything else remains constant. Aging is said to decrease logarithmically

with time and will eventually drop off to a low rate of a few parts per million per year or less. Aging can be kept to a minimum by using the lowest crystal drive current possible. The most efficient way to control drive is with an AGC circuit. That way the circuit gain is initially high to start oscillation, but then is reduced to a level just high enough to maintain oscillation.

## The Oscillator Circuit

If you read the references listed below you will find out that there are dozens of oscillator circuits, all claiming to have some advantage over another. The oscillator I chose is similar to the Goral circuit, which is a variation of the Colpitts circuit. The Goral circuit adds a follower (Q2) which provides power gain. This permits using much larger values for the capacitors, C1 and C2, which reduces drift caused by minor variations in these component values with temperature change. It also reduces any capacitance effect caused by the oscillator device, (Q1) itself.

The main difference between my oscillator and the Goral circuit is the use of amplified AGC to control the drive level, rather than the simple scheme used in the original Goral circuit. The negative AGC voltage (typically -2 volts) is applied to the gate of

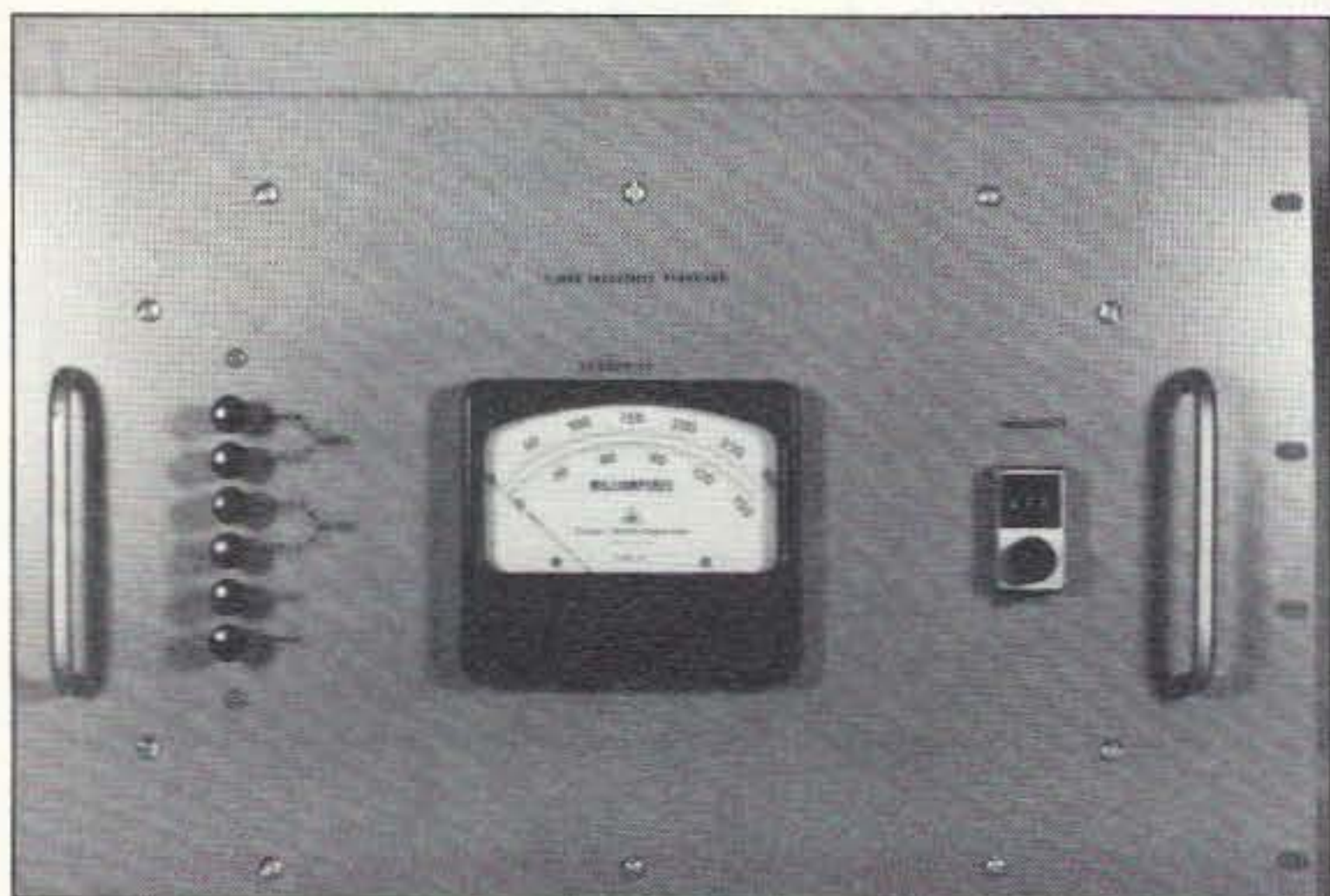

Photo A. A view of the frequency standard front panel.

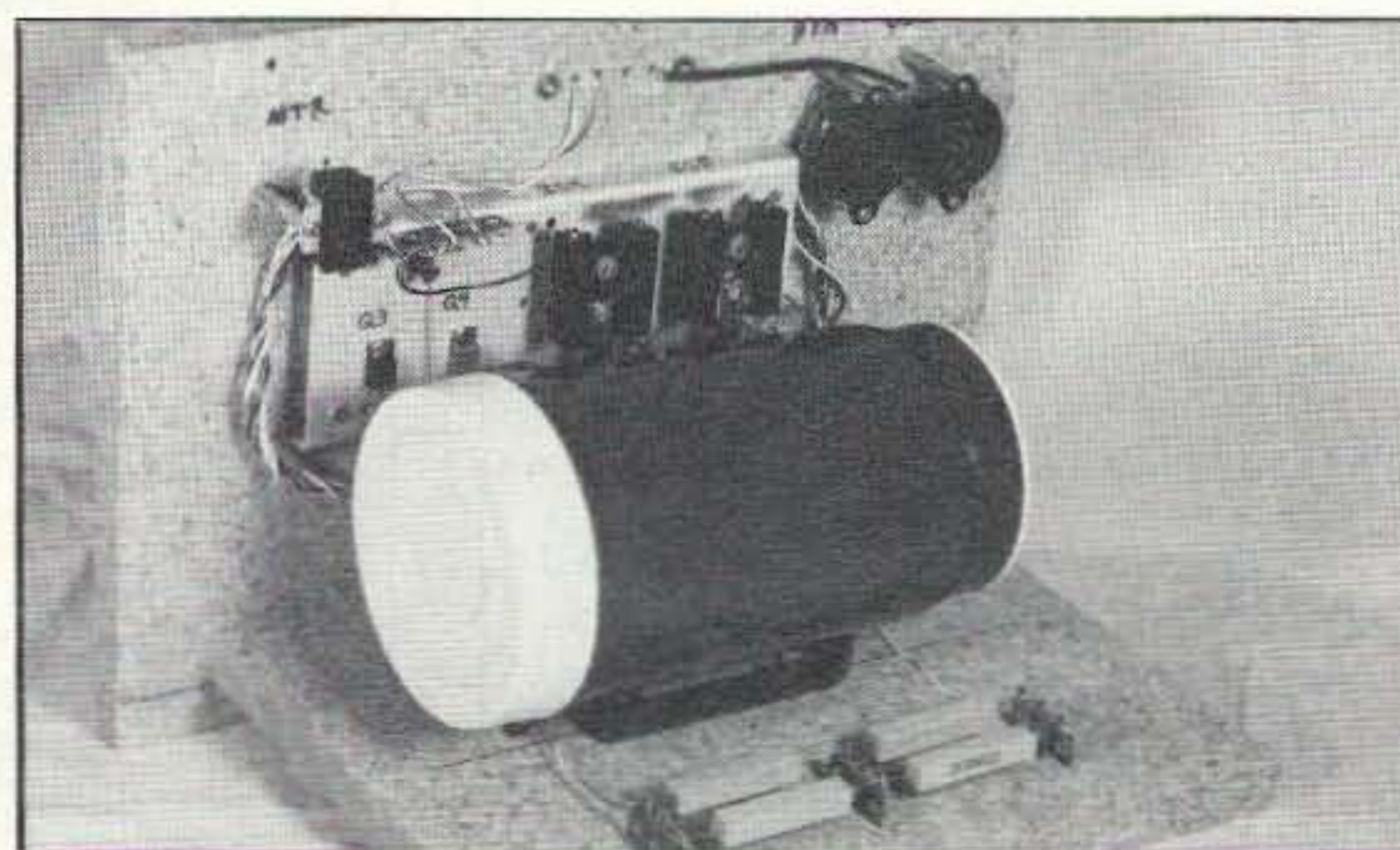

Photo B. A view from the rear showing the shelf and thermos bottle. Note the power transistors, voltage regulators, and outer oven heater resistors.



WE SHIP WORLDWIDE

# Barry Electronics Corp.

WORLD WIDE AMATEUR RADIO SINCE 1950

Your one source for all Radio Equipment!

For the best buys in town call:  
**212-925-7000**

Los Precios Mas Bajos en Nueva York

**WE SHIP WORLDWIDE!**

Export orders expedited.

IC-R71A, R72A, R100, R7000A, R7100A, R9000A,  
IC-725, 728, 729, 735, 737, 765, 781. IC229H,  
IC3230A, IC901A, GPS Receiver: GP-22



Wherever I go, I take my radio.  
Specialist in **RADIOS**;  
Business marine aviation,  
ham radios and scanners.

**KITTY SAYS: WE ARE OPEN 7 DAYS A WEEK**  
Saturday 10-5pm/Sunday 11-4 pm  
Monday-Friday 9 to 6:00 PM  
Come to Barry's for the best buys in town



CONTACT US FOR THE LATEST IN  
BUSINESS AND HAM RADIOS,  
SHORTWAVE RECEIVERS &  
SCANNERS, MOTOROLA, YAESU,  
ICOM, KENWOOD, ALINCO,  
STANDARD, MAXON, RELM, BENDIX  
KING, SONY, SANGEAN



**ICOM**

### Telephone Autopatch

Patches telephone calls from your radio to phone line. Great for making and receiving phone calls where there are no phone lines. Simple to use. Write or fax for inquires. Simplex, semi-duplex, full duplex, CES & CSI Models stocked: SDI-50, PPV, CS700/800/900 etc. Our service Lab will wire in systems for you if requested.

Save money on batteries.  
Ask for Special Prices.

## KENWOOD



**ANTENNAS**  
A-S, AES, Cushcraft, Hy-Gain, Hustler, KLM, METZ, Urban, MODUBLOX, TONNA, Butternut, Multi-Band

## "YAESU Ham and Business Radios"

FT-767GX, FT-890, FT-747GX, FT-990, FRG-8800,  
FRG-100B FT-736R, FT-1000D, FT-416/816, FT-530,  
FT-5200, FT-2400, FT-470, FT-530- FT-411E

**YAESU ICOM**  
FT-23R/26/76 IC2/3/4SAT  
FT411E-811-911 IC02AT/2SRA  
FTH-2008/7008 IC2/4GAT/24AT  
IC-A21/U16

Landmobile HT's  
ICOM: U16, H16, V100, U400  
MAXON, MOTOROLA,  
YAESU: FTH 2008/7008  
UNIDEN, REGENCY, KING,  
MARINE ICOM: M7, M56, M700  
AVIATION ICOM: A21 A200 H.T., TAD



ICW2A W2IAT P2AT/4AT  
IC-H16/U16 IC2IA  
MOTOROLA RADIUS COMMERCIAL RADIOS  
TH-78A FT-530

"TS-50S", TS450S/AT, R-5000, TS-850S,  
TM 241A/441A, TR-751A, Kenwood Service  
Repair, TS140S, TS690S, RZ-1, TS-790A,  
TS950SD, TH-78A, TH28/48A, TM-941A,  
TM-741A, TM-732A, TM-641A, TM-742A.

### SCANNERS

**AOR:**  
900, 1000,  
1500, 2500,  
2800, 3000A  
**ICOM:**  
R-1, R100,  
R71A, R72A,  
R7000,  
R7100,  
R9000  
Bearcat

**MARINE RADIOS**  
ICOM M7, M11, M56, M700TY, M800  
AVIATION PORTABLE ICOM A-21  
MOTOROLA MARINE KING KX 99

**Budwig ANT. Products**  
FLUKE 77, 83, 85, 87 Multimeters

**Linear Amplifier**  
Ameritron, Icom, Kenwood, Yaesu

## Shortwave Receivers

- SONY • GRUNDIG
- SANGEAN • ICOM

Call 212-925-7000

Satellite telephone in suitcase for worldwide use. WRITE.



**Computer Interfaces**  
Stocked: MFJ-1270B,  
MFJ-1274, MFJ-1224, AEA  
PK-88, MFJ-1278T, PK-900, PK-232  
MBX W/FAX, DRSI PRODUCTS  
DSP 2232



**MOTOROLA**

**Antenna Tuners:**  
MFJ, AEA AT-300,  
ICOM, KENWOOD,  
YAESU.

**COMMERCIAL & HAM REPEATERS STOCKED. WRITE FOR QUOTES**

Kantronics  
KAM PLUS, KPC 2/3/4,  
KPC2400, SUPER FAX II,  
KPC IV, Data Engine, D4-10, etc.

**SHORTWAVE RECEIVERS STOCKED**

**MOTOROLA AUTHORIZED DEALER**  
**KACHINA COMMUNICATIONS DEALER**

**AUTHORIZED DEALER**  
**SONY**

Shortwave Radios Stocked  
DIGITAL FREQUENCY COUNTERS  
OPTOELECTRONICS model 1300 H/A, 0-1300MHz  
2300, 2210 H, 0-2200 MHz, 2600H, UTC-3000, 2810

Long-range Wireless Telephone for export in stock

**BENCHER PADDLES**  
**BALUNS, LOW PASS FILTERS**  
**IN STOCK**

**MIRAGE/RFC Amplifiers**  
**ASTRON POWER SUPPLIES**  
Belden Wire & Cable, Int'l Wire  
**OPTO KEYERS STOCKED**

**SR STANDARD.**



**JRC Short-wave radios**  
JST135, NRD-535D

**Ameritron Amplifiers**  
**AMERITRON**

Hy-Gain Towers will be shipped direct to you FREE of shipping cost.

ALINCO DJ580T, 120T, 162T, 460T, 180T, F1TH, DR570T, etc.

Wide selection of SW & Amateur Publications

Telephone scramblers for cellular and regular phones. \$299.00 each

**CAR Stereo with Shortwave**  
Phillips DC-777 @ \$499.95 in stock

**ANTENNAS:**  
AEA, AlphaDelta, ANLI, Antenna Specialist, Barker & Williamson, Comet, Cushcraft, Diamond, GAP, Hy-Gain, Hustler, Larsen, Etc.



(144, 220, 440 MHz), Isoloop.

**EIMAC**  
3-500Z  
572B, 6JS6C  
12BY7A & 6146B

**BIRD**  
Wattmeters & Elements In Stock

**BIRD Wattmeters & Elements In Stock**



MAIL ALL ORDERS TO: BARRY ELECTRONICS CORP., 512 BROADWAY, NEW YORK CITY, NY 10012 (FOUR BLOCKS NORTH OF CANAL ST., BETWEEN SPRING AND BROOME ST.)

**New York City's LARGEST STOCKING HAM DEALER**  
**COMPLETE REPAIR LAB ON PREMISES**

## "Aquí Se Habla Español"

BARRY INTERNATIONAL  
FAX 212-925-7001 Phone 212-925-7000

Monday-Friday 9 A.M to 6:00 P.M.  
Saturday 10- 5pm /Sunday 11- 2pm

IRT/LEX-"Spring St. Station". Subways: BMT-  
"Prince St. Station". IND-"F" Train-Bwy Station"  
Bus: Broadway #6 to Spring St. Path-9th St./6th Ave.  
Station.

**COMMERCIAL RADIOS STOCKED:** ICOM, Motorola, MAXON, Standard, Yaesu. We serve municipalities, businesses, Civil Defense, etc. Portables, mobiles, bases, repeaters...

**ALL SALES FINAL**

Technical help offered upon purchase

**FAX: 212-925-7001**

We stock: AEA, Alinco, Ameco, Ameritron, Antenna Specialist, ARRL, Astatic, Astron, B&K, Belden, Bencher, Bird, Butternut, CES, Cushcraft, Daiwa, Elmac, Henry, Heil, Hustler, Hy-Gain, Icom, KLM, Kantronics, Kenwood, Larsen, Maxon, MFJ, Mirage, Motorola, Nye, Palomar, RF Products, Shure, Standard, TUBES, Uniden, Yaesu, Vibroflex, Duplexers, Repeater, Scanners, Radio Publications

**WE NOW STOCK COMMERCIAL COMMUNICATIONS SYSTEMS**  
HAM DEALER INQUIRES INVITED PHONE IN YOUR ORDER & BE REIMBURSED  
**COMMERCIAL RADIOS stocked & serviced on premises.**  
**Amateur Radio Courses Given On Our Premises, Call**  
**Export Orders Shipped Immediately.**



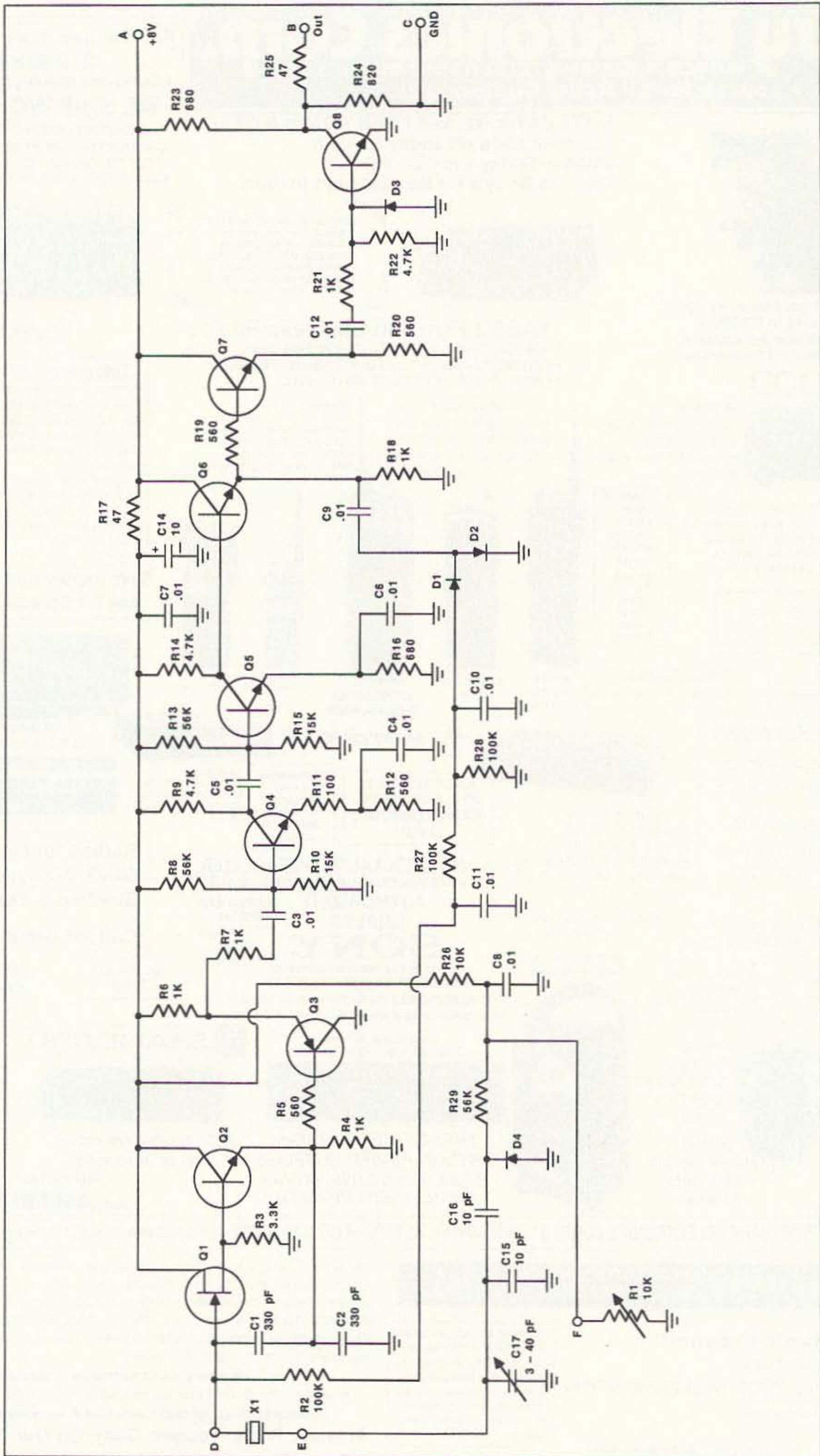

Figure 1. 1 MHz crystal oscillator.



## Parts List, Figure 1

All resistors 1/4 watt.

Desig.	Value/Type	Digi-Key Part No.
C1,2	330 pF	DK P4806
C3-13	0.01 $\mu$ F	DK P4513
C14	10 $\mu$ F	DK P807
C15,16	10 pF	DK P4837
C17	3-40 pF Trim.	DK SG3008
D4	1N4001	
D1-3	1N914	
Q1	MPF102	
Q2,5-8	2N2222	
Q3	MPS2907 or 2N3906	
R1	10k 10-turn pot	DK 73JA103-ND
Dial for R1		DK 316-11CS-ND
R2,27,28	100k	
R3	3.3k	
R4,6,7,18,21	1k	
R5,12,19,20	560 ohms	
R8,13,29	56k	
R9,14,22	4.7k	
R10,15	15k	
R11	100 ohms	
R16,23	680 ohms	
R17,25	47 ohms	
R24	820 ohms	
R26	10k	
X1	1 MHz crystal from Jan Crystals. Specify HC6-U holder, 32 pF parallel load capacitance, 0.001% 55 degrees C operating temperature. Jan Crystals type CE-1.	
X1 Socket		

Q1. With this circuit, crystal drive is reduced to less than 10 microwatts (less than 1/100 of what it would be without AGC).

Q3 is an additional follower to isolate the following stages from the oscillator itself. Because of AGC action, the DC level on the emitter of Q2 operates near ground, so Q3 must be a PNP device to provide proper DC operation.

Q4 and Q5 are high-gain amplifiers and follower Q6 provides a low source impedance for the AGC detector circuit, D1 and D2. Q7 and Q8 provide a TTL-compatible output signal. The output is a nearly symmetrical 5 volt square wave.

D4 and C16 perform as a variable capacitance diode to allow electrical fine-tuning of the oscillator frequency. The control voltage

is provided by the divider consisting of R26 and R1. R1 is a 10-turn precision pot with a counter dial, mounted on the front panel of the unit. Increasing the resistance of R1 increases the frequency. Although the adjustment is somewhat nonlinear, the tuning rate is roughly one part in  $10^6$  per turn.

### The Ovens

To be effective, the crystal and oscillator must be kept at a constant temperature, as said before. This means they must not be affected by changes in the surrounding environment. While testing my original oven unit, which housed everything in a minibox, I noticed that even a few degrees change in room temperature affected frequency. I finally decided that the best and most easily

available housing for this unit would be a thermos bottle. The model I chose is the one-pint Food Jar model 7221. The top cup is not used.

The oscillator circuit is housed inside the thermos bottle and the oven heater consists of four 10 ohm 10 watt resistors (Figure 2, R26-29). Temperature control is provided by a thermistor (Figure 2, RT1) which is connected to the bridge circuit of Figure 2.

Even with the use of the thermos bottle housing and the proportional control scheme, outside temperature changes can still affect the inner temperature. This is solved by a second outer oven which is also proportionally controlled. The housing for the entire unit consists of a 3/4"-thick particle board box attached to the back of a 12"-high relay rack panel. The box dimensions are: 14" wide by 10" high by 10" deep. The inner surface of the front panel is lined with styrofoam insulation. The thermos bottle is

***"To be effective,  
the crystal and oscillator  
must be kept at a constant  
temperature."***

fastened by its handle to a shelf which fastens to the rear panel.

Some of the oven control components (Q3, Q4, IC4, IC5, and associated components) are mounted on a 3" by 7" metal plate that is fastened to the rear panel. Resistors R30-33 mount on terminal strips on the shelf in front of the thermos bottle. (See photos.) Front panel connections to the frequency control pot and the meter selector switch are made through an 8-pin Cinch-Jones connector. A connector assembly is also used on the cabling from the thermos bottle so it can be easily disconnected and removed. Power and the 1 MHz output are connected to a barrier strip on the rear panel. If you use an external meter rather than an internal one as I did, you will need a larger barrier strip than one with only four screws.



Photo C. Detail of the inner oven heater assembly. Note the heater resistors, crystal, and thermistor. The assembly is mounted to the top of the thermos bottle and to the end of the oscillator board prototype.

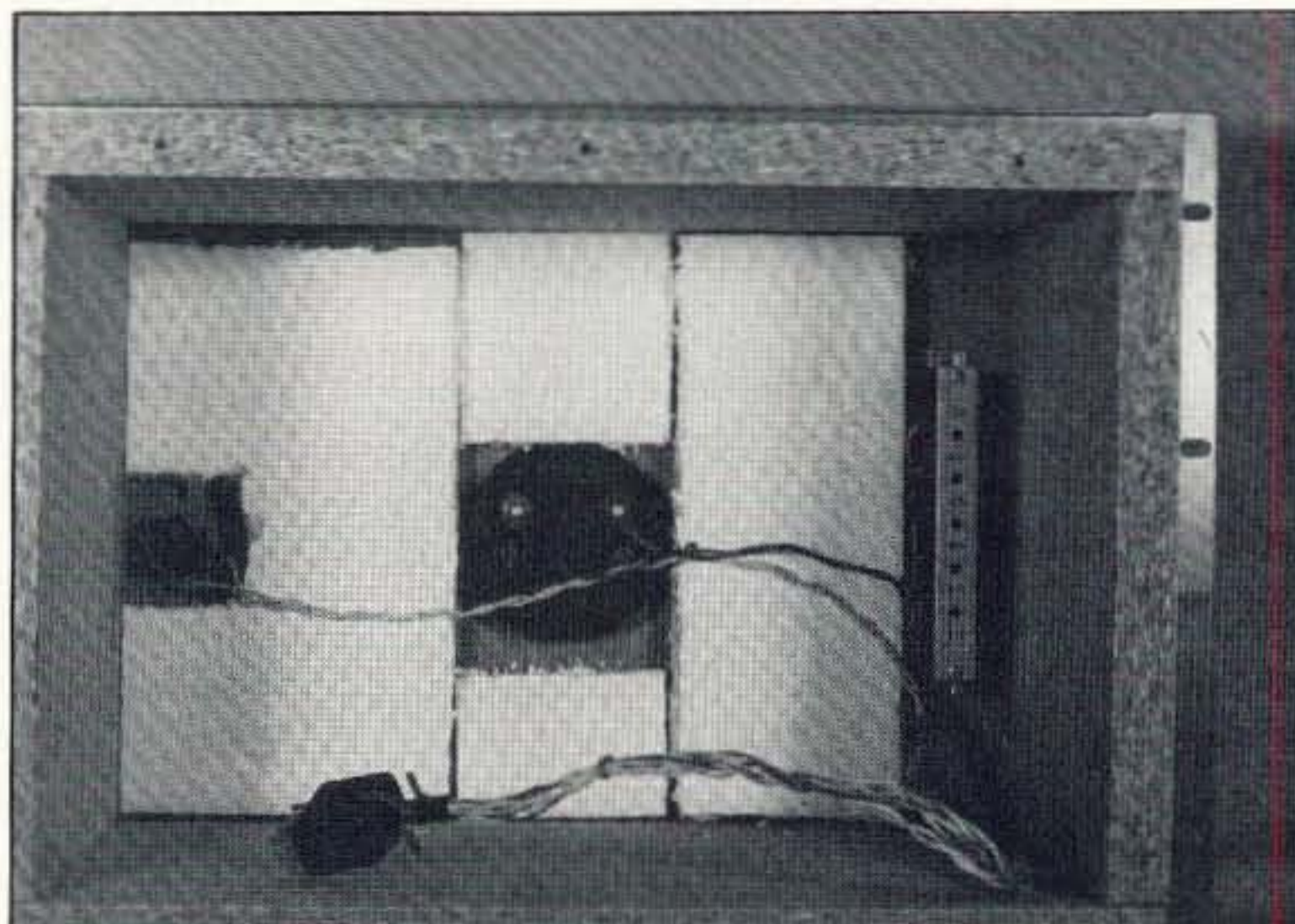

Photo D. Looking inside the box. (Photos by WB9DOF.)



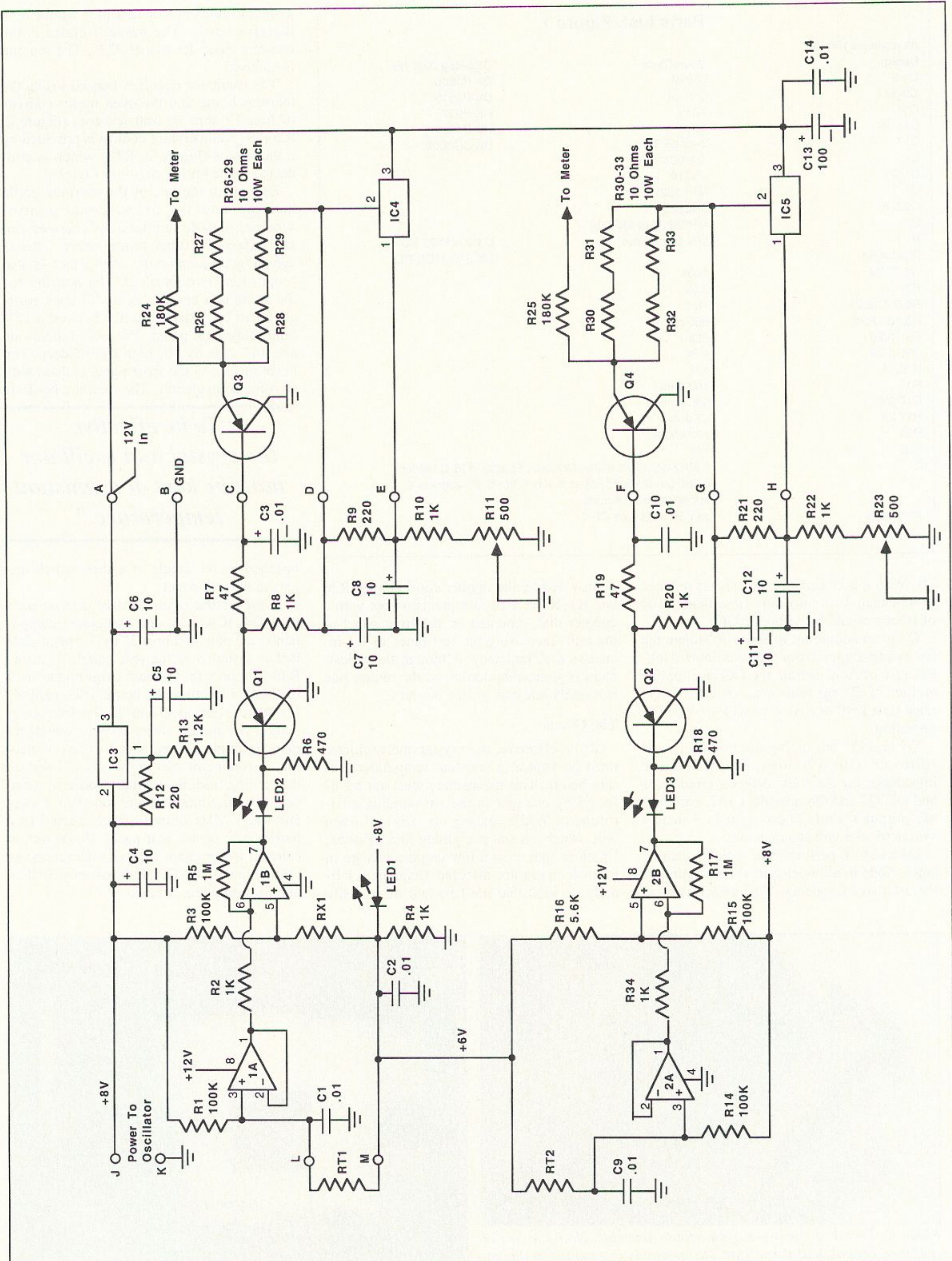

Figure 2. Oven control.



## Parts List, Figure 2

All resistors 1/4 watt unless otherwise specified.

Desig.	Value/Type	Digi-Key/Radio Shack No.
C1,2,3,9,10,14	0.01 uF	DK P4513
C4-8,11,12	10 uF	DK P807
C13	100 uF	DK P833
Q1,2	MPS2907 or 2N3906	
Q3,4	MJEF34	RS 276-2027
IC1,2	LM 1458	RS 276-038
IC3-5	LM 317-T	RS 276-1778
LED1	2 volt panel LED	RS 276-018
LED2,3	2 volt LED	RS 276-046
RT1,2	Thermistor	RS 271-110
R1,3,14,15	100k	
R2,4,8,10,20,22,34	1k	
R5,17	1 meg	
R6,18	470 ohms	
R7,19	47 ohms	
R9,12,21	220 ohms	
R11,23	500 ohm pot	DK 36C52
R13	1.2k	
R16	5.6k	
R24,25	180k	
R26-33	10 ohm 10 watt	DK 10W-10 or RS 271-132
Heat sink for IC3		RS 276-1363
IC socket for IC1,2		RS 276-1995

Q3 and Q4 can be directly mounted to the aluminum panel in back since the collectors are at ground, but IC4 and IC5 must be insulated from the panel. I chose to mount them on individual heat sinks which are insulated from the panel with plastic hardware.

The thermos bottle is prepared by screwing in the stopper fairly tightly. The bottom of the unit will be the side of the bottle with the handle. This will be screwed to the bottom of the shelf. Mark the top edge of the stopper with a marking pen, then remove it.

The inner heater and crystal assembly is constructed on a 2"-square piece of aluminum. This is mounted on the blank end of the oscillator board with three small screws and nuts. The crystal socket mounts near the center of the aluminum with a small "L" bracket so the crystal is centered on the aluminum. On the end of the bracket, drill the board and the aluminum plate to mount two small L brackets which will mount the board assembly to the back of the bottle stopper. Using epoxy cement, glue two of the 10 ohm resistors along the outer edge of the aluminum plate. Then glue the other two resistors on top of these. Apply 8 to 9 volts DC to the oscillator circuit to make sure it and the crystal are operational. Then glue the thermistor (RT1) to the top surface of the crystal. Use sheet metal screws to mount the oscillator board L brackets to the bottle stopper. Make sure you position the board so it will fit into the bottle and be sure the top side of the board is towards the top mark you made on the stopper.

### Tests and Setup

All connections should be made except to the oven resistors and R1. Connect a pair of wires to R1 using the two terminals that increase in resistance as the pot is turned clockwise. This way the resistance of R1 can be read directly from the counter dial.

Temporarily connect the pot to the control board in place of RX1. Ground the frequency control lead of the oscillator circuit (Figure 1, point F). With the oscillator out of the bottle, apply power to the unit. Connect a frequency counter to the oscillator output. This counter should be warmed up for at least 30 minutes in a stable temperature environment and its time base should be as

***"Even with the use of the thermos bottle housing and the proportional control scheme, outside temperature changes can still affect the inner temperature."***

close as possible to its correct frequency. Set the counter for a gate time of 10 seconds so you can read to the nearest 1/10 Hz.

Adjust C17 on the oscillator board for a frequency of 1,000,020 Hz. Turn off the power and install the oscillator inside the thermos bottle. Connect the inner oven leads to Q3 and IC4. Connect a DC voltmeter to the output of IC4. Turn on the power and adjust R11 for 9.5 volts. Connect the voltmeter to the emitter of Q3 to monitor the oven voltage.

The following procedure will determine the crystal turning point temperature and may take several hours. Set R1 to 2k and wait until the voltage across the oven stabilizes. Then note the frequency. Decrease the pot resistance in 100 ohm steps, waiting for

temperature stabilization each time, and note the frequency. Repeat this procedure until at some point the frequency will begin to increase rather than decrease. Reset the pot to the resistance where you obtained the lowest frequency. You have now found the turning point. Do not be surprised if you must have the oven temperature as high as 80 degrees C. Even though you specify a 55-degree crystal temperature, the actual turning point may be much higher than this.

The frequency should read between 999,992 and 999,998 kHz. If it does, you are OK. If not, note the exact frequency and turn off power. Remove the oscillator from the bottle and let it stabilize to room temperature. Then reapply power and adjust C17 to increase or decrease the frequency by the amount it was off from 999,995 kHz.

Disconnect the pot from the oven control board and install a fixed resistor (or resistors) of the same value as the pot for RX1. Now connect the pot as R1 to the oscillator board. With the inner oven at normal temperature, you should now be able to adjust R1 for exactly 1 MHz.

Connect the outer oven resistors to Q4 and IC5. Connect the voltmeter to the output of IC5 and adjust R23 for 9.5 volts. RT2 and R16 will set the outer oven temperature to between 40 and 45 degrees C.

The thermistors and the temperature set resistors (RX1 and R16) are connected to a bridge circuit which is powered by the 6 and 8 volt supplies. This low voltage across the bridge prevents the current from heating the thermistors by the bridge source. The DC output from the bridge is amplified by 1,000. When the oven is cold, the amplifier outputs are near ground. Because of this and the 2 volt drop across LED2 and 3, driver transistors Q1 and 2 are turned on, which turns on Q3 and 4. When the temperature set point is reached the amplifier output swings positive, which forward biases the LED and

turns off the oven control transistors. At normal operating temperature, the inner oven voltage will run around 4 volts and will vary slightly as slight corrections are made.

The entire unit should be continuously powered from a 12 volt battery which is kept charged with a trickle charger to maintain battery voltage. In the event of a power failure, the battery will keep the unit operational down to the point where the battery reaches 11 volts.

R24 and 25 are used to monitor the oven voltages with a 50 microamp meter. This can be the same meter that is used for the WWVB receiver and the digital comparator units.

The output of the oscillator is connected to the 1 MHz input of the comparator and R1 is used to adjust the frequency for minimum phase shift compared to the WWVB signal. The oscillator output can also drive other devices up to the point where it is



loaded down too much. If necessary, you can buffer the output by using a CMOS hex inverter or buffer to obtain six independent outputs.

With a stable operating environment for the crystal oscillator, an accuracy of one part in  $10^9$  or better can be obtained. 73

#### References:

1. "High Stability Crystal Oscillator," *Ham Radio*, October 1974, page 36.
2. "An Experimental Frequency Standard Using ICs," *QST*, September 1974, page 14.

3. "Quartz Crystal Resonators," *Ham Radio*, February 1986, page 85.
4. "Quartz Crystals—Gems for Frequency Control," *Ham Radio*, February 1979, page 37.
5. "Survey of Crystal Oscillators," *Ham Radio*, March 1976, page 10.

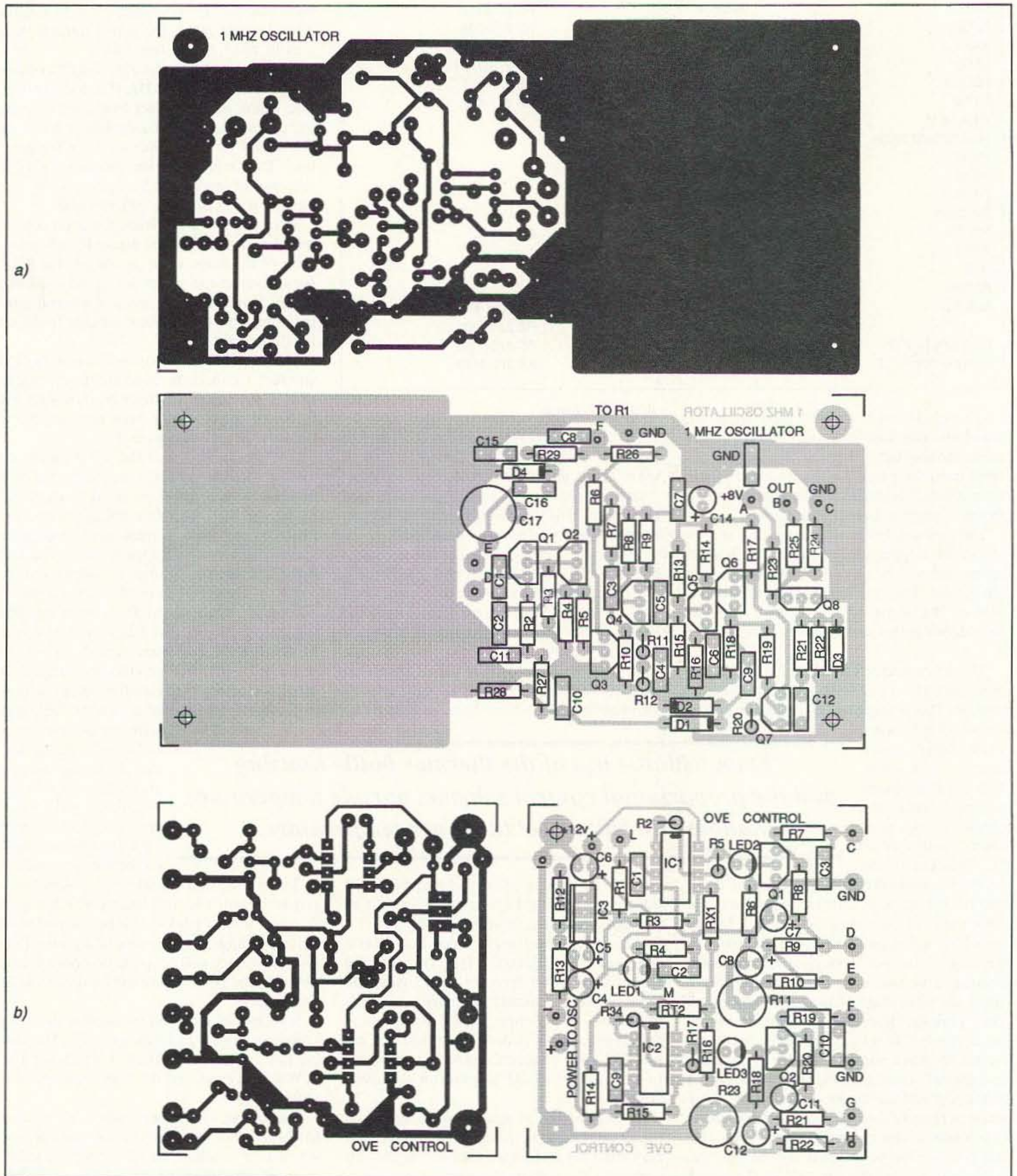

Figure 3. Parts placement and PC board pattern: a) 1 MHz oscillator; b) oven control. The set of both drilled and etched PC boards is available for \$8 plus \$1.50 S & H per order from FAR Circuits, 18N640 Field Court, Dundee, IL 60118.



## ASTRON POWER SUPPLIES

• HEAVY DUTY • HIGH QUALITY • RUGGED • RELIABLE •



MODEL VS-50M

### SPECIAL FEATURES

- SOLID STATE ELECTRONICALLY REGULATED
- FOLD-BACK CURRENT LIMITING Protects Power Supply from excessive current & continuous shorted output
- CROWBAR OVER VOLTAGE PROTECTION on all Models except RS-3A, RS-4A, RS-5A, RS-4L, RS-5L
- MAINTAIN REGULATION & LOW RIPPLE at low line input Voltage
- HEAVY DUTY HEAT SINK • CHASSIS MOUNT FUSE
- THREE CONDUCTOR POWER CORD except for RS-3A
- ONE YEAR WARRANTY • MADE IN U.S.A.

### PERFORMANCE SPECIFICATIONS

- INPUT VOLTAGE: 105-125 VAC
- OUTPUT VOLTAGE: 13.8 VDC ± 0.05 volts (Internally Adjustable: 11-15 VDC)
- RIPPLE Less than 5mv peak to peak (full load & low line)
- All units available in 220 VAC input voltage (except for SL-11A)

### SL SERIES



#### • LOW PROFILE POWER SUPPLY

MODEL	Colors		Continuous Duty (Amps)	ICS* (Amps)	Size (IN) H x W x D	Shipping Wt. (lbs.)
	Gray	Black				
SL-11A	•	•	7	11	2 5/8 x 7 1/2 x 9 3/4	12
SL-11R	•	•	7	11	2 5/8 x 7 x 9 3/4	12
SL-11S	•	•	7	11	2 5/8 x 7 1/2 x 9 3/4	12
SL-11R-RA		•	7	11	4 3/4 x 7 x 9 3/4	13

### RS-L SERIES



#### • POWER SUPPLIES WITH BUILT IN CIGARETTE LIGHTER RECEPTACLE

MODEL	Continuous Duty (Amps)	ICS* (Amps)	Size (IN) H x W x D	Shipping Wt. (lbs.)
RS-4L	3	4	3 1/2 x 6 1/2 x 7 1/4	6
RS-5L	4	5	3 1/2 x 6 1/2 x 7 1/4	7

### RM SERIES

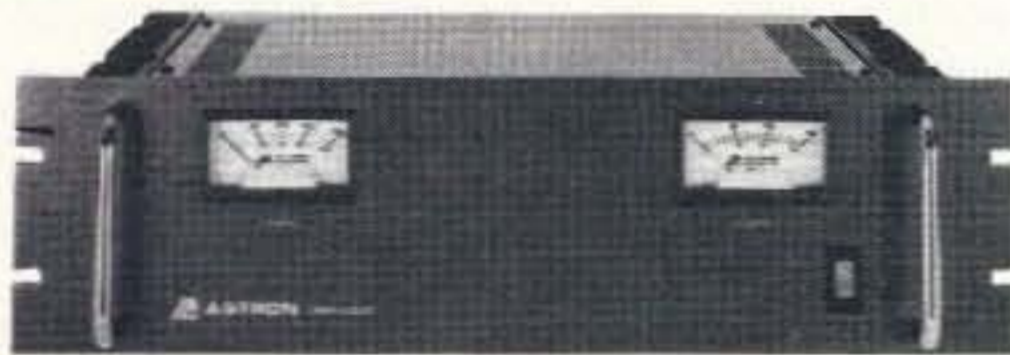

MODEL RM-35M

#### • 19" RACK MOUNT POWER SUPPLIES

MODEL	Continuous Duty (Amps)	ICS* (Amps)	Size (IN) H x W x D	Shipping Wt. (lbs.)
RM-12A	9	12	5 1/4 x 19 x 8 1/4	16
RM-35A	25	35	5 1/4 x 19 x 12 1/2	38
RM-50A	37	50	5 1/4 x 19 x 12 1/2	50
RM-60A	50	55	7 x 19 x 12 1/2	60
• Separate Volt and Amp Meters				
RM-12M	9	12	5 1/4 x 19 x 8 1/4	16
RM-35M	25	35	5 1/4 x 19 x 12 1/2	38
RM-50M	37	50	5 1/4 x 19 x 12 1/2	50
RM-60M	50	55	7 x 19 x 12 1/2	60

### RS-A SERIES



MODEL RS-7A

MODEL	Colors		Continuous Duty (Amps)	ICS* (Amps)	Size (IN) H x W x D	Shipping Wt. (lbs.)
	Gray	Black				
RS-3A		•	2.5	3	3 x 4 1/4 x 5 3/4	4
RS-4A	•	•	3	4	3 3/4 x 6 1/2 x 9	5
RS-5A		•	4	5	3 1/2 x 6 1/2 x 7 1/4	7
RS-7A	•	•	5	7	3 3/4 x 6 1/2 x 9	9
RS-7B	•	•	5	7	4 x 7 1/2 x 10 3/4	10
RS-10A	•	•	7.5	10	4 x 7 1/2 x 10 3/4	11
RS-12A	•	•	9	12	4 1/2 x 8 x 9	13
RS-12B	•	•	9	12	4 x 7 1/2 x 10 3/4	13
RS-20A	•	•	16	20	5 x 9 x 10 1/2	18
RS-35A	•	•	25	35	5 x 11 x 11	27
RS-50A	•	•	37	50	6 x 13 3/4 x 11	46
RS-70A	•	•	57	70	6 x 13 3/4 x 12 1/2	48

### RS-M SERIES



MODEL RS-35M

MODEL	Continuous Duty (Amps)	ICS* (Amps)	Size (IN) H x W x D	Shipping Wt. (lbs.)
• Switchable volt and Amp meter				
RS-12M	9	12	4 1/2 x 8 x 9	13
• Separate volt and Amp meters				
RS-20M	16	20	5 x 9 x 10 1/2	18
RS-35M	25	35	5 x 11 x 11	27
RS-50M	37	50	6 x 13 3/4 x 11	46
RS-70M	57	70	6 x 13 3/4 x 12 1/2	48

### VS-M AND VRM-M SERIES

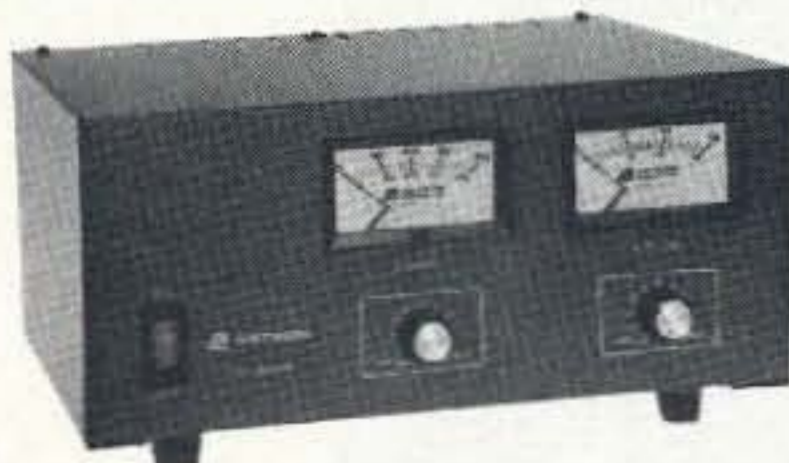

MODEL VS-35M

#### • Separate Volt and Amp Meters • Output Voltage adjustable from 2-15 volts • Current limit adjustable from 1.5 amps to Full Load

MODEL	Continuous Duty (Amps)			ICS* (Amps)	Size (IN) H x W x D	Shipping Wt. (lbs.)
	@13.8VDC	@10VDC	@5VDC			
VS-12M	9	5	2	12	4 1/2 x 8 x 9	13
VS-20M	16	9	4	20	5 x 9 x 10 1/2	20
VS-35M	25	15	7	35	5 x 11 x 11	29
VS-50M	37	22	10	50	6 x 13 3/4 x 11	46
• Variable rack mount power supplies						
VRM-35M	25	15	7	35	5 1/4 x 19 x 12 1/2	38
VRM-50M	37	22	10	50	5 1/4 x 19 x 12 1/2	50

### RS-S SERIES



MODEL RS-12S

#### • Built in speaker

MODEL	Colors		Continuous Duty (Amps)	ICS* Amps	Size (IN) H x W x D	Shipping Wt. (lbs.)
	Gray	Black				
RS-7S	•	•	5	7	4 x 7 1/2 x 10 3/4	10
RS-10S	•	•	7.5	10	4 x 7 1/2 x 10 3/4	12
RS-12S	•	•	9	12	4 1/2 x 8 x 9	13
RS-20S	•	•	16	20	5 x 9 x 10 1/2	18
SL-11S	•	•	7	11	2 3/4 x 7 1/2 x 9 3/4	12



# The TW-1 Cheap Digital Front Panel

*Easy thumbwheel tuning for the Techno-Whizzy 1.*

by John Welch N9JZW

Way back in the December 1992 issue we built a Direct Digital Synthesis (DDS) HF CW Transmitter called the Techno-Whizzy 1. It was quite a nifty gizmo, but it had a few limitations. One of the most annoying was that the frequencies were hardwired in, using diodes for 11 "channels" with one "channel" being set, in binary, via dip switches. This limited you to only 12 different frequencies, with no easy way to go "up 10" if "your" frequency was in use.

Using diodes, however, did have one big advantage—it was cheap. Doing a real front panel with keypad input, LCD display, tuning knob, memories and so forth is a moderately expensive proposition. It will give you the most features, but it will cost about \$150.

While Victor Morin VE1ABC was solving this shortcoming one way (see his article, "Computer Control for your Direct Digital Synthesis VFO," *73 Amateur Radio Today*, February 1994), I was working at another solution.

What I wanted was something small, simple and portable. It should add little to the power consumption, but give me the freedom to change to whatever frequency I wanted without needing to carry a whole PC along.

Mix three parts frustration with one part inspiration and you get the TW-1 Cheap Dig-

ital Front Panel. It doesn't have all the bells and whistles that a real radio would have, but then again it doesn't cost an arm and a leg either. It's simple to build, uses parts that are readily available on the surplus market (cheap), and requires no adjustments. Just plug it in and it works!

The TW-1 Cheap Digital Front Panel uses thumbwheel switches as the display and input device. Using the most common scheme for a look-up table would not have worked well, due to the number of output bits (23) and the large number of address lines (26). This would have required several megabytes of EPROMs and a board about a foot square. Not good enough!

A massive brain-hiccup got me thinking—I could make it run to 21.50 MHz in 10 kHz steps using three 27C256s, since that was only 14 bits of address and 23 bits of data out. I could go from 0 to 9990 Hz in 10 Hz steps using 12 address bits, which meant another two 27C256s. By adding the outputs, I would get the correct frequency input to the TW-1 for a fraction of the cost! And so it was done.

## How It Works

By now, the power supply section should be pretty familiar stuff: +12 comes in J1, through diode D1 (to prevent damage in case

you plug the unit in backwards), past an anti-ripple cap (C1), through the three-terminal 5 volt regulator U1 and past another anti-noise anti-ripple filter cap (C2). Diode D2 is there as a safety feature—if you're driving an inductive load this prevents the power-off spike from blowing up the voltage regulator.

The frequency is selected on the thumbwheel switches, SW-1 through SW-7. SW-1 through SW-4 (a block marked U13 on the schematic) control the high-position EPROMs and SW-5 through SW-7 (U14) control the low-position EPROMs. This allows setting the frequency in 10 Hz steps from 0 to 21.5 MHz (the upper limit on the TW-1 VFO board).

The thumbwheel switches are connected to the address lines of the EPROMs, at the junction of the pull-up resistors and the EPROMs. On the EPROMs, the address lines are pulled to +5 volts by resistors (RP1 and RP2). The thumbwheel switches pull some of these lines to ground, based on the switch settings.

The EPROMs form a look-up table; the output of the EPROMs are the binary settings to the TW-1 VFO board needed to make it run on the frequency you've selected at the switches. There are five EPROMs, with each PROM giving a portion of the 23 data bits needed.

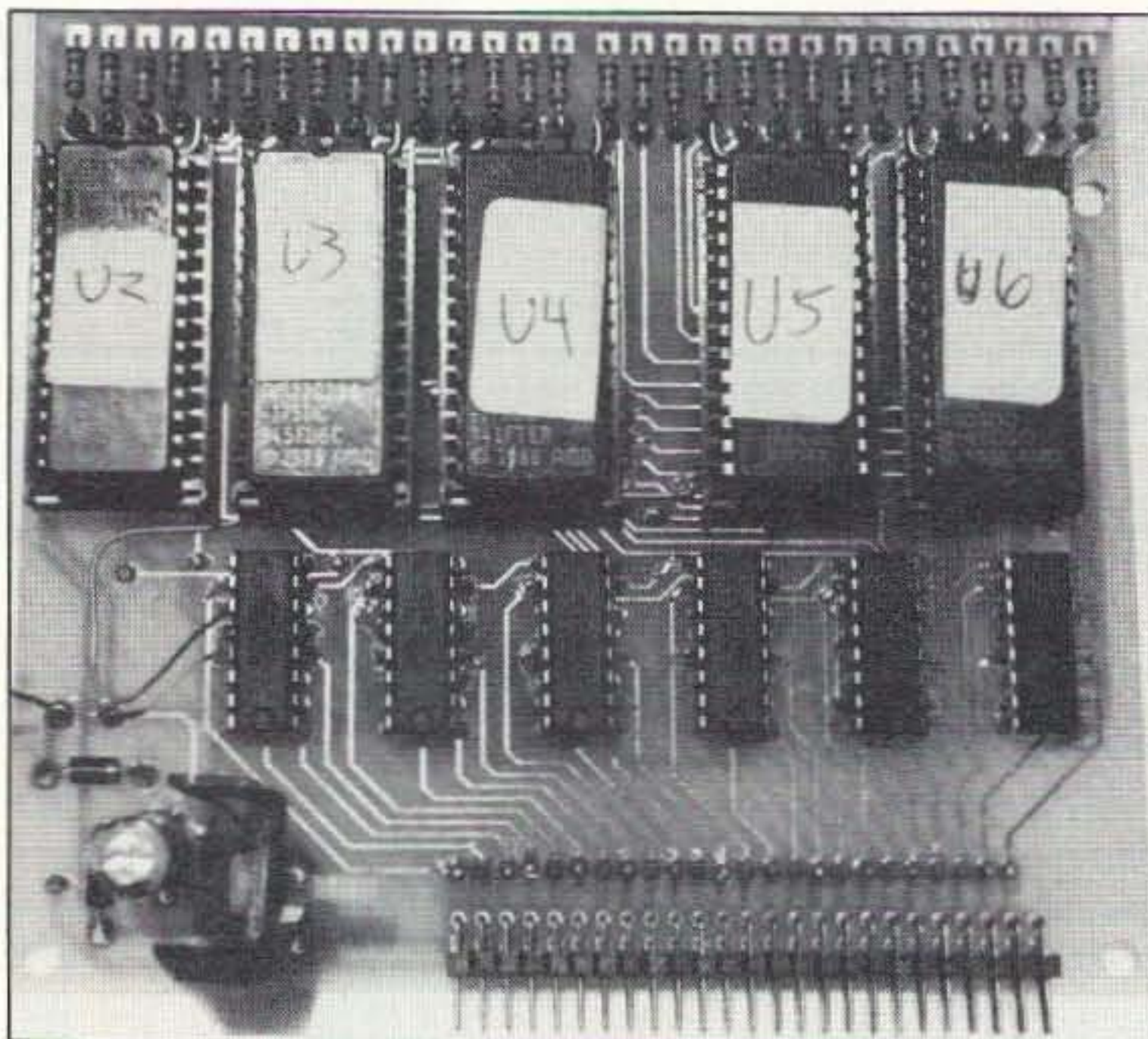

Photo A. The completed board.

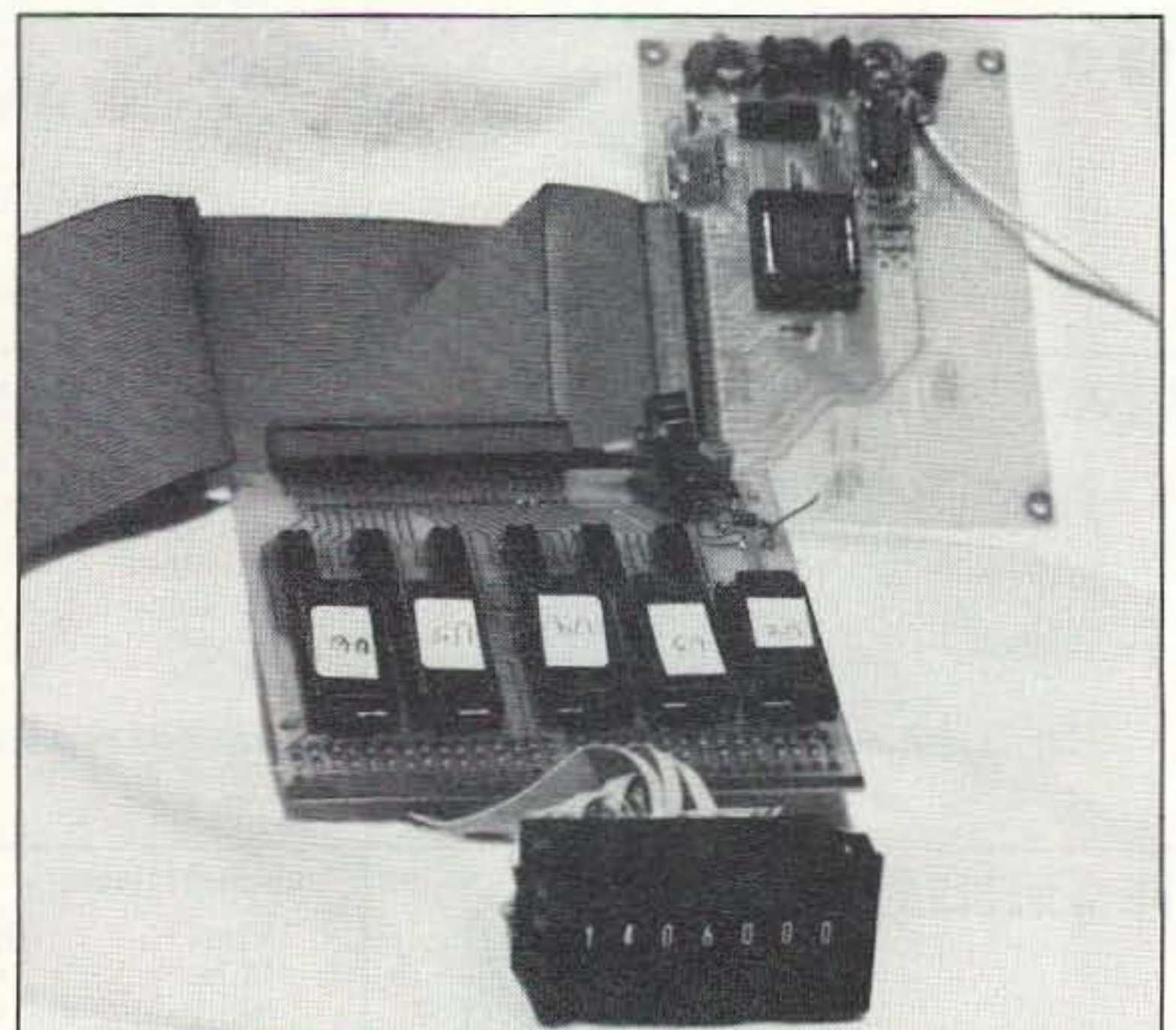
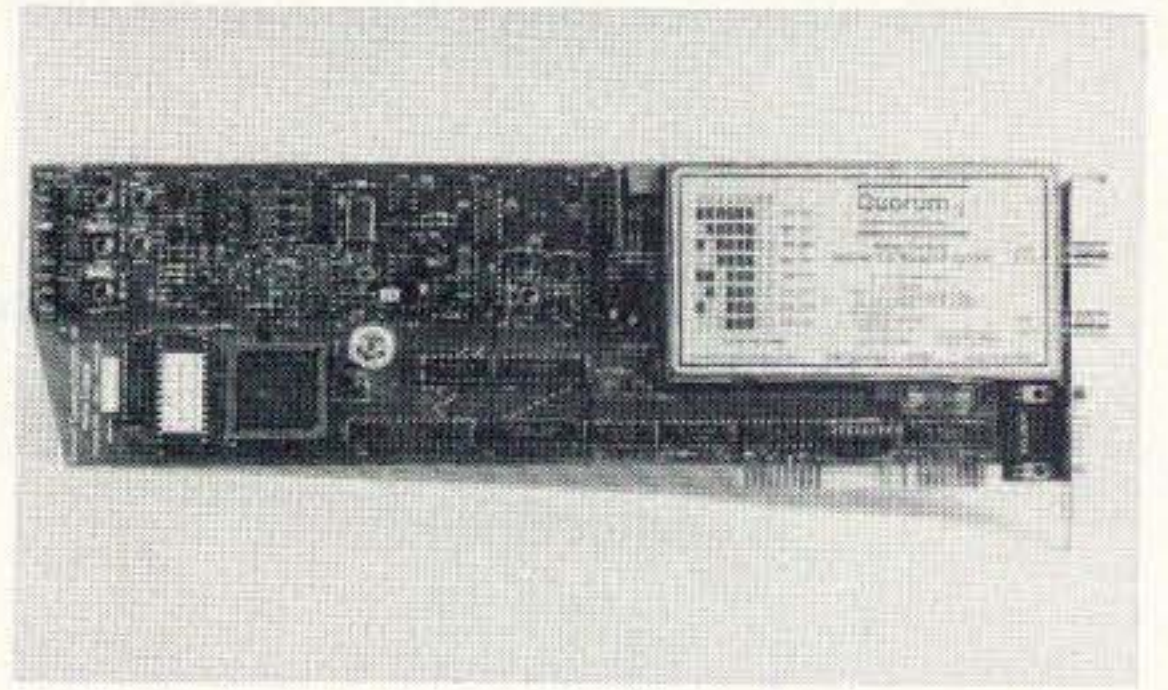
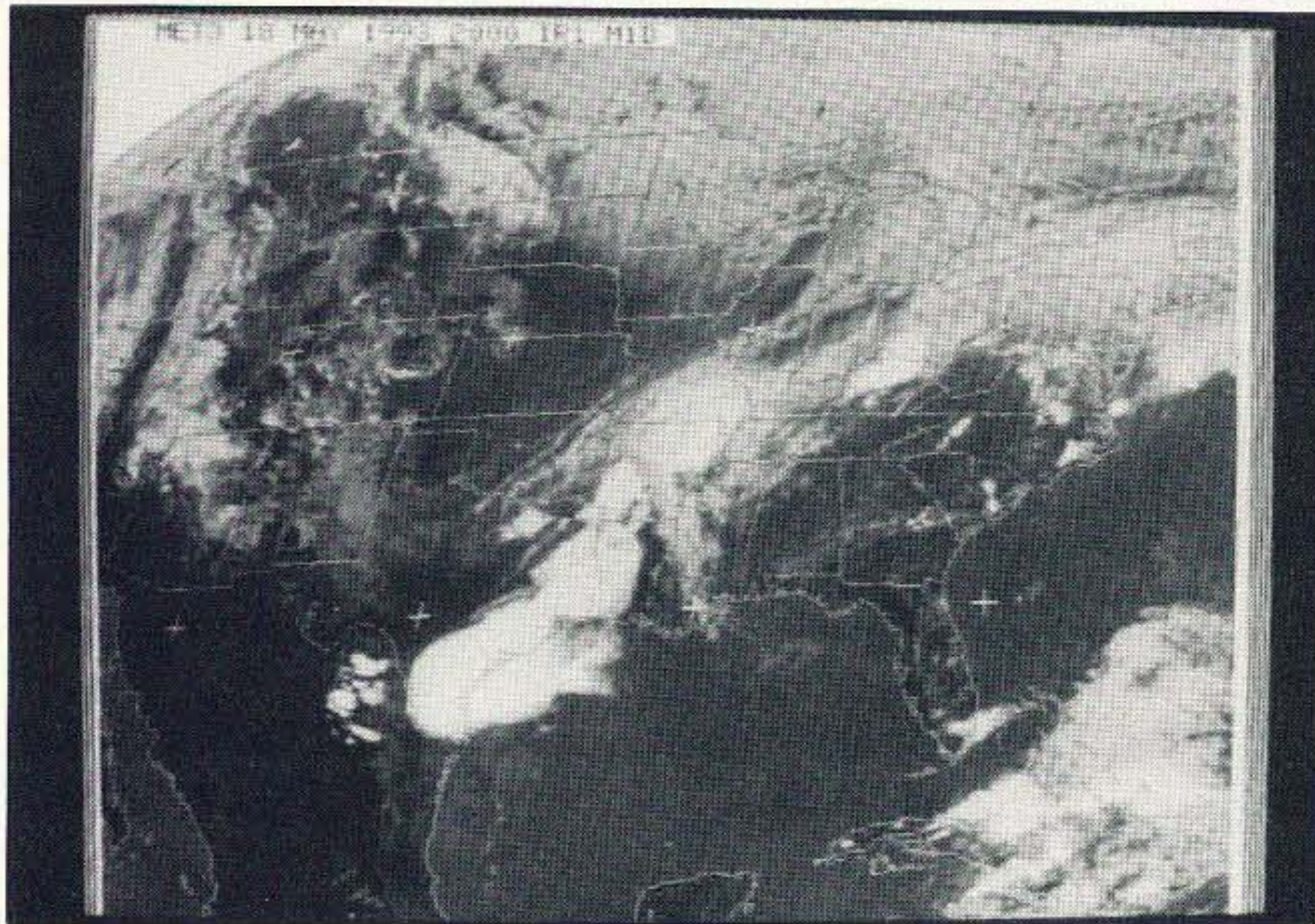

Photo B. The new board connected to the TW-1 DDS board.



# Explore The World of Quorum Wefax



## Wefax Explorer

Integrated Wefax / APT Receiver and Scan Converter with Qfax software.

**\$695.00** complete  
shipping and taxes not included

## The Best Price / Performance. Period!

Construct a Wefax / APT reception system from individual component receivers, scan converters and image processing software and you'll spend more money for fewer features, poorer performance, no automation and a jungle of wires. With the Wefax Explorer, simply connect an antenna and a few mouse clicks later you're receiving the highest quality images possible. The Explorer is backed by a 1 year limited warranty and the extensive experience of the leading Wefax hardware manufacturer. Quorum equipment is used by virtually all wefax suppliers in worldwide amateur, commercial and military systems.



## QFAX Features

- **GOES / Meteosat Wefax Reception**
- **NOAA / Meteor APT Reception**
- **HF Nafax Reception**
- **Dual RF ports for geosync and polar reception under software control**
- **Integrated preamp and down converter power inserters**
- **50 user definable configurations**
- **Software controlled receiver with 2 UHF, 10 VHF memories and scan**
- **On board audio amplifier and speaker with software controlled volume, squelch and mute**
- **Automatic Unattended Animation works continuously**

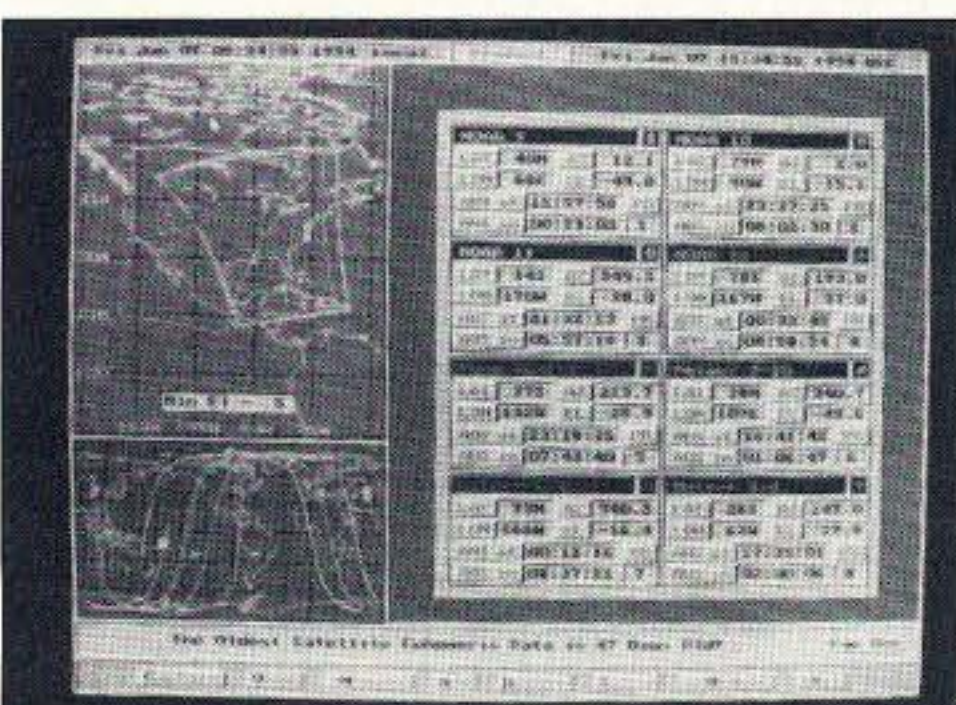

- **Integrated Satellite visibility prediction with automatic capture for up to 8 satellites simultaneously**
- **Automatic time and ephemeris stamping for navigation**
- **27 day programmable schedulers**
- **Automatic digital gain lock in ALL modes, PLL clocking**

- **8 bit data for up to 256 gray levels**
- **View at up to 1280 x 1024 256 color**
- **Use TIFF, GIF or PCX file formats and convert to BMP, JPEG, EPS and binary**
- **Contrast, Brightness, 3D effect, Sharpen, Smooth, Noise, Histograms and other image processing**

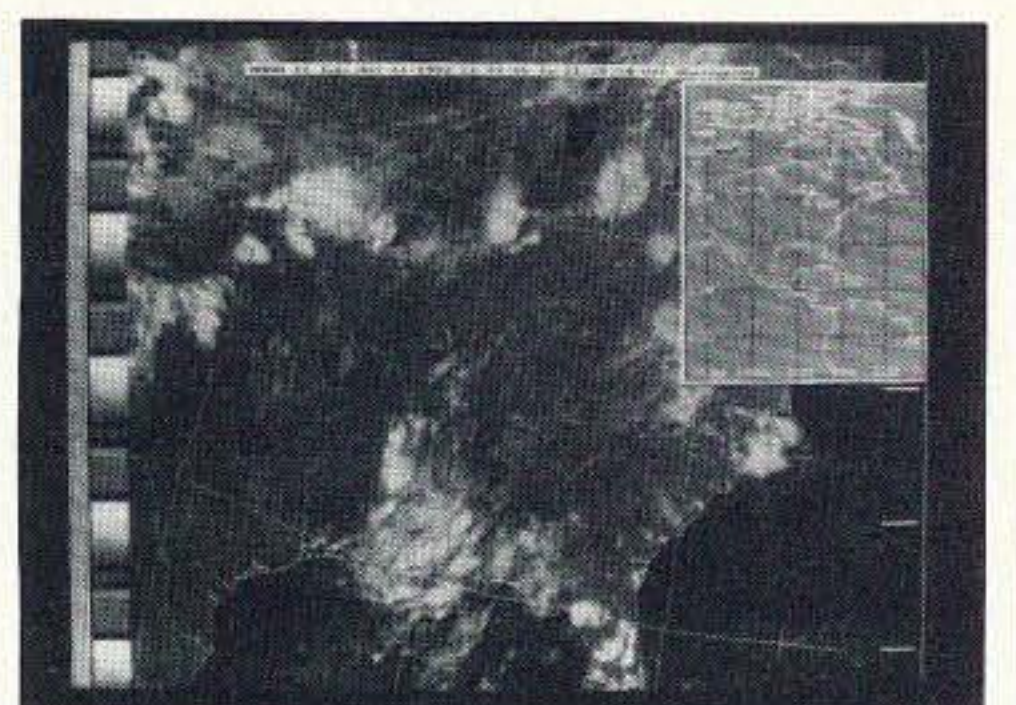

- **Ephemeris based NOAA APT navigation with geo-political and Lat-Lon overlays**
- **NOAA Tools show satellite path, Lat-Lon of cursor, distance and bearing to reference point**
- **Automatic Temperature Calibration**
- **Color Palettes and NOAA curves**

**Quorum Communications, Inc.** FAX (214) 915-0270  
8304 Esters Blvd. - Suite 850 - Irving, Texas 75063 (214) 915-0256 BBS (214) 915-0346







# Select any 5 books for only \$4.95

(Values up to \$114.75)

when you join the  
**Electronics Book Club®**

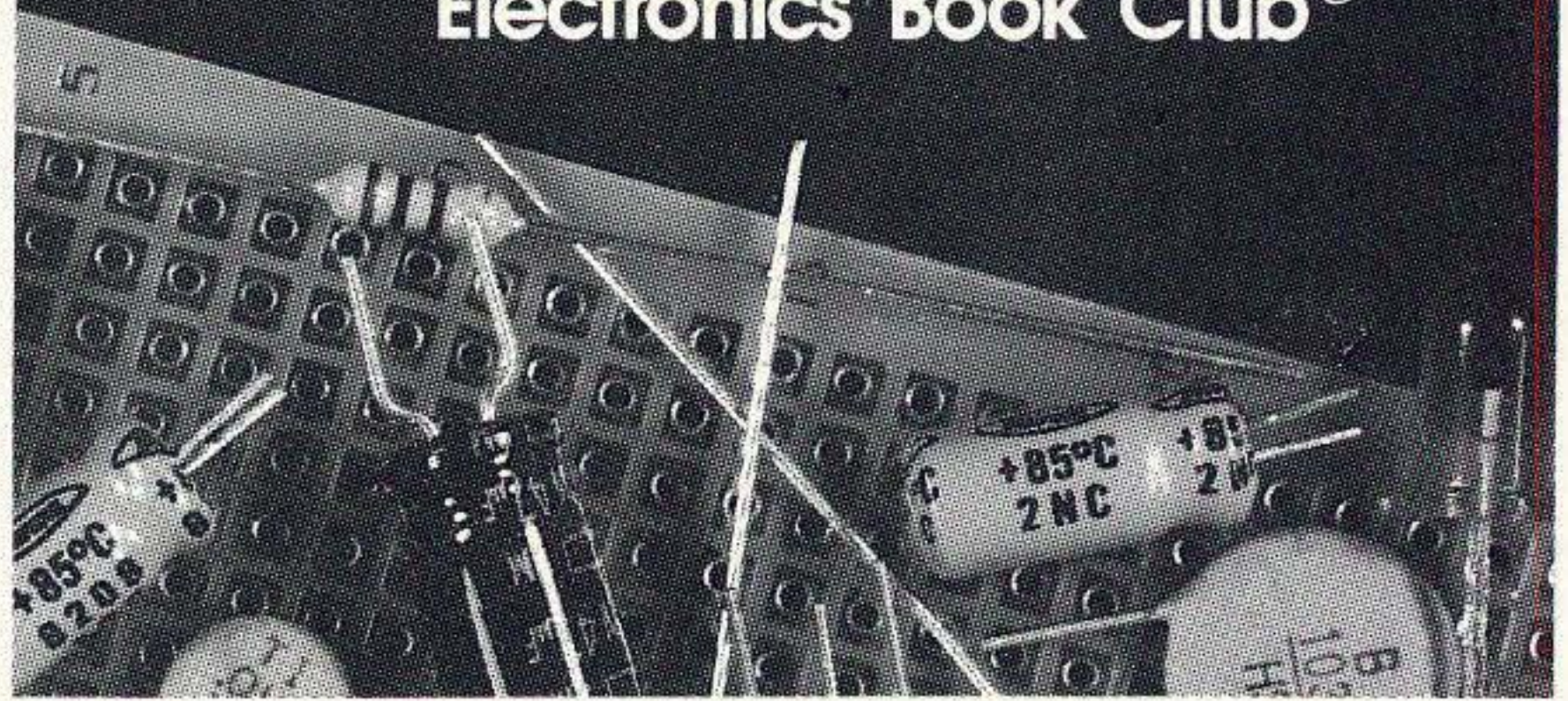

3887H \$26.95  
Hardcover

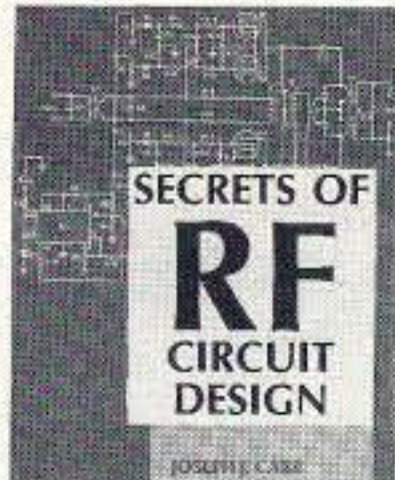

3710P \$19.95

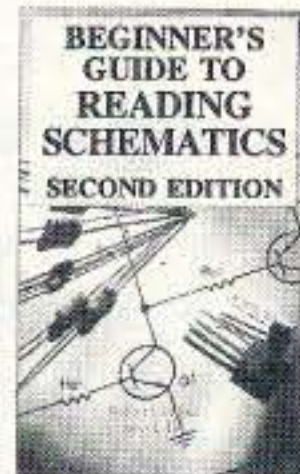

3632P \$10.95

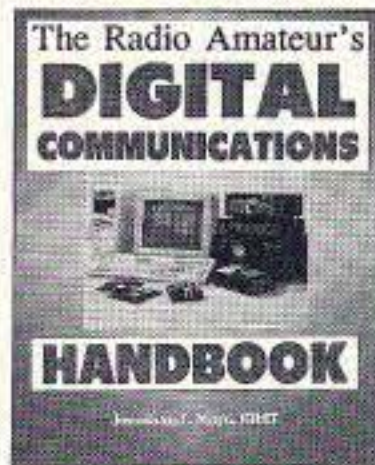

3362P \$14.95

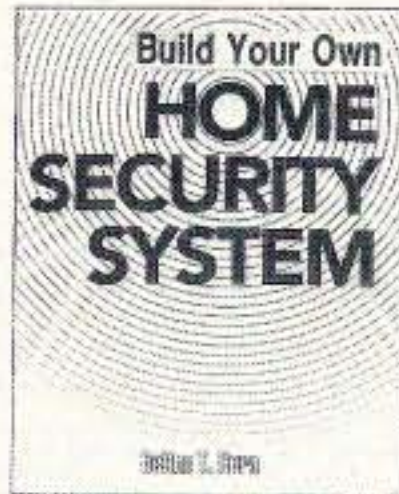

4139H \$27.95  
Hardcover

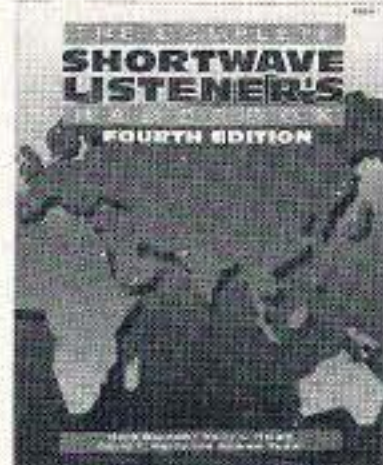

4354P \$19.95

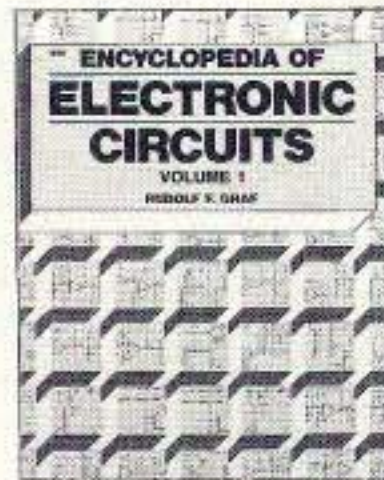

1938H-XXX \$60.00  
Counts as 3/Hardcover

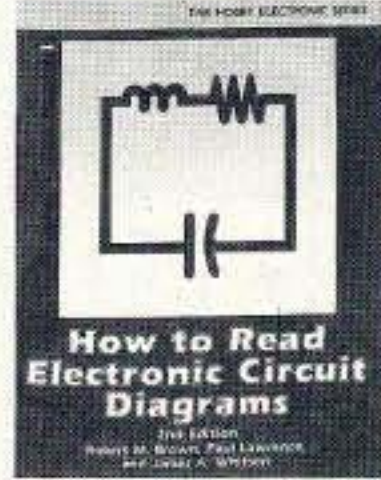

2880P \$15.95

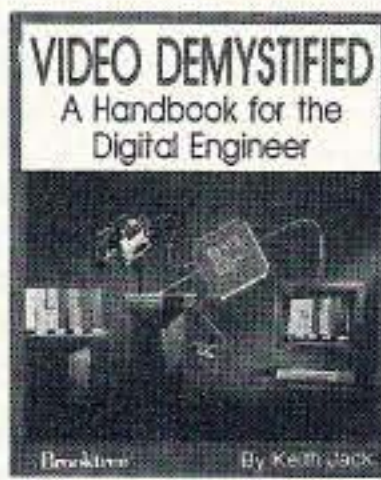

586446H-XX \$29.95  
Counts as 2/Hardcover



1604P \$17.95

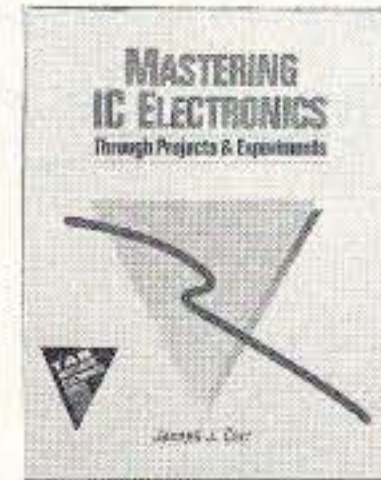

3660H-XX \$32.95  
Counts as 2/Hardcover

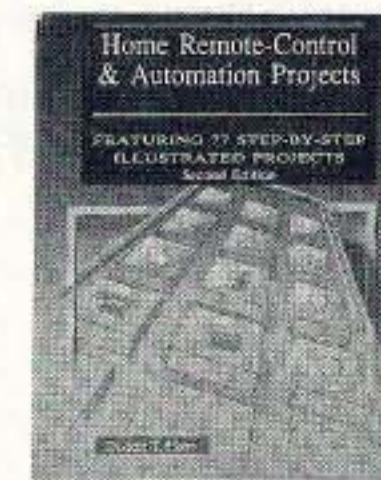

3765P \$19.95

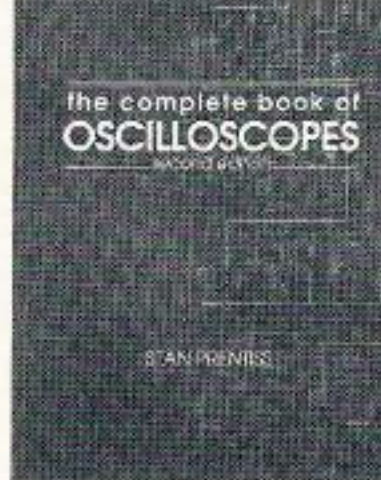

3825P \$17.95



4227P \$14.95

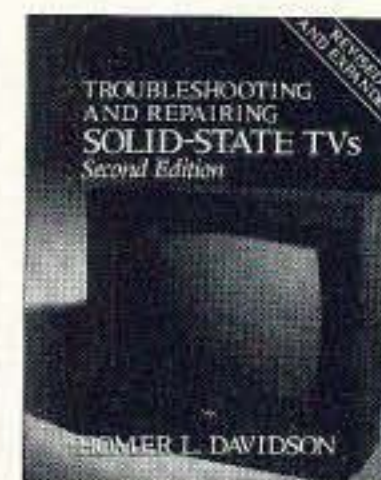

3700H-XX \$36.95  
Counts as 2/Hardcover

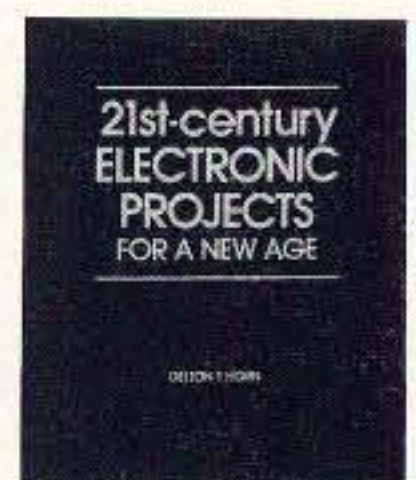

4111P \$16.95

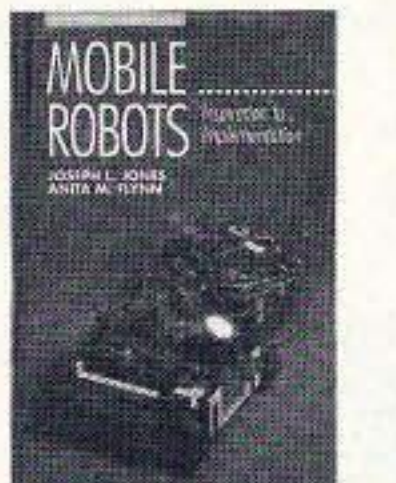

586445H-XX \$39.95  
Counts as 2/Hardcover

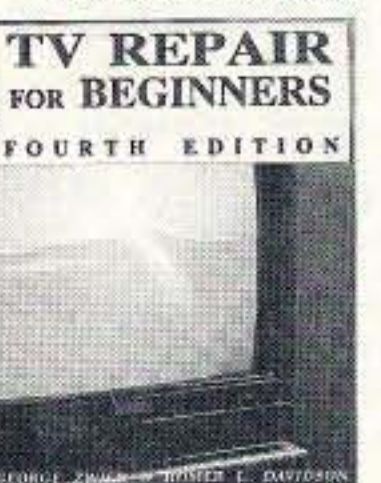

3627P \$19.95

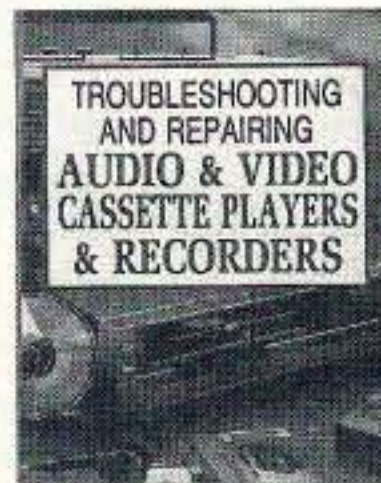

3795P \$19.95



4230H-XX \$39.95  
Counts as 2/Hardcover



3475P \$18.95

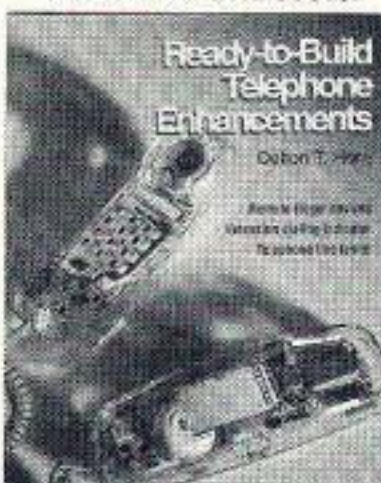

4362P \$16.95

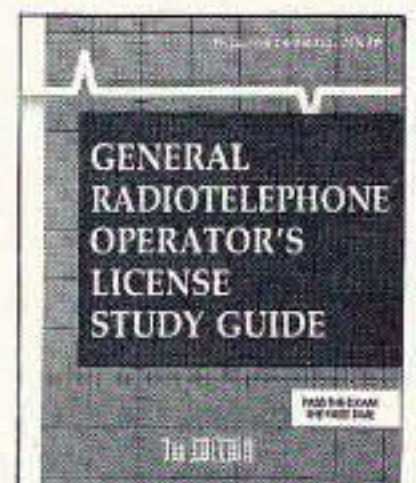

4075P \$17.95

If coupon is missing, write to: Electronics Book Club, Blue Ridge Summit, PA 17294-0810

## As a member of the Electronics Book Club . . .

. . . you'll enjoy receiving Club bulletins every 3-4 weeks containing exciting offers on the latest books in the field at savings of up to 50% off regular publishers' prices. If you want the Main Selection do nothing and it will be shipped automatically. If you want another book, or no book at all, simply return the reply form to us by the date specified. You'll always have at least 10 days to decide. And you'll be eligible for **FREE BOOKS** through our Bonus Book Program. Your only obligation is to purchase 3 more books during the next 12 months, after which you may cancel your membership at any time.

Publishers' prices shown. All books are softcover unless otherwise noted. If you select a book that counts as 2 choices, write the book number in one box and XX in the next. If you select a Counts as 3 choice, write the book number in one box and XXX in the next 2 boxes. A shipping/handling charge & sales tax will be added to all orders. ©1994 EBC

**Your most complete and comprehensive source for the finest electronics books.**

## Electronics Book Club®

Blue Ridge Summit, PA 17294-0810

**YES!** Please send me the books listed below, billing me for just \$4.95 plus shipping/handling & tax. Enroll me as a member of the **Electronics Book Club** according to the terms outlined in this ad. If not satisfied, I may return the books within 10 days without obligation and have my membership cancelled.

--	--	--	--

If you select a book that counts as 2 choices, write the book number in one box and XX in the next.  
If you select a Counts as 3 choice, write the book number in one box and XXX in the next 2 boxes.

Name \_\_\_\_\_

Address \_\_\_\_\_

City/State \_\_\_\_\_

Zip \_\_\_\_\_ Phone \_\_\_\_\_

Valid for new members only, subject to acceptance by EBC. Canada *must* remit in U.S. funds drawn on U.S. banks. Applicants outside the U.S. and Canada will receive special ordering instructions. All books are softcover unless otherwise noted. Publishers' prices shown. A shipping/handling charge & sales tax will be added to all orders. STAR394



There are two banks of EPROMS, one for the MHz and high kHz digits (U2-U4) and one for the low kHz through 10 Hz (U5 and U6). The output of each bank is added together by U7 through U12, six 4-bit adders with carry. The resulting 23-bit value gets connected to the input of the Q2220 DDS chip via the 50-pin header (J1) and ribbon cable.

The whole frequency selection stage is static (that means it uses no clock signals, it's just DC voltages). Changing frequency is as easy as flipping the switch. There is some propagation delay through the Q2220 chip, but it takes so little time (110 nanoseconds) that it's effectively instantaneous. There's little or no drift using the Epson oscillator, so you'll be right on frequency from the moment you turn the TW-1 on.

### The Program

For those of you with an EPROM burner and Borland C 2.0 or later, I've included the source code for the program to build the EPROM tables. For those without these, I've also included the 5 EPROM files. U2 through U6. These are available on the *73 Magazine* BBS at (603) 924-9343, 300 through 2400 baud, 8 bits, no parity. There is a source for kits for this project at the end of the article. And that leads us to . . .

### How to Build It

I would *strongly* suggest buying the circuit board for this, unless you can make your own plated-through holes. There are quite a few connections from the top to the bottom (called "vias"). Also, there are traces that connect under the adder chips. These make life very difficult if the connections are not plated through. You *can* do it (I did. Once. Never again!) but doing so takes a *lot* of patience and time for debugging. Be forewarned!

Build the power supply first. Install U1, the 5 volt regulator. Make sure it matches the outline on the silk-screen. Also, U1 will get hot so put a TO220-type heat sink on it.

Install the two protection diodes, D1 and D2, making sure the banded end points the same way as the silk-screen. Install the filter caps, C1 and C2, next. Finally, install the wires that will lead to your 12 volt supply at J2.

Temporarily solder a 10k resistor in parallel with C2 (from +5 to ground) and apply power. Across the resistor you should read 5 volts DC (plus or minus about 0.2 volts is fine). If you get nothing (0 volts), check D1 for correct polarity. The cathode (banded end) goes towards the voltage regulator. If you get 12 volts, check D2 for correct positioning. If that's correct, you may have a bad regulator (or it may be installed backwards). Correct any problems here before continuing.

Remove that 10k resistor and proceed by soldering in the 50-pin cable connector J1. Solder in the adder chips, U7 through U12. Either 27HC283 or 27LS283 chips will work, but the HC parts consume slightly less power.

Attach the ground jumpers, following the

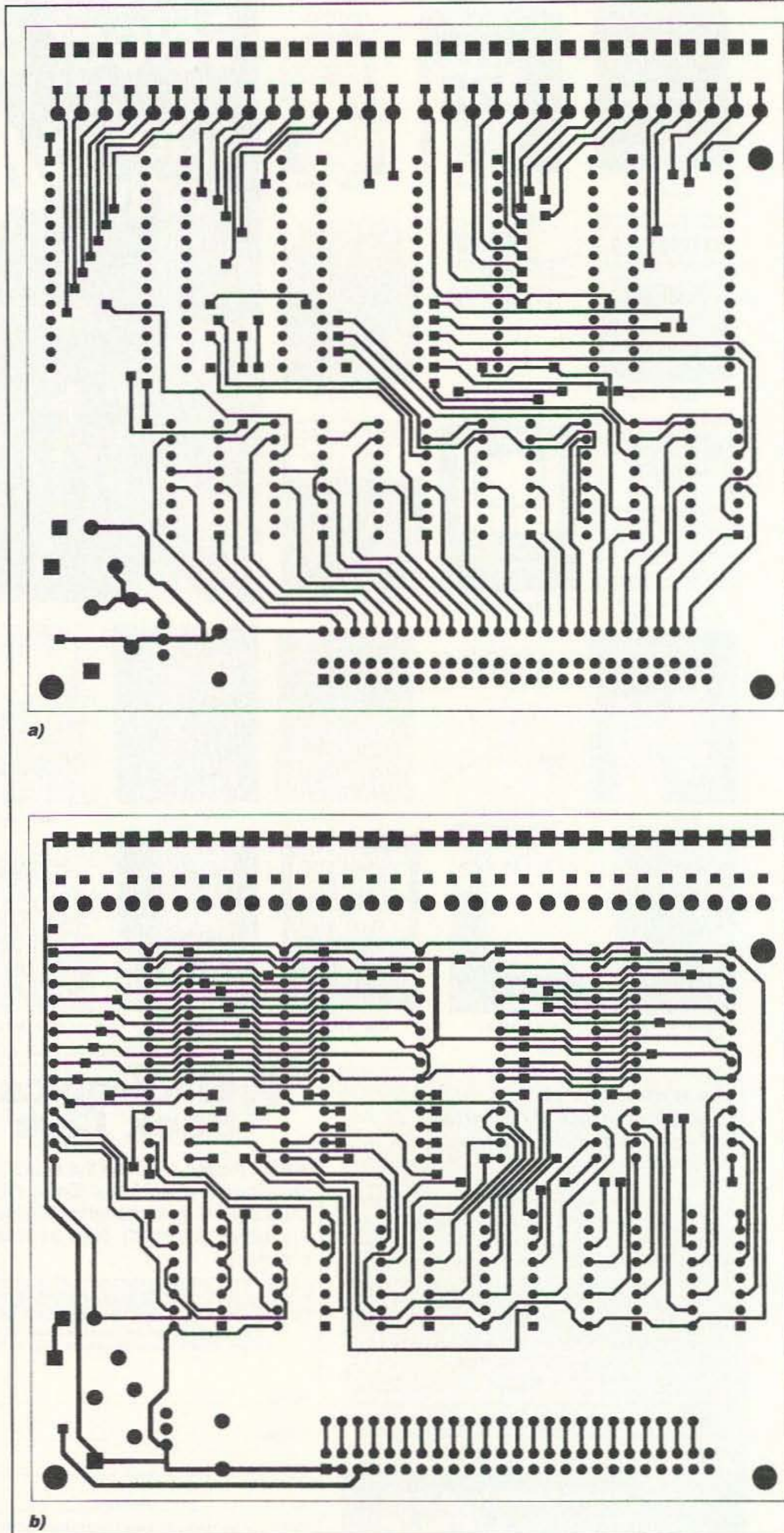

Figure 2. PCB artwork: a) Top; b) Bottom as seen from top;







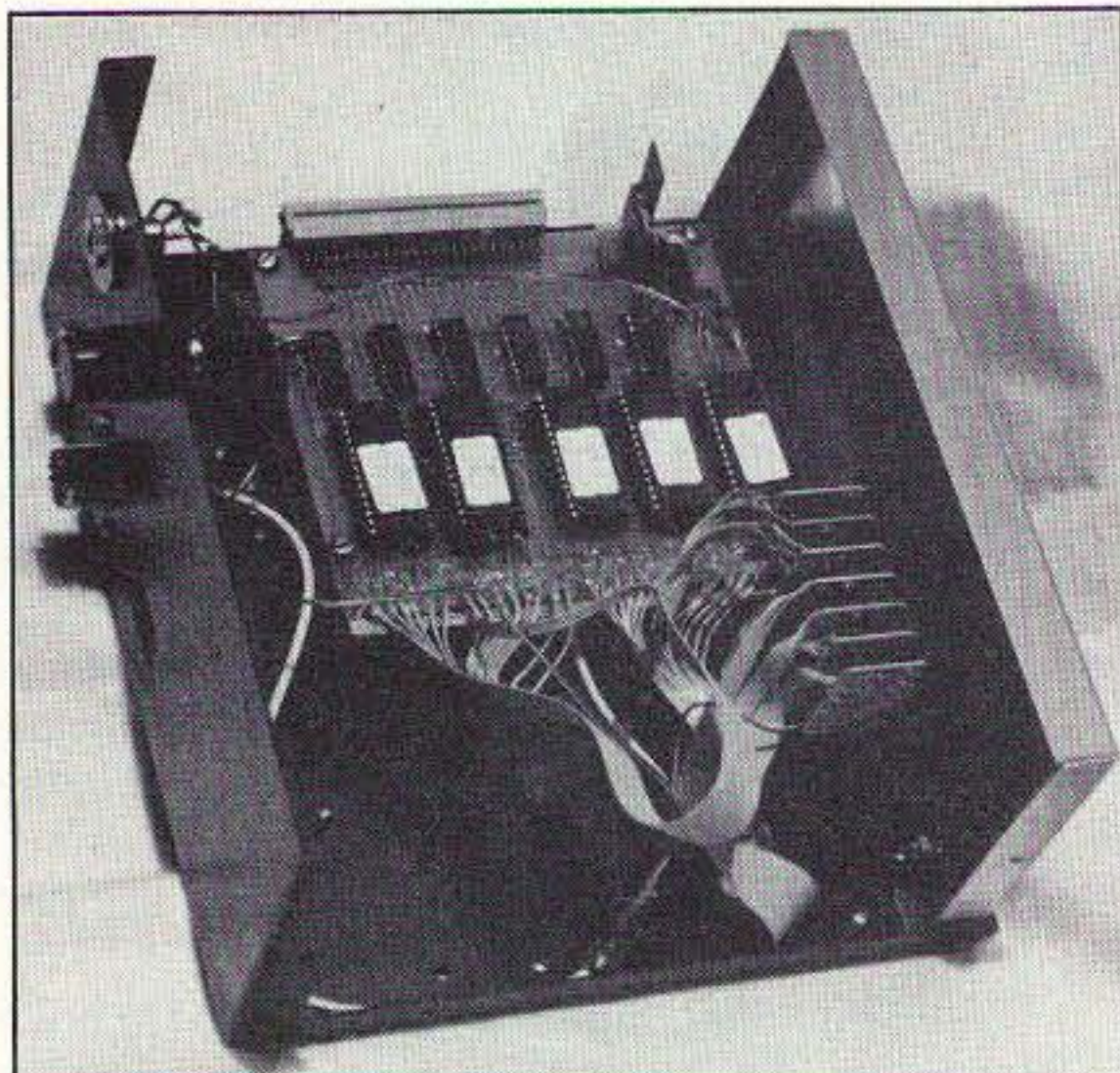

Photo C. The new TW-1 in a nice enclosure.

have mis-wired the switch or you may possibly have a short on the circuit board.

Now, set the switches to 1431300, and check the voltages again. You should have (from left to right on J2) 100001010011110110110100, where 1 indicates 5 volts and 0 indicates 0 volts. If not, trace the signal back as above.

If you've gotten this far, the board seems to be functional. We can give it the final test now. Remove power and attach it to the TW-1 DDS board by plugging the 50-pin cable to the 50-pin connectors on each board. Note: You shouldn't have the diode board hooked up at the same time.

Hook the thumbwheel board back up to 12 volts and hook a frequency counter to the output of the DDS board. As you change the switches, the DDS output should also change to your new setting. If it doesn't change to the frequency you've got set, check the wiring on the switches (Did you hook a 4 up to a 1 by accident, like I did?).

When it does track correctly, you're all done with the electronics. Take some time to glop a little RTV or silicon bathtub caulk over the resistors and ribbon cable connections. This helps keep those connections from breaking while you install it.

Put it back in your TW1 case, attach the



Photo D. The TW-1 DDS board surrounded by the new TW-1 and the original TW-1.

amplifier and start calling CQ. You've got a stable digital wideband VFO, and you're on your way to having a complete, state-of-the-art DDS transceiver.

#### About the TW-1

The TW-1 is a modular Direct Digitally Synthesized radio. So far, the rig consists of the DDS VFO board that will cover from 3.2 Hz to 21.5 MHz in 3.2 Hz steps, the Class A amplifier board (with additional optional filtering), and three different frequency selection boards, the Thumbwheel Switch board described above, a computer-controlled parallel interface and a cheap, less functional diode matrix board. Feel free to design your own board for it (I'm still looking for a good receiver and a better amplifier . . . hint . . .).

Kits for these boards are available from Elktronics at 12536 T.R.77, Findlay OH 45840, telephone (419) 422-8206, for \$79

ppd. Circuit boards for the above are available from FAR Circuits, 18N640 Field Ct., Dundee IL 60118 for \$20 plus \$1.50 shipping and handling. Programmed EPROMS are available in small quantities from the author.

Future boards will include a receiver and bandpass filter, an improved amplifier, an up-mixer to complete the HF coverage, and an SSB generator. Others planned include a fully digital front panel, a tracking signal generator, 6m and 2m transverters, and perhaps a different DDS board.

For more information, or if you've designed a board you'd like to tie into the TW-1, write to me at either of the following addresses:

jjw@seastar.org  
or  
John Welch  
1307 N. Richmond Rd. Apt H  
McHenry IL 60050  
USA

Parts List			
Item	Quantity	Reference	Part
1	1	C1	1 $\mu$ F 16V electrolytic
2	1	C2	0.1 $\mu$ F ceramic
3	2	D1,D2	1N4001
4	1	J1	Header 25X2
5	1	J2	12 volts in
6	30	RP1,RP2	20k 1/8 watt (10k-20k OK)
7	1	U1	LM7805
8	5	U2,U3,U4,U5,U6	27C256
9	6	U7,U8,U9,U10,U11,U12	74LS283 or 74HC283
10	7	U13,U14	BCD true out thumbwheel switches

## ▼ ELECTROMAGNETIC FIELD METER ▼

Reduce exposure to potentially harmful electromagnetic fields. AlphaLab's handheld TriField™ Meter measures AC electric fields, AC magnetic fields and radio/microwave power density. Find ground faults, AC current wires or measure high-field generators with the **Magnetic** setting (.2 - 100 milligauss, 60 Hz); identify poorly grounded or shielded equipment, high VDT or fluorescent light fields, distinguish hot vs. ground wires with **Electric** setting (.5 - 100 kV/m, 60 Hz); measure antenna radiation patterns, leaky microwave ovens, etc. on **RF/microwave** setting (50 MHz to 3 GHz, .01 to 1 mW/cm<sup>2</sup>).

Electric and magnetic settings are omnidirectional, measuring full magnitude of fields without the need to reorient the meter. Price of \$145 includes delivery and one-year warranty.

AlphaLab, 1272 Alameda Ave, Salt Lake City, UT 84102  
Call (801) 532-6604 for speedier service or free literature on electromagnetic radiation health risks.

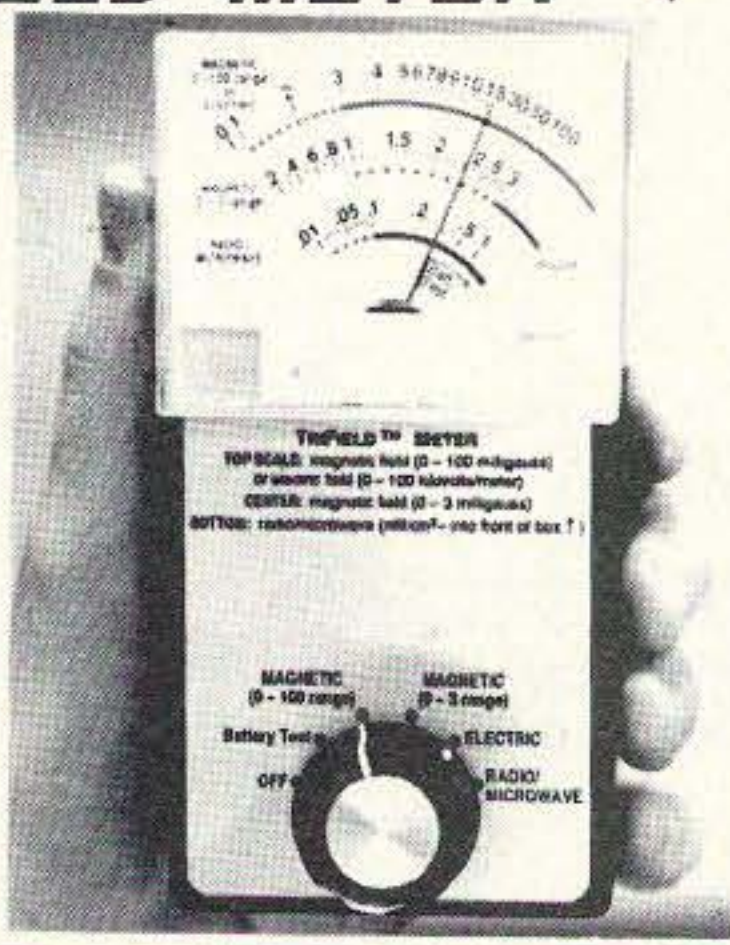

### WEATHER FAX

Satellite & HF FAX for IBM / Clones

**New!**

**New!**

Features: Receives WEFAX, VIS & IR NOAA, METEOR, APT, 240 LPM, 120 LPM and HF WEFAX. Connects to Computer Line Printer Port. The software was created by Dr. Ralph E. Taggart, WB8DQT. For details see chapter 5, Fifth Edition of the Weather Satellite Handbook.

Complete Kit Only . . . . . \$ 159.95  
Assembled & Tested . . . . . \$ 189.95  
Optional 20 LED Tuning Aid . . . add \$ 40.00  
*CA Residents add 7.75% sales tax. S&H: \$6.50 (insured)  
Foreign orders add 20%. For catalog send legal size SASE (52¢) to:*

## A&A Engineering

2521 W. LaPalma # K • Anaheim, CA 92801 • 714-952-2114



# DAYTON hamvention® '94

April 29, 30 & May 1, 1994

General Chairman, Dave Grubb, KC8CF

Asst. General Chairman, Ken Allen, KB8KE

**\* Giant 3 day Flea Market      \* Exhibits      \* Activities for the Non-Ham**

### Information

General Information: (513) 276-6930  
or, write to  
Hamvention, Box 964, Dayton, OH 45401-0964  
Lodging Information: (513) 223-2612  
(No Reservations by Phone)  
Flea Market Information: (513) 276-6932

### Lodging

Please write to **Lodging, Dayton Hamvention, Chamber Plaza, 5th & Main Streets, Dayton, OH 45402-2400** or refer to our 1993 Hamvention program for a listing of hotel/motels in the Dayton area.

### Special Awards

Nominations are requested for Amateur of the Year, Special Achievement and Technical Excellence awards. Refer to the Hamvention Program for nomination form or contact Hamvention Awards Chairman, Box 964 Dayton, OH 45401-0964.

### 1994 Deadlines

Award Nominations: March 1  
Advance Registration and Banquet  
USA - April 8    Canada - April 1  
Flea Market Space: February 1

### Flea Market

Flea Market Tickets (valid all 3 days) will be sold IN ADVANCE ONLY. No spaces sold at gate. A maximum of 3 spaces per person (non-transferable). Electricity is available in a portion of the last Flea Market row for \$40 additional per space. Rental tables and chairs are not available in the Flea Market. Vendors **MUST** order an admission ticket when ordering Flea Market spaces. Please send a separate check for Flea Market space(s) and admission ticket(s). Spaces will be allocated by the Hamvention committee from all orders received by February 1. Please use 1st class mail *only*.

Notification of Flea Market space assignment will be mailed by March 15, 1994. Checks will not be deposited until after the selection process is complete.

### License Exams

Novice thru Extra exams scheduled Saturday and Sunday only. Send FCC form 610 (Aug 1985 or later) - with requested elements shown at top of form, copy of present license and check for prevailing rates (payable to ARRL/VEC) to Exam Registration, 708 Mapleside Dr. Trotwood, OH 45426

### Free bus service

Free bus service will be provided between Hamvention and our satellite parking areas. In addition, some motels may offer transportation to Hamvention.

**HAMVENTION is sponsored by the Dayton Amateur Radio Association Inc.**

## Advance Registration

Enclose check or money order for amount indicated in U.S. dollars and type or print your name and address clearly.

### Make checks payable to:

Dayton HAMVENTION Mail to -  
Dayton Hamvention Box 1446, Dayton, OH 45401-1446

**Flea Market tickets**    *Please enclose two checks*  
 Send admission tickets **only** if flea market space(s) assigned.  
 Send admission tickets **regardless** of flea market space assignment.

	<i>How Many</i>	
Admission (valid all 3 days)	_____ @ \$11.00*	\$ _____
Grand Banquet	_____ @ \$22.00**	\$ _____
Alt. Act. Luncheon (Saturday)	_____ @ \$8.50	\$ _____
(Sunday)	_____ @ \$8.00	\$ _____
Flea Market ‡ (Max.3 spaces)	_____ \$30/1 space _____ \$60/2 adjacent _____ \$150/3 adjacent	\$ _____
Electricity add	_____ \$40.00/space	\$ _____
Covered tent	_____ \$215.00 ea.	\$ _____
<b>Total</b>		<b>\$ _____</b>

Name \_\_\_\_\_ Call \_\_\_\_\_

Address \_\_\_\_\_

City \_\_\_\_\_ State \_\_\_\_\_ Zip+4 \_\_\_\_\_ - \_\_\_\_\_

Daytime Phone # ( ) \_\_\_\_\_ Evening Phone # ( ) \_\_\_\_\_

\* \$14.00 at door  
\*\* \$24.00 at door, if available  
‡ Admission ticket must be ordered with flea market tickets



by Jim Hovanik N3KHM

Connect Systems, Inc.

2259 Portola Rd.

Ventura CA 93003

Telephone: (800) 545-1349

Price Class: \$349 (suggested list)

# The CS-800

*Connect System Inc.'s Full Duplex Interconnect.*

The CS-800 Full Duplex Interconnect is both a phone patch and a repeater controller/maker. When connected to a repeater, it can perform the basic repeater control functions and/or phone patch functions. When connected to a dual-band radio, it has the ability to make the dual-band radio a "legal" one-way crossband repeater and/or allow for phone patch functions. It is not designed for simplex operation.

The CS-800 provides all of the required controls for repeater operation. You set the CW identification, the identification time interval, the hang time, the time-out timer, and the courtesy beep CW character. The repeater can be turned on or off remotely via DTMF tones.

The CS-800 also provides a slew of phone patch functions and options. The unit is capable of tone or pulse dialing. There are nine programmable speed-dial memories. The phone patch can be operated either full-duplex or semi-duplex. When in the semi-duplex mode, the mobile side of the conversation is not transmitted. Instead, beeps are sent over the air while the mobile is transmitting. This allows for a little privacy. You also set the activity timer, the time-out timer, and the identification options. It is possible to block the dialing of numbers over 10 digits in length. This prohibits dialing numbers out of the local area code. Four prefix restrictions are also available. Restrictions can be any number or combinations of numbers, such as 1, 0, 976, etc. Two access codes for the phone patch are available. One of the access codes can be set to override the toll and prefix dialing re-

strictions. Manual dialing can be disabled. With manual dialing disabled, dialing is limited to those numbers stored in the nine speed-dial memories.

An optional plug-in relay is available. It can be activated remotely and can be configured as either a normally open or normally closed switch. Some radios need this relay to key the transmitter.

## Installation

The manual does a good job of explaining the installation, setup, and programming instructions. You must have some technical skill and ability to install this unit. *[Editor's Note: See the factory postscript at the end of this review for more information.]*

The Audio-In must be connected to either the discriminator output or the high side of the receiver's volume control.

A COS (Carrier Operated Squelch) input is required. It must be connected to a point that has a voltage swing when a signal is received. You may choose to use your radio's CTCSS decode ability; just connect the COS to the logical output that goes either high or low when the properly encoded signal is received.

The Audio-Out will connect to the mike-high line.

The PTT connects to the transmitter's PTT line. It sends the PTT line to ground through a transistor. If your transmitter is keyed differently, the optional auxiliary relay will furnish a relay closure to key your transmitter.

The power requirement of the CS-800 is 12 volts at 300 mA. It is reverse polarity pro-

tected and has a low voltage sensor that will shut the unit off if the voltage drops too low. This protects the EEPROM's programming.

There are level adjustment pots for the mobile-to-land level, land-to-mobile level, DTMF level, status tones levels, CW ID levels, COS threshold level, and repeater audio. There is also a hybrid alignment procedure that lessens the feedback when using the full-duplex phone patch with a full-duplex rig. The instructions are clear and easy to follow.

Inside the cover is a keypad and a two-digit LED display. They are used to program the unit. The manual's programming instructions are easy to follow, and when you are done, the program is saved in the EEPROM. The LED display also shows the DTMF tones as they are received and decoded.

## The Law

Although the CS-800 was made primarily for commercial use, it can be put to good use in the amateur service. There are features in this unit that, if used or used improperly, would be illegal on the amateur bands. It is your responsibility to see that the specific application and use is legal.

Many of the newer dual-band rigs offer crossband repeater operation. However, without a three-minute timer, or automatic station identification every 10 minutes, the legality of using these rigs as repeaters has been questioned. The CS-800 will allow you to operate a legal one-way crossband repeater by providing for all the required automatic controls. There is also a question as to whether a dual-band 2 meter/440 radio used for phone





patching is an auxiliary station. If it is an auxiliary station, you must transmit to it on the specific frequencies allowed by Part 97 of the FCC rules.

If you are setting up a repeater operation, consider setting up your frequencies with the local repeater coordinator.

### User Observations

My CS-800 is connected to an Alinco DR-570T 2 meter/440 dual-band radio. The Audio-In is connected to the high side of the volume control. The COS is connected to the CTCSS decode board. A home-brewed rotary switch box allows the radio's mike input and PTT to be connected to either the CS-800, a TNC, or the hand mike.

Whenever I am done using the DR-570T on packet or for a QSO, I set the two VFOs and the rotary switch to the preset phone patch settings. Then I just have to remember to turn on the system before I leave the house.

The hybrid circuitry does a good job of reducing feedback when working a full-duplex phone patch using a full-duplex mobile. Most people say that it sounds like I am on a cordless phone. Working the patch with a dual-band handie-talkie is a little tricky because of feedback. If you can turn off the HT's full-duplex mode, the feedback will be eliminated and it will operate as if you were using a repeater phone patch. You can also use an earphone with the HT and retain the full-duplex convenience.

I have used the repeater function with my dual-band radios. As expected, it performs well, but feedback is a problem. The only way to eliminate the feedback is to turn off the radio's full-duplex feature or to use an earphone. The repeater option can be used to uplink to a distant repeater that you can hear, but not reach with an HT. Keep in mind that mobile radios are not made to be repeaters. They will burn out if run at full power for long periods.

### Conclusions

My CS-800 has been in use for two years and has not had a single problem. I purchased it so that I didn't have to use the local repeater for phone patches when I was near my home. I wanted the insurance of having a second patch available both for personal emergencies and for when I'm involved in local emergency management. Using your own phone patch gives you a little more privacy than using the local repeater, and working full-duplex is so much better than semi-duplex that most people on the other end don't even realize you are on a phone patch unless you tell them. From my town there is only one repeater with autopatch capabilities that can be accessed with an HT. Boy was I glad I had the CS-800 when that system went off the air for a year and a half while it changed locations!

While the CS-800 has served me well at emergencies, most of my phone patches are to other hams for short QSOs.

[Factory Postscript: Sometime after the au-

thor purchased his unit, instructions were added to give the user a choice of connecting the CS-800 internally or externally. The author has described the internal connection method. When the external connection method is used, the only connections made to your dual-band radio are to the mike and speaker jacks, which can be accomplished

with minimal technical skill. When connected externally, the CS-800 operates correctly as a Full Duplex Interconnect, but the repeater controller mode will not operate. Most amateur installations use the external connection method for ease of installation and because the repeater controller is not used in most installations.]

**TNT** All Band Field Day Antenna

No pruning, TNT is No-tune on 80 cw, 40, 20, 17, 12, 10. TNT/2 is No-tune on 40, 20, 10. Work other bands w/ tuner. DX & Gain rise w/ frequency. Ready to Use. Includes isolation balun & 99 ft RG8x. The modern coax-fed version of the classic off-center fed antenna. Technote 120—56.95 ppd.

No tuning, Kink-proof Wx-Sealed Low Noise

No knobs to twist. TNT/2 is No-tune on 40, 20, 10. Gain rise w/ frequency. No Traps or Resistors. Insulated to 3000 V. Rated 500 Watts

**Antennas West**  
Box 50062S, Provo, UT 84605

**TNT** \$89.95 + \$8 P&H  
135 ft. long

**TNT/2** \$79.95 + \$7 P&H  
67 ft. long

Order Hotline 801-373-8425

CIRCLE 135 ON READER SERVICE CARD

**IT MAY BE WINTER IN MONTANA BUT OUR PRICES ARE SIZZLING!!**

### Wolfe Communications

1113 Central Ave  
Billings, MT 59102  
406-252-9220 FAX: 406-252-9617  
Call or write for our current flyer  
**BUY — SELL — TRADE**

CIRCLE 20 ON READER SERVICE CARD

## 24 HOUR SHIPPING ELENCO • HITACHI • B&K PRODUCTS GUARANTEED LOWEST PRICES

TO ORDER CALL TOLL FREE 1-800-292-7711 1-800-445-3201 (Can.)

**AFFORDABLE - HIGH QUALITY 2 YEAR WARRANTY**

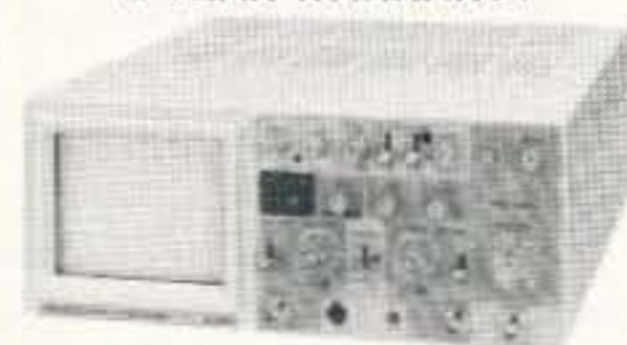

**STANDARD SERIES**  
S-1325 25MHz \$349  
S-1340 40MHz \$495  
S-1365 60MHz \$849

- Features:
- High Luminance 6" CRT
  - 1mV Sensitivity
  - X-Y Operation
  - Voltage, Time, + Frequency differences displayed on CRT thru the use of cursors (S-1365 only)
  - Plus much, much more
  - TV Sync
  - 2 - x1, x10 Probes
  - Complete Schematic

**ELENCO OSCILLOSCOPES**

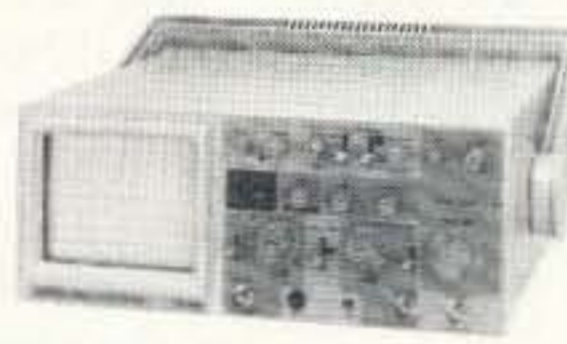

**DELUXE SERIES**  
S-1330 25MHz \$449  
S-1345 40MHz \$575  
S-1360 60MHz \$775

- Features:
- Delayed Sweep
  - Automatic Beam Finder
  - Z Axis Modulation
  - Built-in Component Test
  - Plus all the features of the "affordable" series
  - Dual time base
  - Illuminated internal grid/trace

**Hitachi Compact Series Scopes**

V-212 - 20MHz Dual Trace	\$399
V-525 - 50MHz, Cursors	\$995
V-523 - 50MHz, Delayed Sweep	\$949
V-522 - 50MHz, DC Offset	\$895
V-422 - 40MHz, DC Offset	\$795
V-222 - 20MHz, DC Offset	\$649
V-660 - 60MHz, Dual Trace	\$1,149
V-665A - 60MHz, DT, w/cursor	\$1,325
V-1060 - 100MHz, Dual Trace	\$1,395
V-1065A - 100MHz, DT, w/cursor	\$1,649
V-1085 - 100MHz, OT, w/cursor	\$1,995
V-1100A - 100MHz, Quad Trace	\$2,495
V-1150 - 150MHz, Quad Trace	\$2,395

### B&K OSCILLOSCOPES

2120 - 20MHz Dual Trace	\$389
2125 - 20MHz Delayed Sweep	\$539
1541B - 40MHz Dual Trace	\$695
2160 - 60MHz Dual Trace, Delayed Sweep, Dual Time Base	\$949
2190 - 100MHz Three Trace Dual Time Base, Delayed Sweep	\$1,395
2522A - 20MHz / 20MS/s Storage	\$875

**Digital Capacitance Meter CM-1550B by Elenco**



**\$58.95**

9 Ranges  
1pt-20,000uFd  
5% basic acy.

Big 1" Display Zero control w/ Case

**Digital LCR Meter LC-1801 by Elenco**



**\$125**

Measures:  
Coils 1uH-200H  
Caps 1pt-200uF  
Res .01-20M

**Digital Multimeter DVM-638 by Elenco**



**\$39.95**

11 Functions with Case

### FLUKE MULTIMETERS

Scopemeters (All Models Available Call)	
Model 93	\$1,225.00
Model 95	\$1,549.00
Model 97	\$1,795.00
Model 10	\$62.95
Model 12	\$79.95
70 Series	
Model 70II	\$65.00
Model 77II	\$149.00
Model 79II	\$169.00
80 Series	
Model 87	\$289.00

**Quad Power Supply XP-580**



**\$79.95**

2-20V @ 2A  
12V @ 1A  
5V @ 3A  
-5V @ 5A

Fully regulated and short circuit protected  
Made in USA by Elenco

**Triple Power Supply XP-620**



**Assembled \$75**

**Kit \$50**

2 to 15V @ 1A,  
-2 to -15V @ 1A  
(or 4 to 30V @ 1A)  
and 5V @ 3A

Made in USA by Elenco  
All the desired features for doing experiments.  
Features short circuit protection, all supplies.

**AM/FM Transistor Radio Kit**

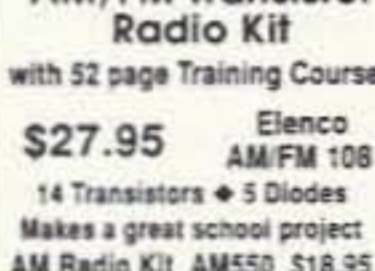

**\$27.95**

with 52 page Training Course  
Elenco AM/FM 108  
14 Transistors + 5 Diodes  
Makes a great school project  
AM Radio Kit AM550 \$18.95

**True RMS 4 1/2 Digit Multimeter M-700T by Elenco**



**\$135**

.05% DC Accuracy  
.1% Resistance  
with Freq. Counter  
Data Hold

**Sweep/Function Generator with Freq. Counter**



**\$239**

Elenco Model GF-8026  
Sine, Square, Triangle, Pulse, Ramp  
2 to 2MHz, Freq. Counter .1-10MHz  
Internal Linear & Logic Sweep

**Function Generator Blox #9600 by Elenco**



**\$28.95**

Provides sine, triangle, square wave from 1Hz to 1MHz  
AM or FM capability  
Kit \$26.95

**Learn to Build and Program Computers with this Kit**



**\$129.00**

Model MM-8000  
by Elenco

Starting from scratch you build a complete system. Our Micro-Master trainer teaches you to write into RAMs, ROMs and run a 8085 microprocessor, which uses similar machine language as IBM PC.

**Elenco Wide Band Signal Generators**



**SG-9000 \$119**

RF Freq 100K-450MHz AM Modulation of 1KHz Variable RF output  
SG-9500 w/ Digital Display & 150MHz built-in counter \$239

### XK-500 Digital / Analog Trainer

A complete mini-lab for building, testing, prototyping analog and digital circuits. Elenco's Digital/Analog Trainer is specially designed for school projects, with 5 built-in power supplies. Includes a function generator with continuously variable, sine, triangle, square wave forms. All power supplies are regulated and protected against shorts.

**Power Supplies**

- Variable Power Supply
- +1.25 to 20VDC @ 1 Amp
- +1.25 to 15VDC @ 1 Amp
- 1.25 to -20VDC @ 1 Amp
- 1.25 to -15VDC @ 1 Amp
- +12VDC @ 1 Amp
- +12VDC @ 1 Amp
- +5VDC @ 1 Amp
- 30VAC Center tapped @ 15VAC @ 1 Amp

**Analog - Section**

- Function Generator Sine, Triangular, Square wave forms
- Frequency adjustable in five ranges from 1 to 100KHz
- File frequency adjust
- Amplitude adjust
- DC offset
- Modulation FM-AM

**Digital - Section**

- Eight data switches
- Two no bounce logic switches
- 2 LED readouts TTL buffered
- Clock frequency 1 to 100KHz
- Clock amplitude 5VPP square wave

**Breadboards** \$159.95  
Assembled \$129.95 Kit

**WE WILL NOT BE UNDERSOLD**  
UPS SHIPPING: 48 STATES 5% OTHERS CALL  
IL RES add 7.75% TAX  
PROBES INCL. ALL SCOPES & METERS

**C&S SALES INC.**  
1245 ROSEWOOD, DEERFIELD, IL 60015  
FAX: 708-520-0085 • (708) 541-0710

**15 DAY MONEY BACK GUARANTEE**  
FULL FACTORY WARRANTY  
WRITE FOR FREE CATALOG  
PRICES SUBJECT TO CHANGE

CIRCLE 184 ON READER SERVICE CARD



## 73 Review

by Michael Bryce WB8VGE

# The Ten-Tec Scout

*Easy, affordable and best of all, fun!*

Ten-Tec  
1185 Dolly Parton Parkway  
Sevierville TN 37862  
Telephone: (800) 833-7373  
Fax (615) 428-4483  
Price Class: \$495

Since the introduction of the microprocessor into ham radio, we've seen the size of our transceivers go down. At the same time, we also have seen the complexity of their operation go through the roof. Is there an affordable blend of microprocessor technology and simple easy-to-use circuitry available?

Well, yes there is. It's called the Scout and it's made by the folks at Ten-Tec. Ten-Tec calls it their model 555. The Scout is a small transceiver with a microprocessor mated with time-proven analog circuits. The entire package is affordable, even for the ham with a slim budget. And talk about easy to use! Getting on the air when you're new to ham radio can sometimes be a real Maalox moment. That's not the case with the Scout. It's made to be simple to use, and that's especially pleasing to the new ham. Old-timers will like the ease of use, too.

## An Introduction

The receiver has a superhet design using an IF of 6.144 MHz. The Scout's superhet receiver is single-conversion. Receiver sensitivity is 0.35  $\mu$ V for 10 dB @ 2.5 kHz bandwidth. The dynamic range is 85 dB @ 2.5 kHz bandwidth.

Monoband operation with plug-in modules allows you to cover all the ham bands. That's operation from 160 meters through 10 meters. There is some overshoot on all bands. A large 0.56" four-digit LED display has 100 Hz resolution. The actual transmitted CW signal is 750 Hz below the display frequency on 160, 80, 40 and 30 meters. The transmitted CW frequency is 750 Hz above the displayed frequency on the higher bands. The display will show you the receive signal's frequency minus the MHz digit. That digit is printed on the front of each module. The microprocessor has no control over the output of the VFO, except for the Frequency Lock System, or FLS. The microprocessor adds features to the Scout, while analog circuits provide the muscle.

The optional noise blanker takes care of ignition noise while you're hamming down the road. The patented "Jones" filter is front-panel-adjustable from 500 Hz to 2.5 kHz. Full CW QSK, a Ten-Tec tradition, and push-to-talk SSB round out the features.

The Scout provides a solid 50 watts of RF output to the antenna while drawing a scant 10 amps from a 13.8 volt power supply. If the cigar lighter in your automobile will handle the current, and some of them won't, you can power the Scout directly from it. On receive, the Scout requires 600 mA. The Scout can be tilted up by the bail handle. The entire pack-

age weighs in at only 5 lb. 3 oz.

## A Closer Look at the Scout

The Scout is a mix of both old technology and the high-tech stuff of today. The VFO used by the Scout is a permeability-tuned oscillator, or PTO. Ten-Tec has been using these for years in their many transceivers, such as the Argosy line and the Corsair line. This time around the Scout has a new wrinkle with the Frequency Lock System.

The Scout uses a RISC, or Reduced Instruction Set Computer, to control several main functions of the Scout. It takes care of the LED display, and emulates a Curtis type B iambic keyer with adjustable speed from 5 to 50 wpm. You can tell Ten-Tec has always been a CW operator's rig; the default speed is 25 wpm. When you put the SPEED-RIT switch in the speed position, the current keyer speed comes out on the display. To change the speed, you hit the DAH paddle to decrease speed or hit the DIT paddle to increase the speed. The speed changes one word per minute for each dit or dah. Since there is no internal back-up battery, any speed changes will be lost at power down and the speed will be reset at 25 wpm every time you turn on the Scout.

## The Frequency Lock System

The largest task for the computer is the

FLS. The Frequency Lock System is complex, so I'll try and explain it in as simple a concept as I can.

The main VFO is a permeability-tuned oscillator, or PTO. The oscillator covers 2.2 to 2.7 MHz, with some overlapping on the band edges.

When you finish tuning a signal, the microprocessor waits for approximately two seconds before allowing the system to lock. This allows the operator to make fine adjustments to the frequency without the microprocessor thinking it's drifting, and correcting. The frequency reading is then stored in a register for reference. The microprocessor compares each new reading with the reference reading and if the difference is in excess of a preset amount, it automatically corrects the PTO by means of a varactor diode. The theoretical stability is to  $\pm$  10 Hz compared with the frequency counter reading.

Since RIT is used intentionally to make small frequency corrections, a circuit was added to detect any movement of the RIT control and shut off the lock feature. This is indicated in the display by the right-hand decimal point being lit when the system is not locked.

The maximum amount of drift correction is approximately  $\pm$  600 Hz. The drift correction system is reset when any tuning is done or if the power is turned off and then back on.

If frequency drift is within 10 Hz of the previ-



Photo A. The Ten-Tec Scout. Simple, affordable and fun.





\$5<sup>45</sup>\* for 2 Day Delivery

\*Up to 12 lbs. in Continental USA

1-800-426-2891

Fax (612) 786-6513

Call for Catalog Ask for Ext. 22

Phone Hours 1-800-426-2891 M-F 8 am- 8 pm Sat. 10 am - 5 pm CST

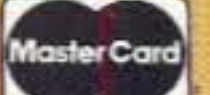

Orders received by 1:00 pm shipped the same day

# YAESU

Hot Price Supplies limited

## FT-1000D



Fun's fun, but you can be very serious with this heavy duty competitor. Dual receivers, 200 watt output, 99 memories and 108 dB dynamic range gives you the performance edge.

CALL

## FT-840



This new transceiver delivers the fun and performance you're looking for while staying on a budget! It has 100 watt output, 100 memories, DDS, IF Shift FET front end and a general coverage receiver.

\$799<sup>95</sup>

## FT-736R



Satellite and all-mode 2m/70cm work gets exciting with this full-feature transceiver. Many features plus room for 2 more bands gives value and performance.

\$1719<sup>95</sup>

## FT-530



The newest member of the dual band family. This handheld sports auto tone search, 82 memory channels, automatic power off, built-in VOX, dual in-band receive feature, built-in cross band repeat function and much more.

\$449<sup>95</sup>

## FT-416G



This VHF handheld transceiver provides the latest features- auto tone search, automatic battery saver, automatic power off, 41 memories, CTCSS encode/decode, DTMF paging, backlit keypad and display and a choice of two colors (black or gray) FT-816 UHF version available. Supplies limited

\$221<sup>42</sup> gray only includes all discounts

## FT-890/AT



A blend of high performance features borrowed from the FT-1000 family are combined in this affordable transceiver. Pass band tuning, variable notch filter, variable noise blanker, VOX and antenna tuner are included.

SPECIAL PRICE

## FT-5100



This dual band mobile features 100 memories, cross band repeat, lighted keypad, built-in duplexer and a small footprint. Dual watch capability rounds out this 50/35 watt VHF/UHF transceiver. Packet ready.

\$599<sup>95</sup>

## FT-5200



The removable front panel lets this dual bander fit any installation. It features 50w out on 2 meters, 35w out on 70 centimeters, 32 memories, CTCSS encode and PAGE mode.

\$629<sup>95</sup>

## FT-2200



This compact, full-featured mobile comes with 49 memories, 10 DTMF autodial memories, A.R.S., CTCSS encode, digital squelch and lighted keypad are standard features.

\$369<sup>95</sup>

## FT-2400



This rugged military-grade, 2 meter mobile provides wide band receive, 3 power output levels, a lighted keypad and 26 memories. Join the fun! FT-7400 UHF model available.

\$349<sup>95</sup>

\*Icom has extended their coupons to March 31, 1994

# ICOM

Services you need... at the right price!

# KENWOOD

Price Setter

## IC-728



The IC-728 is a full featured transceiver providing pleasurable HF operation with features such as passband tuning and speech compression. Perfect for mobile operation too. Also available IC-729 with 6 meters

\$839<sup>95</sup>

With \$100 COUPON!

## IC-735



The classic HF all-band transceiver that you've been looking for... the most compact and advanced full-featured radio with general coverage on the market.

\$974<sup>95</sup>

With \$75 COUPON!

## IC-2GXAT



High power & compact design set a new performance pace. This new HT offers 40 memories, Die cast case, CTCSS. Its fresh and exciting from Icom. IC-2GX with out key pad

\$284<sup>95</sup>

With \$10 COUPON!

## TS-850S/AT



Kenwood's technology endows the TS-850S/AT with specs that place it at the top of amateur radio equipment. Automatic antenna tuner, 100 memories, three scan modes, DDS, digital PLL system plus more.

\$1729<sup>95</sup>

CHECK FOR COUPONS

## TS-50S



Enjoy high performance communications plus go-anywhere convenience with the world's smallest 100w mobile HF transceiver. All modes and all bands complete this package. Limited supplies.

\$989<sup>95</sup>

CHECK FOR COUPONS

## TH-22AT



Small just got smaller. Kenwood's new TH-22AT is in a category all its own. This new FM transceiver features long battery life, DTMF keypad, user-friendly menu system, scan functions, 41 memories, CTCSS encode, DTSS, and much more.

\$277<sup>55</sup>

CHECK FOR COUPONS

## IC-3230H



Get ahead with dual band superiority. Even though it is loaded with many attractive functions for complete dual band capability, it is compact. Like a mono-band transceiver, it fits anywhere, in any vehicle. 36 memories, DTMF microphone, and 3 power levels.

\$659<sup>95</sup>

## IC-2iA

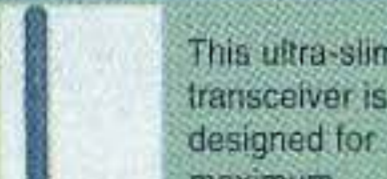

This ultra-slim transceiver is designed for maximum portability and convenience. CTCSS, clock and 100 memories are standard features.

\$269<sup>95</sup>

With \$50 COUPON!

## IC-W2A



A return to design fundamentals has produced something truly unique in dual-band FM transceivers. Even though it is the smallest in its class, it is packed to the limit with features to expand your fun out-of-doors, on the road, or at home.

\$449<sup>95</sup>

With \$30 COUPON!

## TS-790A



The TS-790A breaks new ground in terms of features and performance. With the optional 1200 MHz unit, it offers in-band coverage for maximum versatility. Supporting its dual-frequency receive capability are separate readouts and controls for main and sub bands, even full-duplex cross-band operation is possible.

\$1746<sup>17</sup>

CHECK FOR COUPONS

## TM-732A



Attuned to the fast-moving world of mobile communications, this dual-band transceiver offers many features including a detachable front panel in a compact design.

\$599<sup>95</sup>

CHECK FOR COUPONS

## TH-78A



Compact and confident, this dual band HT sets exciting new standards for portable communications by combining simplicity of operation with a multiplicity of features.

CALL

CHECK FOR COUPONS

Not responsible for typographical errors.



2663 County Road I, Mounds View, MN 55112  
Metro: (612) 786-4475 • Nat'l Watts: 1-800-426-2891 • FAX: (612) 786-6513  
Store Hours: M-F, 10:00 am- 8:00 pm, Sat., 10:00 am - 5:00 pm  
Phone Hours: M-F, 8:00 am - 8:00 pm, Sat., 10:00 am - 5:00 pm

Expires March 31, 1994

Prices subject to change without notice

CIRCLE 153 ON READER SERVICE CARD





Photo B. A band module. One module of your choice comes with the rig.

ous reading, there is no correction. If it is greater than 10 Hz but less than 40 Hz, the microprocessor will correct. Readings are taken every 200 ms. If the reading is outside the  $\pm 40$  Hz window, the microprocessor assumes you are tuning and will reset the window.

In SSB transmit, the frequency correction works as it does in receive. CW operation is more complex. If the internal keyer is being used, it will take preference over any other operation. There will be no correction during CW transmit but, since it is a QSK system, corrections are made between characters, words and any other pauses. To minimize error when transmitting CW, the correction window is increased from  $\pm 40$  Hz to  $\pm 100$  Hz. When the transmission is over, the frequency is compared to the reference, and if less than 100 Hz, is corrected. After the correction, the window is reset to the  $\pm 40$  Hz value.

#### The Manual

Ten-Tec has always had great manuals with all of their products. The manual for the Scout is no exception. It contains a description of every control and every jack on the rig. A complete circuit description of each and every module making up the Scout is also inside the manual. This is very handy for fixing the rig should the need arise. What? Fix your own rig? Yes, it is very possible and easier than you think. If you have a problem with the Scout, a phone call to Ten-Tec's service department may be able to step you through to find a bad board. Ten-Tec will send you a replacement board in exchange for your defective board on a 30-day billing invoice. You re-

move the suspect board and return it to Ten-Tec for full credit. If that won't fix the problem, then send the complete unit to Ten-Tec. Their service is legendary.

#### Using the Scout on the Air

When you first look at the Scout, you'll notice something strange: The lack of control knobs! Best of all, you don't have to wade through several displays of menus either. That's because the Scout is built to be simple to use! If you already have an antenna up, and a source of power, you can have the Scout up and running in as little as five minutes.

There is no band switch. To change a band, you remove the band module and replace it with another one. Just like that, your monobander just changed bands. I did not see any explanation in the manual about powering down to change the band modules, but it would be a good idea. On the other hand, I've just pulled one out and swapped in another one with the power on. Nothing happened, so I guess it's all right to do. There is a small lever on each module so you can pull it out of the case. Of course, the module mounts up front, next to the display.

The modules contain the low-pass filters for their particular band and the mixer/crystal oscillator to convert the PTO to the correct local oscillator frequency. There is also a 3 MHz

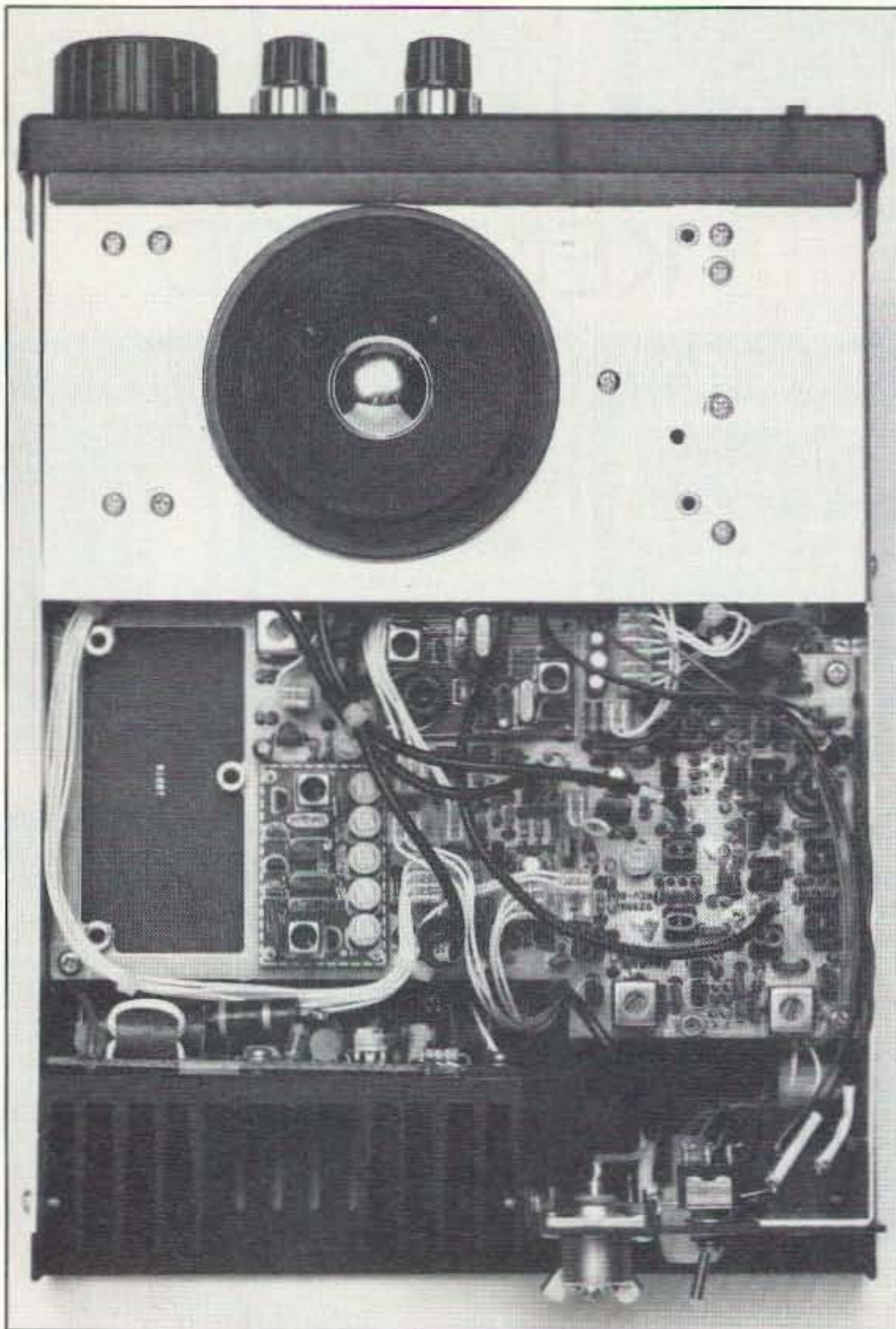

Photo C. Inside view of the Scout. The noise blanker is not installed in the unit. Notice the PA and its heat sink mounted out of harm's way.

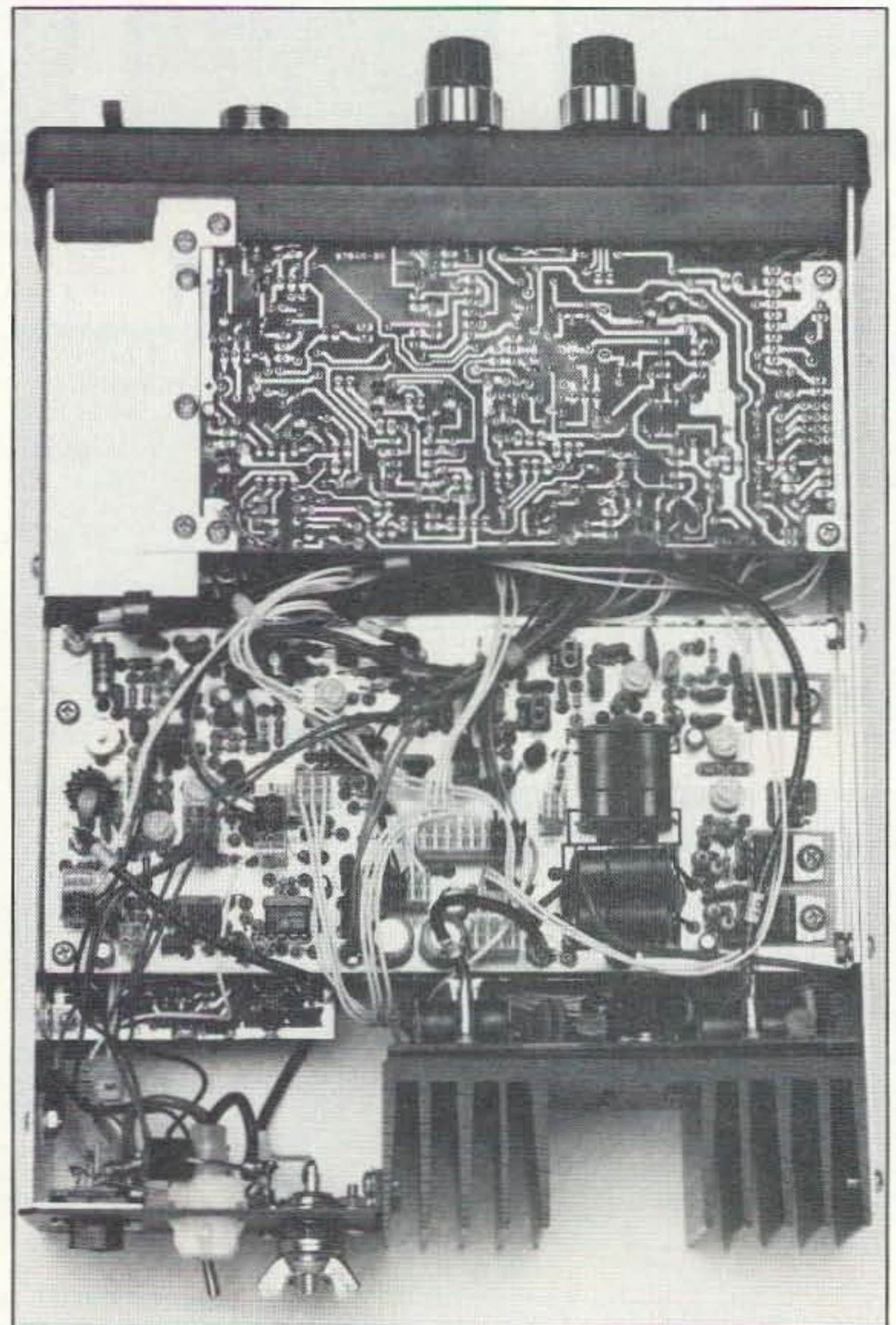

Photo D. Bottom view showing the low-level driver stage and PA.





# Now The Company That Takes You Around The World Lets You Take The World Around With You.

The Drake SW8 – Finally, Professional Desktop Performance In An Affordable, Portable World Band Shortwave.

The company that has been setting the standards in premium-quality world band shortwave performance now puts top-of-the-line features and technology at your fingertips with the SW8... wherever you want to take it. Designed for both desktop use and easy portability, the

Drake SW8 includes many of the same features that have made Drake a perennial favorite of experts – superb audio, versatility, and the unique combination of professional quality and functional simplicity. So tune in the world and get the best of all worlds – quality and affordability, desktop

technology and portability.

The Drake SW8.

To order your SW8 direct, for more information, or for the dealer nearest you call:

**1-800-968-7753**

**DRAKE**

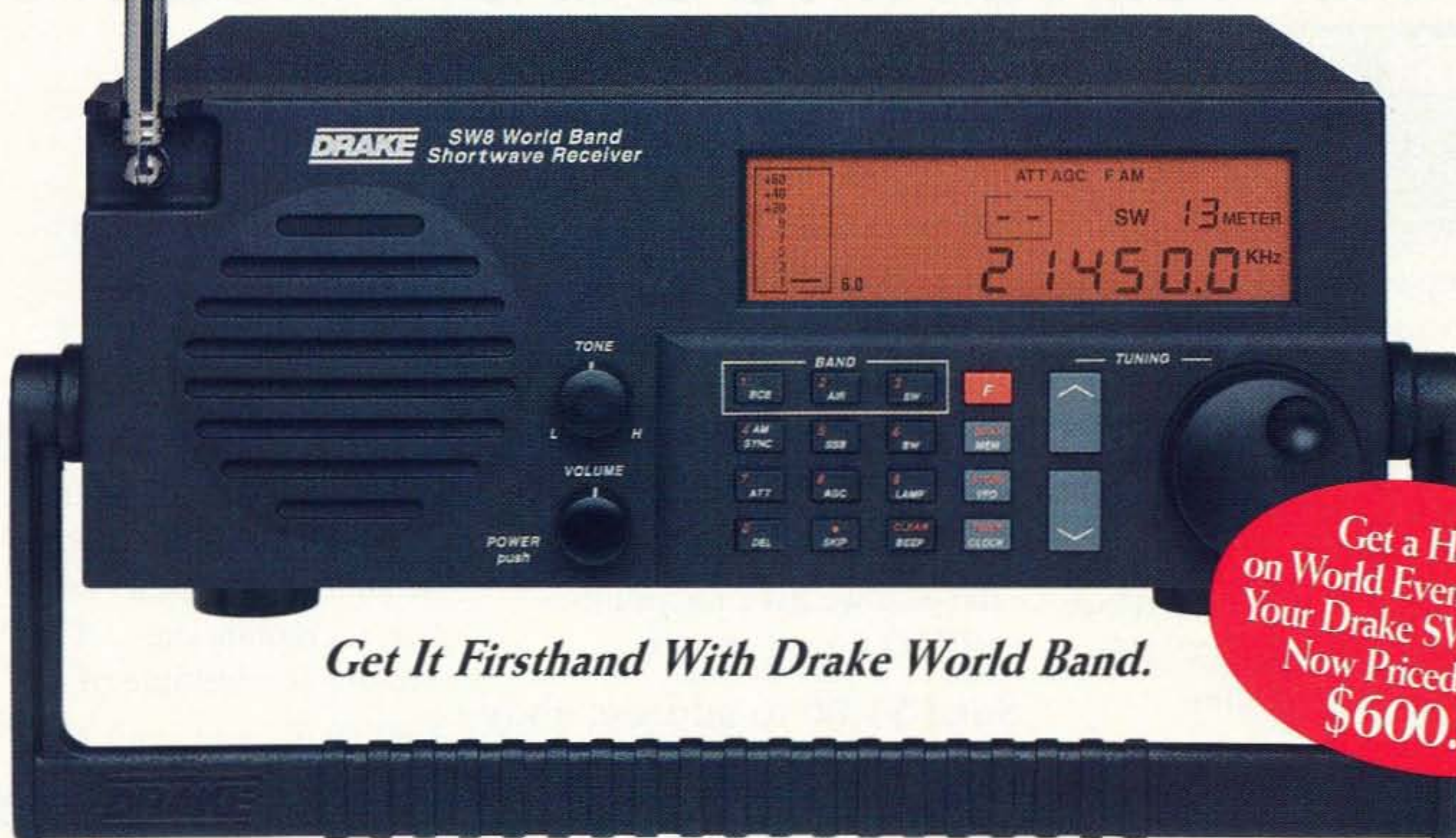

*Get It Firsthand With Drake World Band.*

Get a Handle  
on World Events... Order  
Your Drake SW8 Today.  
Now Priced under  
**\$600.00**



low-pass filter in each module to keep the 50 watts of RF out of the PTO circuits. A coaxial jack and plug arrangement route the RF in and out, while an edge-card-type plug and jack connect the rest of the circuitry to the Scout. Each module is about the size of a pack of cigarettes. One module of your choice comes with the Scout. Extra modules are \$25 each.

You'll need a power source capable of at least 10 amps to fire up the Scout. Ten-Tec makes two different power supplies for the Scout in case you don't have one: A linear model and a high-efficiency switcher weighing only three pounds.

A standard SO-239 antenna socket is used to connect your antenna to the Scout. The analog meter measures RF power and SWR. You flip a switch on the back of the Scout to read SWR, otherwise you set it to read forward power. The tune switch places the rig in transmit and reduces the RF output to 15 watts. You don't need to worry about calibrating the meter, it's done for you automatically.

You tune the Scout with the main tuning knob. The tuning is stiff, *and it's suppose to be that way.* You're moving a slug in and out of a coil. You won't find a finger spinner hole on this knob. The stiffness is kinda nice when bouncing around mobile—the VFO won't be accidentally bounced off frequency by a rough

ride. There are no memories to mess with or dual VFOs to get you into trouble (like operating out of band as so many of us did a while back).

Of course, you can turn the RIT on (the RIT has +/- 1 kHz of range) and fine-tune a station, and you can use the variable bandwidth filter to cut out QRM. This is especially helpful during CW. You can set the Jones filter to just the right amount of filtering required by band conditions. There is no RF gain control on the Scout. There's plenty of receive audio from the Scout, even with its small internal speaker. You can use an external speaker or headphones, too. A front panel 1/4" stereo jack allows you to use your walkthing headphones with the Scout. To use my mono headphone with the Scout I had to insert the plug halfway to cut off the internal speaker, or all the way to have audio in both the internal speaker and headphones at the same time.

There is no sideband select switch either. That's done for you automatically. The Scout selects lower sideband on 160 through 40 meters and upper sideband on the rest of the bands.

If you want to operate CW you close your key, or you can use the built-in keyer. The sidetone level is adjustable (from an access hole on the bottom of the Scout), but not the pitch. The access hole requires a fine jeweler's screwdriver and a very steady hand. If

some SSB grabs you, you push the microphone button. The only adjustment is the setting of the microphone gain control. Adjust it so the LED flashes on voice peaks. There is no mode control.

I like to listen to CW with the filters wider than most people do. This is very easy to do with the Jones filter and the Scout. But, if you have the filter too wide and a strong signal is in the bandpass, the AGC will be controlled by the stronger signal. The fix is simple: Just tighten up the bandpass of the receiver. A simple turn of a knob is all it takes.

The internal keyer requires a 1/8" plug and the microphone requires a four-pin connector. Both are supplied by Ten-Tec. It's interesting to note that Ten-Tec has supplied all the Radio Shack part numbers for various plugs and adapters. That's a nice touch and it makes life easier for the new operator, too.

#### Impressions

The receiver in the Scout holds up quite well on the air. Granted, if you connect the Scout to a large super antenna and then compare it to something out of the same price range, you will be able to tell the difference. I used one of the pre-production Scouts during this year's Field Day, and had no complaints about the receiver. Yes, it did get swamped from the other stations we had set up, but they all got hit just as bad.

# TOWNSEND ELECTRONICS, INC

P.O. Box 415, Pierceton, IN 46562 219-594-3661

## TRANSCEIVER KITS & RADIO MOUNTS



Complete transceiver for all HF Amateur Bands. Digital readout kits for all receivers and transceivers. Professional looking gear for your shack that you can use. We carry kits from C. M. Howes, Walford Electronics AND we carry the entire TEJAS RF TECHNOLOGY line.

80 or 40 meter, 5 Watt, HOWES CW transceiver Only.....\$164.95  
 160 Meter DSB Phone XCVR, 3 to 10 Watts PEP.....\$134.95  
 80 meter SSB transceiver, 10 to 35 Watts PEP.....\$239.95  
 80/40/20 TRI-BAND SSB XCVR. 12 to 40 Watts..\$399.95  
 Digital readout kit for any superhet or DC receiver or transceiver.....\$116.95  
 This is just a sample listing of the gear we have for you to BUILD for your shack.

**Send \$1.00 to address above for our newest catalog!**



Heavy Duty HT Mounts will mount any Hand Held in almost any vehicle.....\$29.95  
 Mobile radio mounts for heavier mobile rigs ....\$39.95  
 Mounts for multiple rigs starting at .....\$49.95

CIRCLE 299 ON READER SERVICE CARD



With 50 watts of RF, you're only 1/2 S-unit below that of a 100 watt rig. The difference between 50 watts and 100 watts is only 3 dB. An S-unit is defined as 6 dB. You'll have no trouble making and keeping a QSO with the power of the Scout. Under bad band conditions, sometimes 100 watts won't cut it, either. You can get the Scout in a QRP version for about \$26 less, but I don't recommend it for a first-time ham. While God knows QRP is great fun, beginners in ham radio should have the benefit of 50 watts to get their feet wet. You can turn down the power of the Scout to QRP levels, but you'll end up losing transmitter efficiency.

Unsolicited comments from stations complemented the transmit audio on SSB. I used the hand-held Ten-Tec microphone for SSB. Microphone input is 200 to 100k ohms and it accepts microphones with 5 mV output. The microphone jack will also supply a low-voltage, low-current source for electrets.

I used the Scout on AMTOR with good results. It's more than stable to use just about any digital mode. I did not try RTTY. Since the heat sink gets very warm, almost hot on long-winded SSB QSOs, running full key down would require some sort of extra cooling, like a small fan. Be advised, though, that the Scout's main purpose in life is CW and SSB. Running digital modes is quite possible with the Scout, but you'll need to keep the PA heat sink cool.

Since the Scout selects the proper sideband for phone use, I had to adjust the software I used to invert the receive signal and the transmit as well. Most digital modes are done on lower sideband.

And, of course, what can you say about Ten-Tec's legendary QSK for CW? I operated with both the internal keyer and an external keyer. The sidetone is a pleasant 750 Hz, to match the offset during transmit.

The Scout is really at home in your car running HF mobile. A mobile mounting bracket is available. The noise blanker works very well with ignition-type noise pulses, I highly recommend this option for mobile use. Using less than perfect mobile antennas, I have been able to work states all over the country. Most don't believe me when I tell them I'm running only 50 watts mobile.

The Scout is also happy sitting on your operating table. While it's true, the Scout does not have all the bells and whistles of some of the other rigs in use today, it will still give you quite a lot of operating pleasure. The Scout is especially appealing to the new ham on a tight budget. One or two band modules (you get one with the Scout) would be all you need. The most popular modules are 40, 30, and 20 meters.

It's not a contest rig, and it was never designed to be one. However, I plan to put the Scout though this up-and-coming CQ World

Wide DX contest this October. I did use the Scout on the QRP ARCI CW contest with excellent results.

The Scout would be an ideal *second* rig also. You could throw it under your arm, grab the microphone with the other hand, and set up an emergency communication center in minutes.

What really took me by surprise while doing this review was a comment my wife made. With a basement full of radios and other electronic equipment, she said, "Why, I might even be able to operate this one. I don't think I could break it if I did something wrong." That's an interesting point. You can't do anything wrong that will hurt the Scout. There are no memories to overwrite, no dual VFO to worry about, and no complex multi-function knobs either. I could just see Donna sitting down in front of an IC-781. All I'd be saying would be: "Don't touch this knob, don't touch that, and watch out for this, but don't worry about that one."

So, no matter where you are, be it camping, tooling down the road, at Field Day, or operating from home, the Scout will provide you with a lot of fun. In fact, I had such a good time with the Scout, Ten-Tec won't be getting this one back. I bought it!

Overall, I think Ten-Tec summed it up the best: "The Scout is easy, affordable and best of all, fun!"

73



Serving The LORD  
Since 1987

**\$49.95!**

## THE POWER STATION

The POWER STATION is a 12V x 6.5 AmpHr gel-cell battery complete with voltmeter, wall charger and a cord for charging via automobiles. It will power most HT's at 5 Watts for 2-4 weeks (depending upon how long-winded you are). Also VHF, UHF, QRP, or HF mobiles such as the KENWOOD TS-50 (at 50W). There are no hidden costs, all you need is your mobile, HT power cord or cigarette lighter adapter.

The POWER STATION provides 12V from a cigarette plug and has two recessed terminals for hardwiring. A mini-phone jack with regulated 3V, 6V, or 9V output can be used separately for CD players, Walkmans, etc. THE POWER STATION can be charged in an automobile in only 3 hours, or in the home in 8 hours. The charger will automatically shut off when the battery is completely charged, so you can charge it even when it has only been slightly discharged, (unlike Ni-Cads that have memory). Our charging circuit uses voltage sensing circuitry, other brands are timed chargers which always charge the battery a full cycle, this damages their battery and shortens its' life if it only needs a partial charge. The POWER STATION has a voltmeter that shows the exact state of charge of the battery, not worthless idiot lights that tell you "YOUR BATTERY IS NOW DEAD." The voltmeter can even be used to measure voltages of other sources.



To order, send check or money order for \$49.95 + \$8.50 for shipping, along with your shipping address and telephone number to:



Joe Brancato

**THE HAM CONTACT**

P.O. Box 3624, Dept. 73  
Long Beach, CA 90803.

CA Residents Add 8 1/4% Sales Tax. Canadian Residents Please Send U.S. Money Order & \$17.10 Shipping.

If you wish more information please send a SASE to the above Address. For COD orders, call (310) 433-5860, outside of CA Orders Only call (800)933-HAM4 and leave a message.



# The FOXBOX

A voice ID T-hunt controller.

by Rex Drake KI5GH

Do you need a simple, effective controller for use during foxhunts? I wanted such a device, but was unable to find one that fit my desires. Most controller circuits use some form of PROM chip, which I did not want to use. I did find a controller circuit<sup>1</sup> that used 8-bit shift registers to form a programmable memory. To get the required number of programmable bits to create the memory, the device needs 16 register chips. Buying this many chips could become expensive and the device still can only operate in CW.

I was browsing through the local Radio Shack and found a chip which intrigued me. The ISD1000A is billed as a voice record and playback IC. Even though the chip is

somewhat expensive, the price is roughly equal to, or slightly cheaper than, buying a PROM or buying 16-shift register chips. The ISD1000A can be used to identify a hidden transmitter with voice, or in CW like the other controller circuits I discovered.

### The ID Circuit

The ISD1000A comes packaged with application notes<sup>2</sup>. I made a few changes to the "simple record and playback" circuit. The chip has an addressable memory. I decided to use the memory to store a single message—so the addressing circuitry was not used. I obtained the microphone recommended by the application notes. The notes and the mike data differ slightly in the circuits required to

power the electret mike. The data included with the mike described a simpler circuit than that included in the notes. I used the simpler approach and have encountered no problems. My final modifications were made to the speaker output of the ISD1000A. I inserted a 1k potentiometer (R11) which can be used to adjust the audio level sent to the transmitter. I also included a 1:1 audio transformer to provide isolation between the ISD1000A and the transmitter. Other than these changes, I built the circuit as described in the notes.

### The Timer Circuits

Two timers are required for the FOXBOX. I used a 556 dual-timer IC to reduce the circuit size. The chip includes two separate 555

**MORSE CODE MUSIC!**

**SENSATIONAL NEW WAY TO LEARN CODE—Do Aerobics, Sing, Jog, or Drive while learning code! A fun & easy way to learn or retain Morse Code skills. Now the secret is yours with this amazing synchronized breakthrough! Great for Novice, Technician or the classroom. Order:**

**"THE RHYTHM OF THE CODE"**  
Version 2 cassette today!

Send \$9.95 and we'll pay the shipping to:

**KAWA RECORDS**  
P.O. Box 319-ST  
Weymouth, MA 02188

Check or money order only. We ship all orders within 5 days.  
Overseas please add \$2.00 for air mail.  
MA residents add 5% sales tax.

CIRCLE 2 ON READER SERVICE CARD

**ONV SAFETY BELT CO.**  
P.O. Box 404 • Ramsey, NJ 07446  
800-345-5634  
Phone & FAX 201-327-2462

**ONV Safety Belt With Seat Harness**  
**\$89.95**



**OSHA**  
We Ship  
Worldwide  
Order Desk Open  
7 Days/Week

**ONV Tool Pouch \$15.95**

Add \$4.00 For Handling VISA M/C CHECK

**ONV Belt W/O Seat Harness**  
**\$74.95**

CIRCLE 102 ON READER SERVICE CARD

**RC-99**  
**REPEATER/REMOTE**  
**CONTROLLER**

FEATURES INCLUDE: Hang up proof • User Programmable Initial/Normal CW ID's, passwords and timers • IC-900 pgm. • ICOM HF pgm. with scan and offsets • Selective Muting • Molex con. • Complete Audio Interface • Aux. Outputs • Key Delay Adjustment • Subtone Inputs • Small Size • Telemetry Response

\$149.00 Assembled and tested  
Optional Autopatch \$49.00

**PLUS TEN**  
1067 E. Main St. Elbridge, NY 13060-1157  
(315) 689-1340  
(315) 689-1345 Fax



CIRCLE 396 ON READER SERVICE CARD

**RACK AND CHASSIS BOXES**



RACK CHASSIS			METAL CABINETS		
MODEL	DESCRIPTION W x D x H (inches)	PRICE \$	MODEL	DESCRIPTION W x D x H (in.)	PRICE \$
1RU5	19 x 5 x 1.75	30.85	MC-1A	4 x 3 x 2	18.50
1RU7	19 x 7 x 1.75	33.10	MC-2A	6 x 3 x 2	18.75
1RU10	19 x 10 x 1.75	35.25	MC-3A	8 x 3 x 2	20.95
2RU5	19 x 5 x 3.5	33.10	MC-4A	4 x 4 x 3	18.75
2RU7	19 x 7 x 3.5	35.25	MC-5A	6 x 4 x 3	20.95
2RU10	19 x 10 x 3.5	37.90	MC-6A	8 x 4 x 3	23.15
3RU5	19 x 5 x 5.25	41.90	MC-7A	4 x 7 x 4	20.95
3RU7	19 x 7 x 5.25	44.10	MC-8A	6 x 7 x 4	23.15
3RU10	19 x 10 x 5.25	46.30	MC-9A	8 x 7 x 4	25.75

USA AND CANADA ORDERS (800) 634-3457  
FAX ORDERS (800) 551-2740  
SESCOM, INC., 2100 WARD DRIVE  
HENDERSON, NEVADA 89015 USA  
TECHNICAL HELP (702) 565-3400

VISA AND MC ORDERS  
SHIPPED GROUND AT  
NO CHARGE (48 STATES)

CIRCLE 167 ON READER SERVICE CARD

**PERSONAL COMPUTER REPEATER CONTROLLER**  
**PCRC™**

*Speaks for Itself*



- ✓ Full Duplex Autopatch
- ✓ 911 Emergency Access
- ✓ Reverse Autopatch
- ✓ Voice Mail
- ✓ Voice/Tone/DTMF Paging
- ✓ Hardware Logic I/O
- ✓ Morse Code Practice
- ✓ Toll Restriction
- ✓ Voice ID's
- ✓ BSR X10
- ✓ Scheduler
- ✓ HF Remote Control
- ✓ Remote Base

PCRC/2 Combines the power of your XT/AT platform with a high quality play and record voice digitizer creating the ultimate repeater controller.

**from \$695**  
516-563-4715  
Fax: 563-4716 BBS: 286-1518



CIRCLE 198 ON READER SERVICE CARD

From Micro Computer Concepts

**RC-1000**  
**REPEATER**  
**CONTROLLER**

- Autopatch • Reverse Autopatch
- User Programmable CW ID, Control & User Codes & Timeouts

Manual with schematics • 90-Day Warranty  
Wired & Tested w/ manual .... **\$239.95**

**Micro Computer Concepts**  
8849 Gum Tree Ave.  
New Port Richey, FL 34653  
**813-376-6575**



CIRCLE 160 ON READER SERVICE CARD



timers. Timer 1 controls the overall time period of the FOXBOX. The timer is used in the astable mode to provide a continuous repeating cycle. At the end of every timer cycle, the ID circuit is activated. The time period is adjustable by use of a potentiometer for R4. The cycle adjusts between approximately 30 and 90 seconds. A 1 megohm pot, used for R4, will allow for timer periods up to approximately 200 or 300 seconds.

The second timer is used to control the time the transmitter is held in the transmit mode. Timer 2 operates in the monostable mode. A trigger signal is needed to start the timer cycle, which runs for a set time period. The trigger signal is provided by Timer 1 at the end of each of its cycles. Timer 2's cycle adjusts via R1, providing a period of 10 to 25 seconds. The adjustable period allows keying of the transmitter only as long as the ID message lasts.

### Keying Circuit

I built several radio keying circuits before I found one which works reliably in this application. I wanted to be able to key several different radios with the circuit. Therefore, the circuit could not be built specifically for any particular radio. One of the requirements I had for this device was the electrical isolation of the timer from the radio's press-to-talk (PTT) circuitry. I wanted the isolation to prevent current flow between the two circuits. I

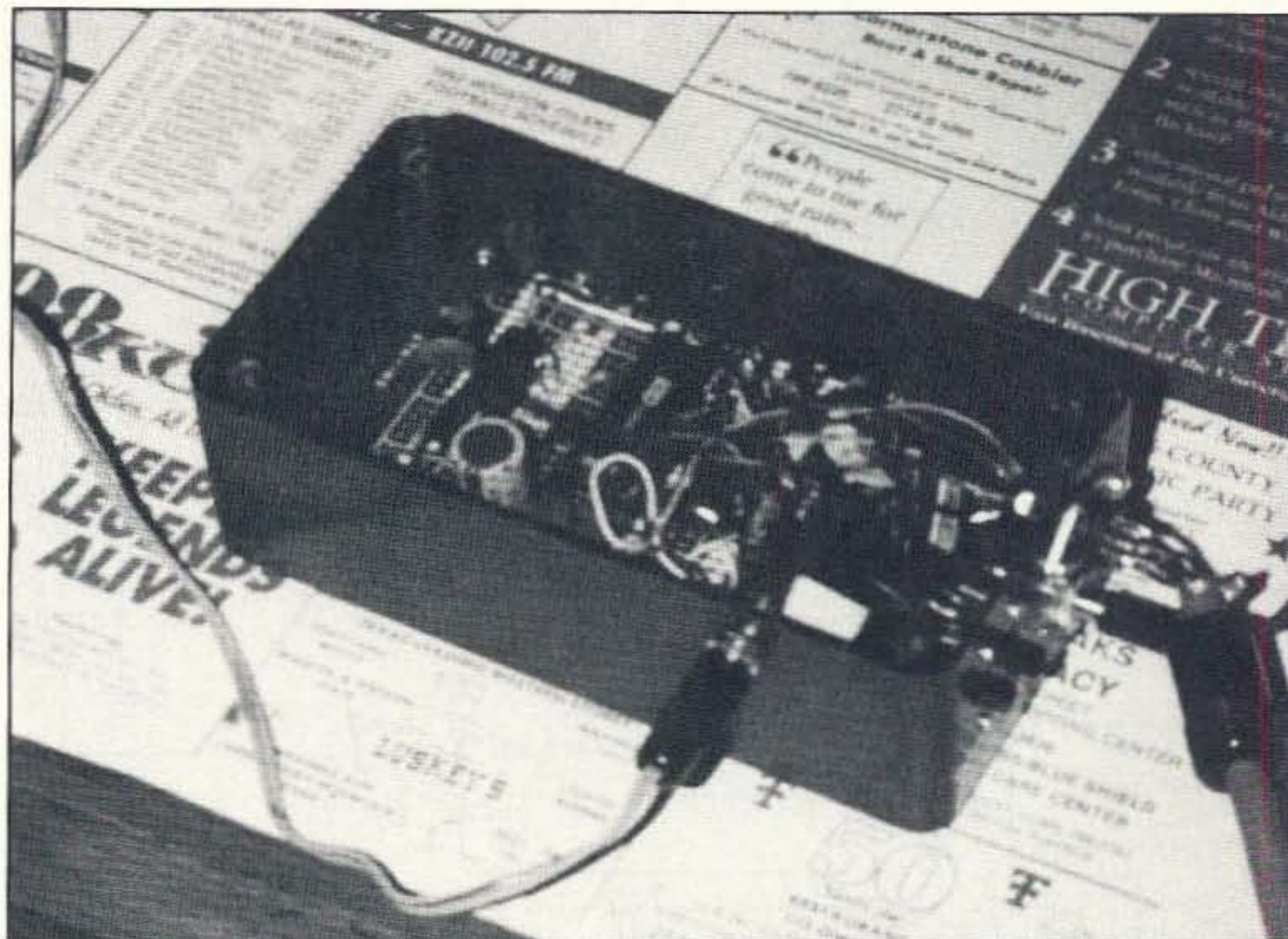

Photo A. The assembled prototype showing the external switches and connections.

did not want audio signals interfering with the timer output. When using my HT for the fox, the mike and PTT circuits have to be placed in series.

I solved the keying problem by using an

optoisolator. The optoisolator IC contains an infrared LED and an infrared phototransistor. The two components are connected only by an infrared light beam. The isolator's LED is driven by the output of the transmit timer

## - Packet Radio - Portable & Affordable!



- ★ Simple Installation
- ★ No External Power
- ★ Smart Dog™ Timer
- ★ Perfect For Portable
- ★ Assembled & Tested
- ★ VHF, UHF, HF (10M)

Model BP-1  
Packet Modem  
Made in U.S.A.

Whether you're an experienced packeteer or a newcomer wanting to explore packet for the first time, this is what you've been waiting for! Thanks to a breakthrough in digital signal processing, we have developed a tiny, full-featured, packet modem at an unprecedented low price. The BayPac Model BP-1 transforms your PC-compatible computer into a powerful Packet TNC, capable of supporting sophisticated features like digipeating, file transfers, and remote terminal access. NOW is the time for YOU to join the PACKET REVOLUTION!

Just...  
**\$49.95**  
+Shipping

**Tigertronics**  
Incorporated

400 Daily Lane  
P.O. Box 5210  
Grants Pass, OR  
97527

**1-800-8BAYPAC**

1-800-822-9722  
(503) 474-6700

CIRCLE 269 ON READER SERVICE CARD

## SOLDER PL-259s A SNAP!

SOLDER MINIATURE CONNECTORS WITH EASE  
SOLDER ALUMINUM AND MOST METALS

Solder-It is stronger and more conductive than regular solder and since it is a paste, flows at lower temperatures so you don't burn your work. Just apply and heat.



Our Kit includes four different Solder Pastes. A professional grade precision refillable butane Pencil Torch with Stand, Vinyl Storage Pouch, Complete Instructions, Warranty.

The Reviewers agree... read  
CQ, Jan 1993 ✓  
QCWA Journal, Fall 1992 ✓  
Nuts & Volts, Dec 1992 ✓  
Or ask someone who has used  
**Solder-It.**

**FREE CATALYTIC TIP WITH  
ORDERS BEFORE DAYTON**

Send \$59.00 + \$3.50 S&H for The  
Solder-It Kit to

**Solder-It Co.,**  
P.O. Box 20100 Dept. A,  
Cleveland, OH 44120  
Check OK. Ohio add 7.5% Tax.  
We ship in 48 hrs.

For info or COD orders call 216-721-3700

CIRCLE 325 ON READER SERVICE CARD



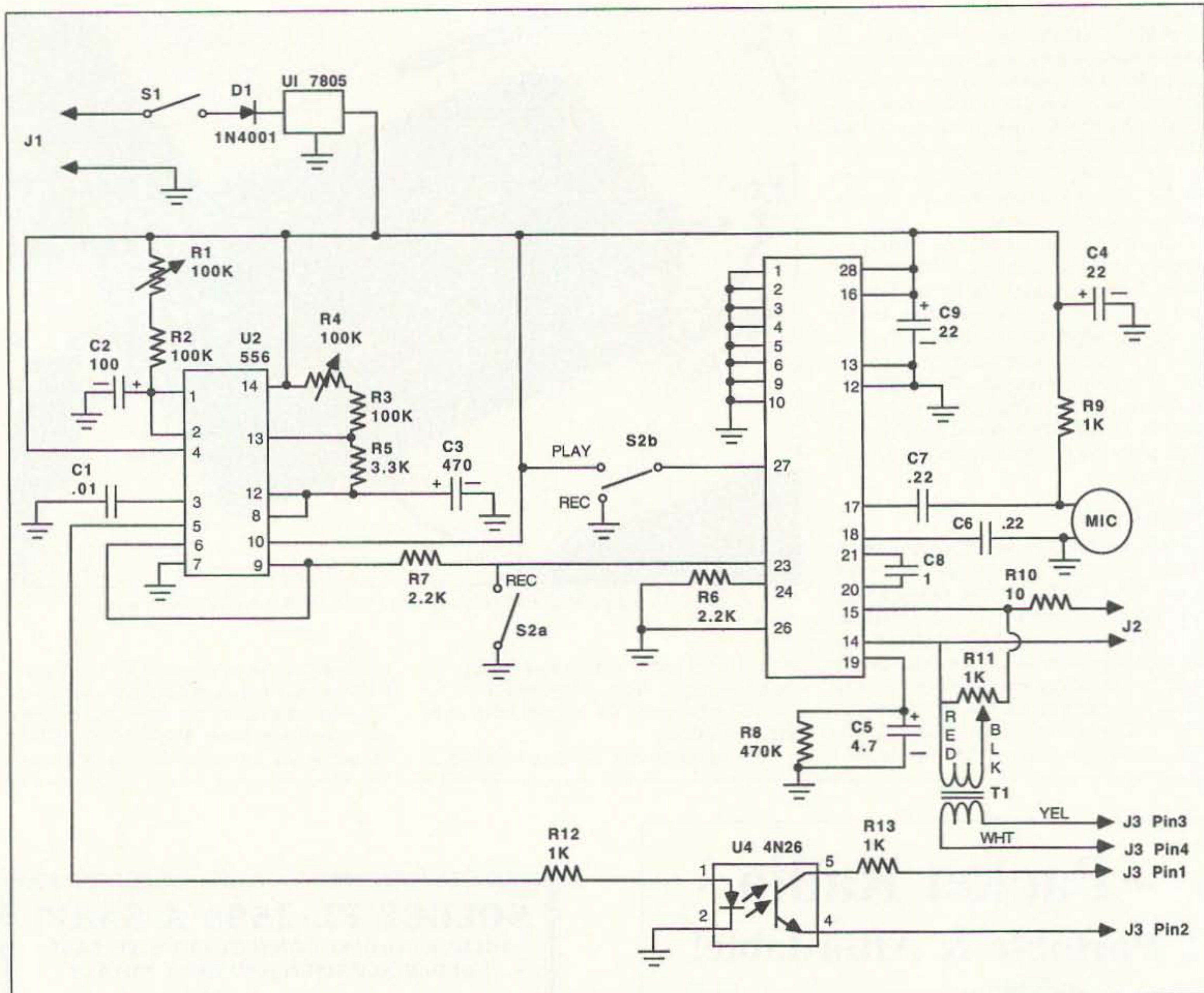

Figure 1. FOXBOX circuit schematic. Notes: All capacitance values in microfarads. For ICOM and similar HTs, short pins 2 and 3 of J3.

(Timer 2). The LED current is limited by R12. When the LED is lit, the phototransistor is turned "on," acting as a PTT switch to key the transmitter. R13 limits the current from the radio's PTT circuit to avoid destroying the phototransistor. The resistor value may need adjustment to allow reliable keying of some rigs. Ohm's Law can be used to calculate R13.

Let R equal the value of R13. V is the volt-

age measured at the radio's PTT pin. I is the maximum current desired to flow through R13. Try to set the current at about 20 mA. Do not let the current become greater than 100 mA or the optoisolator could be destroyed.

The optoisolator I used is not available at Radio Shack. To build a FOXBOX entirely from Radio Shack parts, a small 5V relay (#275-240) can be substituted for U4. R12,

and R13. The relay coil is connected directly to the output of Timer 2. The relay's normally open (NO) contacts can then be used for the PTT switch.

#### FOXBOX Power

The FOXBOX is designed to operate from 8V to 12V battery power. The circuitry actually operates at 5V. A 7805 voltage regulator (U1) is used to achieve the nec-

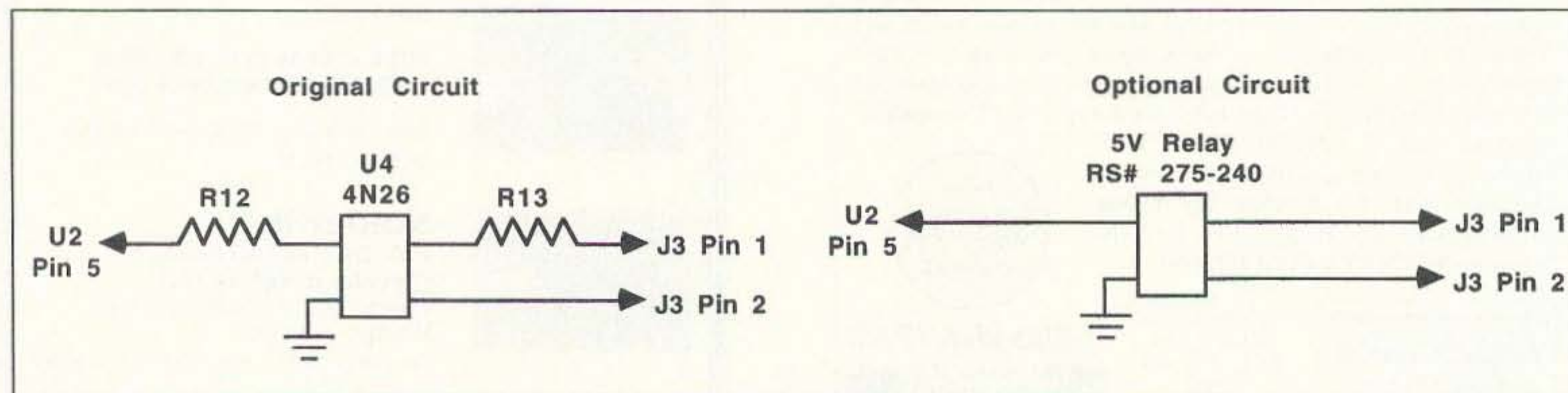

Figure 2. Original and optional keying circuits for the FOXBOX.



## Tired of struggling with the code?

If you're tired of the frustration that comes with learning the code, then get a proven performer that has helped thousands upgrade. Over the past four years, Morseman+ has taken the frustration out of Morse Code, and put upgraded tickets in the hands of many amateurs.

Morseman+ can do what no other computer-based code trainer can do - it lets YOU choose which training method is best for you. Pick between random characters, true random words, realistic random call signs, random QSO's, and much more. When you're ready, Morseman+ will even give you a simulated exam, complete with scoring. You can even send ASCII text files, generate tests for others (complete with answer key), or key up an external device through your computer's serial port. If you have an Adlib or Soundblaster compatible sound card, Morseman+ will send the code through it - even with background static on some options, if you desire. You say you don't know the code - yet? No problem, Morseman+ will be your teacher, and you won't get "code tape memory" from it either! All of this comes in an easy-to-use program that you can be productive with right out of the package.

Thousands of users can't be wrong, so why not order Morseman+ 4.0 today at our discount price of \$24.95 (+ \$4 s/h) - a \$10 savings over our regular price.

## Morseman+ 4.0

The Morse Code Confidence Builder

Morseman+ 4.0 requires an IBM/PC or compatible with at least 512k RAM, and two floppy drives (or one 3.5" drive). A hard drive is HIGHLY recommended. An Adlib or Soundblaster compatible card is not required. Overseas orders please include \$11 shipping for air freight.

## Amateur Radio Software for the IBM-PC

**HamPak 1** - a great collection of software for the radio amateur. Includes our disks 1082-1150 and 1801-1823. Programs for rig control, satellites, logging, SSTV, contesting, CW decoding, packet, maps and much more. Also includes the very popular Morseman+ Morse Code trainer that has helped thousands of hams get their license or upgrade. This is a total value of \$184.95, regularly priced at \$119.95, now only \$89.95 (\$119.95 for 3.5" disks). Makes a great gift!

**HamPak 2** - The same as HamPak 1, but does not include Morseman+. A total value of \$150, now only \$79.95 (\$109.95 for 3.5" disks).

**Engineering Pak** - Nice assortment of software for engineers or technically oriented hams. Includes programs for circuit analysis, circuit board design, schematics, radio restoration and much more. A total value of \$60, regularly \$44.95, now only \$27.95 (\$40.95 for 3.5" disks).

**HamPak Plus** - The grand assortment! All disks from our group one and group two ham collections, plus Morseman+. A \$250.95 total value, regularly priced at \$159.95, now only \$119.95 (\$169.95 for 3.5" disks).

To order, call 1-800-525-7235 (orders only, please) and use your Visa/MC, fax (206)767-8664, or send via mail. WVE include \$4 s/h, overseas \$11 for airmail.

renaissance software & development

killen plaza box 640 - killen - al - 35645

## BATTERIES

Nickel-Cadmium, Alkaline, Lithium, Sealed Lead Acid For Radios, Computers, Etc. And All Portable Equipment

YOU NEED BATTERIES?  
WE'VE GOT BATTERIES!  
CALL US FOR FREE CATALOG



E.H.YOST & CO.

7344 TETIVA RD.  
SAUK CITY, WI 53583  
(608) 643-3194  
FAX 608-643-4439

CIRCLE 114 ON READER SERVICE CARD

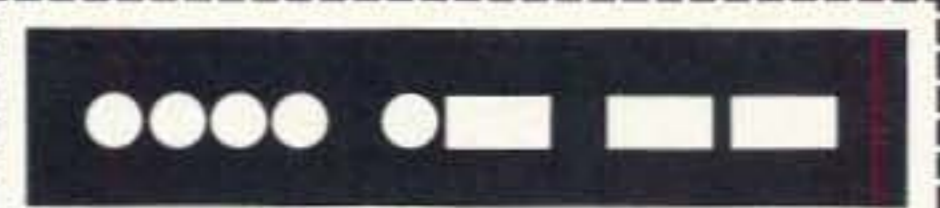

Factory Authorized Dealer & Service For

**KENWOOD  
YAESU  
ICOM**

Call Us For  
Great Prices & Great Service

TOLL FREE ORDER LINE 1-800-344-3144  
Continental U.S. & Texas

ICOM, INC. **THE HAM CENTER** SAN ANTONIO TEXAS  
SALES AMATEUR RADIO SERVICE

5730 Mobud San Antonio, TX 78238 (512) 680-6110  
FAX (512) 647-8007

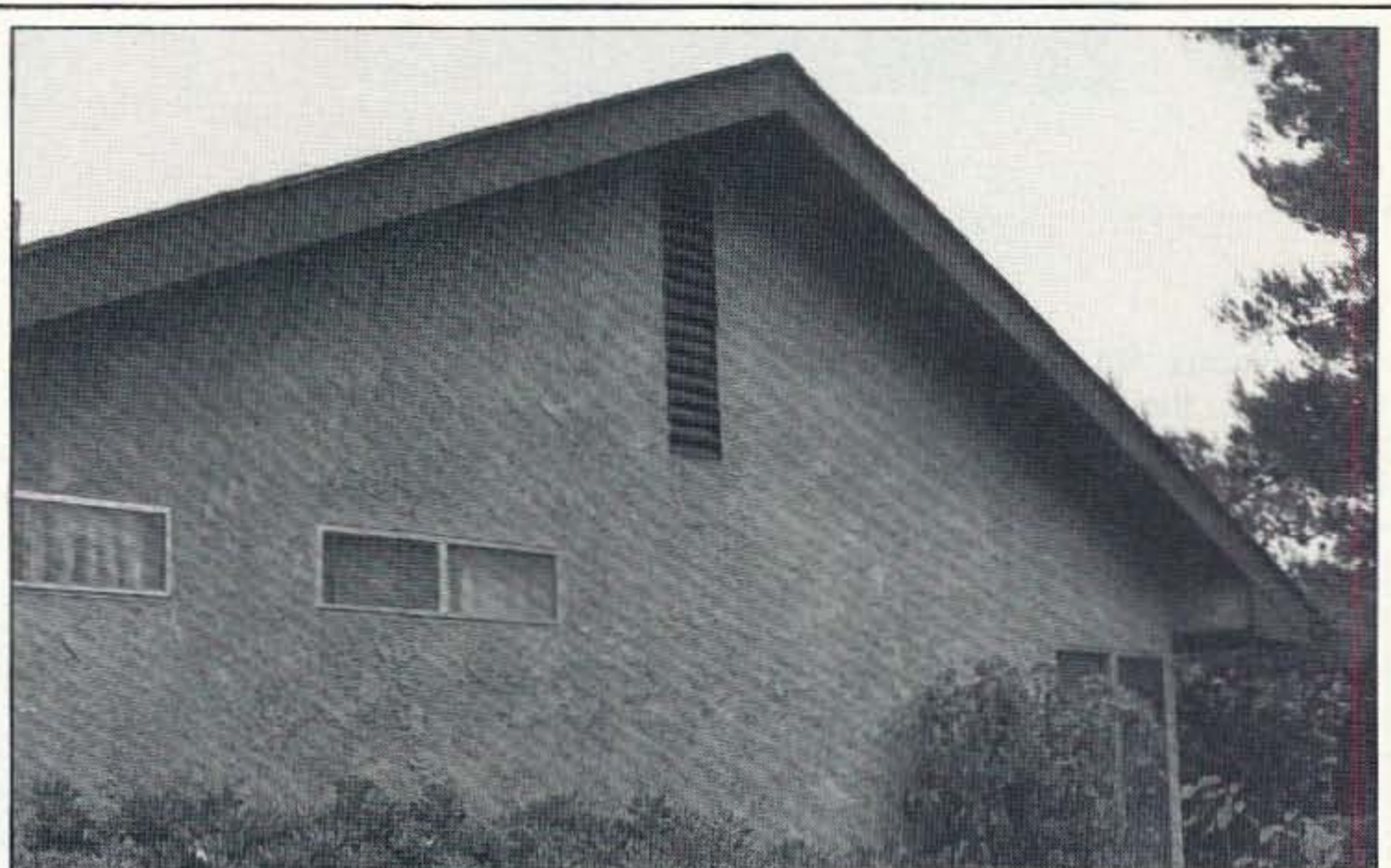

## SGC's Hidden (160-10) Antenna

Covenants, building codes and neighbors limiting your HF operations? SGC would like to share a simple solution using 90 feet of wire, some TV twin lead stand-offs and the legendary SG-230 Smartuner™. Here's part of a letter from Jerry Davis of Amateur Radio Installations, in Los Angeles, California:

"Dear SGC:

I recently installed the system you see here for an elder ham who lives in a retirement community. This was one of those cases where a ham wanted top notch performance on all bands-and boy, did you guys deliver!

As you'll see, the Smartuner is mounted under the peak of the roof and two #8 stranded insulated wires run under the eaves down from the peak and down either side of the building. Each is 45 feet long. I hope you can see this in the close up picture. This antenna only took a few hours to install and no one noticed us doing anything as it looked like we were working on the eaves!

When we fired it up, the system tuned perfectly on every band. My client is pleased and even asked me to send along her picture, but she had to hide her features because there are still a lot of people in the retirement community who don't realize she's running 9 band DX.

Thank you for your suggestions on this installation.

By the way, I worked Madrid, Spain from the car using the SG 2000, SG-303 and Quick Mount System the other day around 1 PM local time.. Believe it or not, I had a better signal than almost all the fixed stations here in the LA area. Keep it up and best 73's

Jerry Davis, KK6YO"

For a free information package, call SGC at 1-800-259-7331 or circle our Reader Service number. We make our great transceivers, antenna couplers, antenna systems and accessories right here in the U.S.A.



A proud owner of a hidden antenna system using an SG-230 Smartuner™ from SGC.

**SGC**

PO Box 3526  
Bellevue, WA 98009 USA  
Fax (206)746-6384  
(206)746-6310 or  
1-800-259-7331

CIRCLE 188 ON READER SERVICE CARD







### Pin Assignments for J3

Pin #	Function
1	PTT
2	PTT Ground
3	Mike
4	Mike Ground

Note: For use with ICOM or similar handhelds, jumper pins 2 and 3 together in the interface cable plug.

helpful for preventing wiring mistakes.

I mounted most of the components on the top side of the circuit board. The three adjustable resistors and the microphone were mounted on the underside of the board. The underside mounting is due to the board's location close to the inside of the case. I drilled three holes in the case in order to allow for timer and mike level adjustments to be made externally just before hiding the fox. A fourth hole was made to allow direct access to the microphone.

I chose to use a readily available ABS plastic case, even though it offers no RF shielding. To date, I have not experienced any problems with RF interference.

For hiding, I wanted to use a piece of large-diameter PVC pipe to house the FOXBOX and transmitter. The pipe would help with disguising the fox and would also provide protection to the devices inside. Because the FOXBOX was to be placed in the pipe, I wanted all of the external jacks and

*Continued on page 50*

### Parts List

Part	Description	RS Part #
U1	7805 5V regulator	276-1770
U2	556 dual timer	276-1728
	14-pin IC socket	276-1999
U3	ISD1000	276-1325
	28-pin IC socket	276-1997
U4	4N26 optoisolator	*Mouser #570-4N26
	8-pin IC socket	276-1995
R1,R4	100k PC mount pot.	271-284
R2,R3	100k	271-1347
R5	3.3k	271-1328
R6,R7	2.2k	271-1325
R8	470k	271-1354
R9,R12,R13	1k	271-1321
R10	10	271-1301
R11	1k PC mount pot.	271-280
C1	0.01 $\mu$ F	272-131
C2	100 $\mu$ F	272-1028
C3	470 $\mu$ F	272-957
C4,C9	22 $\mu$ F	272-1026
C5	4.7 $\mu$ F	272-1024
C6,C7	0.22 $\mu$ F	272-1070
C8	1 $\mu$ F	272-996
D1	1N4001 rectifier	276-1101
T1	1:1 audio transformer	273-1374
S1,S2	Mini DPDT slide switch	275-407
J1	Power input	274-1563 or preference
J2	1/8" speaker jack	274-248
J3	5-pin DIN jack	274-006 or preference
Microphone	Electret type	270-090
Optional:		
Perfboard		276-162 or 276-168
Case	Size to fit	
Relay	5V SPDT micro	275-240

Note: The relay, if used, would replace U4, R12, and R13. See text.

A drilled and etched PC board for this project is available for \$4.25 plus \$1.50 S&H from FAR Circuits, 18N640 Field Court, Dundee IL 60118.

### 2 Additional RS-232 Ports for HamWindows™!

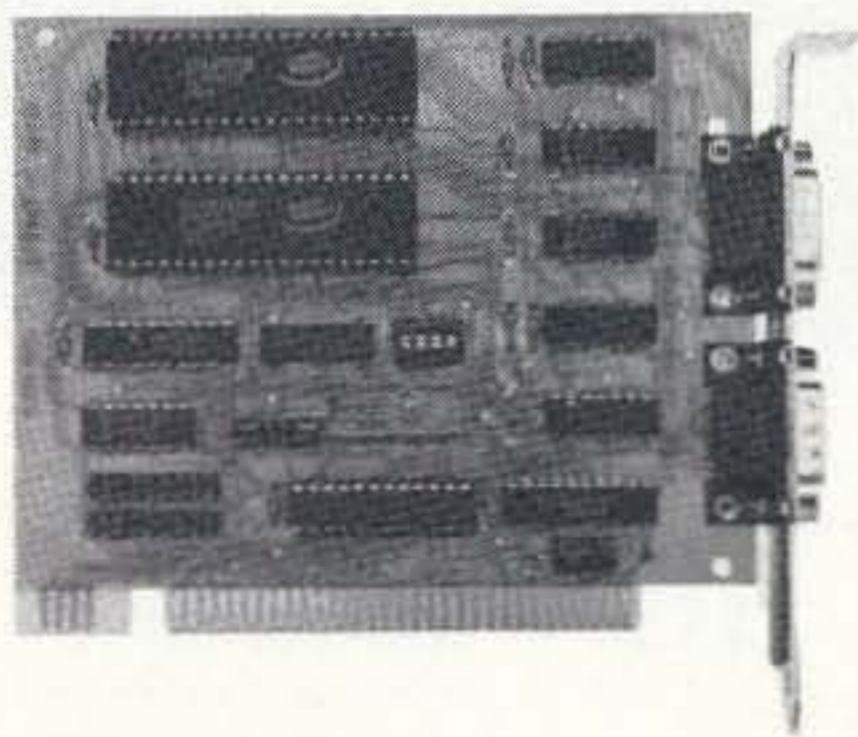

- Two RS-232 Ports with full Modem Control Signals
- Individually Selectable Address and Interrupt (2-5, 10, 11, 12 and 15)
- FREE Technical Support
- 16550s Standard
- MasterCard, VISA and COD accepted!
- Next Day Service available!
- 30 Day Money Back Guarantee
- Part #3088

PRICE: \$89.00

SEALEVEL SYSTEMS INCORPORATED  
P.O. BOX 830 102 W. MAIN ST.  
LIBERTY, SC 29657  
(803) 843-4343  
FAX (803) 843-3067

**SEALEVEL**  
COMMUNICATIONS & I/O

CIRCLE 364 ON READER SERVICE CARD

### PC HF FASCIMILE 7.0 \$99

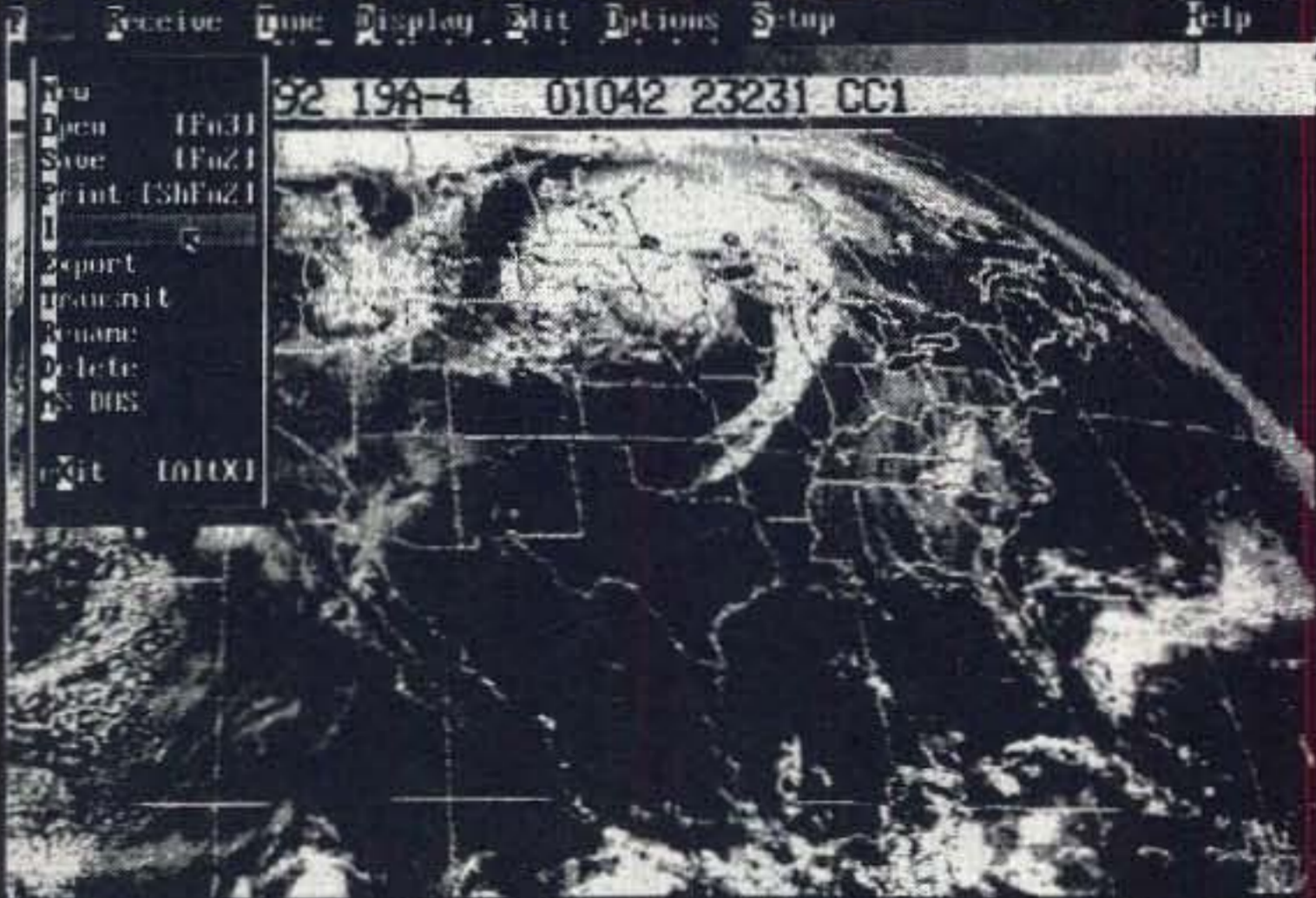

### Now under Windows or DOS

PC HF Facsimile is a simple, yet comprehensive shortwave fax system for the IBM PC and compatibles. It includes an FSK demodulator, advanced signal processing software, tutorial cassette, and complete reference manual. With your PC and SSB receiver getting FAX is a snap. Here are just some of the features:

- |   |   |
|---|---|
| <ul style="list-style-type: none"> <li>• Mouse or Menu Driven</li> <li>• Unattended Operation</li> <li>• Easy Tuning Oscilloscope</li> <li>• Start/Stop Tone Recognition</li> <li>• Up to 256 Levels</li> <li>• Single Scan per Line with EMS Memory</li> <li>• Programmable Colorization</li> <li>• Brightness and Contrast Control</li> <li>• Transmit Option Available</li> <li>• Image Zoom, Scroll, Pan, Rotation</li> </ul> | <ul style="list-style-type: none"> <li>• Grayscale on all Popular Printers</li> <li>• Worldwide Broadcast Schedule</li> <li>• Worldwide Frequency Listing</li> <li>• CGA,HGA,EGA,VGA &amp; Super VGA</li> <li>• Time Lapse Frame Looping</li> <li>• Slide Shows</li> <li>• Programmable IOC &amp; Line Rates</li> <li>• Image Cropping</li> <li>• Automatic Radio Control</li> <li>• NAVTEXT &amp; RTTY Option Available</li> </ul> |
|---|---|

Call or write for our free catalog of products. Visa & MasterCard welcome.

**Software Systems Consulting**  
615 S. El Camino Real, San Clemente, CA 92672  
Tel.(714) 498-5784 Fax.(714) 498-0568

CIRCLE 250 ON READER SERVICE CARD



**WORLD**

# Setting New Standards

IN THE WORLD OF

## Communications, Test & Surveillance

**Further • Better • Faster**



**Model 3000A \$329.**

World's most highly advanced hand held counter.

- Digital Filter: Reduces false counts - no loss of sensitivity
- Digital Auto Capture - auto hold & store; works even near strong RF Fields
- Stores and recalls frequencies
- 5-6 hour battery operation
- Fast - 250 million counts per second for high resolution - 250 MHz direct count
- 10 Hz to 3 GHz
- Ultra sensitive bargraph w/ 16 segment display
- Multi-Function Counter with Frequency, Period, Ratio and Time Interval
- Optional  $\pm .2$  PPM TCXO- \$100.

**Model M1 \$229.**

Full Range Pocket Sized Counter

- Digital Filter
- Digital Auto Capture - Auto Hold
- Stores & Recalls Frequencies
- 4-5 hr. battery operation
- 10 Hz to 2.8 GHz
- 10 digit LCD with EL backlight

**Model 8040 \$679.**

Multi-Function Bench/Portable Counter Measures Frequency Period, Ratio, Time Interval and Average.

- Digital Filtering to eliminate false counts
- Auto Capture/Auto Hold
- 16 Segment Signal Strength Bargraph
- Dual 50 OHm and 1 Meg OHm input amplifiers with AC/DC Coupling,  $\pm$  Polarity, Triggers Level Adj., Low Pass Filter and Attenuator
- .05PPM, 0-50°C Oversized Time Base Option
- Internal/External Clock Input
- RS-232 Serial Computer Interface

**800 • 327 • 5912**

(305) 771-2050 • FAX (305) 771-2052 • 5821 NE 14th Ave, Ft. Lauderdale FL 33334





**Model DC440 Decoder \$259.**

- 50 Sub-Audible (CTCSS) tones
- 106 Digital (DCS) Codes
- 16 Touch Tone (DTMF) characters/126 character recall
- Serial Data Interface
- Update older service monitors
- Ideal for testing two way radios
- Tone log software available
- Exceptional 2x16 character backlit display
- Small size - 1.8" x 4.5" x 4" deep



**Model 3300 MiniCounter \$129.**

- Super Compact
- 10 digit LCD - longer battery life
- 1 MHz to 250 MHz direct count for high resolution (1 Hz/Second)
- Maximized Sensitivity
- Hold Switch to lock display
- Ni-Cad plugs into board - no soldering to change outpack



**Model CF-802 \$149.**

835 MHz ± 10 MHz filter/amplifier. 10 times the pick-up distance when used with our counters or R-10.

**Model R-10 \$359.**

The R-10 is a unique FM Communication Test Receiver with security and surveillance applications. 30 MHz to 2 GHz. Measures deviation and relative signal strength. Demodulates FM

**Model APS104 \$995.**

Tunable band pass filter covers 10 MHz to 1,000 MHz. Tunes continuously over more than 5 octaves. Increase pickup distance 10 times. Ultimate Security Sweeper.

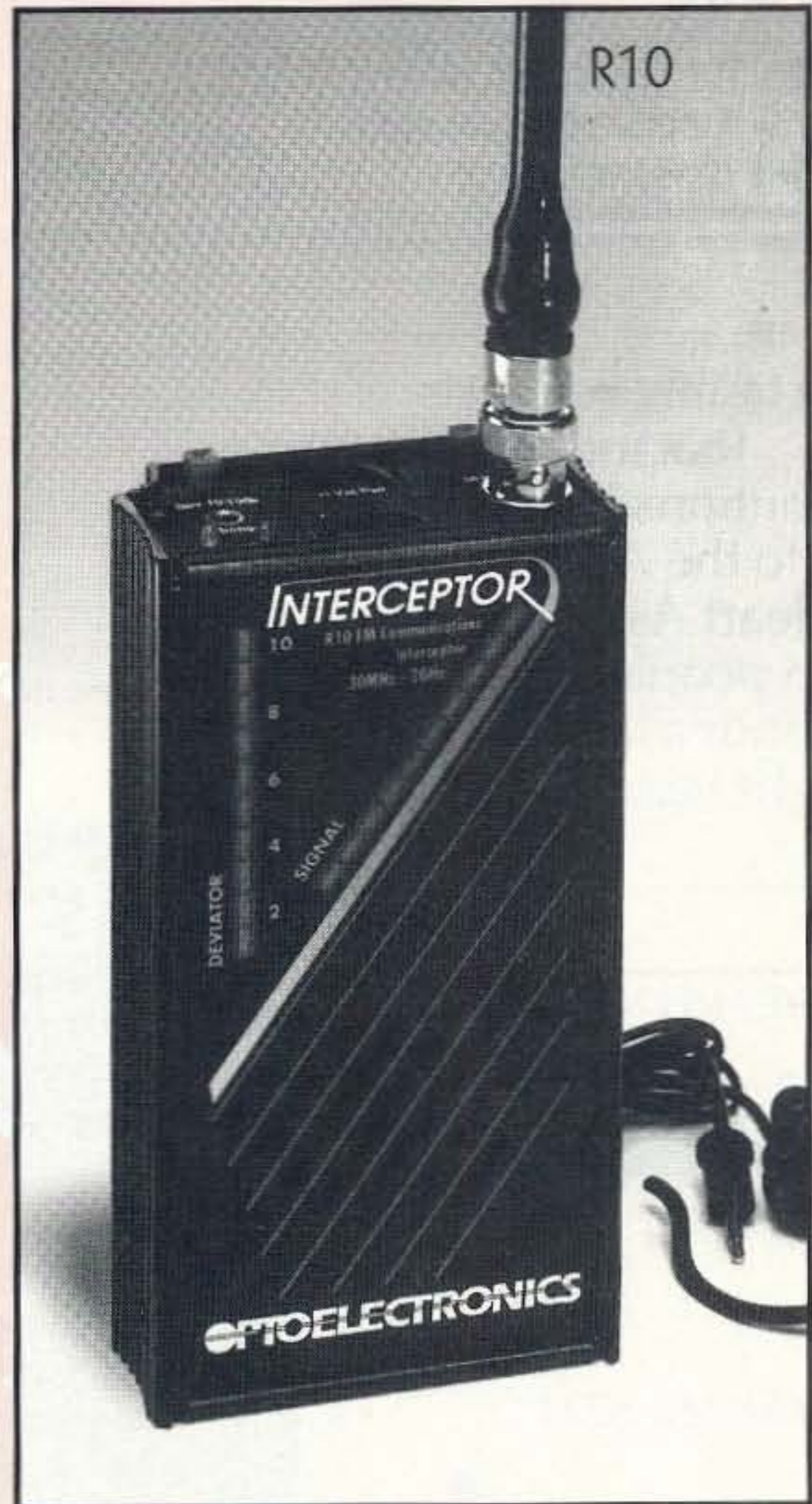

5% Ship/Handling (Max \$10) U.S. & Canada. 15% outside continental U.S. Visa Master Card, C.O.D., Cash or Money Orders only. All specifications and prices are subject to change without notice or obligation.

**MADE IN THE U.S.A**

**COMING FROM THE FUTURE**



## How To Get Started In Packet Radio



Enter the exciting world of **packet radio** today with *How To Get Started In Packet Radio*. Dave Ingram, K4TWJ, wrote this beginner's guide to **packet radio** in an easy-to-understand manner. It starts with a non-technical description of packet radio, followed by chapters that include getting started, setting up your station, networks, BBSs, portable and high-frequency operation and even a *Packet Radio Equipment Survey*. There's also an appendix that includes circuits for interfacing equipment. **Join the most exciting and rapidly growing area of ham radio today!** Order your copy of *How To Get Started In Packet Radio* book for only \$9.95! (plus \$2.00 S&H).

**NARA**  
NATIONAL AMATEUR RADIO ASSOCIATION

**CALL US TODAY!!**

P.O. Box 598, Remond, WA 98073  
Orders Only 1-800-GOT-2-HAM  
Inquiries (206) 869-8052

CIRCLE 223 ON READER SERVICE CARD

"The family suggests that memorial contributions be made to the American Heart Association." When people want to honor a loved one and fight heart disease.

THE AMERICAN HEART  
ASSOCIATION  
MEMORIAL PROGRAM

1-800-242-8721

American Heart  
Association



This space provided as a public service.  
© 1992, American Heart Association

## The Fox Box

Continued from page 47

switches at one end of the case. I achieved the placement goal with one exception: I did not leave enough room on the end of the timer case to place the jack for an external monitoring speaker. Placing the jack on the side of the case caused only a minor problem because the speaker would not be used when the FOXBOX was hidden. Careful attention should allow all jacks and switches to be placed on the end of the case.

### Connectors and Switches

Three external connection jacks and two switches are used for the FOXBOX. For the power jack, I chose a coaxial power connector identical to the one used by my ICOM HT. The speaker uses a standard 1/8-inch phono jack. I chose to use a 5-pin DIN plug for interfacing the radio. Any 4-or-more-pin jack would have worked well here. The DIN plug was the least expensive option explored.

I wanted the switches to be low-profile slide switches. A DPDT switch is required for playback/record selection. An SPDT switch is required for power. I used two small DPDT switches because they were easily available.

### Operation

Operating the FOXBOX is straightforward. Apply 8 to 12 VDC, then put the play/record switch (S2) into the RECORD position. Speak at a normal level into the microphone to record a message up to approximately 20 seconds long. The message *must not* be long enough to entirely fill U3's memory or message playback may not occur properly. At the end of the message, place S2 back in the PLAY position. The newly recorded message will now play back once at the end of every cycle of Timer 1.

An interface cable is required between the FOXBOX and the hidden transmitter. I want

to be able to use two different radios for the hidden T. The first radio, an Alinco 570 uses a four-conductor interface cable to carry PTT, PTT ground, MIC, and MIC ground signals. The second radio, an ICOM O2-AT handheld, only needs a two-conductor cable. To use the HT, the MIC signal from the FOXBOX is placed in series with the PTT ground connection.

I had originally intended to use a third switch in the FOXBOX to accomplish the series MIC connection for HT use. I decided not to use the switch and instead just shorted the appropriate pins in the interface cable connector. The decision to eliminate the switch saves the space required to mount the switch on the case.

### Conclusions

Designing and building the FOXBOX was quite fun. If the relay keying circuit is counted, I achieved my goal of building the device entirely of parts available at any Radio Shack store. Future improvements to the FOXBOX could include filters for the audio output. Addressing circuitry could be used to allow the record and playback of several short messages by the ISD1000A. The FOXBOX will serve well to control many types of hidden transmitters. If the FOX is to be hidden for a long period of time, provide plenty of battery capacity for the transmitter. The FOXBOX itself draws only a small amount of power so large batteries are not needed. Creative housings for the entire FOXBOX package will allow limitless hiding possibilities. Let the imagination fly. 73

### References:

1. Moell, Joseph D., KØOV, and Thomas N. Curlee WB6UZZ. *Transmitter Hunting: Radio Direction Finding Simplified*. Blue Ridge Summit: Tab Books, 1987, p. 193.
2. Tandy Corporation. *ISD1000A Voice Record/Playback IC*. Fort Worth: Tandy Corporation, 1992.

## HUGE 100 PAGE CATALOG

- Communications Receivers
- Portable Receivers
- Scanners
- Amateur HF Transceivers
- VHF-UHF Transceivers
- HT's and Mobiles
- Amateur and SWL Antennas
- Accessories and Parts
- RTTY and FAX Equipment
- Books and Manuals

*This catalog includes prices!*

Send \$1 to

**Universal Radio**  
6830 Americana Pkwy. 73  
Reynoldsburg, OH 43068  
Tel. 614 866-4267

**VISA** **SLOW SCAN TV** **Master Card**  
with the Sound Blaster!

New! Copy 8, 12, 24, 36 sec. B&W, 36 & 72 sec. Color (in B&W), Scotty 1 & 2 (in B&W) with your Sound Blaster compatible sound card. Requires VGA 640x480-256 colors. ONLY \$40.00 - Shipping \$5 Illinois residents add \$2.50 tax

Harlan Technologies 815-398-2683  
5931 Alma Dr. - Rockford, Illinois 61108

CIRCLE 187 ON READER SERVICE CARD

Say You Saw It In  
**73 Amateur Radio Today**

**NEON CALL "SIGNS"**

- Real NEON tubing (each character 4" H x 3" W)
- Hand crafted, lasts for years
- The ultimate in "Shack" decor
- Mounted between acrylic for durability
- Available in NEON red, "clear" blue, orange, white, sky blue, rose, pink & green
- Complete with transformer and hardware
- 1 year limited warranty
- Available with bottom NEON accent strip, boarder or other custom design

Complete custom unit, tested and delivered: \$225.00.  
Allow 4-6 weeks delivery. Send order with check or MO (sorry, NO COD's) to:

**JUST NEON** H. Cohen, WA2TVE  
409 James Street, Utica, New York 13501  
(315)724-9150 • (315)792-9032 FAX  
N.Y. States Residents Add Sales Tax



# Simply A Superior 1.3 GHz Spectrum Analyzer

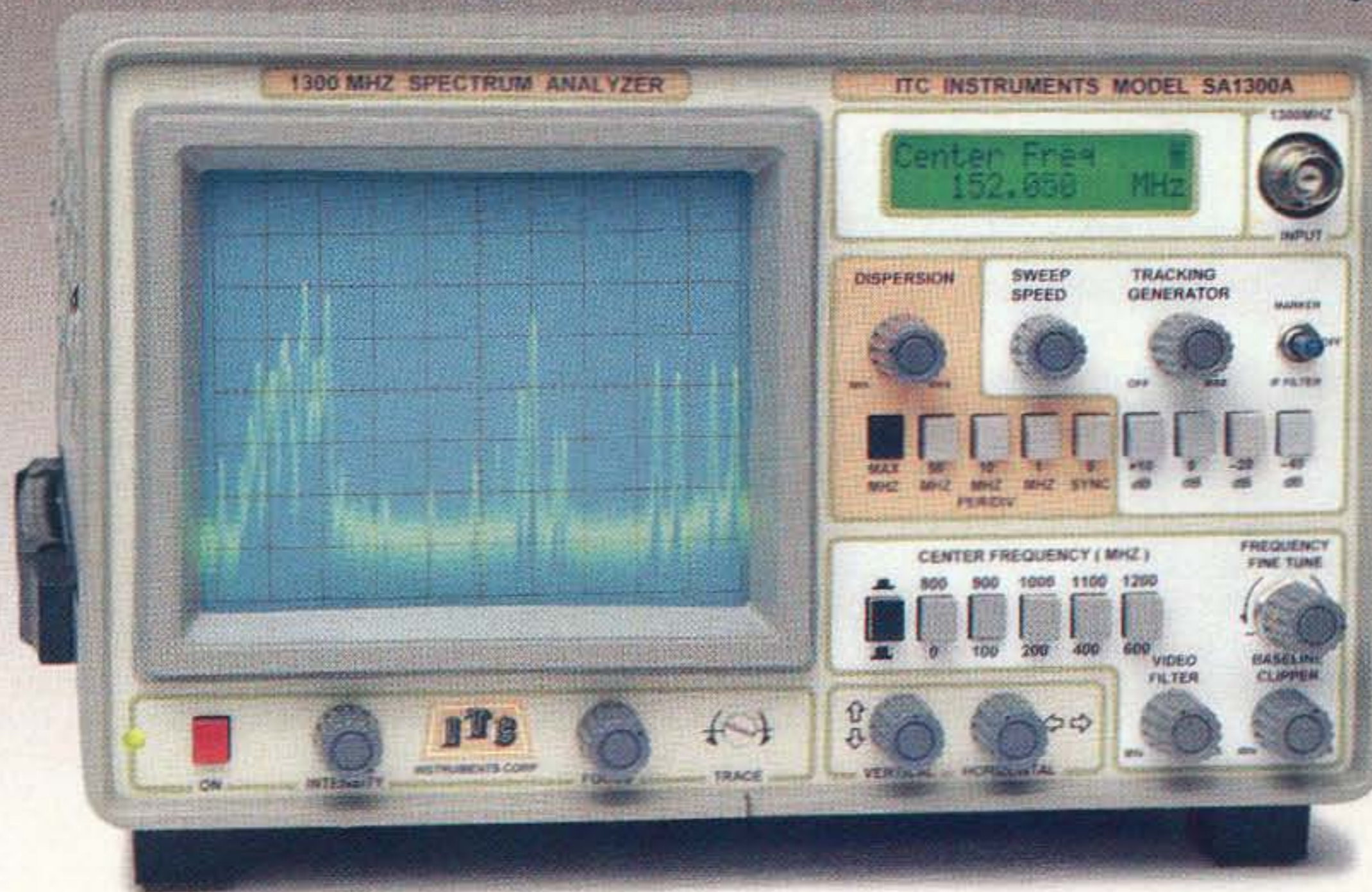

## 1-1300 MHz In One Sweep \$1,795.

**MADE IN USA** -10KHz Resolution Band Width -7 Digit Center Frequency Display

**MARINE, TWO-WAY, HAM, AM FM SW BROADCAST RADIO - CATV, SATELLITE. SYS., SURVEILLANCE  
TUNE DUPLEXERS, AMPS, FILTERS, SECURITY TRANS, & RECEIVERS - EMI, RFI, FCC, TESTING**

### EXCLUSIVE DISPERSION ZOOM

ITC SA Series exclusive Dispersion Zoom lets you zoom in on **any Center Frequency** signal, from any one of five calibrated Dispersion positions. Preset at >140 MHz, 50MHz, 10MHz 1MHz and zero MHz per division. The SA1300A displays greater than 1300 MHz on the screen at one time yet allows instant zoom to any Dispersion Scan Width as low as zero MHz per div. Allowing for total control over all **Dispersion Scan Widths** settings.

### 80 dB ON SCREEN

130 dB total Dynamic range **110 dBm Sensitivity**. At Narrow and Wide Band Width settings. Performance you would expect only from a \$10,000 Analyzer.

### ULTIMATE LOW COST ANALYZER

ITC Spectrum Analyzers are the best performance to price ratio Analyzers on the market today. No other low cost Analyzer comes close to the Superior performance and quality of an ITC Analyzer. **Total flexibility and ease of operation.** SA1300A gives you full control over the Resolution Band Width and Freq. Span widths. Plus Vertical Position, Baseline Clipper, Sweep Speed, Video Filter, 4 Input Attenuator settings, 10 Frequency Select settings.

### MODEL SA1800B 1800 MHz

Covers 1-1300 MHz and 850-1850 MHz in one sweep. Ideal for Satellite service. The **SA1800B** has the same general specifications as the model SA1300A.

### INTRODUCTORY OFFER

**SA1300A & OPT.s 1, 3, 6  
ONLY \$1795.00** note 1

**SA1800B & OPT.s 1, 3, 6  
ONLY \$2195.00** note 1  
\$1995.00 Opt. 1, 6 ONLY

SA1300A	\$1595.00
SA1800B	\$1895.00
OPT. 1 50MHz MARKER	\$200.00
OPT. 3 +/- 5KHz Res B.W	\$350.00
OPT. 5 1000 MHz Tracking Generator	\$250.00
OPT. 6 7 Digit Center Frequency Display	\$300.00

Note 1: Introductory Price for limited time only.

**TAKE ADVANTAGE  
CALL 1-800-566-1818**

To: Order - For Information & Special Intro. Offer  
Terms MC, VISA, AE, Check, COD, PO (OAC), LC, Transfer

DISTRIBUTED BY: **ADVANTAGE** INSTRUMENTS CORP.

3276 KITCHEN DR. P.O. BOX 2152 CARSON CITY NV. 89702

1-800-566-1818 702-885-0234 FAX 702-885-7600

PRICES & SPECIFICATIONS SUBJECT TO CHANGE WITHOUT NOTICE OR OBLIGATION. F.O.B. CARSON CITY NV. NV. RESIDENTS ADD SALES TAX.

CIRCLE 149 ON READER SERVICE CARD



# The Commercial General Radiotelephone Operator License

*Pass that test!*

by Gordon West WB6NOA

You may remember the FCC's very tough examination for the First Class Radiotelephone Operator License, better known simply as the "1st phone;" the license necessary to work on and adjust broadcast radio equipment. If you worked on two-way radios, you needed the "2nd phone." And if you operated over boat radios that carried passengers for hire, you needed the "3rd class license."

Then the FCC lumped the 1st and 2nd class licenses into one common license called the Commercial General Radiotelephone License, and gave it lifetime status. Then the Commission went on to deregulate the land mobile radio service maintenance laws, and threw out the requirement that fixing this equipment required the GROL (General Radiotelephone Operator License).

But the rules still require that all technicians who repair and adjust marine and aviation radios must have a GROL to work on transmitter sections. The radar endorsement is also necessary if the technician goes inside a ship's radar for internal adjustments.

Meanwhile, the FCC has been hit with cutbacks. The commission was not able to keep up with a current question pool nor a schedule of when the GROL examinations could be offered. In fact, there was a period about a year ago when the FCC would not give an applicant the exam unless that applicant could prove that he or she really needed the license in the first place!

So now it's a whole new ball game—the commercial radiotelephone operator license is fast becoming that coveted "wallpaper" to get. The good news is, the GROL exam

has never been easier!

Recently, the FCC released "new" (ha) test questions and appointed nine private organizations to administer the examinations. These private organizations are called Commercial Operator License Examination Managers or "COLEMs." Serving the amateur radio operator who wants to take the new tests is our familiar W5YI VEC group (telephone: 817/461-6443), working as a COLEM under the name "National Radio Examiners Division." Commercial examinations are given by the same team of W5YI examiners who give ham tests, and they very well could offer the GROL test right after the amateur radio tests.

"The COLEM system is similar to the VEC system in that a specified number of questions are selected for the written exami-



**JADE PRODUCTS, INC.**  
P.O. Box 368  
E. HAMPSHIRE NH 03826-0368  
PH 603-329-6995 8AM-9 PM EST  
FAX 603-329-4499 24 HRS/DAY

PUTTING THE AMATEUR BACK IN RADIO

**HIGHLY PORTABLE TWIN-LEAD  
2 M J-POLE ANTENNA**

GREAT FOR APARTMENT DWELLERS W/O SPACE FOR AN OUTDOOR ANTENNA. ONLY 60 IN. (1.5M). RUGGED CONSTRUCTION. COMES WITH STANDARD SO-239 COAX CONNECTOR. NEEDS NO ASSEMBLY! ROLLS UP FOR TRAVEL—TAKE IT ON YOUR NEXT TRIP!

JADE-POLE \$14.95

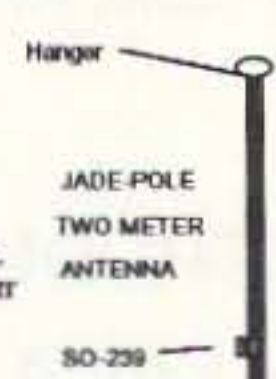

Hanger  
JADE-POLE  
TWO METER  
ANTENNA  
SO-239

FUN-KIT LINE

**BC01 BATTERY CHARGER KIT**  
(LEAD-ACID/CEL. CEL.) USES THE UC3906 I.C. CONT. DUTY, KEEPS BATTERY CHARGED. QUALITY COMPONENTS USED. PCB MOUNTED. PWR. XFMR., EMI LINE FILTER, AMMETER, ENCLOSURE & ASSY MANUAL FOR 12V BATTERIES (BULK RATE 1A). PROGRAM OTHER VOLTAGES. 110/220 VAC, 50/60 HZ. .... \$79.95

**BC02 BATTERY CHARGER MODULE** BC01 LESS ENCLOSURE, EMI FILTER & METER. MOUNT IN YOUR OWN ENCLOSURE. .... \$39.95

**BC03 BATTERY CHARGER MODULE** BC02 LESS TRANSFORMER. NEEDS 16-21 VAC 50/60 HZ AT 1.2 AMPS. .... \$29.95

**TWIN-LEAD MARCONI ANTENNA**

EASIER TO ASSEMBLE. TRIM TO LENGTH & ADD COAX. HALF THE SIZE OF A DIPOLE. NEEDS NO TUNER. MAX. PWR: 700 W/ 50 Ω.

AN-01 160 METER TWIN-LEAD ANTENNA \$39.95  
AN-02 80 METER TWIN-LEAD ANTENNA \$34.95

**EK01, EXPERIMENTER'S KIT**  
PROTOTYPING KIT FOR RADIO. INCLUDES PCB, NE602AN, MC1496, LM386, 7.5 x 8.5 x 3.5 ENCLOSURE WITH HARDWARE AND ASSY MANUAL. .... \$39.95

10-00001 EXPERIMENTER'S PCB ..... \$12.95  
11-00001 CHIP SET (NE602AN, MC1496, LM386) ..... \$ 6.00  
31-00001 ENCLOSURE: 7.5 x 8.5 x 3.5" (H/W & ASSY MANUAL) ..... \$33.95  
45-00001 NE602AN MIXER OSCILLATOR \$2.25EA OR 6 FOR ..... \$10.00  
45-00002 MC1496L MIXER ..... \$ 3.00  
45-00003 UC3906 BATTERY CHARGER ..... \$ 7.50  
45-00004 NE604AN IF-LIM-PHASE DETECTOR ..... \$ 5.00  
45-00005 8044ABM CURTIS KEYSER CHIP ..... \$17.95  
MC-00003 DOG-BONE ANTENNA INSULATORS ..... \$ .65

VISA, MASTER CARD, CHECK OR MONEY ORDER ACCEPTED  
USA SHIP COST: \$4.75 FOR 1ST \$1.00; \$1.00 FOR EA. ADD'L \$1.00. NO MIN. ORDER.

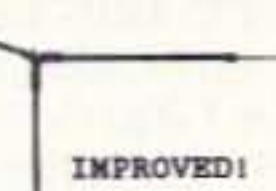

IMPROVED!

CIRCLE 133 ON READER SERVICE CARD

Sell  
Your Product In

## 73 Amateur Radio Today

Call Dan Harper  
Today . . .

# 1-800-274-7373

VOICE KEYS & CW INTERFACE  
RIGHT IN YOUR PC!

## The Contest Card

This plug-in board turns your PC into a high-powered contest machine. Record your call, CQs, contest reports, etc. for play back under control of your PC — both phone and CW! Works with XT-486 PCs, does not use up valuable disk space storing audio. Compatible with CT™ & NA™ contest software. See the Sept. '93 QST magazine article (pg.31) on the Contest Card.

ASSEMBLED & TESTED \$179.95. KIT \$119.95  
(Cable not included) \$5.00 S&H per order. WI add 5% sales tax.

Send check or money order to: **UNIFIED MICROSYSTEMS**  
(414) 644-9036 P.O. BOX 133 B  
SLINGER, WI 53086

CIRCLE 317 ON READER SERVICE CARD

# FREE 1994 CATALOG



Your Reliable Source for a World of Crystal Clear Communications  
JAN Crystals  
CRYSTAL CATALOG, NO. 17 - 1994

SAVE MONEY-HIGH QUALITY,  
FAST DELIVERY

General Communication • Industry  
Marine VHF • Scanners • Amateur Bands  
CB Standard • CB Special • Microprocessor

CALL TOLL FREE: 1-800-JAN-XTAL

# JAN Crystals

P.O. BOX 60017 • Fort Myers, Florida 33906  
(813) 936-2397



CIRCLE 240 ON READER SERVICE CARD



# ALL ELECTRONICS

Courteous Service · Discount Prices · Fast Shipping

## 5 WAY MULTI-POINT TEST LEADS



High quality, flexible, cloth covered red and black test leads with telecom industry

standard 5 way multipoint test clips on one end and spade lugs on the other end. 5 ways to connect clips: 1) U-shaped nose for qc terminals; 2) Notched jaw for gripping screws, wires or terminals; 3) Serrated teeth for threaded or wire wrap terminals; 4) Cluster of small needles for piercing small gauge wires; 5) Large piercing needle for piercing larger wires. 4 feet long. At one end of the cord is a 1500 ohm resistor that can be switched in and out of circuit.

**\$3.50** per set

CAT# TL-200

## SUPER SPECIAL!

### 11 Vdc, 500 ma. WALL TRANSFORMER

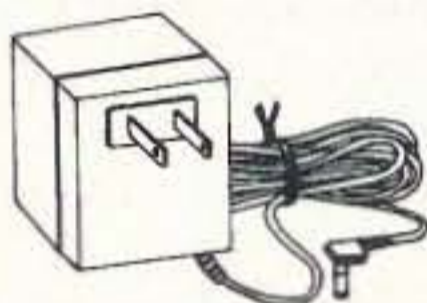

White-UL listed wall transformer. 11 Vdc, 500 ma. output to a 2.1 mm co-ax plug with center positive.

CAT# DCTX-115

**\$2.00** each

100 for \$175.00

## 10 BUTTON MEMBRANE KEYPAD



10 button, matrix encoded keypad. Peel-and-stick backing for easy mounting. Originally designed for use on a satellite TV tuner, the keys have satellite names and related text on them in addition to numerals 0 through 9. Overall dimensions are 9" X 1.625", but half of the strip can be cut off with a knife or scissors, leaving a self-sticking keypad of 4.5" X 1.625". Silver keys with charcoal numerals and background. 6.5" flexible ribbon cable, terminated with 7 pin socket connector - 0.1" spacing.

CAT# KPM-10

**\$1.25** each

10 for \$10.00

ORDER TOLL FREE

**1-800-826-5432**

CHARGE ORDERS to Visa, MasterCard or Discover

TERMS: Minimum order \$10.00 Shipping and handling for the 48 continental U.S.A. \$4.00 per order. All others including AK, HI, PR or Canada must pay full shipping. All orders delivered in CALIFORNIA must include state sales tax (7.25%, 7.5%, 7.75%, 8.25%, 8.5%) Quantities Limited. NO C.O.D. Prices subject to change without notice.

Call Or Write For A Free **64** Page CATALOG

Outside the U.S.A. send \$2.00 postage.

MAIL ORDERS TO:  
ALL ELECTRONICS CORPORATION  
P.O. Box 567  
Van Nuys, California  
91408

FAX (818) 781-2653

CIRCLE 194 ON READER SERVICE CARD

**\$489!!**

2M/440

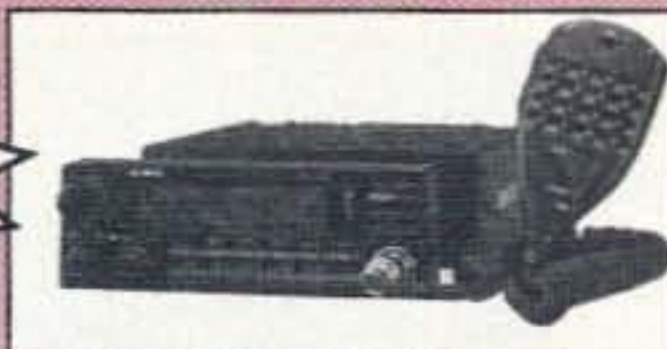

## DR-592T DUAL BAND MOBILE

45 Watts/2M (Rx 137-173/Tx 144-148), 35 Watts/440 (Rx 410-470/Tx 440-450). Head can be remoted up to 16 feet from radio with optional EDC-20. Cross-Band Repeater, can be turned on and off remotely, frequencies can be changed, all from your HT (DR-592T requires EJ-8U for HT Remote Control). 30 Memories + 10 additional automatic

repeater memories + 2 call channels. Tone Encode, remote control/DTMF encode microphone included.

Options: EJ8U DTMF Decoder \$43.95  
EDC-19 9-Ft Remote Kit \$36.95

EJ7-U Tone Squelch \$62.95  
EDC-20 16-Ft Remote Kit \$39.95

## LARSEN ANTENNAS

Every Model in Stock!

**KG144** 2.4 dBd \$47.95

2M ON-GLASS

**KG220** 2.4 dBd \$47.95

1.2M (222MHz) ON-GLASS

**KG2/70** 2.5, 4.5 dBd \$67.95

2M/70CM (440MHz) ON-GLASS

## DJ-162TD 2 Meter HT

2M (Rx 137-174/Tx 144-148). 20 Memories + Call channel. DTMF Encode and Decode. Tone Encode (Decode W/EJ6U). Paging functions, Scanning, etc. Comes with AA Cell Battery case, see below for Nicad Packs/Chargers

**\$195**

2MHT

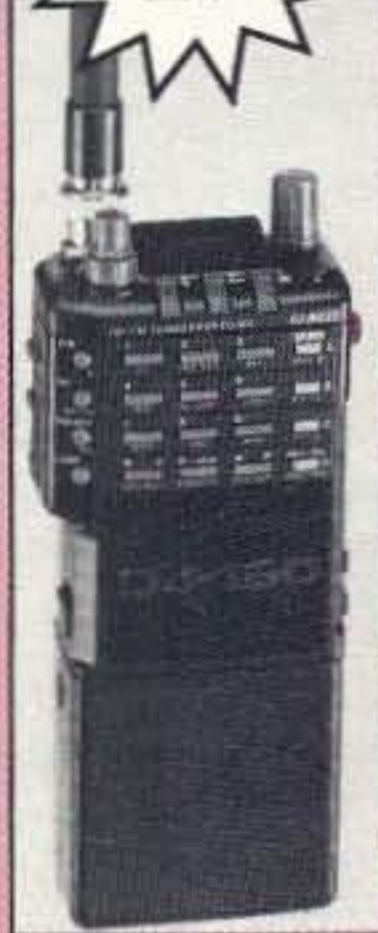

Optional Battery Packs for DJ-560 & DJ162-TD  
EBP-10N 7.2V x700MAH Only \$25.00!!

EBP-10NA/12NA can be used with the EDC37 Smart Charger or wall chargers  
EBP-10NA 7.2V x 700MAH only \$45.95 EBP-12NA 12V x 700MAH only \$59.95  
EDC-17 charger for EBP-10N/NA or EDC-18 wall charger for EBP-12A \$15.95

These are some of the best deals of all time, where can you find a brand new 2M/440 Mobile for under \$500.00 with all these features, Dual Band HT for under \$300, or 2 Meter HT for under \$200?

To order, send check or money order with \$8.50 for shipping, along with your shipping address (sorry no U.S. Post Office Boxes, UPS will not deliver) and Telephone number to:

Joe Brancato  
THE HAM CONTACT  
PO Box 3624, Dept 73  
Long Beach, CA 90803

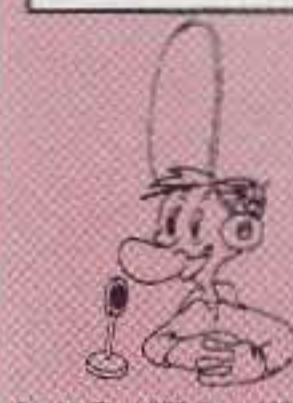

Serving The LORD Since 1987

CA Residents Add 6 1/4% Sales Tax. Canadian Residents please send U.S. Money Order + \$17.10 for shipping. If you wish more information please send a SASE to the above address. For COD orders, call (310)433-5860, outside of CA **Orders Only** call (800)933-HAM4 and leave a message.

CIRCLE 384 ON READER SERVICE CARD

## Join the FUN on the SATELLITES

YES! Anyone with a Technician Class license or higher can work the



via the

## OSCARS

Learn how: Join AMSAT today!

Special Offer: Until March 31, new members receive:

ORBITs - Satellite tracking software by W0SL

How to Use the Amateur Satellites - A great book by KB1SF

Dues \$30 U.S. \$36 Canada/Mexico, \$45 elsewhere VISA/MC accepted

write or call



## AMSAT

PO Box 27 Washington, DC 20044  
301-589-6062

CIRCLE 110 ON READER SERVICE CARD



nation from a publicly-released pool of questions and multiple choices," comments Fred Maia W5YI. "The National Radio Examiners Division of the W5YI Group is organized into seven testing regions, and we are happy to supply any amateur operator or any test candidate with a list of test center managers."

The Commercial General Radiotelephone License consists of Element 1 questions covering rules and regulations and Element 3 questions covering technical skills. There are 170 questions covering marine radio operator Element 1 rules and regulations, and you must answer correctly at least 18 out of 24 questions from the Element 1 pool.

There are 729 questions found in the commercial Element 3 pool, and you must answer correctly at least 57 out of 76 questions to pass the Element 3 test. And now, here's where it gets interesting for the amateur radio operator . . . the Element 3 technical examination for the Commercial General Radiotelephone License is broken up into eight sub-elements:

1. Operating procedures—three questions
2. Radiowave propagation—three questions
3. Radio practice—five questions
4. Electrical principles—16 questions
5. Circuit components—13 questions
6. Practical circuits—22 questions
7. Signals & emissions—nine questions
8. Antennas & feedlines—five questions

Similar to a ham test, a specific number of questions must be used out of each sub-element.



Photo A. It takes a commercial license to work on marine and aviation transmitters.

ment. And where did these questions come from? They were submitted by a very few interested parties when the word went out that the FCC was looking for new updated technical questions. In fact, the response was so poor that the Commission needed to come up with hundreds of questions to add to the few questions that were submitted for this pool.

And where did they get over 500 questions on the Element 3 question pool? You guessed it. Here is the breakdown:

- 729 total Element 3 questions
- 315 taken from amateur Advanced question pool
- 236 taken from amateur Extra Class question pool

Wayne is mad as hell ...  
...and he doesn't want you  
to take it anymore!

## Declare War!

On Our Lousy Government

Fed up with the mess in Washington?  
The mess in your state capital?  
Poverty, crime, our failing schools?  
Wayne Green has solutions.  
Clever solutions.

Wayne Green's unique reasoning is intriguing — even delightful. Whether you are horrified by his proposals or you embrace them, it is impossible to ignore the basic lesson he presents: It is time to bring logic — not emotions — to bear on America's dilemmas. His spin on America in the 90's helps us to understand how simple the seemingly complex issues are. All it takes is looking at them from an entirely new viewpoint.

Now available in one complete volume, *Declare War!* is full of thought provoking ideas and solutions to some of the most difficult problems facing our country today.

Regular price: \$12.95

Special For 73 Readers  
Only—\$10.00

(plus \$3.50 shipping & handling)

Order Toll-Free: 800-234-8458

RECEIVE PICTURES LIKE THIS DIRECTLY  
FROM SPACE ON YOUR COMPUTER!



**MultiFAX** offers two fully featured weather satellite demodulators: One model plugs directly into the expansion slot of your IBM compatible desktop PC, the other model interfaces to your PC (laptop, notebook, or desktop) through the parallel (printer) port—perfect for "crowded" computers.

Both versions offer the same powerful capabilities—PLL circuitry for perfectly straight edges on NOAA and GOES satellites. Capture ALL the high resolution the NOAA satellites can provide (2-3 miles) in visible and infrared with a full 12 minute recording.

**FEATURES INCLUDE:** NOAA, Meteor (Russia), Meteosat, GOES, and HF Fax ■ Direct Write to Disk (Extended or Expanded memory NOT Required) ■ Images have Straight Edges - Even from NOAA and GOES Audio Tape Recordings ■ "Point & Shoot" User Interface with Full Mouse Support ■ 256 Colors/64 Shades of Gray, 1024x768 Pixels with SVGA ■ VESA Video Support ■ Zoom to 800% ■ Powerful Image Enhancement ■ GIF File Output ■ False Colorization ■ Unattended Timer Recording ■ Animation (looping) for GOES and Meteosat ■ Calibrated IR Temperature Readout ■ Dot Matrix and Laser Printer Output ■ "3D" Enhancement ■ Latitude/Longitude and Map Overlays (USA Included) ■ Reference Audio Tape of Actual NOAA, Meteosat, and HF FAX Transmissions ■ Clear, Complete User's Manual ■ Demodulators with Software start at \$289 ■ Much More ...

Call or Write for Detailed Information

**MultiFAX** - 143 Rollin Irish Road - Milton, VT 05468  
MasterCard and Visa - 802-893-7006 - Fax: 802-893-6859

### QUICK, EASY, & COMPACT

Flash cards \*NOVICE thru EXTRA\* theory Key words underlined. Over 4000 sets in use! For beginner, OMs, XYLs & kids.

NOVICE	\$11.95
TECHNICIAN	\$10.95
GENERAL	\$9.95
ADVANCED	\$15.95
EXTRAS	\$14.95
Shipping	1-\$3.00
2 or more	-\$4.00
CLUB DISCOUNTS	

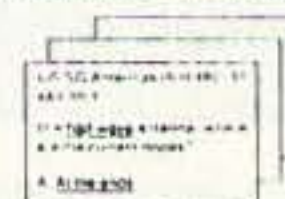

Order Today!  
from

**VIS STUDY CARDS**

P.O. BOX 17377  
HATTIESBURG, MS 39404



CIRCLE 104 ON READER SERVICE CARD

Say You Saw It In  
**73 Amateur Radio Today**

### SPY ON THE EARTH



See live on  
your PC  
what  
satellites in  
orbit see

Capture *live* breathtaking images of the Earth for fun or profit. Zoom in up to 20X. Send \$39 check or M.O. (\$45 air, \$50 overseas) for our *fantastic* 12 diskette set of professional quality copyrighted programs (IBM type) that does satellite tracking, image acquisition, image processing, 3-D projections and more. Direct reception from the satellites guaranteed worldwide without a satellite dish. Schematics included for interface. For FREE information log-on to our bulletin board anytime at: (718) 740-3911.

**VANGUARD Electronic Labs**

Dept. A, 196-23 Jamaica Ave.  
Hollis, NY 11423 Tel.718-468-2720



178 new questions modified from old commercial exams

Hang on, it gets better if you have already studied the Advanced and Extra Class ham question pools—you now know at least two-thirds of what could be asked on the commercial test. Here is the precise breakdown between the commercial questions and the ham question pool:

Commercial Sub-Element	Amateur Radio Sub-Element
3A1-3A5	ADV. 4AB-1.1 - 4AB-1.5
3A6-3A18	XTRA 4BB-1A.1 - 4BB-2A.9
3A19-3A41	New questions.
3B1-3B10	ADV. 4AC-2.1 - 4AC-4.5
3B11-3B14	XTRA 4BC-2.1 - 4BC-3.3
3B15-3B22	New questions.
3C1-3C39	ADV. 4AD-1.1 - 4AD-7.3
3C40-3C51	XTRA 4BD-1A.1 - 4BD-3A.3
3C52-3C97	New questions.
3D1-3D40	ADV. 4AE-1.1 - 4A-8.10
3D41-3D96	XTRA 4BE-1.1 - 4BE-6B.5
3D97-3D115	New questions.
3E1-3E46	ADV. 4AF-1.2 - 4AF-5.5
3E47-3E72	XTRA 4BF-1A.1 - 4BF-5.3
3E73-3E-75	New questions.
3F1-3F72	ADV. 4AG-1.1 - 4AG-9.7
3F73-3F110	XTRA 4BG-1A.1 - 4BG-4B.3
3F111	New question.
3F112-3F130	XTRA 4BG-4B.5 - 4BG-8.2
3F131-3F139	New questions.
3G1-3G58	ADV. 4AH-1.1 - 4AH-10.2
3G59-3G93	XTRA 4BH-1A.1 - 4BH-6A.3
3G94-3G97	New questions.
3H1-3H45	ADV. 4AI-1.1 - 4AI-12.4
3H46-3H76	XTRA 4BI-1A.1 - 4BI-6D.2
3H77-3H143	New questions.

These questions will remain unchanged for at least a year—but when it comes time to revise the Element 1 and 3 questions, you can be assured that most of the amateur-type Element 3 questions will be replaced with some real “brain busters” that will have little or no amateur radio question heritage.

Amateur radio Advanced and Extra Class study guides adequately explain how to solve for two-thirds of the commercial Element 3

questions. The following books could help you get through the “new” questions, plus add tremendous background behind all commercial questions:

*General Radiotelephone Operator's License Study Guide*, LeBlanc, Tab Books.

*Radio Operator's License Manual*, Kaufman, Hayden Books.

*Practice Tests, GROL Exams*, Veley, Tab Books.

*Electronic Communication*, Shrader, McGraw-Hill.

*Land Mobile and Marine Handbook*, Noll, WPT Publications.

3 examinations—a total of 100 questions on the combined tests—and earn your Commercial General Radiotelephone ticket. Even though this license is no longer required for the maintenance of land mobile radio gear, it is still a good license to have—it could cover you if you ever need to pop open a marine radio, a radar system, or an aviation transceiver. And with two-thirds of the questions coming straight out of the amateur radio question pool, the time to take the test is **RIGHT NOW**.

Element 1 (was Element 1 and 2): Basic radio laws and operating requirements; 24

**“Hang on, it gets better if you have already studied the Advanced and Extra Class ham question pools—you now know at least two-thirds of what could be asked on the commercial test.”**

*ARRL Handbook*, American Radio Relay League.

The combined Element 1 and Element 3 question-and-answer pool is available for \$12.95 from Gordon West Radio School, 2414 College Drive, Costa Mesa CA 92626.

There is more good news for licensed Extra Class amateurs—you have already satisfied the 2nd class radiotelegraph CW Element 1 and 2 requirements, having passed your 20 wpm code test. Extra Class hams who have passed the ham 20 wpm requirements won't need to take the 16 wpm groups/20 wpm text tests.

Soon the Commission will release the question pool for ship radar endorsement, Element 8. They will also release the question pools for radio operator and radio maintainer licenses to operate satellite radio systems aboard U.S. flag vessels.

So if you are a technical ham and are looking for one more piece of “wallpaper” to put up at the shack, consider taking the commercial Element 1 and commercial Element

questions out of a 170-question pool.

Element 3: Electronic fundamentals and techniques to adjust and repair marine and aviation radios; 76 questions out of a 729-question pool.

Element 5: Radiotelegraph operating practices; 50 questions out of a 250-question pool.

Element 6: Advanced radiotelegraph operating procedures; 100 questions out of a 500-question pool.

Element 7: Global maritime distress and safety service practices and regulations; 76 questions out of a 360-question pool. The FCC is soliciting this question pool now.

Element 8: Ship radar, technical, theory, and practice; 50 questions out of a 250-question pool. The FCC is soliciting questions now.

Element 9: Global maritime distress and safety service radio maintenance questions; 50 questions, 250-question pool. The FCC is presently looking for input to the question pool.

**ULTIMATE MODIFICATION BIBLE**

**MOST COMPLETE, GREATEST IN IT'S TIME !!!**  
 OVER 800 MIKE WIRINGS CB/HAM.  
 OVER 125 MOD. HAM RADIOS.  
 OVER 50 COMPLETE CRYSTAL CHARTS.  
 OVER 20 MOD. CRYSTAL CHARTS.  
 OVER 15 SCANNER MOD.  
 TEN METER RADIO MOD.  
 LINEAR/COAX ANT. INFO.  
 OVER 200 PAGES OF INFO.

KDC SOUND 1-800-256-9895  
 5 PINE MEADOW \$ 29.95  
 CONROE, TX 77302



CIRCLE 151 ON READER SERVICE CARD

**Quality Microwave TV Antennas**

**WIRELESS CABLE - IFTS - MMDS - Amateur TV**  
 Ultra High Gain 50db(+) • Tuneable 1.9 to 2.7 Ghz.

- 55-Channel Dish System \$199.95
- 36-Channel Dish System \$149.95
- 20-Channel Dish System \$124.95
- Optional Commercial Grid Antenna (not shown) Add \$50.00
- Yagi Antennas, Components, Custom Tuning Available
- Call or write (SASE) for "FREE" Catalog

**PHILLIPS-TECH ELECTRONICS**  
 P.O. Box 8533 • Scottsdale, AZ 85252  
 (602) 947-7700 (\$3.00 Credit all phone orders)  
 MasterCard • Visa • American Express • COD's • Quantity Pricing

**LIFETIME WARRANTY**



CIRCLE 249 ON READER SERVICE CARD

**Amateur Radio Language Guide**

- Hundreds of phrases, especially for the ham radio operator
- Vol. 1 - French, Spanish, German, Japanese, Polish
- Vol. 2 - Swedish, Italian, Portugese, Croatian, Norwegian
- Vol. 3 - Russian, Danish, Czech, Korean, Hawaiian
- Vol. 4 - Chinese, Dutch, Finish, Romanian, Vietnamese
- Vol. 5 - Hungarian, Arabic, Phillipino, Turkish, Indonesian

Send \$10. per volume U.S., \$12 outside U.S. to:  
 ROSE, P.O. Box 796, Mundelein, IL 60060-0796

**Speak To The World**

CIRCLE 134 ON READER SERVICE CARD

**THIS MONTH'S GOODIE FROM THE CANDY STORE**

**RDC** **TELEX HY-GAIN HAM-IV ROTOR \$325.00**

Similar Savings on Yaesu, Astron, Icom, Kenwood, Alinco, Etc. All L.T.O.

**ROTOR T2X \$397.00**

Over 9034 Ham Items in Stock, all Prices, Cash FOB Preston.  
 More Specials in HAM-ADS. Looking For Something Not Listed??  
 Call or Write  
**Call Today (208) 852-0830**  
**ROSS DISTRIBUTING COMPANY**  
 78 S. State Street, Preston, Id. 83263  
 Hours Tue.-Fri. 9-6 - 9-2 Mondays. Closed Sat. & Sun.



CIRCLE 254 ON READER SERVICE CARD

**PAY TV AND SATELLITE DESCRAMBLING**  
**OUR BEST YET...1994...OUR BEST YET**

Includes the latest cable box and satellite (PLUS, B-MAC) fixes. Lots of schematics and chip files (all new), bullets, ECM's, etc. ONLY \$15.95. Our best yet. Other Pay TV editions, volumes 1-5 (all different). \$15.95 each. **The Complete Wizard VCI PLUS Hacking**, \$15.95. **Satellite Systems Under \$600**, \$12.95. **Wireless Cable Hacking**, \$12.95. **Hacker Video**, \$19.95. Any 3/\$34.95 or 5/\$52.95. **Scrambling News** monthly, \$29.95. **Scrambling News Year One** (176 pages), \$39.95. Everything listed here and more, \$129.95. Includes all our information, Catalog, \$1.00. C.O.D.'s are OK, add \$6.00.

**SCRAMBLING NEWS**  
 1552 Hertel Ave., #123, Buffalo, NY 14216  
 Voice/FAX (716)874-2088

CIRCLE 36 ON READER SERVICE CARD

**UHF REPEATER**

**Make high quality UHF repeaters from GE Master II mobiles!**

- 40 Watt Mobile-Radio \$199
- Duplexing and tuning information \$12
- Information without radio \$40

**Versatel Communications**  
 Orders 1-800-456-5548 For info. 307-266-1700  
 P.O. Box 4012 • Casper, Wyoming 82604

CIRCLE 259 ON READER SERVICE CARD



## AMIGA AND COMMODORE SUPPORT SERVICES

Now utilize the same repair facilities used by dealers and other Commodore service centers. Take advantage of direct low pricing, fast turn-around (24-48 hours), extended warranties, service contracts, low-cost system upgrades (such as 1 MB Agnus), Toaster problems and most important —PROFESSIONAL SERVICE.

For every piece of equipment repaired and returned to our customers, we will include the following FREE:

- A Commodore or Amiga diagnostic diskette (\$10.00 value).
- A Commodore Diagnostician or Amiga Troubleshooter (\$10.00 value).

### SPECIAL LIMITED TIME OFFER

Between now and April 15th, every customer who sends us their Amiga for repair has the option to purchase "Where in the World is Carmen Sandiego" software for the low price of \$10.95, while supplies last.

CALL FOR RETURN AUTHORIZATION NUMBER

### GLOBAL UPGRADES, INC.

3 CHESTNUT STREET, SUFFERN, N.Y. 10901  
914-357-7339 • FAX: 914-357-6243

1-800-426-8693

HOURS 9-6 E.T. MON.-FRI.



### COST OF SERVICES\*

AMIGA FLAT RATE LABOR		COMMODORE FLAT RATE LABOR	
A500	\$55	A3000 CALL	C64 \$25
A2000	\$85	A4000 CALL	C128 \$45
*PLUS UPS SHIPPING		CDTV	\$60

CALL FOR PRICING ON MONITOR REPAIR & OTHER ITEMS WE SERVICE

CIRCLE 338 ON READERS SERVICE CARD

## All Aluminum

- |                    |                         |
|--------------------|-------------------------|
| Chassis Kits       | Rack Shelves            |
| Cabinet Kits       | Rack Equipment Cabinets |
| Assembled Cabinets | Antenna Grounding Kits  |
| Slope Box Kits     | Tower Mounted Box Kits  |
| UHF & VHF Antenna  | Dipole Hangers          |
| Power Divider Kits | Other enclosures        |

Small sheets Aluminum and Brass

### Byers Chassis Kits

Charles Byers K3IWK  
5120 Harmony Grove Road, Dover, PA 17315  
Phone 717-292-4901

Between 6PM and 9:30PM EST. Eves.  
"Distributorship Available"

CIRCLE 222 ON READER SERVICE CARD

## BASIC REPEATER INTERFACE ONLY \$50!

Have your own repeater or link system!

Easy repeater setup without modification to your radio gear, simply plug in and go! Ideal for emergency or portable/mobile repeaters! The BRI-2 works with ANY receiver (or scanner) and ANY transmitter. Super sensitive VOX operation makes setup quick. Includes Hang and timeout timers. Passive audio interface for clean audio. Only 4.5" x 3.5" x 1.5" and choice of 12 VDC or 9V battery power (please specify when ordering). ORDER BRI-2 \$50.

For bi-directional links order our BRI-2-DUAL model which contains two of the above in one box. ORDER BRI-2-DUAL \$85

The BRI-2-RB has a built in "remote base" interface so you can link your repeater with other frequencies or repeaters. Simple and easy to use. ORDER BRI-2-RB \$85

MANY MORE PRODUCTS, CALL/WRITE FOR INFO!  
ELECTRON PROCESSING, INC. (616) 228-7020  
P.O. BOX 68 CEDAR, MI 49621

Please add \$5 ship/handl US, \$8 Canada, AK, HI MI, NY add sales tax also

## TIRED OF PLAYING GAMES? Finally, a practical use for your sound card.

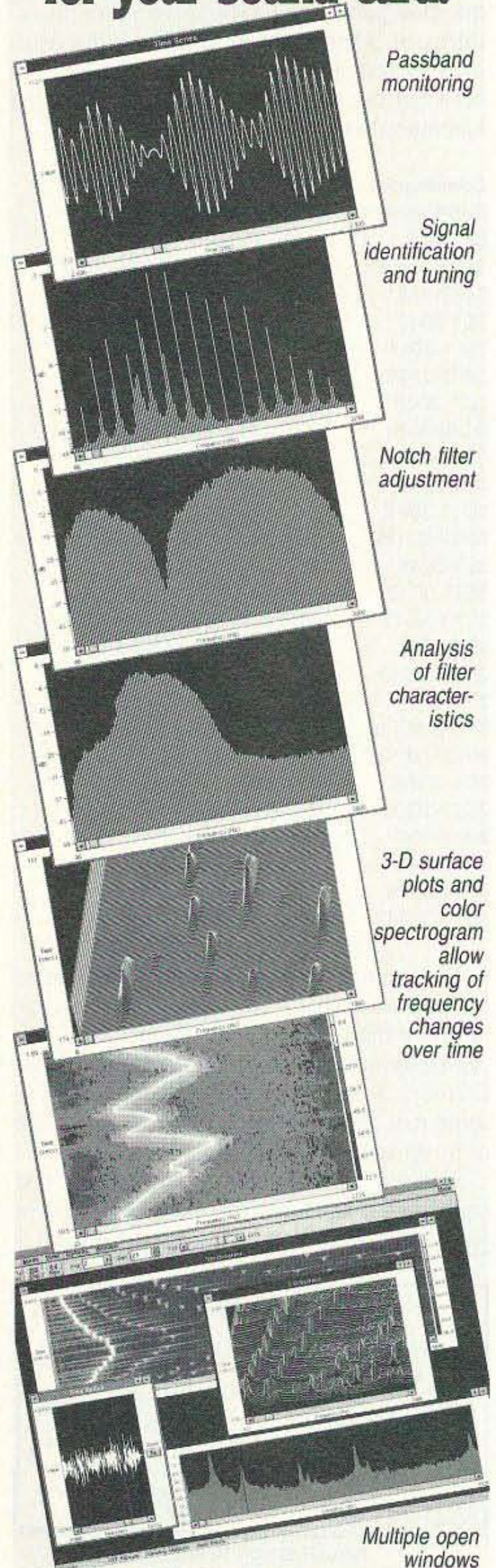

### Spectra Vision - \$89.00

Real-time audio spectrum analyzer. Full control over FFT size, sampling rate, scaling, gain, and averaging. Requires 386, Windows 3.1 and any Windows compatible 8 or 16 bit soundcard.

### Spectra Plus - \$179

All of the above plus data record/playback, post-processing, and more! "A stroke of brilliance... a groundbreaking program" - Monitoring Times

800-401-3472 fax/voice 206-697-3472

Visa, MasterCard, Check or Money Order

### Pioneer Hill Software

24460 Mason Rd., Poulsbo, WA 98370  
S & H included, foreign delivery add \$10.00  
Demo disk \$4.00 (credit toward purchase)

CIRCLE 311 ON READER SERVICE CARD

## BUY AMERICAN, BETTER PRICE AND QUALITY

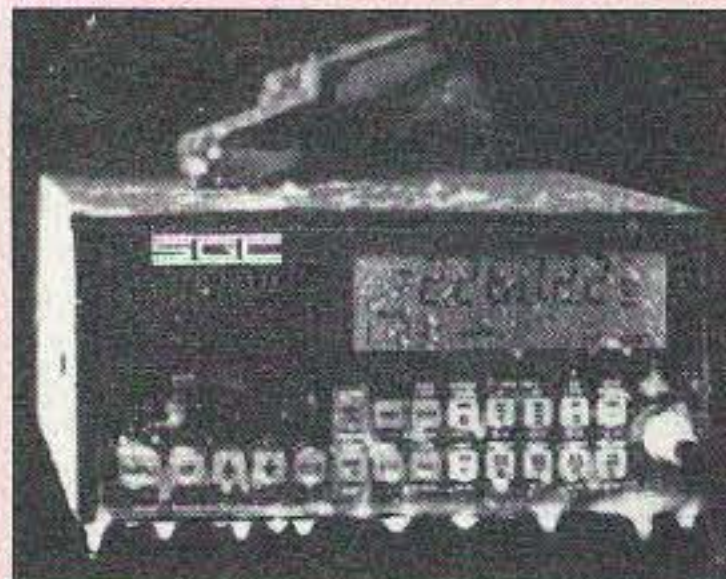

"BURN-IN" rack and keyed down for 24 hours non-stop at full power CW. Don't try that with the foreign radios. 4) EVERY SG2000 is then re-checked for alignment and put in the "TORTURE RACK" where they are keyed on and off every 10 seconds for 24 hours. 5) The SG2000 is then re-evaluated and all control functions are verified to ensure that the microprocessor is up to spec. THEN AND ONLY THEN IS THE SG2000 ALLOWED TO LEAVE THE FACTORY.

The bottom line is price. you know how expensive commercial rigs are normally, we are selling the SG2000 BELOW DEALER COST at only \$1,585.00 each!! That's a \$400.00 savings! We guarantee the best price.



The SG230 SMART-TUNER is the best HF autotuner at any price, and to promote a product that is made in the USA, we're offering it at the guaranteed best price of only \$449.00!! WHY THE SG230? BECAUSE: When you tune an antenna at it's base you are resonating the antenna, instead of just matching the coax to the radio as with other tuners such as the AT50, etc. The result YOUR SIGNAL GETS OUT MUCH BETTER. The Kenwood AT50, AT450 and other similar tuners can only match 3:1 mismatches (YES only 3:1) so forget matching anything but a fairly decent antenna. The SG230 can match from 0.5 Ohm to 10 kilohm antennas (up to a 200:1 mismatch), so it can easily match random wires, dipoles, rain-gutters, shopping carts, etc. The result MORE POWER.

To order, send check or money order with \$8.50 for shipping, along with your shipping address (sorry no U.S. Post Office Boxes, UPS will not deliver) and Telephone number to:



Serving The LORD  
Since 1987



### Joe Brancato THE HAM CONTACT

PO Box 3624, Dept 73  
Long Beach, CA 90803

CA Residents Add 8 1/4% Sales Tax. Canadian Residents please send U.S. Money Order + \$17.10 for shipping.

If you wish more information please send a SASE to the above address. For COD orders, call (310)433-5860, outside of CA Orders Only call (800)933-HAM4 and leave a message.

CIRCLE 384 ON READER SERVICE CARD



## Amateur Radio Teletype

Marc I. Leavey, M.D., WA3AJR  
6 Jenny Lane  
Baltimore MD 21208

I've got to start out this month with a vivid memory. One year ago this month, my family joined most of the East Coast in welcoming the Blizzard of '93. This "storm of the century" arrived late on Friday, March 12, 1993, and continued through most of the day on Saturday, March 13. It remains as a vivid memory to my family, as my daughter's Bat Mitzvah was scheduled for that weekend. After two years of planning, studying, and arranging, we had to cope with the unexpected and regroup. She had her Bat Mitzvah three months later, and all came out OK, but that frosty weekend remains as a symbol of the unexpected, and the need to be able to adapt to the situation. After all, isn't that one of the things ham radio prepares us all for? Anyway, just thought I'd share a memory with you, my friends.

### CoCo Programs

Keeping with the theme of the unexpected, I received a letter from Ed Barr K2HD of Spring Hill, Florida, who says that he is still fooling around with a Radio Shack Color Computer. He is looking for a copy of the program that we published awhile back for the CoCo.

The program was printed in the January 1988 issue of "RTTY Loop," with a correction prompted by the automated typesetters' garbling of BASIC statements published a few months afterwards. The CoCo SIG

on Delphi has carried the programs for many years; I believe they are still there. As with the "RTTY Loop" disks, copies of previous columns are also available, for the same deal: \$2 per column and a self-addressed, stamped mailer. You don't need to send paper, though!

### Help! CP-1/C-64 Connection?

Another ham toodling around with older equipment is Bill Shimmin W7GBC of Tacoma, Washington. Bill is attempting to get onto computerized digital modes, with an AEA CP-1, Commodore C-64, ICOM 735, and "appropriate software."

He has run into a problem making the connecting cables. The connection between the CP-1 and the C-64 seems to be different, depending on the reference material. One source has the cable going to the joystick port of the C-64, and another says it should go to the user port. So, he is looking for information on which port of the computer should be used, and which pins of the selected port are needed. The CP-1 uses a five-pin connector with TTL levels; he does not have the RS-232 option.

Bill calls these items "relics of a bygone past," and he suspects that this information may be gathering dust in some ancient file. Well, Bill, I would rather say that there are quite a few hams out there using just this setup, and I fully expect to be inundated with information on the proper configurations for the CP-1/C-64 combination. I'll print the best of them in a future column.

### Santec HT-1200 on Packet

My sincere thanks to Michael Geier KB1UM who writes the "Ask Kaboom" column here in 73. He noticed my request for information on putting the Santec HT-1200 onto packet and, having just completed such a modification, sent it along. As soon as I get the time (Isn't that a laugh?), I'll try to do the same. Meanwhile, if there is enough general interest in this, I'll be happy to share the modification with you all in these pages. Just drop me a line and let me know.

### Helpful Reference Publications

I often receive requests for information on monitoring digital modes, for frequencies of commercial stations, and the like. One of the finest sources for this information I know is Klingenfuss Publications.

Jorge Klingenfuss has devoted years to producing a series of publications that directly addresses the needs of the RTTY amateur. His *Guide to Utility Radio Stations* is the only international publication to cover some of the latest military and political events, including frequencies in use in the Balkans, Africa, and Asia. Schedules of various transmission type, including facsimile, are all included.

In addition, a *Radioteletype Code Manual* contains detailed descriptions of various radioteletype systems, including Baudot, SITOR/AMTOR, Arabic, Cyrillic, Hebrew, Amharic, Greek, Korean, Thai, Japanese, and more. He even covers non-standard Morse alphabets in Arabic, Cyrillic, Greek, Hebrew, and Japanese.

Weather buffs will appreciate his *Air and Meteor Code Manual*, which contains details for decoding meteorological data from systems in use all over the world, including the Aero-

nautical Fixed Telecommunication Network (AFTN).

If you are interested, and who wouldn't be, drop Jorge a line at: Klingenfuss Publications, Hagenloher Str. 14, D-72070 Tuebingen, Germany. All of the prices in his catalog are given in deutsche marks, so you will have to check the current conversion rates before you order. Many of his materials are also available in French, as well as in German and English, so be sure to mention that as well if language is an issue. Above all, don't forget to mention that you saw it here, in "RTTY Loop"!

### RTTY Software

Many of you have been taking advantage of what must be the best value in software around. The four "RTTY Loop" disk collections feature a veritable plethora (you have no idea how long I have wanted to use that term in a column) of MS-DOS software. Disks #1, #2, and #4 contain amateur radio, RTTY, and packet software; disk #3 contains DOS and Windows utilities for archiving, dearchiving, and viewing software. Each collection exceeds one megabyte in size, almost filling a 3.5" high density (1.44 Mb) diskette. Each one may be yours if you send me a mailer with return postage, and a blank diskette with \$2 in US funds for each collection desired. If you would like to receive a listing of programs in each collection, just send me a self-addressed stamped envelope and request the latest listing for the "RTTY Loop" software collection.

More answers to your questions next month, as spring breaks and we all get the urge to clean up the shack. Drop me a note at the above address, or via Email on CompuServe (ppn 75036,2501), Delphi (username MarcWA3AJR), or America Online (MarcWA3AJR). 73

## THE FAMED 2 METER

Also the ultimate for scanners bcb to 1300 MHz.

# A. S. A. 9209

+9 db Co-Linear "MultiWave" Base Station Double 5/8 over 1/4 wave delivers up to +9 db gain. All fiberglass & solid aluminum construction. Fits masts up to 1-1/2". 2 Meter Base Station 10' length.

Made in USA

# \$36.73

+ \$5.00 S&H

(SC RES. 5% SALES TAX)

CHECK IN ADVANCE OR C.O.D.

ALSO AVAILABLE IN 220 & 440

ASA

"Service is the Reason For Our Success"

Model 9209  
+9db

Tel: (803)293-7888 P.O. Box 3461  
Watts: 1-800-722-2681 Myrtle Beach, SC 29578

CIRCLE 18 ON READER SERVICE CARD



ARK30

### SYNTHESIZED QRP CW TRANSCEIVER KIT

Get Yourself the BEST Kit!

- Coils & Transformers Pre-wound
- MIL Quality Silkscreened PCB's
- Complete Kit w/118 P Manual
- Superhet Single Signal RCVR.
- Sensitivity 0.3µv, 10db (S+N)/N
- Tune 100 Hz steps, RIT +/- 500 Hz
- SMALL 2-3/4" x 5-1/2" x 8"
- Extruded AL Chassis
- GUARANTEED TO WORK
- 100 milliwatts to 5 W out
- FULL QSK, built-in speaker
- Immediate Recovery AGC

... RAVE REVIEWS ...  
... Military grade solid. "73" Magazine  
... stood up to Field Day conditions ... "World Radio"  
● The Ideal Traveler's rig - just add Key, Power & Antenna ●  
20, 30, or 40 METER KIT ..... \$269.95  
Optional Adj. Speed Keyer Kit ..... \$ 39.95



To Order Call  
S & S ENGINEERING  
precisely qrp



301-416-9661

(FAX) 301-416-0963

CIRCLE 294 ON READER SERVICE CARD

## SCARED OF THE CODE?

IT'S A SNAP WITH THE ELEGANTLY SIMPLE MORSE TUTOR ADVANCED EDITION FOR BEGINNERS TO EXPERTS—AND BEYOND

Morse Code teaching software from GGTE is the most popular in the world—and for good reason. You'll learn quickest with the most modern teaching methods—including Farnsworth or standard code, on-screen flashcards, random characters, words and billions of conversations guaranteed to contain every required character every time—in 12 easy lessons.

Sneak through bothersome plateaus in one tenth of a word per minute steps. Or, create your own drills and play them, print them and save them to disk. Import, analyze and convert text to code for additional drills.

Get the software the ARRL sells and uses to create their practice and test tapes. Morse Tutor Advanced Edition is approved for VE exams at all levels. Morse Tutor is great—Morse Tutor Advanced Edition is even better—and it's in user selectable color. Order yours today.

For all MS-DOS computers (including laptops). Available at dealers, thru QST or 73 or send \$29.95

+ \$3 S&H (CA residents add 7.75% tax) to:

GGTE, P.O. Box 3405, Dept. MS,  
Newport Beach, CA 92659  
Specify 5¼ or 3½ inch disk  
(price includes 1 year of free upgrades)



CIRCLE 193 ON READER SERVICE CARD



Joseph J. Carr K4IPV  
P.O. Box 1099  
Falls Church, VA 22041

## Repairing Water-Damaged Ham Gear

Three full days of heavy, hurricane-driven rains pelted the East Coast of the United States. In my county, the Potomac River crested 11 feet above flood stage. In the narrow mountain river canyons of West Virginia, 80 miles upstream, it welled up to a 54-foot-high wall of water that overwhelmed the best efforts of hundreds of bone-tired volunteers. Despite backbreaking heroic efforts, the sandbag wall at the edge of one town gave way under the relentless pressure of an angry river. Over the next 24 hours the water rose, completely flooded basements and gushed into the first floor of most homes and businesses to a height of six feet.

Scenes like these were repeated throughout the mountain and coastal regions of the Southeast. As the waters receded, the governor of one Southeastern state called out the National Guard to prevent looting, and the people returned to their homes to salvage what they could. After cleaning out the poisonous cottonmouth water moccasins that inevitably come along with the flood waters in our Southern states, they found their possessions soaked and mud-caked. Among the damaged goods were many electronic products, including ham gear, which they brought to their local service shops in hopes that something could be salvaged.

Although most flood damage scenarios are not as dramatic as that described above, we nonetheless often hear of ham gear and other electronic equipment that has taken a bath: boating accidents, plumbing failures, basement flooding and a variety of other problems splash equipment out of service. The author recalls one incident where a hospital plumber burst a three-inch-diameter water pipe that he was repairing (in a nursing station workroom). Water came pouring out of the pipe at a high rate, causing a massive flood that damaged patient monitoring equipment in the Operating Room and Post Anesthesia Recovery Room on the floor below. After the smirks died over the public address announcement "All housekeepers STAT to 2-east," a major effort was undertaken to save nearly \$150,000 worth of electronic equipment that was freshwater damaged. Fortunately, there are certain things that a skilled person can do to restore operation.

If the insurance company pays off well enough, then one can go out and buy a new rig. But if the insurance company refuses to pay ("Sorry . . . wind-driven water damage exclud-

ed . . ."), or if there is no or insufficient insurance, then you might want to attempt restorative action. Even if the insurance company does pay off, customers can often buy the equipment back from them for salvage value. I recall a guy who received \$325 for a two-year-old hand-held 2 meter rig, and then "bought it back" from the insurance company for \$20. The company sent him a check for \$305, and he kept (and restored) the "carcass."

### Restoration Steps

Some of the steps recommended may sound a little bizarre to you from a normal perspective, but they are capable of restoring an expensive piece of equipment. Some of the steps might cause a little damage that will also have to be repaired (especially those involving baking the moisture out, or using chemicals for cleaning). If that makes you nervous, then please remember that in the case described you cannot harm the equipment anymore; IT IS ALREADY A TOTAL LOSS! Any restoration is therefore pure gain; any further damage is no big deal. If you are a professional service technician, before making any wild promises make sure that the customer understands that you are undertaking heroic measures that may not be successful. One of the most frequently cited causes of bitter customer dissatisfaction is not your poor performance, but rather dashed expectations. If your customer is led to believe that the job will turn out much better than is possible, then he or she will not be in a forgiving mood when you fail to catch the bullet in your teeth. But if the job is a lot better than their expectations, then you will probably hear word-of-mouth "advertising" around town about your ability to walk on (or at least get rid of) water.

The first thing to do is refrain from turning the equipment on, even for a brief test to see if it is broken. Satisfy yourself right now that even a short dunk will cause fatal damage! Still, the all-too-natural urge is to see if the equipment survived the flood: IF IT WAS IMMERSSED IN WATER, THEN IT DID NOT SURVIVE!

### Give It a Bath

The first job is to remove the covers and give the equipment a bath. A shop in a seaport town finds saltwater damage to electronic equipment common. One such shop where I worked in the late 1960s received an \$1,800 UHF-FM radiotelephone set (the kind typically used in taxicabs, police cars, fire trucks and ambulances) that had been immersed the night before during a coastal storm. A saltwater river tributary overflowed its banks just high enough to cover the radio mounted in the equipment well of a service vehi-

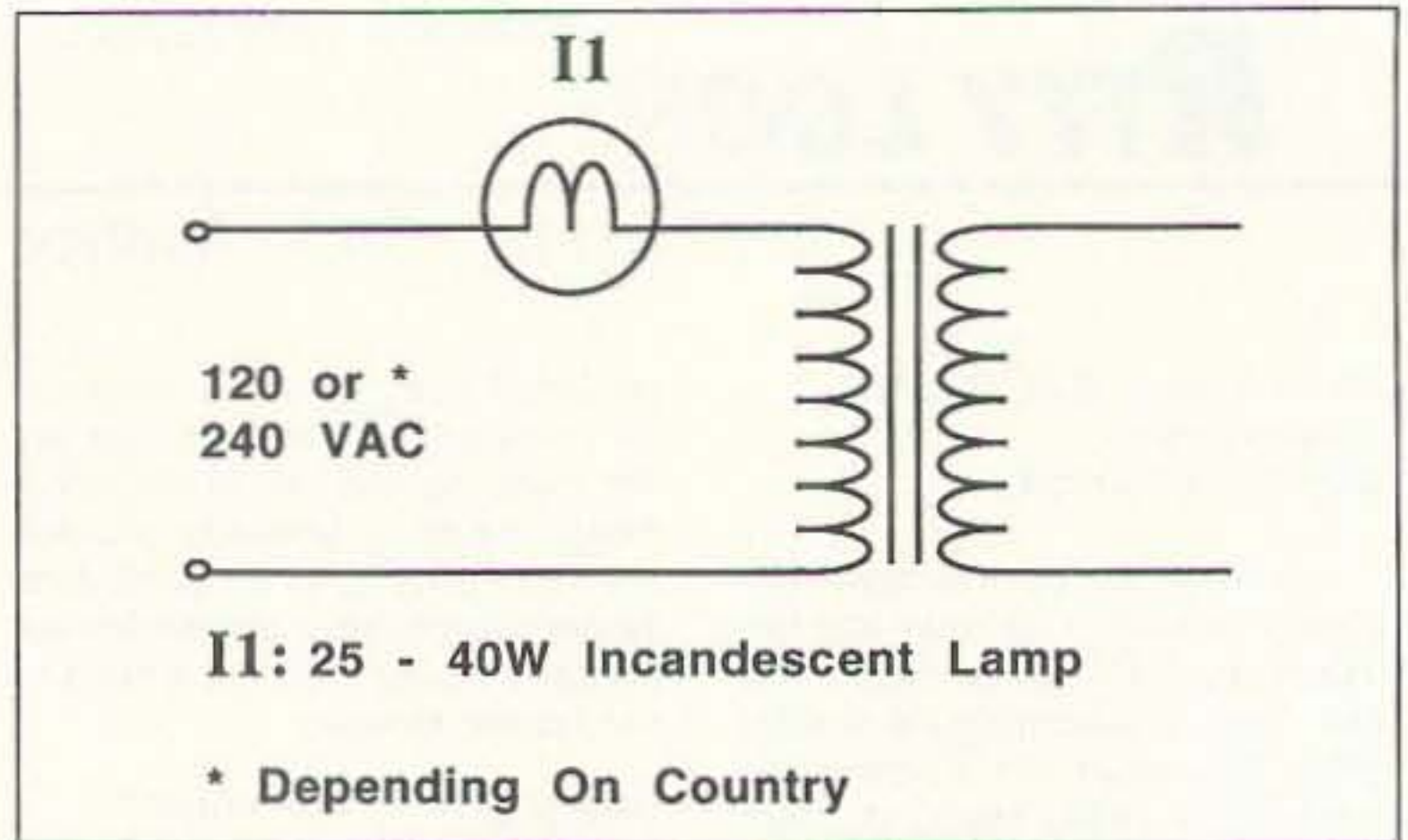

Figure 1. One method for drying a power transformer.

cle! The first thing the technician did was take the transceiver out on the back parking lot and give it a 10-minute shower with a garden hose. He had lived in that town all his life, and therefore had much experience with saltwater-damaged radio gear. Incidentally, if the damage is due to saltwater, then do the cleaning job immediately. The longer salt residue remains in the equipment, the greater will be the corrosion damage, and the lower the chance of successful restoration.

In some cases, it will be necessary to follow the shower with an immersion bath. One technician uses a 25 gallon washtub, the kind you might use to give a large dog a bath. He mixes together in the tub two to four quarts of a product like Lestoil, a small bottle (2-4 fl.oz.) of either fingernail polish remover or acetone (same chemical) and enough tap water to fill the tub all the way to the rim. Leave the equipment in the bath for an hour, then pour out the solution. Rinse the tub out thoroughly and refill with plain tap water (some people prefer distilled water, which is available in bottles in some areas). This second bath removes the residue left by the chemicals in the first bath. BE CAREFUL OF FUMES! DO THIS JOB OUTDOORS OR IN A WELL-VENTILATED SPACE. NOTE: This bath may damage some plastics. If this worries you, then use plain soapy water. It isn't quite as effective a solvent, but it works somewhat. Keep in mind that most plastic pieces can be replaced, and the damage will not usually prevent the equipment from operating: it is already a total loss, so don't worry about trivial secondary damage!

### Dry It Out

The next step is drying the unit out thoroughly. If you live in North Africa or Arizona (Yes, they have floods in the desert! Some of the worst rain storms I've been through were in Tucson!), then simply leave the equipment out in the sun for about a week. Residents of other terrains will have to use some other method. The kitchen oven is a good bet, provided that it can be regulated to maintain a temperature of 125 to 130 degrees Fahrenheit. That

range is low for many kitchen ovens, and some might not be able to remain that cool. Higher temperatures will dry the set out faster, but they will also melt some of the plastics used in it, so beware. The drying process takes several days, perhaps as long as a week. Of course, if plastics can be removed before baking, then do so.

Another alternative is to build a box of cardboard (or other material), and use several hundred watts of incandescent lamps to provide heat. Use a thermometer inside the enclosure to ensure that a) the 130 degree "melt limit" is not exceeded, and b) the box doesn't catch fire from neglect (cardboard burns). Again, up to about a week is needed, although in one case a car radio that was dropped in a freshwater lake for a few minutes dried out in only one day.

### Test It

Now comes the BIG TEST!!!! In some cases, the only way to test the equipment is to turn it on and look for smoke. The more conservative approach sneaks up on it one step at a time. The first step in the test is to disconnect the DC power supply; this step can be absolutely essential to the future health of the set being repaired, especially those with high voltage (HV) power supplies. Without connecting the set to AC power, connect a bench power supply to the circuitry that was previously connected to the rig's internal power supply. It is essential that you use a DC power supply that will provide the same voltage(s) as the original internal supply, and additionally (this is important) has a current limiter control. The output voltage is set to the DC voltage normally supplied by the equipment power supply, and the current limiter control is set for a short-circuit current only a little above the normal operating current of the circuit under test.

Why go to such trouble? The reason is prevention of secondary damage. There is almost inevitably a short circuit or other condition that draws loads of current. If such a condition exists in the equipment, then the internal power supply normally used probably produces enough current to burn up components, printed wiring board



tracks and other components. After the circuit is checked out, then check out the power supply and (if working) reconnect it.

The low-voltage DC power supply should be checked out separately, especially if it uses a series-pass regulator (most equipment does these days). If the voltage regulator circuit is not working, then several possible faults allow the rectifier output to be connected to the regulator output; this occurs when the series-pass transistor is either shorted or hard biased to full turn-on. Since the rectifier voltage is always higher than the regulator output voltage, it can damage circuits that were just pronounced healthy.

High voltage DC power supplies have special problems all their own. These supplies are common in CRO video monitors, TV sets, as well as high power radio equipment. Small amounts of moisture that are no problem in low voltage supplies will permanently damage an HV supply. The special problem is the HV transformer. If moisture has penetrated the transformer, then the unit may have to be replaced. It may help to provide some extra drying for the transformer, but be prepared to replace it. Figure 1 shows a method for drying a power transformer. A low wattage AC lamp in series with the primary of the HV transformer is used to generate internal heat to the transformer. The current

flow is enough to cause internal heat build up, but not enough to cause additional damage to the equipment if it is shorted. Keep the lamp on for a total of about a week, although as with all electrical situations, monitor it to prevent fire.

Some remaining areas of concern (and probable damage) are those components where moisture can get in and remain hidden. Candidates include: trimmer capacitors, air variable capacitors, IF and RF transformers, switches and potentiometers, paper capacitors and electrolytic capacitors. Where high voltages are used, such as in RF power amplifiers, it may be necessary to pull variable capacitors and clean the plates and bearings individually. Residue that may be unimportant in lower power, lower voltage, situations can be a real problem at 1,800 volts. With regard to trimmer capacitors, we can open the capacitor up to the minimum capacity position (screw all the way out) and apply a hair dryer or incandescent lamp for 10 or 15 minutes. Whether or not this step is needed can be determined after the initial power-on test shows a specific problem. Otherwise, you will destroy the alignment of the set for nothing. This step should not, therefore, be used merely as a matter of course; use it only in response to a specific symptom. Similarly, air variable capacitors may have corroded contact wipers between the rotor and

stator, and this will be apparent when the rig is turned on.

Paper and electrolytic capacitors can absorb water, especially if they have a fiber or cardboard end cap. If the capacitor shows signs of being soggy, then replace it; capacitors are, after all, relatively low cost items.

If there remains a lot of scum on the printed wiring board, then spray clean it with an environmentally safe solvent. Some professional technicians prefer to use a small paint brush or "cheese cloth" to help remove the material. Flood damaged ham equipment is often salvageable. The methods described above have been used by professional service technicians for a lot of years and have proven successful.

#### More Cleaning Hints

Recently the author heard from a reader who added some advice of his own. He was a former Navy officer who used to have electronics technicians working for him on board a naval ship. He said they used to repair salt-water-soaked electronic equipment in an unusual manner. A sailor would take the equipment into the shower, and slosh it down with warm water. They then took the desalinated equipment to the galley ("kitchen" to landlubbers) and dried it out in the ovens with low heat and good air circulation. The retired officer also advised that distilled water is best, and that tap

water in some locations is too hard (i.e. contains minerals); anyone using this method must either buy distilled water or use an in-line water softener. For a chassis covered with oily dirt, the equipment can be cleaned with a mixture of 8-10 ounces of household ammonia, 4-6 ounces of a cleaner such as Mr. Clean or Lysol, 4-6 ounces of acetone (the ingredient in some fingernail polish removers), and enough distilled (or soft) water to make one gallon of solution. The equipment is dunked into this mess. For larger equipment, proportionally larger amounts can be used. An old dental "Water Pik" can be used to hose off equipment that is too large to dunk. The equipment is then dried in an oven set to 140 to 150 degrees Fahrenheit (Note: Some plastics used in electronic equipment will melt at temperatures over 130 degrees, so beware) for four to five hours. All lubricants in switches, potentiometers and air variable capacitors (where used) must be replaced after this treatment. The black asphalt-like paste that oozes out of overheated transformers can be easily removed from chassis by using either freeze spray, or a blast from a CO<sub>2</sub> fire extinguisher (use an under-pressure one that already needs refilling, don't waste your protection on cleaning jobs). The frozen paste becomes brittle and can be flaked off using a dental tool or soldering aid tool. 73

### W9GR DSP FILTER

**11 Switch Selectable Filters in One**



**Just turn the switch to select one of:**

- 4 Filters** which enhance SSB signals by reducing hiss, static, ignition, and powerline noise with no perceptible time delay combined with **Multiple Automatic Notch** filters to remove heterodynes instantly.
- 4 "Brick-wall" CW Filters** with bandwidths of 50 Hz to 200 Hz.
- 3 unique linear phase bandpass filters** for **RTTY, HF Packet, and SSTV.**

Installs easily between the receiver and external speaker or headphones.

<b>W9GR DSP Filter</b>	<b>\$299.95</b>
<b>12 VDC Power Supply</b>	<b>\$11.95</b>

Shipping and Handling US \$5, overseas \$15



30 day money back guarantee.  
90 day parts & labor warranty.



j•Com • 793 Canning Pkwy • Victor NY 14564  
(716) 924-0422 • FAX (716) 924-4555

# \$40 Special

## To Charge You Up...

### Periphex Power Packs for Longer QSO Time



replacements for	regular price
<b>FNB-12 YAESU 600ma</b>	\$ 54.50
<b>BP-84S ICOM 1400ma</b>	\$ 63.00
<b>PB-13S KENWOOD 1200ma</b>	\$ 49.75
<b>EBP-24S ALINCO 1500ma</b>	\$ 62.00

Now Only \$40 Each

- One Year Warranty
- Matched cell construction
- Case re-build service
- Long life, extended operating time
- Made for HAMS, by HAMS

Add \$4.00 Shipping & Handling for first battery.  
\$1.00 for each add'l battery - U.S. only  
Connecticut residents add 6% tax.



the only thing low about our charge is the cost...

1-800-634-8132

Available from your dealer...

115-1B Hurley Road • Oxford, CT 06478 • (203) 264-3985 • FAX (203) 262-6943



# HOMING IN

Number 13 on your Feedback card

## Radio Direction Finding

Joe Moell P.E. K00V  
P.O. Box 2508  
Fullerton CA 92633

### The Foxcopter

Who says hams don't build anything nowadays? Although few home experimenters take on powerful transmitter or sensitive receiver projects, lots of us are willing to warm up the iron for simple gizmos such as battery chargers and audio filters. Nothing makes you feel more like a member of the traditional ham community than pointing with pride to a piece of gear and saying "I made it!"

Radio Direction Finding (RDF) enthusiasts (sometimes called T-hunters or foxhunters) often get started by building their own mobile VHF quad antennas, RF attenuators, and external S-meter boxes. Sometimes they have so much fun building them that they are inspired to start more ambitious projects.

"Homing In" features on the rotating antennas and cathode ray tube displays of KK6CU (October and November 1992) and KA6SOX and KK6OS (November 1993) have inspired many RDFers, including Bill Rupp N0MKJ of Pewaukee, Wisconsin. "I really enjoy reading about and building the creative equipment that people have come up with for foxhunting," he says.

Bill submitted some photos of his motorized quad RDF system, showing the results of his creative mechanical engineering and parts scrounging. He mounted it on a frame in the bed of his pickup truck (Photo A). The five-element quad (Photo B) is his own design, based on formulas in the *ARRL Antenna Compendium, Volume 1*.

"When constructing the quad I used arrow nocks to hold the wires firmly in place under tension," says Bill. "I use 5/16-inch diameter wood dowels for shafts and a 25-cent pencil sharpener

to shape the dowel ends for the nock. This allows me to adjust the length of the shafts very closely. I originally had 2 x 2 lumber for the boom, but I now use a one-inch-diameter Fiberglas tube, which is much more rugged.

"I built the support frame out of one-inch angle iron purchased at a local Farm and Fleet store. The frame is welded in much the same configuration as KK6CU's. I use a four-foot Fiberglas rod, one inch in diameter, for the mast. I got the pillow blocks for \$12 each from the local Grainger dealer (Photo C)."

"I picked up a 12 volt DC drive motor from American Scientific and Surplus (3605 Howard Street, Skokie IL 60076). It was intended to be a down-rigger motor on a boat. It's marine quality with stainless steel throughout, all for 20 bucks (Photo D). I had to drive the antenna shaft with cogged belts because the motor has 15-tooth XL gears. I picked up 36-tooth cogs for the mast from McMaster-Carr Supply Company. That gives me a rotation rate of 40 RPM."

McMaster-Carr is a large industrial supplier headquartered near Los Angeles, with branch warehouses in the East and Midwest. The company's thick catalog is available to qualified customers by calling (310) 692-5911.

"Rotary coax connectors don't have to be home-brew or expensive," Bill adds. "I found one in the McMaster-Carr catalog for \$20, part number 7631K42 (Photo E). It has two conductors with separate mercury pools for low noise. If you order one, be sure to order the matching connectors, part numbers 7631K47 and 7631K48. They are cheap and very hard to find elsewhere."

For the sine-cosine potentiometer azimuth sensor, Bill chose the model PS-340 from Servo Systems, Incorporated, which costs \$19.50. He reports



Photo A. His friends call it the "Foxcopter," but it never leaves the ground. Bill Rupp N0MKJ adapted a design of JaMi Smith KK6CU and built this motorized quad antenna for mobile RDF. (Photos by N0MKJ.)

that Servo Systems' minimum order is now \$50, so it's a good idea to arrange a group buy with other T-hunters. Whereas KK6CU put his sine-cosine pot at the bottom of the mast and the RF slip rings above it, N0MKJ did the opposite (Photo F).

"I disassembled the sine-cosine pot and knocked out the pin that holds the shaft to the wipers," says Bill. "The wipers then just slid off. I replaced the shaft with 1/4-inch tubing, doubled up inside for strength. To mount the rotary coax connector, I just added the next two larger sizes of tubing on the end. The coax could then be fished through the shaft."

An inexpensive Astron 200 watt 12 VDC-to-110 VAC inverter powers N0MKJ's storage oscilloscope display unit, which is configured for easy installation and removal (Photo G). "I've got all the electronics attached to the

scope," he says. "After the hunt, I pick up the scope and pull the whole assembly out, unplugging it from the inverter in the back of the King Cab."

### Frigid Foxhunting Fun

While many general-interest ham clubs sponsor hidden transmitter hunts, the Milwaukee area is unusual because it has one club devoted entirely to T-hunting. "My first ham radio foxhunt was when I was in the Air Force in Minot, North Dakota," says N0MKJ. "When I came here and found that there was an RDF club, I really got hooked."

The Milwaukee Fox Hunting Club has been active for more than 12 years, with hunts every three weeks. Hunts start at 7:30 p.m. Fridays, and are scheduled to last 90 minutes. Boundaries are 15 miles from the starting point, which is declared in ad-

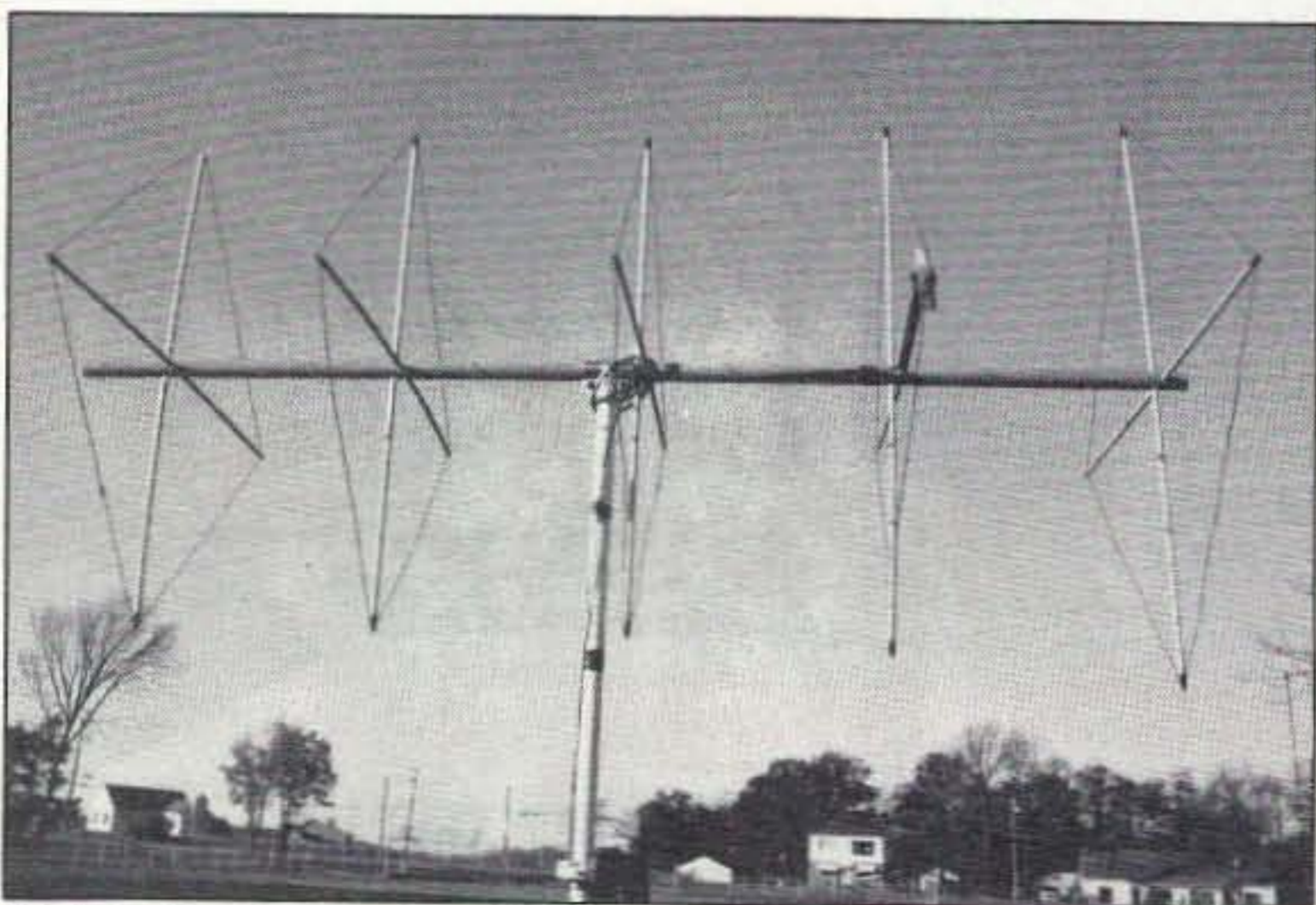

Photo B. For sharp bearings, N0MKJ uses a five-element 2 meter cubical quad. The steel bracket holding the boom to the mast is sold as a product for making boat cover frames.

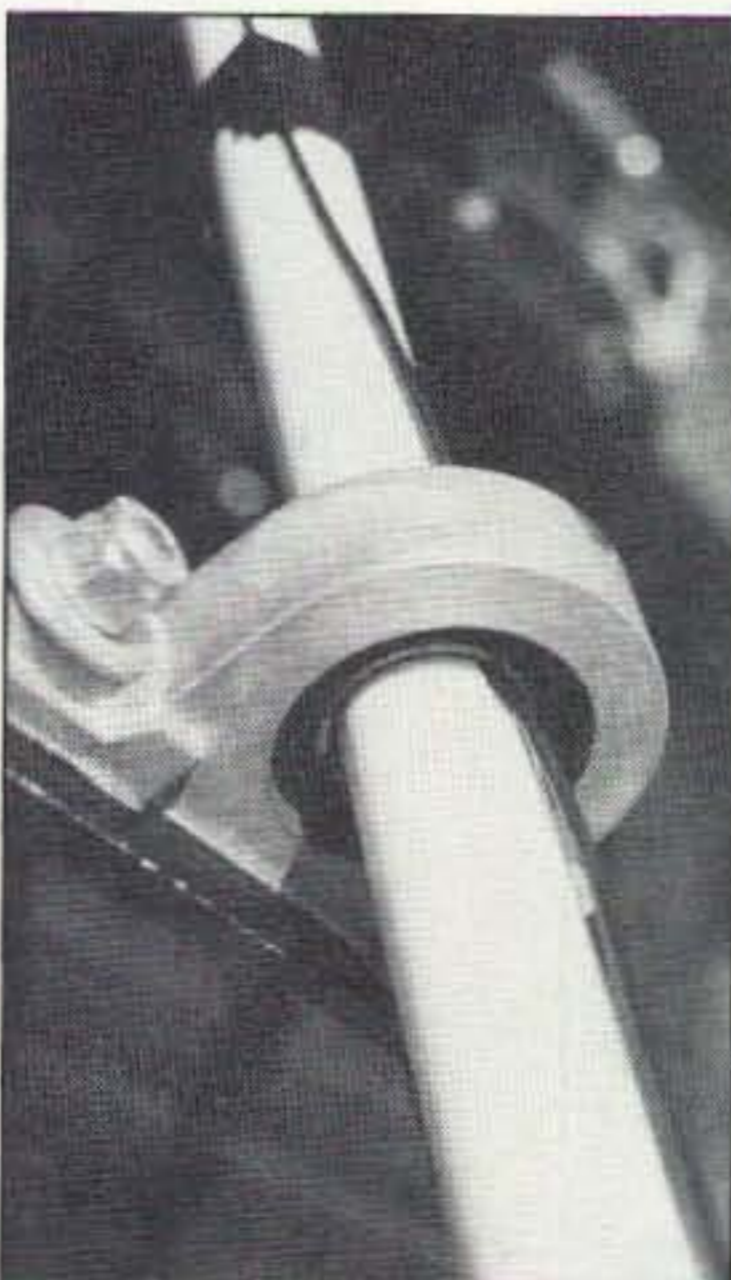

Photo C. Pillow blocks support the mast and provide low-drag rotation. Note the notch for passing the RG-174 coax.

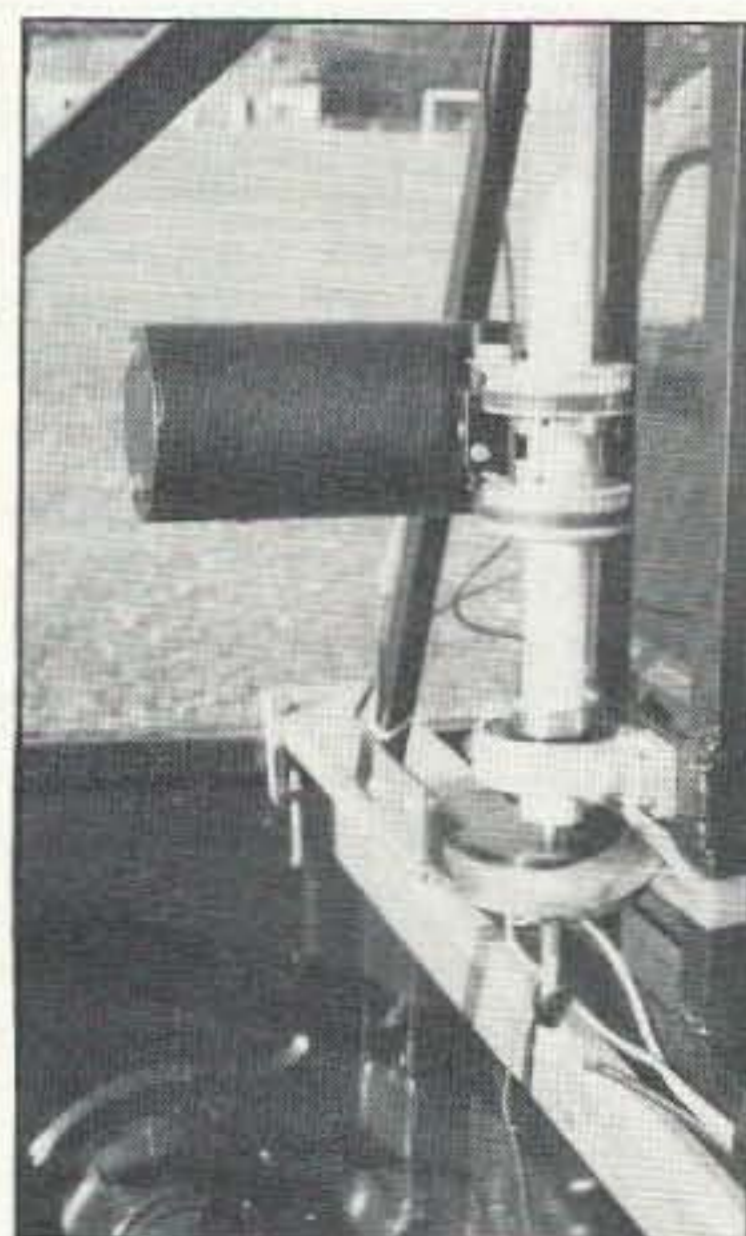
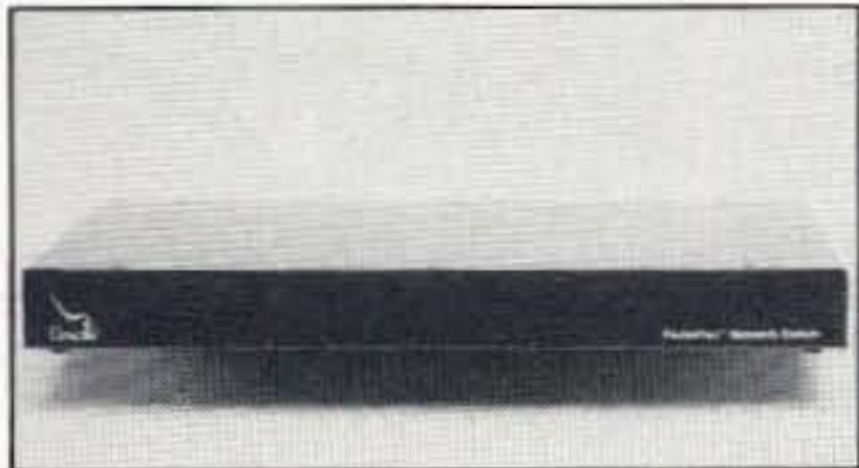

Photo D. N0MKJ's motor drive system uses two cogged belts for balance and reliability. Below the bottom pillow block are the sine-cosine potentiometer and coax connector.



## Introducing two of the best reasons to use packet radio



### The PackeTen™ Network Switch

The PackeTen Network Switch is a stand-alone, five-port, low power CISC/RISC packet switch/router designed exclusively for use with AX.25, TCP/IP, and NET/ROM® wireless networks.

- Port speeds as high as 4Mbps possible with throughput into the mega-bit range
- Multiple RS-422, RS-232, and integral modems eliminate the need for complex node-stacks
- Integral conference bridge supports 100 channels with 40 users on each

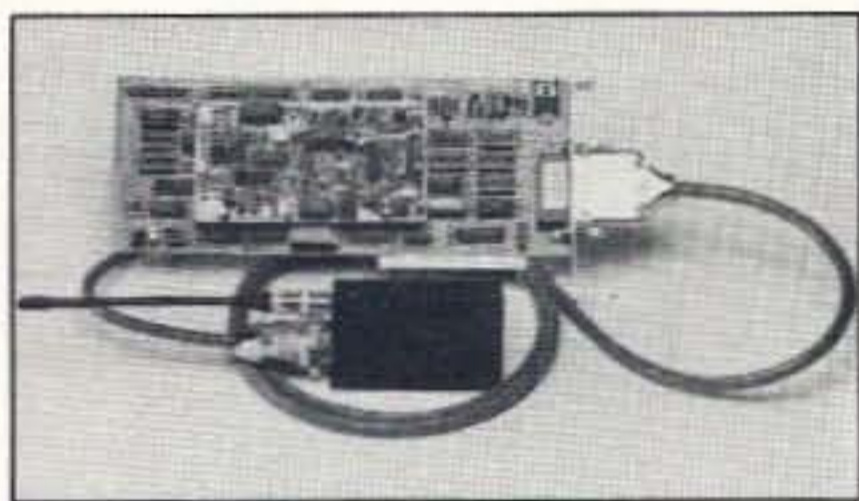

### The PackeTwin™ System

The PackeTwin System is a complete wireless communications system for IBM® compatible PCs that provides ideal access to 9600 baud packet radio networks.

- Available with an on-board G3RUH 9600 baud modem and palm-size outboard 2W UHF radio (1200 baud available)
- Uses the PC's DMA channels to support data rates as high as 1Mbps—eliminating the asynchronous COM port bottleneck
- Second channel operation using RS-232 or RS-422 interface
- Includes free communications software

For information, contact your distributor or...



The new name in Packet Radio

Gracilis, Inc.  
623 Palace Street  
Aurora, IL 60506  
Ph: (708) 801-8800/FAX: (708) 844-0183  
Email: info@gracilis.com



All trademarks are property of their respective owners

CIRCLE 291 ON READER SERVICE CARD

## For High Performance in Repeater Technology, Go with the Leader—

# SPECTRUM

### S-7R Basic Repeater

- "Stand Alone" or use with your controller



- 10–40 Watt Units
- 2M, 222, 440 MHz
- Super Sensitive/Selective Receivers
- Unusually Good Repeat Audio
- Proven Performance throughout the World!

For that new Machine—Spectrum makes 2 lines of Repeaters—the Deluxe SCR1400 and the new basic low cost S-7R line.

The S-7R Repeaters maintain the quality of design, components and construction which have made Spectrum gear famous throughout the world for years.

However, all of the "bells & whistles" have been eliminated—at a large cost savings to you! The S-7R is a real "work-horse" basic machine designed for those who want excellent, super-reliable performance—but no frills! For use as a complete "stand-alone" unit, or with a controller.

Of course, if you do want a Full Featured/Super Deluxe Repeater with Full panel metering and controls, and a complete list of 'built-in' options, then you want our SCR1400—the new successor to the "Industry Standard" SCR1000/4000.

Available with Autopatch/Reverse Patch/Landline Control; TouchTone Control of various repeater functions; 'PL'; "Emergency Pwr./ID; High/Low TX Power; Tone & Timer Units; Sharp RX Filters; Power Amps, etc.



**10–150 Watts**

**SCR1400  
REPEATER W/150 WT. 2M Amp  
& 30A POWER SUPPLY.  
(All items available separately)**

Shown in optional cabinet.

Call or write today for details and prices!  
Get your order in A.S.A.P.  
Sold Factory Direct or through Export Sales  
Reps. only.

■ Complete Line of VHF/UHF Rcvr. & Xmtr. Link Boards & Assemblies also available. Plus ID, COR, DTMF Control Bds., Antennas, Duplexers, Cabinets, etc. Inquire.



## SPECTRUM COMMUNICATIONS CORP.

1055 W. Germantown Pk, S4 • Norristown, PA • (610) 631-1710 • FAX: (610) 631-5017  
CIRCLE 51 ON READER SERVICE CARD

73 Amateur Radio Today • March, 1994 61



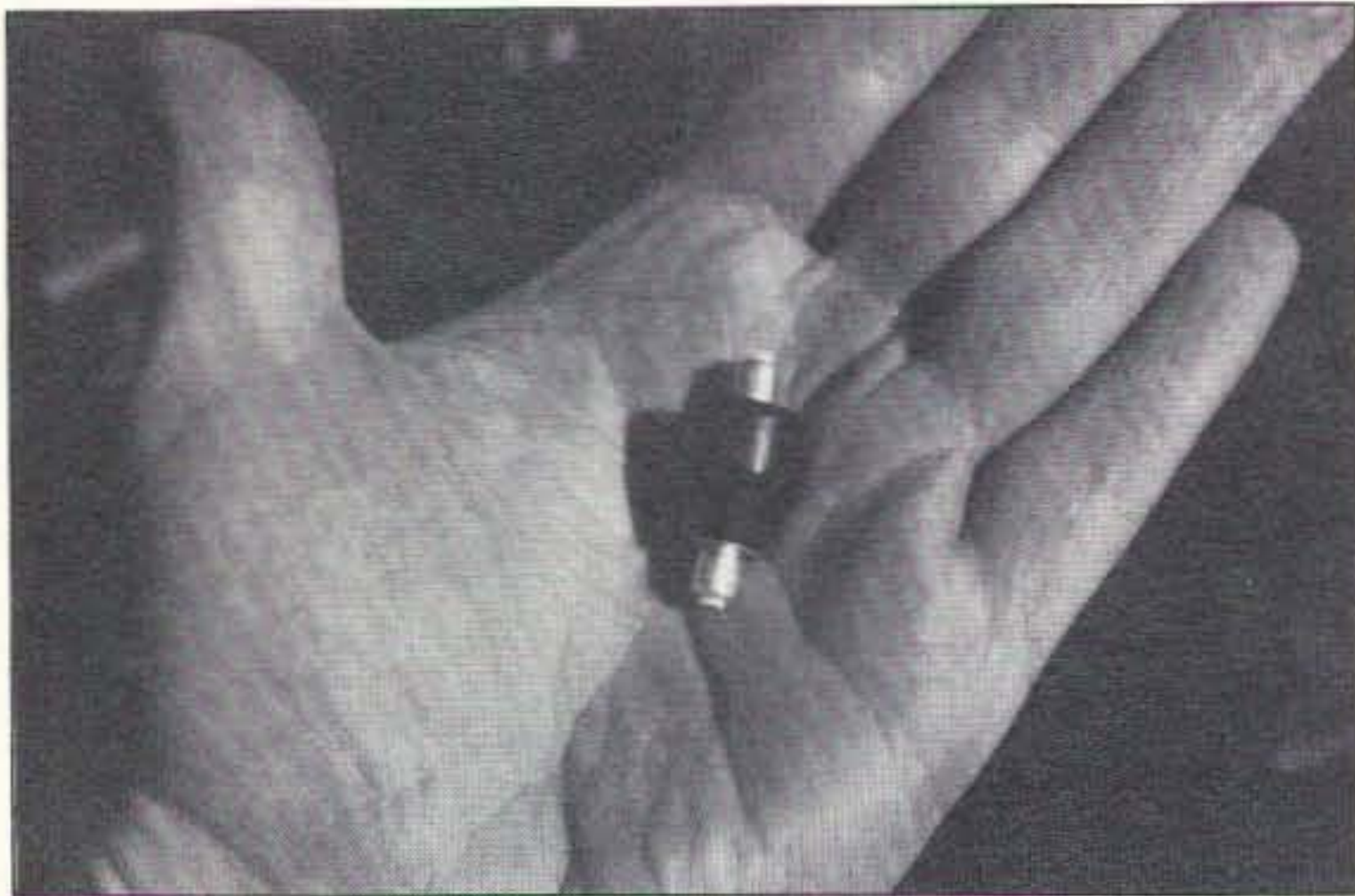

Photo E. Bill is holding an inexpensive rotary coax connector that can be mounted either horizontally or vertically.

vance by the hider. Having different start points allows for variety and opens up fresh territory.

The hidden transmitter on 146.43 MHz must have distinctive audio and be on for 15 seconds per transmission, with 45 seconds between transmissions. The first team to find the T and report on the separate call-in frequency wins the hunt and hides three weeks later.

In addition to after-hunt get-togethers, the group meets every Friday for lunch and a discussion of T-hunting topics, technical and otherwise. Hunt rules are regularly reviewed and re-

vised at these sessions. Bernie Gratz WA9BFH publishes the club's newsletter, with hunt results and stories, distributed at hunts and other club events.

It was probably at a luncheon that fellow hunters learned of Bill's motorized RDF system. He says, "The other members of our foxhunting club heard I was building this thing and they labeled it the 'Foxcopter.' I got quite a bit of ribbing, but they don't laugh so much now."

When I asked Bill if the Foxcopter has made him invincible, he laughed and said, "It has proven to be an odds-

evener. I'm a newcomer going against guys who have been doing it for 15 years and know all the parks and other nooks and crannies. I now have at least a five-minute advantage over other teams on the driving portion of the hunt. Unfortunately, I can't use it when 'sniffing' away from the truck. I've made it into the fox's area first on many occasions, but I always seem to lose on the foot hunt."

Winter weather doesn't stop the intrepid hunters of Milwaukee, who hunt storm or shine, hot or cold. According to NØMKJ, "We had three inches of snow during our February 1993 hunt, which made for a very interesting (and slippery) time. The transmitter was hidden halfway up a steep embankment that was covered in solid ice."

Bill says his favorite experience as the hider was last January. "It was perfect because there were big flakes of fresh snow covering everything. After we hid the transmitter, snow came down and covered it up. I put decoy footprints everywhere but where the transmitter was."

The sport of T-hunting is rapidly catching on in Wisconsin. NØMKJ reports that there are regular hunts in Racine and Sheboygan. Other readers have reported activities in the Appleton/Green Bay area. According to Bill, there have been discussions of areawide and statewide championship events. Apparently lots of Wisconsin hams agree with NØMKJ when he

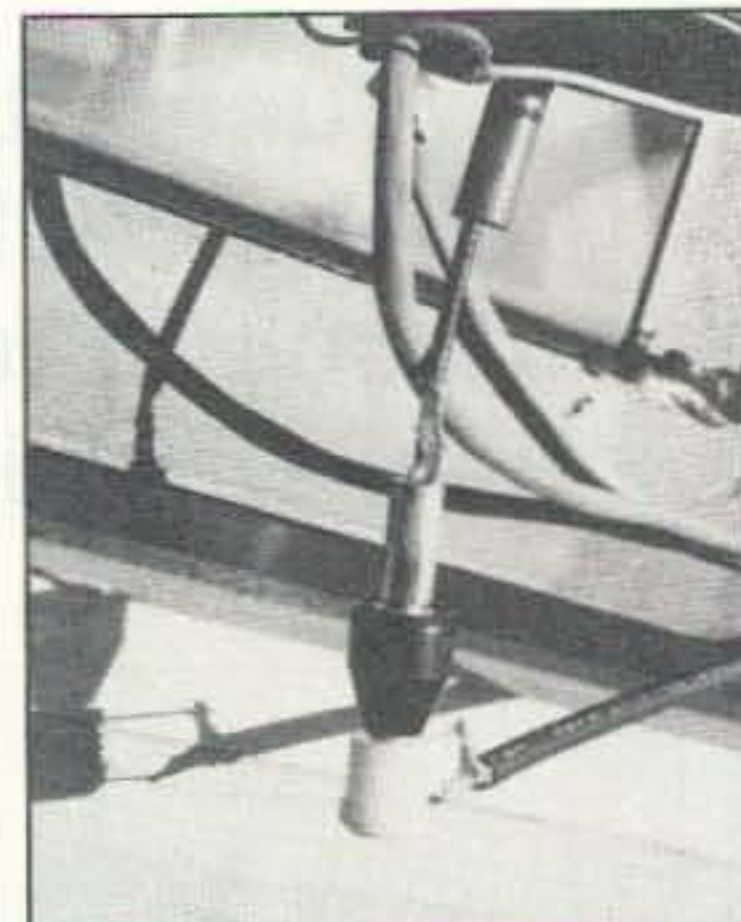

Photo F. The rotary coax connector in place at mast bottom with connectors and coax attached.

says, "T-hunting is the most enjoyable thing I've run into in ham radio!"

#### Spanning the Globe . . .

Regular "Homing In" readers know that hidden transmitter chasing goes on around the world. In most countries it's done only on foot, as an athletic event similar to orienteering. Interest in European/Asian-style on-foot foxhunting is building here, with more hams telling me they would like to see North American representation at international foxhunt gatherings.

Well, it's time to get busy, because the championship organizers are wait-

## INTERFERENCE LOCATION

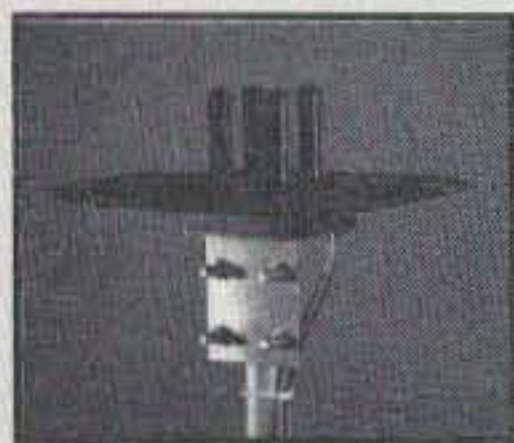

- ★ 50 to 1000 MHZ
- ★ Stuck Microphones
- ★ Cable TV Leaks
- ★ Jammed Repeaters & Cell Sites

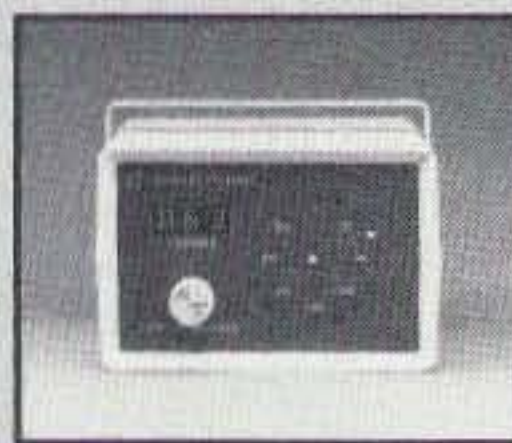

New Technology (patented) converts any VHF or UHF FM receiver into a sensitive Doppler shift radio direction finder. Simply plug into receiver's antenna and external speaker jacks. Models available with computer interface, synthesized speech, fixed site or mobile - 50 MHz to 1 GHz. Call or write for details.

**DOPPLER SYSTEMS, INC.**

P.O. BOX 2780 (602) 488-9755  
CAREFREE, AZ 85377 FAX (602) 488-1295

CIRCLE 13 ON READER SERVICE CARD

## EVERY ISSUE of 73 on microfiche!

The entire run of 73 from October, 1960 through last year is available.

You can have access to the treasures of 73 without several hundred pounds of bulky back issues. Our 24x microfiche have 98 pages each and will fit in a card file on your desk.

We offer a battery operated hand held viewer for \$75, and a desk model for \$220. Libraries have these readers.

The collection of over 600 microfiche, is available as an entire set, (no partial sets) for \$285 plus \$5 for shipping (USA). Annual updates available for \$10.

Your full satisfaction is guaranteed or your money back. Visa/MC accepted.

**BUCKMASTER  
PUBLISHING**  
"Whitehall"  
Route 4, Box 1630  
Mineral, VA 23117  
703-894-5777  
800-282-5628

CIRCLE 168 ON READER SERVICE CARD

## Heterodyne Headache #14.226.5

Get fast relief with a  
**Magic Notch**®  
automatic notch audio filter



Magically removes all heterodynes caused by tuners, carriers, CW, computer RFI and other similar QRM!

Why listen to carriers?  
The MagicNotch filter:

- is fully automatic. No tuning is necessary.
- easily installs between the rig and an external speaker or headphones.
- can be left on all the time while operating SSB.
- shows filter operation with its 2 color LED.
- allows you to work an s4SSB signal under a 20 over 9 carrier.
- requires 12VDC—usually available from the accessory jack on your rig.

30 day money back guarantee

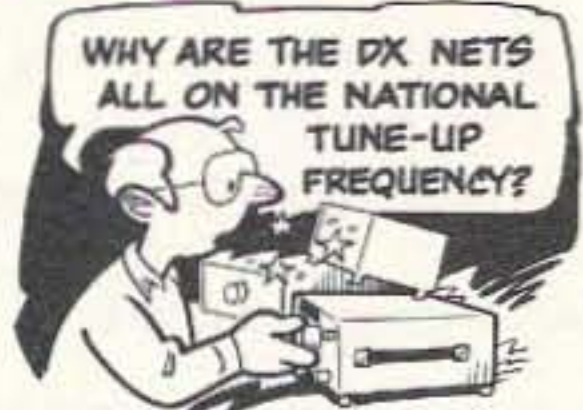

**\$109<sup>95</sup>**  

Shipping & handling \$5.00  
Foreign orders \$10.00

j-Com · 793 Canning Pkwy · Victor NY 14564 · (716) 924-0422 · FAX (716) 924-4555

CIRCLE 55 ON READER SERVICE CARD



ing for us. Lars Nordgren SMØOY tells me via Internet that the seventh Amateur Radio Direction Finding (ARDF) championships are scheduled for September 12 through 17. The Swedish Amateur Radio Society and International Amateur Radio Union (IARU) Region 1 are sponsoring the events, to be held in Loka Brunn, about 190 miles west of Stockholm, Sweden. Hunts for four categories of participants will take place on the 80 and 2 meter bands, in accordance with international ARDF rules.

P. A. Nordwaeger SMØBGU, the Chair of the organizing society, has invited national amateur radio societies around the world to send their best teams. SMØOY, who is responsible for all the courses for the championships, says he expects teams from 25 countries to enter, but his list does not include USA, Canada, or Mexico. That's because there are no national foxhunt committees or championships on our continent, even though the IARU International Secretariat is in the USA.

The deadline for all national societies to submit official entry forms for the ARDF Championships is March 12, so it's too late to form a committee and formally field a team this year. However, Lars indicates that observers and individual participants will be welcome at the Games. Don't worry too much about your command of foreign tongues because English is



Photo G. Bill's storage oscilloscope readout sits astride the transmission hump and front seat, with RF attenuators mounted to the top.

the official language of the Championships.

If you would like to visit Sweden and participate in the search for the world's greatest foxhunting athletes, send E-mail to SMØOY at his Internet address, ECSLN@kiera.ericsson.se, or write to the ARDF World Champi-

onships Secretariat, Grevlingsvegen 59, S-16137 Bromma, Sweden.

"Homing In" will have more information on international championships in future months. Meanwhile, dig out your October 1993 issue of 73 *Amateur Radio Today* to learn about the rules and requirements for Euro-

pean/Asian style foxhunting. To help set up a committee for national championships in the USA, write to me at my California address or send E-mail to JoeMoell@cup.portal.com (Internet) or 75236,2165 (CompuServe). My packet address is KØOV@WB6YMH. #SOCA.CA.U.S.A.NOAM.



P.O. Box 6522  
220 N. Fulton Avenue  
Evansville, IN 47719-0522

Store Hours  
MON-FRI: 8AM - 5PM  
SAT: 9AM - 3PM  
CENTRAL TIME

SEND \$1.00 FOR  
NEW AND USED  
EQUIPMENT SHEETS

WARRANTY SERVICE CENTER FOR:  
ICOM, KENWOOD, YAESU

FOR SERVICE INFORMATION CALL  
(812) 422-0252  
MONDAY-FRIDAY

**TERMS:**

Prices Do Not Include Shipping.  
Price and Availability Subject to  
Change Without Notice  
Most Orders Shipped The Same Day  
COD's Welcome



**SAVE \$75**



**IC-735  
HF Transceiver**

**SAVE \$10**



**IC-2GXAT  
2 Meter HT**

**SAVE \$50**



**IC-2iA  
2 Meter HT**



**DAYTON  
DISCOUNT  
DAYS MEANS  
BIG COUPON  
SAVINGS**

**HURRY  
ENDS 3/31/94  
DON'T DELAY**

IC-2330A	2M/220MHz Mobile	Save \$150
IC-Δ1A	2M/440/1.2 GHz HT	Save \$100
IC-V21AT	2M/220MHz HT	Save \$50
IC-X2A	440MHz/1.2GHz HT	Save \$165

**SAVE \$100**



**IC-737  
HF Transceiver**

**SAVE \$100**



**IC-728  
HF Transceiver**

**SAVE \$30**



**IC-W2A  
2 M/440MHz  
Handheld**

USED EQUIPMENT BBS 812-424-3614

ORDERS & PRICE CHECKS  
**800-729-4373**

NATIONWIDE & CANADA

LOCAL INFORMATION  
**812-422-0231**

FAX 812-422-4253

CIRCLE 131 ON READER SERVICE CARD



# HAMS WITH CLASS

Number 14 on your Feedback card

Carole Perry WB2MGP  
Media Mentors, Inc.  
P.O. Box 131646  
Staten Island NY 10313-0006

## Twin Wells Indian School Speaks with I.S. 72

Early in the fall of 1993 the kids in my ham radio classes were really excited about a contact we made with children from the Navajo Indian Reservation in Arizona on the CQ All Schools Net. Our initial contact was with a teacher, Gary Ragsdale KB7PXL. Gary's enthusiasm and wonderful way of describing things on the reservation made the children at my end eager to making contacts each week.

It was fun to watch the incredulous looks on my students' faces as they listened to Gary describe their school in Sun Valley, Arizona, as having less than 100 children in grades one through eight. You can appreciate the culture shock when you realize that we have over 1,800 students in our intermediate school in grades six, seven and eight.

After several phone conversations, Gary and I quickly realized the enormous potential for culture sharing that we had. He is busily convincing the administration to allow him to set up a regular scheduled ham radio class at Twin Wells. As of this writing, he must walk the children to his ham shack from whatever class they're in. So far, according to Gary, the administration likes what they see.

After the first radio contact in October, I was delighted to see that some of my 6th graders really got into it by suggesting to me that they be *allowed* to do an extra-credit report about the Navajos. In my classes, I never assign homework. I do encourage the youngsters, however, to do extra-credit projects when something is especially in-

teresting to them. I am always amazed at how well this approach works. I have no doubts that the fact it's a ham radio program we're talking about makes a big difference. What other subject comes close to offering the myriad of adventures and opportunities for exploration that ham radio in a classroom does?

### Sharing Experiences

This first group of eager beavers educated the rest of the class with some background about the Navajos, like the fact that the Navajos call themselves "Dine" (pronounced "di-nay"), which derives from the group's traditional Athabaskan language, and can mean both "people of the earth" and "man." The term "Navajo," we learned, has no clear meaning and was bestowed by the Spanish during the period that they claimed control over the 17 million acres that is now Navajo land. One of my 7th graders brought in an article from the local Staten Island newspaper in December titled, "Navajos Want to Change Their 'Foreign' Name." It seems as though the 200,000-member Navajo Nation has begun holding public hearings on a proposal to abandon the term "Navajo" in favor of "Dine." Many older Navajos cannot even pronounce the word, because the "v" sound does not exist in their language.

While my students were busy assimilating all the information they could about their counterparts in Sun Valley, Gary's students were expressing an interest in learning more about the Verrazano Bridge and the Staten Island ferry. Living on the country's largest Indian reservation, which stretches into Arizona, New Mexico and Utah, on over 16 million acres of forests, sand dunes, mountains, mesas and buttes, Gary's kids were of course curious about Manhattan,

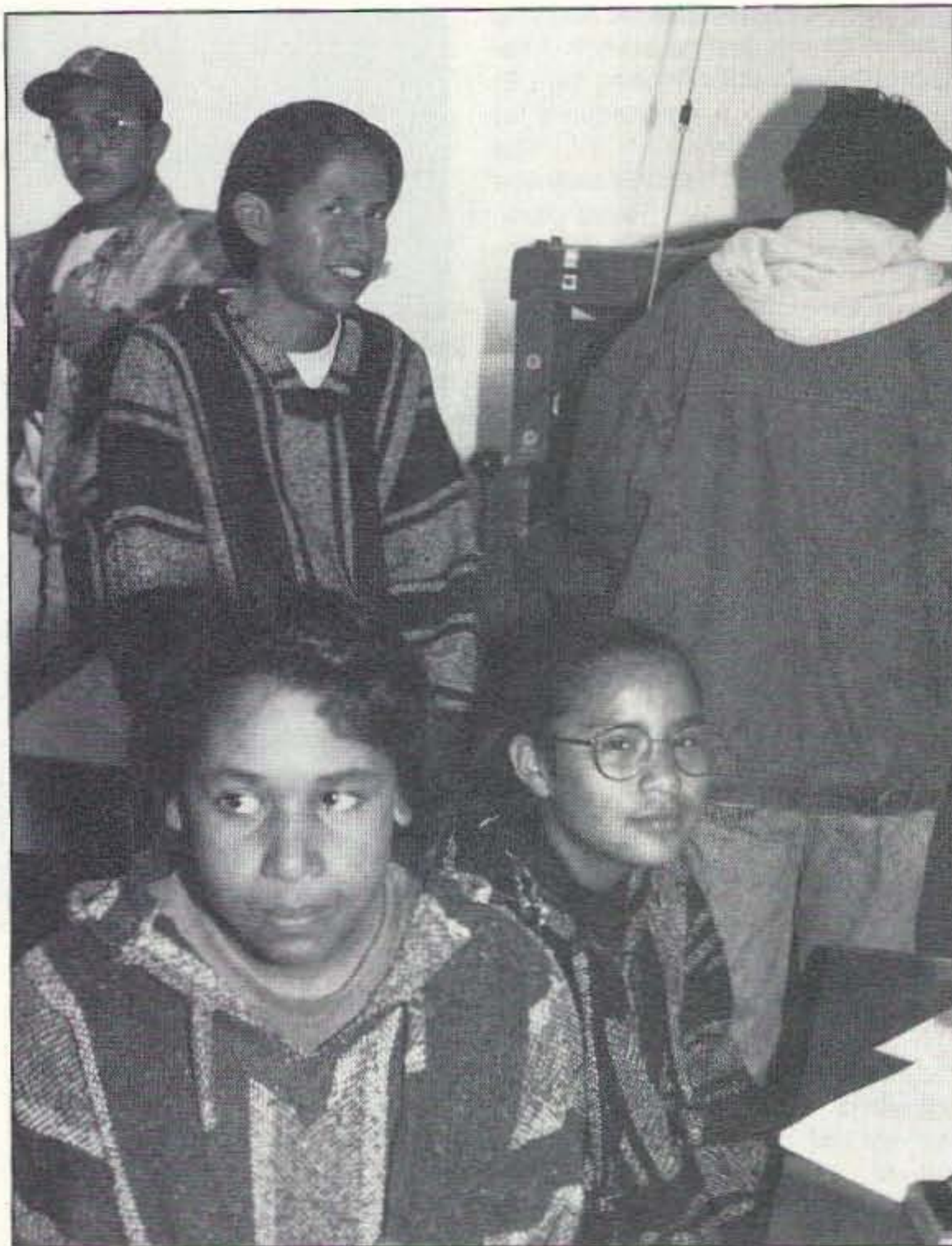

Photo A. Navajo students from Sun Valley, Arizona.

skyscrapers, bridges and big city life in general. Altitudes range from 4,000 to more than 10,000 feet above sea level on the reservation.

Gary put several of his youngsters on the air with some of mine, and the kids took it from there. The Twin Wells Indian School has provided a Christian education to Native American children for over 31 years. I suggested to the

children that we each videotape our respective schools, along with our "ham pal" letters. Students at both ends loved the idea. My kids made a major production out of the video so that their new friends could

see what a day in a big New York City school was really like. Everything and everybody got taped. Our entire school soon knew about the project. We videotaped all the shop classes, school assembly programs, gym classes, concerts, and of course the cafeteria.

At the children's suggestion, we collected items that highlighted New York and put together a package before Christmas vacation began. The kids brought in loads of photos of New York attractions, like Radio City Music Hall, the Empire State Building, and the Statue of Liberty. Many children wrote letters and enclosed photos of

themselves. We also sent a school sweat shirt along with copies of the school newspaper. The whole project took on such an air of fun that even other teachers got caught up in it. Several teachers would stop by each morning to see what we were doing with the "Navajo Project." They would encourage students in their classes to stop by my room to get an update.

Sample items that children make in our shop classes came pouring in. Children contributed stationery items from our fine graphic arts shop, and beautiful ceramic and stained glass pieces from those shops.

We haven't received Gary's tape yet, but we did get a package of beautiful samples of petrified wood along with a wonderful sample of handcrafted work. He sent us a handcrafted Navajo woman making bread. The details on it are incredible. I keep it on my desk. The kids are fascinated with it.

Both Gary and I are looking forward to a fun and educational year through our radio contacts on the CQ All Schools net. Please join us on Tuesdays and Thursdays at 17:30 UTC on 28.303 MHz. Also look for the Educator's Workshop and the Youth Forum at the Dayton Hamvention this April. Stop by and say "hello."



Photo B. Bronson Yazzie.



Photo C. Valvadia Woody.



## Low Power Operation

Michael Bryce WB8VGE  
2225 Mayflower NW  
Massillon OH 44646

This month, I'll clean up some of the loose ends laying around. But first, the biggest event of the year is very close at hand: the annual Dayton Hamvention, held in Dayton, Ohio. The Dayton Hamvention has become the Mecca for ham radio fans. Every ham should make it to this hamfest once in his lifetime.

Again this year the QRP ARCI club, along with others interested in QRP and low-power ham radio, will be staying at the Days Inn-Dayton South. It's the same place as last year. All those who made the trip in '93 agree it's the best place we have ever been in. Why, even the cockroaches are well-mannered. What really surprised me about this hotel is that it has several ice makers that work! That's a quantum leap from the Belton Inn we used to stay at. There is a swimming pool, sauna, weight room and a very large conference room. We filled this place to standing room only on Saturday night. An excellent (but not cheap) sit-down restaurant is also inside the hotel. If

you don't want to eat at the hotel, hamburger alley is right down the road. And, the Dayton Mall is just down the street from the hotel.

It's not as close to the Hamvention as some of the other hotels and motels, but it's not too far down the beaten trail either. Of course, you can (should!) leave your car at the hotel and ride the Hamvention buses to and from Hara Arena, where the Hamvention is held.

The room rate is \$70 a night. If we, the QRP ARCI, fill up more than the allotted rooms we have reserved, we may get a price break. Since I'm writing this in the first week of November, I can't say what the final price per night will be, but figure on \$70 a night.

If you would like to stay with a bunch of QRPers all under one roof, then you need to send Myron Koyle, 1101 Miles Avenue SW, Canton OH 44710, several items. First, you need to send him two business-sized SAS-ES. Next, you'll need a check made out to the Days Inn-Dayton South for one night. The last item is a list of who will be staying with you in your room. Don't wait too long. Rooms go quite quickly and there is always a waiting list. You

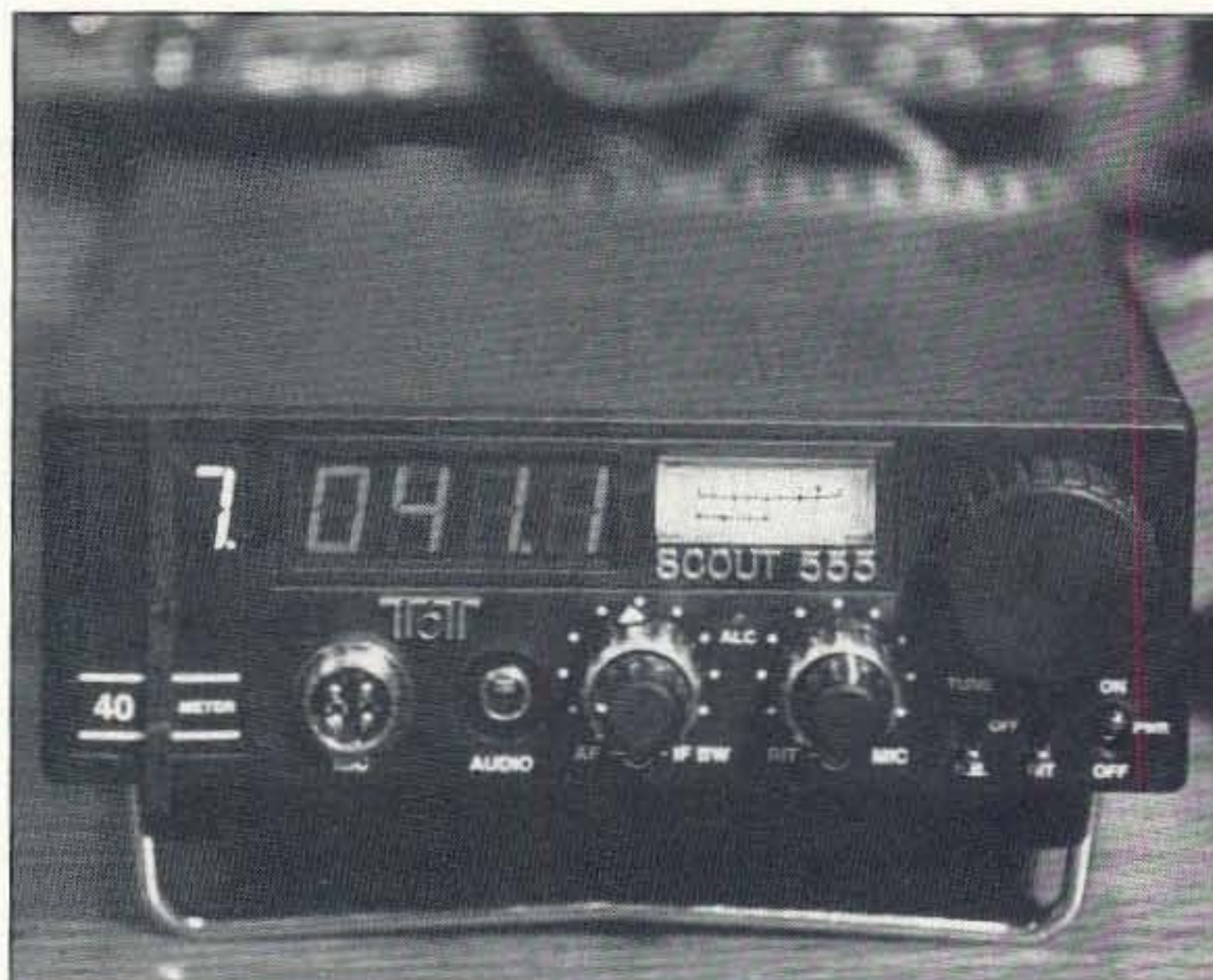

Photo A. Ten-Tec's new Scout getting a shakedown during the fall QRP ARCI contest.

can call Myron at (216) 477-5717. Please, don't call collect.

We always have a great time at the Dayton Hamvention. You can meet many of the people behind the calls in the hospitality room. Last year Roy Lewallen W7EL and Wes Hayward W7ZOI stopped by Saturday night. Many of the QRP vendors bring in their newest wares to show in the hospitality room. Last year, Oak Hill Research showed off the new QRP Spirit, S&S

Engineering introduced their digitized ARK-40 transceiver, and Bill Hickox had his Tejas RF products on display, too. Of course, the G-QRP club was there as well with their goodies to show. Why, even Mike Bryce WB8VGE showed up hocking his newest solar panels and control systems. There are usually several QRP stations operating at any given time in the hospitality room.

Of course, you don't have to stay at

### PCB and SCHEMATIC C.A.D.

EASY-PC

\$195

EASY-PC

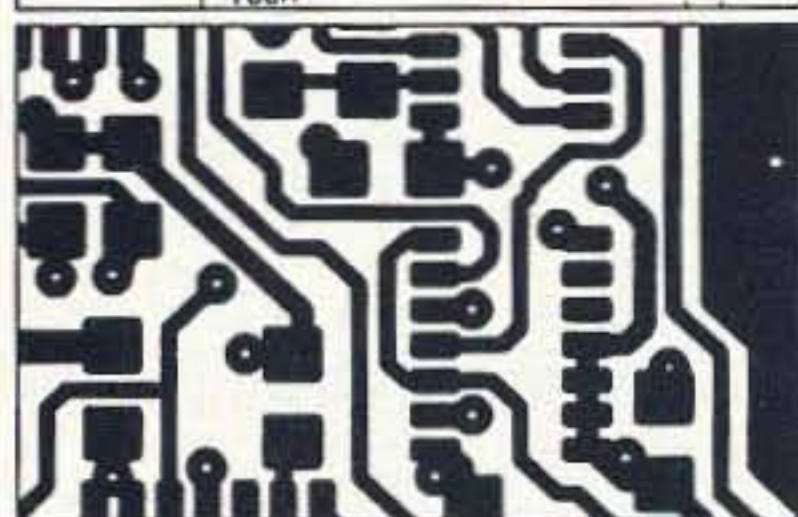
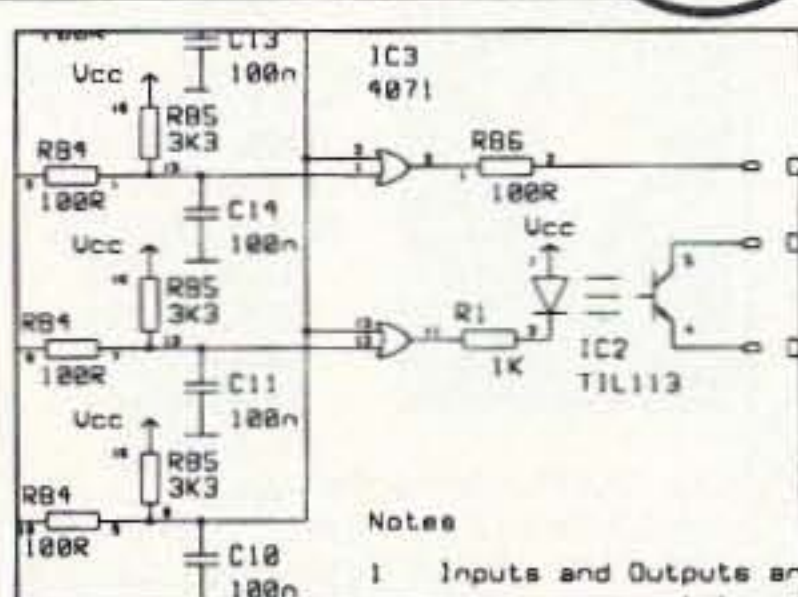

- Runs on PC/XT/AT/286/386 with Herc, CGA, EGA, VGA.
- Design Single sided, Double sided and Multilayer boards.
- Provides Surface Mount support.
- Standard output includes Dot Matrix / Laser / Inkjet Printers, Pen Plotters, Photo-plotter and N.C. Drill.
- Award Winning EASY-PC is now in use in over 17,000 Installations in 70 Countries World-wide.
- Much easier than Lightbox and tapes.
- SUPERBLY EASY TO LEARN AND USE.
- Not Copy Protected.

Options:- 1000 piece symbol library \$75.00,  
Surface Mount library \$112, Gerber Import facility \$195.00

For full info', write, fax, call or use Inquiry #

**Number One Systems**

REF: 73AR, 1795 Granger Avenue, Los Altos, CA 94024

Telephone:

USA: (415) 968 9306

Intl:- +44-480-461778

UK :- 0480 461778

Fax:

USA: (415) 968 9306

Intl:- +44-480-494042

UK :- 0480 494042

VISA and  
MasterCard  
Welcome

BRITISH  
DESIGN  
AWARD  
1989

CIRCLE 1 ON READER SERVICE CARD

# PROTECTING YOUR HAM SHACK

Next two issues of PolyPhaser's  
Striking News (newsletter)  
will cover proper shack  
grounding and  
protection  
techniques.  
to receive  
your free  
copies  
contact

## PolyPhaser

CORPORATION

(800) 325-7170 ■ (702) 782-2511 ■ FAX:(702) 782-4476  
2225 Park Place ■ P.O. Box 9000 ■ Minden, NV 89423

CIRCLE 49 ON READER SERVICE CARD



the Days Inn South to be part of the hospitality group. Drop by anytime during the hamvention, but make plans for Saturday night. It's our biggie. Saturday night is an informal ARCI meeting, pizza party and radio time all in one room. Stop by and join in the storytelling. After all, anytime you're more than 25 miles from home, you're an expert!

#### Clubs to Join

I listed the QRP ARCI in my "Challenge of QRP" article in the October '93 issue of *73 Amateur Radio Today*. If you want a PR handout about the club, all you need to do is drop me a note with \$2 for shipping to my address above. There is no need to include an SASE. If you want to include one, an address label will speed up your request.

Since QRP is becoming a hot item today, there are several other clubs you may want to join. The Michigan QRP club has been around for a while. Their *Five Watter* is an excellent source of information for the QRP'er. Their address is: M-QRP Club, 5346 West Francis Road, Clio MI 48420. Membership is \$7 to join and \$5 for a club renewal.

The G-QRP, based in England, is also worthwhile to join. It's even easier to join than it was when I became a member. Today you can join the G-QRP club by sending a check or money order for \$12 for a new member or \$10

for renewal to: Luke Dodds, 2852 Oak Forest, Grapevine TX 76051.

The New England QRP club has grown steadily in the past few years. Their QRP NE newsletter, 72, is full of reviews of products, club projects and membership news. Their address is: Northeast QRP Club, Membership Manager, Jack Frake NG1G, P.O. Box 1153, Barnard VT 05031. I don't know what the dues are, but a check for \$12 should cover it. If not, by all means let me know so I can update all our readers.

I can't find in my piles of paper the mailing address for the Northwest QRP club. Help!

Do you go through more soldering iron tips than QSL cards? If so, you might be interested in *Home-brew; For Amateur Radio Designers and Builders*. If you're interested, contact George DeGrazio WF0K, editor and publisher, P.O. Box 260083 Lakewood CO 80226-0083. For subscriptions and ad orders contact them at 1-800-5-HAM RIG.

If you can make it to Dayton, you can join, renew and inquire about membership in most of the clubs listed. Be sure you stop by and say hello to everyone at the booths.

#### Kits and More

The Northern California QRP club is also very active, but alas, I don't have an address for them. Anyone know who and how much? Drop me a note



Photo B. The Howes 30 meter transceiver going together.

with the details. I can tell you their Nor-Cal 40 club kit is very popular. In fact, it has been sold out several times. It's nothing real fancy, but a step up and in the right direction. The receiver is a superhet with an IF of 4.915 MHz. The novel receiver design uses no IF amplifiers. The VFO operates at 2.085 MHz. The audio output is not enough to drive a speaker and the AGC is audio-derived. Even with these limits, it sure beats a sloppily-designed direct con-

version receiver.

The transmitter produces 2 watts of output on 40 meters. You get about 35 to 40 kHz coverage on 40 meters. Tuning is via a single-turn pot, not a variable capacitor. If you want more information about the Nor-Cal 40, contact Jim Cates, 3241 Eastwood Road, Sacramento CA 95821. Don't send me hate mail if the kits are all sold out again.

Looking for crystals for the popular

## ID-8 Automatic Morse Station Identifier

Compatible with Commercial, Public Safety, and Amateur Radio applications. Uses include Repeater Identifiers, Base Station Identifiers, Beacons, CW Memory Keyers, etc. Great for F.C.C. ID Compliance.

- Miniature in size, 1.85"x1.12"x0.35".
- Totally RF immune.
- All connections made with microminiature plug and socket with color coded wires attached.
- CMOS microprocessor for low voltage, low current operation: 6 to 20 VDC unregulated at 6ma.
- Low distortion, low impedance, adjustable sinewave output: 0 to 4 volts peak to peak.
- Crystal controlled for high accuracy.
- Transmitter PTT output (to key transmitter while ID is being sent), is an open collector transistor that will handle 80 VDC at 300ma.
- Field programmable with SUPPLIED keyboard.
- Confirmation tone to indicate accepted parameter, plus tones to indicate programming error.
- All programming is stored in a non-volatile EEPROM which may be altered at any time.
- Message length over 200 characters long.
- Trigger ID with active high or low.
- Inhibit ID with active high or low. Will hold off ID until channel is clear of traffic.
- Generates repeater courtesy tone at end of user transmission if enabled.
- Double sided tape and mounting hardware supplied for quick mounting.
- Operating temperature range, -30 degrees C to +65 degrees C.
- Full one year warranty when returned to the factory for repair.
- Immediate one day delivery.

### Programmable Features

- Eight programmable, selectable, messages.
- CW speed from 1 to 99 WPM.
- ID interval timer from 1-99 minutes.
- ID hold off timer from 0-99 seconds.
- CW tone frequency from 100 hz to 3000 hz.
- Front porch delay interval from 0 to 9.9 seconds.
- CW or MCW operation.

**\$89.95 each**  
programming keyboard included

**COMMUNICATIONS SPECIALISTS, INC.**  
426 WEST TAFT AVENUE • ORANGE, CA 92665-4296  
(714) 998-3021 • FAX (714) 974-3420  
Entire U.S.A. (800) 854-0547 • FAX (800) 424-3420

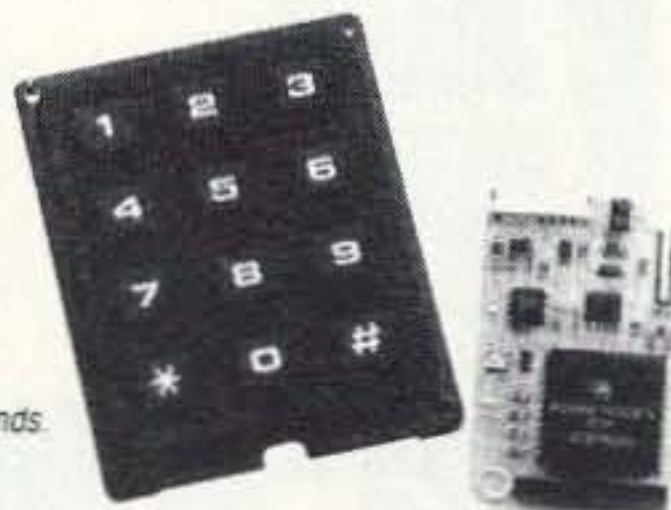

CIRCLE 10 ON READER SERVICE CARD

## PUBLICATIONS TO MAKE RADIO FUN!

<p><b>NEW HAM ATLAS!</b></p>  <p><b>INCLUDES RADIO INFORMATION FOR EVERY COUNTRY!</b></p> <p><b>MAKES QSO'S MORE INTERESTING!</b></p> <p>Our new <b>WORLDWIDE RADIO ATLAS</b> will help make your QSO's more fun and interesting. When you talk to an overseas ham you will know more about his country. Includes radio and geographical information for over 320 countries. More than 325 pages!</p> <p><b>ORDER NOW! \$19.95</b></p>	<p><b>REPEATER MAPBOOK</b></p> <p><b>NEW!</b></p> <p><b>1994-95</b></p> <p><b>NOW INCLUDES AUTOPATCH AND CTCSS TONES!</b></p> <p><b>INCLUDES:</b></p> <p><b>10M, 2M</b></p> <p><b>220 MHz</b></p> <p><b>440 MHz</b></p> <p><b>900 MHz</b></p> <p><b>1.2 GHz</b></p> <p>Our quality Repeater Maps are now available in book form! That's right, our new book includes all U.S. States, all Canadian Provinces, Mexico, Central America and the Caribbean! Maps show city location, repeaters, highways, ham dealers, and tourist information! <b>PERFECT FOR TRAVEL!</b> More than 175 pages!</p> <p><b>ORDER TODAY! \$9.95</b></p>
<p><b>NEW REGIONAL REPEATER MAP GUIDES</b></p> <p>A whole new way to enjoy our map cards! The regional guide includes six laminated state cards, spiral bound for easy use. Very handy, and super for regional travel!</p> <p><b>SETS AVAILABLE:</b></p> <ul style="list-style-type: none"> <li>#1- AK, WA, OR, ID, MT, NV</li> <li>#2- AZ, CA, HI, NM, NV, TX</li> <li>#3- CO, MT, ND, SD, UT, WY</li> <li>#4- IA, KS, MN, MO, NE, OK</li> <li>#5- AL, AR, LA, MS, MO, OK</li> <li>#6- AL, GA, FL, LA, MS, TN</li> <li>#7- KY, MD, NC, SC, VA, WV</li> <li>#8- IL, IN, KY, MI, OH, WI</li> <li>#9- DE, MD, NJ, NY, OH, PA</li> <li>#10- CT, ME, MA, NH, RI, VT</li> </ul> <p><b>PLUS \$3.00 S/H COLOR/LAMINATED \$9.95</b></p>	<p><b>REPEATER MAPS</b></p> <p>Repeater maps for every state, plus Canada. Maps are full color, and laminated in plastic. Shows 2m, 220, 440, 900, and 1.2 GHz. Newly Updated!</p> <p><b>Add 50¢ S/H \$3.95ea.</b></p> <p><b>CATALOG \$2</b> REFUNDED WITH PURCHASE</p> <p><b>INDIVIDUAL MAPS</b> ADD 50¢ SHIPPING</p> <p><b>BOOK ORDERS</b> ADD \$3.00 SHIPPING</p>

**F B Enterprises**  
23801 NW 1st Ave.  
Ridgefield, WA 98642-8830  
CALL TODAY! 1(800) 377-2339  
Dealer Inquiries Welcome

CIRCLE 33 ON READER SERVICE CARD



QRP frequencies, but can't make the minimum order from Bob's Crystal Company? Well, you can pound brass to your heart's content if you order your rocks from Bill Kelsey N8ET, 3521 Spring Lake Drive, Findlay OH 45840. He has a stock of crystals on the popular QRP frequencies for only \$5 each. By the way, Bill also stocks Kanga kits, the Techno-Whizzy kit from *73 Amateur Radio Today*, and other QRP goodies as well.

If you're looking for some serious building without spending all your beer money, then how about a 20 meter superhet QRP transceiver for \$50? This project comes from the *QRP Quarterly* and was designed by Dave Benson NN1G. It's an NE602-based superhet with 2 watts of RF on 20 meters. I have one I'll be showcasing here in the coming months. You can pick one up from Danny Stevig KA7QJY, Dan's Small Parts and Kits, 1935 South 3rd West #1, Missoula MT 59801; (406) 543-2872. Add \$3 shipping for the superhet receiver.

Dan always has a great selection of parts for the home operator. His catalog is just a couple of sheets of paper, but if you build your own gear, you need those sheets! Dan also has several other kits at very good prices. The ever-popular Two-Fer is featured (the version I did in this column). There is no minimum order from Dan's Small Parts.

If you're looking for kits from the ARRL, you might be interested in 624

QRP NETS			
Net Name	Freq.	Day	UTC
BC Group (SSB)	3.729	Every day	0300/0530
New England QRP	3.855	Monday	0200
North West QRP	10.123	Monday	0200
SEN (QRP ARCI)	7.030	Tuesday	0100
Michigan QRP	3.535	Tuesday	0200
GLN (QRP ARCI)	3.560	Wednesday	0200
GSN (QRP ARCI)	3.560	Wednesday	0200
WSN-80 (QRP ARCI)	3.560	Wednesday	0300
Northeast Illinois	3.560	Thursday	0200
NEN (QRP ARCI)	7.040	Saturday	1300
Northwest QRP	7.035	Saturday	1530
WSN-40 (QRP ARCI)	7.040	Saturday	1700
OK QRP Group	7.060	Sunday	1330
VE QRP	14.0606	Sunday	1800
TSCN (QRP ARCI)	28.332	Sunday	1900
TCN (QRP ARCI)	14.060	Sunday	2300

KITS, 171 Springlake Drive, Spartanburg SC 29302; 1-803-583-1304. Most of their kits are based on the work done by Doug Demaw. I've never assembled any of their kits, but they sound good.

Townsend Electronics, P.O. Box 415, Princeton IN 46562, handles the Howes kits from England. There are quite a few different kits available from Howes. Drop Jim Townsend a note asking for his latest catalog. I'll have a full review of the Howes 30 meter transceiver in *73 Amateur Radio Today*. Watch for it.

Of course, if you don't want a complete kit, you more than likely can get just the PC board you need from FAR Circuits, 18N640 Field Court, Dundee IL 60118. FAR carries PC boards from

just about every project in *QST*, *CQ*, *Radio Fun*, and *73 Amateur Radio Today*. All the PC boards FAR makes are made of G-10 Fiberglass and then solder-reflowed. Most of the PC boards have a silk-screened parts overlay on them. FAR Circuits PC boards are first-class all the way.

A&A Engineering, 2531 West LaPalma, Unit K, Anaheim CA 92801, also carries many popular kits for the QRP-er. Of note is their popular transceiver for either 20 or 40 meters. This project came from *QST*, October '90 and January '91, and was designed by Gary Breed K9AY. This transceiver works very well indeed.

And, Ten-Tec has introduced a line of kits. I don't have the full details yet on what they offer. I suspect they will

be small modules of some sort. Did you know Ten-Tec used to sell only kits? These older kits became the basic PM series of QRP transceivers.

Tejas RF Engineering will be introducing a line of kits to build your own rigs. These will be *building blocks* you can connect together, and should be very popular with QRP builders. All you have to do is interconnect the assembled PC boards into the configuration you require.

#### Spring ARCI QRP Contest

Take some time off from your building to operate the spring ARCI QRP contest. I won't get into the scoring, as it gets a bit complex. The frequencies are the QRP calling frequencies plus or minus the QRM. Most of the activity is centered on 7.040 MHz and on 14.040 MHz. Also check 7.030 MHz and 14.060 MHz. Check the various magazines for contest days and times.

The exchange is simple. All you need is the RST, QRP ARCI member number and state. If you don't have a number, then you use your power instead. By the way, this is one of the few contests in which everyone is not 5NN!

That's all this month. I will be working the contest off and on, depending on my work schedule. I'll be running a home-brew 40 meter transceiver. We can lie about how great we did when we meet at Dayton '94. See you there!

## DON'T MISS THIS ONE!

# GREATER BALTIMORE HAMBOREE AND COMPUTERFEST

HOST TO THE  
ARRL MD STATE CONVENTION

MARCH 26 & 27, 1994  
Maryland State Fair Grounds  
Timonium, Maryland

THE LARGEST SHOW OF ITS KIND  
IN THE MID-ATLANTIC AREA

ARRL Forums & Programs • Banquet  
10 Acres of Indoor and Outdoor Sales  
3 Buildings • 1,100 Indoor Spaces  
Buildings for Dealers & Manufacturers  
Indoor Fleamarket • Outdoor Tailgate  
FCC Exams • Acres of Parking  
Over 16,000 Attended Last Year!  
VENDORS: All spaces by advance sale! Register NOW!

Call: 410-HAM-FEST  
Or: 1-800-HAM-FEST  
Anytime, for Voice or FAX Info

Write: G.B.H. & C.  
Post Office Box 95  
Timonium, MD 21094

## MoTron Electronics

310 Garfield St. Suite 4 PO Box 2748 Eugene, Oregon 97402

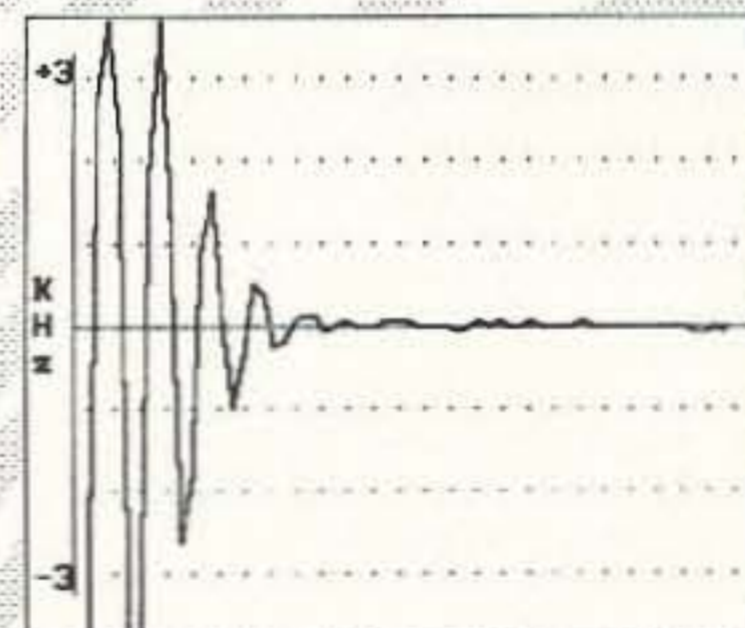

This is an actual FingerPrint captured by the TxID-1

## TxD-1 Transmitter FingerPrinting System

Now Shipping!

FM/AM radio transmitters have a unique frequency versus time start-up characteristic--even radios of the same make and model. This "FingerPrint" can be captured, stored and analyzed. Our exclusive TxID Software and the patented technology of the TxID-1 IBM/Compatible circuit board can help you identify the abusers on your repeater! Or help you keep track of the number of radios per account on commercial repeaters. CTCSS and DTMF decoding, as well as Spectrum Occupancy and Deviation measurement features further enhance the system.

Call or write for a brochure with full details, additional examples, and technical specifications.

**TxD-1 with Software \$699.00**

Shipping/Handling UPS Ground USA: \$8.00  
Visa/MC and AMEX accepted. COD on cash or Money Order basis only.  
Government Purchase Orders accepted.

Orders: (800) 338-9058

Info: (503) 687-2118 Fax: (503) 687-2492



Jeffrey Sloman N1EWO  
P.O. Box 636  
Franklin IN 46131

### Getting Started with TCP/IP, Part 6

Well, like some very large percentage of the rest of the US, the flu (I am told it comes from Beijing) struck here. For a week I have been unable to do any substantial work, and as I type this, I am under the weather. Because I don't want to leave you without useful information this month, here are a cou-

ple of important files that are used by JNOS—a working AUTOEXEC.NOS file, and a description of how to assign user permissions in the FTPUSERS file. I'll talk more about these next month, but at least you'll have them in front of you, and you can experiment with them until then.

Note that this AUTOEXEC.NOS file may produce errors with certain versions of JNOS, but it should still work. Unfortunately, JNOS does not necessarily maintain compatibility between

versions. The differences are usually minor, though. In any of the text files used by JNOS, any line or portion preceded by a pound sign (#) is considered a comment and ignored.

This is pretty much the AUTOEXEC.NOS used here at N1EWO. We will discuss some of the more esoteric entries in future columns. Be sure to use your OWN call and IP address if you try to copy this file!

### FTPUSERS

JNOS uses a file called FTPUSERS to assign permissions to the users who connect to your station. The entries in the file are very simple, for example:

```
n1ewo blort /public 63
```

where:

n1ewo is the call of the user;

blort is the assigned password (an

asterisk (\*) indicates that any password should be accepted);

/public is the directory into which the user is placed when making an FTP connection to your station.

The user can then access and directory below, but none above, the specified one; and, finally, 63 is a number indicating the permissions granted to the user. This is a "bitwise" operation and each bit which is turned on in a binary version of the number indicates a granted permission. Don't worry, though, no binary math is required—just add up the numbers corresponding to the permissions you wish to grant from the list below; the result is what you need. I hope you find this information useful. We'll get back to tutorial discussion next month. 73 de N1EWO.

Figure 1

```
attended on # Allows TTY link connections
isat yes # 286/386 clock
log yes # Turns on log (earlier versions
# need a filename, not "yes"
mbox tmsg "[m Welcome to N1EWO. [44.48.70.21] [m"
# This line sets the message that stations see when
telneting
# to your station. It is displayed before the login
prompt.
mold "Congratulations, you've connected."
# This line sets the message that is displayed when
a
# station connects to your ttylink server.
domain cache size 30 # The max number of
resolved addresses
# that will be cached by JNOS
domain suffix ampr.org. # The suffix that will
be appended when
# none is otherwise provided
domain translate off # Determines whether
JNOS will try to
# translate from numerical addresses
to
# host names. Turning this off can
# speed things up.
ip address 44.48.70.21 # This host's IP ad-
dress
hostname n1ewo # This host's name
ax25 mycall n1ewo # This host's AX.25 call
# MUST precede 'attach'
#-----TNC-----
attach asy 0x3f8 4 ax25 dsp 2048 256
4800
# This attaches the TNC to JNOS
# asy = async (comm port)
# 0x3f8 = base address
# 4 = IRQ
# ax25 = mode
# dsp = name
# 2048 = buffer
# 256 = MTU (Maximum Transmission Unit) like
PACLEN
# 4800 = port speed in bps
trace dsp 111 # Turns on monitoring for
this
# interface: 1 = ASCII
# 1 = input on
# 1 = output on
#-----initialize-----
#NOTE: The TNC must be set to KISS mode for JNOS
# to work. This is not accomplished in this
file.
# It can be done manually—with a comm program.
# most TNCs use the command KISS ON.
param dsp 1 20 # TX delay (x 10mS)
param dsp 2 63 # Persistence (0-255)
param dsp 3 10 # Slot Time (x 10mS)
param dsp 4 10 # TX tail (x 10mS)
param dsp 5 0 # 0=HDX
param dsp dtr 1
param dsp rts 1
#-----SLIP-----
# This section is like the previous attach,
# except that it sets up a SLIP (Serial Line
# Internet Protocol) interface over a wired
# connection. This is used here to connect
# two machines together.
attach asy 0x2f8 3 SLIP wire 2048 256
4800
trace wire 111
#-----AX.25-----
# This section sets the AX.25 parameters for the
station
ax25 bcinterval 840
ax25 bctext "[m N1EWO mailbox [44.48.70.21] [m"
ax25 digipeat dsp on
ax25 irtt 2500
ax25 maxframe 2
ax25 paclen 256
ax25 pthresh 128
ax25 retry 10
ax25 t3 65000
ax25 t4 300
ax25 timertype linear
ax25 version 2
ax25 window 2048
mode dsp datagram # Sets the transmis-
sion mode for the
# dsp interface. Sends TCP/IP in
# unconnected mode.
#-----inconfig-----
# This section configures the various attached in-
terfaces
# dsp
ifconfig dsp broadcast 44.48.255.255
ifconfig dsp netmask 0xFF000000 # This line
sets the IP mask,
# which determines the addressing class of the sta-
tion. Most amateur
# TCP/IP nets use the mask shown here.
ifconfig dsp description "Radio port [145.510]"
# This is the
```



Figure 1 (continued)

```
# text description used by JNOS for informational
displays about this
# interface.
# wire
ifconfig wire broadcast 44.48.255.255
ifconfig wire netmask 0xFF000000
ifconfig wire description "SLIP to 44.48.70.22"
#---TCP/IP defaults---
ip ttl 10 # IP Time-To-Live Parameter
tcp mss 216 # Maximum Segment Size
tcp irtt 65000 # Initial Round Trip Time estimate-
# which is used as a guess until the actual time can
be determined.
# If your LAN is very busy and your station seems to
send a bunch of
# retries and then settle down, this number should
probably be higher.
tcp window 216
#---servers---
# This section starts the various servers built into
JNOS
start ax25
start convers
```

```
start finger
start ftp
start pop3
start remote
start smtp
start telnet
start ttylink
```

```
#---IP routing---
route addprivate default dsp
route drop 44/8 wire
route add 44.48.70.22 wire
arp publish 44.48.70.22 ax25 nlewo dsp
```

```
#---mailbox---
third-party on # Allows the BBS to handle
third party mail
smtp timer 600 # Timer for SMTP polling
smtp usemx on
smtp mode route
smtp kick
```

```
#---FTP---
ftype binary
eol standard
```

Figure 2

(hex)					
1	0x1	Read files	1024	0x400	No send command from BBS
2	0x2	Create files	2048	0x800	No read command from BBS
4	0x4	Overwrite or Delete files	4096	0x1000	No third-party mail from BBS
8	0x8	AX.25 gateway operation from BBS	8192	0x2000	User is a BBS
16	0x10	Telnet gateway operation from BBS	16384	0x4000	Expert User flag
32	0x20	NET/ROM gateway operation from BBS	32768	0x8000	No convers command from BBS
64	0x40	Remote Sysop access	65536	0x10000	No escape character from BBS
128	0x80	User is banned from the BBS	131072	0x20000	No lists displayed on BBS

**SURVEILLANCE**  
& COUNTERSURVEILLANCE Electronic Devices

Bugging/Phone Tapping Detectors • Caller IDs • Covert Video  
• Phone Scramblers • Voice Changers • Shotgun Mics  
Vehicle Tracking • Transmitter Kits • Locksmithing • AND MORE!

**NEW!** Telephone Recording Systems Disguise Video Cameras

**EDE** FOR CATALOG SEND \$5.00 TO...  
P.O. Box 337, Buffalo, NY 14226 (716) 691-3476

**Walking-Stick Yagi?**

Hold it in your hand—it's a walking stick made of aluminum with rubber ends. But inside are all the elements of a 4 element yagi that goes together in 2 minutes. Ready for the T-Hunt. Ready to get your signal out of a hole into the repeater. No little bits to drop and get lost. Everything fits clean and tight and tough. 2meters \$79, 70 cm \$49. Weighs only 1 lb. Add \$6 Shipping & Handling. Info \$1.

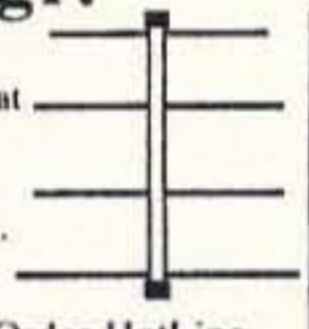

**AntennasWest** Order HotLine  
Box 50062-S Provo UT 84605 801 373 8425

CIRCLE 324 ON READER SERVICE CARD

4309 Northern Pike Blvd.  
Monroeville, PA 15146  
(412) 374-9744

FOR ORDERS ONLY CALL  
(800) 854-0815

**FOR HAMS ONLY**

SPECIALIZING IN PREOWNED  
AMATEUR AND SHORTWAVE EQUIPMENT  
**BUY • SELL • LOVE TO TRADE**  
We Carry All Major Brands Of New Equipment

CIRCLE 329 ON READER SERVICE CARD

Sell your product in **73 Amateur Radio Today**  
Call Dan Harper today. . . 1-800-274-7373

Do you use a  
**JURASSIC REPEATER**  
then fast forward to **1994**

- Add A Digital Voice Messaging System To Your Repeater
- Leave Voice Messages For Each Other
- Get Packet Cluster Info In Voice
- Schedule Voice Announcements
- Computer Board And Software \$259

Call Toll Free For Info Package  
1-800-563-5351 Toll Free From USA  
1-306-781-4451 Direct

**DIGITAL Communications Inc.,**  
General Delivery, Pilot Butte, SK, Canada S0G 3Z0

CIRCLE 181 ON READER SERVICE CARD

**Actual Circuit Emulation**  
A better way than ICE!

• More power with much less cost **The eBoard™**

- Drivers for LCD,DTMF,more
- External power supply for 24 hour a day operation
- Runs independently of PC
- Versatile Interface Adapter on eBoard, simple expansion
- Board resident Forth option
- Use as programmable PCcard
- All source is included. Kernal, Forth. PC Debugger and Assembler
- Cable, Breadboard, Power supply

**\$195<sup>95</sup>**

This is a limited time price for the 6502, 6522 versions. Includes shipping and handling.

**Highlands Electronics**  
13720 LakeShore Drive  
ClearLake, CA 95423  
Phone 707 994-1024  
Fax 707 994-5823

**Object Oriented Hardware™**

**DIGI-FIELD**  
FIELD STRENGTH METER

Are you worried about electromagnetic radiation, TV coax distribution loss, poor antenna performance, or EMI/RFI? The DIGI-FIELD field strength meter will put you at ease. With its frequency response of DC up to 12 GHz, it readily detects potential electromagnetic radiation hazards. It is an excellent tool for measuring TV coax distribution loss. In addition DIGI-FIELD can easily find 60-Hz AC-line interference, as well as RFI/EMI instrumentation disrupting set-ups. Sensitivity: @ 100 MHz Model"A" 150 nano Watts. Model"B" 2 nano watts.

**\$139<sup>95</sup>**  
Plus \$6.50 s/h

**To order call - (800) FIELD 58 (343-5358)**  
**I.C. Engineering** 16350 Ventura Blvd.  
Suite 125, Encino, CA 91436 PH.(818) 345-1692 • 818-345-0517 Fax

CIRCLE 293 ON READER SERVICE CARD



## Ham Television

Bill Brown WB8ELK  
c/o 73 Magazine  
70 Route 202 North  
Peterborough NH 03458

### ATCO Repeater System

Several members of the ATCO (Amateur Television in Central Ohio) group have recently put together a wide-coverage ATV repeater system (WA8RUT/R). From its vantage point on top of the tallest building in downtown Columbus, the repeater signal has been providing fantastic coverage around the region.

### Split-Site Repeater

To overcome the inherent problems with an in-band repeater (439.25 MHz in and 427.25 MHz out), they decided to go with a split-site system. The transmitter is located on top of the State Office Tower (650 feet above street level) and, although the receive

site is low profile at the moment, it will soon be located at the 300-foot level of a TV tower about one mile from the transmit site. The two sites are linked together on 910.25 MHz. In essence, there are two crossband repeaters linked together. In fact, several ATVer's in the area are using converted license-free transmitters to access the transmit site repeater on 910.25 MHz, some with only a few milliwatts of output power.

### The Transmit System

Designed by Ken WA8RUT, the transmit site (see Figure 1) functions as a fully functional crossband repeater with an input on 910.25 MHz and outputs on 427.25 MHz as well as 1258 MHz FM ATV. This versatile system allows ATVer's the flexibility of using a variety of modes and frequencies to work through the repeater system. The 427.25 MHz transmitter puts

out about 35 watts after going through the VSB filter and goes through a relatively short run of hardline up to the dual-slot omnidirectional horizontally-polarized antenna on top of the building. The 1258 MHz FM transmitter puts out about 18 watts to a single slot (horizontal) antenna. The slot antennas were built by Art WA8RMC.

The 910.25 and 427.25 MHz receive and transmit modules are manufactured by P.C. Electronics and the 1258 MHz FM transmitter is based on a Wyman Research exciter board that runs through a Mitsubishi power amplifier brick. The 910.25 MHz antenna is a 6 dBd gain vertical originally designed for cellular use.

The many functions of the repeater are controlled via a Micro Computer Concepts model VS-100. Touch-Tone commands via 147.45 MHz can control several different video selections, such as a roof camera, weather radar, a bulletin board, and NASA Select Shuttle rebroadcasts.

### The Remote Receive Site

Soon to be located about one mile away at a height of 300 feet, this site functions as a crossband repeater with

an input of 429.25 MHz and an output on 910.25 MHz (see Figure 2). It uses a horizontal slot antenna for receive (built by Shawn KB8MDE) and a loop yagi to direct the signal at the State Office Building. It contains its own IDer (an Elkronics VDG-1) and will soon have an additional receiver on 1280 FM ATV. When the 1280 FM receiver is installed, the whole repeater system can work as a repeater with 1280 FM in and 1258 FM and 427.25 AM out as well as 429.25 in and both 1258 and 427.25 out. Essentially it will operate as an in-band and crossband repeater on two bands and two modes. If you include the 910.25 MHz link, the system operates on three bands simultaneously. The control logic and tone decoder is being built by Dale WB8CJW.

### Shuttlevision Link

Tom KA8ZNY has built up a 910.25 MHz transmitter using a low-power "rabbit transmitter" fed into a power brick to link NASA video into the repeater. He plans on installing a VS-100 repeater controller at his house to allow remote access of the NASA Select video feed from his satellite dish.

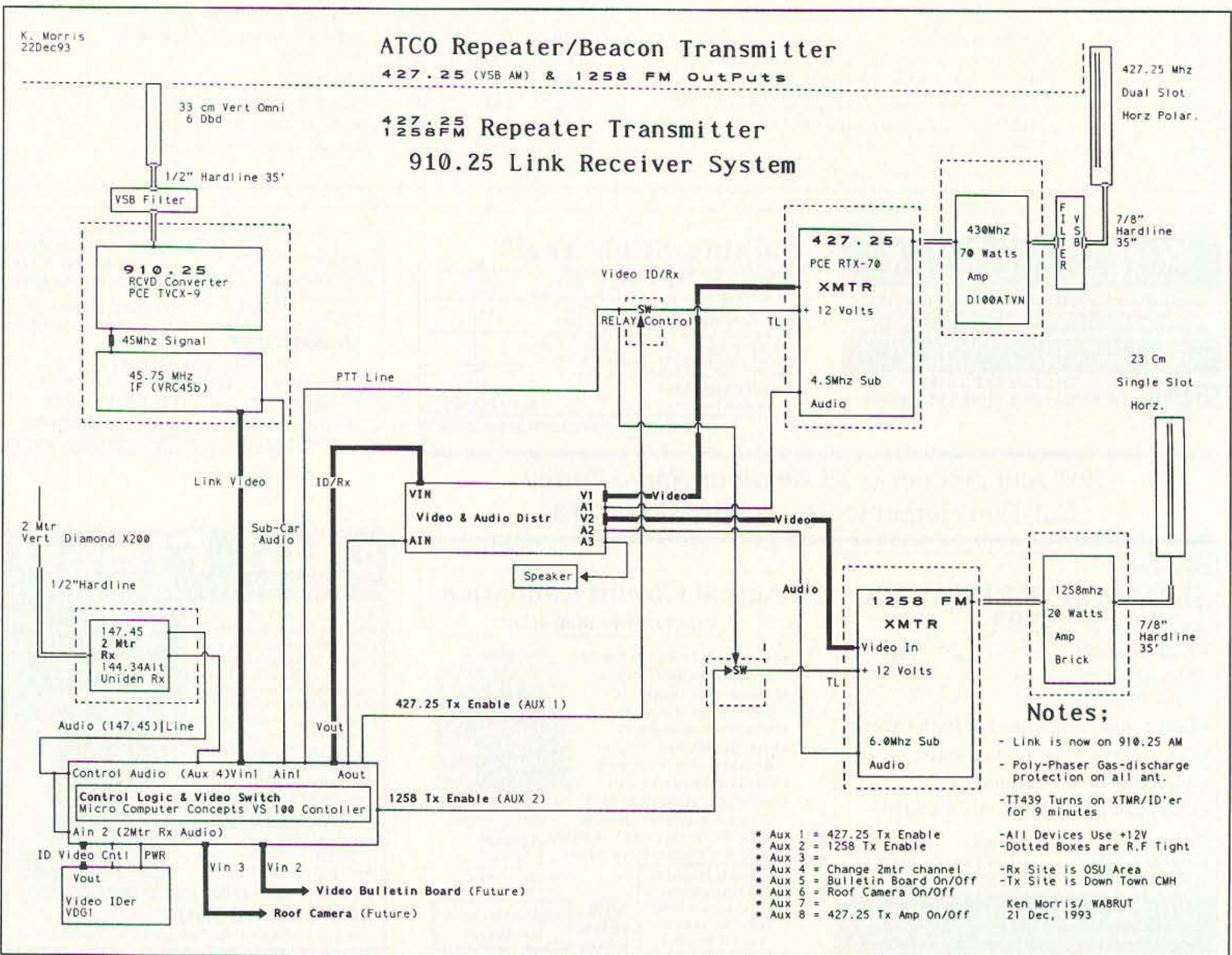
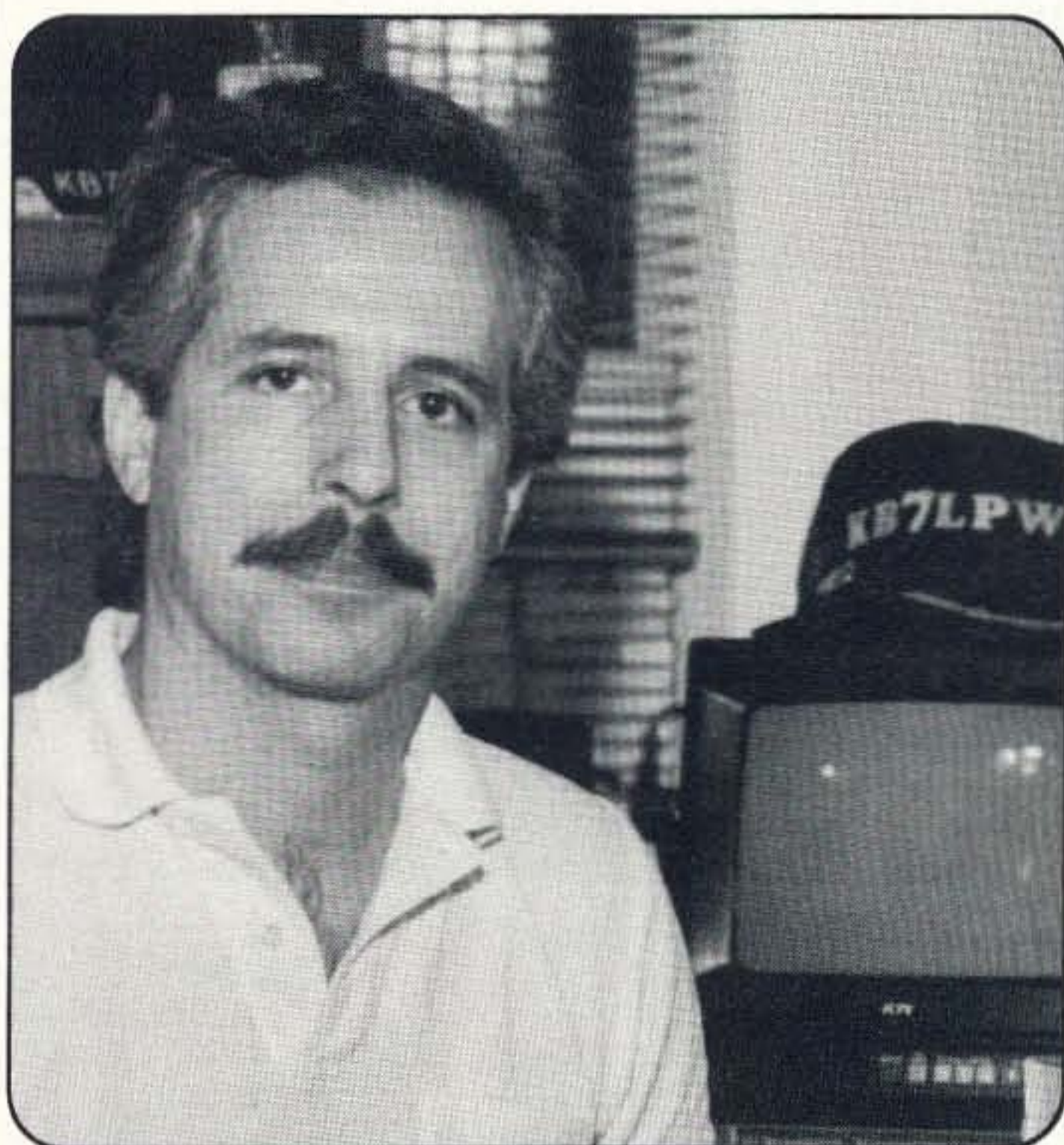

Figure 1. Block diagram showing the ATCO ATV repeater transmit site that is located on top of a 650-foot building in downtown Columbus, Ohio.



# HAM RADIO & MORE

National Talk Radio Show With Len Winkler, KB7LPW



**America's Only  
Ham Radio  
Show On The  
Broadcast  
Bands!**

**Sundays  
6:00 pm EST**

Weekly Co-Host, John Moore, NJ7E – Weekly DX Update With Lee Finkel, KY7M

Tune in each week for national ham radio news, FCC news, weekly guests from the amateur radio community, ham trivia contests, prizes, listener call-in and more!

Sponsored in part by Antique Electronic Supply and *73 Amateur Radio Today*.

#### "Ham Radio & More" Upcoming Programs

- |      |  |
|------|--|
| 2/27 | David Cassidy N1GPH, Associate Publisher/Editor, <i>73 Amateur Radio Today</i> and <i>Radio Fun</i> magazines.           |
| 3/6  | Dayton Preview; Open Line America!   |
| 3/13 | Al Gross W8PAL, Inventor of the 1st Handie-Talkie, 1st Digital Beeper, Calculator, Surface Mount Technology & much more. |
| 3/20 | Joe Lynch N6CL, QCWA Newsletter Editor   |
| 3/27 | Steve Mendelsohn WA2DHF, ARRL Hudson Division Director.  |

Find out what radio station airs "Ham Radio & More" in your local area by calling the originating station, KFNN, at 602-241-1510.

For sponsorship information contact Ron Cohen at 602-241-0482.



During the Hubble rescue mission Tom provided viewers with some spectacular video while testing this linkup.

#### Weather Radar

Art WA8RMC is currently designing a video capture system and link transmitter to relay the local weather radar image up to the repeater system. The overlay video ID and tone decoder for this system has been built by Charles WB8LGA. The weather radar feed should be opera-

tional in the very near future.

#### Reception Reports

The repeater can be seen p5 (even while mobile) around central Ohio (out to over 20 miles). I've personally seen it in full color on a hand-held portable TV directly tuned below channel 14 from over 15 miles away. Charles WB8LGA has reported consistent p5 in Marengo (35 miles) and can actually view the 1258 MHz FM output at a p2 level using just the LNB input of his satellite receiver (no preamp). Mel

KA8LWR sees the repeater at around a p3 level from 56 miles and has seen it several times mobile. Even stations over 80 miles away can frequently see the repeater at a p4 level. The carrier has been heard in Ft. Wayne, Indiana (135 miles), as well.

A number of people (including non-ham observers) are finding it easy to tune in to the action using a cable-ready VCR or a TV tuned to cable channel 58. Some report seeing the repeater using just rabbit ears inside of their apartments.

#### ATCO Net

If you'd like to find out more about the repeater system or ATV activity in the central Ohio region, listen to the ATCO net every Tuesday evening at 9 p.m. EST on 147.45 MHz (the local ATV calling frequency). The group is quite active, and you can usually find somebody on frequency just about anytime. The other primary ATV calling frequency is on 144.34 MHz and you can find activity there early in the morning (7:30-8:00 AM) and during the evenings.

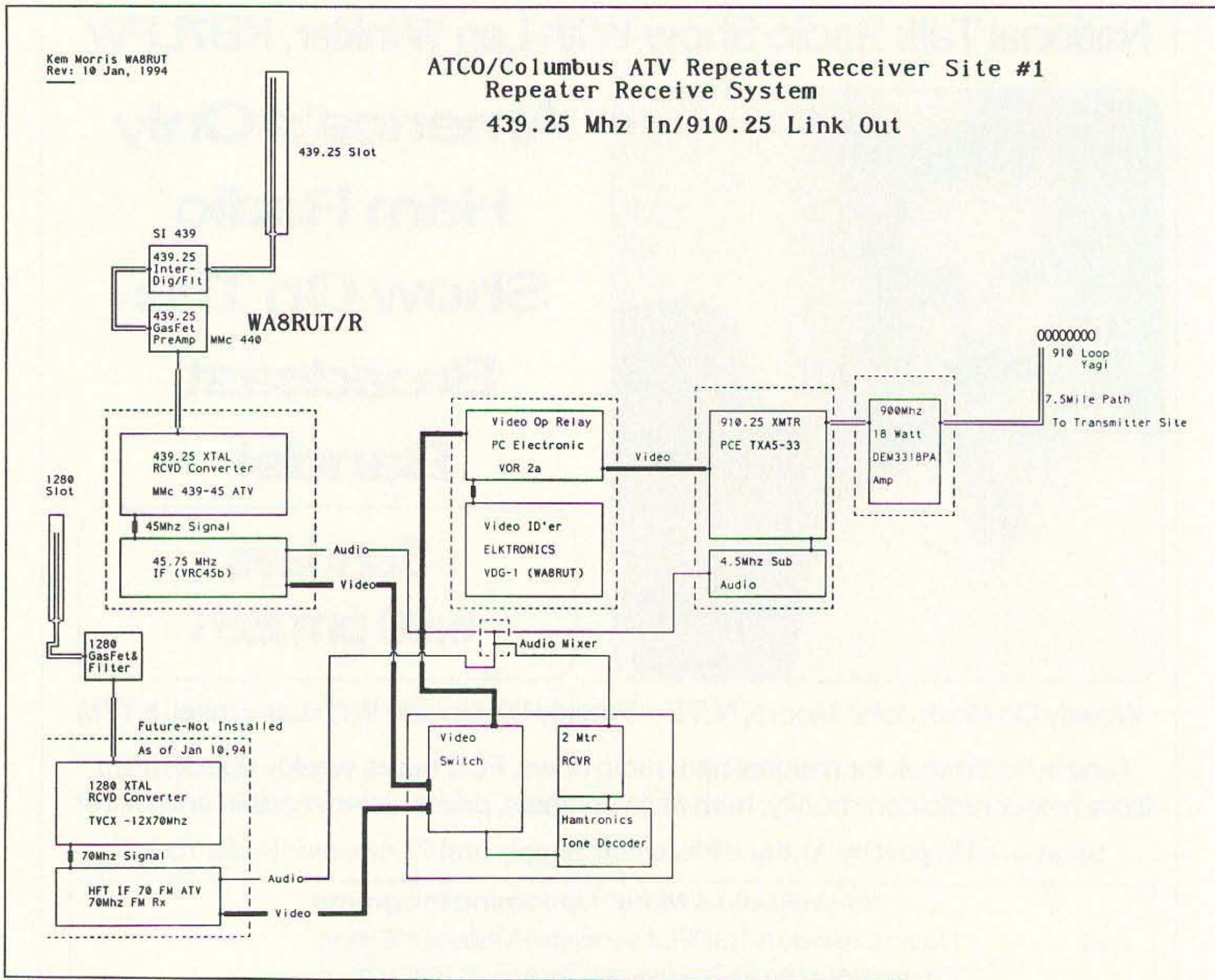

Figure 2. Block diagram of the remote receive site which will soon be located at the 300-foot level of an old commercial TV tower.

#### CornerBeam?

SWR < 1.2:1 across the band  
Gain of a 15 ft Yagi  
No dimension over 7 ft  
40 dB Front-to Back Ratio  
60° Half-power Beamwidth  
Mounts directly to mast  
Vertical or Horizontal Polarization  
2meters \$145, 220 MHz \$145, 70 cm \$115, Dual 146/440 \$165  
Weighs only 10 lbs. Add \$11 Shipping & Handling. Info \$1.



AntennasWest  
Box 50062 Provo UT 84605  
Order HotLine  
801 373 8425

CIRCLE 380 ON READER SERVICE CARD

#### CB-TO-10 METERS

We specialize in CB radio modification plans and hardware. Frequency and FM conversion kits, repair books, plans, high-performance accessories. Thousands of satisfied customers since 1976! Catalog \$2.

#### CBC INTERNATIONAL

LOU FRANKLIN/K6NH - Owner  
P.O. BOX 31500X, PHOENIX, AZ 85046

#### GIVE YOUR HR-2510 HR-2600

the same features as the "BIG RIGS"

#### CHIPSWITCH

4773 Sonoma Hwy. Suite 132  
Santa Rosa, CA 95409-4269

Write or call (707) 539-0512 for FREE information

CIRCLE 265 ON READER SERVICE CARD



# New Amateur Publications



**Radio/Tech Modifications 5A & 5B**  
Expanded RX /TX Modifications & alignment controls  
Vol 5A for Kenwood, Icom & Scanners  
Vol 5B for Alinco, Standard, Yaesu, CB's & others

\$ 19.95 each

## Federal Government Frequency Assignments

A must for scanner listeners

Frequency use assignments for Departments of Agriculture, Air Force, Army, Commerce, Defense, Energy, Health and Human Services, Housing and Urban Development, Interior, Justice, Labor, Navy, State, Treasury, and Transportation. Also 29 Independent Agencies

\$ 24.95

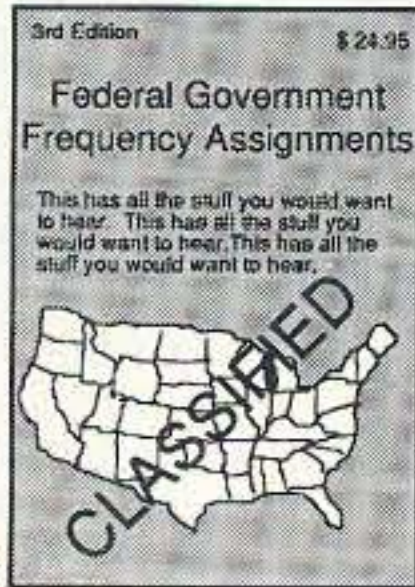

## North American Shortwave Frequency Guide

.5 - 30 MHz listing of all shortwave activity, listed in frequency order.

International Broadcasts from around the world, Military and Public services. All broadcast modes. The most handy reference book for the band scanner.

Add \$ 4.00 Shipping to all orders in USA

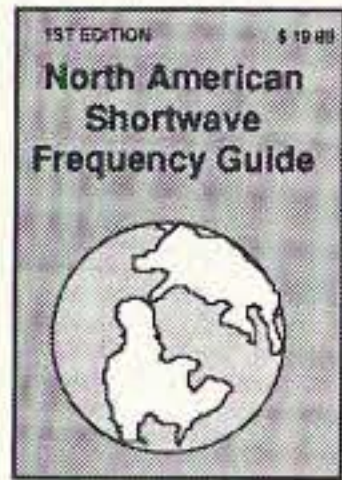

\$ 19.95

*artsci*

Artsci inc  
P.O. Box 1848  
Burbank, CA 91507  
(818) 843-4080  
Fax (818) 846-2298

CIRCLE 276 ON READER SERVICE CARD

# AMATEUR TELEVISION

## GET THE ATV BUG



**New 10 Watt Transceiver Only \$499**

Made in USA  
Value + Quality  
from over 25years in ATV...W6ORG

Snow free line of sight DX is 90 miles - assuming 14 dBd antennas at both ends. 10 Watts in this one box may be all you need for local simplex or repeater ATV. Use any home TV camera or camcorder by plugging the composite video and audio into the front phono jacks. Add 70cm antenna, coax, 13.8 Vdc @ 3 Amps, TV set and you're on the air - it's that easy!

TC70-10 has adjustable >10 Watt p.e.p. with one xtal on 439.25, 434.0 or 426.25 MHz & properly matches RF Concepts 4-110 or Mirage D1010N-ATV for 100 Watts. Hot GaAsfet downconverter varicap tunes whole 420-450 MHz band to your TV ch3. 7.5x7.5x2.7" aluminum box.

Transmitters sold only to licensed amateurs, for legal purposes, verified in the latest Callbook or send copy of new license. Call or write now for our complete ATV catalog including downconverters, transmitters, linear amps, and antennas for the 400, 900 & 1200 MHz bands.

(818) 447-4565 m-f 8am-5:30pm pst.

Visa, MC, COD

**P.C. ELECTRONICS**

Tom (W6ORG)

2522 Paxson Lane Arcadia CA 91007

Maryann (WB6YSS)

# You'll be amazed

WITH WHAT YOU CAN DO WITH Quickyagi

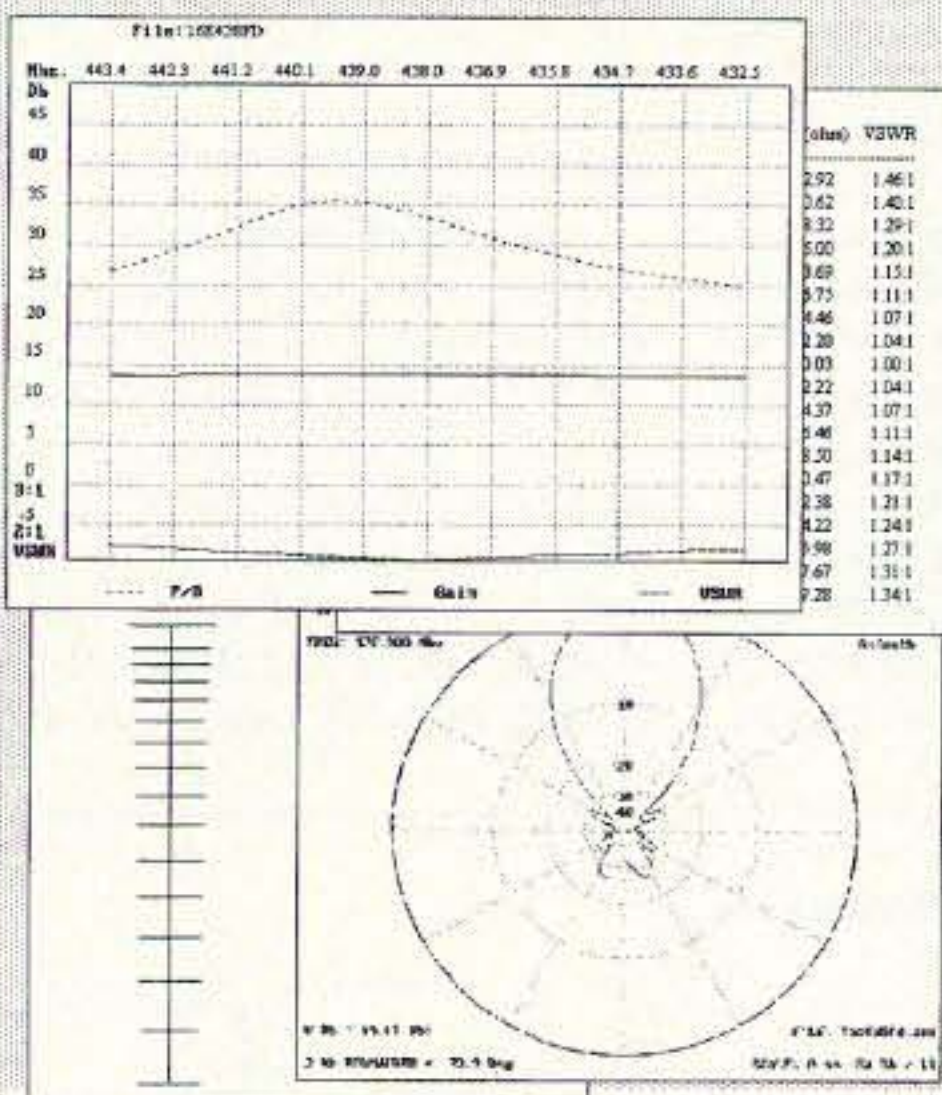

This high speed, easy-to-use yagi software features auto-design, auto-optimize and performance analysis. It will accurately calculate up to 17 elements to 1 Ghz. with boom and tapered element compensations, a folded dipole option, and prints all files, charts and graphs. Includes both co-processor & no co-processor versions.

For XT / AT w / 640 K RAM, VGA, EGA, CGA, Herc and DOS 3 or greater

**HOT! NEW VERSION 3.0 upgrade**

Upgrade from any antenna software for only

**Quickyagi \$19.95**

Add \$3.00 s&h or \$5.00 for non-USA orders • Incl. Callsign w/order  
Send SASE for complete info. • US Check or Internat'l Money order  
Arizona orders add 5.5% state tax • Specify 3.5" or 5.25" floppy disk



**RAI Enterprises** (602) 848-9755  
4508 N. 48th Dr. Phoenix, AZ 85031

## A NO-RADIAL VERTICAL THAT COVERS 80 OR 75 METERS?

**THERE'S ONE NOW!**

No, we won't insult your intelligence by telling you that it's a "halfwave" or that ANY vertical will operate more efficiently without a good radial system than with one; it certainly won't! If you want expensive fairy tales talk to our competitors! If, however, you've no room for even the smallest radial system just install the most efficient multiband vertical in the business, the HF9V-X, over our counterpoise kit. You'll not only save a tidy sum but you'll work DX that the shorter and more lossy no-radial "halfwaves" can't touch because both the HF6V-X and HF9V-X use longer active element lengths for higher radiation resistance and greater efficiency on more bands than any of the so-called halfwaves. Ask for our free brochure for complete specs on all Butternut models and receive technical note DLS-1 "Dirty Little Secrets from the Antenna Designer's Notebook") that shows you how to calculate the probable efficiency of any vertical antenna using the manufacturer's own specs so you won't have to learn the truth the hard way!



**Model HF9V-X (shown to the left) for 80/75, 40, 30, 20, 17, 15, 12, 10 and 6 meters.**



**Model CPX counterpoise kit for Butternut models HF9V-X, HF6V, and HF6V-X; substitutes for ground or elevated radials. Self-supporting tubing bolts onto base of antenna. Mast not provided.**

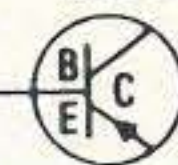
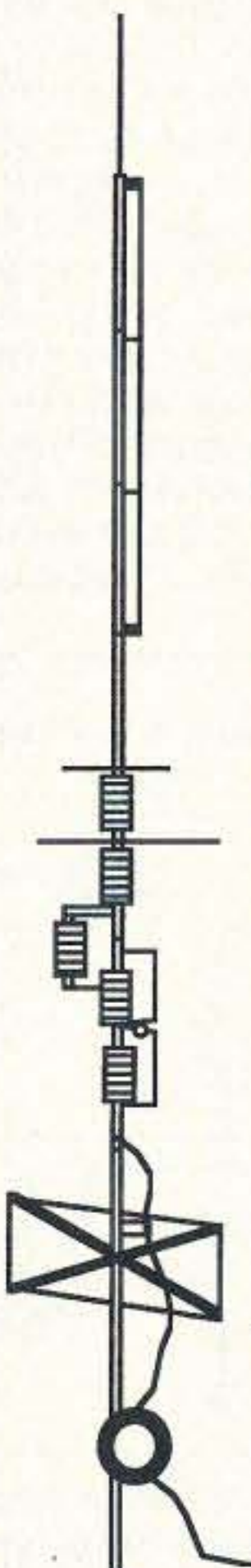

**BUTTERNUT ELECTRONICS CO.**

P.O. Box 1234, Olmito, TX 78575 (210) 350-5711



# ABOVE & BEYOND

## VHF And Above Operation

C. L. Houghton WB6IGP  
San Diego Microwave Group  
6345 Badger Lake Ave.  
San Diego CA 92119

### Log Amplifiers

This month I want to cover a commercial specialty amplifier called a log amplifier. Last month I covered a homebrew 30 MHz RF preamplifier and some component selection considerations. The preamplifier was intended for use in RF applications for power and low noise receiver or transmitter applications. The log amplifier is similar to the RF type amplifier, with some circuitry changes allowing its output to be handled in a logarithmic fashion. Let's explore this special type of amplifier and cover some amateur radio applications.

A log amp is a multi-stage IF amplifier that has some special circuitry added by design into the amplifier. Basically, the circuitry consists of a diode summing network and output stage. The log amplifier has eight or so stages, with each stage's gain/dynamic range set to 10 dB. The output of each one of these eight or so stages is connected to a diode summing network/limiter. The outputs of these diodes are all tied by common feeding of a video output or associated video amplifier. The output of this video amplifier is the business end of the log amplifier circuit. Additional connections may be made to bring out the standard IF output on the log amplifier, labeled "linear" output. All log amps can be coupled with this output, but not all are.

This makes the amp very usable in both a log function and as a common IF amplifier for a multitude of projects. If used in this case (as an IF amp), it will have a gain of some 70 to 80 dB gain at the amp's specified frequency. Figure 1 shows a block diagram of a typical log amp. Most amplifiers have a preamplifier and a buffer amplifier used to drive six to eight identical stages in tandem.

Each stage is set for about 10 dB of dynamic range/gain as determined by circuit parameters.

### Trawling for Log Amps

Locating a log amp in surplus can be somewhat misleading. The ones that I have located came disguised inside plug-in type units with shielded cover plates. I suppose they were made to be inserted into a mother board assembly. They look unobtrusive on the outside, having lots of inputs and output connectors, including several SMA types. In other words, they look like something you might not want to pick up unless you are into scrap aluminum. Looking at the designations on the connectors can help you determine what might reside inside, if it is labeled. Most I have found were not labeled with anything I could understand, just cable hookup designators for a specific piece of equipment.

Details to look for are amplifier video output, switched IF in, linear or, even better, log out. These are some of the key words used. Photo C shows an amplifier stating 0.75 to 18 GHz and connectors labeled log, lin, RF in, and power. It does not go to 18 GHz as stated, but was part of a radar receiver assembly that did go to 18 GHz. This amp is strictly low frequency RF, 60 MHz and lots of gain (90 dB).

If you are confused or not sure about an amplifier you might locate, take the cover off to see what is inside. (That's why you should take a small tool kit to a swap meet). Sometimes it can be discrete circuitry and not of importance except for parts. However, if you don't look, your chances of finding a log amp in surplus are slim to none.

There are many different manufacturers who produce these devices in ranges that cover frequencies from a few MHz to about 1 GHz or so. Commercially, they cost upwards of \$1,000 each. This cost is indicative of miniature

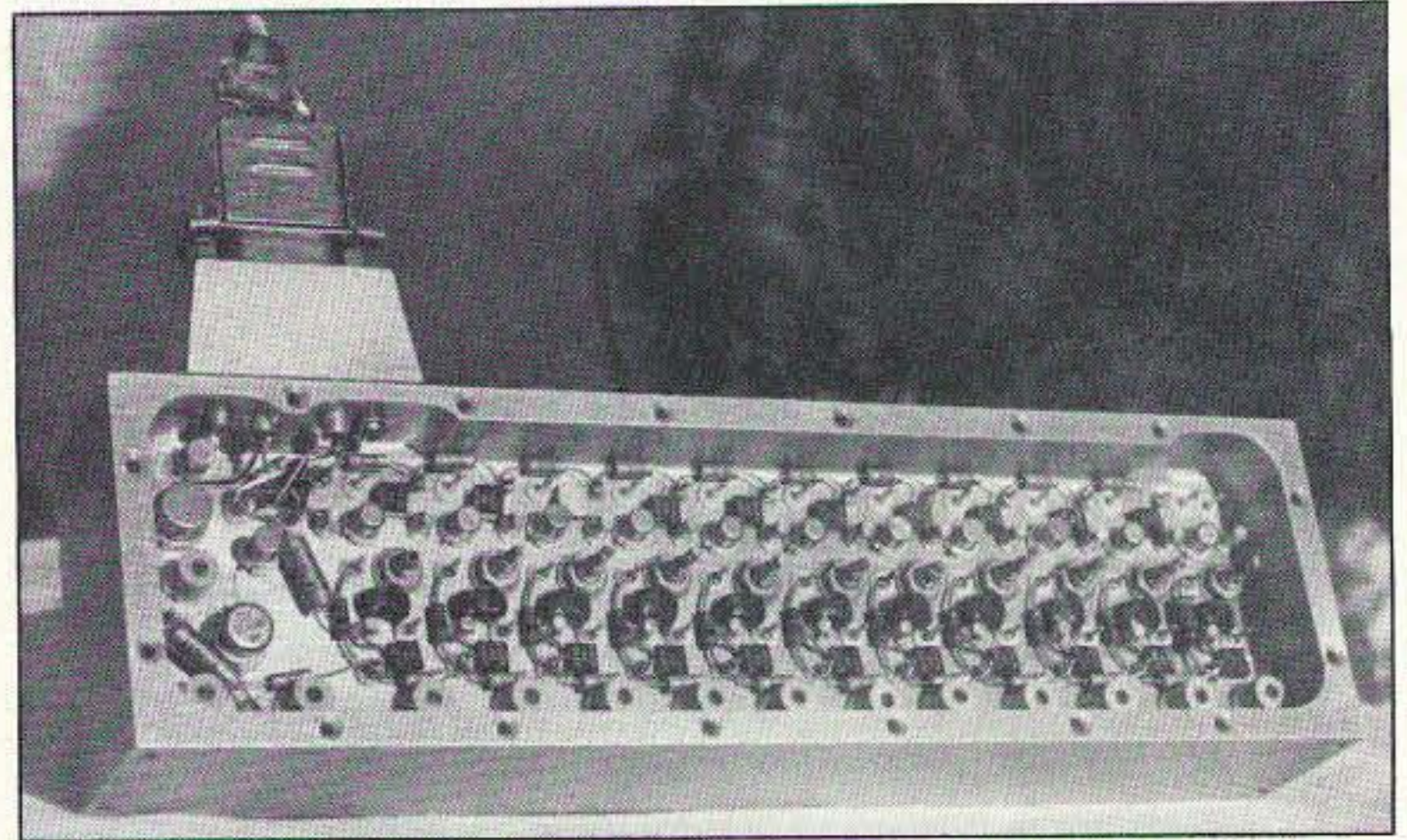

Photo A. Old discrete 60 MHz log amplifier, 12" long. This one has 11 stages.

monolithic substrate type of construction, with assembly under a microscope necessary. Accordingly, they are very small; several can fit into a cigarette flip-top box. Photo B is typical of this type amp. Commercial cost for this baby is \$1,700. How many do you want?

I always keep my eyes open at our local electronics swap meet. Some time ago I ran into a dealer having a box of seven or eight modules that looked quite nondescript on the outside. They were inexpensive (less than \$10 each), so I looked under the cover. Bingo! I found not just an amplifier, but a log amplifier and several SMA .141 solid coaxial cables.

### What to Look For

Now you say, "What is a log amplifier?" Well, it's not a preamp, but it is quite remarkable. It is an instrument amplifier that has a bandwidth centered about a design center frequency, say 60 MHz. The log amp has multi-stages that are all cumulative, summed in a diode network to form a video output of the total amplifier string. The issue isn't the gain of this type amplifier; rather, it is the dynamic range which relates to input sensitivity (in dB) that will still meet output linearity requirements. In other words, we want minimum sensitivity that still can produce a true reproduction at its output and keep the output relationship different for strong signals in the presence of weak signals.

Quite an amplifier.

Uses for a log amp can range from IF amplifiers for spectrum analyzer applications to electronic countermeasures receivers for military applications. It's the ability of this log amp to be able to qualitatively analyze low-level signals in the presence of high power signals that makes it special. In this application it keeps the output representation of these signals in their original condition, (linear). The output is presented as a video signal that varies between 0 and 2 volts; 2 volts represents the maximum signal received.

A typical log amp has eight or so stages of gain, with an impedance matching preamp and frequency filter in the first stage. This first stage sets the frequency bandwidth and VSWR of the unit. The next seven or eight stages comprise the main IF amplifier. The summing diode/limiters are all in common with a video output op amp for video information output signals.

### Building a Spectrum Analyzer

Putting these devices to work in constructing a spectrum analyzer is quite easy compared to constructing one by hand. The components needed to accomplish this are: an oscilloscope for display; a voltage-controlled oscillator (VCO); sweep control circuits to produce a DC ramped sweep voltage to drive the VCO; and a bandpass filter and log amplifier (see Figure 3). The

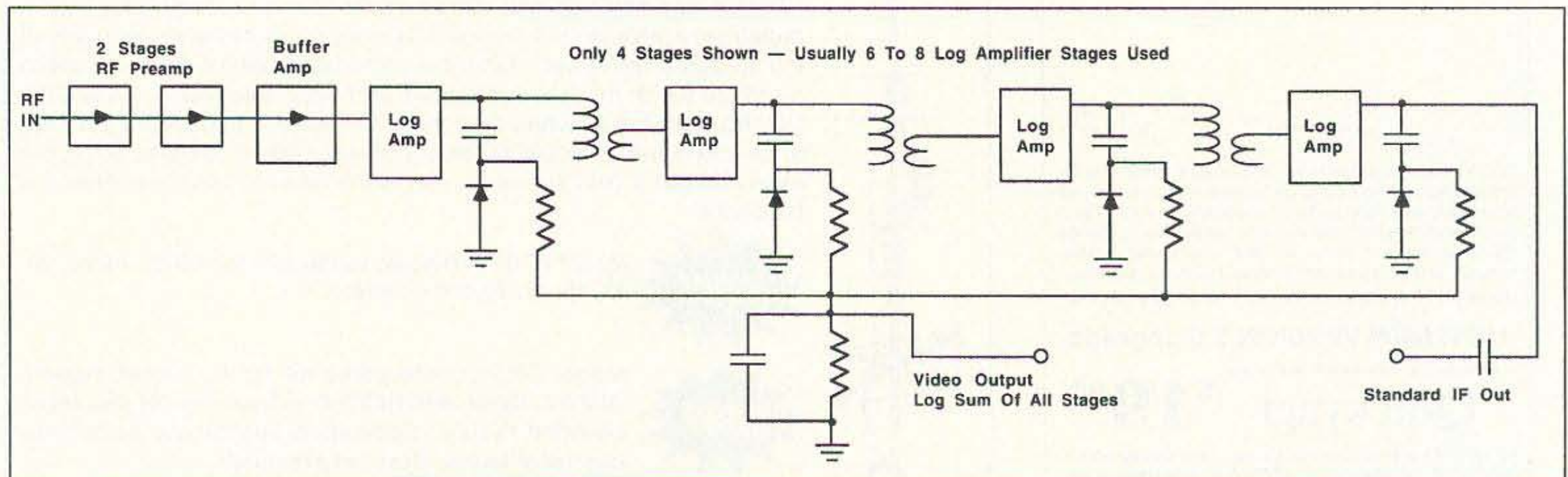

Figure 1. Block diagram of a typical log amplifier. The input preamp is usually followed by a buffer amp stage. Other stages cascade in normal RF fashion, but note the diode coupling network. It is a summing network for video information output. Each stage adds voltage to sum total of output voltages in logarithmic order. This can be used as a standard IF amp if the connection to the last amp stage has output from LC tank circuit.



# RF POWER AMPLIFIERS

**NEW!**  
400 WATTS  
AVG.  
(144-148 MHz)

Pin Pout Ic Gain/NF (13.8 V)  
Model (W) (W) (A) (dB) (dB) Type

50 MHz					
0503G	1-5	10-50	6	15/0.6	LPA
0508G	1	170	28	15/0.6	Standard
0508R	1	170	28	+	Repeater
0510G	10	170	25	15/0.6	Standard
0510R	10	170	25	+	Repeater
0550G	5-10	375	60	15/0.6	HPA
0550RH	5-10	375	60	+	Repeater HPA
0552G	25-40	375	55	15/0.6	HPA
0552RH	25-40	375	55	+	Repeater HPA

144 MHz					
1403G	1-5	10-50	6	15/0.6	LPA
1406G	25	100	12	15/0.6	Standard
1409G	2	150	25	15/0.6	Standard
1409R	2	150	24	+	Repeater
1410G	10	160	25	15/0.6	Standard
1410R	10	160	24	+	Repeater
1412G	25-45	160	20	15/0.6	Standard
1412R	25-45	160	19	+	Repeater
1450G	5	350	56	15/0.6	HPA
1450RH	5	350	56	+	Repeater HPA
1452G	25	350	50	15/0.6	HPA
1452RH	25	350	50	+	Repeater HPA
1454G	50-100	350	40	15/0.6	HPA
1454RH	50-100	350	40	+	Repeater HPA

220 MHz					
2203G	1-5	10-40	6	14/0.7	LPA
2210G	10	130	20	14/0.7	Standard
2210R	10	130	19	+	Repeater
2212G	30	130	16	14/0.7	Standard
2212R	30	130	15	+	Repeater
2250G	5	220	40	14/0.7	HPA
2250RH	5	250	40	+	Repeater HPA
2252G	25	220	36	14/0.7	HPA
2252RH	25	250	36	+	Repeater HPA
2254G	75	220	32	14/0.7	HPA
2254RH	75	250	32	+	Repeater HPA

440 MHz					
4403G	1-5	7-25	4	12/1.1	LPA
4410G	10	100	19	12/1.1	Standard
4410R	10	100	18	+	Repeater
4412G	20-30	100	19	12/1.1	Standard
4412R	20-30	100	18	+	Repeater
4448G	5	100	22	12/1.1	HPA
4448R	5	100	22	+	Repeater HPA
4450G	5-10	175	34	12/1.1	HPA
4450RE	5-10	175	34	+	Repeater HPA
4452G	25	175	29	12/1.1	HPA
4452RE	25	175	29	+	Repeater HPA
4454G	75	175	25	12/1.1	HPA
4454RE	75	175	25	+	Repeater HPA



MODEL 1410G  
STANDARD



MODEL 1450G  
HPA

All amplifiers (non-rptr) are linear, all-mode with fully automatic T/R switching and PTT capability. The receive preamps use GaAs FET devices rated at .5 dB NF with +18 dBm 3rd order IP. LPA, Standard and HPA amps are intermittent duty design suitable for base and mobile operation. Repeater amps are continuous duty, class C.

**Amplifier capabilities:** High-power, narrow or wideband; 100-200 MHz, 225-400 MHz, 1-2 GHz, Military (28V), Commercial, etc. - consult factory. A complete line of Rx preamps also available.

## RX Preamplifiers

Band	Model	NF (dB)	Gain (dB)	Connector
50 MHz	0520B	.5	25	BNC
50 MHz	0520N	.5	25	N
144 MHz	1420B	.5	24	BNC
144 MHz	1420N	.5	24	N
220 MHz	2220B	.5	22	BNC
220 MHz	2220N	.5	22	N
440 MHz	4420B	.5	18	GNC
440 MHz	4420N	.5	18	N
1.2 GHz	1020B	.9	14	BNC
1.2 GHz	1020N	.9	14	N



Consult your local dealer or send directly for further product information. All Products Made in USA.

**TE SYSTEMS** TEL. (310) 478-0591  
P.O. Box 25845 FAX (310) 473-4038  
Los Angeles, CA 90025

SEE YOU  
AT DAYTON

# RF POWER TRANSISTORS AND TUBES

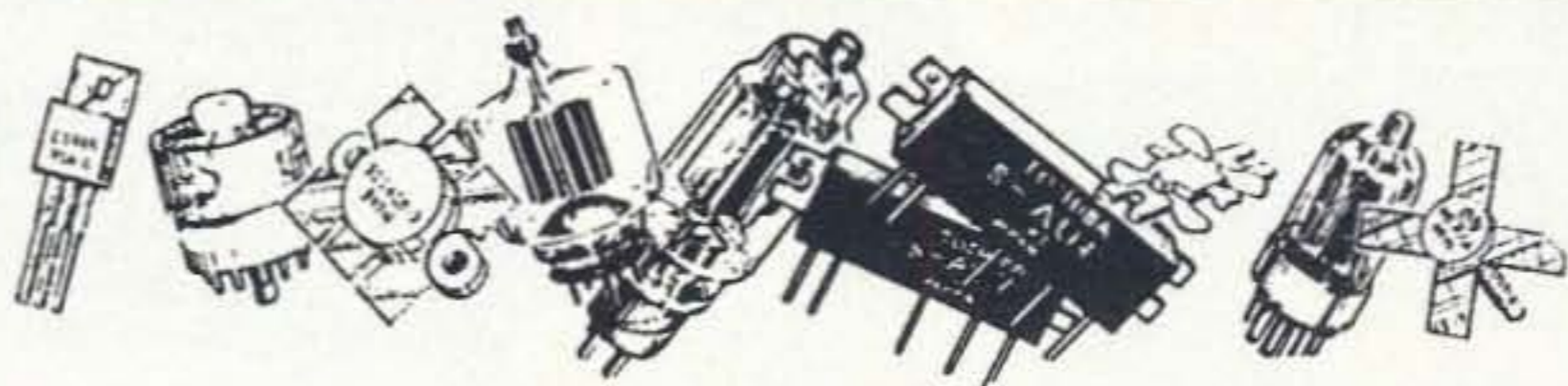

## RF PARTS BRAND PREMIUM GRADE POWER TUBES

100% POWER TESTED • 2 YEAR LIMITED WARRANTY • BEST VALUE

572B	3-500Z	3-500ZG/GRAPHITE
MATCHED SET/2 \$104.95	SPECIAL PRICE \$94.95	SPECIAL PRICE \$109.95
MATCHED SET/4 \$209.90	MATCHED SET/2 \$199.95	MATCHED SET/2 \$219.95

### ADDITIONAL TRANSMITTER TUBE VALUES

811A RFP	3-500Z EIMAC	3-500Z AMPEREX	6146B GE
MATCHED SET/2 \$38.90	SPECIAL PRICE \$148.80	SPECIAL PRICE \$148.80	SPECIAL PRICE \$28.95
MATCHED SET/3 \$58.35	(List Price...\$183.00)	(List Price...\$183.00)	MATCHED SET/2 \$64.95

### PARTIAL LISTING OF POPULAR TUBES AND TRANSISTORS IN STOCK

MGF1302	\$7.95	MRF479	\$15.00	2N6080	\$12.95	2SC2904	\$34.95	M67749M	\$44.40
MRF134	18.00	MRF485 KEN	CALL	2N6081	12.95	2SC2905	41.40	PF0011	CALL
MRF136	21.00	MRF492	14.95	2N6082	14.35	2SC3101	8.95	MHW SERIES	CALL
MRF137	24.00	MRF497	14.95	2N6083	14.35	3SK121Y	3.95	ICOM SC SERIES	CALL
MRF140	69.00	MRF515	2.90	2N6084	14.35	3SK174	4.23	OVER 15,000 RF	
MRF141	84.50	MRF555	3.50	2SA1012	1.30	MB8719	6.35	MODULES IN STOCK.	
MRF141G	172.70	MRF559	2.25	2SB754	2.50	NE602	5.50	Call if P/N not shown.	
MRF150	63.75	MRF586	1.95	2SC730	4.50	PLL02A	11.95	POPULAR TUBES	
MRF151G	158.50	MRF629	4.25	2SC741	5.90	TA7205AP	2.25	12BY7	\$13.95
MRF174	69.90	MRF630	4.25	2SC1307	CALL	TA7222AP	2.20	572B PL/Pride	45.00
MRF224	17.75	MRF641	19.95	2SC1419	2.95	MP-Tested Matched Pr		807	10.95
MRF237	4.40	MRF644	23.00	2SC1729	17.95	OUTPUT MODULES		810	99.50
MRF240, A	16.50	MRF646	24.75	2SC1945	6.65	SAU4	\$49.90	811A RFP	15.95
MRF245	32.00	MRF648	29.95	2SC1946, A	19.95	SAV6	39.95	811A RCA	CALL
MRF247	26.95	MRF650	30.00	2SC1947	6.75	SAV7	39.95	813 RFP	37.95
MRF260	11.50	MRF652	11.50	2SC1955	9.00	SAV17	69.70	833A, 833C	89.95
MRF262	12.75	MRF653	19.95	2SC1969	2.65	M57710A	49.90	6146B	15.95
MRF264	13.45	MRF646	36.90	2SC1970	2.45	M57714	54.50	6146W-MP	69.95
MRF317	57.70	MRF847	39.70	2SC1971	4.80	M57719N	54.95	7289/2C398 #	69.90
MRF327	62.00	MRF901	1.50	2SC2029	3.50	M57726	67.95	8560A MOTO	124.95
MRF329	69.90	MRF966	4.75	2SC2075	2.43	M57727	69.95	6560AS EI	CALL
MRF338	53.95	MRF1946	15.00	2SC2094	15.95	M57729	79.95	3-500C PL/Pride	105.00
MRF340	9.50	MRF1946A	15.50	2SC2097MP icom	61.90	M57732L	32.95	4-400A/C/G	CALL
MRF392	107.70	MRF2628	10.00	2SC2166C	1.75	M57735	69.95	4-1000A EI	CALL
MRF421	22.95	SRF2072	13.75	2SC2221	8.25	M57737	49.95	4PR1000A EI	CALL
MRF422	38.00	SRF3749	CALL	2SC2237	9.30	M57739C	53.25	3CX400A7 EI	CALL
MRF422MP KEN	85.00	SRF7000	CALL	2SC2289	11.95	M57741 L, M, H	57.70	3CX400U7 EI	CALL
MRF427MP	40.00	2N3055	1.45	2SC2290	14.95	M57762	79.95	3CX800A7 EI	CALL
MRF433MP	32.00	2N3553	2.85	2SC2290MP	35.95	M57785M	62.95	3CX1200A7/D7 EI	CALL
MRF450	13.50	2N3771	3.35	2SC2312C	4.95	M57787	59.95	3CX1500A7 EI	CALL
MRF454	13.95	2N3866	1.25	2SC2509MP KEN	37.70	M57791	84.95	3CX3000A7 EI	CALL
MRF455	10.95	2N4048	16.95	2SC2630	24.95	M57792	88.80	4CX250B SPECIAL	89.95
MRF455A	11.95	2N4427	1.25	2SC2640	21.90	M57796MA	34.95	4CX350A, F EI/SVT	CALL
MRF458	17.95	2N5109	1.75	2SC2782	34.75	M67705M	47.90	4CX5000A EI # 1095.00	
MRF475	9.25	2N5179	1.25	2SC2783	54.85	M67715	59.95	We have large inventories	
MRF476	5.00	2N5591	14.50	2SC2879	16.95	M67742	109.85	of new EIMAC tubes. Call	
MRF477	11.95	2N5946	15.00	2SC2879MP	42.95	M67748H, L	39.90	for numbers not shown.	

## \$2 HAND. CHARGE ON ORDERS BELOW \$20

SHIPPING METHOD & CHARGES:  
BEST WAY: UPS. ORDERS RECEIVED BEFORE 4 p.m. PST (7 p.m. EST) SHIPPED SAME DAY BY UPS.  
Federal Express / Airborne / DHL / USPS are also available.  
GROUND SERVICE: 3-7 working days (max.) depending on destination. \$5.00 minimum. Add \$.50 per pound above 2 pounds.  
3-DAY SELECT GROUND SERVICE: UPS ORANGE, \$6.00 minimum. Add \$.75 per pound above 2 lbs.  
2-DAY AIR SERVICE: UPS BLUE, \$7.50 minimum. Add \$1.00 per pound above 2 pounds. Federal Express also available at same charge.  
NEXT DAY DELIVERY: UPS RED, \$16.50 minimum. Ask for shipping charges above 1 lb. For Saturday delivery add \$10.00  
CANADA: \$5.50 minimum shipping/handling charge up to 1 lb. for postal. UPS available, call for charges.  
CALIFORNIA: Residents add appropriate sales tax.

Mfg: EI = Eimac, PL = Penta Labs • RFP = RF PARTS CO. • Note: (#) = Industrial Boxed Eimac/Amperex  
Price & availability subject to change without notice • Quantity Pricing Available

PAYMENT METHOD:  
PREPAID with check or money order. Personal checks must have reprinted address and are limited to \$40.00. Any overpayment will be returned.  
VISA/MASTERCARD accepted.  
C.O.D.: Add \$4.50 UPS charge. Cash, Cashiers Check, Money Order, or Pre-approved Company Check only.  
No C.O.D. to Alaska / Hawaii / Puerto Rico / Canada.  
FOREIGN: Bank check drawn on U.S. Bank, or VISA / M.C.  
WIRE TRANSFER: Contact us for account information.  
OPEN ACCOUNT: Net 30 to firms whose credit has been pre-approved.  
FOREIGN: Insurance/Registration is often available. Advise if desired.  
SMALL PACKET: Ideal Air shipment for small orders of parts. \$10.00 up to 8 oz.; 4 lb. max. 8"x8"x8" box.  
AIR PARCEL POST/FED EX/DHL/UPS is available.

	Monday - Friday 7:00 a.m. - 5 p.m. PST / 10:00 a.m. - 8 p.m. EST	
• EXPORT • O.E.M. • SERVICE • R&D • AMATEUR • MARINE		
ORDERS ONLY	<b>1-800-RF-PARTS</b> <b>1-800-737-2787</b>	NO TECHNICAL
MAIN ORDER LINE	<b>619-744-0700</b>	DELIVERY INFORMATION
CUSTOMER SERV. OR WARRANTY	<b>619-744-0750</b> (10 a.m. - 4 p.m. only)	TECHNICAL & APPLICATIONS
FAX	<b>619-744-1943</b>	FAX



**RF PARTS**  
435 SOUTH PACIFIC STREET  
SAN MARCOS, CA 92069





Photo B. New monolithic 160 MHz log amp 2-1/2" long. This one has 90 dB gain with 60 MHz dynamic range.

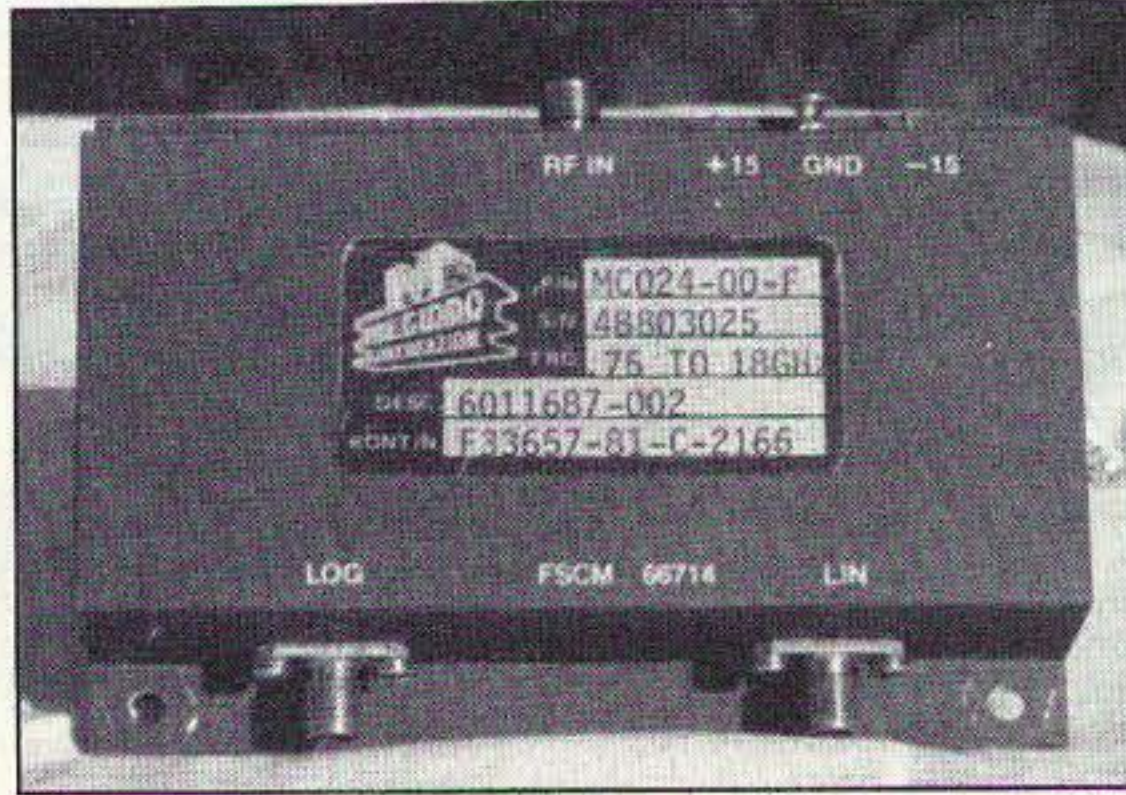

Photo C. Monolithic 60 MHz log amplifier has both video and linear (normal) IF output. Gain is 85 dB at IF, -90 dB for logarithmic (linear) applications.

main consideration for bench use or mobile use is dictated by the o-scope requirements. If you have a small pocket o-scope, the unit will be, needless to say, a versatile base or mobile. If you have to drag an AC plug for the scope, a very long extension cord may be required.

An alternative for the o-scope in surplus would be a medical heart-rate o-scope display unit. These are the units you see on many different emergency-type TV shows that show a scope representation of your heart rate on the screen. Sometimes you hear them "beeping" along with the heart rate. A straight line on one of these babies is bad news, to say the least. For our spectrum analyzer application, they are ideal. They have long persistence not available on normal o-scopes, allowing the trace to remain intensified on the scope screen, with slow sweep cycles.

Being very solid-state and rather new, most operate from AC-derived +12 volts DC power (what a break for us—+12 volts, an easy modification). Also, they are already set up with an internal sweep providing a DC ramp which can be brought out for our VCO; thus we don't need to construct that part

of the circuit. Connect an RF preamp and mixer with the VCO and a medical scope and of course our log amp and you have a spectrum analyzer. True, it's not an HP unit, but it does work.

I am not going to go into the mixer or RF circuit here except to say that a suitable unit could be constructed from a TV solid-state tuner. This module covers both the VHF and UHF TV frequencies, and has a built-in oscillator mixer and VCO oscillator IF amplifier. The normal IF output is quite broad and can be anything from 30 to about 90 MHz in most units, which is ideal for this application. Couple an IF filter and the log amp with a suitable display and you have a spectrum analyzer that can be used from about 50 to 800 MHz. This of course has some frequency gaps due to the standard TV frequency assignments, but it does give very good coverage.

I wish I had this approach available to me years ago. Back then I saw an article in the August 1982 issue of 73, titled "Poor Man's Spectrum Analyzer." This article gave full construction details on assembly, including details on construction of a log amp. I not only built the unit but designed PC boards for the

project and built the entire unit. It worked fine, covering 10 MHz to over 250 MHz. This was my first spectrum analyzer, of many that were to follow. The log amp in that case was constructed out of 40673 dual-gate MOSFETs for each stage in the log amp. The IF transformers were hand-wound toroids from Amidon and resonated at 60 MHz. Did it work? You bet, but the log amp was about 10 inches long and about two inches wide. Not too bad for home construction. I still have this amplifier around, along with many other early projects, to remind me of my humble beginnings.

Now, if construction of that log amp back then doesn't sound too humbling, maybe I should tell you that the first PC board I ever built used house paint as a resist, applied with a small artist's paint brush. Crude but it worked. I guess I am trying to make my point the hard way. It all boils down to this: You do not need to have a computer to do your design as it can be done with pencil and paper. All the computer does is do the same job faster. If the original thought is not put into proper perspective, there is no fast computer that can help.

Back to the home-built log amp us-

ing 40673 FETs. Initially I saw the original article as an interesting project, but without PC boards it would be too difficult to construct. After some time it was determined that I would construct PC boards in order to complete this project. I laid out the component parts on paper using a set of drawing aids that mirror component part sizes either in 1:1 size or two times scale for drawing ease. After laying all component parts on the paper from the schematic, it was just a matter of connecting all the dots from each component to make all connections.

Some of the components may have to be moved to make connections but it's kind of easy once you get the hang of parts placement. It's about as difficult as working a familiar crossword puzzle and many times the fun. Check out Photo D, showing the original spectrum analyzer that I constructed. It works nearly as well as its commercial counterparts. If you can't locate one in surplus (miniature unit) you can build a log amp just as I did. I still have the artwork and silkscreens available and can reproduce the PC boards if there is interest.

By today's standards it's quite large for its function, but it still can hold its own when stacked up to a commercial equivalent. It was made for 90 MHz and has 80 dB of gain and exhibits just over 75 dB of dynamic range. It was constructed over 10 years ago when the alternative available to me was the converted (tube type) IF strips out of WWII radar receivers.

At that time the miniature log amps used commercially were truly UNOBTAINIUM! Most of the test equipment and station apparatus were tube-type equipment. How our lives have changed! Back then my spare tube stock would rival a refrigerator box for space; today my spare tube stock consists mostly of museum pieces.

Whatever type of log amplifier you acquire or build in your application,

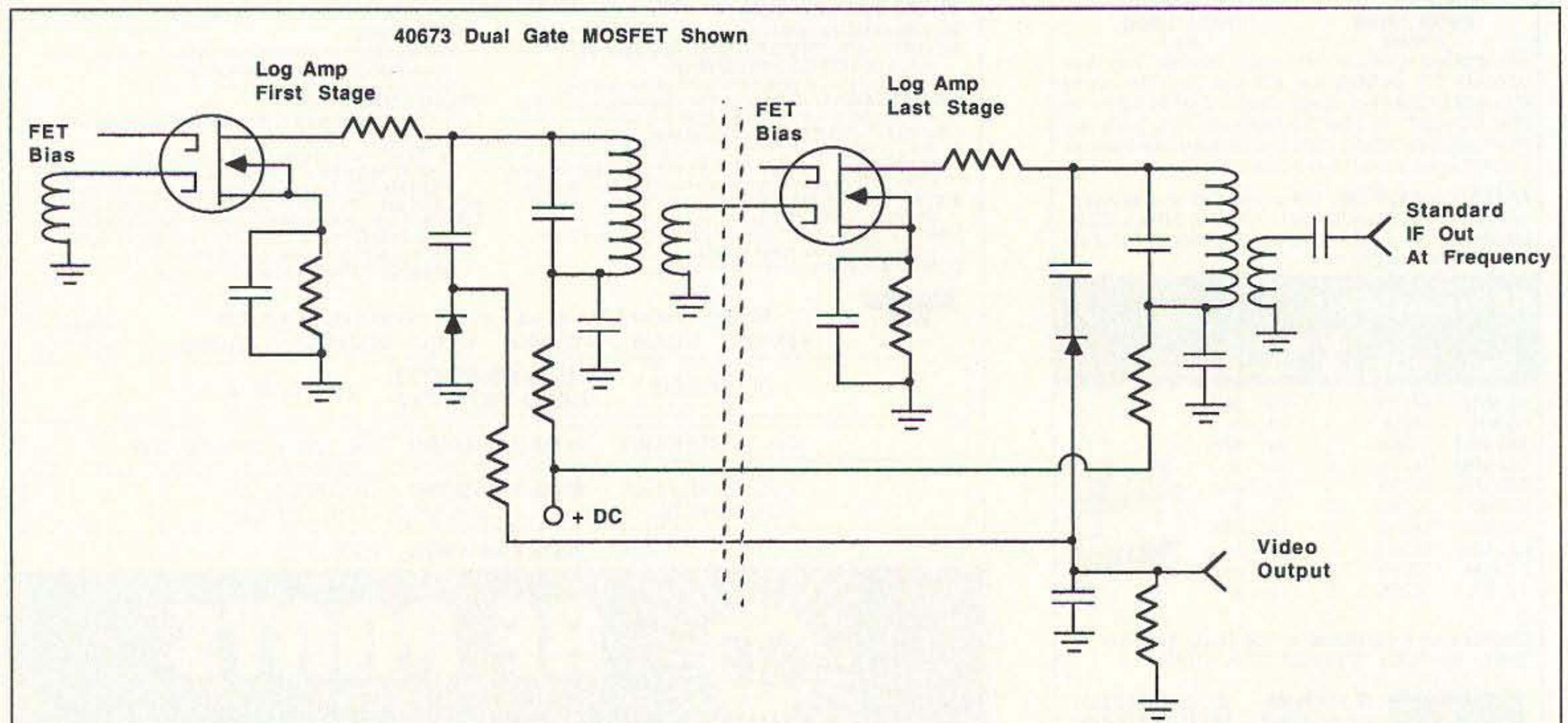

Figure 2. Schematic detail of diode log amplifier showing interconnections. There are usually 6 to 8 stages in cascade.



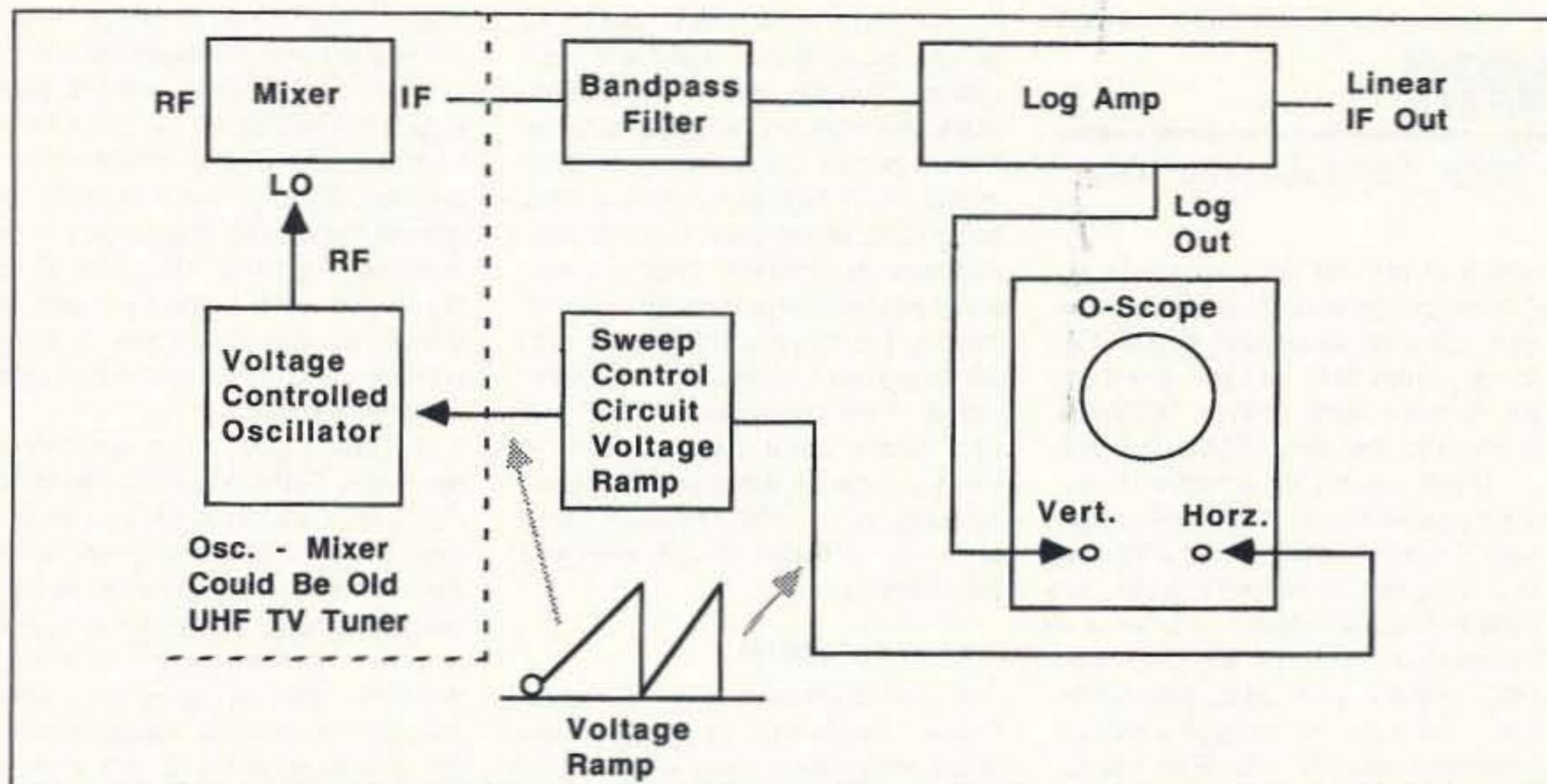

Figure 3. A spectrum analyzer can be constructed from a TV tuner, low frequency oscilloscope, RF filter, log amplifier, and a sweep voltage supply.

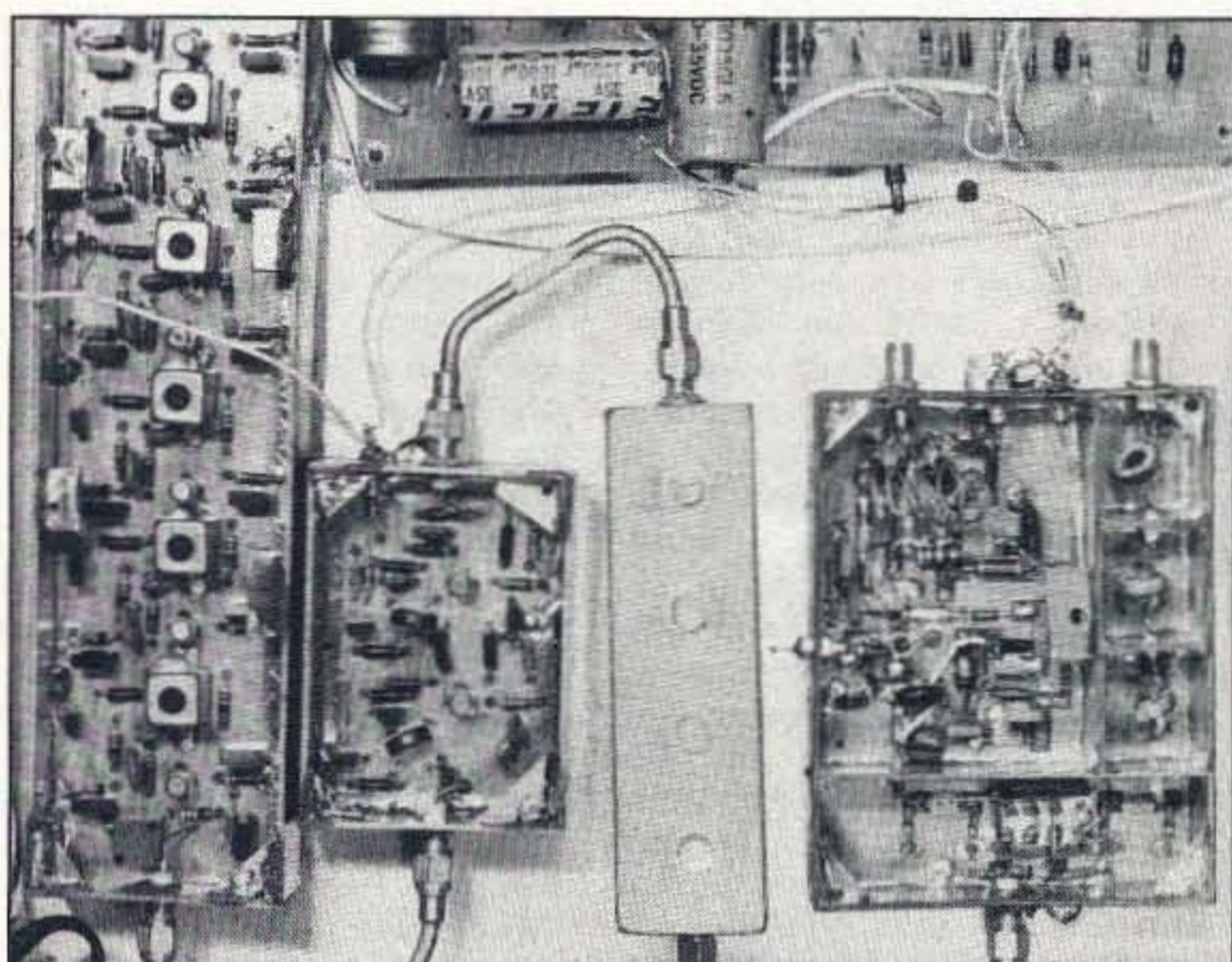

Photo D: Old original home-built spectrum analyzer showing five stages of log amplifier, power sweep circuits, RF preamp and filter, and VCO mixer circuitry.

you will appreciate its dynamic range, abilities, and usefulness in spectrum analyzer applications. I mentioned earlier that with a log amp, a filter, and an RF amp/local oscillator you can make a small unit that is capable of display-

ing data on almost any type of oscilloscope. However, as I stated earlier, a long-persistence type unit would be best, similar to a heart-rate display monitor.

The basic system for a spectrum

analyzer can be easy to set up. Using a TV tuner front-end removes the construction of both the tracking RF amplifier and oscillator requirements. Now only the filter and log amplifier units are required if you can find a medical heart rate monitor (it has the sweep circuits). Hope you have good luck checking out your local swap meets and surplus material sources for equipment.

#### Mailbox Comments

Sean KB8JNE of Hilliard, Ohio, writes that he wants me to mention in the column that there must be quite a few Columbus, Ohio, area amateurs with 10 GHz equipment in their basement or attic. He is interested in seeing if those who have equipment are willing to dust it off and give it a try again. He says most of the folks around there have played with it (10 GHz) at one time or another, but found the band empty in the area and filed the equipment away. If that's the case, get the equipment out and contact Sean KB8JNE, 3700 Westbrook Drive, Hilliard OH 43026. He would like to organize a local microwave enthusiast group in the Columbus area. Drop him a line. Sean, I hope you get a good re-

sponse to your efforts.

Arthur W1PXL wrote to inquire about an antenna noise bridge for VHF/UHF use and asked about schematic information on the construction of such a unit. Well, there is an antenna noise bridge for 1.8 through 30 MHz in the *ARRL Handbook*, 1989 edition, pages 25-32. The same circuit appears in the *ARRL Antenna Handbook*, 1988 edition, pages 27-15. A similar circuit appears in the *RSGB Handbook*, 4th edition, 1983, pages 11.19-11.20. This unit covers low frequency to 200 MHz and will give good results to 432 MHz. The books from the RSGB, Radio Society of Great Britain, are quite good and describe almost all circuits in great clarity of construction. Most seem to be based on a heavy involvement in home construction. They're good books to have on the bookshelf.

Carl AA4H writes that he recently purchased a multimode VHF transceiver. He found many stations to work on 6 and 2 meters and a fair amount of activity on 70 cm; however the activity level on 222 is very disappointing. He reports making only a few QSOs on 222 MHz and most were in the UHF contest except for a few locals. Why is there such a lack of 222 MHz activity? Is it because of the recent loss of the bottom 2 MHz? Carl wants others to use this band as he feels we will lose further parts of the band if we do not increase our activity in this area. For further information, contact Carl AA4H at 5971 Hwy. 126, Blountville TN 37617.

Well, that's it for this month. Next month I plan to start a construction project modifying an SSB transceiver for microwave use. First I will present a basic 28 MHz platform constructed dead-bug style, showing a simple system. Later we will cover a converter to 2 meters using two of the Hamtronics modules to wrap up the 28 MHz to 2 meter SSB transverter. See you next month. As always, I will be glad to answer questions on this or related topics. Please send an SASE for prompt response—family, contest and workbench time permitting. 73 Chuck WB6IGP.

Subscribe to  
**73**  
**Amateur**  
**Radio**  
**Today**  
Call  
**800-**  
**289-0388**

"Our products *speak...* for themselves"

#### DIGITAL VOICE RECORDER

**AudioQ218**

- ✓ UP TO 218 SECONDS RECORD TIME
- ✓ UP TO 8 MESSAGES
- ✓ 4 SAMPLE RATES
- ✓ SPEAKER OUTPUT
- ✓ LO LEVEL OUTPUT
- ✓ 4 MEG OF RAM
- ✓ LO POWER
- ✓ TX ENABLE 400ma
- ✓ BATTERY BACKUP
- ✓ 8-15v DC OPERATION
- ✓ SMALL SIZE 2.5" X 2.5"

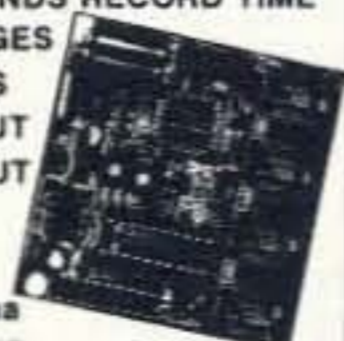

NOT A KIT  
**\$149.00**  
PLUS S+H

#### REPEATER CONTROLLER VOICE ID'er--KE2AM VER B

SEE REVIEW OF VERSION A  
JUNE 1991 ISSUE OF 73 MAG.

- ✓ DIGITAL VOICE ID
- ✓ BATTERY BACKUP
- ✓ TIME-OUT TIMER
- ✓ TX HANG TIMER
- ✓ AUDIO MIXING
- ✓ ID TIMER
- ✓ MUTING
- ✓ TX ENABLE 400ma
- ✓ COR OR SQUELCH KEYED
- ✓ 8-15v DC OPERATION
- ✓ SMALL SIZE 3.2" X 3.4"



NOT A KIT  
**\$119.00**  
PLUS S+H

Both units are fully assembled and tested. Full documentation is included. For more information, call or write.

SPECIFICATIONS AND PRICES SUBJECT TO CHANGE.

**GET-TECH**  
201 RILEY ROAD  
NEW WINDSOR, NY 12553  
(914)564-5347

**HamCall CD-ROM**  
U.S. and International Callsign Lookup  
Nearly 1,000,000 Listings  
Thousands of Public Domain Programs  
Includes Clubs & Military  
Still \$50, + \$5 Shipping  
& Handling per Order  
Works on PC and Mac



Buckmaster's HamCall CD-ROM looks up calls in seconds. U.S. calls can be searched by any element, including name, city, state, etc. A TSR is included to look up callsigns from almost any text application. Prints labels. No hard disk required, everything is on one CD-ROM! New CD-ROM disc every April and October, with updated listings and dozens of new programs!

**BUCKMASTER**  
Publishing

Rt. 4, Box 1630-Mineral, VA 23117  
703-894-5777 800-282-5628



CIRCLE 56 ON READER SERVICE CARD



# ASK KABOOM

Number 19 on your Feedback card

## Your Tech Answer Man

Michael J. Geier KB1UM  
c/o 73 Magazine  
Route 202 North  
Peterborough NH 03458

### Ground Loops and Other Bugaboos

Not long ago, I was on my local packet radio BBS and I noticed a bulletin requesting information about ground loops. I answered it, and it occurred to me that I ought to discuss the topic here in the column, since it can be a source of hard-to-find problems in your station. So, let's take a look at ground loops and other things related to ground problems.

#### Around and Around

What the heck is a ground loop anyway? Isn't everything that's connected to ground "grounded"? It seems reasonable to think so, but it just ain't so. In a perfect universe, it would be, but we live here on Earth, and on this planet, and every other place we know of, no material is perfect. In particular, every conductor has some resistance, and any long piece of wire will have some inductance, too. But what is "long"?

#### It's All Relative

That depends on the frequency you're trying to pass through it! Let's say you have a ground wire for a station transmitting on 80 meters. That wire is 15 feet long. Well, 80 meters is about 240 feet, so 15/240 is 0.0625. That's the fraction of a wavelength the ground wire represents. It isn't much. If you imagine an 80-meter-long sine wave drawn over that wire, you can see that the potential difference between what's at the beginning and

what's at the end will be quite small. Consequently, your 15-foot wire is a good ground connection at that frequency. Now let's say you switch to the 10 meter band. Hmmm, 10 meters is about 30 feet, and 15/30 is 0.5, and . . . uh oh, sounds like a problem! Yup, your ground wire is a half wavelength long. So what? Well, draw a 30-foot sine wave over it. As you can see, the voltage potential between the ends is tremendous. So how, exactly, does that "ground" your equipment when the ground point's voltage won't be anywhere near the voltage on the radio's chassis at any given moment?

### "What the heck is a ground loop anyway? Isn't everything that's connected to ground 'grounded'?"

The answer is, it doesn't. At 10 meters, this ground wire will actually make things worse by resonating and building up voltage; it's a tuned circuit. You're gonna have one hot rig, and RF feedback into your microphone circuitry is pretty likely. But what's this got to do with ground loops?

#### A Smaller Scale

The basic idea is the same. Let's say you have several pieces of gear connected together, all with nice, shielded cable. After you connect lots of stuff, the cable length all the way around from the first box to the last can add up. If it happens to hit a 1/8 wavelength, 1/4 wavelength or 1/2 wavelength, watch out when you transmit, 'cause here comes trouble.

The same thing can happen right on a radio's chassis, especially when

the frequency of operation goes way up. At microwaves, even a 1-inch spacing between where two "ground" points are soldered can be a very significant part of a wavelength, or even several wavelengths, resulting in their being at different voltage potentials, and thus ungrounded! That's one reason microwave gear is harder to build; you can't even take anything as simple as ground for granted! That kind of problem can occur even in VHF and UHF radios, but it usually doesn't in HF rigs because the wavelengths are so much larger. Still, I've seen some squirrely 10 meter setups; now and then it happens.

#### Passive Aggressive

But what about receive problems? Ground loops can get you into all kinds of problems even when you're not putting out any energy; ask any

recording studio engineer. How? Consider this: There is no such thing as true ground, unless you mean the earth we walk on. Each piece of equipment has a common point it calls ground, but what does that mean in relation to other equipment? Not much. If they're all using the same power supply or at least have their common "grounds" connected to each other, they all should have these common points at the same voltage potential. In theory, at least. In the real world, the length of the cable between the power supply and the rig induces some resistance and inductance, so the radio's chassis may be at an ever-so-slightly-different voltage than the power supply's common point. For most circuits, the millivolts of difference are meaningless, but for low-level amplifiers like microphone input

stages, they can be as big as the signal you're trying to amplify in the first place! If current flows from one piece of gear to another, via the ground connection or, more likely, the shield of a shielded cable, you've got a bona fide ground loop, even though you're not transmitting a thing. The usual symptom is AC hum, because it gets induced into the ground wire or shield causing the problem, and it isn't properly grounded out.

In some cases, it can result in RF feedback. That's why most newer HF rigs use a separate ground wire in their microphone jacks. Even though the schematic shows the wires both going to ground, the mike's wire goes directly to ground at the mike amp, while the other one goes somewhere else on the chassis. I experimented with that once on my TS-940. With the mike's ground wire connected to the correct point, all was fine. But, if I used the chassis ground wire, I got terrible RF feedback whenever I keyed up. Actually, I found it out by accident once when the two wires touched inside a little mike switchbox I'd built. Oh well, no harm done, but it proved the point: Those two wires, both grounded, were not at exactly the same voltage potential, or there wouldn't have been any difference between them. And that was between two grounds in the same radio!

In audio studios, they sometimes disconnect the braid at one end in order to break the loop. Because the braid is still connected at the other end, it still shields the inner conductor from stray noise, so it works. With RF, though, you can be asking for trouble with that approach, because it can let in enough transmitter energy to cause problems. Remember, we're talking millivolts here.

#### A Way Out?

Is there another way out of ground loop troubles? Well, with an RF resonance problem, you need to do two

### Now! A full-size antenna with low SWR from 50 to 1300 Mhz. The FLYTECRAFT™ Model KFN

- Model KFN features low-angle radiation and low SWR across the full range.
- Large capture area - antenna is 6 ft. tall and 54 in. across.
- Heavy-duty construction, yet light in weight and windloading.
- Rated 500 watts, 50 ohm input impedance, S0239 connector, type N optional.
- Quick assembly, ideal for indoor and outside use.
- Futuristic appearance.



Based on the design of our popular CFN, in use the world over.

Built with pride & sold worldwide - FLYTECRAFT™ USA

FLYTECRAFT™ Model KFN - \$99.95  
Send Check or \$ Order to: FLYTECRAFT™ P.O. Box 3141  
Simi Valley CA 93093 - Shipping Additional

VISA/MC PHONE ORDERS Satisfaction Guar.  
800-456-1273 M-F 9A-5P (PT) 805-583-8173

CIRCLE 251 ON READER SERVICE CARD

### MAKE CIRCUIT BOARDS THE NEW, EASY WAY

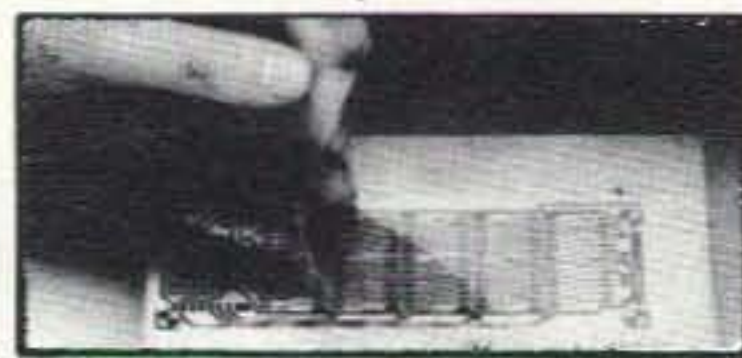

### WITH TEC-200 FILM

#### JUST 3 EASY STEPS:

- Copy circuit pattern on TEC-200 film using any plain paper copier
- Iron film on to copper clad board
- Peel off film and etch

convenient 8 1/2 x 11 size  
With Complete Instructions

SATISFACTION GUARANTEED

5 Sheets for \$4.95 10 Sheets only \$6.95  
add \$1.50 postage NY Res. add sales tax

The MEADOWLAKE Corp.

Dept. C P.O. Box 497  
Northport, New York 11768

### VECTOR FINDER

ZERO-IN THE SIGNAL!

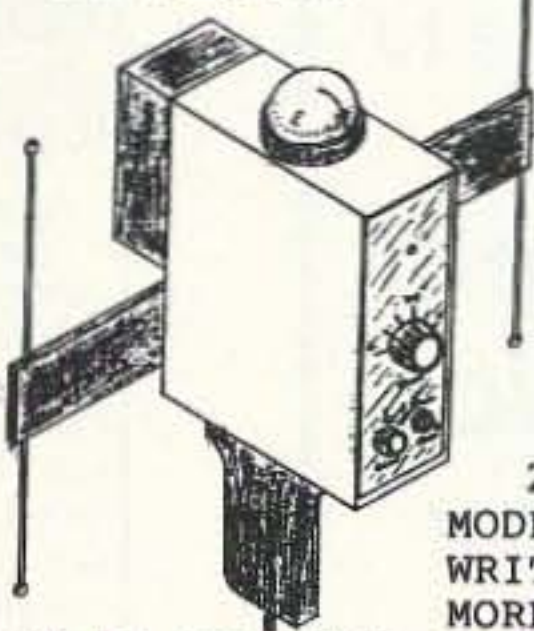

HAND-HELD PHASE SENSE ANTENNAS FOR VHF DIRECTION FINDING. USES ANY FM XCVR. COMPASS GIVES DIRECTION. ARMS FOLD FOR STORAGE. TYPE VF-142 COVERS BOTH 2-MTRS & 220MHZ. OTHER MODELS AVAILABLE. WRITE OR CALL FOR MORE INFO.

\$3.50 SHIPPING & TYPE VF-142  
CA. ADD TAX) \$139.95 619-

RADIO ENGINEERS 565-1319  
3941 MT. BRUNDAGE AVE.  
SAN DIEGO CA. 92111

CIRCLE 58 ON READER SERVICE CARD



# Scanners/Shortwave/GMRS/Ham

## COMMUNICATIONS ELECTRONICS INC.

### Emergency Operations Center

We're introducing new Uniden *Bearcat* scanners that are just what you've been searching for. Order your *Bearcat* scanner today.

## 25th Anniversary Special FREE Ni-Cad battery pack for Bearcat® 2500XLT scanner. (\$57.95 value)

Get a free Bearcat rechargeable ni-cad battery pack with the purchase of your Bearcat 2500XLT scanner from Communications Electronics Inc. This coupon must be included with your prepaid order. Credit cards and quantity discounts are excluded from this offer. Offer valid only on orders mailed directly to Communications Electronics Inc., P.O. Box 1045 - Dept. 730394, Ann Arbor, Michigan 48106-1045 U.S.A. Coupon expires March 31, 1994. Coupon may not be used in conjunction with any other offer. Coupon may be photocopied. Add \$15.00 for shipping in the continental United States of America.

## Radio Scanners

### Bearcat® 2500XLT-H

List price \$649.95/CE price \$339.95/SPECIAL  
400 Channels • 20 Banks • Turbo Scan  
Rotary tuner feature • Auto Store • Auto Sort  
Size: 2-3/4" Wide x 1-1/2" Deep x 7-1/2" High  
Frequency Coverage: 25.0000 - 549.9950, 760.0000 - 823.9950, 849.0125 - 868.9950, 894.0125 - 1,300.0000 MHz.

Signal intelligence experts, public safety agencies and people with inquiring minds that want to know, have asked us for a world class *handheld* scanner that can intercept just about any radio transmission. The new Bearcat 2500XLT has what you want. You can program frequencies such as police, fire, emergency, race cars, marine, military aircraft, weather, and other broadcasts into 20 banks of 20 channels each. The new rotary tuner feature enables rapid and easy selection of channels and frequencies. With the AUTO STORE feature, you can automatically program any channel. You can also scan all 400 channels at 100 channels-per-second speed because the Bearcat 2500XLT has TURBO SCAN built-in. To make this scanner even better, the BC2500XLT has AUTO SORT - an automatic frequency sorting feature for faster scanning within each bank. Order your scanner from CEI.

For more information on Bearcat radio scanners or to join the Bearcat Radio Club, call Mr. Scanner at 1-800-423-1331. To order any Bearcat radio product from Communications Electronics Inc. call 1-800-USA-SCAN.

## Great Deals on Bearcat Scanners

- Bearcat 8500XLT-H base/mobile \$369.95
- Bearcat 890XLT-H base/mobile. \$244.95
- Bearcat 2500XLT-H handheld ... \$339.95
- Bearcat 855XLT-H base ..... \$149.95
- Bearcat 760XLT-H base/mobile. \$199.95
- Bearcat 700A-H info mobile ..... \$149.95
- Bearcat 560XLA-H base/mobile... \$84.95
- Bearcat 350A-H info mobile ..... \$104.95
- Bearcat 200XLT-H handheld ..... \$199.95
- Bearcat 148XLT-H base ..... \$88.95
- Bearcat 100XLT-H handheld ..... \$149.95
- Bearcat BCT2-H info mobile ..... \$139.95

## New FCC Rules Mean Last Buying Opportunity for Radio Scanners

On April 19, 1993, the FCC amended Parts 2 and 15 of its rules to prohibit the manufacture and importation of scanning radios capable of intercepting the 800 MHz. cellular telephone service. Supplies of full coverage 800 MHz. scanners are in *very* short supply. If you need technical assistance or recommendations to locate a special scanner or solve a communications problem, call the Communications Electronics Inc. technical support hotline for \$2.00 per minute at 1-900-555-SCAN.

### Bearcat® 8500XLT-H

List price \$689.95/CE price \$369.95/SPECIAL  
500 Channels • 20 banks • Alphanumeric display  
Turbo Scan • VFO Control • Priority channels  
Auto Store • Auto Recording • Reception counter  
Frequency step resolution 5, 12.5, 25 & 50 KHz.  
Size: 10-1/2" Wide x 7-1/2" Deep x 3-3/8" High  
Frequency Coverage:

- 25.000 - 28.995 MHz. (AM), 29.000 - 54.000 MHz. (NFM),
- 54.000 - 71.995 MHz. (WFM), 72.000 - 75.995 MHz. (NFM),
- 76.000 - 107.995 MHz. (WFM), 108.000 - 136.995 MHz. (AM)
- 137.000 - 173.995 MHz. (NFM), 174.000 - 215.995 MHz. (WFM),
- 216.000 - 224.995 MHz. (NFM), 225.000 - 399.995 MHz. (AM)
- 400.000 - 511.995 MHz. (NFM), 512.000 - 549.995 MHz. (WFM)
- 760.000 - 823.9875 MHz (NFM), 849.0125 - 868.9875 MHz (NFM)
- 894.0125 - 1,300.000 MHz. (NFM).

The new Bearcat 8500XLT gives you pure scanning satisfaction with amazing features like Turbo Scan. This lightning-fast technology featuring a triple conversion RF system, enables Uniden's best scanner to scan and search up to 100 channels per second. Because the frequency coverage is so large, a very fast scanning system is essential to keep up with the action. Other features include **VFO Control** - (Variable Frequency Oscillator) which allows you to adjust the large rotary tuner to select the desired frequency or channel. **Counter Display** - Lets you count and record each channel while scanning. **Auto Store** - Automatically stores all active frequencies within the specified bank(s). **Auto Recording** - This feature lets you record channel activity from the scanner onto a tape recorder. You can even get an optional **CTCSS Tone Board** (Continuous Tone Control Squelch System) which allows the squelch to be broken during scanning only when a correct CTCSS tone is received. **20 banks** - Each bank contains 25 channels, useful for storing similar frequencies in order to maintain faster scanning cycles. For maximum scanning enjoyment, order the following optional accessories: **PS001** Cigarette lighter power cord for temporary operation from your vehicle's cigarette lighter \$14.95; **PS002** DC power cord - enables permanent operation from your vehicle's fuse box \$14.95; **MB001** Mobile mounting bracket \$14.95; **BC005** CTCSS Tone Board \$54.95; **EX711** External speaker with mounting bracket & 10 feet of cable with plug attached \$19.95. The BC8500XLT comes with AC adapter, telescopic antenna, owner's manual and one year limited warranty from Uniden. Order your BC8500XLT from Communications Electronics Inc. today.

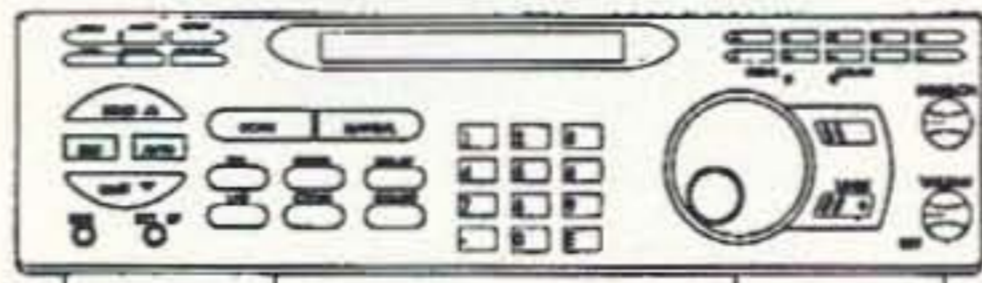

## CB/GMRS Radios

The Uniden GMR100 is a handheld GMRS UHF 2-way radio transceiver that has these eight frequencies installed: 462.550, 462.725, 462.5875, 462.6125, 462.6375, 462.675, 462.6625 and 462.6875 MHz. This one watt radio comes with flexible rubber antenna, rechargeable ni-cad battery, AC adapter/charger, belt clip, F.C.C. license application and more.

- Uniden GMR100-H GMRS Handheld ... \$169.95
- Uniden WASHINGTON-H SSB CB Base \$189.95
- Uniden GRANTXL-H SSB CB Mobile .... \$149.95
- Uniden PC66XL-H CB Mobile ..... \$78.95
- Uniden PC76XL-H CB Mobile ..... \$99.95
- Uniden PC122XL-H SSB CB Mobile .... \$107.95
- Uniden PRO510XL-H CB Mobile ..... \$36.95
- Uniden PRO520XL-H CB Mobile ..... \$49.95
- Uniden PRO538W-H CB & Weather ..... \$69.95

## Shortwave

- ICOM R1-H ultra compact handheld wideband receiver ..... \$469.95
- ICOM R100-H mobile 500 kHz.-1.8 GHz./121 memory ..... \$649.95
- ICOM R71A-H 100 kHz.-30 MHz. base (add \$39.00 shipping) \$1,029.95
- ICOM R72A-H 100 kHz.-30 MHz. base (add \$39.00 shipping) ... \$954.95
- ICOM R7000-H base with 99 memory (add \$49.00 shipping) . \$1,249.95
- ICOM R7100-H base with 900 memory (add \$49.00 shipping) \$1,289.95
- ICOM R9000-H base 30 kHz.-2 GHz. (add \$149.00 shipping) \$4,999.95
- ICOM AH7000-H super wideband discone type antenna ..... \$109.95
- Grundig Satellit 700-H portable with 512 memory & AC adapter \$449.95
- Grundig Satellit 500-H portable with 42 memory & AC adapter \$349.95
- Grundig Cosmopolit-H with integrated mini-cassette recorder ... \$179.95
- Grundig Yacht Boy 230-H portable shortwave ..... \$139.95
- Grundig Traveller 2-H portable shortwave ..... \$79.95
- Sangean ATS202-H ultra compact 20 memory shortwave ..... \$79.95
- Sangean ATS606-H ultra compact 45 memory shortwave ..... \$149.95
- Sangean ATS606P-H shortwave with antenna & AC adapter ... \$169.95
- Sangean ATS800-H portable 20 memory shortwave ..... \$79.95
- Sangean ATS803A-H portable with SSB reception & AC adapter \$159.95
- Sangean ATS808-H portable 45 memory shortwave ..... \$159.95
- Sangean ATS818-H portable without cassette recorder ..... \$189.95
- Sangean ATS818CS-H with cassette recorder ..... \$209.95
- Sangean ANT60-H portable shortwave antenna ..... \$9.95

## Weather Stations

Public safety agencies responding to hazardous materials incidents must have accurate, up-to-date weather information. The Davis Weather Monitor II is our top-of-the-line weather station which combines essential weather monitoring functions into one incredible package. Glance at the display, and see wind direction and wind speed on the compass rose. Check the barometric trend arrow to see if the pressure is rising or falling. Our package deal includes the new high resolution 1/100 inch rain collector part #7852-H, and the external temperature/humidity sensor, part #7859-H. The package deal is order #DAVI-H for \$524.95 plus \$15.00 shipping. If you have a personal computer, when you order the optional Weatherlink computer software for \$149.95, you'll have a powerful computerized weather station at an incredible price. For the IBM PC or equivalent order part #7862-H. For Apple Mac Plus or higher including Quadra or PowerBook, order part #7866-H.

## Other neat stuff

- Uniden EXP9100-H 900 MHz. spread spectrum cordless phone \$299.95
- ICOM GP22-H handheld global positioning system ..... \$699.95
- WR200-H weather radio with storm alert ..... \$39.95
- RELM WHS150-H VHF handheld 5 watt, 16 ch. transceiver ... \$349.95
- RELM RH256NB-H VHF 25 watt synthesized transceiver ..... \$289.95
- Ranger RC12950-H 25 watt 10 meter ham radio ..... \$244.95
- Ranger RC12970-H 100 watt 10 meter ham radio ..... \$369.95
- Uniden LRD9000W1-H Super Wideband Laser/Radar Detector \$169.95
- PWB-H Passport to Worldband Radio by IBS ..... \$10.95
- POL1-H Police Call for CT, ME, MA, NH, NY, RI, VT ..... \$5.95
- POL2-H Police Call for DE, MD, NJ, PA ..... \$5.95
- POL3-H Police Call for Michigan & Ohio ..... \$5.95
- POL4-H Police Call for IL, IN, KY, WI ..... \$5.95
- POL5-H Police Call for IA, KS, MN, MO, NE, ND, SD ..... \$5.95
- POL6-H Police Call for DC, FL, GA, NC, PR, SC, VA, WV ..... \$5.95
- POL7-H Police Call for AL, AR, LA, MS, OK, TN, TX ..... \$5.95
- POL8-H Police Call for AZ, CO, ID, MT, NM, NV, UT, WY ..... \$5.95
- POL9-H Police Call for California, Oregon & Washington ..... \$5.95
- USAMBNCH magnet mount scanner antenna with BNC ..... \$29.95
- USAK-H VHF scanner/VHF transmitting antenna with PL259 ... \$29.95
- USASGMBNC-H glass mount scanner ant with BNC connector . \$29.95
- USASGMM-H glass mount scanner antenna with Motorola jack \$29.95

## Buy with confidence

It's easy to order from CEI. Mail orders to: Communications Electronics Inc., Emergency Operations Center, P.O. Box 1045, Ann Arbor, Michigan 48106 U.S.A. Add \$15.00 per radio for U.P.S. ground shipping and handling in the continental U.S.A unless otherwise stated. Add \$8.00 shipping for all accessories and publications. Add \$8.00 shipping per antenna. For Canada, Puerto Rico, Hawaii, Alaska, P.O. Box, or APO/FPO delivery, shipping charges are two times continental U.S. rates. Michigan residents add state sales tax. No COD's. 10% surcharge for net 10 billing to qualified accounts. All sales are subject to availability, acceptance and verification. Prices, terms and specifications are subject to change without notice. We welcome your Discover, Visa, American Express or MasterCard. Call 1-800-USA-SCAN to order toll-free. Call 313-996-8888 if outside the U.S.A. FAX anytime, dial 313-663-8888. Order your new electronic equipment from Communications Electronics Inc. today.

Scanner Distribution Center and CEI logos are trademarks of Communications Electronics Inc. Sale dates 2/15/94 - 3/31/94. AD #011294GEN Copyright © 1994 Communications Electronics Inc.

## For credit card orders call 1-800-USA-SCAN Communications Electronics Inc. Emergency Operations Center

P.O. Box 1045, Ann Arbor, Michigan 48106-1045 U.S.A.  
For information call 313-996-8888 or FAX 313-663-8888



things: get your cable lengths away from any multiple of 1/8 wavelength (usually, avoiding multiples of 1/4 wavelength will do), and keep your antenna as far as you can from the gear, to reduce the amount of signal you pick up in the first place. Also, be sure to connect all the radios' ground terminals to the same point, and then send that on its way to ground. Because of the way it looks, that's called a "star ground." In particular, avoid running your ground braid from radio to radio, with only the last one going to ground; that kind of configuration actually tries to force a ground loop to occur.

With hum problems caused by a passive ground loop, the hard part is figuring out which item is making the trouble. The only way is to disconnect the audio cables one by one. When you hit the culprit, the problem will go away. The cheapest, easiest fix is to disconnect one side of the braid. Try that and, if it works and doesn't cause RF feedback problems when you transmit, you're in business. If it does feed back, though, consider putting a small transformer between the offending items. That makes the ground potentials, at least at the input points which are causing the trouble, irrelevant, because the incoming energy is "floating" with respect to ground anyway! For low level signals, it's pretty easy to do. For microphone cables and such, you can use two small audio transformers back-to-back. In oth-

er words, connect the high-impedance sides to your gear, and connect the low-impedance sides to each other. Just be sure to shield the transformers in a metal box, or they may pick up all kinds of RF.

I remember one problem I had with a computer connection to a shortwave receiver. The idea was to pick up weather facsimile transmissions and decode them with the computer, using a simple homemade interface and some nifty decoding software. It worked, but the computer's RF noise made a terrible mess in the receiver whenever it was connected. If I broke the connection, the noise went away, even though the computer was only a few feet away from the receiver. What was going on here?

Well, it wasn't actually a ground loop. I know because I tried running the shortwave on batteries, and the problem didn't go away. Remember, you can only have a ground loop if there's some attempt at a common ground; a floating device can't exhibit the problem. In this case, computer noise was being induced into the ground braid of the connecting cable. So, I tried the transformer approach. That should have done it, but it didn't. Apparently, the noise was strong enough that a little bit of it was still being induced, either through the transformer or through the air, and the garbage was still there. I dreamed of a fiber-optic connection, but I never built

it, and I never solved that problem. The interface went into a drawer somewhere. Of course, an outside antenna for the shortwave probably would have cured it, but I didn't have a way to do that where I was living at the time. Oh well, you can't solve 'em all.

Hey, let's look at some letters:

**Dear Kaboom,**

In the September '93 issue, there was an article discussing compressed antennas. Instead of buying the variable capacitor and coil specified, can I just use my MFJ tuner with this thing?

**Signed,  
Wanna Make Do**

**Dear Wanna,**

Well, I'm not an antenna maven, but it seems reasonable to try it, as long as the antenna doesn't require its tuner to be right at its base or something. There's a big difference between tuning an antenna at the antenna and way back down the coax line by your rig. But I'd try it. You don't have anything to lose, and you should be able to see on the SWR meter whether your tuner is doing any good. But, even if you get a good SWR, that doesn't mean the antenna necessarily is getting out the way it should. Remember, a dummy load always has the best SWR! In this case, you could see a great SWR at the rig, and the antenna still could be working poorly, especially if you have a long coax run.

In any event, give it a try and see what happens. Certainly, if you put the tuner right at the base of the antenna, it should work as long as the project's coil-cap combination is similar in configuration. Unfortunately, I don't have that article handy, so I can't say for sure.

**Dear Kaboom,**

My old HT-144 walkie has a bad IC. It's the second time it's gone bad, and, unfortunately, it's a proprietary product. I really want to save the rig. Is there anything I can substitute for it?

**Signed,  
Twice Fried**

**Dear Twice,**

The IC you indicate is the audio power amplifier. If you haven't been playing the rig real loud for long periods, you should wonder why it keeps blowing! The speaker coupling cap, C35, could be leaky. In any event, I have no idea where you can find that 6-pin chip, part number MFC 6070. You can, however, use an LM-380 or even an LM-386, which you can get at Radio Shack for \$1.19. Since the LM-series chips are 8-pin devices, the pins won't match up, but you should be able to figure out what goes where by looking at the schematics. Those single-chip mini audio amps are all fairly similar. Gather up your ham spirit and go to it!

Until next time, 73 de KB1UM. **73**

## Look What You Could Be Missing...

Multiple Heterodynes White/Pink Noise Power Line Noise And More . . .

## DSP Noise Reduction Products From JPS



**NRF-7 General Purpose Noise Remover and Filter Unit**  
Only \$249.95

The NRF-7 reduces atmospheric noise through dynamic peaking. Removes multiple tones from voice signals. High performance CW and Voice Filters. CW filters have selectable center frequency. State-of-the Art Digital Signal Processing.



**NIR-10 Noise/Interference Reduction Unit**  
Only \$349.95

The NIR-10 allows reception of difficult to read signal and reduces listener fatigue. Operates on radio receiver audio outputs. NIR mode reduces or eliminates heterodynes, white/ignition noise, RTTY interference, and power line noise. PEAK function reduces white noise interference. The Notch Filter mode removes multiple heterodynes and acts in 3 milliseconds. Band Pass mode is continuously adjustable center frequency.



**NTR-1 Wide Band Noise and Tone Remover**  
Only \$169.95

The NTR-1 provides wide band operation for AM or FM reception. Narrow band operation for SSB, CW or data reception. State-of-the-Art Signal Processing in "Real Time." Rapidly removes multiple tones from voice signals and operates on receiver audio output.



**JPS Communications, Inc.**

P.O. Box 97757, Raleigh, NC 27624  
(919)790-1011 FAX:(919)790-1456 TECH:(919)790-1048

**TOLL FREE ORDER LINE: 800-533-3819**

We accept Mastercard, VISA, checks, money orders in US\$.  
Free shipping within the continental U.S.



# ADVERTISERS

R.S.#	page	R.S.#	page	R.S.#	page	R.S.#	page
• A & A Engineering	32	• Dayton Hamvention	33	234 Lentini Communications	89	• SAMS	90
18 A.S.A.	57	181 Digital Communications	69	47 Link-Com	87	• Schnedler Systems	46
18 A.S.A.	16	13 Doppler Systems	62	• Meadowlake Corporation	78	36 Scrambling News	55
351 Absolute Value Systems	17	• Down East Microwave	16	86 MFJ Enterprises	11	364 Sea Level Systems	47
164 Ace Communications of Indianapolis	16	114 E. H. Yost	45	160 Micro Computer Concepts	42	167 Sescom, Inc.	42
• Advanced Electronic Applications	9*	• Eavesdropping Detection	69	144 Micro Control Specialities	89	• 73 Amateur Radio Today	87
149 Advantage Instruments, Inc.	51	• Electron Processing	56*	114 Mr. Nicad	45	188 SGC Inc.	45
281 Agrelo Engineering	93	• Electronics Book Club	29	248 MoTron Electronics	67	250 Software Systems	47
194 All Electronics Corporation	53	33 FB Enterprises	66	• Multifax	54	244 Software Systems	90
• Alphalab	32	118 Flytecraft	17	223 National Amateur Radio	50	325 Solder-It Company	43
76 Amateur Networking Supply	17	251 Flytecraft	78	54 NCG	5	51 Spectrum Communications	61
113 Amsoft	93	329 For Hams Only	69	1 Number One Systems Ltd.	65	183 Spectrum International	91
135 Antennas West	35	253 Free Radio Tech—Berkeley (FRB)	16	82 Oak Hills Research	85	247 Startek	1
324 Antennas West	69	• Gap Antenna Products	92	102 ONV Safety Belt	42	232 TE Systems	75
380 Antennas West	72	• Get-Tech	77	172 Optoelectronics	48-49	• Ten-Tec	2
90 Antennas West	90	193 GGTE	57*	• P.C. Electronics	73*	124 Texas Bug Catcher Antenna	91
296 Antennas West	91	338 Global Upgrades	56	321 Patriot Communications	12	• The Ham Center	45
5 Antennas West	92	291 Gracilis	61	68 Periphex	59	384 The Ham Contact	41
236 Antennas West	93	• Greater Baltimore Hamboree	67	198 Personal Computer Repeater Controller	42	384 The Ham Contact	53
276 Artsci Publications	73	• Ham Radio & More	71	249 Phillips Industries, Inc.	55	384 The Ham Contact	56
16 Astron Corporation	25	• Hamtronics, Inc.	7	311 Pioneer Hill Software	56	131 The Ham Station	63
21 B & B, Inc.	92	187 Harlan Technologies	50	396 Plus Ten	42	269 Tigertronics	43
41 Barry Electronics Corporation	19	• Highlands Electronics	69	49 Polyphaser	65	299 Townsend Electronics	40
42 Bilal Company	91	293 IC Engineering	69	257 Quorum Communications	27	11 Transel Technologies	92
137 Box Products	17	179 Icom	CV2*	147 R.L. Drake Company	39	22 Tri-Ex	46
56 Buckmaster Publishing	77*	283 Innotek, Inc.	17	110 Radio Amateur Satellite	53	• Uncle Wayne's Bookshelf	94-95
7 Buckmaster Publishing	90*	42 Isotron	91	153 Radio City	37*	317 Unified Microsystems	52
168 Buckmaster Publishing	62*	175 J-Com	59	58 Radio Engineers	78	• Universal Radio	50
• Butternut Electronics	73	39 J-Com	90	• Radio Fun	81	• Vanguard Labs	54
222 Byers Chassis Kits	56	55 J-Com	62	• RAI Enterprises	73	259 Versatel Communications	55
184 C & S Sales, Inc.	35	26 J.M.S.	17	34 Ramsey Electronics	15*	104 Vis Study Guides, Inc.	54
• Cable X-perts	17	133 Jade Products	52	• Renaissance Development	45	191 W & W Associates	83
• CB City International	72	240 Jan Crystals	52	• RF Enterprises	91	20 Wolfe Communications	35
265 Chipswitch	72	285 JPS Communications	80	• RF Parts Company	75*	• Yaesu Electronics Corporation	CV3
99 Communication Concepts, Inc.	92	• Just Neon	50	134 Rose	55	• ZD Engineering	16
10 Communications Specialists, Inc.	66*	• K-Comm	45	254 Ross Distributing	55		
356 Communications Electronic	79	2 Kawa Productions	42	• RT Systems	90		
15 Comtelco	16	151 KDC Sound	55	294 S&S Engineering	57		
		• Kenwood USA Corporation	CV4				

**Bold listings are 73's new advertisers this month.**  
\*Advertiser who have contributed to the National Advisory Committee (NIAC)



# Radio Fun

“The beginner’s guide to the exciting world of amateur radio.”

Radio Fun is packed full of information to help you get more fun out of amateur radio. Basic “how-to” articles will get you up and running on packet, ATV, RTTY,

DXing, and the dozens of other activities that make amateur radio such a great hobby. You’ll get equipment reviews geared toward the newcomer. We’ll help you upgrade to a higher class license with monthly columns designed to teach you what you need to know in a fun and exciting way. You’ll find it all, and more, in the pages of Radio Fun.

Don’t wait another minute. Subscribe today for only \$12.97 for one year. That’s 12 issues of the only ham radio magazine that is geared especially for the newcomer, or any ham who wants to get more fun and excitement out of amateur radio—Radio Fun!

**12 issues for only \$12.97**

**1-800-257-2346**

**YES! Sign me up right now!** 12 issues of *Radio Fun* for \$12.97.

NAME \_\_\_\_\_ CALL \_\_\_\_\_

ADDRESS \_\_\_\_\_

CITY \_\_\_\_\_ STATE \_\_\_\_\_ ZIP \_\_\_\_\_

Check \_\_\_\_\_ MC \_\_\_\_\_ Visa \_\_\_\_\_

CARD# \_\_\_\_\_ EXPIRES \_\_\_\_\_

Class License \_\_\_\_ Year licensed \_\_\_\_ 73 Subscriber \_\_\_\_

QST subscriber \_\_\_\_\_ CQ Subscriber \_\_\_\_\_

Mail to: *Radio Fun*, P.O. Box 4926, Manchester, NH 03108  
[Or call 800-257-2346 (in NH call 625-1163), FAX: 603-669-2835]

Canada add \$7.00 plus .70 GST. Foreign add \$12.00 surface, \$36.00 airmail. Newsstand Rate \$18.00. Basic Subscription Rate \$14.97.

07P



Arnie Johnson N1BAC  
43 Old Homestead Hwy.  
N. Swanzey, NH 03431

## Notes from FN42

Well, we made it through Christmas and the New Year celebration without any trouble. But a bug has cropped up in my computer. It seems to have a mind of its own at times, freezing for no reason, rebooting, etc. Luckily, it only froze up once while writing this column, so I didn't have to retype much (good reason to save quite often). But, I won't press my luck any further this month. Much more next month from Israel, Monaco, South Korea, and who knows where else.

73 for now. Arnie N1BAC

## Roundup

**Brazil** Iwan Thomas Halasz PY2AH is author of the world's first *Radio Amateur's Handbook* in Portuguese. The handbook is published by Edusp (the editorial branch of the University of Sao Paulo) and is destined for the five Portuguese-speaking and also the 18 Spanish-speaking countries. *Handbook do Radioamador* is endorsed by both REP (National Amateur Radio League of Portugal) and LABRE (National Radio League of Brazil). With 633 pages, it is half the size of the present *ARRL Handbook* but almost three times that of the first (1926) edition of the *Radio Amateur's Handbook*, written by Francis Edward Handy W1BDI, to whom the author renders homage in his preface.

Since none of the Portuguese-speaking leagues have editorial facilities and amateur radio literature in Portuguese has been very scarce over seven decades, the new *Handbook* had to fill in the lack of information for amateurs who do not read foreign languages (more than 95% of them), providing them with a worldwide horizon to see their activities in proper perspective. It is expected that the presence of a *Handbook* in most of the shacks in Portugal, Brazil, Angola, Mozambique, and Cape Verde will give amateur radio new thrust and interest in these countries.

The *Handbook* is not only a convenient way for the public to get acquainted with amateur radio and decide about the possibility of becoming a ham, but also the only means to get a comprehensive view of amateur radio as the mass media only refer to it when it becomes news.

Author Iwan Halasz, a broadcast transmitter industry executive and a ham for 20 years, has published more than 130 articles on amateur radio in Brazilian technical magazines. Presently he is a free-lancer and consultant to the two foremost telecommunication magazines of Latin Ameri-

ca: *RMT* (in Portuguese) and *Telepress Latinoamerica* (in English and Spanish). For more information, write to 1662 Cardoso de Almeida, 05013-001 Sao Paulo, Brazil.

**Chile** Downloaded on packet from the *HR AMSAT News Bulletin 226.03*: The first MICROSAT from Chile, to be named CEsar-1, will be launched in early 1995. This announcement was made by the Radio Club Federation in Santiago. The Radio Club Federation will also provide the ground control station for CE-1 after it is on-orbit.

The satellite will be a MICROSAT class similar to AO-16, LO-19, WO-18, and DOVE. The orbit will be sun-synchronous and the altitude will be about 900 km.

The design will include some scientific experiments which will be constructed by students from three local universities, along with some help from the Chilean Air Force.

The estimated cost of the design and assembly of CE-1 will be about US\$1 million. The Radio Club Federation said that CE-1 is designed to help facilitate communications between Chilean radio amateurs and amateurs around the world. [*The AMSAT News Service (ANS) would like to thank LW2DYZ of AMSAT-LU for the bulletin item.*]

**Dominican Republic** Letter from Bill Meara N2CQR/H18: When I first walked into the Dominican Radio Club several months ago, I was struck by the fact that in its outward appearances, the club was very similar to my first radio club (Crystal Radio Club—W2DMC). There were the piles of old *QST* magazines, musty old QSL cards, and piles of old radio gear. It was all very familiar. Aside from the different language being spoken, the membership of the club also reminded me of W2DMC—there was the same mix of old-timers and enthusiastic youngsters along with a "character" or two to liven up the club house! Above all, there was the same friendly spirit, the same willingness to help out a fellow ham that has always been the hallmark of our hobby. While our ham bands every day provide very pleasing evidence of radio's ability to forge international friendships, I think that the face-to-face experience in a radio club can be even more gratifying. Soon after arrival at the club, I found myself sharing experiences with new friends in a foreign country: H18OMA and I laughed together as we both admitted to waking up our parents after contacting our first ZL! H18LEZ and H18RMQ and I howled with laughter when we recounted the difficulties of demonstrating ham radio to non-hams (Murphy stalks the DR also!). Ham radio does have the power to bring people together.

Radio Club Dominicano (H18RCD) has recently gone through a noticeable reinvigoration. In addition to our Tuesday night meetings, the Club sponsors a "Can" (a sort of party/get-together) every Saturday afternoon. Our newsletter is back in print and a new yagi tribander is on the roof of the clubhouse. We have an active, informal club net on 146.5 FM simplex.

The holiday season brought a very successful and enjoyable Christmas party in our now renovated clubhouse. A party is not a party in the Dominican Republic without high-volume merengue music! When your correspondent saw the audio equipment being assembled for the party, he speculated that the gear might allow the club to carry out some audio frequency DX! A good time was had by all, with the more animated club members partaking of the merengue music while the more staid amateurs retired to the back yard for some good conversation.

December also brought a club-sponsored foxhunt competition. Here in the DR a foxhunt is a "Caceria de Pichon" which translates as "Hunt for the Young Pigeon." One Saturday, the streets of Santo Domingo were invaded by earnest radio enthusiasts armed with bizarre multi-element 2 meter yagis! After some struggle, the "pigeons" were all captured and the hunters returned to the radio club for an awards ceremony and an afternoon of good fellowship.

1994 promises to be a good year for ham radio in the Dominican Republic. The club plans to offer a Morse code course and we'll be working with a local school interested in adding ham radio to its set of extracurricular activities. We'll also continue to work with a local Boy Scout group. As always, Radio Club Dominicano will continue to be a happy place where hams from all over are welcome. Best of luck in 1994 to all. 73 from H18! [Bill Meara, N2CQR/H18, Unit 5510, APO AA 34041.]

**Ecuador** For those of you who enjoy listening to foreign broadcasts, quite a few of those stations send out program notes and one of those is HCJB, The Voice of the Andes, Quito, Ecuador. If you wish to be put on their mailing list, send your request to HCJB, Casilla 17-17-691, Quito, Ecuador, South America.

## AUSTRALIA

David Horsfall VK2KFU  
PO Box 257  
Wahroonga NSW 2076  
Australia

A recurring thread in past columns was how the Department of Transport and Communications (DoTC) was going to deregulate the Australian regulations, with such things as allowing code-free "Limited" amateurs access to 10m FM, granting packet privileges to Novices, etc. These changes were going to be introduced "Real Soon

Now," but for one reason or another (a Federal election and a change of name to "SMA" [Spectrum Management Authority]), they never actually saw the light of day. The latest word was that these changes were going to be introduced in the next session of Parliament (around the time this appears in print), so hopefully this long-outstanding matter will be decided soon; until then it is pointless commenting any further. I was hoping to describe the Australian licensing situation, but there was always the danger it would be obsolete by the time it appeared in print.

Some things, however, never change. It is worth pointing out that the national body in Australia, the Wireless Institute of Australia (or just WIA), actually consists of several autonomous bodies in each state, and a federal-based office that produces the magazine and provides representation to government, etc. All member services are provided at the state level, and these vary (including membership fees) from state to state. As can be imagined, this can lead to some interesting situations, with disgruntled amateurs blaming the wrong body for perceived shortcomings, etc. The NSW division can lay claim to being the oldest division of the oldest amateur society in the world (founded in 1910), and in spite of this (or perhaps because of it) it has experienced a few ructions lately. As I write this (late December), certain matters have still not been resolved (such as an Extraordinary General Meeting to debate a "No Confidence" motion in the Committee!), and I hope to have further news in a later column.

Cheers for now. Those with access to packet or Internet can contact me as "VK2KFU @ VK2RWI.SYD.NSW.AUS.OC" and "dave@esi.COM.AU" respectively.

## CANARY ISLANDS SPAIN

Woodson Gannaway N5KVB/EA8  
Apartado 11  
35450 Santa Maria de Guia  
(Las Palmas de Gran Canaria)  
Islas Canarias  
Espana

(With apologies to Bing Crosby) "Chestnuts roasting on an open fire, (the smell of roasting) dried squid nipping at your nose . . ." Isn't that how the song goes? Well, this is the Canary Islands, after all, and things are a little different. No chestnut blight so we still have chestnuts every year in the fall. And for some unknown reason, the street vendors roast and sell dried squid over their charcoal braziers right alongside the chestnuts and the odor is pretty pungent. But I like dried squid so it's no problem. Another difference being here is that Santa's (Papa Noel) or the Three Wise Men's helpers often wear bikinis.



Speaking of dried squid, it figured in one of those pleasant little events that help so much to make life bearable. As I've said before, most of my English tutoring students are Oriental children, while when my wife taught, her students were Spanish adults. The very same day that one of her students gave her a box of high-quality chocolate candy, one of my students gave me a dried squid as a present. In the culture of each student, the present had about the same meaning, and both were greatly appreciated.

Do you think you know Spanish? Are you ready to confront daily life in Spain on Spanish terms? Well, please pack your sense of humor and plan to use it often, mostly to laugh at yourself. If you studied Spanish, you already know about the subjunctive and some of its pitfalls. In a few years you'll get it mostly sorted out. But I'm talking about the things you thought you already knew and could count on. That's where the torpedoes really come at unexpected angles . . . It was Thanksgiving, and the guests eating with us were some Spanish friends who didn't speak English and two Mormon missionaries from the U.S. who spoke some Spanish, so we spoke Spanish. Things were going fairly well until one of the Americans, translating literally from English, said, "Pasame

el vestido de la ensalada, por favor." But in Spanish that didn't come out as "Pass me the salad dressing, please," but instead as "Pass me that clothing that the salad wears, please." An instant of absolute silence followed, then a period of laughter from me and my wife (after we had gone through the reverse translation and realized what had happened), confusion from the Spaniards (who didn't know what was happening), and finally an explanation in Spanish and English for all parties so they all could have a good laugh. And I bet you thought "salad dressing" was pretty safe and tame.

Is the tooth fairy "la hada de los dientes"? Not on your life! In Spain it's "el Ratoncito Perez" and don't you forget it. In fact, yesterday some friends gave our baby a Ratoncito Perez doll that plays several tunes about 50 dB too loud, and I'm thinking about how to cut down the volume, short of smothering it under two or three pillows. The first thing will be to put in a jumper instead of one of its two batteries, and halve the voltage.

Thanksgiving was yesterday, and a couple of nice people left a package of brownies for me outside our door with a nice note. There are fine people everywhere, but sometimes you have to look to find them. 73, Woodson N5KVB/EA8. 73

## HAM HELP

Number 21 on your Feedback card

We are happy to provide Ham Help listings free on a space available basis. To make our job easier and to ensure that your listing is correct, please type or print your request clearly, double spaced, on a full (8 1/2" x 11") sheet of paper. You may also upload a listing as E-mail to Sysop to the 73 BBS /Special Events Message Area #11. (2400 baud, 8 data bits, no parity, 1 stop bit. (603) 924-9343). Please indicate if it is for publication. Use upper- and lower-case letters where appropriate. Also, print numbers carefully—a 1, for example, can be misread as the letters l or i, or even the number 7. Specifically mention that your message is for the Ham Help Column. Please remember to acknowledge responses to your requests. Thank you for your cooperation.

I am in need of the schematic and adjustment instructions, or the dual trace pre-amp, for my surplus scope. Scope type is AN/USM-117C. Pre-amp type is MX 2995 A/ USM117. Mel Wardean K6QXE, 18193 Fisher

Dr., Visalia CA 93292.

WANTED: Circuit diagram for SEIF DM-2000 DVM. I will pay costs. Keith Ralph VK4VQ, 10 Thredbo Dr., Worongary 4213 QLD, Australia.

## UPDATES

Number 22 on your Feedback card

### Micro IDer

In the January 1994 issue, a very discerning reader spotted an error in Program #1 of the above mentioned article. In the listing on page 26, the 29th line says:

{ 44, "11111010101101110"}, /\* , \*/

The line should be:

{ 44, "1110111010101101110"}, /\* , \*/

The correction will produce a proper Morse code comma.

TNX Keith Rice.

# BATTERIES

BUY DIRECT FROM US, THE MANUFACTURER!



### YAESU/MAXON

FNB-2	10.8v @ 600 MAH
FNB-3/3A	9.6v @ 1200 MAH
FNB-4	12v @ 750 MAH
FNB-4A	12v @ 1000 MAH
*FNB-10(S)	7.2v @ 1150 MAH
FNB-12(S)	12v @ 600 MAH
equiv. to FNB-11 (1/2" shorter)	
FNB-17	7.2v @ 600 MAH
*Same size case as FNB-12	
*FNB-25	7.2v @ 600 MAH
FNB-26	7.2V @ 1000 MAH
**FNB-26-S	7.2v @ 1500 MAH
*FNB-26A	9.6v @ 800 MAH
*Same size as FNB-26 case	
FNB27	12v @ 600 MAH
**FNB-27S	12v @ 800 MAH
**(1/4" longer than FNB27)	

SPECIAL  
FOR THE  
MONTH OF MARCH

10%  
OFF  
ON ALL  
YAESU

Replacement  
Battery Packs  
LOOK FOR APRIL'S  
SPECIAL OF THE MONTH

MONTHLY DISCOUNTS  
APPLICABLE TO END-USERS ONLY

### Powerpac+®

6 V for Camcorders & 12 V for 2-way



Prices and specifications subject to change without notice

## W & W ASSOCIATES

800 South Broadway, Hicksville, N.Y. 11801

WORLD WIDE DISTRIBUTORSHIPS AVAILABLE. PLEASE INQUIRE

In U.S. & Canada Call Toll Free (800) 221-0732 • In NYS (516) 942-0011 • FAX: (516) 942-1944

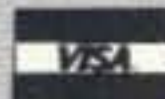

NYS residents add 8 1/4% sales tax. Add \$4.00 for postage and handling.

MADE IN THE U.S.A.  
SEND FOR FREE CATALOG AND PRICE LIST

CIRCLE 191 ON READER SERVICE CARD



## NEVER SAY DIE

Continued from page 4

what's happened to your beans is also happening to your mice. And the book explains about it happening to rabbits, chinchillas, and so on down the food chain.

While you're growing those beans, try some in front of your TV set and see what the radiation from that monster is doing to the things around it—including you and your kids. Even try some in the next room, 15 feet or so away from the set. A bean can tell you more than any but the most sophisticated (and expensive) lab instruments.

You'll read about endless cancers being cured, arthritis, diabetes, and so on. Children in school rooms under fluorescent lights have cavities, attention deficits, hyperactivity, poor classroom behavior, poor grades, and learning disabilities. Within weeks of installing full-spectrum lights these problems begin to disappear. It's almost enough to make you think.

They tested hamsters with identical diets under cool-white and full-spectrum fluorescent lights and found they had 10 times as many cavities under the white lights. Chickens raised under full-spectrum lights are larger, healthier, live twice as long, lay more eggs, and their eggs have 25% less cholesterol.

It turns out that sunbathing causes less skin cancer, not more, despite all the phony-baloney you've been seeing lately. Heck, they had me so convinced I haven't had a sunburn in years.

I had a little spare time in San Francisco recently, so I visited Alcatraz—where they kept the most incorrigible prisoners in tiny cells with no direct sunlight. And when they caused trouble they put them in "The Hole," where they had no light at all. Talk about doing things in reverse. This confirmed the validity of my proposal for cutting the cost of prisons to almost zero—one which would encourage the prisoners to be outside in the sun, tending to their gardens, growing their own food. How do you grow a Danish?

Is there a connection between the growing crime rate, street gangs, riots, the increase in divorce, the troubles we're having with children, and even the incivility we see all around us, and what we're doing to ourselves with artificial light and window glass which prevents those critically important light frequencies from reaching us? The research reported in this book is very compelling. I think you'll be convinced—maybe even enough to actually want to do something about it.

I guarantee you'll be installing full-spectrum lights in your home and your office after reading this book. And you might just have enough gumption to work to get your local schools to change too. I'm convinced that we could substantially lower our health care costs just by letting more sun reach our eyes and skin. Gumption

seems in pathetically short supply these days—I wonder if that's got any connection with light?

When you do your bean-growing and mice or rat experiments, be sure to document your work with pictures. If you can set up a video camera for stop-motion photography you'll have a great record, but plain photos will tell the story. And I am going to be very upset if you don't send me a copy of your results.

### Pro-fusion & Con-fusion

Here comes Wayne again with another of his enthusiasms. When 2 meter FM and repeaters came along I tried to get you interested. That eventually developed into cellular radio, with many of the top people in the new industry, oddly enough, being hams who'd gotten involved through their interest in repeaters. Then there was computers, which have turned into a fairly big business. Now I think I'm on to an even bigger new technology.

It all started five years ago when Drs. Stanley Pons and Martin Fleischmann announced that they'd discovered what seemed to be a new and mysterious source of power. They suggested it might be cold fusion. Well, that was enough to upset the fission industry, and to threaten the hot fusion scientists even more. Worse, many of the hasty early researchers were unable to get the promised excess heat from their experiments, so they pooh-poohed the whole thing. And that's probably all you've read about cold fusion . . . unless you read more than I think you do.

I'm just back from the Fourth Cold Fusion Conference on Maui, where I sat getting more and more excited through four days of scientific papers, all demonstrating remarkable successes in generating heat from both heavy and light (regular) water—heat far beyond anything attributable to chemical reactions. One of the presenters was a youngster from Texas who, though he's invested less than \$5,000 in the last four years while working in his basement, has been generating significant heat. He hasn't done anything that just about any ham with a pioneering drive couldn't do.

Yes, of course I'm starting a cold fusion magazine to try to help the field grow faster and help newcomers come up to speed. It worked with repeaters, computers and digital audio, so maybe I can do it again.

If you've been doing your homework as I've asked you to, you read the article in the August 1993 *Popular Science* on the subject. You also should get Gene Mallove's book, *Fire From Ice*. Gene, by the way, is the editor of my new magazine. It looks to me as if we're right at the beginning of a new trillion-dollar industry—one that will help end automobile pollution and cut energy prices substantially. It's a little early to sell your oil stocks short, but I sure wouldn't recommend them for an investment. Cold fusion is super bad news for the Middle East. They'd

better stop wasting their oil dollars and make some long-term investments.

I'm using the term "cold fusion" because that's what they're calling this newly discovered reaction between palladium and heavy water (deuterium). The scientists haven't yet been able to figure out a theory they can agree on for why it works. Some experimenters have been reporting as much as 10,000 times the heat output from their experiments than they've put in to get it started. They're having success not only with palladium, but also with nickel, platinum, rhodium, and ruidium so far.

Though the effect was first discovered by Americans, the Japanese have already taken a big lead in research, and in smothering us out of the field with patents. Though our government doesn't yet believe in it, Japan's MITI has just budgeted another \$30 million to help speed their research and patenting positions.

Well, I could write for pages on what's happening in cold fusion—but please remember, I let you in early on this one, just as I did on microcomputers and cellular telephones. In those cases other people made millions (and billions), and you didn't. I didn't do too badly myself, much to my surprise.

If you're interested in knowing more about all this you may want to get a charter subscription to *Cold Fusion*. It's \$100 a year. Send your check or credit card information to Peterborough NH 03458-1107 or call (603) 924-0058. Who knows, maybe you'll be giving a paper at the next cold fusion conference. I hope so—and I'll be there cheering you on. Or perhaps you'll be manufacturing a thermos-bottle-sized water-powered generator to power cars, trucks and homes.

### Other Scientific Frontiers

Did I pique your curiosity or perhaps even your entrepreneurial spirit with my piece on a cure for AIDS in my February editorial? Have you written to me yet? It looks to me as if a few people will jump at this opportunity and (a) make big fortunes, (b) provide a desperately needed service. What's it worth to clean up HIV-infected blood supplies? What's it worth to save the lives of millions of people with AIDS who now believe they are eventually doomed?

Then there's the need for more research in plant and animal bioelectricity and magnetism. There's a need to look into an almost endless number of anomalies. But watch out for the pathological skeptics. I'm skeptical about new things, but that doesn't stop me from being open to finding out more about them.

One of my problems is that I'm busy in every spare minute reading more and more books. I've been traveling a lot recently . . . the Caribbean, Germany, Maui, Indiana, New York, San Francisco, Los Angeles . . . complete with a suitcase full of books in my baggage. When I consider all the things I want to do, I get discouraged

when I see people playing golf or kids hanging out in malls or on corners, doing nothing. What a waste!

Now that I've met Pons and Fleischmann personally, I want to talk more with them . . . and with the other key researchers in the field. I want to learn more about fusion, about bioelectromagnetics, about memory, UFOs, psi, and so on.

### Politics

I have to admit to being discouraged at the way virtually all Americans are putting up with the baloney that's going on. There are perfectly good solutions to all of our major problems. We could have an incredibly great country instead of a good one, but we won't unless someone finds a way to get people interested in changing things. When we refuse to try and do something to solve our problems, then we're condoning them. We've been putting up with major messes, and putting up with them by just sort of quietly complaining, but not doing one damned thing to bring about change.

We know that we've allowed Congress to be a disgusting bunch of crooks. We know the Clintons have just socked us with a huge tax increase and are fighting every proposed budget cut, doling out pork bribery for acquiescence. We know our whole country is awash in drugs, that we've got the worst crime problem and the most murders of any developed country in the world (at an estimated cost of \$450 billion a year), that our school system is horrendously expensive and pathetically ineffective, that we're up to here in lawsuits, in escalating health care costs (\$1 trillion a year), that we're being screwed over by the IRS, FDA, CIA, FBI, FDIC, and a bunch more government agencies, that despite hundreds of billions wasted we still have poverty, street gangs, welfare families, and so on. Not one of these problems is insoluble. I've proposed inexpensive solutions to all of 'em. So we're floundering in Somalia and Bosnia, and wondering what to do in a few dozen other countries where we have no real strategic interest. We're throwing away billions on foreign aid. Phooey. What a bunch of wimps we Americans are! What does it take to actually get us mad enough to do something?

We're watching an endless parade of TV exposé programs showing us where billions of our dollars are being stolen by fraud. But does this get anyone upset enough to do something? No, a few people are busy parading against abortion, acid rain, global warming, and stuff like that. Did you read the lead article in the February *Reader's Digest* yet? How much do you know about Janet Reno and the other Clinton picks? We're up to here in messes and we're wondering what sitcom to watch.

### That Loud Noise Again

It's opportunity, still trying desperately to get you out off the couch to



answer the door. In January I suggested an easy way to get into your own small business. All it takes is a digital audio tape (DAT) recorder, a couple good mikes, and some gumption. The recorder and the mikes are the easy part. Unfortunately, our school system has done a fantastic job of making sure that a minimum of gumption emerges from our high-priced socialist unionized brainwashing system.

I suggested you go out and make some recordings of street performers. Well, that's just for starters. No matter how far out in the sticks you live, you've got plenty of recording possibilities. You've got enough potential customers to pay for the cost of a recording system in short order and build a nice little spare-time business . . . so I don't want to get any more letters whining about the high cost of rigs and magazine subscriptions. Get off your butt and take charge of your life.

So what can you record? Well, I was going to suggest to the people with recording studios that they go after the school and church markets, but after thinking it over, I realized that most of them are so wrapped up with recording local rock groups that I'd probably never get them off their duffs. School market? Churches? You bet!

Just about every high school and college has a glee club and a school band. Some have a few student musical groups too . . . even some (ugh!) rock bands. Every one of these musical (or pseudo-musical) groups needs compact discs and cassettes to sell to make money. Find 'em. Sell 'em. Record 'em. The Independent Music Producers Syndicate (IMPS) will take it from there and ship you the CDs and cassettes.

You can sell 'em a thousand CDs for \$5 each and they can turn around and sell 'em for \$16.95. That's an easy way for them to generate an extra \$12,000. That'll go a long way toward new instruments, concert tours, costumes, or whatever. And by the time they've sold 300 CDs the whole works will have been paid for. The rest is gravy! They can probably even pre-sell that many so they won't even need any money up front.

If you get busy right away you may be able to get a bunch of schools to invest in CDs to sell to the graduating class and their families come June. These might feature selections from the glee club, the school band, and any other school musical (or semi-musical) groups or performers. All you need to do is learn how to make some decent DAT recordings and do some selling.

Church choirs are another group that can be recorded. Some churches have boys choirs and would love to have CDs to sell to make money to help pay for summer choir camp. When I was a tad I sang soprano in the St. Paul's Church choir and we had a great time at summer choir camp. Churches are always in need of money for things, and CDs are a great

way for them to make money.

A good DAT recorder and a pair of mikes shouldn't cost much over \$1,000 these days. If there's much of a demand I'll talk with some of the manufacturers and see if I can make a deal and get some discounts. Who knows, between schools, churches, and other local musical talent, you might find yourself in a full-time business. It beats the heck out of working for someone else.

What's in it for you? Figure around 50¢ a CD as your cut of the deal. That's \$500 for every thousand you sell. Hey, if you only make one deal a week that's a couple thou' a month to help beef up your hamshack . . . or to get the XYL a better fur coat. Fix up your hamshack first.

By the way, each of your recordings will be checked out by a Music Research Foundation focus group. If any get high marks from this tough team of experts they could be accepted for national distribution through our network of over 5,000 independent record stores and be promoted to radio station music directors. Then we could be talking big bucks.

Yeah, I know . . . it's too much trouble. Where's the microwave popcorn?

#### United We Fall

Perot's United We Stand America looked like a good deal . . . for a while. From what I could see in trying to deal with them it suffered from massive mismanagement at the Dallas headquarters, and that helped keep it from growing quickly at first. I don't know about the paid state coordinators in other states, but the chap they picked in New Hampshire never seemed to bother to pick up the ball, or when he did, then he soon dropped it. We got precious little coordination or communications. Then came the Perot NAFTA debacle, and pffft went interest in UWSA up this way.

That was discouraging because it was the only group that looked as if it might gear itself up to try and clean up the mess the administration and Congress are making out of things. We know the Democrats and the Republicans aren't going to change anything much. And the Libertarians, though they have some great ideas, are almost invisible. Now, with the vaporizing of UWSA, what's left?

#### Wayne in Hawaii

I was able to make a few contacts as I visited all six of the main islands, but precious few. And what few repeaters I found open seldom had anyone listening. I called and called over one repeater after another. Phooey. My best repeater experience was the W6KAG repeater on Molokai. I first talked through it from Lanai, and then met Butch on Molokai, where he drove Sherry and me from one end of the island to the other, including a fantastic view of the old leper colony from high atop a cliff overlooking that corner of the island.

I was out there for the cold fusion



Wayne whips up some contacts from Lanai.

conference on Maui, so I left a few days early and got in some scuba diving on Kauai, Oahu, Molokai, Kona, Lanai, and Maui. The water was awfully cold, so I had to borrow wet suits to keep from freezing. I had my underwater video camera along, but outside of a bunch of small fish at Kona and several big turtles at Maui, the pickin's

were pretty crummy. It doesn't hold a candle to a bunch of the diving spots in the Caribbean. No sharks. No whales. No manta rays. I did get a fleeting glimpse of some porpoises. I was hoping for better.

The conference was exciting. There I had an opportunity to meet the movers and shakers in the cold fusion world. I'll be writing a lot more about that.

If you're interested in a day-by-day report on the trip, I've put it together into a 24-page booklet, *Uncle Wayne's Hawaiian Adventure*. Send \$3 for a copy postpaid. Eventually I'll probably add it to some other stuff I've been writing and have another book. I've finished one on my submarine adventures in WWII (52 pages), another on my diving adventures (96 pages), and one on my recent travels (48 pages). But then you haven't invested in my *We The People Declare War On Our Lousy Government* yet. Tsk. Well, a few hundred of you have bought the book, and I thank you for your wonderful letters.

#### Ordering Books and CDs

[Editor's Note: Wayne often references books and CDs in his editorials. The books are often available from Uncle Wayne's Bookshelf; the CDs from IMPS by Mail. Both can be ordered by telephoning (800) 234-8458 or (603) 924-4196, or by faxing (603) 924-8613.]

73

## OAK HILLS RESEARCH

### QRP Headquarters

# QRP WATTMETER KIT



- A wattmeter designed specifically for the QRP operator & builder (1.8 to 54 MHz)
- Measures forward & reflected power at QRP levels
- Select from three full scale power levels: 10W, 1W, or 100mW
- Measure power down to 1mW
- Large easy to read 2" meter
- Low current drain meter circuit uses 9V battery (battery not included)
- Great for portable use
- Easy to build & align
- Align with a digital voltmeter. Source of RF not required
- Measures (HWD): 4 1/2" x 3 1/2" x 5"
- 100% complete kit (less battery) including cabinet, all components and instructions



CAT #WM-1

# \$89.95

plus \$4.50 S & H



Send \$5.52 stamp for latest catalog

9AM to 6PM  
Mon.-Fri.  
EST.

## OAK HILLS RESEARCH

20879 Madison Street  
Big Rapids, MI 49307

Michigan Residents  
Add 4%  
State Sales Tax

Fax: (616) 796-6633 Orders 616-796-1460 Tech. Info (616) 796-0920

CIRCLE 82 ON READER SERVICE CARD



# SPECIAL EVENTS

Number 23 on your Feedback card

## Ham Doings Around the World

### MARCH 5

**ABSECON, NJ** The Shore Points ARC will sponsor its 12th annual hamfest, "Springfest '94," at Holy Spirit H.S., Rte. 9, 1/2-mi. south of Rte 30. Doors open at 9 AM (7 AM for sellers). Talk-in on 146.385/.985. Contact SPARC, P.O. Box 142, Absecon NJ 08201.

**DENVILLE, NJ** The annual North Jersey Hamfest, sponsored by Split Rock/West Morris, will be held on Morris Ave. starting at 8 AM (sellers 6 AM). VE Exams at 9 AM sharp. Sign up by 9 AM. Talk-in on 146.985 and 223.86. Contact *Bernie WB2YOK*, P.O. Box 251, Flanders NJ 07836; (201) 584-4423.

**LANCASTER, NH** Twin Mountain NH Town Hall (near the intersections of U.S. Routes 3 and 302), will be the location of a Hamfest and Fleamarket to benefit D.A.R.E. The North Country ARC and Littleton ARK will co-host this event from 8 AM-3 PM EST. Talk-in on 146.55 MHz simplex. Contact *Richard C. Force WB1ASL*, 12 Cottage St., Lancaster NH 03584. Tel. (603) 788-2202.

**TUSCALOOSA, AL** The Black Warrior Swapfest will be held from 8 AM-4 PM at Northport Civic Center, Hwy 82 at Hwy 43, Northport AL. VE Exams at 8:30 AM; contact *David Drummond WB4HHY*, (205) 339-7915. Indoor Swap Area. For details contact *Kelly Bruce WD4DAT*, (205) 339-7882 after 6 PM. Vendor/Table info: *Danny Buford KC4RLR*, P.O. Box 032171, Tuscaloosa AL 35403; (205) 339-5812, after 6 PM. Talk-in on 147.300, 146.820, 147.060+, 145.350-, or 444.700+.

### MARCH 6

**NORTHAMPTON, MA** The Smith Voc. School on Rte. 9 has been chosen as the site for the 10th Annual MTARA Amateur Radio Flea Market. This event will be presented by the Mt. Tom Amateur Repeater Assn. Inc., starting at 9 AM (8 AM for vendors). ARRL VE Exams at 10 AM. Vendor Reservation Contact: *Jim K1MEA*, (413) 527-3199 eves. before 2200 EST. VE Exam Registration: *Jim WA1ZUH*, (413) 245-3228; or @ MTMBBS via packet. Advanced registration strongly recommended.

### MARCH 11

**ST. LOUIS, MI** The Jefferson Barracks ARC will hold their 34th annual RADIO AUCTION at Concordia Turner's Hall, 6432 Gravois, in south St. Louis City. Doors open at 5 PM; the auction starts at 7:30 PM. Talk-in on 146.34/.94, 144.61/145.21. Contact *Vivian W0EMS*, or *Scotty KA0FJA*, 4121 Fabian Dr., St. Louis MO 63215. Tel. (314) 631-4068.

### MARCH 12

**COLBY, KS** The Trojan ARC's 1st annual Swapfest will be held from 9AM-5 PM CST at the Colby Nat'l. Guard Armory on K-25. VE Exams March 11th at 6:30 PM at Sirlain Stockade. Early-

bird dinner. More. Contact TARC, Box DX, Colby KS 67701.

### MARCH 13

**BRISTOL, CT** The Insurance City Repeater Club will hold its annual Hamfest and Computer Flea Market from 9 AM-1 PM at Bristol Eastern H.S., King St. (RT 229). Talk-in on 146.88 and 224.80. VE Exams by pre-registration only. Write ICRC, P.O. Box 165, Pleasant Valley CT 06063. SASE required. Flea Market contact: *Chuck Motes K1DFS*, 22 Woodside Ln., Plainville CT 06062. Tel. (203) 747-6377.

**INDIANAPOLIS, IN** The Indiana Hamfest/Computer Show will be held by the Morgan County Repeater Assn., starting at 8 AM, at Indiana State Fairground's Pavilion Bldg. Advance reservations recommended. Talk-in on 145.25. Contact *Aileen Scales KC9YA*, 3142 Market Place, Bloomington IN 47403. Tel. (812) 339-4446.

**YORK, PA** The 7th annual York Springfest (Ham & Computer) will be held at the York Fairgrounds. Doors open at 8 AM. ARRL VE Exams 8 AM. Talk-in on 146.97-, 447.275- and 53.97-. Write with SASE to *York Springfest*, P.O. Box 526, Red Lion PA 17356; or call (717) 843-7864 to leave a FAX or message.

### MARCH 14-17

**TORONTO, CANADA** The Internat'l Symposium on Digital Audio Broadcasting (DAB) "The Sound of 2000" will take place at the Sheraton Centre Hotel and Towers. Contact *DAB Symposium '94*, 126 York St., #401, Ottawa, Ontario Canada K1N 5T5. Tel.: (613) 241-9333; FAX: (613) 565-2173.

### MARCH 15-17

**VISALIA, CA** The 1994 Internat'l DX Convention will be presented at Holiday Inn-Plaza Park by the Southern California DX Club. Pre-registration deadline March 15. For info contact *Don Bostrom N6IC*, (818) 784-2590 or (310) 334-8717. For lodging: *Holiday Inn*, (209) 651-5000; *The Raddison Hotel*, (209) 636-1111; *the Lamplighter Hotel*, (209) 732-4511.

### MARCH 19

**MOREHEAD CITY, NC** VE Exams will be administered by the Carteret County ARS at First Presbyterian Church Fellowship Hall, 17th & Arendell St. Please pre-register. Contact *Art Sylvester KC4QD*, 613 North Forty Rd., Moorehead City NC 28557-3075. **WEST ORANGE, NJ** A Hamfest will be held by the Irvington-Roseland AC, from 8 AM-2 PM at West Orange H.S., 600 Pleasant Valley Way. Talk-in on W2QR Rptr., 147.415/146.415; 146.520 simplex. Contact *Howie Greenwald W2VHI*, (201) 994-4057, or *Jim Howe N2TDI*, (201) 402-6066.

### MARCH 19-20

**FORT WALTON BEACH, FL** The Playground ARC will hold their 24th annual Ham/Swapfest at the Ft. Walton Beach Fair Grounds from 8 AM-5

Listings are free of charge as space permits. Please send us your Special Event two months in advance of the issue you want it to appear in. For example, if you want it to appear in the January issue, we should receive it by December 31. Provide a clear, concise summary of the essential details about your Special Event. Check Special Events File Area #11 on our BBS (603-924-9343). for listings that were too late to get into publication.

PM Sat., and 8 AM-3 PM on Sun. For RV space, call *Stan WD4PEU*, (904) 243-8801. To pre-register for tables, call *Bud K8YNU*, (904) 243-5404, 3 PM-6 PM CDT; or *Jerry N4ZYB*, (904) 862-0419, 6 PM-9 PM CDT. For info regarding commercial space, meetings, or forums, write to P.A.R.C., P.O. Box 873, Ft. Walton Bch FL 32549.

**MIDLAND, TX** Midland ARC will hold their annual St. Patrick's Day Swapfest at the Midland County Exhibit Bldg., Sat. from 9 AM-5 PM, and Sun. from 8 AM-2:30 PM. VE Exams at 12 PM on Sat. Contact *AA5RS* or *N5TQU* via M.A.R.C., P.O. Box 4401, Midland TX 79704.

### MARCH 20

**LEXINGTON, MA** The Minuteman Repeater Assn. will hold their MMRA Flea Market at the Westboro MA H.S., beginning at 10 AM (set-up at 8 AM). Talk-in on 146.61, 146.82, 449.925 and 223.94. Send table requests and pre-payment to MMRA, P.O. Box 2282, Lexington MA 02173. A walk-in VE session is available. For info, call A. Morrison N1BHI, (508) 489-2282.

**MILTON FREEWATER, OR** The 48th annual W7DP Swapfest, sponsored by the Walla Walla Valley ARC, will be held from 8 AM-3:30 PM at the Milton Freewater Community Center bldg. Talk-in on 147.280. Contact *David L. Pence KB7WRT*, 810 E. Sumach St., Walla Walla WA 99362-1348. Tel. (509) 525-2529.

**MONROEVILLE, PA** The Two Rivers ARC will hold its 22nd Hamfest/Computer Show at the Pittsburgh Expomart on Business Route 22, from 8 AM-3 PM. Talk-in on 146.73. Check-in (good for a prize) on 146.52. For reservations and info, send SASE to *Two Rivers ARC*, P.O. Box 225, Greenock PA 15047-0225.

**STERLING, IL** The Sterling-Rock Falls ARS 34th annual Hamfest will be held at the Sterling High School Field House, 1608 4th Ave. Talk-in on 146.25/146.85 W9MEP Rptr. Contact *Lloyd Sherman KB9APW*, P.O. Box 521, Sterling IL 61081. Tel. (815) 336-2434.

**YONKERS, NY** The Westchester Emergency Comm. Assn., Inc. will hold "WECAFEST 1994" at Yonkers Raceway, (Intersection of I-87, Central & Yonkers Ave.) from 9 AM-2 PM. Talk-in on 147.06/.66. Contact *Jeanne Raffaelli*, (914) 962-9666.

### MARCH 26

**ELIZABETHTOWN, KY** The Lincoln Trail ARC has chosen the Pritchard Community Center as the location for their indoor Hamfest. This event will be open from 8 AM-4 PM (set-up Fri. 7 PM-9 PM). Talk-in on 146.98. Contact *Whitey Hensley*, P.O. Box 342, Vine Grove KY 40175. Tel. (502) 877-2234.

**MICHIGAN CITY, IN** Visit Rogers H.S., Pals Rd. between Woodland Ave. and Johnson Rd., to enjoy a Hamfest being presented by the Michigan City ARC, between 8 AM-2 PM (Set-up 6:30 AM). Talk-in: 146.49 simplex or 146.37/.97 Rptr. (131.8 Hz PL).

VE Exams. Contact *Gene Ward KD9VB*, 312 Ash Pkwy., Westville IN 46391. Tel. (219) 785-4295.

**UPPER SADDLE RIVER, NJ** The Chestnut Ridge Radio Club will sponsor its annual Flea Market from 8:30 AM-2 PM, at the Education Bldg., Saddle River Reformed Church, East Saddle River Rd., corner Weiss Rd. Talk-in on 246.955 Rptr. Contact *Chestnut Ridge Radio Club Inc.*, Box 110, Teaneck NJ 07666.

### MARCH 27

**MADISON, OH** The 16th annual Lake County ARA Hamfest will be held at the Madison H.S., intersection of Middle Ridge and Burns Rds. Doors open from 8 AM-3 PM. Flea Market. VE Exams. DXCC Field Card Checking, and more. Talk-in on 147.21 and 224.50. Contact *Roxanne, LCARA*, 6899 Meldridge, Concord OH 44060. Tel. (216) 352-6756 (6 AM-9 PM EDT weekdays; 10 AM-4 PM weekends).

### APRIL 2

**COLUMBUS, IN** The Columbus ARC will host a Hamfest at Bartholomew County 4-H Fair Grounds, Family Arts Bldg., on State Rd. 11, from 8 AM-2 PM. Talk-in on 146.790/146.190. Make reservations thru *Marion Winterberg WD9HTN*, 11941 W. Sawmill Rd., Columbus IN 47201. Tel. (812) 342-4670.

**LONGMONT, CO** The Longmont ARC will hold its annual LARCFEST from 8 AM-3 PM at the Boulder County Fairgrounds, Hover and Nelson Rds. VE Exams at 1 PM. Talk-in on 147.27/.87 or 146.52. Contact *Randy Stevens N0NMD*, 5280 Cypress Dr., Boulder CO 80303. Tel. (303) 499-1106.

## SPECIAL EVENT STATIONS

### MARCH 12

**TITUSVILLE, FL** The Titusville ARC will operate 1400Z-2300Z to commemorate the 150th Anniversary of Brevard County, and the 3rd Anniversary of the Mosquito Net. Frequencies: CW—near the bottom of the Novice 10, 15, and 40 subbands; phone-28.333 (Mosquito Net freq.) and near the bottom of the General 15 and 40 subbands. For a certificate, send QSL and a 9x12 SASE to TARC, P.O. Box 73, Titusville FL 32781.

### MARCH 12-13

**DAYTON, OH** The Farout ARC presents "The Last Blast of Green," a Special Event Station operating from St. Patrick (Shelby County) OH during the period 1800Z 12 Mar.-1800Z 13 Mar. Operation will be from the final St. Patrick's Church Parish Festival; the church is scheduled to close its doors July 1st. Frequencies: Lower portions of: 80, 40, 15, 10m Novice CW; 20m General CW; 80, 40, 20, 15m General phone; 10m Novice phone (as band conditions dictate). The Farout ARC QSL's 100% to amateurs and SWL's; via the bureau, or a business-size SASE to: *WB8SMC*,



Farout ARC, P.O. Box 9181, Dayton OH 4509-9181.

**EUGENE, OR** The Quarter Century Wireless Assn. will hold their QCWA phone QSO Party from 0000 UTC-24000 UTC. Operation will start at 30 kHz inside the General phone band. The WARC frequencies will not be used. Regular callsigns will be used for all contacts. Send logs to *Bob Reed WB2DIN, 597 Brewers Bridge Rd., Jackson NJ 08527.* For info contact *Bill Miller, K2GCE Activities Manager, 217 Porterfield Pl., Freeport NY 11520.*

#### MARCH 13-14

**MILWAUKEE, WI** The West Allis RAC will sponsor the 1994 Wisconsin QSO Party from 1800Z Mar. 13th-0100Z Mar. 14th, for CW and phone. Mail logs by March 31st. For details, contact *WARAC, P.O. Box 1072, Milwaukee WI 53201.*

#### MARCH 20

**PISCATAWAY, NJ** Member stations of the Piscataway ARC will operate their stations, signing /VOA, from 0000Z-2400Z, to commemorate the World War II operation of the Voice of America relay station WBOU, in the Bound Brook section of Piscataway. Frequencies: CW—All Novice bands; Phone—Lower 1/3 of General 75-15m bands, and the Novice 10m band. For a certificate, send QSL and 9x12 SASE to the call book address of the station worked.

#### MARCH 26

**SANDUSKY, OH** The Sandusky Radio Experimental League will operate W8LBZ 1500Z-2400Z to celebrate its 60th Anniversary. Operations will be in the General 40, 20, 15 meter bands and on 146.655 and 444.375. For a certificate, send QSL, contact number, and SASE to *Sandusky Radio Experimental League, 2909 W. Perkins Ave., Sandusky OH 44870.*

#### MARCH 26-27

**MACON, GA** The Macon ARC will operate W4BKM 1300Z-2000Z on March 26th and 27th at the 12th annual Macon Cherry Blossom Festival. CW: 7.135, 14.035, 21.135, and 28.135. Phone: 7.235, 14.235, 21.335 and 28.335. For a certificate, send QSL and 9x12 SASE to *Macon ARC, P.O. Box 4862, Macon GA 31208.*

#### APRIL 7

**GLENBROOK, N.S.W.** In commemoration of the 140th Anniversary of the first morse telegraph circuit in Australia (between Melbourne and Williamstown), the Sydney Morsecodians Fraternity will establish a morse link between Melbourne and Williamstown (with the venues at each end yet to be identified). The Science Centre in Canberra will be linked with both terminals so that messages may be exchanged between the three centers. Visitors will be able to send brief telegrams to relatives or friends, without charge.

Number 24 on your Feedback card

# DEALER DIRECTORY

#### DELAWARE New Castle

Factory authorized dealer! Yaesu, ICOM, Kenwood, Ten-Tec, AEA, Kantronics, DRSI Mfg., Ameritron, Cushcraft, HyGain, Heil Sound, Standard Amateur Radio, MFJ, Hustler, Diamond, Butternut, Astron, Larsen, and much more. **DELAWARE AMATEUR SUPPLY, 71 Meadow Road, New Castle DE 19720. (302) 328-7728.**

#### NEW JERSEY Lodi

North Jersey's newest Two Way Radio and Electronics Dealer is now open. Sales of Ham, Business, Marine and C.B. two way equipment as well as Scanners, Shortwave, Electronic Kits, Antennas, Books, Cable Boxes and more. Friendly service and low prices. **Advanced Specialties, 114 Essex Street, Lodi NJ 07644. (201) VHF-2067.**

#### NEW JERSEY Park Ridge

North Jersey's oldest and finest Shortwave and Ham Radio Dealer. Three minutes from Garden State Pkwy and NY Thruway. Authorized Dealers for AEA, Alpha Delta, Diamond, ICOM, Japan Radio Company, Kenwood, Vectronics, Yaesu, Ham Sales, Lee WK2T. **GILFER SHORTWAVE, 52 Park Ave., Park Ridge NJ 07656. (201) 391-7887.**

#### NEW YORK Manhattan

Manhattan's largest and only ham Radio Store, also full line of Business, Marine, Aviation, Shortwave Radios and Scanners, and Cellular Phones and Beepers. Large selection of Books, Antennas, Test Equipment, coaxial cable and parts. Full

Service Repair Lab on premises. Our 44th Year . . . We carry all major lines: MOTOROLA, ICOM, KENWOOD, YAESU, BENDIX-KING, ASTRON, AEA, SONY, PANASONIC, MFJ, CCTV CAMERAS AND MONITORS, BIRD WATTMETERS, FREQUENCY COUNTERS, SCANNERS, HY-GAIN, VIBROPLEX, HEIL, CALLBOOK, ARRL, OTHER PUBLICATIONS. Open 7 days M-F, 9-6 p.m.; Sat., 10-5 p.m. Sun. 11-4 p.m. We ship *Worldwide*. Call, Fax, or write for information and prices. Your one Source for HAM and Business Radios . . . **BARRY ELECTRONICS, 512 Broadway, New York NY 10012. (212) 925-7000. FAX (212) 925-7001.**

#### OHIO Columbus

Central Ohio's full-line authorized dealer for Kenwood, ICOM, Yaesu, Alinco, Japan Radio, Standard, AEA, Cushcraft, Hustler, Diamond and MFJ. New and used equipment on display and operational in our new 10,000 sq. ft. facility. Large SWL Department, too. **UNIVERSAL RADIO, 6830 Americana Pkwy., Reynoldsburg (Columbus) OH 43068. (614) 866-4267.**

#### PENNSYLVANIA Trevose

Authorized factory sales and service. KENWOOD, ICOM, YAESU, featuring AMERITRON, B&W, MFJ, HYGAIN, KLM, CUSHCRAFT, HUSTLER, KANTRONICS, VIBROPLEX, HEIL, CALLBOOK, ARRL Publications, and much more. **HAMTRONICS, INC., 4033 Brownsville Road, Trevose PA 19047. (215) 357-1400. FAX (215) 355-8958. Sales Order 1-800-426-2820. Circle Reader Service 298 for more information.**

DEALERS: Your company name and message can contain up to 50 words for as little as \$420 yearly (prepaid), or \$210 for six months (prepaid). No mention of mail-order business please. Directory text and payment must reach us 60 days in advance of publication. For example, advertising for the April '93 issue must be in our hands by March 1st. Mail to 73 Amateur Radio Today, 70 Rte. 202 N, Peterborough, NH 03458

# 73 Amateur Radio Today

PUT SOME EXCITEMENT INTO YOUR HOBBY!!

No other magazine brings you the exciting world of amateur radio like **73 Amateur Radio Today.**

- Construction projects: The most homebrew projects *anywhere.*
- Product Reviews: Belly-to-belly matchup of new gear.
- ATV: Find out about amateur television.
- HAMSATS: Get the latest news on amateur satellite.
- Never Say Die: And you bet I won't.
- 73 International: **73 Amateur Radio Today** is the only ham magazine with monthly news from every corner of the world.

12 issues for \$19.97

That's a 43% savings off the newsstand price!

CALL 1-800-289-0388

or send \$19.97 to: **73 Amateur Radio Today**  
70 Rte. 202N, Peterborough, NH 03458



## Link Communications RLC-II Repeater and Linking Controller

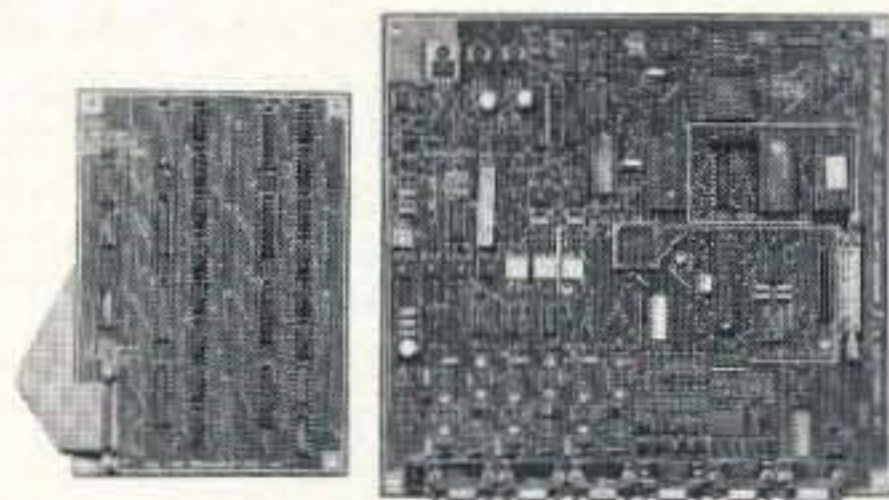

### RLC-II Features:

- (1) Full Featured Repeater port
- (2) Linking Full-Duplex ports
  - Linking ports capable of operating as stand alone repeater ports
  - Separate ID's, Time-Out Timers, Hang timers, and Courtesy Beeps
- (4) Analog Lines Programmable for Temperature and Voltage Readings
- (4) Input Lines for Contact closure Readings
- (8) Output Lines for control of external peripherals

- Clean and Understandable Voice Synthesizer with 400+ words
- All Ports have both COR and PL inputs allowing off site access changes
- DTMF Access from ALL Ports
- 2400 Baud Serial Port allows remote programming of the RLC-II
- Optional Full Duplex Autopatch with 200 Number Dialer Only \$199.95 plus s&h
- Optional 19" Steel Rack Mountable Enclosure Only \$100.00 plus s&h
- (20) Time Scheduler Slots with Hourly, Daily and Weekly Events Voice Time of Day Clock
- Complete Remote Programming using DTMF Tones
- Multiple Password Priority Assignable to each command
- All Commands can be renamed from 1 to 6 digits in length
- Independent DTMF mute function can be assigned to all ports
- Doug Hall RBI-1 Remote Base control of Kenwood Radio support

**ONLY \$599.95 plus s&h**

Link Communications

P.O. Box 1071

Bozeman, MT 59771-1071

(406)587-4085



CIRCLE 47 ON READER SERVICE CARD



# NEW PRODUCTS

Number 25 on your Feedback card

Compiled by Charles Warrington WA1RZW

## ICOM



ICOM has introduced the IC-Delta 100H multiband transceiver, with features never before imagined in a mobile radio. This beauty has a full-control microphone which allows total control of the entire operational menu. In addition, you can electronically mix and match the three bands according to your personal preferences.

The IC-Delta 100H has independent 144, 440, and 1200 MHz band units; each display can be freely selected for the band of your choice. A duplexer or triplexer can be connected

without any mismatching antenna loss, using a single antenna connector. Mobile installation is a breeze, especially with the optional OPC-332 or OPC-333 detachable front panel separation kit.

Each band has 100 memory channels, six scan edge channels (three pair for program scan) and one call channel. There are two banks of these channels for divided programming. Therefore, the total number of memory channels available is an amazing 642!

For further information, contact your local Icom dealer, or contact Icom America, Inc., 2380 116th Ave. NE/P.O. Box C-90029, Bellevue, WA 98009-9029; (206) 454-7619, Telex 152210. FAX (206) 454-1509. Or circle Reader Service No. 201.

## CABLE X-PERTS, INC.



Cable X-perts, Inc. has added two new 50 ohm low-loss cables to its product line—the LMR 400 and the LMR 600. The LMR flexible communications cables use a specially designed solid-copper-clad aluminum center conductor and a unique foam dielectric that is moisture- and crush-resistant.

The LMR 400 has an o.d. of 0.405, which is the same as the 9913, yet it has lower attenuation and a smaller bend radius. This cable uses standard PL259 or N type connectors.

The LMR 600 has an o.d. of 0.560 that is smaller than jacketed 1/2" hardline. This cable has only slightly higher attenuation and is approximately 30% lower in cost per foot.

The velocity of propagation for these new cables is 89%. The shielding is a tinned copper braid over 100% bonded aluminum foil, providing a shielding efficiency of 90 dB. The polyethylene jacket is ultraviolet-resistant and suitable for direct burial. For further information contact Cable X-perts, Inc., 113 McHenry Rd., Suite 240, Buffalo Grove, IL 60089; (800) 828-3340. Or circle Reader Service No. 202.

## UNIFIED MICROSYSTEMS

Unified Microsystems has introduced the Contest Card, a PC plug-in interface board that contains a voice recorder/keyer and CW interface. This unit allows hams to record their CQs, callsigns, contest exchanges, or other voice messages for transmission under control of their computer.

Primarily designed for contesters and DXers, the Contest Card can also be used with PC-based repeater controllers for ID and special voice messages, VHF meteor scatter transmissions, and for other applications. The

board can also directly drive an external speaker for non-radio applications.

The Contest Card is available in kit form for \$119.95 or assembled and tested for \$179.95. Shipping is \$5 for the US and Canada. Cable not included. For further information contact Unified Microsystems, P.O. Box 133, Slinger, WI 53086; (414) 644-9036. Or circle Reader Service No. 204.



## RF INDUSTRIES

RFI has announced the stainless steel Gripper Nipper hand tool Model RFA-4084. This unique wire cutter will hold the cut piece of wire firmly in the cutter until it is released by opening the

tool. This feature eliminates a major problem with most cutting pliers: small pieces of wire flying from the tool into equipment where they can cause short circuits.

The RFA-4084 Gripper Nipper is priced at \$12 and is available at RFI dealers. For more information contact RF Industries, LTD, 7620 Miramar Road, San Diego, CA 92126; (800) 233-1728. Or circle Reader Service No. 207.

## HAMTRONICS, INC.

The popular Hamtronics line of VHF and UHF FM Repeaters has just been expanded to include some very interesting new models.

The new REP-200T Repeater has all the features of the standard microprocessor-controlled REP-200 Repeater, with the addition of a new DVR-3 Voice Digital Recorder Module. This allows messages to be recorded off the air remotely. It is no longer necessary to use a microphone attached to the repeater to record messages. DTMF commands control the record and playback modes. Thus, the control operator can change the message at any time and repeater users can request a playback at any time.

With the availability of low-cost digital voice recorders, Hamtronics also

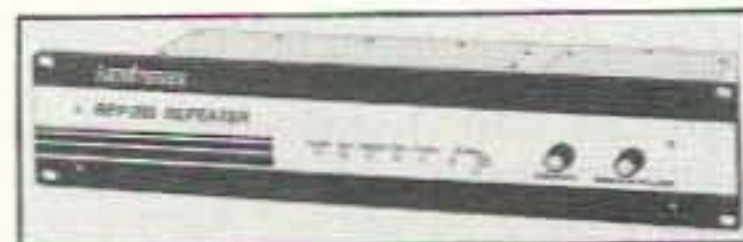

has developed an economy repeater with a voice ID built in. The new REP-200C Repeater uses a new COR-6 controller module with voice ID, but no DTMF decoder or autopatch.

Either of these new repeaters can be ordered for 6 meter, 2 meter, 222 MHz, and 440 MHz ham bands. The Model REP-200T is priced at \$1,145 in kit form; \$1,395 wired and tested. The Model REP-200C is priced at \$795 in kit form; \$1,095 wired and tested. For more information contact Hamtronics, Inc., 65-F Moul Rd., Hilton, NY 14468-9535; (716) 392-9430, FAX (716) 392-9420.

## AMSOFT



AmSoft has released its new 1994 edition of "The World of Ham Radio" on CD-ROM. New

this year is the inclusion of the FCC amateur radio license database. CALLSIGN will search over 700,000 new and previous callsigns, and find any licensed amateur in just seconds.

Users can view CALLSIGN on line or save to disk. Also new for 1994 is a front-end menu system called CDVIEW. CDVIEW will operate the disk with simple onscreen commands, on-line help files, and instant information

files from anywhere within the CD-ROM.

Over 7,000 program files cover many of the latest software releases for amateur radio. Subjects include antennas, CAT, CW, engineering, exams, formulas, logging programs, MUF, multimode, controllers, packet, RTTY, satellites, SWL, weather tracking, and much more. AmSoft has placed all of these programs onto one ISO-9660 IBM compatible CD-ROM priced at \$40 plus shipping (\$3 USA, \$5 foreign). For more information or to order contact AmSoft, P.O. Box 666, New Cumberland, PA 17070-0666; (717) 938-8249, FAX (717) 938-6767. Or circle Reader Service No. 203.



## CURRY COMMUNICATIONS

Curry Communications has introduced the MKII Noise Annihilator, a professional grade low frequency receiving processor. This receiver accessory will considerably enhance reception for low frequency communication enthusiasts at low cost.

Many hams and other radio enthusiasts enjoy monitoring the LF and VLF

bands, receiving European longwave DX, aeronautical beacons, 1750 meters, and other signals of interest. The major drawback is noise. More sophisticated receiving technology is called for. At this time there are no other products on the market that provide the operator the control and dramatic improvement of this product.

The MKII removes noise ahead of the receiver, opening a new world of DX reception, particularly in urban and suburban environments. It is priced at \$189 plus shipping (\$5 US, \$8 overseas). For more information contact Curry Communications, 737 North Fairview Street, Burbank, CA 91505; (818) 846-0617. Or circle Reader Service No. 205.

## JUST NEON

Did you ever think of having your callsign in neon lights? Well, now you can! Just Neon has introduced its new Neon Call Signs to hams everywhere. These handcrafted works of art last for years and are made out of real neon tubing. Each character is 4" X 3" and signs come with complete instructions, mounting hardware and transformer, custom-made with your callsign.

The ultimate in shack decor is available in neon red, clear blue, orange, white, sky blue, rose, pink, or green. Your sign will be mounted between

two durable sheets of clear acrylic, and comes with a one-year limited warranty. These signs

are also available with a bottom accent strip, border, or other custom design.

The basic custom unit, tested and delivered, is priced at \$225. For ordering information, please contact Just Neon, 409 James Street, Utica, NY 13501; (315) 724-9150; Fax (315) 792-9032. Or circle Reader Service No. 206.





# BARTER 'N' BUY

Number 26 on your Feedback card

Turn your old ham and computer gear into cash now. Sure, you can wait for a hamfest to try and dump it, but you know you'll get a far more realistic price if you have it out where 100,000 active ham potential buyers can see it than the few hundred local hams who come by a flea market table. Check your attic, garage, cellar and closet shelves and get cash for your ham and computer gear before it's too old to sell. You know you're not going to use it again, so why leave it for your widow to throw out? That stuff isn't getting any younger!

The 73 Flea Market, Barter 'n' Buy, costs you peanuts (almost)—comes to 35 cents a word for individual (noncommercial) ads and \$1.00 a word for commercial ads. Don't plan on telling a long story. Use abbreviations, cram it in. But be honest. There are plenty of hams who love to fix things, so if it doesn't work, say so.

Make your list, count the words, including your call, address and phone number. Include a check or your credit card number and expiration. If you're placing a commercial ad, include an additional phone number, separate from your ad.

This is a monthly magazine, not a daily newspaper, so figure a couple months before the action starts; then be prepared. If you get too many calls, you priced it low. If you don't get many calls, too high.

So get busy. Blow the dust off, check everything out, make sure it still works right and maybe you can help make a ham sure it still works right and maybe you can help make a ham newcomer or retired old timer happy with that rig you're not using now. Or you might get busy on your computer and put together a list of small gear/parts to send to those interested?

Send your ads and payment to the Barter 'n' Buy, Judy Walker, 70 Rt. 202N, Peterborough NH 03458 and get set for the phone calls.

The deadline for the April classified ad section is February 10, 1994.

**ALL ABOUT CRYSTAL SETS.** Theory and construction of crystal set radios. \$7.95 each, ppd USA. Send to: **AL-ABOUT BOOKS**, Dept. S, P.O. Box 22366, San Diego CA 92192. BNB200

**CUSTOM MADE-HAND TOOLED** leather products with your initials, name, call letters. Photo's & estimates available. Key rings, wallets, belts, purses, hanging signs, specialty items. **GREAT GIFT. LEATHER & WEST**, 67 Causeway Rd., West Swanzey NH 03469. (603)352-6256. 9-4 pm. M-F ET. BNB215

**TEST EQUIP.** Fluke 8020A multimeter, HP 400D VTVM, Optoelectronics UTC-3000 counter, 1 pr. Nady PRC-3 full duplex wireless headsets, all exc. cond. Also approx. 100 assorted tubes, most in boxes. No reasonable offer refused. Marc (914)769-7179 eve (NY). BNB235

**QSL SAMPLES-** 50 cents. **SAM-CARDS**, 48 Monte Carlo Dr., Pittsburgh PA 15239. BNB275

**COLLINS 32V-1 SERIAL #1 A.M.** transmitter, mfg. appx 1946. Cash only offers solicited. A set of 6 professional color photos will be sent upon the receipt of \$6, refundable. Contact Bob Travis Keagle, KB4NGZ, 5929 Antilla Dr., Orlando FL 32809. Phone (407)351-5939. BNB280

**COMMODORE 64 REPAIR.** Fast turn around. **SOUTHERN TECHNOLOGIES AMATEUR RADIO**, 10715 SW 190th Street #9, Miami FL 33157. (305)238-3327. BNB295

**RADIO RUBBER STAMPS** free brochure. **REID ASSOCIATES**, 6680 Mellow Wood, West Bloomfield MI 48322. BNB297

**KENWOOD AUTHORIZED REPAIR.** Also ICOM, Yaesu. **GROTON ELECTRONICS**, Box 379, Groton MA 01450. (508)448-3322. BNB310

**RCI-2950 OWNERS:** New modification manual including Power increase. Clarifier modification. Modulation increase. Operating hints, and more. Parts included. Only \$20.00 ppd in U.S. (Missouri residents add \$1.15 tax). **SCOTT**, P.O.

Box 510408, St. Louis MO 63151-0408. (314)846-0252. Money Orders or C.O.D. BNB340

**THE MODULATORS MATCH RADIO TO AMP.** All kits will greatly increase your modulation while suppressing the carrier. **GRANDMA MOD** fits RCI2950. **GRANDPA MOD** fits HR2510. Only \$19.95 each. (800)536-0109. Dave. BNB350

**KIT BUILDERS!** Complete list of 155+ kit vendors. #10 SASE + \$3.00 USD to: **RUTENBER ENGINEERING**, 38045 10th St. E. #H75-AR, Palmdale CA 93550. BNB365

**QSL CARDS** — Standard and custom. Your ideas or ours. Excellent quality. Foil stamping available. Many designs and type styles. Catalog and samples \$1.00 refundable. **WILKINS**, Dept. A, Box 787, Atascadero CA 93423. BNB370

**NEW NN1G CW SUPER-HET SINGLE BAND TRANSCEIVER KIT.** Available in 20M, 30M, 40M, 80M. \$59.95 plus \$3.75 S/H. (Catalog-2 Stamps). **DAN'S SMALL PARTS & KITS**, 1935 South 3rd West #1, Missoula MT 59801. BNB385

**SERVICE MONITORS WANTED.** Any late model test equipment. (408)241-7376. BNB390

**MAHLON LOOMIS, INVENTOR OF RADIO**, by Thomas Appleby. Available from Johan K.V. Svanholm, N3RF, Svanholm Research Laboratories, P.O. Box 81, Washington DC 20044. Please send \$25.00 donation with \$5.00 for S&H. BNB420

**BROWNIES QSL CARDS SINCE 1939.** Catalog & samples \$1 (refundable with order). 3035 Lehigh Street, Allentown PA 18103. BNB430

**HIGH QUALITY PERSONAL QSL's** insure greater returns! Customize one of 26 standard formats, or your own unique design. FREE info-packet (75 cent stamp appreciated). **CHESTER QSL's**, Dept. A, 2 S. Commercial, Emporia KS 66801. (316)342-8792, FAX (316)342-4705. BNB434

PERFORMANCE  
AND VALUE  
WITHOUT COMPROMISE

## KRP-5000 REPEATER

Word is spreading fast—  
"Nothing matches the KRP-5000  
for total performance and value. Not GE, not even Motorola."

2 METERS-220-440

RF performance really counts in tough repeater environments, so the KRP-5000 receiver gives you 7 helical resonators, 12-poles of IF filtering, and a precise Schmitt trigger squelch with automatic threshold switching. The transmitter gives you clean TMOS FET power

Enjoy high performance operation with remote programmability, sequential tone paging, autopatch, reverse autopatch, 200-number autodial, remote squelch setting, status inputs, control outputs, and field-programmable Morse messages.

Call or write for the full performance story... and the super value price!

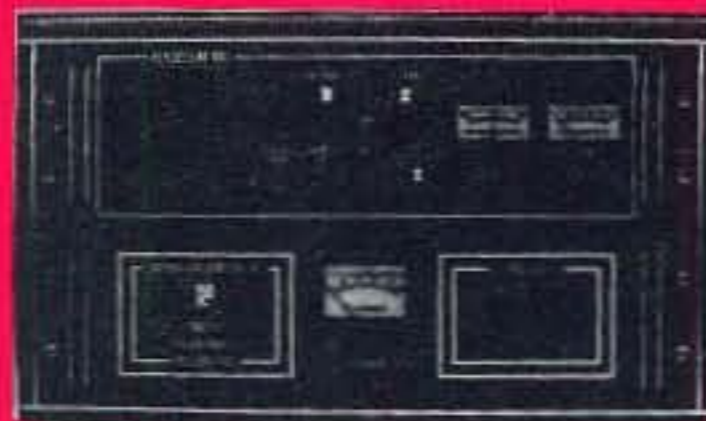

KRP-5000 Repeater shown with PA-100 Amplifier

Micro Control Specialties  
23 Elm Park, Groveland, MA 01834  
(508)372-3442  
FAX: (508)373-7304

The first choice in  
Transmitters - Receivers  
Repeaters  
Repeater Controllers  
Power Amplifiers  
Voice Mail Systems

CIRCLE 144 ON READER SERVICE CARD

TOLL FREE 1-800-666-0908 PRICING AND ORDERS ONLY

### KENWOOD



CALL FOR ALL KENWOOD

### YAESU



CALL FOR ALL YAESU  
RADIOS & ACCESSORIES

### ALINCO



CALL  
FOR  
ALL  
ALINCO

### ICOM



CALL FOR ALL ICOM

### STANDARD



CALL FOR ALL STANDARD

AEA • ASTRON • AZDEN • COMET • CUSHCRAFT • DIAMOND • KANTRONICS  
MFJ • SANGEAN • SONY SHORTWAVE • DRAKE • MANY MORE...

NEW EQUIPMENT PRICING AND ORDERS 1-800-666-0908 OUT OF STATE  
TECHNICAL, USED GEAR, INFO 203-666-6227 24HR. FAX 203-667-3551

**LENTINI COMMUNICATIONS INC.**  
21 GARFIELD STREET, NEWINGTON, CT 06111

Hours: M-F 10-6,  
SAT. 10-4



C.O.D.s Same Day  
OK Shipping

CIRCLE 234 ON READER SERVICE CARD

73 Amateur Radio Today • March, 1994 89



## Field Day Antenna Packs

EmergencyPacks contain QRV All Band kink-proof wx-sealed multi-band Dipole-V-Sloper antenna, 70' coax feedline, Quick Launch system, rotproof dacron support braid, 40 p Tech Manual. Complete. Ready for Action. One person installs in 15 minutes. Infopack \$1

**Fastest Antennas in the West**  
Box 50062-S, Provo, UT 84605

**AntennasWest**  
(801) 373-8425

CIRCLE 90 ON READER SERVICE CARD

## NEW ONLINE CALL DIRECTORY

Our new **HAMCALL** service gives you 494,114+ Hams, via your computer. \$29.95 per year — unlimited use!

**BUCKMASTER PUBLISHING**  
Route 4, Box 1630 Mineral, VA 23117  
703: 894-5777 800: 282-5628

CIRCLE 7 ON READER SERVICE CARD

**HR2510, HR2600, LINCOLN OWNERS:** Amazing new speech compressor circuit uses your "Mike Gain" switch as controller. Super loud & clear, natural sound. No gimmicks. Send S.A.S.E. for details to: **J&D CREATIONS**, Dept. 73, P.O. Box 60228, Santa Barbara CA 93160. **BNB440**

**ICOM-781 RAFFLE:** One hundred tickets ONLY at \$100 a piece. Drawing to be held at 3pm on June 24 at the RC of JHS 22 in NYC. Tickets/Questions-RC of JHS 22, POB 1052, New York NY 10002. Phone (516)674-4072, FAX (516)674-9600. **BNB455**

**WANTED: Kenwood TR851A** all-mode (SSB, CW, FM) 70 CM transceiver. Call Bill, (505)524-5165 or 524-5184. **BNB485**

**CRYSTALS:** High quality for your VHF/UHF and SHF transverter projects. SASE. WA3IAC, 7148 Montague St., Philadelphia PA 19135. **BNB515**

**CDROM-94 HAM RADIO CALLSIGN DATA BASE** Ham Radio Callsign Database with hundreds of PC Compatible programs, radio mods, TCP/IP Usenet, Ham Radio Archives, FCC Rules & Regulations, current exam question pools, and Canadian Call Signs. Only \$24.95, with Windows/DOS Interface. Includes shipping! Send check to: **CDROM**, 2348 Karen Dr., #6, Santa Clara CA 95050 or call (408)241-7376 with your Visa or MC. **BNB540**

**DACRON ROPE, WHY RISK ANTENNA SUPPORT FAILURES??** Mil Type, black, strong, high UV/stretch resistant, 3/32": \$.06/ft., 3/16" (770 lb. test): \$.11/ft., 5/16": \$.16/ft. IMMEDIATE SHIPMENT **DAVIS RF CO.** 24 HOUR ORDERS: (800)484-4002, CODE 1356. **BNB557**

**LEARN TO EARN COURSES:** Electronics, robot, radio, others. Free Catalog. **A&A PRODUCTS**, Rt 1 Box 482-L, Rockdale TX 76567. **BNB560**

**"FOR SALE: Tentec Triton** w/external dig dsply, 150/260HZ CW filter, Tentec 20A PS, manuals, worn front panel, works OK. Pickup only. N. Ind.-WA9PYH-(219)277-1786. \$275." **BNB565**

**DON'T BUY QSL CARDS UNTIL YOU SEE MY FREE SAMPLES.** Also I specialize in custom cards and QSL business cards. Write or call for free samples and custom card ordering information. **LITTLE PRINT SHOP**, Box 1160, Pflugerville TX 78660. (512)990-1192. Mastercard and Visa now accepted. **BNB595**

**WANTED: Western Electric** and other tube-type audio equipment. (800)251-5454. **BNB615**

**DUPLEXER TUNING GUIDE.** A complete booklet showing step-by-step instructions on tuning all types of duplexers. Included is theory of operation, detailed diagrams and much more. Send \$9.95 plus \$2.50 s&h to **RGM PUBLICATIONS**, 533 Main Street, Hillsboro NM 88042. For faster service using a major credit card call (505)895-5333 and order today. 30 day money back guarantee. **BNB635**

**SATELLITE EQUIPMENT AT 40%-50% OFF.** Toshiba TRX-1420, \$479.00; 25° LNB, \$59.00 w/rec. purchase. VCRS w/\$30.00 Program credit, \$399.00; .6° Ku, \$89.00. Call (800)851-6534 for wholesale price list. **SATELLITE WAREHOUSE**, Tucson AZ. Fax (602)624-1629. **BNB640**

**UNIVERSAL PROGRAMMERS** Data IO, XELTEK, Logic Devices, Magic IO, EETools, Needhams, from \$399.00. EPROM programmers from \$117. Call for free catalog. (408)241-7376. **BNB645**

**VHF-UHF-SHF Large SASE.** VHFer, P.O. Box 685, Holbrook AZ 86025. **BNB660**

**ELEGANT QSL CARDS AT LOW PRICES.** Samples \$1 (refundable with order). **AACO**, Dept. S43, 1639 Fordham Way, Mountain View CA 94040. **BNB670**

## Sell Your New & Used Gear In BARTER 'N' BUY

Classified Ads Work! Call Judy Walker today. 1-800-274-7373

## SAM AMATEUR RADIO CALLSIGN DATABASE 1994

Look up by CALL, NAME, City, State and Zip Code  
Edit or Add Entries. Print Lists or Labels Comment field for personal notes  
Direct interface to many popular logging and BBS programs  
Requires MS-DOS, 17MB actual free hard disk, and High Density floppy for install.

SAM 1994 coming in December.

'94 VERSION ONLY \$39.95

Semi-Annual Subscription \$55.00 Quarterly Subscription \$ 80.00

RT SYSTEMS, INC. POB 8. LACEYS SPRING, AL 35754

1-800-723-6922

## Personal Autopatch

Make and receive telephone calls from your mobile or HT with your own personal autopatch. Connect to phone line and transceiver microphone, PTT, and speaker jacks.



**NEW! Now with memory backup.**



- Full duplex or simplex with courtesy beeps.
- Programmable local and long distance codes.
- Automatic CW identification.
- Microprocessor controlled timeout protection.
- Controlled by VOX or carrier detect.
- Regenerated DTMF or pulse dialing.
- Separate external remote control output.
- 1.5"Hx4.6"Wx5.05"D shielded metal cabinet.

Personal Autopatch SDP-600 .... \$249.95

12Volt power adapter ..... 11.95

Shipping and handling \$5 in US, \$15 foreign.



30 day money back guarantee.  
90 day warranty.



j-Com 793 Canning Pkwy - Victor, NY 14564  
(716) 924-0422 · Fax (716) 924-4555

CIRCLE 39 ON READER SERVICE CARD

Say You Saw It In

## 73 Amateur Radio Today

## Why buy a TNC?

PC HF FAX + PC SWL \$179.00

### SPECIAL COMBINATION OFFER

For a limited time, if you order PC HF FAX \$99 (see our other ad in this issue), you can add our new and improved PC SWL 3.0 for \$80.00 instead of our regular low price of \$99.00.

PC SWL contains the hardware, software, instructions and frequency lists needed to allow you to receive a vast variety of digital broadcasts transmitted over shortwave radio. All you need is any IBM PC or compatible computer and an SSB shortwave receiver. The product consists of:

- Demodulator
- Digital Signal Processing Software
- 200 Page Tutorial Reference Manual
- World wide Utility Frequency List
- Tutorial Audio Cassette with Samples

PC SWL automatically decodes Morse code, RTTY, AMTOR, SITOR, NAVTEX and ASCII.

PC SWL lets you tune in on world press services, meteorological broadcasts, ham radio operators, coastal shore stations, aviation telex and much more digital action on the shortwave bands. Why pay for another expensive box when a simple interface and your PC can do the job?

#### ADVANCED FEATURES:

- Tuning Oscilloscope
- Digital Waveform Presentations
- Auto Calibration and Code Recognition
- Continuously Tunable Filter Frequencies
- Variable Shift
- Adjustable CW Filter Sensitivity
- Unattended Capture and Printing
- Integrated Text Editor
- Integrated Log and Database
- Shell to DOS applications
- Seamless Integration with PC HF Facsimile

Call or write for our complete catalog of products. Visa & MasterCard welcome.

## Software Systems Consulting

615 S. El Camino Real, San Clemente, CA 92672  
Tel:(714)498-5784 Fax:(714)498-0568

CIRCLE 244 ON READER SERVICE CARD



**CONCENTRATOR SOLAR CELLS.** High efficiency cells rated at 20ma or 40ma 555mv in direct sunlight will output up to several amps at close to one volt per cell when used with magnifying lens and a good heat sink. Data sheet included \$1.25 and \$2.50 each. \$5.00 minimum SASE to: James Carter, P.O. Box 23243, San Jose CA 95193. (408)729-8131. BNB695

**HAM RADIO REPAIR-** All makes and models. Fast, Professional Service. **AFFORDABLE ELECTRONIC REPAIR**, 7110 E. Thomas Rd., Scottsdale AZ 85251. (602)945-3908. BNB700

**ROSS' \$\$\$\$ NEW MARCH (ONLY) SPECIALS.** SAVE TIME AND MONEY HAVE MODEL NUMBER AND MANUFACTURER READY WHEN YOU CALL OR WRITE. KENWOOD, TM-411A, \$330.00; TR-751A, \$630.00; TM-241A, \$348.50; TR-8400, \$315.00; TM-631A, \$600.00; AEA CALL; ALINCO CALL; YAESU CALL; ICOM 900A AND UX-49A, \$700.00; 900A AND UX-39A, \$750.00; ASTRON CALL; MFJ CALL; TEN-TEC, 222 \$30.00; 535, \$1,150; 425, \$2,700.00; BARKER & WILLIAMSON CALL; CUSHCRAFT CALL; TELEX HY GAIN CALL; KLM CALL; RF CONCEPTS CALL; MIRAGE CALL, LARSEN CALL. ALL LIMITED TIME OFFERS. OVER 9035 ham-related items in stock for immediate shipment. Mention ad. Prices cash, F.O.B. Preston. HOURS TUESDAY-FRIDAY 9:00 TO 6:00, 9:00-2:00 P.M. MONDAYS. CLOSED SATURDAY & SUNDAY. **ROSS DISTRIBUTING COMPANY**, 78 SOUTH STATE, PRESTON ID 83263. (208)852-0830. BNB707

**GIANT SOLAR PANELS \$44.00 EACH!** Excellent Prices/Solar Equipment/Accessories. Free Information/Send Stamped Envelope, Catalog \$3.00. To: **QUAD ENERGY**, P.O. Box 690073, Houston TX 77269. (713)893-0313. BNB715

**ELECTRON TUBES:** All types and sizes. Transmitting, receiving, microwave . . . Large inventory = same day shipping. **DAILY ELECTRONICS**, 10914 NE 39th ST. Suite B-6, Vancouver, WA 98682. (800)346-6667 or (206)896-8856. BNB719

**MINIATURE POLICE RADAR TRANSMITTER** One mile range, \$41 assembled, \$31.00 kit, (219)489-1711. P.O. Box 80096, Fort Wayne IN 46898. BNB725

**QUALITY:** coax cables, connectors, antennas and amateur radio equipment. Send \$3.00 for latest catalog. **R. C. KONTES**, 465 Croft, Idaho Falls ID 83401-4419. BNB730

**HAM RADIO REPAIR**—Prompt service. **ROBERT HALL ELECTRONICS**, 1660 McKee Rd., Suite A, San Jose CA 95116. (408)729-8200. BNB751

**WANTED: HAM EQUIPMENT AND OTHER PROPERTY.** The Radio Club of Junior High School 22 NYC, Inc. is not only the Big Apple's largest Ham club but also the nation's only full time, non-profit organization, working to get Ham Radio into schools around the country as a theme for teaching using our EDUCOM-Education Thru Communication-program. Send your radio to school. Your donated amateur or related property, which will be picked up or shipping arranged, means a tax deduction to the full extent of the law for you as we are an IRS 501 (c) (3) charity in our fourteenth year of service. Your help will also mean a whole new world of educational opportunity for children around the country. Radios you can write off, kids you can't. Start spring off helping someone else and yourself. Please, write-phone-or FAX the WB2JKJ "22 Crew" today: The RC of JHS 22, P.O. Box 1052, New York NY 10002. Telephone (516)674-4072 or FAX (516)674-9600. Young people, nationwide, can get high on Ham Radio with your help. Meet us on the WB2JKJ CLASSROOM NET: 7.238 MHz. 1200-1330 UTC and 21.395 MHz. 1400-2000 daily. BNB762

**THE ISOTRON**  
COMPACT ANTENNAS FROM 160-10 METERS

NO TUNERS  
NO RADIALS  
NO RESISTORS  
NO COMPROMISE

FIVE EXCELLENT REVIEWS JUST DON'T HAPPEN BY CHANCE  
CALL US FOR A FREE CATALOG.

\*See review in Oct. 73, 1984 \*Sept. 73, 1985 March 73, 1986  
CQ, Dec. 1988 Mar. W.R. 91

**BILAL COMPANY**  
137 Manchester Drive  
Florissant, Colorado 80816  
(719) 687-0650

VISA  
MasterCard



CIRCLE 42 ON READER SERVICE CARD

**Fast & Fun G5RV QuicKits™**  
created by Antennas West Box 50062-S, Provo, UT 84605

Fast & Easy To Build

- Fail-Safe visual instructions
- No measuring or cutting
- Everything included
- Finish antennas in minutes

Quality Components

- Presoldered Silver Fittings
- Kinkproof QuietFlex wire
- Fully insulated, wx sealed, no-corrode, low noise design
- Tune All Bands Incl WARC

Want Plans, Patterns, Data? Order TechNote #124-D \$6.95 ppd USA

- Double Size G5RV \$59.95
- Full Size G5RV \$39.95
- Half Size G5RV \$29.95
- Quarter Size G5RV \$25.95
- ReadyMade 102 ft G5RV \$50.00
- ReadyMade 51 ft. G5RV/2 \$40.00
- 200' Dacron 250# line \$11.95

Order Hot-Line: Add \$5 P&H  
1-801-373-8425

CIRCLE 296 ON READER SERVICE CARD

**Texas BugCatcher**  
"The SERIOUS HF Mobile Antenna"

Unmatched in Quality  
Unmatched in Performance

CALL OR WRITE FOR FREE BROCHURE  
**GLA SYSTEMS**  
P.O. Box 425  
Caddo Mills, Texas 75135  
903-527-4163

We can supply everything you need for that BIG mobile signal you have always wanted!  
The Texas BugCatcher can be custom designed to fit YOUR particular vehicle.  
Are you ready to own the BEST???

HENRY ALLEN WB5TYD --- TINA ALLEN



**FOLD-AWAY ANTENNA MOUNT**



FOLDS TO ALLOW DOORS TO OPEN FOR MINI VANS AND UTILITY VEHICLES  
BOLTS TO TRAILER HITCH OR FLAT PLATE  
SUPPORTS LARGE HF MOBILE ANTENNAS  
NON FOLD OVER MODEL ALSO AVAILABLE

CIRCLE 124 ON READER SERVICE CARD

Sell your product in **73 Amateur Radio Today**  
Call Dan Harper today. . . **1-800-274-7373**

**1691 MHz Weather Satellite System**

- 1691 MHz Hemt Pre-amp. model TS-1691-P. Amp \$250
- 1691 MHz Receiver model TS-1691-Recvr \$450
- Decoder Board & Software model TS-VGA-SAT4 \$349
- Low Loss (microwave) Coaxial Cable (65ft) with connectors. model 1691-coax ass'y \$65
- Track II Satellite Orbital Program. Tracks ALL satellites, world map, print out \$99
- 1691 MHz Loop Yagi Antenna model 1691-LY(N) \$99
- 1691 MHz Loop-Yagi Extension model 1691-LY-XTN \$85
- Demonstration Disc (IBM-PC VGA compatible) of signals recorded from WX-SAT system. \$3

Shipping: FOB Concord, Mass.  
Prices subject to change without notice.



**SPECTRUM INTERNATIONAL, INC.**  
Post Office Box 1084, Dept. S  
Concord, Mass. 01742, U.S.A.  
Phone: (508) 263-2145  
Fax: (508) 263-7008

CIRCLE 183 ON READER SERVICE CARD

**RF ENTERPRISES**

TO ORDER: 1-800-233-2482

Service & Info: 218-765-3254 Fax: 218-765-3308

**Complete Inventory**

**ANTENNAS**

TELEX/hy-gain  
CUSHCRAFT  
DIAMOND

**TOWERS**

ROHN  
HY-GAIN  
ACCESSORIES

**YAESU ICOM MFJ AEA**

**BELDEN COAX:**

- 9913 Low loss; 50 ohm.
- RG-213/U (8267) 50 ohm. Mil-spec.
- RG-8/U (8237) 50 ohm
- RG-8/U (8214) 50 ohm. Foam.
- RG-8X (9258) 50 ohm; foam

Don't settle for less than the best

**ASTRON POWER SUPPLIES**

- RS-4A RS-7A RS-12A
- RS-20A RS-35A RS-50A
- RS-20M RS-35M RS-50M
- VS-20M VS-35M VS-50M

CALL US FOR YOURS!

**COPPERWELD ANTENNA WIRE:**

Solid: 12 ga.; Solid: 14 ga.; & Stranded 14 ga. Cut to your specs.

**ROTOR CABLE:**

Standard (6-22, 2-18)  
Heavy Duty (6-18, 2-16)

We stock Amphenol Connectors  
Connectors Installed! Jumpers & custom cable assemblies.  
Call or write today! We ship worldwide.

**VISA Mastercard**  
Prices subject to change without notice.  
Shipping additional except as noted.  
Returns subject to 20% restocking fee.  
No antenna or tower returns.

**RF ENTERPRISES**

HC 86 Box 580  
Merrifield, MN 56465

CIRCLE 171 ON READER SERVICE CARD



**Next Day** **QSLs**  
Two-Color  
Rainbow Assortment

Sarabon, Wisconsin  
Sauk County  
**K9ZZ**

Info 51  
Antennas West  
(801) 373-8425

Call Today &  
We Ship **Next Day** **2nd Day** **ASAP**

100	\$29.95	\$24.95	\$19.95
200	\$39.95	\$34.95	\$29.95
400	\$49.95	\$44.95	\$39.95
500	\$54.95	\$49.95	\$44.95
1000	\$99.95	\$89.95	\$79.95

All orders ppd 2nd day air/ priority mail.  
For overnight air delivery add \$10.  
Box 50062-S, Provo, UT 84605

**CIRCLE 5 ON READER SERVICE CARD**

**CABLE T.V. CONVERTERS**

Jerrold™, Oak, Scientific Atlantic, Zenith, & many others. "New" MTS stereo add-on: mute & volume. Ideal for 400 & 450 owners.

**1-800-826-7623**

**B & B INC.**  
3584 Kennebec, Eagan MN 55122

**CIRCLE 21 ON READER SERVICE CARD**

**JOIN TAPR-TUCSON AMATEUR PACKET RADIO** (non-profit R&D group). Membership benefits include: supporting the development of new communications technology, quarterly newsletter, low-priced software/shareware, 10% discount on kits and publications. \$15/year (foreign higher). Visa/MC accepted. Bonus with new membership: mention 73, receive TAPR Packet Radio General Info booklet (a \$7 value)! Call (817)383-0000, P.O. Box 12925, Tucson AZ 85732. **BNB765**

**SOLAR POWERED HAMS!** The Sunswitch is a charge controller to protect your batteries from over charge. Power MOSFETs are used, no relays! Assembled tuned and tested. Now with Wall Mount Case, \$55.00 plus \$3.00 shipping. **SUNLIGHT ENERGY SYSTEMS**, 2225 Mayflower NW, Massillon OH 44647. **BNB774**

**AGGRESSIVE SALES REPRESENTATIVE** seeking additional employment. Would like to sell amateur radio equipment. (910)299-1298. **BNB800**

**R-390A COVER SET.** New \$55 each. Ballast tubes, \$25. (ppd) PO Box 3541, Toledo OH 43608. **BNB813**

**FREE SHAREWARE AND HAM CATALOG** for IBM or COCO. Morse code Computer Interfaces, \$49.95. **NEW TWO METER** Mobile Antenna Pattern Switcher for two vertical antennas, \$59.95. **DYNAMIC ELECTRONICS**, Box 896, Hartselle AL 35640. (205)773-2758, FAX-773-7295. **BNB815**

**SENSATIONAL NEW WAY TO LEARN CODE-Do** Aerobics, Sing, Jog, or Drive while learning code! Now the secret is yours! Order **THE RHYTHM OF THE CODE**-Morse code music cassette today! \$9.95 ppd **KAWA RECORDS** P.O. Box 319-S, Weymouth, MA 02188. The HIT of the 1993 Dayton Hamvention! **BNB824**

**EXPANDED C64 BEAM P.D. PROGRAM**, 500+ sites, \$3.50, 5.25 disk. F. Aden, N7SOK, 4096 Marcia Place, Boise ID 83704. **BNB835**

**FCC COMMERCIAL LICENSE PREPARATION** **RADIOTELEPHONE-RADIOTELEGRAPH.** Latest home study fast easy audio video. Q & A pool disks. **FREE** details **WPT PUBLICATIONS** (800)800-7588. **BNB840**

**COLLINS HF-380 MILITARY SPEC.** Not a converted KWM-380. Continuous coverage 1.6 MHz to 29,9999 transmit. Serial #440. All mods & updates. Mint condition. Includes the following accessories: Noise blanker, speech processor, digital control interface with external keypad, kiron memory module, 1.4, 1.7, 3.6 MHz filters, SM 280 & SM 281 microp hones, rack mount kit, blower kit, microphone foot switch, owner manuals, service manuals, all factory correspondence \$2,650.00 or trade 1000D, 1C 781, R 9000. KC4VGL, "Turk". (303)469-3355, evenings (303)465-0776. **BNB845**

**ELECTRONICS GRAB BAG!** 500 pieces of new components: inductors, capacitors, diodes, resistors. \$5.00 postpaid. **ALLTRONICS**, 2300 Zanker Rd., San Jose CA 95131. **BNB855**

**WANTED: COLLINS ANTIQUES**, anything old from, speakers, receivers, transmitters, and all accessories, any condition. Top \$\$\$ paid. Rick. (800)462-2972 anytime. **BNB865**

**RF ENGINEERS WANTED** **SGC**, a world leader in HF SSB equipment is seeking experienced RF Engineers. Experience in transmitter and receiver design, A/D converters, digital voice processing, and low noise oscillators is required. Preference to licensed amateurs. **SGC, INC.**, PO Box 3526, Bellevue WA 98009. Principals only. **BNB880**

**SCHEMATIC DESIGN PROGRAM.** Free brochure, write Dept. 7, **SCHEME-ADDICT**, 8622 West 44th Place, Wheat Ridge CO 80033. **BNB905**

**SELL YOUR PRODUCT IN 73 MAGAZINE**  
**CALL DAN HARPER 800-274-7373**

**ATV CONVERTERS • HF LINEAR AMPLIFIERS**

DISCOVER THE WORLD OF FAST SCAN TELEVISION

70 CM  
33 CM

**HF AMPLIFIERS per MOTOROLA BULLETINS**

Complete Parts List for HF Amplifiers Described in the MOTOROLA Bulletins.

AN758 300W \$160.70	EB63 140W \$ 88.65
AN762 140W \$ 93.25	EB27A 300W \$139.20
AN779L 20W \$ 83.79	EB104 600W \$448.15
AN779H 20W \$ 93.19	AR305 300W \$383.52
AR313 300W \$403.00	

**NEW!! 1K WATT 2-50 MHz Amplifier**

**POWER SPLITTERS and COMBINERS**

600 Watt PEP 2-Port	\$ 69.95
1000 Watt PEP 2-Port	\$ 79.95
1200 Watt PEP 4-Port	\$ 89.95

**100 WATT 420-450 MHz PUSH-PULL LINEAR AMPLIFIER - SSB-FM-ATV**

KEB67-PR (Kit)	\$159.95
KEB67-PCB (PC Board)	\$ 18.00
KEB67-1 (Manual)	\$ 5.00

**UNIVERSAL DIGITAL FREQUENCY READOUT**  
TK-1 (Wired/tested).....\$149.95

**HEAT SINK MATERIAL**

Model 99 Heat Sink(6.5x12x1.6)	\$ 22.00
CHS-6 Copper Spreader(6x6x1/4)	\$ 18.00

**CHIP CAPS-Kemet/ATC**  
**METALCLAD MICA CAPS-Uneico/Semco**  
**RF POWER TRANSISTORS**  
**MINI-CIRCUIT MIXERS**

SBL-1 (1-500MHz)	\$ 6.50
SBL-1X (10-1000MHz)	\$ 7.95

**ARCO TRIMMER CAPACITORS**

VK200-20/4B RF Choks	\$ 1.20
56-500-65-3B Ferrite Bead	\$ .20

**Broadband HF Transformers**

Add \$ 3.50 for shipping and handling.

**AMATEUR TELEVISION CONVERTERS**

ATV2 420-450	\$ 44.95 Kit
ATV3 420-450 (GaAs-FET)	\$ 49.95 Kit
ATV4 902-928 (GaAs-FET)	\$ 59.95 Kit

**AUDIO SQUELCH CONTROL for ATV**  
SIL \$ 39.95 Kit

**2 METER VHF AMPLIFIERS**

35 Watt Model 335A	\$ 79.95 Kit
75 Watt Model 875A	\$119.95 Kit

Available in kit or wired/tested

For detailed information and prices, call or write for our free catalog.

**CCCI Communication Concepts Inc.**  
508 Millstone Drive • Xenia, Ohio 45385 • (513) 426-8600  
FAX 513-429-3811

**WE SHIP WORLDWIDE**

**CIRCLE 99 ON READER SERVICE CARD**

THE ANSWER IS GAP TECHNOLOGY • THE ANSWER IS GAP TECHNOLOGY

**Q An Antenna with No Earth Loss?**

**A Yes... the answer is GAP'S revolutionary technology.**

If you're looking for an antenna that can out perform the others and give you the edge, you're looking for a **GAP**. The Challenger DX-VIII is the revolutionary design that answers your demands for multi-band operation and unequalled efficiency with low noise. This is the technology that eliminates Earth Loss. **GAP** delivers from an elevated feed; your power doesn't disappear into the ground. Put it up. Turn it on. No tuning. No frustration. **GAP** delivers everything but the hassles. And — **GAP** delivers at a fraction of the cost of the "so-called" competition.

COMPLETELY PRECISION PRETUNED

ELEVATED GAP FEED CONQUERS EARTH LOSS

NO TRAPS ANYWHERE

AMAZING 8 BANDS

MOUNTS BACKYARD OR ROOF

Pat. Pend.

**The Challenger DX-VIII**  
80m 40m 20m 15m 12m 10m 6m 2m

**\$259**  
Plus Shipping

**GAP**

6010 Bldg. B  
N. Old Dixie Hwy.  
Vero Beach, FL 32967  
(407) 778-3728

ANTENNA PRODUCTS... Commercial Frequencies Available

THE ANSWER IS GAP TECHNOLOGY • THE ANSWER IS GAP TECHNOLOGY

**TRANSEL TECHNOLOGIES**

A DIVISION OF LJ ELECTRONIC INDUSTRIES  
123 East South Street • Harveysburg, Ohio 45032  
1 (800) 829-8321

**Model TSC1**  
Transel Suction Cup Mounting Kit  
**\$12<sup>95</sup>**

**Model TDC1**  
Transel Heavy-Duty Hat Clip  
**\$12<sup>95</sup>**

**Model TWM**  
Transel Slim Line Window Mount Kit  
**\$24<sup>95</sup>**

**Model T144-10**  
Transel Modified Gain Quarter Wave Antenna  
**\$14<sup>95</sup>**

Write for a Full Line Antenna Catalog at No Cost!  
— DEALERS WELCOME —  
Made In The USA...Because It Matters!

**CIRCLE 11 ON READER SERVICE CARD**



PRINTED CIRCUIT BOARDS for 73, QST, etc. Club orders welcome. US orders deduct 20%. Free list. **B-C-D ELECTRONICS**, Box 20304, 858 Upper James St., Hamilton, Ontario, Canada L9C 7M5. BNB910

WANTED: BUY & SELL All types of Electron Tubes. Call (612)429-9397, Fax (612)429-0929. **C & N ELECTRONICS**, Harold Bramstedt, 6104 Egg Lake Road, Hugo MN 55038. BNB915

COMMODORE 64 HAM PROGRAMS-8 disk sides over 200 Ham programs \$16.95/\$.29 stamp gets unusual software catalog of Utilities, Games, Adult and British Disks. **HOME-SPUN SOFTWARE**, Box 1064-BB, Estero FL 33928. BNB917

INEXPENSIVE HAM RADIO EQUIPMENT. Send postage stamp for list. Jim Brady WA4DSO, 3037 Audrey DR., Gastonia NC 28054. BNB927

USED AND NEW AMATEUR RADIO, SWL, AND SCANNERS. We buy, sell, consign and trade used equipment. Thirty day warranty. Western Pennsylvanias' newest Amateur Radio supplier. We also offer complete repairs on most types of equipment. Call for quotes. **FOR HAMS ONLY, INC.** INFO (412)374-9744. ORDERS ONLY (800)854-0815. ROBB KE3EE. BNB929

RADIO REPAIR Amateur and commercial, professional work. Fred Fisher WF9Q, 6866 W. River Rd., South Whitley IN 46787. (219)723-4435. BNB930

SEIZED GOODS, radios, stereos, computers, and more by FBI, IRS, DEA. Available in your area now. Call (800)436-4363 Ext. C-6223. BNB940

TUBES AND R.F. TRANSISTORS. Large inventory 6146B, 4CX250B, 6KV6A, 807, MB8719, 2SC2312, 2SC2290, 2SC2879, 2SC1969, MRF455. **WESTGATE** (800)213-4563. BNB950

FREE HAM GOSPEL TRACTS. SASE. N3FTT, 5133 Gramercy, Clifton Heights PA 19018. BNB960

PRINTED CIRCUIT BOARDS for projects in 73, Ham Radio, QST, ARRL Handbook. List SASE. **FAR CIRCUITS**, 18N640 Field Ct., Dundee IL 60118. BNB966

AZDEN SERVICE by former factory technician. **SOUTHERN TECHNOLOGIES AMATEUR RADIO, INC.**, 10715 SW 190 St. #9, Miami FL 33157. (305)238-3327. BNB979

PICTURE QSL CARDS of your shack, etc., from your photo or black ink artwork. 500 \$28.00, 1,000 \$44.50. Also non-picture cards. Custom printed cards, send specifications for estimate. Send 2 stamps for illustrated literature. Generous sample kit \$2.00, half pound of samples \$3.00. **RAUM'S**, 8617 Orchard Road, Coopersburg PA 18036. Fax or Phone (215)679-7238. BNB988

TALK TO YOUR COMPUTER...OVER THE AIR. Control your computer from your VHF handheld. Many unique and entertaining projects. Save and retrieve VOICE recordings from your hard disk. Turn equipment on and off. Burglar alarm. Easy to use VOICE MAIL SOFTWARE included. Works with repeaters. You set it up the way you want. In any language or voice. Translate DX PACKET CLUSTER announcements and transmit in voice. **COMPUTER BOARD & VOICE MAIL SOFTWARE \$259. PROGRAMMER'S SUBROUTINE KIT** included (non-disclosure required for source code). If you want to have more fun than you have had in a long time, then call DCI... TOLL FREE for a complete info package via FAX or MAIL. (800)563-5351 TOLL FREE from anywhere in the U.S.A. (306)781-4451 Direct. BNB995

ROTOR PARTS ROTOR SERVICE, ROTOR accessories: Brak-D-Lays, Quik-Connects, Pre-Set mods. NEW models for sale. Free catalog. **C.A.T.S.**, 7368 State Road 105, Pemberville OH 43450. BNB996

**The World of Ham Radio and CALLSIGN Database**

The World of Ham Radio CD-ROM which is dedicated to amateur radio software, now includes the FCC amateur call sign database. Scan over 700,000 US license records in seconds with CALLSIGN. You will have the latest releases in ham radio software from all over the World at your fingertips, using CALLSIGN to speed you through over 7,000 IBM files, over 1,000 radio modes, and thousands of QSL frequencies. Why wait any longer, get the best for less today. USA shipping \$3 each, Foreign Air Mail shipping \$5 each. **AMSOFT** PO Box 666, New Cumberland, PA 17070-0666 USA, Fax 717-938-8747

**\$40 CD-ROM**

**AMSOFT 717-938-8249**

VISA MasterCard

CIRCLE 113 ON READER SERVICE CARD

**Field Day Solar**

The \$349.00 Bullet-Tested QRV Solar Power Supply keeps your repeater on the air 'round the clock or powers your 100w HF station 60 hrs a month. Control circuit speeds charge, protects gel cells & sealed batteries. Fully assembled, QRV, portable. Easily Expanded.

**Antennas West**  
Box 50062 Provo, UT 84605

(801)373-8425

CIRCLE 236 ON READER SERVICE CARD

**Sell Your New & Used Gear In BARTER 'N' BUY**  
Classified Ads Work! Call Judy Walker today. **1-800-274-7373**

**Small Talk**  
MICRO 1.1 & 2.1 VOICE RECORDER IDENTIFIERS

FULLY ASSEMBLED (NOT A KIT), INCLUDING MICROPHONE, SWITCHES AND FULL DOCUMENTATION

**MICRO 1.1 INTRODUCTORY PRICE**  
\$69<sup>95</sup> - 16 SECOND  
60 SEC. - \$79.95

**MICRO 2.1 INTRODUCTORY PRICE**  
\$109<sup>95</sup> - 16 SECOND  
60 SEC. - \$119.95

**MICRO 2.1: ADDITIONAL FEATURES**  
- COR OR SQUELCH KEYED - VARIABLE I.D. TIMER  
- 5v KEY OUT PUT - MULTI-FUNCTION DIPSWITCHES  
- AUDIO MIXING

**AGRELO ENGINEERING**  
1145 CATALYN STREET SCHENECTADY, NY 12303

ORDERS ONLY: CALL 1-800-588-4300  
TECH. SUPPORT: (518) 381-1057  
TECH. FAX: (518) 381-1058

ORDER BY PHONE OR MAIL - IN U.S.A. ADD \$3 FOR SHIP  
- C.O.D. CHARGES APPLY - NYS RESIDENTS ADD 7% SALES TAX

MICRO 1.1:  
- FITS IN A MICROPHONE  
- SMALL SIZE  
1-1/4" X 1 1/16"

MICRO 2.1: 2 1/2" X 1 1/2"

CIRCLE 281 ON READER SERVICE CARD

**BARTER 'N' BUY Classified Ads**  
73 Amateur Radio Today, 70 Route 202 North, Peterborough, NH 03458

If your product or service is of interest to radio amateurs, spread the word!

For instant classified ad orders call Judy Walker  
**Orders only 1-800-274-7373**  
Information (603) 924-0058 Fax: (603) 924-9327

**RATES:** Individual (private for sale or wanted) \$.35 per word  
Commercial (for profit for sale) \$1.00 per word

YOUR AD:

1. _____	2. _____	3. _____	4. _____
5. _____	6. _____	7. _____	8. _____
9. _____	10. _____	11. _____	12. _____
13. _____	14. _____	15. _____	16. _____
17. _____	18. _____	19. _____	20. _____

First and last name (1 word), Street (1 word), City (1 word), State and Zip (1 word)

Name \_\_\_\_\_  
Address \_\_\_\_\_  
City \_\_\_\_\_ State \_\_\_\_\_ Zip \_\_\_\_\_  
Telephone \_\_\_\_\_  
Payment \_\_\_\_\_ Check \_\_\_\_\_ MC \_\_\_\_\_ VISA \_\_\_\_\_ AMEX \_\_\_\_\_  
Card # \_\_\_\_\_ Expiration Date \_\_\_\_\_

Please make checks payable to **73 Amateur Radio Today.** BNB0394



# Uncle Wayne's Bookshelf

## REFERENCE

**20N102 Practical Digital Electronics Handbook** by Mike Toolley RA Contains nine digital test gear projects. Digital circuits, logic gates, bistables and timers, microprocessors, memory and input/output devices. \$14.50

**20N103 Electronic Power Supply Handbook** by Ian R. Sinclair Covers many types of supplies—batteries, simple AC supplies, switch mode supplies and inverters. \$16.25

**20N104 Electronic Test Equipment Handbook** by Steve Money A guide to electronic test equipment for the engineer, technician, student and home enthusiast. \$18.00

**20N105 Digital Logic Gates and Flip-Flops** by Ian R. Sinclair A firm foundation in digital electronics. Treats the topics of gates and flip-flops thoroughly and from the beginning. \$18.00

**01C80 Master Handbook of 1001 Practical Electronic Circuits** Tried and proven solid state circuits. \$19.95

**01P68 Pirate Radio Stations** by Andrew Yody Tuning in to underground broadcasts. \$12.95

**01T01 Transmitter Hunting** by Joseph Moell and Thomas Carlee Radio direction finding simplified. \$19.95

**03R02 Rtty Today** by Dave Ingram Modern guide to amateur radioteletype. \$8.50

**05E03 First Book of Modern Electronics** Unique projects that are money saving. \$12.95

**09D22 The World Ham Net Directory** by Mike Witkowski New 2nd edition. Introduces the special interest ham radio networks and shows you when and where you can tune them in. \$9.50

**09P33 Pirate Radio Directory** by George Zeller Where to tune in on secret entertainment stations. \$7.95

**10F093 1993 International Callbook** The new 1993 International Callbook lists 500,000+ licensed radio amateurs in the countries outside North America. It covers South America, Europe, Africa, Asia, and the Pacific area (exclusive of Hawaii and the U.S. possessions). \$29.95



**10D093 1993 North American Callbook** The 1993 North American Callbook lists the calls, names, and address information for 500,000+ licensed radio amateurs in all countries of North America. \$29.95

**05H24 Radio Handbook, 23rd Ed.** by William L. Orr W6SAI \$40 pages of everything you wanted to know about radio communication. \$39.95

**02B10 Heath Nostalgia** by Terry Perdue K8TP 124 page illustrated history of the Heath Company. Includes many fond memories contributed by long-time Heathkit employees. \$9.50

**10DF92 1993 Callbook Supplement** An update to the 1992 International and American callbooks. \$10.00

**12E76 Basic Electronics** Prepared by the Bureau of Naval Personnel Covers the important aspects of applied electronics and electronics communications. \$10.95

**12E41 Second Level Basic Electronics** Prepared by the Bureau of Naval Personnel Sequel to Basic Electronics, thorough treatment of the more advanced levels of applied electronics. \$9.95

**01D45 The Illustrated Dictionary of Electronics, 5th Ed** by Rufus P. Turner and Stan Gibilisco An exhaustive list of abbreviations, and appendices packed with schematic symbols and conversion tables. \$26.95

**20N091 Most-Often-Needed Radio Diagrams and Servicing Information, 1926-1938, Volume One** compiled by M.N. Beitman An invaluable reference for anyone involved in Vintage Radio restoration. \$11.95

**20N096 How To Read Schematics (4th Ed.)** by Donald E. Herrington Written for the beginner in electronics, but it also contains information valuable to the hobbyist and engineering technician. \$14.95

**20N097 Radio Operator's World Atlas** by Walt Stinson, W0CP This is a compact (5x7), detailed, and comprehensive world atlas designed to be a constant desk top companion for radio operators. \$17.95

**20N020 Secrets of RF Circuit Design** by Joseph J. Carr Written in clear non-technical language, covers everything from antennas to transistors. \$19.50

**20N109 73 Magazine Index 1960-1990** A complete index to every article published in 73 Magazine through 1990. Book \$15.00 IBM software (specify type) \$20.00

**20N110 Product Reviews Since 1945** Contains an index to 3,400 product reviews that have appeared in QST, CQ, HR, 73 and Radcom. Book \$12.95 IBM Software 5.25 \$10.00

## SHORTWAVE

**06S57 1993 Passport to World Band Radio** by International Broadcasting Services, Ltd You'll get the latest station and time grids. \$16.50

**03S11 Shortwave Receivers Past and Present** edited by Fred J. Osterman Guide to 200+ shortwave receivers manufactured in the last 20 years. The Blue Book of shortwave radio value. \$8.95

**07R25 The RTTY Listener** by Fred Osterman New and expanded. This specialized book compiles issues 1 through 25 of the RTTY Listener Newsletter. Contains up-to-date, hard-to-find information on advanced RTTY and FAX monitoring techniques and frequencies. \$19.95

**03C09 Shortwave Clandestine Confidential** by Gerry L. Dexter Covers all clandestine broadcasting, country-by-country; tells frequencies, other unpublished information; spy, insurgents, freedom fighters, rebel, anarchist radio, secret radio. \$8.50

**03M221 US Military Communications (Part 1)** US Military communication channels on shortwave. Covers frequencies, background on point-to-point frequencies for the Philippines, Japan and Korea, Indian and Pacific Oceans, and more. \$12.95

**03M222 US Military Communications (Part 2)** Covers US Coast Guard, NASA, CAP, FAA, Dept. of Energy, Federal Emergency Management Agency, Disaster Communications, FCC, Dept. of Justice. From 14 KC to 9073 KC. \$12.95

**03M223 US Military Communications (Part 3)** Completes the vast overall frequency list of US Military services, from 8993 KC to 27,944 KC. \$12.95

**09S42 The Scanner Listener's Handbook** by Edward Soomre N2BFF Get the most out of your scanner radio. \$14.95

**11T88 Tune in on Telephone Calls** by Tom Kneitel K2AES Formatted as a frequency list with detailed description of each service and its location in RF spectrum. \$12.95

**03K205 Guide to Radioteletype (RTTY) Stations** by J. Klingenfuss Updated book covers all RTTY stations from 3MHz-30MHz. Press, Military, Commercial, Metro, PTTs, embassies, and more. \$12.95

**11AS10 Air Scan Guide to Aeronautical Communications (5th Ed.)** by Tom Kneitel K2AES Most comprehensive guide to monitoring US aeronautical communications. Covers all Canadian land airports and seaplane bases, plus listings for Central America, the Caribbean, North Atlantic, and the Pacific Territories. \$14.95

**07A66 Aeronautical Communications Handbook** by Robert E. Evans Exhaustive, scholarly treatment of shortwave aeronautical listening. \$19.95

**11RF13 The "Top Secret" Registry of US Government Radio Frequencies (7th Ed.)** by Tom Kneitel K2AES This scanner directory has become the standard reference source for frequency and other important information relating to the communications of federal agencies. \$19.95

**11F52 Ferrell's Confidential Frequency List, New Revised Edition** compiled by A.G. Halligey All frequencies from 4 MHz-28MHz covering ship, embassy, aero, Volmet, Interpol, numbers, Air Force One/Two, more. \$19.50

**15A002 Scanner and Shortwave Answer Book** by Bob Grove Most frequently asked questions by hobbyists. \$13.95

**11SR97 National Directory of Survival Radio Frequencies** by Tom Kneitel K2AES Handy and concise reference guide to high interest communications frequencies required by survivalists. \$8.95

**11SM11 Scanner Modification Handbook, Vol. 1** by Bill Creek provides straightforward step-by-step instructions for expanding the operating capabilities of VHF scanners. \$17.95

**11EE06 Guide to Embassy Espionage Communications** by Tom Kneitel K2AES Candid and probing examination of worldwide embassy and (alleged) espionage communications systems and networks. \$10.95

**20N094 A Flick of the Switch, 1930-1950** by Morgan E. McMahon Discover the fast-growing hobby of radio collecting. \$8.95

**07R26 World Wide Aeronautical Communications** by Robert E. Evans Aircraft/Air Traffic Control, Aircraft/Company Operations, Aviation Weather Broadcasts, Aeronautical Flight Tests, Worldwide Military Air Forces, Aero Search & Rescue, Aero Law Enforcement, NASA Flight Support, Aero Terms & Abbreviations and Aero Tactical Identifiers. \$6.95

**11T89 Scanner Modification Handbook Vol. 2** by Bill Creek Here it is—a companion to Vol. 1. In fact, Vol. 2 has a section that provides improved approaches and updated techniques for the mods in Vol. 1. There's 18 new exciting modifications for popular scanners. \$17.95

**03R01 World Press Services Frequencies (RTTY) New 5th Ed** A comprehensive manual covering radioteletype news monitoring—contains all information—antenna, receiving, terminal units, plus three extensive frequency lists. \$8.95

## SOFTWARE

**04M54 GGTE Morse Tutor** From beginner to Extra class in easy self-paced lessons. Code speeds from 1 to over 100 words per minute. Standard or Farnsworth mode. Adjustable tone frequency. Create your own drills, practice or actual exams. Exams conform to FCC requirements. 5 1/4" floppy for IBM PC, XT, AT, PS/2 or compatibles. \$19.50

**04M55 Advanced Edition \$29.95**  
**20N021 No Code Ham Radio Education Package** Computer software package. Includes computer aided instruction software (IBM compatible), 200 page Ham Radio Handbook. \$28.95

**20N022 Ham Operator Education Package** Computer software contains five IBM compatible discs with all questions for all license classes, plus "Morse Academy" code teaching software that takes you from 0-20 wpm. \$28.95

**Lanze Code Programs—(Available on 5 1/4" disk.)** Inexpensive complete study guide code programs for both the C64/128 Commodores and the IBM compatibles. Programs include updated FCC questions, multiple choice answers, formulas, schematic symbols, diagrams, and simulated (VE) sample test.

IBM Part#	Commodore Part#	Price
Novice	IBM01 COM01	\$14.95
Tech	IBM02 COM02	\$14.95
General	IBM03 COM03	\$14.95
Advance	IBM04 COM04	\$19.95
Extra (New Pool)	IBM05 COM05	\$19.95

**IBM06, COM06 IBM/Commodore Tech No Code—Lanze Code Program** Contains all the authorized FCC questions and answers used in testing formulas, schematic symbols, diagrams, and sample test for passing the new Technician No Code license. \$24.95

**IBM97 Amateur Radio Part 97 Rules** New Edition, complete FCC rules. \$9.00

**VIS Study Cards** Compact, up-to-date Flash Cards with Key Words, Underlined, Quiz on back. Formulas worked out. Schematics at your fingertips. Used SUCCESSFULLY by ages 6 to 81!

NOVICE	VIS01	\$11.95
TECH	VIS02	10.95
GENERAL	VIS03	9.95
ADVANCED	VIS04	15.95
EXTRA	VIS05	14.45



## ARRL BOOKS

AR1994 **ARRL 1994 Handbook (71st Ed.)** Features: added DSP, improved treatment of Pi and Pi-L, all new all-digital-logic, plus lots more. \$25.00

AR1993 **ARRL 1993 Handbook (70th Ed.)** 39 chapters, featuring 2,100 tables, figures and charts. Comprehensive, well organized and affordable. \$25.00

AR1086-4 **ARRL Operating Manual (4th Ed.)** Information on how to make the best use of your station, including: interfacing home computers, OSCAR, VHF-UHF. \$18.00

AR0194 **Antenna Compendium Vol. 1** Materials on verticals, quads, loops, yagis, reduced size antennas, baluns, Smith Charts, antenna polarization. \$10.00

AR2545 **Antenna Compendium Vol. 2** Covers verticals, yagis, quads, multiband and broadband systems, antenna selection. \$12.00

AR4017 **Antenna Compendium Vol. 3** More verticals, yagis, quads, plus loops, arrays, mobile, direction finding, controlled currents, computerized, installation, overloads, plus 40 new articles for beginner's to advanced. \$14.00

AR2626 **Companion Software for Antenna Compendium Vol. 2** 5 1/4" MS-DOS floppy. \$10.00

AR0488 **W1FB's Antenna Notebook** by Doug DeMaw W1FB Get the best performance out of unobtrusive wire antennas and verticals. Build tuners and SWR bridges. \$9.50

AR0348 **QRP Notebook** by Doug DeMaw W1FB Presents construction projects for the QRP operator. \$9.50

AR4141 **W1FB's Design Notebook** by Doug DeMaw W1FB Filled with simple practical projects that can be built using readily available components and common hand tools. \$10.00

AR2200 **Antenna Impedance Matching** by Wilfred N. Caron Most comprehensive book written on using Smith Charts in solving impedance matching problems. \$20.00

AR0402 **Solid State Design** Good, basic information, circuit designs and applications; descriptions of receivers, transmitters, power supplies, and test equipment. \$12.00

AR3193 **Weather Satellite Handbook (4th Ed.)** by Dr. Ralph Taggart WB8DQT Expanded and revised to reflect today's weather-fax satellite technology. \$20.00

AR3290 **Companion Software for Weather Satellite Handbook** 5 1/4" MS-DOS Floppy. \$10.00

AR3291 **Now You're Talking! All You Need To Get Your First Ham Radio License (2nd Edition)** A complete study guide for the Technician and Novice written exam. Practical information every beginner needs is written clearly and simply and in small doses. \$19.00

AR3292 **Your Introduction to Morse Code: Practice Cassettes** Kit includes two 90 minute cassette tapes. Prepares you for the 5 WPM Morse code exam to earn your Novice license or add high-frequency worldwide communications privileges to your code-free Technician license. \$10.00

AR0437 **ARRL Repeater Directory 1993-1994** 19,000+ listings with digipeaters, bandplans, CTCSS (PLTM) tone chart, frequency coordinators, ARRL special service clubs, and beacon listings from 14 MHz to 24GHz. \$6.00

AR1033 **The DXCC Companion** by Jim Kearman KRIS Spells out in simple, straightforward terms what you need to be a successful DXer. \$6.00

AR1250 **Log Book—Spiral** \$3.50

ARA341 **Interference Handbook** RFI sleuth's experience in solving interference problems. \$12.00

AR2197 **ARRL Data Book** Valuable aid to the RF design engineer, technician, radio amateur, and experimenter. \$12.00

AR2960 **Transmission Line Transformers (2nd Ed.)** by Dr. Jerry Sevick W2FMI Practical designs and specific information on construction techniques and sources of material. \$20.00

AR0410 **Yagi Antenna Design** A Ham Radio series polished and expanded by Dr. Lawson. \$15.00

AR2171 **Hints and Kinks** Ideas for setting up your gear for comfortable, efficient operation. \$8.00

AR3169 **QRP Classics** Compilation of ARRL publications on building receivers, transmitters, transceivers, accessories. \$12.00

ARRL **License Manuals** Complete FCC question pools with answers.

AR2375 **Technician Class** \$6.00  
AR2383 **General Class** \$6.00  
AR0166 **Advanced Class** \$8.00  
AR2391 **Extra Class** \$8.00

AR3185 **The Satellite Experimenter's Handbook, (2nd Ed.)** by Martin Davidoff K2UBC Expanded and revised. Focusing on satellites built by and for the international radio amateur community. \$20.00

AR2456 **FCC Rule Book (9th Ed.)** A must for every active radio amateur. \$9.00

AR2030 **Your Gateway to Packet Radio (2nd Ed.)** Tells everything you need to know about this popular new mode. \$12.00

AR2103 **Satellite Anthology** The latest information on OSCARs 9 through 13 as well as the RS satellites, the use of digital modes, tracking antennas, RUDAK, microcomputer, and more! \$5.00

AR2083 **Complete DX'er (2nd Ed.)** by Bob Locker W4KNI Learn how to hunt DX and obtain hard-to-get QSL cards. \$12.00

## CODE TAPES

73T05 **"Genesis"** \$5.95  
5 wpm—This beginning tape, takes you through the 26 letters, 10 numbers, and necessary punctuation, complete with practice every step of the way.

73T06 **"The Stickler"** \$5.95  
6+ wpm—This is the practice tape for those who survived the 5 wpm tape, and it's also the tape for the Novice and Technician licenses. It is comprised of one solid hour of code. Characters are set at 13 wpm and spaced at 5 wpm.

## WAYNE'S PICKS

SS8756 **Warning! The Electricity Around You May Be Hazardous To Your Health** by Ellen Sugarman An invaluable guide to the risks of electromagnetic fields, and steps you can take to protect yourself and your family. \$11.00

"We The People" **Declare War! On Our Lousy Government.** by Wayne Green A "must read" for every American taxpayer. Solutions to every problem facing our government today. \$12.95

## NEW STUFF

AR3782 **Your QRP Operating Companion** No special rigs or expensive equipment to enjoy the excitement and challenge of low-power operating. \$6.00  
AR3959 **Your Packet Companion** Perfect for the packet newcomer. \$8.00

AR2065 **ARRL Antenna Book** The new 16th Edition represents the best and most highly regarded information on antenna fundamentals, transmission lines, design, and construction of wire antennas. \$20.00

AR2898 **Space Almanac** by Anthony R. Curtis K3XXK Recent news from space. \$20.00

AR3293 **Morse Code: The Essential Language** by L. Peter Carron Jr. W3DKV Expanded and revised in its 2nd edition. How to handle distress calls heard not only on the hambands but on maritime and aircraft frequencies. \$6.00

AR4114 **Low Profile Amateur Radio** For the Ham who lives where antennas are frowned upon. From hiding your antenna to operating with low power. This book tells you how to get on the air using these techniques—and others—without calling attention to yourself. \$8.00

73T13 **"Back Breaker"** \$5.95  
13+ wpm—Code groups again, at a brisk 13+ wpm so you'll be really at ease when you sit down in front of a steely-eyed volunteer examiner who starts sending you plain language code at only 13 per.

73T20 **"Courageous"** \$5.95  
20+ wpm Congratulations! Okay, the challenge of code is what's gotten you this far, so don't quit now. Go for the extra class license. We send the code faster than 20 per.

ED86751 **Dumbing Us Down: The Hidden Curriculum Of Compulsory Schooling.** by John Gatto If you enjoyed "Declare War", you'll enjoy this also. A Wayne Green recommended reading. \$9.95.

78572 **How to Teach School Real Good** by Dick Gaillard Good reading. A true insight on the school system. What our teachers teach, how and why they teach. You will not be able to put this one down. A Wayne Green recommended reading. Limited Quantity. While supplies last. \$10.00

AR3878 **Your VHF Companion** Explore the fascinating activities on the VHF bands: FM and repeaters, packet, CW & SSB, Satellites, ATV, transmitter hunting and more. \$8.00

## ANTENNAS

20N108 **The Easy Wire Antenna Handbook** by Dave Ingram K4TWJ. Gives you all of the needed dimensions for a full range of easy to build and erect "sky wires." \$9.50

10A343 **All About Cubical Quad Antennas** by William Orr and Stuart Cowan "The Classic" on Quad design, theory, construction, operation. New feed and matching systems. New data. \$11.95

01A70 **Practical Antenna Handbook** by Joseph J. Carr Design, build, modify, and install your own antennas. \$22.95

10A342 **All About Verticle Antennas** by William Orr Comprehensive coverage of amateur communications. \$10.95

10A345 **Beam Antenna Handbook** by William Orr and Stuart Cowan Everything you need to know about beam design, construction, and operation. \$11.95

10A346 **Simple, Low-Cost Wire Antennas For Radio Amateurs** by William Orr and Stuart Cowan All New! Low-cost, multi-band antennas; inexpensive beams. "Invisible" antennas for hams in "tough" locations! New data. \$11.95

## UHF/VHF/PACKET

01P22-2 **The Packet Radio Handbook (2nd Ed.)** by Jonathan L. Mayo KR3T "...the definitive guide to amateur packet operation."—Gwyn Reedy W1BEL Only \$16.95

20N019 **U.S. Repeater Mapbook** by Robert Martin The Guide for traveling radio amateurs. \$9.95

09V11 **The Basic Guide to VHF/UHF Ham Radio** by Edward M. Noll Provides a first rate introduction to the 2.6 and 1.25 meter bands as well as 23, 33, and 70cm. \$6.50

03R02 **RTTY Today** by Dave Ingram K4TWJ Most comprehensive RTTY guide ever published. \$8.50

## BOOKS FOR BEGINNERS

02D42 **Digital Novice** by Jim Grubbs Geared to make you a more knowledgeable participant. \$8.50

05C25 **Basic A.C. Circuits** A step-by-step approach for the beginning student. \$24.50

20N018 **Technician Class License Manual: New No-Code** by Gordon West This book covers everything you need to become a Technician Class Ham. Every question and answer on the examinations is found in this one book. FCC Form 610 application. \$9.95

20N092 **The Wonderful World of Ham Radio** by Richard Skolnik, KB4LCS Simple, clear, and fun. Introduces young people to amateur radio. \$7.95

01A87 **Shortwave Listener's Antenna Handbook** Primer antenna theory. \$13.95

20N100 **Electronics Build and Learn (2nd Ed.)** by RA Penfold Combines theory and practice so that you can "learn by doing." \$12.50

20N099 **Digital Electronics Projects for Beginners** by Owen Bishop Contains 12 digital electronics projects suitable for the beginner to build with the minimum of equipment. \$12.50

AR2871 **W1FB's Help for New Hams** by Doug DeMaw W1FB Complete for the newcomer. Put together a station and get on the air. \$10.00

AR2286 **First Steps in Radio** by Doug DeMaw W1FB Series of QST articles. \$5.00

## Uncle Wayne's Bookshelf Order Form

You may order by mail, telephone, or fax. All payments are to be in US funds. Allow 3 weeks for delivery.

Item	Title	Qty.	Price	Total

Shipping: All US/Canada orders add \$5.00 shipping. U.S. orders shipped UPS. (Please provide street address.) (Alaska & Hawaii shipped via mail.) Airmail to Canada by actual weight.

Foreign Orders: Shipping charges by actual weight. Surface or Airmail (Surface delivery may take 2 to 3 months.)

SHIPPING  
TOTAL

Name \_\_\_\_\_

Street \_\_\_\_\_

City \_\_\_\_\_ State \_\_\_\_\_ Zip \_\_\_\_\_

TOTAL \$ \_\_\_\_\_  Check/Money Order

AE  MC  VISA

Card # \_\_\_\_\_ Expiration Date \_\_\_\_\_

Telephone: (603) 924-4196 (800) 234-8458  
FAX: (603) 924-8613

Mail: Uncle Wayne's Bookshelf, 70 Route 202N,  
Peterborough, NH 03458

UW0394



David Cassidy N1GPH

## Coincidence?

A week after I submitted last month's column about missing children, I received a press release in the mail. It is from an organization called The Friends of Mark Himebaugh Foundation, and the coincidence of it arriving shortly after I wrote last month's column is spooky.

Mark Himebaugh, whose picture is presented on this page, disappeared from the area of Cape May, New Jersey, on November 25, 1991. A massive search and investigation have turned up nothing. Mark is still missing.

Mark's father, Jody Himebaugh, is KB2QCJ. The press release I received (printed in its entirety in the April issue of *Radio Fun*) stated that Jody had formed The Friends of Mark Himebaugh Foundation for the purpose of heightening and maintaining national public awareness of missing children. Jody Himebaugh has asked hams to help in some simple ways.

"Whenever QSL cards are mailed, include the poster of a missing child," Himebaugh stated in the press release. "During CW, packet and voice communications, discuss the issue of missing children and the crime of abduction. Transmit images of missing children when working SSTV."

**MISSING PERSON**

30,000



Mark Himebaugh

REWARD

**DESCRIPTION:**  
 Date of Birth: 5/22/80 Place of Birth: Cape May, NJ  
 Height: 5'6" Weight: 85 lbs.  
 Hair: Red Eyes: Blue  
 Complexion: Freckles Hair: White  
 Build: Medium Occupation: 6th grade student  
 Scars & Marks: Fresh healed broken left foot  
 Last Seen: 3:15 PM, November 25, 1991  
 by his mother in Del Haven, New Jersey  
 Wearing: Blue sweatshirt, gray duckie style pants, gray jacket, white sneakers.

**PLEASE CONTACT:**  
**MAJOR CRIME UNIT**  
 81 Mechanics St.,  
 Cape May Court House,  
 NJ 08210  
 (609) 884-8700

Most states have a clearinghouse for missing persons where you can obtain posters, stickers (great for attaching to QSL cards) and other information concerning missing children in your area. You can also contact the National Center for Missing and Exploited Children, 2101 Wilson Boulevard Suite 550, Arlington Virginia, 22201. Their telephone number is (703) 235-3900.

I sent Jody Himebaugh an advance copy of last month's editorial and asked him to contact me, which he did. He

sounds like an intelligent and thoughtful man. As someone who has never had to deal with personal tragedy anywhere near the magnitude of losing a child, I am always amazed at the inner strength of many of those who have. Jody Himebaugh strikes me as a man possessing immense inner strength.

We talked about the formation of Amateur Radio Child Search. We talked about what is and isn't being done to aid missing children. I shamelessly asked him to help organize ARCS in New Jersey, which he agreed to help do. We both agreed that nothing could be accomplished without the assistance of hundreds of hams all across the country. We agreed that the only thing we could do was wait until people had a chance to read the February editorial and see what kind of a response I received.

In the meantime, I promised Jody that I would publish his son's picture. There are over 50,000 people reading these words (closer to 100,000 if you consider that most copies of this magazine are read by two or more people). I want each and every one of you to take a long look at Mark Himebaugh's picture. Notice the red hair. Notice the freckles across his cheeks and nose.

Look at the statistics concerning his height and weight and remember that he is now 2-1/2 years older. Those of you in the New Jersey area, try to remember where you were on November 25, 1991. Dig out your old appointment calendar or search through your journal. When you get on the air this month, instead of talking about what kind of rig you have, ask the ham on the other end if he has read this column. If not, tell him about Mark and send him a photocopy of this page (you all hereby have my permission to do that).

Somebody out there knows something. Somebody reading these words has seen Mark Himebaugh sometime in the last 2-1/2 years. If you

have any information, you can contact the agency listed under Mark's picture, or contact The Friends of Mark Himebaugh Foundation at P.O. Box 551, Cape May, New Jersey 08204-0551. Their phone number is (609) 884-6275.

I have one last request for all of you. Pull out last month's issue. With this issue open to this page, reread last month's column. Every few sentences, stop and take a look into the eyes of 11-year-old Mark Himebaugh.

Now, tell me you're too busy to get involved. 73

Jim Gray W1XU

Jim Gray W1XU  
 210 East Chateau Circle  
 Payson AZ 85541

March is likely to provide excellent DX conditions during the month, with only a very few days rated at less than Fair (F). You can expect some erratic conditions on the HF bands during March 20th (first day of spring) and 21st, but recovery will be rapid. Virtually half of the month will exhibit good-to-excellent propagation for DX to all parts of the world.

Although we are approaching the lowest part of the Cycle 22 sunspot minimum, and lowest solar flux values in the past nine or 10 years, springtime conditions are usually quite good, even at reduced sunspot numbers and low flux values. Therefore, the following conditions should apply for Good (G) and Good-to-Fair (G-F) and Fair-to-Good (F-G) days:

### 10 and 12 Meter Bands

Occasional F2 layer openings toward South and Central America (also Europe-Africa openings and general north-south path openings to other parts of the world) during daylight hours. Don't expect much from these bands, but keep an ear open for a good day.

### 15 and 17 Meter Bands

Consistent DX from the Northern Hemisphere to countries below the equator on many Good (G) days. Short-skip openings will also be quite good for much of this month during daylight hours, and out to about 1,000 miles or so.

### 20 Meter Band

This will be your band of choice for DX and short-skip operations during daylight hours, and there will even be some good openings after local darkness into areas of the Southern Hemisphere. Short skip will be good out to 2,000 miles or so during the day. Also, consider some grey-line DXing around the sunrise and sunset hours (local time).

### 30 and 40 Meter Bands

These two bands will provide you with DX from sunset to shortly after sunrise. You may expect

good signal strengths from the East, peaking between sunset and midnight, and signals from all other directions between midnight and sunrise local time. Daytime short skip ought to be favorable out to about 1,000 miles, and at night out to about 2,000 miles. High absorption between about 1100 and 1300 hours local time will depress band conditions, but won't cut them off entirely. 30 meters will act somewhat like 20 meters, and somewhat like 40 meters, exhibiting some of the best (and poorest) qualities of both.

### 80 and 160 Meter Bands

Fairly good DX conditions between sunset and sunrise to most parts of the world on evenings when the QRN is low enough for good copy. This is the time of year for thunderstorms and "atmospherics." Paths to the East will peak near midnight local time, and to other parts of the earth between midnight and sunrise. Daytime short skip will be nil to negligible, but nighttime short skip will offer respectable distances on both bands. 73

EASTERN UNITED STATES TO:											
GMT	00	02	04	06	08	10	12	14	16	18	20
ALASKA							20	20			
ARGENTINA	20	20						15	15	15	15
AUSTRALIA						40	20	20			15
CANAL ZONE	20	40	40	40	40		20	15	15	15	15
ENGLAND	40	40	40				20	20	20	20	
HAWAII		20			40	40	20	20			15
INDIA							20	20			
JAPAN							20	20			
MEXICO		40	40	40	40		20	15	15	15	15
PHILIPPINES							20	20			
PUERTO RICO	40	40	40	40			20	15	15	15	15
SOUTH AFRICA									15	15	15
U.S.S.R.							20	20			
WESTCOAST		80	80	40	40	40	40	20	20	20	

CENTRAL UNITED STATES TO:											
GMT	00	02	04	06	08	10	12	14	16	18	20
ALASKA									15		
ARGENTINA	20	20								15	15
AUSTRALIA	15	20				40	20	20			15
CANAL ZONE	20	20	20	40	40	40			15	15	15
ENGLAND	40	40					20	20	20	20	
HAWAII	15	20	20	20	40	40	40				15
INDIA							20	20			
JAPAN							20	20			
MEXICO	20	20	40	40	40	40			15	15	15
PHILIPPINES							20	20			
PUERTO RICO	20	20	40	40	40	40			15	15	15
SOUTH AFRICA									15	15	20
U.S.S.R.							20	20			

WESTERN UNITED STATES TO:											
GMT	00	02	04	06	08	10	12	14	16	18	20
ALASKA	20	20	20			40	40	40	40		15
ARGENTINA	15	20				40	40	40			15
AUSTRALIA	15	20	20			40	40				15
CANAL ZONE			20	20	20	20	20	20			15
ENGLAND										20	20
HAWAII	15	20	20	40	40	40	40				15
INDIA							20	20			
JAPAN	20	20	20				40	40	40		20
MEXICO			20	20	20	20	20	20			15
PHILIPPINES	15						40			20	
PUERTO RICO			20	20	20	20	20	20			15
SOUTH AFRICA										15	15
U.S.S.R.							20				
EAST COAST		80	80	40	40	40	40	20	20	20	

MARCH 1994						
SUN	MON	TUE	WED	THU	FRI	SAT
		1 G	2 G	3 G	4 G-F	5 F
6 F	7 F-G	8 G	9 G	10 G-F	11 F	12 F
13 F-G	14 G	15 G	16 G-F	17 F	18 F-G	19 F
20 F-P	21 P-F	22 F-G	23 G	24 G	25 G	26 G
27 G	28 G	29 G	30 G-F	31 G-F		



**NEW**

"What a great field radio. Mobile, too! I couldn't afford an HF rig until now.."

"What a great price! Terrific features, high performance – and within my budget."

"Yaesu did it again!"



## FT-840 Compact HF Transceiver

- Direct Digital Synthesis (DDS)
- Frequency coverage:  
RX: 100 kHz-30 MHz  
TX: 160-10 m
- IF Shift
- 100 Memory Channels (Independent TX/RX per memory)
- Twin Band Stacking VFOs
- FM\* Repeater Operation Automatic 10-Meter Repeater Offset w/Selectable CTCSS Encode
- CW Reverse Feature
- Choice of Two Optional Antenna Tuners:  
FC-10 Matching External Antenna Tuner  
FC-800 External Remote Antenna Tuner
- **Accessories:**  
Contact your Dealer for full details.
- \* Optional

# It's a small price to pay for such a wealth of features.



If you're trading up from an older rig, but have a budget, you want the most you can afford in top-notch HF. Then the FT-840 is for you. It's right on the money! Considering a mobile HF or field radio and doubt the quality and features of tiny HF rigs? Then the FT-840 is for you. It won't disappoint you!

Built to handle rigorous field operation, the new intense LCD display affords sharp visibility in bright sun-

light. Die-cast heat sink and internal thermally switched fan keep the FT-840 running cool. Modular design circuit boards ensure operating efficiency – manufacturing excellence you'd expect in much higher priced radios.

For high performance, the FT-840 features a low noise front end that uses the latest in FET RF amplifier design. Two DDSs and magnetic encoder for silent, smooth tuning and fast switching. Twin band-stacking VFOs. And,

automatic 10-m FM (optional) repeater offset with selectable CTCSS. Even two optional external antenna tuners to customize your rig.

Top of the line quality and features at a remarkably low price. Just what you'd expect from Yaesu! For high-tech performance, and a wealth of features that won't break your budget ask your dealer about the FT-840.

# YAESU

Performance without compromise.™



# You Asked for It, And Kenwood Delivers!

**NEW  
TS-60S:**  
Super Compact,  
90W, 6 meter  
Transceiver

**TS-50S:**  
Super Compact  
100W, HF  
Transceiver

## Features

- 100W (TS-50S), 90W (TS-60S) on 5SB, CW, FM modes, 23W on AM mode
- 100 memory channels
- DDS (Direct Digital Synthesizer) with fuzzy logic control
- Large LCD panel with digital bar meter
- Auto-mode capability
- Menu system selects custom operating features
- AIP (Advanced Intercept Point) for increased receiver dynamic range
- Switchable AGC Circuit (SLOW/FAST)
- All-mode squelch
- CW reverse mode
- Full break-in and semi break-in
- 20dB attenuator
- Relay & ext. ALC terminals
- Multi-function microphone supplied
- Auto power off function
- 3-position RF output power control
- Optional 500Hz CW filter (YK-107C)
- Optional AT-50 external antenna tuner (TS-50S only)
- Optional computer interface (IF-10D)

Meet the new set of twins from Kenwood -- The TS-60S all mode, 6 meter, 90W transceiver, and the TS-50S all band, 100W HF transceiver with general coverage receiver. Due to the amazing response to our super compact TS-50S transceiver, we have come up with a companion 6 meter transceiver in the same package, the TS-60S. Compact enough to mount in a vehicle or take into the field, both models provide desktop power and such sophisticated features as 100 memory channels, microprocessor controlled Direct Digital Synthesis (DDS) with innovative "fuzzy logic" control, and Kenwood's own AIP for superior dynamic range. There's also IF shift and CW reverse mode for interference reduction, TF-SET, and a noise blanker - plus everything you need for split - frequency operations. The menu function enables you to customize and select operating features to suit your individual needs.

TS-50S and TS-60S -- the new set of twins from Kenwood. Innovative, rugged, super compact - choose one for your shack, mobile, or portable operations today!



KENWOOD COMMUNICATIONS CORPORATION  
AMATEUR RADIO PRODUCTS GROUP  
P.O. BOX 22745, 2201 East Dominguez St., Long Beach, CA 90801-5745  
KENWOOD ELECTRONICS CANADA INC.  
6070 Kestrel Road, Mississauga, Ontario L5T 1S8, Canada

93ARD-0840

The TS-60S has not been approved by the Federal Communications Commission. This device is not, and may not be, offered for sale or lease, or sold or leased until the approval of the FCC has been obtained.

# KENWOOD