

# AMATEUR RADIO

# 73

May 1963  
An Insignificant  
40¢

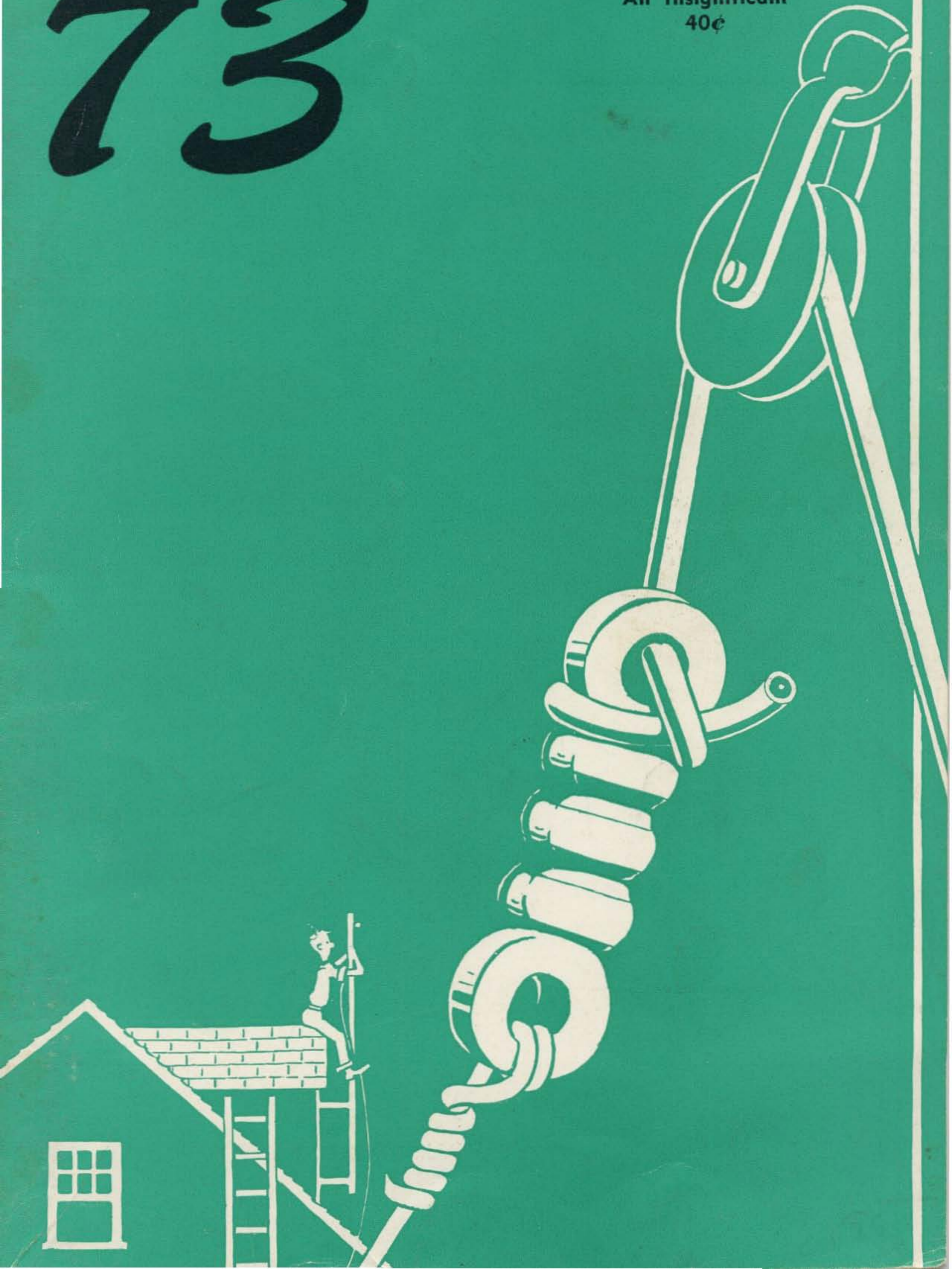



# "S" SERIES

## AUDIO & POWER TRANSFORMERS & REACTORS For Complete Ham Systems

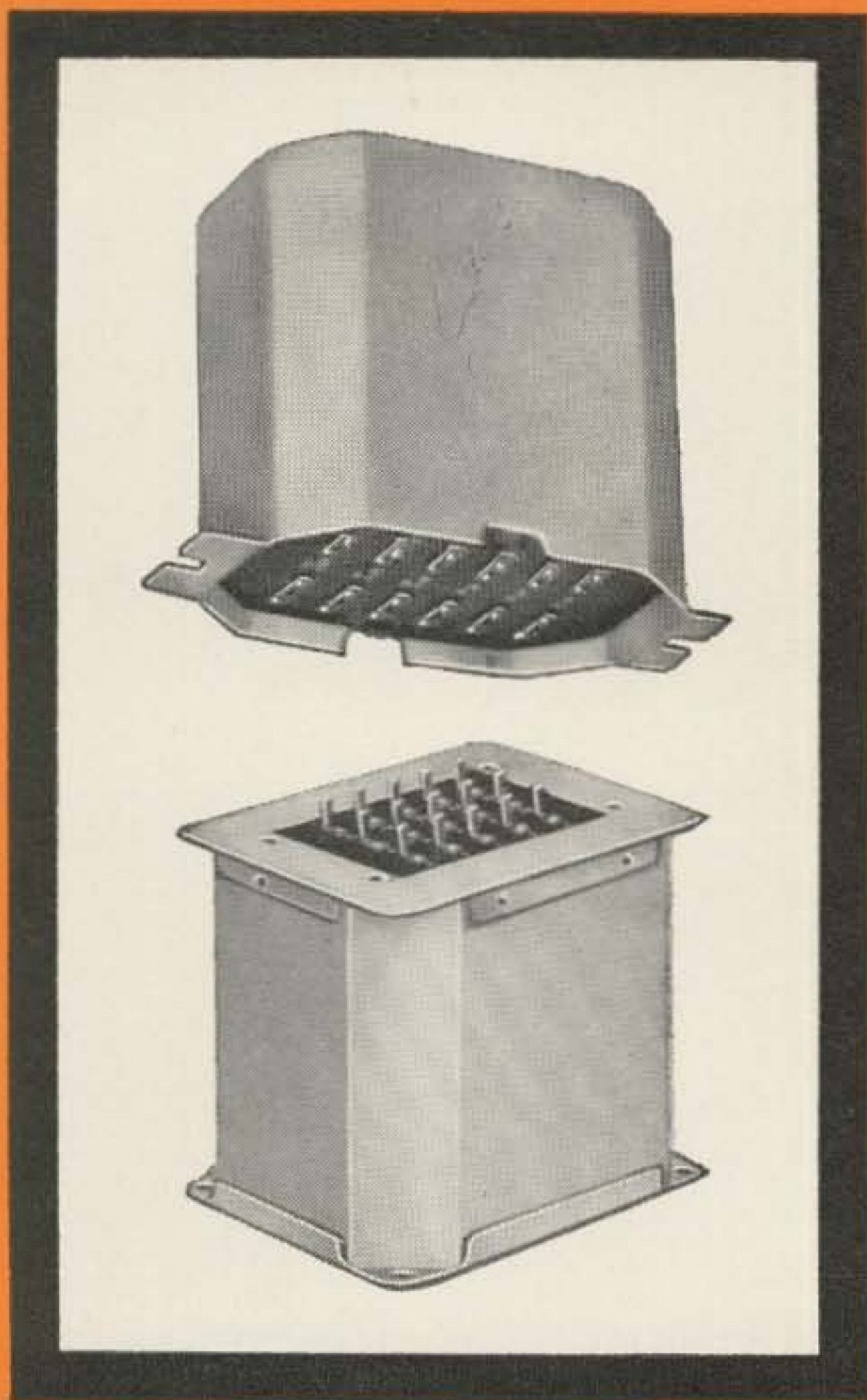

**Popular Priced  
Matched Components  
for  
Power Supplies  
Modulation  
Pre-Amp &  
Power Amplifiers  
... for entire ham rigs**

Thirty years of attention to ham requirements have resulted in a complete line of reliable, high quality components geared especially to your needs. The "S" series of audio and power transformers and reactors, designed specifically for ham and PA service, are completely matched for compatibility in constructing a rig. These are popular priced units which afford the ham the full benefits of UTC's established excellence for quality components coupled with high reliability.

Write for catalog of over  
1,000 STOCK ITEMS



### UNITED TRANSFORMER CORP.

150 VARICK STREET, NEW YORK 13, N. Y.

PACIFIC MFG. DIVISION: 3630 EASTHAM DRIVE, CULVER CITY, CALIF.  
EXPORT DIVISION: 13 EAST 40th STREET, NEW YORK 16, N. Y.

CABLES: "ARLAB"

Wain Green, W2NSD/1  
Editor, etcetera

May, 1963

Vol. XIV, No. 5

Cover:  
Bob Kelly, K2VLO

Six Meter Transceiver .....	K3NHI	8
Cute little five transistor hand-held unit. Parts kit available.		
6DJ8/ECC88 Converter .....	WA2HVK	11
Six meters down to 14 mc using really hot front end tube.		
Simple T-R Switch .....	W4MLE	12
For the CW man who wants full break-in without TVI.		
All Band Linear Kilowatt .....	W2LPC	16
Using the new Amperex 8179 you've been reading about.		
Reducing Receiver Noise .....	Gabus	24
Read this one, it is really important . . . no kidding.		
The Mark IV .....	K2HQY	30
Nice six meter rig, 6146 final.		
Multi-channel Pre-amp .....	W9CWG	38
Feed several rigs from one mike and preamp.		
A Challenge to the Antenna Experimenter .....	W4AZK	42
Quads: tri-band, five band, two-three-four element, etc.		
Panoramic Spectrum Analyzer .....	W $\phi$ BMW	52
Build your own.		
Shielding the Breadboard .....	W1ISI	58
Some ideas on neat breadboarding.		
Coax Folded Dipole .....	W3HJR	62
Broad bands things.		
Getting into Electronics .....	W6JAT	66
It's a good business too.		
Selected Circuits .....	W4WKM	71
Altec Lansing Modular transistorized audio components.		
Diode Modulators .....	Staff	74
BIG technical article.		
73 tests the Knight-kit P2 .....	K6UGT	80
A new SWR meter kit.		

73 Magazine is published monthly by 73, Inc., Peterborough, N. H. The phone number is 603-924-3873. Subscription rates are still abysmally low at \$3.50 for one year, \$6.50 for two years, and \$9.00 for three years in North America and U.S. possessions. Foreign subscriptions are \$4.00 per year. Second class postage is paid at Peterborough, New Hampshire and at additional mailing offices. Printed in the U.S.A. Entire contents copyright 1963 by 73, Inc. Postmaster: please send form 3579 to 73 Magazine, Peterborough, New Hampshire. Readers should stop reading the fine print and stick to the articles and editorial.

Good as New .....	10	Letters .....	51
Viking Challenger .....	28	I'd like to see .....	55
Foreign Subs .....	34	Homebrew .....	65
Vibroplex Bugs .....	40	73 Tests Compre Amp .....	86
Knockout Punch .....	41	Letters, more .....	88



de W2NSD

Never say die

### Notice to ARRL Members

It is now obvious that QST is going to keep beating the drums for their building fund until you all pay up. If you'd send in the money then QST could get back to their detailed operating news reports. After all, Egypt has its pyramids and China has its wall, so why shouldn't we have our ARRL Skyscraper? Get with it fellows; you joined the ARRL, now support it in its time of crisis. Of course this won't stop you from needling them a bit by marking your check out to the ARRL BUILDING FUND (73 WING). Send it to ARRL, West Hartford 7, Conn. Save just a little in case we get too jealous of the new building and have to have a shanty fund for 73 (we'd never be able to get enough for a building).

### 73 Parts Kits

My introduction of parts kits for our simpler construction projects back in March brought on mixed reactions. The readers wrote in complimenting us on the move. Some even went so far as to order kits, though not many. Remembering how long it took the Bookshop to build up steady orders I was encouraged that even twenty kits should be ordered the first month.

CQ, in an attempt to hurt us with the parts distributors, where my latest figures show we are outselling CQ by better than two to one, sent out a letter viewing the 73 kits with great alarm and worrying that we might shortly put parts distributors out of business. Though their intent was unfriendly, the result was very helpful for CQ's hysteria made many parts distributors aware of our kits and they were thus more disposed to go along with us on handling the parts kits through their companies.

It was obvious from the first we would not be able to finance more than a short test of the kit idea. You see, keeping our subscription rates and advertising rates very low keep us from making any money, so if something costs more than a few hundred dollars we have to forget it. The kit program won't make any money for anyone for a long time and I doubt if I could have convinced many parts distributors (or *any*) to participate without CQ's attack.

Now that we are getting better organized with the kits we will be looking into our back issues for good kit projects and will try to work up a good comprehensive kit list for you to select from.

### April Cover

Old timers probably got a kick out of our April Fool cover last month. I am happy to report that the HQ gang seemed to enjoy it . . . see, they're not as stuffy as you thought. I did consider doing a parody of CQ, but couldn't think of anything funnier than they have now so turned my attention to QST.

### Small Issue

We had planned upon running 128 pages again this month, but several factors interfered. For one thing the cost of running the 128 pages last month was considerably higher than had been estimated. Then I was laid low by a cold at advertiser harassment time and didn't get quite as many ads this month as I could have. And finally, Virginia, who does most of the work around here, had to take a couple of days off to have a baby. Next month we're going to have a really big issue, so wait it out. (It's a girl.)

(moron 4)

*New!*



HE-80WX

**139<sup>50</sup>** NO MONEY DOWN



KT-390

**69<sup>50</sup>** NO MONEY DOWN

*New!*



HE-45-B

**119<sup>95</sup>** NO MONEY DOWN



HE-30

**89<sup>95</sup>**

NO MONEY DOWN

# LAFAYETTE RADIO

## QUALITY AMATEUR GEAR SINCE 1923

**INVITATION:** Stop in at any of our locations and visit our fully stocked **HAM SHACKS** — **FREE DEMONSTRATIONS** without obligation. Lafayette carries a complete line of famous brand amateur equipment and accessories.

### 1. NEW LAFAYETTE HE-80 Professional Quality 14-Tube Amateur Communications Receiver

- 5 Bands: 550KC to 54MC • Extra RF Stage, Mixer/OSC For Dual Conversion on 6-Meters • 1 RF Plus IF Stages for High Gain Reception on all other Bands • Product Detector Circuit for Improved SSB Reception • Separate BFO and Q-Multiplier Circuits (can be used simultaneously) • Crystal Calibrator for Checking Receiver Calibration Markings • Improved Automatic Noise Limiter • Voltage Regulated Power Supply

Designed for Today's Congested Amateur Bands

### 2. **STARFLITE**<sup>T.M.</sup> 90 WATT PHONE and CW TRANSMITTER KIT

- 90 Watts Phone or CW on 80 Thru 10 Meters • Built-in 3-Section Low-Pass Filter • Clear, Chirpless, Grid Block Keying

Dollar for dollar you can't beat this new Lafayette Starflite transmitter. Easy to build and operate, it glistens with quality and performance all-over.

### 3. LAFAYETTE HE-45-B DELUXE 6-METER TRANSCEIVER

- High Efficiency—Up To 100% Modulation • New Modulation and Power Transformers plus 7868 Power Pentode • New Heavy-Duty Communications Vibrator • Front Panel Antenna Loading Controls • New Standby Switch; VFO Power Jack • Sensitive Superheterodyne Receiver • Built-in 117 VAC and 12 VDC Power Supplies • Rugged Push-to-Talk Ceramic Microphone

#### LAFAYETTE HE-50A 10-METER TRANSCEIVER

Similar to above except for 10-meter operation **89.95**

### 4. THE LAFAYETTE HE-30 Professional Quality Communications Receiver

- Tunes 550 KCS to 30 MCS in Four Bands • Built-in Q-Multiplier for Crowded Phone Operation • Calibrated Electrical Bandsread on Amateur Bands 80 Thru 10 Meters • Stable Oscillator and BFO for Clear CW and SSB Reception • Built-in Edgewise S-Meter

Sensitivity is 1.0 microvolt for 10 db. Signal to Noise ratio. Selectivity is  $\pm 0.8$  KCS at -6db with Q-MULTIPLIER.

## LAFAYETTE RADIO ELECTRONICS



**FREE!**

CUT  
OUT

PASTE ON CARD

SYOSSET	JAMAICA	NEW YORK	BRONX	NEWARK
PARAMUS	PLAINFIELD	SCARSDALE	NATICK	BOSTON

LAFAYETTE RADIO DEPT. 73E-5  
P.O. BOX 10, SYOSSET, N.Y.

*Send me the FREE  
388 Page 1963 Catalog 630*

Name .....

Address .....

City ..... Zone ..... State .....

# 40 FT. CRANK-UP TOWER

At

# 68 MPH

\*At 40 Feet

USING A TRI-BAND  
10-15-20 METER BEAM

Assembled Weight—20 lbs.  
Wind Surface Area—4.9 sq. ft.  
Wind Load—86 lbs.  
Maximum Element Length—26'8"  
Boom Length—12'  
Turning Radius—14.9'

OR

# 148 MPH

with your Tri-Bander at 25'



\*Certified by Reg. Prof. Eng.

# \$119.50

Model 40-1

F. O. B.

WITH HEAD MOUNT PLANT

BRACKET MTG. KIT \$9.50

Tilts over on a heavy base plate for access to motor and array.

Horizontal bracing throughout.

Available from your local distributor, or direct from manufacturer.

**SUPREME  
ELECTRONICS  
INC.  
FRONT & MAIN STS.  
UPLAND, PENNA.**

## Europe!

The main topic of conversation around the 73 offices is the coming trip to Europe. Every time we hire a new employee we find them with their foot on the running board along about the second day on the job. Shirley, who is handling the subscriptions (and getting them straightened out pretty well, considering) is going to get her mother to substitute for her so she can go along. Pamela, our cute little bookkeeper, is already buying clothes for the trip.

The most worn books around here now are our old copies of "\$5 a Day in Europe" (the new edition is due any day now) . . . \$1.95 from Bookshop. Lee Gunther W6THN/1 of the Ham Hop Club has been dropping letters to the tourist bureaus for the countries we are going to be visiting and as a result we have been inundated with interesting literature about these countries, maps, history, etc.

We'll be visiting London, Paris, Geneva, Rome and Berlin. If you have to make just a short trip to Europe, these are the five most important places to see. The trip starts October 6th from Idlewild via Sabena and lands in London the morning of the 7th, Monday. We'll spend four days in each city, returning the 27th from Berlin.

In my past trips to Europe I've had the most fun staying at the second class hotels. These are immaculate and are where the bulk of the Europeans stay when they travel. They are usually less formal and you have a better chance to get to meet Europeans instead of Americans. Also it keeps the cost of your trip down amazingly. This makes it so we can fly the entire trip and have our hotel bills and breakfasts paid for much less than the usual tourist plane fare. For example, on this trip the plane fare normally would run \$630 round trip. Flying in a group and economizing on hotels we can make the entire trip, including all hotels and breakfasts, for \$550. Further, since we'll all be hams we'll all have a common interest which will make the trip a lot more fun than if we were all strangers.

I'm doing all I can to set up get-togethers in all of the cities we'll be visiting . . . but you can help by making a date with any DX ham you contact who can meet you there. If you get an invite to dinner accept it by all means for you will have a wonderful chance to get to know the foreign hams this way . . . and the people of that country.

This is not going to be an escorted tour . . . there will be no schedule for you to follow when you arrive in a new city. We'll give you

# FREE

# 1963 INTERNATIONAL CATALOG

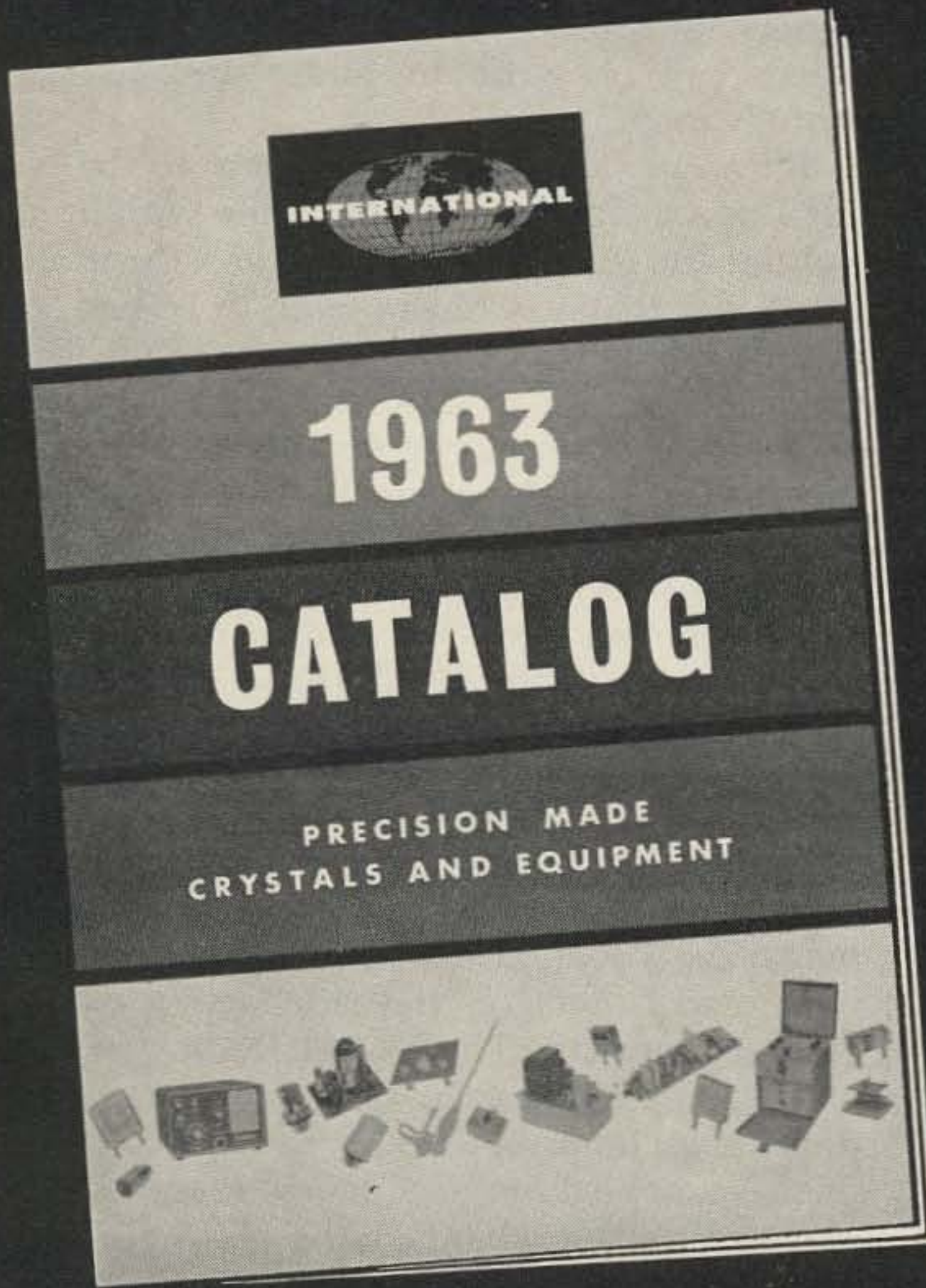

*... your buying  
guide for precision  
radio crystals  
and quality  
electronic  
equipment ...*

- Transmitters
- Amateur Crystals
- Citizens Band Crystals
- Citizens Band Transceivers
- Converters
- Transistor Subassemblies
- Converters
- Power Supplies
- Antennas
- Oscillators

**AMATEURS • EXPERIMENTERS • CITIZENS LICENSEES**

Mail coupon today for your FREE copy of International's 1963 catalog.

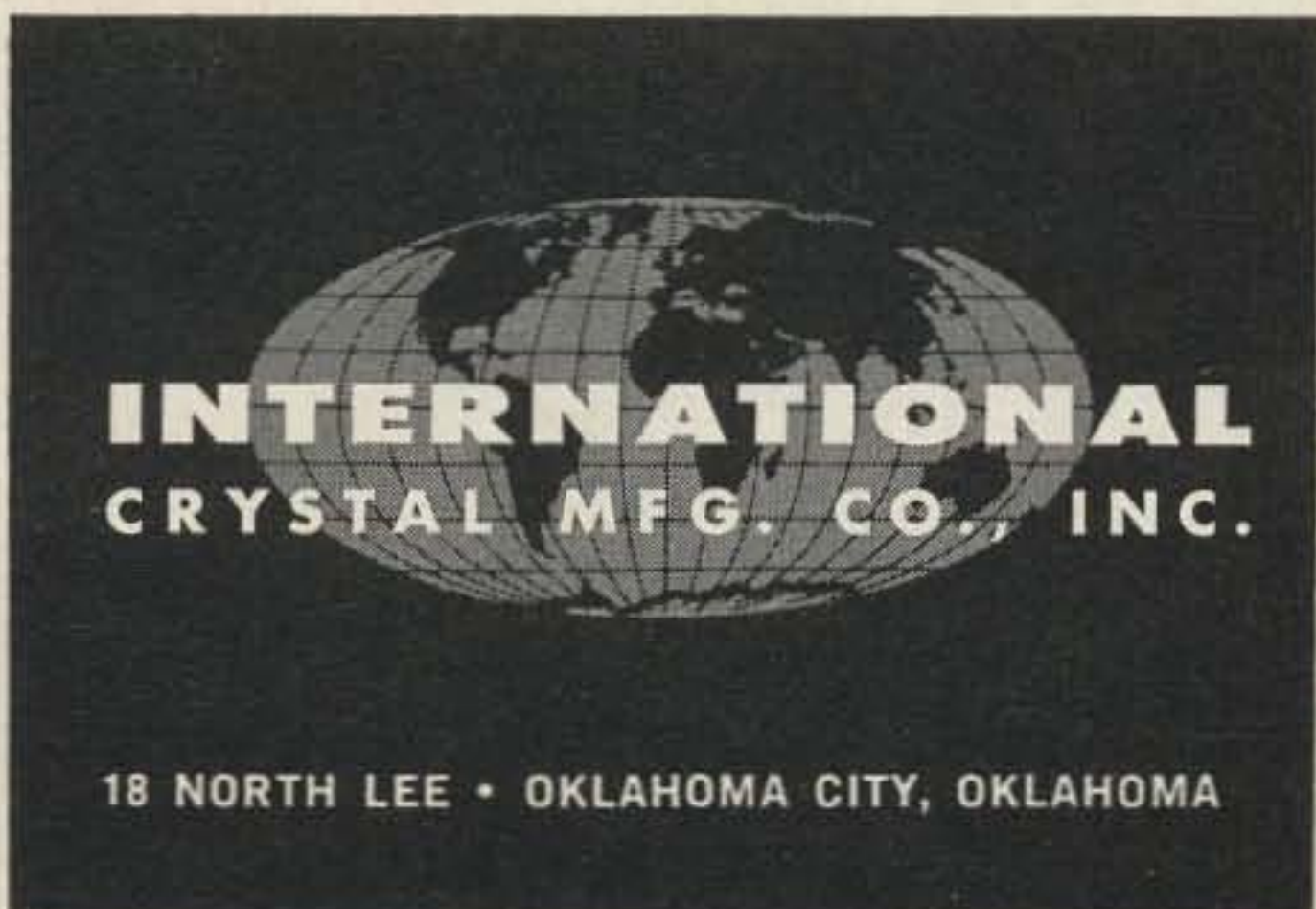

International Crystal Mfg. Co., Inc.  
18 North Lee, Oklahoma City, Okla.  
Rush FREE 1963 Catalog.

73M

Name \_\_\_\_\_

Please Print

Address \_\_\_\_\_

City \_\_\_\_\_ Zone \_\_\_\_\_ State \_\_\_\_\_

**"Sixty for Six"**

**WRK 6M at...** MODEL 60-46

**60 Ft. - NO GUYS!**

Here's a real cloud buster! 60 ft. of tower, E-Z Way quality, that will put you way out in front on 6 meters.

COMPLETE  
**2 Men - 2 Hours**  
INSTALLATION TIME

E-Z installation? You bet! This one goes up like a rocket. . . and it is only a two man job. All the space needed is one sq. ft. Crank up to 60 ft. and down to 21 ft.

**only \$199.50**  
Model BA-60-46P

Model	
BA-60-46G...	\$259.50
GP-60-46P...	264.00
GP-60-46G...	324.00

*If triband or 20 M operation is desired, this model may easily be converted to a Medalist "40"!*

**Freight prepaid anywhere 48 U. S. A.**

*For free information write Department "B"*

**E-Z WAY TOWERS, Inc.**  
P.O. BOX 5767 TAMPA 5, FLORIDA

(From four)

all the info we can on what is most interesting to see, and where the best reasonable restaurants can be found . . . plus anything else we can think of that will help make the visit more interesting.

One thing I guarantee: you'll have a wonderful time on this trip and never forget it as long as you live. Even if you have to borrow the money, splurge this once. One chap is selling his car so he and his wife can make the trip. We will have enough room for all comers until about mid May. After this time please call or write to make sure we have enough room.

Since we are obviously going to be well filled up on this trip and probably with a good waiting list for cancellations. Thus I can guarantee you that we will be able to refund your money should you be unable for some emergency reason not to make the trip. Send \$250 per person with your reservation, made out to the Institute of Amateur Radio. The balance will be due sixty days before the trip. This money is necessary for reserving planes, hotel rooms, busses, etc. See the editorial in the March 73 for more details. Send your reservation to 73, Peterborough, New Hampshire.

### Galaxy 300

In line with our policy of having a minimum of at least one major error per page of the magazine I would like to report that there were two beauts on the sideband transceiver chart last month. The World Radio Labs Galaxy 300 uses a crystal lattice system and not phasing as reported. Somehow we got the two lines scrambled on frequency range and the Davco was shortchanged the six meter band, which was donated to the Drake. Give six back to Davco.

### Next Month

We've got another big issue coming up in June. This one will be aimed at the 83% of our readers who try their hand now and then at surplus conversions and buying. Some of the articles scheduled (we may not be able to cram them all in) are: BC-348, AN/DMQ-2, BC-230/BC-430, ART-26, RT-91/ARC-2, ARC-5, R-48/TRC-8, BC-453, BC-455, RT-45/ARQ-1, T67/ARC-3, R105A/ARR-15, R-508ARC, BC-442, PE-97A, PE-201A, etc. In addition to all these articles we expect up to 20 pages of special surplus ads which will make one of the finest surplus catalogs you've ever used. This issue will be quickly sold out, so don't miss out . . . subscribe.

(Skips to page 57)



BRAND NEW FROM CLEGG LABS . . . THE

**POWER PACKED**

**THOR 6**

TRANSCEIVER FOR 6 METERS.



Come on up out of the noise . . . let 'em know you're around! For contests, marginal openings or just overriding the Qrm . . . your new sixty watt, VFO controlled, 100% high level modulated THOR 6 transceiver makes you the "Voice of authority" on six . . . and what's more you'll hear them too! The receiver section with its crystal lattice filter, is selective to the nth degree and so sensitive that even S1 signals are Q5. Sound good? Here's the rest of the story.

**TRANSMITTER FEATURES:**

- FULL 60 watts input on phone or CW to 6883 final.
- BUILT-IN VFO that automatically tracks the receiver or switches to crystal control for fixed frequency operation.
- ALL stages broadbanded for easy QSY.
- SPEECH-CLIPPING FOR MAXIMUM talk power.
- BUILT-IN PUSH-TO-TALK.
- BUILT-IN Keying relay for clean chirpless keying.

**MOBILE OPERATION**

Now you can run a mobile "power house" using the new Clegg Model 418 transistorized 12V DC power supply/modulator unit to power your THOR 6 transceiver.



**RECEIVER FEATURES:**

- NUVISTORIZED front end for extreme sensitivity at lowest noise level.
- CRYSTAL lattice filter for maximum selectivity.
- BFO with variable carrier injection for SSB reception.
- ULTRA-STABLE tuneable local oscillator that also functions as VFO for transmitter.
- EXCELLENT audio characteristics. 2 watts into 3.2 ohm speaker.
- Sharp reduction in spurious responses and cross modulation.
- Effective noise limiter.

The THOR 6 is of two unit construction with attractively styled receiver and transmitter rf section mounted in one cabinet for convenient desk top operation. The power supply/modulator section is mounted in a second cabinet for remote location. A ten foot interconnecting cable is provided.

Amateur net price for AC operation \$349.95. 12V DC Mod./Pwr. Sup. \$100.

**COMING IN APRIL - SSB - THE VENUS 6**

**LABORATORIES**

DIVISION OF TRANSISTOR DEVICES, INC.

RT. 53, MT. TABOR, N. J. • OAKwood 7-6800

See your Distributor  
or write for information.



# Six Meter Ultra-Midget Transceiver

*73 Parts Kit Available*

Robert Kopski K3NH1  
Philco Corporation  
Lansdale, Pennsylvania



The new Philco MADT transistors, though inexpensive, have brought about a minor revolution in VHF equipment and permit, for the first time, really miniature equipment to be constructed. Two of the transceivers shown here were made to illustrate this application. The unit uses five transistors in a superregenerative receiver and crystal controlled transmitter and modulator.

While not designed for the DX'ing crowd on six meters, this little gadget has received over an 80 mile path using an inside dipole. The more usual range is about a half mile between two identical units using built-in whips. Considering the simplicity of the rig it is difficult to imagine why any amateur who occasionally travels wouldn't pack one of these little gems in his suitcase so he could get in touch with local hamdom.

## **Circuit**

Q1 is a single transistor superregenerative

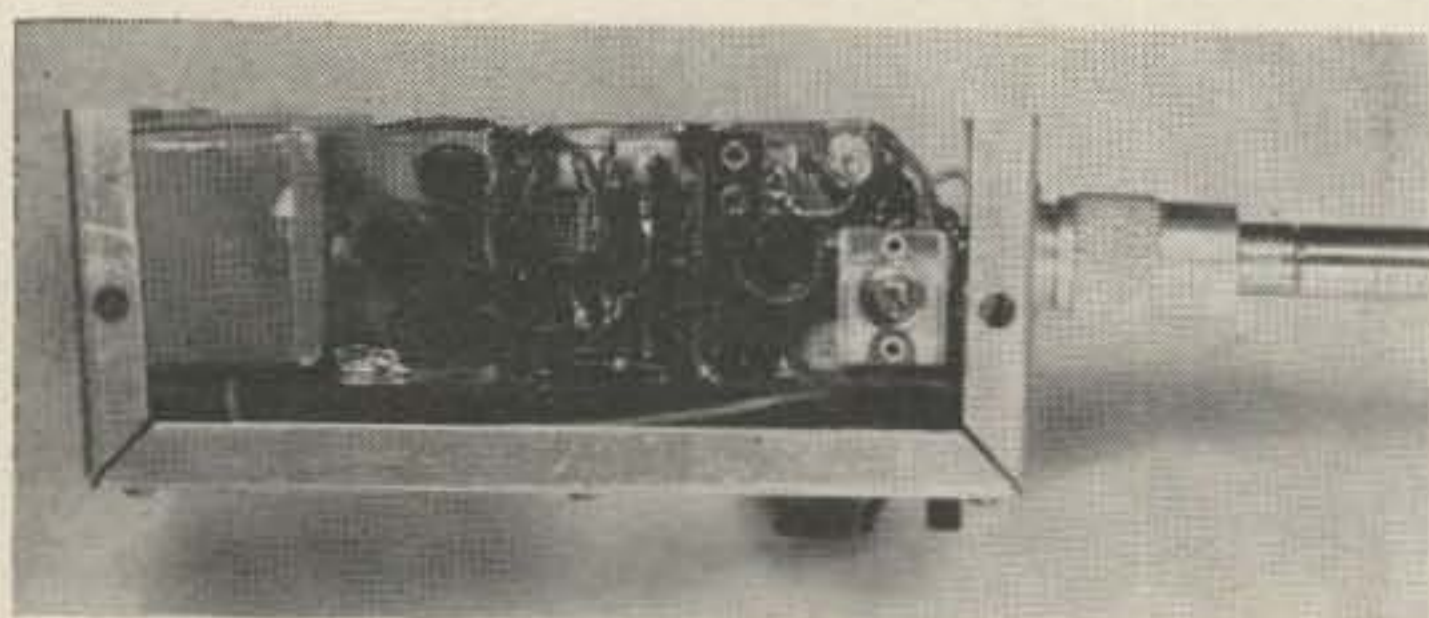

receiver! Perhaps just a word should be put in here in support of this type of receiver. Heath uses this in their Sixers for the circuit is not only extremely simple, but very sensitive. It takes quite a superhet to do better on sensitivity. Selectivity suffers, and you can have some real problems if a very strong signal comes on near your frequency.

The detector is reflexed in that detected audio is fed back to the base of Q1 through C2 and is amplified. The operating point of Q1 is established by R1, R2, R3 and R4. R4 controls the regeneration. Tuning is achieved by varying C5. C7, C8 and R5 form a low pass filter to prevent the quench signal from overloading the audio section.

The transmitter uses two transistors, Q2 a fifth overtone oscillator and Q3 the final class C amplifier running a mighty 50 mw input. The output is on the order of 25 mw, down somewhere in the microbe-power division.

The audio/modulator uses two transistors, RC coupled, and a permanent magnet speaker which doubles as a dynamic mike. The receiver output transformer primary is used as a choke for Heising modulating the final on transmit, giving a healthy 90% modulation. Neutralization of the final might permit slightly higher modulation. The D1-C21 circuit prevents high voltages from the Heising choke

from damaging Q5.

A four-pole-double-throw switch transfers all the circuits. Power is supplied by the usual 9 volt battery. In this unit a 5¼" x 3" x 2½" aluminum minibox was used and the circuit was mounted on a piece of double-sided copper-clad printed circuit board. The double-sided board acts as a fine shield between the audio and rf circuits. This board is excellent construction material for it is easily cut, drilled and soldered to. Shields can be soldered to it, making an extremely rigid assembly.

The whip antenna was mounted using a coax connector (photo) so that other antennas could easily be connected for better DX. The whip can easily be permanently mounted on a plexiglass or micarta mounting plate.

### Tune-Up Procedure

The tune up procedure is straight forward. With S5 on, receiver regeneration control R<sub>4</sub> is adjusted for a strong rushing sound in the speaker. Final trimming of R<sub>4</sub> is best achieved while listening to an incoming signal. Capacitor C<sub>3</sub> may be adjusted slightly for bandsetting, and tuning capacitor C<sub>5</sub> should cover 2 megacycles of the six meter band. Quieting of the

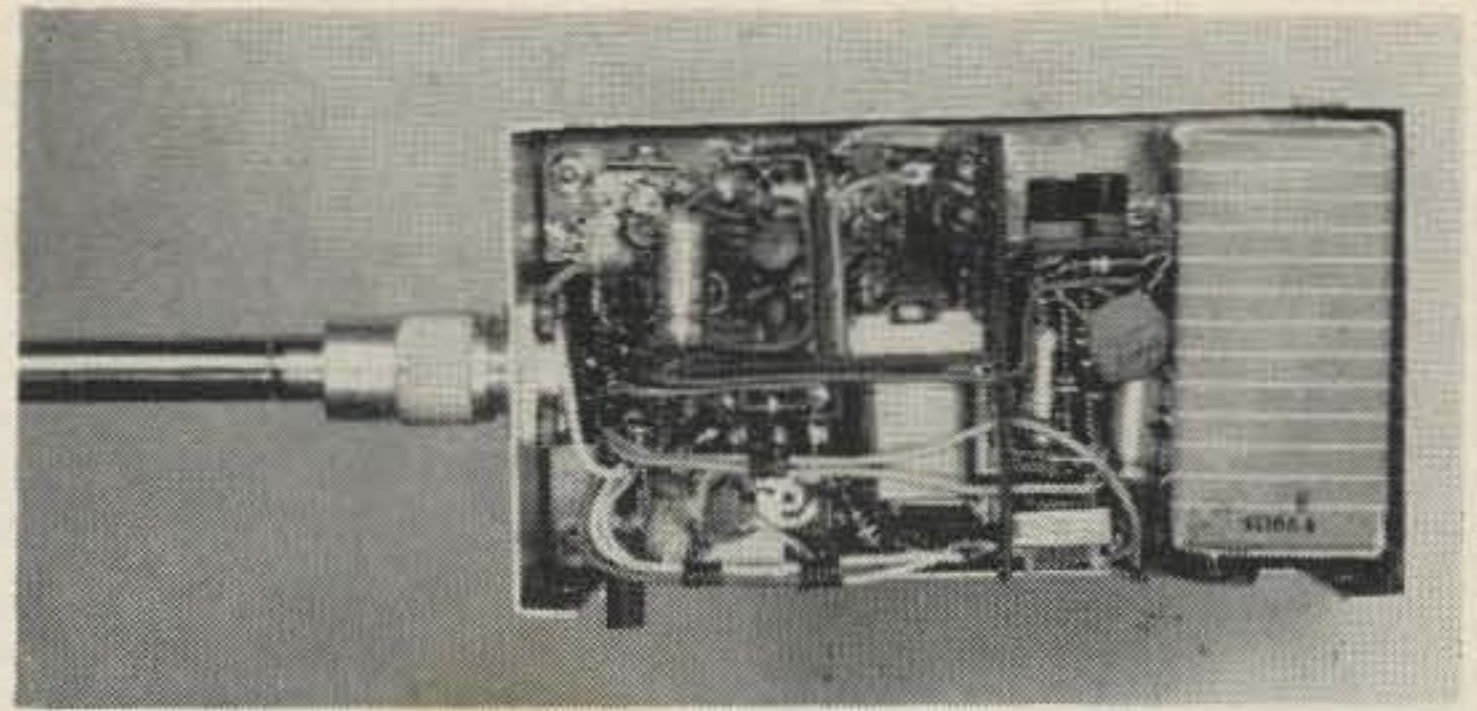

rushing sound should occur with an incoming carrier.

Transmitter tune up is also straight forward. The oscillator and final tank circuits can be initially set with a grid dipper. With S5 on, depressing the push to talk switch should cause immediate operation of the transmitter. Transmitter operation can be checked with a grid dipper, a field strength meter, or another receiver. If the oscillator fails to start when the push-to-talk switch is depressed, adjust C<sub>11</sub> until it does so. Final transmitter adjustment is best achieved with the antenna fully extended and the case closed and held steady on a table with one hand. With a field strength meter nearby, adjust C<sub>11</sub>, C<sub>15</sub> and C<sub>16</sub> for maximum output. Check to make sure the oscillator

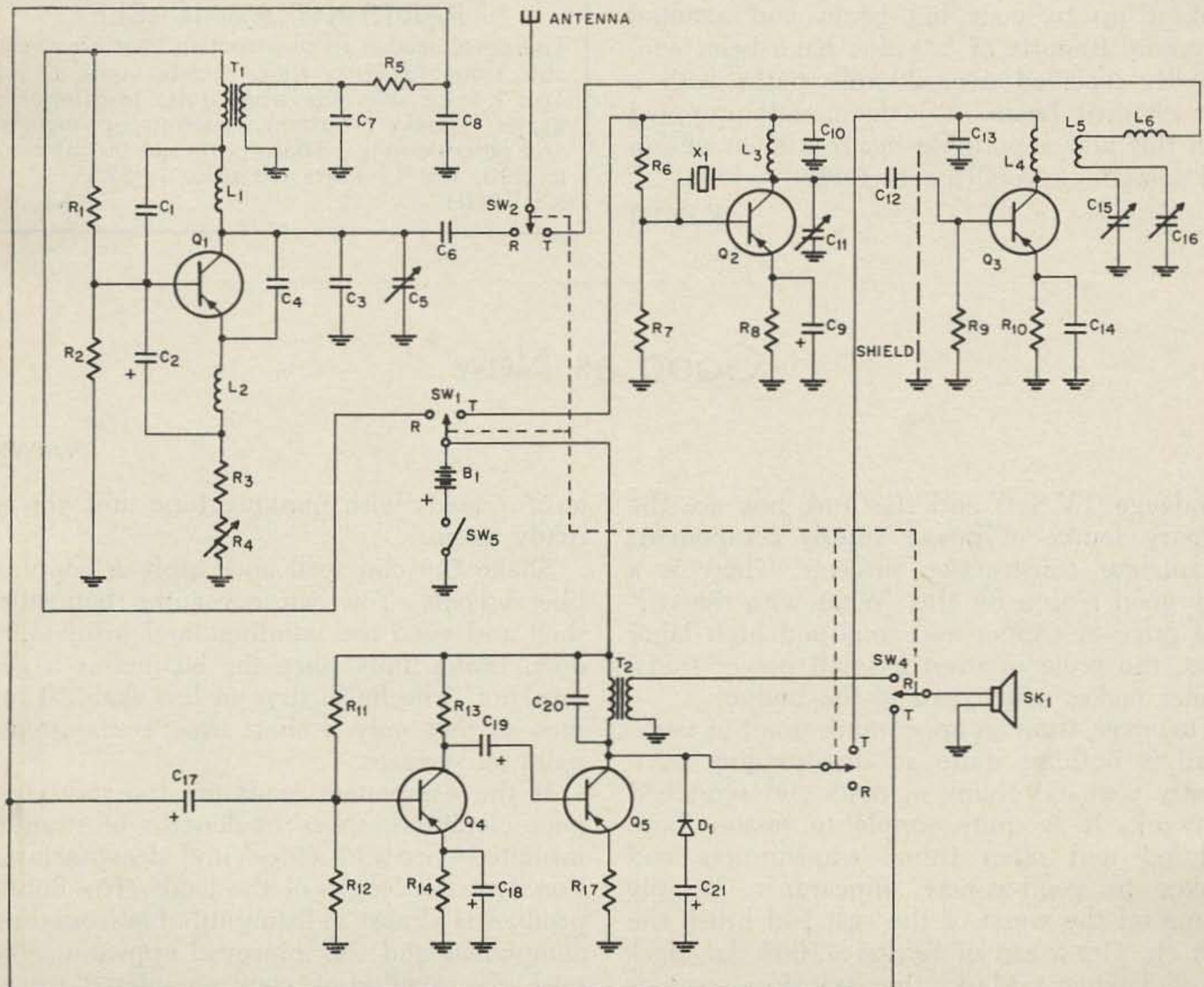

add 2 resistors from junction C19-Q5 R 15 to junction C20-R 13 and R 16 to ground

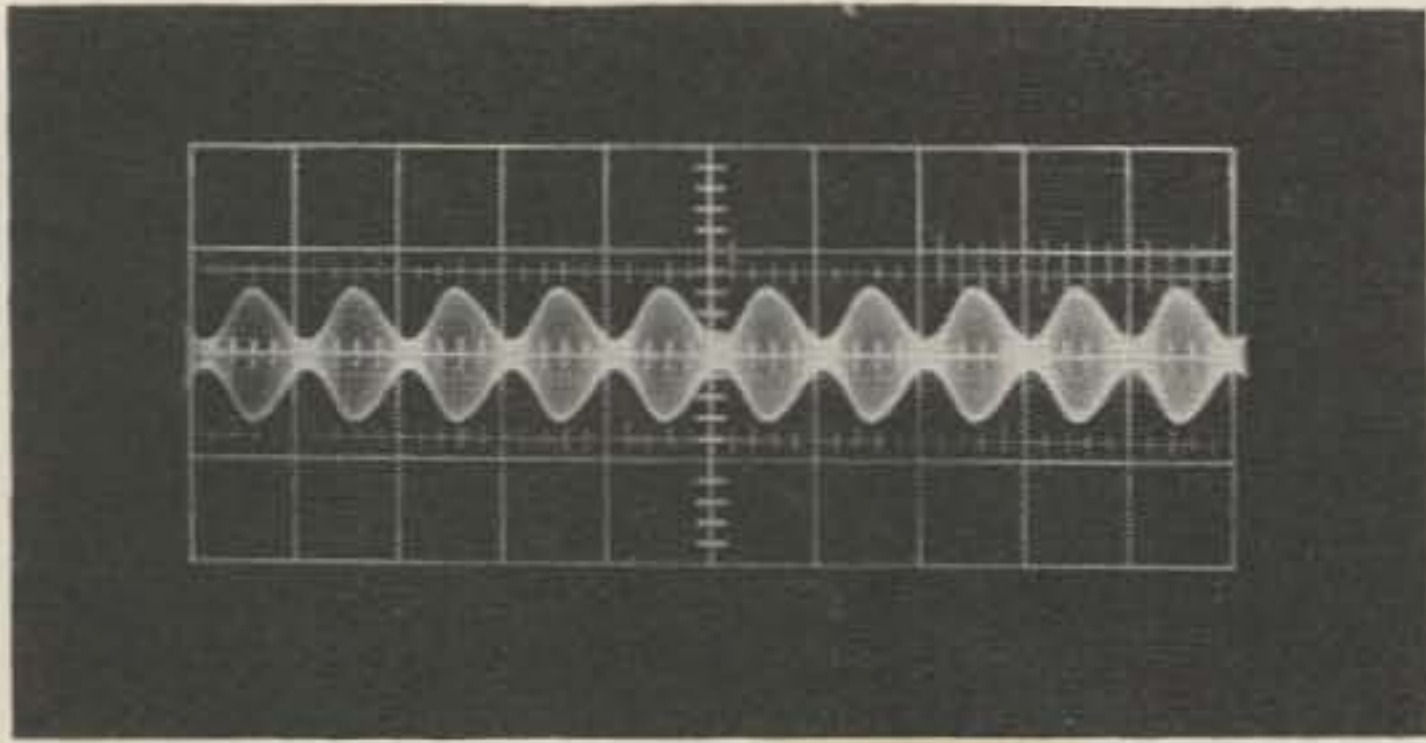

Actual photo of the transmitter output modulated with a whistle and observed with a 100 mc scope. Note relatively clean envelope.

starts easily by depressing the push-to-talk switch several times. It should start each time. If it does not, back off on C<sub>11</sub> slightly. Check for modulation by listening with another receiver. The signal should be crisp and clear. It is not necessary to hold the "mike" close or shout. Normal talking four to six inches from the "mike" should permit full modulation.

These little transceivers are a lot of fun, whether you pull them out at the local ham club meeting, talk all around conventions, meet hams in towns you are visiting, or even hook it up to your big beam and astound everyone. Reports of 5-9-plus have been consistently received over 20-mile paths with a four element beam. A little mountaintopping with this and a portable beam is a lot of fun and something you'll never forget.

. . . K3NHI

Table I

Receiver: dc input current	15	ma
Osc: dc input current	4.5	ma
dc input power	40	mw
Final: dc input current	6	ma
dc input power	50	mw

Parts List

(1/2 watt carbon)	C16—280 mmfd trimmer
R1—39,000	C17—30 mfd 10v
R2—12,000	C18—30 mfd 10v
R3—2200	C19—30 mfd 10v
R4—5000 pot	C20—.01 mfd 50v
R5—3900	C21—30 mfd 25v
R6—10,000	Q1, Q2—2N1499A
R7—1000	Q3—2N1749
R8—100	Q4, Q5—2N2374
R9—1200	D1—1N34A or equiv.
R10—22	SKI—2 1/2" 3.2 ohm speaker
R11—220,000	X1—6 meter 5th overtone
R12—10,000	HC6U type
R13—3900	ANT—52" telescopic antenna
R14—100	L1—10 turns 3/8" i.d. #16
R15—47,000	enam
R16—4700	L2—6.8 uh rfc
R17—22	L3—8 turns 3/8" i.d. #16
C1—100 mmfd	enam
C2—2 mfd 10v elect.	L4—8 turns 3/8" i.d. #16
C3—10 mmfd	enam
C4—6.8 mmfd	L5—2 1/2 turns #20 hook up
C5—15 mmfd MAPC var.	wire over L4
with 4 plates removed	L6—9 turns #20 plastic hook
C6—4.7 mmfd	up wire 1/4" i.d.
C7—.01 mfd	T1—Calrad CR60 20K-1K or
C8—.05 mfd	equiv.
C9—.002 mfd 50v	T2—Calrad CR40 1.2K—3.2
C10—.01 mfd 50v	ohms or equiv.
C11—4-30 mmfd trimmer	B1—9v Battery, Everready
C12—15 mmfd	#246 or equiv.
C13—.01 mfd 50v	SW—4 PDT push-to-talk
C14—.01 mfd 50v	switch, Lafayette SW92
C15—4-30 mmfd trimmer	

PARTS KIT AVAILABLE

The parts needed to construct this kit are available from 73 Parts Kits, Peterborough, N. H. This kit includes the transistors, transformers, diodes, speaker, battery, resistors, condensers and potentiometer. These parts net out at close to \$30, the 73 Parts Kit price is \$25. Kit K3NHI-1 . . . . . \$25.00

Good as New

W4WKM

Salvage TV sets and the junk box are the primary source of power supply components in amateur construction projects. There is a very good reason for this. What with the current price of copper and steel and high labor costs, the price of even a small power transformer makes a big dent in the budget.

However, from an appearance point of view, there is nothing quite so discouraging as a twenty year old chunk of rusty and scratched ironwork. It is quite simple to restore both inclosed and open frame transformers and chokes to good-as-new appearance. Simply scrape off the worst of the rust and brush the dust off. Get a can of Krylon #1602 flat black spray lacquer. Mask the transformer lugs

and/or leads with masking tape and you are ready to go.

Shake the can well and apply a couple of liberal coats. You can cover the laminations shell and even the windings and insulation of open frame units since the lacquer is a good insulator. The finish dries in less than 10 minutes so that only a short time is required to paint all surfaces.

If the component leads are too short or in poor condition, splice on lengths of stranded, insulated wire and slide Vinyl sleeving insulation over the length of the leads. The finished product is almost indistinguishable from a new component and the improved appearance will raise the quality of your completed project.

# A 6DJ8/ECC88 Converter for Six

*Parts Kit Available, too!*

Bill Pasternak WA2HVK  
1525 West 8 Street  
Brooklyn 4, New York

In November of 1960, 73 published an article on improving the sensitivity and the signal to noise ratio of the Gonset Communicator III by replacing the 6BZ8 front end tube with a newly developed dual triode called the 6DJ8/ECC88. As a matter of fact virtual step by step instructions were given at that time to make this simple conversion. Anyone who did it realized an improvement in their equipment right away. Hence, you would think that this tube would be a natural for a converter article, but as fate would have it about this time RCA developed the Nuvistor, and a whole new trend in converters was started. Though many articles appeared using Nuvistors, the poor little 6DJ8 was all but forgotten. This held true until about a year ago when Clegg Labs brought out the now famous 99'er (see May 1962 73) and chose the 6DJ8 for the front end. After owning and operating one of these transceivers for about five months, I realized that they had made a good choice in the 6DJ8.

Since it had been about a year and a half since the last was heard of this tube it appeared that no one had taken the incentive to design a converter around this tube, so I did.

## Construction

Basically this converter is quite similar to many others recently described. It is built on one half of a 2¼ x 2¼ x 5 Bud Minibox with the other half being used as the bottom cover. The 6DJ8 is used in a cascode circuit with neutralization being accomplished by R<sub>1</sub>, a 12 to 25 ohm resistor and a shield plate that bisects the socket of V<sub>1</sub>. The antenna is link coupled to the grid of the first section of the cascode amplifier as is the output of the amplifier to the mixer. This breaks a long standing trend toward capacitive coupling because of its ease of construction and lower cost. Although a little more difficult to construct, this system affords excellent image rejection and very good passband characteristics. In addition, because of the excellent isolation between the input

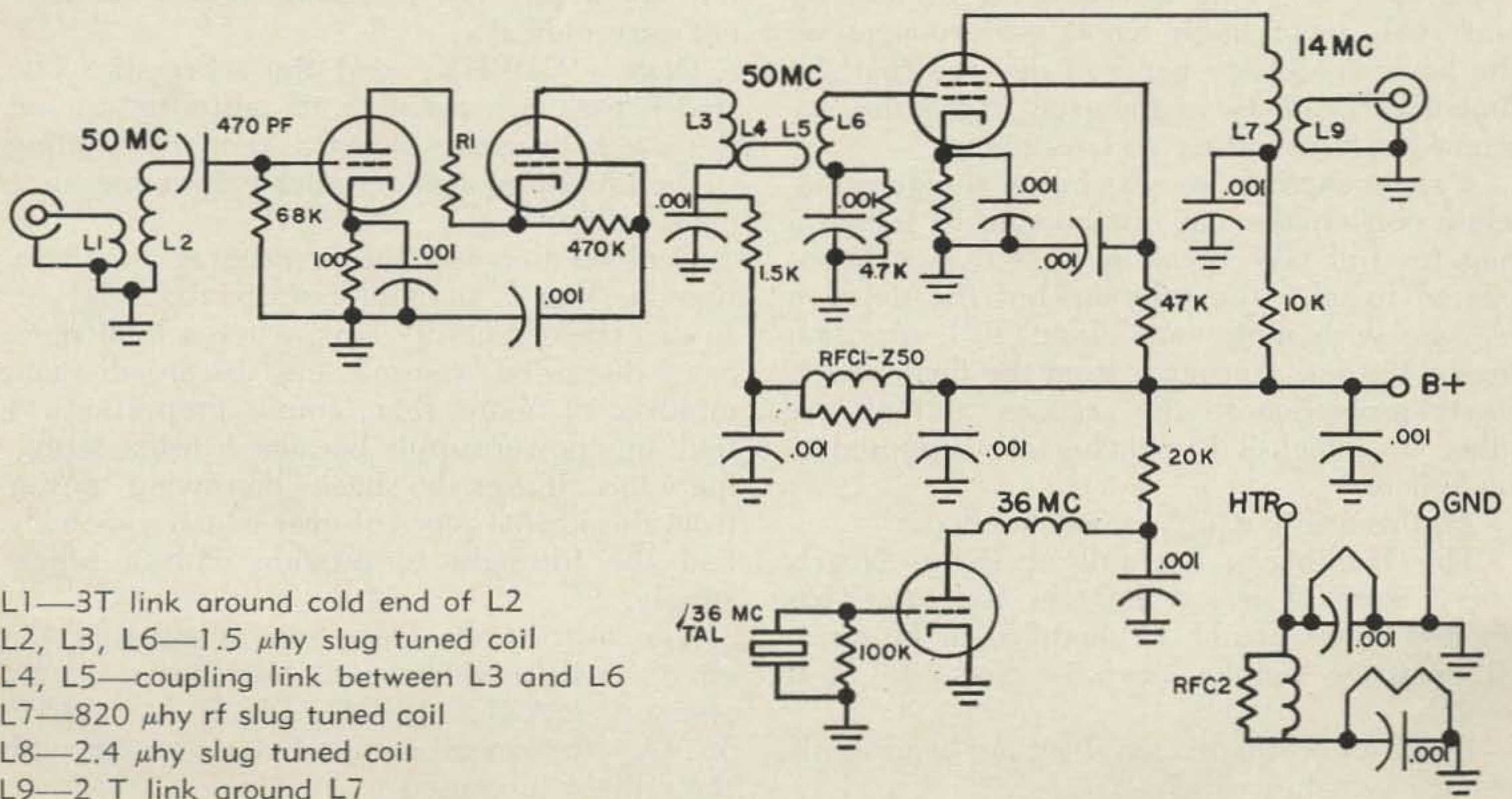

- L1—3T link around cold end of L2
- L2, L3, L6—1.5 μhy slug tuned coil
- L4, L5—coupling link between L3 and L6
- L7—820 μhy rf slug tuned coil
- L8—2.4 μhy slug tuned coil
- L9—2 T link around L7

and the output of the converter, it removes the need for trap circuits at the antenna usually found in most cascode converters. When laying out the chassis be sure that  $L_3$  and  $L_6$  are in the same plane about 1 inch apart. Then after ALL other wiring has been fully completed and checked for errors, install the link coil between  $L_3$  and  $L_6$ .

The mixer stage is conventional and uses a 6CQ8 as a combined oscillator and mixer. A type 6U8A or 6EA8 can be substituted without any changes in circuitry. There is no difference in the sensitivity, however the 6CQ8 being a tetrode is less apt to overload due to a strong local signal. The output of the mixer is again link coupled to the output jack, J2. The *if* frequency chosen was 14 mc, and a 36 mc overtone rock was used in the conversion oscillator. The tubes own interelectrode capacity will afford plenty of oscillator injection as the tube was specifically designed for this use.

### Alignment

Alignment is simple, all you need is a GDO.

George Thurston W4MLE

## A Simple T-R Switch

Since I spend most of my operating hours as a CW traffic hound and gumbater, and DX has been mainly an afterthought, I've used a separate antenna on the receiver for all of my 15 licensed years.

Recently with the DX contests coming up and with increasingly good performance on the lower frequency bands, I decided that the time had come to begin using the same antenna for transmitting and receiving.

A change-over relay was out of the question. They don't make 'em fast enough to follow a bug for full CW break-in. A T-R switch appeared to offer the solution—but the decision left me with misgivings about TVI, insertion losses, birdies, shot-noise from the final, inadequate protection to the receiver and all the other ills which T-R switches are supposed to be heir to.

All this aside, which circuit to choose?

The handbooks are full of them. Nearly every issue of every amateur magazine has another new (or old, or modified or better or different or simpler or more versatile) T-R switch.

Being an obstinate cuss, I set my head firmly against switches which:

Pretune  $L_2$ ,  $L_3$  and  $L_6$  to approximately 50 mc.  $L_7$  should dip at 14 mc and  $L_8$  at 36 mc. Now apply power to the converter and using the grid dipper as a wave meter adjust  $L_8$  for slightly less than maximum output. Now tune in a weak station and tune everything else for maximum. You are now ready to go.

### Results

While this is not the ultimate in converters, it does compare favorably with most of the Nuvistor jobs around today. According to the 6DJ8 specs the noise figure should be in the realm of 4 to 4.5 db. I can tell you that it has the ability to dig out the weak ones and make them Q5 copy, which is what counts.

... WA2HVK

### 73 PARTS KIT

We've rounded up everything you need to knock this one together (except the chassis), including tubes, sockets, coils, coax connector, capacitors, resistors, rf chokes, etc. The whole kaboodle catalogs out at \$18.60,

KIT WA2HVK-1 ..... \$17.50

- (1) had to be bandswitched
- (2) had to be tuned
- (3) which cause insertion losses rather than gain.

The switch I wanted had to just hang in there and do its job with no more attention from the operator than the HV rectifier tubes.

I was commiserating with W4WHK on 80 M CW one evening about the Utopian nature of such aims and he offered the circuit he uses, developed by himself and W9PUH/K4PNS, but apparently not published and apparently not very radical.

Dave (W4WHK) sent the schematic. The switch took two evenings of puttering around the shack because the NCS kept interrupting in the middle of a solder joint to give me some more traffic.

Construction was the essence of simplicity because there's nothing critical about layout. In fact, there's hardly any layout. I built mine on a discarded, re-used and discarded again minibox of more than ample proportions. I built in a power supply because I dislike stringing wires all over the shack "borrowing" power from this or that piece of gear which somebody had the foresight to provide with a power supply.

The instructions Dave sent along said the circuit "will produce some gain in the overall system. 12AX7, 12BH7, 12AU7, 12AT7, 5814A, etc. can all be used. Gain varies with the type of tube used.

# NEW

FROM

## LINEAR SYSTEMS

# ADCOM 350-12

### DC - DC TRANSISTORIZED CONVERTER

## INCREASED POWER



4 1/2" x 6 1/2" x 8" . . . Approx. 8 lbs.

Encased in Gleaming Cabinets of Nickel-Plated Steel

### CHOICE OF HIGH VOLTAGES TO ACCOMMODATE ANY OF THE NEWEST TRANSCEIVERS !

LINEAR SYSTEMS, INC., manufacturers of QUALITY PROVEN transistorized converters for mobile operation and power supplies for fixed station — are proud to announce a POWER-FULL first — the latest addition to our expanding line of popular supplies — the ADCOM 350-12, replacing the ADCOM 250-12\*.

THE  
MOST

- POWERFUL
- RUGGED
- RELIABLE

CONVERTER ON  
THE MARKET TODAY

\*Factory conversion of the ADCOM 250-12 to 350-12 current ratings for \$10 plus freight.

- 800 V @ 400 MA or
  - 600 V @ 500 MA and
  - 275 V @ 200 MA
- 0-110 V @ 30 MA Negative Adjustable Bias

FOR MAXIMUM  
TUNE-UP POWER

**This Universal Converter Will  
Provide Maximum Power to Your:**

- COLLINS KWM-2 or S Line
- SWAN (All Models)
- HALLICRAFTER SR-150
- NATIONAL NCX-3
- GALAXY 300
- DRAKE TR-3

NO INCREASE  
IN PRICE  
**\$125**  
net

IMMEDIATE DELIVERY

## LINEAR SYSTEMS INC.

605 UNIVERSITY AVENUE  
LOS GATOS, CALIFORNIA

"Some lengths of coax (or combinations of lengths)," Dave continues, "tend to give some loss in the system and vary with the transmitter, receiver and antenna system. The right lengths have to be determined experimentally. Generally, the line length from the final to the T-R switch and from the switch output to the receiver tend to be the most critical."

So much for the theory.

Actually, I used the lengths of coax which were handy. They work. The switch produces a little gain. I left things alone. I haven't any idea whether other lengths of coax would work any differently. If you build the switch you can find out and let me know.

Since I run fairly high power (600 w to 1 kw on CW) I chose to put a third tube in parallel. I have no idea whether this is essential. W4WHK runs some 600 watts, uses two tubes in his switch and hasn't blown anything yet. I use 12AX7s because they were in the junk box. As an added precaution in the interest of receiver safety, I connected 1N34's back to back across the receiver antenna terminal connections. These diodes have *no* effect on the signal at the level used for receiving. However, when the forward voltage applied to them exceeds a few millivolts, the diodes conduct heavily, offering an effective short circuit to rf potentials of anything like damaging proportions.

So far the switch has met all my specifications.

Even with the minibox completely unbuttoned and no low pass filter in the line, there is no TVI.

I haven't experienced any birdies.

Although the 4-125As in the final draw 10 or 15 ma of idling plate current, I have experienced no difficulty with shot noise or similar effects.

The switch works on 15, 20, 40 and 80 meters, without tuning, and provides gain on each band. Actually, tuning the transmitter final tunes the switch. There is a very perceptible increase in strength of received signals as the transmitter final tuning capacitor is rotated through resonance. In fact, I have used this for "rough tuning" the final before putting plate power on, with fairly close approximations of resonance.

Total cost of the project was nil. I had everything in the junk box except two coax connectors which I scrounged from a fellow-ham. Total cost if everything is bought new (how ridiculous!) would be somewhere between five and ten dollars—closer to ten if you include the power supply. Some saving in cost can be realized if phono-cable connectors are used to connect the switch to the receiver. The same type of connector can be used for low-power transmitters (probably anything from a pair of 6146's down) at another saving in cost. A coax "T" connector is *not* necessary. You can simply use another panel-type connector mounted in the T-R switch.

The unit could easily be built into a chassis along with an antenna tuner, SWR bridge, antenna switching circuit or similar device. It could even be incorporated into the chassis of a transmitter if space exists or a new one is under construction. There's a further saving in cost here, because it eliminates the need for a separate chassis and power supply.

Additional savings in cost can be achieved by using only one tube if the T-R switch is to be used strictly with transmitters in the 90-watt-and-under power category.

If I go any further, I'll be offering to pay you to build the thing, and I can't afford that, even with all the money I saved by building it myself.

... W4MLE

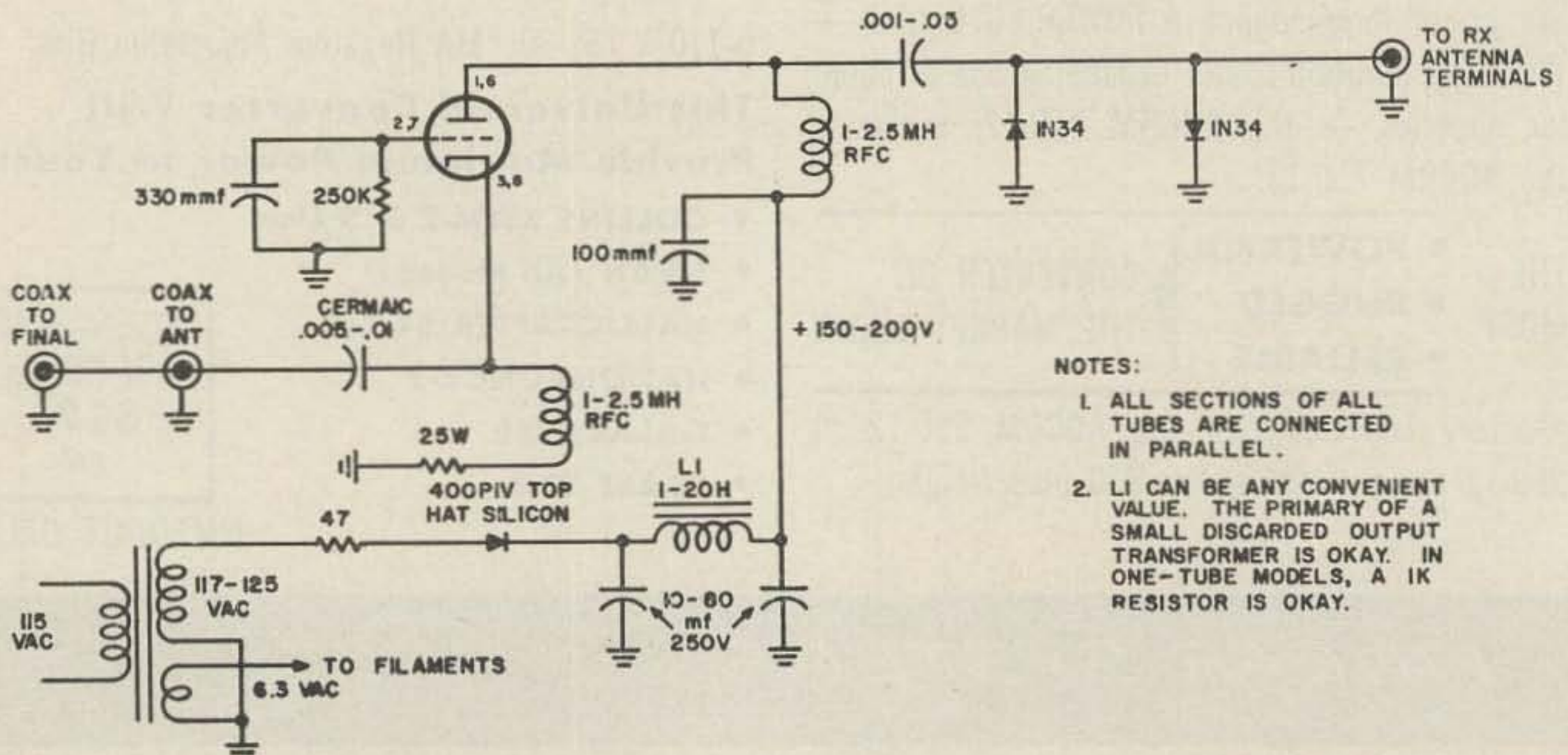



**B&W**

# MODEL 6100 TRANSMITTER



**SSB**

**CW**

**AM**

*With the All New*  
**CRYSTAL CONTROLLED  
FREQUENCY SYNTHESIZER**

***A New Standard of Frequency Stability!***

**A MATCHED PAIR**

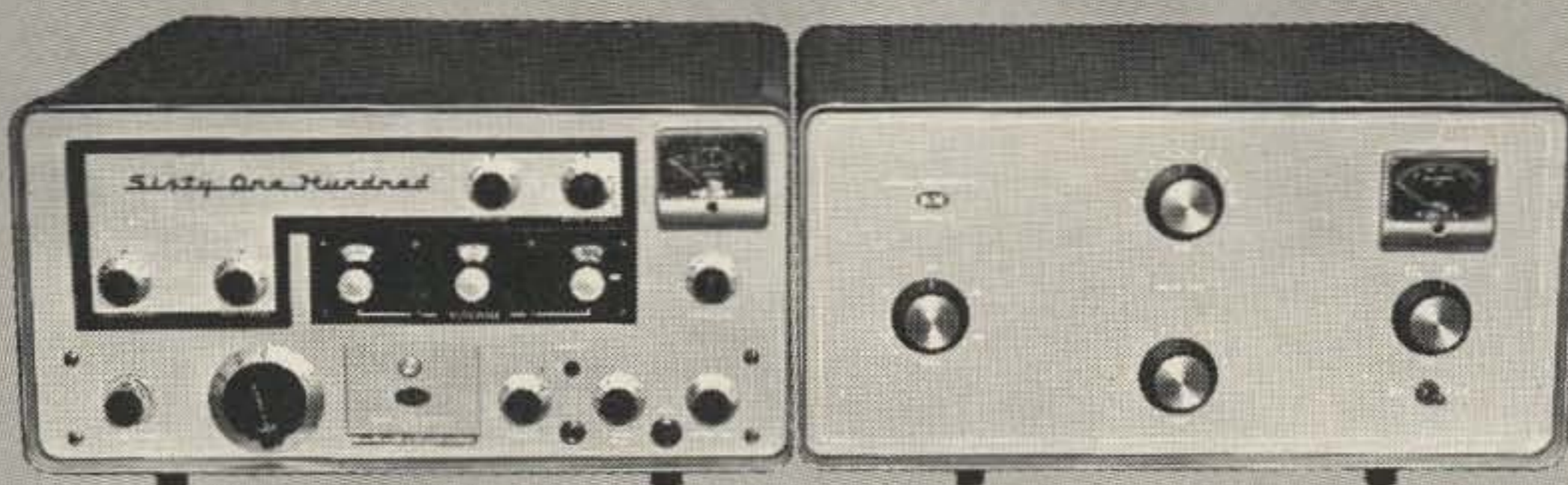

MODEL 6100  
PRICE!  
\$875.00

Model 6100 Transmitter

Model LPA-1 Grounded Grid Linear Amplifier

MODEL LPA-1  
PRICE!  
\$375.00  
(less Power Supply)

**THE B & W KILOWATT**

**BARKER & WILLIAMSON, Inc.**  
BRISTOL, PENNSYLVANIA • Stillwell 8-5581

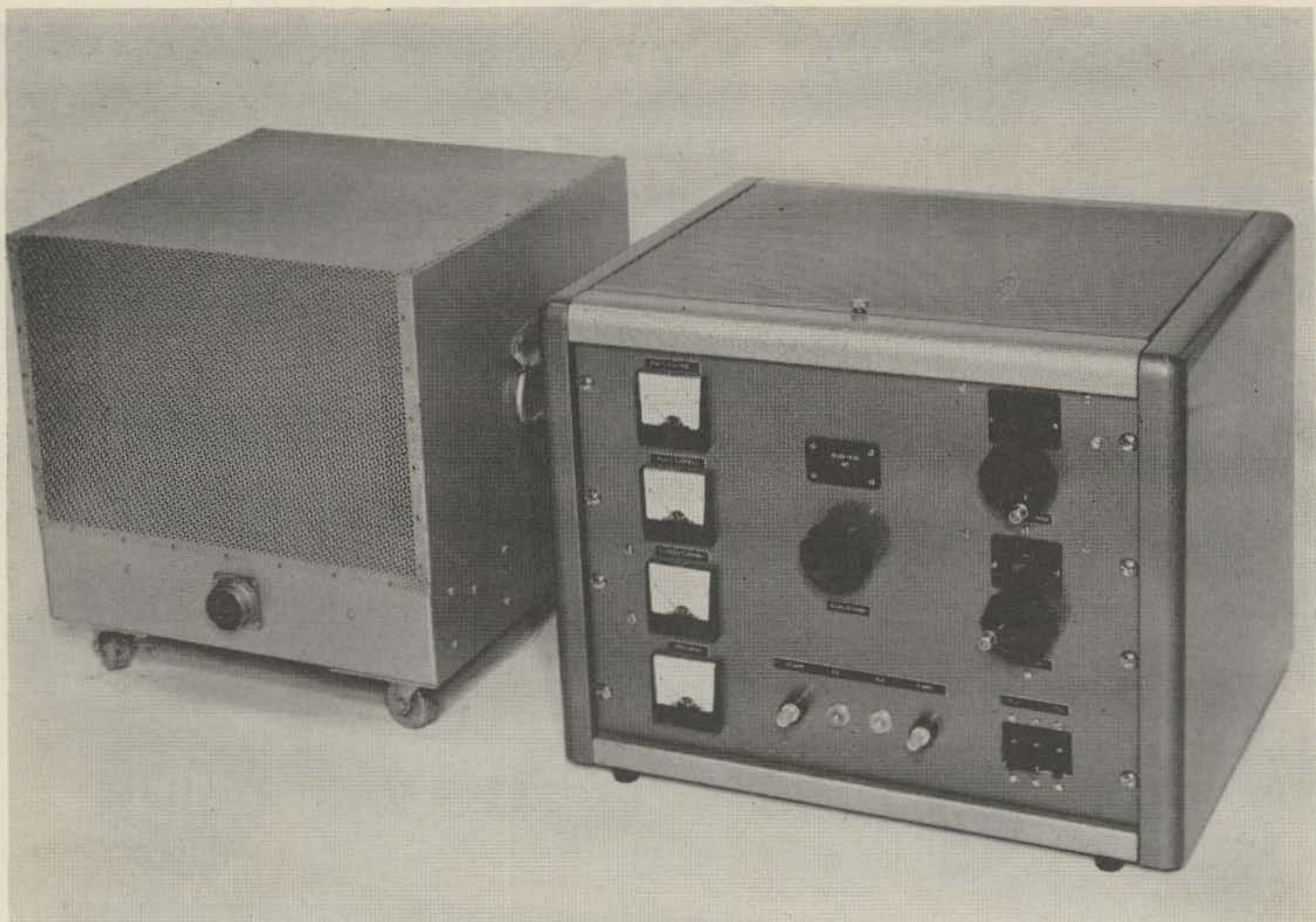

*Low distortion*

## All Band Linear Kilowatt

Bert Green W2LPC  
George Phillips WA2PDI  
Amperex Electronic Corp.  
230 Duffy Avenue  
Hicksville, New York

When designing a kilowatt linear amplifier that will handle a full gallon input as a side-band, CW or AM linear, the selection of the tube depends on the following:

A. The linearity of the tube without feedback.

B. The overall physical size of the tube, socket, and blower.

C. The overall cost of the tube, socket and blower.

In category A, linearity, the Amperex 8179 was rated for lowest distortion with the 3rd order I.M. products being down better than

40db in a grounded grid circuit.

Category B, size, showed up as a close tie between three contenders. While the Amperex 8179 was physically larger than the other tubes it was able to utilize a much smaller blower for cooling. The 8179 only requires a small flow of air over the surface of the tube which means that any small centrifugal blower may be used. The external radiator type tubes required a larger type blower to deliver the required air flow against the radiator back pressure.

In category C, cost, the 8179 was the lowest

priced tube by only a few dollars. However, the socket for the 8179 listed at 1/5 to 1/7 of the price of the sockets for the other two tubes. In addition the lower cost of the blower resulted in the 8179 tube, socket, blower price combination being much below the other choices.

### Power Supply

The plate power supply is constructed on a 17 x 17 x 4 steel chassis enclosed in a perforated aluminium cover. The use of a choke input filter combined with silicon rectifiers and a husky transformer provide a power supply with extremely good regulation. Since the silicon rectifiers are used in series, each one is shunted with a one megohm resistor to equalize the inverse voltages across each diode. Being on the cautious side a few extra diodes were used to provide a safety factor.

A shielded cable, terminated in an Amphenol type 97-3106-28-410 connectors, carries primary power to, and high voltage from, the power supply.

### Amplifier

The amplifier unit contains the rf amplifier itself, the bias supply, the screen supply, the filament supply, and the metering and control circuits.

The amplifier is a cathode driven, double grounded grid stage, with pi network input and output. A pi network was used for the input circuit for two reasons; first, it provides a proper impedance match between the 50 ohm input line and the 110 ohm input impedance of the 8179, thereby reducing drive power requirements.

The second reason for using a pi network input circuit is to reduce the harmonic input to the amplifier. In a grounded grid stage, the cathode impedance of the tube varies from a very high value to a low value at different points on the rf cycle. This causes a varying load to be presented to the driver and produces considerable second harmonic distortion. This second harmonic drive increases the plate input to the tube, but does not appear as usable output since the plate tank is an effective short at the harmonic frequency. This results in low tube efficiency and high plate dissipation. By driving the amplifier through a pi network input circuit, the amount of second harmonic appearing at the amplifier grid is reduced and the plate efficiency is increased, thereby producing more usable output for the same plate input.

The pi network used on the input of the

8179 amplifier is bandswitched to cover the 80, 40, 20, 15, and 10 meter bands and is designed to have a low Q in order to cover each band without the need for retuning. Trimmer capacitors on the input and output of the pi networks allows the SWR to be adjusted to close to 1:1 on each band.

The rf signal from the output of the pi is capacity coupled to the tube filament, while the 60 cycle ac power is fed to the filament by means of a B & W all-band bifilar filament choke.

The control grid is by-passed to ground by means of three Erie 1500 mmfd stand off capacitors connected in parallel to carry the rf current.

The screen grid of the 8179 is brought out to two pins and each of these is bypassed to ground by 5 Centralab 1000 mmfd transmitting capacitors in parallel. This was done because at 30 megacycles the output capacity of the tube is a large portion of the total tank capacity and much of the circulating tank current flows through the screen bypass capacitor.

The plate circuit is a bandswitched pi network constructed around a modified Illumitronix #P1 195-2 pi network inductor. A Radio Switch Corp. Model 86 rotary switch is used to change taps on the coil and on certain bands to place fixed capacitors in parallel with the variable loading capacitor. The plate tuning capacitor and the loading capacitor are 250 mmfd variable vacuum capacitors. The pi dux coil is modified by removing the 10 meter section and substituting a coil of 6 turns of 1/4" copper tubing, 2 1/4" long on a 1 1/2" I.D. The tapping points for the different bands were also changed. These changes were made in order to maintain the best L to C ratio for each band. The pi network is connected to the plate of the tube through a blocking capacitor made of 3 centralab 500 mmfd TV type high voltage capacitors in parallel. The B+ is shunt fed to the tube through a Raypar all band plate choke. Several homemade and commercial chokes were measured and the Raypar unit was found to have the best impedance characteristics over the desired frequency range. A Z-28 rf choke was connected from the output side of the pi to ground to prevent high dc voltage from appearing at the antenna terminals in case of a shorted blocking capacitor.

The grid bias supply is a simple half wave rectifier with a pi section filter and an OB2 VR tube. This provides a grid bias of 105 V which is stable and has very low ripple. Since

there is no grid current drawn from this supply, it was made variable merely by connecting a potentiometer across its output. A resistor is placed in series with the potentiometer to prevent the bias from accidentally being turned down to zero.

In a linear amplifier, in order to maintain low distortion, the screen grid power supply must be regulated. Ordinarily, this can be

done with V.R. tubes. The 8179, however, draws more current than can be obtained from normal V.R. tubes, thereby, making necessary an electronically regulated screen supply. Electronic regulation generally requires considerable chassis space and can be quite expensive. For this transmitter, however, a regulator was designed which compares very favorably in cost and occupies less space than a

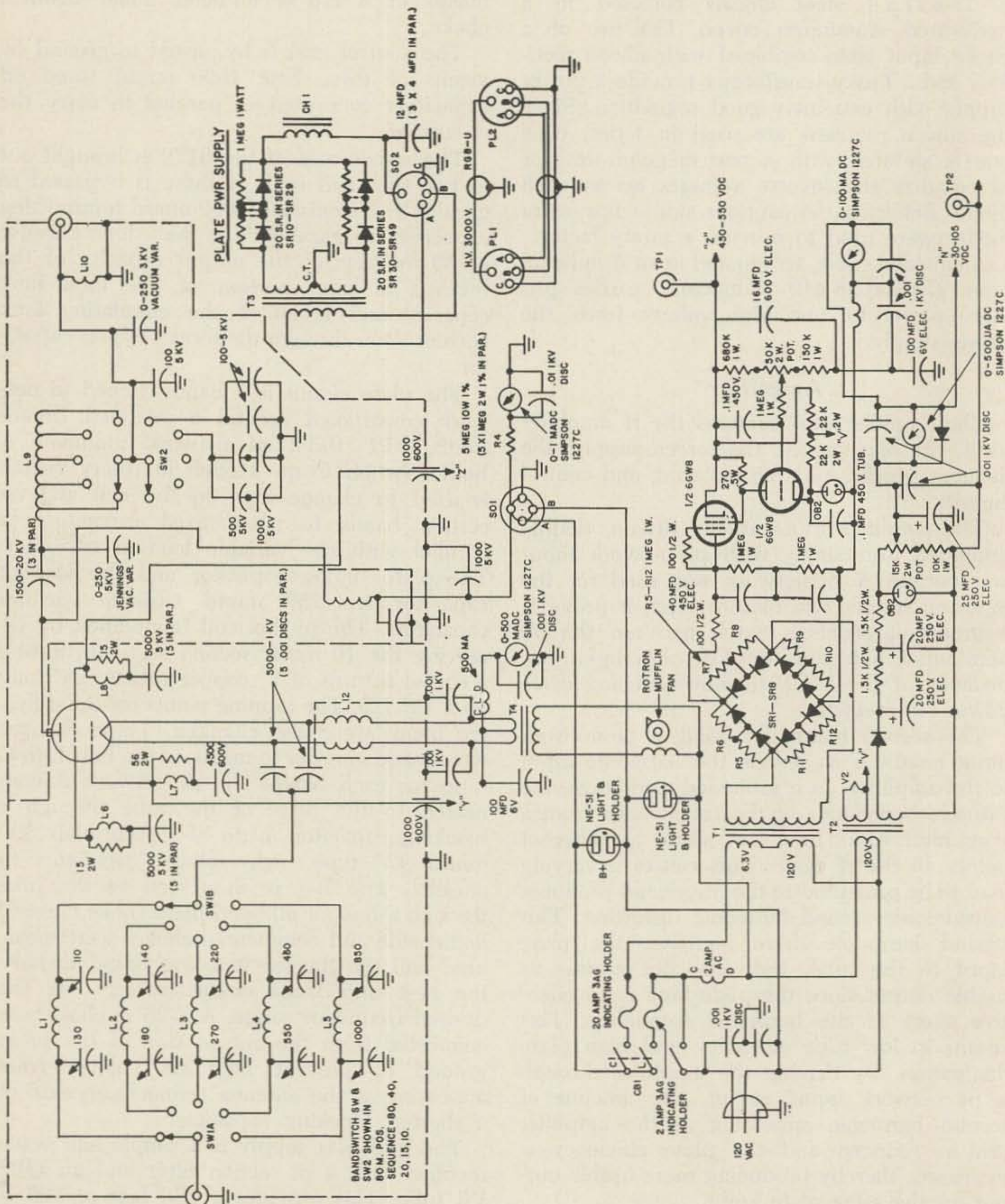

All values mmfd. unless otherwise specified

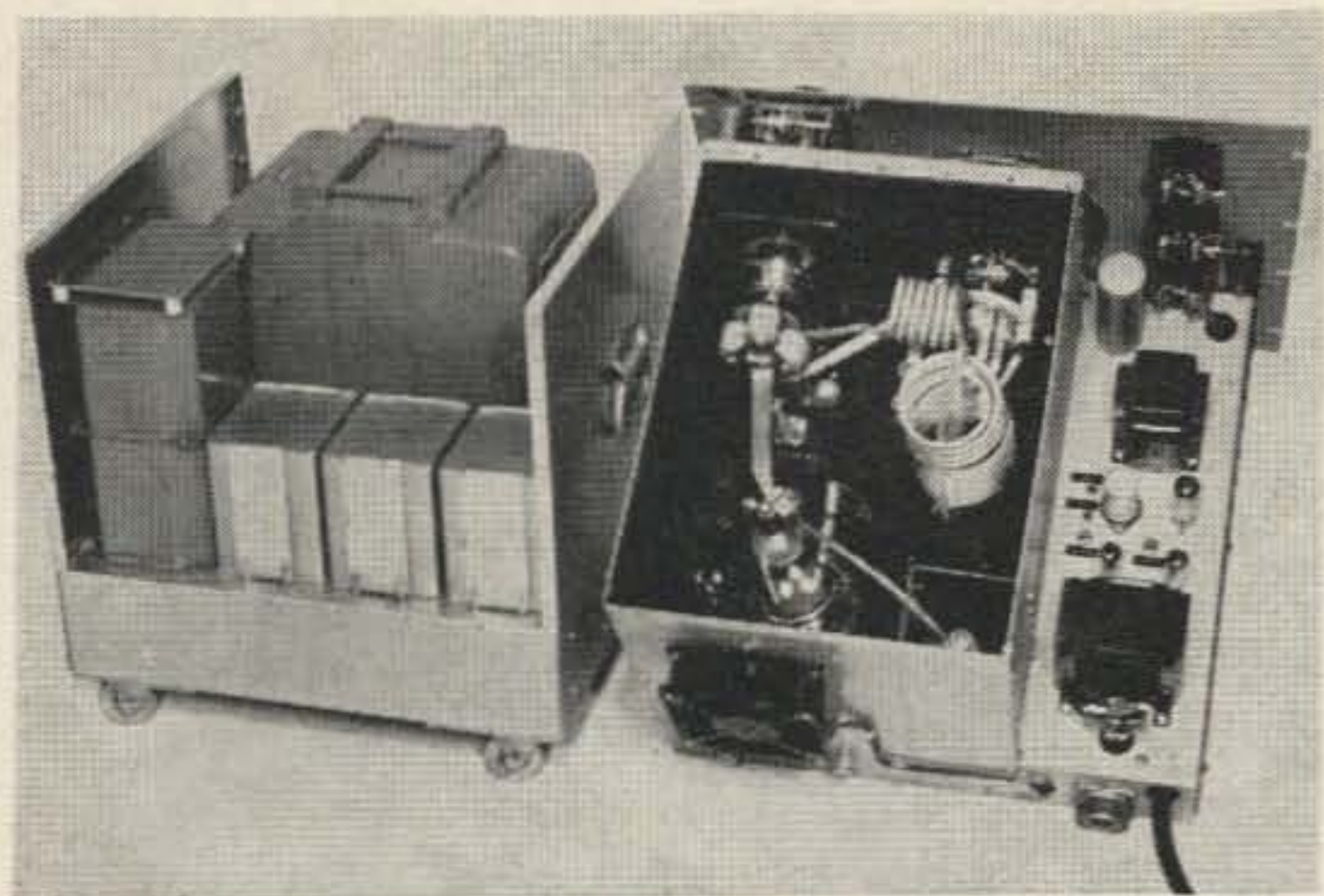

string of V.R. tubes would, even if they could handle the current. This regulator offers performance which is very much superior to the V.R. tubes plus the advantage that it is adjustable. The regulator consists of 2 tubes, 7 resistors, 2 tubular capacitors and a potentiometer. One of the tubes is an OB2 used as a voltage reference and the other is a 6GW8 triode-power pentode used as a series regulator and feedback amplifier. Power is supplied to the regulator by a Stancor PC8420 transformer and a bridge rectifier consisting of eight BY-100 silicon diodes and a single section capacitor filter.

Four 2 inch meters allow for monitoring the operating conditions of the amplifier. Since the amplifier plate input is above 900 watts, both plate voltage and plate current meters are necessary to meet FCC regulations. The screen current meter in combination with the plate current meter allows the loading to be properly adjusted, and the grid current meter indicates if the amplifier is being driven beyond Class AB<sub>1</sub>.

Full circuit protection is provided by fuses and a modified three pole Heinemann circuit breaker on the front panel. A Rotron muffin fan on the rear of the unit provides a small flow of air past the tube and tank coil. This is necessary since the amplifier is completely enclosed and would overheat unless forced ventilation was provided.

The amplifier is constructed on a 17" x 17" x 4" aluminum chassis with a 19" x 14" aluminum front panel. The rf amplifier is at one end of the chassis and is completely enclosed in an aluminum compartment to minimize TVI.

In the photograph of the top of the chassis, the top cover is left off allowing the component layout inside the rf section to be shown. Also, in the top view, the filament transformer and the bias and screen supplies can be seen.

In the photograph of the under side of the chassis, the bottom cover of the rf section is

## ELIMINATE HETERODYNES and other Unwanted Signals with WATERS Q-MULTIPLIER/NOTCH FILTER

The WATERS Q-MULTIPLIER/NOTCH FILTER will permit you to tune out annoying heterodynes. It gives a null of at least 40 db tunable across the entire IF passband.

The WATERS Q-MULTIPLIER/NOTCH FILTER combines an isolating amplifier and a tunable LC Bridged-T network with a Q Multiplier.

Designed specifically to fit the Collins 75S-1 or Collins KWM-2, the unit comes assembled ready for installation. Escutcheon plates and knobs are matched to equipment so there is no discernable change in appearance of equipment.

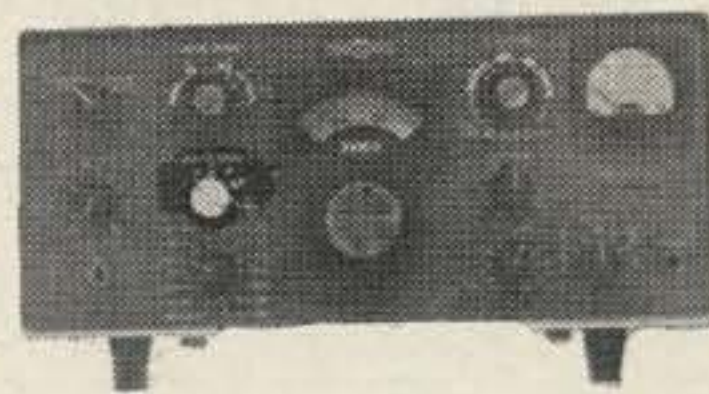
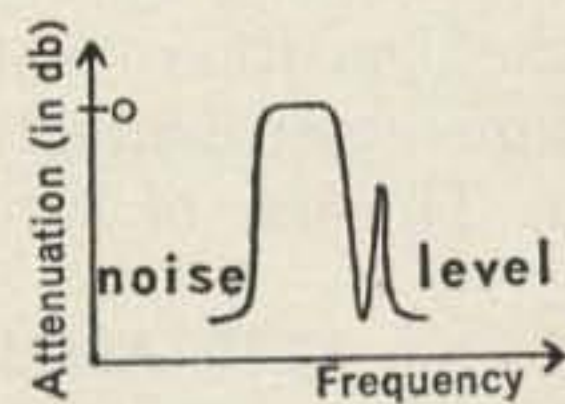
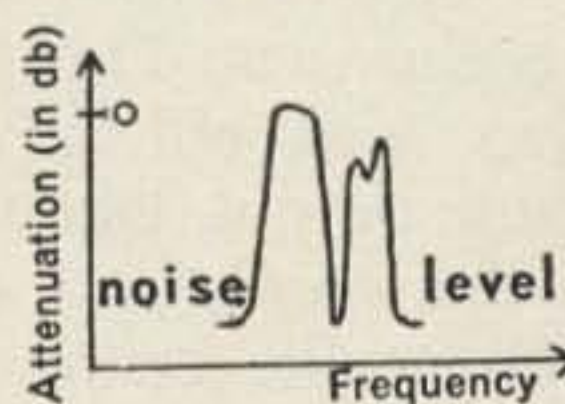

Response of IF Passband for Various Positions of Q-Multiple/Notch Filter

### 2 New Models Available:

337-S1A for Collins 75S-1 .....	\$39.95
340A for Collins KWM-2 & KWM-2A .....	\$53.75

### OTHER WATERS PRODUCTS:

Universal Hybrid Coupler (See Sept. '62 Adv. in 73) .....	\$49.50
Coaxial Transfer Switch (See Aug. '62 Adv. in 73) .....	\$11.45
Coaxial Selector Switch (See Aug. '62 Adv. in 73) .....	\$12.95
Antenna System Transfer Switch (See Aug. '62 Adv. in 73) .....	\$11.45

Available at leading distributors

Some territories available for representation

**WATERS MANUFACTURING, INC.**  
**WAYLAND, MASSACHUSETTS**

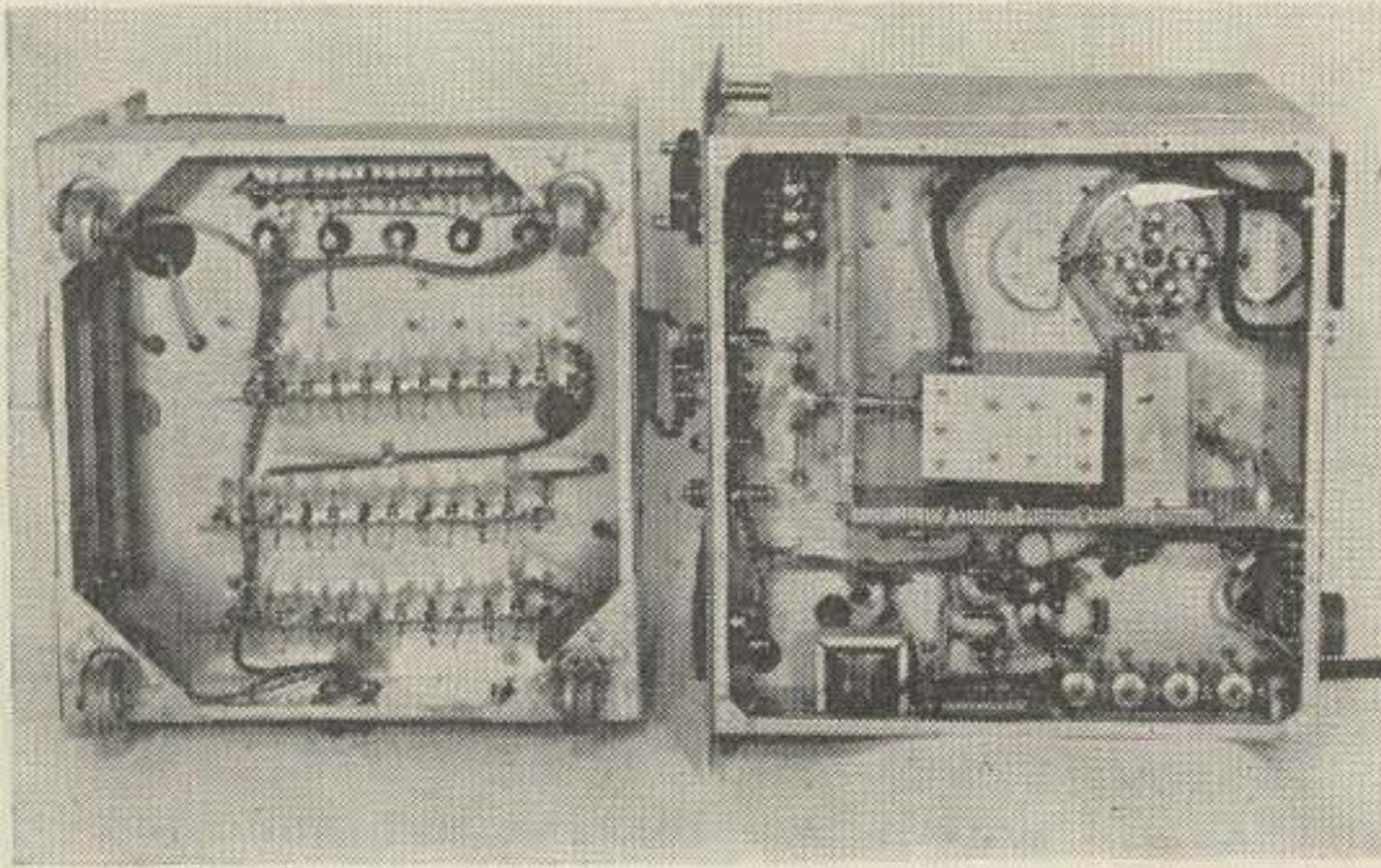

also left off to show the components. This cover is made of perforated aluminum to allow air to be drawn up through the bottom, through the tube socket, around the tube and out through the exhaust fan in the rear. A few holes were also drilled under the tank circuit to allow some air to flow past the coil.

In the bottom view, a small enclosed box can be seen with a coax cable coming from the side and a shaft coming from the front. This is the input pi network which is ganged to the output pi network bandswitch by means of a pair of pulleys and a bronze dial cord. (The pulley arrangement is shown in Fig. 1).

The ten adjusting screws seen on the pi net cover are the input and output trimmer capacitors for each of the five bands and are adjusted for minimum SWR at the center of each band.

Spring fingers along the partition which encloses the rf section assure good contact to the perforated metal cover. The use of exten-

sive shielding and by-passing of all leads entering the rf section minimizes TVI and reduces stray feedback from the plate to the grid, thereby increasing the stability factor of the amplifier. It also prevents rf from getting into the power supplies which can cause loss of regulation, damage to rectifiers, etc.

Between the upper shield compartment and the front panel, are mounted the two Johnson turn counting dials for the vacuum capacitors used in the plate pi network. Also, in this space is a plastic disc which rotates behind a window in the front panel. On the disc are numbers which show through the window to indicate which band is in use. The shaft which turns this disc is an extension of the band change switch and extends through the front panel to the band change knob. On this same shaft is the pulley which drives the band-switch on the cathode pi network circuit.

The rf amplifier section is housed in a brown hammer-tone desk top cabinet with perforated top and rear covers. A square cut-out was made in the rear cover to allow the muffin fan to protrude out of the back of the cabinet. A series of 2" holes were cut in the floor of the cabinet to allow air to enter the bottom of the chassis. On the rear chassis deck are the rf input and output connectors, the plate power supply connector, and the line cord.

When first placed into operation, the amplifier was found to parasite at about 120 mc. This could have been cured by placing a

TABLE I 8179 AMPLIFIER SINGLE TONE TEST DATA

Freq. (Mc.)	PWR (Watts)	Out	Drive (Watts)	Test Conditions		
				No Sig.		Max. Sig.
3.75	960		34	$E_b$	3275 V	3100 V
7.15	910		33	$I_b$	165 MA	470 MA
14.2	920		28	$E_{c2}$	500 V	500 V
21.25	920		30	$I_{c2}$	8 MA	93 MA
28.8	900		29	$E_{c1}$	-87 V	-87 V
				$R_L$	—	3400 $\Omega$

TABLE II PLATE TANK CIRCUIT CONSTANTS (Approximate Values)

Freq. Mc	Plate Tuning Dial Setting <sup>1</sup>	CAP mmf <sup>2</sup>	Loading Cap.			Tank Q
			Dial <sup>1</sup>	mmf	+ Fixed	
3.75	0712	157	0519	156	760	12.5
7.15	1160	66	0927	64	300	10
14.2	1300	38	0714	118	100	11.5
21.25	1587	27	0215	217	100	12.5
28.8	1362	31	0640	133	100	19

Note 1. Dial set to 000 at Max Capacity (Tune Max. = 272 mmfd, Load Max. = 257 mmfd).  
Dial Settings are approximate only and will vary somewhat with different capacitors.

Note 2. These values do not include tube output capacity.

# NOW! TWO METER SSB

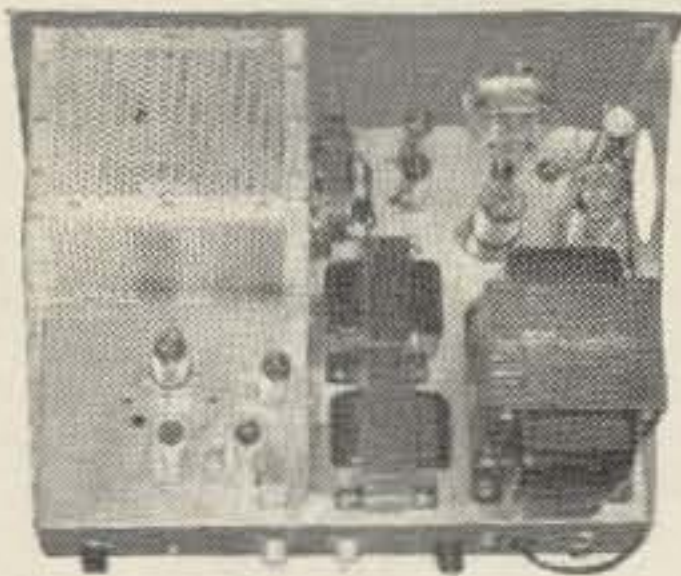

**175 WATTS  
WITH  
P&H 2-150  
TRANSMITTING  
CONVERTER**

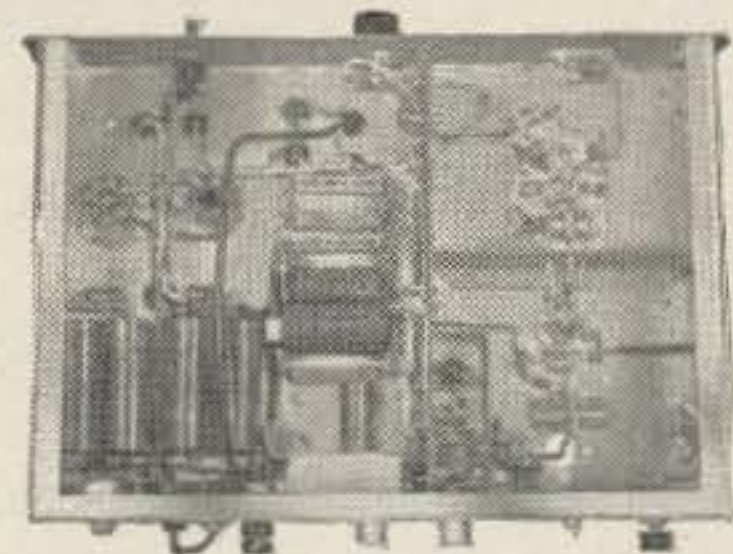

Here's the simple easy way to go VHF on TWO METERS! Just feed the 20 meter output of your present SSB, AM or CW exciter into the P&H 2-150 and you have 175 Watts PEP on TWO METERS, either crystal or VFO controlled, depending on your exciter features. Resistive Pi-Pad and switchable Half-Power Pad permits operation with any 5 to 100 Watt exciter. Since the 2-150 is a high stability mixing device, the output signal stability is the same as that of your exciter. Uses a 6EA8 Crystal Oscillator/Tripler; a 6360 Balanced Mixer; a 6360 Class A driver and a 7854 push-pull Output Tube. Power input to 7854 final: 175 Watts PEP on SSB, 165 Watts

CW, 90 Watts linear AM. Entire chassis and all shielding is COPPER PLATED. Output jack provided to furnish oscillator signal injection for receiving converter. Quiet 200 CFM forced-air cooling. 50-70 ohm input and output impedances. Husky built-in power supply has three separate rectifiers and filter combinations. Meter reads; PA GRID, PA PLATE and RELATIVE RF OUTPUT. Modernistic curved corner grey cabinet; 9" X 15" X 10½". The P&H 2-150 is so thoroughly shielded, by-passed and parasitic-free that it operates as smoothly as an 80 meter transmitter. P&H also manufactures the Model 6-150: 175 Watts on 6 Meters.

WRITE FOR LITERATURE

**Complete — With Built-in Power Supply,  
All Tubes and Crystal, for Only \$329.95\***

\* Slightly higher west of Rockies

**P & H ELECTRONICS INC.**  
424 Columbia, Lafayette, Ind.

parasitic suppressor in the plate lead of the tube, but this would have inserted considerable resistance in series with this lead at 30 mc. Due to the high output capacitance of the tube, a good portion of the plate tank current flows through the tube and any resistance in the plate lead would cause high losses resulting in low tank circuit efficiency at 30 mc. For this reason, parasitic suppressors were placed in the control grid and screen grid leads instead of the plate. Since much of the plate tank current flows through the screen, the amount of resistance inserted in the screen lead was kept to a minimum, while the resistance inserted in the control grid was allowed to be as large as necessary to prevent the parasitic. This introduces some loss in the grid circuit, but in this manner high plate tank efficiency is maintained at the expense of a small increase in drive power.

The amplifier was tested into a 50 ohm dummy load on all bands for drive requirements and power output. The results of these tests are shown in Table I.

Table II shows the approximate capacitances, dial settings and Q used for the plate tank circuit at the center of each amateur band.

A test was also run on seven megacycles with

a two tone signal to determine the amount of distortion present in the amplifier. The conditions were as in Table III.

When the amplifier was first constructed, the distortion was found to be quite bad (about -30DB). This was caused largely by the fact that the current meters and the circuit breaker coils in the negative leads of the power supplies were not bypassed for audio frequencies, causing an audio voltage to be superimposed on the power supply voltages. By bypassing the meters and circuit breaker coils with electrolytic

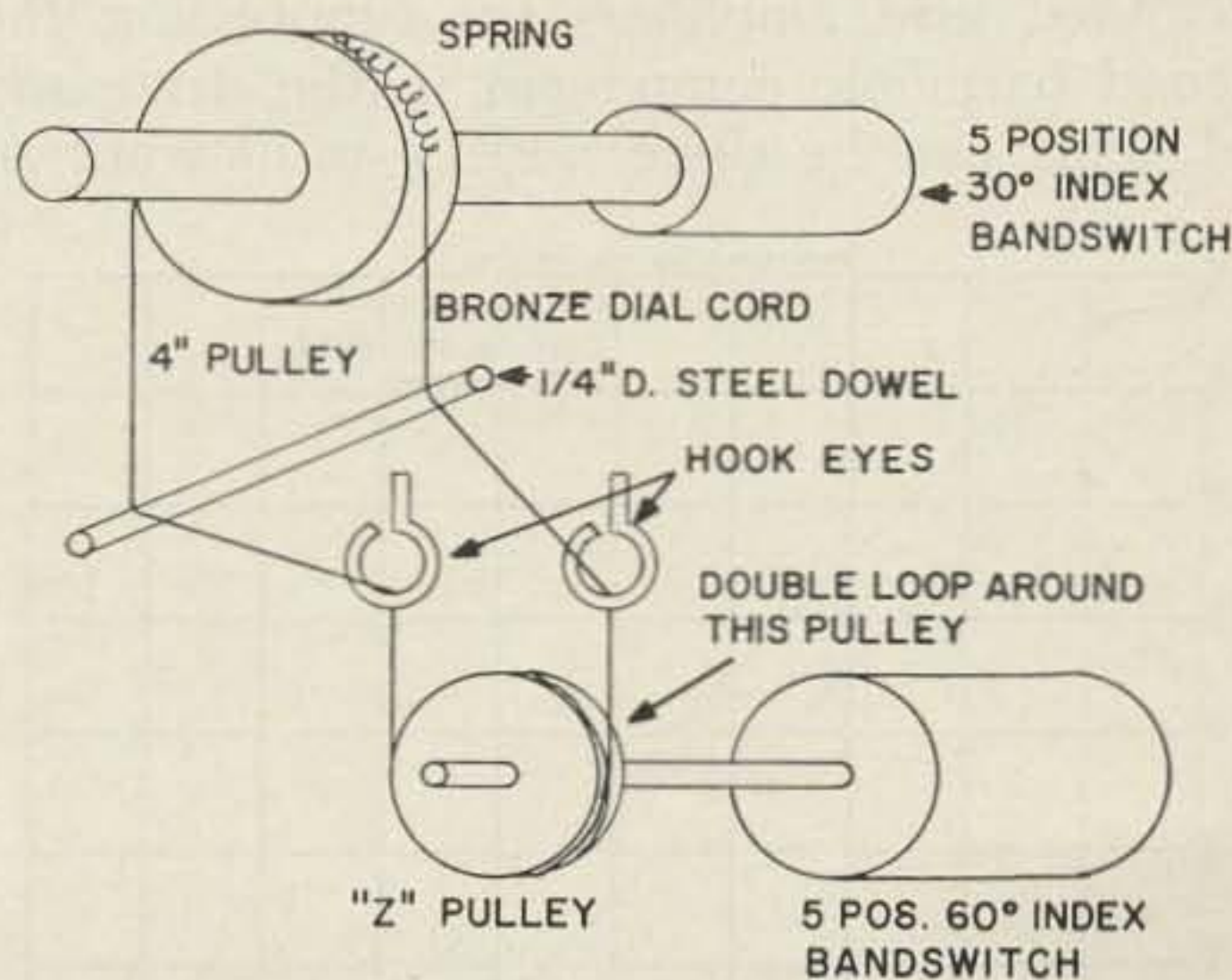

BANDSWITCH GANGING ARRANGEMENT

FIG. 1

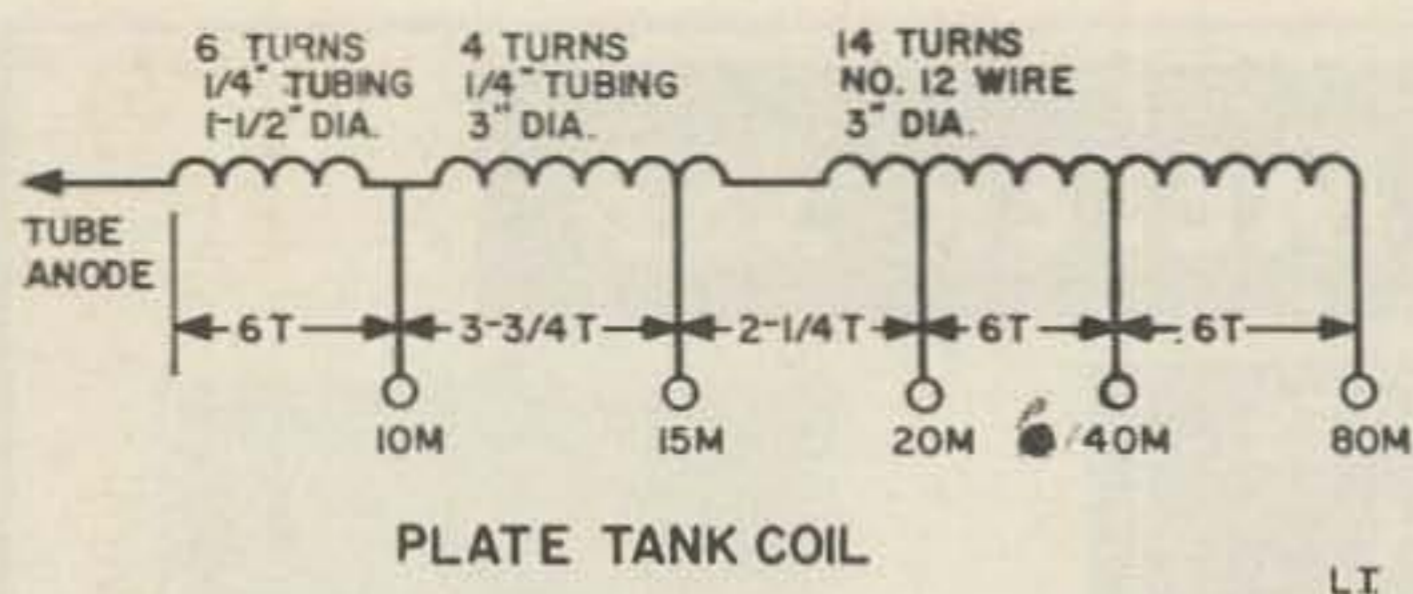

capacitors, the distortion was decreased considerably.

The distortion was decreased still further by leaving the unused turns on the plate tank coil unshorted when switching from band to band, instead of shorting them as was done when the amplifier was first constructed.

The 8179 data sheet states that the tube must be operated in a vertical position only. During testing, the amplifier was operated on its side and it was noted that the distortion figures became slightly degraded. This is normal and is probably caused by misalignment of the control and screen grids due to sagging of the elements when the tube is operated on its side.

### General Linear Amplifier Design Considerations

In designing a low distortion linear amplifier for a tube such as the 8179, certain precautions must be taken to maintain low distortion and reasonably high efficiency. Some of these apply primarily to the 8179, while others are general in nature and apply to the design of any linear amplifier. Some of these precautions are listed below.

1. Any impedance in series with the power supplies must be bypassed for audio frequencies as well as rf. The power supplies themselves should have good audio regulation, i.e., a large filter capacitor across the output.

2. Some means should be provided in grounded grid amplifiers for suppressing the second harmonic component in the drive signal. This can be done with a pi-network or

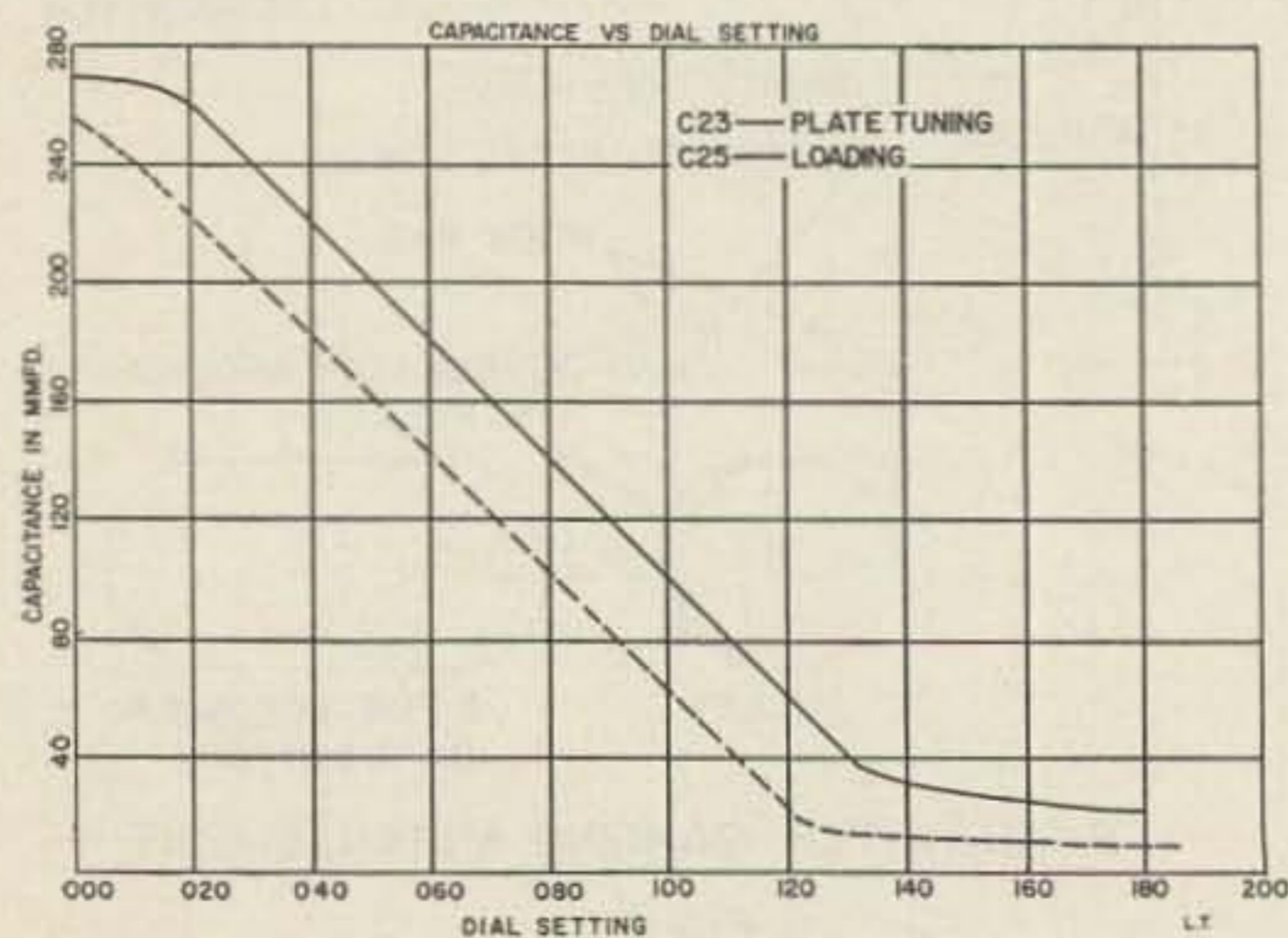

TABLE III 8179 AMPLIFIER 2 TONE TEST DATA

	ZERO SIGNAL	MAX. SIG. (2 Tone)
F	—	7 + 7.002 MC
$E_b$	3275 V	3150 V
$I_b$	165 MA	330 MA
$E_{c2}$	500	500 V
$I_{c2}$	8 MA	36 MA
$E_{c1}$	-87 V	-87 V
$R_L$	—	3400
PO (AVG.)	—	460 Watts
PO (Peak)	—	920 Watts
D3	—	-42 DB
D5	—	Better than -45 DB

other tank circuit tuned to the fundamental, a low-pass filter with a cut-off just above the operating frequency, or a series tuned second harmonic trap to ground. The pi-network and tapped coil methods also have the advantage of matching the line impedance to the tube input impedance, thereby reducing drive requirements.

3. The screen and control grid power supplies should be well regulated since a slight change in operating point produces a considerable increase in distortion. For instance, if the no signal plate current of the 8179 is changed 5 ma from the nominal 165 ma, the distortion increases 2-3 db.

4. The exciter distortion should be kept as low as possible. The exciter distortion should be at least 20 db better than the amplifier distortion in order not to increase the amplifier distortion by more than 1 db.

If extra drive power is available, the non-linear loading of the driver by a grounded grid amplifier may be reduced by swamping the driver output with a resistive load.

5. The plate tank coil should be progressively opened instead of shorted when changing bands.

6. Parasitic suppressors should, if possible, be kept out of the plate tank circuit in order to keep the unloaded Q and, therefore, the plate tank efficiency as high as possible. At high frequencies, where the tube capacity becomes a good portion of the total tank capacity, this precludes the use of the normal parasitic suppressor in the plate lead. As much of the suppression should be done in the control grid circuit as possible with only as much suppression as is absolutely necessary in the plate and screen circuits. Suppressors should be made with the lowest values of resistance and inductance that will suppress the parasite to avoid excessive loss on the operating frequency.

### Conclusion

The excellent performance of the 8179



# MARS

SP-1000 2 KW PEP SSB  
LINEAR AMPLIFIER

The greatest value in a completely self-contained table top Linear Amplifier, with a full 2 KW S.S.B. signal. A husky ruggedly-built power supply that will deliver 800 mills, . . . yes that's right 800 mills at 1550 volts . . . and does it like the champion it is . . . no straining, no groaning, and you will be surprised at how cool the transformer remains, even after hours of operation. And we'll let you in on something . . . there is still reserve built into it. Why not find out for yourself as others have? Reliable grounded-grid circuit. Requires 50-75 watts drive, 4 811 A's and 2 866 A's. Comes complete ready to operate, less tubes at just

**\$299.50**

WRITE DIRECT FOR INFORMATION



BAND SWITCHING 80-10 PI-OUTPUT  
ALL THE OUTSTANDING FEATURES



**STANDING  
WAVE BRIDGE**

Measures both 52 or 75 ohms. Takes full kilowatt.

**\$17.95**

**MARS TRANSISTORIZED  
ELECTRONIC KEYS**

**\$29.95**

10 to 50 words per minute. Has it's own built-in power supply. No batteries to buy. Monitoring audio and speaker. Nothing to compare at anywhere near this outstanding price.



**HYBRID  
PHONE PATCH**

Use on AM or SSB. Built-in R.F. Filters. Gain controls, null controls. VU-meter.

**\$27.95**

**PAUSAN COMPANY • SAN RAFAEL, CALIF.**

linear amplifier shows what can be done in designing a low distortion, high efficiency amplifier by following the above recommendations and by using an extremely linear tube, designed specifically for single sideband use, such as the 8179. . . . W2LPC

- L1—.38  $\mu$ HY 8 Turns #406 Air Dux
- L2—.49  $\mu$ HY 9 Turns #408 Air Dux
- L3—.75  $\mu$ HY 11 Turns #410 Air Dux
- L4—1.4  $\mu$ HY 18 Turns #510 Air Dux
- L5—2.8  $\mu$ HY 12 Turns #616 Air Dux
- L6, L7, L8—3 Turns #14 Wire Wound on R1, R2, R3
- L9—Plate Tank Coil Illumitronic P1 Dux #P1 195-2 Modified as per Figure 11
- L10—RF Choke OHMITE Z28
- L11—Raypar All Band Plate Choke
- L12—B & W All Band Filament Choke 25 Amp.
- T1—Stancor PC-8420 Transformer
- T2—Stancor PA-8421 Transformer
- T3—U.T.C. Type CG307 Transformer
- T4—Triad F-28-U Transformer
- CH1—16 HY 300 MA Choke (2 x U.T.C. 5-33 in series)
- SW-1—2 Pole 5 Pos 60° Index Rotary Switch, CENTRAL LAB #P-275 & (2) #Z-D
- SW-2—2 Pole 5 Pos 3° Index Rotary Switch, Radio Switch Co. #86
- CB-1—Circuit Breaker Heinemann Electric #XAM 666 Left Coil—500 MA DC Inst. Center Coil—75 MA DC Inst. Right Coil—2 Amps. AC Curve 3 Modified by removing companion trip connection between center and right poles.



**3.5-30 MC RF PRESELECTOR.** Built-in AC power supply. 18+ db gain. Continuous tuning. RF gain control. Compact, 6" x 4" x 5". Order your SK-20 Preselector kit today. Only \$18.98 post-paid! **HOLSTROM ASSOCIATES**, P.O. Box 8640-G, Sacramento 22, California (Stocking distributor of Air-Dux Coils. Send 25c for valuable data sheet! Hy-Gain antenna list free!)



**EASY TO LEARN CODE**

Learn to increase speed with an Instructograph—the Code teacher that takes the place of an operator-instructor and enables anyone to master code without further assistance. Available tapes from beginners alphabet to typical messages on all subjects. Speed range 5 to 40 WPM. Always ready—no QRM. Thousands have "acquired the code" with the Instructograph System. Write today for convenient rental or purchase plans.  
**INSTRUCTOGRAPH COMPANY**  
4713 SHERIDAN ROAD, CHICAGO 40, ILL.  
4700 Crenshaw Blvd., Los Angeles 43, Calif.

**WANTED**

**Navy Type "TED-7" Transmitters (CFT-52373)**  
and/or parts for same. Call or write

**SPACE ELECTRONICS CO.**  
218 W. Tremont Ave.  
Box 53, N. Y. TR-8-5222

# Reducing Receiver Noise

George Gabus  
14 Church Street  
Deposit, New York

From time to time construction articles appear in the various publications dealing with the technical aspects of Amateur Radio. This suggests that amateurs are dissatisfied either with the price or with the performance of commercial receivers. Perhaps both.

A common frustration arises when we attempt to tune in that elusive DX station. As we raise the volume the noise level rises also. We reach a point of diminishing returns and give up. If we cannot read them we cannot work them.

Of course we have assumed that the noise originates somewhere "out yonder" and is all coming in via our antenna. That our receiver generates most of this noise has not occurred to many of us.

It is the purpose of this short paper to discuss this problem and offer suggestions whereby a receiver, either factory built or home-brew, may be greatly improved. The "practical" ham is invited to skip theory, if he must, and come back to learn the WHY after he has grasped the HOW of receiver noise reduction.

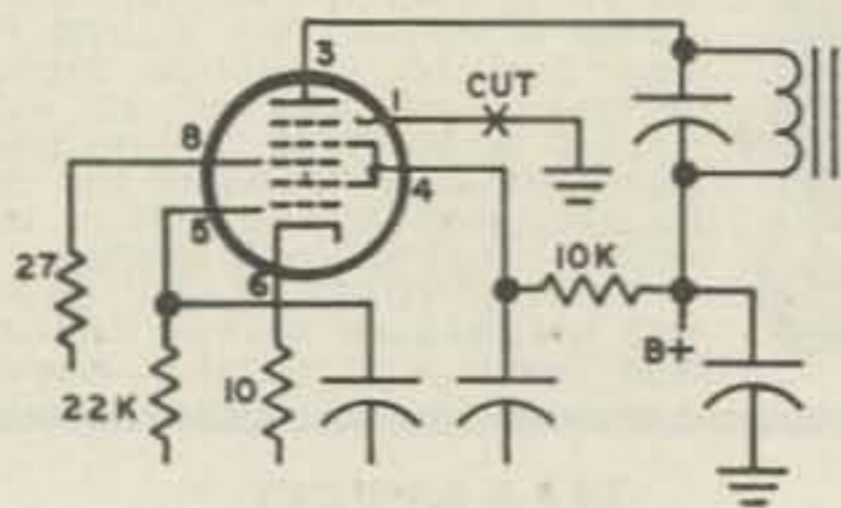

FIGURE 1

Cut socket terminal 1 loose from terminal 2 and from ground and connect directly to socket terminal 6.

Consider the vacuum tube. Positively charged ions, either emitted by the cathode or produced by the collision of electrons with residual gas molecules, produce noise in this manner: since the ion is some 1800 times heavier than an electron it moves sluggishly and remains in the electron stream for a finite period of time before being neutralized by combination with an electron. These positive charges affect the electron stream in an erratic, or random, manner; both when appearing and also when disappearing.

Electronic devices, including tubes, transistors, rectifiers and the like, are essentially diodes through which current passes. Multigrid tubes which combine several "diodes" in one envelope are notoriously noisy. Every component carrying current is a potential noise generator.

Since ions are produced by collision of electrons with gas molecules, we should reduce all B plus voltages below the ionization potential of the gas left in the vacuum tube. To those accustomed to think of ionization voltages in terms of "runaway" tubes, neon lamps, and voltage regulator tubes, it may come as a surprise that B plus voltages must be reduced to a maximum of 18 volts, or less. Remember that in noise reduction, we are not concerned with "breakdown" or "avalanche" effects.

There is always a certain amount of leakage current, either from one electrode to another or to ground. This, together with that which we have called "diode" current, is reduced when we reduce the voltage applied to the tube.

In superheterodyne receivers a large part

# OVERLOAD? NOISE? CROSS-MODULATION?

Not with the Amplidyne Nuvistor Converters

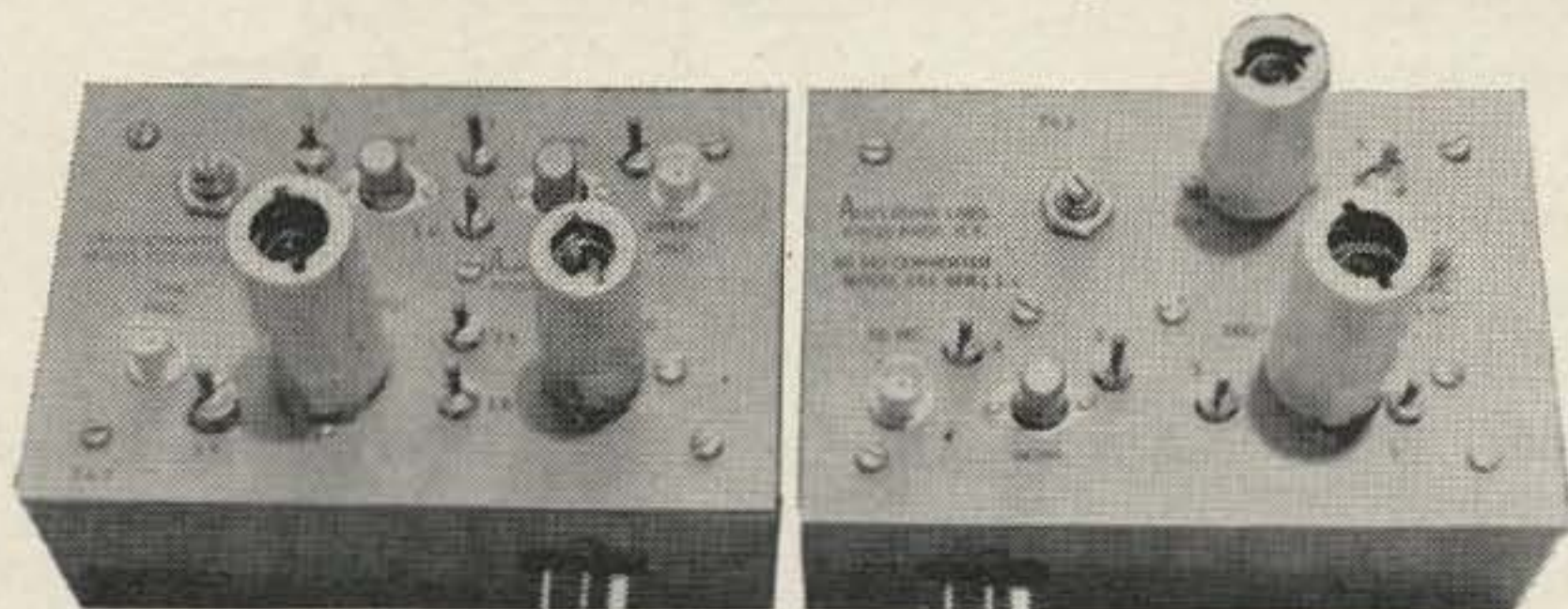

C-23 4x6x2" C-61

	C-61	C-23
Input	50-54	144-148
Noise figure	2.5db	3.0db
Gain	25db	30db
Output	14-18mc standard (any other \$11 additional)	
Impedance	50 ohms	50 ohms
PRICE	\$28.50	\$34.25

ADJUSTABLE I.F. GAIN, TRIODE MIXER, .005 XTAL INSIDE CHASSIS TO PREVENT DRIFT, 6CW4 GRID R.F. AMPS

### NUVISTOR PREAMPS

P-25-144-138 mc \$9.75  
P-62- 50- 54 mc 9.75

All Amplidyne products are guaranteed for TWO years against component failure and one year on tube failure.

### MATCHING SUPPLY FOR

C-61 and C-25 solid state \$9.75

### COMING SOON

6 & 2 meter 60 watt xmtr, plate modulated.  
220 & 432 nuvistor converters

Send check or money order today

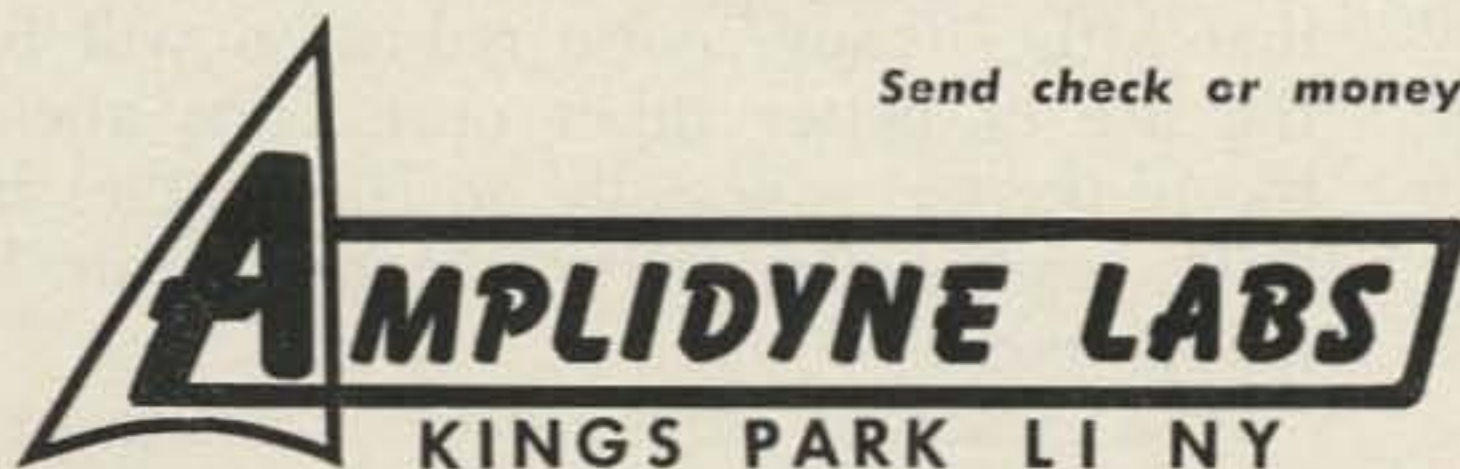

KINGS PARK LI NY

BOX 673

Write for technical info

of the noise originates in the two oscillator circuits. This is mixed with the desired signal and passed along for further amplification. This suggests that noise be minimized in the two, or more, oscillator circuits.

Each stage not only contributes its own quota of noise but also amplifies any noise from previous stages. It follows that the front end is the most likely part of the receiver to begin attempts at noise reduction.

Think of the cathode of each tube as the ground return for all circuits associated with that particular tube. Contrary to accepted practice each cathode should have its own insulated ground wire connected to a single point on the chassis, either directly or through a suitable capacitor. For example, if more than one tube is grounded through one wire, current flowing through one tube will be directly coupled into the other tube's circuits through the common ground wire. What is not so obvious is the fact that the chassis may act in the same manner if used as a common ground connection for two, or more, circuits.

Each stage should be shielded from its neighbors by putting each component associated with a tube in its own metal box. All by-pass capacitors should be grounded directly to the cathode socket terminal using a mini-

imum length of wire. Ceramic disc capacitors have long leads which should be shortened to  $\frac{1}{4}$ ", wherever possible. Tube layout should be such as to keep control grid lead lengths to a minimum. If other, more important, considerations make this impractical, run the grid lead through shielded braid and connect the shield, not to the chassis but to the cathode socket terminal of the tube being driven.

While physicists and radio engineers have known all this (and more) for years, very little of this valuable information has been applied practically. Manufacturing costs must be kept to an absolute minimum. "Good enough is best" appears to be the motto of the industry. This means whatever minimum of performance the trade will accept. For the "do-it-yourself" builder no such motto need apply.

Recognition of the various sources of noise will suggest methods of dealing with them. For example, consider the noise produced by ions in the electron stream. Having previously reduced all B plus voltages, if the cathode temperature is slowly reduced a point will soon be reached where ions no longer will be emitted. Electron emission, though reduced, will continue. It has been found by experiment that the best signal-to-noise ratio occurs at

about 75% of the manufacturer's rated heater voltage.

At this juncture we can imagine you, the reader, saying: "What good will this do me since I live in a noisy location?" We live in an apartment house, one door from State Highway 17. A power line runs along on our side of the highway. The roof of our building bristles with TV antennas, some connected to radiating TV receivers. We suspected that much of the hash was coming in over the power circuits. An effective line filter was constructed which reduced a part of the interference. After this it became possible to hear lesser sources of disturbance. We located two, a farmer's fence-charger, a couple of miles away, and an intermittent power leak where a wild grape vine had chosen to climb into a mess of wires on a utility pole. These were reported to their respective owners who were glad to co-operate promptly.

"Dirt" has been defined as "matter out of place." In like manner "noise" may be defined as "signals out of place." Our problem of "noise reduction" changes its appearance. It has become a matter with which we are more familiar; signal control.

There is a simple test anyone may make to check the noise produced by a receiver. With the antenna and ground leads disconnected, connect the receiver antenna and ground terminals together. A dime will do nicely. Now turn the rf and audio gain controls to maximum with avc control in the OFF position. Turn the AM-CW switch, if any, to the CW position. The noise, issuing from the speaker, did not come from outside. It was manufactured inside the receiver.

In case your receiver has been hissing at you it is easy to determine where most of the noise comes from. With gain controls full on try removing tube after tube, beginning with the rf amplifier, until the noise is sufficiently

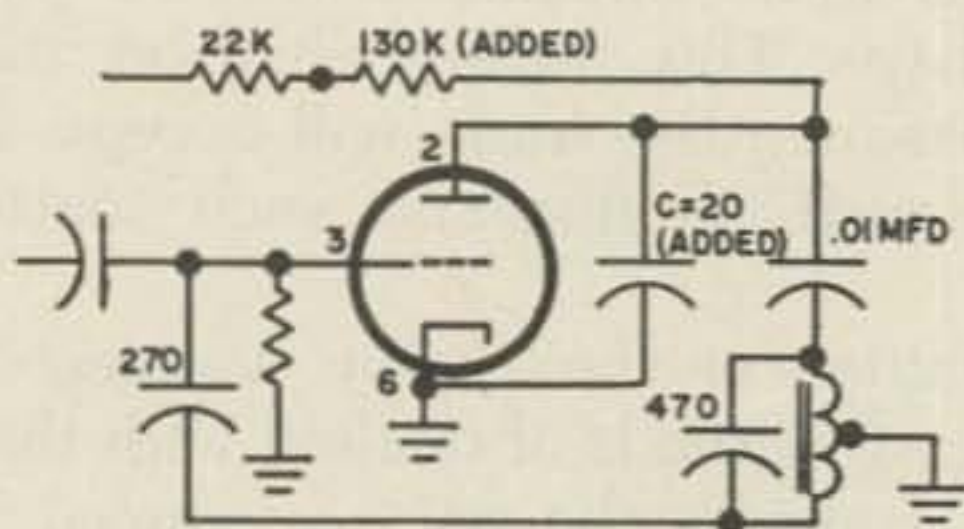

FIGURE 2

After adding resistor and condenser as shown retune pitch control to 455 KC by removing knob and turning shaft with pliers.

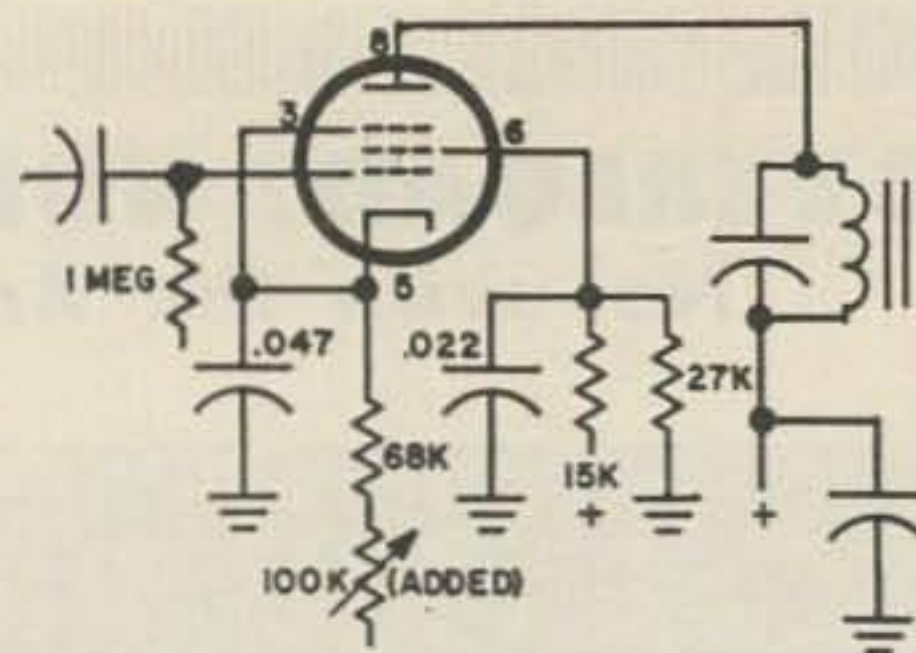

FIGURE 3

LI

After determining proper maximum and minimum values with the 100 K ohm variable resistor it should be replaced with a fixed resistor of the minimum value and a variable resistor in series with the proper value to cover the entire range. One of the gain controls may then be replaced with a dual control to enable the operator to make front-of-panel adjustments possible.

reduced to be acceptable. The noise reduction which usually follows the removal of the converter tube has led to the erroneous belief that little, if any, noise reduction will follow the use of better tubes or circuits ahead of the converter, especially on frequencies below thirty megacycles. Let us repeat, this belief is erroneous.

The studious investigator no doubt has observed that much of the noise seems to come from the bfo and from the converter. We acquired a second-hand SX99 which had been modified by the previous owner. Having this to work with we decided to find out if theory would be verified by actual experiment. For it became evident that this receiver, like many others, had been producing plenty of noise without outside assistance.

Let us re-examine the circuit of the BFO. We found it was feeding much too much power into the *if* strip. Enough, in fact, to block the receiver completely when the avc was turned ON. The "gimmick" capacitor was reduced to a minimum by cutting the lead from the bfo back to the shield braid and by placing a wire as a shield between this lead and the *if* transformer. Bfo output was reduced further by feeding voltage to it through 150K ohms instead of 22K ohms. Finally a 20 mmfd capacitor was connected between plate and cathode at the socket and the circuit then retuned to 455 kc. While this greatly reduced strong signals and also strong noise it had very little effect upon weak signals. Most evident of all, it reduced the hiss appreciably.

Since a large part of the noise appears to come from the bfo and the converter let us re-examine their circuits. Turning to the converter circuit it was noted that the suppressor grid, instead of connecting directly to the

cathode (as it should), was connected to the chassis. Since this violated two basic theoretical considerations it was cut loose from the chassis and connected directly to the cathode socket terminal.

Returning to a physical examination of the converter circuit, as modified by the previous owner, an OB2 had been installed to stabilize the voltage to plate and screen circuits and thus reduce drift. A 0.0047 mfd ceramic disc capacitor, which we connected directly across the OB2, resulted in still further quieting. However, this had the adverse effect of preventing the converter from functioning on the low frequency end of band four. It was found necessary to introduce a 1000 ohm isolation resistor between the OB2 and the converter circuits to restore it to normal.

We would like it known that noise reduction followed each change. This was evident to the ear as well as by the built-in S meter. Between changes a foot long antenna was connected in place of the short from antenna terminal to ground terminal. This was done to make sure that received signals were not being reduced along with the noise. Finally the receiver was connected to an outside vertical antenna, 22 feet high, for further tests under normal working conditions. Truly, we were amazed!

It was decided to carry decoupling of stages a bit farther than had been done at the factory. The rf amplifier stage was decoupled by adding a 0.5 megohm resistor in series with the 1.0 megohm connected to the control grid of the first tube. Then the junction of these two resistors was connected, through a 0.0047 mfd disc capacitor, to the tube cathode at the socket. Although this resulted in some further improvement, in some positions of the rf gain control the receiver would motorboat accompanied by flickering in the OB2. In spite of this (or perhaps because of this) we decided to similarly de-couple the first *if* tube.

Then the unforeseen occurred! We installed the second decoupler, using a 2.2 megohm resistor. When we tested the receiver, regardless of any adjustment we might make, silence reigned and the S meter indicated zero current. We were about to disconnect the receiver and open it up when a weak signal came from the loud speaker, but with absolutely no noise! Although we had anticipated a little noise reduction, we were unprepared for total elimination of noise as it seemed we had achieved. Upon turning both rf and audio gain controls wide open, however, many other stations leaped out at us, accompanied by very little

TIME TO GO MOBILE  
WITH WIDE CHOICE OF  
EXCELLENT  
NEW TRANSCEIVERS

GOOD MOBILES GO

HUSFLER

MOBILE ANTENNA  
10-15-20-40-75 - METERS

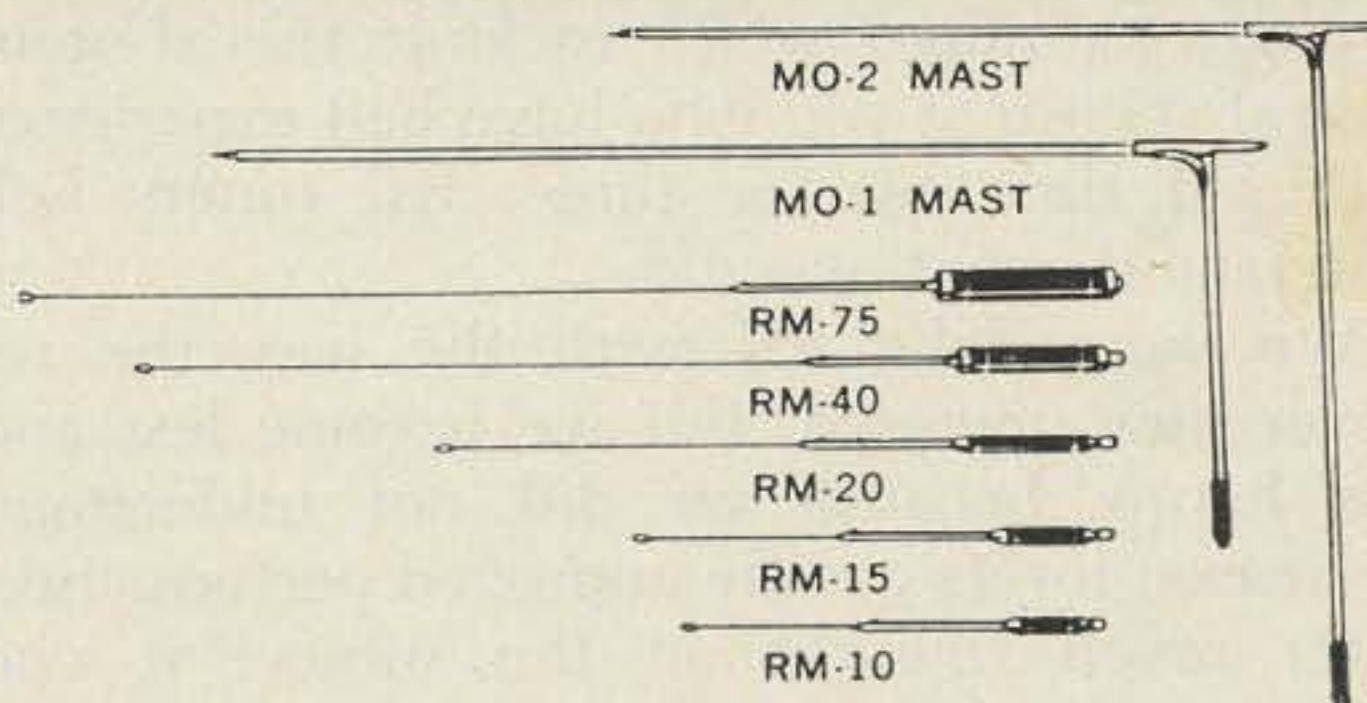

Buy only the mast and resonators for the bands you operate. NO NEED FOR MATCHING DEVICES, NO FEED LINE LENGTH PROBLEMS. Use any length of 52 ohm cable. New, efficient concept of center loading. Each resonator has a coil specially designed for maximum radiation for a particular band. Center frequency tuning is by an adjustable stainless rod in the resonator. The fold-over aluminum mast permits instant interchange of resonators. Mast folds over for garage storage. Mast has 3/8-24 base stud to fit standard mobile mounts, but will perform better with New-Tronic mounts. Power rating is 75 watts dc input A.M. - 250 watts PEP input for SSB.

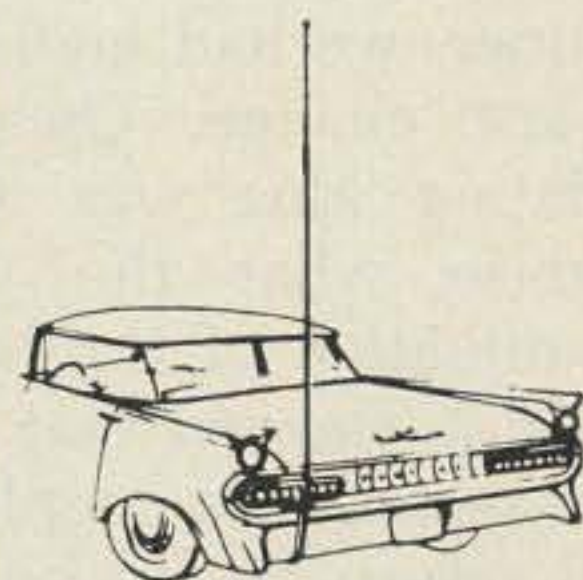

Mast and resonator in mobile position



Mast and resonator folded over

RESONATOR WILL WORK PROPERLY ONLY IF USED WITH MO-1 OR MO-2 MASTS. ANTENNA ASSEMBLY CONSISTS OF 1 MAST and 1 RESONATOR.

MODEL	DESCRIPTION	TOT. HGT. of ASSY.	NET
MO-1	54" mast folds at 15" fr. base	Rear deck or fender	\$ 7.95
MO-2	54" mast folds at 27" fr. base	Bumper	7.95
RM-10	10 meter resonator	80" max. - 75" min.	5.95
RM-15	15 meter resonator	81" max. - 76" min.	6.95
RM-20	20 meter resonator	83" max. - 78" min.	7.95
RM-40	40 meter resonator	92" max. - 87" min.	9.95
RM-75	75 meter resonator	97" max. - 91" min.	11.95

ANY MAST OR RESONATOR MAY BE PURCHASED SEPARATELY

Ask your distributor to show you these and other fine NEW-TRONICS products. Write for literature on the complete NEW-TRONICS line.

NEW-TRONICS CORP.  
3455 Vega Avenue Cleveland 13, Ohio

noise. We had stumbled onto a circuit that was bringing in signals from all over, with a minimum of noise.

Although we were using a loud speaker the volume left much to be desired. It would have been ample for headphone reception but we wanted to use a speaker and avoid being tied to the set.

We thought that the 2.2 megohm resistor was too large and that volume would be increased if a resistor of lower value were substituted. In order to learn its exact value a 100K variable was connected across the 2.2 megohm resistor. We were surprised to learn that the signal-to-noise ratio could be varied over a considerable range merely by turning the 100K rheostat very slowly in one direction through its range while rocking the rf gain control. Those of you who have had experience with old time two or three dial tuners will understand what we did.

We were delighted with the way the receiver now operated. But we became less and less happy because we did not understand the reason for its greatly improved performance. After much thought on the subject it was finally assumed that in some, as yet, unknown manner, we had goofed while making the next to last change. Once this unflattering, ego-deflating idea was accepted it was easy to surmise what the goof might have been. Examination of the base diagram of the tube, a 6SG7, showed that we must have connected our second de-coupler circuit, not into the grid return circuit but into the cathode return circuit of the tube. By making this goof we had unwittingly verified the theory by greatly reducing all B plus voltages, as measured from the cathode.

Close examination of the socket terminals showed us just how the goof had occurred. The manufacturer had joined terminals one and two together and connected both to the chassis as a unit. We had counted the two as one! What we had counted as pin terminal number four was actually number five!

The most outstanding improvement which came about as the end result of these various modifications, however, is this. Using a separate, small size receiving antenna, it is now possible to work break-in without other equipment of any kind. Another convenience is that we may now raise the gain to the limit without being assailed with a hiss like a steam locomotive letting off steam. Limiting the power of the bfo tends to limit strong signals to a point where they no longer prevent one from hearing DX stations. These latter come through much better, not having to compete with an overpowering beat frequency oscillator.

In conclusion we offer a word of advice to those who wish to profit by our experience. Should you decide to make any of these modifications to your present receiver, **MAKE BUT ONE CHANGE AT ONE TIME**. Then give your receiver a thorough test. This is because it is much easier to locate, and clear, one "goof" at a time than to find, and fix, many. Being human, we all make mistakes. The trick is to be able to profit by our mistakes.

Do not imagine that we have achieved the ultimate in noise reduction. This is only a small beginning. A whole unexplored field lies ahead for the researcher to delve into. We will continue experimenting and should further discoveries warrant publication, we will rush to the typewriter. . . . Gabus

---

## The Improved Challenger

Some time ago a Viking Challenger was purchased by WA6BXZ. After a considerable period of time it was evident that the 6DQ6A's used in the final and driver were subject to instability and overheating. In fact, one plate cap of a 6DQ6A driver melted off! It was decided to replace the 6DQ6A's with 6146's.

The conversion is quite simple, and involves only shifting the base connections from the 6DQ6A's to those of 6146's. New plate caps had to be purchased, however, since the heat-dissipating caps for 6DQ6A's do not fit 6146's. The original parasitic suppressors were re-

moved, since the heavy wire used could not be soldered to the new plate-caps, and new suppressors were wound, consisting of five turns of number 18 wire on 100 ohm two watt resistors.

Care should be taken to re-neutralize the driver and final stages after the conversion. If this is done properly the rig is a real improvement over the "stock" Challenger. There is plenty of grid drive on all bands, and the signal must be heard to be believed. The rig will load up to ratings and possibly higher.

. . . K6TBW

SINGLE  
SIDEBAND

# SBT-1K

TRANSMITTER SERIES

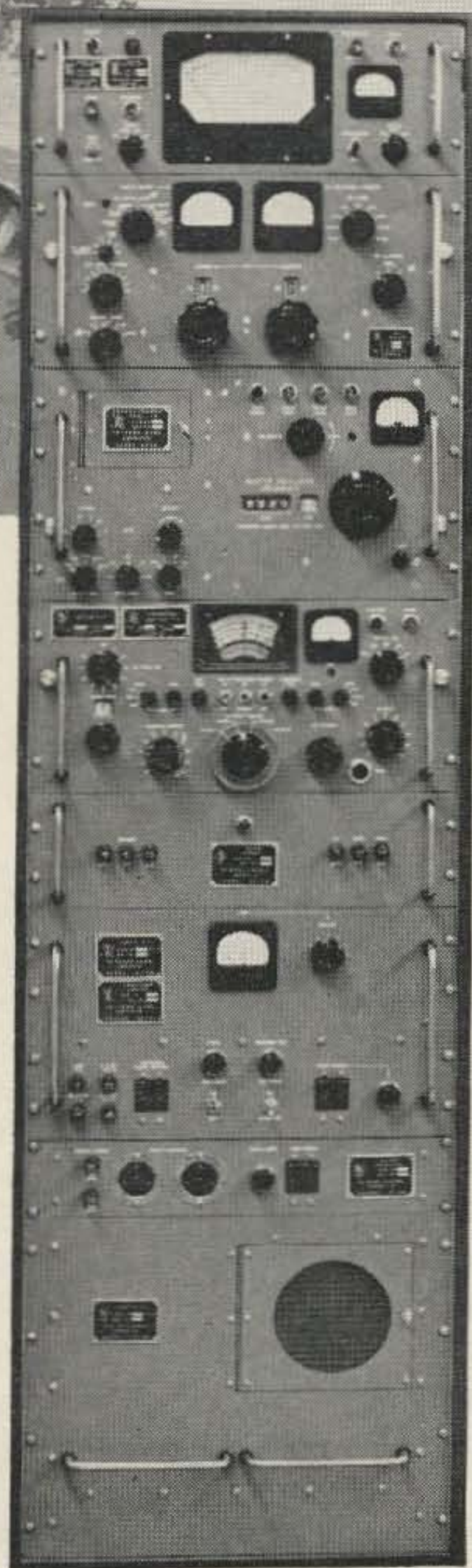

AN/FRT-53  
AN/FRT-56  
AN/FRT-57



AM · FSK · SSB · ISB · CW · FAX

TMC Models SBT-1K series of transmitters provide conservatively rated 1 kw PEP output in SSB modes, with Signal to Distortion ratio of 40db, and 1 kw average power in conventional communication modes within the frequency range of 2 to 32 Mcs.

Stabilities of 1 part in  $10^6$  to synthesized accuracy of 1 part in  $10^8$ , with 100 cps incremental tuning, are featured in this series of transmitters.

The TMC SBT-1K series of transmitters are attractively housed in semi-pressurized cabinets with many customer options for wide band or narrow band audio, antenna tuners, base mount or rugged MIL accepted shipboard mounts for all mobile applications.

For information on this transmitter series, request SSB number 1001.

## THE TECHNICAL MATERIEL CORPORATION

*and Subsidiaries*

OTTAWA, CAN. - ALEXANDRIA, VA. - GARLAND, TEX. - LA MESA, CAL. - POMPANO BEACH, FLA. - LUZERN, SWITZ. - SAN LUIS OBISPO, CAL.

# The Mark IV

## 60 Watt Six Meter Transmitter

The transmitter shown in this article is the end result of some five years of on-again off-again spare time work. Using the same chassis, the author has rebuilt, added on and modified the rig so often that about all that is left of the original rig (2E26-10w) is the front panel controls. This final edition, the Mark IV, runs 60 watts input on 6 meters, fully plate modulated.

### Circuit

The rf section of the rig consists of a 12BH7 harmonic oscillator-doubler feeding a 6146 run with about 500v on the plate. Eight megacycle crystals are used in the third overtone oscillator, the plate of which is tuned to 24mc by L1. The output of the oscillator then feeds a standard doubler stage tuned by C1 and L2. Under loaded conditions a good 4.5ma of drive is available for the 6146. Detuning C1 slightly will bring this down to the required 3.5 ma. The plate of the final is tuned by double spaced capacitor C2 and L4 and rf is coupled into the load by means of fixed link L5 and C3, a 100mmfd variable. The 10 ohm cathode resistor provides a small amount of self bias for the 6146. Both grid and plate meters are provided for the final. The two coils, L2 and L3, act as an rf transformer so that the doubler plate tank will "appear" to be in the grid circuit of the final, a condition necessary for neutralization. Were an rf choke substituted for L3 as is seen in some circuits, neutralization could not be achieved. Cn does the neutralizing.

The modulator design is straight forward and a close copy of one that appeared in the ARRL Mobile Manual.<sup>1</sup> That circuit would not supply sufficient power to fully modulate the 6146 at 60w input so I substituted a pair of 6L6-GC's for the 6L6's and upped the plate supply voltage to 450v. Lest some of you be aghast at applying such a high voltage to a pair of 6L6's

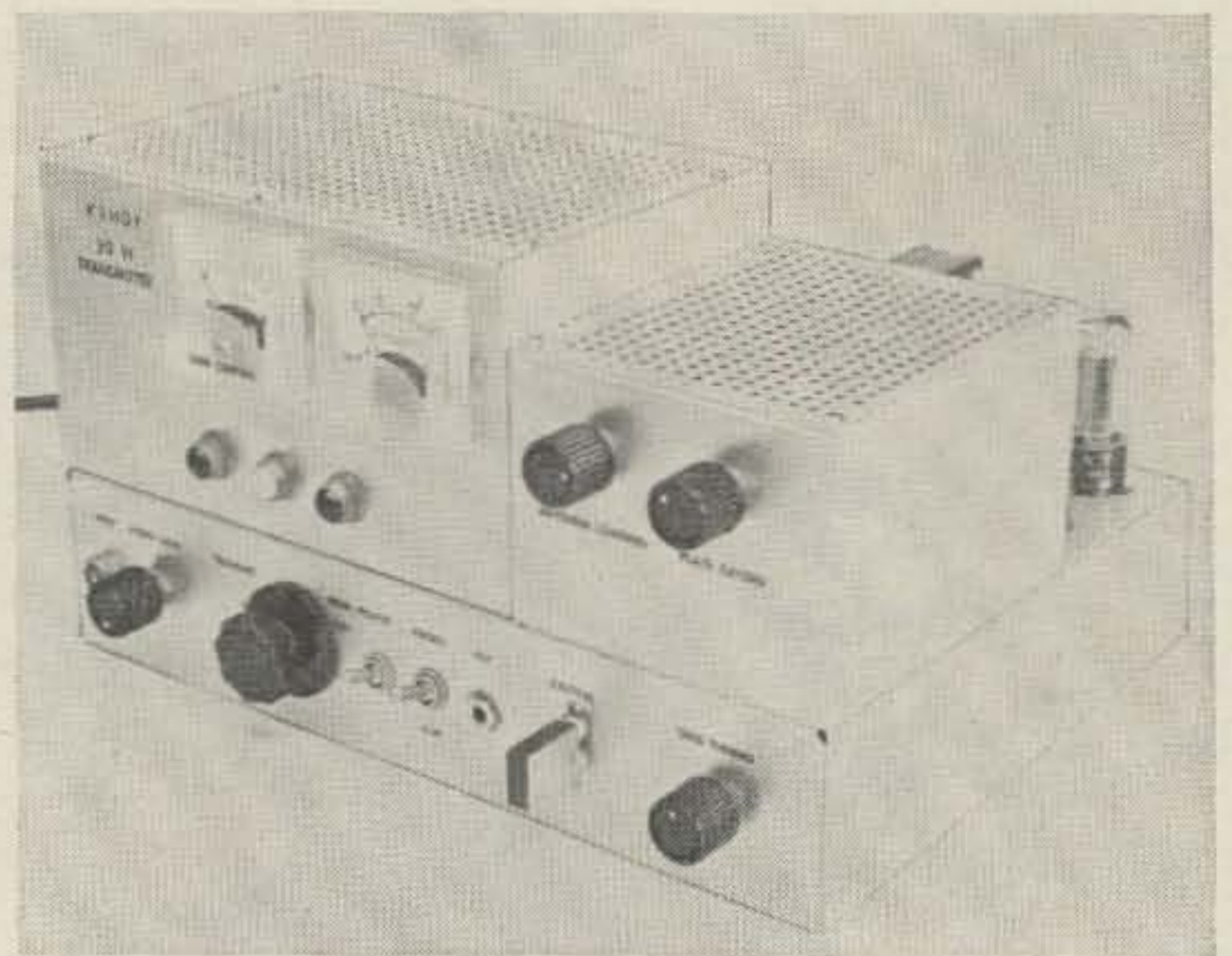

**Front View:** It should say 60 W on the panel, of course. The audio section is to the left (in the box with the meters and pilot lights on it) and the rf section in the smaller box on the right. Covers for the two boxes are cut from a sheet of Reynolds Do It Yourself Aluminum. The control labeling should be self explanatory. The right hand meter reads plate current.

let me hasten to explain. These 6L6-GC's have a new form of plate construction which allows them to have better heat conduction and radiation than the old style plates, hence the higher allowable plate voltages. In fact, GE claims that a pair of 6L6-GC's, operated with 450v on the plates and 400v on the screens will give 70 watts output in AB1.<sup>2</sup> A 125 watt transmitter could easily be modulated by a pair of these tubes driven by a single 12AX7. In this rig, the pair easily overmodulates the final and care must be taken to prevent this. Some form of negative peak limiter would be nice but the author has not had a chance to try anything like this.

Power is obtained from a self contained

<sup>1</sup> ARRL Mobile Manual, First Edition.  
<sup>2</sup> GE Ham News; Jan.-Feb., 1960.



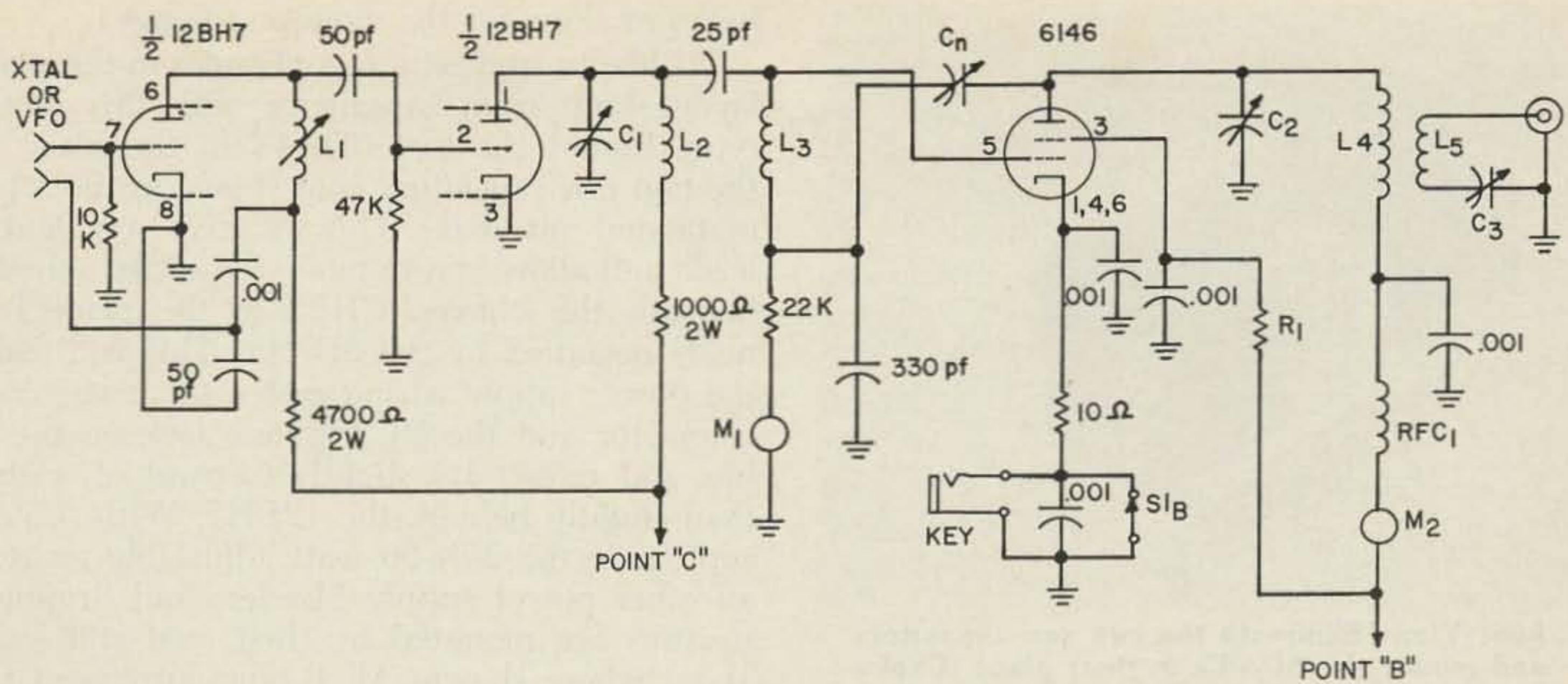

RF Section

"economy" type power supply using a 5U4-GB and a pair of 6DA4's in a bridge circuit. The power transformer (T3) was lifted from an old 16" television set as was CH2. Under load some 500v is obtained from the high voltage output and about 250 volts from the low voltage output. This low voltage output is used to feed the 12AX7 stages and operate the plate supply relay. Make sure that the transformer that you use is at least 375-0-375v on the high voltage winding. If it came from a large screen TV set the current ratings on the windings will be OK for this use.

You could easily omit the plate supply relay mentioned above, but I feel that it provides more positive control over switching than the rotary switch originally used which arced over badly a number of times. The relay contacts K1a and K1b have .01mfd capacitors across them for spark suppression. As the control circuit is set up now, the rotary switch (S2) controls the pilot lights, activates the control relay

and provides three spare sets of contacts (SPDT) which are brought out to a Jones terminal strip on the rear of the chassis. These extra contacts may be used to control an antenna relay, disable receiver B-plus, etc. The relay is mounted on a small "L" bracket near the 6DA4 sockets. You are not limited to this control circuit, of course. If you wish you may buy one relay with say a 6.3v ac coil, which will handle all the functions mentioned above and have push to talk. I like my method for fixed station use.

### Construction

The entire transmitter fits nicely on to a 10"x14"x3" aluminum chassis with the audio and rf sections enclosed in small aluminum boxes for shielding purposes. A bottom plate is attached to the chassis for the same reason. The 5"x6"x9" box holds the audio section and mounts the meters and the 6"x5"x4" box houses the rf section. Shielding is complete in this

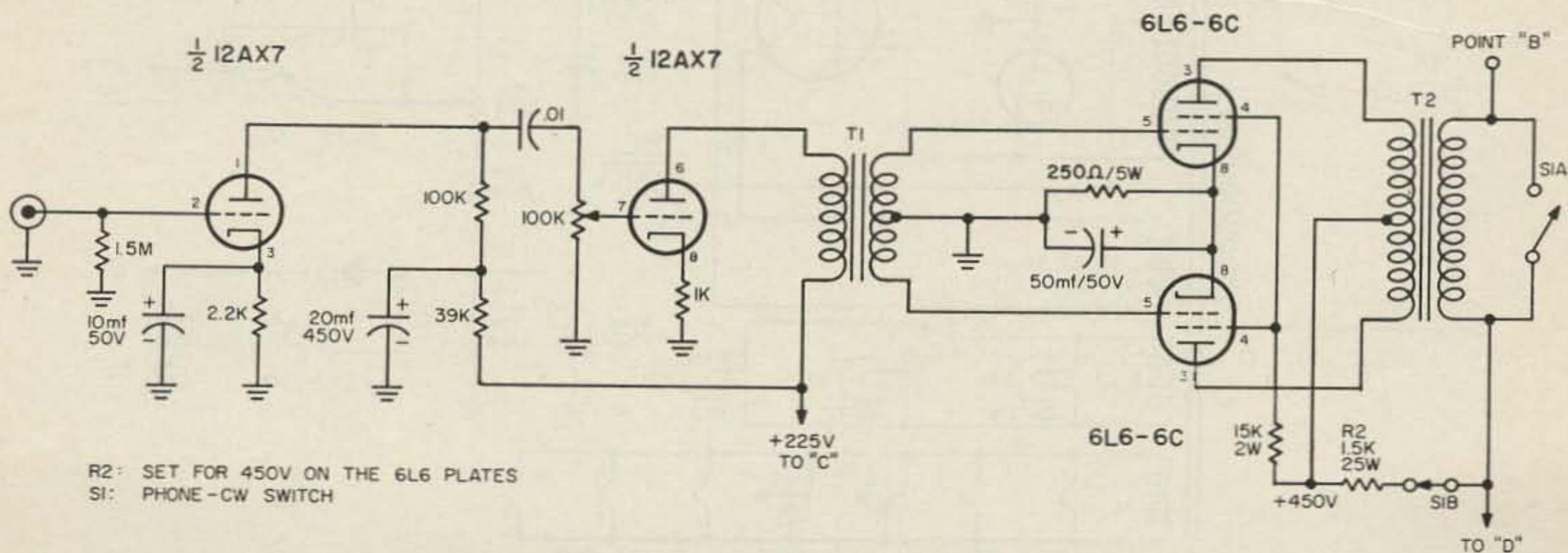

R2: SET FOR 450V ON THE 6L6 PLATES  
S1: PHONE-CW SWITCH

Audio and Modulator Section

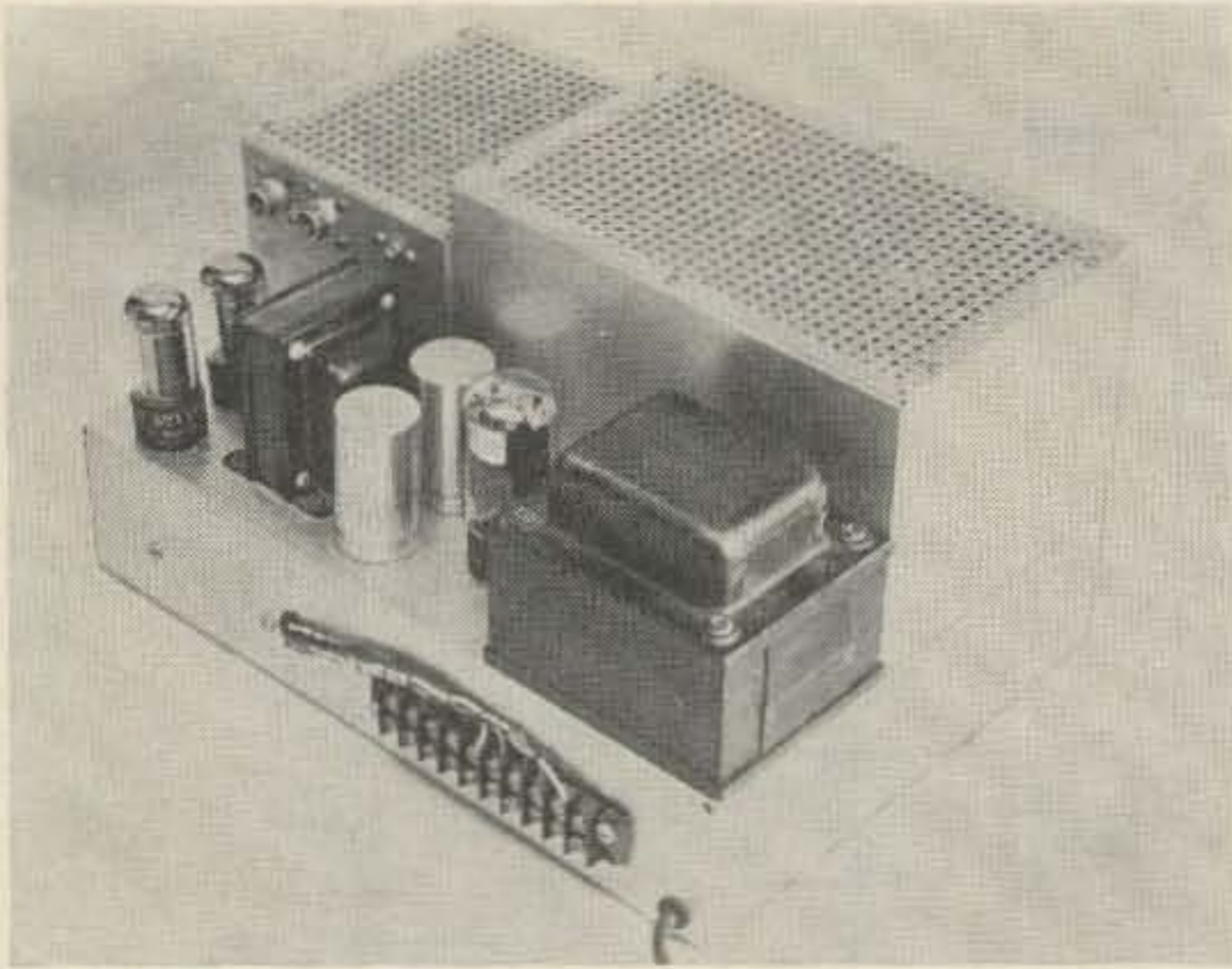

**Rear View:** Eliminate the two can capacitors and mount the 6DA4's in their place. Choke CH2 can then be mounted in place of the 6DA4's. The leads to the barrier terminal strip are all "dead" and run to the TR switch for external control purposes.

way and very little TVI has been experienced. Pieces cut from perforated aluminum sheeting are used as covers for the boxes to allow for good ventilation.

As you will notice from the photos, the chassis has a number of unused holes. This comes from all the rebuilding mentioned before. When you build the rig try to omit some of the more glaring things like that absurd hole the modulation transformer mounts in. I assure you, the rig will work just as well with a nice rectangular hole. Mount all of your large parts on the chassis after scribing lines on it to indicate the boundaries of the boxes (Don't forget to do this on the inside as well as the outside of the

boxes to allow for the mounting flange).

I'd like to suggest a few changes in the parts layout born from experience with this prototype. Mount the two 6DA4's in the place of the two can capacitors (not shown in the schematic and not used). This will give you shorter leads and allow you to move the choke (shown beneath the chassis—CH2) to the place formally occupied by the 6DA4's. This will make the power supply wiring easier. Omit one coax connector and the RCA phono jack on the rf box and mount L1 slightly forward of, rather than slightly behind, the 12BH7. With the exception of the 25K-50 watt adjustable resistor, all other power supply bleeders and dropping resistors are mounted by their own stiff leads about where shown. All B-plus outputs of the supply are brought to a terminal strip near the center of the chassis.

Wire up the rig, section by section, beginning with the power supply. Some 800v should be obtained under no-load conditions. Do the rf section next. As each section is completed it can be checked out separately—using a grid dipper and a 50 mc receiver. when the oscillator is running and stable, putting a finger on the crystal or near the plate tank should cause only a slight shift in frequency. Listen on a receiver at 50 or 24 mc with the bfo on. If the oscillator proves to be unstable, decrease the feedback by increasing the 50mmfd capacitor slightly. This should not be necessary since the circuit appears to be quite stable with respect to tube changes, etc. Keep your leads as short as possible and keep the rf leads away from the

#### POWER SUPPLY AND CONTROL CIRCUITS

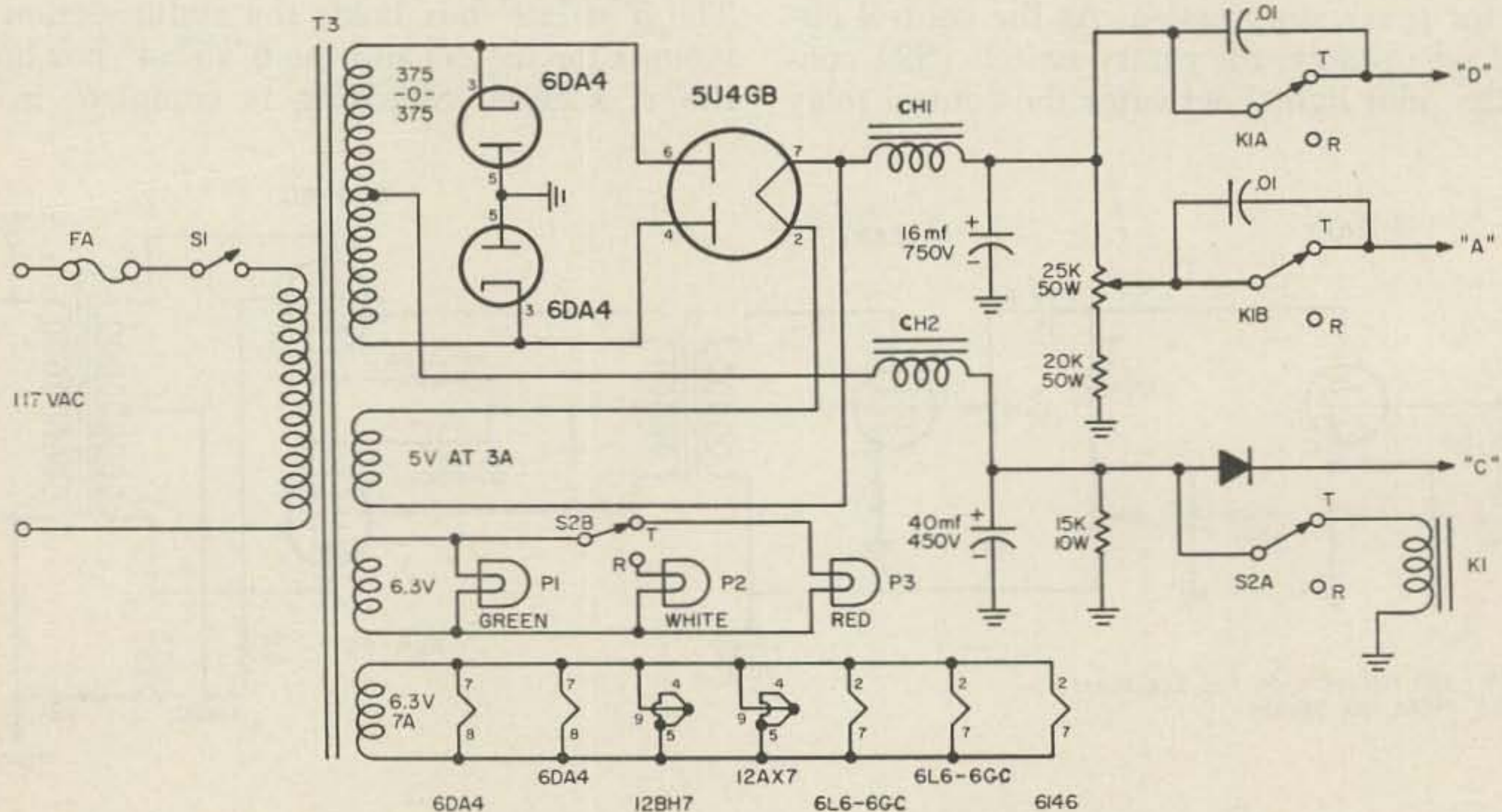

T. MCGIRT

# **SWAN SW-240 THREE BAND SSB** **TRANSCEIVER FOR 20-40-75 METERS**



## THE ULTIMATE IN TALK POWER AT LOW COST

with proven reliability... highest quality...  
superior craftsmanship.

**MATCHING POWER SUPPLIES!**

Model SW-12DC (transistorized)

\$115

Model SW-117AC, with matching cabinet and speaker \$95

**\$320**



**SWAN**

ENGINEERING CO.

Oceanside, California

chassis. Filament and metering lines in the section are all run in small diameter shielded mike wire. The output link is constructed by slipping a 4" piece of non-plastic spaghetti over a piece of hookup wire and winding two full turns over the cold (B-plus) end of L4. Make sure the spaghetti you use will not melt. It gets warm in there. Twist the two leads to hold the link in place. You should be able to slide this coil up and down L4 about  $\frac{1}{4}$ " to adjust coupling. Resistor R1 is made up of two 100k, 2 watt and two 470k, 2 watt resistors all connected in parallel. When testing this section from the internal supply, series resistors will be needed in the B-plus leads to keep the voltages down. The 6146 should receive from 500 to 550 volts and the osc-doubler stage about 300v. Coils L2 and L3 must be spaced very closely because the drive is highly dependent upon the coupling between them. I got over 5 ma with the circuits peaked. Anything over 4 ma is sufficient. Neutralization is accomplished in the usual manner by removing B-plus from the final and adjusting Cn until the grid current shows no flicker as the plate tank is tuned through resonance. Under normal conditions, with 500v on the plate and 3.5 ma of drive, plate current will be 110 to 120 ma for 60



Columbia Products Co.  
Columbia, South Carolina

*Shakespeare*  
**WONDEROD**  
fiberglass  
antennas

—recognize us  
in Marine green?

Your own WONDEROD shares the  
same know-how and construction  
that designed and produces the  
AT-1011/U for the U. S. Marine Corps.



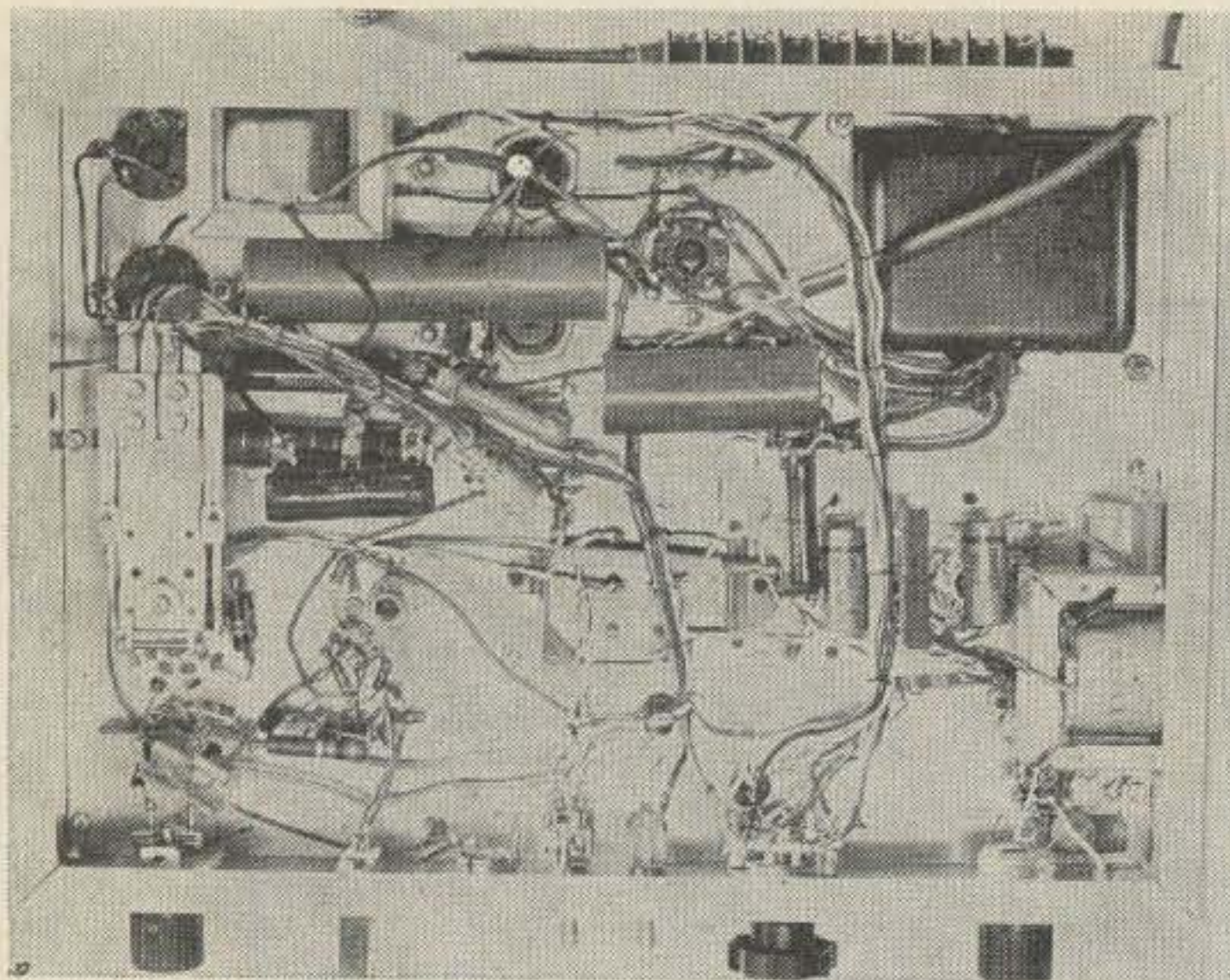

**Bottom View:** The audio driver transformer is mounted in the upper left hand corner just below the 12AX7 driver stage. Choke CH2 (lower right of the chassis) should be moved to the top of the chassis and L1 moved slightly forward to shorten its leads as suggested in the text. The neutralizing capacitor now resides on the terminal strip just below the grid tuning capacitor. The screen resistor of the 6146 (near the upper left hand corner of the relay) is now two 470K-1w and two 100K-2w resistors in parallel. The filter capacitors are mounted by their own leads as shown and the decoupling capacitor for the audio stages is placed below the audio driver transformer.

watts input. Without drive the current rises to well over 150 ma. The audio section is wired next and no special precautions are necessary. It would be a good idea to wire the 12AX7 socket before the driver transformer is mounted though. The phone-CW switch is also wired in now and the entire unit tested. With 450v on the plates of the 6L6-GC's screen voltage is 400v and cathode voltage is 33v. 100% modulation occurs with the gain control half open when close talking the mike in a normal tone. Before putting the rig on the air you should put the output on a 'scope so that you will know at exactly what point overmodulation occurs with your mike and voice.

As you can see from the photos, I have made liberal use of surplus parts and components. Scavenge an old TV set for the power supply parts and go through whatever surplus houses you have available for the audio transformers and such. At the time of writing, the modulation transformer (I used a Collins 7R3, nominally 20 watt job) was available for two bucks, the driver for 97 cents and 6146's were going for about \$1.80 in the New York Cortlandt Street area. These items represent the major cost of any transmitter and buying them surplus (and using TV set parts) will keep the cost of this rig way down. Inexpensive meters

help too. You'll probably have to buy the 6L6-GC's new.

That just about covers it. I have had good success and pleasing reports using this rig on 6. Even into an indoor dipole it was rare not to have a comeback when I went on. It appears that even in this day and age 50 watts is quite a bit of power on this band. TVI has been practically nil on a color set whose antenna is only 15' from the transmitting dipole. Give the rig a try, I think you'll like it. Oh yes, if you want to use a VFO with the rig, feed the 8 mc signal into the crystal oscillator between the grid and ground, not between the crystal socket pins.

. . . K2HQY

#### PARTS LIST

In addition to the small parts shown on the three schematics the following items are required. Coil data is included

- L1—16 turns #30 enam. on National XR-91 Coil Form (3/8" dia.-slug tuned)
- L2—5 1/4 turns 16 TPI 5/8" dia. B&W #3007
- L3—7 turns 16 TPI 5/8" dia. B&W #3007
- L4—4 1/2 turns 8 TPI 3/4" dia. B&W #3010
- L5—2 turns hookup wire tight wound on cold end of L4
- C1—15 mmfd. miniature variable Hammerlund HF-15
- C2—15 mmfd. miniature variable Double spaced HF-15X
- C3—100 mmfd. miniature variable HF-100
- Cn—Use standard 8 mmfd. variable with airgap sufficient to handle 1200 to 15,000 sudras E. F. Johnson 160-104 1.8 → 8.7 mmfd.
- M1—0-5 ma. Shurite MT-317
- M2—0-150 ma. Shurite MT-323
- T1—Interstage Transformer Chicago Standard IN-16 or Equiv. Ratio pri; entire sec., 1:3
- T2—#30 watt modulation transformer 1 :1 ratio. Surplus or use UTC S-19
- S1—DPDT toggle switch
- S2—6 pole, 2 position ceramic rotary switch. Centralab 2019
- T3—TV Power transformer. Salvage from old TV set or use Stancor P-6315
- CH2—Exact value unknown (removed from TV set). Can use hy at 75 ma
- CH1—5 hy. 200 ma choke
- K1—Hi-voltage Relay Coil resistance (dc) 10K. Requires 3 make contacts. 6.3v ac relay off filament line would work as well
- Misc: Three pilot lamps, #47 bulbs, knobs, hardware, mike connector, tube sockets, plate cap for 6146, Jones barrier strip, terminal strips, Key jacks, 10x14x3 inch aluminum chassis, 5x6x9 aluminum cabinet, 4x5x6 inch aluminum cabinet XR-91 coil form

#### FOREIGN SUBSCRIPTIONS

The foreign subscription rate to 73 is \$4.00 U. S. per year, however we will accept cash or checks in foreign funds at the following rates:

Canada	\$3.75	Germany	16 DM
Mexico	\$44	Hong Kong	\$23
Austria	115 sh	Italy	2500 Lx
Australia	36/	Netherlands	14.50 F1
Belgium	200 BF	Norway	29 NKr
Denmark	27.60 DKr	Portugal	1150 Es
England	28/6	Spain	200 Ptas
Finland	1.42 FM	Sweden	20.80 SKr
France	20 NF	Switzerland	17.50 SFr

# 1st Choice Among Nation's Amateurs!



## Matched Pair

Outstanding performance on SSB, AM and CW with absolutely no compromise on any mode!

**"SSB ADAPTER"**—The new filter-type SSB generator—with bandswitching 80 through 10 meters . . . more than 50 db sideband suppression . . . more than 45 db carrier suppression! When used with the Viking "Valiant" or "Valiant II" it places 275 watts P.E.P. at your command. Two compact units and interconnecting cables . . . RF unit is only 8" wide—may be placed on your operating desk. Power supply unit may be placed in any convenient location. Features built-in multiplier requiring VFO input only—band-pass interstage couplers require no tuning—design and front panel make operating practically fool-proof. Superb audio fidelity and balanced audio response; excellent sideband, spurious and carrier suppression. Other features: positive VOX and anti-trip circuits with built-in anti-trip matching transformer and adjustable VOX time delay. With remote power supply, tubes and crystal filter, less microphone.

Cat. No. 240-305-2—Wired, tested . . . . . Net \$369.50

**INVADER**—More exclusive features than any other Transmitter/Exciter on the market today! Specially developed high frequency, symmetrical, multi-section band-pass crystal filter for more than 60 db sideband suppression—more than 55 db carrier suppression! Instant bandswitching 80 through 10 meters—no extra crystals to buy—no realigning necessary. Delivers a solid 200 watts CW input: 200 watts P.E.P. SSB input; 90 watts input on AM! (25-30 watts output—upper sideband and carrier). Built-in VFO—exclusive RF controlled audio AGC and ALC (limiter type) provide greater average speech VOX and anti-trip circuits. Fully TVI suppressed. Self-contained heavy-duty power supply. With tubes and crystals.

Cat. No. 240-302-2 Wired, tested . . . . . Net \$619.50

**INVADER 2000**—Here are all of the fine features of the "Invader", plus the added power and flexibility of an integral linear amplifier and remote controlled power supply. Rated at a solid 2000 watts P.E.P. SSB, 1000 watts CW, and 800 watts AM! (250 to 300 watts output—upper sideband and carrier.) Wide range output circuit (40 to 600 ohms adjustable). Final amplifier provides exceptionally uniform "Q". Exclusive "push-pull" cooling system. Heavy-duty multi-section power supply. With power supply, tubes and crystals.

Cat. No. 240-304-2 Wired, tested . . . . . Net \$1229.00

**HIGH POWER CONVERSION**—Take the features and performance of your "Invader" . . . add the power and flexibility of this unique Viking "Hi-Power Conversion" system . . . and you're "on the air" with the "Invader 2000". Wired, tested, includes everything you need—no soldering necessary—complete conversion in one evening.

Cat. No. 240-303-2 . . . . . Net \$619.50

**"VALIANT II"**—Outstanding flexibility and performance—bandswitching 160 through 10 meters—delivers 275 watts input CW or SSB (with auxiliary SSB exciter or Viking SSB adapter) and 200 watts AM! Low level audio clipping—differentially temperature compensated VFO provides stability necessary for SSB operation! High efficiency pi-network tank circuit—final tank coil silver-plated. Other features: TVI suppression; time sequence (grid block) keying; high gain push-to-talk audio built-in low pass audio filter; self-contained power supply; and single control mode switching. As an exciter drives any popular kilowatt level tubes and provides quality speech driver system for high power modulators. Provision for plug-in SSB operation with no internal modification. With tubes, less crystals.

Cat. No. 240-105-1—Kit . . . . . Net \$375.00

Cat. No. 240-105-2—Wired, tested . . . . . Net \$495.00



**E. F. JOHNSON COMPANY**  
WASECA, MINNESOTA, U.S.A.

## SSB TUBES DON'T JUST HAPPEN



From its radiation-cooled graphite anode and all-glass envelope, to its unique internal structure, the new Amperex 8179 Tetrode was designed from concept through accomplishment to be a better SSB linear amplifier than any other tube ever before available in its power class.

## THEY

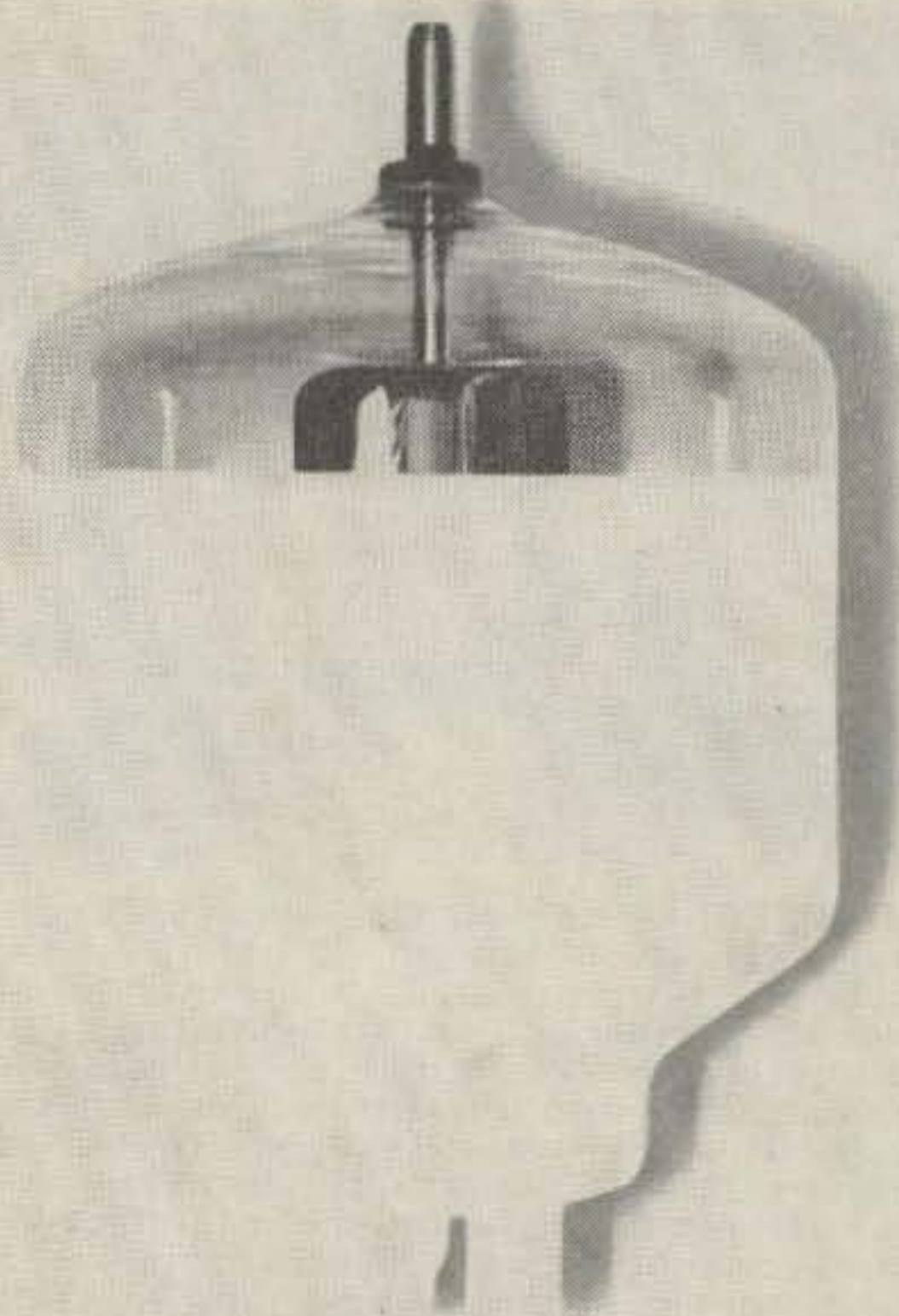

How well Amperex has achieved its objective is expressed in the significant facts that the 8179 will provide **more power, with lower intermodulation distortion, at higher operational efficiency** than ever before attainable in SSB linear service—and we mean **linear!**

The highly efficient heat radiation properties of the 8179 eliminates the need for costly, space-consuming cooling fans, blowers and related accessories. The tube incorporates a thoriated tungsten filament with high reserve emission rated at 7.5 volts and 22.6 amperes.

HAVE TO BE



DESIGNED  
FOR SSB



Class AB<sub>1</sub> Grounded Cathode Linear RF Amplifier  
Single Sideband Suppressed Carrier Operation

Typical Operation at 2 Kw PEP Input

DC Plate Voltage .....4000 volts  
DC Grid No. 2 Voltage .....600 volts  
Zero Signal DC Plate Current .....150 Ma  
Max. Signal DC Plate Current .....515 Ma  
Max. Signal DC Grid No. 2 Current .....115 Ma  
Tube Efficiency at Peak of Envelope .....68%  
Average DC Plate Current (two tone test) ..360 Ma  
Average DC Grid No. 2 Current

(two tone test) .....60 Ma  
Peak Envelope Plate Power Output ...1410 Watts  
3rd Order Intermodulation Distortion .....34 db  
5th Order Intermodulation Distortion .....38 db

For complete data on this and other transmitting tubes, write: Amperex Electronic Corporation, Communication and Industrial Tube Department, Hicksville, Long Island, New York.



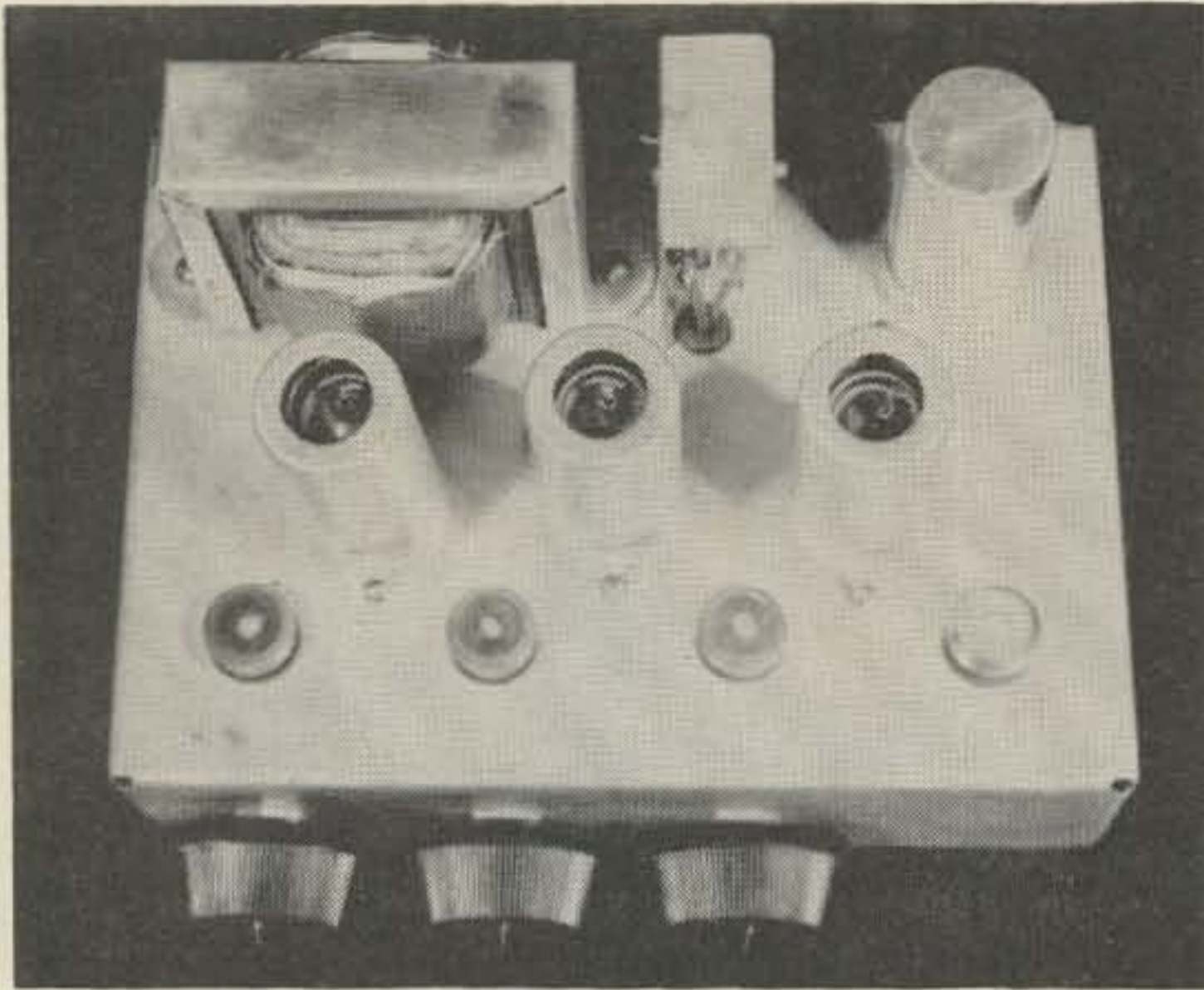

73  
*Parts Kit  
 Available*

## A Multi-channel Pre-amp

Donald Wiggins W9CWG  
 807 Lincolnway  
 Valparaiso, Indiana

The pre-amp described here evolved as a result of having several transmitters on different frequencies, each with its own microphone or needing the microphone already tied to another transmitter. It was reasoned that with one pre-amp stage feeding several cathode-follower stages one microphone could be used on the operating table with each

cathode-follower connected to a different transmitter. The low impedance of the cathode-follower would match the input of the two meter FM transmitter, this being one of the obsolete commercial two-way units, made obsolete by the FCC's so-called "split channel regulations." Most manufacturers of mobile two-way radios designed around the carbon

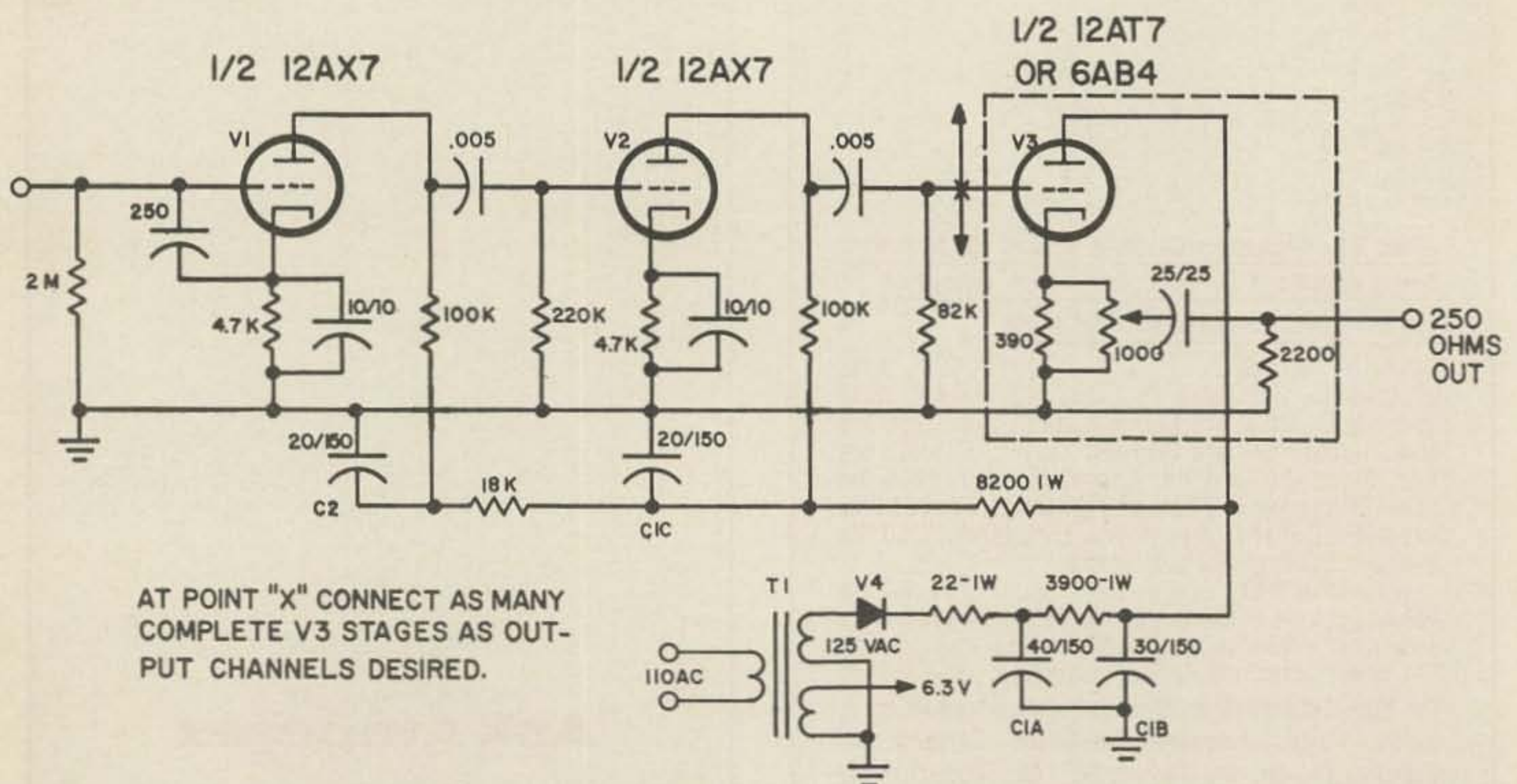
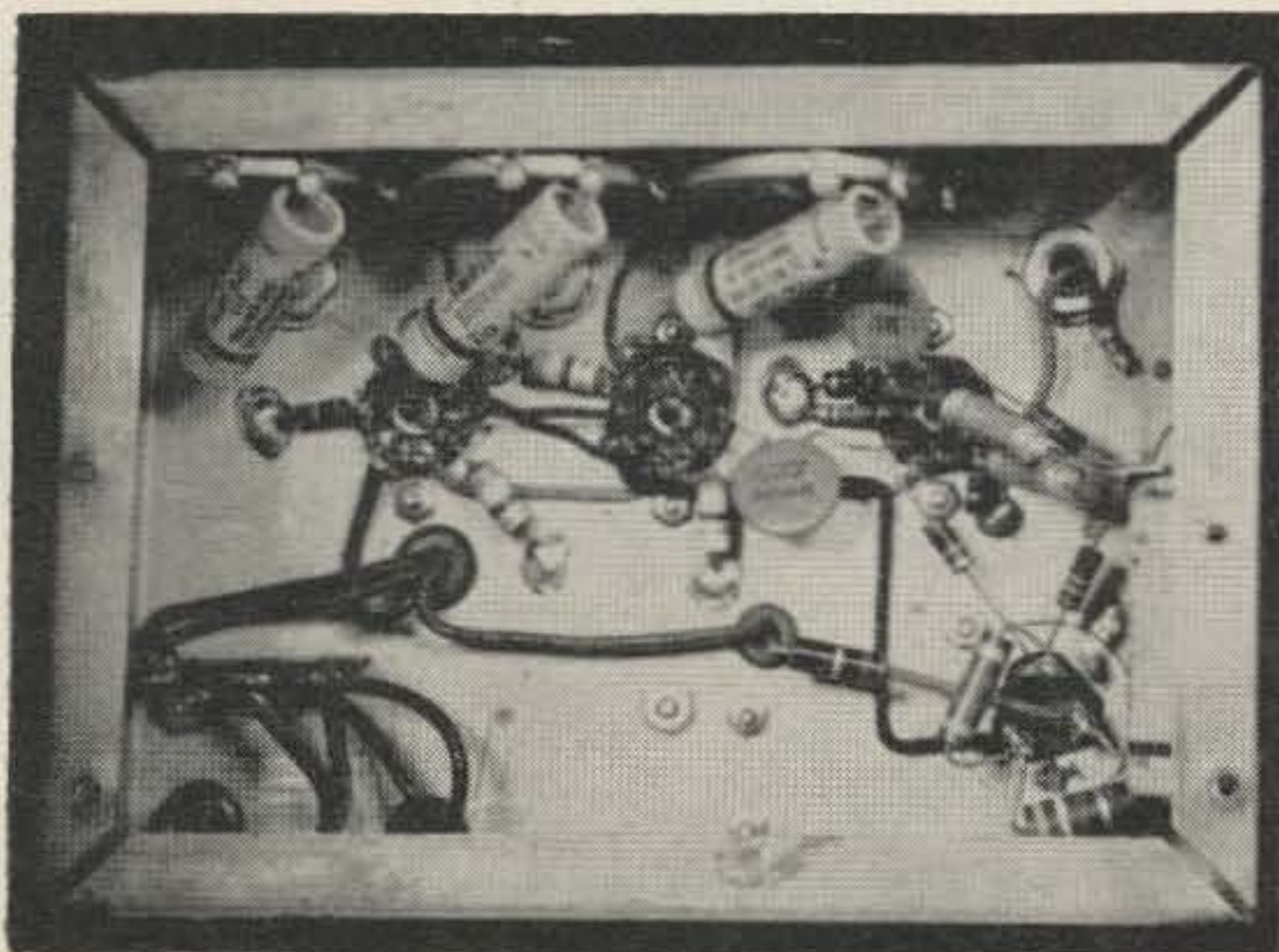

FIG 1



microphone in the days prior to the transistorized dynamics now available. Also, the low impedance can be connected directly to the high impedance microphone inputs of most ham transmitters with a minimum of hum pickup problems. A word to the wise here. Use conventional shielded cables and wiring techniques when tying into any transmitter. Why ask for trouble?

The circuit and wiring of the unit is straightforward in all respects, as evidenced by the schematic and photos. The 12AX7 stages are used in conjunction with as many V3 stages as your particular application requires. The gain control in each V3 stage cathode permits adjusting the individual channel gains as required. Here, 1k pots were available so they were used in parallel with a 390 ohm to give the proper value of bias resistance. 250 ohm pots could be used if they must be purchased.



Interstage coupling was chosen to cause considerable low frequency rolloff. As shown in Fig. 2 the response is down approximately 18 dbm below the mid-frequency range. The mid-frequency output level is -8.5 dbm or approximately 0.3 volts. This level is more than adequate for transmitters previously using carbon microphones. Coupling capacitors could be changed from those shown if a different frequency response is desired. In my particular case, other operators objected to the excessive bass response in the original model. A standard input level of -50 dbm was used. Hum and noise measured 52 dbm below max output level. The transmitter audio characteristics are relied upon to give the necessary high frequency roll-off.

As noted in the schematic, no off-on switch was used. This unit is mounted under the operating table since after it is initially adjusted no further access to it is needed. It runs all the time that power is turned on to the operating table. Its very small power con-

## ROHN Superior Design

### CRANK-UP TOWERS



#### Versatile • All-Purpose

**ROHN** Crank-Up Towers are especially engineered for amateur and experimental use. They represent the finest, most practical towers of their kind available. **ROHN** Crank-Ups feature (1) construction of welded steel; (2) hot-dipped galvanizing **after fabrication** throughout; (3) special roller guides between sections on SD & HD Series to eliminate friction for smooth raising and lowering. Also, **ROHN** towers assure uniform structural strength **regardless** of tower extension from highest to lowest height! Available in 37', 54', 71', 88', 105' and 122' heights. Prices start at less than \$100.

Also available are **ROHN** communication and microwave, TV reception, amateur radio and general purpose towers for all heights to 800'; telescoping masts and roof towers; and complete accessories including microwave passive reflectors and lighting equipment.

WRITE FOR FREE LITERATURE AND FULL FACTS AS TO WHY **ROHN** CRANK-UPS ARE BEST! See for yourself before you buy.

## ROHN

Manufacturing Company

P. O. Box 2000 • Peoria, Illinois

"World's largest exclusive manufacturer of TV-Communication towers - Representatives world-wide"

### 6 METER BARGAIN

Assembled, tested, and guaranteed! 5 watt 50-54 mc. printed circuit transmitter complete with 6AU8 tube and crystal only \$6.00 ea. ppd.

Matching modulator with 12AX7 and 6AQ5 tubes also only \$6.00 ea. ppd.

**VANGUARD ELECTRONIC LABS** Dept. H-5  
190-48—99th Ave. Hollis 23, N. Y.

TONS OF AMATEUR EQUIPMENT IN STOCK

## WESTERN RADIO

SAN DIEGO

1331 India Street

BE 9-0361

MON - FRI 8:30 to 8:00

SAT 8:30 to 5:00

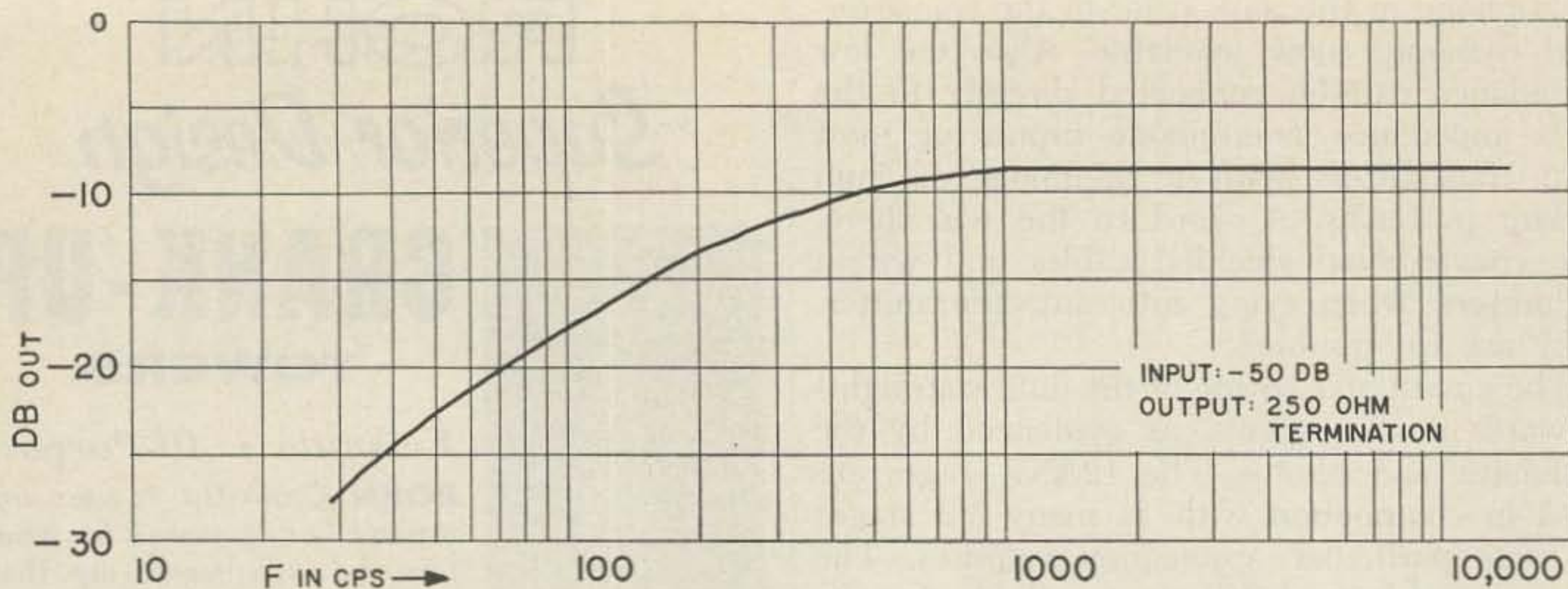

FIG. 2

sumption is negligible even if you happen to be operating CW.

The choice of power transformer, T1, will depend on how many output channels are required. Base this choice on the basis of 0.3 amps of filament for each 12AT7 or 0.15 amps of filament for each 6AB4. The 12AX7 also requires 0.3 amps. Select the transformer having adequate filament current rating.

... W9CWG

Parts List

All resistors are half-watt unless otherwise stated.  
 T1—Stancor PS-8415 or PA-8421. See text for selecting proper transformer.  
 V4—50 ma selenium or silicon diode  
 C1—40-30-20 ufd, 150 volt electrolytic  
 All other parts should be self explanatory.

73 Parts Kit

You want to build one of these don't you? Well, we have a little box of parts that will make building this a snap . . . includes tubes, sockets, power transformer, diode, condensers, resistors, potentiometer, etc. Catalog price is \$14.15. KIT W9CWG-1 . . . \$12.00

## Modifications of Vibroplex Bugs

The easiest to modify for the "Do It Yourself" is the type of "Bug" using the solid-cast pivot housing.

The following ten step by step method is easy to accomplish with simple tools:

(1) Remove spring and vibrating arm from armature by filing the heads off of the two rivets and forcing out with a punch.

(2) Buy or fabricate a contact similar to

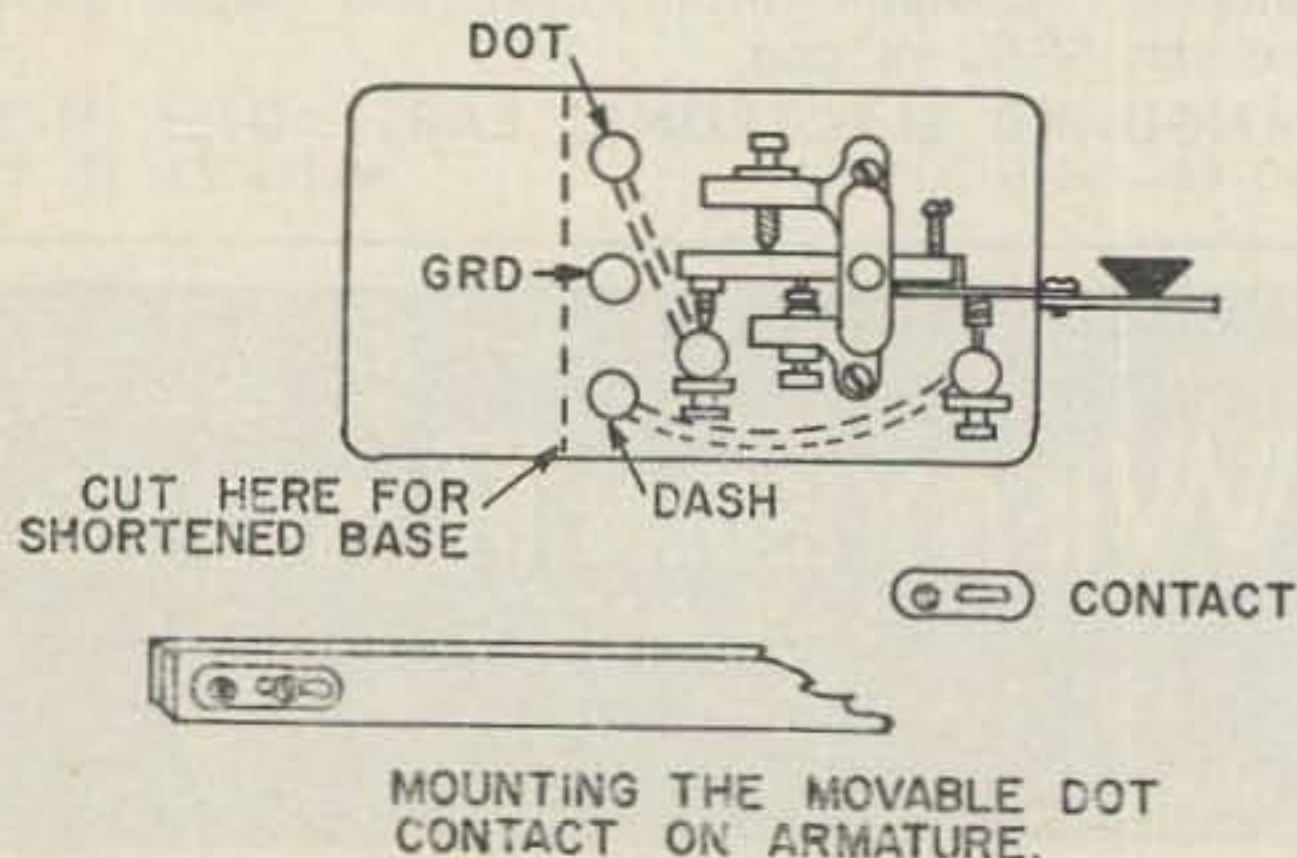

the one used for the moveable dash contact (an old antenna relay contact is fine).

(3) Drill and tap the armature for 6-32 screw so that the contact will be as close as possible to the end of the armature on the left rear side.

(4) Cut the left hand arm of the pivot housing frame between the dot stop and the tension spring. This makes clearance for the repositioning of the stationary dot contact.

(5) Drill holes for the new stationary dot contact and for the grounded (base) binding post. (See diagram).

(6) Cut stationary dot contact support post to match the height of the dot contact on armature, mount in position with insulated sleeve and washers. Connect to insulated binding post on right side of base with short brass connecting strip under base.

(7) Mount insulated binding post in previ-

ous stationary dot contact hole. Use long connecting strip from dash contact after shaping it to clear new dot contact mounting screw.

(8) Mount uninsulated binding post between insulated dot and dash bp. Clean top and bottom of base down to bare metal and use star lockwasher for good electrical contact.

(9) If desired cut base behind binding posts and re-mount rear rubber foot.

(10) Total cost: 1 contact \$.25, one binding post \$.25.

... W2CDJ

more use

for the

## Knockout Punch

Many users of screw actuated, knockout punches may not be aware of their utility in cutting plastic and fiber material. Such punches are widely used for metal chassis work but their use often stops there.

Some insulation material, such as laminated Bakelite, is especially processed for superior punching characteristics. Printed circuit stock is a good example of this. Try a sample hole in a piece of scrap first. Some plastics, such as Lucite, will not punch without cracking while others will cut cleanly. Masonite hardboard, in both the  $\frac{3}{8}$ " and  $\frac{1}{4}$ " thicknesses, cuts nicely.

Give it a try. The punches work well with most materials. One word of warning: Be careful with small pieces of thin work. If there is insufficient material around the hole, the beveled cutting edge of the punch may bend and crack the more brittle plastics. ... W4WKM

# Cush Craft "BLITZ BUG" COAXIAL LIGHTNING ARRESTER

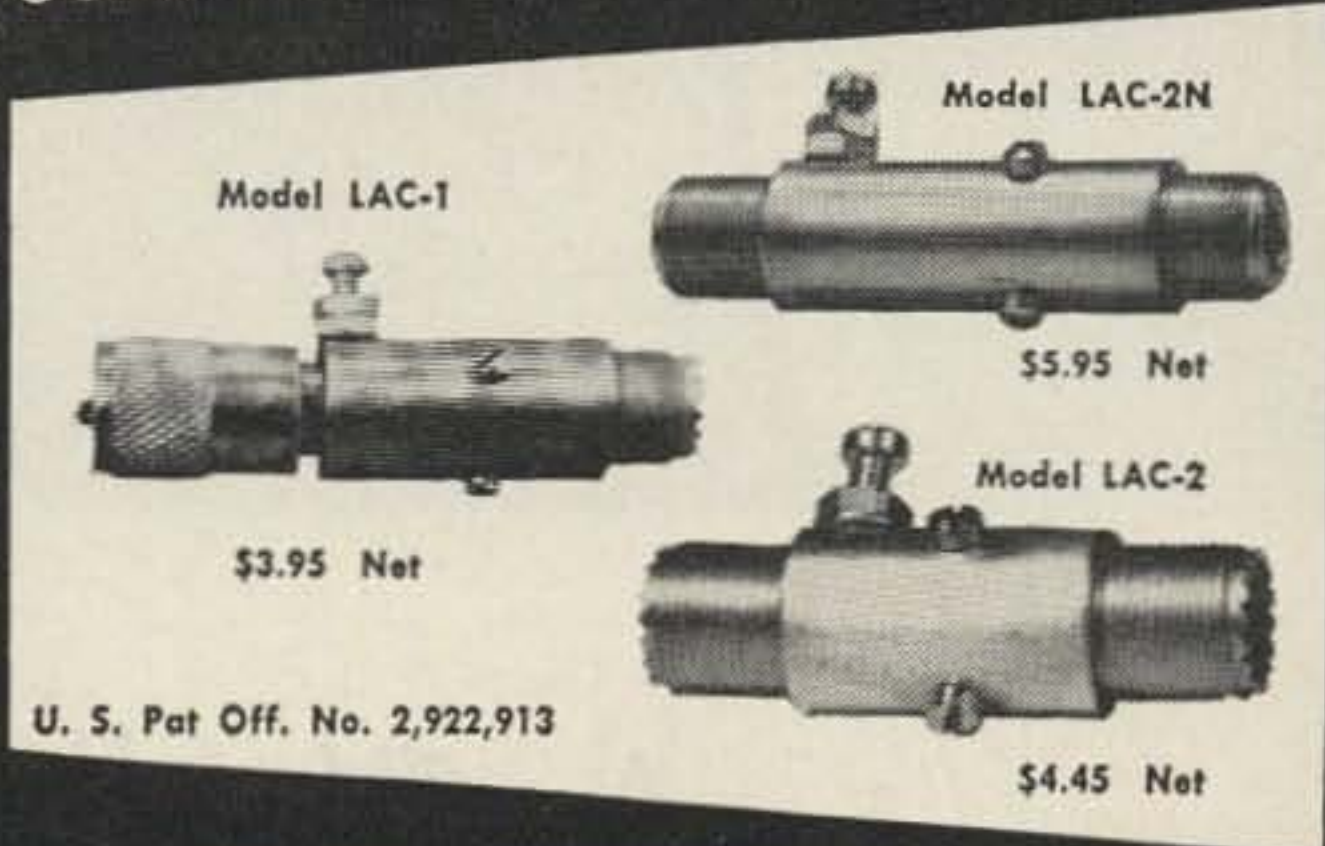

**LIGHTNING PROTECTION for  
AMATEUR • CITIZENS BAND  
COMMERCIAL RADIO EQUIPMENT**  
Models for All Applications

**LAC-1** Type 83 connectors, 1 male, 1 female for direct to equipment installation. \$3.95 Net

**LAC-2** Type 83 connectors—2 female for insertion in cable. \$4.45 Net

**LAC-2N** Type N connectors—2 female for commercial installations, inserts in cable \$5.95 Net

**THERE'S NO BETTER INSURANCE THAN  
"BLITZ BUG"**

See your distributor or write for Free Catalog

# Cush Craft

621 HAYWARD ST.

MANCHESTER N. H.

## The CUBEX MK III De Luxe 3 BAND QUAD

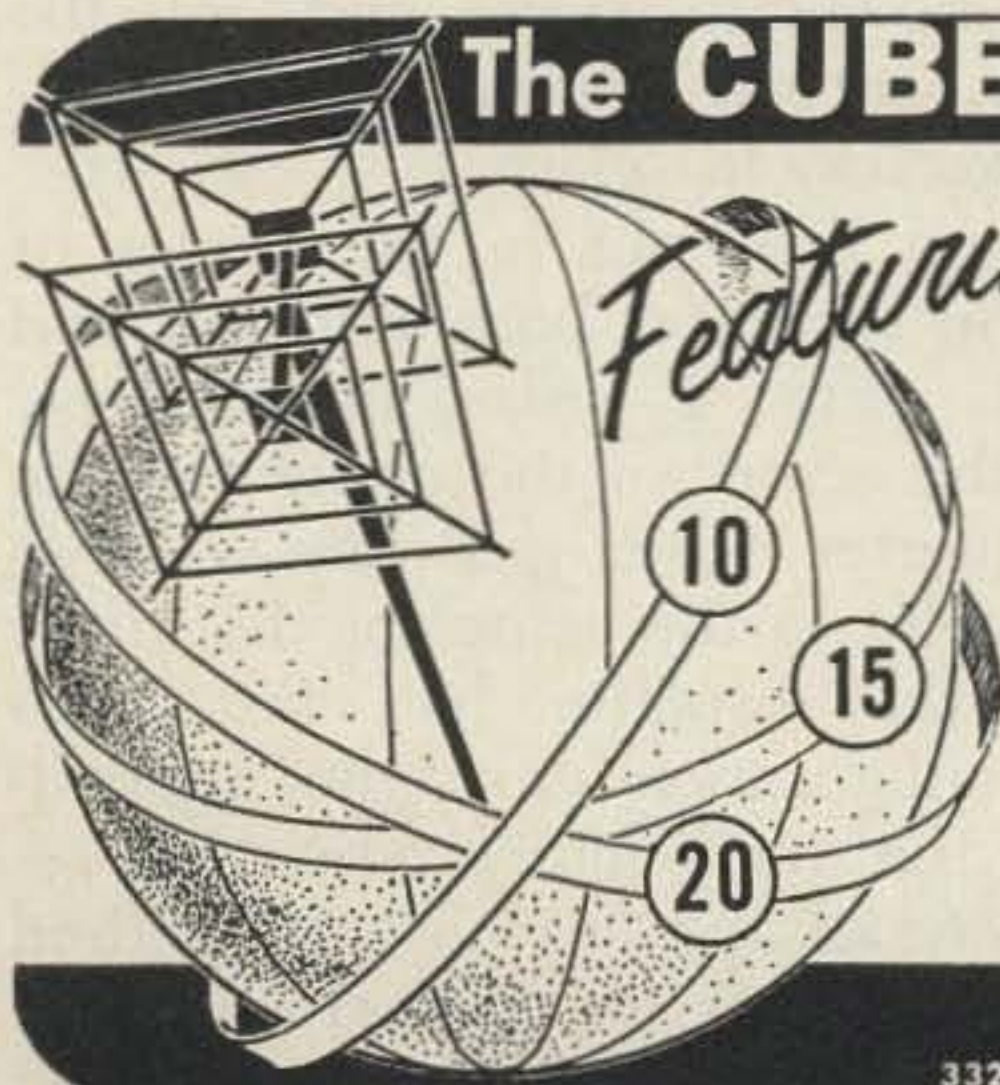

*Featuring*

- Now 3 ways
- **FIBERGLAS SPREADERS** ..... only \$99.50
  - **ALUMINUM SPREADERS** ..... only \$79.50
  - **BAMBOO SPREADERS** ..... only \$67.50

All models use the heavy duty Cubex support structure—2" O.D. tubular alum. boom—Heat treated alum. spiders—Hi-Gain—Hi-FBR—Single feedline optional.

*Low Wind Resistance—Light Weight, only 27 lbs.—TV Rotor Handles—Low SWR—Pre-tuned Refletcor Coils—No Stubs*

The CUBEX MK III gives you 3 FULL SIZE, FULL EFFICIENCY, beam antennas with separate FULL WAVE driven elements on each band. All this in half the horizontal space required by a 3 el, 20 mtr. beam.

WRITE FOR FREE BROCHURE "F"

## CUBEX COMPANY

3322 TONIA AVENUE

ALTADENA

CALIFORNIA

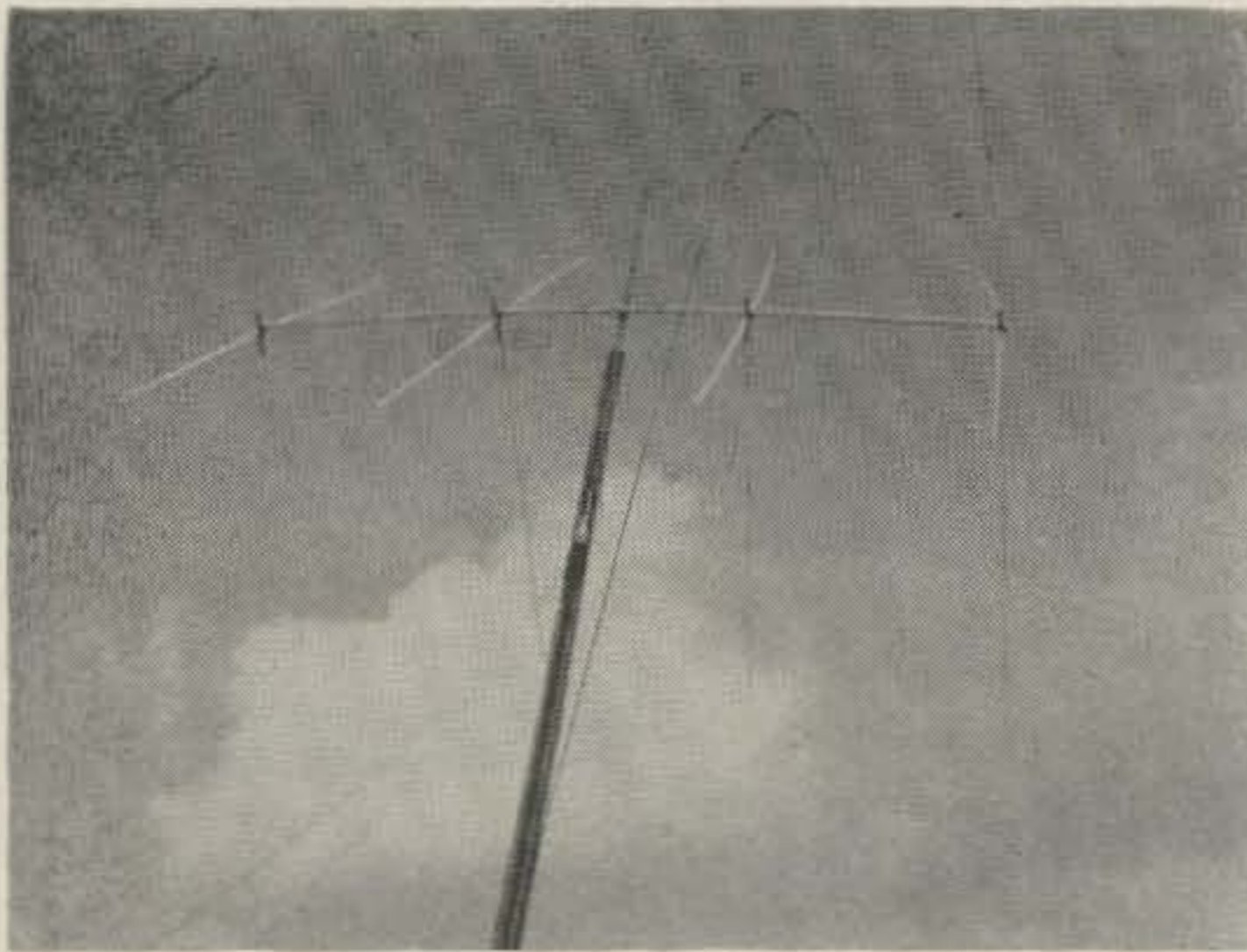

David Traer W4AZK  
 P.O. Box 215  
 Naples, Florida

## A Challenge to the Antenna Experimenter

This very controversial subject will be dealt with here, not so much from the technical angle but on practical operating results produced, the methods of achievement, mechanical structures and other odd bits of observations that may well be utilized by the quad experimenter.

Many years back questions arose as to "What is a quad?" "How does it operate?" Not having an antenna testing range nor other such technical equipment, I set out to learn as much as possible about quad operation under practical operating conditions. Results had to be obtained with equipment that could be found around most any ham shack and with the meager information found in other writings.

A small quad was built in the vicinity of 90 mc. This set up was about eight feet off ground and some surprising results were obtained. Two similar closed square loop elements were made, using .25 wave lengths per

side, and spaced .2 wave lengths apart. A grid dip oscillator was coupled at the center of the bottom horizontal section. An FM tuner was set up several wave lengths away tuned to the resonant frequency of this driven element. The general method of tuning the reflector with a small stub was used by turning the reflector toward the FM receiving antenna and tuning for minimum signal. The usual results were obtained with a minimum backlobe and very sharp deep side nulls.

Then, laying out the current distribution around the quad on paper, lead to the theory that two two-element yagis stacked one-quarter wave lengths apart and fed in phase should produce the same results. These two stacked yagis were found already available in the quad itself except the one-eighth wave length on each end of the top sections were bent down to meet the one-eighth wave ends of the bottom sections bent up, thereby voltage feeding the upper section in phase.

Insulators were then put in the center of each side of the quad on both reflector and driven element. (Fig. 1) Also, an insulator was placed in the center of the upper section. A transposed quarter wave open line was run from the feed point to the center of the upper section where the insulator had just been placed. This configuration gave the approximate results of the quad configuration but required more material and left no easy method of tuning the reflector or driven element. Sufficient power was supplied to the feed

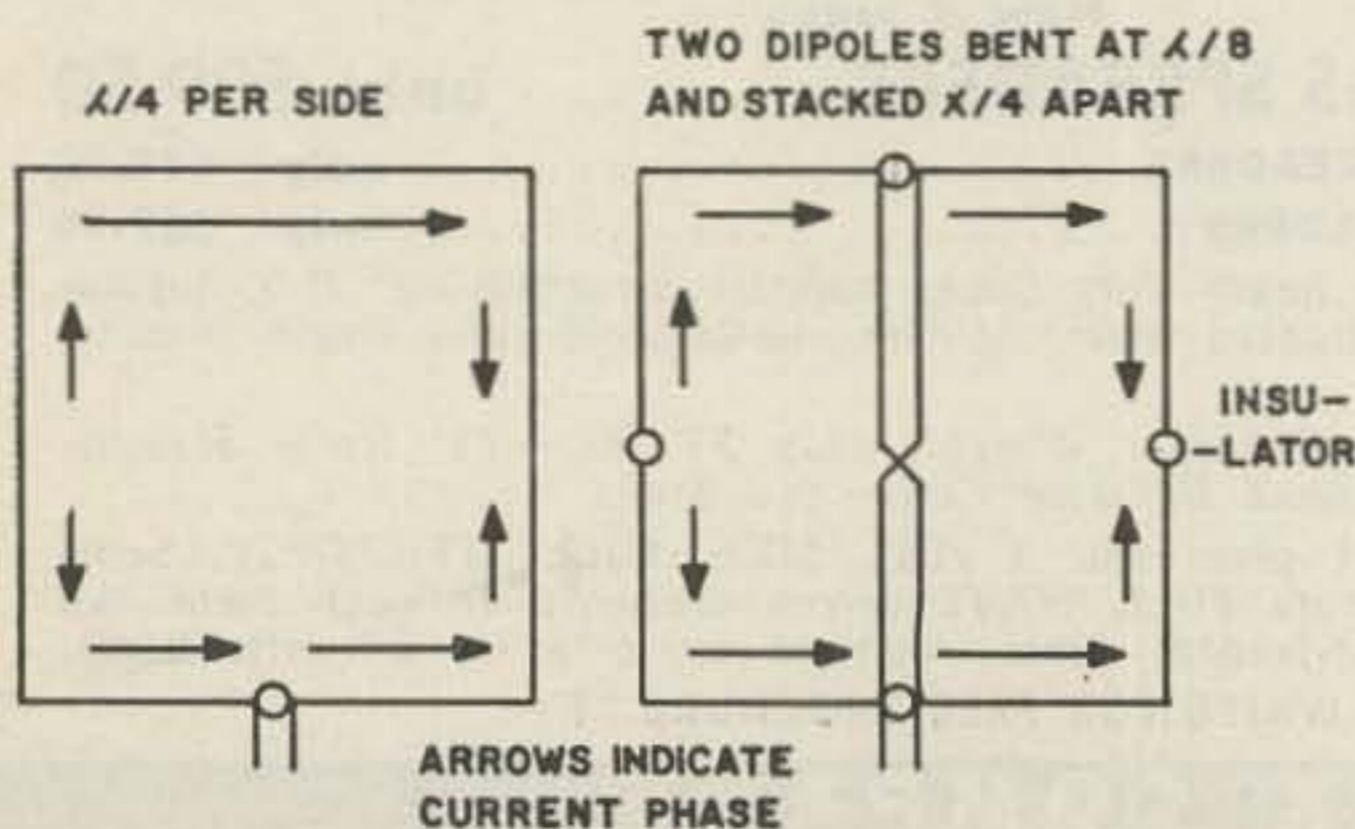

FIG 1

# Now!

for discriminating amateurs  
who are satisfied  
with nothing less than *THE VERY BEST*

## McCoy SINGLE SIDE BAND FILTERS

### The GOLDEN GUARDIAN (48B1)

#### TECHNICAL DATA

Impedance: 640 Ohms in and out (unbalanced to ground)

Unwanted Side Band Rejection: Greater than 55db

Passband Ripple:  $\pm .5$ db

Shape factor: 6 to 20db  
1.15 to 1

Shape factor: 6 to 50db  
1.44 to 1

Package Size:  $2\frac{7}{16}$ " x  $1\frac{1}{32}$ " x 1"

Price: \$42.95 Each

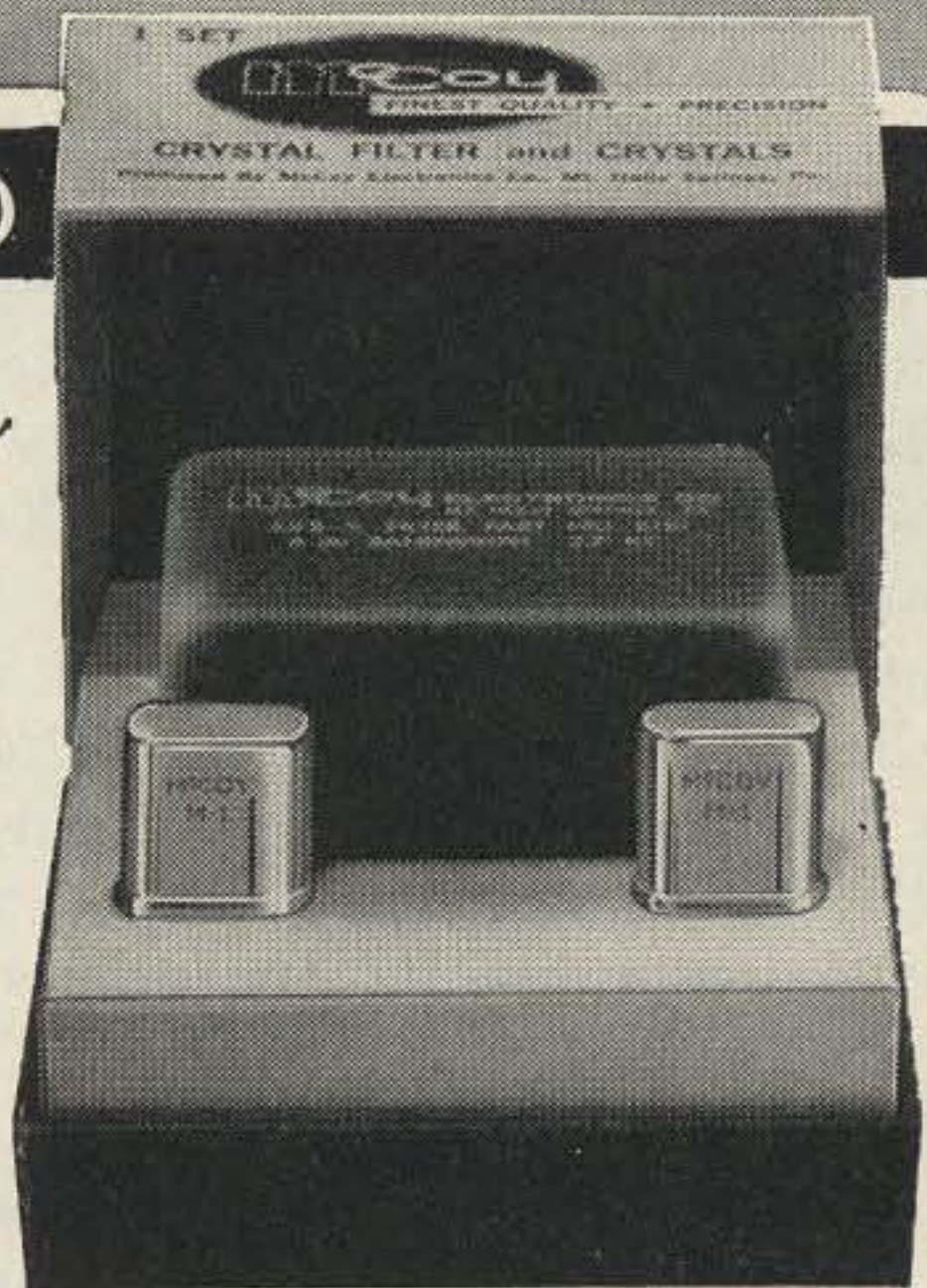
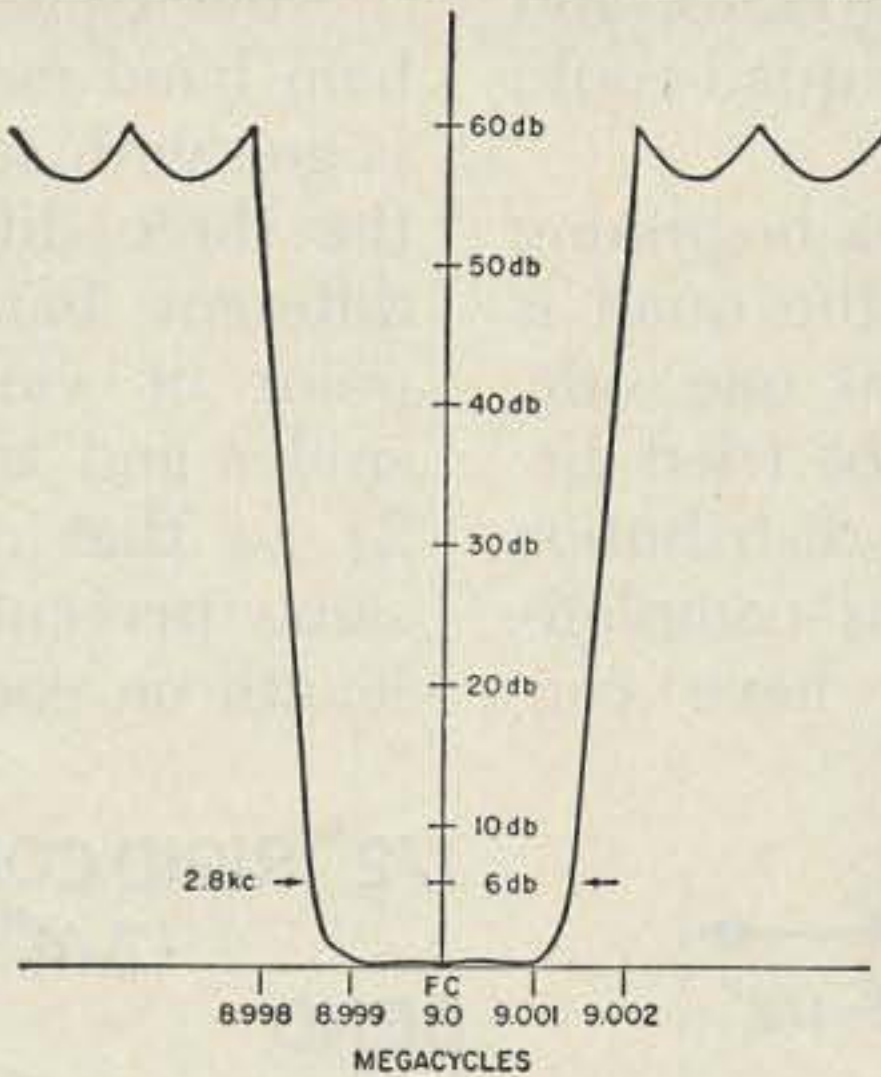

### The SILVER SENTINEL (32B1)

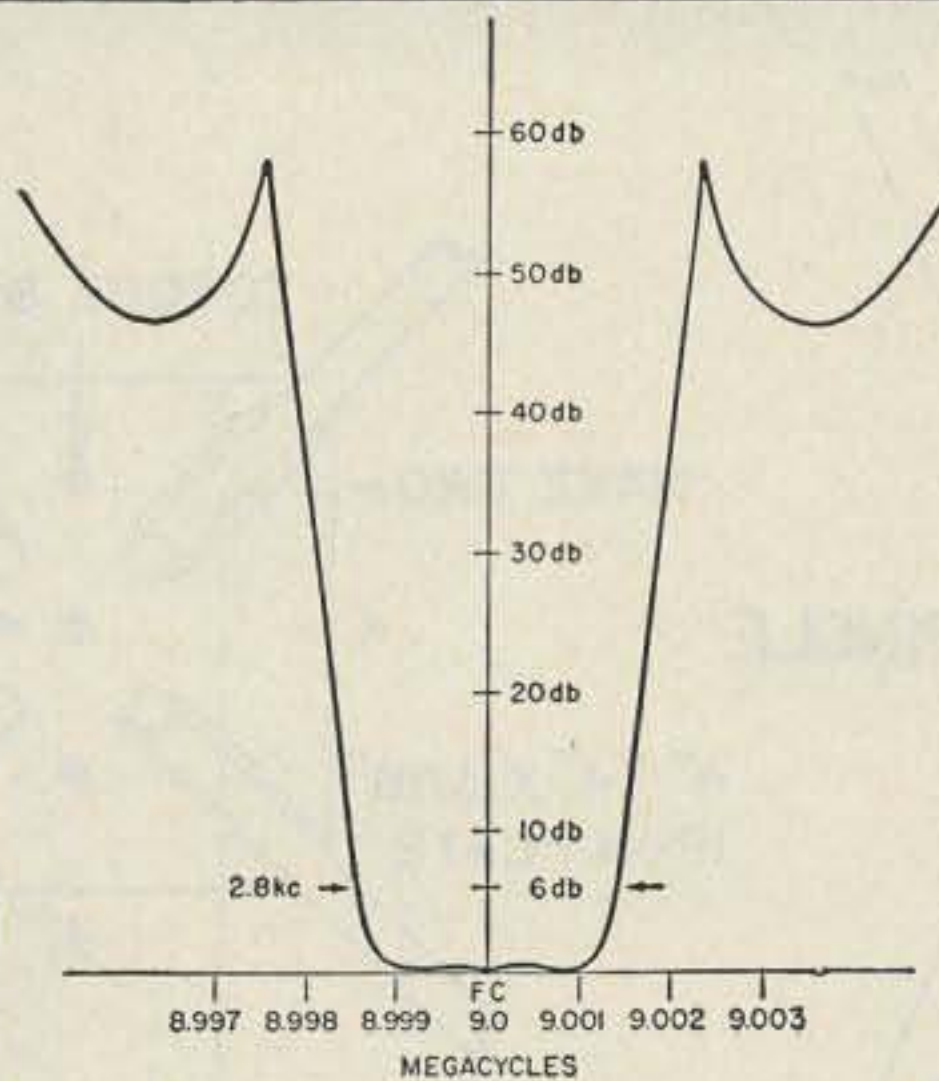
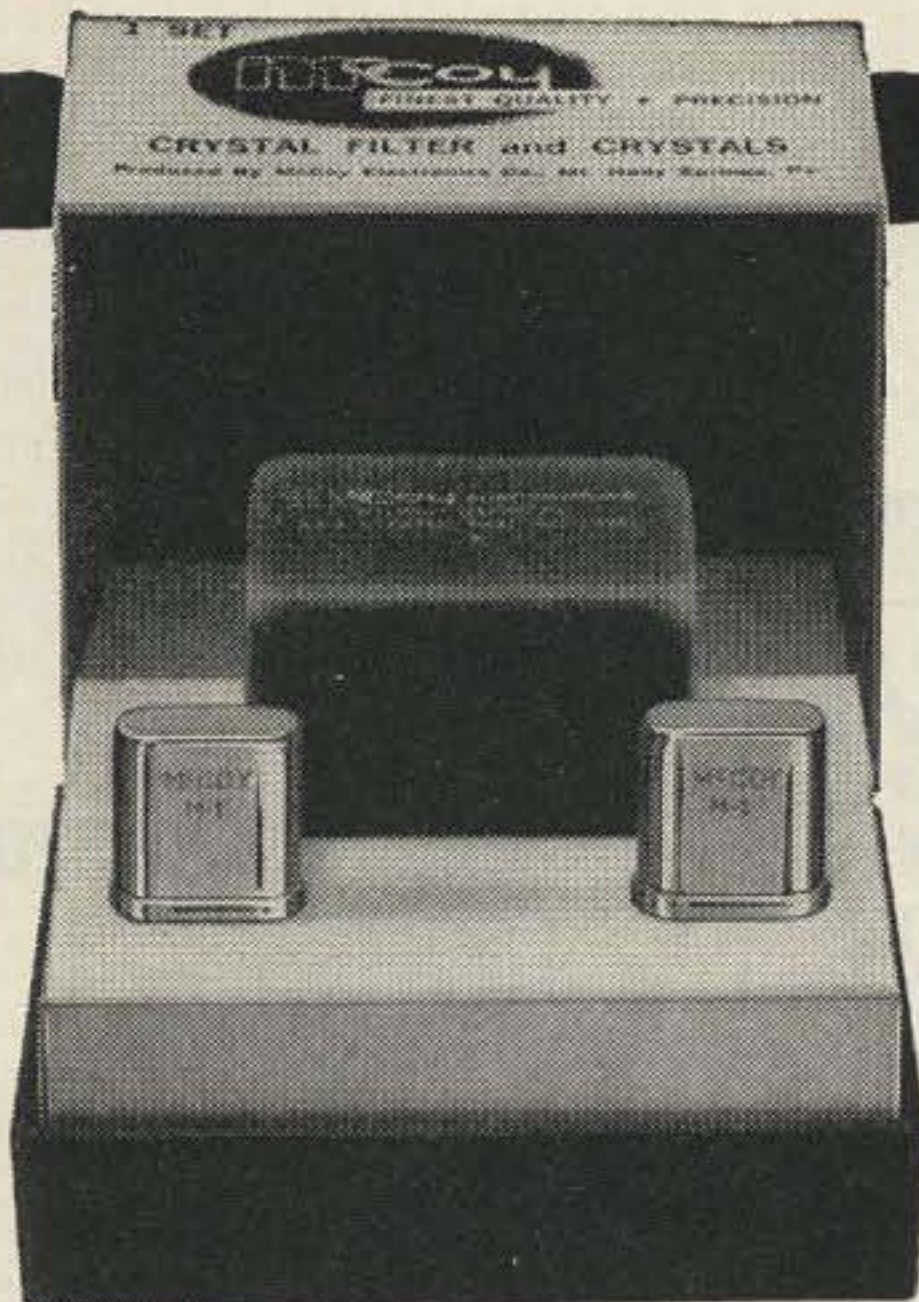

#### TECHNICAL DATA

Impedance: 560 Ohms in and out

Unwanted Side Band Rejection: Greater than 40db

Passband Ripple:  $\pm .5$ db

Shape factor: 6 to 20db  
1.21 to 1

Shape factor: 6 to 50db  
1.56 to 1

Package Size:  $1\frac{3}{4}$ " x  $1\frac{1}{4}$ " x 1"

Price: \$32.95 Each

Both the Golden Guardian and the Silver Sentinel contain a precision McCoy filter and two of the famous M-1 McCoy Oscillator crystals. By switching crystals

either upper or lower side band operation may be selected. Balanced modulator circuit will be supplied upon request.

Both sets are available through leading distributors. To obtain the name of the distributor nearest you or for additional specific information, write:

# McCoy

**ELECTRONICS CO.**

Dept. 73-5

MT. HOLLY SPRINGS, PA.

Phone: HUnter 6-3411

SUBSIDIARY OF OAK MANUFACTURING CO

point so that a neon bulb would light at the side ends of the driven element. As the bulb was moved up or down toward the center of the upper or lower section of the driven element, it would extinguish itself. An rf galvanometer confirmed the neon light conditions.

Because of the difficulty of tuning the director and reflector using this configuration, tests were made on the simple closed loop of the quad configuration with the same results thus showing that the high voltage points were on each side of the quad and the high current points at the center of the upper and lower elements. This experiment was to satisfy myself of a theory that had already been proven in previous antenna articles, and the satisfaction of knowing that the quad could be treated as a stacked yagi array.

Primitive methods? Yes, but still a beginning of practical application. Basically the quad is horizontally polarized unless fed at one side. The diamond configuration was not tried because it appeared from the current distribution that the side null would not be as complete. However, experiments by others have con-

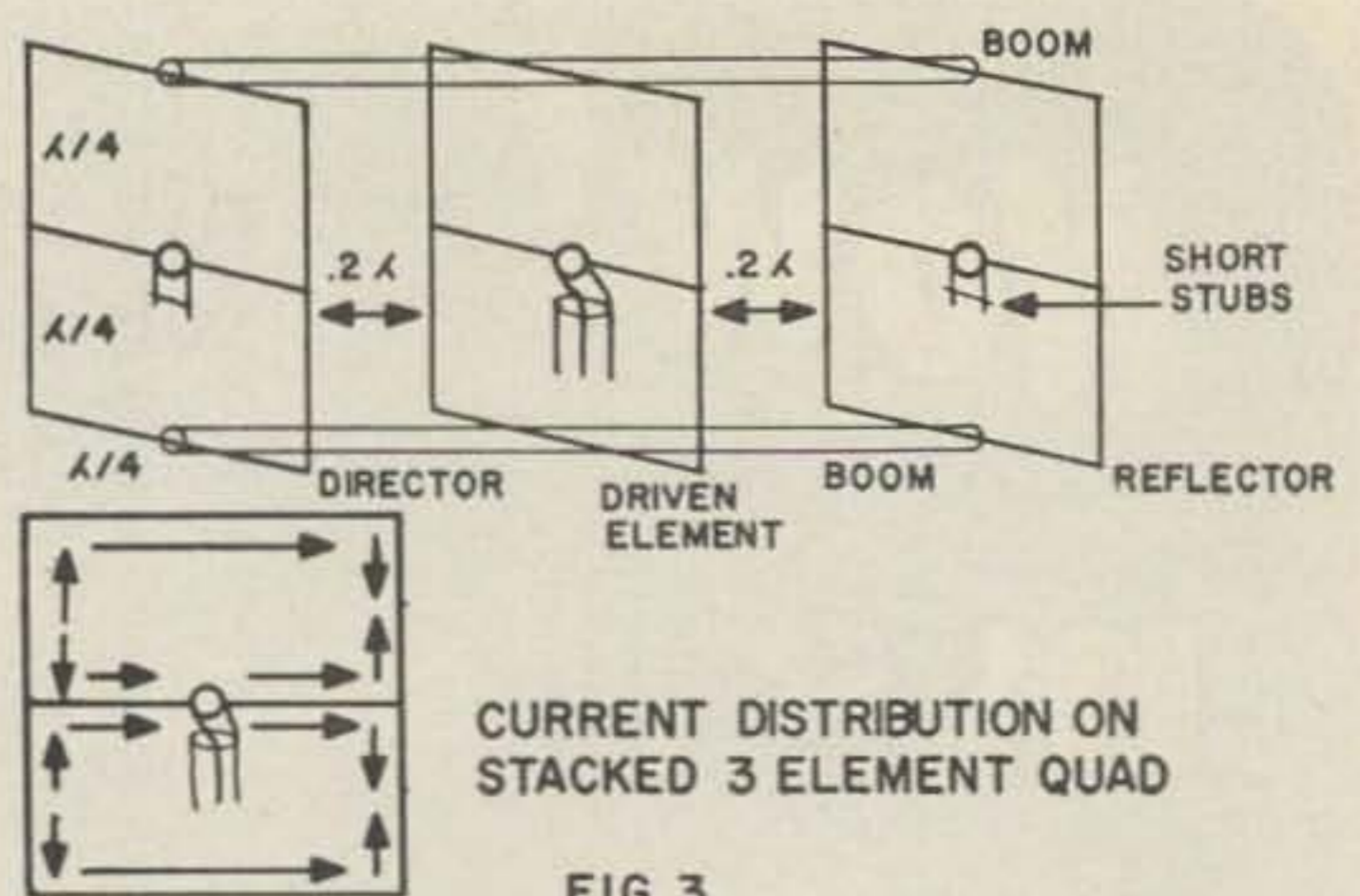

FIG. 3

firmed there is no difference in operation of the diamond configuration.

Now came the time to try the full sized ham band models. The tri-band quad being in vogue with separate transmission lines used for the three different impedances for the three different bands didn't look good from this point of view. After several tries a simple spider and tri-band quad was designed (Fig. 2) so that all three bands would have the same percentage spacing. That is, .15 wavelength on each band. This spider type of con-

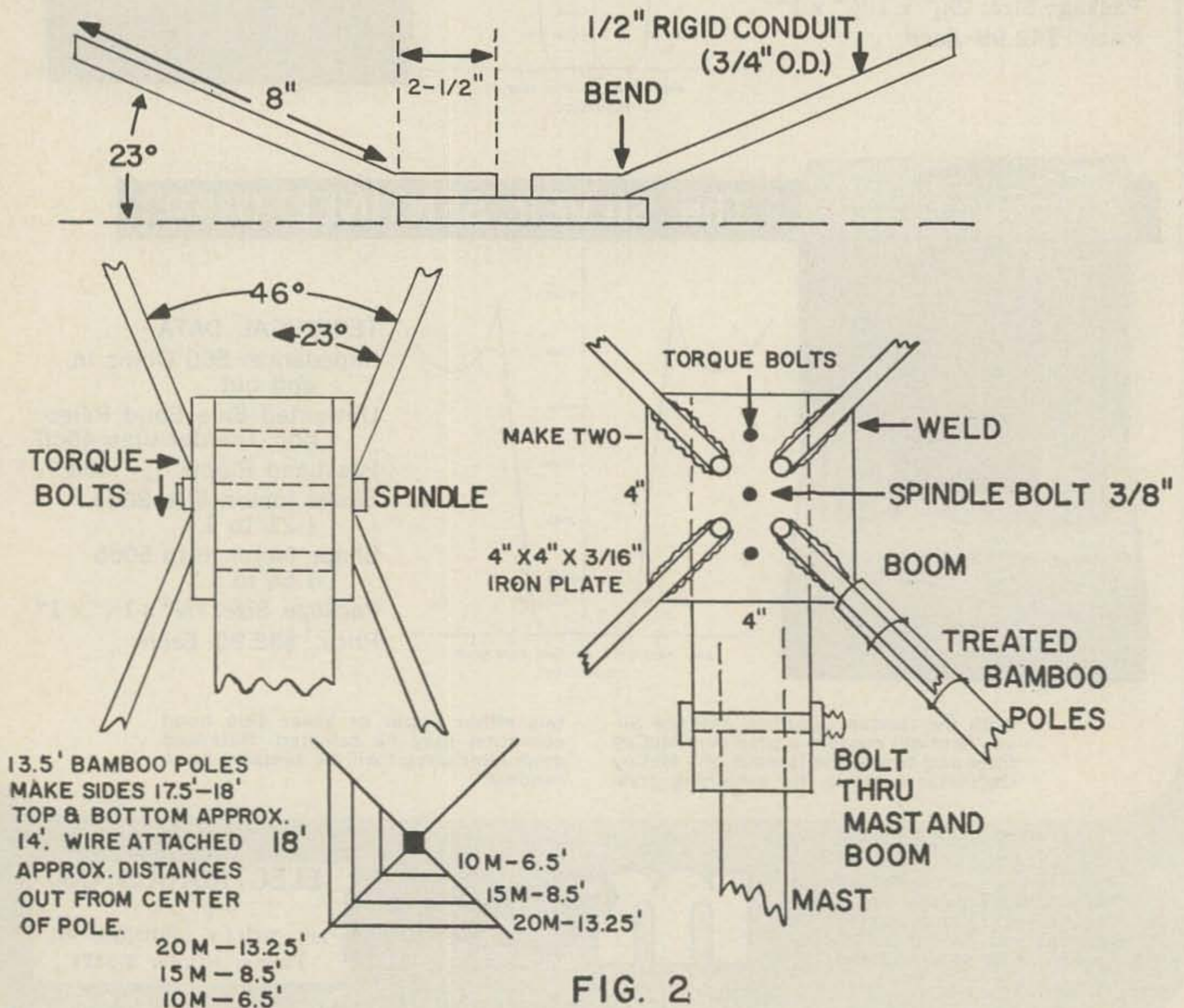
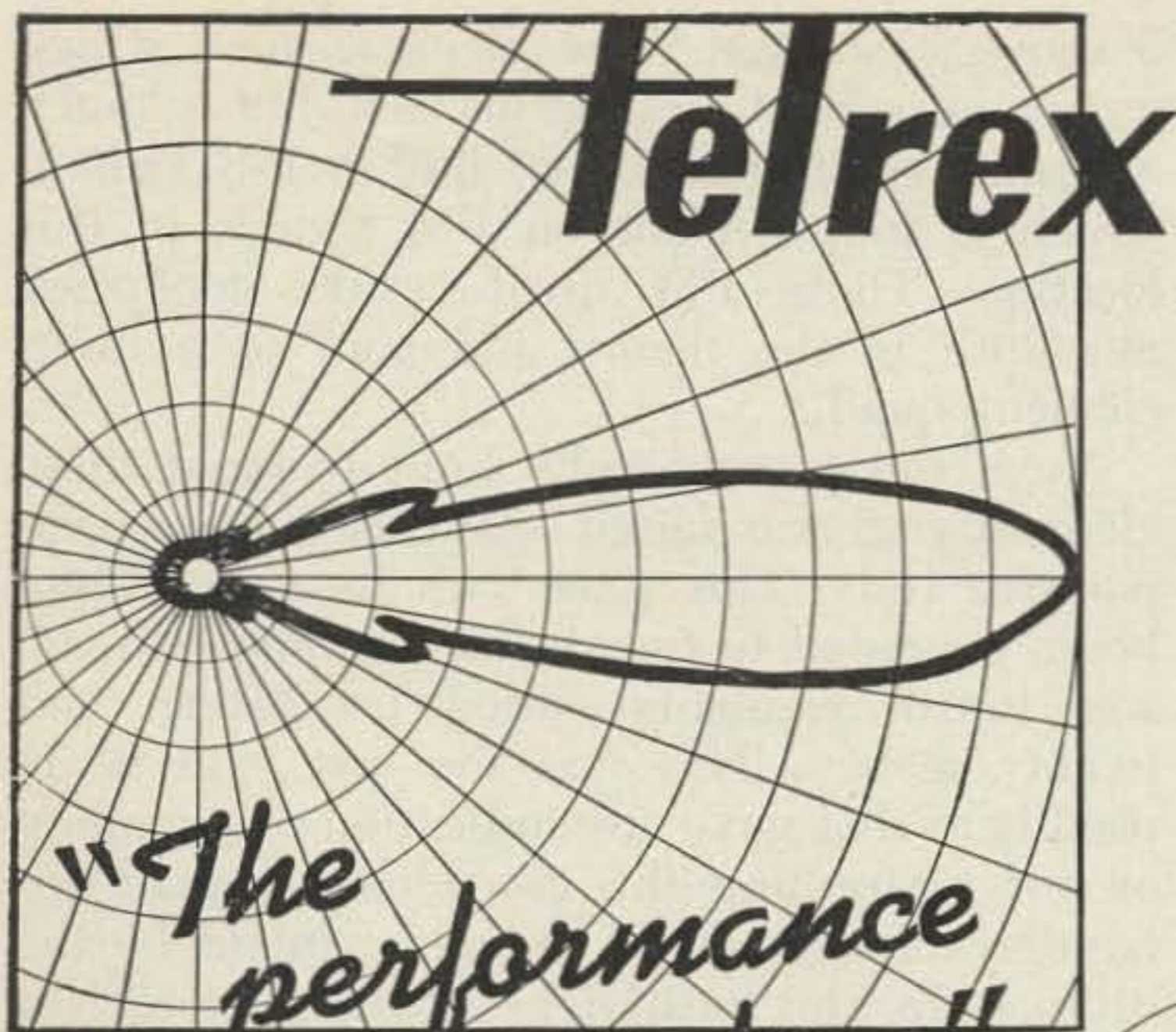

FIG. 2



*"The performance line"*  
 "— with a MATERIAL DIFFERENCE!"

## "BEAMED-POWER" ANTENNAS and ANTENNA SYSTEMS

The Choice of the Discriminating Communication Engineer... the Man who Never Settles for Anything Less than THE-VERY-BEST!

You too — can enjoy World renowned Telrex performance and value!

Send for PL77 condensed data and pricing catalog, describes 107 popular amateur antennas from \$6.95 to \$999.00. Expanded data sheets — Your favorite band, also available.

ANTENNAS SINCE 1921 **telrex** LABORATORIES  
 Communication and TV Antennas  
 ASBURY PARK 40, NEW JERSEY, U.S.A.

struction at a height of twenty feet withstood 170 miles per hour winds during Hurricane Donna. Impedance measurements showed all three bands to be within a few ohms of 60, also that the spider angle design would allow additional quad elements up to 144 mc on the same spider.

The driven elements of the 10-15 and 20 meter bands were all paralleled at the feed point with no change of impedance because of the parallel arrangement. Measuring the driven elements, either singly or in parallel, the three bands showed very close to the same impedance.

A 52 ohm coax feed line was used and SWR measurements showed extremely broad banding on all three bands, ten meters going the highest of 1 to 3.7 at 30 mc at a design frequency of 28.7 mc.

Hours were spent with a fellow ham about four miles away to properly tune the reflector stubs on all bands. This, however, was not to be as critical an adjustment as at first thought. Of course, for maximum gain at a single frequency this adjustment would be critical. Depending upon the portion of the band for single frequency use, this could tune the reflector within the band thereby causing the driven and reflector elements to become both resonant at some other frequency making the beam become bi-directional. The method of tuning, explained later, eliminates this possibility with negligible loss in gain. This tri-band quad (actually five bands as six and two meter elements were added to the 10-15 and 20 with a single additional transmission line)

WEATHERVANE . . . \$4.75 pp. in U.S.

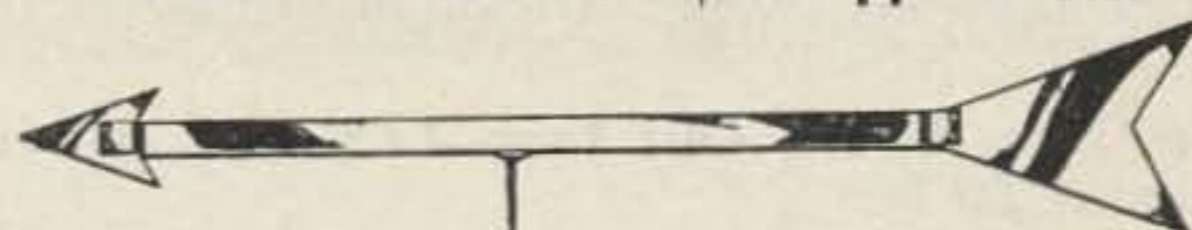

30" long  
 precision made  
 aluminum and

stainless steel,  
 ball bearing for  
 sensitive accuracy.

OUT-O-DOOR Products, Alden 1, Mich.

**PREVERTER**  
**50 & 144**



Low Noise. Transistorized Preamplifier. 6 or 2 Meter model \$14.95 post paid. Available from the following dealers or order direct.

### California

Henry Radio Inc.  
 Los Angeles, California  
 Mission Ham Supplies  
 Riverside, California  
 Radio Products Sales, Inc.  
 Los Angeles, California  
 Western Radio & Television Supply Co.  
 San Diego, California

### Illinois

Klaus Radio & Electric Co., Peoria, Illinois

### South Dakota

Burghardt Radio Supply, Inc.  
 Watertown, South Dakota

### Texas

Diehl Radio & T.V. Supply, Port Arthur, Texas  
 Radio & T.V. Parts, San Antonio, Texas

**IRVING ELECTRONICS CO.**  
 P. O. Box 9222, San Antonio, Texas

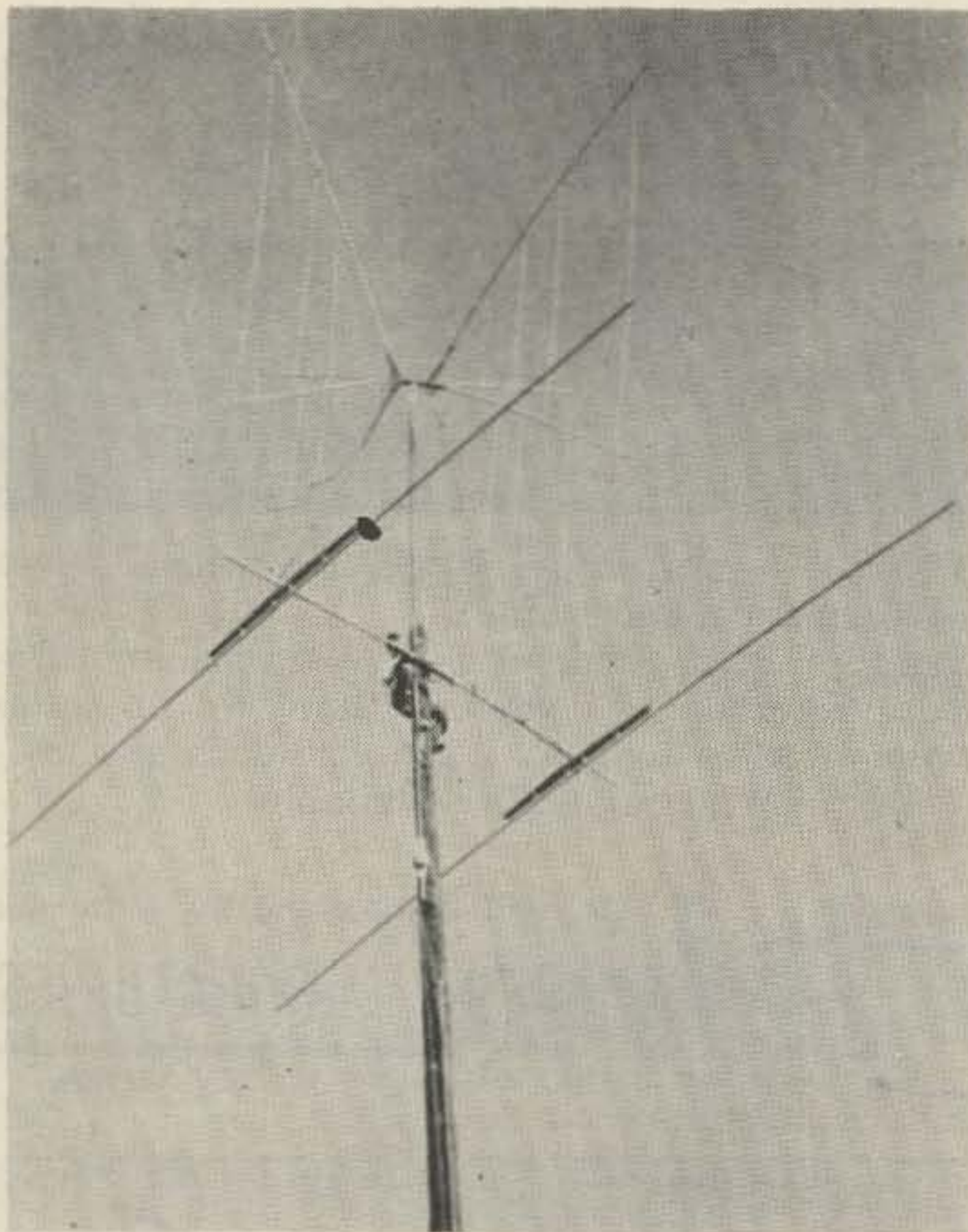

**The "Box Kite." This took 175 mph winds down at 20 ft.**

was operated for two years and compared against a manufactured medium spaced trap tribander with far better average DX reports from the quad.

On local station's signals little difference of strength was noticed. The quad would receive DX signals earlier and stay in longer than the comparison antenna. This observation may be due to the quad's automatic height adjustment of up to one-quarter wave between the lower and upper horizontal quad elements which possibly could be accomplished if it were possible to instantly lower or raise a yagi the same amount during skip changes.

Next, a three element quad was constructed on a twenty foot boom but was quickly discarded, only because a proper allowance could not be made for the driven element to swing around the 55 foot pole that was used for a tower. Initial tests, however, did prove promising, as this was used for a few months with a decided improvement in general overall signal strength over the long path.

Further development on the quad was temporarily interrupted for experiments with a stacked three element quad for FM reception. Our local broadcast station had been using an eight wave length per leg terminated rhombic antenna pointed to Miami for FM rebroadcast as part of the Florida hurricane network. It became necessary to pick up FM stations in more than the one direction. Fig.

3 shows a stacked three element quad which gave an excellent account of itself, not so much in gain over the rhombic, but in less fading, which is so prevalent on FM signals in this location. These FM quad results confirmed our faith in the theory and gain of a multi element quad.

Next, the commercially built tri-band three element yagi was raised again for further comparative tests. This time with its sixteen foot boom extended to twenty-six feet and two full size fourth elements added for fifteen and twenty meters. This was the first yagi beam used here that gave any indication of equalling or out performing the two element quad tribander and seemed as though it might be the ultimate for this location as a height of 55 feet is the maximum that can be used here. Wonderful results were obtained during the ARRL DX contest. However, with the "Long Johns" starting to increase in number around the States on towers with heights up to 140 feet, it became necessary to start something new. A five element yagi or a four element quad? The quad was chosen for further tests to maintain a "big signal." The four elements of the quad would mount properly, perfectly and very simply on a thirty foot boom and no difficulty would be encountered in turning the elements around the pole. The ten foot spacing between

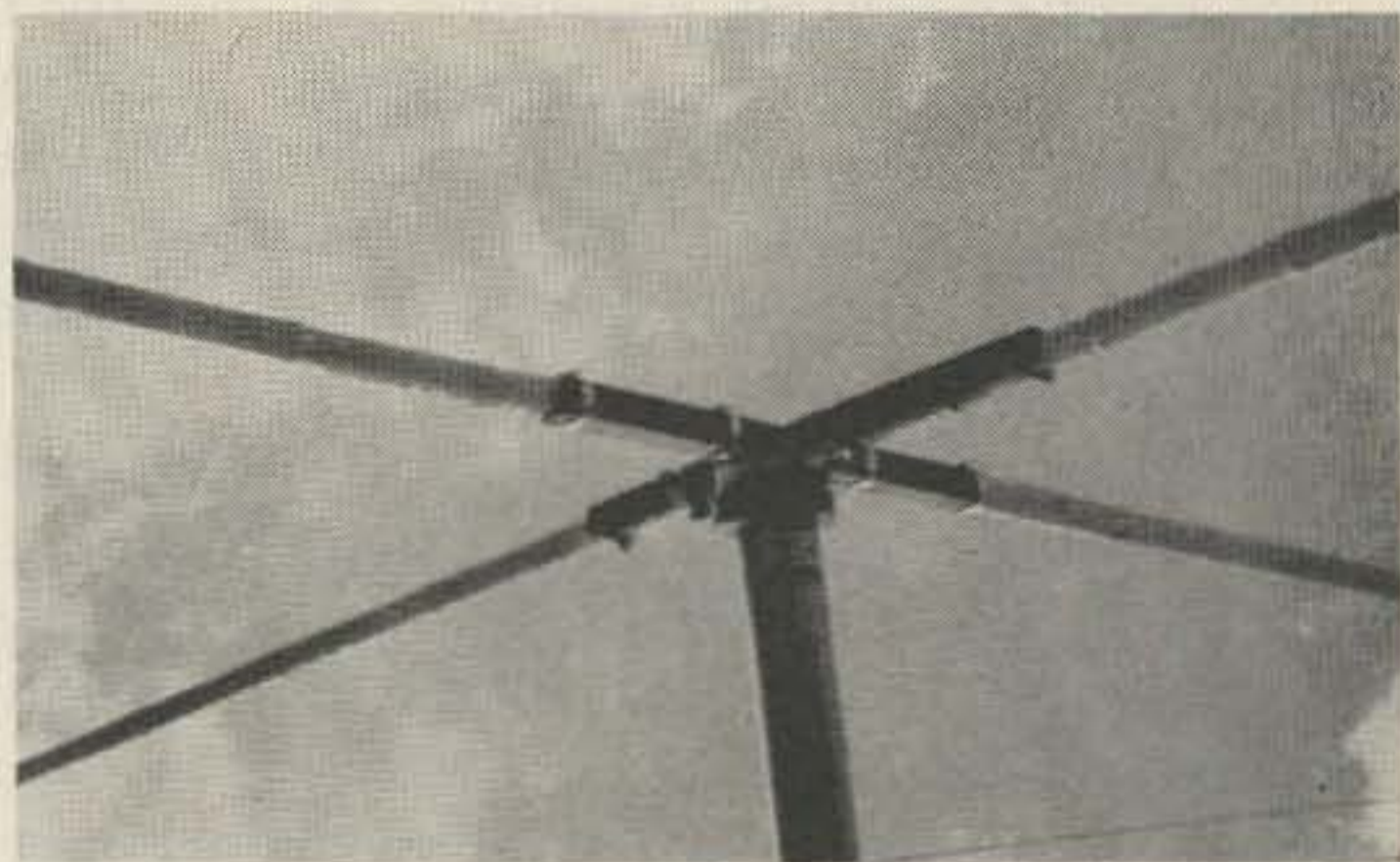

**Construction of spiders, four element quad.**





# HENRY HAS

The **SWAN SW-240** is in stock for immediate delivery — **RIGHT NOW!**

Ask about our liberal time payment plan



**HENRY IN  
LOS ANGELES (64)**

11240 W. Olympic Blvd.

**HENRY IN  
ANAHEIM**

931 N. Euclid

**HENRY IN  
BUTLER  
MISSOURI**

elements gave plenty of clearance.

Fig. 4 shows the simple mechanical construction. The problem: How do you go about tuning the four element quad? Previous experience had proven one point; the closed quad loop as director or reflector was not as critical in tuning as was first supposed. Over a period of time a formula has been derived for element lengths that had met with all other previous requirements. These are somewhat longer than other published lengths to allow plenty to *cut off* rather than to *add on*. Stub lengths are never left more than approximately eight inches long. After initial resonating, should a longer stub be left, take out this portion of the stub by adding the excess stub wire to the perimeter of the square.

The driven element is equal to  $996/FMC$ . Reflector is equal to  $1,044/FMC$ . Director was equal to  $946/FMC$ .

Electricians' "bugs" are used to hold the stub connectors and any other connections, then sprayed with Krylon to prevent corrosion. With no transmission line connected, but with the loop closed, the driven element is grid dipped to about 50 kc lower in frequency than the desired design frequency. The reflector is grid dipped to outside the low end of 20 meters to approximately 13.5 to 13.8 mc. The first director was grid dipped to outside the

high end of 20 meters to approximately 14.4 mc and the second director resonated to approximately 14.4 to 14.45 mc. Resonating the parasitic elements outside the band prevents any possibility of the beam becoming bi-directional with little loss of forward gain and F/B ratio.

These adjustments were made with the boom about 20 feet off the ground. The lower sections were easily reached on a step ladder. Making adjustments at this low height requires resonating the elements approximately 50 kc lower than the design frequency as when raised to operating height (40-60 feet), the resonant frequency is raised about 50 kc or more.

The impedance measured about 38 ohms, a little low for 52 ohms,—but read on—when raised to 55 feet the SWR was almost flat from 14.0 to 14.350 mc!

This broad banding effect on the SWR was obtained with a beam impedance some 25% or more lower than the feed line impedance. Note that the SWR does not fall to unity at any given frequency, but that there is a general overall broad banding which proves much better than the unity at center of band and 4 or 5 to 1 SWR at either end of the band. (See G4ZU article CQ November 1959 page 67.)

Tests on front to back ratio naturally would

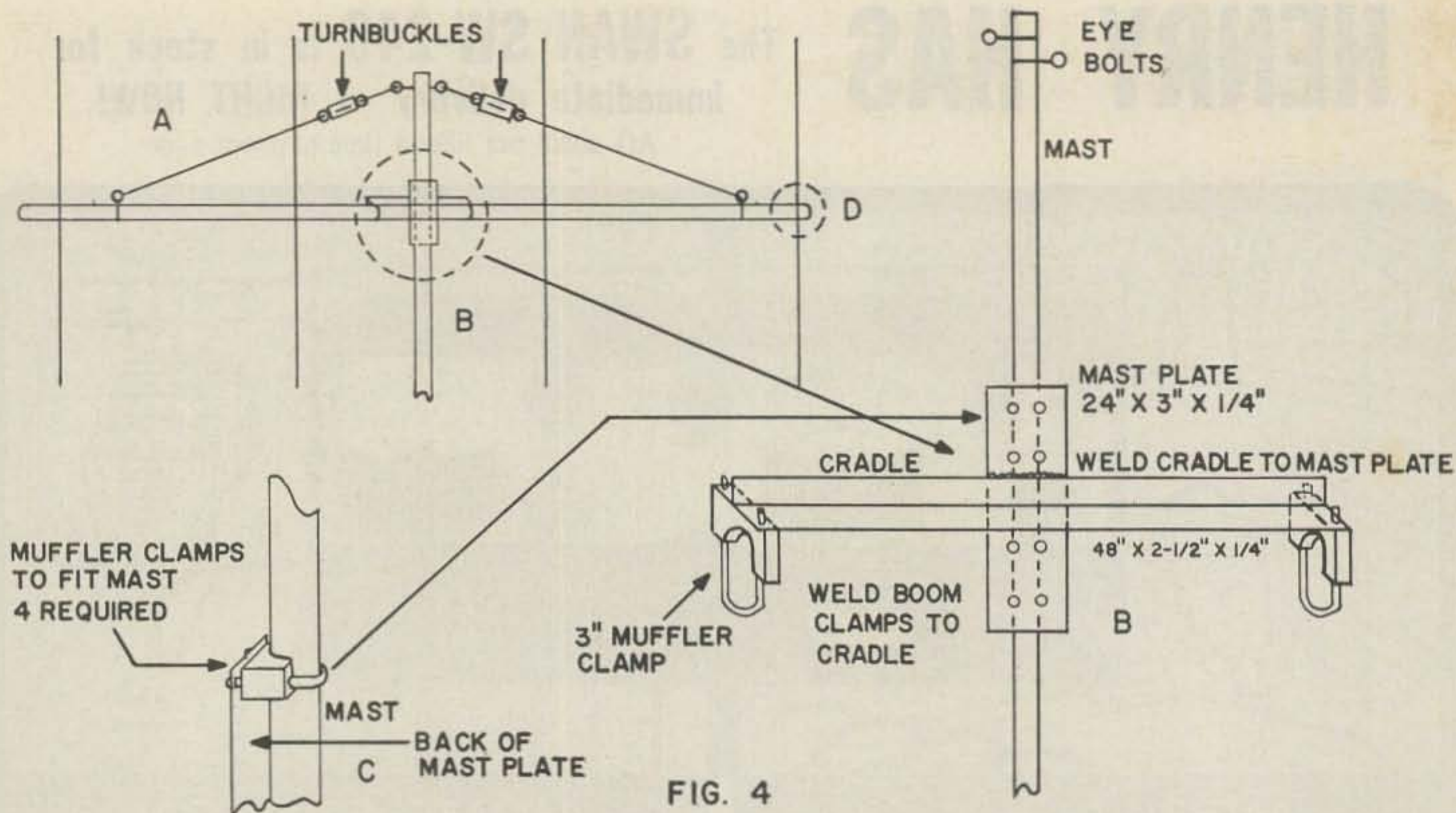

FIG. 4

be variable as with any beam antenna, depending upon the conditions at that time. Safely, the four element quad has 23 to 35 db front to back ratio. The forward gain showed 12 to 14 db over a dipole erected at the same height for test purposes. Of course, under some conditions of back scatter these figures are somewhat lower. The greatest gain is apparently on some lower vertical angle. Our tests methods did not include vertical angle measurements. However, a 2 S unit gain over a dipole is not to be sneezed at.

It is true that many yagi type beams show 10 db or more gain, but when it comes to getting a db or more, the average ham disregards this. "Well, it won't show up on the S meter." True, but has it ever been noticed that the "big signals" get to the Dx'er (who may not even have an S meter other than his own two ears) by a margin of only one-half of an S unit or less over the gang in a pile up? (3 db gain is enough for a noticeable change to the ear). How this apparent additional gain is achieved is not fully understood.

A further experiment with the four element quad was to operate two of the elements on 40 meters. The method used was stub switching.

The characteristics exhibited by transmission line segments as can be obtained from most any handbook, show that a half wave section of transmission line at a given frequency shorted at one end will exhibit the same impedance at the opposite end. That is zero or shorted regardless of the characteristic impedance of the transmission line. This property, coupled with the fact that a similar line

one quarter wave length at a given frequency shorted at one end offers an infinite impedance at the opposite or shorted end. Thus, the same stub at 14,200 kc will offer a short opposite the shorted end, but at 7,100 kc will exhibit an infinite impedance or insulator opposite the shorted end. When this principle applied to

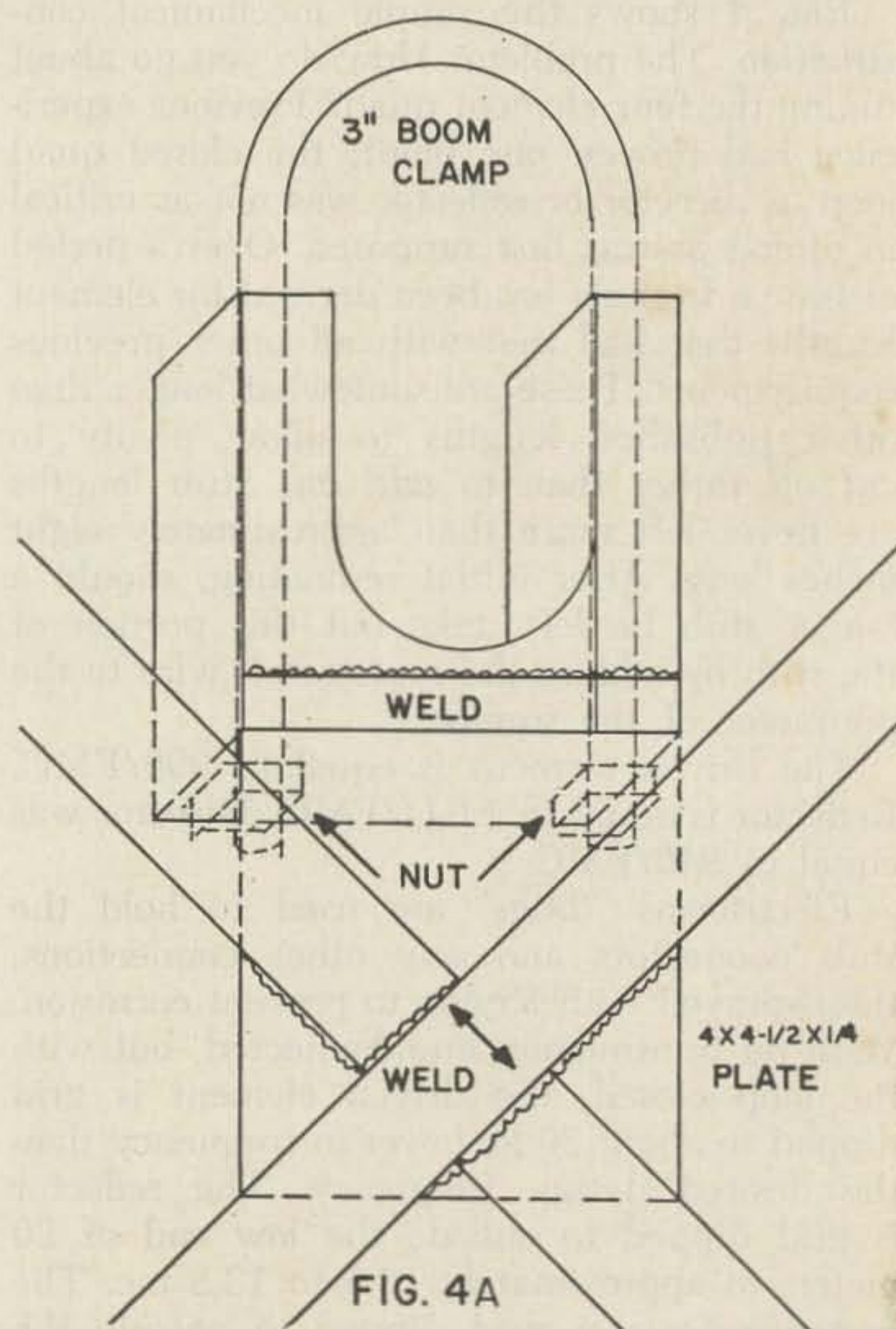

FIG. 4A

# DRAKE 2-B

2-B Receiver  
\$279<sup>95</sup>  
amateur net

2-BQ  
Q-Multiplier/Speaker  
\$39.95 amateur net

For more information ask your distributor or write us for brochure with complete specifications and schematic.

**"The most talked about  
HAM RECEIVER"**



The Drake 1-A Sideband Receiver was introduced in 1958. The 2-A with improvements for all modes followed in early 1960. The present Model 2-B with improved selectivity for SSB, CW and AM was announced in April 1961.

In this short time the Drake Receiver has become the most popular and talked about receiver on the ham bands. Whether you are a Novice or 60 wpm operator, a beginner AM or experienced SSB'er you will discover the 2-B has been engineered for all your receiver needs.

Just ask the ham who owns one.

**R. L. DRAKE COMPANY • Miamisburg, Ohio**

## TVI CAN BE ELIMINATED WITH DRAKE FILTERS

### The Drake Amateur Low Pass Filters

have four Pi Sections designed for sharp cut-off between 6 meters and channel 2 and to attenuate all transmitter harmonics falling in any TV channel and the FM band. 52-ohm impedance. Low insertion loss.

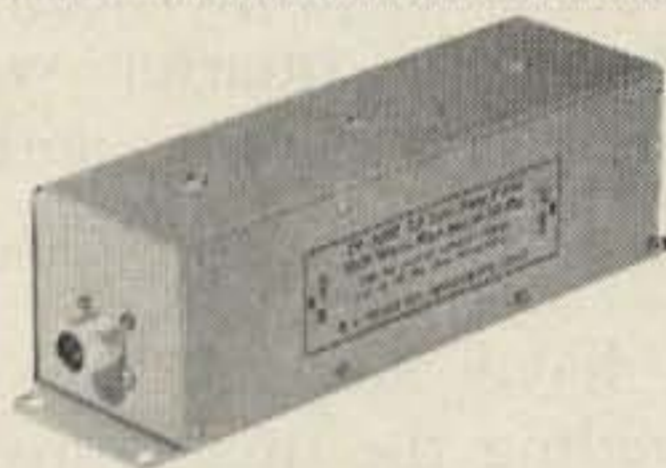

**TV-1000-LP** rated 1000 watts input, 200 watts on 6 meters. SO-239 connectors built-in.  
\$16.95 amateur net



**TV-100-LP** rated 100 watts input, 20 watts on 6. Solder it in or use your own SO-239 connectors.  
\$5.95 amateur net



**THE  
DRAKE  
TV-300-HP**

... peer of high pass filters, provides more than 40 db attenuation at 52 MC and lower. Protects the TV set from all amateur transmitters 6 thru 160 meters. Three models—TV-300-HP 300-ohm, TV-72-HP 72-ohm, TV-300-HP(RCA) 300-ohm plug-in for RCA sets.  
Any model \$3.97  
amateur net

### The Drake TV-CB-LP Citizen Band Low Pass

is a four section filter designed with 43.2 MC cut-off and extremely high attenuation in all TV channels for citizen band and other transmitters 30 MC and lower. Rated 100 watts input. SO-239 connectors built-in.  
\$6.95 amateur net



\$2.55 amateur net

### TV-300-FMT 88 to 108 MC Band Rejection Filter.

FM broadcast transmitters are responsible for considerable TV interference being blamed on radio amateurs. The problem has become quite serious due to recent increase in the number and the power of FM broadcast stations. Overload problems and beats between FM and TV stations in TV front ends cause breakup in color pixs and wavy lines in black and white. The Drake TV-300-FMT installed in TV antenna lead and adjusted to frequency of interfering FM station will clear up pix.

SEE YOUR DISTRIBUTOR  
FOR DRAKE FILTERS

For details about TVI, write for free brochure  
**R. L. DRAKE COMPANY • Miamisburg, Ohio**

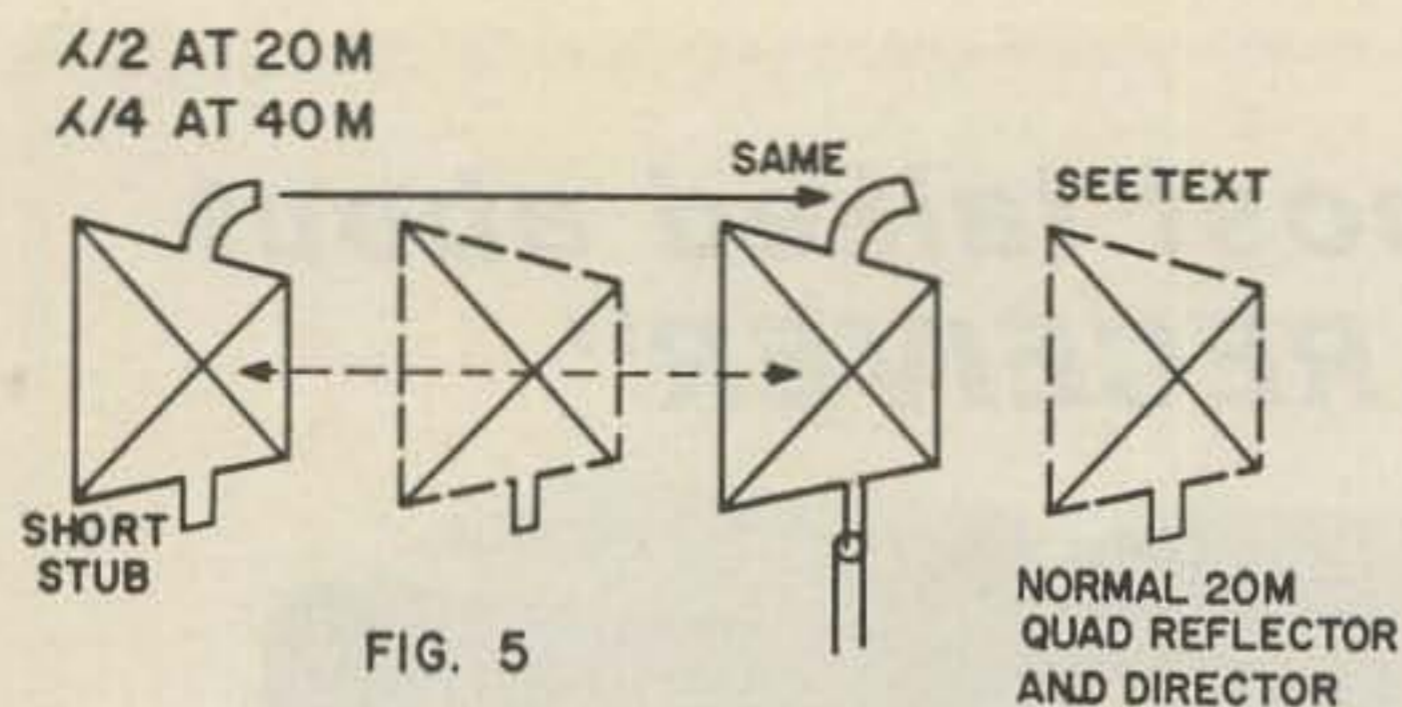

two of the elements of the four element quad as shown in Fig. 5, it becomes possible to have a two element 40 meter parasitic beam with one-half wave elements folded in the shape of a square. These stubs had absolutely no affect on the 20 meter quad operation.

At this writing no further adjustments have yet been made to improve the operation of the 40 meter elements which do exhibit some directivity but with little front to back ratio.

Time has not permitted further experiments along this line but one wishing to have a four element 20 meter quad and a 40 meter beam antenna with the same transmission line and no relays or switches, this may be worth further investigation. Fig. 5 shows how the stubs are attached. It must be noted, however, that the word "beam" was used as it has been "sweatfully" learned that a so-called shortened quad with loading coils or stubs will take a load and show some directional properties, but with anything less than one quarter wave spacing between upper and lower and/or side to side wires the arrangement loses the quad characteristics.

Some readers may have noticed the unbalanced method of feeding the quad directly with the coaxial cable. Various horizontal pattern measurements have been made and in each, only the small rear lobe is partially distorted with no effect on the forward lobe. This was a very minor consequence from this point of view. Of course, a balun or gamma match could be used to rectify this situation and again one may refer to most any handbook.

Reversing the coax leads will, of course, reverse the slight distortion of the pattern on the rear lobe.

The final outcome of these quad experiments has been very gratifying. The signal from here has been greatly improved from

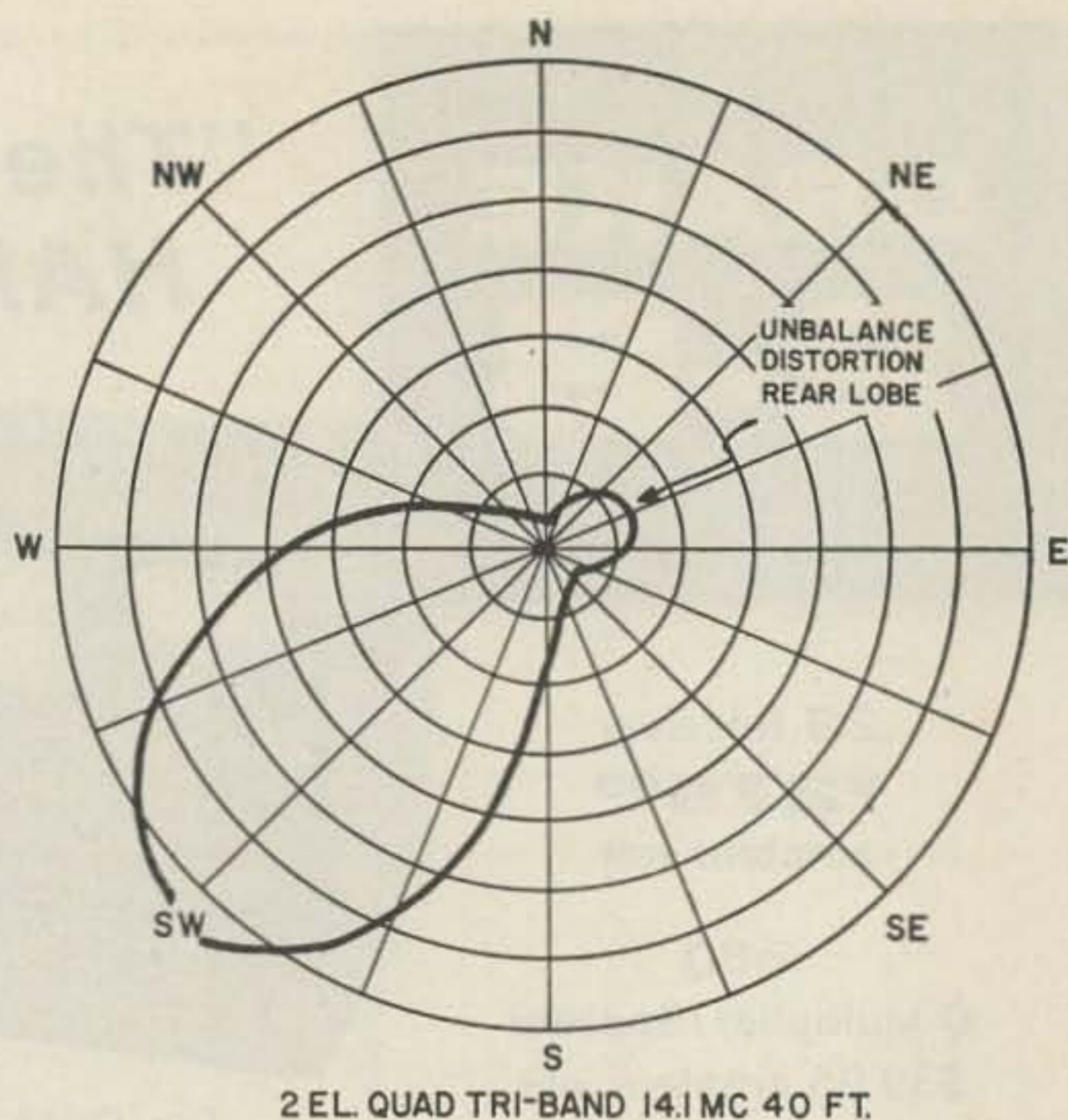

over the past few years and those with an experimental nature will find numerous new features in the antenna field within which to explore.

Experiments are now under way on a full sized dual band four element quad for 40; 20 and 15 meters. Gain figure for 15 meters should exceed 15 db and 8 db on 40 meters.

For invaluable help on tests over long and

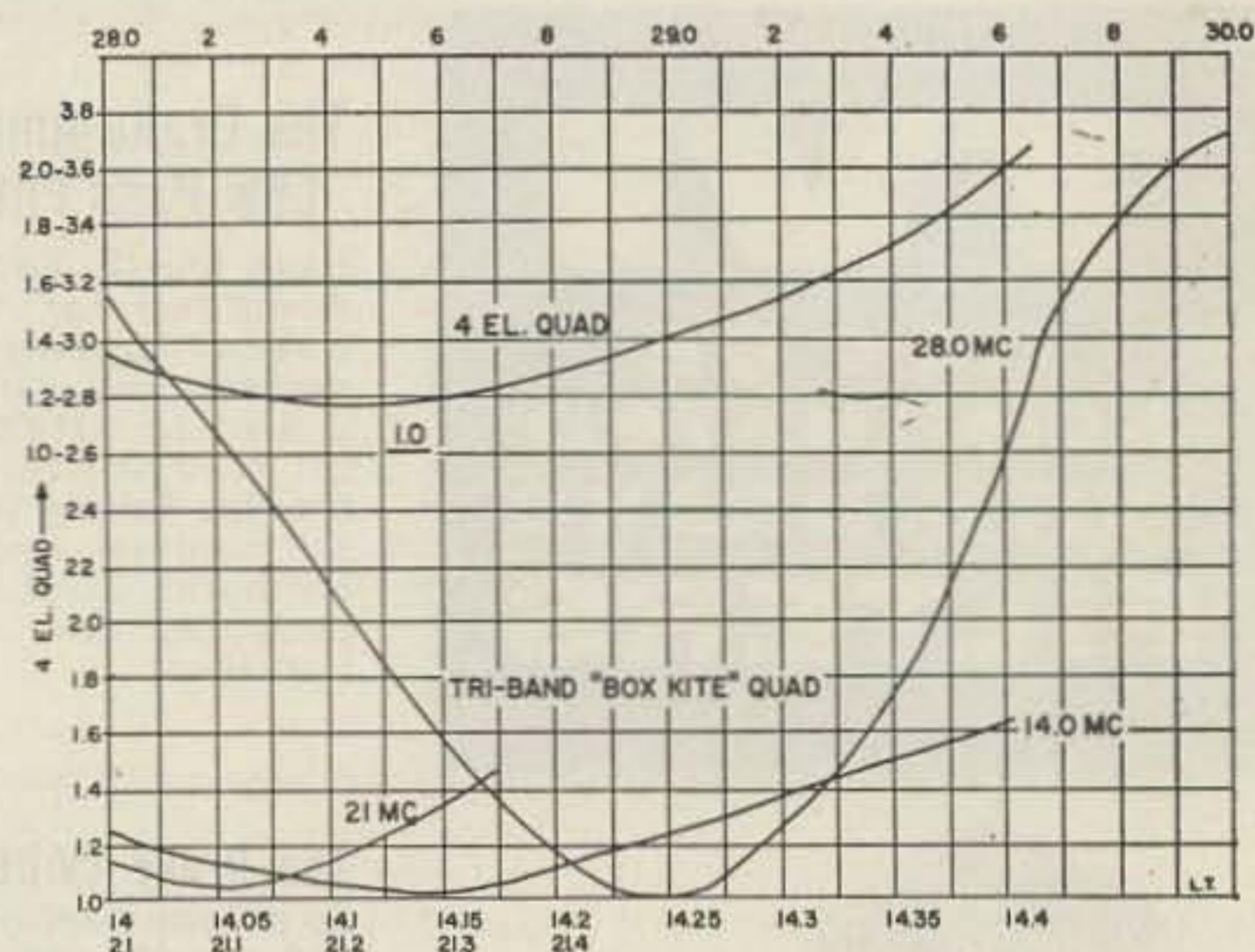

short paths it is gratefully acknowledged of Reeve K4AW, Walt the late K5JLO in New Orleans, Jim VK6SA and Lambert ZS6IF. Locally to Armon K4FOM, Frank K4YPA, John K4UGE and others who graciously gave of time and energy. . . . W4AZK

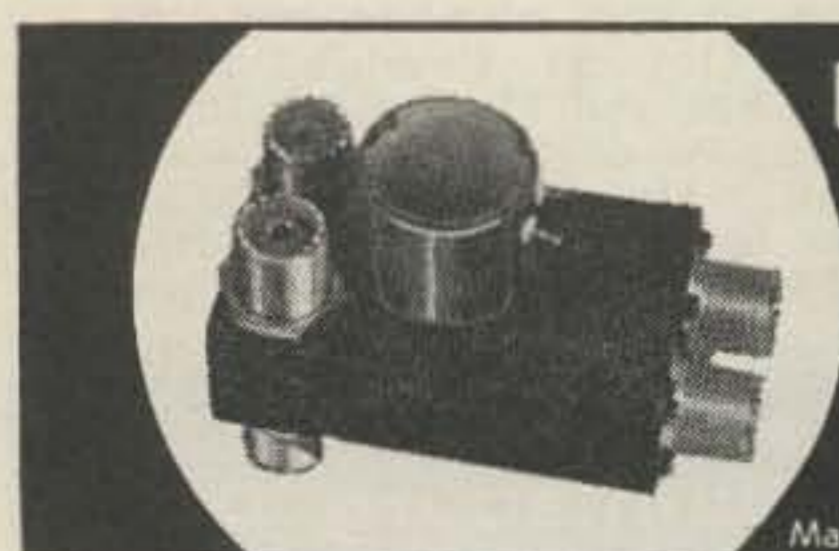

**DOW-KEY'S DK2-60**

**DPDT r.f. SWITCH**

DK2-60 with UHF Connectors, each \$19

Manufactured and Guaranteed by

**For Switching 2 Coaxial Lines Simultaneously!**

Freq. 0 to 500 mc; Power Rating to 1 kw; VSWR, less than 1.15 to 1 from 0 to 500mc; Standard coil voltage.....and other r.f. Connectors available.

**DOW-KEY CO., Thief River Falls, Minn.**

## New! "COMPREAMP" Transistorized Audio Preamp

This new audio preamplifier increases "talk power" up to 10 times . . . provides up to 10 db compression when inserted in hi-impedance microphone lead of a radio transmitter.

This device will prevent overloading of the transmitter on the peak energy spikes normally present in speech waveforms.

Send check or  
money order to

The METRODYNAMICS Corporation  
8 WESTOVER AVENUE • CALDWELL, NEW JERSEY

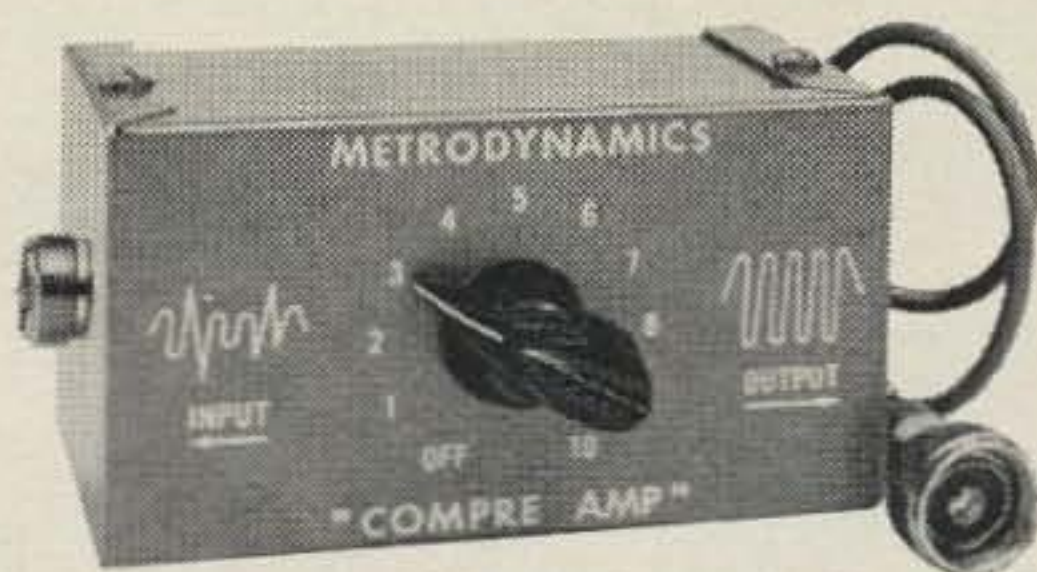

Model CPH-1, as illustrated  
Model CPH-2, 3-wire for push-to-talk, less connectors  
Price, delivered, with battery, \$13.95

### LETTERS

Dear Wayne:

I would like to point out an error in the schematic of my article, "Building a 6 & 2 meter portable." (March, Page 33) The Ant. connector, switch S1-A, relay K1-A and K1-B, all are connected with coax, and the shield is grounded, not the center conductor as shown.

Also it should be noted that coil L1 is tapped 1/3 the way up from ground for the Ant. connection.

A very limited supply of the mmfd 27 mmfd variable, can be obtained by sending \$1.59 to "Red" Johnson Electronics, 3311 Park Blvd., Palo Alto, Calif.

. . . Richard Juengel K8KDX16

### PHL Revisited

Gentlemen:

I would like to comment on Fred Doughty's article "Double Sideband" in the Feb. '63 issue. I have long been a supporter and booster of DSB and concur with Fred's excellent comparison of modulation systems. However, to be fair about things, I think it should be pointed out that these comparisons are only valid when the final stage is coupled directly to the antenna. When, as is customary, the signal generated is amplified by a linear amplifier many of the advantages described are lost. This is particularly true of power in for power out comparisons. It is significant that even with the "linear equalizer" in the system we still have two sidebands for the receiver to select with DSB. Further, one point that seems to have been overlooked is the ease of bandswitching with DSB as compared to SSB. How about some expert coming up with plans for a good high power DSB transmitter with modulation applied at the final stage so that the "lazy linear" can be discarded?

W. E. English KØDLF/I1DFB

Dear Wayne,

In your capacity as editor of 73 how did the article by W3PHL in Feb. '63 on DSB ever get by your editing and appear in the Mag. It is the biggest bunch of garbage I have ever heard. It is untrue, contradictory all the way through and nothing but a bunch of doubletalk. Its proper place should have been for an April fool joke.

John Badali WA2VME

Att. Wayne Green Editor??

I have been a ham for 36 years and I have never seen any article published as stupid as the one you published by W3PHL. I will not spend any more money for your magazine.

G. V. Lichtenfels W3AQT

Dear Wayne,

I enjoyed the thoroughly informative article by Fred Doughty W3PHL on the subject of double sideband.

Dick Genaille K4ZGM

### F M FREQUENCIES

52.525 mc  
146.94 mc

## FM FM FM FM FM

FMTRU 30D 150mc \$45.00	FMTRU 41V 30-50mc \$85
FILTR 30D 30-50mc \$45.00	50BR base sta. 30-50mc \$85
FMTRU 80D 150mc \$65-\$100	80Y base sta. 30-50mc \$150
FMTR 80D 30-50mc \$65-\$100	T44A6A 450mc \$100 and up

Also-GE gear \$35 and up. Dumont and Link gear available.

northwest electronics  
Box 7, Chesterton, Indiana



ONLY  
8x5x2

QSO-LOG the modern QSO filing system

NO CARDS TO REFILE, MISFILE, OR LOSE  
COMPACT—REPLACES 800 FILE CARDS  
CAN BE EXPANDED INDEFINITELY  
DURABLE CONSTRUCTION FOR LIFETIME USE  
PERSONALIZED WITH YOUR CALL LETTERS  
ONLY \$9.95 COMPLETE POSTPAID  
(CALIF. RESIDENTS ADD 4% SALES TAX)  
COHRS-Dept. 75 Box 504 Charter Oak, Calif.



### WANTED

Transistors, Tubes all types, Test Equip., Ground Equip., PRC, GRC, TS, URM, UPM, Aircraft Communications & Navigation Equip. Write or phone

V & H RADIO

2053 Venice, L.A. 6, Calif.

### Reyco Multiband Antenna Coils

Traps for dipoles . . . high strength . . . moisture proof guaranteed to handle a full KW.  
Model KW-40 coils will, with a 108 foot antenna, provide operation on 10-15-20-40-80. \$12.50 set.

For information on other models write:

FRED L. REYNOLDS W2VS, 492 Ravenswood Ave.,  
Rochester 19, New York

### QSLs

Samples 25c (refundable) Wildcat Press, 6707  
Beck Av., North Hollywood, Calif.

## TELETYPEWRITER EQUIPMENT • COLLINS

51J2, 51J3, R-390A/URR Receivers (.50-30.5 MC). Teletype Printers #14, #15, #19, #20, #26, #28. Kleinschmidt Printers #TT-4A, TT-76, TT-98, TT-99, TT-100, GGC-3. Telewriter Frequency Shift Converter. For general information & equipment list, write to TOM, W1AFN, ALL-TRONICS-HOWARD CO., Box 19, Boston 1, Mass. Richmond 2-0048.

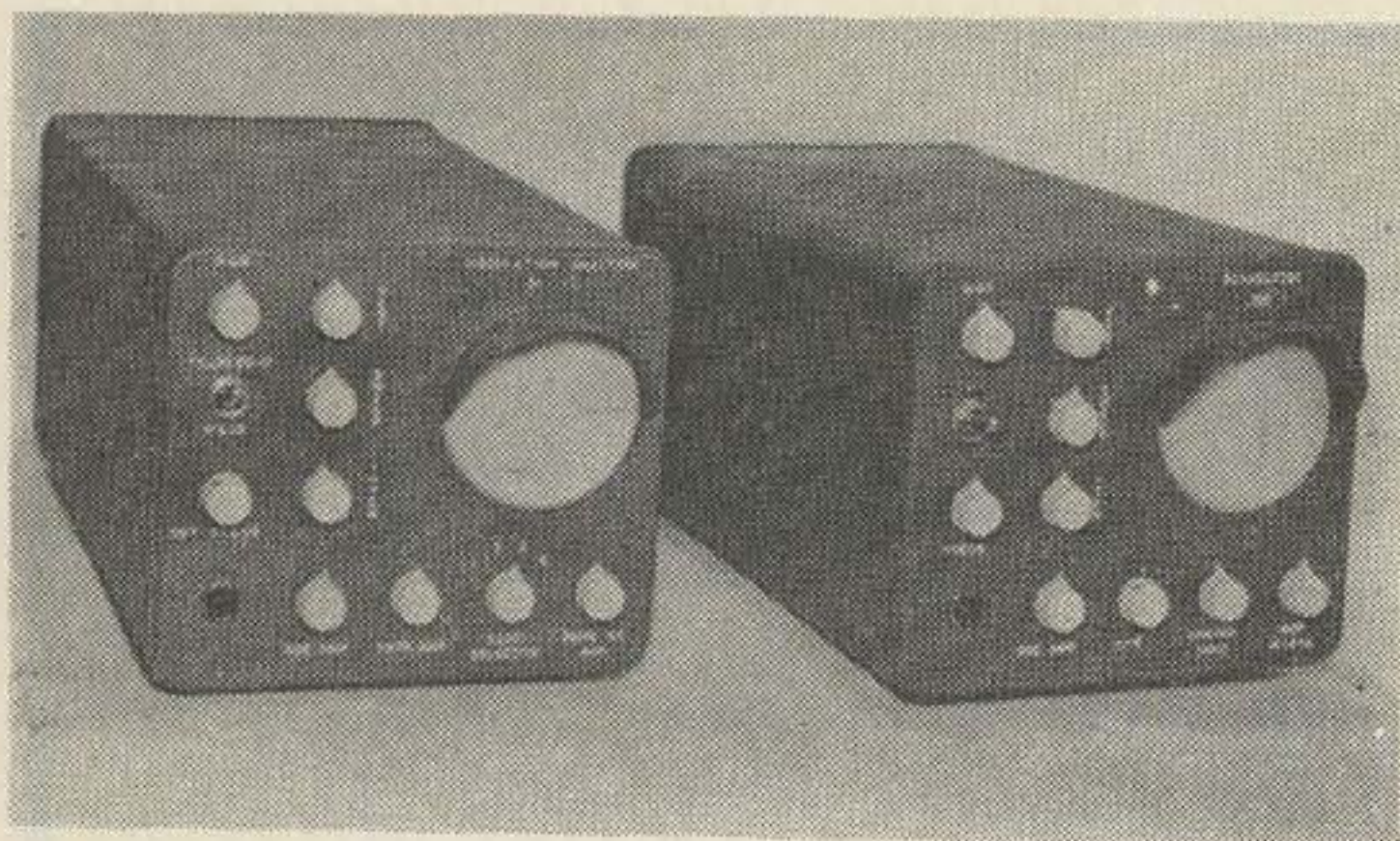

Denys Fredrickson WØBMW  
3923 East Funston  
Wichita 18, Kansas

## Panoramatic Spectrum Analyzer

HAVE YOU EVER wondered how congested the band was on either side of the frequency to which you were listening? Is there a hole in the QRM for one to which to QSY? Should one QSY up or down? How far should one QSY? When he did QSY, where did he go? How close am I to the edge of the band? How can one zero beat or check for splatter without changing the receiver dial? Does the received signal have carrier shift? These are but a few of the questions that can be answered by building this unique and easy to operate panadaptor. It is also a tremendous aid in chasing DX and for net operation.

The Panadaptor was designed and built as a twin to the Modulation Analyzer<sup>1</sup>. The same size chassis and case were used. The *if* and sweep circuits are similar to those in the "Snooper" built by W7HEA<sup>2</sup>. The components are all available commercially which eliminates reworking surplus gear which many times is difficult to obtain.

The signal input to the panadaptor is obtained from the first or second conversion stage in the receiver. Although connecting to the first stage will allow a greater bandwidth to be observed, the writer used the second stage because of convenience. A satisfactory bandwidth of 70 kc was obtained.

### Circuit

The first consideration should be the signal from the receiver because the input of the panadaptor will have to match the frequency obtained from the receiver. The Panadaptor

rf input transformers were stagger tuned to obtain the best linearity and bandwidth as possible.

The mixer-oscillator was tuned to a frequency of 630 kc so when mixed with the 455 kc signal from the receiver, the mixer-oscillator output frequency will be the panadaptor *if* frequency of 175 kc. A different rf input and/or panadaptor *if* frequency may be used if desired by changing the transformers and/or retuning the mixer-oscillator to produce the desired *if* frequency.

A 6AK5 reactance modulator is used to sweep the spectrum on each side of the center frequency by varying the reactance of the oscillator circuit which causes the oscillator frequency to change. The 50K resistor and 10 mmfd capacitor in the reactance modulator and oscillator circuit are somewhat critical for proper reactance tube and oscillator operation.

A question may arise concerning the 1 meg resistor which is connected between the rf gain control and B plus. This little device will allow a smoother and broader control of the gain rather than have it all bunched up on one end of the control.

The 12AX7 operates as a sawtooth generator and amplifier to drive the reactance modulator and horizontal sweep of the CRT.

The length of the base line can be adjusted with the horizontal width control. The sweep pad control (broad adjustment) and the sweep width control (fine adjustment) will control the amount of radio frequency spectrum that is to be viewed. By adjusting the sweep, the display can be varied until only one signal appears on the CRT. Centering the received signal on the base line is accomplished by the center frequency control. The

<sup>1</sup>Modulation Analyzer, CQ, January, 1961

<sup>2</sup>The Snooper, CQ, August, 1952

TO REC.

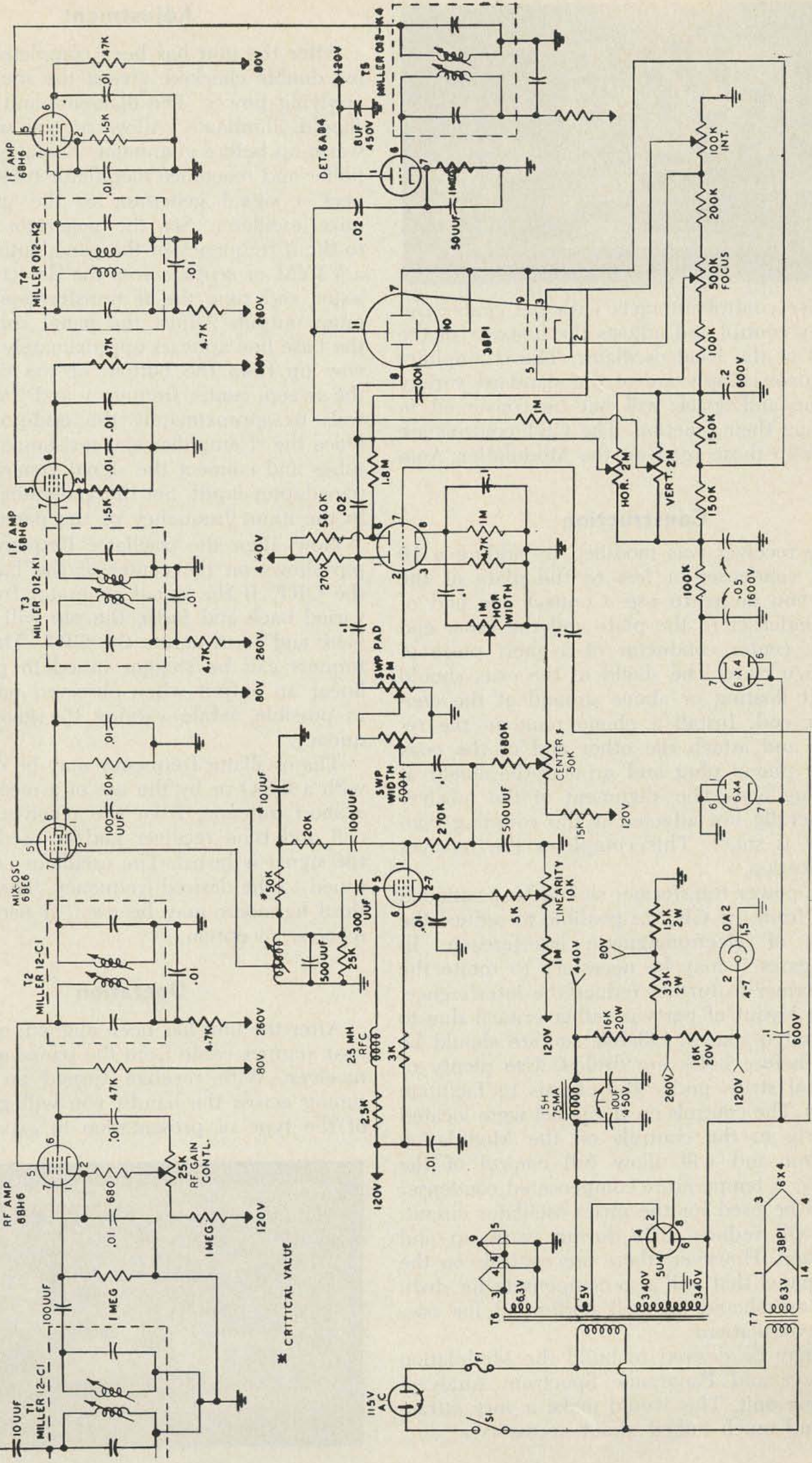

\* CRITICAL VALUE

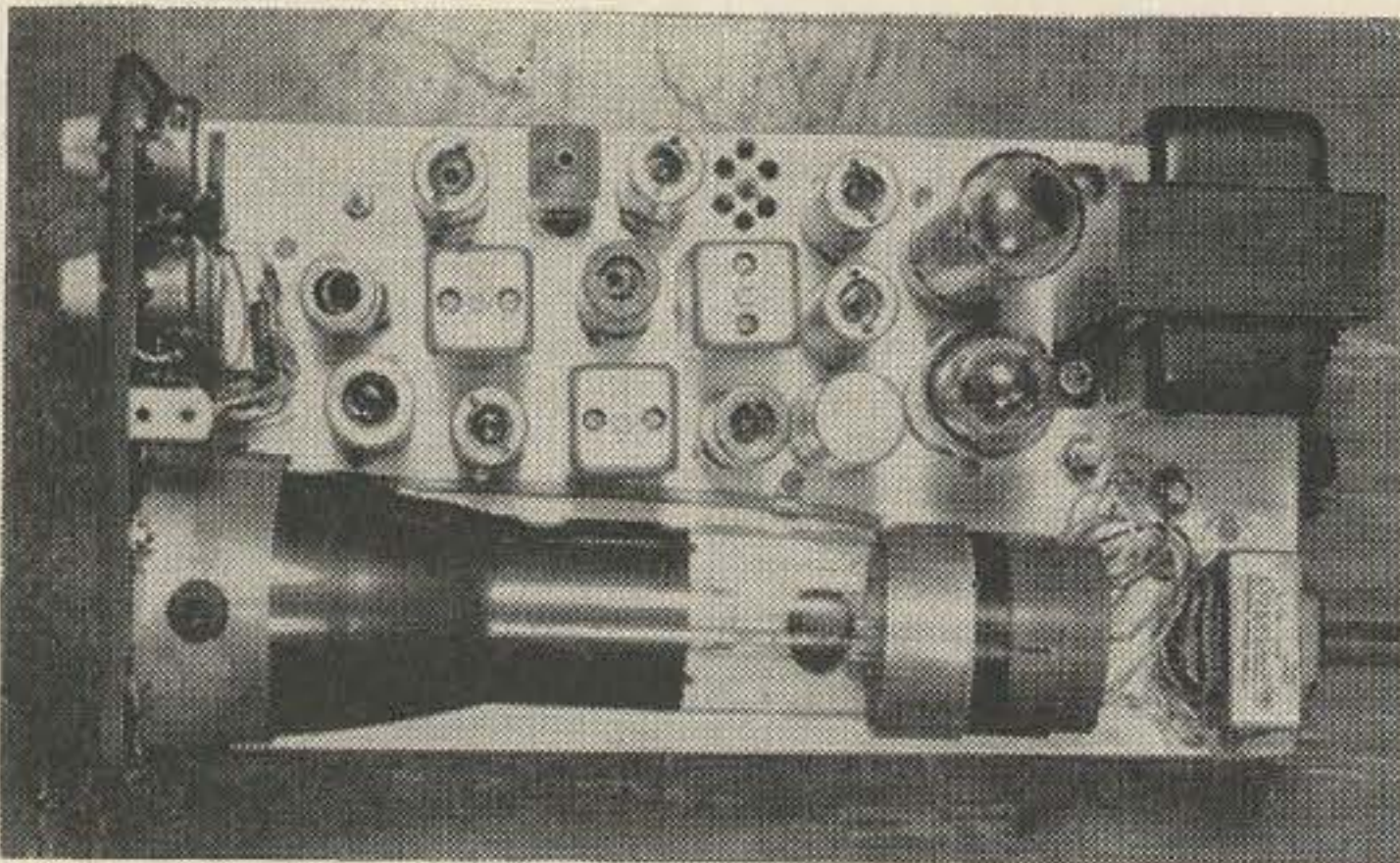

linearity control interacts with the center frequency control and adjusts the linearity of the sweep of the local oscillator. The *if* amplifier and power supply are of the standard variety so time and space will not be consumed in outlining their function. The CRT controls are similar to those used on the Modulation Analyzer.

### Construction

The receiver was modified by adding a 10 mmfd condenser or less to the plate of the stage you desire to use. Connect one end of the condenser to the plate and the other end to the center conductor of a short piece of RG-58/u coax. The shield of the coax should be left floating or above ground at the condenser end. Install a phono plug on the receiver and attach the other end of the coax to the phono plug and ground the shield at the plug end. The alignment of the receiver is generally not affected if the coupling condenser is small. This completes the receiver modification.

The power transformer should be positioned as far from the CRT as possible to reduce the affects of electromagnetic interference. In some cases it may be necessary to rotate the transformer to further reduce the interference.

The layout of parts is rather critical due to the limited space available, so care should be taken before holes are drilled. Use plenty of terminal strips under the chassis to facilitate wiring. The controls on the panel were located similarly to the controls on the Modulation Analyzer and will allow full control of the display. A temperature compensated condenser should be used for the mixer-oscillator circuit. This will reduce drift during warm-up and operation. However, there are controls on the front panel that will also compensate for drift. The case should be well perforated for adequate ventilation.

It may be desired to build the Modulation Analyzer and Panoramic Spectrum Analyzer into one unit. This would make a very attractive and much talked about accessory.

### Adjustment

After the unit has been completed and wiring double checked, give it the smoke test by applying power. The filaments and pilot light should illuminate. Allow several minutes for warm-up before alignment. Remove the rf amplifier and reactance modulator tubes and connect a signal generator to the grid of the mixer-oscillator. Set the generator frequency to the *if* frequency of the panadaptor. Connect a VTVM or scope across the detector load resistor and tune the *if* transformers for maximum output. Adjust the panel controls until the base line appears approximately 1/3 of the way up from the bottom of the CRT. Place the sweep, center frequency and linearity controls to approximately the mid-position. Replace the rf amplifier and resistance modulator tubes and connect the signal generator to the panadaptor input. Set the generator frequency to the input frequency of the panadaptor.

Now align the oscillator frequency until a pip shows on the center of the base line on the CRT. If the signal generator frequency is varied back and forth, the pip will also move back and forth across the CRT. The rf transformers can be stagger tuned to produce as linear an output when observed on the CRT as possible, while varying the generator frequency.

The oscillator frequency may be determined with a GDO or by the use of a receiver. Place a short antenna, from the receiver, near the coil and tune receiver and/or oscillator until the signal is heard. The oscillator can now be tuned to the desired frequency. The second or third harmonic may be used, if necessary, for receiver reception.

### Operation

After the unit has been aligned, connect the coax jumper cable from the panadaptor to the receiver. With receiver turned on and then tuning across the bands, you will get an idea of the type of presentation to expect on the





CRT. You may desire to touch up the alignment as a final adjustment.

The height of the pip will double when the modulation is 100%. Carrier shift is indicated by a sidewise movement of the pip under modulation. Splatter is evident when smaller pips appear and disappear on either side of the received signal when modulated. Zero beating is simply accomplished by moving the pip from your VFO to coincide with the received signal. Out-of-band operation can be eliminated when using a crystal calibrator and the panadaptor. You can immediately see if your signal is "In or "Out" of the band by its position with respect to the crystal calibrator signal. After calling CQ you can see the signals replying (within limits) without touching your receiver. The face of the CRT can be calibrated by using an overlay or thin strips of tape as markers.

The signal may be monitored by using a pair of headphones and by adjusting the center frequency or receiver the desired signal can be heard.

It is also a considerable aid for SSB and CW operation. It is the writer's opinion that it could be used in copying code visually for those that are deaf.

When chasing DX, the signals are sometimes quite weak. As you are tuning across the band you will see the signal before you hear it, thereby tuning more carefully when you approach his frequency. If the DX signal should take a dip at the time you tuned to his frequency, chances are you would have missed a rare one without the panadaptor.

The writer has worked 125 countries on phone in approximately two years and quite a few of these are attributed to the use of the panadaptor. It is a very versatile piece of equipment and will also enhance the beauty of the shack.

The writer wishes to thank Mr. Dick Azim, KØJEJ, for the fine job of photographing the equipment. . . . WØBMW

---

*We'll pay \$1 each for ideas good enough to print.*

I'd like to see . . .

. . . coaxial cable made lower loss by silver plating the surface of the inner conductor since most of the skin effect loss is on this surface. Tinning increases skin effect losses, silver reduces it. . . . W2WLR

## New Heavy Duty RFI Suppression Kit For Mobile Radio



**CB** OPERATORS can now enjoy clearer, less tiring mobile communications at longer ranges.

Sprague's Type SK-1 SUPPRESSIKIT provides effective R-F Interference suppression—at moderate cost—up through 400 mc. Designed for easy installation on engines with 6-volt or 12-volt generators, the Suppressikit makes possible high frequency interference control by means of Sprague's new, extended range, Thru-pass® capacitors.

The components in the SK-1 are neatly marked and packaged, complete with easy-to-follow installation instructions.

The generator capacitor is a heavy-duty unit rated at 60 amperes, and will operate at temperatures to 125°C (257°F). There's no chance of generator failures from capacitor "short outs," as with general purpose capacitors. The Thru-pass capacitors for use on voltage regulators are also rated at a full 60 amperes.

Containing only 5 easy-to-install capacitors, the Deluxe Suppressikit is a well-engineered kit. The net price is a little higher than that of many thrown-together kits, but it saves you so much time and aggravation it's well worth the slight extra cost.

For additional information on the Type SK-1 Suppressikit, see your Sprague Electronic Parts Distributor.



65-105-63

# 500 Watts PEP!



Complete transmitter, including heavy duty power supply.

## TRI-X-500

### Features

- Upper and lower sidebands on all ranges + AM & CW
- Power output control 75-500 watts
- Automatic level control (A. L. C.)
- Meter for monitoring plate current and transmitter output
- Rugged heavy duty cast aluminum chassis
- Modern styling and extra compact for table top use
- Heavy duty full time blower
- Smooth tuning 100-1 VFO tuning
- 500 watts PEP to 4X150
- 400 watts CW
- 300 watts AM
- Carrier suppression more than 50 db
- Unwanted sideband suppression more than 45 db
- Spurious frequencies down more than 45 db
- All Crystals included
- VFO Stability: 50 cps. after one-half hour warmup
- Pi network output. 45-100 Ohms
- Voice control
- Anti-trip circuitry

**Frequency Ranges:** 3.5-4.0 mc, 7.0-7.5 mc, 14.0-14.5 mc, 21.0-21.5 mc, 28.0-28.5 mc, 28.5-29.0 mc, 29.0-29.5 mc.

For more information write to:

**TRI-STATE Electronics, Inc.**  
2734 Lee Hwy., Falls Church, Va.

Distributed in the New York area by  
**Two-Way Radio Communications**  
232-236 Hylan Blvd.  
Staten Island 5, N. Y.

# The Smallest Amplifier Yet



## The Three Musketeers New Grounded Grid Amplifiers

Musketeer Quad 80-15 meters	\$329.90 w/PS
Musketeer Six 6 meters	\$319.90 w/PS
Musketeer Two 2 meters	\$319.90 w/PS

All amplifiers use an RCA 8122 final in a grounded grid high frequency circuit. Drive with any 70 to 250 watt exciter. KW on SSB and CW, 600 watts on AM. All units housed in 12" wide, 8" high, 7" deep cabinets. Quad in gray, VHF models in gray and white.

## J & D LABS

73 Highway 35 Eatontown, N. J.  
Dealers Write

## HARMONIC/TVI PROBLEMS???

### 6 METERS

#### TUNABLE LOW-PASS MAVERICK

The only low-pass filter designed expressly for 6 meters. With 9 individually shielded sections and 5 stages tunable forming a composite filter of unequalled performance. 1 DB loss. Handles 400 watts PI. 35 DB rejection. Size 5" by 2" by 3".

AMATEUR NET \$16.95

#### MAVERICK II WITH POWER MONITOR

Same as above but with 6 meter power indicator calibrated in watts output. Indicator Size 4" by 4" by 4½". Slant Face. Reads 0-50. 0-400 watts.

AMATEUR NET \$34.95

### 2 METERS

#### BAND-PASS MODEL BP-144

A narrow band-pass filter with 6 mc pass band and 146 mc center frequency. 1 DB insertion loss. 35 DB attenuation of harmonics. Handles up to 185 watts PI. Size 4" by 2¼" by 2¼".

AMATEUR NET \$11.85

#### MODEL F810

Five separate filters housed in one package and selected by a front panel switch. Each filter is tuned for maximum attenuation of the second harmonic for that particular band. Attenuation - 35 DB. Handles up to 1 kw. Size 5" by 6" by 4".

AMATEUR NET \$24.75

Write for complete brochures. See your local dealer.  
Manufacturers of the finest UHF TV Converter

**GAVIN**  
INSTRUMENTS, INC.

DEPOT SQUARE &  
DIVISION STREET  
SOMERVILLE, N.J.  
TEL: 722-6311  
AREA CODE 201

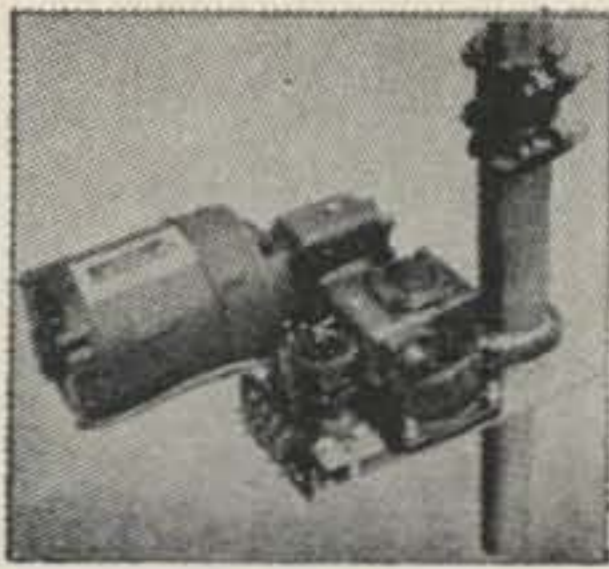

### TELREX ROTATOR-INDICATOR SYSTEM MODEL TS238-RIS

• **MAST FEEDS THRU ROTATOR FOR SAFER AND EASIER INSTALLATION MAINTENANCE**

- 1300 IN/LBS ROTATION TORQUE
- SELF LOCKING BY STURDY WORM GEARS
- AZIMUTH INDICATION BY SELSYNS
- AUTOMATIC LIMIT OF ROTATION
- DESIGNED FOR 2" O.D. MASTING
- MALLEABLE CAST MASTING CLAMP SUPPLIED
- OUTPUT SPEED APPROX. 1 RPM
- WILL FIT INTO OR ONTO A 6" SIDED TOWER

A REALLY STURDY ROTATOR-INDICATOR SYSTEM NOT A MODIFIED TV ROTATOR

WILL HANDLE A TM30-C OR EVEN A 20M-436 B IN WINDS UP TO 110 MPH

**238<sup>00</sup>**

EQB ASBURY PARK N.J.

OTHER TELREX ROTATORS LARGER HIGHER TORQUE RATING MODELS AVAILABLE

MODEL TS435-RIS \$435<sup>00</sup>

8,000 IN/LB TORQUE

MODEL TS535-RIS \$535<sup>00</sup>

8,200 IN/LB TORQUE

(CUSTOM DESIGNED MODELS AVAILABLE)

**TELREX LABS.**

ASBURY PARK N.J.



(W2NSD/1 from page 6)

S-920

The portents are good for the reciprocal licensing bill this time. Senator Goldwater fought it through all of the various agencies involved last year and was able to reword the bill so that all of the objections raised were taken care of. No great problems are envisioned in getting it through this year. The following are the reasons why I believe it important for us to give this bill all the backing we can. You may keep in mind that I am a well known worry-wart, though I alibi this deficiency in my makeup by pointing out that I haven't been wrong yet.

Passage of the bill will, I believe:

- 1) Permit us to operate from a great many countries of the world while traveling. This would allow us to do a lot more DXpeditioning and would also make it possible for us to meet the local amateurs through on-the-air contacts and achieve better people-to-people relations.
- 2) Foreign amateurs visiting the U. S. would be able to meet the lower powered U.S. amateurs and get to know them better.
- 3) The expense of visiting the U. S. is high and unfortunately it is the important and influential foreign amateurs who suffer from not being able to operate while in our country. We will have quite an advantage if we make this demonstration of international good will toward foreign amateurs. This will come home to roost at the next Geneva Conference when reallocations of the short waves will be the major matter of moment.

In this day and age of inexpensive tours and miniature transceivers we can benefit much from the passage of this bill.

### Continental QSL Club Kaput

It seemed to me that the chain-letter economics of the Continental QSL Club would eventually be their downfall . . . well I was wrong. Section 25 of the Postal Regulations did it instead. You see, the Post Office has been set up as a monopoly by law so that there cannot possibly be any competition to their service. This possibly has a lot to do with the shape the P.O. is in now. The part that

(more trivia on page 85)



## DOW RADIO & Electronics

1759 E. Colorado Blvd. ---PASADENA---Mu 1-6683  
222 West Main St. ----SANTA MARIA----WA 2-1765  
5857 Hollister Ave. -----GOLETA-----WO 7-3401  
1505 S. Oxnard Blvd. -----OXNARD----HU 6-6353



### DOW-KEY CONNECTORS

#### PANEL MOUNT

Durable, silver plated, precision made. Only  $\frac{5}{8}$ " hole is needed, no screws.

ea. . . . .70

#### DOUBLE MALE

Favorite everywhere Precision made, rugged locking type. Silver plated.

ea. . . . .1.25



DOW-KEY COMPANY, Thief River Falls, Minn.

## USED EQUIPMENT -

### GUARANTEED A-1 CONDITION

2-VIKING "500" transmitters (new price \$1050) only \$495.  
B & W 5100 \$179. DX-100 \$129. COLLINS 32V-1 \$159.  
PIERSON KP-81 \$225. VIKING II and vfo \$149. GONSET  
GSB-101 \$219. CE 20A & vfo \$159. VIKING INVADER "200"  
\$459, "2000" \$895. SX-101MkIII \$239. HQ-170C \$249.  
\*\*\*GONSET G-66 Rcvr w/12VDC thin pack . . . . . \$119.\*\*\*  
\*\*\*GONSET G-77A Xmtr w/ power supply . . . . . \$159.\*\*\*

Many others in stock. Write & ask. Top Trade-ins!

Complete line of Antennas & Ham Parts.

Distributor for Collins, Hammarlund, Johnson, Hallicrafters, Gonset, National, Drake, B & W.

Equipment above prepaid in Continental U. S.

### MISSION HAM SUPPLIES

5472 Mission Blvd. Riverside, California  
Phone (area code 714) OV 3-0523

## ARROW ELECTRONICS

7035 Laurel Canyon Blvd., North Hollywood, Calif.

Phone (213) 765-7040

Largest Ham Department in the Valley  
NATIONAL - HALLICRAFTERS - GONSET - JOHNSON - POLYCOMM - MONARCH - and others

Up to 20% off on demonstrators

Complete line of tubes, components, & tools for Amateur, CB, TV, Stereo & Hi-Fi

Other Stores at:

4736 W. Century Blvd., Inglewood (213) OR 8-5406  
2713 S. Main St., Santa Ana (714) KI 5-0405  
2650 E. Colorado Blvd., Pasadena (213) MU 1-4138  
4686 Long Beach Blvd., L.B. (213) GA 3-3813  
1015 S. Figueroa St., L.A. (213) RI 7-0271

# Shielding the Breadboard

Charles Miller W1IS1  
General Radio Company  
West Concord, Mass.

It appears that few circuits ever become successful without passing through what is known as the breadboard stage. The importance of this stage of development is not to be minimized, and some knowing individuals have even formulated laws for the construction of breadboards.<sup>1</sup> A number of materials have become available in recent years which are designed expressly for use in breadboard construction. One of the most useful of these has been perforated, insulated board. Most manufacturers supplying this material also supply complementary components specifically designed for breadboard work. Unfortunately, the need often arises to shield circuits from stray fields present either in the work area or between various parts of the circuit. The photographs illustrate my solution to this problem.

Basically, the breadboard should be a time saver. That is, it should allow the desired circuit to be constructed with the least possible attention to mechanical details. To avoid making odd packages for each new breadboard, the author built several standard packages. Each package has a variety of connectors and miscellaneous holes in at least one side. A section of standard perforated board may then be mounted on spacers permanently attached to the bottom. Breadboard construction then proceeds normally. A lid is provided for shielding purposes. When shielding is required between several circuits, they are simply mounted in separate enclosures and connected by means of shielded cables. Although the author's primary use is with transistor circuits, the total height is sufficient for vacuum-tube work, though ventilation should be provided.

The enclosures shown are deep-drawn aluminum boxes manufactured by the Zero Manufacturing Company.<sup>2</sup> Although standard, less expensive electronic chassis or boxes could have been used, the absence of the lip is highly desirable. The enclosure and its lid are identical, measuring  $6\frac{1}{8}$  by  $9\frac{1}{8}$  inches,  $2\frac{1}{2}$  inches deep. This leaves sufficient clearance behind permanently mounted components such as connectors and switches, so that a section of Vector-board® may be readily inserted or removed. The choice of connectors, of course, is up to the individual, but it is recommended

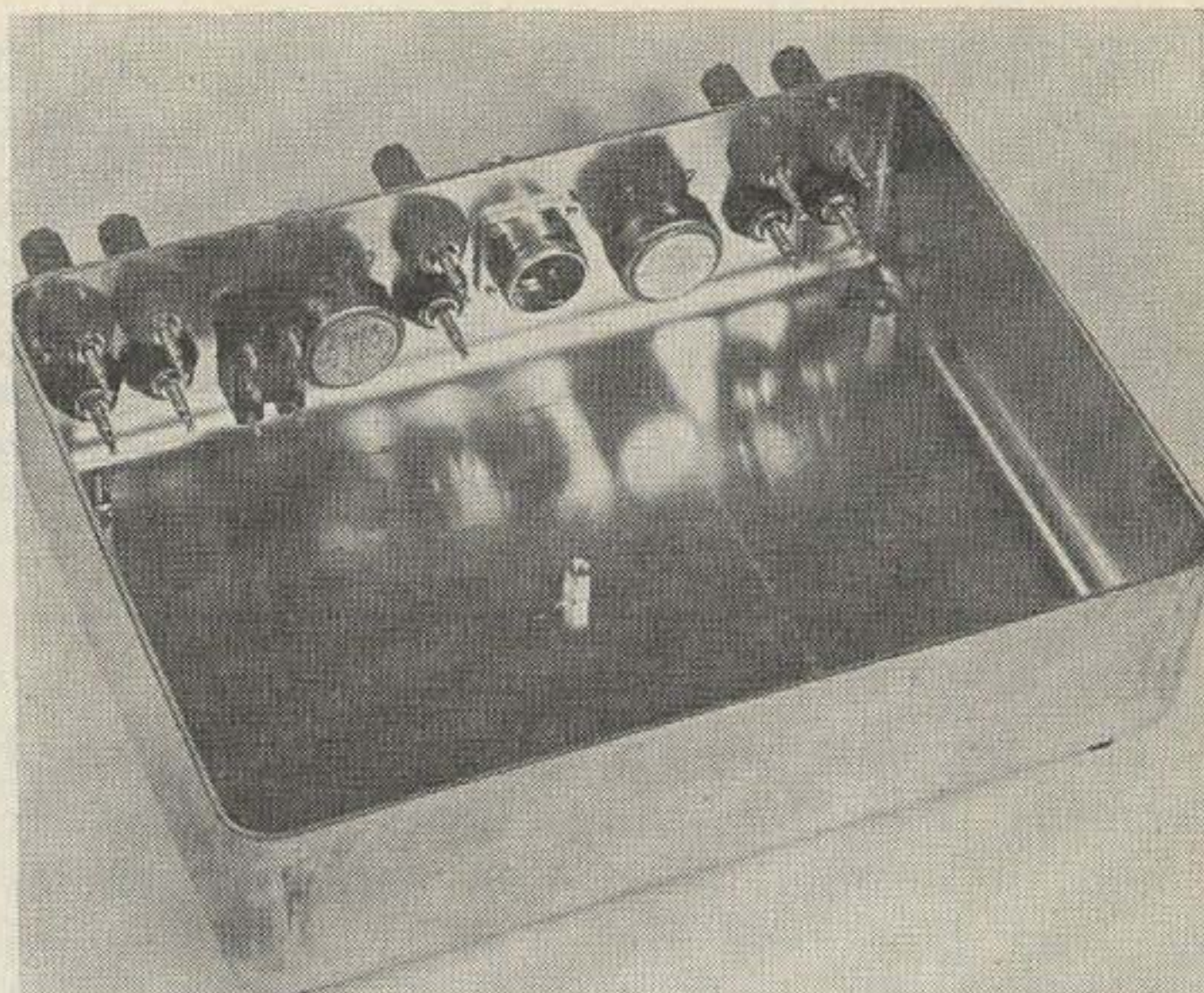

Shielded breadboard cabinet illustrating a variety of components and connectors mounted on one face.

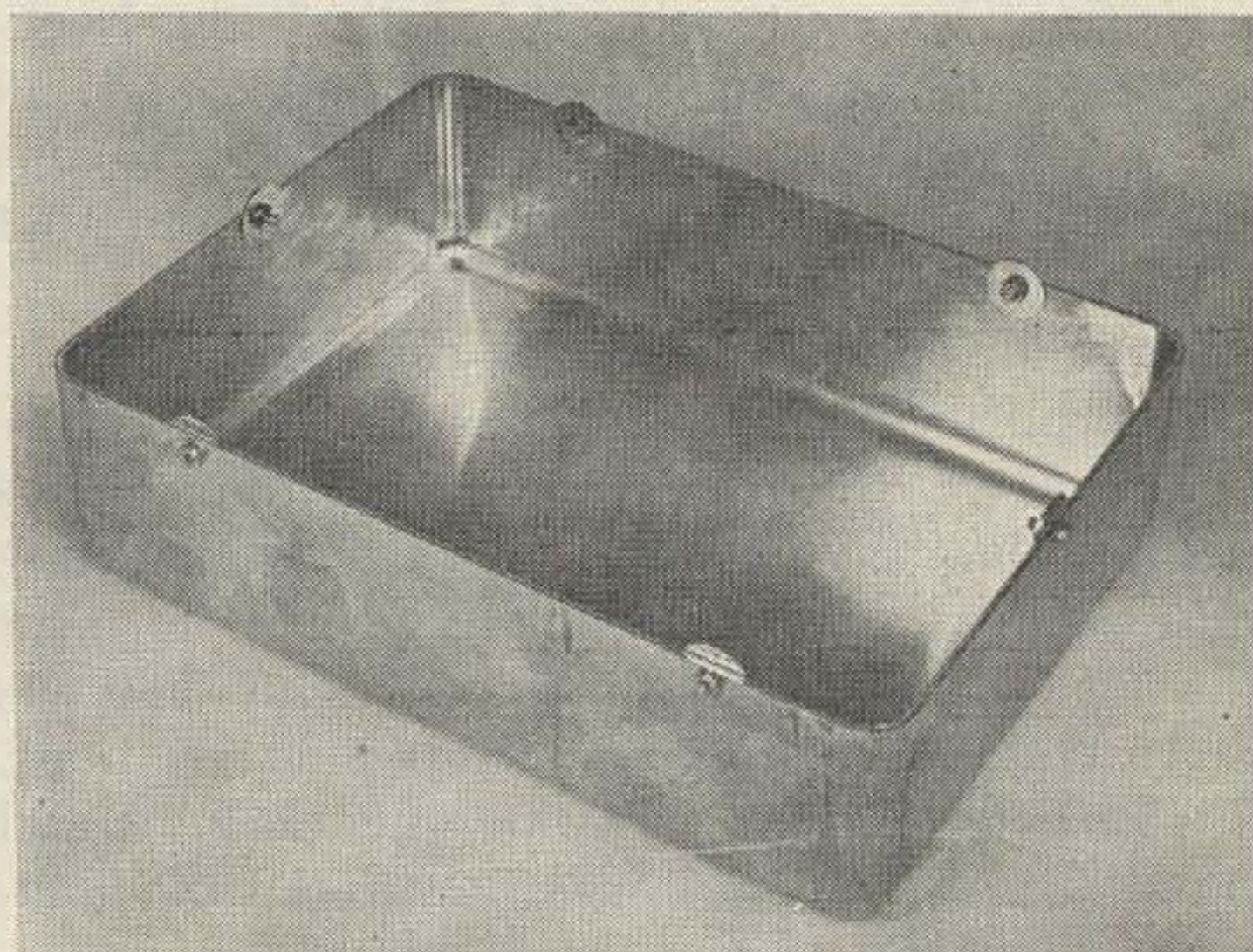

Cover is made by bolting washers to inside of box of same dimensions. Total height is adequate for vacuum-tube circuits (see text).

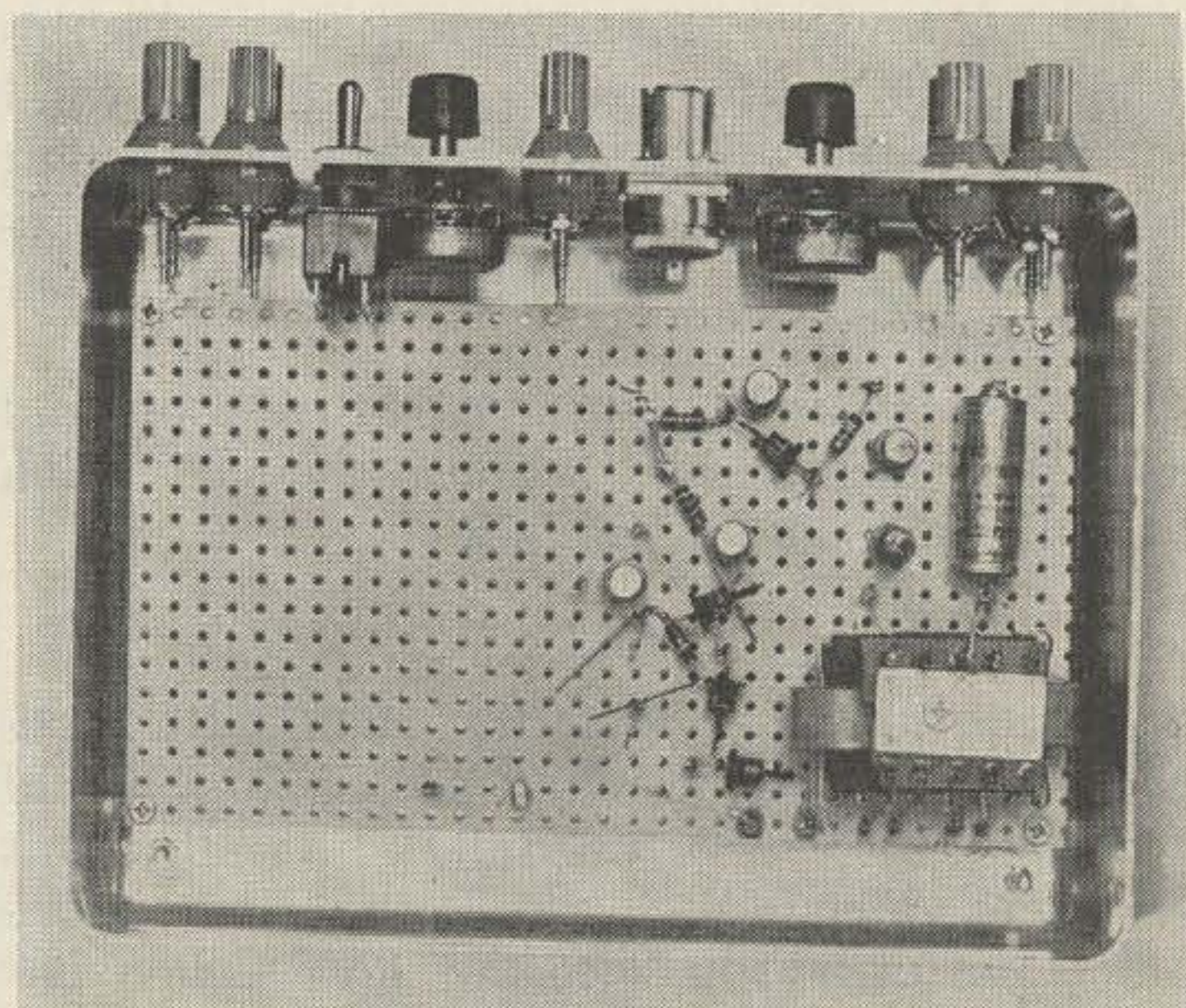

Top view showing perforated board in place. Note accessibility of terminals on panel-mounted components through the use of a deep-drawn box. Additional components may be mounted on rear face, if required.

# QUEMENT



# NOTICE!

IN A RECENT SURVEY, OUR CUSTOMERS VOTED

## 4 to 1

### FOR THE FANTASTIC NEW NATIONAL NCX-3 TRANSCEIVER

- IN STOCK — IMMEDIATE DELIVERY
- 200 WATTS — PROVEN PERFORMANCE
- WE PREPAY DELIVERY ON NCX-3's IN U.S.A.

California residents include 4% Sales Tax

SINCE 1933

ONE DAY SERVICE

Phone CY 4-0464

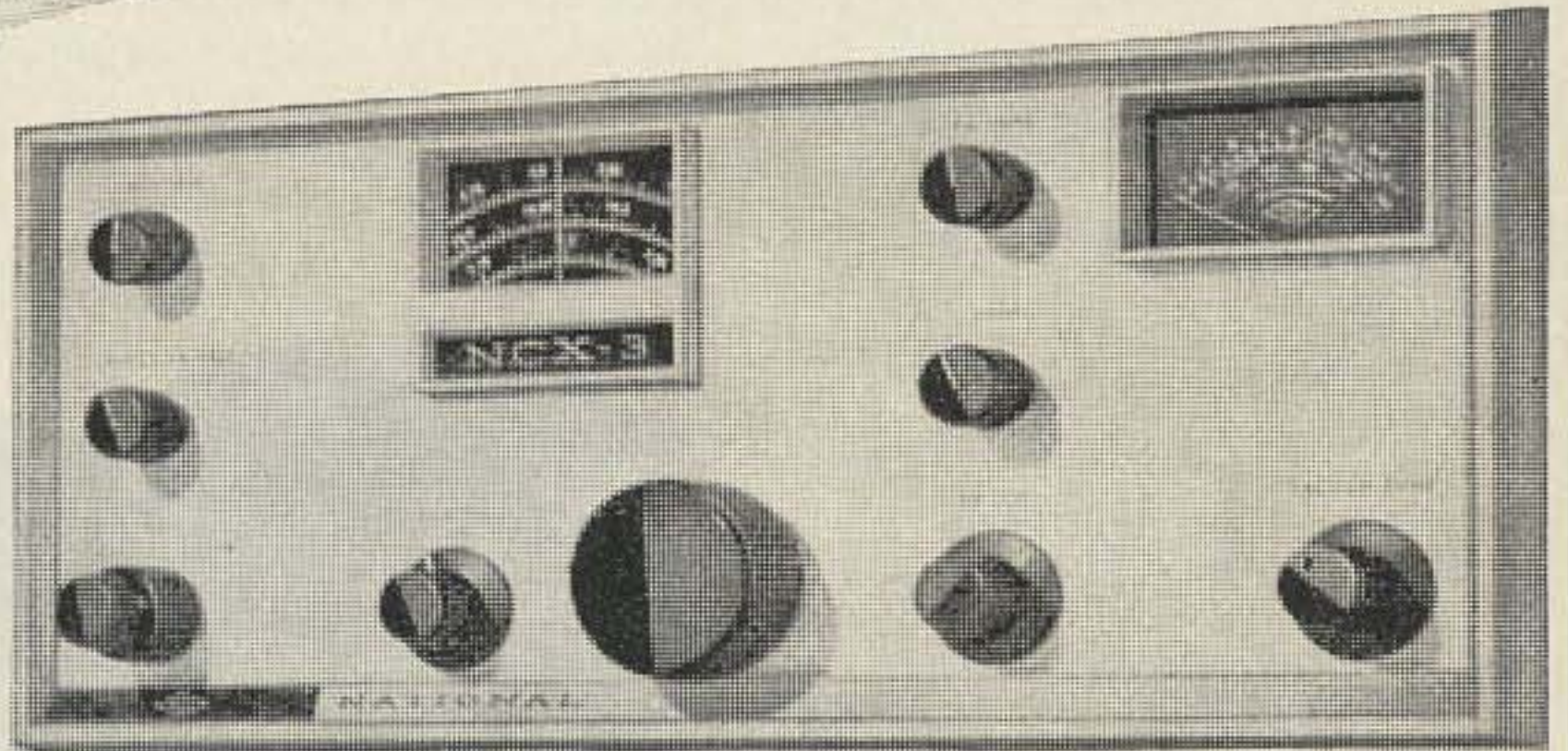

# QUEMENT ELECTRONICS

1000 SOUTH BASCOM AVENUE

SAN JOSE, CALIFORNIA

"Northern California's Most Complete Ham Store"

that they be of high quality as they will undoubtedly remain permanently attached to the cabinet and receive a great deal of wear. As many as possible should be installed as they constitute the only electrical access to the circuit when the cover is in place. The binding-post type shown is extremely versatile and when properly spaced may be used with commercially available banana plugs and shielded cables. Good coaxial connectors should be provided for higher frequency use. Additional holes accommodate switches, potentiometers, etc. Five spacers have been provided, placed

so that they line up with hole centers in the Vector-board. The fifth spacer (center) will be found necessary if it is intended to use the standard Vector push-in terminals. The added support eliminates the possibility of breaking the board or causing a short when inserting terminals. Rubber feet are provided to prevent marring bench tops by the heads of the screws holding the spacers down. Photos 2 and 3 illustrate some breadboard work in progress. The enclosure as shown was adequate for this particular circuit. Had this not been the case, additional components and/or connectors could have been mounted along the rear face of the enclosure without hampering the removal of the entire board.

The integrity of the shielding will be maintained if snap buttons are employed whenever the components are permanently removed. Covers are made by simply bolting washers around the inside edge of identical cans as shown in Photo 4. If vacuum-tube work is anticipated, adequate ventilation must be provided. Screen-type snap buttons may be used on the sides of the main cabinet and the top of the cover.

... WIISI

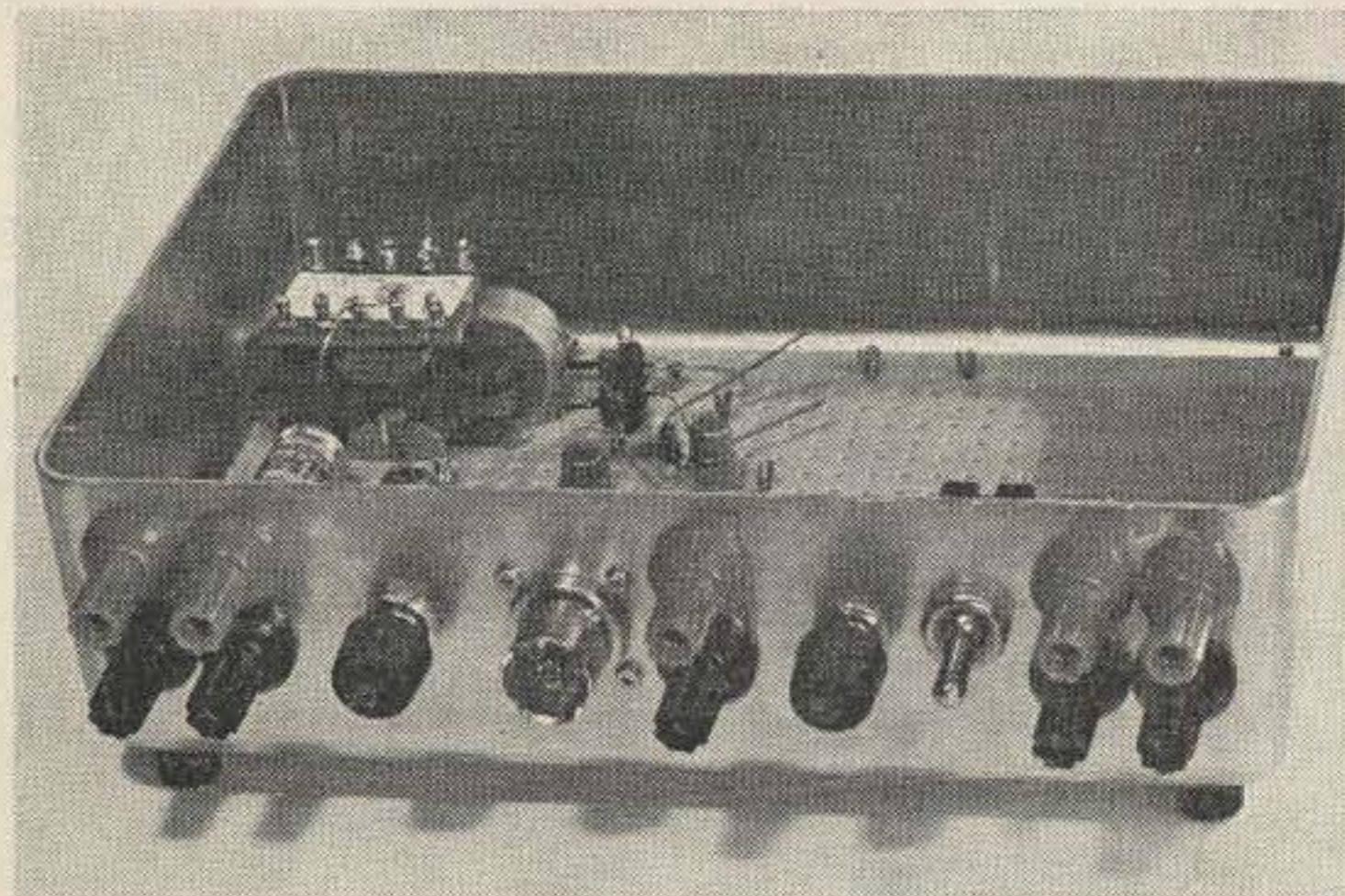

Front view of cabinet with perforated board in place.

<sup>1</sup> Johnson, R. W., The Art of Tacking, Electronic Design, July 19, 1961, p. 176.

<sup>2</sup> Zero Manufacturing Company, 1121-23 Chestnut Street, Burbank, California.



# ALL PURPOSE UNIVERSTER

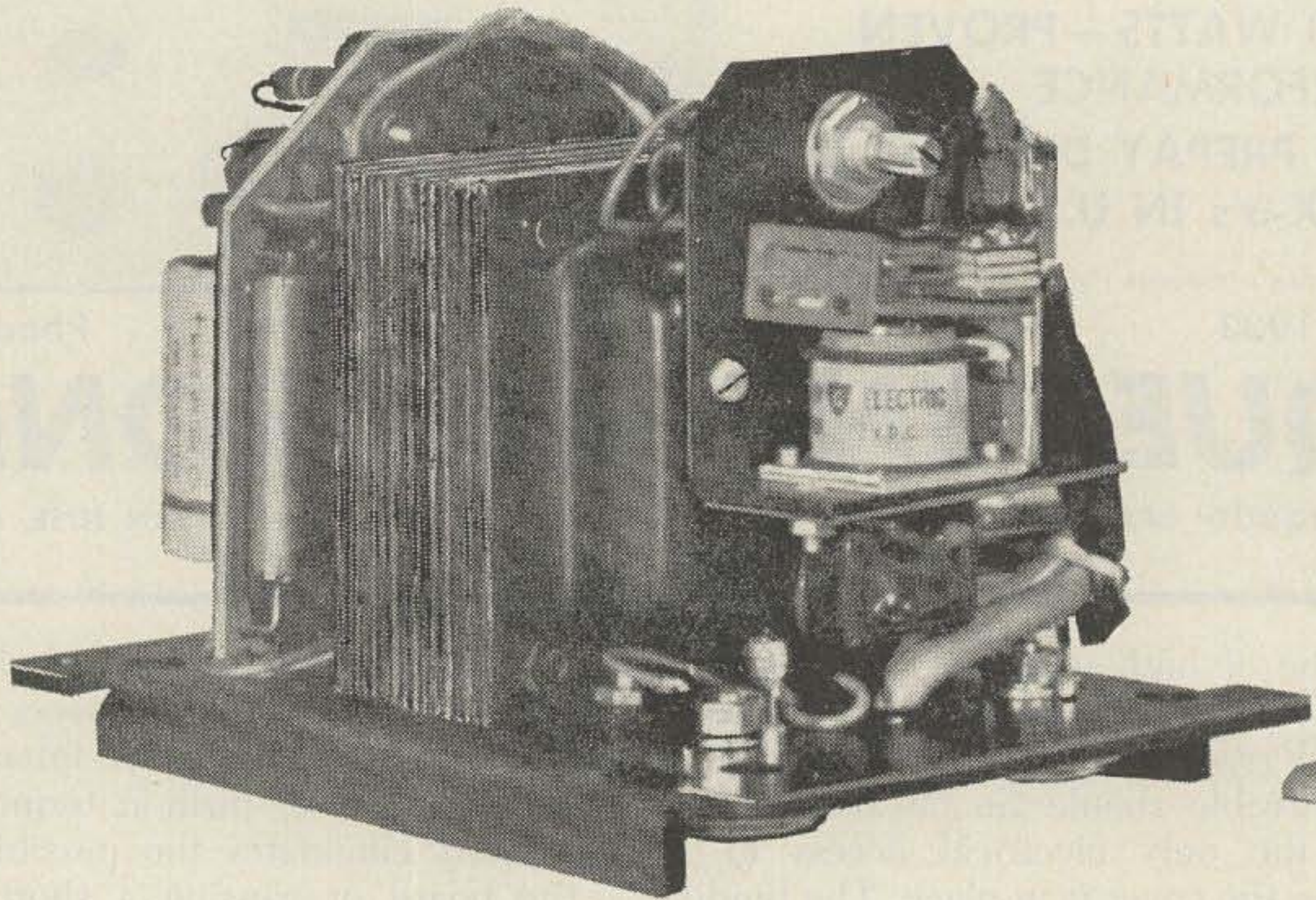

# TOP

I N C O R P O

3802 HOUSTON ST., SAN DIEGO 10,

# 300XL

A UNIVERSAL 300 WATT MOBILE POWER SUPPLY WITH SELECTABLE OUTPUT VOLTAGES. CHANGE TRANSCEIVERS WITHOUT CHANGING POWER SUPPLIES.

## FEATURES

- 300 WATTS
- SELECTIVE OUTPUT VOLTAGE
- REVERSE POLARITY SAFE
- FOOLPROOF ELECTRONIC CIRCUIT BREAKER
- INTERNAL POWER RELAY
- CABLE ATTACHED

## SPECIFICATIONS

- VOLTAGES: 800, 700, 600 VDC Hi B+ (selectable)
- 275 VDC, Lo B+
- -50 to -90 VDC potentiometer bias adjust
- INPUT: 11 to 15 VDC
- WEIGHT: 8 pounds
- SIZE: 6-1/2 x 5 x 4-11/16
- TEMP: -30° to +130° F.



**A Z**  
R A T E D

CALIF. • CYPRESS 7-4815

**PRICE \$119.95**

Unconditionally guaranteed against defects in materials and workmanship for a period of 6 months

# A Broad Band, Coax, Folded Dipole

Ray Abraczinskas W3HJR/ $\phi$   
412 Elm Grove Lane, Apt. 7  
Hazelwood, Missouri

I have heard numerous comments on the bands lately such as, "Don't work any CW here on 80 meters because my antenna is tuned for the phone band and won't load up down there." "I can't talk to him because he works on 3810 and my antenna is cut for 3950." "I'm using an inverted V antenna and the apex angle is sharp causing the bandwidth to be narrow." "I want an antenna that will perform well with a low SWR across the whole 20 meter band." "I can't put up a low frequency dipole because I haven't got the room." This article is presented for these persons' benefit.

Many oldtimers who have used the folded dipole antenna will recall that shorting the two wires of the ribbon a distance out from the center equal to the velocity factor of the ribbon times a free space quarter wavelength, see Fig. 1, will cause the antenna to have a more constant impedance match over a wider range of frequencies thereby giving better bandwidth characteristics. This is the theory on which the material presented here is based with minor variations to suit one's need and fancy.

Since most new commercial transmitters have a relatively small variation in output impedance, 52 ohm coax is a natural choice for a transmission line. When connected to an ordinary wire dipole antenna, coax will match adequately over a relatively narrow range of frequencies provided the dipole is at the proper height

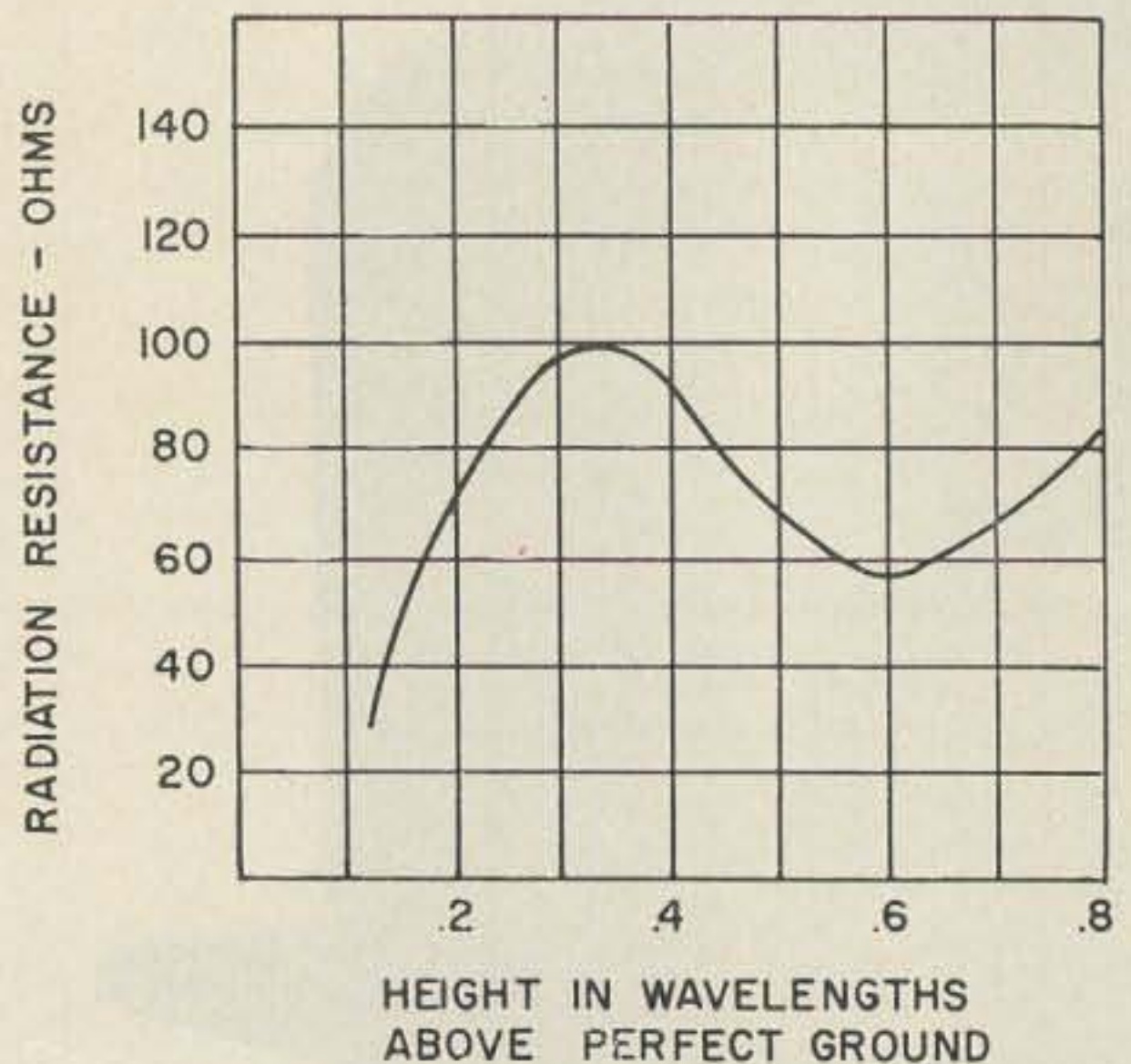
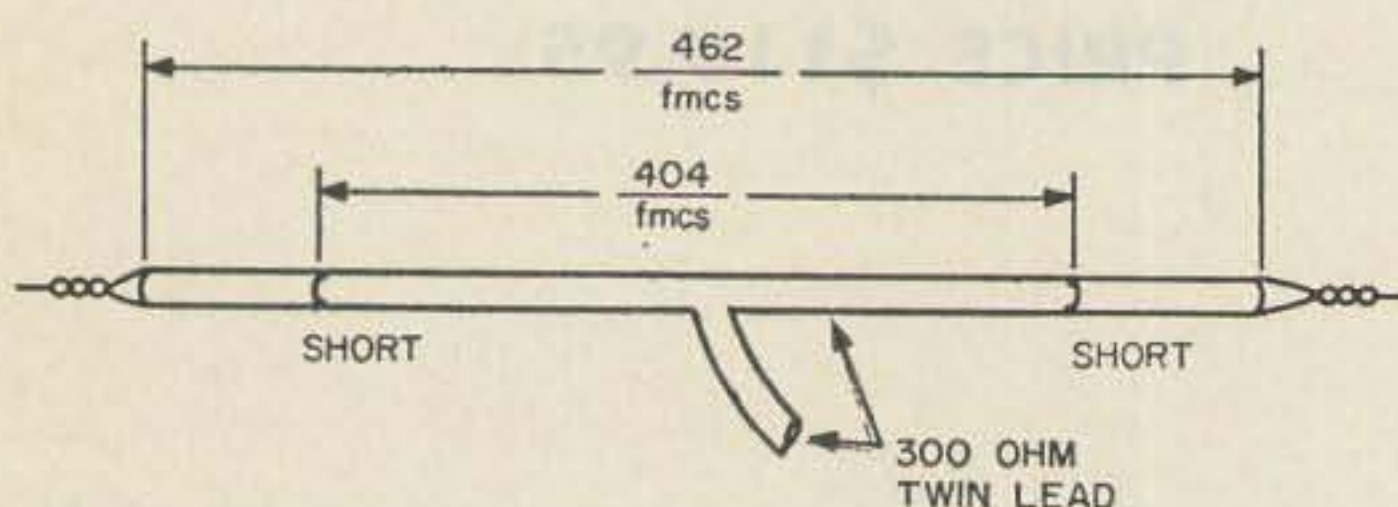

above good conducting ground, see Fig. 2, and effects from surrounding objects is held to a minimum (get it out of those trees and above the house roof). The antenna described here will perform over a comparatively wider range of frequencies than the conventional dipole.

Basically the antenna is a folded dipole made from coax cable. The flat top portion of the antenna is constructed of coax cable (of the same impedance as the feedline) with the end extensions made either of coax, copper wire or twin-lead. The end extensions can be fanned or dropped, see Fig. 3, depending on how large your lot is. Fanning the ends (either horizontal or vertical) is desirable in that the Q of the antenna is lowered more by further decreasing the effective length to diameter ratio, hence the antenna bandwidth is increased. This type of construction is very effective on 80 meters especially if the fanned wires are coax cable. It must be kept in mind that fanning the ends of a dipole will shorten its resonant length. The factor depending upon the degree of fanning.



# BUYING? TRADING?

Ward Hinkle W2FEU has the NCX-3 in stock — and complete financing available!

Or have you a good trade?



only \$369.00

Features: 20-40-80 meters  
complete coverage!  
SSB-AM CW

National **NCX-3** SSB Transceiver

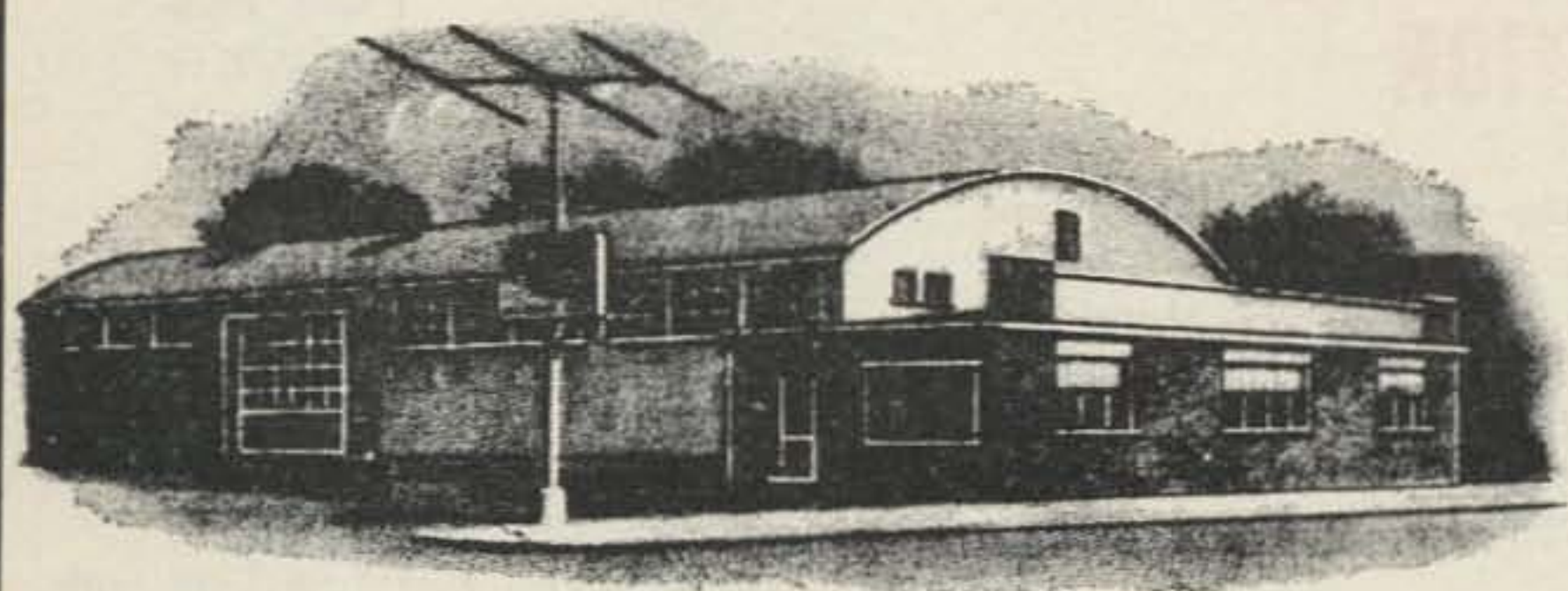

# ADIRONDACK

Radio Supply, Inc.

185 West Main St., Amsterdam, N. Y.

The total length of the shorted center portion which should be made with RG-8U coax (RG58 will work OK with decreased results) is;

$$L_T = \frac{492 \times .66}{f_{mcs}}$$

$L_T$  = Length in feet of center part

$f_{mcs}$  = Mean frequency of operation (megs.)

The length of the end extensions would then be;

$$L_E = \frac{231 - L_T}{2 \times f_{mcs}}$$

$L_E$  = Length in feet of one end extension

$f_{mcs}$  = Mean frequency of operation (megs.)

Hence the total length of "shorted" coax in the flat top portion for 80 meters would be 86.6 ft. and the length of each end extension would be 19.2 ft. making the overall length of the antenna 125 ft. At each end of the coax in the center of the flat top portion the braid is shorted to the center conductor by stripping the insulation, pushing the braid back, stripping the polyethylene and twisting the two conductors together. At this point the end extension wires can be twisted together with the "short" and the connection soldered. Make sure this connection is substantial both electrically and mechanically because these connections support

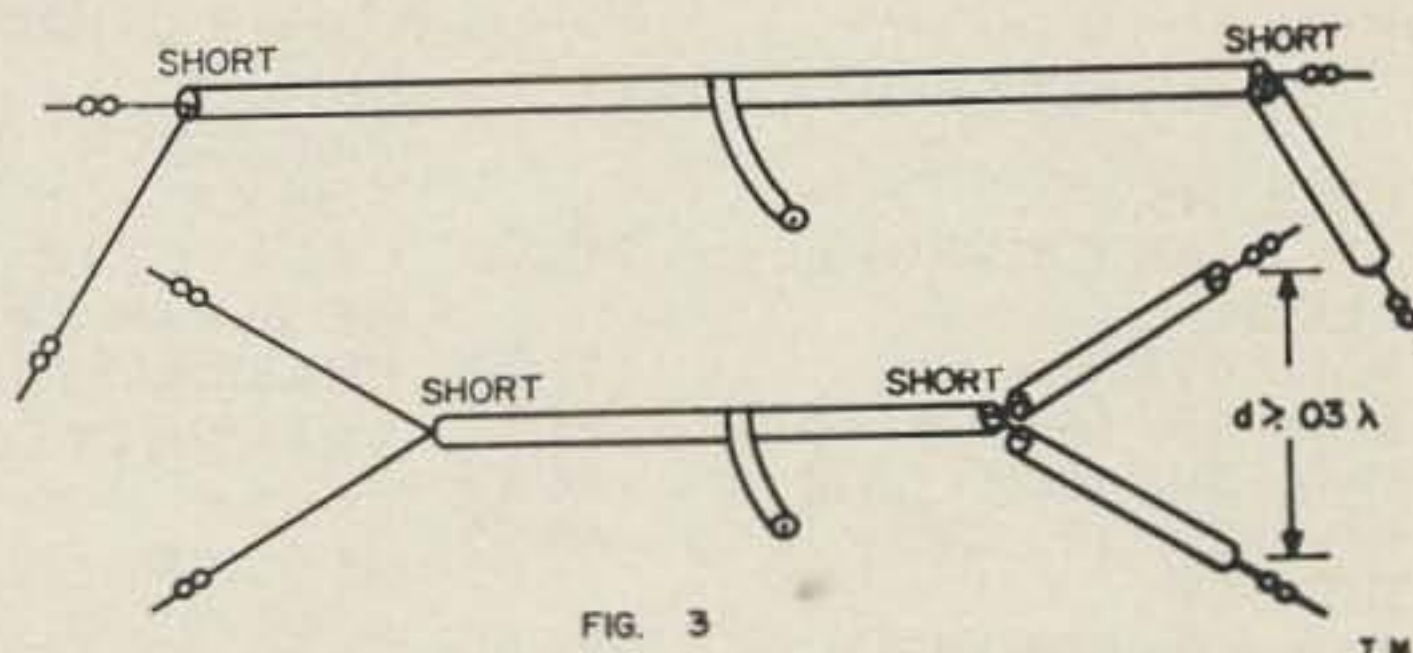

the weight of the antenna. The feedline is fastened at the center by cutting the braid exactly at the center of the flat top portion without disturbing the center conductor and its insulation. The braid is then separated not more than 1½" and pigtailed so the feedline can be soldered to it, see Fig. 4. When soldering the feedline to the parted braid use long nose pliers to conduct heat away from the polyethylene to prevent excessive heat damage. The completed connection is then taped sufficiently to prevent

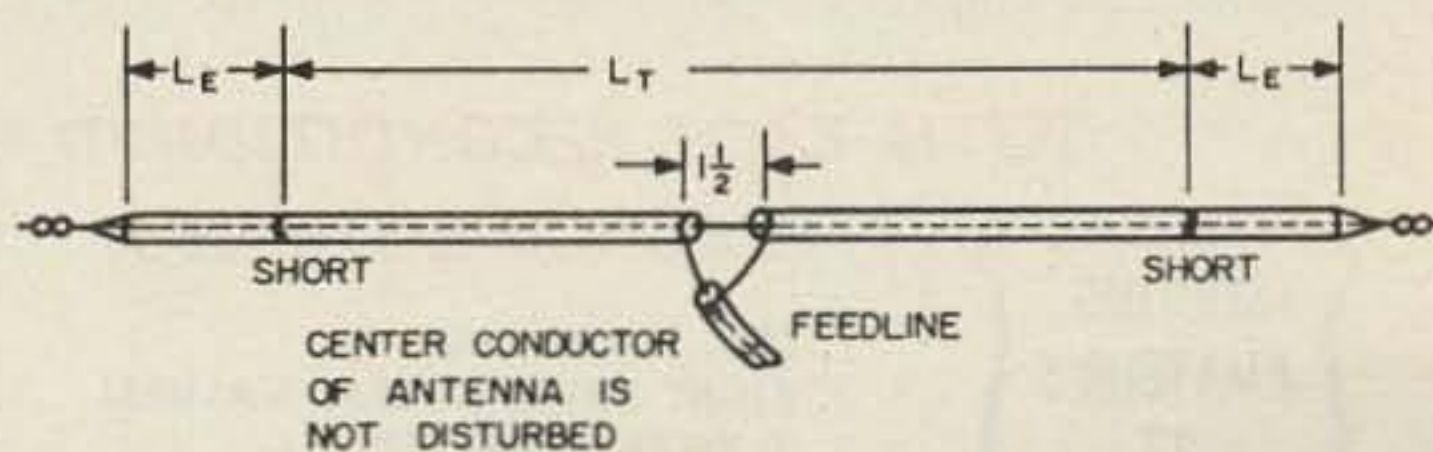

$L_T$  - TOTAL LENGTH OR SHORTED PORTION  
 $L_E$  - LENGTH OF EACH END EXTENSION

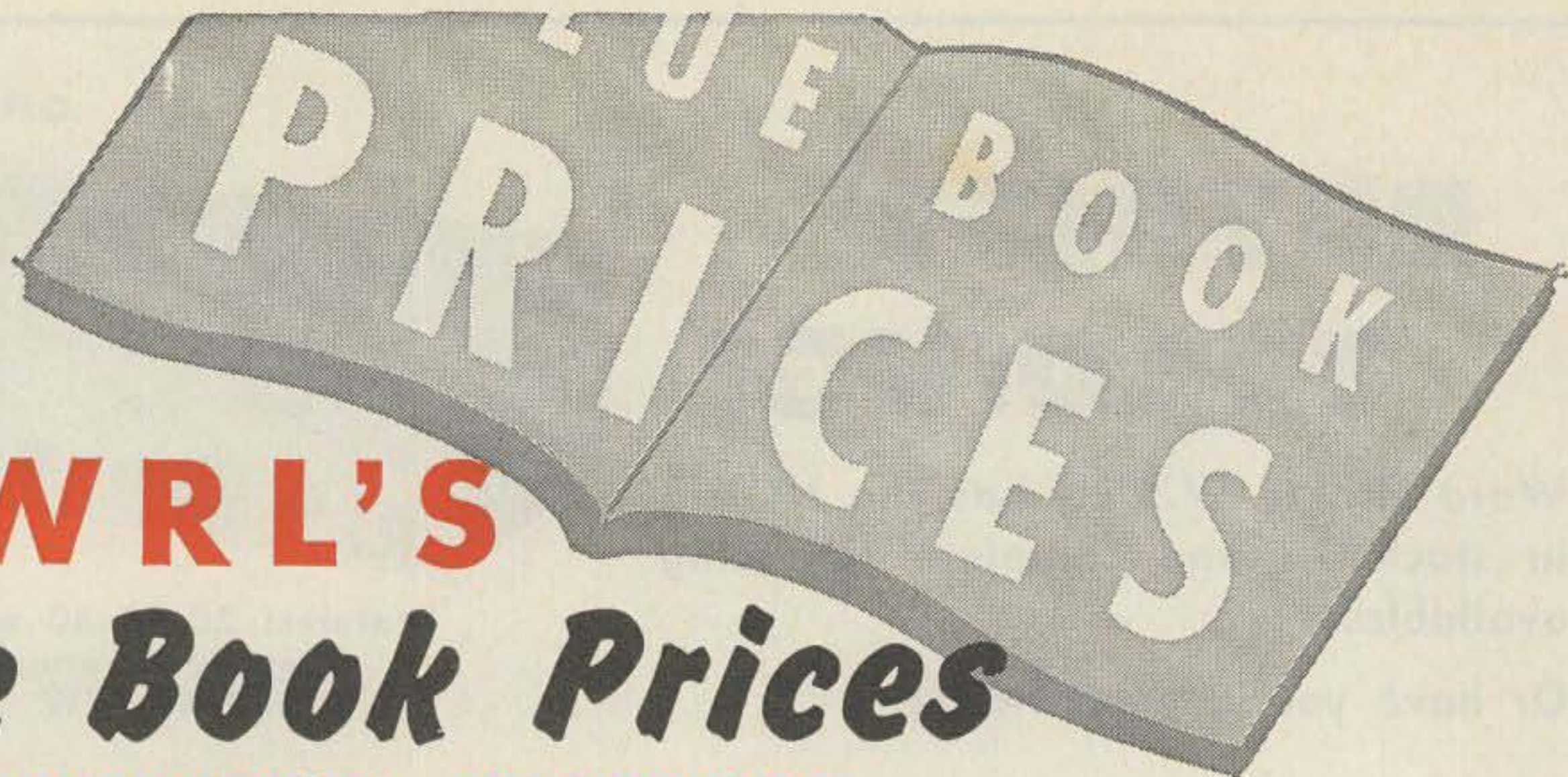

# WRL'S Blue Book Prices

**OUR REPUTATION - KNOWN THE  
WORLD OVER - IS YOUR GUARANTEE  
OF SATISFACTION**

WRL's used equipment listings have set the pace for 27 years and are informally known as the "Blue Book of Reconditioned Equipment." All units (over 1000) are expertly reconditioned. Hundreds of other items available — write for latest "Blue Book Listings." No money down on our *Charg-A-Plan* and up to 36 months to pay. Send orders and inquiries to Kenny Akins, WØPZJ, o/o WRL, Council Bluffs, Iowa for **FAST PERSONAL SERVICE.**



**CLOSE-OUT! NEW**

**TOPAZ  
POWER  
SUPPLY  
12 VDC**

**Transistorized  
C 10WD6-12**

**\$69.95**

Reg. \$99.95

FOR Swan, Collins, Sonar & others  
600 VDC + 300 DC (250 watts) .0120 V  
Adj. Bias & Primary relay—Post Paid Cash with  
Order. Send for other TOPAZ specials.

## May - June SPECIALS

TRANSMITTERS - FIXED	
COLLINS	
32V-3 (AM-CW-VFO) . . . . .	249.00
GLOBE	
Scout 65A (AM-CW) . . . . .	49.95
Scout 680 (AM-CW, 80-6) . . . . .	64.95
Chief 90A (90W. CW) . . . . .	44.95
HG-303 (75W. CW) . . . . .	69.95
GONSET	
GSB-100 (SSB-VFO) . . . . .	329.00
GSB-101 (KW Linear) . . . . .	259.00
HAMMARLUND	
HX500 (SSB) . . . . .	499.50
HARVEY WELLS	
TBS50 (80-2, AM-CW) . . . . .	49.95
CE-20A (SSB) . . . . .	169.00
EICO 723 (60W. CW) . . . . .	49.95
HEATH	
DX-35 AM-CW . . . . .	44.95
DX-100 AM-CW, VFO . . . . .	169.00
DX-40 AM-CW . . . . .	49.95
JOHNSON	
Adventurer CW . . . . .	29.50
Challenger AM-CW, 80-6 . . . . .	79.95
Viking II AM-CW . . . . .	169.00

KNIGHT	
T-60 AM-CW, 80-6 . . . . .	49.95
T-50 CW . . . . .	34.50
LAFAYETTE	
HE-25 (AM-CW) . . . . .	99.50
PHASEMASTER II (SSB) . . . . .	139.00
TRANSMITTERS FIXED-MOBILE	
ELMAC	
A54/A54H (10,20,75,VFO) . . . . .	59.50
AF67 (80-10, VFO) . . . . .	89.95
GONSET	
G76 X-CVR (12VDC-PS) . . . . .	359.95
G77 (VFO-6/12VDC-PS) . . . . .	139.95
COLLINS	
KWM-1 (10-15-20, SSB) . . . . .	399.95
MT-1 (VFO, AM, 80-10) . . . . .	99.95
CLEGG 99'er (6M-AM) . . . . .	109.00
TC6A (6M X-CVR-AC/PS) . . . . .	44.95
SWAN	
SW140 X-CVR SSB-40M . . . . .	189.00
RECEIVERS - FIXED	
COLLINS	
75A-2 . . . . .	269.00
75A-3 . . . . .	349.00
75A-4 . . . . .	429.00

HALLICRAFTERS	
SX-76 . . . . .	109.00
SX-99 . . . . .	109.00
S-108 . . . . .	99.50
SX-101 early . . . . .	239.00
HAMMARLUND	
HQ-105TR (REC/XMTR) . . . . .	159.00
GELOSO G-209 . . . . .	169.00
RECEIVERS FIXED - MOBILE	
ELMAC PMR6A (12V.) . . . . .	59.95
GONSET G-66 . . . . .	99.95
GONSET MOBILE CONVERTERS	
"Super 6" (80-10) . . . . .	29.95
"Super 12" (12V only) . . . . .	49.95
3066 (6M) . . . . .	29.95
ACCESSORIES	
Speakers (For most rcvrs.) . . . . .	9.95
VF-1 (VFO, 160-10M) . . . . .	14.95
HG-10 (VFO, 160-6M) . . . . .	24.95
MP-1 (12VDC P.S.) . . . . .	29.95
HP-10 (12VDC P.S.) . . . . .	34.95
GELOSO VFO (80-10M) . . . . .	19.95
JOHNSON 6N2 (6-2VFO) . . . . .	39.95
WRL (115VAC-PS/SWAN) . . . . .	34.95
GLOBE V-10 (160-6M,VFO) . . . . .	49.95

**WITH EACH RECONDITIONED UNIT  
YOU SAVE 5 WAYS**



1. TOP TRADE-INS!
2. RIGHT PRICE — BEST VALUES!
3. 2 WEEK HOME TRIAL!
4. FULL 90 DAY GUARANTEE!
5. 90 DAY RETURN PRIVILEGE ON NEW EQUIPMENT!

**WRL**

F.O.B. WRL

**WORLD RADIO  
LABORATORIES**

3415 West Broadway  
Council Bluffs, Iowa—Phone: 328-1851

Leo: \_\_\_\_\_  
 I want a model \_\_\_\_\_, reconditioned.  ship  hold  
 \$\_\_\_\_\_ enclosed.  charge my account.  
 Ship new TOPAZ Supply postpaid  69.95  charge  
 NAME \_\_\_\_\_  
 ADDRESS \_\_\_\_\_  
 CITY \_\_\_\_\_ STATE \_\_\_\_\_

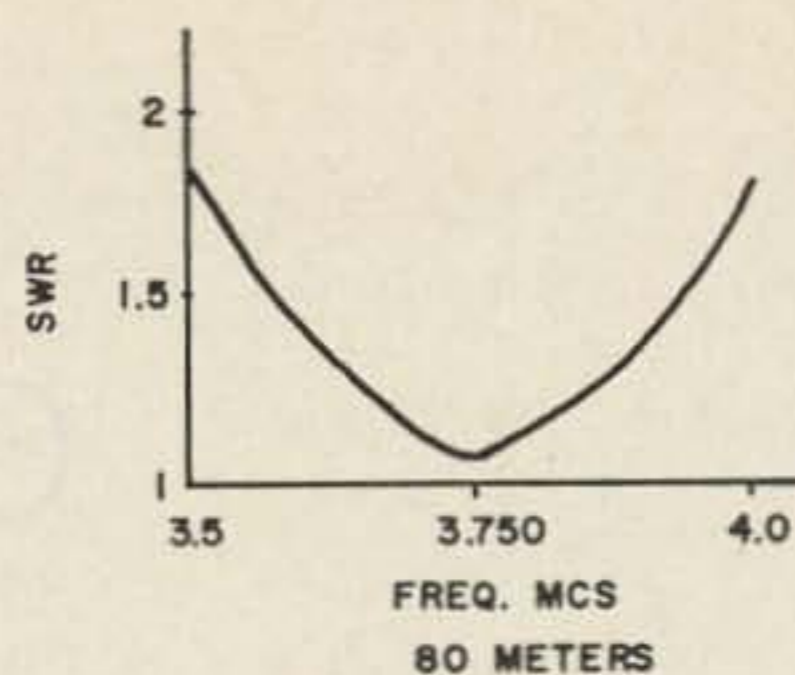
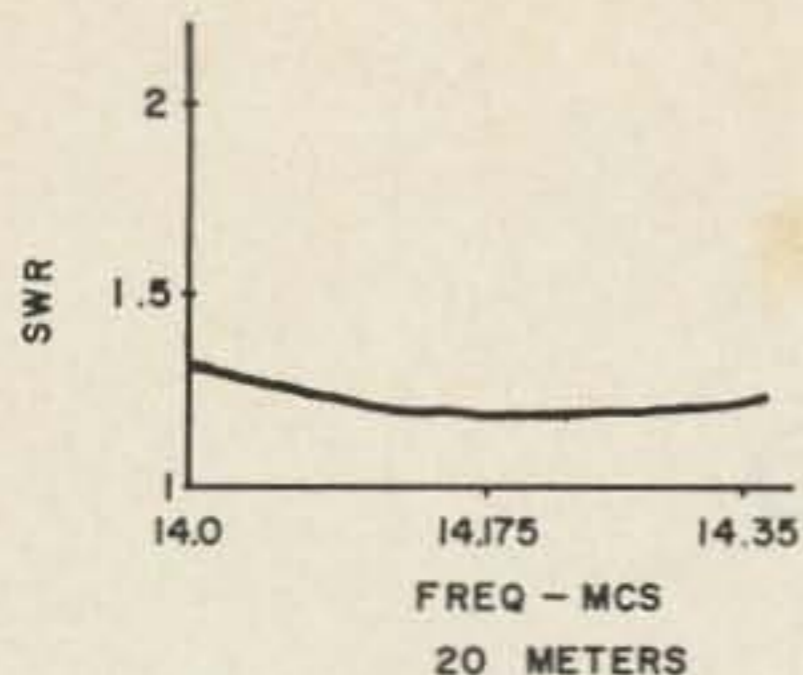

FIG. 5

water from entering the coax. (Note: this connection when made properly is sufficient to support the heavy coax feedline.)

Halyards can be fastened at the feedpoint and ends to raise the dipole and provide a means of adjustment of feedpoint impedance by adjusting the height of the antenna while observing the SWR at the design frequency. Since coax is heavy, end insulators with sufficient strength should be used to support the antenna. It is desirable to support the center of the antenna as high as possible and adjust the ends for lowest SWR at the design frequency. The reason for this is because most of the radiation takes place from the center part of the antenna. The antenna lends itself to be used as

an inverted "V" very nicely with an increase in bandwidth over the usual wire inverted "V" which generally has a narrow bandwidth due to a sharp apex angle.

Two of the described antennas have been constructed at this QTH with results as presented, see Fig. 5. No gain or fantastic increase in signal strength is claimed with this antenna as it is still only a dipole but the improvement in operation at frequencies far from design resonance is advantageous and noticeable. This improvement could be considered as a gain. Many hams throughout Michigan, Indiana and Ohio are using this antenna on 75 meters with variations in construction as shown with similar results as presented.

## Homebrew Exposed

W5HJV

We never cease to be amazed at the homebrew construction articles in the ham radio magazines. You know, the ones where the chassis doesn't have a single extra hole, and is all decked out with store bought parts.

Down about the third paragraph, the author casually mentions that part number F-1 (Multi-Frammis Snickafoo Filter) can be special

### Parts List

- 19" x 12" Chassis
- 350 mmfd variable (Raunchy Radio Co. Part. #QQ-4X4)
- 1 mfd 400V tubulan
- 16 mfd 700V electrolytic
- Inductor, 9½T. #20, 1" O.D., 4 T.P.I.
- 750 uh RFC)
- 2.5 mh RFC)
- 26,000 Ohm, 2W resistor
- 50,000 Ohm, 4W potentiometer
- Fused Line Plug
- 900VCT 200 ma power xfmr
- 8 Henry 300 ma filter choke

### Translation

- Any size available. Check kitchen for suitable cake pans, etc.
- Tuning condenser removed from XYL's clock radio.
- This is for the key-click filter, stupid . . . leave it out.
- Any electrolytic in the junk box which will handle the voltage. Check possibility of using assorted sizes in series.
- Any size wire wound around varnished toilet paper tube. Cut and try for resonance.
- Two rf chokes from junk box . . . inductance unknown.
- Any combination of junk box resistors which hits within 5000 Ohms.
- Grid drive control removed from front panel of brother-in-law's rig.
- No fuse necessary. Use cord and plug from XYL's hair dryer.
- Cannibalized from stand by rig if within 300V either way.
- Secure from K5BNK's garage. Flashlight and sneakers are strongly recommended for this operation.

ordered from Shifting Sands Electronics Corporation for only \$75. And of course old Charlie down at the machine shop was happy to make the gears for the dial drive for \$25.

Needless to say, this is enough to make the average amateur return to stamp collecting. One must inevitably conclude that the amateur builder must be either a fabulously wealthy eccentric, or a bright young engineer with sticky fingers.

Fortunately, fellow amateurs, such is not the case . . . and in support of this statement the following parts list, complete with translation, is respectfully submitted.

# Getting into Electronics

Paul Barton W6JAT  
Jennings Radio  
San Jose 8, California

The ads for courses in electronics read so rosy, it is misleading. The electronics course is an excellent thing to have, but is only the barest beginning towards a career in electronics. These courses only put you in a position to *begin* to learn how to actually *do* things. To get paid, you must be able to *DO* things. Experience as a ham is one of the best qualifications for an electronics technician career. The engineers are supposed to furnish most of the theory and the technicians are the practical workers that put the theory into practice. Many an engineer's lamp would be very dim without the backup of some sharp technicians.

Let's take a look in the Jennings Radio's Radio Frequency testing laboratory to see what technicians might be doing on a typical day.

"Tut" Tuttle, senior electronic technician in Jennings Radio's Radio Frequency laboratory arrived as usual at about seven thirty A.M. As foreman, he is not "on the clock." He is privileged to keep his own time. So, he arrives

about thirty minutes early every day—no overtime either—and usually is fifteen minutes or more late getting away at the day's end. But there are few things that would worry him less than a few extra minutes of his time on the job.

In the past half century or so, he has made a long string of tracks that has given him the wide experience that is so valuable on his present job. He has been on his present job for over 6 years. His previous job was as electrical maintenance foreman for Westinghouse during World War II. Before that was power house operator, and various other comparable jobs.

Most of his family are grown up now. Two have gone to college. He is active in community work.

Only in recent years has Tut gotten a ham ticket, though he has had the ham instincts all his life. Now he is as ardent a ham as any high school boy.

The brief few minutes before the gang arrive is about the only time till quitting time Tut will get to sit at his desk. He turns over a fresh page on the desk calendar and initials the work cards of his crew from the day before. He knows from experience that this must be done before eight or they will likely not be done by the time the girl from accounting comes for them.

As the rest of the crew arrives, Tut exchanges pleasantries with them, while considering the jobs to be worked on that day. The rest of the crew consists of technicians of various skills and levels of experience.

There is the usual load of rf testing to be done, plus some special tests. Tut discusses this with Bob Goddard, leadman.

Bob arrived with a ham ticket and a high school diploma some eight years earlier. Start-



Leonard Espinosa operating Jennings Rig No. 3, a 20 KW linear amplifier with a 4 W 20,000 in the final.

ing as a junior electronic technician, he worked up to leadman due to an excellent personality and a natural aptitude for getting things done. He was willing and able to accept responsibility and figured that if he worried about the work, the pay would take care of itself.

Like most of the technicians, Bob has set up an excellent ham station at his home, including SSB & Teletype. His other activities include bowling in the two-hundreds, and flying a Cessna 150.

Bob prepares for the day's testing by examining the test reports left on his desk by the night crew. He puts these in the basket to be filed later by the secretary. Now he checks that his various operators are assigned and have work before them. By the time he has made a couple of telephone calls regarding units to be tested, made out a consolidated report for the supervisor's attention, and helped re-tune one of the transmitters that was a little balky, the noon whistle is stopping all official activity. Actually, tho, the difference is small. Many of the tests are on a basis of time, and the operators are reluctant to interrupt them, so they pull out their "sacks" and eat while watching the test.

Bob has four test operators helping him with his regular testing, plus four more on special tests. His equipment includes a 50 by 150 foot building full of rigs from a few kilowatts to a hundred KW. There are rf generators to test switches, capacitors, insulators, etc. Most of the rigs are linear amplifiers for ease of controlling the output and low harmonics. The operators have all been trained on the job, usually arriving with a ham ticket as their main credential. Besides operating, they often maintain the equipment when needed.

Lloyd, the senior operator of the test crew, has had a ham ticket for 34 years. He proudly boasts 11 grandchildren. Very soon he will be great grandpa. Now he takes his test request sheet from Bob, along with a capacitor to be rated and returns to his 100 KW SSB rig, which has been warming up for 30 minutes. It takes only a few minutes to jig up for the test, then excitation is applied to the proper output level. Now he settles back for the long, dull, but very exacting job of determining just how much current and voltage this capacitor can be expected to handle. A man of less experience could have trouble with this job. It is very easy to get wrong results that look correct. A crystal ball and a witchcraft license are probably part of Lloyd's regular equipment.

## TRANSCEIVER HIT PARADE!

These are the leaders. There is one here to fit your needs and also your pocket book.

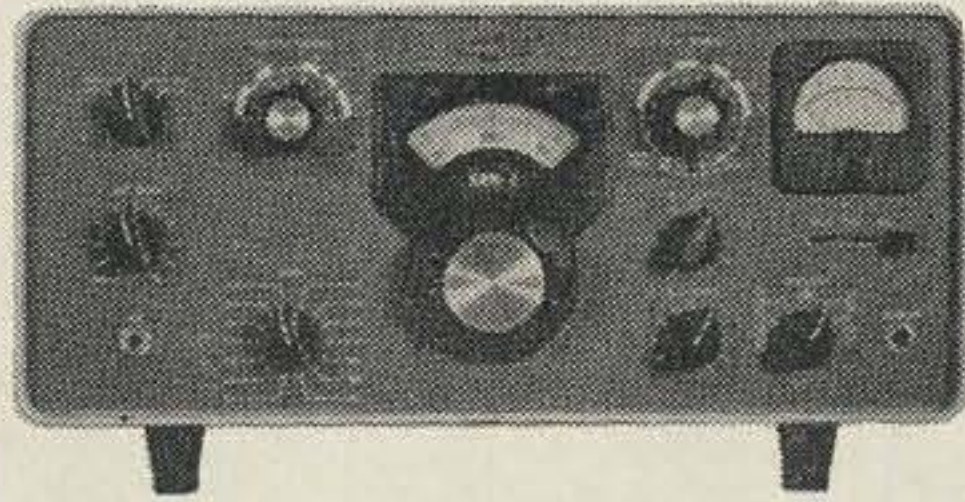

### COLLINS

KWM-2 \$1150  
516-F2 ac supply \$115  
351-D2 mntg rack \$120  
MP-1 dc supply \$198

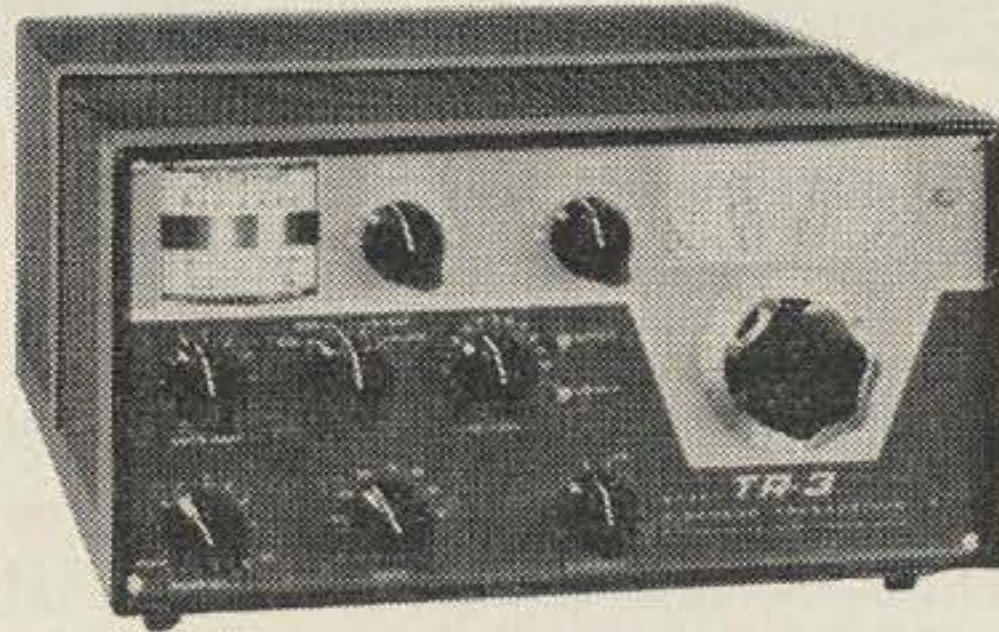

### DRAKE

TR-3 \$495  
AC-3 ac supply \$79.95  
DC-3 dc supply \$129.95  
Speaker \$19.95

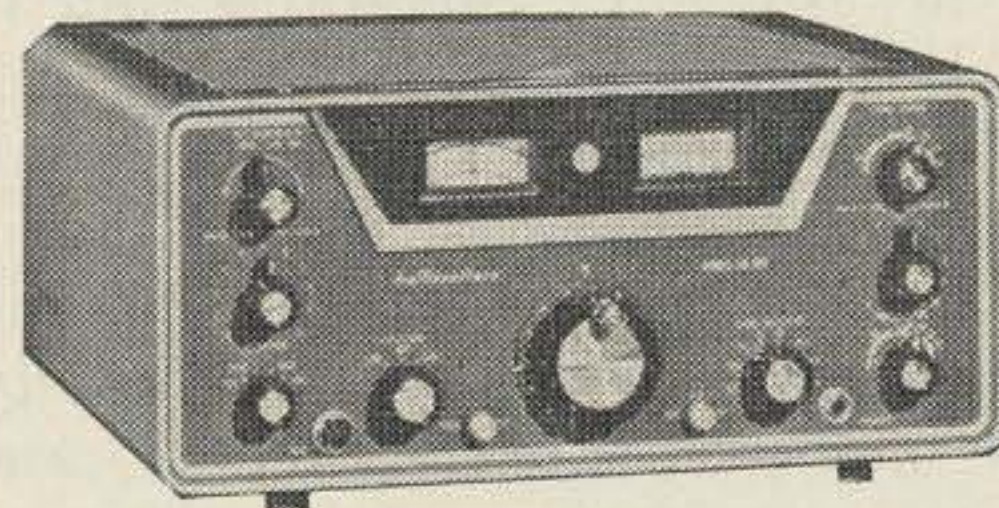

### HALLI-CRAFTERS

SR-150 \$650  
P-150 ac supply \$99.50  
P-150 dc supply \$109.50  
MR-150 mntg rack \$39.95



### NATIONAL

NCX-3 \$369  
NCX-A ac supply \$110  
NCX-D dc supply \$119.50



### SBE

SB-33 \$389.50  
ac supply built in  
dc supply \$59.50  
mntg rack \$12.50

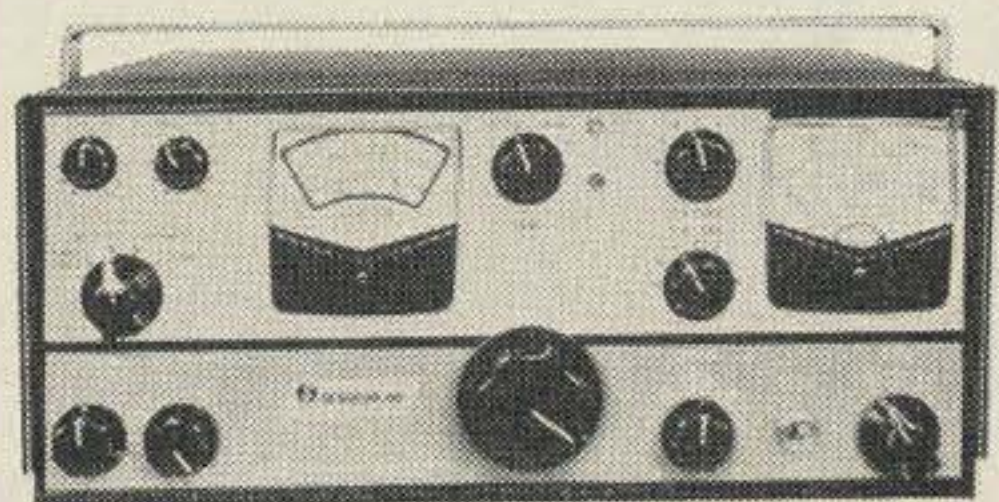

### SWAN

SW-240 \$320  
SW-117 ac supply \$95  
SW-12 dc supply \$115

Ask for our new equipment catalog #163 just out. Also our latest used gear bulletin, revised monthly.

BOX  
37A

**Burghardt**  
RADIO SUPPLY, Inc.

PHONE  
886  
5749

WATERTOWN, SOUTH DAKOTA

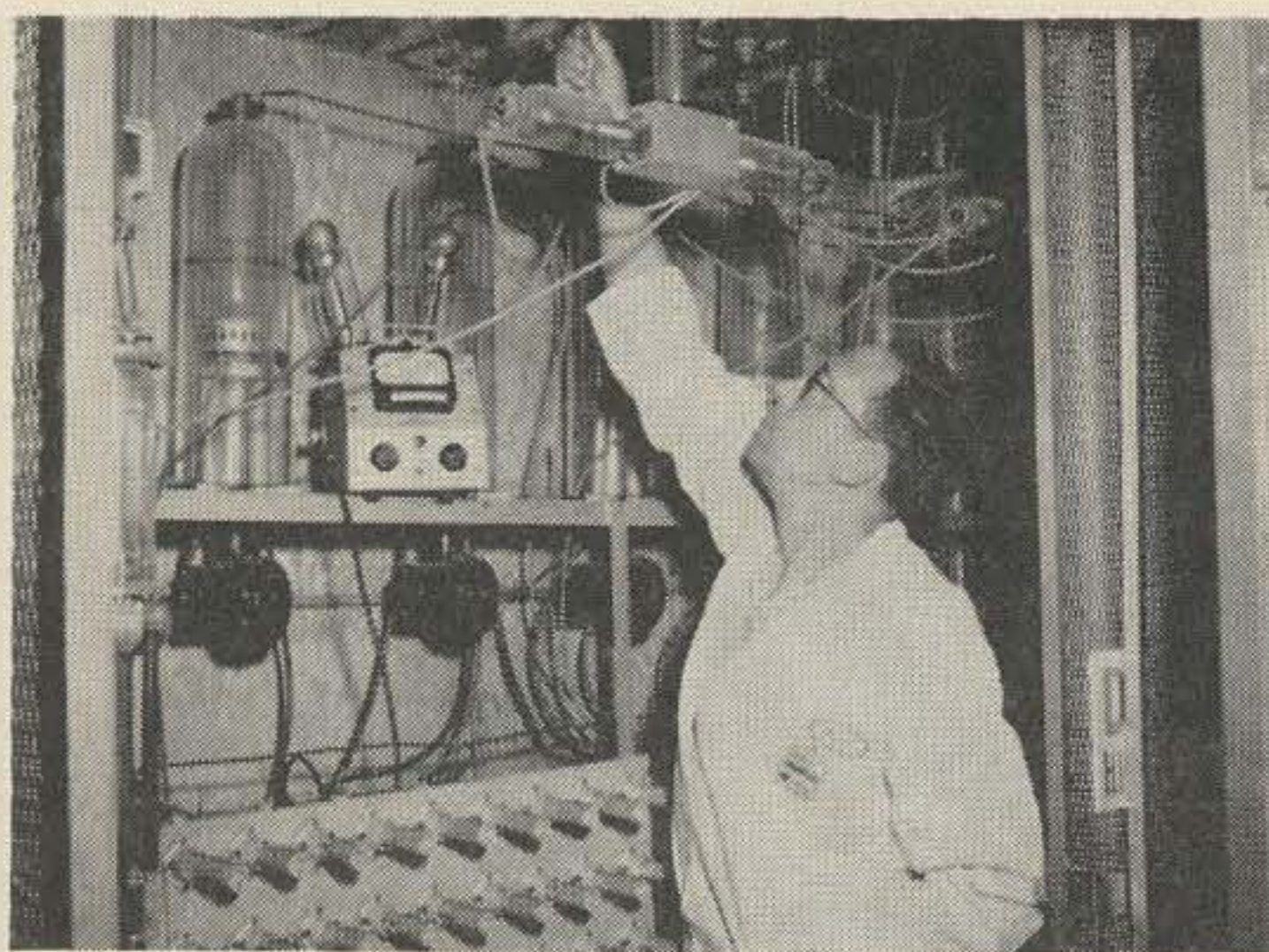

**Bert Newkirk WA6 SIX inside power supply enclosure of 25 KW output 600 Mc Klystron transmitter.**

Leonard is one of the younger operators. He took two years of college, but family responsibilities dictated that he go to work and take his college on a part time basis. He will likely get his BA or EE some day, but in the meantime he is a test operator in the RF testing Lab. He is an excellent testing operator, but his academic ability is constantly being used to real advantage in compiling and analyzing test results for condensed reports. This is a rare ability seldom found in non-college graduates.

Among the younger operators, but a veteran of several years testing, is Roy. Of course he is an avid ham. He was net control of one of the MARS nets for over a year. Today, he will spend several hours running a 600 mc, 25 KW output klystron to test some switches that are destined for high powered radar use. Later in the day, he will likely run some rf voltage tests on some capacitors, a part of getting them ready to ship to customers. Of course, at any time, some special "hot" job may come through and Bob may very well put Roy on it.

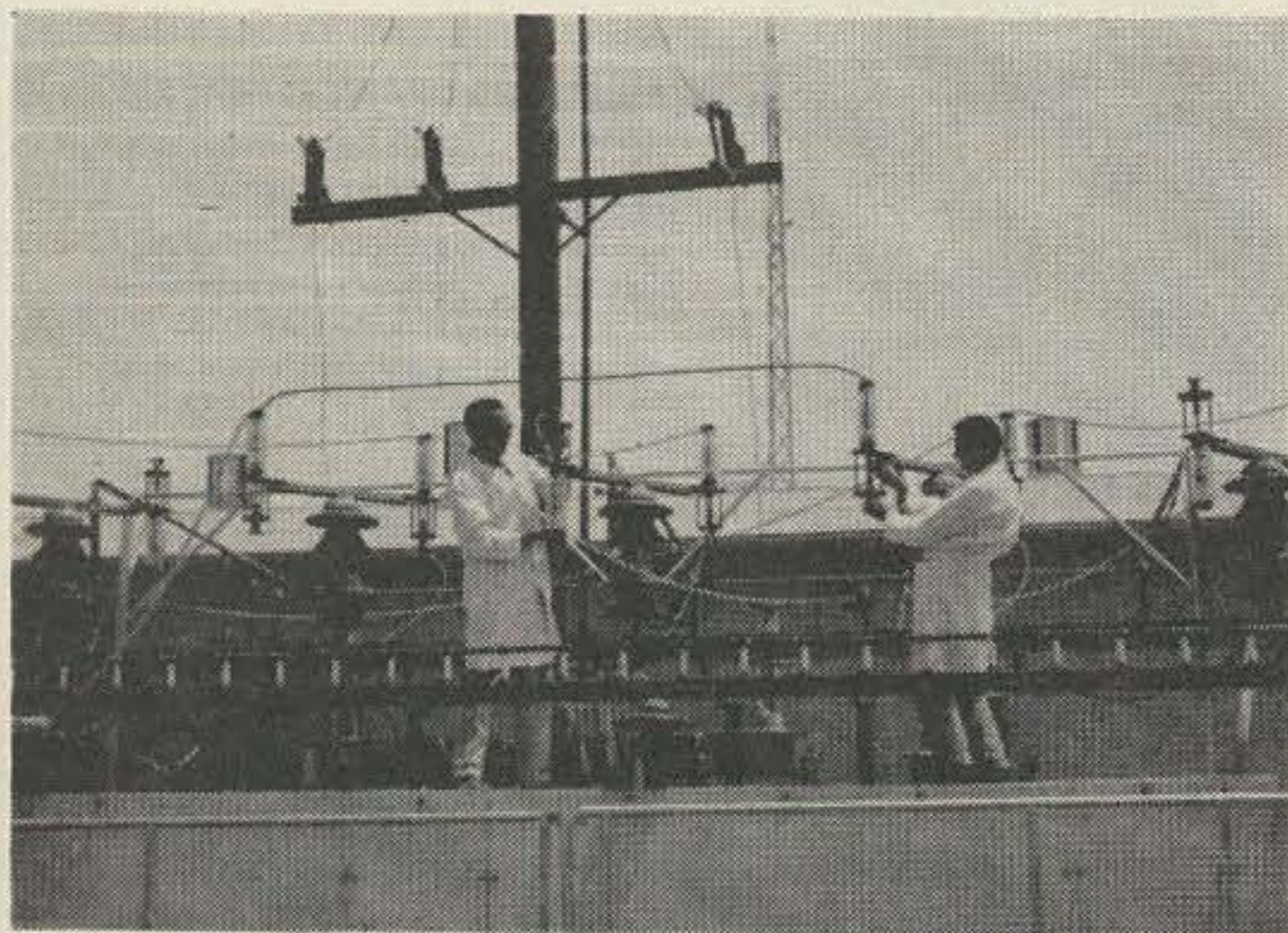

**Bert Newkirk WA6 Six and Tut Tuttle WA6 LUM adjusting switches on a 500,000 watt power supply.**

The youngest member of the family is Dick. (Naturally, he's a ham—in fact that was his only qualification when he arrived a couple of years ago.) Now he is literally growing up in the job. He operates any of the dozen or so rigs including the 100 KW rig. But lately, he has tended to specialize in high voltage dc testing. He takes a tray of capacitors and applies 50 to 100 KV dc to them to determine their ability to withstand dc.

Howard is one of Bob's most valuable test operators. He retired from the Quartermaster Corps as a major several years ago and decided to start over in a new line so he went to work as a jr. electronic technician. Practically his only qualification was his desire. He has made out very well. Most of his training was on the job, but he took some night school courses and studied at home on his own. His maturity is to his advantage. Hasty judgment in the testing field can be very expensive. Now, Howard specializes in high power dc switch testing. His two main pieces of equipment are a 13,000 volt dc at 50 amps power supply, which can be overloaded to 200 amps on short duty cycles, and a 75 to 100 KV dc supply rated at 7 amps continuous, but often operated at 20 amps for a quarter of a second or so. The 100 KV supply uses a 50 horsepower fan to cool the load resistors.

For better utilization of the equipment, two men (and sometimes more) work a night shift. Bill and Henry work as a team on the night shift, running whatever equipment is necessary for the test at hand. Bob tries to keep Bill and Henry on catalogue rating work, but often he has to use them for other "hot" tests. Both Bill and Henry learned most of their technical know how on the job.

With testing for the day under way under Bob's eagle eye, Tut turns his attention to some of the technical problems before him.

There are some special set ups to be done on the 300 kc rig. A cranky time delay relay on rig #3 is clamoring for attention. A 5 KW exciter being built for some special tests needs "eyeballing" before it goes much farther. There is some clean up work to do in the transformer's yard, etc. There is no end of jobs that he would like to get done. By carefully hopping from job to job, Tut keeps the hottest jobs going and even gets some of them finished now and then. He knows he can never get it all done, but as long as he doesn't fall too far behind, he feels he is doing OK.

There are three college part time workers. They will likely be engineers some day, but now they are getting experience and going to

college. One of these men, Bob, of course a ham, Tut puts on the special 300 kc set-ups. Bob will likely stay on this special low frequency testing all summer, operating the 5 KW rig, changing set ups, repairing the rig, making reports, etc.

Another college man, Rudy, has been assigned recently to some special low power dc testing, of a type that a sharp ham/college man would be good at. Rudy has shown a particular aptitude with transistors, so he has been called on to design and construct transistor gear for the lab several times. It was desired to hear what was going on in one of the test cabinets that had to be kept closed during testing for safety reasons. So, Rudy made a little audio amplifier with microphone and speaker, using transistors, to monitor the testing sounds in the enclosure.

Dave, another college man, has worked part time the longest. He is letting his college work "age" a bit. In fact, he may never finish, and the world will have lost a fine engineer to the technician ranks. Dave has helped build most of the equipment in the lab in the past 3 years. Today, Tut puts him to checking out a truckload of large transformers just received to be used in various large power supplies. Some time during the summer, Dave will be a high-climber and paint the 100 foot steel antenna tower that the lab's 20 meter beam is topping off.

Tut has two journeyman technicians that can build or repair anything that comes along. Both migrated to the west about 2 years ago with considerable electronic experience behind them. They broke in very quickly and were earning their pay in a few weeks.

One of them, Bert, a ham of many years standing, goes on with his present assignment of building a 25 KW autotune amplifier to be shown at the fall Electronics show. The other one, Ernie, a ham, of course, has just completed a 5 KW rig so he and a junior technician are working on installing a 20 KW band-switching rig.

The junior technician, Ron, started a few months before with his only qualification being a willingness to learn. He is picking up shop practices and construction know how under Tut and the other more experienced "experts." He will be an expert himself in a couple of years.

In this lab, a strong effort is made to determine the strengths of each worker, and then play to those strengths. There is such a variety of jobs to do that there is usually enough of the right kind of work for each kind of worker



## SATURN 6

the original

# HALO

Saturn 6 Antenna only \$11.95

Saturn 6 plus mast & bumper mount \$16.95

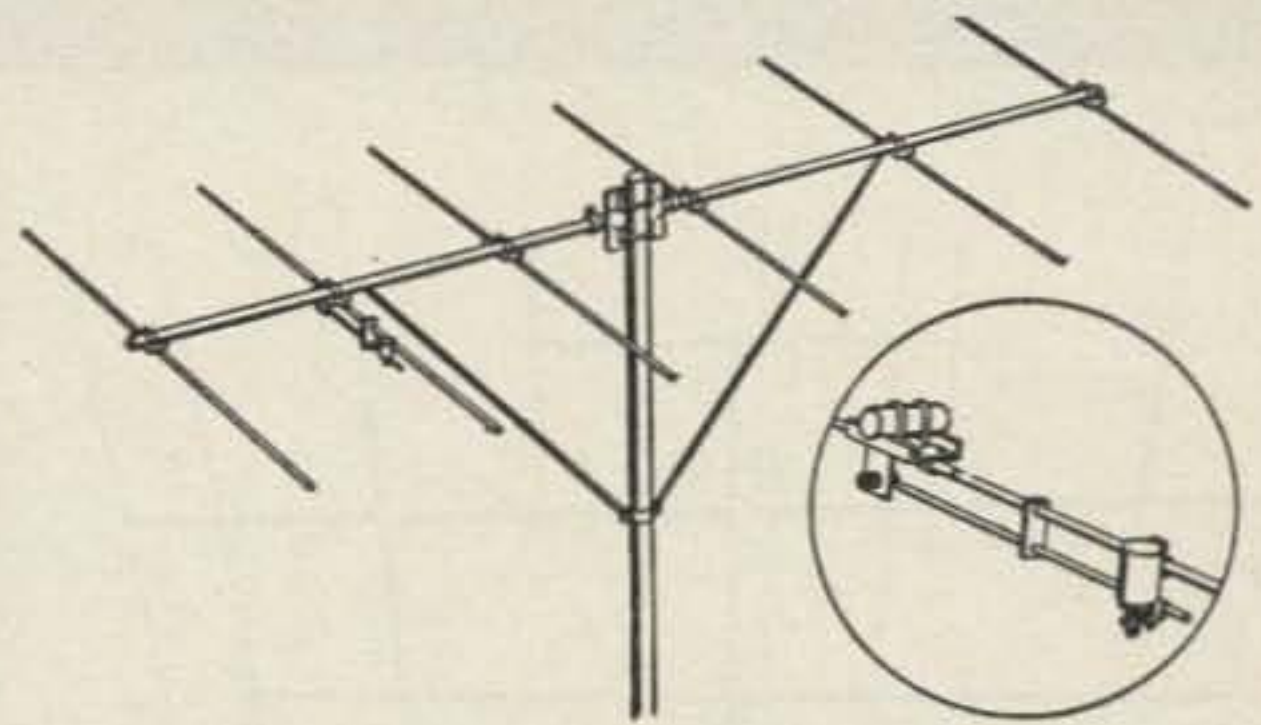

Long John  
for Six Meters . . . . . \$34<sup>95</sup>

#### FEATURES

- Designed for maximum forward gain.
- Gamma Match for co-ax feeder.
- Finest grade aluminum tubing.
- Exceptionally strong since there are no drilled holes.
- All aluminum construction eliminates electrolysis.
- Entire beam and supports can be grounded for lightning protection.

We are proud of this new Long John Antenna. We've tried to put in every feature you could want. The result is a reasonable cost high gain beam which can easily be put up and which will stay there practically forever. It has a wide enough lobe so you don't have to swing it around all the time, yet gives you tremendous gain where you want it.

AT YOUR DISTRIBUTORS OR WRITE DIRECT

# HI-PAR

## Products Co.

FITCHBURG, MASSACHUSETTS

# YOU JUST CAN'T BEAT A TRI-EX TOWER FOR THE REALLY BIG ANTENNA LOADS!

For example—look at the picture below—from top to bottom the antenna consists of 4 elements wide spaced, 15 meters at 90 feet; 6 elements optimum spaced, 20 meters at 80 feet; 3 elements wide spaced, 40 meters at 71 feet.  
Note: ENTIRE TOWER ROTATES!!

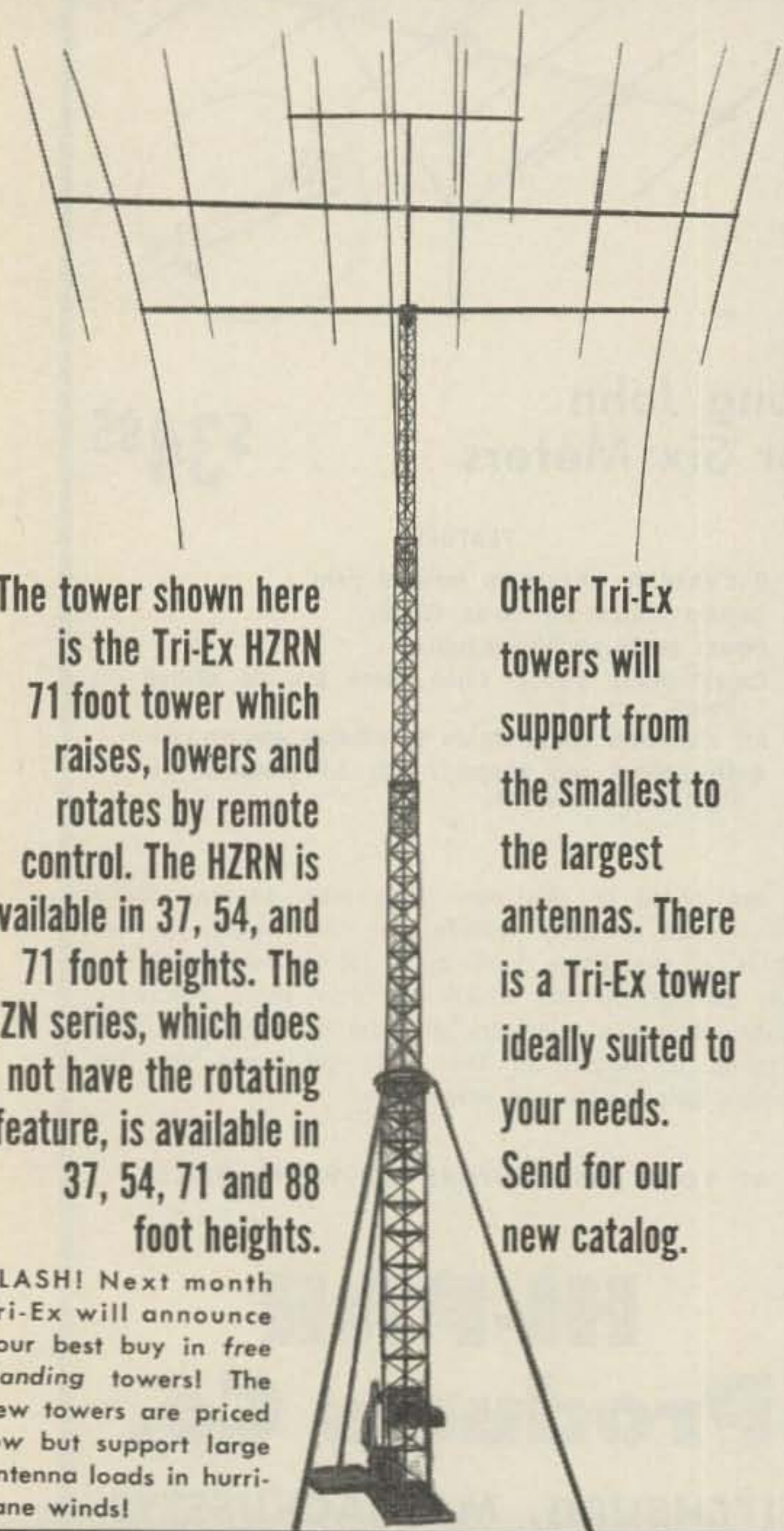

The tower shown here is the Tri-Ex HZRN 71 foot tower which raises, lowers and rotates by remote control. The HZRN is available in 37, 54, and 71 foot heights. The HZN series, which does not have the rotating feature, is available in 37, 54, 71 and 88 foot heights.

Other Tri-Ex towers will support from the smallest to the largest antennas. There is a Tri-Ex tower ideally suited to your needs. Send for our new catalog.

FLASH! Next month Tri-Ex will announce your best buy in free standing towers! The new towers are priced low but support large antenna loads in hurricane winds!

with some left over.

The main requirement is that a worker be eager and willing. If he is eager and willing, he can learn. Actually the work in each lab tends to be so special that a new worker has to be broken in almost from scratch even though he has some experience. However, the man with experience will break in much quicker.

It costs a company a great deal to train a technician. Therefore, a company will try to select a prospective trainee very carefully before investing in his training. Any evidence of instability such as previous job hopping will count against him. Usually there is a probationary period for new employees. During this time, the company can size him up, and if they don't like what they see, they can let him go with little or no explanation. Once accepted as a regular full time employee, it is not as easy (from a supervisor's standpoint) to let an employee go. Seldom is an employee clearly and definitely "no good." This kind of worker would have been weeded out in the first few days of his probationary period. It is more common to find a man to be not as good as you had at first hoped he would be. But it may be difficult to find sufficient reason to satisfy the personnel office that the man should be let go. Therefore, a supervisor really takes a look during that probationary period of a new man. Once accepted, if a worker becomes a small problem in one position, it is best to protect the company's training investment by trying the worker at a different position. This often works out very well to the company's and to the worker's best interest.

The first step is usually the hardest—getting your foot in the door. For a new, inexperienced worker, it is best to "take what you can get," even perhaps not directly an electronic job, to get into a desirable company. Then, after you have shown your willingness to work, you will likely be able to transfer into electronics when there is an opening. This opening problem is often a major obstacle. Everyone wants to get into the act, so there are not always openings.

Many good technicians, working for a good company, have found that if they have genuine interest in their work, show willingness to work and learn, and when the time is right, a willingness to accept responsibility, the pay and promotions are taken care of without worry on their part. The worker who will work harder *after* he gets more pay is not likely to get the promotion. The worker that makes himself valuable to the company is the one who gets the promotions.  
... W6JAT



**Tri-Ex TOWER CORPORATION**  
127 EAST INYO STREET / TULARE, CALIFORNIA



# Selected Circuits

Roy Pafenberg W4WKM  
316 Stratford Avenue  
Fairfax, Virginia

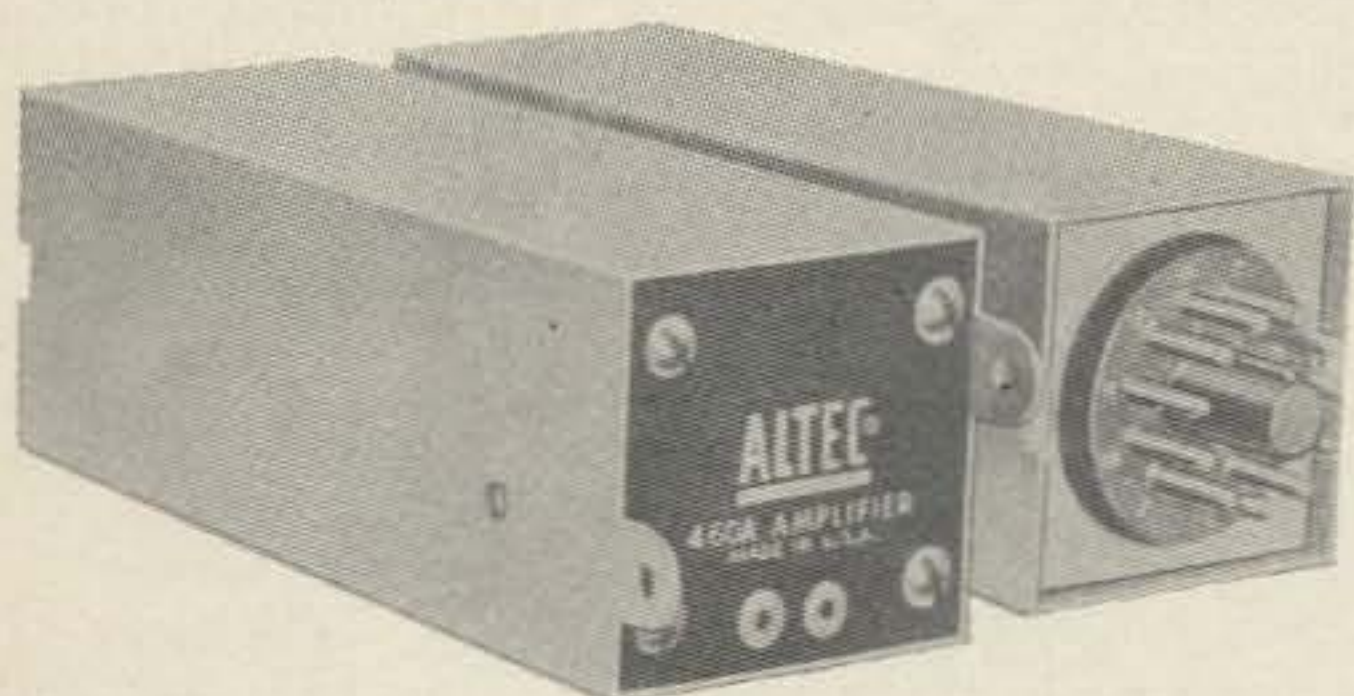

**The ALTEC 460A Transistor Compressor Amplifier is typical of the transistorized, modular audio assemblies. All are housed in identical, plug-in cases.**

The communications industry has long recognized the practical utility and flexibility of modular or "building block" construction. Even the most complex multi-channel carrier systems consist of large numbers of relatively few types of circuits inter-connected to meet specific system requirements. Where minor differences occur, such as oscillator and filter frequencies, these elements are often made plug-in to permit fullest flexibility in manufacturing, installation and maintenance.

The ALTEC Lansing Corporation of Anaheim, California, manufactures and markets a line of compact, modular plug-in units to meet the requirements of the telephone industry. This line includes transistorized line, compression and power audio amplifiers. The circuitry of these audio components is of particular interest to amateurs who may desire to pattern their construction projects along these lines. The ALTEC line is rounded out by a series of attenuators, equalizers, line transformers, hybrids and networks of similar construction.

These individual system elements are housed

in compact, plug-in cases. The basic package is similar to the Western Electric V-3 vacuum tube line amplifier. This unit is used in great quantities by the telephone companies as repeater amplifiers. The compact construction of these units is shown in the photograph of the ALTEC 460A Transistor Compressor Amplifier which measures 1 $\frac{3}{4}$ " x 1 $\frac{3}{4}$ " x 6".

The various units may be mounted and inter-connected to meet specific system requirements. An example of this is shown in the photograph of the ALTEC 7300A Telephone Repeater Terminating Unit. While other assembled packages are available, probably the greatest use of the line amplifiers is to replace existing vacuum tube amplifiers or to expand existing installations. Several models of the basic transistor line amplifiers are available for operation from various supply voltages. Other variations include dual input and output impedances with optional simplex taps on the transformers and monitor output options.

The ALTEC 457B Transistor Amplifier is typical and the schematic is shown in Fig. 1. This unit provides 37 db gain from and into 600 ohm loads and delivers a maximum output power of +18 dbm. Distortion is low and output is flat within 1 db between 200 and 3,000 cps.

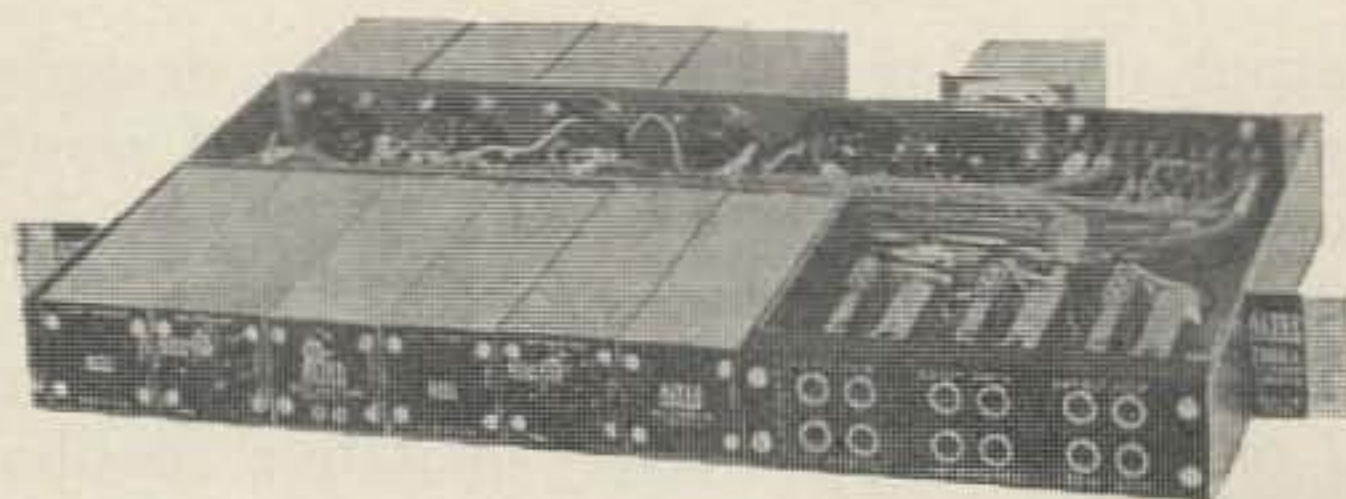

**Typical grouping of the modular assemblies is shown in the ALTEC 7300A Telephone Repeater Terminating Unit. The units are easily removed for service.**

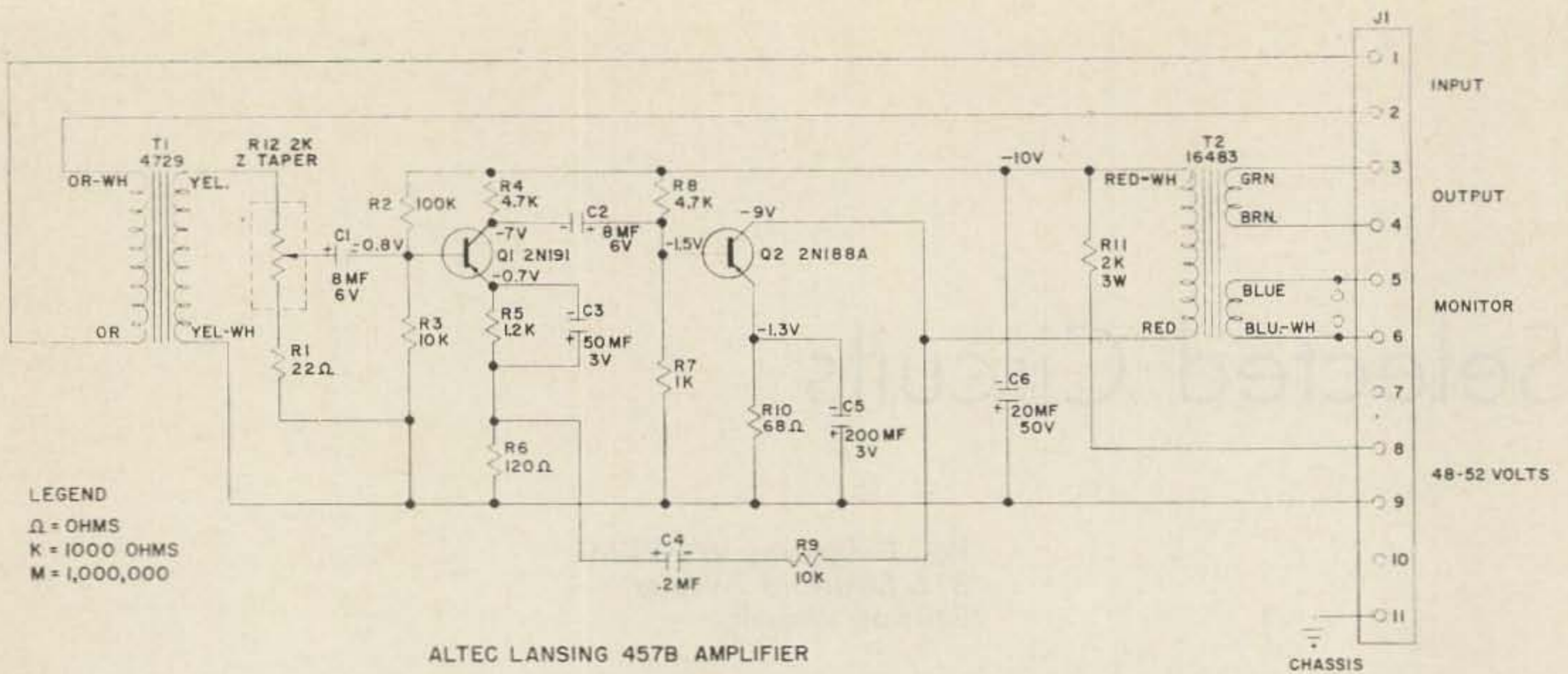

**Fig. 1 Schematic diagram of the ALTEC 457B Transistor Amplifier. This little unit provides 37 db gain and has a maximum output of +18db. Gain may be increased to over 50 db by opening the C4-R9 feedback loop.**

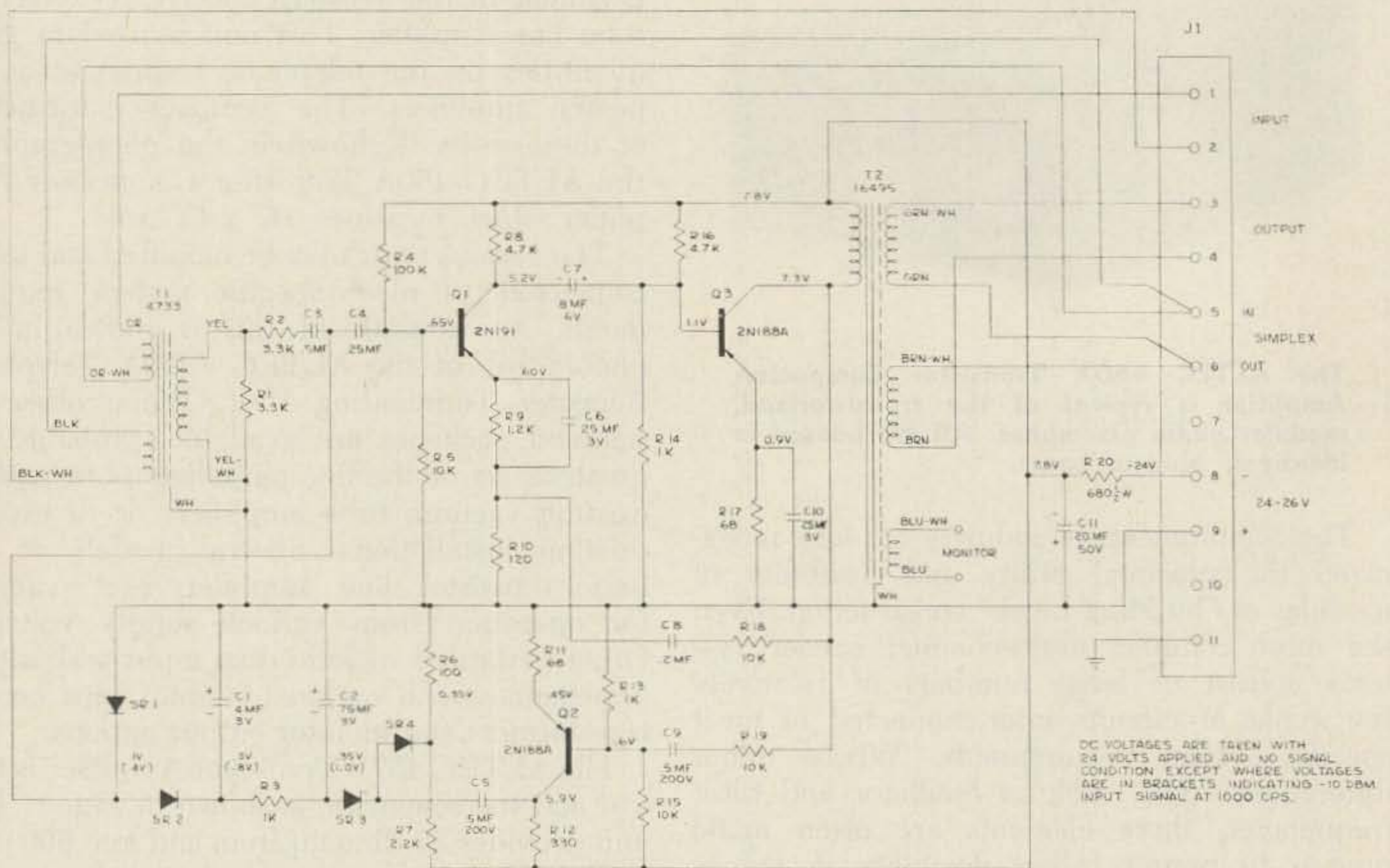

**Fig. 2 Schematic of the ALTEC 460A Transistor Compressor Amplifier. While designed for telephone repeater service, the circuit is ideally suited for amateur transmitter applications. Output level varies less than 20 db for an input range in excess of 50 db.**

Output noise level is -70 dbm. As designed, the unit draws 25 ma from a 52 volt source. However, the majority of this power is dissipated in the R11 dropping resistor. The actual power requirement is approximately 25 ma at 10 volts. Heavy negative feedback is utilized to reduce distortion and stabilize the gain of the amplifier. Gain is constant within 0.3 db for a 25% variation of supply voltage and within 0.2 db for an ambient

temperature increase from 75° F. to 110° F. While the circuit is usable, as is, for many amateur applications, more gain may be required for others. For these applications, gain may be increased to more than 50 db by opening the C4-R9 feedback loop. While this will make the gain of the amplifier more susceptible to temperature and supply voltage variations, no great difficulty should be encountered in fixed installations.

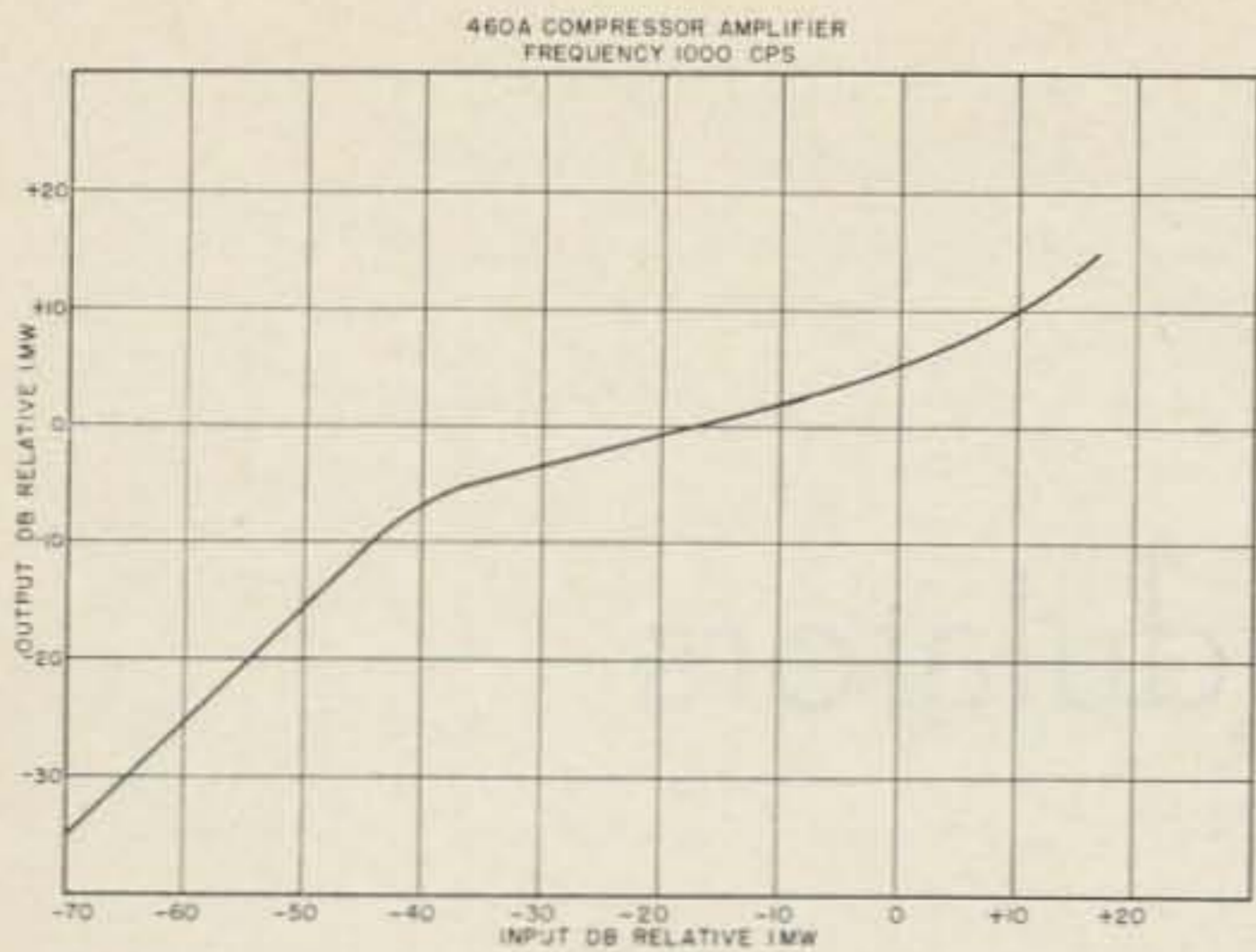
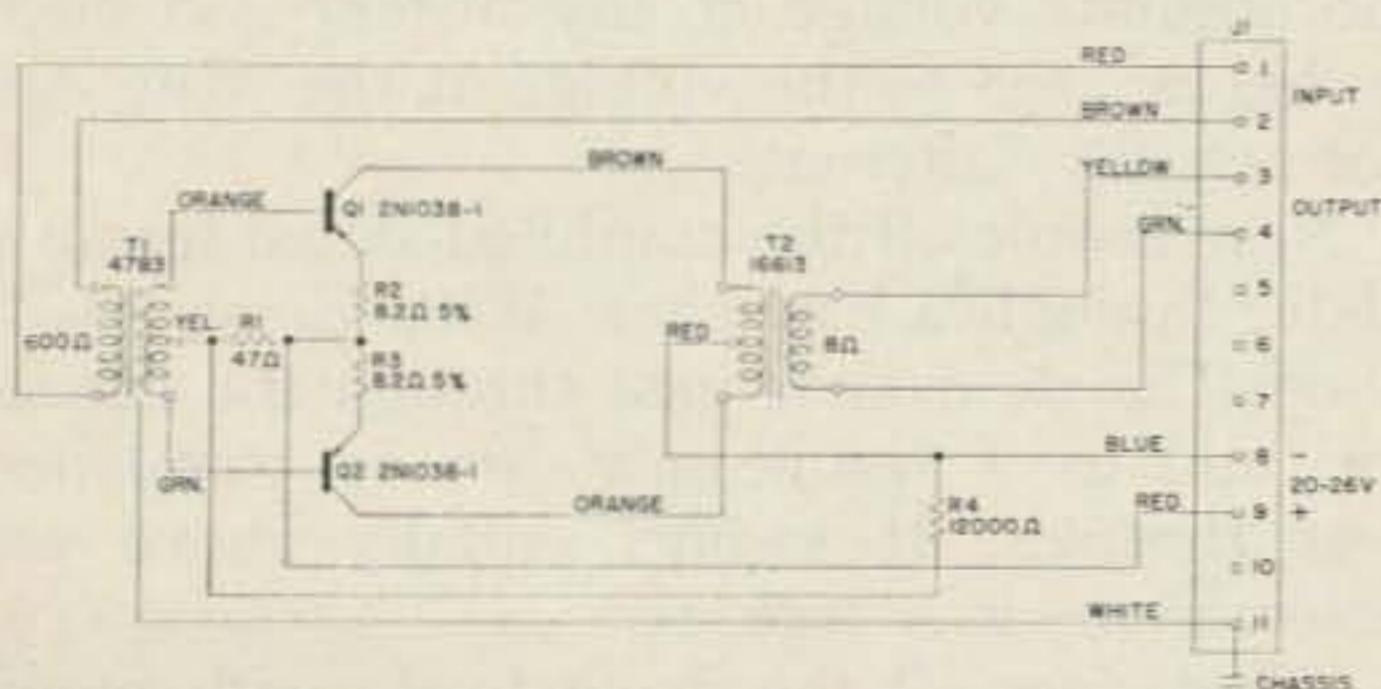

**Fig. 3 Performance curve of the ALTEC 460A Compressor Amplifier. While designed for automatic equalization of telephone circuit levels, it is ideal for amateur speech applications.**

The ALTEC 460A Transistor Compressor Amplifier is designed for use in communications systems, where it is desirable to maintain a relatively constant output level for a wide range of input levels. Since the problem is similar to that encountered in amateur transmitter speech systems, the circuitry of this unit, shown in Fig. 2, should be of amateur interest. As in the line amplifiers, input and output impedances are 600 ohms. Below compression, the gain of the amplifier is approximately 35 db. Compression characteristics of this amplifier are shown in Fig. 3.

The last of the ALTEC units to be described is the type 461A Transistor Power Amplifier. This compact little unit is housed in the same style package as the other units and will deliver 2 watts output into an 8 ohm speaker. The amplifier is designed for use in a speaker type, telephone terminating set but the circuit should be valuable in amateur audio work. Fig. 4 gives the schematic diagram of this little amplifier. Input impedance is the standard 600 ohms which makes it compatible with the other units described.

While the writer is certainly not recommend-



**Fig. 4 Schematic of the ALTEC 461A Transistor Power Amplifier. This modular building block provides 2 watts of audio to an 8 ohm speaker.**

THREE IMPORTANT REASONS WHY YOU NEED THE

# NEW 1963 SPRING CALLBOOK

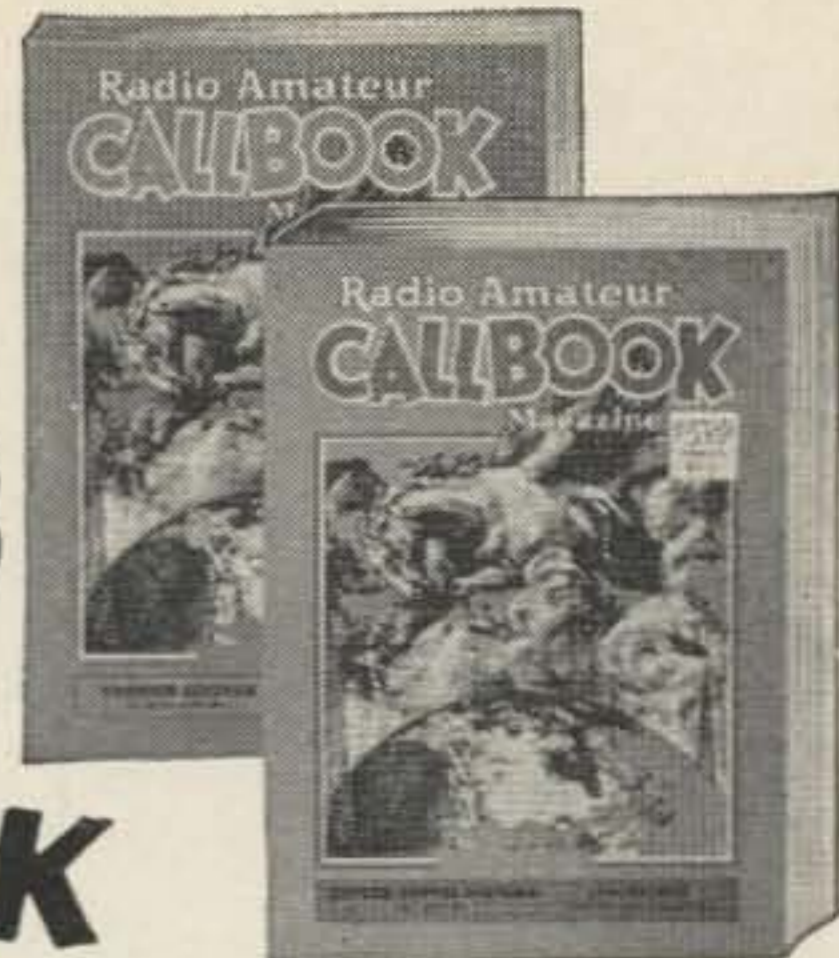

• If your present CALLBOOK is only a year old, over 20% of the listings have been changed or added!

Foreign Listings (All outside U.S.)

**\$3.00**

U.S. Listings (All K and W calls)

**\$5.00**

• Over 13,000 new amateurs added since the Winter, 1962 issue—another major license increase!

• Completely revised essential data—latest international prefixes, Q signals, postal info., airline distances, time chart, etc.

Now on sale at your amateur equipment dealer; if not conveniently located you may order by mail (please add 25c for mailing) from:

### RADIO AMATEUR CALLBOOK

Dept. B, 4844 Fullerton Ave., Chicago 39, Ill.

**P.S.** Write for illustrated brochure on exclusive WORLD ATLAS . . . DX GUIDE . . . SPECIAL FULL COLOR MAPS.

## ALL BAND AMATEUR RADIO TRAP ANTENNAS!



Reduces interference and noise on all makes short wave receivers. Makes world wide reception stronger. Clearer on all bands!

For ALL Amateur Transmitters. Guaranteed for 500 Watts Power for Pin-Net or Link Direct Feed. Light, Neat, Weatherproof

Complete as shown total length 102 ft. with 87 ft. of 72 ohm balanced feedline. Hi-impact molded resonant traps. (Wt. 3 oz. 1" x 5" long). You just tune to desired band for beamlike results. Excellent for ALL world-wide short-wave receivers and amateur transmitters. For NOVICE AND ALL CLASS AMATEURS! NO EXTRA TUNERS OR GADGETS NEEDED! Eliminates 5 separate antennas with excellent performance guaranteed. Use as inverted V for all band power gain. NO HAYWIRE HOUSE APPEARANCE! EASY INSTALLATION! 80-40-20-15-10 meter bands. Complete . . . \$14.95 40-20-15-10 meter bands. 54-ft. ant. (best for swl's) . . . 13.95 SEND ONLY \$3.00 (cash, ck., mo) and pay postman balance COD plus postage on arrival or send full price for postpaid delivery. Complete installation & technical instructions furnished. Free information.

Available only from:

WESTERN RADIO — Dept. A7-5 — Kearney, Nebraska



**CALL-LETTER SIGNS**  
ORDER your call in neat 2-inch die cut letters with base. Just right for the shack. You assemble—Letters: 3/32" silver showcard stock. Base: Satin finish black plastic.

**Price \$1.50 postpaid**  
NEW PRODUCTS  
Dept. D, Box 481  
Grand Haven, Mich.

ing that every amateur go out and buy a truck load of these ALTEC audio components, there is much to be said for the modular concept employed in their design. Think it over carefully. You may want to use modular packaging in your next construction project.

. . . W4WKM

# Diode Modulators

Staff

One of the first points at which SSB construction details vary drastically from the older AM techniques is in the wide use of diode modulators with SSB.

This sometimes causes much head-scratching and consternation among sideband neophytes. Who ever heard of a diode being able to modulate a signal?

However, as many, many on-the-air signals will testify, it works. And it works quite well, if a few simple precautions are followed.

Before we dive into the depths of the several diode-modulator circuits available for our use, let's settle this question of how a diode can act as a modulator:

To do this, we'll have to back up and examine first the differences between ac and dc. For our purposes, the essential difference is that ac voltages go *equal* distances either side of zero on adjacent half-cycles. If you have an ac voltage which goes farther positive than negative, it's not true ac—rather, it's ac superimposed on a dc component.

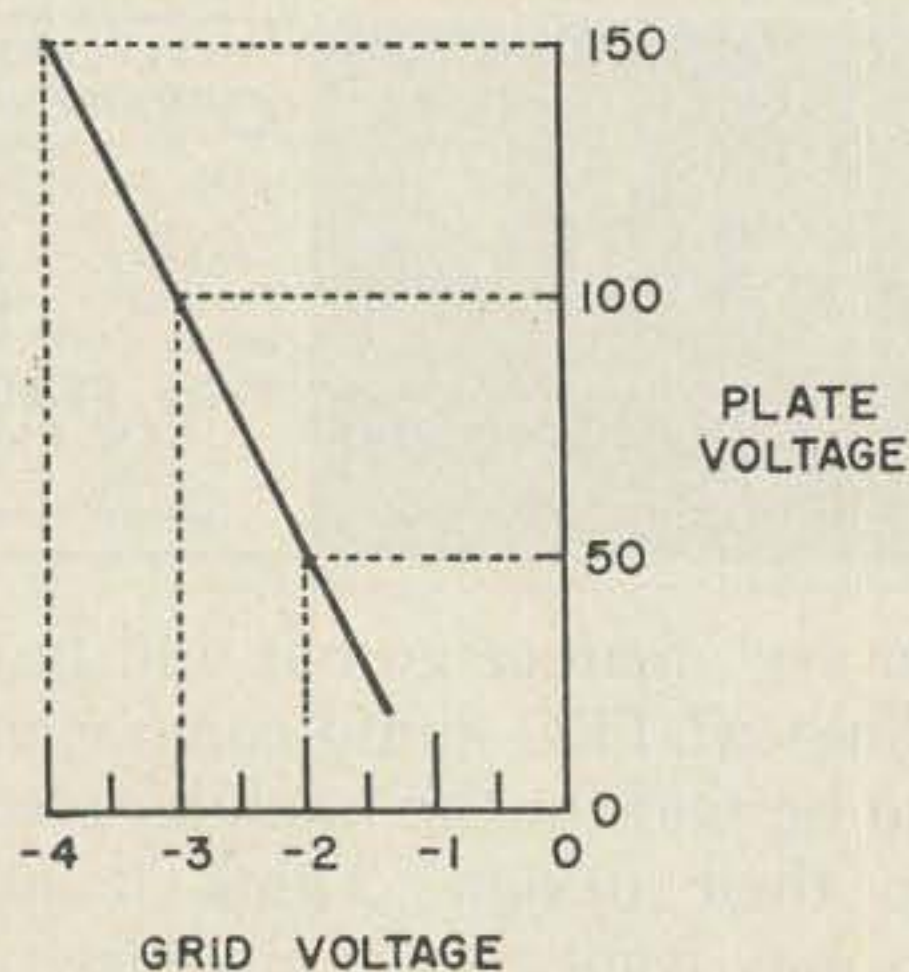

FIG. 1

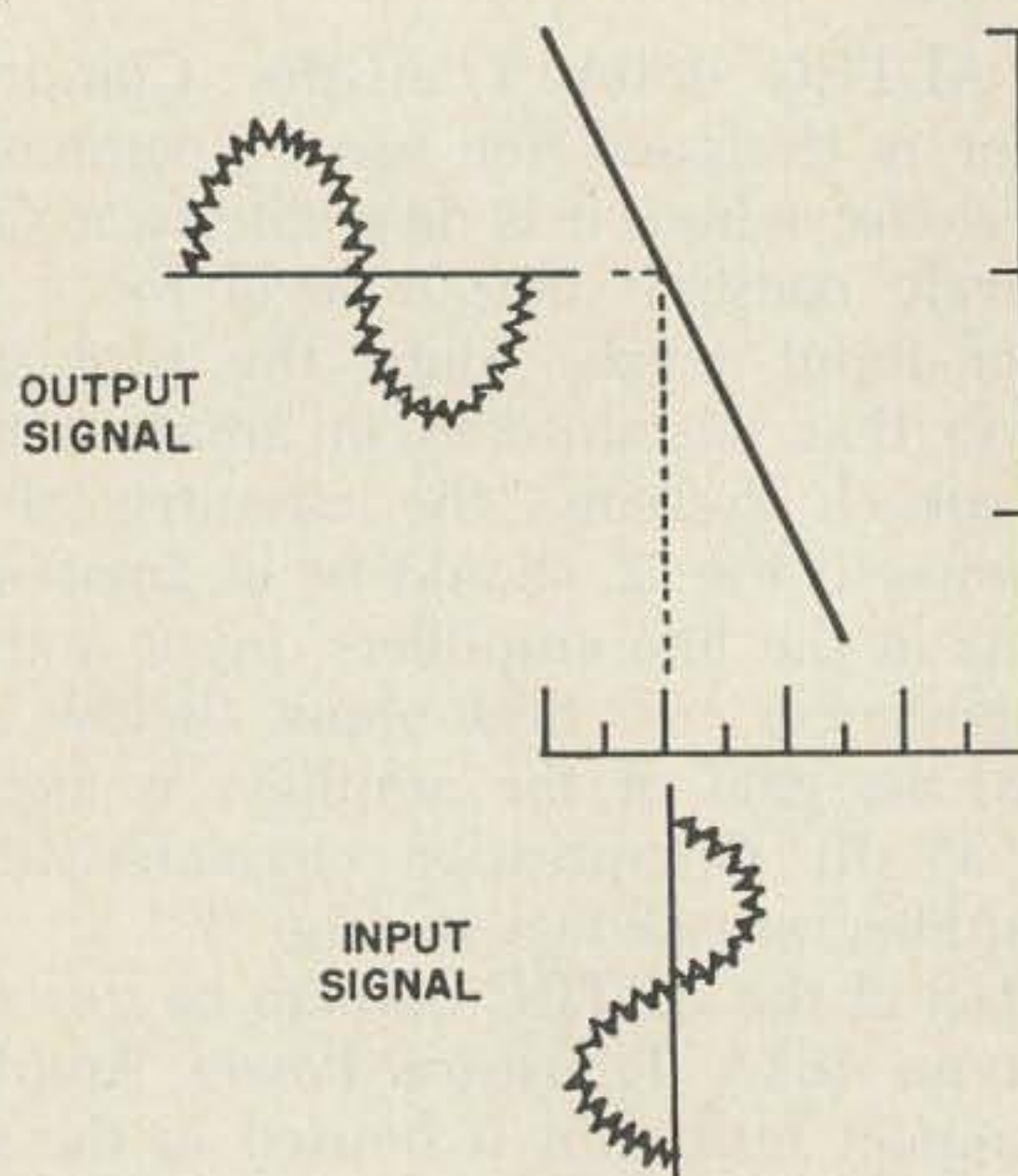

FIG. 2

Let's look at this a little more closely. Take an ordinary amplifier and feed some ac into the grid circuit. What do you have at the plate? If you answered "more ac," go to the foot of the class. Your amplified ac is there, to be sure, but the dc plate voltage is also present—and if the amplifier is working within its limits, the absolute voltage at any instant will never go below zero so the voltage at the plate cannot actually "alternate."

Now couple off the amplified signal from the plate, through a capacitor. What do you have now? The dc cannot pass through the capacitor, and as a result only the ac component gets through. It swings equally above and below zero; it is *true* ac.

What does all this have to do with modulators? To answer this, we have to draw a couple of pictures of "transfer characteristics."

The "transfer characteristic," for those un-

familiar with the term, is simply a graph which shows output voltage of a circuit in relation to input voltage. For a triode amplifier, it would read instantaneous plate voltage on the vertical scale in relation to instantaneous grid voltage on the horizontal scale (Fig. 1).

Taking that amplifier in Fig. 1, let's examine it. The graph says that when the grid voltage is minus 3, plate voltage is 100. When grid voltage is minus 2, plate voltage drops to 50. When grid voltage is minus 4, plate voltage rises to 150.

Such an amplifier is linear, in that the output voltage changes the same amount for equal changes of input voltage. What goes into a linear amplifier comes out unchanged.

Now, let's put two ac tones into the input of this amplifier (Fig. 2). The two tones are completely separate, and as a result neither of them is true ac; the higher-frequency tone "rides" the lower-frequency one. So far as the higher tone is concerned, the lower tone is its zero-voltage reference. But since the amplifier is linear, the tones come out unchanged.

At this point, let's take a look at the transfer characteristic of a perfect diode. It's shown in Fig. 3. Note that, unlike our amplifier, this characteristic is *not* a straight line. It has a sharp break in it; the sharper the break, the better the diode.

Now, in Fig. 4, let's apply those same two ac tones to the diode. When the input signal swings positive, the diode conducts and an output signal appears. When it swings negative, nothing happens. Thus, the output signal is *not* a replica of the input. The diode is said to be "non-linear."

Note that in all four illustrations, the output signal is *not* true ac. All have some dc components present. However, passing them through a capacitor will remove the dc and the output will then be true ac.

The output of the diode, when treated in this manner, becomes completely true ac; it's

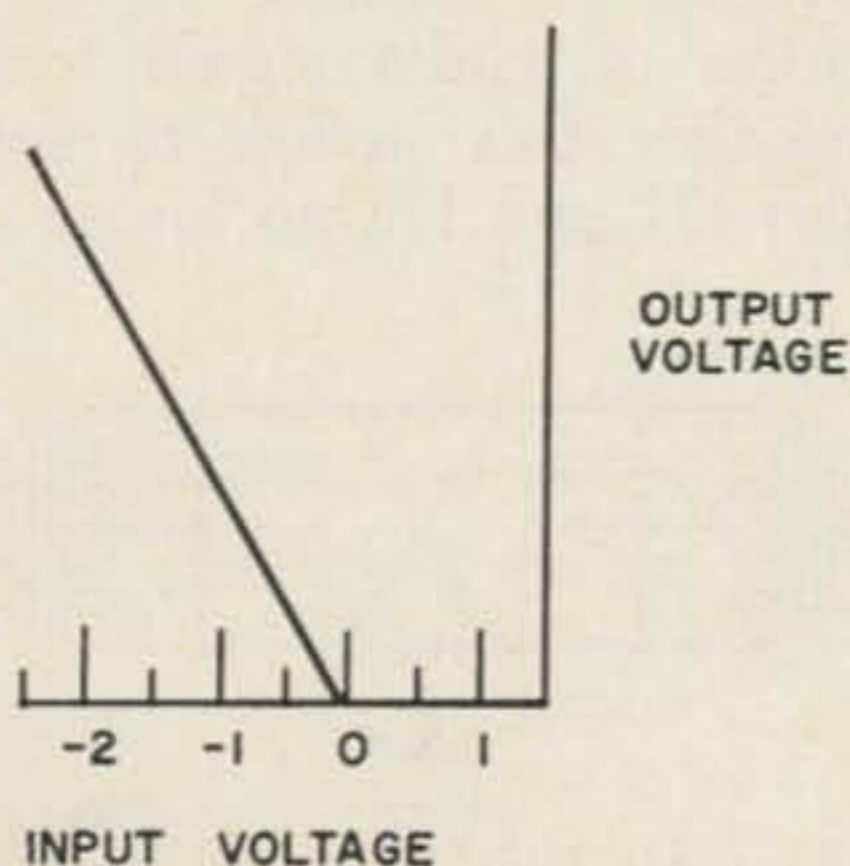

FIG. 3

Want High Efficiency and Small Size?

# 6 10 15 20 METERS MINIATURIZED-4-BANDS

★ 500 Watts AM.

★ Turning Radius - 7'

★ Total Weight - 11 lbs.

★ Size - 5' x 11'

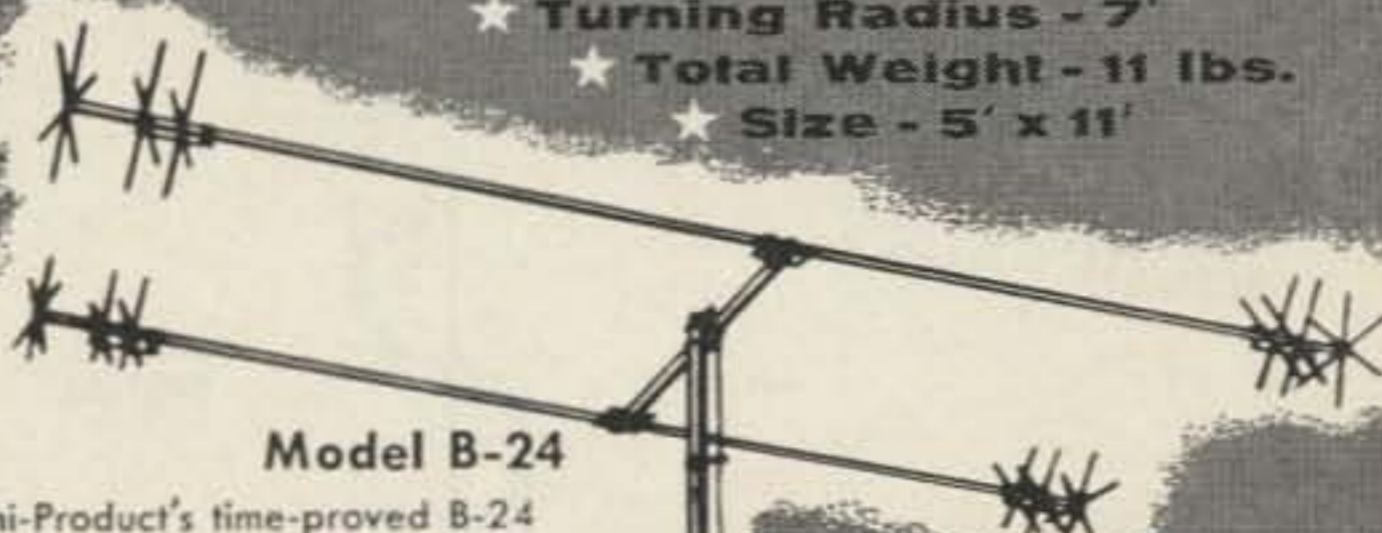

Model B-24

Mini-Product's time-proved B-24 4-band antenna combines maximum efficiency and miniaturization to provide hams with an excellent antenna where space must be considered.

Like all Mini-Products antennas, the B-24 employs "Multiple Hat" loading for maximum efficiency. TV rotor adequate; Feed line, 50 ohm coax; SWR 1.5:1.

Amateur Net

**\$59.95**

**Mini-Products, Inc.**

Write for data on the B-24 and other compact antennas:

• Model B-4010—40 and 10 M. two 18' elements, 10' boom

Net \$79.50

• Model C-4—Coax Vertical (no radials) 6, 10, 15, 20 M.

Net \$34.95

• Model M-4 Mobile 6, 10, 15, 20 M.

Net \$16.95

Patents pending

1001 WEST 18th STREET • ERIE, PENNSYLVANIA

See your local distributor or order direct from factory

## MOBILE POWER KIT

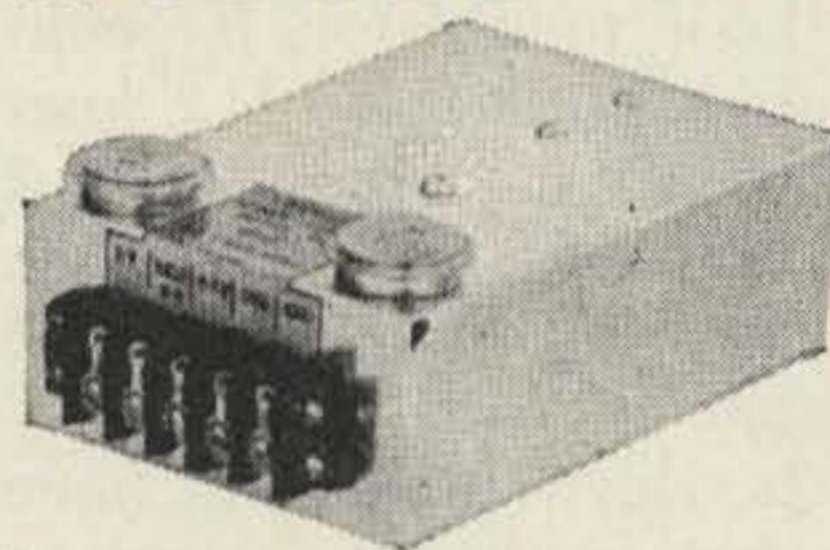

150 WATTS  
CONTINUOUS

**\$29.95**

BF ELECTRONICS proudly presents the all new transistorized Mobile Power Supply Kit at the **LOWEST PRICE** anywhere. A new concept in kit construction gives you top **QUALITY** and **PERFORMANCE** for a minimum investment.

### FEATURES INCLUDE:

1. 150 watts continuous power output at 130° F.
2. Highest quality parts manufactured in USA.
3. Fully transistorized with silicon rectifiers.
4. Toroidal transformer gives 85% efficiency.
5. Heavy filtering gives less than 1% ripple.
6. Bleeder resistor for capacitor discharge.
7. Low price is possible because of a new idea by BF Electronics. Complete instructions with special construction aids let you wind the toroid transformer easily in less than two hours.

PC-1 Input 12.5 VDC. Output: 500 VDC at 300 MA and 250 VDC at 500 MA. Maximum power: 150 watts. KIT ... \$29.95

Completely Wired ... 41.50

PC-2 Input 12.5 VDC. Output: 600 VDC at 250 MA and 300 VDC at 500 MA. Maximum power: 150 watts. KIT ... \$34.95

Completely Wired ... 47.50

PC-3 Input 12.5 VDC. Output: 600 VDC at 250 MA and 300 VDC at 500 MA and -100 VDC at 20 MA. Maximum power: 150 watts. KIT ... \$39.95

Completely Wired ... 52.50

PC-4 Input 12.5 VDC. Output: 300 VDC at 500 MA. Maximum Power 150 watts. KIT ... \$29.95

Completely Wired ... 41.50

PC-5 Input 12.5 VDC. Output: 500 VDC at 300 MA, 250 VDC at 500 MA and -125 VDC at 20 MA. Maximum power: 150 watts. KIT ... \$39.95

Completely Wired ... 52.50

PC-6 Input 13.5 VDC. Output: 800 VDC at 300 MA, 270 VDC at 500 MA and -100 VDC at 20 MA. Maximum power: 300 watts. Available only as completely wired and tested ... \$89.95

For **SWAN**, **COLLINS**, and **SONAR** use the PC-6 for full output power. Use the PC-3 for these units with slightly reduced P.E.P. and a lower price. For the **HALLICRAFTERS** transceiver use the PC-5. For **ARC-1** and other surplus gear use the PC-4. Other output voltages are available as special units. Write for prices. All prices are F.O.B. Cardiff, Calif. Shipping Wt. 3 lbs. California customers include 4% sales tax.

**BF ELECTRONICS**

BOX 602, CARDIFF, CALIF.  
PHONE 714-753-2895

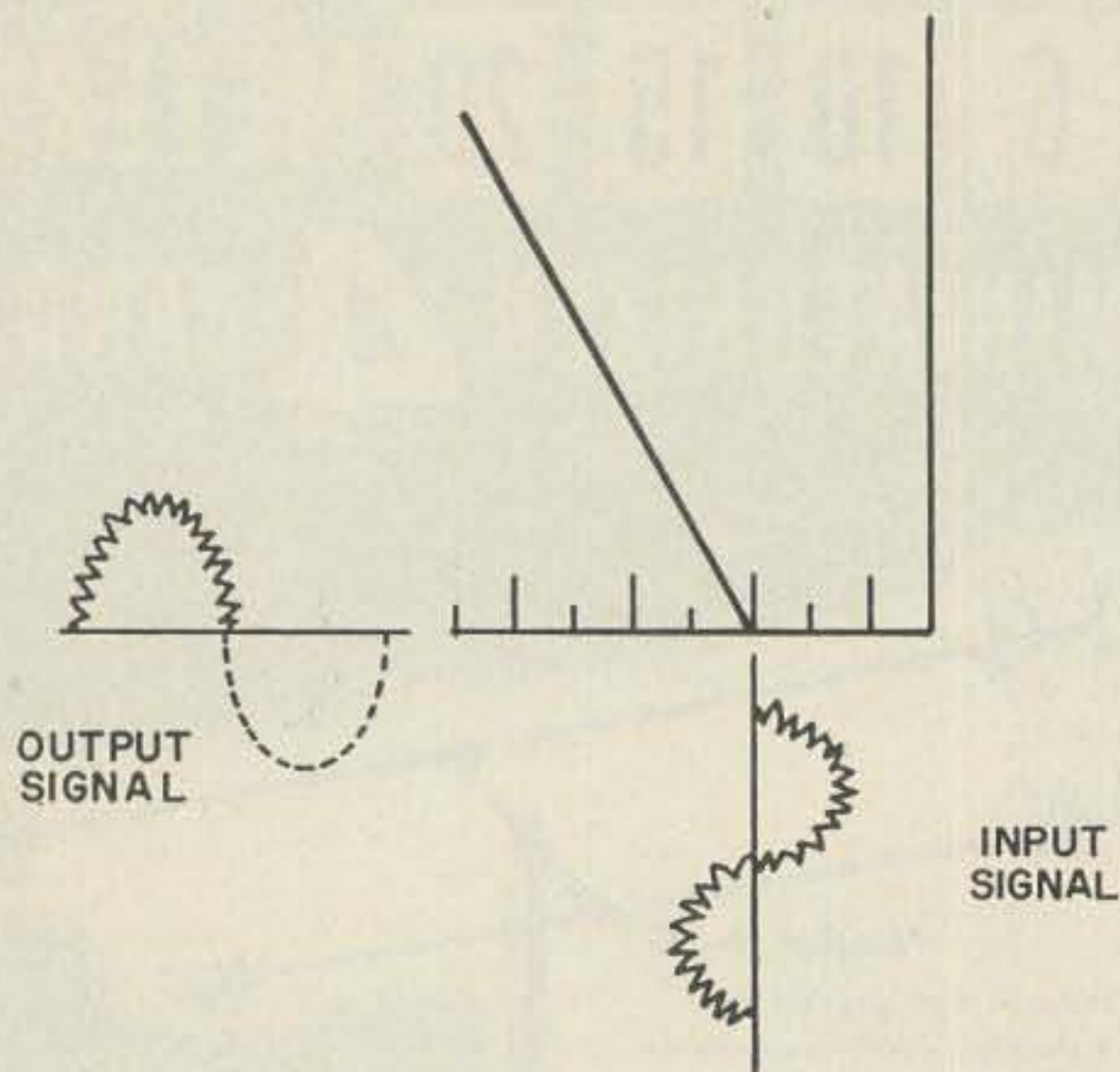

FIG. 4

no longer a pair of separate tones. The lower-frequency tone has *modulated* the higher one. And that's how a diode can modulate.

One point deserves careful attention. For our diode to act as described, the levels of all the signals must be very carefully controlled and bias level on the diode is also critical. This is never a difficult thing to do, but since it is so vital to proper circuit operation deserves this special mention.

The simple single-diode modulator we just discussed is a basic diode modulator. It could be used for amplitude modulation of a low-level signal, or for a mixer in a receiver, but it is not especially useful in sideband. In a sideband modulator, we want to get rid of the carrier at the same time.

A number of circuits which will do this have appeared in the literature, under the common family name of "balanced diode modulators." They may be divided for study into several categories, but unfortunately authorities differ on these categories.

Collins Radio Company, in their excellent manual "Fundamentals of Single Side Band," declare that only three types of diode modulators exist: ring, shunt, and series.

Going on to the ARRL publication, "Single Sideband for the Radio Amateur," we run into a fourth type—the bridge modulator. Except that this bridge modulator is identical to the one Collins calls a series circuit, and the circuit known as the series circuit in most references is not included in the Collins manual! Confusion is still rampant in the field, apparently.

So we won't try to classify the types here. We'll simply go through the published references, describe the workings of each, and list some advantages and disadvantages as reported in the original scattered descriptions:

**The Ring Modulator.** This modulator is usually referred to as the "classic ring" circuit, since it was developed by telephone engineers in the very early days of commercial sideband and is possibly the oldest balanced-modulator circuit. A typical ring-modulator circuit is shown in Fig. 5, and one suitable for ham use in the 455 Kc region appears in Fig. 6 with parts values.

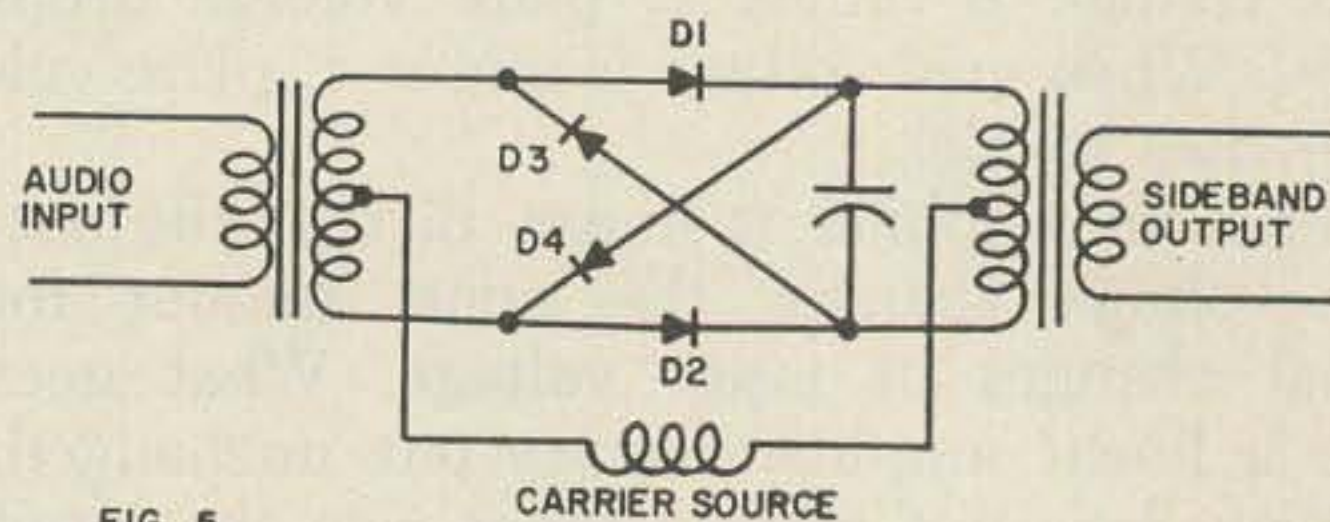

FIG. 5

According to the Collins reference, the ring modulator has the highest efficiency of all diode balanced modulators, being able to provide twice as great an output voltage for the same inputs as the other types of modulators. However, as Hooton points out, the diodes must be more closely matched in this circuit to obtain satisfactory carrier suppression than is necessary with other circuits which contain balance adjustments.

Here's how the ring modulator works: both the audio input and the sideband output are push-pull circuits, while the carrier input is single-ended. In the absence of any audio signal, the carrier is balanced out in the output tank. When carrier voltage at the audio-input center-tap is positive, rf current will flow through the output tank (from center-tap to both ends), D1 and D2, the audio transformer, and back to the carrier generator. When carrier voltage at the same point is negative, current flow reverses—but in either case, the current flow through the output tank is from center-tap to both ends at the same time. This means the potential at each end is the same, and with no voltage drop across the entire coil no output current flows.

Application of audio signal to the transformer modifies this action to some extent. Now diodes D1 and D2 no longer conduct at

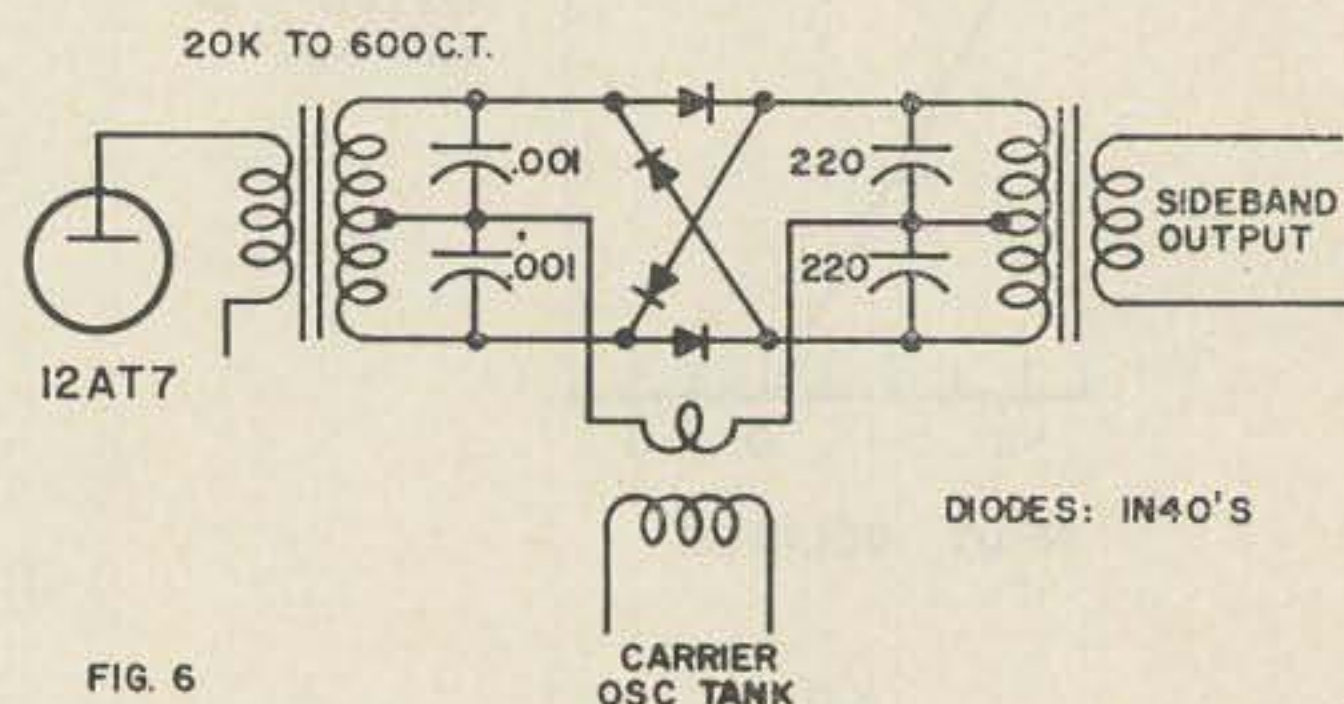

FIG. 6

exactly the same times; the one which tends to be turned "on" by the audio signal conducts for a longer time than does the one which tends to be turned "off." The same is true for D3 and D4. Now, current from the carrier generator flows for a longer period through one half of the output tank primary than through the other. The result is a series of pulses in the output circuit, whose polarity and frequency are determined by the carrier, and whose height is determined by the audio. After passing through the tank circuit, these pulses are not distinguishable from the sideband components of an AM signal.

Input and output impedances of the ring modulator are low, according to Stoner. Figures in the neighborhood of 600 ohms are usually quoted. For the audio input, a plate-to-600-ohm transformer is satisfactory; for the sideband output, much more capacitance than usually used would be indicated.

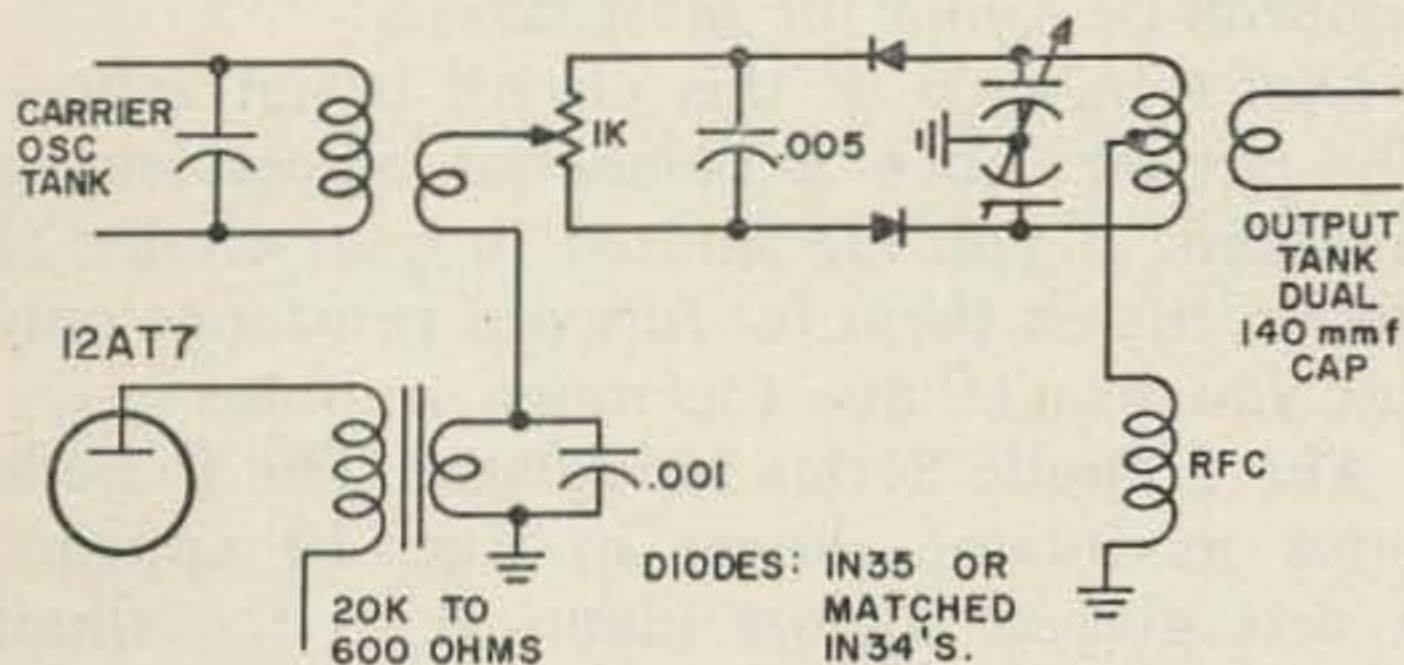

FIG. 7

Stoner describes also a "modified ring modulator" which was used in W2KUJ's "SSB-Jr." exciter described in a 1950 issue of *GE Ham News*, and later in the Central Electronics line. The circuit for this modulator is shown in Fig. 7.

In this circuit, carrier and audio frequencies are applied, in series, to the arm of balance pot R1. The voltages appear at each end of this pot, in ratio determined by the setting of the potentiometer, and pass through diodes D1 and D2.

In the absence of audio signal, the carrier passes through the bypass capacitor; this places the rf voltage across the diodes at the same level on each side, and as a result no rf current flows.

With audio applied, the diodes are unbalanced in the same manner described for the classic ring, and sideband-signal current flows through the output tank.

The rf choke from output-tank center-tap to ground is essential; without it, no carrier balance is possible. In addition, the audio transformer should be by-passed for the carrier frequency. The carrier-injection link usually has no effect on the audio.

## for the no-QSB QSO

Space Raider brings you the amazing Polarized Diversity Beam designed by K6CT and proven by DX men the world over. P. D.\* virtually eliminates the 80% of QSB caused by polarization shift. P. D. Beams offer vastly improved forward gain, front-to-back and side rejection ratios. Space Raider beams priced from \$44.50. Write for particulars.

P. D. Beams Available for 20, 15, 10, 6 and 2 Meters

**P.D.\***

\*Polarized Diversity

*Space-Raider*

1076 E. WALNUT ST., PASADENA, CALIF.

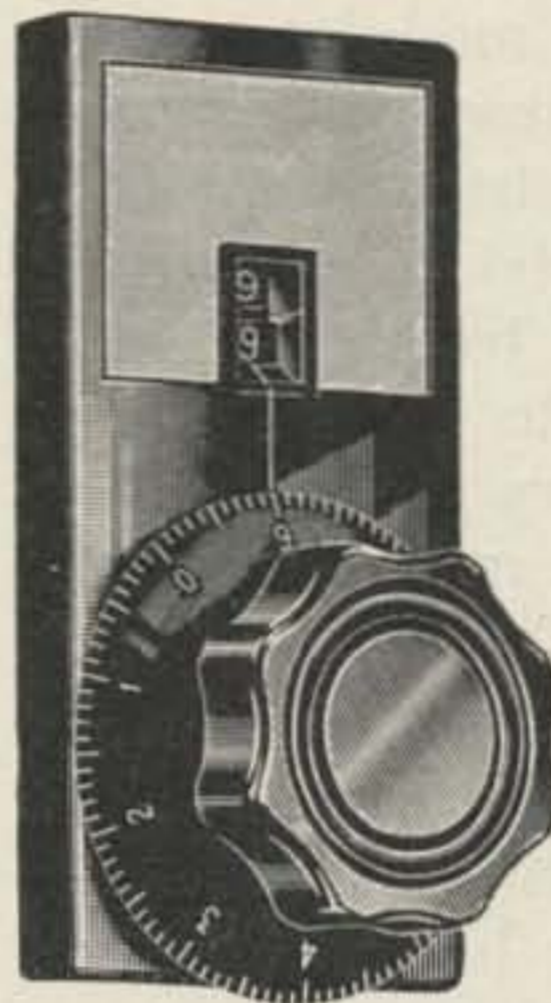

## Groth TURN COUNT DIAL

Registers Fractions to 99.9 Turns

For roller inductances, INDUCTUNERS, fine tuning gear reducers, vacuum and other multiturn variable condensers. One hole mounting. Handy logging space. Case: 2" x 4". Shaft: 1/4" x 3". TC 2 has 2 1/4" dial—1 1/2" knob. TC 3 has 3" dial—2 1/2" knob. Black bakelite.

TC 2 \$5.50 — TC 3 \$5.75

Spinner Handle 75¢ extra

Add 16¢ for Parcel Post

**R. W. GROTH MFG. CO.**

10009 Franklin Avenue  
Franklin Park, Illinois

## TV MONITOR

**\$99.50**  
and up

Basic Parts Kit

Details

**FREE**

LIST #771



**Denson Electronics Corp.**  
Rockville, Connecticut

## WALKIE-TALKIE!

6 meter, 150 mw., 4 channel, transistorized transmitter with AM modulator. Complete with transistors and 50.5 mc. crystal. Requires only 12 volts at approx. 35 ma. Ideal for walkie-talkie or get 10 to 15 mile range with a beam.

Only \$14.95 ppd. while they last.

**VANGUARD ELECTRONIC LABS** Dept. H-5  
190-48-99th Ave. Hollis 23, N. Y.

## LOOKING? SHOPPING? TRADING? TRYING TO SAVE MONEY?

Write Bob Graham for Special Deals on New and Re-conditioned used gear. Cash or Budget.

**Graham Radio**

Dept. C., Reading, Mass.

Tel: 944-4000.

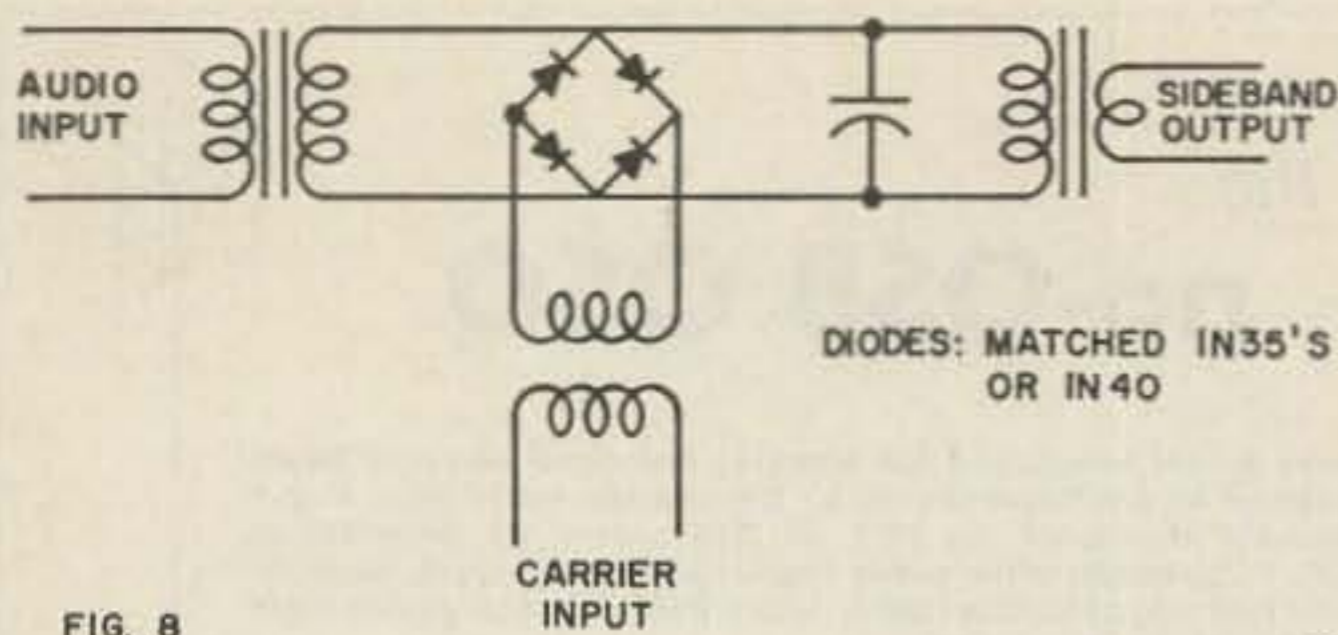

FIG. 8

**The Bridge Modulator.** For understanding more clearly how it's possible to balance the carrier out, there's nothing like a study of the bridge balanced modulator.

As the name implies, this modulator (Fig. 8) is based on the Wheatstone bridge, with diodes replacing the usual resistance arms.

Audio input and the sideband output are taken from the same set of terminals, while the carrier input is applied to the remaining terminal set. If all diodes have identical characteristics, the bridge will be in balance at all times (if no audio is applied) and the carrier will find no path to the output.

However, application of audio will affect the diodes in the upper half of the bridge differently than those in the lower half, because of diode polarities—and the bridge is no longer balanced. The signal finds its way from carrier input to sideband output.

To understand how this is sideband signal, rather than pure carrier, you have to go back to the basic diode modulator and note that all signals reaching the output consist of *both* audio and carrier, and all have passed through at least one diode before reaching the output.

The bridge is seldom used in practice any more, since it (like the classic ring) requires four diodes and equally satisfactory results may be had from either the modified ring, the 2 diode shunt, or the 2 diode series modulators. For this reason, no "practical circuit" with parts values is included.

**The 2 Diode Shunt Modulator.** The 2 diode shunt modulator is similar to the bridge type

except that the two lower diodes are replaced by a push-pull carrier input. A typical circuit is shown in Fig. 9.

The key feature of this modulator is that the carrier signal causes the diodes to short out the audio signal. Depending on carrier-half-cycle polarity, the pulse in the output tank will be either positive or negative going. For the shunt modulator to operate properly, great care must be taken with circuit impedances.

For instance, all diodes (in practice) have some forward resistance. Their back resistance, also, while high is not infinite. Thus, if the audio signal source impedance is too low the diode will not "short it out," while if audio impedance is too high the inactive diode will still tend to short out the signal.

This is the reason for the 1,000 ohm resistor shown in Fig. 9. It establishes 1,000 ohms as the circuit source impedance. This is a good compromise value for most diodes.

Diode balance in this circuit is not especially critical, since a balancing adjustment is provided. If you are limited in your choice of diodes, match them for *forward* resistance only and you won't have too much trouble.

**The 2 Diode Series Modulator.** The 2 diode series modulator shown in Fig. 10 appears, at first glance, almost identical to the shunt modulator of Fig. 9. However, it works in a radically different manner.

Where the shunt modulator uses the carrier to short out the audio, the series modulator uses the carrier to establish a signal path through which the audio can travel.

So far as we have been able to determine, this circuit was first described by Fred Berry WoMNN in the September 1952 issue of QST. It has since been republished in almost all sideband manuals.

Like the shunt modulator, this circuit requires fairly well matched diodes so far as the forward-resistance characteristic is concerned. However, this resistance need not be excep-

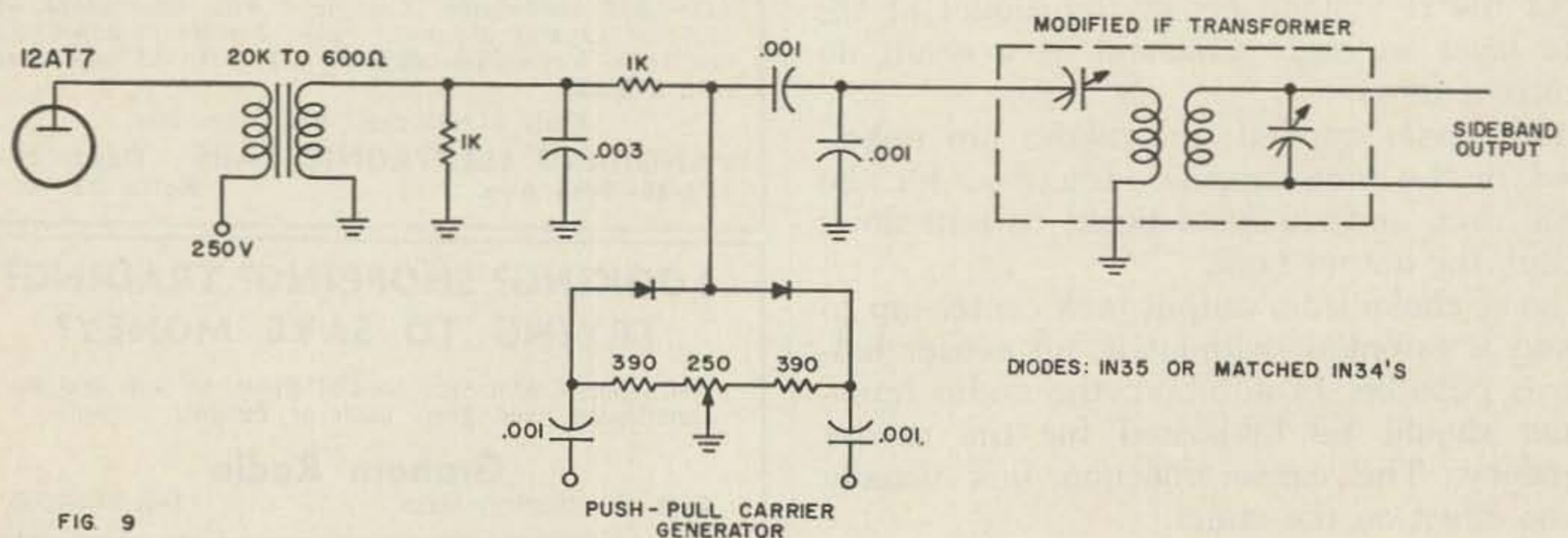

FIG. 9



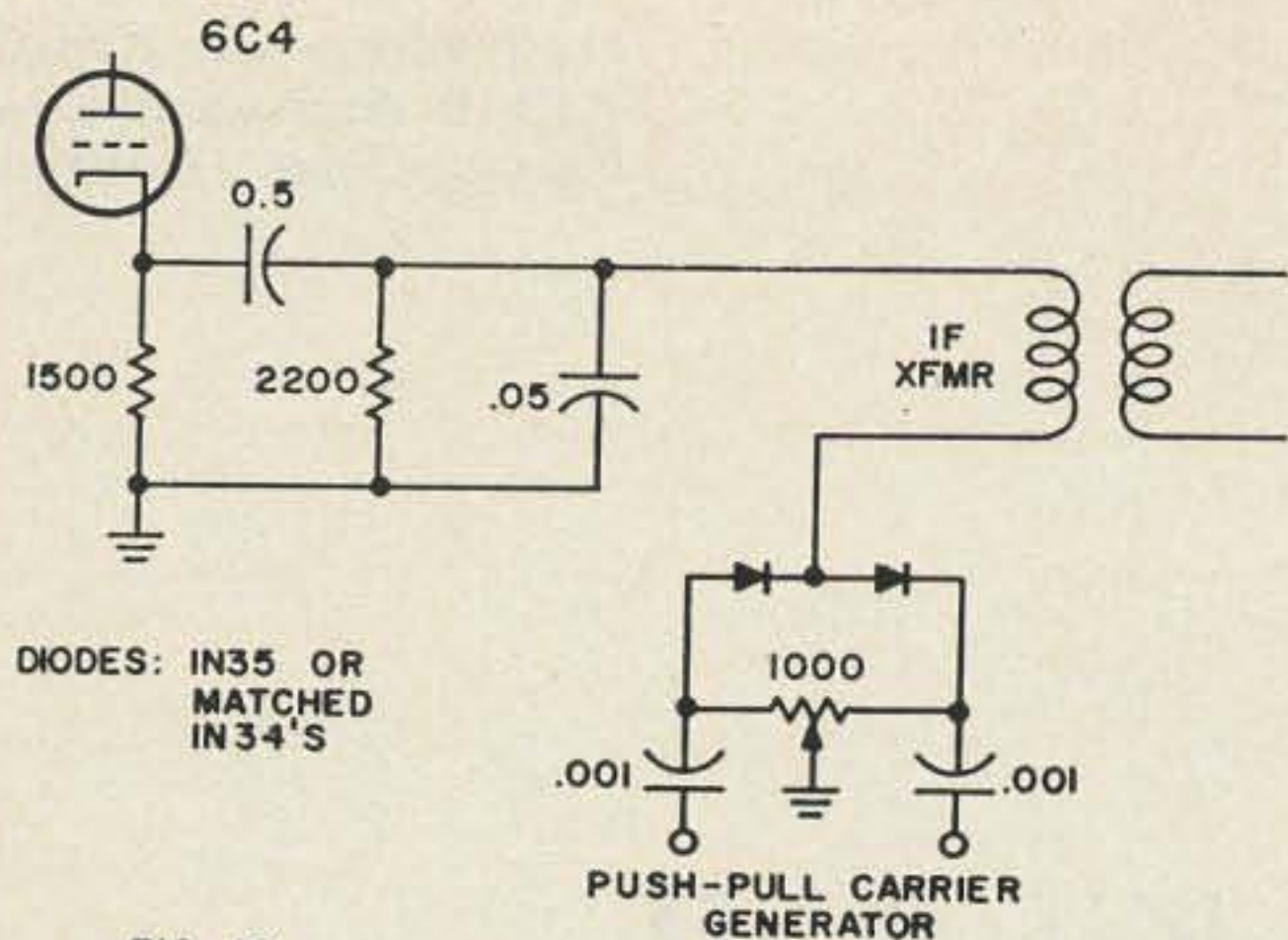

FIG. 10

tionally low; the original circuit used vacuum-tube diodes instead of semiconductors!

The major disadvantage of the series or shunt modulators is the requirement for push-pull carrier injection. In a filter-type exciter, this is no particular problem, and as a result these modulators are widely used in filter rigs. However, phasing becomes slightly more difficult with these circuits—so most phasing rigs end up using the modified ring circuit which allows single-ended carrier injection.

Up to now, we have simply discussed the circuits without much mention of their place in the overall scheme of sideband. Naturally, the major use of diode modulators is in generating the original set of sideband signals from audio and a carrier—and in all our descriptions we have taken this for granted.

But the balanced modulator has many other uses; it can be used anywhere you would use a mixer (mixing and modulation are two names for the same process) and frequently such use makes circuit design much simpler.

In a receiver, using a balanced modulator means you have one signal (the local oscillator) you don't have to worry about getting through the *if*. As a product detector, a balanced modulator eliminates any worries about overloading the audio section with the BFO injection.

However, diode balanced modulators are only half the story. Balanced modulators can be—and are—built with active devices such as tubes and transistors, also. Such active modulators offer a wider variety of subjects—and that's the subject of the next instalment.

#### BIBLIOGRAPHY

- American Radio Relay League, *Single Sideband for the Radio Amateur*, First and Second editions.
- Collins Radio Company, *Fundamentals of Single Side Band*, Second Edition (\$5, no more to be printed when present stock is exhausted as complete rewrite is in progress).
- Harry D. Hooton, W6YTH, *Single-Sideband Communications Handbook*, Howard Sams, Publisher, \$5.95.
- Don Stoner, W6TNS, *New Sideband Handbook*, Cowan Publishing Corp., \$3.

"Your Friendly Supplier"

OFFERS

THE LARGEST INVENTORY  
of USED EQUIPMENT in the  
NORTHEAST. SEE SAMPLES BELOW.

Collins 32V1	\$189.95
Collins 32V2	249.00
Collins KWS-1 W/Station Control	1100.00
Gonset G-28 10 Meter Communicator	179.00
Gonset GSB-101	259.00
Gonset 500-W R.F. Power Amplifier	169.00
Hallicrafters SX-71	135.95
Hallicrafters SX-96	154.95
Hallicrafters SX-100	199.00
Hallicrafters SX-101 Mk 1A	239.00
Hallicrafters SX-101 Mk III	264.00
Hammarlund HQ-110	189.95
Hammarlund HQ-110C with Clock	194.95
Johnson Courier	174.95
Johnson Pacemaker	255.00
National NC-98	89.95

"MAY SPECIAL"

National NC-300 \$224.95

WRITE FOR LATEST COMPLETE LIST

**Evans RADIO**

P.O. BOX 312 FONE 603-22-53358 CONCORD, N. H.

**2 ANTENNAS IN 1**

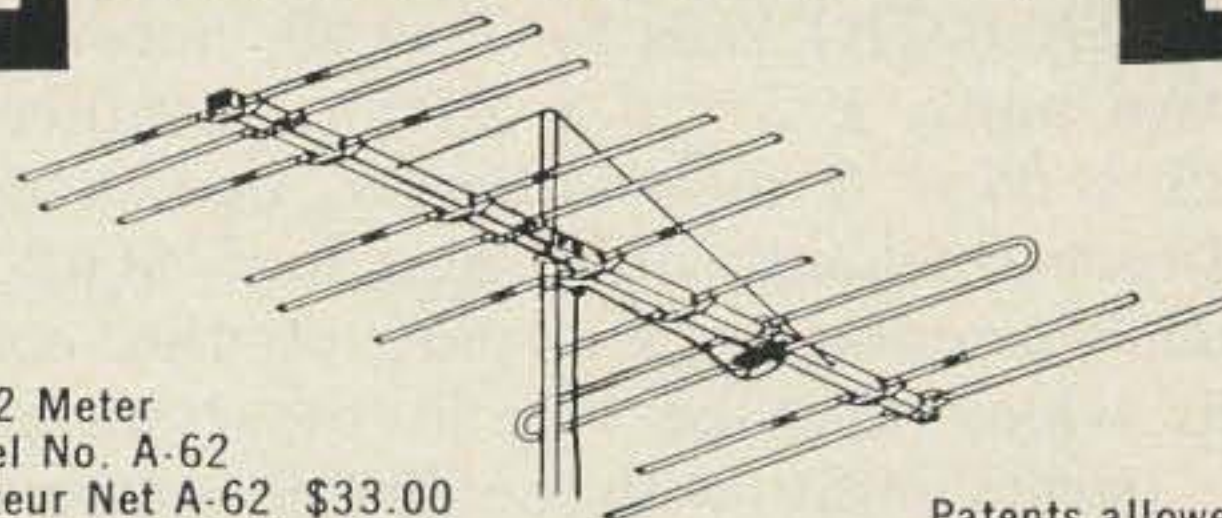

6 & 2 Meter  
Model No. A-62  
Amateur Net A-62 \$33.00  
Stacking Kit AS-62 \$2.19

Patents allowed  
and pending

The Only Single Feed Line  
6 and 2 METER  
COMBINATION YAGI ANTENNA

another first from **FINCO**®

#### ON 2 METERS

- 18 Elements
- 1 — Folded Dipole Plus  
Special Phasing Stub
- 1 — 3 Element Colinear Reflector
- 4 — 3 Element Colinear Directors

#### ON 6 METERS

- Full 4 Elements
- 1 — Folded Dipole
- 1 — Reflector
- 2 — Directors

See your FINCO Distributor  
or write for Catalog 20-226

**THE FINNEY COMPANY**

Dept. 20

Bedford, Ohio

## 73 Tests

# the Knight-Kit P-2

## SWR/Power Meter

Standing wave ratio is a subject of discussion and controversy on the amateur airwaves, and is of special concern to those limited in transmitter power. Like the weather, everyone talks about swr, but no one seems to know much about it! However, Allied Radio (100 N. Western Ave., Chicago 80, Illinois) has just made a new Knight-Kit available which is bound to stir up the curiosity of newcomers and old-timers alike regarding swr.

The P-2 SWR/Power Meter Kit (Catalog # 83 YX 627R) sells for \$14.95, and consists of two units, a 2 x 5 x 2½ inch coupler and a 2¾ x 6¼ x 3 inch indicator, connected by a 4-foot shielded cable. Standard SO-239 rf coaxial receptacles are part of the coupler unit, which may be left in the transmission line permanently with negligible power loss.

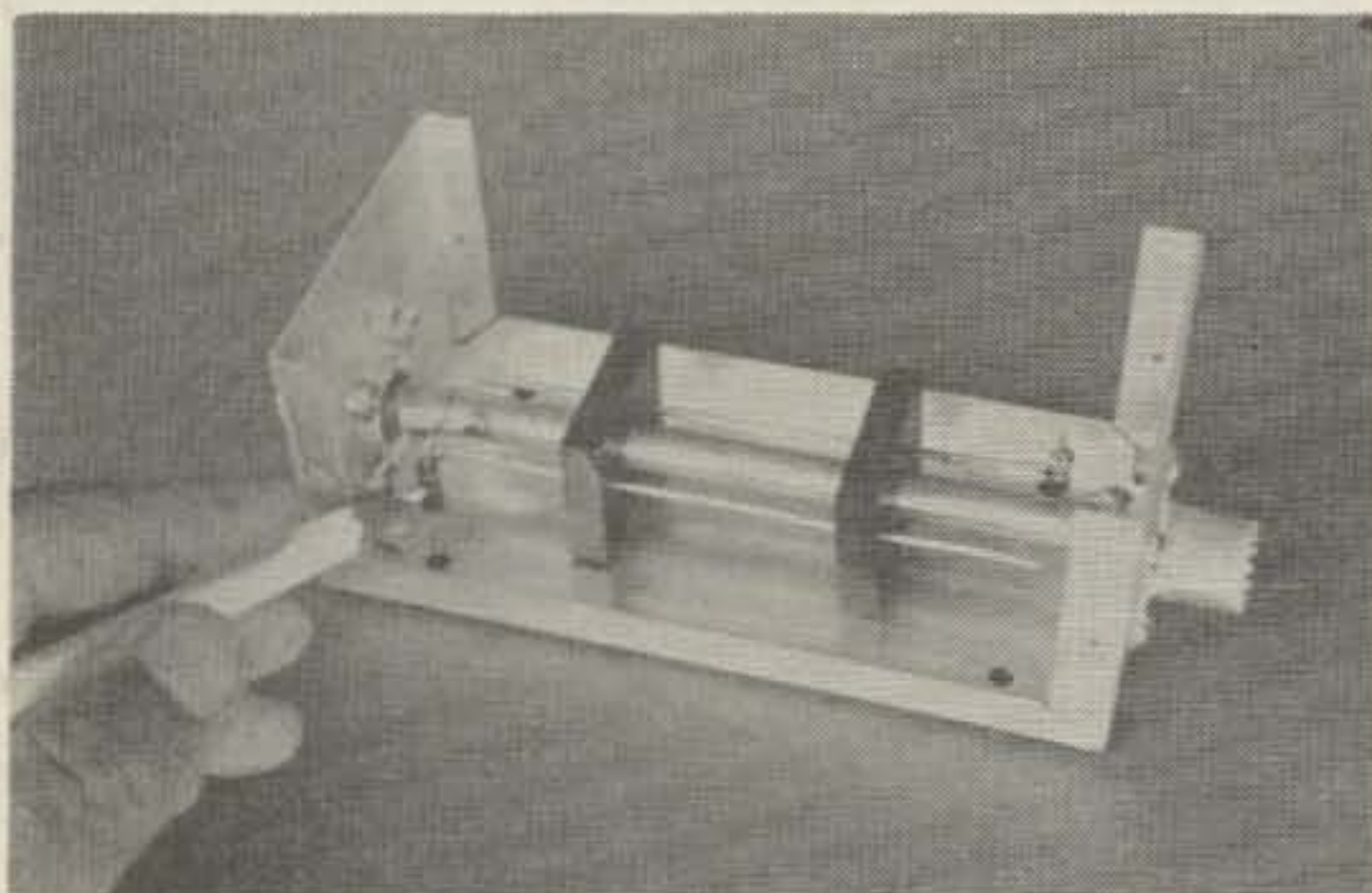

The "coupler" is built in a separate enclosure, with standard coaxial connectors to allow convenient attachment to the transmission line.

The resistor value used depends on the impedance value of the transmission line with which the coupler is to be used.

The coupler may be assembled for use with either 52 or 72 ohm coaxial transmission line, and may be used from 3.5 to 432 megacycles. No external ac power or batteries are required for its operation. It will handle a kilowatt of rf power, yet requires less than a watt at 432 mc for a full scale reading of the 100 micro-amp meter in the indicator unit. Unfortunately, the red and black meter scales are on a gray background (to match the unit two-tone gray color scheme); a white meter background would enhance visibility in subdued lighting, since the meter is not illuminated.

Assembly of the units is very clearly shown in the detailed assembly manual and the photos accompanying this article. No real problems were encountered in the construction, which takes about 1½ hours if done carefully, as it should be. The author's unit worked perfectly when completed, and no adjustments were required.

During construction of the indicator unit, it would be wise to mount the knobs on the power switch and sensitivity potentiometer shafts right after placing the meter dress panel on the meter sub-panel. This makes it much easier to handle the panel as it is being installed in its case. The black sheet metal screws used to hold the rubber mounting feet are rather brittle, and should be installed without too much "brute force" to avoid breaking the tips of the screws. Also, avoid over-tightening these screws, or they will go *through* the rubber feet; just tighten until the feet are snug, or use a flat washer under the head of each screw.

When assembling the coupler, the place-

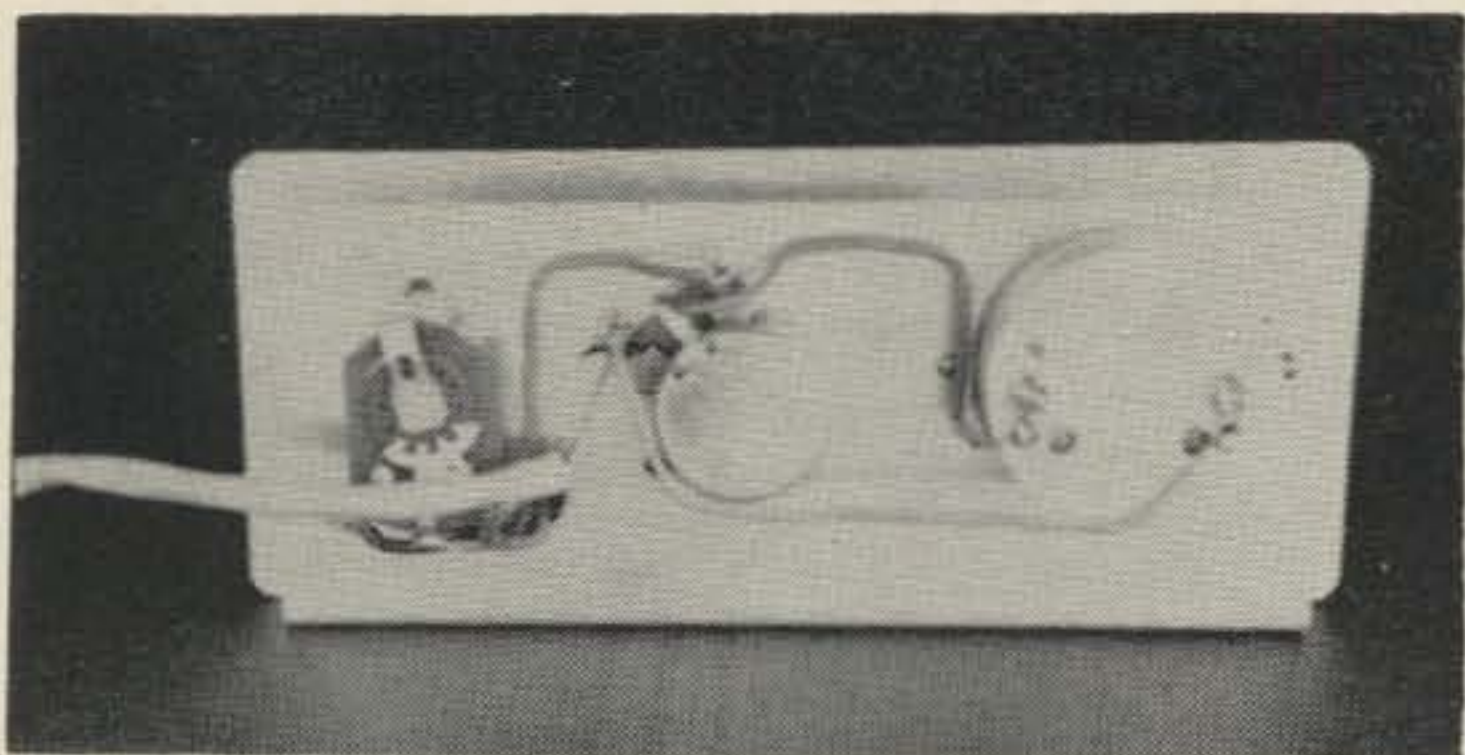

The complete wiring of the indicator sub-panel involves only a few wires, and a 2-conductor shielded cable which goes to the coupler unit.

ment of several of the parts is critical, and the instructions should be followed closely. Two sets of resistors are supplied with the unit. If you intend to use the coupler with 52 ohm transmission line use the 160 ohm resistors; for 72 ohm line, use the 100 ohm resistors. If the parts tend to shift during handling, use pencil marks on the copper rod and chassis to allow you to return the parts to the proper location when ready to solder. The coupler has no markings on it, and it would be wise to mark J1 XMTR on the end with the connecting cable, and J2 ANT on the other end.

The schematic diagram of the P-2 SWR Meter is shown in Fig. 1. The design of the instrument follows that of the time-proven and justly popular Monimatch of QST and ARRL Handbook fame. This instrument, sometimes known as a reflectometer, consists of a short section of coaxial transmission line with two pickup loops which are connected to rf voltmeter circuits. One of these circuits is so positioned with respect to the center conductor of the transmission line section as to read the incident or forward power component of voltage in the line while the other reads the reflected component. In the P-2 instrument, the circuit associated with diode CR-1 is the forward power voltmeter and the circuit associated with CR-2 is the reflected power voltmeter. Resistors R-1 and R-2 must be adjusted to match the characteristic impedance of the line being measured to balance out the undesired voltage component. In use, the instrument is switched

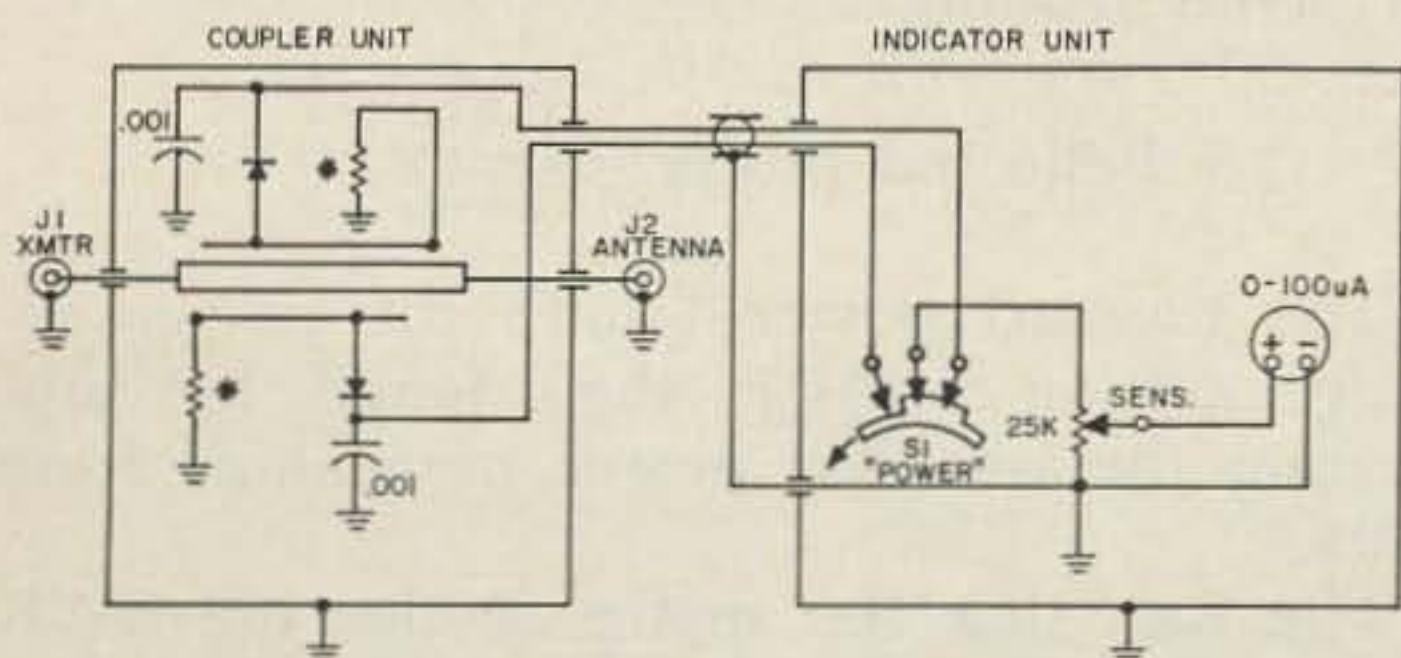

FIGURE 1

## GENERALIZE YOURSELF! LEARN RADIO CODE

### The EASY WAY

No Books To Read—No Visual Gimmicks To Distract You. Just listen and learn

Based on modern psychological techniques — This course will take you beyond 13 w.p.m. in LESS THAN 1/2 THE TIME

Available also on magnetic tape

See Your Dealer Now!

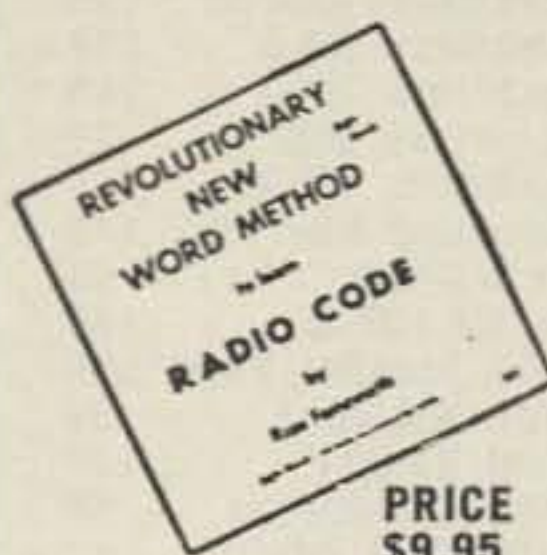

PRICE \$9.95

Album Contains Three 12" LP's 2 1/2 Hr. Instruction

## Life Story of Nikola Tesla

Now, learn code and something else at the same time. Fascinating story and code practice at same time. \$2.49



EPSILON RECORDS

2769 CAROLINA  
REDWOOD CITY, CALIF.

## 2 METER CONVERTER

Now at last a 2 meter converter complete with 3 VHF transistors and crystal for output in the 6 meter band. Operates on 12 V. D.C. A real bargain, for only \$10.00 while supply lasts.

For output in other bands use this with our 6 meter converter advertised in 73.

VANGUARD ELECTRONIC LABS Dept. H-5  
190-48-99th Ave. Hollis 23, N. Y.

## CALAMAR Electronics Co.

K6HYU  
WA6HYU

COLLINS, HAMMARLUND, MOSLEY,  
SWAN, SIDEBAND ENGINEERING,  
NATIONAL, GONSET

2163A FULTON AVE, SACRAMENTO, CAL.

## NEW! GROUND RADIAL SYSTEM KITS

Take the work out of fabricating your antenna ground system

Here are ground radial systems for getting improved performance from long-wire, vertical and other "HAM" and "SWL" antennas which are operated against ground. These radial systems will also improve the efficiency of ungrounded antennas such as doublets, zepps and directive arrays reducing the losses resulting from ground imperfections. Excellent as permanent or temporary ("Field Day") installations. Complete, ready to roll out radial systems in two sizes to satisfy most "HAM" and "SWL" requirements. Uses No. 14 gauge solid copper radial wires electrically and mechanically bonded to central hub. Drive pegs are provided for securing radial wire ends. Just locate center hub where you want it, roll out the radials and you're in business. Radials can be easily buried to preserve the beauty of your front or back yard lawn. Full instructions in kit. Send for free antenna ground system fact sheet.

1,000 FOOT KIT (10-60', 8-33', 8-17' RADIALS) . . . \$24.95

2,000 FOOT KIT (20-60', 16-33', 16-17' RADIALS) . . \$42.95

Send only \$5.00 (cash, ck., M. O.) and pay balance COD plus express or postage charges on arrival or send full price for prepaid delivery.

Ready-Radials

P. O. Box 5496  
Winston-Salem, N. C.

## FANTASTIC BARGAINS ON RECONDITIONED EQUIPMENT!

Central Electronics 20-A	\$149	Hallicrafter S-53A	59
Central Electronics MM-2	89	Hallicrafters SX-100	195
Central Electronics MM-1	75	Hallicrafters HA-6	249
Central Electronics 600L	249	Hallicrafters HA-2	249
Collins KWM-2	895	Hallicrafters P26	79
Collins 75A-4	495	Hallicrafters HT-37	375
Collins 312B-2	89	Hammarlund HQ-110	179
Drake 1A receiver	149	Heath DX-100	159
Eico 723	55	Heath DX-100-B	169
Elmac AF-67	89	Johnson Invader 2000	895
Elmac PMR-7	99	Johnson Viking I	99
Elmac A54H	44	Johnson Ranger	179
Elmac PMR6A & Elmac PSR116S	59	Johnson Challenger	89
Elmac M-1470	39	Johnson 500 excint cond	499
Globe Champ 300A	225	Johnson Valiant	299
Globe King 500A	279	Johnson 250-23-3	65
Globe Scout 680A	59	Mosley CM-1	150
Globe 755 VFO	29	National NC-300	239
Gonset GSB-101	229	P&H 6-150 6 mtr. xmtng converter	189
Gonset Communicator I 6 mtr	89	RME VHF-152A	45
Hallicrafter SX-101A	299	RME 84 receiver	49
Hallicrafter SX-111	189	Swan SW-120	199
Hallicrafter HT-40	79	Tecraft TR-20-50	39
		Tecraft PTR-2 supply (new)	30
		Tecraft TR-20-144 (new)	45

Box  
37A

**Burghardt**  
RADIO SUPPLY, Inc.

Phone  
886  
5749

Ask for our new equipment catalog #163 just out. Also our latest used gear bulletin, revised monthly.

WATERTOWN, SOUTH DAKOTA

## SEMI-CONDUCTOR SALE!

NO CHANCE TO TEST 'EM! FULLY GUARANTEED!

- ( ) 20 Amp Power Rect. Stud, Silicon \$1
- ( ) 15 Silicon Diodes, 'Epoxy' \$1
- ( ) 20 Top Hat Rects. to 750 ma, silicon \$1
- ( ) 15 PNP Transistors, asst types \$
- ( ) 15 NPN Transistors, asst types \$
- ( ) 10 Surface Barrier Trans't'rs, pnp \$
- ( ) 5 Power Transistors, 2N155 case \$1
- ( ) 2 40W Power Transistors, 2N174 case \$1
- ( ) 10 2-Amp Rects, stud, silicon \$1
- ( ) 25 Rect, Trans't'rs, Diodes, asst \$1
- ( ) 15 CK722 Type Transistors, pnp \$
- ( ) 10 Transistors, 5 pnp, 5 npn \$
- ( ) 25 Silicon Germanium Diodes \$
- FACTORY TESTED! GUARANTEED!
- ( ) 1 Watt Zener, choose 3 to 30V \$
- ( ) 25 Amp Trans't'rs, Car Ignition \$
- ( ) 30 'Klip-in' Diodes, Germanium \$1
- ( ) 15 IN34 Diodes, Glass, Submini \$
- ( ) 4 2N35 Type Trans't'rs, npn \$
- ( ) 4 2N107 Type Trans't'rs, pnp \$
- ( ) 3 2N170 RF, OSC Trans't'rs, npn \$1
- ( ) 6 2N377 Transistors, npn \$

**FREE!**

**WE  
PAY  
THE  
POSTAGE**

( ) CAR IGNITION BASIC  
incl: 2N174,  
zeners, rect,  
sink, instruc-  
tions \$7.99

**POLY PAKS**

P. O. Box 942A  
S. Lynnfield, Mass.

Send 10c  
for parts  
catalog!

## SKYLANE QUADS

"famous the world over!"

**\$59.95** Three Bands **\$99.95**

Bamboo 40 M QUAD KITS AVAILABLE Fiberglass

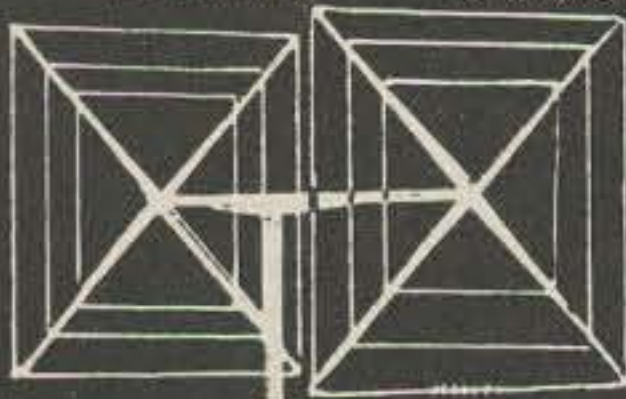

FOR FREE LITERATURE  
WRITE DEPT. C

- HIGH F/B RATIO
- VERY LOW SWR
- HIGH GAIN
- LOW Q - BROADLY TUNED
- EASY TO MATCH
- LOW WIND RESISTANCE
- RUGGED CONSTRUCTION

**SkyLane** PRODUCTS 406 BON AIR DR.  
TEMPLE TERRACE, FLA.

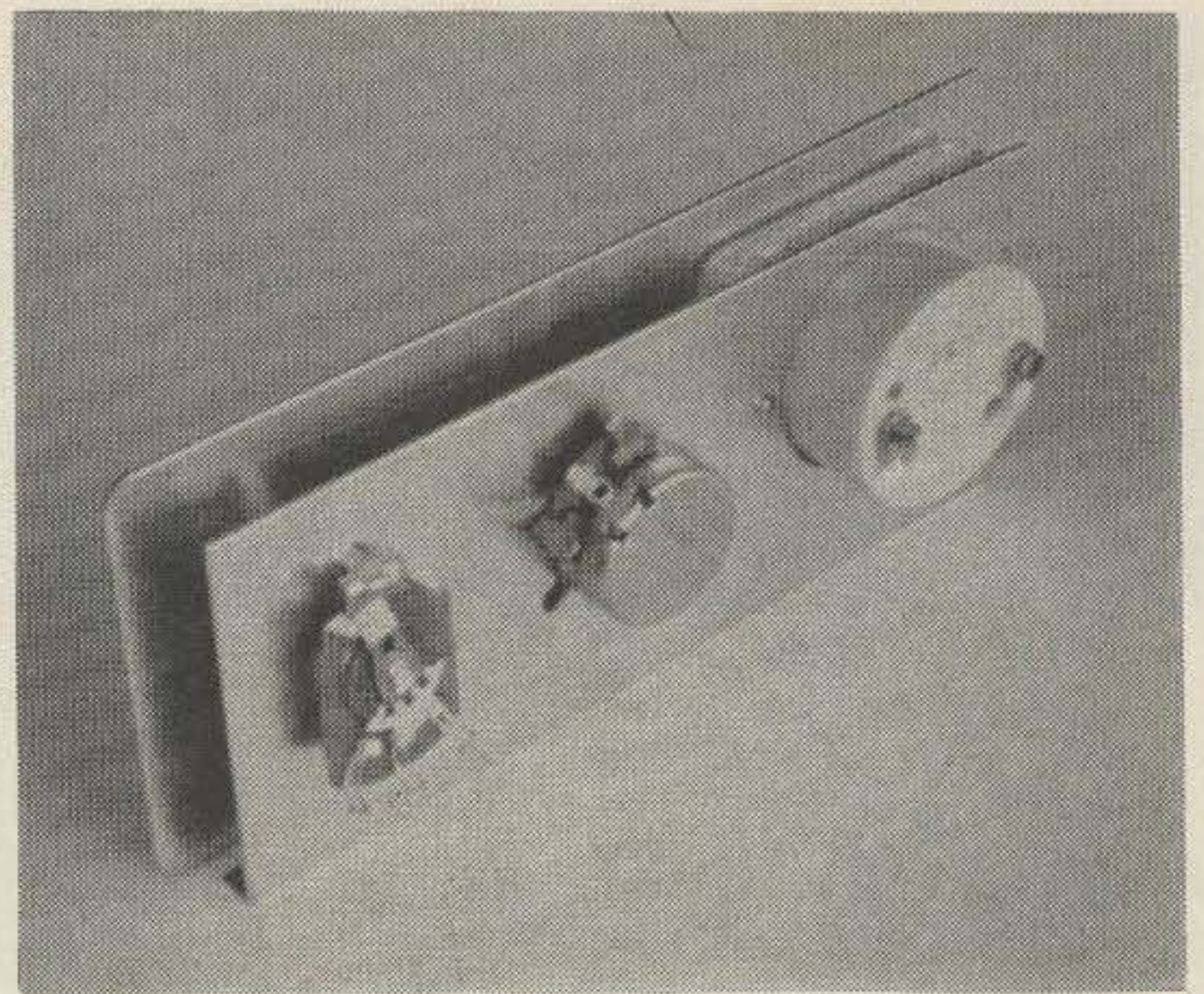

The indicator unit contains a sub-panel to hold the meter, switch and pot, with a "dress" panel for the nomenclature.

to the forward power position and the sensitivity control adjusted for full scale meter deflection. The instrument is then switched to the reflected power position and the existing standing wave ratio read directly from the meter scale.

In use, the J1 receptacle of the coupler is connected to the transmitter output connector (using a jumper cable or a double-male connector) and J2 goes to the transmission line feeding the antenna. The transmitter is turned on and tuned in the normal manner, with the sensitivity control on the indicator unit positioned to keep the meter on scale. (The swr meter Power switch must be in the Forward position. You can peak your transmitter output very conveniently by tuning for maximum deflection of the swr meter). Adjust the sensitivity control, once you are tuned up, so the meter reads CAL. (full scale). Now switch the Power switch to Reflected, and read the swr directly on the meter top scale. Although the operating instructions fail to mention it, the REL. POWER scale of the meter, if multiplied by 10, reads the percentage of reflected power! Notice that only 11% power is reflected at an SWR of 2.0, and 25% is reflected at SWR of 3.0. You may calculate the reflected power percentage quite simply from the SWR reading:

$$\% \text{ Reflected power} = \left( \frac{\text{swr}-1}{\text{swr}+1} \right)^2$$

The forward power (that's the power actually getting out) is then found by subtracting the reflected power percentage from 100%.

The fact that the meter of the P-2 SWR Meter is calibrated in relative power deserves

some explanation. The reflectometer type of SWR meter is quite dependent on frequency for any given output indication. Note that 45 watts is required for full scale deflection at 1.8 mc while only ½ watt is required for full scale deflection at 432 mc. This ratio is perfectly normal for this type of meter. However, it prevents the inclusion of absolute power scales in an all band instrument. Despite this, the relative power scale is quite convenient for transmitter tuning, etc.

The calibration of the completed unit may be checked several ways. The instructions go through an alignment procedure which requires a non-reactive dummy load. At the higher frequencies and for high power this might pose a problem. A simple way to make a quick check is to *reverse* the coupler in the transmission line, connecting J2 to the transmitter output, and J1 to the transmission line. Now set CAL on the meter with the Power switch in the Reflected position, and read swr in the Forward position. If the same swr is obtained as using the coupler the correct way, the unit is well balanced. If not, the position of the diode connections to the pick-up wires in the coupler must be adjusted slightly, as described in the manual. The author's unit required no adjustments.

Be careful about quoting your swr readings with too much certainty. You see, it just so happens that the swr read at the transmitter is *always lower* than the actual swr at the transmitter. The reason is simple: the forward power is attenuated on its way to the antenna by line loss, and the power reflected at the antenna is also attenuated by the transmission line on its way back to the transmitter. Therefore, the percentage of reflected power reaching the swr meter is less than it should be, compared to the outgoing forward power.

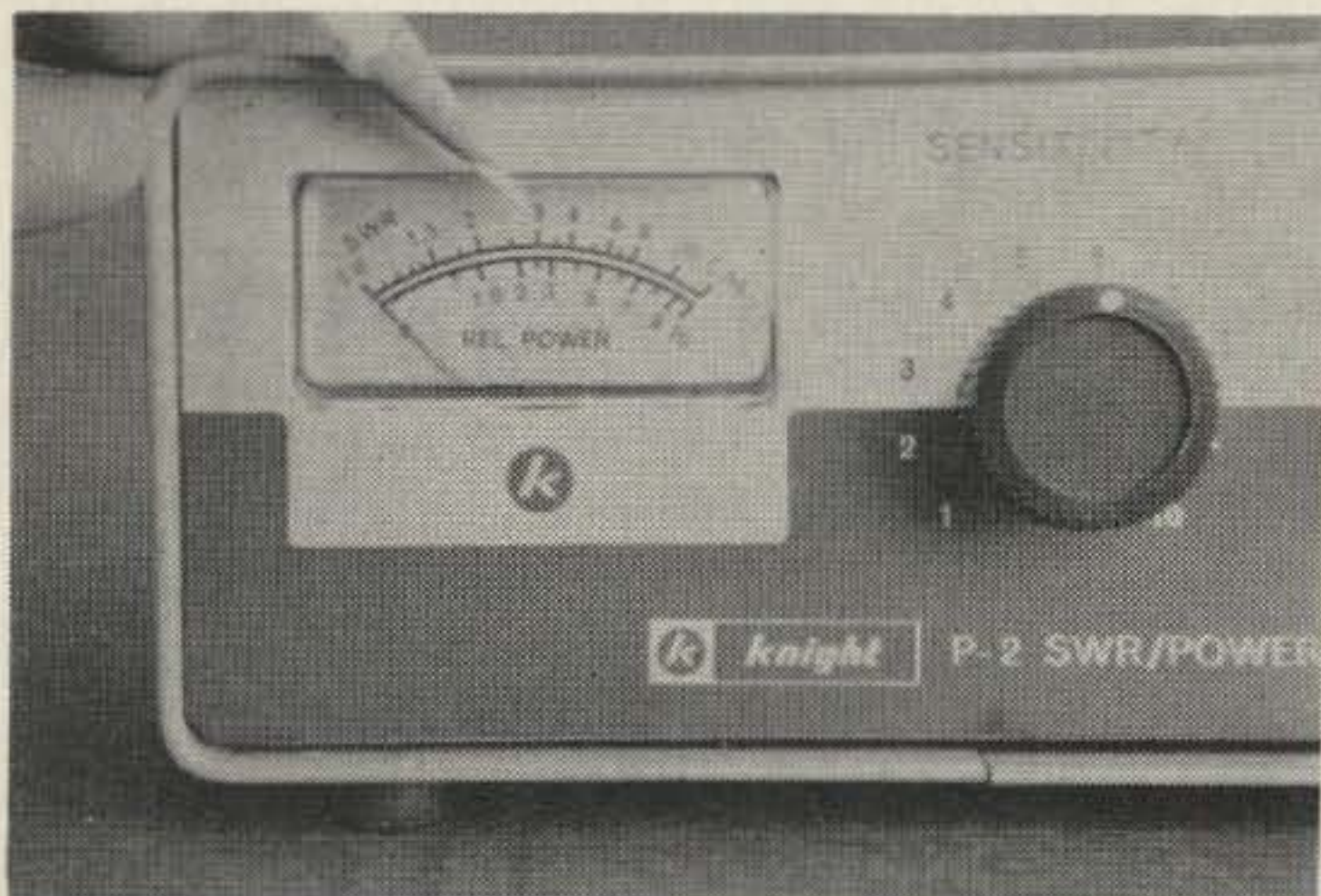

The meter is calibrated to SWR of 20. The lower scale, multiplied by 10, reads percent reflected power. For example, at SWR of 3, 25% power is reflected from the load.

## CONVERTER SALE

6 meter converter \$8.00 postpaid. Complete with 3 high frequency transistors and 49.4 mc. crystal for output in broadcast band or 36 mc. crystal for output in 14-18 mc. band. Low noise and better than 1 microvolt sensitivity. Operates on 6-12 V D.C.

Limited quantity—send your order today.

VANGUARD ELECTRONIC LABS Dept. H-5  
190-48-99th Ave. Hollis 23, N. Y.

### IMPROVED VHF—UHF RESULTS

J Beam Skeleton Slots for 50-144-220-432 Mc.  
Tremendous results at moderate costs.

#### Specials

300 to 52 ohm waterproof baluns—83 connectors 50-54 megacycles  
\$10.75; 144-148 megacycles \$8.60

RG8U Name Brand Polyfoam Insulated cable ..... ft. .13

#### FOR THE DX BOYS

G4ZU Minibeams 10-15-20 A low, low ..... \$74.95

#### BE PROUD OF YOUR SIGNAL

GAIN, Inc., Dept. 73-5, 1209 West 74,  
Chicago 36 — Ph.: 874 2610

## TV CAMERA

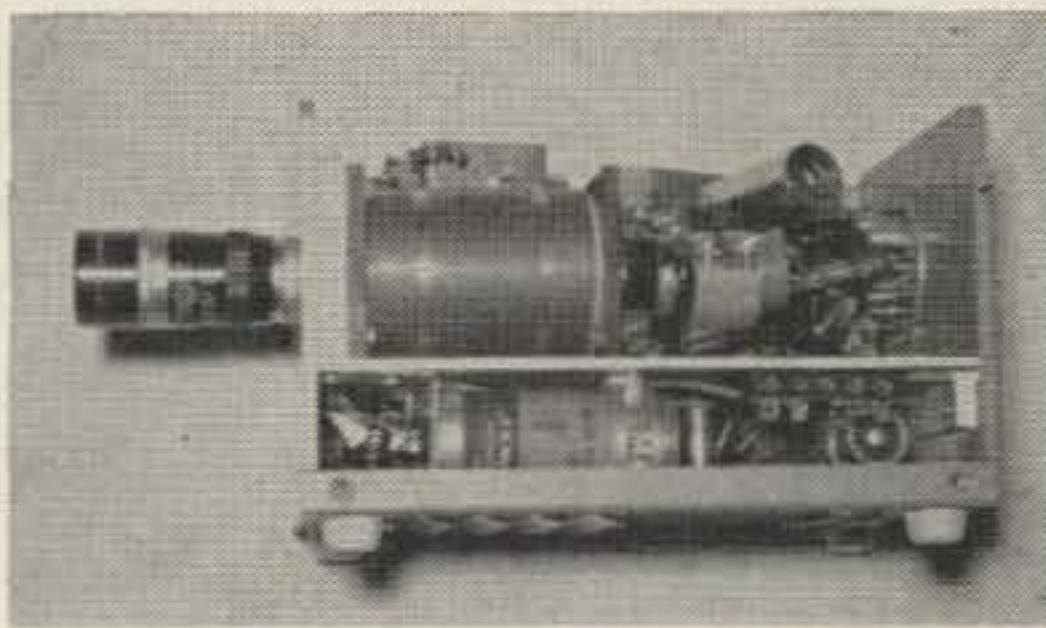

\$99.50

and up

Basic  
Parts  
Kit

Details—FREE List #771

DENSON ELECTRONICS CORP.

Rockville, Connecticut

## FREE Catalog

OF THE WORLD'S FINEST  
ELECTRONIC GOV'T  
SURPLUS BARGAINS



#### HUNDREDS OF TOP QUALITY

ITEMS—Receivers, Transmitters, Microphones, Inverters, Power Supplies, Meters, Phones, Antennas, Indicators, Filters, Transformers, Amplifiers, Headsets, Converters, Control Boxes, Dynamotors, Test Equipment, Motors, Blowers, Cable, Keyers, Chokes, Handsets, Switches, etc., etc. Send for Free Catalog—Dept. 73.

FAIR RADIO SALES  
2133 ELIDA RD. • Box 1105 • LIMA, OHIO

## LOOK!

BC-221 Freq Meter with orig. calib. book and xtal, lab checked out, XLNT cond. .... \$69.50

Crystal Oven—Bliley crystal stabilizer, type TCO-1 for 1HC/6 crystal. Requires 6.3v at 0.85 a, 1¼" dia. x 1½" octal plug in base. BRAND NEW ..... \$2.75

85 kc if Transformers—spares for ARC-12. Same as BC-453 with ceramic base & air trimmers except higher "Q" & different base pins. BRAND NEW 79c ea, 3/\$2.25

RF Crystal Probes—for VOM with Klipzon tips, made by General Cement. List \$4.35, BRAND NEW in cello. bag ..... \$1.25

Super Midget Relay—P&B SM-50S. Herm. sealed plug-in, fit 7 pin min. tube socket, SPDT, 250 ma contacts. Coil 6 vdc, 80 ohms ..... \$1.25

ART-13 Calib. Crystals. 200 kc. herm. sealed w/octal plug-in base ..... \$1.50

Write for Bulletin #38 "Loads of Bargains"

R. W. Electronics, Inc.

2430 South Michigan Ave. Dept. 735 Chicago 16, Illinois  
Phone: CAlumet 5-1281

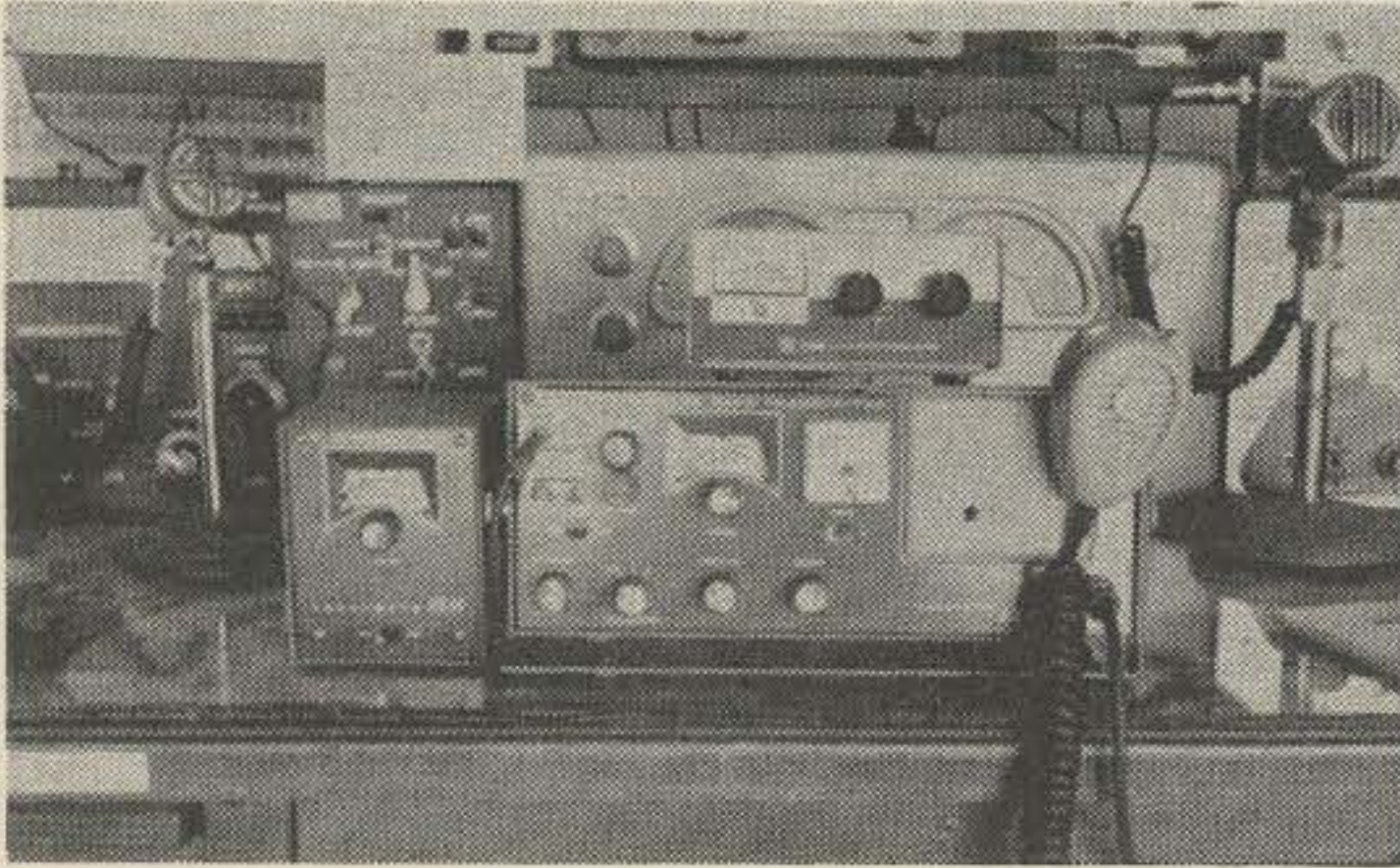

A typical "neat" station!

Since the swr meter is usually located at the transmitter, this variation can be considerable. Look at Fig. 2 for a shock. If the basic transmission line loss (at swr of 1.0) is 6 db, and the swr at the antenna is 4.0, the swr meter will only read 1.37. You can estimate your basic line loss from tables that list the loss per 100 feet for different types of transmission line at various frequencies; the *Radio Amateur's Handbook* has this information in a graph in the transmission line section.

Swr has a couple of other villainous features: it increases your transmission line loss, and lowers the power limitation of the transmission line. Fig. 3 shows the added loss to a transmission line due to swr. For example, if the line loss at swr of 1.0 is 6 db, but the actual swr at the antenna is 2.5, the line loss will be increased by another .79 db. At higher swr this effect can be a lot worse; at swr of 10, with a basic line loss of 6 db, the

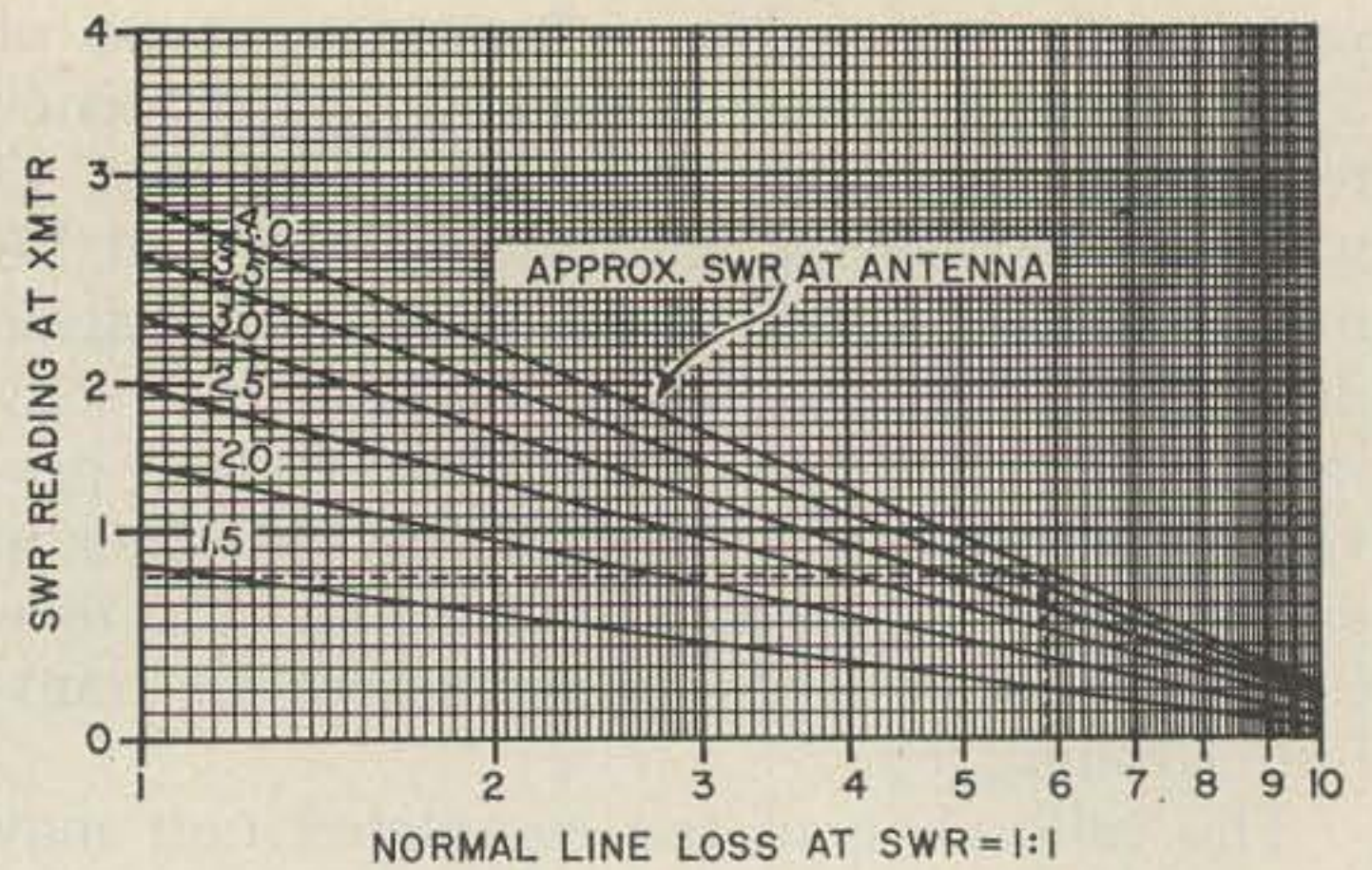

FIGURE 2

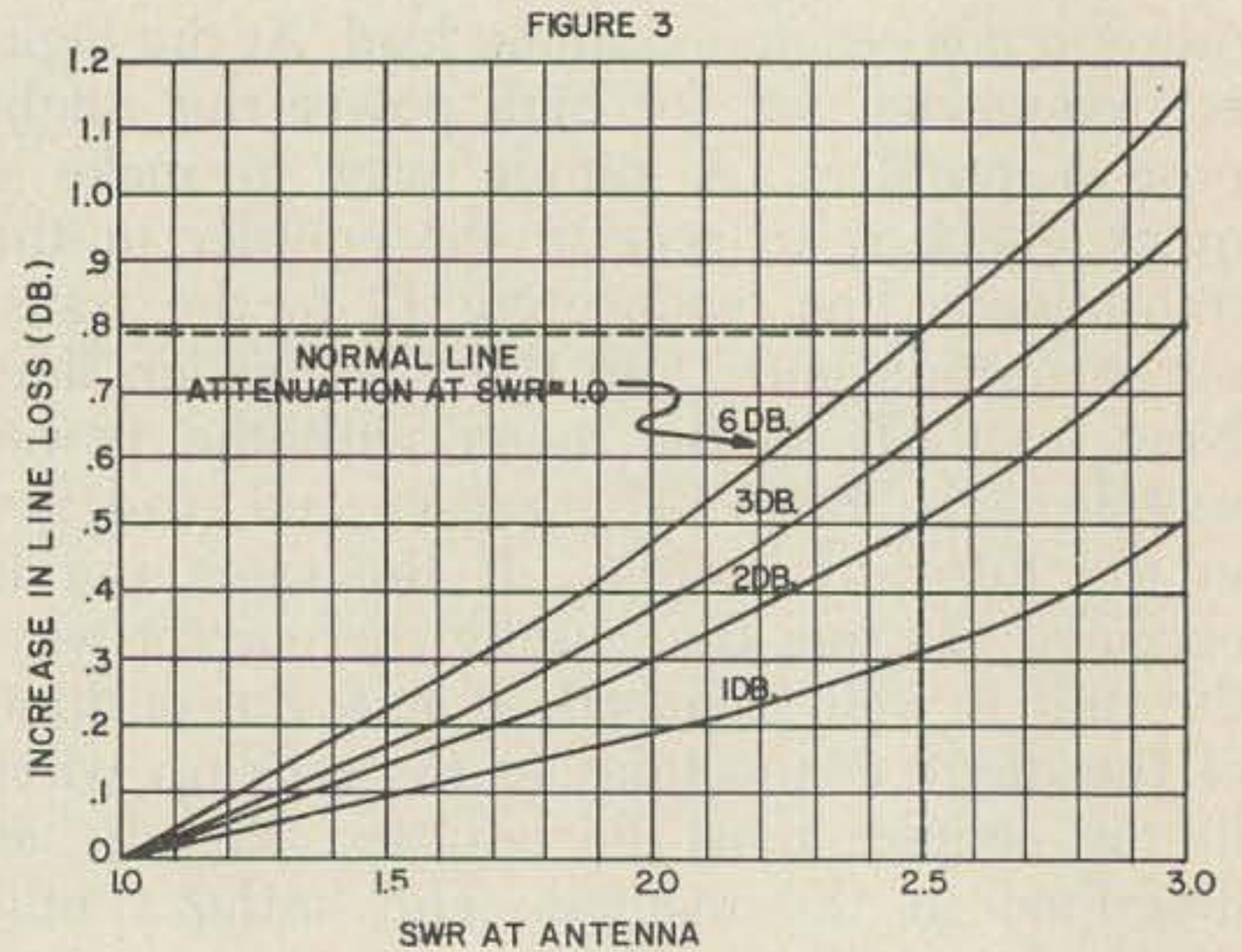

FIGURE 3

increase in loss will be 4.5 db. As for the power limitation, caused by the increased peak voltages of the standing waves, the allowable power is equal to the rated power (at swr of 1.0) divided by the swr:

$$\text{Allowable power} = \left( \frac{\text{Rated power}}{\text{SWR}} \right)$$

Generally speaking, unless you have high transmission line losses to begin with, an swr of 3.0 or less will make very little difference at the receiving end. Remember, one S unit is 6 db. at the receiver. But it all makes for good conversation on the air.

### Specifications of the Knight-Kit P-2 SWR/Power Meter

<b>Minimum rf power for full scale deflection</b>	45 watts at 1.8 mc 1/2 watt at 432 mc
<b>Maximum rf power</b>	1 kilowatt
<b>Input and output impedance</b>	52 or 72 ohms
<b>Power requirements</b>	none
<b>Frequency coverage</b>	1.8 to 432 mc
<b>Meter sensitivity</b>	100 microamperes full scale
<b>Meter scales, standing wave ratio</b>	1:1 to 20:1
<b>Relative power</b>	0 to 10
<b>Kit assembly time</b>	1 to 2 hours
<b>Cost</b>	\$14.95 in kit form

## REPEAT-Best Sellers in 73

NUVISTORS — price includes postage and insurance.

6CW4 or 6DS4 Triodes choice, any 3 \$5.25

7587, industrial tetrode, \$3.65; 3 for \$10.50

3 sockets, with order of 3 nuvistors 50c

1625 tubes, Syl. NU, RCA, Ken-Rad or Tung-Sol

BRAND NEW, minimum mail order 12 for \$2.00

902P-1, 2" CRT \$3.00; 6DQ5 \$1.75; 6DQ6B \$1.00;

3B28 \$3.25; 807 \$1.00; 5933 \$1.85; 837 \$1.50;

6146 \$3.00; 6AN5 \$1.00; 5T4 60c; 1616 \$1.00.

MD7/ARC-5, plate modulator, ex., used \$5.50

85 KC IF, for BC-453, \$1.00 ea.; 3 for \$2.75

85 KC IF, later type, ceramic form, male plugs, higher "Q", \$1.25; 3/\$3.50

"GOODIE" sheet free with orders only. Flyer only, please send self addressed, stamped envelope. PLEASE include sufficient for postage & insurance. Excess returned.

SAVE YOUR LOOT, I'll be at

Rochester, N. Y. May 11

Breezshooters hamfest, near Pittsburgh May 26

Starved Rock, near Ottawa, Ill. June 2

### BC ELECTRONICS

2333 S. MICHIGAN AVE.

CHICAGO 16, ILL. CALumet 5-2235

(NSD/1 from page 57)

got the QSL Club was this: "It is not permissible for two or more persons . . . to establish a system . . . to reduce the amount of postage they pay, by assorting, grouping and mailing in one envelope their . . . letters to be forwarded to one customer . . ." This means that it is illegal for a person or group to receive bulk mailed QSL's, sort them out and remail them in groups to the addressees. This is terrible.

How come our government is blasting away at monopolies wherever possible in business and yet chooses not to practice what it preaches. It seems to me that some competition could do the P.O. a lot of good. If they had to automate to keep business going they would soon be able to give us service on the order of that which you get in Europe . . . and they make our service look sick.

### Boy Out Back

Last month, in a burst of enthusiasm, CQ's publisher opined that they actually have more active hams reading CQ than QST. Since we only have their hilarious "sworn statement" to go by . . . their true print run and circulation are closely guarded secrets . . . we have to figure out what is going on by other indications.

For instance I judge by little things such as the dropping number of ads, the tremendous falling off of mail-order advertising which is a sure indication of the effectiveness of a magazine, the inability to continue providing the half-cent wrapper for subscriber copies, the cutting down for the first time in years from 128 pages to 112 pages, the use of the cheapest paper I've seen yet in a ham magazine, the loneliness at CQ booths at conventions, and leaks from members of the CQ staff.

Putting all this together with candid comments by advertisers who have compared results recently between the two magazines I come to the conclusion that QST must have about 2.3 times the circulation of CQ.

### K2CM Absolved

Tom McCann K2CM thought I went a little too far in rewriting his review of the Waters Coaxial Switches in the April issue and wants everyone to know that this piece, which he calls "the most inept piece of writing which throughout that I have ever read on a printed page" was written by me and not him.

. . . W2NSD/1

### FREQUENCY-METER BARGAINS

Navy LM, .125-20 mc w/matching book, xtl, **\$57.50**  
schematic, instruct., 100% grtd  
AC Pwr for LM: Modify new EAO, w/LM plug, silicon diodes, instructions we furnish \$ 9.95  
TS-173 w/AC pwr sply, 90-450 mc, .005% \$150.00  
TS-174, 20-280 mc, .01% \$150.00  
Gen. Radio No. 620A, 10-3000 mc, .01% \$199.50  
TS-186, 0.1-10 KMC, .01%, xtl calib \$295.00  
Also C-Band & X-Band Cavity Freq. Meters. State needs.

### ARC-3 TECH MANUAL!

Handbook mainten., oper., theory, schem. **\$10.00**  
dwgs, etc. Postpaid

### 2-METER RECEIVER & 2/6/10 METER XMTR

SCR-522 revr, xmtr, rack & case, exc. cond. 19 tubes include 832A's. 100-156 mc AM. Satisfaction grtd. Sold at less than the tube cost in surplus. Shpg wt 85 lbs. Fob Bremerton, Wash. **\$14.95**  
Only

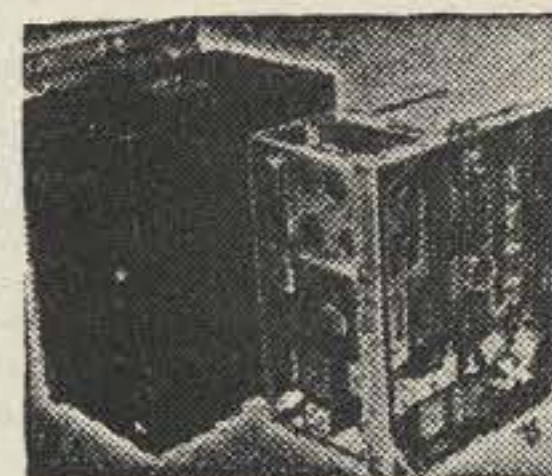

Add \$3.00 for complete technical data group including original schematics & parts lists, IF, xtl formulas, instruct. for AC pwr sply, for revr continuous tuning, for xmtr 2-meter use, & for putting xmtr on 6 & 10 meters.

### COMMUNICATIONS RECEIVER BARGAINS

BC453B: 190-550 kc 6-tube superhet w/85 kc IF's, ideal as long-wave revr, as tunable IF & as 2nd convert. W/all data. CHECKED ELECTRICALLY **\$12.95**  
Grtd. OK! 11 lbs. fob Los Angeles

Same, in handsome cabinet w/pwr sply. spkr. **\$37.50**  
etc., ready to use, is our QX-535, 19 lbs.

RBS: Navy's pride 2-20 mc 14-tube superhet has voice filter for low noise, ear-saving AGC, high sens. & select. IF is 1255 kc. Checked, aligned, w/pwr sply, cords, tech data, ready to use, fob Charleston, S. C. **\$69.50**  
or Los Angeles

R-45/ARR-7 brand new, 12-tube superhet .55-43 mc in 6 bands, S-meter, 455 kc IF's, xtl filter, 6 sel. positions, etc. Hot and complete, it can be made still better by double-converting into the BC-453 or QX-535. Pwr sply includes DC for the automatic tuning motor. **\$179.50**  
Fob San Antonio

Time Pay Plan: \$17.95 down, 11 x \$16.03  
With QX-535, \$21.70 down, 12 x \$17.90.

### RADIO RECEIVER AND/OR SPECTRUM STUDIES

R-54/APR-4 revr is the 11-tube 30 mc IF etc. for the plug-in tuning units; has S-meter, 60 cy pwr sply. Pan. Video & Audio outputs. AM. Checked, aligned, with heads for 38-1000 mc, pwr plug & Handbook, **\$164.00**  
fob Los Angeles

(Add \$30.00 for 60 cy AM/FM instead of AM.)

Write for price on TN's to get up to 4 kmc. and/or Panadaptors.

### SILICONS LESS THAN 13c!

Rectifier Package: 50 top-hats & 50 stud-mts. PIV's range from 50-600, currents 0.3-1.8 A dc. Rejected for Astronauts, unmarked, but large percentage OK for Earth People. You grade them with instructions we include. Guarantee: Grade them within 10 days; if you don't get enough value to delight you, return for refund. Be smart, do your own grading!  
100 Diodes, **\$12.95**  
POSTPAID

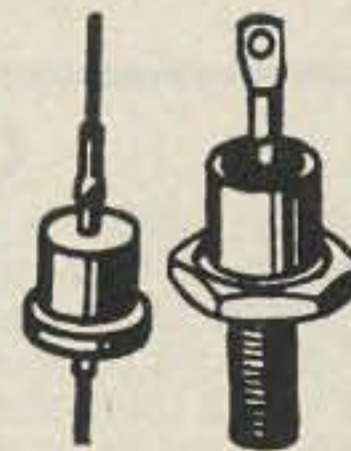

### 60 CY AC FROM 12 V DC... & VICE VERSA!

Combination transistorized Inverter & 12 v battery charger. Ideal for Boats, Camping, Field Trips, Autos. Plugs into 115 v 60 cy to charge battery at 8 amp rate, tapers to 2 amps. Switch to inverter and the 12v battery supplies 115 v 60 cy (sq wave) for lights, TV, radio, electric drills, etc., anything at all except capacitor-start motors. Thousands sold at double these prices to Automotive trade. This is new material, guaranteed OK, factory over-run, with Instruction Booklet.

250 W 2.3 amp int., 200 W 1.8 amp continuous. **\$57.50**  
15 lbs. net fob Los Angeles

500 W 4.0 amp int., 300 W 2.5 amp cont. Metered. Starts dead cars from 115 v line! **\$137.50**  
55 lbs.

(Intermittent use means 15 minutes total in any 1 hour.)

Write stating your specific needs in lab-type test equipment: Scopes, Signal Generators, Recorders, Tuning Forks, etc.

**R. E. GOODHEART CO., INC.**  
Box 1220-GC BEVERLY HILLS, CALIF.

SCR 522 Transceiver 2 meter or 2/6/10 on Trans. complete with tubes and 4 random crystals L/N	\$19.95
R4/ARR2 Versatile Receiver	New 4.95
T61/AXT2 420 MC Transmitter	New 15.95
BC 929 Scope	New 10.95
ID59/APAII Scope	L/N 14.95
BC 375 Transmitter (less T. U.)	Exc. 12.95
RM 52 Phone Patch	New 1.95
SA 325/U Coaxial Switch (See Aug. 73)	L/N 12.95
RTTY SSB Etc.—etc. Versatile Multimatch Transformer also phone patch	New .79
BC 433 B/C Band Rec. (400 cycle)	Exc. 9.95
Ni-Cad Batteries 1.2V	1.75
Blower AC-DC 12 V to 65 V	2.95
MD 7 Modulator	New 7.95—Used 5.95
BC 458 (T21) 5-7 MC	New 7.95—Used 4.95
BC 457 (T20) 4-5.3 MC	New 7.95—Used 4.95
T 18 2-3 MC	New 7.95—Used 4.95
BC 1206 200-400 KC Rec. Less Tubes	1.95
R28/ARC 5 VHF Receiver 100 to 156 mc	19.95
T47/ART 13 Transmitter complete w/tubes	47.50
Crystals Send self addressed envelope for list	
Beam Filter or lazy man's Q-5'er	1.95
Antenna Wire Copper weld #14-2200ft coil	7.50
RG8A/U 35ft with PL 259 each end	3.69
RG8A/U 15ft with PL 259 each end	1.69
RG54/U 65ft for 2.50 370ft for 9.95	

**MOTOR SPECIAL** Fasco type 6  
115v-60cy 1750 rpm, dual 1/4" shaft 3/8" dia x 2 1/2"  
shipping weight 3 1/2 lbs **\$1.98 ea 3 for \$5.00**

**ARROW SALES-CHICAGO, INC.**  
2534 S. MICHIGAN AVENUE  
CHICAGO 16, ILLINOIS  
CA 5-4750-4751

**Good ole reliable dynamotor**, 12 vdc input, 500 vdc 250 ma, int. duty new, 12 lbs shipping wt.,  
**Special this month \$4.79**  
**Contacto** 12 vdc, spst 50 amp, new **\$1.59 delivered**  
**Rectifier**, selenium, 140 vrms, input 115 dc, out 5.25 amps, new **\$4.59 delivered**  
**SCR-522** Modulation Transformer new **\$2.25 delivered**  
**T C S** Modulation Transformer, 6,000Z C.T. to 6,000Z **\$1.69 delivered**  
**Plate Transformer**, UTC S-46 1000, 750-0-750, 1000 vac 300 ma, 115/60/1 pri., new, shipping wt. 21 lbs. **\$14.50**

We have all kinds of goodies in stock.  
What do you need?

**HIWAY COMPANY**  
SATISFACTION GUARANTEED

1147 Venice Blvd., Los Angeles 15, Calif.

### CONDENSERS

10 mfd. 1000V w/br.	\$ .98
Ceramic—100 assorted	2.00
470 mmf. disc ceramic 1000V	.10
220 mmf. disc ceramic 1000V	.10
Door knob 500 mmf. 20,000V	.30
4 mfd. 2000V G.E. Pyranol	1.90
.0004 10,000V mica 1.8 amp. with corona balls— Aerovox	.60
Wire Wound Resistors Pkg. of 25 assorted 5 to 25W	1.98
Tube Socket—Johnson #122-237-1 for 813's	.60
Diodes 1N55B PIV 150 V 500 microamp	.30
Diodes 2N264	.20
Trans. 2N224	.50
Trans. 2N414	.40
Var. Cond.—Johnson #149-7-2 Type R 150 mmf.	.75
Johnson Var. Cond. 2 sect. 416 mmf. per section 4500V air gap .125	8.95
General Radio Co. Potentiometer Type 371-A 10K ohm 15W Wire	.50
RF Choke—2.5mh 500 Mil 1.9 to 30 mc	.50
Power Trans., com. type shell-upright. pri. 115V 60 cy. Sec. 1120V. CT 150 Mil; 5V 3A; 6.3V 3A; 7.5V 2.5A	4.75
Westinghouse Fil. Trans.—Pri. 115V 60 cy.; Sec. 5V 10A 20KV ins.	5.00
Terminal strip blocks—10 screw single row	.15
S meter #112-005 1-30 db—used in some Gonset equip. 1 7/8" x 1 7/8"	2.00

**VERN'S** 7701 S. Normandie  
Los Angeles 44, Calif.  
All Orders FOB L. A. — Phone (213) PL 1-0278

## 73 Tests The

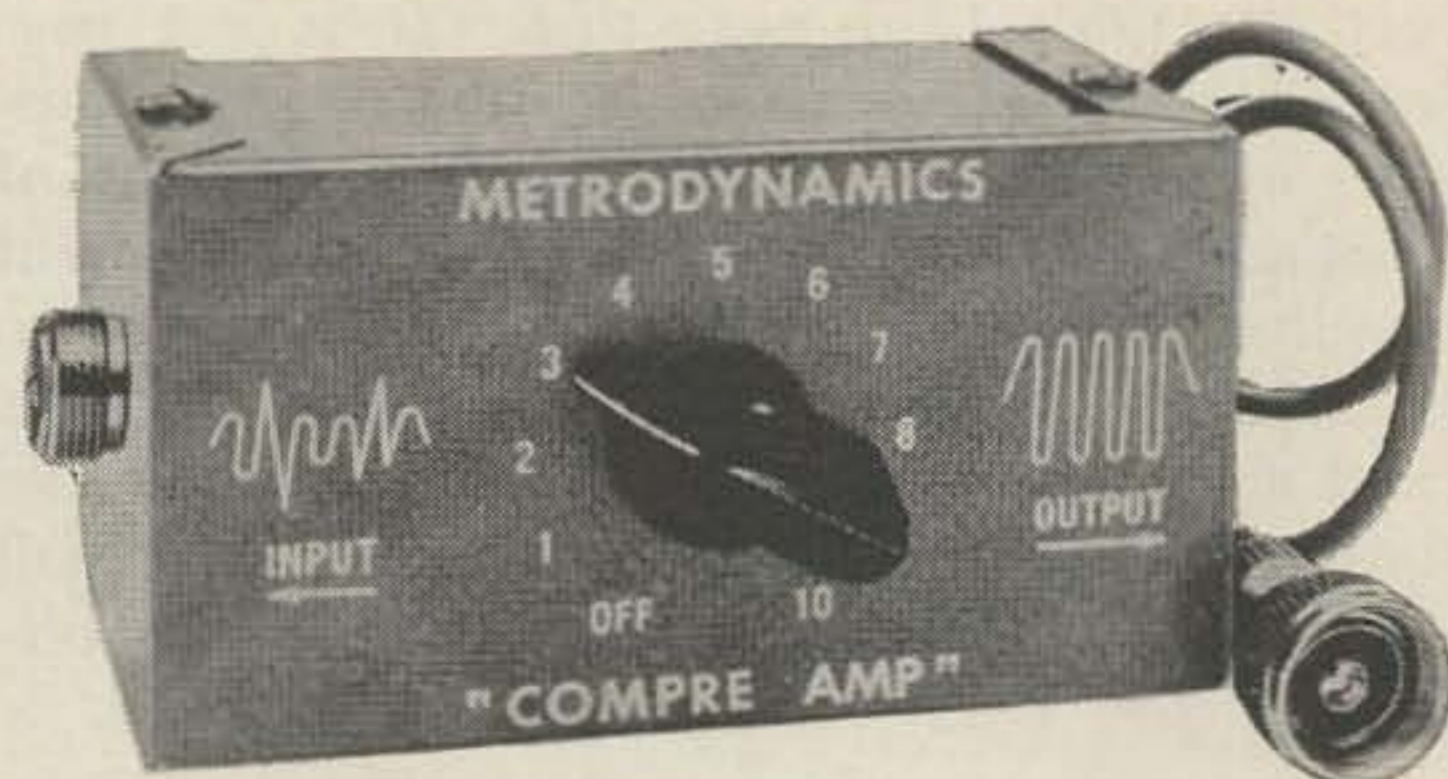

Wayne Green W2NSD/1

Listening in on our bands, one might be inclined to suspect that amateurs are incapable of agreeing on anything. There is one area of rather complete agreement however: our bands are miserably crowded.

There are many approaches to meeting the challenge of trying to get through the QRM curtain. Some chaps string up one antenna after another, others build up rather impressive final amplifiers, some just build bigger modulators, some wait until the wee hours of the morning, etc. But, even after you've moved to that salt marsh on top of the mountain, put up the hundred foot tower with the twelve element beam, and done everything else known to man to put out a signal, there is still an area for improving the punch your signal puts into that DX receiver.

Naturally you can get the same improvement in punch with any rig. The idea is to increase the percentage of modulation or (in the case of SSB) the average power output without creating the splatter that accompanies your turning up the gain control. When you try to get through a little better by increasing your mike gain you flattop on the positive peaks and clip on the negative peaks. The result is a bandful of furious hams and not much improvement in your ability to get out.

There is, of course, nothing really new about using clippers or compressors to increase the modulation percentage of transmitters and many designs of both have been around for a long time. The Metrodynamics Compreamp is a much more modern application with a two transistor logarithmic compressor, matched silicon diodes in the clipper and a cleverly designed RC filter to eliminate the harsh resultant frequencies usually associated with clippers. The result is a smoothly working compressor which connects between your mike and your mike jack.

It is obvious that the Compreamp will change the sound of your voice a bit as more compression is used. Thus you would normally



run it with the control in the off position and would increase the compression when fading or QRM become apparent. It sometimes seems almost magical how your voice can get through a seeming solid wall of QRM even though you may be running lower power than a lot of the big boys on the channel . . . unless, of course, one of the big boys has a compressor too.

The Compreamp is small, being transistorized, and costs only \$13.95 complete with built in battery. Write Metrodynamics Corp., 8 Westover Avenue, Caldwell, New Jersey for info.

. . . W2NSD/1

## SURPLUS SPECIALS

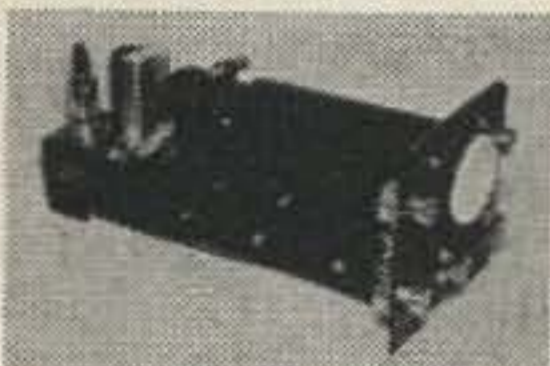

Monitor sub-unit for freq-shift converter CV-89A/URA-8A, with 2BP1 CRT, 1Z2, 12AX7, 5 controls, tube shield, etc. 4 1/2" x 5" x 12". Shpg. Wt. 7 lbs. Schematic incl. . . . \$6.95

Pi-network Loading Capacitor, 5 sections, each 20-400 mmf. 2000mmf. total. 3/8" shaft. 4 lbs. . . . \$2.00  
Power Transformer. 350-0-350 v. 135 ma dc, 5v 3A, 6.3v 3.6A. 3" x 4" x 3 1/2". uncased. 7 lbs. . . . \$1.95

Our catalog is finally in print. Send for your copy. Please add postage with your order.

## JEFF-TRONICS

4791 Memphis Ave. Dept. 7 Cleveland 9, Ohio

# COLUMBIA GEMS!

GONSET special 18 watt AM transceiver. Tunes 118-174 mc (covers two meters and can be adapted to 6M), 8" x 12" x 5", 18 lbs. xtal controlled on xmt and rec. 12 volts, built in power supply. Like New, including tubes . . . \$99.50

Q-5er Command Rec 190-550 kc, exc . . . \$12.95

2.1 - 3 mc Command xmtr NEW . . . \$5.95

3 - 4 mc Command xmtr exc . . . \$6.95

4 - 5.3 mc Command xmtr exc \$4.95; NEW . . . \$6.95

5.3 - 7 mc Command xmtr exc \$4.95; NEW . . . \$6.95

HS-23 hi imp headset; NEW . . . \$4.95

HS-33 lo imp headset 600 ohms, NEW . . . \$5.95

BC-211 Freq. Meter, 125kc-20mc, EXC. Cond \$69.50

Japanese Import Tape Recorder, tested and OK excellent condition, reg. net \$19.95 . . . \$9.95

I-177B Tube Tester Power Transformer, HS, w/ schem. . . . \$3.95

### TUBES: ALL NEW, ALL GUARANTEED

4-125A . . . . . \$19.95	4X150A . . . . . \$9.95
4-400A . . . . . \$24.95	807W . . . . . \$2.49
4X250B . . . . . \$19.95	832 . . . . . \$3.95

AND BEST OF ALL: WRITE FOR OUR 48 PAGE CATALOG

Phone 213-WE 8-3731

(minimum order \$3.50 please)

## COLUMBIA ELECTRONICS

4365 WEST PICO BLVD. LOS ANGELES 19, CALIF.

# SURPLUS FROM SPACE

## TEKTRONIX 511A SCOPES

AS IS . . . . . \$115.00  
CHECKED OUT . . . . . L/N 215.00

### Read-N-Save

PL 258 double female connector . . . . .	59c
DB Meters 3 1/2" rd—10 to +6db 1mw @ 600 ohms	\$275
Sperti Vacuum Switches for ART-13, etc. . . . .	NEW \$1.00
Velvet Verniers w/large knob . . . . .	NEW \$1.00
600 Ohm 300 Watt Non-inductive Resistors . . . . .	\$2.50
WE-255A Polar Relays for TTP . . . . .	\$4.50
Sockets for use with above relay . . . . .	NEW \$2.50
Ohmite Z 28 rf Chokes . . . . .	3/1.00
Ohmite Z 144 rf Chokes . . . . .	4/1.00
Leach Relay #1351 110 vac spst . . . . .	2.00
PL-259 or SO-239 coax conn . . . . .	3/1.00
Push-on-coax conn . . . . .	3 pairs for \$1.00

### NEW SURPLUS TUBES GUARANTEED

2C39A . . . . . \$7.50	8005 . . . . . \$14.00	250TH . . . . . \$18.50
3CX100A5 . . . . . \$9.50	4-250A . . . . . \$21.00	4X250F . . . . . \$25.00
6161 . . . . . \$35.00	5881 . . . . . \$1.50	807 . . . . . \$1.00
829B . . . . . \$8.50	4-125A . . . . . \$20.00	6AN5 . . . . . \$1.25
4-65A . . . . . \$7.50	4X250B . . . . . \$27.50	4D32 . . . . . \$13.50

We buy & sell large quantities of Military and Commercial Test Equipment. AN/GRC, PRC, TRC and test equipment TS and AN/UPM or URM. What have you for sale or trade?

T18/ARC-5 Xmtr, 2.1-3 mc BRAND NEW original sealed cartons . . . . . \$9.95

7580 Tubes brand new in sealed mfg. cartons . . . . . \$34.80

RG-11A/U Coax Cable (72 ohm) 100 ft roll w/PL-259 ea end . . . . . \$7.50

RCA 1698 Tubes for ham TV New boxed . . . . . \$5.95

BC-463A Transmitter and AM Modulators converts to 6 mtrs. uses 815 final 2 ea 6L6 Modulators—new w/tubes . . . . . \$19.50

4x150 Tubes brand new in sealed mfg. cartons . . . . . \$11.50

T-179/ART-26 Transmitters 300-600mc, 35w Brand new w/tubes, for ham TV . . . . . \$59.50

WE-416B Tubes Tested and Guaranteed . . . . . \$12.95

—MONEY BACK GUARANTEE ON ANYTHING WE SELL—

ALL SHIPMENTS F.O.B. BRONX, N. Y.

## SPACE ELECTRONICS CO.

218 West Tremont Ave., Bronx 53, N. Y.

TRemont 8-5222

## 432 MC FM GEAR

18 w transmitter, 6uv receiver  
crystal controlled mobile

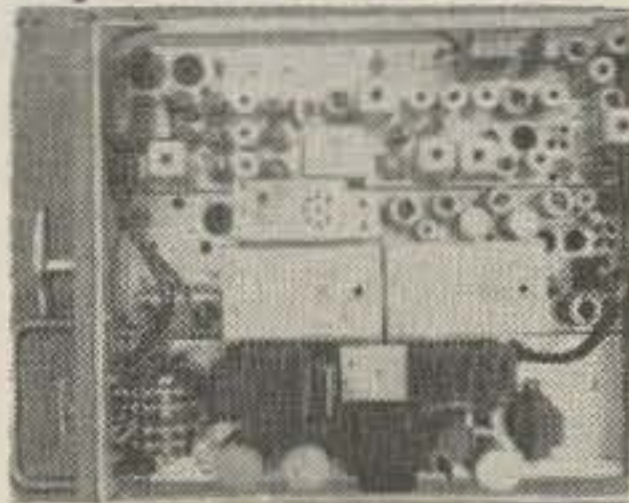

450-470 mc mobile trans-  
mitter has 2C39 tripler,  
2C39 final

Final will operate with cool 80 w input—40 w output. No mechanical changes required in cavities to tune to 432 mc. Final can be AM plate modulated. FM receiver converts to 432 mc with simple mechanical changes. All units complete with 2C39 tubes and diagrams and alignment instructions. No control heads or cables.

T44A - 6 V missing few tubes and crystals ..... \$40.00  
T44A-6 6G12V complete less receiver crystals ..... 54.50  
Receiver strip complete ..... 25.00  
Transmitter strip complete ..... 25.00

Write for list of 30-50 mc gear and 150 mc gear.

### 6 & 2 METER FM GEAR

Complete Trans., Rec., & Power Supply	Chassis	
FMTRU-80D 150 mc 30 watt (2-2E26) .....	6 volt	42.50
	12 volt	49.50
FMTR-80D 30-50 mc 30 watt (2-2E26) .....	6 volt	44.50
	12 volt	52.50
FMTRU-140D 150 mc 60 watt (829B) .....	6 volt	54.50
	12 volt	59.50
FMTR-140D 30-50 mc 60 watt (829B) .....	6 volt	54.50
	12 volt	59.50
Motorola 55 amp alternator (new) ..	12 volt	64.50
Motorola Transistorized Ignition ..	12 volt	39.95

Sales To Amateurs Only

Write for list of 30-50 Mc gear and 150 Mc gear

**F M SURPLUS  
SALES CO.**

1100 Tremont St.  
Roxbury 20, Mass. • GA 7-3513

## \* TWO-WAY \* COMMUNICATION CRYSTALS



**UNCONDITIONALLY  
GUARANTEED  
FAST SERVICE**

American specializes in two-way communications. Frequency correlation date for G.E., Motorola, R.C.A., Collins, Lear, Narco, Hallicrafters, Link, Gonset, Aerotros, Heath, Bendix, Johnson, Globe, U.S. Gov't and many other companies. Send postage.

Frequency Range	Com- mercial Oven 002%	Com- mercial Room 002%	Amateur 01% 20 mmf
3 to 9.9 mc. Fund	\$4.25	\$3.75	\$2.85
15 to 29.9 mc. T.M.	4.25	3.75	2.85
30 to 50 mc. T.M.	4.50	4.00	3.35
10 to 17 mc. Fund	4.50	4.00	3.35
2 to 2.9 mc. Fund		4.00	3.35
50 to 60 mc. F.M.	5.50	5.00	4.00
50 to 80 mc. F.M.	6.00	5.50	5.00
1.0 mc. to 2.99 mc.	8.50	7.50	6.50

C.B. .104% crystals, all channels, all equipment, \$2.85  
Amateur, 6 meters; 8.3 to 8.6 mc 6th multiple Trans. FT243,  
\$1.50

Do It Yourself Kits—Three 7 mc Xtals, Two holders, \$1.95

Write for quantity discounts or phone Victor 2-5571

**AMERICAN CRYSTAL CO.**  
P.O. BOX 2366 • KANSAS CITY 42, MO.

## LETTERS

Dear Wayne:

Just a couple of thoughts in connection with your proposed junket to Europe this fall. First, I think it is a wonderful idea and all those able to go along should have a wonderful time.

The only fly in the ointment appears to be your choice of a foreign carrier.

What is the matter with a good old US carrier? You know the airlines of this country are having a hard time filling their seats and feeding all the people necessary to operate an air carrier. Just think of the money spent by these airline people for everything from ham gear to groceries.

Another factor is the balance of payments. Our gold is melting away at an alarming rate and it is just such deals as you are cooking up that helps us get further in the hole in this area.

A very large percentage of the fare money will do no one any good in this country, it will go over seas along with the other millions we spend or give to them.

So, while you are pacing up and down your office just think about this a little and I think you will agree that I have a point some where in here.

Only wish I could go with you . . .

. . . R. C. Multon WB6BFR

*Yep, it sure is too bad you can't go . . . and maybe find out a little bit of what the world is about. Our gold is melting away because we have inflation here and the U. S. dollar is weakening. I have watched the dollar shrink to a 25c piece in my short lifetime. I work a lot harder for the few dollars I have than most people even imagine and it infuriates me to have Uncle Sugar give them away, but every time I spend a dollar in Europe that is a dollar that doesn't have to be sent over as a gift . . . I like it a lot better that way. Now, regarding the use of Sabena Belgian Airlines for our trip . . . let me tell you about that. After letters and phone calls to all U. S. trans-atlantic airlines I found that only Pan Am could handle the cities that we are going to visit. After many phone calls, letters and a personal visit to the New York HQ of Pan Am to see one of the top men in traffic there, I found that Pan Am was "completely sold out" on all charter flights for this year. The only other way they could handle us would cost everyone an extra \$75 for the flight and about \$100 extra for hotels. So much for all those empty seats. Now, while I was busy trying to force Pan Am to carry us, several other airlines were calling me and trying to sell me on using them. Sabena went so far as to send two men up to our New Hampshire HQ and explain all the things they could do for us. Having travelled both Pan Am and Lufthansa to Europe in the past I had been impressed by the service and hospitality of the European airlines compared to the U. S. lines. There is a tremendous difference in attitude. We are going Sabena and I guarantee that everyone will have a flight whose pleasures they will never forget.*

Dear OM:

Please put a notice in 73 requesting those Kiiwanians who are hams to send a QSL to me. We hope to establish a Kiiwanis net.

Bob Fleming KGLS  
1007 W. Summit  
Fergus Falls, Minn.

OK.

**GUARANTEED RECONDITIONED**

**Amrad**

**HAM GEAR**

Phone: (415)  
DI 2-5757

**ELECTRONICS**

**WRITE NOW  
FOR MONTHLY  
FLYER.**

999 HOWARD AVE-BURLINGAME, CAL.

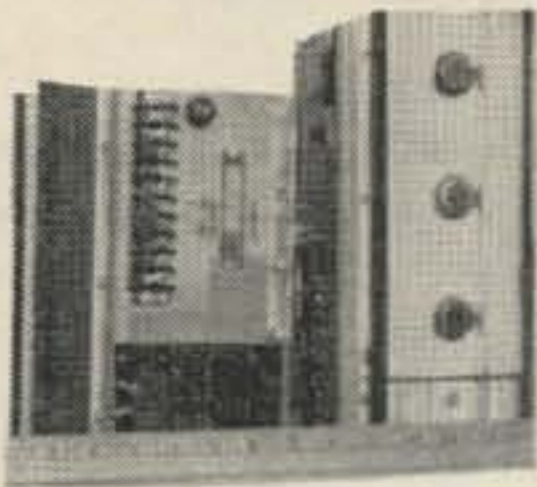

### SOLID STATE SUPPLIES

surplus from sophisticated equipment

- Regular 115 volt 60 cycle input.
- #1 Output 12 volt 12 amp, transistorized regulated ..... \$35.00
- #2 Output 12 volt 8 amp, transistorized regulated ..... 30.00
- #3 Output 6 volt 8 amp, transistorized regulated ..... 25.00
- #4 Output 3 volt 5 amp ..... 20.00

Stud mount rectifiers, vary from .5-10 amp up to 600 PIV. You grade 'em. Bag of 8 silicon stud rectifiers. .... \$1.00



NAVY RANGE FILTER (illustrated) for CW. Almost a lost item. Ours brand new boxed. .... #FL-5 \$3.00

UNDERWATER MICROPHONE (HYDROPHONE) unused Navy Surplus, with 60 feet mike cable on spool. Mike approx. 2 inches. .... #SSB \$5.50

1N82 DIODES, UHF MIXER, good for gen. purpose. Short leads, snap-in style. #1N82 bag 25 \$1.00



2N38 AUDIO FREQ. TRANSISTORS. #2N-38 bag 12 \$1.00



POWER TRANSISTORS, mixed, up to 40 watts #PT bag 5 \$1.00



### FREQUENCY METERS

LR, Navy Standard, made by Gen. Radio— 160kc-60 mc,  $\pm$  .003. Xtl Calib. 100 kc xtl,  $\pm$  1 cps. Multivibrator Freq. 10-20-100 kc. Interpolation meter range 0-.5.5 kc. One only available. Shipping wgt 200 lb. Shipped from Miss. \$175.00  
BC-221-AK (modulated) Brand new condition, less supply \$100.00

LAMBDA REGULATED POWER SUPPLIES, used, good shape.

C-481M	\$100.00	C-881M	\$100.00
33M	75.00	32M	75.00
35	75.00		

**NOTE:** If you've been a little annoyed at some slowness on our part we ask your forgiveness. The responsibility for this lies squarely on 73, for my wife and I have been unable to keep up with the unbelievable demand for catalogs and the mountain of orders. Yours will be along momentarily.  
John Meshna

All material FOB Lynn, Mass. Send for new catalog #63-S just out.

**John Meshna Jr. 19 Allerton St. Lynn, Mass.**

## DISCOVERY!

The postage bill on last month's 128 page issue was enough to curl your eye-teeth. We've been holding the sub rates at \$3.50 for a long time now, but we just can't do it and keep making the magazine larger. The next issue looks like another big one . . . a special Surplus Issue, so we'll just have to jog up the subscription rates to \$4.00 soon. Vote here for a smaller 73 . . . send your \$3.50 subscription now while we are vacillating.

Name ..... Call .....

Address .....

City ..... Zone ..... State .....

- \$3.50 One Year
- \$6.50 Two Years
- \$9.00 Three Years
- \$40 Life (yours or ours)

50c each enclosed for the following back issues .....

(Jan. '61 out of print) Class license .....

\$1.00 enclosed for one year membership in Institute of Amateur Radio.

Send to: 73, Peterborough, N. H.

# 73 Products

Peterborough, N. H.



## MICKEY MIKER 50c

Complete and exhaustive construction project for building a precision capacity tester. Very thorough.

## IMPEDANCE BRIDGE PRINTS \$1.00

A complete set of full scale prints (15) of all parts of the precision impedance bridge which originally appeared in the August 1961 issue of 73. Comes complete with a reprint of the original article.

## NEW RTTY BOOK \$2.00

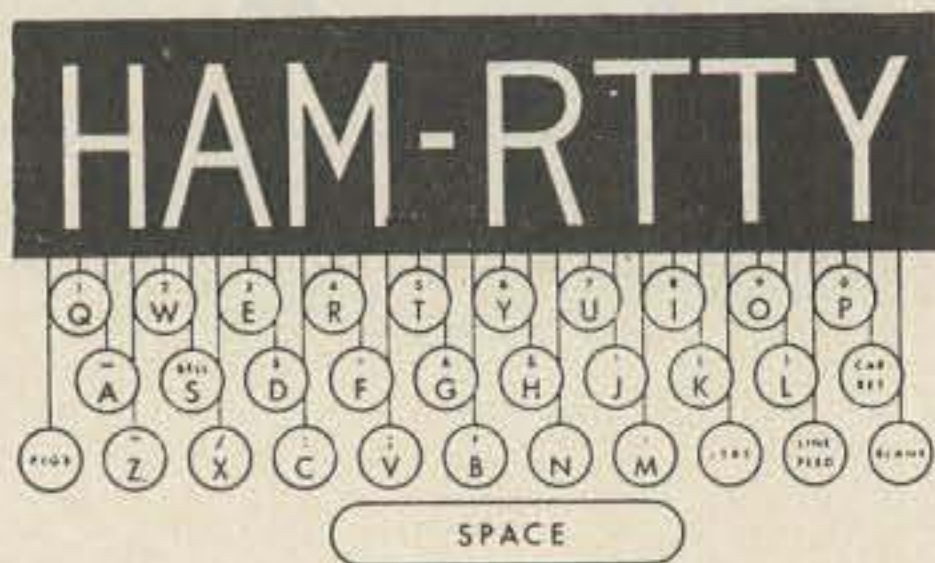

This handbook is written for the beginning RTTY op, but due to the profusion of info, pictures, circuits, etc., it will be valuable to all RTTY'ers and those who may RTTY themselves. If you don't know what RTTY means don't buy it. For \$2 what can you lose? It's worth almost that much in paper.

## BINDERS FOR 73 \$3.00

Keep your issues of 73 all in good shape and keep them from straying. Specify year: '60-61, '62, '63. Red Leather binder with gold stamped "73" and year. Darbs.

## BACK ISSUES 50c

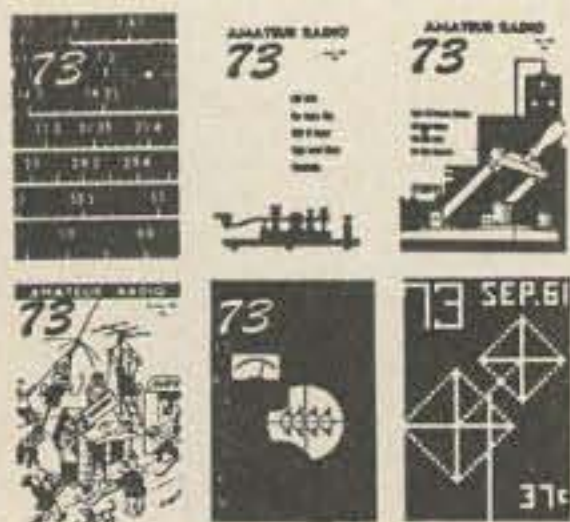

You can enjoy back issues of 73 just as much as current. Send for one each month to pad out those dreary days. All back issues now available except January 1961. Early issues going to \$1 soon. Supply very limited.

## SIMPLIFIED MATH 50c



This booklet takes you gently by the hand and leads you through the mysteries of Ohm's Law, squares, roots, powers, frequency/meters, logs, slide rules, etc., and does it by an amazingly new method.

## SURPLUS TV SCHEMATICS \$1.00

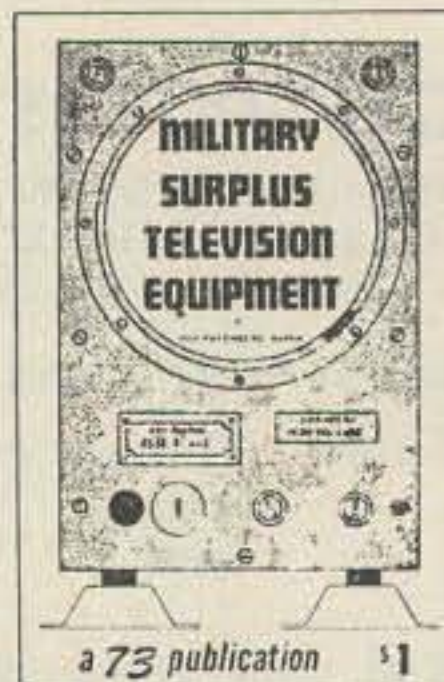

TV'ers who are interested in saving a lot of construction time and still want to have elaborate TV gear will do well to watch those surplus ads and invest in this booklet, the only source of the diagrams you'll be needing.

## CW \$1.00



Written by an expert. One of the best methods for learning the code yet devised. Lays in a good foundation for later high speed CW ability. CW can be a lot of fun if you go about learning it the right way. This book will be invaluable to the beginner and the ham who wants to really increase his code speed.

## INDEX TO SURPLUS

## INDEX TO SURPLUS \$1.50

This is a complete list of every surplus conversion article that has ever been published, with a brief description of the conversion. Invaluable bibliography.

## HAM-TV \$3.00



This book gives you a blow by blow description of how to get on the air on TV for under \$50. This book is the reason that hundreds of hams are now going on TV. This is not the usual theory book, just a how-to-do-it manual.

**FREQUENCY MEASURING HANDBOOK \$1.00**



Rather thorough exploration of the subject, complete with an exhaustive bibliography. By WφHKF

**AMATEUR TELEVISION EXPERIMENTER \$1.00 per year**

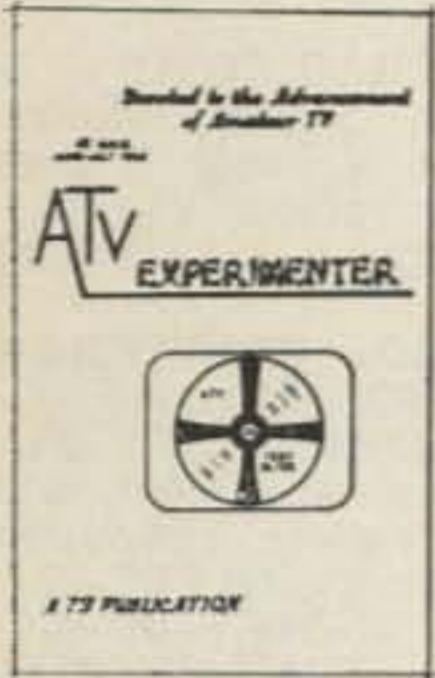

The first five issues of this invaluable bulletin are now in print. Each one is worth more than the year's subscription. Send \$2 for complete set from #1 up through #12. Quantity limited so don't wait.

**CARE AND FEEDING OF HAM CLUBS \$1.00**



K9AMD's interesting book on all aspects of forming and holding together a ham club. This is the result of exhaustive interviews with many club officers and will be invaluable to every club going.

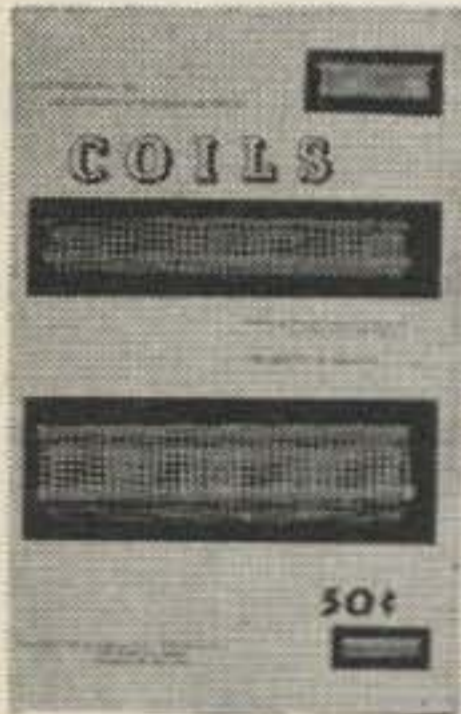

**COILS 50c**

Well illustrated basic book which describes all of the different types of coils to be found in radio work. Covers theory and practical aspects.

**AN/ARC-2 CONVERSION \$1.00**

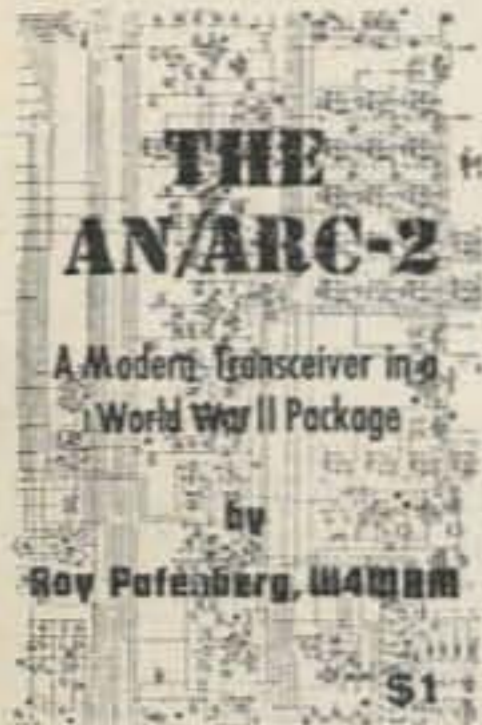

Complete schematics and thorough conversion details on this modern transceiver which covers 2-9 mc (80-40 meters . . . and 160). This unit now sells for \$40 to \$50 surplus and is easily converted into a terrific little transceiver.

**WORLD GLOBE (plus subscription for one year) \$16.95**

Every visitor to the 73 HQ shack is taken aback by the beautiful world globe next to the operating position. We find this invaluable for figuring out beam angles and planning world tours. It is 18" in diameter, normally sells for \$19.95 (via CQ), is nearly five feet around the equator. Canadians please allow a little extra for Diefendollar exchange.

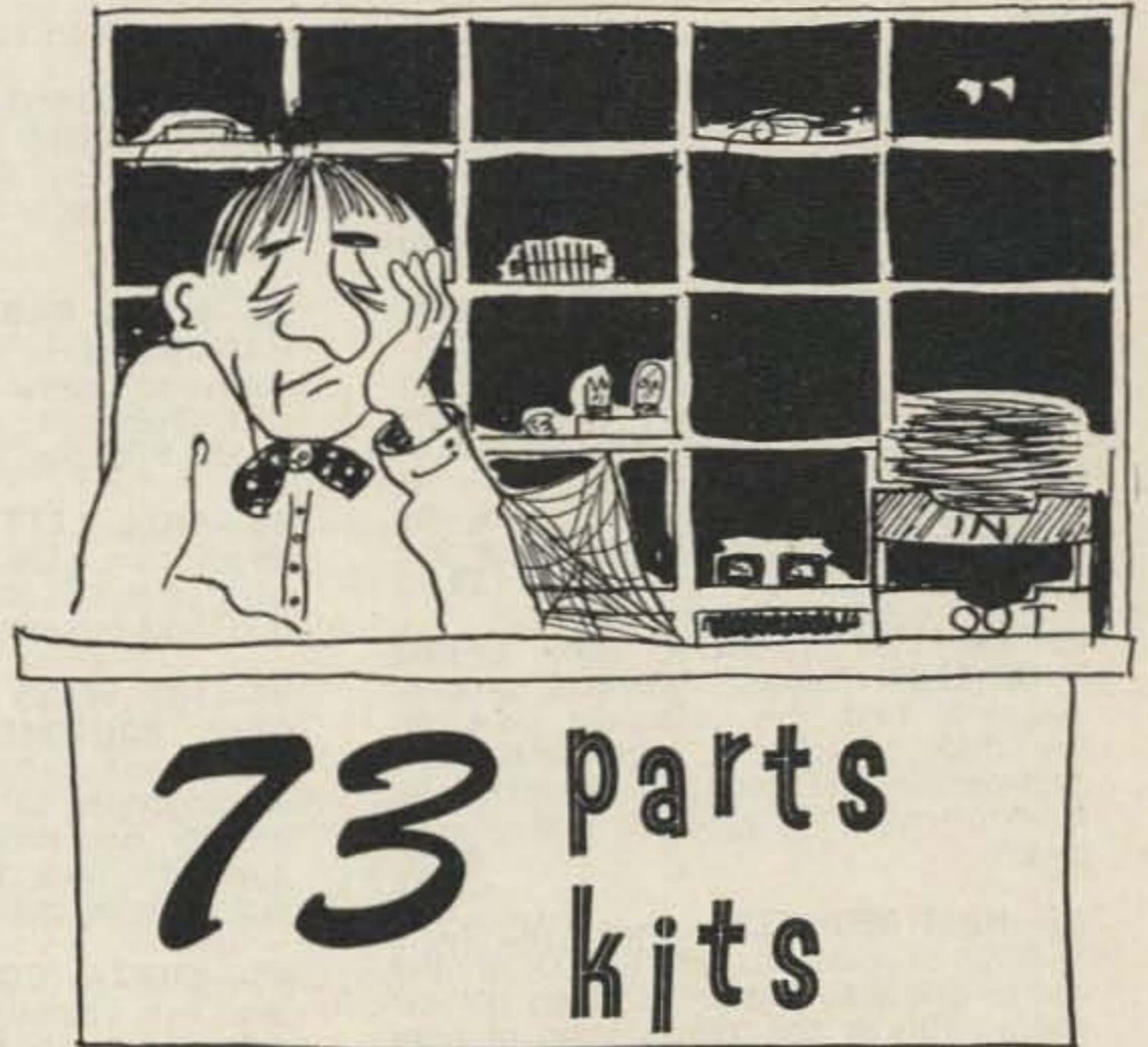

In the interests of making home construction simpler for those readers with anemic junk boxes 73 has gathered together the parts required for building our less complicated projects. These kits are as complete as we can make them, containing good quality parts. Except where the chassis or case is integral to a unit we do not supply it. We will mention when we do supply a case or chassis. We do supply tubes, sockets, condensers, resistors, transformers, connectors, etc. The kits are kept in stock to the best of our ability, though sometimes the distributors who supply us delay us a bit. TWO METER THREE NUVISTOR PRE-AMPLIFIER for perfectionists, complete with self-contained power supply. Kit contains nuvistors, sockets, all condensers, resistors, potentiometers, power transformer, rectifier, switch, antenna coax connector, etc. See article in March 73 page 8. Everything you need, complete with full scale drilling template.

- Kit W9DUT-1 ..... \$18.50
- QRP TRANSMITTER. One tube (1S4) ½ watt 40M rig. Fun to build and really works. See article in March 73 page 22. We've built a lot of 'em here.
- Kit W1MEL-1 ..... \$6.00
- W6SFM-1 ..... \$4.00
- Nuvistor preamp for 15 & 20 meters. March 73.
- ADJUSTABLE REGULATED XSTR P.S. as described page 8 April 73. Five transistors, zener, complete kit of parts. W1ISI-1 . . . \$25.00
- DIODE NOISE GENERATOR P. 15, April 73.
- THOMAS-1 ..... \$9.00
- VECTOR VFO (p. 24 April 73)
- Complete VFO kit. W7IDF-1 ..... \$6.50

# Radio Book Shop

Form your own Book Club! Order one book each month from this list. Just think, in one hundred years you will have a terrific radio library with 1200 volumes. Order the book anyway.

**1—ELECTRONICS & RADIO ENGINEERING**—Terman. One of the most complete text books ever printed. 1078 pages. Theory, but easy on the math. \$15.50

**5—ANTENNAS**—Kraus (W8JK). The most complete book on antennas in print, but largely design and theory, complete with math. \$12.00

**11—16TH EDITION RADIO HANDBOOK**—by Bill Orr W6SAI. This fantastic book is loaded with the most understandable theory course now available in our hobby plus dozens of great construction projects. This is the best ham handbook in print by a wide margin. Easily worth twice the price. \$9.50

**13—REFERENCE DATA FOR RADIO ENGINEERS.** Tables, formulas, graphs. You will find this reference book on the desk of almost every electronic engineer in the country. Published by International Telephone and Telegraph. \$6.00

**16—HAM REGISTER**—Lewis (W3VKD). Thumbnail sketches of 10,000 of the active and well known hams on the air today. This is the Who's Who of ham radio. Fascinating reading. Only edition. Now only \$2.50

**18—SO YOU WANT TO BE A HAM**—Hertzberg (W2DJJ). Second edition. Good introduction to the hobby. Has photos and brief descriptions of almost every commercially available transmitter and receiver, plus accessories. Lavishly illustrated and readable. \$2.95

**21—VHF HANDBOOK**—Johnson (W6-QK1). Types of VHF propagation, VHF circuitry, component limitations, antenna design and construction, test equipment. Very thorough book and one that should be in every VHF shack.

**22—BEAM ANTENNA HANDBOOK**—Orr (W6SAI). Basics, theory and construction of beams, transmission lines, matching devices, and test equipment. Almost all ham stations need a beam of some sort . . . here is the only source of basic info to help you decide what beam to build or buy, to install it, how to tune it. \$2.70

**23—NOVICE & TECHNICIAN HANDBOOK**—Stoner (W6TNS). Sugar coated theory: receivers, transmitters, power supplies, antennas; simple construction of a complete station, converting surplus equipment. How to get a ham license and build a station. \$2.85

**24—BETTER SHORT WAVE RECEPTION**—Orr (W6SAI). How to buy a receiver, how to tune it, align it; building accessories; better antennas; QSL's, maps, aurora zones, CW reception, SSB reception, etc. Handbook for short wave listeners and radio amateurs. \$2.85

**26—S9 SIGNALS**—Orr (W6SAI). A manual of practical detailed data covering design and construction of highly efficient, inexpensive antennas for the amateur bands that you can build yourself. \$1.00

**27—QUAD ANTENNAS**—Orr (W6SAI). Theory, design, construction, and operation of cubical quads. Build-it yourself info. Feed systems, tuning. \$2.85

**28—TELEVISION INTERFERENCE**—Rand (W1DBM). This is the authoritative book on the subject of getting TVI out of your rigs and the neighbors sets. \$1.75

**32—RCA RADIOTRON DESIGNERS HANDBOOK**—1500 pages of design notes on every possible type of circuit. Fabulous. Every design engineer needs this one. \$7.50

**36—CALL LETTER LICENSE PLATE**—Regulation size license plate. Please give your call and the color of letters and background. \$3.00

**37—101 WAYS TO USE YOUR HAM TEST EQUIPMENT**—Middleton. Grid-dip meters, antenna impedance meters, oscilloscopes, bridges, simple noise generators, and reflected power meters are covered. Tells how to chase trouble out of ham gear. 168 pages. \$2.50

**45—CURTA COMPUTER.** The world's smallest computer. Send for detailed information. Makes the slide rule look sick. Like a big Monroe computer only hand size. \$125.00

**48—BASIC ELECTRONICS**—Covers subject completely. Written for use with RCA Institute training course. \$9.25

**49—ELECTRONIC COMMUNICATION**—Shrader. Huge book aimed at giving all information necessary for FCC commercial and amateur licenses. \$13.00

**52—HOW TO READ SCHEMATIC DIAGRAMS**—Marks. Components & Diagrams; electrical, electronic, ac, dc, audio, rf, TV. Starts with individual circuits and carriers through complete equipments. \$3.50

**53—BASIC ELECTRONIC TEST PROCEDURES**—Turner. This book covers just about every possible type of electronic test equipment and explains in detail how to use it for every purpose. Testing: audio equipment, receivers, transmitters, transistors, photocells, distortion, tubes, power . . . etc. \$9.75

**55—TRANSISTOR CIRCUIT HANDBOOK**—Simple, easy to understand explanation of transistor circuits. Dozens of interesting applications. \$4.95

**63—GE TRANSISTOR MANUAL**—6th edition. This is one of the best buys around: 22 chapters, 440 pages, diagrams by the gross, data, facts, charts, etc. If you don't have this one you just aren't up to date. only \$2.00

**66—DESIGN MANUAL FOR TRANSISTOR CIRCUITS BY CARROLL.** Tested transistor circuits for design engineers. Interesting reading too. \$9.50

**67—TRANSISTOR CIRCUIT ANALYSIS AND DESIGN** by Fitch. Written primarily as a college text to teach circuit design. \$13.00

**68—HANDBOOK OF TRANSISTOR CIRCUIT DESIGN BY PULLEN**—This is a handbook which teaches a systematic system for transistor circuit design. Highly recommended by radio schools. \$13.00

**74—HANDBOOK OF ELECTRONIC TABLES & FORMULAS**—Formulas & laws, constants, standards, symbols and codes. Math. tables, misc. data. \$2.95

**76—MODERN OSCILLOSCOPES & THEIR USES**—Ruiter. Second edition. Shows what a 'scope is, what it does and how to use it for radio, TV, transmitters, etc. 346 pages. \$10.20

**80—SURPLUS RADIO CONVERSION MANUAL VOLUME NO. 1** (second edition). This book gives circuit diagrams, photos of most equipment, and rather good and complete conversion instructions for the following: BC-221, BC-342, BC-312, BC-348, BC-412, BC-645, BC-946B, SCR-274N 453A series receivers conversion to 10 meter receivers, SCR-274N 457A series transmitters (conversion to VFO) SCR-522 (BC-624 and BC-625 conversion to 2 meters), TBY to 10 and 6 meters, PE-103A, BC-1068A/1161A receiver to 2 meters, Surplus tube index, cross index of A/N tubes vs. commercial types, TV & FM channels. \$3.00

**81—SURPLUS RADIO CONVERSION MANUAL VOLUME NO. II.** Original and conversion circuit diagrams, plus photos of most equipments and full conversion discussion of the following: BC-454/ARC-5 receivers to 10 meters, AN/APS-13 xmtr/rcvr to 420 mc, BC-457/ARC-5 xmtrs to 10 meters, Selenium rectifier power units, ARC-5 power and to include 10 meters, Coil data-simplified VHF, GO-9/TBW, BC-357, TA-12B, AN/ART-13 to ac winding charts, AVT-112A, AM-26/AIC, LM frequency meter, rotators, power chart, ARB diagram. \$3.00

**82—SURPLUS RADIO CONVERSION MANUAL VOLUME NO. III**—Original and conversion diagrams, plus some photo of these: 701A, AN/APN-1, AN/CRC-7, AN/URC-4, CBY-29125, 50083, 50141, 52208, 52232, 52302-09, FT-ARA, BC-442, 453-455, 456-459, BC-696, 950, 1066, 1253, 241A for xtal filter, MBF (COL-43065), MD-7/ARC-5, R-9/APN-4, R23-R-28/ARC-5, RAT, RAV, RM-52 (53), Rt-19/ARC-4, SCR-274N, SCR-522, T-15/ARC-5 to T-23/ARC-5, LM, ART-13, BC-312, 342, 348, 191, 375. Schematics of APT-5, ASB-5, BC-659, 1335A, ARP-2, APA10, APT-2.

**88—EUROPE ON \$5.00 A DAY**—Europe can be just as expensive as the U. S. unless you know where to stay and where to eat. This book is the standard reference work for European travelers on a budget. This is the latest edition. \$1.95

**90—TELEPRINTERS, MODEL 31A**—This midget, printer, complete with case, measures only 11" x 16" x 12" and is light enough to throw in the car for portable use. Complete with keyboard, ready to operate. \$100.00

**91—DIETZGEN 10" SLIDE RULE**—This is the slide rule that is recommended in the book, "Simplified Math For The Ham Shack." With a little practice you'll have Ohm's Law whipped, and any other calculations too. Has C-D-C1-L-T-A-B-S-K scales. Beautifully made rule, complete with plastic case, looks like five times the price and works that way too. **\$2.85**

**92—QSL DISPLAY PLASTIC POCKETS**—Each set of clear plastic pockets holds twenty QSL's for wall display. Keeps cards flat, clean and perfect. Keeps walls clean too. Or have you tried to hang QSL's yet. This beats thumb tacks and Scotch Tape all hollow. Comes in envelope of three to hold 60 QSL's, give it a try and you'll never use anything else. **Three: \$1.00**

**93—RADAR-TECTOR**—This gadget, though designed to pick up police radar (which it does very efficiently we are told by several amateurs), also picks up two of our amateur UHF bands. Operates entirely from the 12v car battery. Regular price is \$44.95. Bookshop Special **\$28.95**

**94—KIT OF SOLDERING TOOLS**—Used to was a soldering iron was all that was necessary, now you have to have a kit of fool tools. Little doohinkies like scrapers, reamers, forks, and brushes. Forsooth! Made of varnished maple and spring steel (vastly superior to winter steel). **\$4.87**

**95—NE-PAD**—Pilot-type writing desk that elastics to your pants leg for mobile log-keeping. Complete with two pads of 50 special 73 mobile log sheets. You know the logs gotta be good. Extra log pads are only 25c a pad. Ne-Pad with two log pads **\$3.95**

**96—LATEST CALLBOOK**—There are so many changes in the Callbook that you should plan on buying a new one at least once a year.  
USA Callbook ..... **\$5.00**  
Foreign Callbook ..... **\$3.00**

**97—RADIO AMATEUR DX GUIDE**—Crammed with maps, time conversion tables, great circle charts, etc. Each page may be removed for mounting on wall. **\$2.00**

**98—WORLD PREFIX MAP**—Printed in four colors on heavy stock for wall mounting. 29" x 42". Has country prefixes, time zones, radio zones, and alphabetical listing of prefixes. **\$1.00**

**99—RADIO AMATEURS WORLD ATLAS**—16 pages in four colors. Shows all six continents, West Indies, country prefix list, etc. If you work any DX this atlas will be very helpful. **\$1.00**

**ACR-1—ABC'S OF CITIZENS BAND RADIO**—by Buckwalter. How to choose, set up, license and operate CB equipment. Discusses different types of rigs, receivers, antennas, how to tune, install, operate and troubleshoot. **\$1.95**

**ALP-1—GENERAL CLASS LICENSE HANDBOOK**—by Pyle W7OE. A complete guide including typical questions and answers, to help you prepare for the FCC Technician, Conditional or General amateur radio exam. A good writer is quite a help in this sort of thing. **\$2.50**

**AMA-1—AMATEUR RADIO ANTENNA HANDBOOK**—by Hooton W6TYH. Basic theory, construction and tuning of all the well known and effective ham antennas. Good stuff on feed lines and towers too. **\$2.50**

**AMP-1—TROUBLESHOOTING AMATEUR RADIO EQUIPMENT**—by Pyle W7OE. A guide for all hams who want to keep their gear on the air by themselves. Includes complete schematics of many popular ham transmitters and receivers. **\$2.50**

**AMR-1—ABC'S OF MOBILE RADIO** by Martin. Covers subject of two-way FM mobile operation. Equipment, control, range, power supply, receivers, transmitters, installation, and uses. Quite comprehensive. **\$1.95**

**ARN-1—ABC'S OF RADIO NAVIGATION**—by Lytel. Complete info on navigational systems for small boat and plane owners. Covers Loran, Radar, Consolan, Decca, Gee, Omni, Tacan, Vortac, IIs, etc. Well illustrated, simply written and complete. **\$1.95**

**BEO—OSCILLATOR CIRCUITS**—by Adams. This book is designed for the fellow who really wants to know how electronic circuits work. It is written with incredible simplicity and uses four color diagrams to effectively explain just what happens in circuits. Covers all nine basic oscillator circuits. **\$2.95**

**BON—FIRST CLASS RADIOTELEPHONE LICENSE HANDBOOK**. Everything you need to know to get your 1st license. More than a Q & A book, you'll understand what it is all about when you get through this one. **\$4.95**

**EGT—ELECTRONIC GAMES AND TOYS YOU CAN BUILD**. 15 Original games and toys, none available commercially. Test your steady nerves; your reaction time, battle a lie detector, etc. Guaranteed rouser. **\$2.50**

**ELW-1—ABC'S OF ELECTRONICS**—by Waters. Sugar coated basics of electronics: the electron, magnetism, resistance, inductance, ac, impedance, radio waves, vacuum tubes, transistors, the oscillator. Excellent book for beginners. **\$1.95**

**HAP-1—ABC'S OF HAM RADIO**—by Pyle W7OE. How to get a Novice license. Excellent book by a top author. **\$1.95**

**MCN—MODERN COMMUNICATIONS COURSE**—by Noll. Aimed more at commercial radio than amateur, but an excellent book for home study or class work. Covers transmitters and antennas quite well. **\$4.95**

**MMD—ELIMINATING MAN MADE INTERFERENCE**—What makes it, how to find it, how to cure it in homes, factories, automobiles, aircraft, boats, etc. Or maybe you haven't been plagued lately. 160 pages. **\$2.95**

**NHP—BUILDING UP YOUR HAM SHACK**—Pyle (W7OE). A practical discussion of points to consider when you are buying ham equipment, complete with descriptions of much of the available commercial gear. It's just possible that Pyle might keep you from making a mistake which would cost a lot more than his book. **\$2.50**

**QAN—2ND CLASS RADIOTELEPHONE LICENSE MANUAL**—by Noll. Another 73 author makes it in the big time. Q & A manual for commercial ticket. Get one, you never know when it'll be handy . . . and this sure proves what you know, or don't know. **\$3.95**

**SIH—SSB COMMUNICATIONS HANDBOOK**—by W6YTH. This book covers all known methods of generating SSB with details on them. Discussion and schematics on many popular SSB rigs. Very educational, and mostly for the ham. **\$6.95**

**SWL-1—ABC'S OF SHORT WAVE LISTENING**—by Buckwalter. Covers what to listen to, frequencies, antennas, receivers, QSL's, space signals. Good basic cook for SWL'ing. **\$1.95**

**TCM—TRANSISTORS CIRCUIT MANUAL**—by Lytel. Schematics and descriptions of over 200 transistorized circuits, covering just about anything you can possibly want to do with transistors. **\$4.95**

**R261—MAGNETIC AMPLIFIERS**. This new Rider book is a complete home-study course in M-A. Explicitly illustrated. We don't find M-A in ham use yet, but they are growing in industrial use as more engineers understand the applications of this relatively new device. 112 pages. **\$2.45**

**R262—BASIC TRANSISTORS**—by Schure. Incredibly well illustrated book which sugar coats your way to understanding transistors. These little doohinkies been worrying you? Fret no more, read. **\$3.95**

**R235—RADIO CONTROL FOR MODEL BUILDERS**—Winter. One of the best and newest books available on RC. **\$4.25**

**R245—HOW TO USE GRID-DIP OSCILLATORS**—Tuner (K6AI). Construction & uses, an important book. **\$2.50**

**G-93—RADIO CONTROL HANDBOOK** by McEntee. This is the largest and most complete book ever published on the subject. 304 pages! It covers in detail every possible aspect of radio control. **\$4.95**

**G94—TRANSISTORS**. Selected articles from Radio Electronics on how to test transistors and how to build all-transistor test equipment. **\$1.95**

**100—ELECTRONIC CONSTRUCTION HANDBOOK** by W8MQU. Covers all sorts of info on how to build. **\$2.95**

**731—HAM—TV—WOKYQ**. This is the only book available on this fascinating branch of ham radio. Describes complete ham TV station that costs under \$50. Very simple. **\$3.00**

**732—FULL SCALE PRINTS FOR MARK III IMPEDANCE BRIDGE FROM AUGUST 1961 ISSUE OF 73**. These enlargements of the published scale drawings greatly simplify home construction of this terrific piece of test equipment. A complete copy of the original article is also included. **\$1.00**

Send cash, check, money order or anything else we can easily take down to the bank to get them off our backs. Tear our pages and mark books you are ordering, or else jot a note of the numbers on a separate sheet. We also find it helpful when you include your

name, call and address. Make check out to 73, Inc. (or to Wayne Green, Radio Bookshop, 73 Magazine, etc.). Don't make it out to CQ. We won't even get mad if you include \$3.50 extra for a subscription or renewal. Send order to Radio Bookshop, Peterborough, N. H.

## INDEX TO ADVERTISERS

To aid you in finding ads which are not running in this issue we have listed the last ad run by each company in 73.

13	Ad Com	56	Gavin Instruments	Dec. 61	Peterson
63	Adirondack	Nov. 61	Gem Electronics	21	P & H
Jan. 62	A & F Electromart	Aug. 61	General Electric	82	Poly-Paks
Aug. 62	Air	Nov. 61	Glas-Line	Mar. 63	Polytronics
Apr. 63	Alco	Apr. 63	Glass, J. J.	Sep. 62	Propagation Products
Dec. 62	Alden	Jan. 61	Globe Electronics	Mar. 63	Quaker
Dec. 62	Algeradio	Dec. 62	Gonset	59	Quement
96	Allied	85	Goodheart	73	Radio Am. Callbook
51	Alltronics-Howard	77	Graham Radio	92	Radio Bookshop
Mar. 62	Alvaradio	Apr. 63	Grantham School	Apr. 63	Radio Industries
Apr. 63	Amateur Elect. Supply	77	Groth	Dec. 62	Radio Supply & Eng.
Feb. 63	Amateur Radio Exchange	Nov. 62	Ham Aids	Jun. 62	Raytheon
Oct. 62	Amatronics	Jun. 62	Ham Boards	81	Ready Radials
88	American Crystal	Sep. 62	Hamkerchiefs	Jan. 63	Rex
Jun. 61	American Electronics	Dec. 62	Ham Kits	51	Reyco
36	Amperex	Apr. 63	Hallicrafters	Oct. 61	Rider
25	Amplidyne	Mar. 63	Hammarlund	Apr. 63	Ritco
88	Amrad	Mar. 63	Harrison, Ivan	39	Rohn
Apr. 63	Arrow Electronics	Oct. 61	Harrison Radio	83	RW Electronics
57	Arrow Sales, Cal.	Jul. 62	Hartman	Jun. 62	Sar
86	Arrow Sales, Chi.	Dec. 62	Heath	Feb. 63	Schober
Oct. 62	Ashe	47	Henry	Mar. 62	Seco
Nov. 62	Bald Eagle	Apr. 63	H & H	Aug. 62	SEG Sales
Nov. 62	Barrington	69	Hi-Par	Feb. 62	Shure
Nov. 62	Barry	86	Hi-Way	Apr. 63	Sideband Engineers
Jun. 62	Bay Roy	23	Holstrom	Nov. 62	Signal
84	BC Electronics	Sep. 62	Hornet	Apr. 63	S. J. Electronics
Apr. 63	Best	Apr. 63	Hunter	82	Skylane
75	BF	Apr. 63	Hy Gain	Oct. 62	Slep
Oct. 61	British Radio	23	Instructograph	23, 87	Space
Jun. 62	Broadnax	Nov. 62	Inst. and Comm.	77	Space Raider
67, 82	Burghardt	5	International Crystal	Oct. 61	Spencer
May 62	Burk	45	Irving Electronics	Jun. 62	Spera
15	B & W	Apr. 63	J & D Labs	55	Sprague
Apr. 63	Byron Airpark	87	Jeffronics	89	Subscriptions
81	Calamar	Sep. 61	Jennings	4	Supreme
73	Callbook	35	Johnson	33	Swan
Nov. 62	Candee	Aug. 61	JSH Electronics	95	T A B
Feb. 63	CB Electronics	Jan. 63	Kar-Tenna	Feb. 63	Technical Manuals
51	Charter Oak	Feb. 63	KTV Towers	29	Technical Materiel
7	Clegg	Feb. 63	Ladd	45, 57	Telrex
Apr. 63	Cleveland Institute	3	Lafayette Radio	Apr. 63	Tepabco
87	Columbia	Mar. 62	Lefor	Jul. 62	Texas Crystal
33	Columbia Products	Nov. 62	Limachi	Apr. 62	Texonic
Oct. 62	Continental QSL	31	Linear Systems	60	Topaz
Apr. 63	Cornell-Dubilier	Mar. 61	L R Electronics	Jan. 63	Transceivers
41	Cubex	Oct. 62	L W Electronics	Jan. 63	Trembley
41	Cushcraft	Jun. 62	Maps, W5GOS	70	Tri-Ex
Jul. 62	Davco	Apr. 63	Master Mobile	56	Tri-State
Apr. 63	Delta	43	McCoy	Feb. 63	US Crystals
77, 83	Denson	May 61	Mercury	Dec. 62	US #1 Electronics
Apr. 62	Donna's Ceramics	Aug. 62	Mesco	11	U. T. C.
50, 57	Dow Key	89	Meshna	Apr. 63	Valley
57	Dow Radio	51	Metrodynamics	39, 77, 81, 83	Vanguard
49	Drake	Feb. 63	Miller	86	Verns
Mar. 63	Ebco	75	Mini-Products	Jan. 62	Versatronics
May 62	Editors & Engineers	57	Mission	Feb. 63	Vesto
Feb. 63	Ed-U-Cord	Jun. 61	Mobiliers	51	V & H
Feb. 62	EICO	Jan. 63	Mor-Gain	Jan. 63	Vibroplex
Mar. 63	Electro-com	Apr. 63	Mosley	Dec. 62	Waber
Apr. 62	Electronic Specialists	Sep. 62	Multi-Products	19	Waters
May 62	Electrophysics	IV	National	Apr. 63	Webster
Jul. 62	Elliot	73	New Products	Jul. 62	Wegner
81	Epsilon Records	27	Newtronics	39	Western (Calif.)
79	Evans	51	Northwest	73	Western (Neb.)
6	E-Z Way	Dec. 62	Nortronics	51	Wildcat Press
83	Fair	Mar. 62	Organs & Electronics	64, III	World Radio Labs
79	Finney	45	Out-O-Door	Apr. 62	Zalytron
88	F-M	Dec. 62	Pacific Plantronics	34	Foreign Subs
Aug. 62	Fort Wayne	Nov. 61	Palmer	89	73 Subscriptions
83	Gain, Inc.	23	Pausan	90	73 Products
Feb. 63	Gam	Dec. 62	Pel	91	73 Parts Kits
		Dec. 61	Penwood Numechron		





from **ALLIED**

**NEW!**

useful, practical *knight-kit*<sup>®</sup>

**WALKIE-TALKIE!**

ALL-TRANSISTOR 2-WAY TRANSCEIVER KIT



PRICED AMAZINGLY LOW AT ONLY... **\$ 9<sup>95</sup>** EACH

SAVE **\$1.02** BUY A PAIR FOR ONLY... **\$18<sup>88</sup>**



- Use it to tune up antenna in the field
- Ideal for interesting youngsters in electronics
- No license, exam, permit • Range up to 1/4 mile

Here's a *quality* 2-way Knight-Kit designed for real utility and fun. In just a few hours you'll have this 3-transistor job assembled and ready for reliable on-the-move communication. The C-100 is fine for getting your antenna tuned up in the field; useful for camping, hunting, boating or 2-way neighborhood talk. Push-to-talk button puts you on the air (built-in 2" speaker serves as mike). Release button to listen. Fits your hand perfectly—only 5 3/8 x 2 7/8 x 1 3/4". Operates up to 75 hours on one low-cost battery. Includes high-impact blue case, all parts, transmitting crystal, wire, solder, instructions. Less battery (listed below). Wt., 9 ozs.

- 83 Y 804FE.** C-100 Walkie-Talkie Kit. Only **\$9<sup>95</sup>**  
Buy a Pair and SAVE! Two For Only... **\$18.88**
- 83 Y 013.** Leatherette Carrying Case with shoulder strap..... **98¢**
- 83 Y 002.** 9-Volt Battery..... **21¢**

*satisfaction guaranteed or your money back*

GET MORE FOR YOUR MONEY WITH KNIGHT-KITS...

OVER 100 MODELS, INCLUDING OUTSTANDING AMATEUR, SHORTWAVE & CB EQUIPMENT

**ALLIED RADIO**

**ALLIED RADIO**

100 N. Western Ave., Chicago 80, Ill.

Ship me the following:

- ..... C-100 Walkie-Talkie Kit(s) 83 Y 804FE
- ..... Carrying Case(s) 83 Y 013
- ..... 9 V. Battery(ies) 83 Y 002
- \$.....enclosed (check) (money order)

Name \_\_\_\_\_ PLEASE PRINT

Address \_\_\_\_\_

City \_\_\_\_\_ Zone \_\_\_\_\_ State \_\_\_\_\_

**ORDER TODAY**

**the greatest thing that's happened  
to amateur radio in years!**

# Galaxy 300 watt

**SSB/AM TRANSCEIVER 80-40-20 METERS**  
Selectable upper or lower side bands

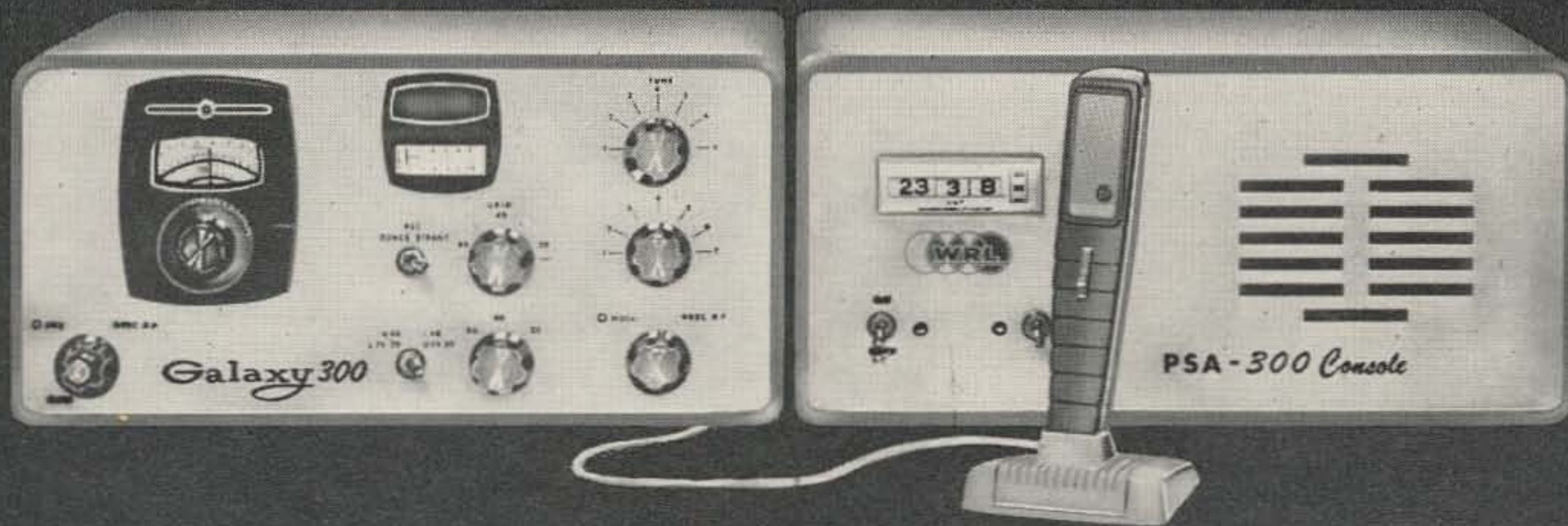

*Exclusive from WRL only!*

**A 300 WATT SSB/AM TRANSCEIVER WITH LUXURY FEATURES  
FOR LESS THAN ONE DOLLAR A WATT.**

**\$299.95 WIRED (the price of a single receiver or transmitter.)**

This is the Galaxy 300. □ It's quite a single side band-AM transceiver. □ It may very well change your ideas about more expensive transceivers. □ It's a full featured SSB/AM transceiver with 300 watts of power—priced like a single receiver or xmitter—less than one-fourth the price of conventional SSB transceivers. □ How can it be priced so low?—Engineering know-how and selling to you direct from our factory—an aggressive business step on our part. □ Here is what makes the Galaxy so good: Input, 300 Watts PEP on SSB, 175-AM—Selectable Sideband—Automatic Load Control—Separate RF & Gain Controls—9.1 MC Crystal Filter—Stable Linear VFO—1 UV Sensitivity for 10 db S/N—Smooth Dual Vernier Tuning: ratio 72:1 or 12:1—P.T.T. & Vox Operation (Vox optional \$24.95)—Mobile or Fixed Station—Full Year Parts Warranty. □ All this for \$299.95 f.o.b. WRL. Relieve that "expense tension" at your home and order a Galaxy now. You must be satisfied—or money back!

#### MATCHING POWER SUPPLY "PSA-300 Console"

Best choice for your AC Supply. Styled to match the Galaxy 300. Designed for "Full Power" operation. Completely wired with speaker. "Numerchron" clock optional.

66NA037	Less Clock	\$ 99.95
66NA038	With Clock	\$119.95

Mobile Supply "G 300 DC" designed for "Full Power" operation.

66NA041	12VDC Transistorized	\$119.95
66NA042	Mobile Mtg. Bracket	\$ 14.95



**WORLD RADIO LABORATORIES**

3415 West Broadway • Council Bluffs, Iowa

• Phone: 328-1851

## **WRL** WORLD RADIO LABORATORIES

3415 West Broadway, Council Bluffs, Iowa

- Rush Detailed "Galaxy 300" Brochure.
- Send "Charg-A-Plan" Credit Application.
- Quote "Trade-ins" on Attached Letter.

NAME \_\_\_\_\_

ADDRESS \_\_\_\_\_

CITY & STATE \_\_\_\_\_

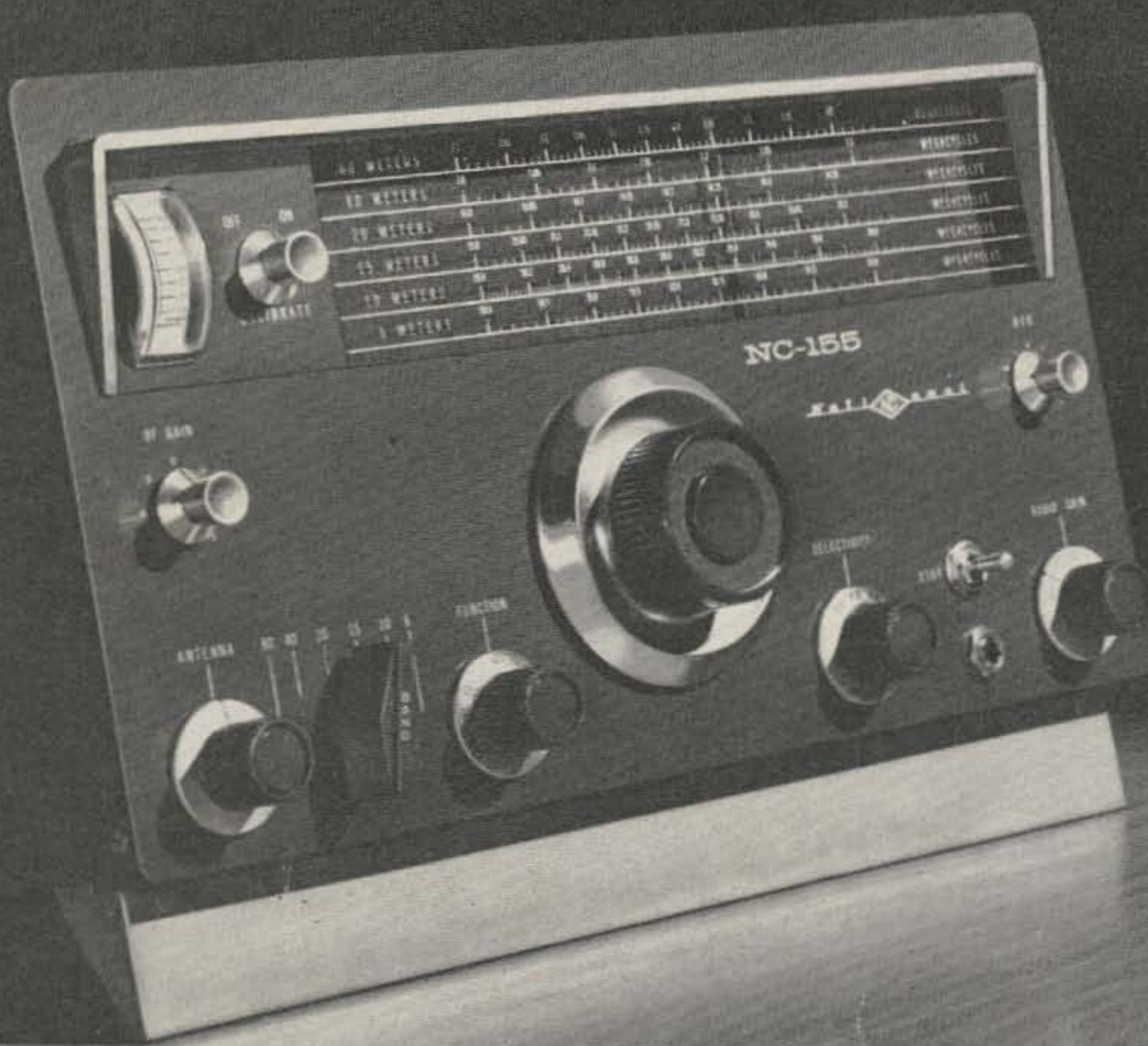

*Still Think SSB is Hard to Tune?*

## **TRY THE AMAZING NATIONAL NC-155**



SSB handles as easily as AM on the NC-155. National designed it that way. For example, the dial drive ratio is 60:1, almost twice as slow as on an ordinary receiver. An exceptional product detector and clean SSB AGC eliminate distortion difficulties. The Ferrite-Filter with three-step variable IF selectivity easily separate crowded SSB signals. Rock-solid mechanical (try the drop-test) and electrical stability eliminate constant "touching up". The NC-155 gives you this ease of performance on all bands from 80 to 6 meters... with double conversion and 1 $\mu$ v sensitivity. Compare the tuning ease of the NC-155 with receivers costing hundreds of dollars more — see if you don't agree that it more than holds its own with the best of them. \$199.95

### WRITE FOR FREE COPY OF NEW NATIONAL EQUIPMENT GUIDE

- Complete technical details and features of all National gear
- Tells all about National's exclusive One Year Guarantee
- Helps you choose the right equipment for your needs



A Wholly Owned Subsidiary of National Company, Inc.

Export: Ad Auriema Inc., 85 Broad St., N. Y. C.  
Canada: Tri-Tel Assoc. Ltd., 81 Sheppard Ave. W., Willowdale, Ontario

### **NATIONAL RADIO COMPANY, INC.**

37 Washington Street Melrose, Massachusetts



**NC-105** — Designed specifically for the beginning amateur. Offers such needed features as general coverage Q-Multiplier, product detector, S-meter and transformer power supply. Also available in handsome walnut cabinet for use in den or living room as a second receiver. \$119.95



**NC-140** — New *double-conversion* general coverage receiver with National's exclusive Dial Selector for calibrated foreign broadcast and amateur bandspread. Q-multiplier, RF stage, and S-Meter. More important features than any receiver in its price class. \$189.95



**NC-190** — First general coverage receiver to offer calibrated foreign broadcast as well as amateur bandspread! Exclusive Dial Selector, double conversion, product detector, and SSB/CW AGC. 60:1 dial drive provides amazing tuning ease on all signals. \$219.95