

\*\*\*\*\*3-DIGIT 857  
J063776 D08 8704 8857 947  
BARRY MISHKIND  
CE  
KXEW  
2038 AUGUSTA PL  
TUCSON AZ 85710

"The Satanic Verses" on Radio  
See page 7

# Radio World

Vol 13, No 7

Radio's Best Read Newspaper

April 12, 1988

## Court OKs 80-90 Appeal

by Charles Taylor

**Washington DC** A federal appeals court here has declared that the FCC did not follow legal notice and comment requirements in a 1984 nationwide omnibus rule making that created 684 new FM channels.

The new channels came about as a result of docket 84-231, following the far-reaching docket 80-90, which in 1983 created three new intermediate classes of FM stations from which the 684 channels were derived.

### "Reeder vs the FCC"

Six petitioners filed the case in a Washington federal appeals court under "Reeder vs. the FCC" and specified several arguments against the Commission's procedures in allocating frequencies within the new classes C-1, C-2 and B-1.

Stations within these classes are

placed geographically closer than the established classes A, B and C.

The court decision does not impose fines or penalties on the Commission, only recommendations of compliance, according to James Bayes, a partner with Wiley, Rein & Fielding, which represented two of the petitioning parties.

"(The court) agreed with the petitioners that the Commission violated the notice and comment requirements of the Administrative Procedures Act, therefore it granted their appeals, but they did not specifically direct what the Commission should do," he said. "The FCC is expected to conduct further proceedings that are not inconsistent with what the court found."

In response, the Commission is preparing a document that will "try to address the court's concerns as much as possible," said Karl Kensinger, chief of the FCC's allocations branch.

He could not discuss details of the response being drafted, though he said the Commission hopes to present it by early summer.

### Overall ramifications

Perhaps the primary concern prompted by the case is the effect the decisions may have for the group of 684 allocations under 84-231.

Kensinger admitted the possibility of the case setting a precedent for other

licensees displeased with their inability to upgrade, but doubted it would occur.

"There is some language in the opinion that could be read broadly," he said. "There are some indications that the court was concerned that there was improper notice and comment to the extent that that undercuts the validity of every one of the (684) allotments made in that proceeding."

(continued on page 8)

## RDS Gives Station IDs

by John Gatski

**Arlington VA** Like most radio receivers, those on display at the recent Sixth Annual World Broadcasters Union conference in Washington, DC, emitted the frequency 105 when switched to WAVA-FM in Arlington.

Unlike most radio receivers, these receivers also digitally displayed the call letters and the station's slogan, "WAVA, Fun All Morning, Music All Day."

The ability to transmit extra data to radio receivers was provided by Radio Data System (RDS), which was developed by the European Broadcasting Union.

RDS data was demonstrated through a subcarrier encoder during a two-week test from WAVA.

Several RDS manufacturers from Europe, including Philips, Ford and Volvo, displayed several auto and home receivers at the conference.

The system is now taking hold in Europe and can offer different services ranging from a station ID to automatically tuning a car radio to a preselected music format even while traveling through different locales.

The EBU and manufacturers of the RDS receivers and encoders are hoping to demonstrate their products at the NAB convention in Las Vegas.

### High frequency subcarrier

According to Andy Baker, a BBC projects engineer involved with RDS, the

subcarrier is located on 57 kHz and is similar to a double sideband suppressed subcarrier.

The subcarrier is a "two phase, phase (continued on page 10)



## DYNAMAX LEADS COMPETITION BY NEARLY TWO TO ONE

The New Professional Audio Marketplace (PAM) Census and Survey from Sheer and Chaskelson Research, Inc. reports that an estimated 47.6% of all broadcast facilities planning to purchase cartridge machines in the next twelve months have chosen DYNAMAX by a margin of nearly 2 to 1 over any other brand of cartridge machine.

For more information, contact Fidelipac Corporation.



Fidelipac Corporation □ P.O. Box 808, Moorestown, NJ 08057 □ U.S.A.  
609-235-3900 □ TELEX 710-897-0254 □ FAX 609-235-7779  
Dynamax is a registered trademark of Fidelipac Corporation.

## Support for Radio Bill

by John Gatski

**Washington DC** Station and group owners reacted positively to radio-only legislation recently introduced in Congress to eliminate payoffs to third parties during license renewal.

The bill, HR 1136, would amend the Communications Act of 1934 by setting up a two-step license renewal process in which the Commission will renew a license if a station presented programming addressing local issues and committed no violations of federal radio regulations during the licensing period.

Other parties could only file competing applications or petitions to deny if the station did not meet these conditions, according to the bill. The bill also prescribes a system for considering informal complaints during the license term.

The move seeks to eliminate the alleged money-making, payoff deals that

(continued on page 15)

## NEWS BRIEFS

### Lyman Starts New Group

**Washington DC** Already, Jerry Lyman's new Radio Ventures acquisition partnership is sifting through "opportunities" for the start-up broadcast group.

The former RKO Radio president left the network 17 March to become president and COO of the group that Lyman launched with The Carlyle Group, an organization of merchant bankers in the headlines

for its buying of Coldwell Banker and Fairchild Industries. Partners also include three Washington, DC, lawyers—Ralph Hardy, Bill Perry and Leonard Baxt, all of Dow, Lohnes & Albertson known as 1255 Equities.

Lyman said Radio Ventures will buy stations in markets 30 to 75 and maybe 75 to 100 that are in the East to Midwest regions.

Lyman's new offices are in

Washington: 1001 Pennsylvania Ave., Suite 220-South, Washington, DC, 20004.

### Radio Marti Anytime

**Havana CUBA** Voice of America's Radio Marti began 24-hour broadcasting of US government programming into Cuba 20 March, increasing air time from 17½ hours.

"The expansion broadcast hours are in response to the continuing need in Cuba for reliable,

objective news and programming," the VOA said in a release.

Radio Marti added a half-hour newscast and other new programs to a weekly broadcast schedule of news, public affairs and entertainment. Additions throughout the daily schedule include an original comedy series reflecting Cuban daily life, human rights programs, an overnight music program and a young people's music program on weekends.

### Bose FMX Report

**Cambridge MA** The Massachusetts Institute of Technol-

ogy (MIT) has made the Bose Corp./MIT study of FMX available as a technical report.

The report titled, "A Theoretical and Experimental Study of Noise and Distortion in the Reception of FM Signals" (RLE Number 540), can be obtained by sending \$7.50 to the Research Laboratory of Electronics, Communications Office, Room 36412, MIT, Cambridge, MA 02139. For more information, call 617-253-2566.

### ADM Reorganizing

**Troy MI** ADM Technology Inc., designer and manufacturer of audio equipment, was acquired by an investor group including Dewey Norton, president and CEO, and Richard Stiennon, marketing VP.

The company also has filed for reorganization under Chapter 11, according to the company. Founder Robert Bloom was retained as a consultant.

Norton comes to the company with an extensive background in finance, and Stiennon was president of an engineering consulting firm he founded.

### World Conference Aims for Cooperation

**Washington DC** Two hundred executives from nine broadcast unions from around the world aimed at securing "long-term international cooperation" at the tri-annual Sixth World Conference of Broadcasting here in March.

Participants, including the European Broadcasting Union, Asia-Pacific Broadcasting Union and the North American National Broadcasters Association, focused in closed sessions on legal, economic and technical problems they foresee in the 1990s.

Topics relevant to radio included satellite and new technologies, deregulation and training. There were also discussions concerning paying for broadcast rights for sporting events.

# WHY DIDN'T SOMEONE THINK OF THIS BEFORE?

## A FAST-PACED PRODUCTION CONSOLE

**T**HE WHEATSTONE SP-6 AUDIO CONSOLE lets production people quickly accomplish 8 and 16-track work, yet easily handle routine transfers and dubbing operations. With its unique track monitor section it can facilitate simultaneous stereo mixdown during the multitrack bed session—almost halving typical production time cycles. Input channels are laid out just like an air console, with machine starts below the channel fader, so staff familiar with on-air consoles can quickly become comfortable in the production environment.

For those interested in more advanced techniques, the SP-6 employs a powerful talent monitor section designed to rapidly call up live mic and track combinations, making difficult punch-ins a breeze. Standard SP-6 input channel equalizers are more comprehensive than

those supplied as optional items on competing products, allowing much greater creative freedom. Input channel auxiliary send sections are designed to be the most versatile in the industry, providing 4 different auxiliary buses to allow digital delay, reverb, talent foldback, and mix-minus feeds. Stereo input channels can provide either mono or stereo effects sends. Even more, the SP-6 has 4 auxiliary effects return inputs that allow effects to be recorded onto the multitrack or sent to the monitor buses.

The SP-6 provides independent headphone, control room and studio monitor feeds, as well as stereo cue solo. Control room and studio mute and tally functions are independently dipswitch selectable on individual input channels. Additional studio modules may be ordered to accommodate larger, multi-studio installations. The SP-6 may be configured with any combination of mono and stereo input modules, in mainframe sizes ranging from 16 to 32 or more inputs. The console is available in either an 8-track production format or a 4 stereo subgroup TV master control configuration. So why not profit from Wheatstone's experience and reputation? Call us today and learn more.



 Wheatstone Corporation

6720 V.I.P. Parkway, Syracuse, NY 13211

TEL 315 455 7740 FAX 315 454 8104

See us at NAB Booth 1034

Circle 70 on Reader Service Card

## INDEX

- Spring Tonic for Tired Stations**  
by John "Q" Shepler 17
- Staying Free From FCC Fines**  
by Harold Hallikainen 18
- The Nitty Gritty of Instrument Miking**  
by Bruce Bartlett 19
- KBRD's Tale of Three Sisters**  
by Dee McVickers 21
- A Tour Through Desktop Audio**  
by Mel Lambert 22
- From Square One to Solid State**  
by Ed Montgomery 25
- How to Set a Pass-Reject Trap**  
by Frank Colligan 27
- AM Stereo and Historic Calls**  
by George Riggins 29

# Ice Storms Prompt Power Cutbacks

by Charles Taylor

**Washington DC** Listeners here wondering why WPGC-FM's signal lost some of its punch during the first week of March could have discovered the reason simply by glancing out a window.

Like much of the mid-Atlantic region, metropolitan Washington was coated in a solid sheet of ice following a winter storm 6 March that prompted a number of stations along the coast to reduce power so that reflected power wouldn't damage transmission lines.

"It was unusual here in the East because of the magnitude of the icing," said WPGC CE Tom McGinley. "We normally don't see storms like this except every five years or so."

Stations in other markets also reported power modifications because of the weather, though in most cases the inconvenience was short-lived.

"We went down to 50% (the morning of the storm) in order to compensate to what I thought was a fair percentage of reflected power, then we raised it to 75% and were back on full as soon as it actually stopped snowing," said Phil Harris, CE at WMMR-FM in Philadelphia.

Harris said that an inch of ice that formed on the station's 730'-tall antenna most likely could have been avoided if

heaters had been installed when the antenna was raised.

"We have a four-bay antenna put up in 1980. They purported to us that heaters are not necessary and a waste of money so they weren't installed," he said. "We've had four periods since 1980 when we had several hundred watts of reflected power, which I consider an unsafe amount."

The station will move its antenna site later this year, Harris said. "You can bet that the new site will have an ice management system."

At WPGC, more than an inch of ice accumulated at the station's antenna site in District Heights, MD. As a result, McGinley said he was forced to cut back 50% of its power for several days pending warmer weather.

"We normally run 40 kW forward and 50 W reverse power. We were detuned all the way to 1200 W reflected when we were running half power at 20 kW," he said.

WAEB-AM/FM in Allentown, PA, was not affected, thanks to a twist of fate.

CE Harry Simon said that because of an unrelated transmission line problem in the station's main antenna, operations were switched to an auxiliary antenna.

"There's no question that we had ice, but it was of absolutely no consequence to us at all," Simon said.

## RF a Hot Topic at EEPA

by John Gatski

**Alexandria VA** Scientists, company and government officials are discussing the myths and reality about RF radiation at the Electromagnetic Energy Policy Alliance's (EEPA) fifth annual meeting and symposium, held here 12-14 April.

The conference is at the Radisson Mark Plaza Hotel in Alexandria and among the topics are the effects of RF exposure to humans from broadcasting facilities.

"For non-ionizing energy, this is really the chief conference of the year," said Barry Umansky, EEPA board member and NAB deputy general counsel.

On Thursday, the morning session, "The Language of Risk and Assessment of Communication," deals with the RF energy's definition and where it is found. During the afternoon session, "Research: In Search of Risk," scientists are to discuss research and what has been discovered about exposure to RF radiation.

The Thursday afternoon speakers include consultant Jules Cohen and Eleanor Adair, Ph.D, a researcher from the John B. Pierce Foundation.

Umansky said Adair conducted some

RF experiments on herself to note their effects.

On Friday, the morning session, "Electricity: Is There A Risk," deals with the possible effects of RF radiation from common sources as electric lines, household appliances and work place machines such as computers.

Common appliance RF exposure is a fear that has gained attention in the last few years, Umansky noted.

Speakers at the Friday session include scientists from AT&T Bell Laboratories and Johns Hopkins University.

The final session wraps up with, "Reality: Litigation, Legislation and Education," a discussion of the regulations and legal risks involved with RF exposure.

Umansky said there are few regulations and guidelines for RF exposure standards other than FCC guidelines for placing transmitters a certain distance from inhabited areas.

The EPA decision not to finish work on national RF guidelines has further complicated the issue, Umansky added.

"That's why, for broadcasters, we can't stress enough to comply with the FCC standards," Umansky said.

For more information, contact Barry Umansky at 202-429-5456.



## Nothing But The Best.

The Studer A730 can identify up to 100 CD's and store up to three start and stop times for each. Playing a pre-selected track on a disc is as easy as loading and hitting a single button. The A730 adds auto-cue, varispeed, auto-pause, a monitor speaker, the widest choice of audio and control interfaces, and rock solid construction.

Call Toll Free 800-732-7665



**BRADLEY  
BROADCAST  
SALES**

Where Service and Engineering Make the Difference

8101 Cessna Avenue • Gaithersburg, Maryland 20879-4177  
MD & DC: 301-948-0650 • FAX: 301-330-7198

## So Many Ways Better

### Broadcast Electronics' FM-3.5A 3500 Watt FM Transmitter

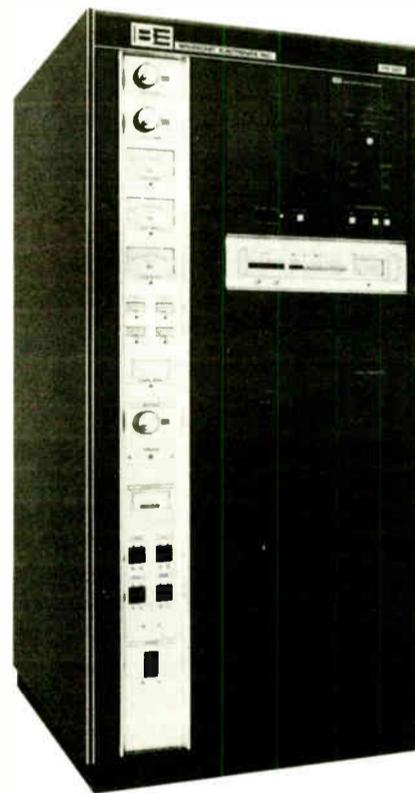

- First with a 4CX3500A one tube design.
- Patented folded half-wave cavity eliminates plate blocking capacitor and sliding contacts.
- Our own solid state broadband IPA in slide out drawer.
- Industry standard FX-30 exciter.
- Emergency 250 watt patching.
- First with automatic power control that maintains constant output power with proportional VSWR foldback protection.
- Ten individual meters.
- Optional microprocessor video display system (MVDS) with diagnostics.

The Model FM-3.5A single tube FM transmitter is the first choice for optimum Class A service. Over seventy on the air in the United States, Canada and overseas.

**BE<sup>®</sup> BROADCAST  
ELECTRONICS INC.**

4100 N. 24th ST., P.O. BOX 3606, QUINCY, IL 62305-3606, (217) 224-9600, TELEX 250142

# One-Armed Bandit Rides Again

by Judith Gross

**Falls Church VA** Awwwk! NAB Convention time again? Las Vegas, here I come.

The shiny metal, the buzz of excitement, the feeling of elation... and that's before you even get out of the casino.

My game is the **one-armed bandits** and I always win (you can verify this with J.G.'s colleagues). Stick with me, I'll tell you more at the end of the column.

Before all 90,000 of you stop us on the exhibit floor and ask "What's new this year?" take a look at the rest of this preview issue, complete with all the listings you need.

But yes, there *are* some real innovations this year, at least a few I'm excited over. Of course, you're gonna have to go and have a look for yourself.

What's going to set things buzzing at the show are the new products that represent **true innovations** in the industry, either new trends or new technology put to practical use.



Definitely worth a close look is **QEI's Digital Stereo Link** which lets stations use T-1 telephone lines for composite signals.

They do it with 16 bit companded encoding and decoding, and it's designed to let stations take advantage of the more cost effective telco lines, now that equalized phone lines are no longer available.

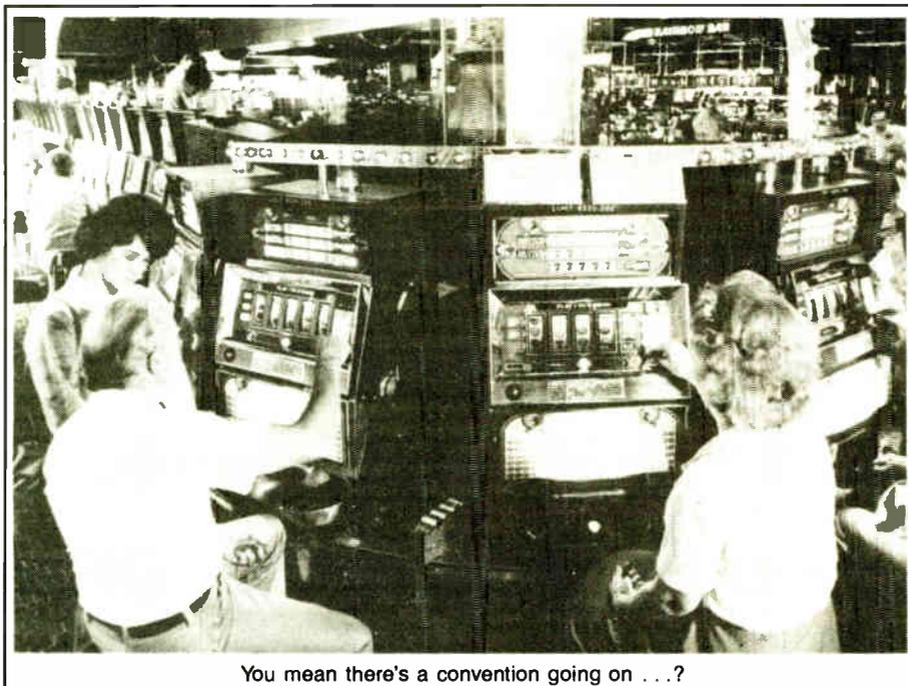

You mean there's a convention going on...?

The development of this product, working in the digital domain, was quite an effort, and **QEI** says it wants to get some feedback on possible features to incorporate. So stop by and let them know what you think.

Then head on over to **AKG's booth** and take a look at a product which really represents a surprise from this company.

The **DSE 7000** is a digital sound editor which will be demonstrated hourly. It's a RAM-based audio workstation designed specifically for radio station work: spots, jingles and the like.

The **DSE 7000** allows digital editing of audio, includes an integral digital mixer with ten inputs, 4.4 minutes of RAM memory (expandable) able to be allocated from one to eight tracks and a variety of other functions.

Lots of companies have been entering the digital audio workstation market, but this is the first designed with a radio station's needs firmly at the forefront.

**Consoles** always comprise a cutthroat

sort of market and recently the trend has been toward more cost-effective models: witness **Radio Systems** product offering at last year's show.

Now how does a console manufacturer keep performance high while meeting the station's budgetary considerations?

Shrouded in mystery is the way **Pacific Recorders & Engineering** has chosen to answer that question. Yes, there's a new console. It's called **Radiomixer** and that's about all the company was saying about it just before the show.

Of course there are lots of other products to look at. **Harris** will have its **DX-50**, the 50 kW version of its digitally modulated transmitter and look for the former **Texar** processing products at **Gentner's booth**, with an innovation or two expected there.

In fact the processing field is getting pretty interesting these days. We have the move into the digital realm, as with **Valley International's** product and lots of smaller companies emerging with their own advances.

On the other hand, we have the general feeling that the loudness and super-modulation wars have taken FM about as far as it can go. So there's a company like **Aphex** pushing audio quality as an alternative, with its audiophile approach to processing.

OK, just one more word about processing and related gear. The term "MIDI" is now firmly entrenched into audio jargon. You can expect to see more of it incorporated into more traditional studio gear.

☆☆☆

What would the NAB show be without those kind-hearted folks to feed us? Two opportunities for **goodies** I want to bring to your attention—although there may be more to munch on once we get to the exhibit floor.

One is a hospitality suite being sponsored by **Teletech Inc.**, a telecommunications and engineering consulting firm. It will be at **Caesar's Palace**, so peel me a grape while you're there, especially on Saturday evening, when the company plans its **Roman Holiday bash**.

And from the company which brought you Philadelphia pretzels last year comes another Philly treat.

**Radio Systems** plans to give away

**Tastykakes** at its booth, so do we dare tell you that the company has actually moved across the Delaware River and is now in its new digs in Bridgeport, (that's right) in **Joisey**?

What's next after all these goodies, **Radio Systems**, a free membership to a health spa?

☆☆☆

And in the interest of helping to clarify the endless convention jargon you'll be likely to hear over the next few weeks, here are some common statements made by convention-goers—with appropriate translations.

**From attendees:** I'm limiting my booth visits to companies where I have serious business. (I'm only going to those booths that give out freebies.)

I want to spend some quality time in the exhibit hall. (I need to kill a few hours 'til the hospitality suites open.)

I'll be getting cassettes of the early-bird sessions. (I was up late last night at the roulette tables.)

I'm interested in receiving your product literature. (I collect brochures to impress the boss.)

This is an item we would budget into our five-year plan. (We won't buy these until we run the ones we have into the ground.)

I've been spending my time at the important sessions. (The seminars are a great place to take a nap.)

**From exhibitors:** The show was good for quality contacts, not quantity. (No one has been by; you could fire a cannon in the aisles.)

We're in a prime location. (Between the cocktail lounge and the restrooms.)

Sorry, Mr. So-and-So isn't in right now, he's in a meeting. (He's sleeping off the partying he did at the hospitality suites.)

This product is our latest innovation. (It's last year's gizmo with a few buttons added.)

This is an engineering prototype. (Who knows if this thing will work?)

We're taking orders right here at the show. (We need the bucks to pay for our rooms and all the partying we're doing here.)

**From the trade press:** It was a record attendance. (Five more people showed up this year, or, we counted everybody twice.)

Show officials say the new floor plan and booth assignments were a success. (Nobody had the slightest idea how to find anything except the bar and the restrooms.)

Attendees reported better food service this year. (The hot dogs weren't as soggy and the beer wasn't so warm.)

The convention chairman's opening remarks were cordially received. (Nobody threw any tomatoes at him.)

Our experienced team of reporters covered the convention thoroughly. (We only left the press room when happy hour started.)

Oh yes. About those **one-armed bandits**. There's really no system but the trick is to pick them very carefully. I only frequent the ones with all the **cherries**. Really. What can I say, it never fails. Especially at the casino in the Sands.

But who has time for gambling? There's a show to cover. See you **on the strip**.

Heard something interesting? Spill your guts to **Earwaves**. Write PO Box 1214, Falls Church VA 22041, or call me at 703-998-7600. Best tidbit of the month wins a coveted 1989 edition **Radio World** mug.

## PRECIOUS METAL Has a whole new ring!



**DYNAMAX Cobalt**—a new generation of tape cartridge loaded with broadcasting's first cobalt tape.

**DYNAMAX Cobalt** cartridges give you more than 2dB of additional headroom where you need it most. So, CD's sound like CD's and your spots and jingles sizzle!

## DYNAMAX

Cobalt Cartridges from Fidelipac

For a great price and the world's fastest delivery, call

**GBS-GIESLER BROADCASTING SUPPLY, INC.**

5914 Maple

Houston, Texas 77074

Toll Free: 1-800-634-8601

# Digital Modulation Over the TV Band?

by Chip Morgan

**Sacramento CA** Audio-only broadcast services have not had a major technical improvement since FM stereo was introduced 28 years ago in 1961.

With the upcoming reallocation of spectrum in the UHF and VHF TV bands, now is the time for digital modulation for broadcast audio. This new type of modulation (which I suggest we call DM) could be transmitted on unused TV channels in each market.

FM was successful primarily (in my opinion) because it was "static free" and in stereo. This was a major improvement over even the best AM transmitters and receivers.

## GUEST EDITORIAL

A new generation of Digital Modulation receivers could easily receive the DM stations and could even scan for available stations spread throughout the present TV band.

Instead of using a frequency or a channel number to identify the station, a display could show a station's logo or identifier such as "Power Hits," or even have a graphic display. The legal ID could be encoded in the data stream.

For the sake of argument, let's suppose that each 6 MHz TV channel could hold 10 DM stations. A small market might only need a single TV channel, a medium market could use two or three channels and a large market could require four or more TV channels.

■ ■ ■

Chip Morgan is president of Chip Morgan Broadcast Engineering, 216 Selby Branch Road, Sacramento, CA, 95864. He may be phoned at 916-973-9734.

The DM signal could be modulated so that there would be no interference to nearby existing TV stations.

Because of environmental concerns and to ensure the best coverage, groups of 10 DM stations could be multiplexed on a single transmitter located at the best TV transmitter site in the market.

### History of broadcast FM and TV

FM operation began in 1941 with 35 channels for commercial and five channels for noncommercial FM. In 1945 the FM band was changed from 42-50 MHz to the present 88-108 MHz. At that time the number of channels was increased, allowing 80 commercial channels and 20 noncommercial educational channels, for a total of 100 channels.

Although TV experiments began as early as 1884, commercial TV began in 1941. In 1945 the FCC allocated 13 VHF channels—12 of the channels were shared with two-way radio. In 1948 TV Channel 1 was deleted and assigned to land mobile and two-way service.

In 1952 the Commission added 70 UHF channels to the 12 VHF channels, for a total of 82 TV channels. No new frequencies have been allocated to commercial broadcast services for 37 years (more than half the age of commercial broadcasting).

Although this is not written with the intention of suggesting technical standards for Digital Modulation, here are a few thoughts for consideration.

In order to comply with CCIR Recommendation 601, allowing compatibility with existing and probable future formats, we would use a sampling rate of 48 kHz with 16 to 20 bits for the audio channels (probably four per DM station). We might consider an extra one or two data channels to go with each DM station.

Current technology could allow receivers to scan for the specific frequencies allocated to each area, allowing the "DM" stations to use unbuilt or unallocated frequencies in each area.

### Other possibilities

Each receiver could also have programming for auto EBS tuning to a spare channel in the system. The EBS channel could be regulated to allow only public service programming such as time, temperature, PSAs, emergency announcements, etc. The primary EBS station in the market could be responsible for programming that channel.

Data channels could be used to control "smart homes."

Home and car receivers could transmit tuning feedback on a data channel giving continuous real-time listening habit information for ratings and research.

Guard bands could be employed to allow the DM bands to be used close to existing TV allocations.

Home receiving antennas and cable TV head-end antennas would already be installed and because the DM transmitter would be co-located with the market's TV transmitter, antennas would already be pointed at the broadcast towers and reception would be equal and predictable. Car radio antennas in existence could work without modification.

"What's hot on the exhibit floor?"—is a question that echoes during the four days the NAB convention sets Las Vegas buzzing.

Too often there's a temptation to focus on the headline-grabbers while overlooking solid breakthroughs which may not appear to be as "sexy."

New products and industry innovations come about after many long and sometimes heartbreaking hours of research and design and not without a heavy cost to the companies which develop them.

Yet better "mousetraps" for radio stations emerge even in a climate that by all rights should work against their introduction.

After all, radio is a 60-year old technology and while stations clamor for the latest gizmo for promotional reasons, most of them have survived and prospered with relatively few changes in the technology over the medium's long history.

## Beyond "Sizzle"

Today, with the high debt service some stations face, with the scarcity of good engineering talent and with the general skepticism that surrounds any new idea, it's a wonder companies take time to design and develop new products for radio stations at all.

Yet they do, with practical applications for new technologies and new uses for existing ones, many times with the customer's bottom line in mind. New products at the NAB this year fall into both categories. There is the continuation of digitally modulated transmitters for AM; the use of T-1 telephone lines in a new STL design; a digital audio workstation and more cost effective yet high-performing console designs.

Visitors to the convention would do best to look beyond the glitter and consider the substance of the exhibits before them.

Healthy skepticism notwithstanding, companies brave enough to venture forth with new products deserve serious attention and a hearty round of applause. —RW

With the upcoming reallocation of TV spectrum, audio broadcasters (FM and AM station operators) should rally to request the FCC to implement a new band for the transmission of digital audio. The

band could be called the "DM" band for digital modulation.

If we don't do something about this now, audio broadcast services won't be competitive at all in ten years!

## READERS FORUM

If you have comments for *Radio World*, call us at 800-336-3045 or send a letter to Readers' Forum (Radio World, Box 1214, Falls Church VA 22041 or MCI Mailbox #302-7776). All letters received become the property of Radio World, to be used at our discretion and as space permits.

### Column in error

Dear RW:

Your 8 March 1989 column mention of the Bose report on FMX is wrong to assert the "NAB's own weekly newsletter to stations only gave the BTP side" of the story.

I quote the second paragraph of that story in its entirety:

"According to news reports, Bose scientist William Short said a Bose test showed the FMX reduces station coverage and degrades performance on existing FM receivers. Bose Corp. also said that FMX receivers are inferior to existing FM receivers for receiving FMX transmissions."

*Radio Week* was very careful to report both sides of this story.

Walter Wurfel, Senior VP, Public Affairs and Communications, NAB Washington, DC

### Pirate not illegal

Dear RW:

I would like to comment on your page two *News Brief* of 8 February 1989. Your brief article about the RNI decision needs some clarification.

Judge McNaught based his decision about Radio New York International on the fact that the MV Sarah was registered to the state of Maine, and this, solely, gave the FCC jurisdiction over the vessel.

The MV Sarah was, in fact, registered with the principality of Sealand. This vessel was outside the territorial limits of the United States during its four days of operation in 1987 and 1988, and the FCC had no more jurisdiction over this station than CKLW, XETRA, or Radio Taino from Cuba, all of which put much stronger signals into the United States.

The ruling implies that if a signal can be received in the United States, the FCC should control it. Our government can sponsor and fund TV Marti, but can not condone RNI? In the words of RNI organizer Allan Wiener, "If we had really broken any laws, we'd all be in the pocky right now."

The RNI case is in appeal. The motive is to make broadcasting accessible to the general public without having thousands or millions of dollars to spend on a license. An amateur broadcasting service, for community use by simple application, would bring the First Amendment's rights to your radios.

Is this too frightening to the FCC and established broadcasters? I can only hope that the greatness of our country will not be slowly eroded by decisions like those of Judge McNaught.

You have my permission to print my comments if you wish. I served as an expert witness during the RNI case hearing in Boston. I have been a broadcast engineer for ABC Television for 12 years.

I also serve as CE of Continental (continued on page 16)

# Radio World

Vol 13, No 7

April 12, 1989

**Publisher:** Stevan B. Dana  
**Assoc. Publisher:** Arthur Constantine  
**Editor:** Judith Gross  
**Assistant Editor:** Alex Zavistovich  
**Buyers Guide:** Richard Farrell  
**News Dept.:** Alan Carter, Editor  
 Charles Taylor  
 John Gatski  
**West Coast:** Frank Beacham  
**Circulation Mgr.:** Marion Alsup  
**Ad Coordinator:** Simone Leaser  
**Art/Production:** Gina Rosario, Mgr.  
 Ginger Bamford  
 James Gillgam  
 Jeanne Pearson



**Radio World** (ISSN: 0274-8541) is published semimonthly by Industrial Marketing Advisory Services, Inc., 5827 Columbia Pike, Suite 310, Falls Church, VA 22041. Phone: 703-998-7600, Fax: 703-998-2966. Application to mail at second-class postage rates is pending at Falls Church VA 22041 and additional mailing offices. POSTMASTER: Send 3579 forms and address changes to Radio World P.O. Box 1214, Falls Church VA 22041. Copyright 1989 by Industrial Marketing Advisory Services, Inc. All rights reserved.

Free subscriptions are available to professional broadcasting and audiovisual equipment users. For address changes, send current and new address to RW a month in advance at the above address. Unsolicited manuscripts are welcomed for review; send to the attention of the appropriate editor.

*Introducing Harris HT FM Transmitters...*

# WORLD-CLASS POWER AND PERFORMANCE FOR ANY SIZE FM MARKET

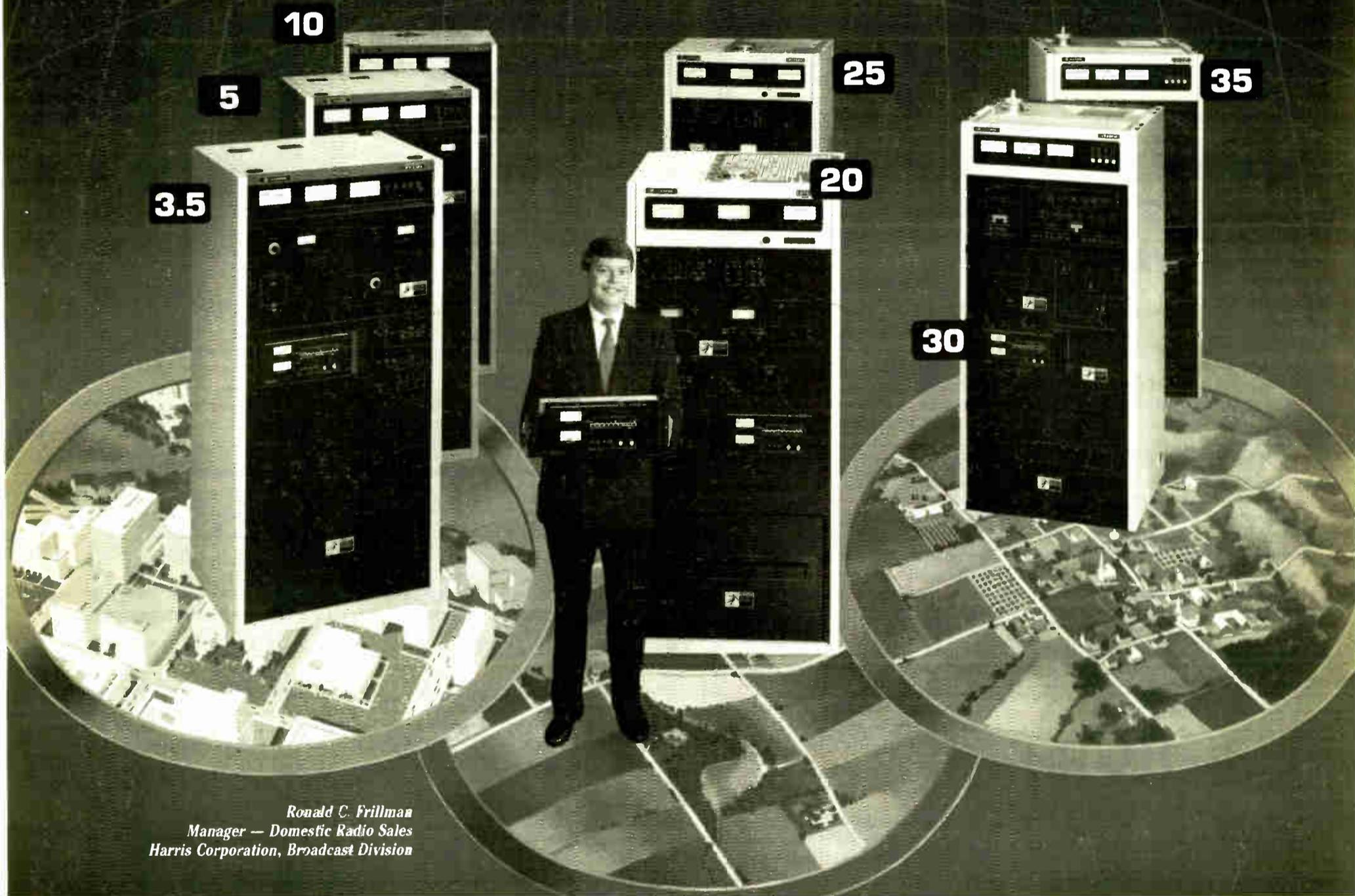

*Ronald C. Frillman  
Manager — Domestic Radio Sales  
Harris Corporation, Broadcast Division*

No matter where you are or what your FM coverage requirements, Harris' new HT FM transmitters will provide the outstanding reliability and performance you want, at the power level you need.

HT transmitters come in 3.5, 5, 10\*, 20, 25, 30 and 35 kW models, with dual configurations available. A perfect blend of rugged construction and proven technology, the HT FM transmitter family will deliver years of top performance and value.

At the heart of every HT transmitter is Harris' new solid-state 55 watt FM exciter,

THE-1™. With two selectable RF power outputs, a low-profile slide-out design, ultra-linear voltage controlled oscillator and full stand-alone capability, THE-1 provides a super-clean signal, maximum reliability and minimum maintenance.

For enhanced signal performance and low synchronous AM noise, HT transmitters use a high-efficiency single tube in a standard quarter-wave cavity. Other on-air features include RF Emergency Bypass or FlexPatch™, automatic VSWR foldback, automatic power control and convenient diagnostic systems.

For complete information on Harris HT FM Transmitters, write: Harris Radio Sales, P.O. Box 4290, Quincy, IL 62305-4290, or phone TOLL FREE:

1-800-4-HARRIS  
Extension 3018

*\*Available in three or single phase models.*

 **HARRIS**

# Satanic Verses Brought to Radio

by Frank Beacham

**Los Angeles CA** The idea jelled while I watched Norman Mailer read from *The Satanic Verses* at a rally of authors in New York.

As Mailer droned away on this live CNN telecast, my mind wandered to what I'd read about the great theatrical presentations of current events in the 1930s. There had been "The Living Newspaper" on stage and "The March of Time" on radio. Both used actors to dramatize the events of day, giving them a clarity and dimension that no simple news report could.

**Missing the impact**

As much as I had read and watched the news reports about the controversy over Salman Rushdie's book, I had no feel for his writing.

The "sound" of his words was missing. Virtually every book store in America had sold out of the book and would have no new copies for weeks. I felt a void existed that only radio could fill.

publisher led me to Rushdie's agent, Wylie, Aitken and Stone in New York. After trading a couple of fax transmissions, rights were granted at no cost for a one-time, non-commercial reading.

Now, I needed a radio station that would give me an hour of air time within a couple of days.

I thought this would be easy. I was wrong.

The controversy surrounding the Rushdie affair and the fear of some kind of reprisal—personally or institutionally—now became an important ingredient in the project. In order to participate in this broadcast, one had to take a personal risk,



Actors Sean McClory (left) and William Schallert (right) perform Salman Rushdie's *Satanic Verses* from the studio of KPFK.

Mailer was still reading on this Wednesday afternoon (22 February) when I decided to produce a radio program with a '30s treatment of Rushdie's *Satanic Verses*. Though it would be a reading, I wanted it to be a timely, live, theatrical production.

And the fact it might be a little dangerous only added to that theatrical quality. The journalist in me felt it had to go on the air within two to three days—before the story dropped from the front pages of the nation's newspapers.

I had no radio station to broadcast it, no legal rights to the Rushdie material, no actors, and no money. On top of that, I couldn't find a copy of *The Satanic Verses*. (I later found that those owning copies were very protective of their books and were not inclined to loan them to anyone.)

I pitched my idea to Peggy Webber, director of the California Artists Radio Theatre. A veteran actress, director and producer, she leads a group of some of the finest actors from radio's Golden Age who are currently producing a series of radio dramas in Los Angeles.

Webber offered to help find actors willing to participate in such an event, and put together and direct a cast for the show.

The next step was to obtain rights for such a broadcast. A phone call to the

whether perceived or real.

The project took on a new excitement because it was forcing the potential participants—from station managers to the actors—to closely examine their beliefs about freedom of speech and other issues and decide whether to take a public stand.

**Just said no**

Two of the most prominent radio stations in Los Angeles said no.

One station manager, with a strong activist track record on issues involving freedom of speech, tried to talk me out of doing it. Other stations offered time ... but far into the future. One station offered a network feed ... but wanted to wait a week and demanded editorial control. I turned that station down.

Finally, on late Thursday, Lucia Shapel, program director of Los Angeles station KPFK-FM, offered an hour of time and studio facilities on Saturday evening (25 February) from 6 to 7 PM.

We had a deal and 48 hours until air time.

The next two days was a blur of activity. I was glued to the telephone, day and night. I contacted the local writers' organization, PEN, to ask for help. In addition to offering to participate in the show, the group suggested a professor

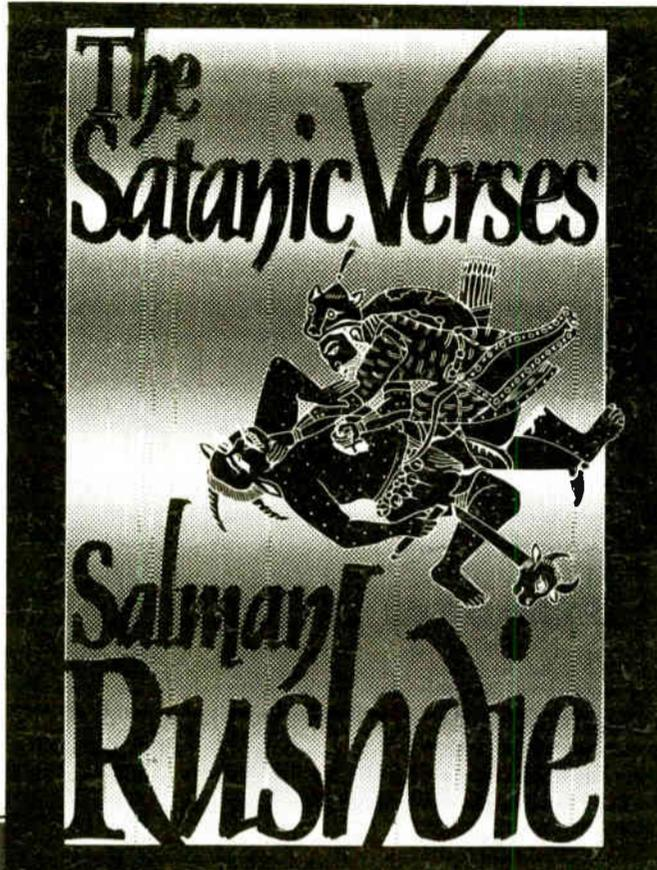

of religious studies at Pomona College in Claremont, CA, who was an expert on the Rushdie book.

I reached Dr. Carl Ernst at home. Not only did he have a copy of *The Satanic Verses*, he offered to help select relevant excerpts for the actors to read and to present an opening interpretation to each passage. (Most Americans need interpreta-

tion to understand why certain passages of the book are offensive to Muslims.) I could tell from Ernst's voice on the phone that he had an authoritative presentation style that would complement the actors. He agreed to select passages and fax the pages to me on Saturday morning.

**Fifteen hours**

As the hours passed participants agreed, tentatively agreed, cancelled or just said no to appearing on the broadcast.

This fluctuation in personnel would continue until the show actually went on the air, making it almost impossible to block out the broadcast until the final hours. But at 3 AM Saturday morning, I began writing around the missing elements and trying to create a framework.

At 6 AM I sent a news release via fax to City News Service, a news service for Los Angeles area media, announcing the broadcast. Omitted were the names of participants. I promised a later release naming the cast but never got around to sending it.

By 10 AM the actors were committed. The cast included veteran actors William Schallert, Sean McClory, Richard Erdman, Kathleen Freeman, Kay Kuter and Peggy Webber. Several literary figures provided short commentaries.

By 11 AM the fax machine started to purr and out came the elusive pages from *The Satanic Verses*. At this point, I felt a great sense of relief. No longer

(continued on page 8)

## LIVE REMOTES ANY TIME ... ANY PLACE ...

**RPT-30 FEATURES:**

- 20% more output power, 52% smaller, 40% lighter.
- Subaudible encoder.
- FM compressor-limiter.
- Illuminated VU meter.
- Dual-frequency capability.
- Four balanced microphone mixing inputs, one switchable to balanced line level.
- Flashing LEDs indicate antenna VSWR problems and over-temperature conditions.
- FCC approved.
- Continuous duty-broadcast quality.

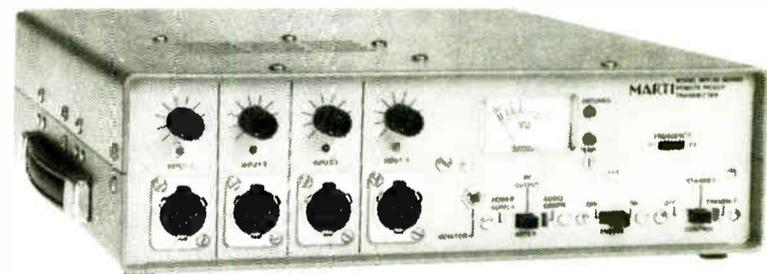

**\$1695**

**NEW Internal plug-in modules available for Audio Companding. \$200 for RPT-30, \$200 for CR-10**

### ... MARTI DELIVERS

How many times has your station missed great opportunities for promotion and revenue because an effective, broadcast quality, continuous duty, remote system wasn't in place for immediate use? Declare your independence from inflexible, re-stricted, low quality remotes by installing a high performance Marti System.

Marti has hand held portables, mobile repeaters and automatic relay stations to give you the coverage and flexibility you need. Put our 30 years experience in broadcast remote pickup equipment to work for you by calling us for assistance in planning your system.

**MARTI** The performance-value leader in Broadcast Equipment.

Marti Electronics, Inc., P.O. Box 661, Cleburne, Texas 76031-0661 (817) 645-9163 Telex #794835 "Marti CLBN" FAX (817) 641-3869

# FCC Loses 80-90 Court Case

(continued from page 1)

He added, however, that the allocations specifically mentioned, at this point, are the only ones clearly affected: "We are doing the best we can to interpret the case so that we can comply with the court's ruling but at the same (time) preserve the finality of as many of the allotments as possible."

An attorney in the FCC general counsel's office who worked on the case but asked not to be identified, said, "At first blush, someone might say, 'This is a very massive proceeding. It's been going on for several years. Logic tells us that if there was a problem in the notice that started the whole proceeding, then my gosh, maybe the Commission has to go back to ground zero and start all over again.'"

"But we don't believe that the practical effect of complying with the court's mandate will require us to do that," the FCC attorney continued.

Bayes also doubted the matter would provoke reconsideration of a massive number of allocations. "I can't imagine that they'd want to or even be able to go over and start again," he said.

## How it all began

The primary complaints in the case were submitted in 1985 by James Reeder, L.M. Communications Inc., and Marine Broadcasting Corp., which each had submitted counterproposals to 84-231 asking the FCC to substitute channels for those proposed or allocated in hopes of upgrading their FMs.

The Commission rejected the counterproposals primarily on the grounds that the petitioners did not meet criteria specified in the original notice, according to court records.

In the case filing, the three companies disputed those rules forbidding the submission of counterproposals that would have enabled petitioners to upgrade low class FM stations, saying that the FCC did not follow the notice and comment requirements of the Administrative

Procedures Act (APA).

The court, which ruled on the issue in January, agreed with the petitioners that the Commission's counterproposal rules did not comply with the requirements of the APA.

Three other petitioners—Roxboro Broadcasting Co., LCH Broadcasting Group Inc., and JAB Broadcasting—argued that specific allocations within 84-231 were not consistent with community allotment precedents, court records showed.

Specifically, Roxboro argued in documents to the FCC that the Commission's second notice allotment of a channel in Semora, NC—replacing a first notice allotment 20 miles away in South Boston, VA—would be in direct competition for

audience and revenue with the company's FM.

Meanwhile, LCH, licensee of an AM in South Boston, had expressed intent to apply for a permit to operate a new station in South Boston and also disputed the Commission's allocation to Semora.

## Defining a community

Both argued that Semora was not a "community" as defined by a section of the Communications Act and thus was not entitled to a preference over South Boston. In later documents, the companies noted that even if Semora were a community, under the "quiet village" doctrine, it could not receive preference over South Boston because the latter has

a larger population.

The FCC, in turn, first did not address the community issue, then later claimed South Boston was a community, yet avoided the "quiet village" issue.

The court ruled that "the FCC failed to engage in reasoned decision making when it allotted an FM channel to Semora; therefore, we grant the petitions of petitioners Roxboro and LCH."

Finally, petitioner JAB Broadcasting challenged the FCC's decision to allot a frequency to Pensacola, FL, blocking JAB's upgrade plans.

The court responded that the company had adequate notice and an opportunity to comment, and that its counterproposal was rejected meritoriously. "We find no merit in (JAB's) claim," the court ruled.

For more information, contact Karl Kensingler at 202-634-6530; or James Bayes at 202-429-7000.

# Performers Deliver Satanic Verses

(continued from page 7)

could I be haunted by the continuous question: What happens if we don't get the book in time?

My associate producer, Deborah Harter, and I began piecing together the final script on a word processor at 1 PM, five hours before air time. Seeing *The Satanic Verses* for the first time, Peggy Webber worked with sound effects designer David Krebbs to locate appropriate effects that could be used to enhance the show.

## Adding atmosphere

Since KPFFK warned us it could promise no tape machines or production time, Krebbs packed some wind chimes which he could play live in the studio to create atmosphere for the story.

Webber also remembered working with an excellent engineer at the station who had previous experience in radio drama. She found Steve Barker at home but was told he had to attend traffic school on the day of the broadcast. However, he agreed to try to make it to the station in time to help with the show.

When I reached the KPFFK studios at 4

PM, two hours before air time, confusion reigned.

Engineer Baker had called to say he would be there at 5 PM for the show but no one was sure which studio or control room would be used. We would have to wait for him to find out.

The actors were seeing the photocopied fax transmissions of *The Satanic Verses* for the first time and most were having trouble with pronunciations and the complex rhythms of Rushdie's prose. Ernst saved the day, joining the rehearsal with Webber and helping the actors understand the material.

The news release worked. As air time approached, five television news crews, still photographers and reporters arrived.

The control room became chaos, with people stumbling over equipment and each other.

Barker arrived and began laying Krebbs' sound effects onto tape. He brought a pristine RCA 44 ribbon microphone so the actors could all work around one bi-directional microphone. This would prevent dead air in case the wrong pot was opened in a multi-mic set up. I had forgotten how wonderful that 44 sounds for the human voice. It still reigns supreme!

At precisely 6 PM, *The Pen and the Sword: The Satanic Verses of Salman Rushdie* went on the air live with an all volun-

teer cast and crew. To me, it seemed like a miracle. Harter, who doubled as the floor manager, made sure the participants were at the mic just before their speech.

Webber cued the actors from the control room—they could not hear the music or effects in the studio. I cued the engineer when to start effects.

Even though the taped sound effects worked well, Krebbs played the wind chimes to great effect in the studio. During the course of the next hour, this act of "guerrilla radio" somehow worked.

We were the "film at 11" on every television newscast in Los Angeles that night. KPFFK was mostly praised for its innovative programming and the show has been sent to Pacifica stations for airing in other markets. They want more programs like it.

For me, as producer, it was a chance to exploit the radio medium for what it does best—stimulate the human imagination and offer a truly unique dimension to an international news event.

Maybe there's something to be learned from those great shows of the 1930's.

■ ■ ■

*Editor's note: Frank Beacham is an independent producer, writer and developer of audio, television and film projects. He is West Coast correspondent for Radio World and sister publication TV Technology.*

\*  
214-388-5800

Service 24 hours a day

This number is your link to the service experts at Continental Electronics where the number one priority is keeping you on the air. Our commitment includes:

- Telephone assistance 24 hours a day, 365 days a year;
- Field service engineers skilled at troubleshooting;
- Critical parts orders shipped the same day;
- Technical training for all Continental transmitters available;
- No charge for telephone assistance.

For parts orders call 214-388-3737. Our job is to keep you transmitting.

varian   
continental electronics division 

P.O. Box 270879 Dallas, Texas 75227  
Telephone: 214-381-7161 Fax: 214-381-4949

## DIGITAL ANTENNA MONITORS

In Stock — Available for Immediate Delivery

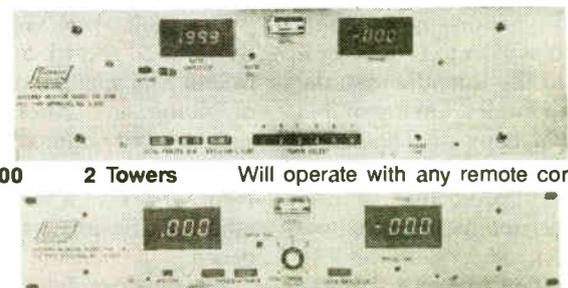

Price \$2400.00 2 Towers Will operate with any remote control equipment.

Price \$1780.00 2 Towers For AM directionals with studio located at transmitter site.

These monitors are state-of-the-art instruments of unequalled accuracy (.5% or better on ratio and .5° or better on phase) and stability. With typical modulation the true ratio readout of these monitors is a factor of 10 more stable than instruments that measure normalized amplitude, and their phase readouts are rock solid. Phase sign is automatic, no extra operation. In addition to the analog DC outputs for remote control the Model CMR has a multiplexed BCD digital output which can be used to drive the Remote Indicator Model CMR-1. RF inputs have dual protection. Gas discharge tubes across the sample line terminations plus relay protection.

GORMAN REDLICH MFG. CO

257 W. Union St. • Athens OH 45701 • 614-593-3150



# Harris-Allied Sales Under One Banner

**Melbourne FL** The broadcast division of Harris Corp. and Allied Broadcast Equipment, which Harris acquired last August, announced an internal restructuring of their sales and marketing under a united Harris-Allied banner.

Under the new setup effective 21 March, Roy Ridge, founder and president of Allied, the nation's largest radio station equipment distributor, expanded his role to include overseeing sales and marketing of Harris AM and FM transmitters and other radio products.

Harris RF Sales Manager Ron Frillman and Allied Studio Sales Manager Tom Harle will now report to Ridge.

Field sales efforts of the two organizations also are unified, with current Allied regional offices serving as support bases and message centers for the Harris radio sales force.

Customers can use a single nationwide toll-free phone number to reach the combined Harris and Allied sales force.

Although this is a significant internal change for the company, Ridge explained that the restructuring isn't going to affect customers very much.

"Customers can still call the Allied salesperson they've been using for years," he said, "and they'll still have the after-hours phone number of the Harris rep that sold them their transmitter."

Ridge also explained that the Harris and Allied names now appear together on all field sales reps' business cards. Allied sales reps' cards now read Harris-Allied radio studio sales, and Harris DSMs will be Harris-Allied radio RF sales, he said.

Many in the industry expected some form of sales and marketing integration between equipment manufacturer Harris and distributor Allied since the merger last summer.

But Ridge emphasized that the new moves involve no planned cutbacks: "It's not a question of eliminating people."

"Naturally, we want to make the most of the synergy between Harris' strength in RF sales and manufacturing and Allied's expertise in studio equipment and overall marketing, but we've told our people that we're definitely looking to build the Allied-Harris division."

Thomas Yingst, who continues as VP and GM of Harris' Broadcast Products division, and Ridge, as president of Allied Broadcast, report to Guy Numann, senior VP and sector executive of the communications sector of Harris Corp.

In addition to supervising sales and marketing functions for Harris radio products, Ridge assumes advertising responsibilities for Harris TV products and its international division.

## Mexico Tests NRSC Standard

by Alan Carter

**Mexico City MEXICO** The Mexican broadcasters' association, the CIRT, conducted tests here 7 March to evaluate the US-developed NRSC standards for AM.

NAB Staff Engineer Stan Salek observed the tests that involved transmitting NRSC and non-NRSC processing from a 10 kW transmitter of station XEFAJ on 1560 kHz to CIRT headquarters about three miles away.

At the transmitter, a spectrum analyzer was used to evaluate occupied bandwidth under NRSC-2. Recordings also were made of the transmission on various quality radios at the receive site to determine the effects of preemphasis under NRSC-1.

Salek said the CIRT will have a report on the tests by the NAB convention, scheduled for later this month in Las Vegas. Other than "a few minor glitches" which appeared to be setup problems, Salek said the tests went well.

"They're taking it slowly," Salek said. "It's something brand new to them."

The transmission was a 30-minute DAT recording of typical Mexican

broadcasting.

The mixture of sounds was broadcast by an NRSC processor with the NRSC operational; then out of mode but with a wide filter and, finally, with a non-NRSC processor.

In one recording setup, the signal was recorded on DAT from an NRSC prototype Ford auto receiver. The second recording was on reel-to-reel from a "boom box" and lastly, from a "cheap" commercial receiver.

Adoption of NRSC by the Mexican government would give the NRSC standard wide acceptance throughout North America, Salek noted.

A rule making is in process at the FCC, with some stations using the preemphasis standard voluntarily. In Canada, Salek predicted the standard may be mandated there before the US acts.

The Canadian government has been "quite progressive" in work, particularly in development of NRSC-2 RF mask, he noted.

In addition to establishing common characteristics for receiver design, adoption of NRSC throughout North America would reduce interference on second adjacent stations.

For information on NRSC, contact Stan Salek at NAB, 202-429-5391.

## THE BIGGEST CHANGE IN CARTS WE'VE EVER SEEN ...OR HEARD



Fidelipac, the inventor of the stereo cartridge, refines technology with the DYNAMAX Cobalt Cartridge.

DYNAMAX Cobalt outperforms all other broadcast tape cartridges in the following critical areas:

- Greater high frequency headroom
- Superior phase uniformity
- Longer service life
- Low flutter and distortion components
- Extended high frequency response
- Reduced head and capstan wear

### DYNAMAX Cobalt

From Fidelipac

For all Fidelipac products, contact



## HOW MUCH OF YOUR CD MUSIC REACHES YOUR AUDIENCE?

If your STL is "composite," you could be losing 30 db of stereo separation and one-third the dynamic range of CD's before your signal reaches your FM transmitter!

If the weak link in your audio chain is a "composite" STL, then take a look at the benefits of the MARTI STL-10 scpc stereo system. This system achieves a noise floor of near -80 dB at a fraction of the receiver signal strength required by "composite" STL's, and the stereo separation is the noise floor! Also you receive the extra dividend of the inherent interference rejection and backup reliability of an scpc system.

Shouldn't your audience enjoy all the CD quality that originates at the studio?

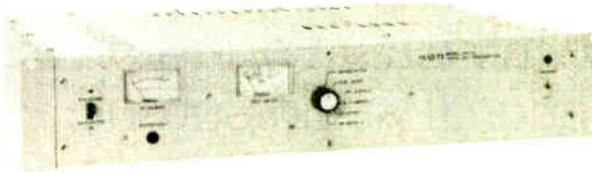

## MARTI

The performance-value leader in Broadcast Equipment. Marti Electronics, Inc., P.O. Box 661, Cleburne, Texas 76031-0661 (817) 645-9163 Telex #794835 "Marti CLBN" Fax (817) 641-3869

# WAVA, BBC Test RDS System

(continued from page 1)

shift key with a phase deviation of plus or minus 90 degrees," according to WAVA CE Chip Fetrow.

The FM transmitter must have an encoder and the receiver must have a decoder to utilize the transmitted information.

Although there are firmly entrenched opinions, pro and con, with regard to subcarriers on FM, Fetrow said he noticed little effect upon WAVA's signal during the test.

"I tend to be anti-subcarrier, but this (RDS) surprised me," he said.

## No listening problems

There was a slight bit of interference on the test instruments, but no problems with listening tests in multipath areas, Fetrow explained.

"The listener would not notice anything," he added.



WAVA's Chip Fetrow makes adjustments to RDS monitor.

Because RDS subcarriers have a low injection level, there is no energy with it to cause problems that have been claimed with other subcarriers, Baker said.

Noise and distortion problems have recently been reported with the signal enhancing system, FMX.

"RDS is compatible with ARI (the subcarrier traffic system), but is not compatible with data paging," Fetrow said.

Baker and Fetrow said the installation of the RDS encoder was quite simple, hooking directly into the stereo generator's meter connection with virtually no modifications.

Because Britain and other European countries have centralized radio broadcasting, the conversion has been relatively swift since RDS's introduction in 1987, Baker said. In Britain, the BBC offers four radio services plus local radio.

## Traffic information

Besides automatic tuning, the RDS system also is used to broadcast traffic

bulletins, Baker explained.

No matter which stations listeners are tuned to, or if the radio is turned off, the RDS tunes a radio to a local traffic bulletin, Baker explained.



BBC's Andy Baker shows monitoring gear for RDS equipment.

**... Fetrow said he noticed little effect upon WAVA's signal during the test.**

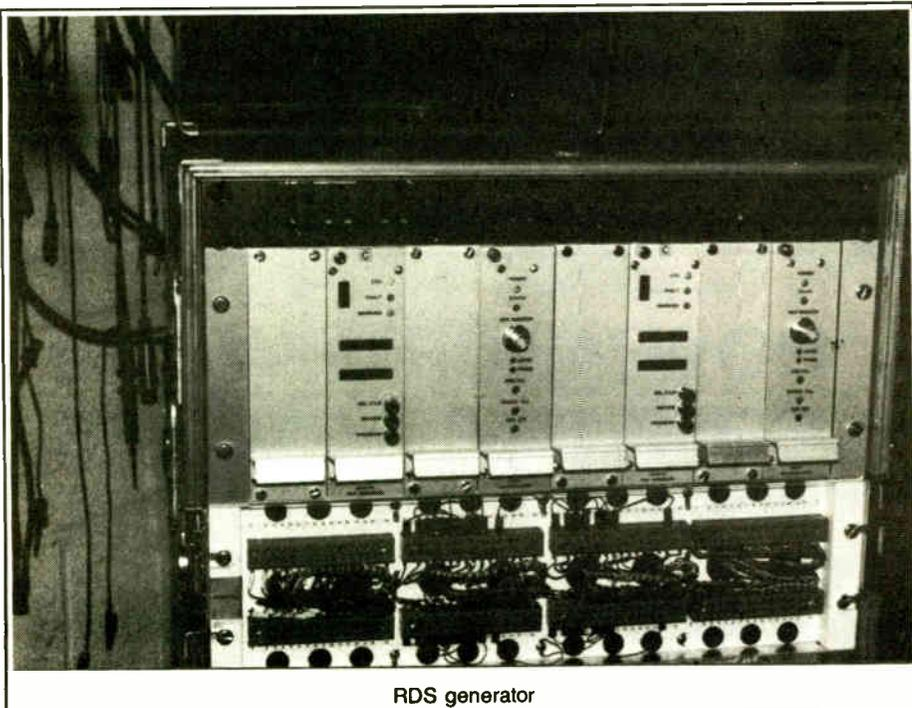

RDS generator

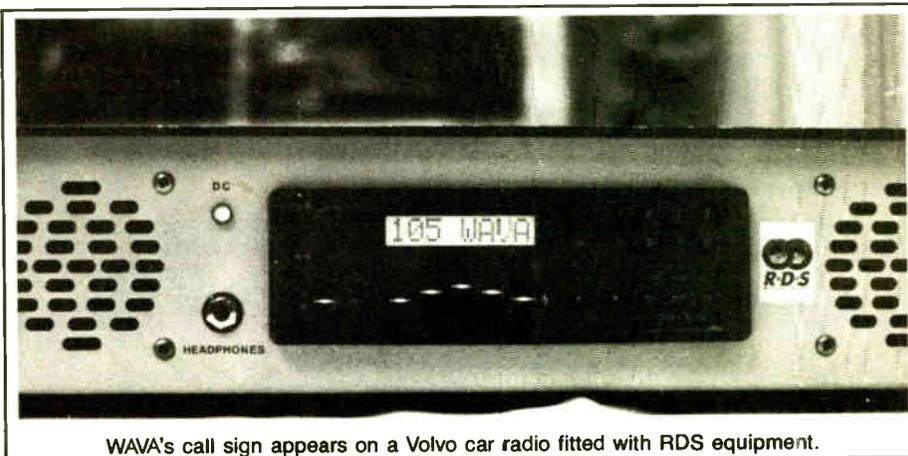

WAVA's call sign appears on a Volvo car radio fitted with RDS equipment.

## LPB introduces the brand new console with a ten year track record.

The full-featured, low profile Citation II Audio Console...

FOR COMPLETE INFORMATION, CONTACT:

LPB, INC. / 28 BACTON HILL ROAD / FRAZER, PA 19355 / TEL (215) 644-1123 / FAX (215) 644-8651

...and LPB Studio Furniture: Standard, Premium and Custom Components for all applications.

## See them both at NAB Booth 1541.

# LPB®

tin, he added.

RDS also offers a time measurement feature that automatically recalibrates total accurate time to the receiver clock with whatever time standard is programmed into it, according to Baker.

In the near future, RDS will offer other services including the radio text option and transparent data channel, according to the EBU.

Fetrow said the RDS application in the US would be different from England and Europe because there are hundreds of stations that are not centrally operated.

"I think that the display of the station ID is something that management would like," Fetrow said of US operations.

For car radios, RDS receivers have eight digits of radio text, enough to announce the call letters and frequency. Home receivers have the capacity for more text, similar to the WAVA display at the World Broadcasting Union conference.

From a programming perspective, it could be used to display the title of a song and the artist or an advertiser, Fetrow said.

For more information about RDS, contact Chip Fetrow at 703-534-0320 or Andy Baker at 011-44-926-411212.

# Motorola Develops A-to-D Chip

by Frank Beacham

**Austin TX** Motorola has announced the availability of the first, 16-bit analog-to-digital converter on a single microprocessor chip, a technological breakthrough the company said it expected to have major performance and cost implications for radio broadcasting.

The new chip is expected to accelerate the fast-track development of new products such as all-digital radio receivers, recordable compact discs, studio-quality audio on cellular phones and redesigned versions of virtually all

tons and knobs needed to allow users to control the radio's functions.

In the radio station control room, Motorola expects the entire audio board to be emulated on the new chips through software. Computer screen icons can replace costly hardware control levers and knobs.

"These massive boards in radio stations will become dramatically better, significantly smaller and much cheaper," Sturiale said.

Manufacturers are developing equipment such as sound processors, equalizers, time compressors and expanders and low cost digital production

workstations for the new chips.

"All of this equipment will have much greater dynamic range and will be drastically cheaper than current equipment," Sturiale said.

Another factor, Motorola predicted, to propel new equipment development with the chip is that engineers with no analog experience can now more easily design circuits.

"The 56ADC is the first analog-to-digital converter that requires virtually no background in analog electronics," said Bryant Wilder, DSP operations manager for Motorola's Austin-based Microprocessor Products Group.

Motorola research found that 95% of today's engineers specialize in designing digital circuitry while only 5% are analog specialists. Prior to the new 56ADC chip, much of the work by those analog specialists went into designing and testing analog-to-digital circuits.

## Plug'n'play

"There's a whole slew of artistry that goes into designing an analog front end," said Sturiale. "This chip takes all those analog parts and makes this thing a plug'n'play. We're talking about a whole new era of accessibility by a new generation of engineers."

The conventional process of converting analog signals into binary bits requires  
(continued on page 16)

**The chip costs less than \$50 and replaces analog parts costing \$500 or more, Motorola said.**

broadcast sound processing equipment, according to Motorola.

The chip may even lead to the extinction of the large audio control "board," the centerpiece of the radio station control room since the beginning of broadcasting.

"This chip will lead to an explosion of applications in the radio world," Motorola spokesman Nick Sturiale said. "It is probably the most significant thing Motorola is doing right now."

## New beginning

The new 56ADC chip, developed by Motorola's Microprocessor Group, combines a complete set of analog-to-digital conversion functions on one chip, the first product ever to do so, the company maintained. The tiny semiconductor brings dramatic advances in speed and integration to digital circuits while decreasing system costs by as much as 10 times over traditional circuits.

The chip costs less than \$50 and replaces analog parts costing \$500 or more, Motorola said. It also does not require the extensive engineering time to design sophisticated analog "front end" circuitry.

The new chip, which is available now, offers 96 dB of dynamic range and a -90 dB SNR. It needs only one 5 V power source, compared to multiple power supplies for conventional analog-to-digital circuitry. Combined with Motorola's previously designed 24-bit 56001 digital sound processing chip, the new device opens many new windows of design opportunity, a spokesman explained.

"You'll be seeing all-digital radios with major improvements in reception quality going into cars within the next three years," Sturiale said. "This chip will take the analog signal off the antenna, and in a very small space with very little power, turn it into a digital output with 90 decibels of dynamic range."

The functions of a traditional radio receiver such as tuning, tone and volume controls will be preprogrammed into the ROM (Read Only Memory) of the DSP chip, the spokesman continued. The only peripheral circuitry will be the but-

**★ LEGAL DAT TODAY ★**

Your Competition Has The Cutting Edge... Why Don't You?

## Enter The True Digital Domain!

**Full Line Of Professional Digital Processors, Recording Consoles And Sound Reinforcement Electronics.**



- **SONY PCM-2000**  
Super production machine
  - AES EBU digital I/O
  - Reproduce SMPTE EBU time code
  - Professional portable DAT recorder
- **SONY PCM-2500**  
Professional two piece studio standard
  - Wireless remote control
  - Fully programmable
  - Switchable sampling freq. 32 44 1 48 khz
- **TECHNICS SV-D1100**  
18 Bit high resolution DAT
  - Full function remote
  - 6-speed CRV digital servo system
  - Reduce conversion error by 75%
- **SHARP SX-D100**  
Professional recording, production and broadcast applications.
  - High quality
  - 2-channel
  - Digital audio tape deck
- **PANASONIC SV-250**  
A masterpiece of miniaturization
  - 9 - 1 3/4 - 5 1/2, under 4 lbs.
  - MASH A/D converter w/ 64X O. Samp.
  - Digital-to-digital editing
- **PANASONIC SV-3500**  
Years of experience w/ rotary head tech.
  - 18 Bit w/ class AA amp circuitry
  - Switchable sampling freq. 32/44.1/48 khz
  - Rack mounting kit & remote control

**Did You Know:**

- DAT recorders offer you better sound quality than CD players, plus all the benefits of a cassette recorder.
- DAT cassettes are half the size of standard analog cassettes and are a higher quality tape.
- DAT recorders are fully programmable, with high speed (up to 300 times playback speed) indexing and music search.

**FLEXIBLE LEASING PROGRAMS**

START AT

# \$69

per month

- NO MONEY DOWN
- QUICK APPROVAL
- COMMERCIAL ACCTS WELCOME

CHOOSE FROM THE FOLLOWING

Sony • Panasonic • Technics • Tascam  
• Kenwood • Pioneer • Akai • Sharp • Alpine  
• Nakamichi • Denon • Yamaha

Knowledgeable, Friendly Customer Service.

## American International Audio Video

127 ROUTE 206 TRENTON, NJ 08610

**DAT HOTLINE**

**609-888-4414**

609-888-2930  
FAX ORDERS



- English Operating Manuals
- All Connecting Cables
- AC Converters

- USA Written Warranty
- Nationwide Service Centers
- Pro User Extended Warranties

# Rinaldo Shares Radio Views

Republican Congressman Matthew Rinaldo has represented New Jersey's 12th congressional district since 1972. In addition to the expected New Jersey station listenership, the area includes many who tune into New York City market radio.

Rinaldo sits on the House Energy and Commerce Committee's Telecommunications and Finance Subcommittee. He has sponsored legislation that impacts on the radio industry, including a radio-only bill, an AM stereo bill and he currently is considering legislation that would exempt radio engineers from state licensing.

Rinaldo recently outlined his thoughts on these and other issues with RW reporter John Gatski.

**RW:** In light of your sponsorship of several bills pertaining to radio, what is your interest in radio's present and future status?

**Rinaldo:** Radio is the grandfather of the electronics mass media and today is more widely listened to than ever. However, radio problems are not as closely debated as they once were. The FCC and Congress have been preoccupied with encouraging new technologies like HDTV.

In our efforts to bring broadcasting and other mass media into the 21st century and expand programming choices for our citizens, I believe we should make sure that radio remains a viable and competitive service.

**RW:** Do you believe the FCC's recent shift away from a "public interest" approach to broadcasting to a "market oriented" approach has hurt the radio industry?

**Rinaldo:** The Communications Act still requires the FCC to license radio stations in the public interest and I think the Commission has generally remained true to that mandate.

What the FCC has done over the past 10 to 15 years, during both Republican and Democratic administrations, is take into account the vast changes in the mass media market that have taken place when it evaluates the need for regulations and to eliminate regulations when they are unnecessary or where the market does a better job.

It's certainly appropriate to do that—although Congress and the FCC sometimes disagree on the conclusions that are drawn from changes in the market.

**RW:** According to the FCC, a lot of uncertainty and confusion exists during comparative renewal of radio licenses, which has led to the abuse of the process. How would your recently sponsored radio-only legislation eliminate these problems?

**Rinaldo:** When a radio station's seven year license term ends, it is confronted with the distinct possibility that its license may be in jeopardy because others will file competing applications for its frequency or file petitions to deny the renewal application.

Some of these competitors or peti-

tioners may be interested in the license; others may file only to harass the incumbent or to apply leverage to obtain some desired reform of the station's programming or administrative policies.



Representative Matthew Rinaldo

In either case, the usual result is for the challenger to accept payment from the broadcaster in exchange for the challenger's dismissing its application or petition to deny. The competing applicant confronts little risk in filing an application and can realize significant financial gain without its application or petition being successful.

This is a costly, time-consuming process in which the radio broadcaster receives little or no benefit from operating in the public interest and is faced with uncertainty during the renewal process.

One could argue that these problems would be acceptable if the public benefited from this cumbersome process. But the public realizes no benefit. Not a single license has been revoked by the FCC during its present comparative renewal process.

My bill would fix this problem. It would give the radio licensee a "renewal expectancy." If the licensee can show that

it has broadcast material responsive to the issue of local concern, that it hasn't committed serious violations of the Communications Act or FCC rules, the FCC would renew the license. If the licensee does not meet this standard, then competing applications can be filed.

My bill would bar payments by licensees to those who file competing applications, petitions to deny or informal complaints. This would remove the incentive to file against licensees expecting profits in exchange for the promise to withdraw these documents further along in the process. These are improvements which are long overdue and are in the public interest.

**RW:** Would approval of legislation mandating the FCC to choose an AM stereo standard, similar to your bill introduced last year, help turn around the ailing AM radio industry?

**Rinaldo:** AM radio clearly is in dire need of help to ensure that it can broadcast at state-of-the-art quality. AM's share of the overall radio audience is down to just 26 percent, as opposed to 75 percent in 1972—a shocking audience decline. The FCC has devoted a great deal of effort to considering a variety of changes to provide improved technical quality for AM radio. I commend them for those efforts, and expect them to continue.

However, the Commission has been studying AM improvements for three years without coming to decisions in many areas. It's time for action. That is why I introduced the AM stereo bill in the last Congress and that is why I intend to introduce legislation in the near future that will address many of the technical issues confronting the entire radio industry. I believe the speedy passage of radio legislation addressing technical quality problems within the industry would greatly benefit AM stations, and provide them with the tools to better compete with FM stations.

**RW:** Are you concerned about litigation involving anti-trust if one AM stereo standard is endorsed?

(continued on page 17)

## ECONCO

Now in our 20th year  
providing quality rebuilt tubes.

These are a few of  
the tubes we rebuild:

3CX2500F3

3CX3000A7

3CX3000F7

4CX5000A

4CX15,000A

4CX3000A

WE BUY DUDS.

WE ALSO REBUILD REFLEX KLYSTRONS.

VISIT US AT THE NAB BOOTH 1675



ECONCO  
1318 COMMERCE AVENUE  
WOODLAND, CA 95695  
TELEPHONE 916-662-7553

OUTSIDE CA 800-532-6626 EXT. 55  
FROM CANADA 800-848-8841  
TELEX 176756  
FAX 916-666-7760

RF Specialties of Florida  
PO Box 397  
Niceville, FL 32478  
Bill Turney  
(904) 678-8943

RF Specialties of Texas  
PO Box 8316  
Amarillo, TX 79114  
Don Jones/Tim Hawks  
(806) 372-4518

RF Specialties of  
Washington, Inc.  
11721 15th Avenue NE  
Seattle, WA 98125  
John Schneider  
(206) 363-7730

## OFF THE AIR?

### ANDREW AND CABLEWAVE CONNECTORS IN STOCK!



Get back on the air fast! These RF Specialties offices now stock a full assortment of Andrew and Cablewave connectors for immediate delivery. For connectors or any other RF needs, call RF Specialties!

**RF Specialties®  
Group**

• System Design •  
• Competitive Pricing •

# Radio-Only Approval Debated

by John Gatski

**Washington DC** Recently introduced radio-only legislation addresses problems faced mainly by the radio industry, but there is uncertainty whether Congress will approve a law that does not apply to TV, according to government panelists at the annual NAB State Leadership Conference.

During the conference, held 28 February-3 March at Washington's J.W. Marriott, House and Senate staffers and FCC officials discussed several issues Congress is likely to face this year including the radio-only legislation (HR 1136), which addresses license renewal reform.

The bill calls for a two-step licensing process that also eliminates payoffs to competing applicants (see related story).

In discussing radio-only legislation, House telecommunications subcommittee minority counsel Terry Haines said the bill is "quite do-able at this time."

He said certain procedures affect radio, but not TV, and should be carried out separately.

## Uncertain passage

Tom Cohen, Senate Communications Subcommittee counsel, was not quite as optimistic about successful passage of a radio-only bill.

"It's difficult to keep radio and TV separate," he said.

Too many senators, he explained, believe the TV and radio license processes are similar, and, unlike the House, the Senate is unpredictable and legislation could be introduced tying radio and television together.

In discussing the FCC's role in radio-only issues, David Donovan, legal assistant to FCC Commissioner James Quello, said Congress must pass legislation in order for the Commission to legally adopt two-step licensing procedures.

He said the FCC currently does not have the power to enact such a process, based on court precedent.

Until legislation is passed allowing the FCC to incorporate such a process, Donovan said the FCC can police the agency's current rules and make close checks of financial backgrounds of competing applicants to ensure fair licensing.

## Rules encourage abuse

FCC Mass Media Bureau Chief Alex Felker said the vagueness of current rules regarding competing applications fosters abuse at renewal time.

"I think there are ways to improve on the process," he said. "I would like to see this area settled sooner than later."

The NAB panel also addressed spectrum management including a recent proposal to charge spectrum fees as a way to chip away at the federal deficit.

Cohen said there is not a lot of support for the spectrum fee proposal in Congress.

The panel acknowledged problems in allocating new stations in the ever-growing FM band and expressed a concern about interference.

In the radio-only legislation, a congressional finding calls upon the FCC to pursue policies to minimize interference.

"It (spectrum allocation) is very difficult to deal with in individual cases," Felker said. "There is a fundamental tradeoff between quality and quantity."

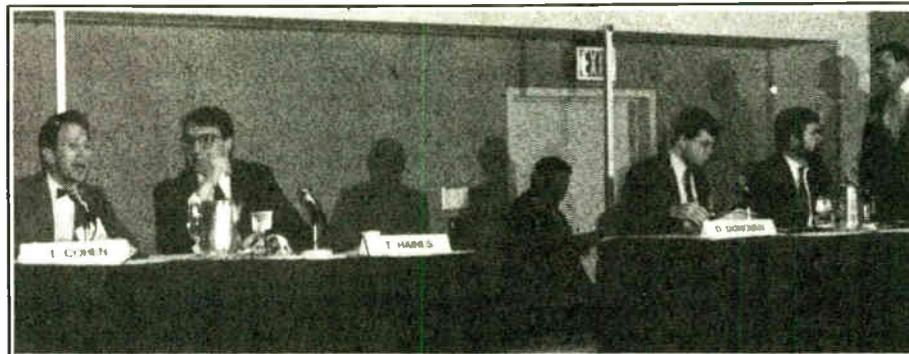

House and Senate staffers, as well as FCC officials, gather to address radio-only legislation at the NAB's State Leadership Conference.

Donovan said the FCC must continue an active role in spectrum management. "It is incumbent on the Commission to respond," he noted. "There is a fundamental obligation to make sure broadcasting works."

FM translators' potential interference to adjacent stations also is a spectrum management concern the FCC will have to address, Donovan said.

The FCC is studying the controversy over the use of translators, which expand a station's market by transmitting a signal on the originally licensed frequency and on another frequency via a translator.

"I don't think the market will take care of this by itself. The rules are woefully inadequate," Donovan added.



# You can rely on STL'S from TFT.

## HIGHEST RELIABILITY

TFT's patented STL design\* achieves high performance and the highest reliability with much fewer components (doing lots of very clever things). The low component count means a higher MTBF. Our extensive nine-step Quality Control and lengthy 144 hour burn-in at elevated temperatures is an additional guarantee you're getting the most reliable STL's made.

And, we back-up this boast with a two year warranty.

## COMPREHENSIVE SELECTION

TFT has the broadest selection of high-performance aural STL systems, including the Model 8300 & 7700B Composites, discrete versions, the economical Model 8600, exclusive IF repeaters and all the accessory gear you need for a complete, state-of-the-art aural microwave system.

If we don't have it, you don't need it!

## ON-CALL SUPPORT, 24 HOURS-A-DAY

Behind all our STL's is a responsive support and service team you may never need. But, if you ever do need help, rest assured that we have technically knowledgeable people to assist you.

Around-the-clock. Seven days a week.

## PERFORMANCE & FEATURES

Our higher reliability, comprehensive selection and responsive support and service team wouldn't mean much if our STL's didn't give you the performance you demand.

Our list of performance and convenience features is unrivaled.

## DEDICATED DEALERS

TFT dealers take pride in selling our products because we support them just like we support you. Each year, TFT dealers attend our Technical & Sales Training Seminar to satisfy their desire to provide you with accurate and useful information.

Contact your favorite TFT dealer today.

\*U.S. Patent No. 4,710,970

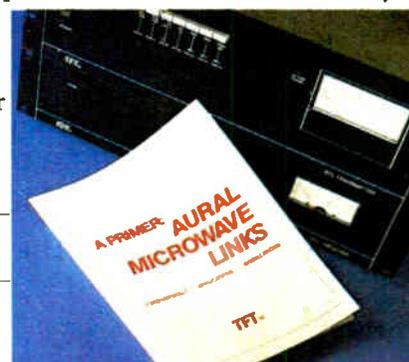

To make your own STL Path Analysis, ask for our free 30 page Engineering Guide.

# TFT INC

3090 Oakmead Village Drive  
P.O. Box 58088  
Santa Clara, California 95052-8088  
(408) 727-7272  
TWX: 910-338-0584  
FAX: (408) 727-5942

© 1988 TFT, Inc.  
See us at NAB Booth 2115

# GET ONE **FREE** AT THE NAB!



***Rush to booth #2037 for your piece of the cake—  
a FREE RS-12 console! (Yes, a real one.)  
Plus—24 other FREE Radio Systems products!***

Here's the deal—come to our booth and pick up a FREE wrapped chocolate or vanilla cake. Unwrap the cake and check if there's a FREE product coupon inside.

If you're a winner—you'll get a Radio Systems distribution amp, or timer, or phono pre-amp, or other Radio Systems manufactured

product. And one lucky broadcaster will get a FREE 12 channel RS console!

And even if you don't win—you can eat the cake.

Contest rules, plus a chance to participate even if you're not going to the show, are on the opposing page.

Radio Systems—continuing a long tradition of great products and FREE food at the NAB.

***Available Only From . . .***



***RADIO SYSTEMS INC.***

110 High Hill Rd. • P.O. Box 458 • Bridgeport, NJ 08014-0458  
609/467-8000 • 800/523-2133 • FAX 609/467-3044

Circle 100 On Reader Service Card

# Bill to Act on Renewal Abuses

(continued from page 1)  
are increasing in frequency in the broadcast industry during petition to deny filings.

According to the bill, it would be illegal for a licensee to pay off a third party in order to have the party drop its competing license or petition to deny. This would not apply to legitimately documented expenses incurred in preparing a competing application or petition to deny.

The bill was sponsored by Reps. Matthew Rinaldo (R-NJ), Tom Tauke (R-IA) Bill Tauzin (D-LA) and Rick Boucher (D-VA).

## Stations support legislation

Many groups and station owners expressed relief that Congress is attempting to stymie payoffs to competing licensees.

"I think it's terrific. We have been waiting for this type of action for a long time," said John Dille III, NAB Congressional Relations Committee chairman and president of Federated Media Inc.

Alabama Broadcasters Association President-elect Houston Pearce said a bill that eliminates payoffs can only benefit broadcasters.

"I really think it's a shame that radio broadcasters can be blackmailed," Pearce said. "It is a shame people can file a petition to deny for money."

NAB officials also support the bill, which the association helped develop.

"It is an outstanding piece of legislation," said L. Lowry Mays, NAB Radio Board Chief and CEO of Clear Channel Communications, Inc. "Certainly, there is support for a two-step licensing process for radio and TV."

## Separate licensing

Addressing radio separately from TV is a good idea, although there are some rumblings in Congress that members may not want to approve separate licensing reform, he said.

"That's our challenge," Mays said. "But I think radio is a hell of a lot different than TV. It's much more competitive."

Several companies that own both radio and TV stations hesitated to comment about the radio-only legislation.

"We're not sure if it's bad or good for our objectives as a company that owns radio and TV stations," said Charles Furlong, director of communications for Westinghouse Group W Radio.

Gannett Inc. spokeswoman Kristen Kent said the company had no comment on whether it would support the radio-only legislation.

Nutmeg Broadcasting President Mike Rice expressed disappointment that the bill contains a section that he thinks may be aimed at stopping Class A FM stations that are seeking a 3000 watt power increase from the FCC.

## Interference finding

Rice was referring to a congressional finding contained within the bill that asks the FCC to "adopt and enforce station allocation and interference protection rules and policies that guard against any increase in, and work toward a diminution of, interference levels currently experienced in the AM and FM

broadcast bands."

Rice said he believes the NAB pres-

on a case-by-case basis rather than a blanket increase—referring to an ongo-

radio-only bill) with that paragraph in there," Rice said.

Terry Haines, minority counsel for the House Communications Subcommittee, said however that the interference finding would not be legally binding and noted that the bill's chief sponsor, Rinaldo, also supports the blanket power increase for Class A's.

For more information, contact John Dille III at 219-295-2500, Houston Pearce at 205-221-2222, L. Lowry Mays at 512-225-4231, Mike Rice at 203-456-1111, Charles Furlong at 212-307-3000 and Kristen Kent at 703-284-6760.

**... it would be illegal for a licensee to pay off a third party in order to have the party drop its competing license or petition to deny.**

sured the sponsors to add that language so the FCC would enact regulations to allow Class A's a 3000 W increase only

ing battle between the Class A's and the NAB over the increase.

"We absolutely can't support it (the



## RADIO SYSTEMS FREE AT THE NAB!

### CONTEST RULES

- Only owners or employees of broadcast facilities or groups (including facilities with valid CP's not yet constructed) are eligible to win prizes.
- Prizes will not be awarded to individuals, but rather to the broadcast companies they represent.
- The decal awarding the console plus 12 other products will be stamped on the underside of a sticker affixed to the outside of the clear cake wrapper and visible when the wrapper is removed.
- Each broadcast company may win only one prize. All prizes will be awarded, and a list of winners published in Radio World Magazine.
- Twelve additional products will be awarded via a drawing at the show of the completed coupons received by mail or faxed to Radio Systems by April 27th. Coupons must be completed fully to be valid. The eligibility rules above apply to coupon entries. The console award is not available to coupon entries.
- Radio Systems reserves the right to disqualify any contest entries.
- All local, state, and federal rules will apply and supersede these rules in the event of a conflict.
- Prizes will be shipped within 6 weeks of the show closing. Winners are responsible for any taxes and shipping charges.

-----  
Fill out and return this coupon only if you won't be attending the NAB

NAME: \_\_\_\_\_

COMPANY: \_\_\_\_\_

ADDRESS: \_\_\_\_\_

\_\_\_\_\_

\_\_\_\_\_

PHONE/FAX \_\_\_\_\_

\*My console and other equipment plans for 1989 are:

\_\_\_\_\_

\_\_\_\_\_

\_\_\_\_\_

\*Coupon must be completely filled out to qualify for one of 12 free studio products. Console not available to coupon entries.

Mail or FAX immediately—must be received at Radio Systems no later than April 26th, 12:00 midnight to qualify.



10 High Hill Road ■ P.O. Box 458 ■ Bridgeport, NJ 08014-0458  
609/467-800 ■ 800/523-2133 ■ FAX 609/467-3044

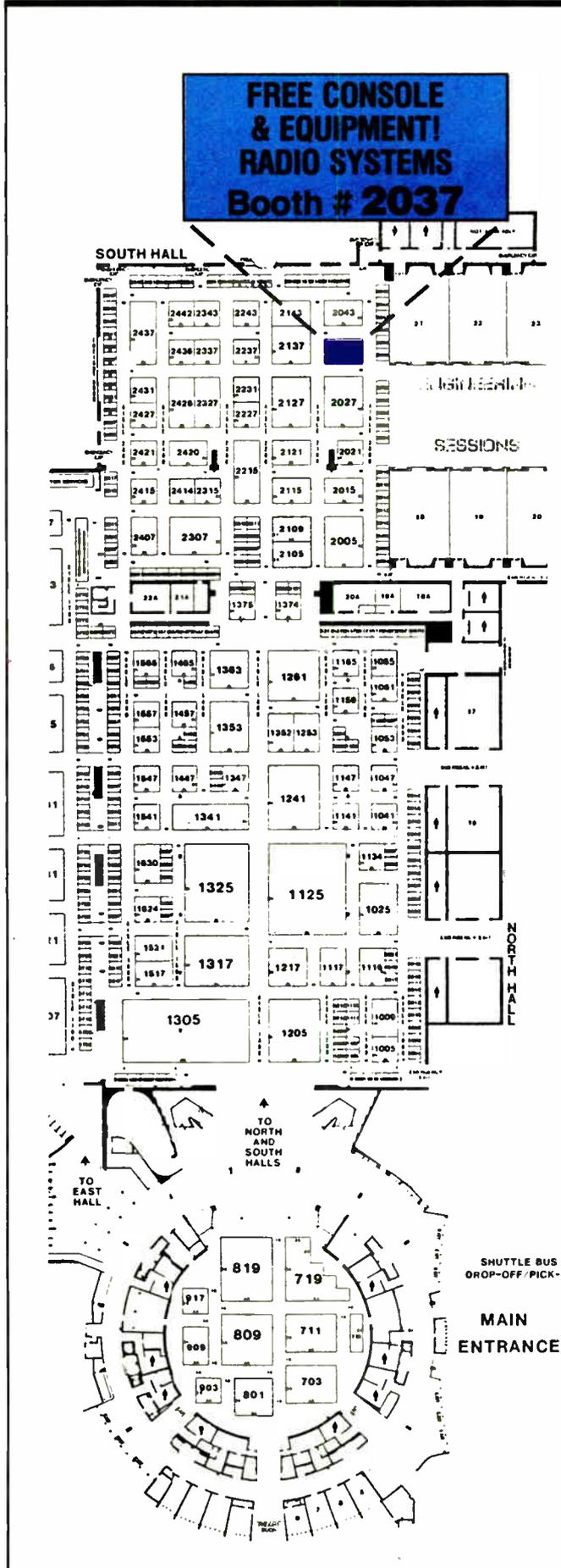

# More Readers Forum

(continued from page 5)

Cablevision's Croton Community Television and am the President of The International Radio Club of America. I write the broadcasting column for Popular Communications magazine and serve as a technical consultant for Lucasfilm, Inc.

Questions or comments can be directed to me at: 914-271-9774 or at work at 1-800-221-7386 X4539.

Thank you very much.

Karl J. Zuk  
Croton-on-Hudson, NY

## Beyond laser

Dear RW:

It's too bad about the demise of the Final Technology turntable; a number of my LP-favoring listeners had been writing asking whatever happened to it—they had great hopes, but *no idea* of the costs involved.

However, there are other ways to bring LP reproduction up to the state of the art of compact discs for broadcast.

The first I would suggest is a record-

cleaning machine. There are numerous models from VPI, Nitty Gritty and Keith Monks. All allow LPs to sound their best and can greatly reduce surface noise on some.

Next, I would suggest treatment with some of the excellent cleaning and preservation products from the Last Factory and Gruve-Glide.

Step three would be to forego the heavy-duty mid-fi tonearms and cartridges standard in the typical control room for those of "full battle duty." Most of the high-end moving-coil cartridges in the \$1000 area and high-end tonearms in the \$2000 area provide vastly superior fidelity, though of course they are not

designed for back-cueing.

Therefore, the final step would be to dub the cleaned-up and treated LPs to DAT, digital VCR tape, Hi-Fi VCR, or dbx I or Dolby A-encoded open reel tape. The DAT cassettes especially would be almost as accessible as the CDs and nearly as long-lasting.

A final tip would be to de-staticize each LP with a Zerostat or similar product before dubbing off and dabbing the stylus with Stylast on each side to bring S/N up even closer to the CDs.

Make this one-time effort and classical and jazz format stations will be easily able to integrate their CD and LP libraries and never again suffer that increasingly catastrophic event of a stuck record! And pop stations may learn to their surprise that their old LP versions of albums (if treated well in the past) are sonically superior to many of the new CD re-issues.

John Sunier  
Audiophile Audition  
Kentfield, CA

## A-to-D Chip

(continued from page 11)

several stages, the spokesman explained.

For example, a microphone receives a musical tone and converts the tone into oscillating wave-like voltage signals. These waves are filtered to remove unwanted signals. Those signals are then sampled many times per second at constant intervals.

Each sample's voltage level is measured and rounded off to a digital value. These digitized samples are then strung together in a series of bits closely approximating the original analog signal.

### Sigma delta

The 56ADC chip uses a conversion technique called sigma delta. This technique uses a sampling and signal measurement process that, Motorola claimed, is many times faster than conventional techniques. The sigma delta process filters out noise as it occurs, which replaces the requirement for special analog circuitry.

With sigma delta's filtering process, the 56ADC has an architecture that is almost purely digital, requiring no external analog circuits.

For the second half of 1989, Motorola promises still another new chip, this one combining full 16-bit analog-to-digital conversion and digital-to-analog conversion on a single chip.

And according to Motorola's Wilder, the company has long term plans to integrate analog-to-digital conversion, digital-to-analog conversion and all of the functions of the 56001 processor onto a single chip.

For information from Motorola, contact Nick Sturiale at 408-982-0400, or Bryant Wilder at 512-440-2033.

# It takes plenty of guts to back our products this solidly.

At QEI, we back our products — and our customers. Our power tubes, for example, carry the best warranty in the industry: 15,000 hours or 2 years. And only QEI includes a FREE comprehensive spare parts kit with every FMQ transmitter, exciter and remote control. Experience shows that you may never use more than 2 or 3 of these "guts". But since we can't be certain *which* 2 or 3, our kits include ICs, transistors, lamps, diodes, fuses — everything you're *unlikely* to need.

### 24 HOUR SERVICE HOTLINE

Giving you the most complete spare parts kits in the industry is just the first step in a customer support program that lasts as long as your QEI transmitter. If you need expert advice on installing a spare whatever, call us any time at 609-728-2020, day or night. And if you ever need factory parts support, we can deliver — fast. We're just 1/2 hour from Philadelphia International Airport, not out in the middle of nowhere.

### MAXIMUM EARNING POWER

You can count on it with every QEI transmitter, because we design them to stay on the air. And as a fully integrated company dedicated to RF and transmission products, we're able to build in quality and reliability — and still maintain our value advantage.

No wonder stations in both large and small markets have been using QEI products as long as we've been making them — since 1971. During that time we've put over 1300 exciters, more than 450 transmitters and over 1000 modulation monitors in service.

### GET THE FACTS

When it comes to standing behind our products — and our stations — we're way ahead of the competition. That may make other manufacturers nervous, but it makes QEI customers very satisfied.

Call us at 800-334-9154, toll-free, for all the facts on the transmitters that deliver a solid return on your investment: the QEI "New Reliablies."



Quality • Engineering • Innovation

QEI Corporation • One Airport Drive, P.O. Box D  
Williamstown, New Jersey 08094  
Toll-free 800-334-9154 • Fax 609-629-1751

NEW  
TEX 20

**BEXT INC.**

SAME  
OLD PRICE

BEXT Introduces The New '89 TEX 20 FM  
EXCITER (20W). Still For Only \$2,795

- With improved performance (i.e. dist. under 0.1)
- New direct capability for synchronous phase locking
- New faster programmability, now in 10 KHz steps
- New terminal board for full remote controllability
- New totally modular construction for easy access

BEXT INC. 619-239-8462  
739 Fifth Ave. San Diego CA 92101  
TLX 229882 FAX 619-239-8474



# Spring Tonic for Tired Stations

by John "Q" Shepler

**Rockford IL** Spring is a wonderful time of year. It's probably the only time when anyone gets serious about cleaning, adjusting and reorganizing.

It's also an important audience rating period. Certainly, springtime is a time to look and sound your best. Here are some ideas that will give your station a helpful spring tonic.

To start with, check out your antenna—take a walk around the tower and guys. No cracks in the base insulator? Lightning gap clear? Paint in good condition? How about the guys?

Are the anchors and safeties OK? Check around in the doghouse. No creatures making a nest in the tuning unit, I hope.

Better get out the binoculars and inspect the FM antenna. Measure the current in the heaters. Yes, this should have been done a long time ago, but you can still get some freak ice storms and an element might

have opened up over the winter. Don't forget the transmission line pressure. No nitrogen leaks? Good.

Next, look at your transmitter. Start clean by blowing out the accumulated dust with your air compressor. Take the filter outside and give it a blast, too.

Some window cleaner will shine up the front panels and meter glass. Get the back sides of the meter glass, too. Any me-

## Q-TIPS

ter in the high voltage line will attract dirt. Lube anything that moves.

Now check the meter readings and tune up the transmitter. Replace any weak tubes. On AM transmitters adjust the filament hum and modulator balance for minimum noise and distortion. New tubes may be needed if the distortion won't come down, even if the meters

look OK.

Before moving on, run a quick frequency response and check distortion again at 100 Hz, 1000 Hz and 10 kHz. Compare the measurements to last year's or last quarter's readings.

Make sure you record all performance measurements, meter readings and tuning knob positions. This data will be invaluable when something goes wrong in the middle of the night.

Tune up the stereo generator for maximum separation with the familiar L-R and pilot phase scope patterns. Null the left channel against the right by adjusting the generator input levels.

Check that input and output levels are correct on your audio processor. On processors with built-in stereo generators, this is where you balance the left and right channels. Get out your notebook and check that the adjustments have not been tweaked behind your back. Don't make any changes yet—save those for after the studio alignment.

Turning to the STL, check for proper audio and RF levels. You can spot check response and distortion now to verify that the STL is OK. If that is too inconvenient, any problems will be caught by a system test later.

### Studio alignment

Your next stop is the control studio. Set the main mic pot to

its normal position and feed a 1 kHz tone into the mic jack at the proper level. Adjust the output level pots to put the meters at 0 VU. This is your reference level.

Now set each source to read 0 VU, left and right, with the pot in the normal position. Many stations use "10 o'clock" on rotary pots or 3/4 open on linear faders as a normal pot setting.

Check the pots for noise. Clean rotary attenuators or re-

place sealed carbon pots if they sound scratchy—they'll only get worse. Make sure that one channel or the other doesn't drop out at any pot setting. Switches should also be checked and cleaned, if needed. Don't forget the headphone and monitor pots.

### Total system check

Run a total system check next. With the transmitter on, turn all channel switches off and check the noise reading on the mod monitor. Turn up the air monitors and listen for hum. The signal should be clean with only a low level hiss—no growls or birds tweeting from the transmitter.

Turn the monitors back down

**...when you complete a full alignment and test on the station all at once, the difference is bound to be heard.**

and run a frequency response and distortion check from the mic channel through the mod monitor. If this is the only response test you are running, set the audio processor to "test" or the gain riding function will cover up any response errors.

Watch the levels so you don't overmodulate. Three frequencies, 100, 1 K and 10 K, are enough for a good spot check. For a thorough job sweep from 20 Hz to 15 kHz.

Check headroom by turning the oscillator output up 10 to 20 dB and re-measuring distortion. The processing should be turned on as normal. The board meters will peg, but distortion

and run a frequency response and distortion check from the mic channel through the mod monitor. If this is the only response test you are running, set the audio processor to "test" or the gain riding function will cover up any response errors.

Watch the levels so you don't overmodulate. Three frequencies, 100, 1 K and 10 K, are enough for a good spot check. For a thorough job sweep from 20 Hz to 15 kHz.

Check headroom by turning the oscillator output up 10 to 20 dB and re-measuring distortion. The processing should be turned on as normal. The board meters will peg, but distortion

(continued on page 26)

## Rinaldo on Radio

(continued from page 12)

**Rinaldo:** Any time the FCC makes significant changes in its regulations, they are challenged in court. I don't believe the possibility of court challenges to technical improvements in radio, including solving the AM stereo problem in some way, should deter the FCC or Congress from doing all it can to make sure all radio stations can use the highest quality signal possible.

**RW:** What effect does state licensing have on radio engineers and how would legislation limiting such licensing affect the situation?

**Rinaldo:** Subcommittee Chairman Markey and I have asked the General Accounting Office to look into this specific question, and we expect to have a report from GAO by the middle of April. The National Association of Radio and Telecommunications Engineers has opposed state licensing of such engineers and called for federal legislation granting such power to the FCC.

Following receipt of the GAO's report, Rep. Markey and I will weigh the evidence on this question and decide whether any legislation superceding state authority is either necessary or desirable.

**RW:** The FCC now is considering whether to grant Class A FM stations a blanket 3000 W power increase or to grant the increase case by case. Which option do you support?

**Rinaldo:** I have long supported the blanket power increase for Class A FM stations; in fact, every Republican on the telecom-

munications subcommittee supported the Class A petition when it was filed in 1987. I assure you that all the members of the subcommittee will be watching this issue very closely to make sure that local communities have the benefit of the best local coverage from their FM stations

# GENTNER HAS BROKEN THROUGH THE TELEPHONE SOUND BARRIER

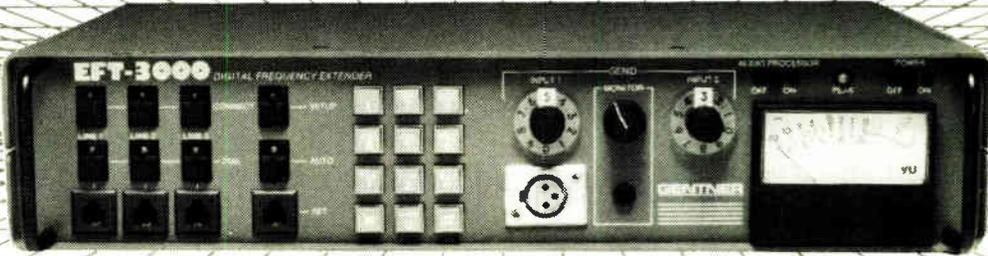

**Now you can have 7.5 kHz Bandwidth audio on standard dial-up telephone lines.**

- Digital Signal Processing allows 7.5 kHz using three dial-up telephone lines or 5 kHz using two dial-up telephone lines
- Easy to set up
- One person can operate
- Automatic group time delay — automatic equalization
- Available now

For complete details contact your Gentner Distributor or call Gentner at (801) 975-7200.

## GENTNER

### ELECTRONICS CORPORATION

1825 Research Way • Salt Lake City, Utah 84119  
Telephone: (801) 975-7200  
Facsimile: (801) 977-0087

# Staying Free From FCC Fines

by Harold Hallikainen

**San Luis Obispo CA** As mentioned last month, I've received a copy of most of the FCC violation notices issued to broadcast stations in 1988. I've also received copies of station replies to these notices. It is interesting reading.

So far, I've keyed 266 separate violations into a data base. Based on mass, this represents 20% of the 7.8 kg of paper I received.

The FCC can issue a fine for a "repeated" or "willful" violation. Quoting from a Notice of Apparent Liability,

"It is a broadcast station licensee's obligation to develop and maintain adequate procedures for ensuring proper station operation at all times. The term 'willful' when used with reference to the commission or omission of any act, means the conscious and deliberate commission or omission of such act, irrespective of any intent to violate any provisions of the Act. The term 'repeated' means the commission or omission of an act more than once or, if such commission or omission is continuous, for more than one day."

Not knowing the rules or not knowing of a violating condition can still result in a "willful" violation, because the

licensee did not have adequate procedures.

## Heavy fines

The FCC issues heavy fines for rule violations resulting in danger to the public or serious interference to another station. Some examples are listed below.

FCC Rule 73.49 requires a locked fence around every tower having RF potential at the base. This requirement obviously protects the public from RF burns. In addition, this section requires "ready access" to be available to each tower base for meter reading and maintenance. This generally means having a key to the lock available.

Stations have been fined \$1000 for violating this section. To prevent your station from getting such a fine, establish a procedure to detect the failure of the locked fence due to vandalism, removing gates, rusted locks, lost keys, etc.

Since you're at the tower at least quarterly (doing the inspection of tower marking, lighting and alarms), check the fence then. Log the results of your check in the station log and fix any problems quickly. This will show that you have adequate procedures to insure against violation of the rule. If the fence is subject to frequent vandalism, check it frequently.

## Tower lighting and marking

Tower lighting and marking is a very serious matter to the FCC (and the FAA). An invisible tower can have very serious consequences.

The FCC has fined stations \$1000 for having lights out and not notifying the FAA. Many stations were cited for having paint chipped and faded. The failure of any flashing light or the failure of any steady burning top light is to be reported to the FAA immediately, if the failure cannot be corrected within 30 minutes [17.48(a)].

## INSIGHT ON RULES

Failure of any steady burning side light is to be corrected as soon as possible, but the FAA need not be notified. Any failure or repair of the tower lighting system is to be logged in the station log [17.49].

Note that a daily (at least once every 24 hours) inspection of tower lighting or the tower lighting indicator is required if a functioning tower light alarm is not installed [17.47(a)].

Although the rules do not require this inspection to be logged, having the operators log it would show an attempt at compliance, should a question arise.

Note also that the tower lighting indicator is to detect the failure of *any* lamp. Measuring a sample of tower light voltage would not indicate the failure of a lamp. Measuring a current sample will, provided you have enough resolution to detect the failure of any lamp and the failure of any flasher.

As part of your required [17.47(b)] quarterly readings (intervals not to exceed 3 months) you are to insure that the tower light indicator works properly. What is the meter reading on failure of one of your side lights?

Finally, several stations got caught for modifying their tower lighting/markings as authorized by the FAA, but not authorized by the FCC.

If the FAA says it's OK to remove your tower lighting/markings, apply with the FCC to modify your license before doing anything. Otherwise, you are operating outside the terms of your license.

## EBS receiver and generator

You can quickly build up a large fine if there are problems with EBS. The FCC considers EBS problems to be very serious, because failure of the system could result in inadequate notification of the public of an emergency.

An inoperative EBS generator can get you a \$1000 fine. Of course, this is tested weekly, so there is very little excuse for it to not be working.

(continued on page 36)



## The mic mixer you would have designed yourself—the Shure M267.

The Shure M267 has become one of the most well-known and widely used mixers in the broadcast industry. One look at it will tell you why.

The M267 gives you the features you've told us were most important. Every channel has a mic line level switch for maximum flexibility. There's also a built-in limiter to keep the M267 from overloading at critical moments. The unit contains a built-in battery pack that utilizes three standard 9-volt batteries. Phantom power and a peak LED are standard, too.

The M267 oscillator provides a clean 1 kHz tone, and is located on the front of the unit for simple access. The headphone output is also on the front and includes a level control. IC design, along with active gain controls, provides greater headroom and quieter operation.

For location work or even studio post-production, the M267 carries on Shure's reputation for reliability and ruggedness.

For more information, call or write Shure Brothers Inc., 222 Hartrey Avenue, Evanston, IL 60202, (312) 866-2553.

**SHURE**

THE SOUND OF THE PROFESSIONALS... WORLDWIDE

# The Nitty Gritty of Instrument Miking

by Bruce Bartlett

**Elkhart IN** Past installments of "Line Out" have focused on microphone types and mic technique fundamentals. Time for the nitty gritty. This column describes exactly what type of mic to use and where to place it for various musical instruments.

## LINE OUT

First note that there is no "one right way" to mic any instrument, because you choose and place the microphone to get the particular sound you want and every instrument is different. Still, there

Figure 1. Two mic placements for recording guitar.

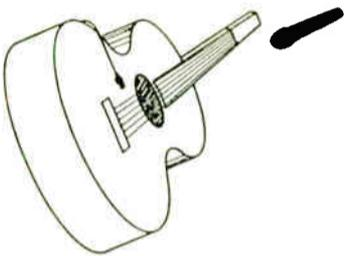

are some common techniques that have evolved in studios.

These are just starting points to reduce the time spent experimenting. They work well in many cases but some people will disagree with these suggestions. If you don't like the results, feel free to change the microphone or its placement.

### Review of microphone types

You'll be using several mics. Your first option is a cardioid condenser microphone with a flat frequency response. This type of microphone is especially good for studio vocals, cymbals and percussion, acoustic guitar and piano. Examples include the Shure SM-81, AKG 414 and 460, Neumann U-87i and KM-84, Audio-Technica 813 and 4051, and

Sennheiser MKH-40.

Your second choice of mic is a cardioid dynamic microphone with a presence peak. This type is good for drums and guitar amps. Examples: Sennheiser 421, Shure SM-57, Audio-Technica 836, Electro-Voice PL-80, AKG D-112 (for kick drum) and Electro-Voice RE-20 (also for kick drum).

You can mic a drum set with the two types just mentioned. A typical setup uses two cardioid condensers for the cymbals overhead, a cardioid condenser or dynamic on the snare and a cardioid dynamic on each tom and kick drum.

### Boundaries and ribbons

Another useful type of microphone is the boundary mic. It's meant to be used on surfaces such as floors, walls, piano lids, or panels. It sounds great for piano and room ambience but can be used in many other applications. Examples of this mic include the Crown PZM series and Shure's SM-91.

A ribbon microphone (such as made by Beyer) produces a warm, smooth sound which works well with digital recording. This type is rather fragile and should not be used in a kick drum.

A miniature condenser mic is similar

Figure 2. Miking a tom-tom or snare drum.

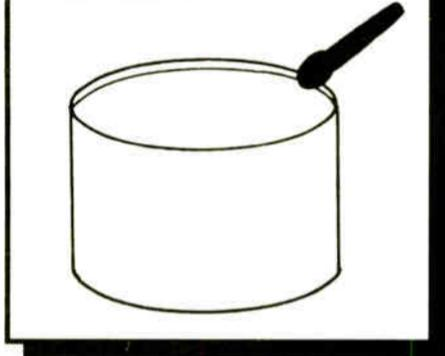

to what the TV newscasters wear. It clips onto an acoustic guitar, banjo, violin, sax, etc. Sound quality is excellent and the price is relatively low.

You can mic a whole drum set with (continued on page 32)

# Miking: What Goes Where

- Vocal: Flat-response cardioid condenser mic with a foam windscreen, eight inches away at eye height to avoid breath pops.
- Acoustic guitar: Flat-response cardioid condenser, 18 inches in front of the sound hole. Or, use a miniature omni condenser mic attached to the guitar sound board, halfway between the bridge and the sound hole, near the low E string.
- Sax: Flat-response cardioid condenser, 18 inches away, a few inches above the horn.
- Flute: Flat-response cardioid condenser, halfway between the mouthpiece and the tone holes.
- Electric guitar or bass: For a clean sound, plug directly into an unbalanced mic input or use a direct box. For a distorted sound, plug into a guitar signal processor (such as the Rockman), then into a mixer input. Or plug into a guitar amp and mic it as described below.
- Electric guitar amp: Cardioid dynamic mic with a presence peak, one inch to one foot from the center of one of the speaker cones. For more bass, place the mic close. For the brightest tone, place the mic near the center of the speaker cone. For a mellower tone, place the mic near the edge of the speaker cone.
- Tom-tom or snare drum: Cardioid dynamic mic with a presence peak, one inch above the drum head and two inches in from the rim, angled down to aim where the stick hits. If the drum rings too much, tape some gauze or a folded handkerchief to the head.
- Kick drum: Cardioid dynamic mic with a presence peak, inside the drum a few inches from where the beater hits. For a tighter sound add a pillow or blanket pressing against the beater head. For a sharp attack, use a wooden beater.
- Cymbal: Flat-response cardioid condenser, aiming down three feet above the edge.
- High-hat cymbal: Flat-response cardioid condenser aiming down eight inches above the edge.
- Grand piano: Boundary mics or miniature condenser mics on the underside of the raised lid, one over the treble strings, one over the bass strings. Or, remove the lid and place two flat-response cardioid condenser mics eight inches over the bass and treble strings, eight inches horizontally from the hammers.
- Upright piano: Remove the panel covering the hammers. Place one flat-response condenser mic near the bass strings, one near the treble strings.
- Xylophone, marimba: Flat-response cardioid condenser, 1½ feet above the instrument and two feet apart.
- Banjo: Flat-response cardioid condenser one foot from the drumhead, or mini omni condenser clipped to hardware and placed a few inches in from the rim.
- Mandolin, dobro, fiddle: Flat-response cardioid condenser one foot away or mini omni condenser attached to the sound board near the f-hole.
- Acoustic bass: Flat-response dynamic microphone, a few inches out front, above the bridge.
- Brass: Flat-response cardioid dynamic microphone, a few feet out front. Mic on-axis to the bell for a bright, edgy tone; mic off-axis to the bell for a mellower tone.
- Woodwinds: Flat-response cardioid dynamic microphone, one foot from the tone holes.
- Harmonica: For a natural sound, use a flat-response condenser mic a few inches to one foot away. For a bluesy, dirty sound, use a "bullet" mic.
- Harp: Flat-response cardioid condenser, aiming at the sound board about 1½ feet away.

## KEITH MONKS

Since 30 billion LPs will never be CDs, THE WORLD'S FOREMOST authority on the care and cleaning of vinyl discs will be in BOOTH 2151 NAB 1989 April 29-May 2



Keith Monks & his record cleaning machine.

Bring your dirtiest disc to Booth 2151. Keith & Jon will show you just how clean it can be.

BOOTH 2151  
**NAB**

ATLANTA, GA CHICAGO, IL DALLAS, TX  
LOS ANGELES, CA RICHMOND, IN

1-800-622-0022

See us at NAB Booth 2027

ONLY FROM

**ALLIED**  
Broadcast Equipment

— A HARRIS COMPANY

## TMD Telescoping Antenna Masts For Remote Broadcasting

- Easily installed on your van or promotional vehicle.
- Quick erecting for fast set ups.
- Cost effective when compared to equalized telephone loops.
- High quality audio from mast mounted RF links.
- Pneumatically raised in minutes.
- Rugged construction for long dependable life.
- Extended heights of 20 to 34 ft. for greater range on remote broadcast.



**WILL-BURT**  
P.O. BOX 900  
Orrville, OH 44667  
216/682-7015

An Employee Owned Company

# Remote Control Will Never Be the Same

On May 1, 1989,  
Advanced Micro-Dynamics  
becomes

**BURK**  
TECHNOLOGY

Why the change?

Well, it's easier to remember. It fits on a single Rolodex card. And it better reflects our personal commitment to broadcast.

We are, after all, a group of real people—Professionals, rich with broadcast experience, designing and building solutions to today's new transmitter control challenges.

It would have been nice to include everyone's name. But it wouldn't fit on the card.

Burk Technology ARC-16 and TC-8 Remote Control Systems are backed by a two-year warranty and are currently in stock. Find out more at the NAB, booth 1563-1662. Can't wait? Call us TOLL FREE at 1- 800-255-8090. You'll talk to a broadcaster.



The ARC-16 team with systems ready to ship.

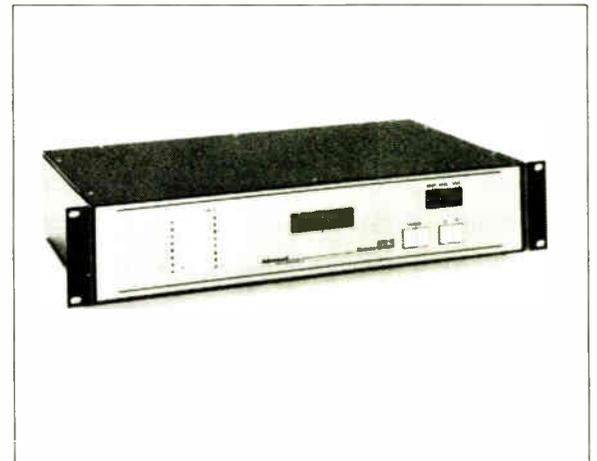

ARC-16 Remote Control System.  
Full-time and/or dial-up  
Total walkaway.



TC-8 Remote Control System.  
Simple, reliable, affordable.

**Advanced**  
micro-dynamics inc.

7 Lomar Drive, Pepperell, MA 01463 • (508) 433-8877

# KBRD's Tale of Three Sisters

by Dee McVicker

**Tacoma WA** Six twenty in the morning, and the snow up on Three Sisters had topped off to hazardous conditions. Down in Tacoma, Washington, the public was waking up to a biting cold day and the sound of KBRD-FM wafting on and off the air.

Within seconds, breakers and fuses at the station's transmitter site snapped and 103.7 went dark.

Chief Engineer Stan MacLafferty reached for the phone. The voice on the other end assured him that he would be up on Three Sisters by 9:00. MacLafferty reserved a helicopter and hung up.

At 8:55, MacLafferty approached Three Sisters mountain range under the whirr of chopper blades. Below him he could make out the outline of the station's 150' tower. What he couldn't make out, though, was the familiar drone of diesel engines feeding the Class C load.

It's on mornings like this that MacLafferty must surely think of that small triangle on the map.

## The Tacoma triangle

The triangle became the focus of conversation in 1979 when KBRD's new owner wanted to move the station up from a Class A to a Class C on the only frequency available, 103.7.

The co-channel and first and second adjacent channel separation requirements put the new site somewhere within a small triangle outlined on the map: the Three Sisters mountain range.

There was no question that Three Sisters would become the new site. The mountain range was not only the station's only option for Class C upgrade, but at approximately 4000 feet above sea level, Three Sisters overlooked the western world and provided ideal radio conditions.

## OFFBEAT RADIO

There was just one exception: no power to feed the new Class C status.

Solar power was not even a consideration. "We'd have to put solar panels all over (nearby) Mount Rainier," said MacLafferty. Electrical power was also outside the realm of financial logistics.

"It would cost approximately \$225,000 just to get the power up there," MacLafferty stated, explaining that the station would have to bury the power lines near roadways, in which case they could expect washouts and expensive maintenance.

"They (the utility company) wouldn't even take the power lines if we gave them to them," he added.

What did make sense was diesel

self-generation. And it still does, although the whine of diesel engines might seem a bit out of place in the remote woodland of Three Sisters.

Two diesel engines take alternate shifts in feeding the average 55 kW AC load. Once a week MacLafferty goes up the mountain—rain or snow—to alter-



The tower of power: KBRD's antenna

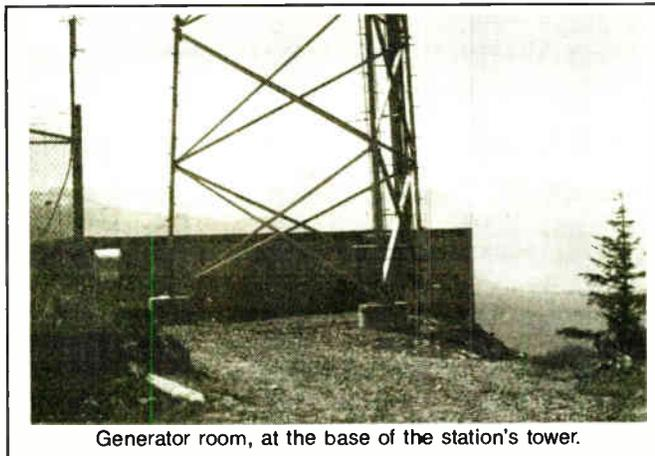

Generator room, at the base of the station's tower.

nate engines and service the generator that comes off line. "I manually transfer them," he said, "to equalize the load."

Should a power failure occur during the week, an automatic transfer panel shifts load control from the defective engine and puts the standby engine in service.

## Engine servicing

The engines, Detroit diesels, undergo an overhaul every other year, usually before winter sets in. MacLafferty commented that he never bypasses this item on his maintenance check list.

Nor does he even think about not ordering diesel fuel. It could be a long dark winter for the station—and

(continued on page 35)

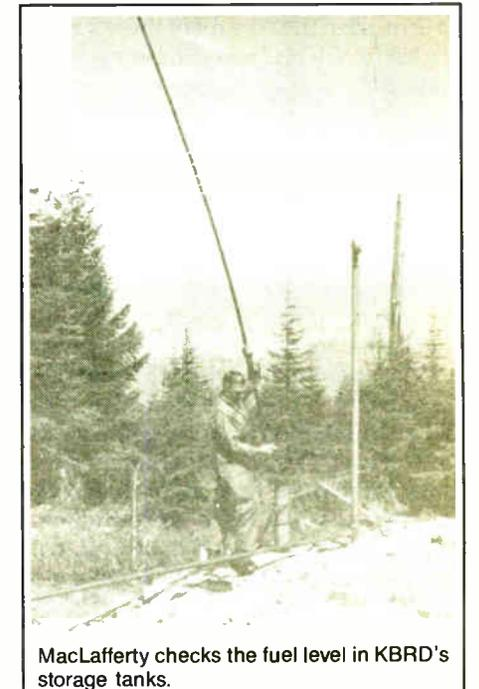

MacLafferty checks the fuel level in KBRD's storage tanks.

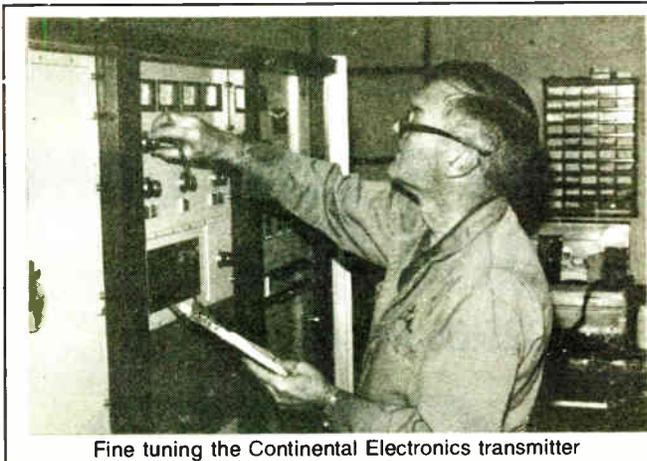

Fine tuning the Continental Electronics transmitter

**Great Sounds From Great Cartridges from ARISTOCART**

*Superb in Quality  
Supreme in Economy*

The NEW SLOPED Aristocart Audio NAB Cartridge AA 2006 and our NAB Standard A Aristocart Cartridge

**SPACE SAVER UNITS** Aristocart's compact racks are simple, lightweight, rugged and ready to wall mount.

Model AW-20, holds 20 cartridges

Model CD-40, holds 40 discs

Place your order today or Call, Write or Telex for descriptive literature

**Aristocart**

**Western International Communications Ltd.**  
17 - 825 McBride Boulevard, New Westminster, B.C. V3L 5B5  
TELEPHONE (604) 526-3214 TELELEX: 04-34639

## CRL SPOTLIGHT

### Need AM Stereo Processing?

CRL's AM2S Matrix processing system was designed to give you the fullest stereophonic fidelity while maintaining maximum monophonic compatibility. The two unit system consists of a wide range two band AGC (SGC-800), followed by our patented tri-band matrix limiter, the SMP-950.

AM stereo processing is very different from FM. To provide the best possible AM stereo signal, we developed and patented our own modified matrix limiter. This circuit ensures maximum mono gain support. The NRSC compliant limiter also features low frequency tilt correction and L-R stereo enhance. If you're not stereo yet, a mono output lets you buy the system today. At only \$4,050 the AM2S is a sound investment. Find out what the CRL AM2S can do for your station. We have a two week trial program available. Call or write for details.

**CRL SYSTEMS**

**CRL Systems**  
2522 West Geneva Drive  
Tempe, Arizona 85282 U.S.A.  
(800) 535-7648 (602) 438-0888  
TELEX: 350464

# A Tour Through Desktop Audio

by Mel Lambert

**Studio City CA** As we stand on the threshold of the digital age, many chief engineers around the country are attempting to conjure up a crystal ball that will allow them to offer cost-effective on-air and production tools—and at the same time trying to stay one jump ahead in the obsolescence race!

In addition to the more familiar CD players, PCM digital processors, PD/DASH-format reel-to-reel digital transports and DAT players used increasingly in air and production studios, growing numbers of stations are looking to centralize the control of these various digital functions from a master workstation.

After all, it makes little sense to pass digital material through a variety of analog signal manipulation and controlling devices if the result is less than pristine audio quality. Not to mention the fact that once audio has been converted into 16-bit words, it makes little sense to reconvert the digital bitstream back into analog before playing it in real-time.

Why stop short with CD and DAT technology? Enhanced control and signal manipulation can be gained from networking these devices through a centrally located, computer-controlled system that can handle the recording and editing of digital material and can control automated replay of digital music and commercial elements from hard disk and optical disk drives.

Such systems are comprised in a PC-based workstation—usually an IBM AT,

PS-2 or Apple Macintosh Plus/SE/II—connected to a variety of recordable media, including SCSI hard/optical drives, that provide high-speed access to the digitized data.

The systems run custom-developed supervisory software for direct-to-disk recording, non-destructive editing and

## DIGITAL DOMAIN

external control of other station hardware.

There are affordable systems now available that provide serial remote control of CD players, analog and digital tape machines (for replaying source elements and recording master air mixes) and even controlling outboard signal processors.

### The playing field

The Digital Products Division of AKG Acoustics is currently developing a RAM-based digital editor that includes an eight-track recorder, editing controller and 10-channel mixer in a standalone unit with CRT. Front-panel controls include conventional channel faders, an edit/scrub wheel, Play/Stop/Record/FF/REW transport controls and assignable keys for track routing and assignment.

Both 32 kHz and 44.1/48 kHz sampling frequencies will be available with the AKG editor. Each RAM card holds a total of 4.4 minutes of mono audio, with

input from either analog or AES/EBU-format digital inputs; a total of four memory cards can be added to provide a storage capacity of 17.5 minutes. Subsequent versions will be able to offer up to 70 minutes of digital capacity.

Advanced Music System's AudioFile system comprises a standalone workstation control panel and CRT display, linked to a rack of processing units and hard drives. It can simultaneously handle a total of eight digital "tracks,"

Recent enhancements to AudioFile include new software that provides automated control of record in/out timings, and the stacking of as many as 30 different takes, plus control of external tape machines. AMS also is developing a pair of all-digital consoles—Logic 1 and Edit 1—scheduled to begin shipping in the first quarter of this year.

### Communing with The Muse

Audio Animation's The Muse is a fully automated two-channel digital console with five-band parametric EQ and dynamics control, settings for which can be made via conventional front-panel ro-

**. . . growing numbers of stations are looking to centralize the control of . . . various digital functions from a master workstation.**

each of which can be edited independently.

A graphic representation of each digital track on the AudioFile CRT enables edit sequences to be constructed as the material flows from the right-hand side of the screen to the left; a "Now Line" in the center of the screen establishes the real-time position of audio being replayed from the hard drives.

In addition to analog ins/outs, AudioFile features digital SDIF-2 (Sony PCM-1630 format) and AES/EBU-format digital interfaces. For editing of mono or stereo audio, access to eight digital channels allows sound elements to be check-boarded, and crossfades or hard edits made between shortened or lengthened material.

tary controls or by using a color CRT display.

Settings for EQ bandwidth, center frequency and cut/boost, as well as compression ratio, threshold and attack/decay times can be stored and recalled at a rate of 100 per second; up to 80 minutes of real-time EQ, compression and level changes can be stored in on-board memory.

The Muse offers analog, AES/EBU and SDIF-2 digital inputs and outputs, at sampling frequencies between 30 kHz and 100 kHz.

Digidesign's Sound Tools for the Apple Macintosh SE/II consist of AD IN, a high-quality analog-to-digital conversion system, the Sound Accelerator D-to-

(continued on page 28)



# INSTALLATIONS

## The Name In Antennas and Filters Lives On In Installations

**ERI** . . . the best name in antennas and filters brings you ERI Installations, Inc. with over ten years experience in the broadcast industry. ERI Installations provides these outstanding services:

**ERI Installations** provides two registered professional engineers on staff and access to the consulting firm of Silliman and Silliman.

**ERI** insures and warrants all installation projects. All installation crew members are factory trained by ERI. In addition, a registered P.E. with 20 years climbing experience is on staff.

**ERI Installations** is fully equipped to rig any tower. The company has two independent installation crews with three double drum hoisting trucks.

**ERI Installations** rebuilds any manufacturer's antenna in the field with engineering and manufacturing support from ERI.

**ERI Installations**, to allow the customer to continue broadcasting during field servicing, provides at no charge a one bay standby antenna capable of over 20 KW input power.

**ERI Installations** provides new installations of FM antennas and feed lines; AM facilities.

**ERI** . . . the name lives on.

**RF Specialties of Washington, Inc.**  
John Schneider  
11721 15th Ave. N.E.  
Seattle, WA 98125  
(206) 363-7730  
FAX (206) 362-5560

**RF Specialties of California**  
Sam Lane  
3463 State Street  
Santa Barbara, CA 93105  
(805) 682-9429  
FAX (805) 682-4396

**RF Specialties of Texas**  
Don Jones & Tim Hawks  
P.O. Box 7630  
Amarillo, TX 79114  
(806) 372-4518  
FAX (806) 372-1833

**RF Specialties of Florida**  
Bill Turney  
271 Grandview  
Valpariso, FL 32580  
(904) 678-8943  
FAX (904) 729-2744

**RF Specialties of Missouri**  
Chris Kreger  
R.R. #2, Box 152A  
Kearney, MO 64660  
(816) 635-5959  
FAX (816) 635-4508

**RF Specialties of Pennsylvania, Inc.**  
Tom Monahan  
121 Conneaut Drive  
Pittsburg, PA 15239  
(412) 733-1994  
FAX (412) 327-9336

Each Office is Independently Owned and Operated

**ERI Installations**  
108 Market Street  
Newburgh, IN 47630  
(812) 853-2618  
FAX (812) 858-5706

**RF Specialties of Washington, Inc.**  
John Schneider  
11721 15th Ave. N.E.  
Seattle, WA 98125  
(206) 363-7730  
FAX (206) 362-5560

**RF Specialties of California**  
Sam Lane  
3463 State Street  
Santa Barbara, CA 93105  
(805) 682-9429  
FAX (805) 682-4396

**RF Specialties of Texas**  
Don Jones & Tim Hawks  
P.O. Box 7630  
Amarillo, TX 79114  
(806) 372-4518  
FAX (806) 372-1833

**RF Specialties of Florida**  
Bill Turney  
271 Grandview  
Valpariso, FL 32580  
(904) 678-8943  
FAX (904) 729-2744

**RF Specialties of Missouri**  
Chris Kreger  
R.R. #2, Box 152A  
Kearney, MO 64660  
(816) 635-5959  
FAX (816) 635-4508

**RF Specialties of Pennsylvania, Inc.**  
Tom Monahan  
121 Conneaut Drive  
Pittsburg, PA 15239  
(412) 733-1994  
FAX (412) 327-9336

Each Office is Independently Owned and Operated

## TFT's Low Cost Aural STL

**\$3325.00 (Monaural)**      SUGGESTED MFG. LIST

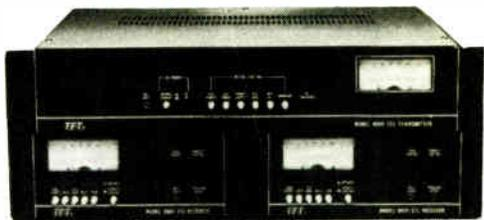

**8600 Series, Single or Dual Channel STL Features:**

- Built-in adjustments for phase and gain matching between dual links.
- Interfaces to optional Automatic Changeover Units.
- Front panel accessible subcarrier SCA generator and demodulator for supervisory or data link.
- Designed to utilize the new FCC narrowband spectrum allocations.
- Spurious-free on-channel power amplification.
- Two Year Limited Warranty.



# The cart machine with bells and whistles your audience will never hear.

Finally, a cart that delivers the creature comforts that other Otari audio machines have offered for years! And not only does Otari's CTM-10 make your job easier, it also delivers outstanding audio performance, so your output sounds more like a CD player than a cart.

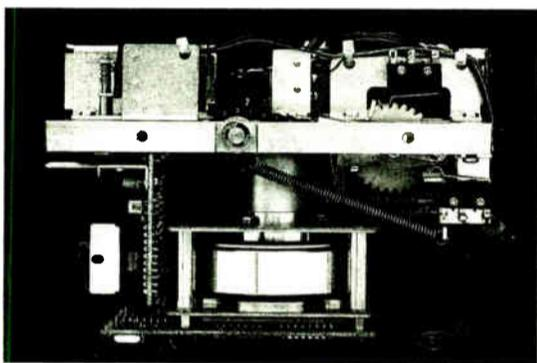

Heavy duty, direct drive capstan provides accuracy and reliability.

You get extensive metering, including dedicated metering for the cue-track. (Now you can verify the cue-tone *before* you go

on-air!) And for adjustments to program length, there's a *true* vari-speed control.

You'll also find a record azimuth adjustment system *with phase display* for when you want to make the best recording possible.

But the CTM-10 is not all just bells and whistles. It's the only cart you can buy with HX-Pro.\* That means that you can get a really hot signal off the tape, and still keep those high frequencies where they need to be for that crisp, clear sound.

And some things we keep real cool, like we don't use solenoids for our pinchroller because they can generate excess heat. You'll also appreciate the CTM-10's fast start time—it lets you cue up tighter without worrying about wow.

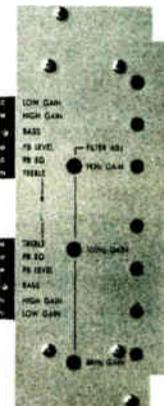

Equalization adjustments are easy to reach and clearly marked, making maintenance and service fast and easy.

And, of course, we give you choice. There are stereo *and* mono record/play decks, *and* a mono/stereo play-only deck.

Call us at (415) 341-5900 for more information about the CTM-10. The cart machine we built for perfectionists.

## OTARI®

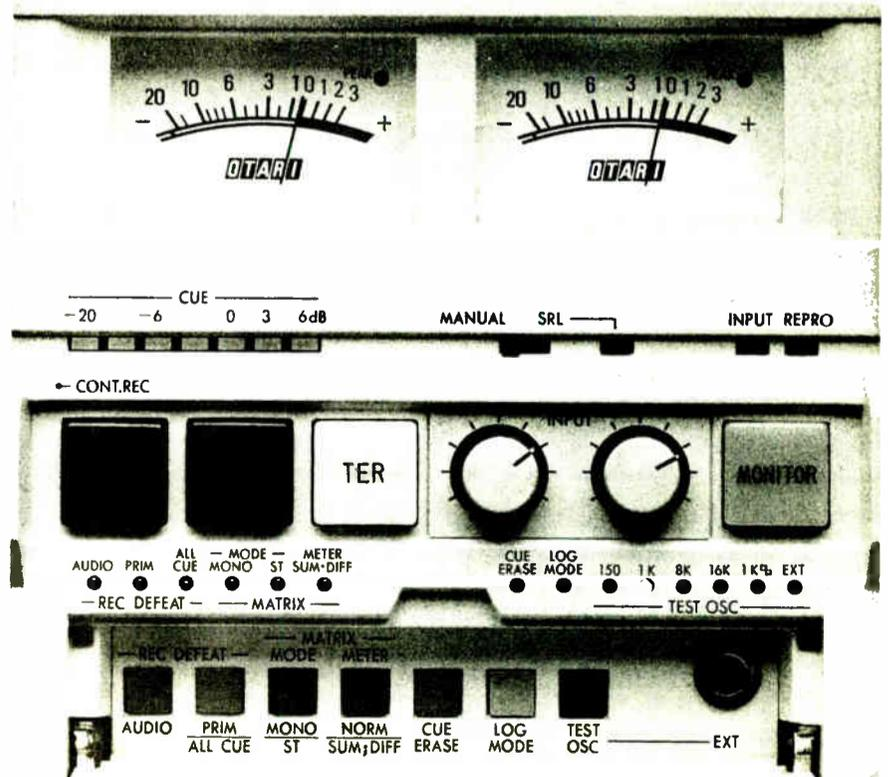
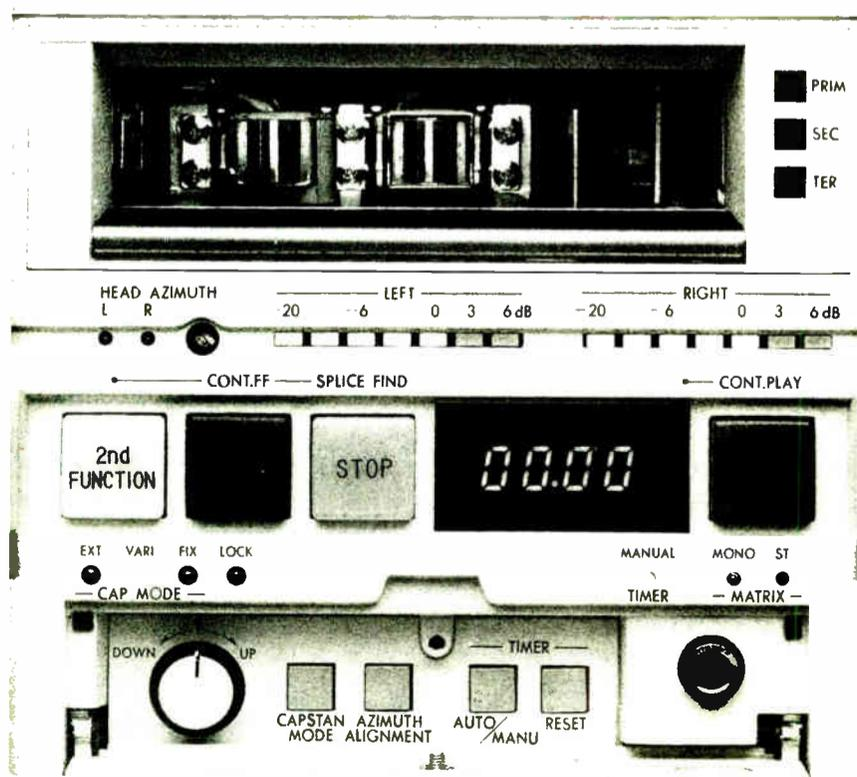

\*HX-Pro is a trademark of Dolby Laboratories Licensing Corporation  
See us at NAB Booth 1353



# Introducing the DAT recorder a professional can't afford to ignore.

The future of audio lies in the all-digital facility. And Panasonic's new SV-3500 DAT recorder/player answers the need for a fully-professional digital audio tape machine.

The SV-3500 is a full-function studio DAT machine from a company committed to servicing and supporting the demanding needs of audio professionals. It features:

- Dual 18-bit ADCs for encoding, and twin 18-bit DACs per channel for playback.
- Industry standard sampling and replay frequencies.
- Interface for digital-to-digital transfers.
- XLR inputs and outputs.
- Switchable +4/-10dB output level.
- Full-feature wired remote.
- 200-times high speed search mode.
- Comprehensive programming and loop functions.
- High-precision peak-reading meters.
- Erasure and re-recording of Start and Skip IDs.

Drop by a Panasonic dealer and ask to see the SV-3500. Because without a DAT recorder with these features, you never know who might ignore *you*. For the name of your nearest dealer, call 714-895-7278. Or, write to Panasonic AVSG, 6550 Katella Avenue, Cypress, CA 90630.

**Panasonic**  
Professional Audio Systems  
Circle 26 On Reader Service Card



The Company We Keep . . .

• ANDREW • AUDIO•TECHNICA • ATI • AUDITRONICS • TELEX • YAMAHA • SOUNDOLIER • DBX • AUDIOPAK • CAPITOL •

• MOSELEY • NAKAMICHI • NAUTEL • NEUMANN • ORRAN • OJELI • CRL

# ACHTUNG!

Das Machine is nicht fur gerfingerpoken und mittengraben. Ist easy schnappen der Springenwerk, blowenfusen und Poppencorken mit Spitzensparken.

Ist nicht fur gewerken by das Dummkopfen. Das rubbernecken Sightseeren keepen Hands in das Pockets. Relaxen und watch das Blinkenlights.

 The **AUDIO**  
broadcast group inc.  
Grand Rapids, Michigan  
616-452-1596

BROADCAST ELECTRONICS • STUDER • TASCAM • TECHNICS • TELFAX

• CROWN • ELECTRO-VOICE • EVENTIDE • ESE • FIDELIPAC • GENTNER • MARANTZ • OTARI • REVOX • SHURE • RAMSA •

# HIGH TECHNOLOGY BROADCAST EQUIPMENT

## Human-Engineered STUDIO SYSTEMS

### Five Reasons Why You Should Buy From The Audio Broadcast Group.

#### 1. We Take Orders 24 Hours A Day.

Fax your order or R.F.O. to us at 616-452-1652.

#### 2. We Match Any Advertised Price.

Should you find the same exact item at a lower price, just send us the advertisement within 30 days of receiving the item and we will credit the difference.

#### 3. All Equipment Has A One-Year Guarantee.

We have our own in-house award-winning service department. We make sure your equipment is

repaired and on its way back to you usually within 24 hours after arrival. No lengthy visits to the manufacturer's service center. You may call Audio's Customer Service Line at 800-798-2342.

#### 4. Pre-Delivery Check Out.

If you wish, we will check out your equipment prior to shipment, to make sure it's operating properly. We will set parameters to your specs and provide you with a proof. Your equipment can be ready to go to work as soon as it arrives.

#### 5. Regular Buyers Program.

By purchasing regularly, you can earn catalog gifts worth up to \$500.

- Studio Systems
- RF Systems
- Audio For Video
- Studio Furniture
- Over 150 Equipment Lines

- Outstanding Workmanship
- Stunning Performance
- On-Time Delivery, Within Budget
- Turnkey Installations Available
- Systems Suggestions and Design
- Single Source Responsibility
- Financing Available



2342 S. Division Avenue  
Grand Rapids, Michigan 49507-3087  
616-452-1596  
Established 1960

Las Vegas, NV

April 28 - May 2

# NAB "On the Air" in Vegas

by Charles Taylor

**Las Vegas NV** A look at new digital audio technology and systems, along with a study of serious issues that will shape the future of the medium, headlines the NAB 67th Annual Convention & International Exposition and 43rd Annual Broadcast Engineering Conference here.

The show, 29 April through 2 May, will feature more than 675 exhibitors occupying up to a record 411,000 square feet of floor space under the theme "On The Air: Proud Tradition • Dynamic Future." The engineering conference opens 8 April.

As in 1988, the event will be held at the Las Vegas Convention Center. Twelve additional exhibits will be housed in the center's Rotunda, being used for the first time, while the nearby Hilton Center will be filled to capacity.

More than 46,000 attended last year's conference, according to the NAB. At least as many are expected this year.

### Mechanics virtually unchanged

Aside from the increase in volume, the mechanics of the exhibition will be virtually unchanged from the 1988 show, according to Rick Dobson, NAB's director of exhibits and associate membership.

"We were very pleased with traffic patterns and the way space was utilized last year, so we pretty much left in place those things we thought worked well last year," he said. "If anything, I think you'll see last year just fine tuned a bit more."

In fact, more of an international presence is expected.

"We had in excess of 4000 international broadcasters last year and I know that we're expecting far more than that this year," said David Parnigoni, NAB's senior VP for radio.

"We've been doing more for international broadcasters because that's an important market for a lot of our syndicators. More and more commercial stations in Europe and other countries are looking to the United States as a program source," Parnigoni added.

Several internationally oriented panels will be offered, including "Tuning the World into Radio" at noon Sunday, 30 April.

### In-depth look at issues

Other convention sessions will take an in-depth look at issues affecting radio broadcasters. Unlike past years, fewer panels will overlap one another.

"I think we're offering more specialized non-competitive sessions," said Chuck Sherman, an NAB senior VP. "Instead of having four or five sessions at the same time, we're trying to concentrate on just a few select issues that we think are the most important facing broadcasters today."

Technical forums relevant to radio will

include: digital audio and radio systems, FM improvement, radio engineering, AM systems engineering, radio production and audio processing, and computers for broadcast engineers.

Also included will be a session on preparing for an FCC technical inspection, as well as discussions on broadcast auxiliary and satellite systems and safety, interference and environmental concerns.

### License renewals

In addition, a session will discuss steps necessary to prepare for license renewals.

"This is the first cycle of radio stations coming up for renewals in seven years," Parnigoni said. "There are questions about whether or not the licensee is ready for renewal. This will address what stations need to do to make sure that they're able to complete the license renewal forms accurately."

Workshops will convene on acoustics; RF radiation regulation compliance; contract engineers; and AM antenna systems.

Radio roundtables will offer broadcast managers the opportunity to discuss le-

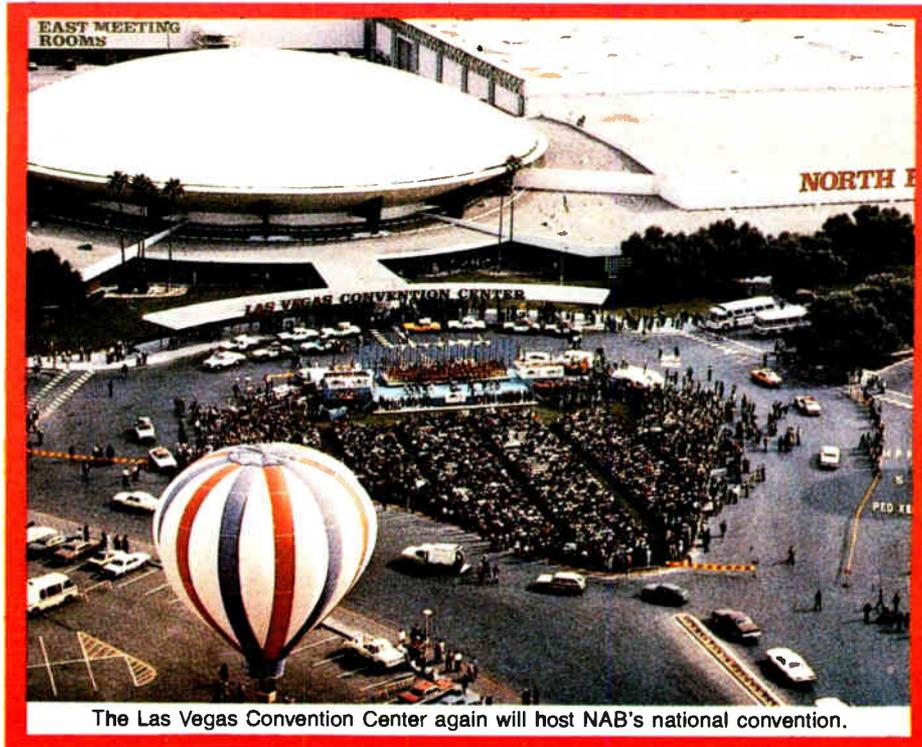

The Las Vegas Convention Center again will host NAB's national convention.

gal, programming and sales dilemmas free of charge with expert consultants.

Finally, a booth will be set up in the

area between the South Hall meeting rooms to demonstrate the implementation and benefits of both the NRSC-1 and NRSC-2 standards for AM broadcasting.

### Honoring William Connolly

Other highlights include the Engineering luncheon 29 April recognizing William Connolly with the Engineering Achievement Award, the industry's most prestigious engineering honor.

Connolly, president and CEO of Sony Advanced Systems, is considered a major contributor to broadcast technology.

Also featured at the luncheon will be writer and lecturer Len Feldman, who will speak on issues relevant to the con-

(continued on page N2)

barrett associates, inc.  
BROADCAST • AUDIO EQUIPMENT

1-800-748-5553

**LOOK FOR OUR ISLAND AT THE NAB**

**#1041 Las Vegas**

**barrett associates, inc.**  
BROADCAST • AUDIO EQUIPMENT

## INDEX

**OVERVIEW:**

- NAB "On the Air" in Vegas **N1**
- NRSC Makes Strides in AM, FM **N2**
- Sessions Span Radio Spectrum **N3**
- NAB 1989 Engineering Conference Planning Guide **N5**
- Tasting the Night Life in Vegas **N12**

**PRODUCT NEWS**

- Added Depth in Source Products **N6**
- RF Gear Keeps NAB Humming **N8**
- Accessory Items Take the Stage **N9**
- Scoping Out Testing Equipment **N10**
- Processing Enters Digital Arena **N11**
- Console Innovations **N13**
- Ringin' in New Interface Gear **N19**

**NAB Exhibitors Directory **N22****

# NRSC Makes Strides in AM, FM

by Alan Carter

**Las Vegas NV** With two standards for AM completed and preliminary work on FM begun, the National Radio Systems Committee still has a busy agenda ahead.

The full NRSC meets here 27 April before the opening of the NAB convention to tackle mostly FM concerns.

In less than three months, a working party of the NRSC FM Technical Subgroup has organized a study to conduct multipath field tests for what is

described as the first scientific data on such interference and a second working party is set to study composite occupied spectrum emission limitation.

The FM work begins as the AM Technical Subgroup sees the realization of the NRSC preemphasis and RF mask standards for AM go through rule making procedures at the FCC. The Canadian and Mexican governments also are studying NRSC standards.

At the meeting there will be a briefing on NRSC action at the FCC. Indications were the Commission could act

on the rule making this spring.

However, some broadcasters oppose the FCC's indication that it would enact an RF mask, known as NRSC-2, as opposed to the preemphasis standard, NRSC-1, which is sought by the NAB and some broadcasters.

On the FM multipath project, coordinator Harry Simons, CE for WAEB-AM/FM, Allentown, PA, said that pending FCC approval of an experimental application, testing could begin at WAEB-FM 8 May and run through 27 November.

Coordinating the tests with Simons are Ted Schober of Radiotechniques and Jim Gotshall of Delco Electronics.

So far, companies donating assistance toward the testing include Delco Electronics Research Inc. (ERI), Broadcast Electronics (BE) and Continental

**. . . a second working party is set to study composite occupied spectrum emission limitation.**

Electronics.

ERI is rebuilding WAEB-FM's four-bay antenna, which is about 15 years old, to certify it as "perfectly tuned" to the station's 104.1 MHz. Also, Continental has volunteered to modify the station's current Continental transmitter for optimum testing.

A rebuilt antenna removes "an awful lot of variables" from the study and will make the test results more valuable, Simons maintained.

Among the tests that will be conducted are transmitter incidental AM modulation, the point of diminishing returns on further reduction of transmitter parameters, receiver design characteristics, antenna bandwidth and stereo versus mono.

The second working party, chaired by Ed Anthony of Broadcast Electronics is evaluating occupied bandwidth, much like the work of the AM subgroup that eventually developed the NRSC AM standards.

For information on the NRSC, contact NAB coordinator Stan Salek at 202-429-5391. Contact Harry Simons at 215-434-4424, and Ed Anthony at 217-224-9600.

## On the Air

(continued from page N1)

sumer electronics industry, including AM improvement.

Feldman is an engineer active in the field of high fidelity audio for more than 30 years. He has organized a testing lab for audio and video equipment, and is a consultant for the Electronic Industries Association.

### Radio Leadership

At the Radio Leadership luncheon 1 May, a national radio awareness campaign will premiere with the theme: "Radio: Where Would We Be without It?" The campaign has been under development over the past year and will hit airwaves nationwide shortly after its debut at the show.

"It has people giving testimony as to the importance of radio in their lives," Parnigoni said. "It could be a trucker, a doctor, a person in the military. The testimonies hope to show that radio is an integral part of our lives, that maybe we take it for granted.

"It's designed to make the public, the advertising community and even to make ourselves in the industry more aware," he said.

Also at the luncheon, longtime sportscaster Red Barber and Nathan Safir, one of the first US broadcasters to air Spanish programming, will be inducted into the Radio Hall of Fame.

For more information, contact David Parnigoni at 202-429-5420.



## The Audio Processor Classic. And the one that endures.

In the arduous two-year development project that produced the 8100A OPTIMOD-FM®, there was always one overriding principle:

While providing competitive loudness where needed, the processor must have an utterly natural, musical sound that not only attracts an audience, but holds it.

Processing artifacts that cause listener fatigue and tune-outs were simply unacceptable. Loudness at the expense of good sound is never worth the price. (A listener can compensate for loudness by simply adjusting the volume control. But there is *nothing* the listener can do to make a dirty signal sound clean again, except change to another station!)

The development project resulted in a *classic*. The most popular FM processor *ever*. The processor that helped build audience and ratings for thousands of stations. The processor

that was the unchanging, indispensable core of countless customized processing setups. The processor with impeccable quality and rock-solid reliability. And the processor backed up with uniquely responsive Customer Service.

Today, OPTIMOD-FM has evolved into a complete system capable of serving any processing goal, and of fitting into any STL environment, thanks to OPTIMOD-FM's accessories. While other processors have come and gone, OPTIMOD-FM's audio quality has yet to be equaled any anyone, regardless of their bells, whistles, or flashing lights. It's the right choice for any station — because it's the one processor that you won't throw away.

OPTIMOD-FM 8100A/1. The Audio Processor Classic. The one that endures.

Call your Orban Broadcast Dealer for our new OPTIMOD-FM brochure, or call us direct.

**orban**

Orban Associates

645 Bryant Street, San Francisco, CA 94107 USA

Telex 17-1480 FAX (415) 957-1070

Telephone (415) 957-1067 or (800) 227-4498

# Sessions Span Radio Spectrum

by Alan Carter

**Las Vegas NV** The importance of digital equipment to radio stations is evident in sessions scheduled for the engineering conference.

The engineering conference opens 28 April, the day before the convention officially begins, at the convention center. (Note: The following noninclusive listing is subject to last-minute changes.)

## The word is digital

Sessions begin bright and early on 28 April with *Digital Audio and Radio Systems*, 8:30 AM-12:05 PM. Among the topics to be covered, Skip Pizzi of National Public Radio will discuss "Digital Audio Interfacing Standards."

Dr. Richard Cabot of Audio Precision will speak on "Digital Audio System for System One." This deals with a newly-developed system for taking audio measurements, interfacing with either direct data or AES/EBS standard formats.

A presentation by Hiroyuki Ukita and Laura Tyson of Denon America will cover "The CD Player in the Broadcast Environment: A Proprietary Cartridge System."

Frank McCoy of WGCI, Chicago, will speak on "Planning a Digital Production Studio."

In "Digital Audio for Links and Subcarriers," Harold Walker of Pegasus Data Systems will detail how to transmit digital audio via microwave links and subcarriers.

Robert Zavrel of Digital RF Solutions will describe a system that can revolutionize the way FM exciters are designed, by using a method of direct digital synthesis in "A Completely Digital FM Broadcast System."

Howard Mullinack of Orban Assoc. will make a presentation on MIDI, and Dietmar Kopitz of the European Broadcasting Union will discuss "New Digital Sound Broadcasting Modulation System for Terrestrial and Satellite Use in the 1 GHz Range."

## Everything for FM stations

In *FM Improvement*, 1:30 PM-4:40 PM Jim McNally, chief, Engineering Policy Branch of the FCC, will report on "FCC FM Regulatory/Technical Action."

Tom Keller, a consultant to Broadcast Technology Partners, will cover FM receiver measurements and how different receiver blend circuits operate, versus the true amount of stereo separation realized in "FM Stereo Separation Versus Receiver Blend."

Martin Hadford of RF Specialities will describe a system for synchronizing FM boosters in "High Powered Synchronous FM Boosters."

"Optimum Bandwidth for FM Transmission" will be covered by Ed Anthony of Broadcast Electronics. He heads a new NRSC FM Subgroup working party looking at this subject. (See separate story, this issue.) Wes Whiddon, chairman of the FM subgroup also will give a status report on the committee's work.

John Kean, of the Moffett, Larson and Johnson consulting firm, will discuss the ramifications of "FM Directional Antennas."

In a final topic, Eldon Haakinson of

## From Digital Technology Through AM Improvement, Engineers Gather to Hear the Last Word

the NTIA will cover "Irregular Terrain Propagation Study" based on the agency's study in development of an irregular terrain model for FM propagation determination.

### In full swing

On 29 April, the day the actual convention begins, the first session will be *Radio Engineering*, 8:45 AM-11:55 PM. The FCC's McNally opens this session with an update of "FCC Remote Control Policy."

Ron Nott of Cortana Corp. will discuss how to consolidate AM and FM transmitter sites in an efficient way.

Also, A.R. Mahnad of Jampro Antennas will present "Determination of the CP Gain of Sidemount CP-FM Antennas," while Tom King of Kintronics will discuss "Diplexing AM Antennas."

Gary Smith of Sun Mountain Engineering will give details on "Real World Maintenance."

NAB Staff Engineer Stan Salek will make a presentation on the "NAB Test CD."

A final topic, "Automated Maintenance Testing," will be covered by Mike Callaghan of KIIS-AM/FM, Los Angeles.

### For AM

On 30 April, the topic is *AM Systems Engineering*, 8:30 AM-11:50 AM. FCC Mass Media Bureau Chief Alex Felker opens this session with an "Overview of FCC AM Action." He will review the technical side of AM broadcasting from the Commission.

NAB Science and Technology VP Michael Rau also will discuss AM developments in "Progress Report on NAB AM Improvement."

Discussing the concept of the "Low Profile AM Antenna System," will be Al

Resnick of Capital Cities/ABC, New York.

Ted Schober of Radiotechniques will make a presentation on "AM Directional Antenna Tuning, New Methodology, New Tools."

Basil Pinzone of Pinzone Communications Products will cover the company's "Low Profile Anti-Skywave Antenna,"

## Tom Keller, a consultant to Broadcast Technology Partners, will cover FM receiver measurements and how different receiver blend circuits operate . . .

and Timothy Cutforth of Vir James P.C. will discuss "Alternate Production of Groundwave by Structures of Inherently Low Skywave Potential."

Several final presentations will be made by Jerry Westberg of Westberg Consulting on "AM Diplexer Design: Q-Matching Techniques" and by John Bisset of Delta Electronics on "The Splatter Monitor and Spectrum Analyzer."

In *Professional Development*, 9 AM-12 PM, Sim A. Kolliner of WHIO-TV, Dayton, OH, and Judith E.A. Sheets of the Calumet Group will address steps engineers can take to further their status in the management chain.

*Computers for Broadcast Engineers*, 1:30 PM-5 PM will include demonstrations of software and hardware on aspects of modem communications to technical documentation for a personal computer.

Workshops this year cover topics ranging from RF radiation regulation compliance and contract engineers to AM an-

tenna systems. Saturday's evening workshop runs from 7 PM-8:30PM.

### Pleasing the FCC

On 1 May, *Preparing for a FCC Technical Inspection* starts things off from 8:45-9:40 AM with William McAllison of Radio Management/Systems who will give a rundown on working with an FCC inspector.

From 1:30 PM-4:40 PM is *Radio Production and Audio Processing*. Opening the

Opening the session is Michael Pettersen of Shure Brothers who will address "Broadcast Applications for Voice Activated Microphones."

Jeffrey Steinkamp of Broadcast Electronics will make a presentation on "Acoustic Noise Measurement and Reduction Techniques for Broadcast Studio Equipment."

With the introduction of digital audio into audio processing, Michael Morgan of Valley International will speak on "A Digital Dynamics Processor for FM Broadcast."

Christopher Moore and Jeffrey Stanton of AKG Acoustics will address "Operational Features and User Interface Considerations of a RAM-based Digital Audio Workstation."

"Analog vs. Digital Technology in Audio Processing" is the topic of Chuck Adams of CRL and Robert Weirather of Harris Broadcast Division will speak on

(continued on page N5)

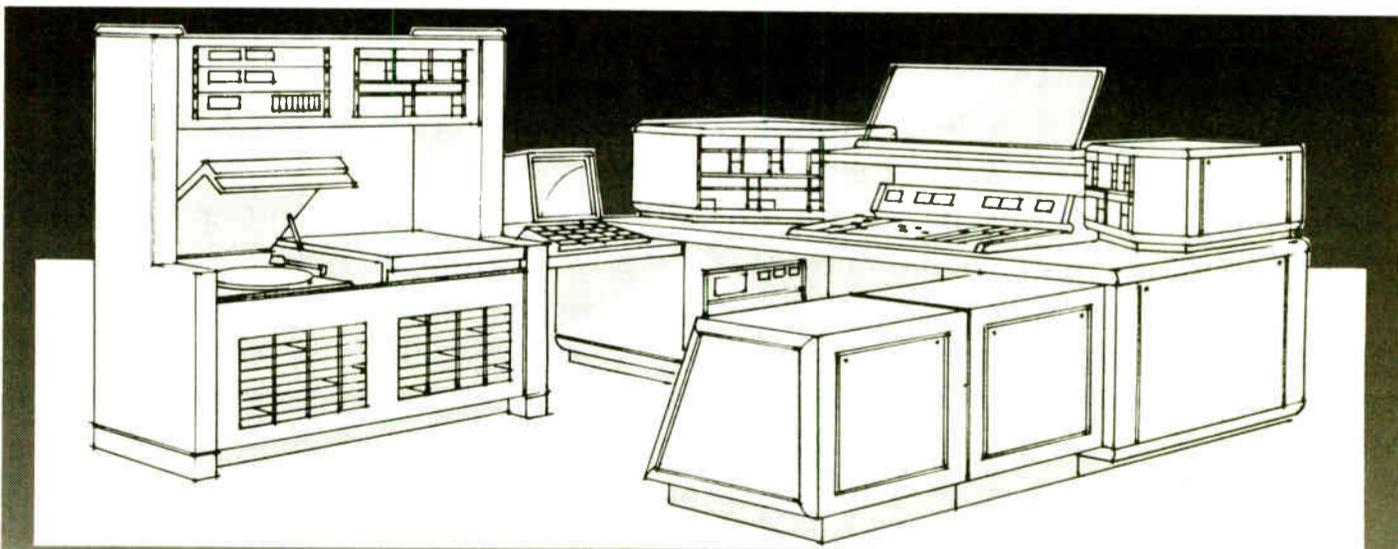

# TWO WEEKS.

The "Express" in Express Group means just that. Express service, Express delivery, with some of our systems deliverable in as little as two weeks.

The choice of Modular Studio Furniture over built-in kitchen grade cabinets is a wise decision. With built-in cabinets you are stuck with one configuration or faced with total replacement should you move or update your

equipment. Our four complete lines of Fine Studio Furniture will meet your present needs while giving you the future flexibility a modern broadcast facility demands.

Each of our four lines are made of the finest materials. All designs feature numerous access panels, hand rubbed hardwood trim, and built-in wire passes.

Don't settle for second best!

Please call or write today for our free color brochure.



**THE EXPRESS GROUP**  
3518 3RD AVE., SAN DIEGO, CA 92103  
(619) 298-2834

Come see us at: Fidelipac booth 1117, Broadcast Electronics booth 1205, Audionics booth 1363

Also: See us at Fidelipac booth for show deal!

# THE BROADCAST DECK FOR PUSHY PEOPLE.

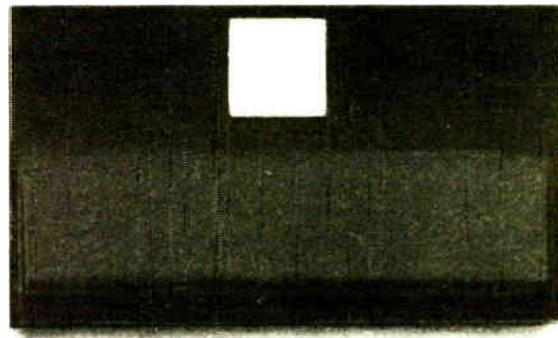
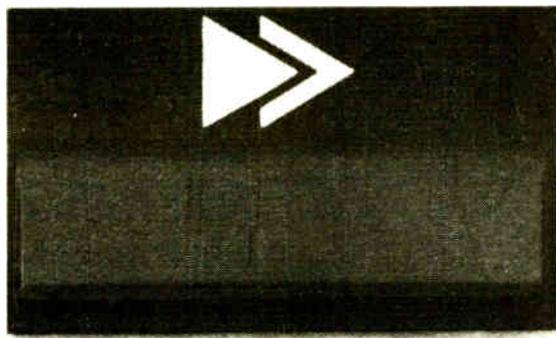
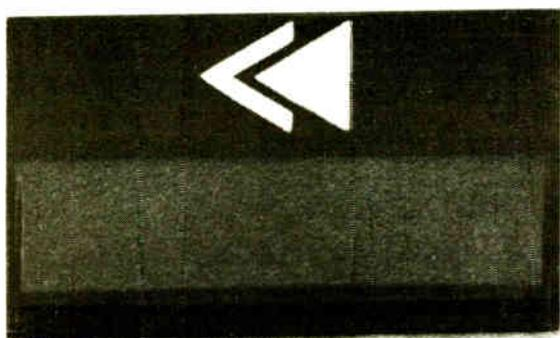

No tape deck gets pushed around more than a professional broadcast deck.

Round-the-clock fast forwarding and rewinding can burn out motors fast, while relentless play takes its toll on the tape heads. That's why the standard for broadcast decks is the 122MKII from Tascam.

Its FG-servo direct-drive capstan motor was designed to prevent tape damage and deliver perfect performance under heavy workloads. The unique Hysteresis Tension Servo Control actually lets you adjust take-up, back tension, torque and azimuth with open-reel precision. All without ever taking the machine off the rack.

At the same time Tascam's three Cobalt Amorphous heads deliver crisp, clean sound that's enhanced even more by a choice of Dolby® B, C and HX-Pro.

With 4-track, 2-channel stereo, Cue and Review, and easy serviceability, the rack-mountable 122MKII lives up to its reputation as *the* professional broadcast deck.

Call or write for more information about the 122MKII. Or ask other broadcast professionals. They're the people who really push our buttons.

## TASCAM



© 1988 TEAC America, Inc., 7733 Telegraph Road, Montebello, CA 90640, 213/726-0303.

<b>Friday, 28 April</b>	
8:30 AM:	Digital Audio and Radio Systems
1:30 PM:	FM Improvement
<b>Saturday, 29 April</b>	
8:45 AM:	Radio Engineering
<b>Sunday, 30 April</b>	
8:30 AM:	AM Systems Engineering
9:00 AM:	Professional Development
1:30 PM:	Computers For Broadcast Engineers
7:00 PM:	Workshops
<b>Monday, 1 May</b>	
8:45 AM:	Preparing For a FCC Technical Inspection
1:30 PM:	Radio Production and Audio Processing
1:30 PM:	Safety Interference and Environmental Concerns
<b>Tuesday, 2 May</b>	
8:30 AM:	New Communications Technology

**NAB 1989**  
ENGINEERING CONFERENCE  
PLANNING GUIDE

*Note: Schedule is subject to change. Check official NAB program guide at the convention.*

# Focusing on Radio

(continued from page N3)

"Digital Audio Tape in the Broadcast Environment."

Also in that session, Jim Woods of In-ovonics will speak on "Audio Processing for NRSC."

In *Safety, Interference and Environmental Concerns*, 1:30 PM-4:40 PM the session opens with Scripps-Howard's Warren Happel covering "Broadcaster Environmental Concerns."

Mukunda Shrestha of Broadcast Electronics will continue with "Personal Safety Considerations with Broadcast Transmitters."

Ramon Upsahl, Skilling Ware Magnusson Barshire, Inc., will address "New Tower Structural Standards ANSI/EIA-222D."

From PSA Communications, Joseph Giardina will review events surrounding a fire in the Empire State Building last

year and how radio stations operating there reacted.

A.S. Richardson, Research Consulting Associates, will report on "Guidelines of Vibration Control of Tower Guy Cable."

"Electromagnetic Interference to Aviation Receivers—FAA Considerations in the Broadcast Site Selection Process" will be covered by William Suffa of Jules Cohen and Associates.

David Marcis, Friendly Broadcasting Co., will cover "Dealing with RF Interference Complaints."

### New high tech

On 2 May *New Communications Technology* from 8:30 AM-12:05 PM features Mark Gehrin of AT&E with a discussion of the "AT&E Receptor System FM Sub-carrier Modulator."

Ken Regnier, COMLUX, will cover

"Digital Fiber Optics for Broadcast Television and Radio Transmission."

And Micro Communications' James Stenber and Walter Pries will report on "Advanced RF System Measurement

Techniques."

For information on the engineering conference, contact NAB's Science & Technology department at 202-429-5346.



**ALLIED**  
Broadcast Systems  
— A HARRIS COMPANY

**PLEASE!!**

Before you start your next broadcast project, we'd like you to touch base with us! Let us show you what we can do for you!

Allied Broadcast Systems doesn't just install equipment; we innovate, to better serve the changing needs of today's (and tomorrow's) radio stations.

MODULINK™ has been designed in consultation with, and is built exclusively for Allied by Arrakis Systems, Inc. It's a manufactured studio system that can be custom-tailored to meet your exact specifications, yet its unique design allows your new facilities to be operational in days, not months.

MODULINK studios come fully pre-wired with multi-pin connector "docking modules" which link all units and interconnect all equipment.



Because of its advanced design, MODULINK lets Allied Broadcast Systems give you more studio for lots less money . . . And that could be the difference between getting exactly the studio package you want, or settling for something less.

3901 MacARTHUR • SUITE 200 •  
NEWPORT BEACH, CA 92660 • USA

**714-752-6664**

# TENNAPLEX

## THE MUSIC MANAGER

**Digital Automation . . . The Radio Studio of the future**

\*\*\*\* no higher quality and no lower price\*\*\*\*

**Automatic Play List Selection with up to 97.9% of your library available for every selection**

**Automatic Playing & Record-keeping under strict control.**

**See it in operation Booths 5441-5442 NAB**

**Phone: 613-226-5870      Fax: 613-727-1247**  
**904-434-1953**

# Added Depth in Source Products

by John Gatski

**Las Vegas NV** Look for new radio source products and further improvement of existing lines during the NAB convention, including greater product offerings in the area of digital equipment.

The digital workstation has slowly been creeping up on the broadcast industry. Last year New England Digital showed that radio stations could benefit from even larger digital systems—albeit with a healthy cash expenditure.

Now AKG's new digital workstation is one of the awaited products planned for show at the convention. The company, noted in the past for its microphones, hinted at such a product at last November's AES show.

AKG's DSE 7000 sound editor is a RAM-based digital workstation with the equivalent of an eight track recorder, editing system and mixer contained in one console unit. According to the manufacturer, the DSE 7000 is specifically designed for radio commercial spots and other short recordings.

New England Digital will debut its enhanced Post-Pro direct-to-disk, multi-track recorder/editor, featuring high speed editing, quick access to special ef-

fects and ability to reconfigure as a eight-track or 16-track recorder.

Lake Systems Corp. also will show its

On the DAT front, Radio Systems Corp. officially will launch its custom line of RS DAT machines for radio and

gramming System) that controls up to 12 DAT decks with full access to all audio selections, music, spots, etc. CAPS II will offer DAT deck access and digital tape loader for total automation control that can provide enough programming for five days.

Also, look for DAT radio formats for automated or live radio for all types of music from the company.

IGM Communications will show its new enhanced software for computer control of programming.

Schafer World Communications Corp.

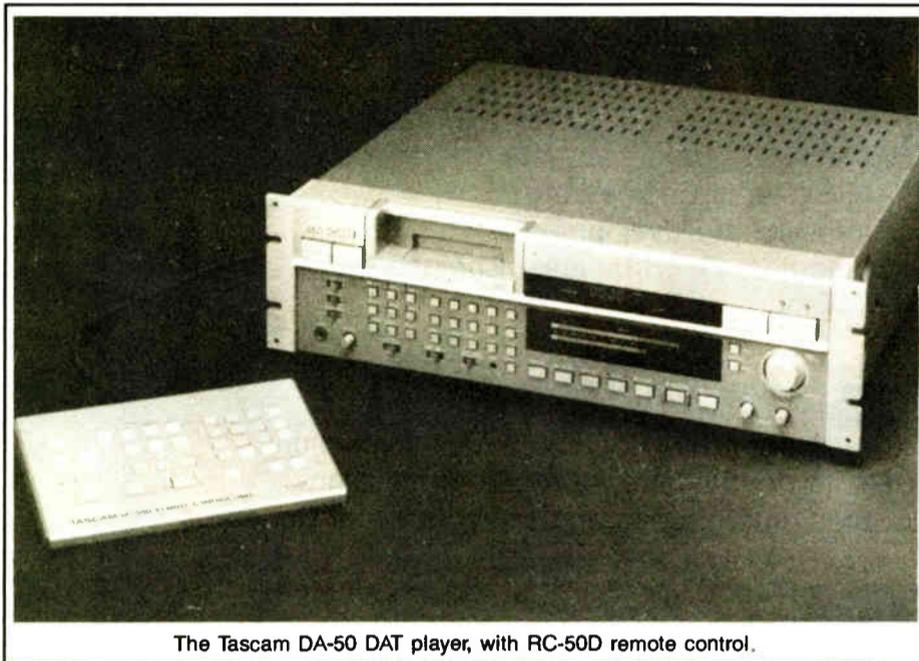

The Tascam DA-50 DAT player, with RC-50D remote control.

**The digital workstation has slowly been creeping up on the broadcast industry.**

is planning to unveil its compact disc automation system that will interface with its automation control systems.

Visitor to NAB also will see Sono-Mag Corp.'s current line of automated music, satellite music and live-assist CD music programming.

Media Touch Systems Corp. will show its touch screen audio editor, automation systems and digital audio storage system.

**Tape recorders/players**

Tape recorders and players continue to be refined for radio use and several com-



Revox's C278 1/2" 8-channel professional recorder.

panies are bringing out new products at NAB.

Tascam will show its 3030 1/2 track, two-track 1/4" recorder/reproducer, TSR-8 eight track, multitrack recorder/player and Models 102 and 103 stereo cassette decks.

Studer Revox announced plans to show its new multichannel recorder, A827-24.

Comad will display the Data Security new line of tape degaussers for audio  
(continued on next page)

new Waveframe Audioframe digital audio workstation/editor.

And Integrated Media is expected to feature the Dyaxis hard disk digital workstation.

accompanying controller/sequencer at NAB.

Harris also will show new DAT recorders/players, according to the company. Systemation will exhibit the Sony EVS800U 8 mm DAT cassette deck.

In another development, according to reports before the show, Matsushita Corp. was planning to unveil an editing system for DAT. Editing capability is one feature which many believe will help DAT's acceptance into the production studio.

Other companies which featured DAT players for the professional market, including Panasonic's Ramsa, Sony, and Tascam were expected to highlight their product offerings at the convention as well.

Automation systems are taking a firmer hold of radio stations as evidenced by the new product list.

Systemation will have a new satellite automation system on display, which reportedly will cost in the \$15,000 range.

Concept Productions Corp. will introduce CAPS I (Computer Assisted Pro-



**"Keeps Playing"**

*"I can't let another day go by..."*

"...without telling you about my Harris SX-5A AM Transmitter," writes R. Dale Gehman, partner and chief engineer of WASG AM Stereo 55 in Atmore, Alabama.

"We got prompt action on our order. Your shipping people followed it through. I was very pleased with the manual, the construction (Built Tough!), the hook-up procedures and the initial turn-on performance. The final numbers were beyond my wildest dreams! Imagine 0.3% distortion, 0.2% intermod, 3% IPM ... I never dreamed I'd see any AM transmitter turn out numbers like these!

"But let me tell you what surprised me most: WASG is located in a lightning belt—more strikes than anywhere in

America. Our 511-foot tower has been popping with static many times, but your solid-state SX-5A just sits there and keeps on playing! We haven't been off the air once. THANKS!"

Harris' SX-5A is your best bet for a rugged, reliable and efficient 5 kilowatt AM transmitter, and it's available for single or triple phase hook-up. There also are 1 and 2.5 kW SX models. SunWatch™ automatic PSAPSSA and C-QUAM® AM Stereo are options. Standard-setting Harris training and service top off the features.

Call today for your SX brochure, 1-800-4-HARRIS, Ext. 3006. Or write: Harris Radio Sales, P.O. Box 4290, Quincy, IL 62305-4290.



**The effects are all digital. The grins are only natural.**

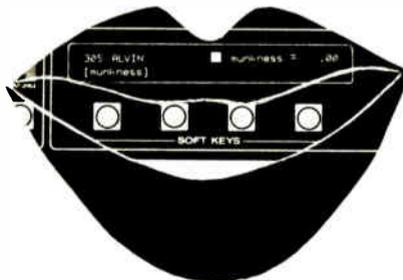

Alvin vocal shift program—one of 70+ Eventide Broadcast Ultra-Harmonizer® digital audio effects designed to stretch your imagination (and your smile). And when you have fun, so do your listeners.

**RADIO'S MOST COLORFUL BLACK BOX**  
EVENTIDE INC  
ONE ALSAN WAY  
LITTLE FERRY, NJ 07643  
TEL: 201-641-1200 • TWX: 710-991-8715 • FAX: 201-641-1640

**Eventide**  
the next step

**SCA RECEIVERS**



\$79.95 7 QTY

**ERKO TECHNOLOGIES**  
7616 Burlington Omaha NE 68127  
402-331-2632



# Showing New Ways to Play

(continued from previous page)

tape and cassettes including metal tape.

Otari plans to show its cost-effective MX-50 tape player introduced at last fall's AES show. It features a built-in timer display and is available in several tape speed configurations. An optional voice editing module (VEM) which provides 2x playback speed



The DSE 7000 digital audio workstation, from AKG

without pitch change is also available.

## Carts and machines

Cart machines remain a viable product at most radio stations and visitors to NAB can expect to see upgraded models and even some new ones, according to manufacturers.

Fidelipac will show its "enhanced" CTR30R series. It's a revised three-deck configuration with DC servo motor providing enhanced flutter specs and universal voltage and frequency capability.

The company will also feature its line of tape and cartridges, including the Dynamax cobalt tape line.

Broadcast Electronics Corp. will have its current line of cart machines on display including the Phase Trak 90 with tape learn mode Model PT-90PS playback with non-encoded phase correction.

Audiopak plans to exhibit its established array of broadcast carts including NAB-standard and extended range carts for digital transfers.

Audi-Cord Corp. also is planning to show its established line of cart recorders/players, according to the company.

Saki Magnetics is offering new cart machine heads, which are made of ferrite. They are said to be nearly 10 times as durable as standard permalloy metal heads.

ITC/3M will show its 99B, Delta and Omega cart machines and its ScotchCart II broadcast cartridge as well as other cartridge gear.

## CD players

No major advances in CD players are seen, other than more customization for radio use and enhanced durability, according to manufacturers.

Studer Revox will show two models: the A730 and A727 CD players.

Tascam announced introduction of its

CD 701 production/on-air CD system and CD 401 player.

And Denon is expected to have upgraded versions of its CD cart player.

## Microphones

Newer radio microphone products are emphasizing more portability for in-the-field and ENG work.

Beyer Dynamic will unveil its MCE 86 short shotgun microphone, TS 190 wireless lavalier system, TS 186 wireless hand-held microphone system, and M58 ENG/EFP microphone.

Shure Brothers will show its Beta Series supercardioid microphones: Beta 57, 58M and 58C. The company will also feature its voice-activated automatic mic mixer.

Audio Technica plans to introduce its ATM 25 high sound pressure microphone.

Gotham Audio will exhibit its new Neumann KM 100 Series condenser microphone and will show the U89 and TLM 170 microphones, featured in the movie *Talk Radio*.

Accurate Sound Corp.'s CR3A, a new

condenser microphone, and Bruel & Kjer's Type 4011 cardioid microphone can be seen at the companies' respective booths.

## Speakers, headphones

JBL will have its current line of Control 5 and 10 monitors, 4400-Series studio monitors, Bi-Radial Monitors and the new 6210 and 6211 speaker amps.

Visitors to the UREI booth will see the existing line of monitors including the Time-Align co-ax monitors.

Tannoy North America announced a premiere of the Playback Monitor Series: PBM 6.5, PBM-8, A.V.M. Monitor and a new 6" two-way speaker with the com-

(continued on page N21)



# DEMANDING STANDARDS

Whether it's a fast-paced talk show, a call-in promotion, or even an occasional on-air caller, your demanding standards require clear, consistent telephone audio.

Demanding standards that won't accept muddled audio created by feedback because of lost null or slow adjustments to line changes. You can't afford distractions from your on-air interview, and more importantly, you can't afford listener aggravation.

## New Advanced Nulling Algorithm

Gentner's new Digital Hybrid ANA meets your standards. Every call and every second of a call is analyzed and modified to insure clean, clear audio. To do this, the unit uses a new Advanced Nulling Algorithm to constantly adjust the null.

## Deeper Null

Gentner has invested in the time and research to create advanced digital nulling techniques that provide the maximum possible isolation between Send and Receive. This Advanced Nulling Algorithm, including precision filtering, creates a hybrid that outperforms ALL competition.

## Fastest Null

Just as important as achieving maximum null is achieving it quickly. The Digital Hybrid ANA provides an almost instantaneous null. So, whether you get varying line quality or audio fluctuations on a single line, the Digital Hybrid ANA tracks and compensates for this continuously.

Its principle goal: Obtain maximum null swiftly...again and again.

## Sound Quality

The Digital Hybrid ANA's flawless performance makes the caller sound as if he's right next to you...and your listeners. And, your on-air staff will love the way they sound. The high quality interaction between caller and talent will also strengthen the natural flow of conversation.

## See us at NAB

Experience Gentner's new hybrid at NAB, Booth #2127. Or, call your favorite distributor or Gentner for more information.

Complete upgrade kits are available for current Digital Hybrid users.

You've set your standards. Gentner intends to fulfill them.

**GENTNER**  
TELEPHONE PRODUCTS

1825 Research Way • Salt Lake City, UT 84119 • (801) 975-7200 • FAX (801) 977-0087

# RF Gear Keeps NAB Humming

by Charles Taylor

**Las Vegas NV** Transmission equipment on the exhibit floor will provide a glimpse into the future with digitally modulated transmitters, FM solid-state transmitters in lower power ranges and a variety of tower, antenna and satellite gear.

Harris Corp. will build on the success of its digitally modulated transmitters for AM by introducing its DX-50, a 50 kW digitally modulated, solid state AM transmitter with typical overall AC to RF efficiency of 86%. According to the company, the system offers highly transparent audio performance with virtually no overshoot, tilt or ringing.

Harris also will display its established HT series of FM transmitters, the THE-1 FM exciter and its SX-A series of solid-state AM transmitters.

Nautel will feature the new AMPFET ND5 5 kW solid state AM broadcast transmitter. It offers on-air serviceability, a built-in standby exciter and zero low frequency phase shift.

Broadcast Electronics Inc. will show its new 20 kW one tube FM transmitter and 1 kW to 35 kW models with microprocessor video diagnostic system (MVDS) and remote control. BE also will exhibit the C-QUAM AM stereo exciter and modulation monitor.

Continental Electronics' products will include its established line of AM and

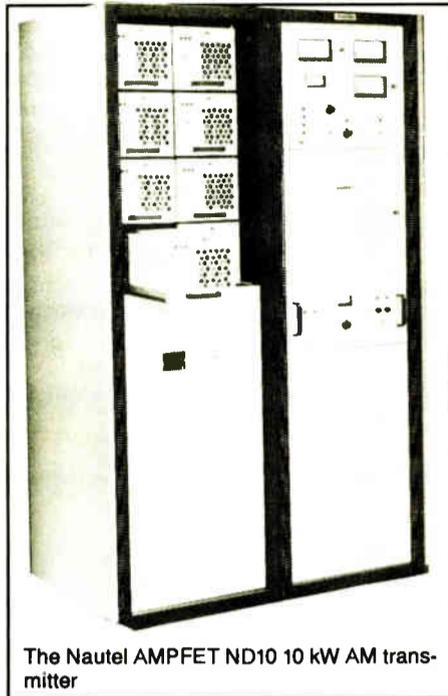

The Nautel AMPFET ND10 10 kW AM transmitter

FM transmitters from 50 W to 70 kW. The company also will show its high-power medium wave and shortwave transmitters.

LPB, with the company now under new ownership, will feature its low power AM transmitters and carrier current transmitting equipment.

#### Transmission gear

Other transmission gear will include RF Technology's Gold Line series

of miniature portable microwave radios featuring wide-band tuning and switchable RF output power options.

TFT Inc. will offer its new Models 886 and 887 "intelligent" EBS systems and FM booster systems.

Dataworld will exhibit its services, including FCC databases, AM and FM directories, allocation and interference studies, population counting, flag service of FCC release notification and 24-hour remote access availability.

Delta Electronics will offer its new AM stereo exciter, which improves in areas of overshoot and tilt, while maintaining

Cablewave Systems Inc. will feature FM antennas type CFMLP and CFMHP, circularly polarized high power. LDL Communications/Larcan will show its established FM panel antenna with spearhead dipoles, which can provide an omni or directional pattern; an FM combiner and a 20' section of a guyed tower with a 4' face, along with a tower beacon and ladder.

Dielectric Communications will display its FM ring, panel and short-spaced antennas, as well as filters, multi-station combiner-multiplexer, combiner/switcher for parallel transmitters.

#### More for FM

The FM 3.5 kW SS solid state transmitter and XL10M FM 10 W modulated transmitter for satellite feed will be

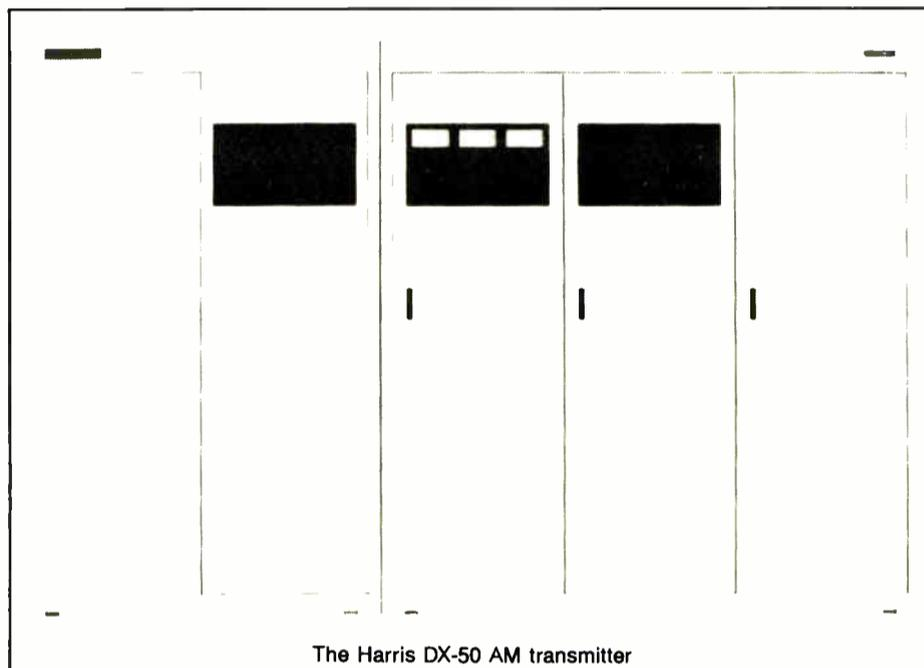

The Harris DX-50 AM transmitter

the benefits of AC coupling. Also, an active whip antenna will debut, a portable collapsible active antenna that can be used with the AM splatter monitor to make in-the-field spectrum measurements.

Motorola/AM Stereo will show its Model 1400 C-QUAM AM stereo exciter and Model 1410 C-QUAM modulation monitor.

Richardson Electronics Ltd. will debut Philips tube cavities for FM use.

Emergency Alert Receivers will present a new EBS receiver that is FCC type-approved. It is rack mountable and crystal controlled.

#### Antennas

Antenna offerings at the show will include Shively Labs' 9" rigid coaxial transmission line and a new cylindrical radome covering the whole FM antenna array; and information on pattern work, particularly for the new Class A FCC directional requirements.

shown by Television Technology Corp. (TTC).

Energy-Onix will showcase its new FM solid state 500 W amplifier, as well as a solid state 2 kW FM transmitter and One Take FM transmitter Models MK-7.5 and MK12.

CCA Electronics Inc. will premiere AM, FM, shortwave and longwave broadcast transmitters and related products.

Inovonics will debut the Model 706, second-generation FMX stereo generator with digital synthesis and remote control.

#### Broadcast accessories

EEV Inc. will show its broadcast tetrodes for AM/FM transmitters including the 15 kW aircooled tetrode type 4C×15,000A and 35 kW tetrode type 4C×35,000C.

Stainless Inc. is one of several companies offering towers and accessories, and

(continued on page N21)



**ALLIED**  
EQUIPMENT EXCHANGE  
— A HARRIS COMPANY

**BUY!!**  
**SELL!!**  
**TRADE!!**

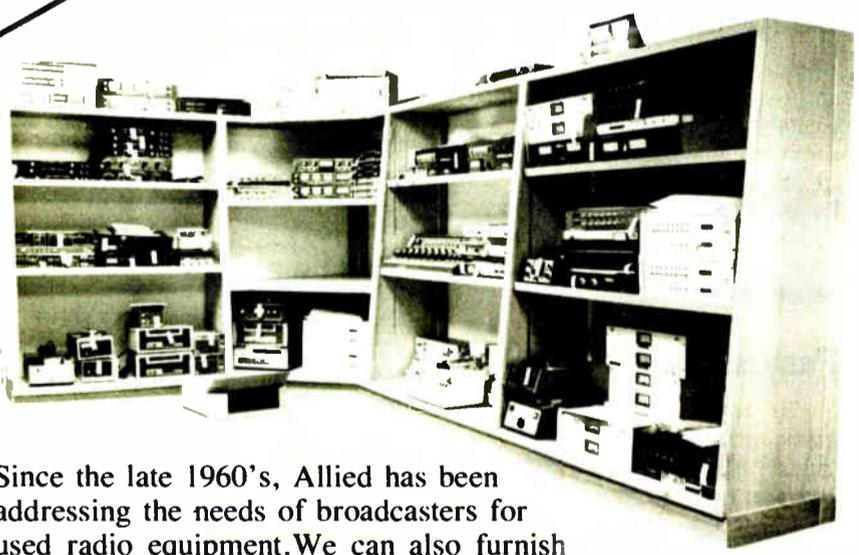

Since the late 1960's, Allied has been addressing the needs of broadcasters for used radio equipment. We can also furnish you with new equipment from over 300 manufacturers. Accordingly, Allied accepts TRADE-INS, SELLS new and used gear and selectively BUYS used equipment.

Call Jim or Chuck — our veteran broadcast personnel — and discuss what Allied Equipment Exchange can do for you! TODAY!!

P.O. BOX 1487  
RICHMOND, IN 47375  
**317-962-1471**

FAX US AT 317-966-6321

### MEETING NOTICE — DIGITAL AUDIO INTERFACING

The National Association of Broadcasters is convening a meeting of a newly formed Digital Audio Interfacing Committee to investigate the status of digital audio interfacing standards as they relate to broadcasting, and make recommendations toward achieving a single, universally accepted and technically complete format.

The meeting will take place during the 1989 NAB Convention in Las Vegas, NV on Sunday, April 30, 1989, in Convention Center Meeting Room 17 from 10am to 12 noon. (This is moved from the previously scheduled date of April 27.)

Representatives from the broadcast industry, professional audio and broadcast equipment manufacturers, or any other interested parties are welcome to attend. For more information, contact Stan Salek, NAB, at (202) 429-5391.

# Accessory Items Take the Stage

by Alan Carter

**Las Vegas NV** Not to be overlooked are the numerous categories of support gear which comprise the "bread and butter" staples of station's equipment.

This year, as last, exhibitors promise a variety of new support equipment for radio broadcasters.

Look for the further integration of CDs and DAT into music libraries and investigate the delivery of weather services via fiber optics.

Radio broadcasters still have to wait for digital interfacing of support equipment.

custom labels.

Audio Accessories will display audio jacks, jack panels, patch cords and pre-wired patch panels.

ADC Telecommunications will exhibit the I.C.O.N., an audio cable distribution frame; SMPTE nine-pin patching system; Pro Patch audio patch bays; VAMP, video/audio modular patch bay; Pro Patch cords; jacks; panels and plugs.

### Connectors

Looking at connecting accessories, Andrew Corp. will present the 82RF and 82RG EIA flange connectors for 2 1/4" air dielectric heliax cable for Class B FMs.

ning or machine-made disturbances on incoming power lines.

Showing new acoustic accessories will be Acoustic Systems. The company will exhibit the BB Voice Over Booths. They are engineered for voiceover or recording requirements. The models will be available in ten sizes.

ATI/Audio Technologies Inc. will introduce the M100 Ultimate Amplifier, a low noise, high gain mic to line amp and will also unveil the MLA 400 and MLA 800, four or eight line amps which serve a variety of applications.

ITC/3M, which broke new ground with the introduction of its audio routing switcher, plans to introduce a summing module in addition to the switcher.

Allied Broadcast, in addition to displaying its regular product line, intends to set up a complete radio facility in its booth which will include a "dub center" with a dedicated mixer for dubbing other source material onto cart. The company's Modulink™ and Modulux™ will also be on display.

Broadcasters General Store will introduce the News Director from Sine Systems. It's a microprocessor controlled 16x2 program audio and routing switcher designed to be used for news workstations.

### Storage

Among the new equipment storage products will be heavy-duty mobile systems from Storeel Corp.

Sescom said it will introduce 15 new products, among them a new product line—the Rack System Electronics, designed for very high quality audio systems such as main broadcast and recording applications.

Stantron will exhibit its established products including equipment racks, modular consoles for editing and production.

Emcor Products/Crenlo will show its modular electronic enclosure systems, EMI/RFI cabinets, computer support furniture, Chassis-Slides, packaged blowers and Instant Encor Quick Ship Program.

Beaveronics will display a new FAVAG LED50 digital clock that runs from either Favag-type second or minute impulses or from an internal time base. The clock, available with character heights of 4" and 8", may be used as an UP timer. Versions are available with days of the week and/or month.

New distribution equipment will be introduced by Auditronics, including a mix-minus for up to eight remote simultaneous correspondent feeds, and stereo distribution amplifiers with VCA control and transparent specifications.

Aphex Systems will introduce its new Model 120 distribution amplifier that has one-in-four out servo-balance.

FM Construction, sharing space this year with Allied, will show the Flagship Series of preconstructed radio broadcast

(continued on page N14)



The News Director audio workstation from Sine Systems.

On the floor in audio accessories, Di-Tech will introduce to NAB its 16x16 and 32x24 stereo switchers. They will be shown with the company's established line of switchers and distribution amplifiers.

Dynair Electronics will present a new "Dynasty" routing switcher and the Series 1200 modular distribution equipment including fiber optics.

Canare Cable will have new 75 ohm BNC connectors and current products including cable for microphones, speakers, multichannel, patch bay, and cable reels and audio/video connectors.

From Farrtronics comes a new 96 Bantam jack patchfield and a 36 pin punch block and monitoring equipment including a self-powered, amplified, mono/stereo package.

### Audio accessories

Companies showing their established line of audio accessories include Patch Bay Designation Co., with its PatchPrints

Audio Developments will show the ADO81 Flexi-Link system that allows each mic or line to distribute a single signal to four separate destinations and also has a 10-way selector switch that enables it to use, as its input source, any one of the other nine modules in the rack.

From Connectronics Corp., on exhibit will be the "J" Bay Patch Bay System, offering 1/4" balanced or unbalanced jack front-panel to 1/4" jack or phono or hard-wire option on the rear. Also shown will be the "X" Bay Patch Bay System that allows for 32-points of any connector to be mounted on the same panel.

In antenna accessories, Current Technology will present the "Power Server" power conditioning with electrical distribution. The company also will show its established line of power conditioners with extended range filtering.

Lightning Eliminators & Consultants (LEC) will exhibit its new surge/transient preventors that detect and dissipate the surges and transients caused by light-

## THE CART YOU CAN COUNT ON...



**Brett Huggins, C.E.**  
**KROZ, Tyler, TX**

"We've been using AA-4s for about a year and a half, and they're working out real well. I use them hard and heavy on both music and commercials, and I've had very few problems. They last a long time."

If you'd like to feel this good about *your* carts, call (800) 522-CART for more information.

## CART AFTER CART.



**audiopak**

audiopak inc. • 1680 Tyson Drive  
PO Box 3100 • Winchester, VA 22601  
Tel (800) 522-CART or  
(703) 667-8125 • Fax (703) 667-6379  
TLX (310) 476-1180

See Us at NAB Booth 1653  
Circle 30 on Reader Service Card

## AUDIO PROCESSING... hnaturally

<p><b>A-MAZE (ā-māze)</b></p> <p><b>HIGH DEFINITION IMPROVEMENT</b> For any existing processing chain plus ... separation enhancement.</p>	<p><b>MIC-MAZE</b></p> <p><b>HIGH DEFINITION MIC PROCESSING</b> Plus ... program gain riding: STL, AM and SCA processing.</p>
--	---

**TRI-MAZE**

**FM STEREO, NRSC AM, OR TV**  
THE ULTIMATE IN FLEXIBILITY AND PERFORMANCE.

# hnat hinders inc

42 Elaine Street • R.R. 1 • Thompson, Connecticut 06277 • (203) 935-9066 • (203) 935-9242

# Scoping Out Testing Equipment

by Charles Taylor

**Las Vegas NV** Test and measurement equipment exhibited at the NAB show will be smarter than ever, more computerized and relevant to newer technology such as CD, DAT, NRSC and AM synchronous noise in FM transmission.

Products on display will offer a look at the latest technology for low power or high power stations, analog or digital, magnetic or electric fields and any num-

Audio Precision will feature its new System One Dual Domain audio test system, an analog and digital dual domain version of its System One, featuring DSP processing for enhanced analog measurements and digital domain testing.

B&B Systems will show its IM-1HR phase tester, which utilizes the company's patented "Imagescope" scope display method of showing how the phasing of the stereo audio being viewed will be heard by a listener in a studio or

Sound Technology Inc., featuring Option 12, a wow and flutter test. The company also will display a number of its other test systems and monitors.

ionizing radiation detectors. The sensor is capable of measuring field strengths from 1 milliamp per meter to 200 amps per meter for magnetic fields and from 1 volt per meter to 200 kilovolts per meter for electric fields.

Dorough Electronics will premiere the Stereo Signal Test Set Model 1200, capable of measuring stereo program signals in both the L/R and Sum/Diff formats down to -65 dBv allowing maximum level set and balance in stereo operation.

Potomac Instruments will highlight its numerous test and monitoring equipment including directional array monitors, audio test system, field strength meters and programmable audio analyzer.

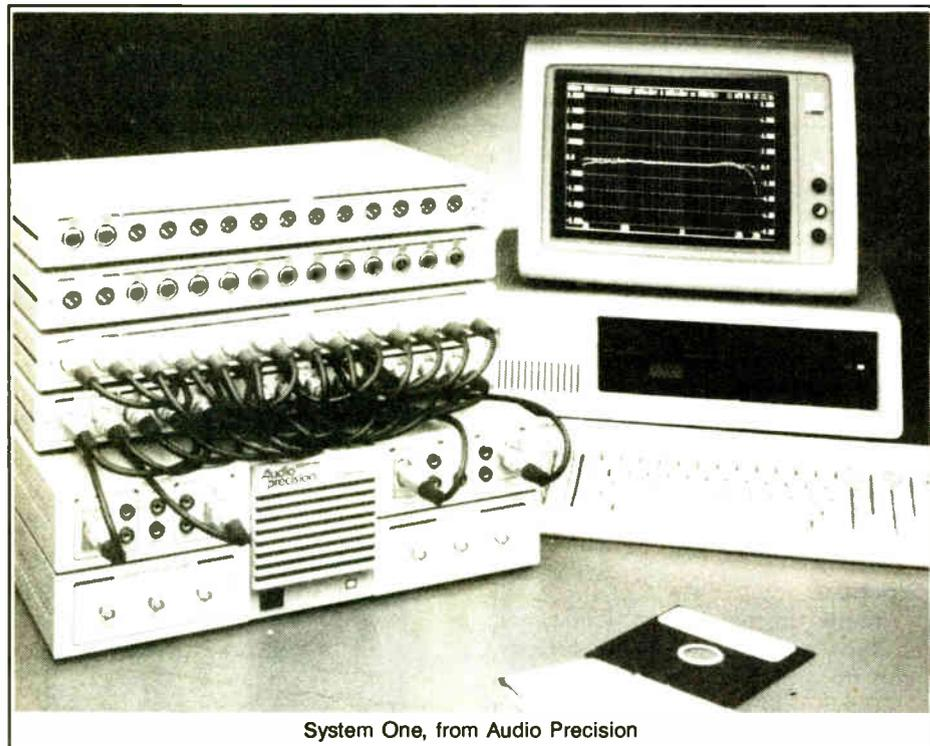

System One, from Audio Precision

ber of other broadcast needs.

Avcom of Virginia Inc. will introduce its PSA-65A portable microwave spectrum analyzer, which covers a frequency range from 2 MHz to 1000 MHz. The system is battery- or line-operated and, according to the company, is ideal for field testing of RF systems, classroom instruction, satellite system alignment, electronic countermeasures, cable TV maintenance and lab use.

home receiver environment.

The system's calibrated screen shows level and stereo directional imaging and includes a built-in audio power amplifier for speakers or headphone with the front panel selection of listening in stereo or left-plus-right sum.

### Audio/analyzer on display

The 3200B programmable transmission audio/analyzer will be offered by

Delta Electronics Inc., will showcase its new stereo noise generator, an audio noise test generator that provides both continuous and pulsed USASI noise that conforms to NRSC recommendations. The generator also will provide white or pink noise test signals with correlation from 0% to 100%.

Also new from Delta will be its series of high-power RF ammeters and sampling toroids. Designed for high-power stations, the units are supposed to withstand high voltages and provide broadcasters a more accurate means of meas-

### Dummy loads

Altronic Research Inc. will display its established Omegaline air and water cooled dummy load from 5 kW to 200 kW, along with its new Omegaline 57100B 100 W single resistor dummy load and Model 57200B 200 kW single resistor dummy load. A number of systems in the Omegaline air cooled dummy loads also will be demonstrated.

Electro Impulse Lab Inc., will include modified versions of its DPTC-25KFM dry, forced air cooled FM dummy load, as well as its RF calorimeters, RF at-

## Products on display will offer a look at the latest technology for . . . any number of other broadcast needs.

urement than other current technologies.

Holiday Industries Inc. will highlight its show offerings with the Extremely Low Frequency (ELF) sensor (from 50 Hz to 60 Hz) for the HI 3600 series of non-

tenuators and dry, convection cooled loads.

dbx will highlight its new RTA-1 Real Time Analysis System, which uses live program sound as its reference signal. (continued on page N21)

## GET YOUR STEREO AUDIO IN GEAR.

with our precision distribution amplifier!

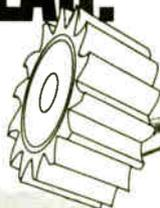

### Model 272 Stereo Audio D.A.

- 3 Stereo outputs
- +/- .05 dB 20 - 60 KHz
- Channel isolation >85 dB
- Tracking <0.1 dB
- +24 dBu output
- -12 to +30 dB gain adj.

Moderately Priced

Model 270 • 1x6 mono D.A. available!



di-tech

48 Jefryn Boulevard, Deer Park, NY 11729  
Tel: (516) 667-6300 • Fax: (516) 595-1012

See us at NAB Booth 3716

Circle 5 on Reader Service Card

## FMX™ Stereo Works!

It doesn't take a Ph.D. to explain FMX System math. How about 240,000 on-air hours to 70 million potential listeners? Those are real numbers.

FMX Stereo works. Scores of U.S. stations and many overseas broadcast authorities have proven the System's total compatibility. Receiver manufacturers are committed and in production, and so are we.

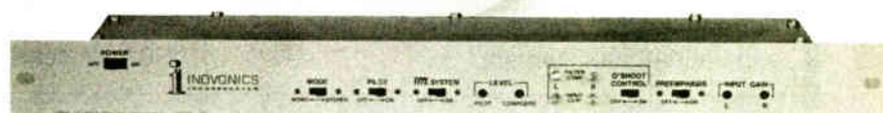

Our Model 705 uses inexpensive digital circuitry. It works with existing station equipment to get you on-air in FMX Stereo for only \$1800.

Inovonics will preview a new FMX Stereo product at NAB '89. Our all-new 706 has full instrumentation and can be remote-controlled.

SEE THE 705 AND 706 AT NAB BOOTH 1473

FMX is a registered trademark of Broadcast Technology Partners.

Inovonics Inc.

1305 Fair Avenue  
Santa Cruz, CA 95060

Tel: (408) 458-0552  
FAX: (408) 458-0554  
TTY: (408) 458-0557  
Tlx: 3730800



World Radio See us at NAB Booth 1473

Circle 22 on Reader Service Card

# Processing Enters Digital Arena

by John Gatski

**Las Vegas NV** Audio processors continue to improve as they enter the digital domain and the NAB convention will not be lacking for new products as well as established lines.

Valley International's Digital Dynamics Processor (DDP) is scheduled for show. Last year the company unveiled the first digital processor to emerge, but in prototype form. The new processor features



Valley International Digital Dynamics Processor

a multiband control with software specifically designed for FM broadcasts. An analog interface also is available for the DDP.

Symetrix Corp. will show and demonstrate its DPR 100 digital processing recorder.

Gentner Electronics, which bought Texar, will show the Audio Prism digital control processor for FM and the Phoenix digital control processor for AM, now under the Gentner name.

Orban Associates will feature the new 764B parametric equalizer/notch filter featuring four channels of equalization and high/low pass filters. It also has the capacity for coupling with other units for up to 100 channels of equalization.

Modulation Sciences Corp. plans to display its StereoMaxx Spatial Image Enlarger. The StereoMaxx is designed to enlarge the stereo spatial image. It is mono-compatible with all existing processors.

Aphex Systems will unveil the Type III aural exciter with noise reduction and the Model 850 Feel Factory, an algorithmic "feel" composer.

Circuit Research Labs will feature its PMC-450 AM peak modulation controller, SMP-950 tri-band AM stereo processor and MBL-100 modulation controller.

Eventide's BD940 broadcast delay unit is said to be a cost effective alternative to the BD980. It features full bandwidth and delays ranging from three and six seconds in stereo to six and 12 seconds in mono.

The company will also feature its UltraHarmonizer with broadcast effects. dbx will highlight its new 563X and 929



Eventide's Model H3000 Ultra-Harmonizer

hiss reducers. The 563X is rack size and the 929 is a module compatible with the 900 series signal processing system.

Ram Broadcast Systems will give visi-

tors to its booth a "hands on" demonstration of the ANI Telcom c4 analog noise reduction system. The company will also unveil the new AC27 Com-pander Card from ANT.



## GET IT IN

In the field or on the run, the **AKG C 522 ENG**, mics it just like you hear it — in stereo. Wherever you are, whatever you're recording, from courthouse interview, press conference, rock concert, to forest fire, the C 522's clarity, rugged performance, and convenience are exactly what you need to add a true-life dimension.

Inside its sturdy housing are two matched cardioid condenser

## STEREO.

capsules, elastic-mounted for low noise and pre-configured to give you a smooth, one-handed XY-stereo field. It's a workhorse mic, with the little extras a working pro needs, like a built-in rechargeable battery, low-power warning LED, integrated on/off switch and boom mount shock suspension.

Get it live in stereo with the **AKG C 522.**

## FCC Database

### ONLINE SERVICES

- 24-hour Remote Access
- AM, FM, FMTX, NCE-FM, TV, LPTV, ITFS Studies/Searches
- Terrain/Population FAA & FCC Tower Databases
- Predicted Contours
- DATAFLEX — user-specified sort/retrieval programs
- FLAG<sup>SM</sup> SERVICE — Broadcast site monitoring report

**dataworld**<sup>®</sup>  
A Service of DW, Inc.

P.O. Box 30730  
4827 Rugby Avenue, Suite 200  
Bethesda, Maryland 20814  
(800) 368-5754 (301) 652-8822



77 Selleck Street  
Stamford, CT 06902

Reporter: Denise O'Brien  
With permission of Colony Communications, Inc.  
© AKG 1987 Akustische und Kino-Geräte GmbH, Austria

# Tasting the Night Life in Vegas

by Gigi Koury

**Las Vegas NV** Even the most ardent conventioneer, after exploring the exhibit hall and schmoozing in the hospitality suites, will have to admit that Las Vegas has more to offer than any other NAB locale.

The entertainment capital of the world traditionally pulls out all the proverbial stops to welcome the National Association of Broadcasters with top name entertainers, lavish stage shows, gourmet dining and diverse non-gaming recreation.

During NAB's Las Vegas run, conventioners have a variety of celebrity entertainment choices. Caesars Palace's Circus Maximus Showroom presents the magic of David Copperfield, while just down the street the Desert Inn's Crystal Room offers an evening of irreverent hilarity with The Smothers Brothers, Jim Stafford and Ron Lucas.

At the Golden Nugget's Cabaret, a jewel of a showroom in downtown Las Vegas, prepare to be part of the floor-show as Don Rickles makes the audience the butt of his jokes. At the Las Vegas Hilton you can relive the wonder years with The Four Tops and Frankie Valli and The Four Seasons.

Meanwhile, The French Quarter at the Four Queens keeps the downtown scene jumping with The Platters.

Just to prove how Las Vegas contributes to the resumes of the country's up-and-coming comics, The Riviera's "Evening at the Improv," Bally's Grand "Catch a Rising Star," The Dunes' "Comedy Store" and the Tropicana's "Rodney's (as in Dangerfield) Place" all present a laugh line-up that changes weekly.

Showgirls are a Las Vegas trademark and nowhere are they better displayed than in the spectacular revues staged at the "strip" hotels.

The Riviera Hotel has three different

shows. At The Versailles Theatre, you can catch the recently expanded aquacade of music, dance and special effects "Splash." The Mardi Gras Entertainment Center features the totally adult "Crazy



Casino gambling offers a night-time diversion to Las Vegas conventioners.

Girls Fantasie de Paris" and "An Evening At La Cage," with Frank Marino portraying a very convincing Joan Rivers.

Across the Strip at The Stardust there's the internationally acclaimed "Lido de Paris" starring Bobby Berosini and his performing orangutans, one of the longest running shows on the Strip. At the Tropicana Hotel's Tiffany Theater check out the world renowned French revue "Folies Bergere."

Over at Bally's Grand in the Ziegfeld Room, "Jubilee!" stages production numbers with dazzling costumes, sets and special effects. In the Congo Theatre at the Sahara Hotel you can see the likes of Cher, Ann-Margret, the Pointer Sisters and others all impersonated by the talented young men in Kenny Kerr's "Boy-lesque."

The magic of Kirby VanBurch is spot-

lighted in "Abracadabra" at the Aladdin's Bagdad Showroom. And you'll think you're in rock 'n' roll heaven at the Imperial Palace Imperial Theater's production of "Legends in Concert," featuring live re-creations of Buddy Holly, Elvis Presley, John Lennon and others.

### Dining out

There are so many restaurants in Las Vegas that the local newspapers' food critics couldn't possibly critique them all. The suggestions that follow fall into one of three categories: buffets, hotel specialty restaurants or gourmet rooms and local hangouts.

Many of these restaurants have been winners in recent "Best of Las Vegas" reader

a problem, and prices range from \$2.29 for breakfast to \$3.89 for dinner.

Many of the hotels in Las Vegas have superb specialty or gourmet restaurants tucked into corners of their casinos, and the Riviera, Bally's Grand, Caesars Palace and the Las Vegas Hilton are fine examples.

The Riviera's Ristorante Italiano serves Northern and Southern Italian specialties, mouthwatering pasta and the freshest fish the market has to offer. Bally's features exquisite French cuisine at Cafe Gigi. The Foie de Veau Saute Gigi is the specialite de la maison.

The Bacchanal Room at Caesars Palace offers an opulent Roman-style, seven course feast served in a setting that would make the Roman god Bacchus proud, if he had made reservations.

The Benihana Village at the Las Vegas Hilton is actually three Japanese restaurants in one, dishing up Hibachi, Tem-



Exotic costumes and dazzling sets are the highlights of Las Vegas' famous entertainment revues.

polls conducted by the Las Vegas Review-Journal.

The buffet at The Golden Nugget in downtown Las Vegas is aptly called The Buffet and offers a spectacular array of consistently well-prepared and presented menu items for breakfast, lunch, dinner and late night munching.

Bally's Grand Hotel serves champagne brunch in the Celebrity Room every Sunday from 10 AM until 2 PM. The spread features a wide variety of breakfast and luncheon items, in addition to several hot entrees, fabulous desserts and free-flowing champagne.

The Palatium Buffet at Caesars Palace is conveniently located across from the Olympiad Race and Sports Book's wall of video, so that diners can monitor live sporting events and horseracing while enjoying their meals.

The Plate of Plenty Buffet at Circus Circus claims to be the world's largest, serving no less than 45 items. There are four serving lines so waiting usually isn't

pura and Robata Yaki specialties in a realistic Japanese Village setting.

### Local eateries

Given the fact that Las Vegas have so many dining choices, it would only be fair to let NAB conventioners know what the locals' favorite eateries have to offer.

Alias Smith and Jones, located on Twain between Paradise and Swenson, has a varied menu featuring great burgers, sandwiches, salads and appetizers. Dinner and lunch entrees include fajitas, cajun steak and chicken, pasta, and fresh fish.

The Flame, just off the Strip on Desert Inn, is a Las Vegas landmark and serves a selection of the finest black Angus steaks. The Flame has been serving Las Vegas breakfast, lunch and dinner, 24 hours a day for over 25 years.

For great hamburgers and tasty break-

(continued on page N21)



## Old Faithful

We still make them like they used to

Today's X-701 stereo and mono cart machines still use the oversized hysteresis synchronous motor, 1kg flywheel, and rugged all-steel case that have made Tapecaster® the budget-priced reliability leader for nearly 25 years. Features include:

- NAB eq at 7 1/2 IPS • Playtime to 31 minutes • Line voltage 115 VAC, 60Hz, 50W standard; 220 VAC optional, 50 Hz optional

For complete information call or write.

**TAPECASTER®**  
a division of

**audiotronics, inc.**

3750 Old Getwell Road • Memphis, TN 38118  
901-362-1350 • Telex: 5333356 • FAX: 901-365-8629

See Us at NAB Booth 1363

Circle 17 on Reader Service Card



## START TAKING HOSTAGES !

**DIAL DOMINANCE** demands a **KILLER** Processing Chain! **CUTTING EDGE TECHNOLOGIES** introduces the "VIGILANTE" FM Limiter. This IS the processor that CURRENTLY HOLDS THE COMPETITION FOR RANSOME in New York, Philly, Miami, Baltimore, and Cleveland! And Now its available for You, from the people who KNOW quality competitive processing, **CUTTING EDGE TECHNOLOGIES!**  
Call Today: (216) 221-7626.

# Console Innovations

by Alan Carter

**Las Vegas NV** As the competition among console manufacturers heats up in the midprice range, there is an obvious attention toward cost effectiveness seen in product at this year's convention.

But there is no slowdown in innovative offerings, with more interfacing to CD and DAT players. Lacking, however, and probably quite far into the future, is any hint of a truly digital console for radio.

Among the new console offerings, Pacific Recorders & Engineering is unveiling its Radiomixer, which PR&E President Jack Williams said "fills out our line of integrated consoles."

PR&E is not disclosing details about the new radio console, except that it is modular, has no set minimum features

able modules and the multi-tier design that permits the console configuration to be individually defined for each application.

Also in the console area, Radio Systems will bring back its cost effective RS Series.

### New to USA

Allen & Heath will introduce to the US its MBI Series 16 on-air broadcast consoles. Options include EQ on mono or stereo inputs, full stereo in place prefade listen, auto muting of loudspeakers and red light operation switchable to either "local" or "distant."

Audio Broadcast Group will display a new multitrack production system with a SMPTE time code option with 24x8 mixing console.

ADM Technology will have its established ST Series II radio broadcast console available in 10, 16, 20 and 24 input main frame sizes. ADM is now under new ownership with Dewey Norton as new president and CEO, and Richard Stiennon as marketing VP. Founder Robert Bloom was retained as a consultant.

Numark Electronics will introduce a new DJ mixer with source assignable EQ and auto-muting talkover and a new preamp/mixer with four-second sampler with four memory banks.

Broadcast Audio will exhibit the Series VI low-profile modular audio consoles with mainframe sizes of 8, 12, 16, 20 and 24 mixers.

LPB will introduce the Citation II audio consoles and the Monogram II audio consoles and also feature its Signature III series audio consoles.

Ram Broadcast Systems will feature its Series-SX consoles for on-air or production. The company will also show the Sierra Automated Systems Model 32000 stereo audio routing switcher. The company says it will also feature several "surprise" products.

And ATI will show its Vanguard series mixer consoles as well as the full "Problem Solver" product line.

### On the table

Harrison Systems will present a new AP-100 console in tabletop and rack

(continued on page N14)

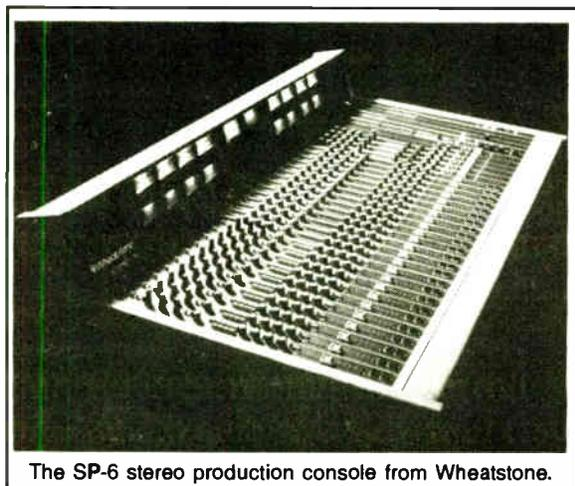

The SP-6 stereo production console from Wheatstone.

and has a universal layout. It also has a feature PR&E is calling "Off-Line Mix Matrix."

### Product looks good

Other consoles to check out are Wheatstone's SP-6a stereo production console and A-500as with auto-sequencer circuits.

The SP-6a is an enhanced SP-6 with addition of simultaneous monitor and mixdown capabilities as well as four additional line level effects return inputs as standard features.

Autogram will exhibit several new Pacemaker consoles: 648 with six-slide pot and 48 stereo inputs of audio; the 828 with eight-slide pot and 28 stereo inputs and the 1032 with 10 slide pot, 32 stereo input audio.

Howe Technologies will present its Series 10K stereo audio broadcast and production console. It has interchangeable

# Sheer Opulence Of Sound



## The Neumann TLM 170

Handcrafted perfection from the world leader in microphone technology. The TLM 170 from Neumann achieves its phenomenal sound and superior transient response through the application of the most modern electronic and mechanical technology. The low self-noise and high SPL tolerance yields a large dynamic range of 126 dB. The TLM 170 has 5 different directional patterns that are switch selectable.

Neumann quality and performance. Often imitated but never duplicated. BSW is proud to offer the complete line of Neumann microphones and accessories. Call us for pricing and complete technical specifications.

# BSW

BROADCAST SUPPLY WEST

America's Full-Time Broadcast Supplier

**1-800-426-8434**

ORDERS • INFORMATION • SPECIFICATIONS  
BSW • 7012 27th Street W • Tacoma, WA 98466 • FAX 206-565-8114

## WEATHER RADIO

Model CRW



Price \$540.00

Sensitivity .28 microvolts for 12 dB quieting. All 3 frequencies. Alert tone demutes receiver, closes relay and gates audio to 600 ohm rear terminals. Another set of rear terminals has continuous 600 ohm audio output. Double conversion crystal controlled, crystal filter in first I.F., ceramic filter in second I.F. Dual gate MOS FET front end. 50 ohm coaxial input. Adjacent channel (±25 kHz) down to 70 dB. 19" rack mount, 3½" H, all metal enclosure. In stock—available for immediate delivery.

**GORMAN REDLICH MFG. CO**

257 W. Union St. • Athens OH 45701 • 614-593-3150

# Accessory Products Featured

(continued from page N9) facilities. The Flagship package provides a station owner with a completely operational facility in a matter of weeks. The facility can be delivered with broadcasting equipment, ready to go on air.

## Programming

A final product area in radio accessories is digital programming. FirstCom will introduce a CD sales library system of Hollywood talent. Century 21 Programming will have an all-digital computerized controller including hard disk commercial storage and CD juke boxes. DeWolfe Music Library will exhibit a variety of new CD productions that are released monthly.

Other companies with digital programming include Manhattan Production, Network Music and Sound Ideas. In weather delivery services AccuWeather will introduce a new line of graphic satellite pictures and new versions of Radarplus and Newrad. Weather Services will have its established customized forecasting service for markets in the US, Canada and the Caribbean.

# Consoles

(continued from page N13) mounting versions. It also will show a new Macintosh II-based hard disk automation system for the SeriesTen automated console. Amek/Tac US will display the new Tac bullet, transportable or rack-mountable mixing console. It is available as standard configured 10/4/2, with four-band EQ, six aux buses and four stereo returns. Soundcraft will introduce a new 3200 recording and production console and also show exciting console lines. Seck will exhibit its line of established compact mixing consoles for production and remote mixing.

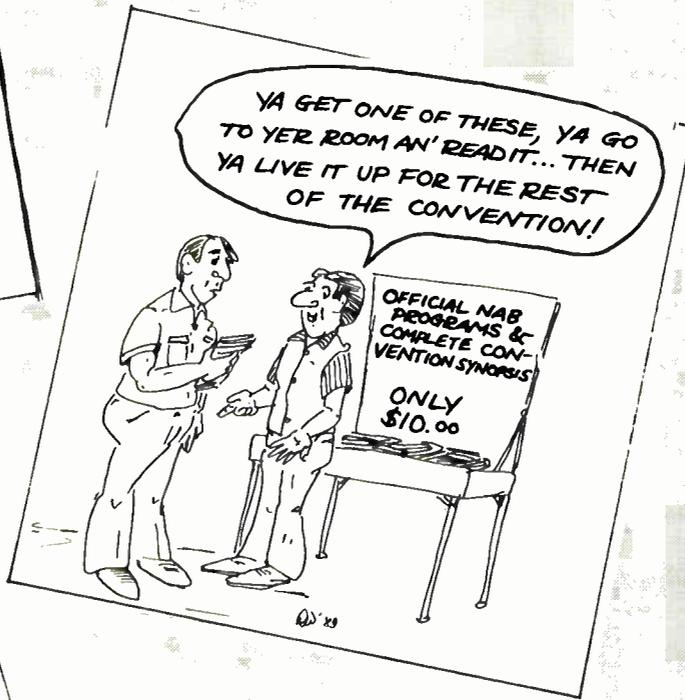
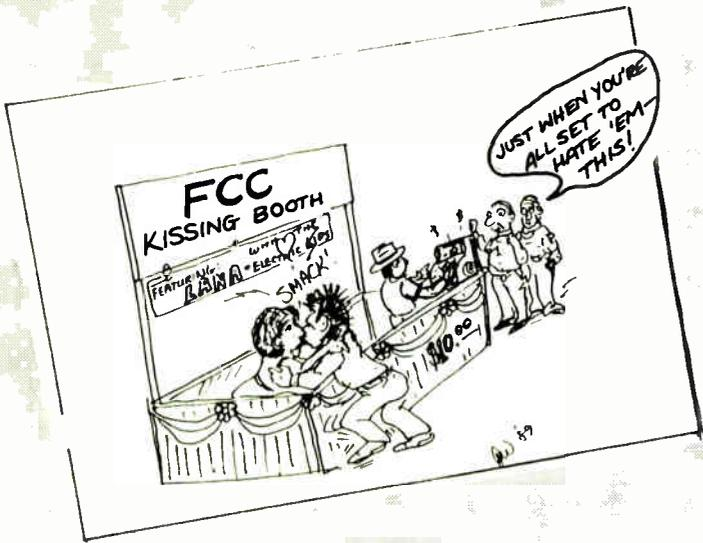

# An NAB View

by Trenton Williams

Summon a windstorm with one finger: Press below.



Windstorm—one of 70+ Broadcast Ultra-Harmonizer™ digital audio effects designed to give you fresh ideas, without letting you go stale trying to make them happen. Put the "special effects department in a box" to work for you.

**RADIO'S MOST COLORFUL BLACK BOX**  
EVENTIDE INC  
ONE ALSAN WAY  
LITTLE FERRY, NJ 07643  
TEL 201-641-1200 • TWX 710-991-8715 • FAX 201-641-1640

**Eventide**  
the next step

Circle 13 on Reader Service Card

Audio effects designed to make your staff more effective.



Traffic Report voice filter with 'coptereffect'—one of 70+ Broadcast Ultra-Harmonizer™ digital audio effects. Put the "special effects department in a box" to work; call your Eventide distributor.

**RADIO'S MOST COLORFUL BLACK BOX**  
EVENTIDE INC  
ONE ALSAN WAY  
LITTLE FERRY, NJ 07643  
TEL 201-641-1200 • TWX 710-991-8715 • FAX 201-641-1640

**Eventide**  
the next step

Circle 14 on Reader Service Card

Pressed for time? Press directly below.



TimeSqueeze™ automatic stereo time compression/expansion—one of 70+ Broadcast Ultra-Harmonizer™ audio effects designed to make you more effective. The H3000B: never before has so little money done so much for your station's sound.

**RADIO'S MOST COLORFUL BLACK BOX**  
EVENTIDE INC  
ONE ALSAN WAY  
LITTLE FERRY, NJ 07643  
TEL 201-641-1200 • TWX 710-991-8715 • FAX 201-641-1640

**Eventide**  
the next step

Circle 15 on Reader Service Card

Introducing radio's most colorful black box.

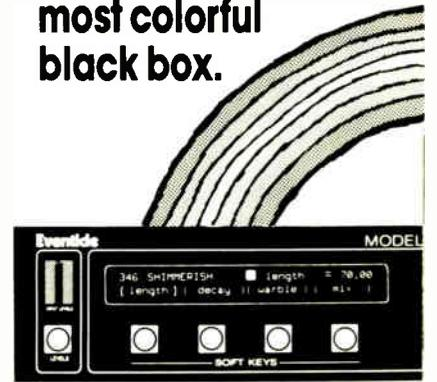

Shimmerish Swept Reverb program—one of 70+ Eventide Broadcast Ultra-Harmonizer™ digital audio effects you can use "right out of the box." Just turn the H3000B on, and it'll turn your listeners on.

**RADIO'S MOST COLORFUL BLACK BOX**  
EVENTIDE INC  
ONE ALSAN WAY  
LITTLE FERRY, NJ 07643  
TEL 201-641-1200 • TWX 710-991-8715 • FAX 201-641-1640

**Eventide**  
the next step

Circle 16 on Reader Service Card



# Not All Games

**Las Vegas NV** When you think of this desert oasis you naturally think of it as "the gambling capital of the US."

But Las Vegas' primary attraction is shifting fast from super resort to super-convention city. And changes over the next few years will be doing much to help foster this new image.

The city sees some 1.5 million convention-goers flock in and out of its borders each year. A 12% annual growth in convention business seems to say that Las Vegas will be the top convention locale by 1990.

By then, as NAB conventioners may be aware, there will be a massive renovation in the convention facilities. Next year's NAB show is slated for Atlanta while the Las Vegas Convention Center undergoes a facelift.

With a total of 1.1 million square feet of convention space, the Las Vegas Convention Center is one of the few facilities large enough to accommodate the more than 90,000 NAB attendees who gather here each April.

Las Vegas plays host to two other of the largest trade shows in the country: the Comdex computer software show and the winter Consumer Electronics show.

For many years, the NAB alternated between Dallas and Las Vegas, with a two-year stint in each city. But exhibitors seem to favor this desert site over Dallas, and there's been a recent move to have the NAB show located here permanently.

In addition to 1.3 million square feet of meeting space in nearby hotels, the city offers 2.4 million square feet of hotel-resort space. Some 67,000 hotel and motel rooms are expected to be available for convention-goers by 1990.

The shift from the city's "resort" to "convention" image is reflected in new hotel accommodations being planned for Las Vegas.

There was a time when a major hotel without a gambling casino was unthinkable. Now, newer facilities are planning accommodations aimed toward the business visitor, more of an "Accidental Tourist" variety, without so much glitter.

Still, the clubs and casinos which made Las Vegas famous are still just as flashy and just as crowded. The big-name entertainment shows are also as well-attended as ever.

And there seem to be few, if any, complaints from broadcasters that there is too much fun to be had in this desert oasis, or that the one-armed bandits and black jack tables are *not* a major NAB attraction.

## Las Vegas' Hotels Still a Madhouse

**Las Vegas NV** You may not have a room with a view, but feel lucky to have a room.

That may be the best attitude to bring here—especially exhibitors who found their accommodations for the show not what they wanted or even nonexistent.

As of late March, the NAB reported that a room shortage was "loosening up," ac-

ording to Exhibits and Associate Membership Director Rick Dobson.

"I am not personally aware of any exhibitors without rooms," Dobson said. "We haven't been able to totally satisfy every company. There will be companies that would have preferred other or better accommodations that we weren't able to help out."

But considering the other alternative, Dobson said exhibi-

tors seem to be rationalizing the best out of a bad situation.

The NAB expected more rooms to become available after the first of April, when some deposits may not be made on rooms already reserved.

The room shortage, which peaked at about 2000, came about when hotels did not block off as many rooms as NAB sought through the Las Vegas Convention & Visitors Autho-

riety. In addition to competing with the more lucrative tourist trade for rooms, the NAB convention occurs at the same time as a golf tournament.

As of March, NAB was advising those still looking for rooms to go through regular travel agents and not try to secure accommodations specifically for the convention.

## MORE radio studio, FASTER delivery, LOWER cost... That's the MAGIC of MODULINK.

Don't let our MODULINK studio's classic good looks fool you. On the inside, MODULINK is really different. It's the first basic improvement in studio design in thirty years.

Designed and built by Arrakis Systems exclusively for Allied, MODULINK is a manufactured, modular radio studio system that can be custom-tailored to meet your exact specifications, yet its unique design allows your new facilities to be operational in days, not weeks or months.

Ideal for both new installations and renovations, MODULINK studio units come fully pre-wired with multi-pin connector "docking modules" which link all units and interconnect all equipment. We preassemble the furniture modules, install the electronics and test the entire package at our own facility. The units are then shipped to you by van. At your station, the fully-systemized MODULINK units are linked together, either by Allied installation crews, or by your own local people. Either way, the studio installation usually takes as little as a single day.

But MODULINK isn't just faster. It's better. The pre-wired, plug-in MODULINK modules offer greater electrical reliability than conventional point-to-point studio wiring methods. What's more, adding new equipment later on or troubleshooting an audio problem are so much easier with MODULINK.

Best of all, MODULINK's advanced design lets Allied give you more radio studio for lots less money. And that could be the difference between getting exactly the studio package you want, or settling for something less.

Before you start your next studio project, call the experts at Allied and let us show you how MODULINK can do it better, faster, for less.

CALL 714-752-6664

**ALLIED**  
Broadcast Systems

3901 MacArthur, Suite 200  
Newport Beach, CA 92660  
FAX: 714-752-0855

Circle (16) on Reply Card



See Us at NAB Booth 2027

SALE SALE SALE SALE SALE

SALE SALE SALE SALE SALE



**arrakis**  
SYSTEMS, INC.

*For 30  
20%*

# 5000 Series Modular Console

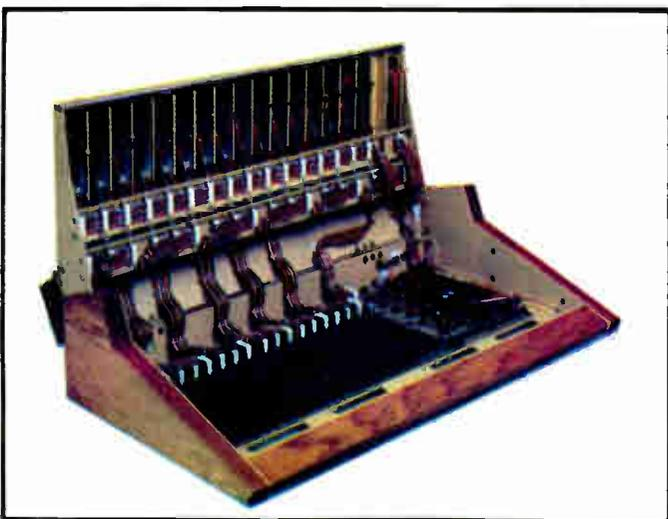
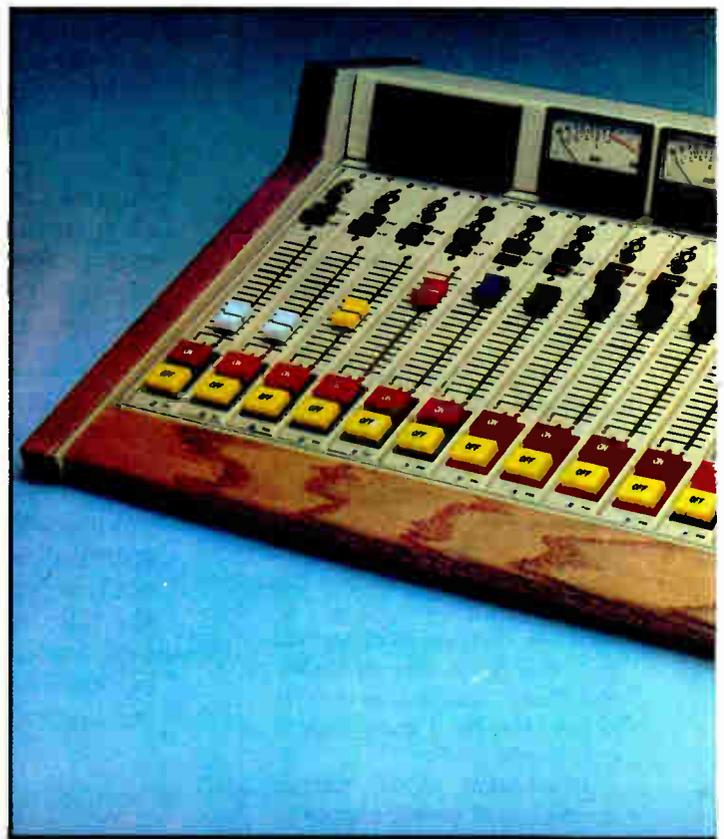

Interior View of the 5000 Series Console

## STANDARD

- MODULAR CONSOLE
- 16 CHANNEL MAINFRAME
- 2 INPUTS PER CHANNEL
- PROGRAM & AUDITION OUTPUTS
- MONO MIXDOWNS STANDARD
- 2 MIX-MINUS BUSES

Circle 67 On Reader Service Card

LE SALE SALE SALE

SALE SALE SALE SALE SALE

30 Days OFF

**SUGGESTED SALE LIST PRICE**

- 8 CHANNEL - \$5,747
- 10 CHANNEL - \$6,265
- 12 CHANNEL - \$6,783
- 14 CHANNEL - \$7,301
- 16 CHANNEL - \$7,819

(Complete)



**BASIC CONSOLE PRICING**

- MAINFRAME \$3,499
- INPUT MODULE \$270

**OPTION MODULES**

- STUDIO MONITOR \$349
- EQUALIZER \$349
- REMOTE SELECTOR \$895

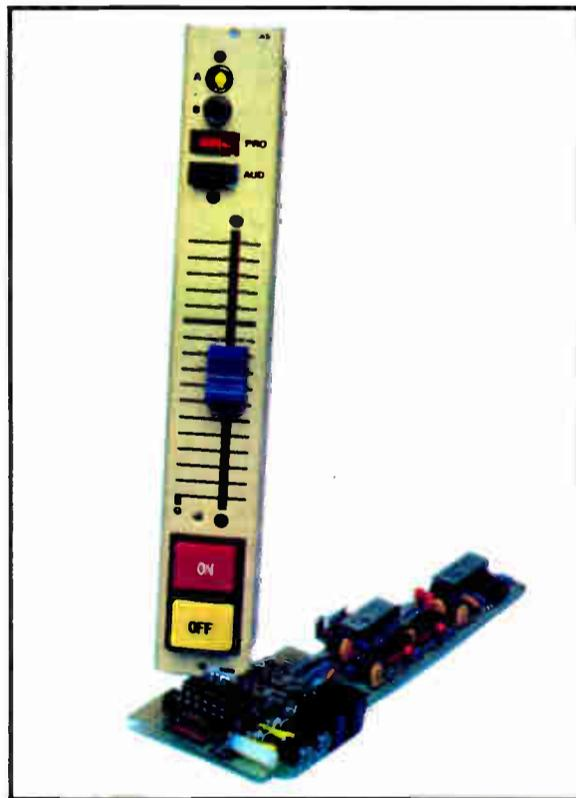

SALE SALE SALE SALE SALE SALE SALE SALE SALE SALE SALE

**FEATURES**

- REMOTE START-STOP
- CLOCK-TIMER STANDARD
- PENNY & GILES FADERS
- VCA LEVEL CONTROLS
- OPTION MODULES
  - STUDIO MONITOR
  - 3 BAND EQUALIZER
  - REMOTE INPUT SELECTOR

2619 MIDPOINT DRIVE • FORT COLLINS, COLORADO 80525 • (303) 224-2248

See us at NAB Booth 2215

SALE SALE SALE SALE SALE SALE SALE SALE SALE SALE SALE

# Not for amateur radio.

You're no amateur at this game, so why play around with amateur CD players in the studio? You've tried consumer models in the past, just to see if they'll work long enough to make sense. We can understand that. But in the long run, they *don't* make sense. And you know it. Even modified or beefed up versions have given you headaches. . . wrong levels, hifi connectors, too many buttons or the wrong ones. Not to mention skips, mutes and breakdowns. Why take chances playing around with an amateur deck in a pro application? Leave that home player at home where it belongs. Check out the Studer A727 and A730—pro players for radio pros.

**A727** ▶ Thousands of A727's prove their reliability in radio stations all over the world—*everyday*. The A727 provides full 16-bit resolution with 4x's oversampling—plus powerful error correction circuits to protect against on-air problems from damaged or dirty discs.



Designed for fast, creative production play, the **A730** is the newest addition to the Studer line of Pro CD players. This machine can recognize 100 discs and store up to 3 start cue points per disc. Its die-cast aluminum transport is built for professional use.

FEATURE	A727	A730	"Brand X" Player	FEATURE	A727	A730	"Brand X" Player
Fader Start	▼	▼		Disc Recognition		100 discs	
Parallel Remote w/Tallies	▼	▼		Varispeed Built-in		▼	
Start & End Review	▼	▼		End of Modulation Sense		▼	
End of Track Alarm	▼	▼		Monitor Speaker		▼	
RS422 Serial Control	▼	▼		Separate PGM & Monitor Outputs		▼	
System Clock in/out	▼	▼		Remote Monitor Speaker Mute		▼	
Digital Output	▼	▼		Audio Channel Reset		▼	
Die-cast CD Drive	▼	▼		Rack Mounts Standard	▼		
Cue Memories		3		Flush Mounting		▼	

## Go ahead. Make the comparison.

Before those amateur machines break again, call your Studer/Revox Full-Line Dealer, or contact us directly.

### STUDER REVOX

Studer/Revox America, Inc. ▶ 1425 Elm Hill Pike ▶ Nashville, TN 37210 ▶ (615) 254-5651  
 Los Angeles: (818) 780-4234. New York: (212) 255-4482. Chicago: (312) 526-1660. Dallas/Ft. Worth: (817) 881-1861.  
 In Canada: Toronto: (416) 423-2631.

# Ringling In New Interface Gear

by Charles Taylor

**Las Vegas NV** Telephone interface gear will include a variety of remote equipment, STLs and frequency extenders at the NAB show this year, highlighted by digital hybrids and QEI's STL using T-1 lines.

QEI's Digital Stereo Link will allow radio broadcasters to link studios and transmitters with T1 telephone company lines. Unlike equalized matched stereo lines, telco T1 lines are readily available and provide multiple pathways for greater reliability, and QEI said, also are considerably lower in cost.

The system provides transparent reproduction of composite signals over T1 lines with 16-bit companded encoding and decoding, so stereo generators can be located at the studio rather than the remote transmitter site, according to the company.

Also, QEI said that because the Digital Stereo Link offers two-way audio and communication capabilities, broadcasters can use it to monitor and process satellite feeds from remote antennas and to operate transmitters via

with the addition of one or two IPA modules.

Telos Systems will offer several new members of the Telos 100 family of digital telephone hybrid systems. Applications for broadcast telecommunications and teleconferencing will be demonstrated.

Comrex Corp. will feature for the first time its Multi-Line range of frequency extenders. The Multi-Line gives a flat 10 kHz audio circuit using three standard-dial telephone lines. The system is modular and can be upgraded to a fully automatic three-line system from the base models.

TFT Inc. will offer its new Model 8888 frequency agile RPU system, available from 6 W to 25 W with DTMF control.

A number of telephone remote systems will also be displayed at NAB, including the new VRC-2000 complete remote control system from Gentner Electronics Corp.; the Statusystem remote control system from DSI Communications Inc.; and Hallikainen & Friends Inc.'s SAT201 remote control system for multiple satellite dishes and receivers over a voice grade circuit.

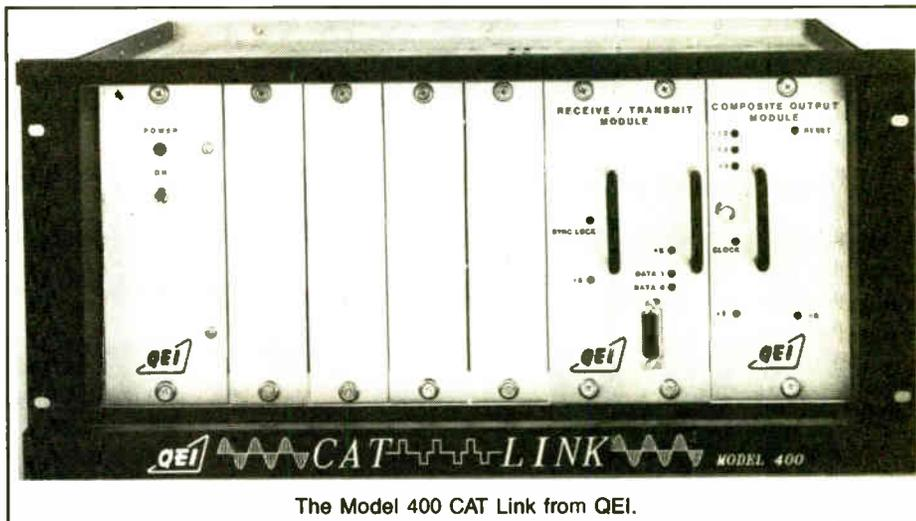

The Model 400 CAT Link from QEI.

ing system for Marti RPU equipment. Marti also will show the new DR-10 low-cost RPU receiver with optional internal companding capability.

Potomac Instruments will unveil its PC

compatible software for interrogating and commanding the 1500 PC Programmable Transmitter Controller. The company will also show its RC-16 Automatic Remote Control System.



The Telos 100 digital hybrid telephone system.



Gentner Electronics Corp. plans to stock its NAB booth with a range of remote control, telco and related broadcast devices.

remote control.

QEI also will introduce the FMQ 15/20/25 kW transmitter, which uses all solid state IPAs for enhanced performance and reliability. The compact two-cabinet transmitter can be upgraded in the field from 15 kW to 20 kW or 25 kW

Advanced Micro-Dynamics Inc., will showcase enhanced options for TC-8 and ARC-16 transmitter remote control systems, along with a new speech unit and computer interface software.

In remote pickup gear, Marti Electronics will premiere an audio compand-

**CENTRAL TOWER INC.**

Complete Manufacturing Of  
AM, FM, TV & Microwave Towers  
• Ground Systems •  
Installation, Structural Analysis  
and Inspection

**Box 530  
Newburgh, IN  
47629-0530**

**812-853-0595  
FAX 812-853-6652**

## Affordable Lightning Protection



Charge dissipation with 1/8", type 304, stainless steel rods ground to needle sharpness. They won't bend from ice and severe weather. They provide a continuous low-resistance discharge path for the static electric charge on tall structures.



Let us design your system at no cost or obligation! ①

Stati-Cat • Stati-Kitty • Crow's Nest

## The Folded Unipole:

The Ultimate Antenna for AM Broadcast!

- Broad bandwidth
- Grounded antenna
- Eliminates isocouplers
- Practical for AM-FM site consolidation
- Effective as detuning skirt
- Fully FCC acceptable
- Custom kit; easy assembly

Designed by nott ltd; ②  
manufactured by Cortana



Write for free brochures.  
Also available from Cortana:  
Ground Radial Wire Detectors  
Mastercard/Visa



P.O. Box 2548  
Farmington, NM 87499  
(505) 325-5336  
FAX 505-326-2337

# ALLIED

## NAB 1989

BOOTH 2027



Visit us in Booth 2027 and experience the new and unusual, as usual. We're proud of our reputation as being the place to see and be seen during NAB. We've had several product introductions which became BE's picks of the show.



NAB 1989 finds Allied's Booth 2027 full of surprises. A complete radio station . . . not just every possible piece of broadcast hardware, but a completely developed building to house it all.



Control rooms that arrive fully preassembled and which can be ready for broadcast in a day or less? It's true and only Allied has Modulink® at NAB 1989.



Leasing . . . what a great way to conserve cash, write off a business expense and eliminate depreciation. We'll have leasing experts in 2027 who will give you the full story.



Talk with your favorite salesperson during NAB . . . Cal, Tony, Rick, Jeff, Jerry, Tom, Pat, John, Dave, Tom, Rick, Judy, Mark, John, Chuck, Dave, Bob and Scott. Why not call right now and learn their schedule?

**Booth 2027 . . . The Only Place You Will Find Radio's Best!**



CAL



TONY



RICK



JEFF



JERRY



TOM



PAT



JOHN



DAVE



TOM



RICK



JUDY



MARK



JOHN



CHUCK



DAVE



BOB



SCOTT

ATLANTA, GA CHICAGO, IL DALLAS, TX  
LOS ANGELES, CA RICHMOND, IN

### 1-800-622-0022

World Radio History

# ALLIED

## Broadcast Equipment

— A HARRIS COMPANY

# Buzz Going About Transmitters

(continued from page N8)

will debut its maintenance products including antenna/transmission line analysis, emergency service and antenna re-harnessing.

R:Scan Corp. will demonstrate its Lightning Data and Information Systems (LDIS), a complete service for tracking, communicating, displaying and archiving data and information on lightning.

Allied Tower Co. will show its towers for AM, FM and microwave, while Central Tower Inc. will offer its guyed towers up to 1500' in height, and its self-supporting towers up to 300' in height.

Kline Towers will display its guyed, self-supporting, platform and multi-array towers; space-frame structures and special type antenna structures. The company designs, fabricates and erects towers.

Magnum Towers Inc. will feature its ra-

dio and microwave towers; and Rohn will have its guyed and self-supporting towers, tower lighting equipment, antenna mounts, tower climbing safety equipment, guy insulators, tower hardware and accessories, fiberglass and concrete equipment shelters and tower installation services.

## High-power applications

United Ropeworks USA Inc. will show the Phillystran HPTG, electrically transparent, maintenance-free tower guys and specially designed systems for high-power applications.

Utility Tower Co. will include its UTC Type 920 SR 84" face width capable of 1500' and UTC Type 720 SR 60" face width capable of 1200'.

Valmont Industries Inc. will show its free-standing and guyed towers for antenna support and tapered tubular poles

for AM broadcast.

The Will-Burt Company/TMD will feature the Model 7-34-157/167 pneumatic telescoping mast assembly to position RF antennas for mobile radio remotes.

TWR Lighting Inc. will demonstrate its aviation obstruction lighting, including medium intensity strobes, red incandescent lighting, controllers, junction boxes and lighting kits.

Satellite equipment will include RF Technology's FOM-13L ultra high-performance fiber optic link for audio or digital transmission requirements.

Standard Communications will debut its CFR800 multi-purpose rack and power supply for audio and data demodulators, its CST810 SCS/FM<sub>2</sub> dual demodulator and audio subcarriers.

Comtech Systems Inc. will debut the EC6 microprocessor antenna controller

with computer interface capable of controlling both antenna and receiver via RS232. It has 64-position memory and software is available for scheduling events in advance.

## Advanced filter system

Nurad Inc. will show its new advanced filter system for central ENG receive systems; Microdyne will introduce the BRK receiver with MAT II.

New from Wegener Communications Inc. is the Series 1800 FM<sub>2</sub> subcarrier receiver for radio networks featuring Panda stereo audio and 15-function network control. Also new is the company's QPSK digital audio subcarrier receiver and the Series 1600 dual audio automatic gain control module.

Scientific-Atlanta will feature the new Series E9700 Mobile B-MAC encoder, which provides simultaneous transmission of hard-scrambled video and digitally encrypted audio, data and teletext. The system is designed to accommodate small space requirements of the mobile uplink.

And Advent Communications Ltd. will showcase its new flyaway system, as well as a satellite transmission system, upconverters, downconverters and modulators.

# Doing the Vegas Scene After Dark

(continued from page N12)

fast fare try Art's Place, a restaurant and cocktail lounge owned by Art Lurie, the mayor's father and member of the Nevada State Boxing Commission. Art's Place is located on East Sahara about two blocks east of Paradise.

The cholesterol conscious shouldn't miss The Fisherman's Broiler at the Palace Station on west Sahara, where mesquite broiled fresh fish and seafood is the name of the game. They even have a special menu of low-cal desserts.

## Fun and games

Now believe it or not, the Las Vegas area has more to offer the entire family than the obvious glitz, glamour and

gaming. Circus Circus, although a gaming establishment, features live circus acts around the clock and a selection of arcade games that will rival the state fairs of your youth.

Wet 'n' Wild, a water theme park, expects to open in mid-April and is located right on the Strip just south of the Sahara Hotel.

A 45 minute drive west of Las Vegas will take you to Red Rock, an awe-inspiring example of nature's geologic wonders and Bonnie Springs Old Nevada, an authentic western frontier village and petting zoo.

In nearby Henderson, just south of Las Vegas, take a tour of the Ethel M chocolate factory and taste the chocolate cordials, made with real aperitifs. South of Henderson visit Boulder City, historic home for the builders of Hoover Dam 52 years ago.

Five minutes from Boulder City you can take a tour deep inside Hoover Dam,

a utilitarian example of art deco architecture. Or take a dip in Lake Mead, the manmade lake created by the dam.

North of Las Vegas, follow Interstate 15 and explore the chilling beauty of Mt. Charleston and view the desert below or drive on a little further to the Valley of Fire, near Overton, Nevada. There the landscape is so red and barren it looks like an episode of "Lost in Space."

There are few cities in the United States as well-suited to host the NAB convention. Las Vegas' competition pales by comparison because after the exhibits close and the sales reps return to their hotels, conventioners have more entertainment, dining and recreational choices at reasonable prices and within easy reach than any other NAB locale.

■ ■ ■

Gigi Koury is a free-lance TV director and production management consultant working in the Las Vegas broadcast and industrial market.

# Sources

(continued from page N7)

pany's new MT metal dome high frequency driver.

BSW (Broadcast Supply West Corp.) will show new Radix headphone amplifiers with EQ, according to the company.

## Related gear

Contrary to some opinions, turntables have not been killed off at radio stations by CDs.

Cartridges and styli are still being made to replace the worn-out ones.

Stanton Magnetics is introducing its 890AL cartridge, DP89L stylus and 680EL-MP and 500AL-MP.

On the intercom side, several companies including McCurdy, and Electro-Voice Corp. are introducing new lines of intercoms.

McCurdy will show the CS9500 digital intercom with features including matrix field expandable beyond 50x50 and programmable point-to-point communication.

Electro-Voice will exhibit the Vega intercom system, along with wireless mics.

Let's not forget telephone interfaces to intercom systems. RTS Systems ATC222 telephone/intercom coupler will be introduced as will its new programmable intercom user station, MCE325.

Also in telephone accessories, Bradley Broadcast will show the Telos 100 digital telephone system.

**Match-Maker™**

**\$259**

**Disc-Patcher™**

**\$209**

**IHF ↔ PRO**

**Level and Impedance Converters**

**BI-DIRECTIONAL FOR**

- Reel to Reel and Cassette Recorders
- Graphic Equalizers and Noise Reducers
- Audio Effects Processors and Digital Reverb
- Dual Line Amp, DA, Splitter or Combiner

**UNI-DIRECTIONAL FOR**

- Digital Compact Disc Players
- ENG Cassette Dubbing
- Off-Air Monitor Tuners
- Console Audition Outputs

Interface consumer/industrial IHF (-10db) stereo source equipment and signal processing devices into professional studio +4dBm, 600 ohm systems without loading distortion, crosstalk, hum, response roll-off or RF pick-up.

True transformer output isolation, balance and protection with less than .01% THD even at 20Hz and +22dBm peak output!

102 db dynamic range...greater than a Compact Digital Disc system!

Self contained power supply, Velcro™ and dual rack mounting.

Free Detailed Brochure and Specifications Available

**AUDIO TECHNOLOGIES INCORPORATED**

**ATJ**

328 Maple Avenue, Horsham, PA 19044  
(215) 443-0330

The 1989 NAB Exhibitors Directory is a listing of information provided by exhibitors who responded to an NAB Radio questionnaire survey. Past and potential NAB exhibitors were asked about new and established radio products scheduled to be shown at the NAB this year.

The questionnaires were mailed to vendors in January 1989. Those returned by the deadline are included in this Directory.

Company Booth

**a**

**Accurate Sound Corp. 5760**  
Intro: AS4000 audio cassette slow speed recorder/logger; CR3A professional condenser studio mic.  
Also: AS200B high speed audio reel-to-reel 1/4" tape duplicator; Model 180 Starbird mic boom/stand; AS6000 tape conditioner/cleaner.

**Accu-Weather, Inc. 7416/7418**  
Intro: Complete line of high resolution and high color resolution weather graphic satellite and radar images; new versions of Radar-Plus and NewRad; new graphics designed for morning news segments.  
Also: Complete line of weather graphics; Forecast/Briefing; Siscorp satellite delivery; WeatherBreak; WeatherShow.  
Contact: Dr. Joel N. Myers  
619 West College Avenue  
State College PA 16801  
814-237-0309

**Acoustic Systems N/A**  
Intro: BB voice-over booth.  
Also: BB voice over-booths; broadcast/recording studios.

**ADC Telecommunications, Inc. 3755**  
On Display: I.C.O.N. audio cable distribution frame; SMPTE 9-pin patching system; Pro Patch audio patch bays; VAMP video-audio modular patch bay; Pro Patch cords; jacks; panels; plugs.

**ADM Technology, Inc. 5151**  
Intro: CH26 DA card rack IU (1 3/4") high, holds 2-1x6 mono cards.  
Also: ST Series II radio broadcast console; RM1083 8 channel rack mixer; other rack products including ADM's mono and stereo DA.

**Advanced micro-dynamics inc.**

**Advanced Micro-Dynamics, Inc. 1563/1662**  
Intro: Enhanced options for TC-8 and ARC-16 transmitter remote control systems; speech unit; computer interface.  
Also: TC-8 remote control system featuring communications options; ARC-16 remote control system with telephone/speech option; multi-site capability.  
Contact: Peter Burk  
7 Lomar Drive  
Pepperell MA 01463  
508-433-8877 1-800-255-8090

**Advent Communications Ltd. Outdoors**  
Intro: Radio flyaway system.  
Also: Satellite transmission system; upconverters; downconverters; modulators.

**AirCRAFT Digital Production Music Library 5444/5445**  
On Display: Production music library on CD; 30 currently available new titles being added at a rate of 10 yearly; available on a yearly subscription basis.

**AKG Acoustics, Inc. 2043**  
Intro: DSE 7000 digital sound editor RAM based digital audio workstation.  
Also: Complete line of mics for broadcast and recording; headphones and headsets for monitoring, communication and digital effects.  
Contact: Timothy DerWallis  
77 Selleck St.  
Stamford CT 06902  
203-348-2121

**Alamar Electronics 4779**  
Intro: Alamar MC-2055 third generation automation system; TD Assistant provides production automation support; LIP-100 general purpose display; Net Delay-NDP-100 provides unattended recording and playback in variable amounts of time.

**Allen and Heath 7434/7436**  
Intro: Scepter Series of rack mount mixer in a 20 input/12 channel format; new MBI Series 16 on the air broadcast console series.  
Also: Audio mixing consoles including the Sigma 24 bus in line format and Sabre 16 bus split console series; SRC Series of 16, 24 and 32 input consoles.

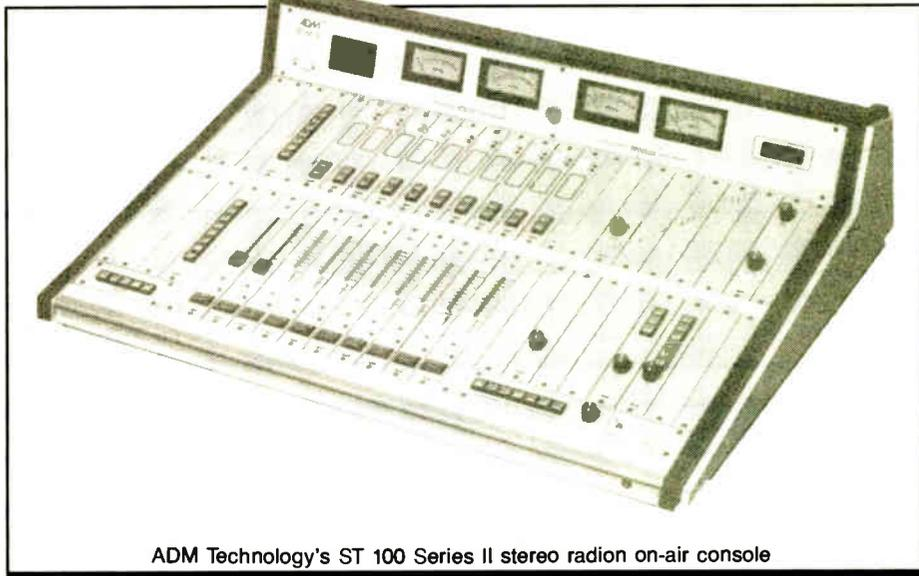

ADM Technology's ST 100 Series II stereo radion on-air console

**AM5/Calrec 1134**  
Intro: AudioFile Version 8 upgrade;

**Andrew Corp. 1721**  
Intro: Models 82RF and 82RG 3 1/8" EIA flange connectors for 2 1/4" air dielectric Heliac cable.  
Also: Transmission lines include: Heliac® coaxial cables and waveguides; MACXLine™ Series; GuideLiner™ Series of circular waveguides.

**Aphex Systems, Ltd. 1058/1062**  
Intro: Model 250 Type III aural exciter; Model 120 DA; Model 800 studio clock; Model 850 Feel Factory.  
Also: Model 300 compellor; Model 700 dominator; Model 612 expander/gate; Model 124 audio level interface.

**Arben Design, Inc. 5763/5764**  
Intro: New line of flats for traditional room settings.  
Also: Lebenset modular set design systems; Cyc-Wedge hard cyclorama system; all products offered through The Set Design Catalog.

**Arrakis 2215**  
On Display: Complete line of console products and furniture  
Contact: Mike Palmer  
2619 Midpoint Drive  
Ft. Collins CO 80525  
303-224-2248

**ATI 2101**  
On Display: Broad line of general audio products and console line.  
Contact: Sam Wenzel  
328 Maple Avenue  
Horsham PA 19044  
215-443-0330

**AT&T 3962**  
On Display: Satellite services; long distance services; voice processing; FAX machines; 3-D animation software; data equipment and teleconferencing services.

**Audico, Inc. 1740**  
On Display: Audio and video cassette tape loaders, rewinders, length verifiers, cyclers; video cassette reloaders; pressure sensitive cassette labels for audio and video cassettes; professional impuler; reel and cart tape winders.

**Audi-Cord Corp. 1113**  
On Display: Analog cartridge recorders and reproducers.

**Audio Accessories, Inc. 1529**  
On Display: Audio jacks; jack panels; patch cords; pre-wired patch panels; polysand polishing cloth; patch cord holders.

**Audio Broadcast Group, Inc. 2427**  
On Display: Multi-track production system w/SMPTE time code option and a complete line of effects equipment incorporated; system is housed in "Human Engineered" studio cabinetry; complete turnkey installations available.  
Contact: David E. Veldsma  
2342 S. Division Avenue  
Grand Rapids MI 49507  
616-452-1596

**ALLIED**

**Allied Broadcast Equipment 2027**  
Intro: New Denon CD Cart Player™; Lexan magazine for permanent disc storage; architect's scale model of available complete radio station facility; "dub center"; Modulux™ ready to assemble studio control room furniture; Modulink™ totally pre-constructed studio control room furniture.  
Contact: Dave Burns  
3712 National Road West  
Richmond IN 47375  
317-962-8596 FAX: 317-962-8961

**Allied Tower Company, Inc. 1565**  
On Display: Towers for AM, FM, microwave.

**Alpha Video and Electronics Co. 5183**  
Intro: IFB 101B; Microwave repeater ENG van.  
Also: Alphatized type 5, 6, 7, 9 VTRs; Safety Raiser Mast high tension sensor.  
Contact: Henry B. Lassige  
200 Keystone Drive  
Carnegie PA 15106  
412-429-2000

**Altronic Research, Inc. 2529/2531**  
Intro: Addition to Omegaline 5700 Series water-cooled loads: Model 57100B-100 kW single resistor dummy load and Model 57200B-200 kW single resistor dummy load; addition to Omegaline 6700 Series air-cooled loads: Models 6705, 6710, 6715 and 6750 with continuous duty rated at 5 kW, 10 kW, 15 kW and 50 kW respectively.  
Also: Omegaline air-cooled and water-cooled dummy loads from 5 kW to 200 kW; high power non-reactive cermet resistors from 1 to 250,000 watts.

**Amco Engineering Co. 3747/48/49**  
On Display: Complete line of enclosure consoles for electronic/electrical applications available in commercial or military; cooling devices; heavy duty structural aluminum for standard or special design applications; desk, test and bench top cabinets; full line of accessories; Instant Amco consoles and accessories available in 5 working days.

**Amek/TAC U.S. 2008-2018**  
Intro: TAC Bullet-transportable or rack-mounting mixing console w/all mic and line inputs, group and auxiliary outputs electronically balanced.

# Introducing the Newest Specialist!

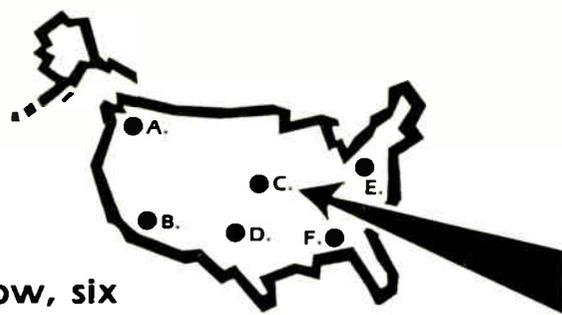

CHRIS KREGLER — RF SPECIALTIES OF MISSOURI

Now, six offices provide coast-to-coast coverage. For all your RF needs, call the RF Specialties office nearest you.

**RF Specialties® Group** SYSTEMS DESIGN COMPETITIVE PRICING

- A. RF Specialties of Washington, Inc.**  
11721 15th Avenue NE  
Seattle, WA 98125  
Phone (206) 363-7730  
FAX (206) 362-5560  
John Schneider
- B. RF Specialties of California**  
3463 State Street, Suite 229  
Santa Barbara, CA 93105  
Phone (805) 682-9429  
FAX (805) 682-4396  
Sam Lane
- C. RF Specialties of Missouri**  
RR #2, Box 152H  
Kearney, MO 64060  
Phone (816) 635-5959  
FAX (816) 635-4508  
Chris Kregler
- D. RF Specialties of Texas**  
P.O. Box 7630  
Amarillo, TX 79114  
Phone (806) 372-4518  
FAX (806) 372-1833  
Don Jones & Tim Hawks
- E. RF Specialties of Pennsylvania, Inc.**  
121 Conneaut Drive  
Pittsburgh, PA 15239  
Phone (412) 733-1994  
FAX (412) 327-9336  
Tom Monahan
- F. RF Specialties of Florida**  
P.O. Box 397  
Niceville, FL 32578  
Phone (904) 678-8943  
FAX (904) 729-2744  
Bill Turney

EACH OFFICE IS INDIVIDUALLY OWNED AND OPERATED.

Circle 34 on Reader Service Card



**Audio Developments Ltd. 3465/3466**  
Intro: AD081 Flexi-Link 3' high rack into which can be plugged a variety of modules, mic input, line input, mixer module, summing amp.  
Also: AD062 multimixer range; AD145 pico mixer range; AD160 ENG mixer; AD260 stereo ENG mixer; AD066 Port-A-Flex system; DAs.

**Audio Precision 2044/2046**  
Intro: System One Dual Domain analog and digital dual domain version of System One.  
Also: System One audio test system; DCX-127 DC test unit; SWR-122 switchers.  
Contact: Tom Mintner  
PO Box 2209  
Beaverton OR 97075  
503-627-0832

**Audio Technica US, Inc. 1631/1633**  
Intro: ATM 25 high sound pressure instrument mic; ATW 1031 and 1032 wireless mic system.  
Also: Unipoint miniature condenser mics; 40 Series studio mics and shotguns; studio monitor headphones; stereo field mixers w/IFB; ATM+ 800 Series mics, cables and accessories.

**Audiopak, Inc. 1653/1655**  
On Display: Audio broadcast cartridges; A-2 carts; AA-3 carts; AA-4 carts; lubricated tape formulas 605, 613 and 614 for reloading.  
Contact: Gordon Stafford  
PO Box 3100, 1680 Tyson Drive  
Winchester VA 22601  
703-667-8125 FAX: 703-667-6379

**Audiotronics, Inc. 1363**  
Intro: Mix-Minus for up to 8 remote correspondent feeds; stereo distribution amplifier w/VCA control and transparent specifications.  
Also: 200 Series on-air consoles; 310 Series 4and8 track production consoles; 400 Series 4, 8 and 16 track production consoles; mono distribution amplifiers; rack mount MIC, line and VCA amplifiers.  
Contact: Murray Shields  
3750 Old Getwell Road  
Memphis TN 38118  
901-362-1350

**Autogram 1026**  
Intro: Pacemaker 648 6-slide pot; Pacemaker 828 8-slide pot; Pacemaker 1032 10-slide pot.  
Also: IC-10 10-channel rotary pot; AC-8 8-channel rotary pot; R/TV-12 12-channel slide pot; R/TV-20 20-channel slide pot; Autoclock counter/real time/temperature; Autocount counter/timer.

**Avcom of Virginia, Inc. 5114**  
Intro: PSA-65A portable microwave spectrum analyzer.  
Also: PSA-37D; PSA-35A; SCPC-2000E; SCPC-3000E; SCPC-500-70; SCS-200.

**b**

**Barco Industries N/A**  
Intro: Prototypes of high resolution microprocessor controlled large monitor displays; series of RF equipment: modulators; demodulators; channel converters; D2 input board option.  
Also: CVS Series broadcast quality monitors; CVM Series high resolution monitors.

**Barrett 1070**  
On Display: Complete range of studio transmission equipment.  
Contact: Barrett Mayer  
3205 Production Avenue  
Oceanside CA 92054  
619-433-5600

**Basys 5568**  
Intro: PC-News system automated news production for radio.

**B and B Systems 3873/3874**  
Intro: IM-1HR phase tester w/"Imagescope" display.  
Also: Full line of stereo audio phase monitors: AM-1B post production; AM-2/2B/2HR 2 channel stereo; AM-3/3B broadcast stereo; IM-1HR stereo "Imagescope"; MP-4 audio level metering.

**Beaveronics, Inc. 1726**  
Intro: New FAVAG LED50 digital clock runs from either Favag-type second or minute impulses or from its internal time base.  
Also: FAVAG Master Clock Systems w/master accurate to 1 sec/year; analog and digital slaves available; ESE timers; audio level indicators; audio DAs.

**Belar Electronics Laboratory, Inc. 1352**  
Intro: New monitoring equipment for AM, FM and TV.  
Also: Monitoring, test and measurement equipment for AM, FM and TV.

**Bencher, Inc. 45584**  
Intro: M2 copy outfit now shipped w/gray baseboard and grid system as standard.

**Beyer Dynamic, Inc. 3738/3739**  
Intro: MCE 86 short shotgun mic; EA 86 and EA 1925 camera and fishpole isolation mounts; DT 770 PRO/DT 990 PRO monitoring headphones; IRS 690 headphones; TS 190 wireless lavalier system; S 186 wireless mic system; SHM 420, 422, 10 Podium Series Mics; M58 ENG/EFP mic.



Beyer Dynamic's M58 microphone

**Bill Daniels Co., Inc. 5277**  
Intro: Technical data and applications information manuals; sales lead and literature fulfillment and 800 number answering service.  
Also: Video, audio, CCTV, A/V presentation and broadcast equipment buyers guides; dealer and manufacturer catalog compiler.

**Bird Electronic Corp. 15522**  
On Display: RF power meters; dummy loads; attenuators.

**Boonton Electronics Corp. 2525**  
On Display: Complete line of RF power meters 1 through 6 channel; RF/RMS voltmeters; distortion and audio analyzers and oscillators; modulation meters and analyzers; signal generators.

**Bowen Broadcast Service Co., Inc. 3429/3430**  
Intro: TCR-100 dynamic magazine brake kits for new or replacement applications.  
Also: Primary services are on-site maintenance of RCA quad video tape equipment; training of maintenance personnel on the maintenance of the equipment; providing maintenance assistance via computer (Teleho) and supplying some TCR-1000 kits plus replacement parts unavailable from other sources.  
Contact: William D. Bowen  
8343 Lynn Haven Avenue  
El Paso TX 79907  
915-598-5556

**Bradley Broadcast Sales 2301**  
On Display: Telos 100 digital telephone system and other products.  
Contact: Neil Glassman  
8101 Cessna Avenue  
Gaithersburg MD 20879  
301-948-0650 800-732-7665

**Broadcast Audio Corp. 1053**  
Intro: Series VI low profile modular audio consoles w/mainframe sizes 8, 12, 16, 20 and 24 mixers; LED clock/timer; peak level indicators; headphone EQ; dual monitor system w/control room "monitor dim" std.  
Also: Series IV stereo audio consoles; RM-6 rack mount console; monitor amplifiers; distribution amplifiers; phono preamps.  
Contact: David W. Evans  
11306 Sunco Drive  
Rancho Cordova CA 95742  
916-635-1048

**Broadcast Electronics, Inc. 1205**  
On Display: Phase Trak 90 cart machines including: Model PT90RPS record/playback; Model PT-90PS playback; Mix Trak 90 modular audio console; 20 kW FM transmitter; 1 kW to 35 kW models w/MVDS; Control 16X program automation system; line of single and three deck cart machines; C-QUAM AM stereo exciter; stereo audio consoles.  
Contact: Curt Kring  
4100 N 24th St, PO Box 3606  
Quincy IL 62305-3606  
217-224-9600

**Broadcast Services Co. N/A**  
On Display: Range of products offered  
Contact: Neal Davis  
Rt 3, Box 45E  
Four Oaks NC 27524  
919-934-6869

**Broadcast Supply West 2015**  
Intro: Radix headphone amplifier w/EQ.  
Also: Audio equipment including: consoles; cart machines; CD players; audio effects processors.  
Contact: Tim Schwieger  
7012 27th St. West  
Tacoma WA 98466  
800-426-8434

**Broadcast Technology Society/IEEE 4586**  
On Display: Membership and information booth w/publications and standards published by the Society and the Institute of Electrical and Electronics Engineers.

**Bruel and Kjaer 7431**  
Intro: Type 4011 cardioid prepolarized condenser mic.

**Cablewave Systems, Inc. 5100/5101**  
Intro: Type CFMLP and CFMHP circularly polarized, high power FM antennas.  
Also: Semi-flexible Flexwell coaxial cable elliptical waveguide; FM antennas; RF connectors; rigid transmission line and accessories; STL antennas; microwave parabolic antennas; pressurization equipment; accessories.  
Contact: William Meola  
60 Dodge Avenue  
North Haven CT 06473  
203-239-3311

# Portable Partnership

When you're on the scene, you're on the air—with a cellular phone and a Comrex. Our PLXmicro converts telephone quality to program quality around town or around the world.

The PLXmicro is the tiniest extender we've ever built. Just about pocket size, it stows-and goes-almost anywhere.

Yet despite its size, it's packed with features: the Comrex frequency extender is built in, along with interface for cellular telephone or standard dial line. There are microphone and tape inputs and automatic send level control.

A monitor decoder, hybrid circuitry and headphone output allow full duplex operation.

Call or write for a demo tape of the difference that a Comrex can make.

**COMREX**

Comrex Corporation, 65 Nonset Path, Acton, MA 01720  
508-263-1800 1-800-237-1776  
Comrex U.K. Ltd., 171-175 Uxbridge Road,  
London W139AA 01-579-2743

**Canare Cable, Inc. 5755/5756**

Intro: 75 ohm BNC connectors.  
Also: L-4E6s Star Quad: microphone cable; speaker cable; multichannel cable; patch bay cable; cable reels and audio/video connectors.

**CCA Electronics, Inc. 1047**

On Display: AM, FM, shortwave and longwave broadcast transmitters and related products.  
Contact: Ron Baker  
PO Box 426  
Fairburn GA 30213  
404-964-3530

**Central Tower, Inc. 2348**

On Display: Guyed towers to 1500 feet; self-supporting towers to 300 feet.  
Contact: David Davies  
PO Box 530  
Newburgh IN 47630  
812-853-0595

**Century 21 Programming, Inc. 1821/1823**

Intro: A11 digital computerized controller including hard disk commercial storage; CD juke boxes.

Also: CD music libraries; CD players for automation and unattended operation; computerized CD juke boxes; CD production libraries; radio station ID jingles.

**Circuit Research Labs 1009**

Intro: PMC-450 tri-band AM peak modulation controller; SMP-950 tri-band AM stereo matrix processor; IPP-100 programmable mic processor; MBL-100 medium wave modulation controller.

Also: Line of audio processors for AM and FM; digital FM generator; Dynafex noise reduction systems; AM NRSC retrofits.

Contact: Deb Erzen  
2522 W Geneva Dr  
Tempe AZ 85282  
602-438-0888

**Clearcom Systems 5346**

Intro: Matrix Plus point-to-point multi-processor controlled intercom system; Models 1020 and 1020M stereo amplified monitor speakers.

Also: Line of fully digital matrix and standard analog intercom systems.

**Columbine Systems, Inc. 4277**

On Display: The Unified System including application software; hardware; IBM mini-computers; IBM software; technical services; leasing.

**Comad Communications Ltd. 2121**

Intro: Data Security, Inc. tape degaussers for audio, video tape and cassettes including metal particle tape, computer and instrumentation tape and recording media.

Also: SIRA UHF, VHF, FM broadband antennas suitable for multistation operation; combiners for UHF, VHF and FM; RF transmission accessories and connectors.

**Computer Concepts Corporation 1061**

On Display: Integrated broadcast systems including traffic, billing, accounts receivable, word processing, general ledger, payroll, accounts payable, music management, station automation, data management and script management; features include on-line logs, on screen editing, copy management, open item accounts receivable, automatic generation of ANA/RAB co-op tearsheets, auto posting; for IBM PCs, compatibles, Novell network, Wang 2200.

**Comprompter, Inc. 5775**

Intro: ENR version 2.00 release of ENR software, includes assignment, writers' and producers' desk workstations, E-mail, wire capture, keyword wire and archive searches; utilities on each desk to customize ENR to individual needs.

Also: ENR Electronic NewsRoom software and systems; PC compatible computerized news room system that provides full word processing, wire capture, archive and wire searches, show production and printouts.

**Comrex Corp. 1521**

Intro: Multi-Line series of modular frequency extenders.

On Display: Complete line of frequency extenders, including new multi-line range of frequency extenders

Contact: Lynn Distler  
65 Nonset Path  
Acton MA 01720  
508-263-1800

**Comtech Systems, Inc. Antenna Div. 2024/2026**

Intro: EC6 microprocessor antenna controller w/computer interface capable of controlling both antenna and receiver (C- and Ku-bands) via RS232; 64 position memory; software is available for scheduling events in advance.

**Comtek, Inc. 5768/5769**

Intro: M-182 handheld, wireless microphone; MR-180 portable, wireless microphone receiver for camera use.

Also: Wireless microphones; wireless intercom systems; wireless IFB systems.

**Concept Productions 1453/1455**

Intro: CAPS I computer assisted programming system featuring DAT, up to 12 digital audio tape decks; CAPS II computer assisted programming system featuring DAT decks and DTL digital tape loader; radio formats available on DAT.

**Conifer Corp. 3858/3860**

Intro: HLN ITFS downconverter; HLN2 high gain ITFS downconverter; HSLN high gain low noise ITFS downconverter.

Also: QL-1010 broadband MMDS block downconverter; QL-30 Series dual band/broadband MMDS block downconverter.

**Connectronics Corp. 1570/1571**

Intro: "J" Bay patch bay system; "X" Bay patch bay system; mixed connector bays supplied in kit form for custom assembly; Bodge Plugs connectors.

Also: Full range of specialized audio wire and cable; fully color-coded flexible mic cable; phono-cable; 32 pair foil-shielded Multipair.

**Continental Electronics, Div. of Varian Assoc., Inc. 1125**

On Display: Complete line of AM and FM radio transmitters w/power levels from 50 watts to 70 kW; high power medium wave and shortwave transmitters.

Contact: Steve A. Claterbaugh  
PO Box 270879  
Dallas TX 75227  
214-381-7161

**Control Concepts Corp. 3902**

On Display: Expanded Islatron product line offering either complete facility protection or system protection for transmitter, studio, satellite system; video editing; control systems and other digital equipment; Islatron Active Tracking filters.

**Cortana**

On Display: Lighting control products

Contact: Evelyn Nott  
PO Box 2548  
Farmington NM 87499  
505-327-5646

**Current Technology N/A**

Intro: "Power Server" power conditioning w/electrical distribution.

Also: Power conditioners w/extended range filtering; "MP" Series of entire environment protection featured.

Contact: Martin Sandberg  
1400 S. Sherman  
Richardson TX 75081  
214-238-5300

**Cutting Edge**

On Display: Audio processing techniques.

Contact: Frank Foti  
12540 Edgewater Dr #1206  
Lakewood OH 44107  
216-221-7626

**d****Datacount, Inc. 6002**

On Display: DARTS accounts receivable and traffic system available for single user PCs and multi-terminal systems.

**Dataworld 1374**

Intro: AM daytime channel studies (permissible radiation); detailed coverage maps; population density maps; terrain shadowing studies; advanced presentation graphics.

Also: FCC databases; AM, FM, TV, LPTV directories; allocation and interference studies; population counting; Flag Service of FCC release notifications; terrain elevation retrieval programs; FM and TV area to locate studies on map overlay; AM groundwave calculations; license assignments and transfers; FCC/FAA tower location studies; unused call-sign listings; industry mailing lists; on-line 24 hour access available.

Contact: Shirley M. Ostmann  
PO Box 30730 4827 Rugby Ave. Suite 200  
Bethesda MD 20814  
301-652-8822 800-368-5754

**dbx, Inc. 2420**

Intro: RTA-1 real time analysis system; 563X and 929 hiss reduction units.

Also: Performer Series rack signal processors; 900 Series flexible modular rack system of signal processors; special systems products.

**Delta Electronics, Inc. 1159**

Intro: Active whip receive antenna; high power sampling toroid; high power toroidal coupled ammeter; noise generator; new AM stereo exciter.

Also: AM splatter monitor; high power pulse reflectometer; impedance bridges and generators; sampling transformers; toroidal coupled transfer switches; antenna monitors and controllers.

Contact: John Bisset  
5730 General Washington Drive  
Alexandria VA 22312  
703-354-3350 FAX 703-354-0216

**DeWolfe Music Library 1736**

On Display: Full service music library on CD; new productions on a regular basis; complete sound effects library on CD also available; original sound tracks & custom sound effects available.

**Dielectric Communications 1025**

On Display: FM ring, panel & short spaced antennas; filters; multistation combiner-multiplexer; combiner/switcher for parallel transmitters; AM/FM tower isol unit; rigid coaxial transmission line; coaxial switches & patch panels; RF directional couplers; air pressurization equipment.

# You Can Stake Your Reputation On Current Technology.

## Power Systems for Today's Technology

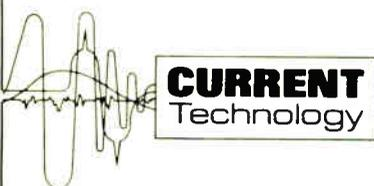

DP professionals at thousands of major companies are depending on Current Technology every day. The Power Sifter®, our line of advanced solid state filtering systems, converts polluted electricity into digital quality power. It's a high tech design to match today's high tech equipment.

How well does it work? Our clients tell us in recommendations. In reorders. And

spontaneous letters. "We have experienced no power related problems since the installation of the Power Sifters," wrote the U.S. Department of Justice. And from TCUL Services, Inc.: "Since installing the Power Sifter, I am happy to say that we have 100% uptime."

If power problems have ever put your reputation on the line, you'll want to hear more.

Call or write for the Current Technology story today.

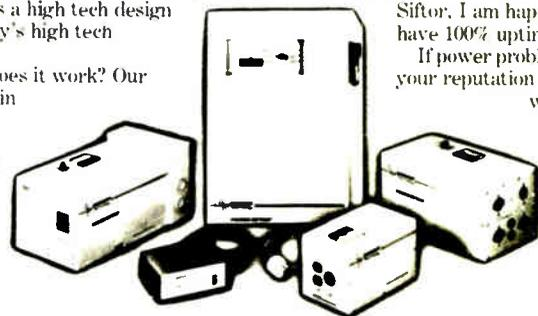

1400 South Sherman, Building 202 • Richardson, Texas 75081 • (214) 238-5300  
Power Sifter is a registered trademark of Current Technology, Inc.

**DI-Tech, Inc. 4574**  
Intro: Model 5616 16x16 stereo audio switcher; Model 5865 32x24 stereo audio switcher.  
Also: Model 5862 64x32 stereo audio switcher; Model 270 1x6 monaural audio DA; Model 272 1x3 stereo audio DA.  
Contact: Dan Mazur  
48 Jeffry Blvd.  
Deer Park NY 11729  
516-667-6300

**DSI Communications, Inc. 1765**  
Intro: Statusystem™ remote control system; complete line of remote control and site monitoring equipment for the radio industry.  
Also: Full service engineering company specializing in design and installation of audio and RF systems; remote site monitoring and control equipment.

**Dynair Electronics, Inc. 1707**  
Intro: Dynasty routing switcher; Series 1200 line of modular distribution equipment including fiber optics.  
Also: High performance video and audio switching and distribution equipment; complete integrated routing and distribution solution for all proposed high definition standards.



**Econoco Broadcast Service 1675**  
Intro: 4CX3500A, now available  
Also: Rebuilt power transmitting tubes.  
Contact: W.R. Barkley  
1318 Commerce Avenue  
Woodland CA 95695

**Editron USA, Inc. 7632/7634**  
On Display: 520 System audio editor/synchronizer; 100 System chase synchronizer.

**EEV, Inc. 4262**  
On Display: Broadcast tetrodes for AM/FM transmitters including 15 kW air-cooled tetrode type 4CX15,000A and 35 kW air-cooled tetrode type 4CX35,000C.

**Electro Impulse Lab, Inc. 1103**  
Intro: New versions of DPTC-25K FM dry, forced-air-cooled FM dummy load.  
Also: Dry, forced-air-cooled RF dummy loads for FM; RF calorimeters; RF attenuators; dry, convection-cooled loads.

**Electronic Research (ERI) 1017**  
On Display: Complete antenna product line.  
Contact: Derek Therios  
108 Market Street  
Newburgh IN 47630  
812-853-3318

**Electro-Voice, Inc. 1641**  
Intro: Vega line of wireless mic and intercom systems.  
Also: Electro-Voice line of broadcast/production mics and accessories; Sentry monitor speakers and broadcast electronics.

**Emcor Products/Crenlo, Inc. 1670/1573**  
On Display: Modular electronic enclosure systems; EMI/RFI cabinets; computer support furniture; chassis-slides; packaged blowers; Instant Emcor Quick Ship Program.



**Energy-Onix 1730/1732**  
Intro: FM solid state 500 watt amp; solid state 2 kW FM transmitter; one tube FM transmitters Model MK-75 and MR12.  
Also: FM broadcast transmitters including: solid state transmitters from 30 to 2000 watts; one tube transmitters to 12 kW; 2 tube transmitters to 50 kW; AM NRSC products; AM broadcast transmitter.

**E-N-G Mobile Systems, Inc. N/A**  
Intro: ENG C-Van compact ENG van with full live microwave capability built on a Ford Aerostar commercial chassis.  
Also: Custom designed News Gathering Suburban four-wheel drive unit.

# Eventide

the next step

**Eventide, Inc. N/A**  
Intro: BD940 broadcast delay; H3000 Ultra-Harmonizer in two software versions.  
Also: BD980 broadcast delay line; PD860 two-channel audio delay.  
Contact: Suzanne Langle  
One Alsan Way  
Little Ferry NJ 07643  
201-641-1200

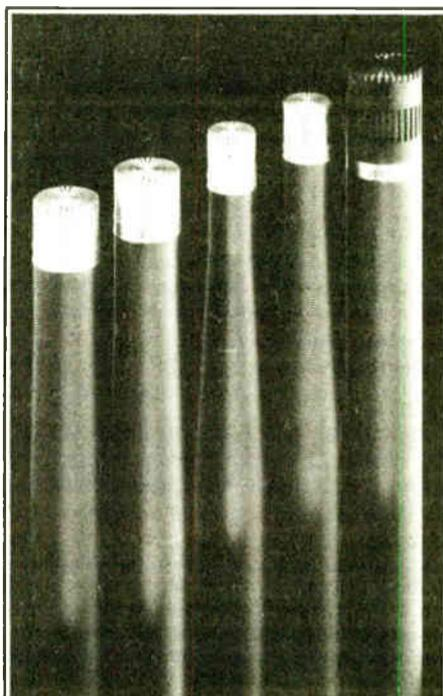

Brul & Kjaer Series 4000 Professional Microphones



**Farrtronics 5448/5449**  
Intro: Model M750-96-PP 96 Bantam jack Patchfield; Model PD36 and PD36-GL 36 pin punch block; Model M86-MON-2 self-powered, amplified, mono/stereo monitoring package.  
Also: Intercom systems; studio and Telco IFB systems; stereo audio distribution packages; punch-down insulation displacement system termination blocks; full line of audio and video patchfields; audio and video patch cords and accessories.

**Fidelipac Corp. 117**  
Intro: Enhanced CTR30R Series.  
Also: Dynamax CTR100 and CTR10 Series cart recorders and players; CTR30 Series three-deck cart recorder/reproducer; ESD10 eraser/splice detector; Dynamax Cobalt, Master Cart, Model 300 and Model 350 NAB tape cartridges; desktop and handheld erasers; 1/4" back-lubricated recording tape; world standard On Air and Recording lights, cart racks; test tapes; accessories.  
Contact: Raylene Kadmas  
PO Box 808  
Moorestown NJ 08057  
609-235-3900 FAX 609-235-7779

**FirstCom 1008/1010**  
Intro: Hot Tickets radio promotion; Guaranteed Sales Library for Radio CD library.  
Also: Music and sound effects libraries for radio, A/V, film, video, commercials or any production; DAT Oldies Library; Radio IDs and TV campaigns.

**Focal Press 7616**  
On Display: A full line of books on methods, equipment and techniques for professionals in the broadcast industry.



**Garner Industries 51/5113**  
Intro: A new model will be introduced to erase S-VHS formats.

**GE American Communications, Inc. 3419**  
On Display: Total program delivery services for broadcasters via satellite; satellite services include digital audio and SCPC network programming, broadcast TV, syndication, satellite news-gathering, international/occasional TV, business video and international broadcast services.

**Gefen Systems 2351**  
Intro: Macintosh Version of the MLE Organizer; The TrackPlanner™ cue sheet film style program for IBM compatibles; Multi MLE Server program to connect multiple edit-bays to one or two CD changers.  
Also: IBM Version of the MLE Organizer system sound effects database w/random access play using multi CD changers; The BBC sound effects library.

**Gentner Electronics Corp. 2127**  
Intro: VRC-2000 complete remote control system; Audio Prism digitally controlled audio processors for FM; Phoenix digitally controlled, NRSC compliant processor for AM.  
Also: Telephone interface products; frequency extenders for remote broadcast over standard telephone lines; transmitter remote control system; audio products.  
Contact: Kelly Maag  
1825 Research Way  
Salt Lake City UT 84119  
801-975-7200

**GML, Inc. 7333/7331**  
Intro: Series 2000 console automation environment software and hardware configurations specifically designed for film/video and broadcast production audio console applications; compressor/limiter.

**Gotham Audio Corp. 3538**  
Intro: Neumann KM 100 Series condenser mics.  
Also: Neumann U 89 and TLM 170 mics; RSM 190 stereo ENG shotgun; digital audio interfaces from Harmonia Mundi Acustica; PRODAT and super dynamic limiter from Audio + Designs; products from Barco-EMT; Studer Revox; Timeline; Lightwave Systems; Klein and Hummel; LaRue Labs.



**Hallikainen and Friends, Inc. 1111**  
Intro: SAT201 remote control over a voice grade circuit; TURBO news software.  
Also: DRC190 remote control system; TEL171 and ITO177 digitize and automate the operation of the Moseley TRC-15A remote control; TVA Series audio mixers.  
Contact: Harold Hallikainen  
141 Suburban Road, Building E4  
San Luis Obispo CA 93401-7590  
805-541-0200

**Harris Corp., Broadcast Div. 1305**  
Intro: DX-50 50 kW digitally-modulated solid-state AM transmitter.  
Also: HT Series of FM transmitters; THE-1 55 watt solid-state FM exciter; SX A Series of solid-state AM transmitters; AM phasor; DAT recorder/playback; FM antenna models; Gold Medalist 12-channel audio console; Sentinel remote control system.  
Contact: Martha B. Rapp  
3200 Wisnann Lane, PO Box 4290  
Quincy IL 62305-4290  
217-222-8200

**Harrison Systems, Inc. 1116**  
Intro: New AP-100 broadcast console; Macintosh II-based hard disk automation system for Series Ten totally automated console.

**Hipotronics, Inc. Power Products Division 3379/3380**  
On Display: Peschel automatic voltage regulator; Peschel variable transformer; optional features include: individual phase control, bypass switch and transient suppression.  
Contact: Peter Rubicam  
Routes 22 & 199 PO Drawer W  
Millerton NY 12546  
518-789-6464

## All Over The World, You Can Count On CSI Transmitters

Dependable • Efficient • Cost Effective

More than 1,000 CSI AM and FM transmitters are spread throughout the world, featuring innovative design features for today's broadcaster.

The CSI transmitter design is straightforward, using time proven stable circuits and mechanical design features, assuring many years of superb performance.

CSI transmitters are designed for the broadcaster who values reliability. Standardization and part interchangeability result in low maintenance cost. CSI's simplicity of design provides reliability and ease of operation.

You can count on CSI transmitters for many exceptional features.

Greatest Value



In the World



CSIELECTRONICS, INC.  
360 Bohannon Rd. • Post Office Box 426 • Fairburn, GA 30213  
Sales: (404) 964-3530 • Parts/Service: (404) 964-3764 • Fax: (404) 964-2222

(A division of CCA Electronics, Inc.)



New England Digital's Direct-to-Disk PostPro™

**Holaday Industries, Inc. 2028**

Intro: The ELF sensor for the HI 3600 series of non-ionizing radiation detectors.

Also: Complete RF radiation exposure measurement system; full line of isotropic broadband field strength meters.

**Howe Technologies Corp. 1465**

Intro: ATC-35 Phase Chaser audio timebase corrector; series 10K stereo audio broadcast and production console.

Also: 2300A Phase Chaser audio timebase corrector; series 9000 stereo audio broadcast console.

**i**

**ICA/Miralite Communications 7530**

On Display: Earth stations for corporate, educational and VSAT data networks; C- and Ku-band antennas; international satellite communications—from consultation to installation.

**IGM Communications 1141**

Intro: Enhanced software for PC based control systems.

Also: IGM-SC program automation control system; IGM-EC program automation controller; InstaCart; GoCart 24.

**ITC/3M 3405**

Intro: Summing Module addition to the ITC audio routing switcher.

Also: 99B, Delta and Omega Series cart machines; ESL V eraser/splice locator; DCM-1 dynamic cart monitor; ScotchCart II broadcast cartridge; audio routing switcher; control panels.

Contact: Jim Woodworth  
2425 S Main Street  
Bloomington IL 61704  
800-477-0414

**Inovonics 1473**

Intro: Model 706 2nd generation FMX stereo generator w/digital synthesis and remote control; Model 397 film reproduce electronics.

Also: Audio recording signal processing and instrumentation; manual and computer-controlled processors for AM/FM/TV; FM-FMX stereo generator; tape and mag-film record and reproduce electronics.

Contact: Jim Wood  
1305 Fair Ave  
Santa Cruz CA 95060  
408-458-0552

**International Music Co./ Akai 7440/7541**

Intro: DR1200 digital tape recorder; S1000 HD stereo digital sampler; S1000PB playback only version of S1000; S950 12 bit sampler.

Also: Akai digital matrix patchbay system; DP3200 audio patchbay; DP2000 video/audio patchbay; PG1000 programmer; MZ1000 monitor; MG1214 14 track recorder/12 channel mixer; MG14D 14 track recorder; MPX820 programmable mixer; GX912 3 head stereo cassette deck; MPC60 MIDI production center; ASQ10 MIDI sequencer.

**j**

**JBL Professional 3577**

Intro: JBL/UREI Models 6210 and 6211 compact power amplifiers for "on-speaker" applications.

Also: Control 5 and Control 10 monitors for production, EFP; 4400-Series studio monitors; Bi-Radial studio monitors; power amplifiers; one-third octave equalizers.

Contact: Mark Gander  
8500 Balboa Blvd.  
Northridge CA 91329  
818-893-8411

**Jefferson Pilot Data Services 1241**

On Display: Bias on-line and JDS in-station computer systems for sales/traffic/billing, general accounting, music rotation, program management for radio stations.

**JH Bergman 2248**

Intro: EBS receiver FCC type approved for station use rack mount crystal controlled.

Also: EBS receivers for all warning systems used by stations for tornado warning networks.

**k**

**Kalamusic N/A**

Intro: "Lite Jaz" a new, unique program format for full or part-time presentation.

Also: Ten program formats for full or part-time radio station presentation on reel-to-reel, R-DAT or cassette.

**Kline Towers 5446/5447**

On Display: Designs for guyed, self-supporting, platform and multi-array towers; space frame and special type antenna structures for the military and broadcasting industry; tower engineering, inspection and maintenance services.

**l**

**Lake Systems Corp. 0819**

On Display: Interformat betacam to edit suite; digital Mix-to-Pix featuring Waveframe; operational, interformat Betacam to D-2 digital edit suite; Waveframe Audioframe digital audio workstation; ergonomically designed custom consoles; portable video teleconferencing system.

**LDL Communication/LARCAN 3652**

On Display: FM panel antenna w/Spearhead dipoles; Alan Dick and Company Ltd. FM combiner w/3 station capability; L & R Communications towers.

**Leader Instruments Corp. 5371/5374**

Intro: Model 5872 version of Model 5870; Model 430 video sweep generator; Model 408 video test signal generator; Model 1602 RCB multiscan video generator.

Also: Video test instrumentation including: waveform monitors; vectorscopes; test signal generators; general purpose electronic test instruments: oscilloscopes; signal generators; function generators; meters and bridges; bench top power supplies.

**Lectrosonics, Inc. 5370**

Intro: Model Pro4-Mini VHF high band 4 channel wireless mic field pack; Model T185 hand-held wireless mic.

Also: Model CR185 ultra-compact VHF high band receiver; Model H185 plug-on transmitter; Model Pro 4 channel wireless mic system.

**Lightning Eliminators & Consultants, Inc. 3919**

Intro: Surge/transient preventors for incoming power lines.

Also: Dissipation Array™ lightning prevention systems; Chem-Rod® grounding electrode; lightning and tornado warning; consulting and engineering design service.

**LPB, Inc. 1541**

Intro: Citation II audio consoles; Monogram II audio consoles.

Also: Signature II series audio consoles; low power AM transmitters; carrier current transmitting equipment; travelers information system equipment.

**m**

**Magnum Towers, Inc. 1501/1503**

On Display: Radio, television and microwave towers.

**Manhattan Production Music 3064**

Intro: CD-13 Passing Time (light fusion funk); CD-14 Sea Breeze, Too (mellow acoustic ballads); CD-15 A Newer Age (new age music); CD-16 Holiday, Christmas and Patriotic Themes; CD-17 Network News Themes; CD-18 Ambience Sound Effects and Station ID Logos; CD-19 and 20 High Energy Rock and Roll.

Also: Complete CD music library.

**MARTI**

**Marti Electronics 1204**

Intro: Audio companding system for Marti RPU equipment; DR-10 low cost RPU receiver w/optional internal companding capability.

Also: Model STL-10 stereo aural STL system; Model TSL-10 multichannel data links; TSL-15 and 30 narrow band data links; Model SCG-10/SCD-10 subcarrier systems; Model RPT-2, RPT-15 and RPT-30 remote pickup systems.

**McCurdy Radio Industries 1755**

Intro: CS9500 digital intercom system.

Also: Integrated digital intercom systems and accessories; audio mixing consoles; audio test sets; audio distribution amplifier systems; digital audio delay systems, TV and radio multi-bus on-air automation systems; other auxiliary products.

**Media Computing, Inc. 5386/5387**

Intro: TECKIE (Technical Equipment Computer Keyboard Interface Emulation) broadcast equipment automation control by personal computer.

Also: ANGIS (Automatic News Graphics Interface System) personal computer interface with character generators; TEN (The Electronic Newsroom) broadcast newsroom software for personal computers.

**Media Touch Systems 2105**

On Display: Touch Screen Broadcast Control Systems: OpLOG air control/automation system; OmniPlay CD and DAT systems; OmniPlay automation engine; DAMS digital mass audio storage; all systems support all audio source equipment.

**Micro Communications, Inc. 1547**

On Display: FM panel antennas: reduces downward radiation, multi-station capability custom patterns; coax switches: local/remote switching of two transmitters between antenna and load; FM switching combiners: local/remote control combines two transmitters to a single output or allows either transmitter to feed antenna while the other goes to a test load; FM multiplexers: combines 2 FM channels, all power levels, close channel spacing, high isolation, low loss; directional couplers: radiation studies: on-site measurement of radiation levels.

Contact: Jennie E. Allen  
Grenier Field, 438 Kelley Ave., P.O. Box 4365  
Manchester NH 03108  
603-624-4351

**Microdyne Corp. 5119/5120**

Intro: BRK receiver with MAT II.  
Also: MAT II automatic programmable satellite delivery system.

**Modulation Sciences, Inc. 5765/5766**

On Display: SCA Series: FM Sidekick and Data Sidekick SCA generating systems; Composite Series: CLD distribution system; CP 803 composite processor; StereoMaxx spatial image enlarger; FM ModMinder FM audio modulation status panel.

Contact: Eric Small  
115 Myrtle Avenue  
Brooklyn NY 11201  
718-625-7333



**Motorola/AM Stereo 1014/1022**

Intro: Model 1400 C-QUAM AM stereo exciter; Model 1410 C-QUAM modulation monitor.

Also: C-QUAM AM stereo excitors, modulation monitors, receivers and decoder ICs; two-way, paging and cellular products; antennas.

**n**



**Nautel 1065**

Intro: New model AMPFET ND 5 5 kW AM broadcast transmitter.

Also: AMPFET Series solid state AM broadcast transmitters 400 to 100,000W.

**Network Music, Inc. 1624**

Intro: Jingle Relyric Library of jingles on CD; Show Music Library features a variety of shows for use in multi-media presentations.

Also: Full service music production including custom music production and several libraries.

**New England Digital 2307**

Intro: Enhanced PostPro direct-to-disk multitrack recorder/editor; MaxTrax software; high speed editing features for remote controller/editor/locator interface.

**NPR Satellite Services 7622**

On Display: Domestic and international interconnection services including: fixed and transportable uplinking; SCPC audio transmission; downlinking; digital fiber optic audio channels; service to Westar IV, Galaxy II, Satcom IR.

**Numark Electronics 7043**

Intro: DM 1912 DJ mixer w/source assignable EQ and auto-muting talkover; DM 1975 preamp-mixer w/45 second digital sampler w/4 memory banks.

Also: VAM 2000 video audio mixer.

**Nurad, Inc. 5538**

Intro: Model 20PT2 portable transmitter; advanced filter system for central ENG receive systems.

Also: 3-Series hot-standby STL system; 4-Series 23 GHz system; 3-Series multihop ICR system; SuperQuad II central ENG receive system; portable transmitters & receivers w/Microrod and ORI-Series compact antennas; Silhouette ENG transmit systems; Super Pod helicopter ENG system.



# Unveiling the Future

No matter how much, or how little, you plan to spend on your next radio console, you owe yourself a visit to our booth at this year's NAB. We'll show you something very special - an all new console which is compact, powerful, versatile and yet very easy to use.

While others have been playing follow the leader with look-a-likes of our industry standard BMX Series, we've been busy designing consoles which stretch our appeal even further.

This is Radiomixer™ and, as with all of our consoles, it's designed to work under the most demanding conditions. Radiomixer is equipped with the extensive features and performance you expect from a Pacific console, plus a comprehensive Off-Line Mix Matrix which is sure to be the *talk* of the show.

To celebrate, we're offering you a special package, available only at NAB. To take advantage of this valuable one-time opportunity, please be prepared to place your order at booth 1325 before the end of the show.

You won't need a crystal ball to see the secrets awaiting you. Simply clip the coupon, and we'll send you more information. But be quick - we predict a rapid disappearing act.

**I know an opportunity when I hear it knocking. Please:**

- Send me a description
- Have a salesperson call

NAME \_\_\_\_\_

STATION \_\_\_\_\_

ADDRESS \_\_\_\_\_

PHONE \_\_\_\_\_

RW

**Return this coupon to:**  
 Pacific Recorders &  
 Engineering Corporation  
 2070 Las Palmas Drive  
 Carlsbad, CA 92009  
 (619) 438-3911



**PACIFIC RECORDERS  
 & ENGINEERING CORPORATION**  
 The number one *choice* for  
 more #1 stations

**O**

**Omicron 2515/2517**  
Intro: Model 416N NTSC sync generator; Model 416P PAL sync generator; Model 546 video/audio IGA switcher; Model 451N NTSC encoder; Model 451P PAL encoder; Omni-Gen Amiga computer genlock/keyer; 701 NTSC; 702 PAL.  
Contact: Kimi Akiyama  
21822 Lassen St. #L  
Chatsworth CA 91311  
818-700-0742

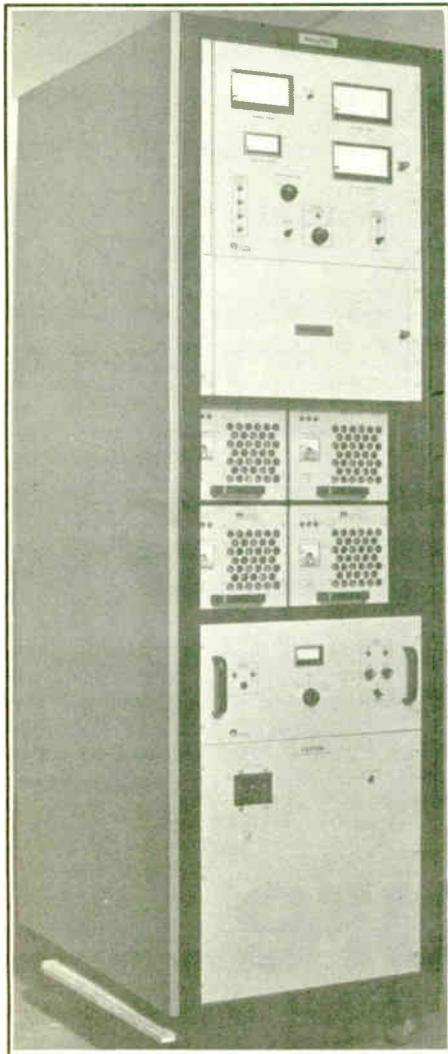

The ND5 5 kW AMPFET transmitter from Nautel.

**Omnimusic 1527**  
On Display: Professional Broadcast Series collection of 60, 30 and 10 second background music edits on CD includes: bumpers, logos, stingers and cues plus music styles specifically conceived for the broadcast market.

**orban**

**Orban Assoc., Inc. 1630**  
Intro: 9105A Optimod-HF audio processing system; 764B programmable parametric equalizer/notch filter.  
Also: Products for: FM broadcast audio processing; AM broadcast audio processing; television stereo; studio audio processing.  
Contact: Dave Roudebush  
645 Bryant Street  
San Francisco CA 94107  
415-957-1067 FAX: 415-957-1070

**p**



**Pacific Recorders and Engineering Corp. 1325**  
Intro: Radiomixer air console; STX stereo television console.  
Also: Systems: major system capability w/cabinetry, logic interfacing, audio wiring and overall system design and integration; air consoles: BMX Series II and Series III; rack mount consoles: Stereomixer and News-mixer; production consoles: AMX and ABX 8-track boards; cart machines: Tomcat; Max-trax; Micromax; peripheral equipment: Dolby SR for cart and open reel; DA; switchers; phono preamp; jack panels.  
Contact: Anders Madsen  
2070 Las Palmas Drive  
Carlsbad CA 92009  
619-438-3911

**Patch Bay Designation Company 5344**  
On Display: Patch Prints-custom labeling for all brands of audio and video patch bays, control panels, racks, mixing boards, rear-illuminated button switches and all other field designation areas.

**Penny and Giles, Inc. 4312**  
On Display: Professional studio faders, rotary faders, joystick controllers, motorized faders, T-bar controllers, Mosses and Mitchell's jackfields and patchbays.

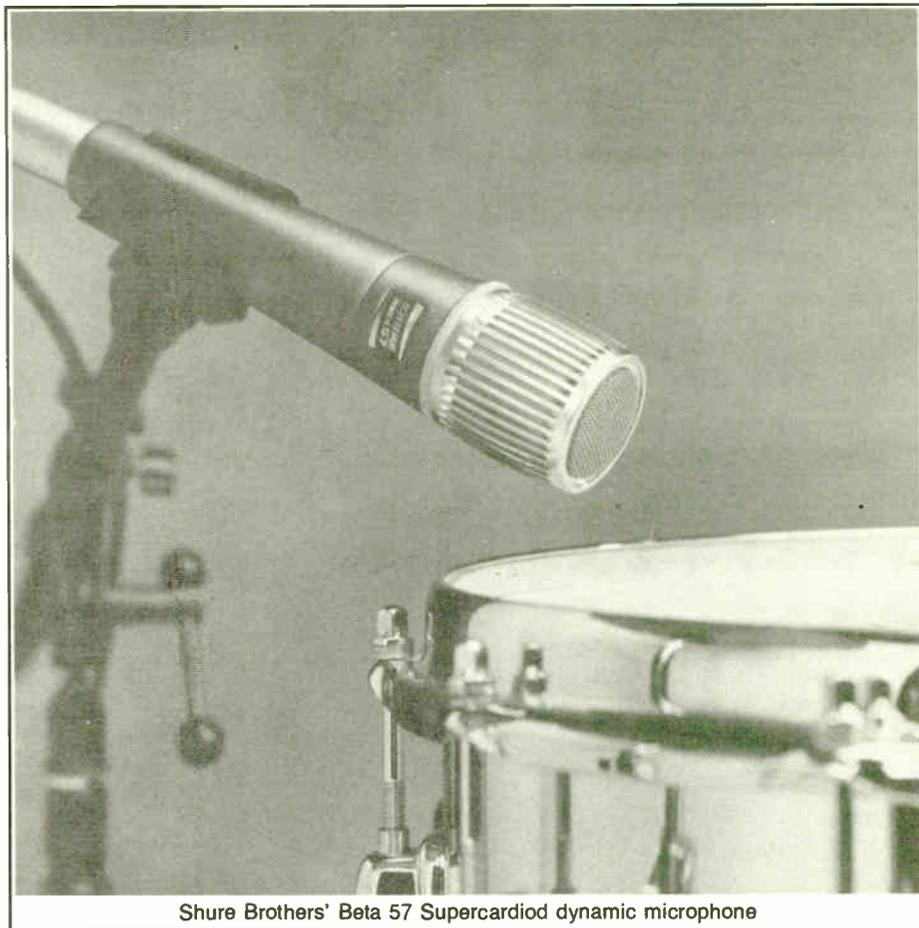

Shure Brothers' Beta 57 Supercardioid dynamic microphone

**Pro Battery, Inc. 3432**  
On Display: Batteries-primary, alkalines, carbon zinc; nicad re-chargeables; lead acids; chargers.

**q**



**QEI Corp. 1147**  
Intro: Digital stereo link; FMQ 15/20/25 kW transmitter.  
Also: FMQ Series FM transmitters; 150 W, 300 W and 500 W FM broadcast transmitters; Model 691 tunable stereo modulation monitor and FM test set; Model 695 FM broadcast exciter.  
Contact: Bill Hoelzel  
PO Box D, One Airport Drive  
Williamstown NJ 08094  
609-728-2020

**r**

**RADIO SYSTEMS**

**Radio Systems 2037**  
Intro: RsDAT broadcast DAT systems; Rs-1000 DAT machine; RsDAT controller/sequencer.  
Also: RS Series consoles; DA-8 and DA-16 distribution amplifiers; PA-1 phono preamp; TM timers and clocks; studio furniture; installation systems.  
Contact: Dan Braverman  
5113 West Chester Pike  
Edgemont PA 19028  
215-356-4700

**Reach Electronics, Inc. 5751/5752**  
On Display: Radio paging equipment including VHF and UHF tone and voice, SCA tone and voice, SCA tone only pagers; dial paging terminals; computerized add-on equipment; manual paging encoders; Interlink phone patch; mobile encoders and decoders.

**Rees Associates, Inc. 3483/3484**  
On Display: Architectural planning and design of broadcast and production facilities; master planning; architecture; equipment planning; interior design; scheduling; budgeting; landscape architecture; construction management.

**Register Data Systems 2337**  
Intro: RDS Traffic Master I includes sales, traffic, logging, billing, accounts receivable and management reporting specifically for smaller stations.  
Also: RDS Broadcast Business System micro-computer business system includes interfaced sales, traffic, logging, billing, co-op, accounts payable and receivable, payroll and general ledger; other options available.

**Research Technology Intl. 1706**  
Intro: V Series professional videotape degaussers for metal and regular oxide tapes; conveyor and manual feed models for all formats.  
Also: TapeCheck videotape evaluators and cleaners help identify defective videotapes before they are used or shown; cleans loose dirt, dust, oxide; polishes tapes for better S/N ratio; models available for U-matic, VHS, S-VHS, Beta, 1" reel-to-reel, pancakes.  
Contact: Tom Tisch  
4700 West Chase  
Lincolnwood IL 60646  
312-677-3000/1-800-323-7520

**INTELLIGENT TRANSMITTER OPERATION**

**HALLIKAINEN & FRIENDS**

**I**NTELLIGENT DIGITAL REMOTE CONTROL. The ITO177 from Hallikainen & Friends, allows fully automatic operation of a Moseley TRC-15 remote control equipped with a TEL171 Digital Telemetry Adaptor. The ITO177 plugs into the memory expansion port of a Commodore-64 personal computer and to the TEL171 data port. Automated transmitter site control of the TRC-15 and access to the meter reading displayed on the TEL 171 is by BASIC statements and functions built in to the ITO 177. An "auto-boot" feature allows the control program to re-load and run in the event of a power failure. 2K of nonvolatile memory saves information from power loss. Make the intelligent choice today based on time tested tradition.

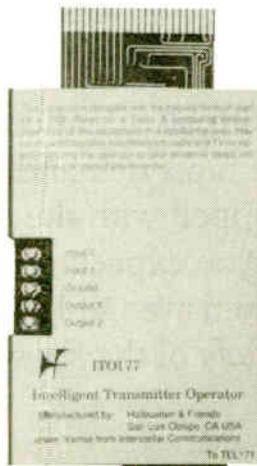

PROGRAMMABLE INTELLIGENT AFFORDABLE ITO177

**HALLIKAINEN & FRIENDS** 141 SUBURBAN E4 805 / 541-0200  
SAN LUIS OBISPO, CA 93401-7590 USA

**RF Technology, Inc. 5451/5453**  
Intro: RF-223B miniature portable full power transmitter for ENG trucks, news cars and helicopters; Pathfinder offset fed antenna system; FOM-13L fiber optic link; Gold Line Series of miniature portable microwave radios.  
Contact: Christina Kallay  
16 Testa Place  
So. Norwalk CT 06854-4613  
203-866-4283

**Richardson Electronics, Ltd. 3852**  
Intro: Philips tube cavities for FM and TV use.  
Also: Eimac, Ampere, Burle and Philips power tubes for transmitters, AM, FM, UHF, VHF and SW; Jenning vacuum capacitors; complete line of RF transistors.  
Contact: Larry Broome  
40W267 Keslinger Road  
LaFox IL 60147  
312-232-6400

**Rohn 4013/4014**  
On Display: Guyed and self-supporting towers; tower lighting equipment; antenna mounts; tower climbing safety equipment; guy insulators; tower hardware and accessories; fiberglass equipment shelters; concrete equipment shelters; tower installation services.

**RTS Systems, Inc. 4151**  
Intro: MCE325 programmable user station; 2528 dual channel remote control mic preamp; CCD214 crosstalk cancellation device; ATC222 automatic telephone coupler.  
Also: 848A programmable matrix intercom station; 802 programmable intercom master station; 927 programmable reference tone generator; TW intercom system; Series 17 intercom system; Series 800 intercommunications; Series 4000 IFB system; Series 2500 amplifier system; Series 400 modular amps; headsets.  
Contact: Kim Murphy  
1100 West Chestnut Street  
Burbank CA 91506  
818-566-6700

**S**

**Saki Magnetics 1673**  
Intro: Long life ferrite replacement heads for ITC model Delta stereo cart.  
Also: Standard line of long life replacement heads for recorders manufactured by Ampex, MCI, Minicom, Otari, Revox, Scully and Studer.

**Samson Technologies Corp. 2308/2310**  
Intro: Infinity system ENG receiver the size of most transmitters available with belt pack or hand held transmitters.  
Also: Broadcast STD synthesized wireless systems; Concert TD; Stage 2 and 22 wireless systems; all transmitters offer brand name microphone cartridges and lavaliers.

**Schafer World Communications Corp. 1347**  
Intro: CD and random access digital automation systems integrated to the full "Schafer" line of program automation products and as stand alone units.  
Also: "Ready-Spot" random access cartridge playback; 8000 and 2000 Series audio consoles; third generation of 7000 and 7000GLS program automation systems.

**Scientific-Atlanta, Inc. 3423**  
Intro: Series E9700 mobile B-MAC encoder provides simultaneous transmission of hard-scrambled video and digitally encrypted audio, data and teletext.  
Also: Model 7350 modulator/demodulator; Model 7450 audio/data receiver; Model AD7550 satellite SCPC receiver; Model 7560 SCPC receiver; DAT 2000 digital audio system; Model 4580 T1 demodulator; complete video uplink system; Model 7670 earth station controller.

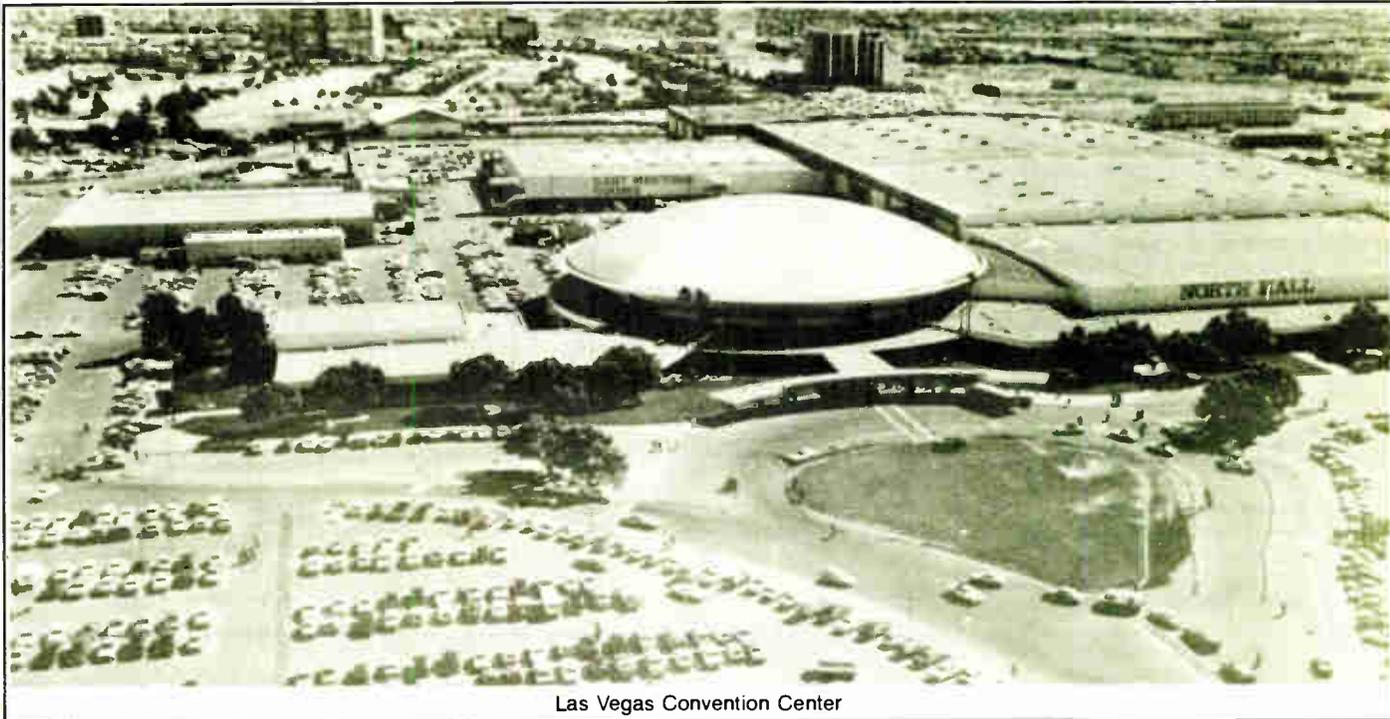

Las Vegas Convention Center

**Seck 3577**  
On Display: Complete line of compact mixing consoles for production and remote mixing; AC/DC operation of some models; high input density; multitrack production consoles offer in-line monitoring, 5 auxiliary sends, 3 band mid sweep EQ and control room & talkback facilities.

**Selco/Sifam 1657**  
On Display: Control knobs and accessories; VU and PPM meters; audio level indicators; snap action disc thermostats and fiber optics components.

**Sescom, Inc. 3413/3415**  
On Display: Introducing 15 new products including a new product line: "Rack System Electronics," which is designed for applications such as main broadcast and recording.

**Shively Labs 1341**  
Intro: Information on pattern work, particularly for the new Class A FCC directional requirements; 9" rigid coaxial transmission lines; new cylindrical radome.  
Also: Side mount and panel FM broadcast antennas; related equipment such as branched and balanced multistation combiners, transmission line, pressurization equipment, patch panels and filters.

**SHURE®**

**Shure Brothers, Inc. 1517**  
Intro: Beta series supercardioid dynamic microphones for vocal and instrumental use; Model numbers include Beta 57, Beta 58M and Beta 58C.  
Also: SM99 Gooseneck Miniature microphone; full line of SM Series professional microphones; full line of portable mixers and amplifiers for ENG/EFP applications; AMS automatic microphone system; wireless microphone systems; BC series broadcast phone cartridges.  
Contact: Jack Kontney  
222 Hartrey Avenue  
Evanston IL 60202-3696  
312-866-2553

**Solutec Ltd. (H.A.) 5748**  
Intro: SOL-333 audio stereo DA; SOL-T trafficable software.  
Also: SOL-6800 automated broadcasting system for commercial inserts; SOL AD.ID. generator for spot identification for commercial inserts; SOL-20/20 audio level meter color keyed in video.

**Sono-Mag Corp. 1105/1107**  
On Display: Automated music programming equipment; satellite music programming systems; live assist CD music programming controls.

**Sound Ideas 3826**  
Intro: Series 3000—a new collection of over 200 ambience sounds, in stereo, on CD, digitally recorded.  
Also: Sound Effects Libraries; over 5200 stereo sounds on 62 CDs; Sampler Library: full range of over 3300 instrumental samples and sound effects on 6 CDs; Production Music Library: new collection of original music themes.

**Sound Technology, Inc. N/A**  
Intro: 3200B programmable transmission/audio analyzer Option 12 wow and flutter test.  
Also: 1500A tape recorder test system; 1510A professional audio test system; 1530A MTS stereo analyzer/monitor; 1710A professional distortion measurement system; 3100B programmable audio generator; 3200B programmable transmission/audio analyzer.

**Soundcraft 3577**  
Intro: Model 3200, a new recording and production console.  
Also: Model SAC 200 and 2000 broadcast and production consoles; 200B/VE consoles for video editing; 6000 and TS-12 post production consoles; 8000 large production console; SMPTE and MIDI based computer automation products.

**Soundmaster USA, Inc. 7340/7341/7343**  
On Display: Integrated audio editing system incorporating Syncro programmable synchronizers; features include Smart Sync mode of operation which enables the user to vari-speed a machine while maintaining a constant offset, variable speed lock, programmable closures, software designation, many other features.

**Stainless, Inc. N/A**  
Intro: Tower maintenance including antenna/transmission line analysis, emergency service, antenna reharnessing.

**Stainless Corp. 5238**  
Intro: New heavy duty mobile systems employing state-of-the-art design.

**From The ALLIED Technical Notebook**

The Denon Cart Player® is the most popular machine in all of radio. Many ingenious methods have evolved to interface it with consoles of all types. Henry put them all in one box.

1. The Denon CD player uses 5 volt logic. Many consoles use 12 volts. Connecting the CD player directly to the console could cause lots of damage. LogiConverter solves this problem by isolating the console logic voltage from that of the Denon CD player. "LogiConverter provides double isolation. Opto-isolators on the inputs, and relays on the outputs."
2. Connecting the remote-control circuits of the Denon directly to the console will probably cause a ground loop, because the audio and control grounds will tie together in the console. LogiConverter prevents this from happening, to preserve S/N performance. "LogiConverter eliminates ground loops."
3. Many consoles use logic outputs for remote control. In many cases, a circuit goes "HI" (+ 12 v) for START. The Denon CD requires a logic LO. LogiConverter eliminates this problem.
4. Some consoles provide only a maintained closure for remote Start. The Denon CD needs a momentary. LogiConverter solves this problem, because it can convert maintained inputs to momentary outputs.



5. Many installations will require both Start and Stop from the console. Most consoles provide start-only outputs. LogiConverter will add the STOP function even if the console doesn't have it. "LogiConverter can be user programmed to add a STOP function even if the console has Start-only outputs."
6. Up to four CD players can be controlled by one LogiConverter, if Start-only operation is desired. (CD stops at end of track automatically.) If Start and Stop is desired, then two CD players can be controlled by one LogiConverter.

RICHMOND  
CHICAGO

LA

**ALLIED**  
Broadcast Equipment  
— A HARRIS COMPANY

DALLAS  
ATLANTA

1-800-622-0022

**Standard Communications 2545/2547**

Intro: CFR-800 multipurpose rack and power supply; CST810-SCS/FM2 dual demodulator; PLL agile stereo demodulator.

Also: Satellite audio reception equipment.

**Stanton Magnetics, Inc. 1649**

Intro: 890AL cartridge; DP89AL stylus; 680EL-MP; 500AL-MP.

Also: Turntable cartridges; replacement styli; stereo headphones; turntable mats; turntable preamp/EQ; announcer earphones; record care products.

**Stantron 1712/1714/1716**

On Display: Equipment racks; modular consoles for editing and production; all accessories.



Broadcast Audio Series IV Console

**STUDER REVOX**

**Studer Revox America, Inc. 1261**

Intro: Studer A827-24 multichannel recorder; Studer A764 professional FM monitor tuner; Revox C270 Series low-speed logging recorders; Revox C270-TC two-channel recorder.

Also: Studer D820X DASH digital audio recorder; Studer A820-24 recorder; Studer A812 recorder; Studer A810 recorder; Studer A807 VUK recorder; Studer A807 2/2 recorder; Studer A730 CD player; Studer SC 4008 synchronizer controller; Studer TLS-4000 synchronizer; Studer A727 CD player; Studer A721 cassette recorder; Studer 961/962 mixing consoles; Studer 963 console; Studer 900 console; Revox C270 recorder; Revox C274 4-channel recorder; Revox C278 8-channel recorder; Revox PR99.

Contact: Charles Conte  
1425 Elm Hill Pike  
Nashville TN 37210  
615-254-5651

**Systemation 1032**

Intro: A complete satellite automation; Sony EVS800U 8mm digital cassette deck incorporating R-DAT type technology.

Also: Satellite cassette automation; complete digital cassette automation; live assist digital cassette automation with Touch Screen; The Informer one-call information center for your listeners; PC Playlist; The Sales Force complete sales tracking/traffic/invoice system.

Contact: Maureen Bellinger  
337 North Water  
Decatur IL 62523  
217-428-7101

**TASCAM**

**Tascam 5577**

Intro: CD 701 production/on air CD system; CD 401 prod/on air CD player; 3030 1/2 track 1/4" 2 track recorder/reproducer; TSR 8 8 track 1/2" multitrack recorder/reproducer; M700 mixing console; 102, 103 stereo cassette deck.

Also: 22-2, 32, 42, ATR 60/2N 1/2 track 1/4" 2 track recorder/reproducer; MSR 16, MS 16, ATR 60/16 16 track recorders; 38, 238, 388 4B, ATR 60/8 8 track recorders; 200, 300, 500, 600 Series mixing consoles; 112, 112R, 122MK II stereo cassette decks; DA 50 RDAT, ATR 60 24 and 32 track recorders; DA 800 DASH.

Contact: Bill Mohrhoff  
7733 Telegraph Road  
Montebello CA 90640  
213-726-0303



**Television Technology Corp. 3500**

Intro: FM 3.5 KWSS 3.5 kW FM solid-state transmitter; XL10MFM 10 watt modulated FM translator for satellite feed.

**Telex Communications, Inc. 3541**

Intro: FMR25 wireless mic systems including backpack transmitter w/attached lapel mic.

**Telos Systems 2301**

Intro: Several new members of the Telos 100 family of products; applications for telecommunications and teleconferencing.

**Tentel Corp. 5223/5224**

On Display: Tentelometer tape tension gauges: T2-H20-ML for 1/4" to 2" tape; T2-H7-AC for all audio carts; T2-H12-2 for all PCM-3324 recorders.



**TFT, Inc. 2115**

Intro: Model 8888 frequency agile RPU system, 6-25 watts w/DTMF control; Model 886 and 887 "intelligent" EBS systems; unique FM booster systems.

Also: 844A and 884 FM modulation monitors; variety of aural STL systems, composite and discrete; AM modulation monitor; remote control systems.

Contact: Jesse Maxenchs  
3090 Oakmead Village Drive  
Santa Clara CA 95051  
408-727-7272

**Thomas J. Valentino, Inc. 1627/1629**

On Display: Production music and sound effects on CD digitally produced in stereo.

**Toby Arnold and Associates 1570**

Intro: "We Are Country" 20 cut country jingle package; "Today's Country" contemporary jingle package.

**Torpey Controls and Engineering Ltd. 5102**

On Display: Master clock systems; timers, both local and remotely controlled; central timer systems; central thermometer systems; slave clocks, both analog and digital.

Contact: R. Torpey  
98-2220 Midland Ave.  
Scarborough, Ontario  
Canada M1P 3E6  
416-298-7788

**Trimm, Inc. 7636**

On Display: Broadcast and telecommunications equipment including audio and video jacks, plugs, patch cords, patch panels, terminal blocks and fuse panels.

**Studio Technologies, Inc. 3828**

On Display: AN-2 stereo simulator; RCU-1 recognition control unit; ISS integrated simulator system.

**Symetrix**

**Symetrix 2304/2306**

Intro: 111 Active Hybrid single line telephone interface; DPR 100 digital processing recorder.

Also: Series 500 product line including signal processors, noise reduction units, gates, expanders and headphone amps; Series 200 product line with headphone amps, parametric EQ and signal line telephone interfaces; telephone interfaces for single and multiple lines.



**Tannoy North America Ltd. 7533**

Intro: The Playback Monitor Series PBM6.5 and PBM-8 discrete loudspeakers; the AVM audio video monitor shielded 6' two-way design utilizing new DMT metal dome.

Also: SGM10-B and LGM reference monitors for studio or broadcast applications.

Contact: Bill Calma  
300 Gage Avenue Unit #1  
Kitchener, Ontario  
Canada N2M 2C8  
519-745-1158/FAX 519-745-2364

**The mike for ENG that doesn't need TLC.**

**The Beyer M 58.** When it comes to durable news-mikes, the M 58 is getting great press. Its heavy-duty construction stands up to the most abusive treatment. And its special shock-mount system prevents vibration and handling noise as well as damage to the transducer. Best of all, it has the clarity and accuracy that has made Beyer the new choice among broadcasters throughout the world.

If your news team still hasn't switched to the M 58, see your local Beyer dealer for a demonstration. ASAP.

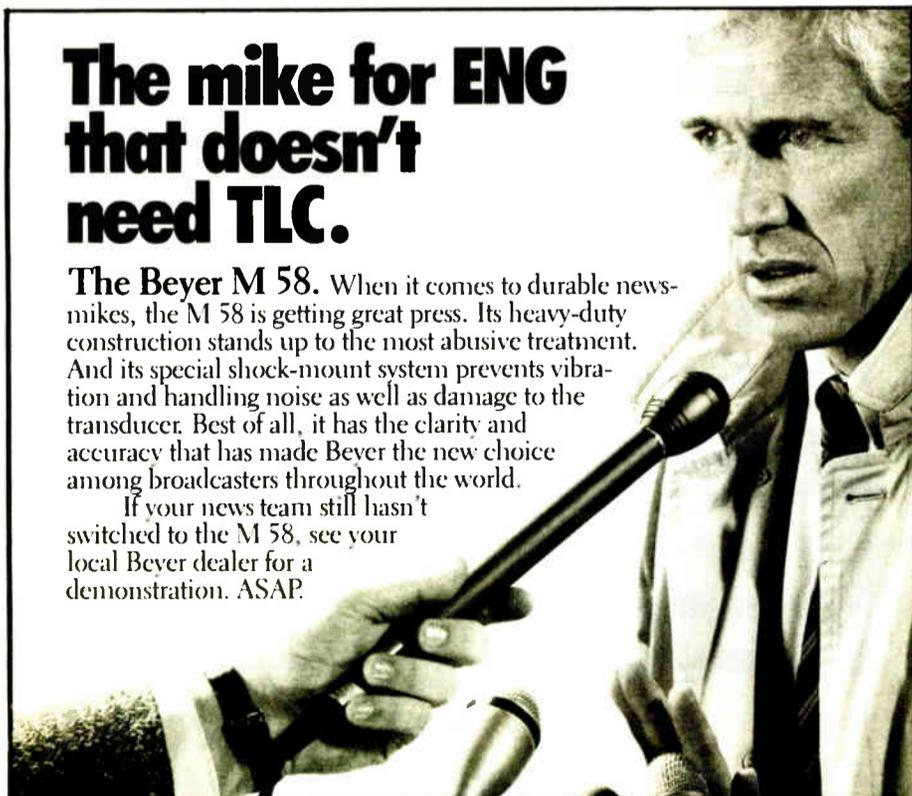

**BroadcastGroup beyerdynamic**

Beyerdynamic 5-05 Burns Avenue, Hicksville, NY 11801 Tel. (516) 935-8000. Fax (516) 935-8018

**TELEX FMR25**

Economy wireless microphone systems

*Imagine, Telex quality at off shore prices!*



**NEW**

**Features include:**

- \* 1000 typical open field range.
- \* Diversity systems available.
- \* Transmitters use 9V alkaline or 8.4V Nicad Rechargeable.
- \* 6 to 8 hour operation with 9V alkaline.
- \* 90db signal to noise ratio.

Complete Systems start at just \$500.00

Professional Audio Supply

5700 E. Loop 820 South

Fort Worth, Texas 76119

Tel. (817) 483-7474  
(800) 433-7668

Fax. (817) 483-9952



**(800-433-7668)**



**TWR Lighting 5115**

On Display: Aviation obstruction lighting, medium intensity strobes, red incandescent lighting (beacons, sidelights), controllers (alarmed and non-alarmed), junction boxes and lighting kits

Contact: Sandra M. Prewitt  
1630 Elmview  
Houston TX 77080

**U****United Ropeworks U.S.A., Inc. 1722**

On Display: Phillystran HPTG, electrically transparent, maintenance free tower guys and specially designed systems for high power applications.

**UREI 3577**

On Display: Model 7110 limiter/compressor w/Smart Slope; on air broadcast consoles in 5, 8 and 12 input models; Time-Align co-axial studio monitors, including the compact 809; equalizers; limiter/compressors; specialty signal processors; the LA-4.

**US Tape and Label Corp. 1533/1535**

On Display: Specialty printing company providing the broadcasting industry with printing and marketing information regarding the use of bumper stickers.

**Utility Tower Company 1447**

On Display: Tower sections—UTC type 920SR: 84" face width capable of 1500 ft.; UTC type 720SR: 60" face width capable of 1200 ft.

**V****Valley International, Inc. 2030/2032**

On Display: DDP digital dynamics processor multi-band, multi-function audio signal processor w/new software for special on-air FM broadcast applications and formats; complementary analog interface featuring: 16-bit A/D and D/A; Apogee 944G lowpass filters; generic digital interface format; compact rack mount package w/XLR connectors for analog input and output; DCE digital compressor expander stereo audio signal processing device; optional analog interface available.

**Valmont Industries, Inc. 3371**

On Display: Free standing and guyed towers for antenna support; tapered tubular poles for AM broadcast.

**VEAM; Div. of Litton Systems, Inc. 3611**

Intro: VSC Series 19-pin heavy duty connector; FOMS 52 channel capacity fiber optic mic snake; CIS Series heavy duty connector.

Also: CIR Series multi-pin cylindrical connectors.

**Vetronix, Inc. 5751/5752**

Intro: New, low profile pushbutton switch w/most of the same features of std. Vetronix switches, but designed w/interlocking grooves to facilitate ease in assembly of keyboards.

Also: Pushbutton magnetically actuated reed switches for keyboard and panel mounting, available in A, B, AA, BB or AB forms; supplied w/either illuminated or non-illuminated caps in different colors; avail. plain, legendable or relegendable; switch caps in either one-space or double-space.

**Video Design Pro 7317**

Intro: Personal engineering design station for PC 386; personal engineering design station for Mac II; master DOC software for system documentation.

Also: Audio, studio and control room engineering design tools for AutoCAD Models VAD CAD, AUD CAD, TC+CAD, Cable Doc, Path Router, AutoCAD.

**Viking Cases 5326**

On Display: Shipping and carrying cases for broadcast equipment.

**Vortex Communications, Inc. 1521**

Intro: Eurogold range of modular broadcast equipment; GC range of routing switchers; CY-400 test signal generator; HETL-2 edit timecode indicator; Vortex World Famous Cookbook.

**W****Weather Services Corp. 3440**

On Display: Customized weather forecasting services to the radio and TV industry throughout the United States, Canada and the Caribbean.

**Wegener Communications, Inc. 2109**

Intro: Series 1800 FM2 subcarrier receiver featuring Panda stereo audio and 15 function network control; QPSK digital audio subcarrier receiver; Series 1600 dual audio automatic gain control module.

Also: SDM 2000 SCPC digital audio transmission system; Panda II STL/TSC subcarrier transmission system; Series 2600 agile automated SCPC products.

Contact: Kenneth D. Leffingwell  
11350 Technology Circle  
Duluth GA 30136  
404-623-0096

**Wheatstone Corp. 1034/1040**

Intro: SP-6a stereo production console enhancements include simultaneous monitor and mixdown capabilities, 4 additional line level effects return inputs; A-500as on-air console; TV-500s master control console; SDA-82a stereo distribution amplifier; 822 stereo selector.

Also: A-20 on-air console; SP-5 stereo production console; 1202 stereo compressor/limiter; 2700 third octave graphic equalizer.

Contact: Pattye Bagshaw  
6720 VIP Parkway  
Syracuse NY 13211  
315-445-7740

**Whirlwind N/A**

On Display: Complete line of audio and video cables; reels; patchbays; rack panels; complete turnkey design of audio and video interface systems; bulk connectors; wire; transformer devices; multi-pair cable; multi-pins; press boxes; distribution systems.

**Will-Burt Company/TMD 4883/4884**

On Display: Model 7-34-157/167 pneumatic telescoping mast assembly to position RF antennas for mobile radio remotes.



## IN THE PAST WE HAD A BIG ADVANTAGE OVER THE COMPETITION. NOW WE'VE GOT A SMALL ONE.

Until UREI's 813 Time Align® Monitor entered the studio, speaker systems had become a "smear" on the industry. A "time smear," in which high and low frequencies subtly assaulted the ear because they arrived out of sync. The results were general listener fatigue and unrealistic sound, particularly on lead instruments and vocals.

The UREI 813 solved the "time smear" problem with Time Alignment™, unifying sound into a single point source. This dramatic breakthrough, along with other major technical advances, soon established the 813 as the industry standard.

Now UREI introduces less of a good thing: the 809 Time Align® Studio Monitor. The 809 delivers all the engineering depth of its big brother, but at a compact size and price that's ideal for small control rooms and near-field applications.

UREI's 809 features a remarkable, all-new 300mm (12") coaxial driver that achieves a true one-point sound source, superior stereo imaging, and tight bass. It incorporates a unique titanium diaphragm compression driver that unleashes unequalled high frequency response.

The 809 has exceptional power handling capabilities, high sound sensitivity, and low distortion. It accomplishes precise acoustic impedance matching and smooth out-of-band response with UREI's patented high-frequency horn with diffraction buffer. And its ferrite magnet structures assure the system's high sensitivity drivers will not degrade with time and use.

UREI's Model 809 Time Align® Studio Monitor. Smaller package. Smaller price. Same impeccable "813" sound quality. See how it fits into your studio today.

IBL Professional  
8500 Balboa Boulevard  
Northridge, CA 91329

UREI

Time Align® is a trademark of E.M. Long Associates, Oakland, CA.

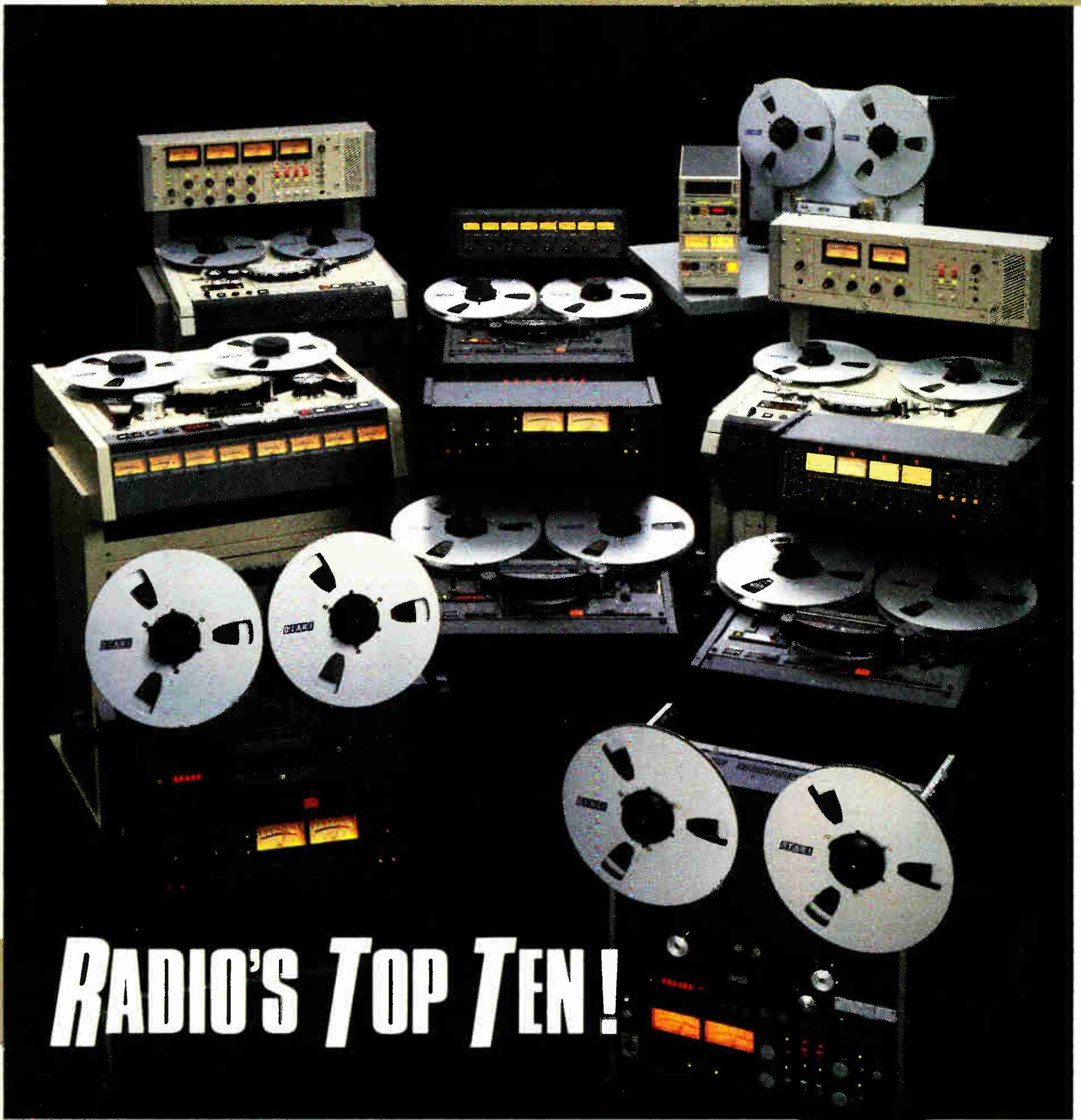

# RADIO'S TOP TEN!

© Otari 1987

For news editing, on-air, or in the production studio, Otari has exactly the equipment and features to fit any application, or budget.

When you are ready for a multitrack recorder, you can choose from our BQII, MKIII/4, MKIII/8, MTR-10, or the MX-70 with 8 or 16 tracks. Need a 2-track? Choose our famous "workhorse" MX5050 BII, MKIII/2, or the brand new MX-55! Looking for top-end performance? The MTR-10 has all the features you need to stay ahead in the competitive world of broadcast. We also offer three models of our CTM-10 cart machine, and if yours is an automated radio station, our ARS-1000 reproducer is the most popular in the world.

So you see, whatever you need for today, or for the future, Otari can provide it from a complete line of high quality, ultra-reliable tape recorders. Call your nearest Otari dealer today, or contact Otari at (415) 341-5900 for "Technology You Can Trust".



Circle 86 On Reader Service Card

See us at NAB Booth 1353

# From Square One to Solid State

With this column, RW begins a 12-part series on Introduction to Active Devices, a home-study course in the fundamental operation of diodes, transistors and similar electronics components. Northern Virginia Community College will mail an examination based on this series to registered individuals and will offer continuing education credits upon successful completion of the examination.

by Ed Montgomery

**Annandale VA** Electronic devices can be classified into two major categories: passive and active. Passive devices have a fixed value or operating parameter. They will not change from this parameter regardless of the variations of current and voltage on the component.

When passive devices are operated within their tolerances, they will perform, without damage, for years. Passive devices include resistors, capacitors, coils and transformers.

Active devices are capable of respond-

ing to electronic variations without the need for human contact. An active device can be placed in a circuit and can be designed to respond to a voltage or current change, restoring it to a previous level or changing it to a new level. The device also can act as a switch, turning the circuit on or off.

### From early use to solid state

The first electronic device placed in service was probably the relay. Morse used this method to implement telegraph communications.

Another active device that was developed in the 19th century was the telephone. The response of the carbon-button transmitter to sound waves and the recreation of these signals in the telephone receiver was a great achievement by Bell.

Electronic devices as we know them today came in 1905 with British engineer

Figure 1. The structure of a silicon atom.

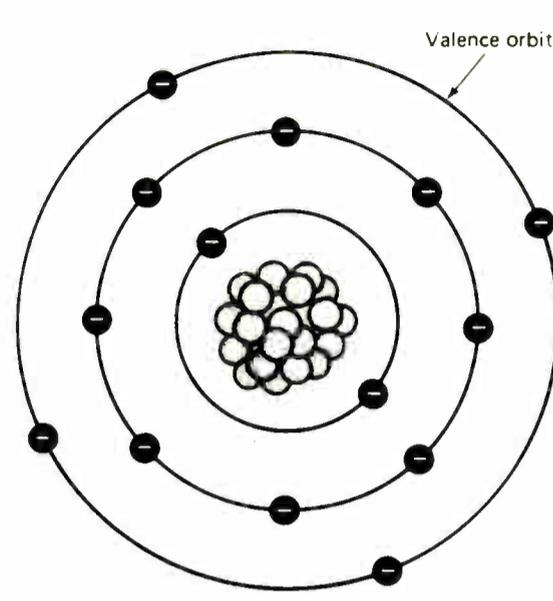

J.A. Fleming. He invented the diode, a device that allows electrons to flow in only one direction.

The first active device that could actu-

ally control or amplify a signal was developed in 1906 when Lee De Forest invented the audion vacuum tube, now known as the triode.

In 1947 Bell Laboratories developed the transistor to replace the vacuum tube in telephone switching circuitry. The solid state era was born.

Solid state electronics operate with semiconductors. These are materials that do not allow current to flow as easily as conductors. Under certain conditions a semiconductor can act as an insulator.

### Basic atomic structure

To understand how solid state devices work it is important to understand something about

Figure 2. A simplified silicon atom.

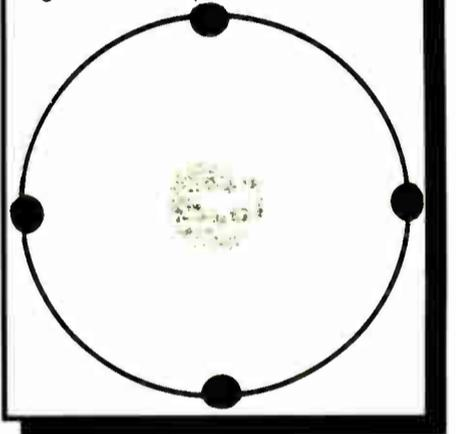

the atomic structure of semiconductors. Let's use silicon as an example; it is the most widely used material in electronics today.

Most readers may know that an atom's structure has a nucleus consisting of protons and neutrons and orbits of electrons spinning around it. Protons have a positive charge, electrons have a negative charge (refer to Figure 1).

What is most important about the semiconductor's atomic structure is the last orbit, or outer shell. A simplified

(continued on page 30)

**NORTHERN VIRGINIA COMMUNITY COLLEGE**  
Director of Continuing Education, Annandale Campus  
8333 Little River Turnpike, Annandale, Virginia 22003

Social Security No. \_\_\_\_\_

Please enroll me in the Community Service Program listed below:

Name \_\_\_\_\_ FIRST NAME \_\_\_\_\_ MIDDLE INITIAL \_\_\_\_\_ LAST NAME \_\_\_\_\_ Home Phone \_\_\_\_\_

Address \_\_\_\_\_ Business Phone \_\_\_\_\_

City \_\_\_\_\_ State \_\_\_\_\_ Zip Code \_\_\_\_\_

Course Title Introduction to Active Devices Fee \$ 20.00

Course Code BCST912.01N Course Dat(e)s and time \_\_\_\_\_

How did you learn about this course? \_\_\_\_\_ Received brochure in mail, \_\_\_\_\_ Newspaper advertisement, \_\_\_\_\_ Library, \_\_\_\_\_ Referral, \_\_\_\_\_ Radio/TV announcement, \_\_\_\_\_ Other

Enclosed is my check payable to Northern Virginia Community College. I understand that enrollment may be limited and if the course is cancelled for any reason, my check will be refunded in full. For office use: \_\_\_\_\_ SA 91 \_\_\_\_\_ RU 97 \_\_\_\_\_ SD 91 \_\_\_\_\_ RU 98

## Your Problem Solvers

from **ATI**



- Mike
- Line
- Phono
- Mixing
- Matching
- Metering
- Monitoring
- Processing
- Distribution
- Rack Mounting

**AUDIO TECHNOLOGIES, INC.**

328 W. Maple Ave., Horsham, PA 19044 • (215) 443-0330 • FAX (215) 443-0394



**Running out of room?  
Plenty of rooms  
in here.**



Locker Room reverb/echo—one of 70+ broadcast-engineered H3000B audio effects you can use "right out of the box". The powerful and versatile Broadcast Ultra-Harmonizer\* is also amazingly affordable—put it to work for you.

**RADIO'S MOST COLORFUL BLACK BOX**

EVENTIDE INC  
ONE ALSAN WAY  
LITTLE FERRY, NJ 07643

**Eventide**  
the next step

TEL 201-641-1200-TWX 710-991-8715-FAX 201-641-1640

# Radio Health Tonic

(continued from page 17)

should stay under 1% for AM and 0.5% for FM. The AGC and limiting of the processors should prevent overmodulation.

Your main broadcast chain is clean at this point. If any problems show up during these tests, it's best to stop checking and start fixing.

## Tape, CD and phono gear

Clean, demagnetize and check all heads for wear. Work through each machine, setting azimuth and phase with a standard test cart.

For faster alignment, you can make a

quickie test cart with low, medium and high frequency tones to set playback response, and pink noise, sweep tones or FM receiver hiss to set phasing. Adjusting phase with only a tone cart and scope will quickly cause you to lose interest in the whole process.

Be sure to check the pinch rollers, as they can cause wow and flutter. Replace any hard, shiny ones.

After you have aligned the record and playback sections, record a bright song from a CD or turntable. Put the cart playback into the audition channel, set the levels to be the same as the input, and

switch your monitors back and forth between program and audition.

You should not be able to hear a difference in the quality of the music if the tape or cart recorder is properly aligned.

You can buy standard test discs in both compact disc and LP formats. Use these to set levels and balance.

Check the frequency response to make sure no components are deteriorating. This is a common problem with electrolytic coupling capacitors. As they age, the low frequencies are affected first, and everything from that source sounds "tinny."

The CD test discs are good enough to substitute for an audio generator to test the studio-transmitter chain. Bent or worn phono styli should be replaced be-

fore they start scratching the record library.

Set timing for the tape sources. Align the reel and cart playbacks like the other tape equipment. Check levels and balance from each source.

Voice announcements might have to be reduced in level 1 to 3 dB to sound balanced with the music. Run a distortion test through at least one input. It is possible to have large amounts of distortion in the system if the main levels are set too low, so that the playbacks have to be cranked up to compensate.

The output from the cart machines should be from -10 dBm to 0 dBm. If it's too low the machine sounds noisy; too high and the output amps clip.

Check the levels and balance from the satellite receiver. When you're out walking around, visually inspect the dish and its mounting for any cracks or loose fasteners. Spring is a time of high winds, and you wouldn't want to be responsible for a "flying saucer."

## The listening test

Now that you are certain that the station checks out on instruments, it is time to hear how it sounds compared to the competition.

This is the only way to properly adjust your audio processing equipment. Everything else should be adjusted with the meters.

If only one source sounds bad on the air, investigate the cause using your test instruments. Don't try tweaking playback response or levels to compensate for bad carts, poor production, or failed amplifiers.

Adjust your processing so that you have the greatest loudness possible while maintaining equal or better quality than the competition. In most cases you'll be judged by how you sound compared to the other stations on the dial.

If you're in a one-station market or truly believe that the competition is CDs on home or car stereos, then it makes sense to back off the limiting for less distortion.

Before finishing the listening test, stop all sources and listen to the dead air for hum, noise, or other strange sounds that you missed in the studio.

## When to apply the tonic

You'll probably find that this is more than a one-night job. At one station I worked for, the program director and I stayed one night a week after sign-off for a few hours. He worked on the music library and I worked down my maintenance checklist until a month later everything was done. We were pretty proud of the results.

In fact, when you complete a full alignment and test on the station all at once, the difference is bound to be heard. The deterioration in quality that naturally occurs with any equipment takes its toll secretly over a period of months and years.

You may find the improvement so dramatic that you'll want to do some of these steps quarterly or even monthly to prevent any loss in signal quality.

A side benefit is that equipment problems just starting to crop up will become apparent during the routine tests. Fix them now and they won't drag you out of bed in the middle of the night later.

■ ■ ■

John Shepler is an engineering manager, broadcast consultant, writer and regular RW columnist. He can be reached at 815-654-0145.

# At this year's NAB, don't just look. Listen.

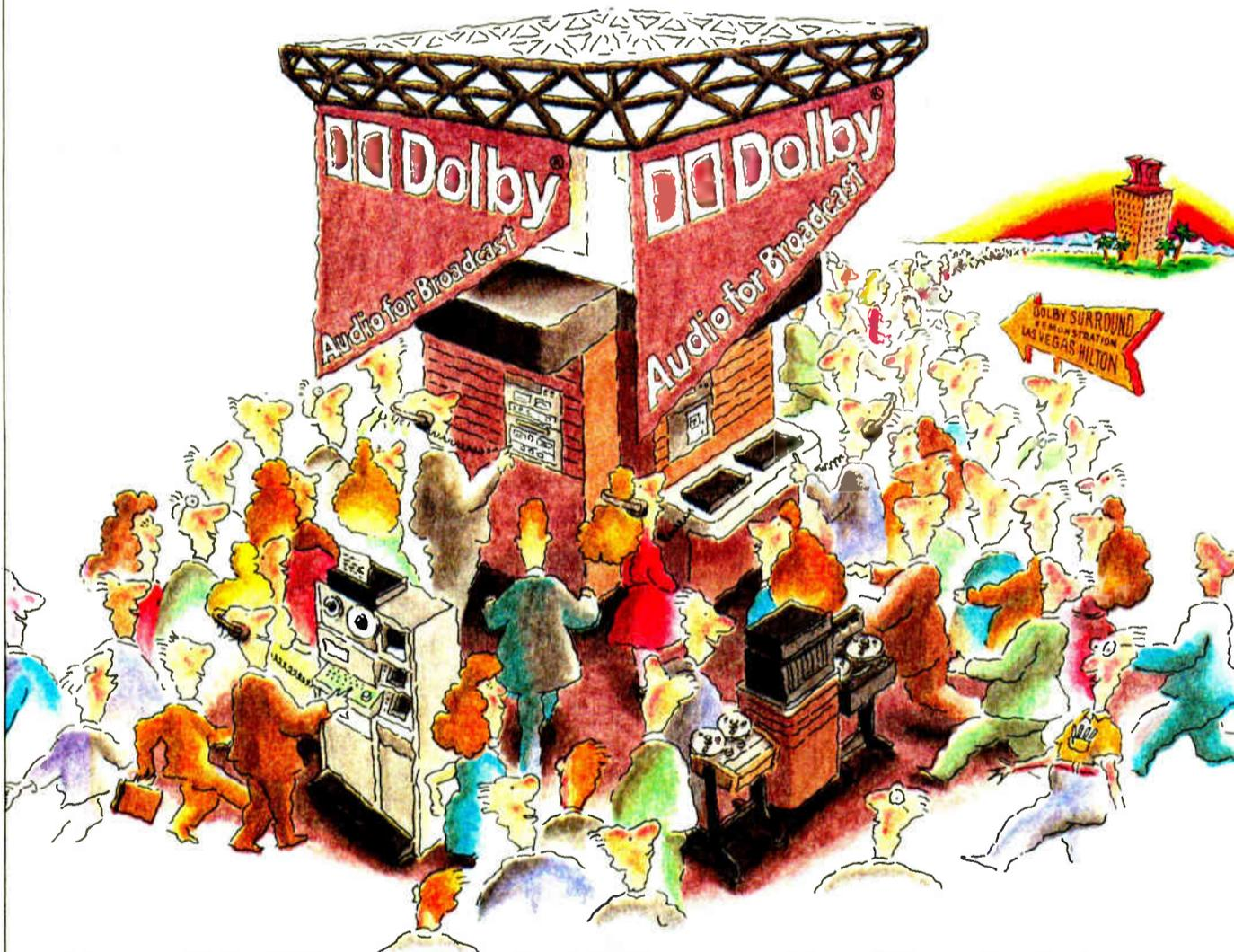

Listen to Dolby SR improve the audio on VTRs, cart machines, STLs, and audio tape machines. And in our suite at the Hilton, participate in a behind the scenes demonstration of a Dolby Surround production—how to use it, when to use it and why to use it. Stop by Dolby and listen.

On display at Booth 1457: Model 363 2-channel unit with switchable Dolby SR and A-type noise reduction; XP series multi-track Dolby SR unit; Model SDU4 Professional Surround Decoder Unit.

Dolby Laboratories, Inc. 100 Potrero Avenue, San Francisco, CA 94103-4813, Phone 415-558-0200, Telex 34409, Facsimile 415-863-1373, 346 Clapham Road, London SW9 9AP, Phone 01-720-1111, Telex 919109, Facsimile 01-720-4118. Dolby and the Double-D symbol are trademarks of Dolby Laboratories Licensing Corporation © Dolby Laboratories Inc., 1989. S89/8626

**Dolby**

# How to Set a Pass-Reject Trap

by Frank Colligan

**Bethesda MD** A new method of quickly and accurately setting pass-reject traps has been developed. This is not a recent development. I have used it for many years in order to determine the long term "track record" of success.

You'll be surprised at the increased accuracy, the rapidity of adjustment, no impedance bridge usage and the use of only two small test instruments. The adjustments are rapid and simple.

Before you say, "What, no bridge?" take a tour through the Hewlett Packard catalog and note that there are many

ple non-DA is not accurately adjusted, immediate chaos can result. There is no margin for anything short of the least possible adjustment error.

The required degree of precision of adjustments is greater than that required for run-of-the-mill networks in DA systems.

The basis for the techniques to be described is simplicity itself. A series resonant circuit can be adjusted by comparing it to a reference short circuit in parallel with it.

Likewise, a parallel resonant circuit can be adjusted by comparing it to an open circuit in series with it. Priorities must be followed.

up RF networks and life will be easier. Ignoring them can make an adjustment routine much more difficult to finalize.

Shunt capacitances can be reasonably assumed to be about 6 Pfds/foot or 3 Pfds per dollar bill. Keeping those points in mind, as well as a dollar bill in your pocket, is well worth the effort.

Figure 1 shows a typical and traditional pass-reject trap. L1 and C1 form a series resonant circuit from points A and B. It forms a short circuit from A to B at the pass frequency, F1.

Assume we wish to reject a frequency, F2, lower than F1. This calls for L2. Going down in frequency, the series net reactance of L1 and C1 becomes capacitive.

L2 in parallel with the pass branch is adjusted to parallel resonance at F2. Thus at F2 we will have an extremely high resistance blocking F2 out of the system.

One of the keys to no-bridge tuning lies in the permanent installation of the heavy shunting bar, between A and B, with J1 in series with it.

This is a reference short circuit one would create with a bridge by adjusting L1 or C1 for a net reactance of zero between points A and B. There is an alternative and more accurate method of making this adjustment with no bridge at all.

At the pass frequency, F1, we simply trade one short circuit for another.

## The operation

The procedure goes like this. Set up a signal generator in the transmitter building tuned to F1, the pass frequency.

This signal may be sent to the tower over the transmission line and the generator need not be hauled out to the tower base.

Caution: an FL-31 filter may be necessary on the output of the signal generator to prevent F2 from playing havoc with the generator's output circuitry.

The matching network may be set either before or after setting the trap network. "Roughing-in" the matching network beforehand might provide more signal from the signal generator with which to set the trap section.

Patch the output of the toroid current sampler into the external input of an FIM-21 field strength meter. Set the latter on the ground and on its back in order to take maximum advantage of its superior shielding.

A high order of shielding is essential to this technique and the FIM-21 does very well in this regard.

Open J2 and short J1. Tune in the F1 signal provided by the signal generator and carefully note its level reading on the FIM-21. Remove the shorting blade for J1 and adjust L1 to exactly repeat the initial level reading on the FIM-21.

The object is to see no difference in (continued on page 31)

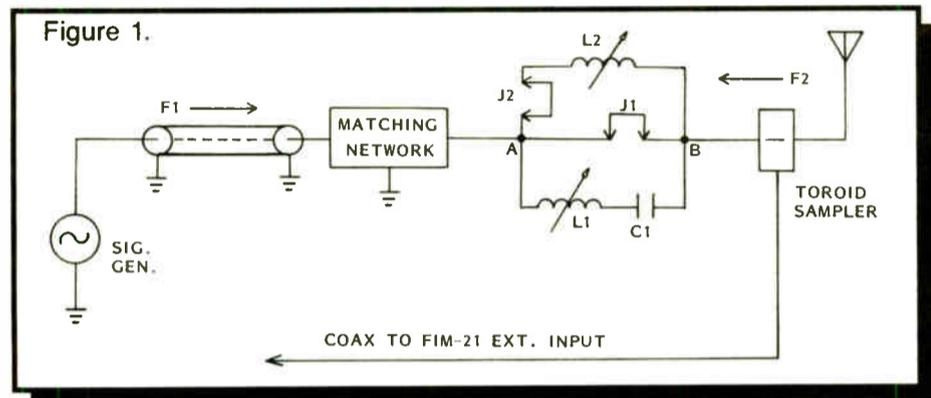

other RF instrumentation devices all of which subtly suggest other and better methods of doing things.

Pass-reject traps are in widespread use throughout the industry to pass a signal from a transmitter to an antenna and reject incoming signals from one or more neighboring stations. The other stations may be near neighbors or actually sharing the same antenna.

## Taking precautions

Tuning a pass-reject trap must be done with great care, particularly the reject function. An eight-tower directional array can drift woefully out of adjustment for one reason or another and not a great deal of immediate damage results.

If, however, a pass-reject trap on a sim-

Series resonant circuits must be exactly set first and forever left alone before setting the parallel resonant elements.

Parasitic stray reactances are inescapable in all RF network systems. These adjustment techniques automatically absorb and compensate for their otherwise obnoxious and obstructive effects.

## First order approximation

Data collected over the years from the field as well as the lab indicate that in AM RF systems a good first order approximation of 4 ohms/foot/MHz of series inductive reactance may be assumed in lead busses, tapping straps, etc.

This equates to about 2 ohms per width-of-a-dollar-bill per MHz. Observe and consider these factors when setting

## Bi-directional RPU for \$250 with The Cellular Production Unit™

by The Davis Communications Group

By connecting our \$250.00 Cellular Production Unit™ to your cellular telephone, you get a fully bi-directional RPU system capable of interfacing with any audio gear you own, including frequency extenders. The CPU™ features a separate output for return



audio, and provides you with instant mobile remote capability from any cellular service location, without FCC licensing or RF problems.

- Sports Events
- Live News Coverage
- On-Site Promotions
- Boom Boxes
- Roving Interviews
- TV IFB/CUE

**BROADCAST SERVICES CO.**

CPU and Cellular Production Unit are trademarks of The Davis Communications Group.

Neal Davis, Four Oaks, NC, 919 934-6869 • Keith Arnett, Front Royal, VA, 703 635-1413  
FAX 919 934-1537

## Performance Times Three!

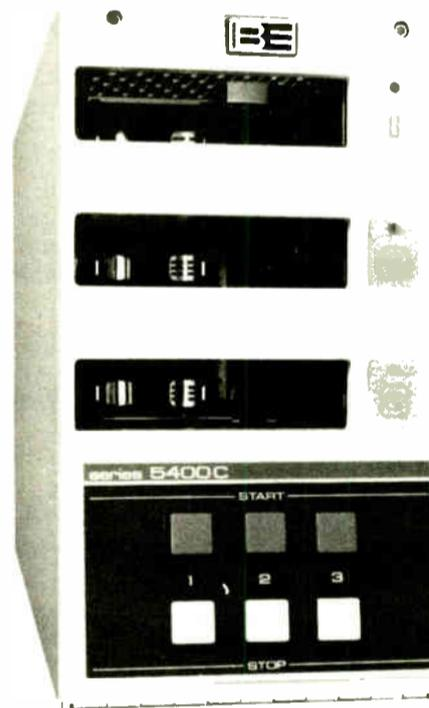

## Series 5400C Triple Deck

- Non-repeat Lockout
- Advanced Electronics (meets or exceeds 1975 NAB Specifications)
- Improved Cartridge Guidance System
- New Larger Solenoid
- Toroidal Power Transformer
- New Phase Lok V Head Block

The 5400C cartridge machine from Broadcast Electronics establishes a new standard of triple deck performance. Frequency response is  $\pm 2$  dB, 40 Hz to 16 kHz and stereo S/N is better than 56 dB. Operation is cool and quiet as the result of a new, larger air-damped solenoid and toroidal power transformer. An optional Record Amplifier provides convenient record capability on the bottom deck.

This Series 5400C is the new three deck performance leader. Order now from your Broadcast Electronics representative.

With one cue tone: \$3800 Mono \$4300 Stereo  
With three cue tones: \$4000 Mono \$4500 Stereo

Prices USA only, 115V, 60 Hz, FOB factory exclusive of sales or use tax.

**BE BROADCAST ELECTRONICS INC.**

4100 N. 24th ST., P.O. BOX 3606, QUINCY, IL 62305 (217) 224-9600, TELEX: 250142, FAX: (217) 224-9607

# A Tour Through Desktop Audio

(continued from page 22)

A card, and Sound Designer II recording, waveform editing and time compression/expansion software.

The Digidesign system allows two channels of 16-bit audio to be recorded directly to and replayed from the Mac's hard disk; storage capacity is dependent on how many SCSI-equipped drives are attached to the Mac SE or II computer.

Digital Audio Research's SoundStation II is now available with a 600-Mbyte WORM (write once-read many) optical drive system holding up to 60 minutes of stereo audio.

Fast access times to/from the SoundStation's optical drive allow real-time playback; multitrack playback from the maximum of eight channels also is available via hard drives. New time-compression/expansion software allows 50% shortening or lengthening of audio material without pitch shifting.

Integrated Media Systems' Dyaxis is a high-speed digital record/replay system controlled from either an Apple Macintosh Plus/SE/II or an IBM AT/PS-2 workstation, which connects to a custom-designed audio processor rack and mass storage system.

Sound sampling to 16-bit resolution can be set on the Dyaxis to either 44.1 or 48 kHz rates—or any 200 other user-selectable frequencies. Audio inputs/outputs are via analog or digital AES/EBU, SDIF-2, S/P DIF and Sony

PCM-601-format ports.

Dyaxis systems are available with up to 1.6 Gbytes of random-access hard disk storage, capable of holding 2.5 hours of two-channel audio. Eight simultaneous digital and/or analog outputs are planned for mid-year.

Typical applications include random-access two-track recording and playback from hard disk, multitrack off-line sound file assembly, and digital format conversion.

In addition to its own MacMix II controller software—now offering faster digital mixing capabilities, scrub editing and custom keyboard macros for dialog editing, along with new upgrades for radio production—Dyaxis also accommodates other sound editing and processing software, including Blank Software's Alchemy, Soundsmiths' SoundBase and Digidesign's Sound Designer II and Q-Sheet A/V.

## Well-tempered Synclavier

New England Digital's Synclavier digital audio workstation is available in a variety of formats and capacities, the smaller of which might find potential application in radio.

Now controlled from a Macintosh front-end controller, the Synclavier 3200 and 9600 systems offer a window-based desktop presentation of recording and editing assignments.

The Synclavier 3200 features up to 32

Mbytes of internal storage and 720 Mbytes of hard disk (capable of storing around 60 minutes of 16-bit stereo audio), while the larger Synclavier 9600 incorporates 96 Mbytes of RAM and 3 Gbytes of storage.

Post Logic Systems' Digital Audio Computer System is a self-contained processor rack with SCSI hard disk drives which, under external computer control, can function as a digital multitrack recorder, or be networked to form a multi-user editing system.

The companion Digital Audio Control Console offers input/output assignment, transport control and digital editing in a desktop format. Both analog and digital inputs/outputs can be accommodated.

Real Word Research's Audio Tablet comprises a two-channel digital editing system that can function at sampling frequencies of 32, 44.1 or 48 kHz and which offers capacities between 60 minutes and six hours of stereo audio.

An interface and hard disk rack for the Audio Tablet accepts analog, AES/EBU and SDIF-2 digital formats and connects to a control surface that features a touch-sensitive screen. Software is available for two-channel music and speech editing, using a dedicated rock-and-roll/scrub wheel.

Solid State Logic's 01 Digital Production Center, while geared primarily for video production, is a standalone combination all-digital mixer/editor/recorder that featuring eight input channels, assignable EQ and dynamics control, plus "transport" controls for two playback and one master disk-based recorders.

Sonic Solutions' Sonic System includes an Apple Macintosh II, hard drives, controller software, and plug-in cards for the Mac that handle analog, AES/EBU and SDIF-2 digital ins/outs at 44.1 and 48 kHz sampling frequencies.

The company's first software release, Sonic System provides digital editing, mixing, EQ and dynamics control, plus NoNOISE processing for removing unwanted noise.

## Topaz—an editing gem

Steinberg Digital Audio's Topaz is a rackmount hard disk recorder and editing system controlled by a companion Apple Mac II; a maximum of eight Topaz units can be connected together for 16-channel operation.

An optional remote control features a pair of servo-controlled audio faders and software-definable keys for real-time gain control. A 360 Mbyte hard drive and A-to-D/D-to-A cards for 32, 44.1 and 48 kHz sampling provide a maximum of just under 100 minutes of mono audio.

Topaz's custom software allows in/out ports, channel level, pan, three-band EQ, filters and a number of other parameters to be controlled from the Macintosh.

Symetrix's new DPR-100 Digital Processing Recorder is configured as a standalone high-speed input/output device designed to be connected to an Apple Mac II for control and signal manipulation. Up to eight audio channels can be digitized, mixed and cut-and-splice edited to a pair of analog or digital outputs.

Audio ins/outs can be analog or AES/EBU and SDIF-2 digital. Real-time digital signal processing tasks include level adjustment, pan and three-band parametric equalization; off-line processing currently includes time expansion/compression.

A four-track version of the Symetrix allows simultaneous two-track recording and four-track playback, while a larger eight-track configuration offers simultaneous four-in/eight-out.

(continued on page 32)

**ALLIED**  
Satellite Equipment  
— A HARRIS COMPANY

**High Technology  
Brought Down to Earth**

**SINGLE-CHANNEL-PER-CARRIER  
SATELLITE RECEIVER**



- ★ Joining a network? Starting a network? Single Channel Per Carrier offers audio quality any affiliate will be proud of and cost benefits that start payback from day one.
- ★ Before the advent of the Micro Phase receiver, the cost or stability of receivers for this format were not the most desirable. Low cost, stability or quality... choose two
- ★ Not any more! Micro Phase receivers feature rock-solid down-converter stability with audio characteristics not less than broadcast quality.
- ★ Channel changes are instant and precise. This agility is achieved with front-panel synthesized tuning.

**Call the ALLIED Experts**

3712 NATIONAL RD WEST • P.O. BOX 1487 •  
RICHMOND, IN 47375

**317-962-8596**



**You  
can measure...**

**with the best monitor and the most accurate test set.**

The FMM-2/FMS-2 series monitors provide an even greater degree of precision measurement than ever before... **You can measure S/N below 90 dB, You can measure crosstalk below 85 dB, You can measure separations of better than 70 dB, You can measure frequency response to better than 0.25 dB, You can measure distortions to lower than 0.01%, and much more...** Our uncluttered panels and autoranging voltmeters make these measurements a dream.

**BELAR** CALL ARNO MEYER (215) 687-5550  
**ELECTRONICS LABORATORY, INC.**  
LANCASTER AVENUE AT DORSET, DEVON, PENNSYLVANIA 19333  
Call or write for more information on Belar AM, FM, Stereo, SCA and TV monitors.

# AM Stereo and Historic Calls

by George Riggins

**Long Beach CA** The proverbial question of which came first, the chicken or the egg, has never been answered as far as I know. A more current question is what comes first, the receivers or the signals. The latter question refers to the question of stereo on the AM band.

Have you tried to purchase a receiver that will decode the stereo signals now available from many of the AM stations? Mine was "lifted" recently and I needed a replacement. Neither of the two local volume electronic chains in Southern Cal offers an automotive receiver that will decode any of the stereo formats.

Several phone calls later, I was able to locate a distributor who stocked two brands of AM stereo/FM stereo receivers with a stereo cassette player.

The two were Delco by GM and German manufacturer Blaupunkt. The former will not fit anything but a GM vehicle, I was told, and the latter takes an outboard amplifier because Blaupunkt does not make an integrated receiver/amplifier.

Blaupunkt was reported to have two grades of equipment. Neither Sony nor any other Japanese manufacturer was mentioned.

Who is falling down? Can we dump on NAB? Should we look in the mirror? Are local promotions with giveaways in order?

Perhaps we should consider all of the above, including programming that would be inviting to the type of person who would spend the money—upwards of \$1100 (yes, that is one-thousand-one-hundred dollars, not including speakers!) for the equipment to listen to programming on the AM band in stereo.

Start throwing the sticks and stones if you want, but remember, people who live in glass houses should be careful because some of the stones just might get returned.

## Radio in the '20s

Now on to more mundane items such as history. I have received many items lately on early radio. The most interesting package of material came from Rick Plummer of Cedar Rapids, Iowa. Rick has

managed to gather radio history from the early 1920s time frame.

Rick writes "Here are some notes on



WLW Cincinnati taken from Robert M. Brockway who worked at WLW starting in 1941. There were five Crosley stations

operating at the WLW transmitter site in Mason, Ohio.

"WLW, 700 kHz, had a 700 cantilever antenna, also WLWK, a "bastard" transmitter consisting of an RCA shortwave transmitter and a modulator/ps designed by the CE of KFAB, Omaha NE.

"W8XAL was a 6 MHz shortwave station which mechanically keyed the station every 30 minutes with the call letters. It was picked up by the NBS so the E layer could be predicted.

"W8XO was WLW's experimental call.

"There was another transmitter site in Bethany, Ohio. WLW was broadcasting

500 kW in '34 or '35 and this continued until '37 or '38. Bob thinks the 700 kW rumor got started one night when the boys decided to see just how high they could crank the transmitter up. They got up to 750 kW and then all of southeast Ohio went dark.

"In 1944 W8XO was operated at 500 kW for one hour every night just after 'Sohio News.' " (A recent phone call indicates that the old WLW 500 kW transmitter is slowly disintegrating. The power supply is reported to be stored in the basement and gets wet during rainy weather.)

Rick enclosed pages from *Radio News*, June 1923, June 1926 and February 1928, listing the broadcast stations in the US.

(continued on page 37)



NEW

AMPFET ND-5



NEW 5 KW SOLID STATE AM TRANSMITTER

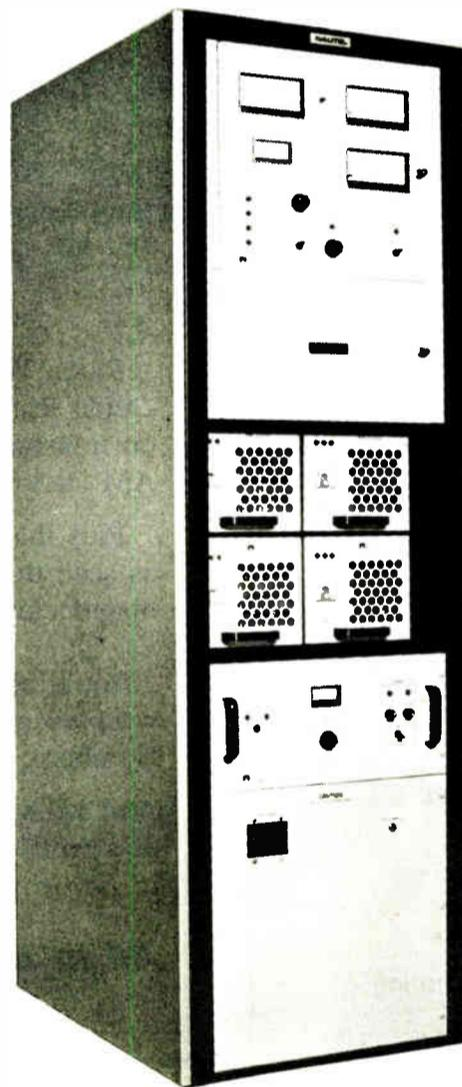

- PROVEN SOLID STATE DESIGN
- 75% OVERALL EFFICIENCY
- 8 INDEPENDENT POWER BLOCKS
- BUILT-IN STANDBY EXCITER
- ON-AIR SERVICEABILITY
- NEW INDUSTRY STANDARD FOR SUPERIOR PERFORMANCE
- 125% POSITIVE PEAK CAPABILITY TO 11 KW
- ZERO LOW FREQUENCY PHASE SHIFT
- THE "PERFECT" TRANSMITTER FOR AM STEREO

MF RADIO

400 W TO 100,000 W

TOTALLY SOLID STATE

AMPFET SERIES

NAUTEL  
 (Nautical Electronic Laboratories Limited)  
 R.R. #1, Tantallon, Halifax County,  
 Nova Scotia, Canada B0J 3J0

Nautel Maine Inc.  
 201 Target Industrial Circle  
 Bangor, Maine 04401 U.S.A.

Phone (902) 823-2233  
 Telex: 019-22552

Phone (207) 947-8200  
 Telex: 944466



## Morning zoo-in-a-box.

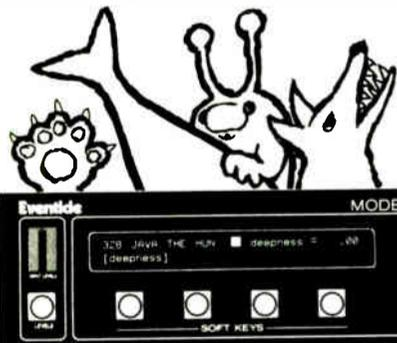

Java The Hun vocal shifter—one of 70+ Broadcast Ultra-Harmonizer™ digital effects designed to let you dial up pre-programmed insanity. It's easy to afford the broadcast-engineered H3000B's power and flexibility: ask your Eventide distributor.

**RADIO'S MOST COLORFUL BLACK BOX**  
 EVENTIDE INC.  
 ONE ALSAN WAY  
 LITTLE FERRY, NJ 07643  
 TEL: 201-641-1200 • TWX: 710-991-8715 • FAX: 201-641-1640

**Eventide**  
 the next step

# The Basics of Semiconductors

(continued from page 25)  
look is shown in Figure 2.

This outer shell is incomplete—that is, it does not contain the total number of electrons an atom with this many shells could have. Therefore, it is considered unstable.

### Crystal formation

This atom is capable of combining with other atoms, creating covalent bonds—sharing the electrons in its outer shell with the outer shells of other atoms.

When silicon atoms share their electrons in this manner, a crystal is created, as in Figure 3. Along with silicon, germanium also can be used to create a crystal of covalent bonds.

Pure silicon is classified as a semiconductor because it does contain a few free electrons to support a flow of current when a voltage potential is applied. The amount of current that flows through silicon is directly related to its temperature.

Both silicon and germanium's resistance to current decreases with the increase of temperature. Silicon has been preferred over germanium because it is less affected by temperature change.

Heat is a factor in all electronic circuitry and its effects must be considered in all component design.

The negative temperature coefficient (a rise in temperature produces a decrease in resistance) of germanium and silicon is not all bad. Oftentimes it is important to have a device that will respond rapidly to temperature changes to protect sensitive circuitry.

Next, we'll look at the role semiconductors play in solid state operation.

Ed Montgomery currently is an electronics teacher at Thomas A. Edison High School in Fairfax County, VA. He has previously taught broadcast engineering at Northern Virginia Community College and worked as a broadcast engineer for several radio stations.

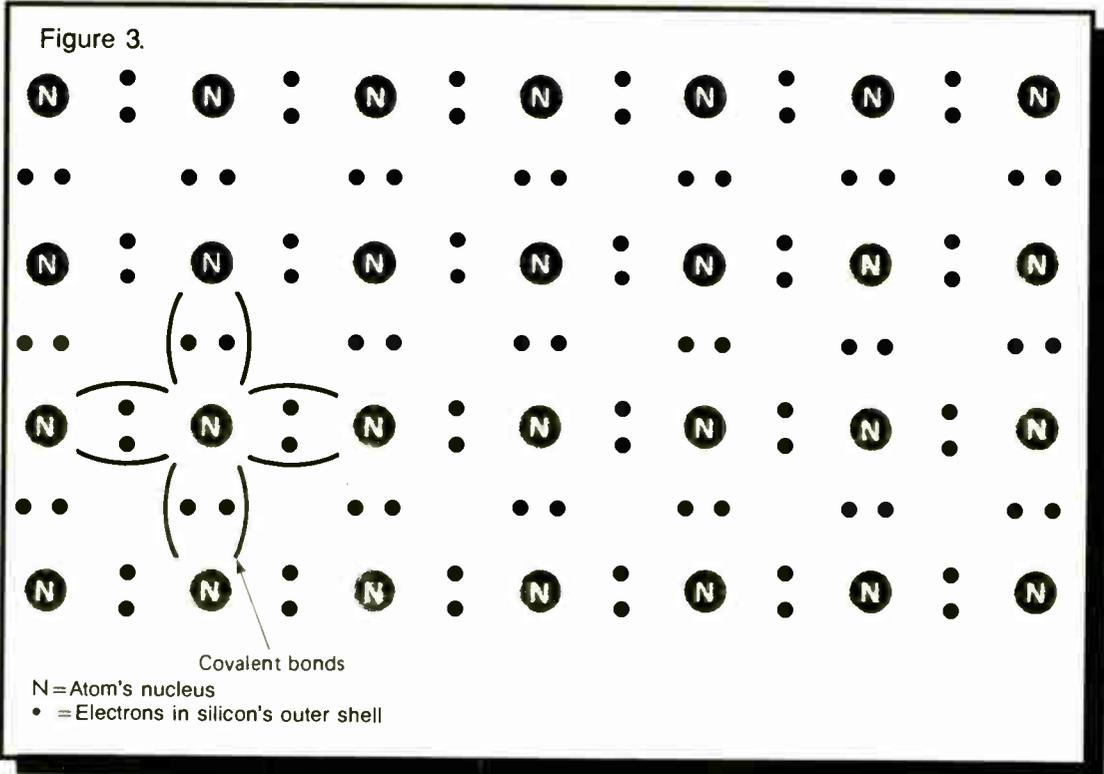

## Silence is Golden and less work with telcom c4 for RADIO and TV.



### The NR system you just set and forget.

- A product of ANT Telecommunications, Inc.
- No overshooting.
- No wasting time with lining up — not even for tape exchanges.
- No pre or post echo.
- Up to 118dB dynamic range — the widest dynamic range available in any noise reduction system today.
- Applications: Cartridge machines, STL, RPU, Reel-to-reels, Cassettes.
- Over 15,000 channels in use worldwide.
- No breathing or pumping.

**telcom c4**  
Silence by Design

Distributed by:

**RAM BROADCAST SYSTEMS INC.**

346 W. Colfax Street, Palatine, IL. 60067

New York (516) 832-8080

Chicago (312) 358-3330

Tennessee (615) 689-3030

## AM Radio Is Alive and Well . . .

and the state-of-the-art in AM transmitters is the industry's hottest news.

Radio World's April Buyer's Guide features the latest word on transmitters and exciters for AM stations . . .

Plus the state of the industry as seen through major manufacturers' eyes.

You'll also get a complete wrap-up of the AES in Hamburg, West Germany . . .

And J.G.'s eye-witness account of a whirlwind Hamburg tour in *Earwaves* . . .

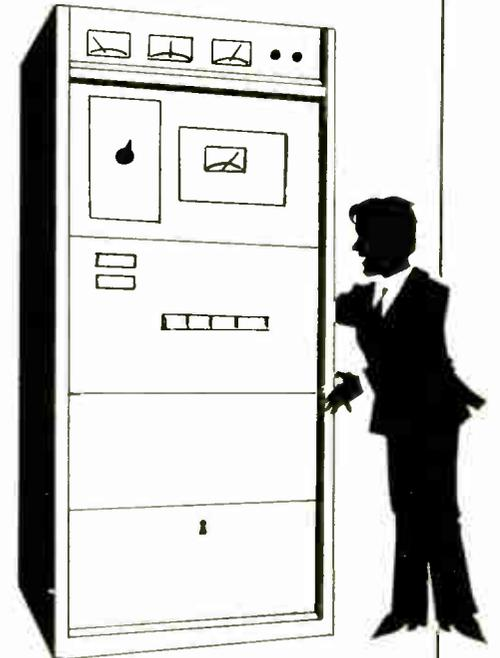

**All in the next RW Look for it April 26!**

### EBS EQUIPMENT

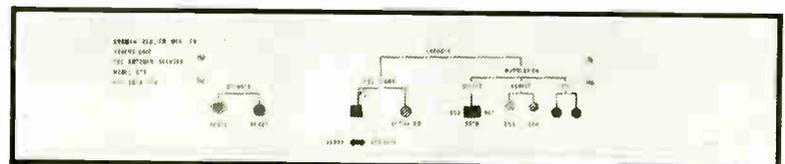

	Price
Model CEB Encoder-Decoder . . . . .	\$540
Model CE Encoder Only . . . . .	\$375
Model CE With Stereo Option . . . . .	\$405
Model CD Decoder Only (REQUIRED FOR LPTV) . . . . .	\$320
Receiver can be supplied to drive Decoder . . . . .	\$100

- Encoder FCC Type Accepted • Decoder FCC Certified •
- Exceeds FCC Specifications •

All interconnections to the EBS equipment are made through a barrier terminal block. No special connectors necessary. In stock—available for immediate delivery.

**GORMAN REDLICH MFG. CO**

257 W. Union St. • Athens OH 45701 • 614-593-3150



# A Bridgeless Pass-Reject Trap

(continued from page 27)

level readings between J1 open and J1 closed. This method provides the closest possible short circuit, at F1, between points A and B. This is the comparison of a series resonant circuit to its ideal condition, a short circuit.

If you wish, take a bridge and check between points A and B with J1 and J2 open. Yes, you may see a few ohms of reactance. In actual operation, the pass branch formed by L1 and C1 will be operating with both ends above ground.

For ultimate adjustment accuracy we should adjust under those conditions as discussed above.

## Consider grounding

The catch with the bridge method is that the bridge demands a ground, hence points A or B must be temporarily grounded to satisfy that demand.

The accuracy of result suffers owing to the distributed reactance effects, particularly the distributive capacitance of the coil.

The performance of the L1/C1 path between points A and B will be noticeably different between both ends floating, as will be in final operation, and one end grounded. The effects of distributed parasitic reactances are quite different between those two conditions.

I prefer to measure and adjust with things as they will be in final operation. Also it is a bit of an irony to use some \$2000 plus worth of additional equipment just to establish a simple short circuit!

Setting the reject path is just as easy. Leaving J1 open, place the shorting blade in J2 to bring L2 into use. While still at F1, tune L2 across its entire range and note no change in the F1 signal level.

This double-check shows that the F1 short circuit formed by L1/C1 is indeed working. By process of elimination it cannot be doing anything else!

Next the FIM-21 is shifted over to F2, the reject frequency. J1 is opened, J2 is closed and permanently so. With F2 clearly tuned in, from the neighboring station, L2 is simply adjusted for a sharp and distinct null of the F2 signal. We're done.

## Desired results

The parallel resonant path is doing just what it is supposed to do and we can measure that directly in terms of just that, what it is supposed to do.

With a bridge, and with its resistance dial limited to a range of no more than 1000 ohms, adjusting a parallel resonant

circuit accurately is rather tricky business.

Of course that major source of error creeps in again, having to establish temporary grounds. They won't be there on final power-up and neither will be the overall performance established with those grounds in the act.

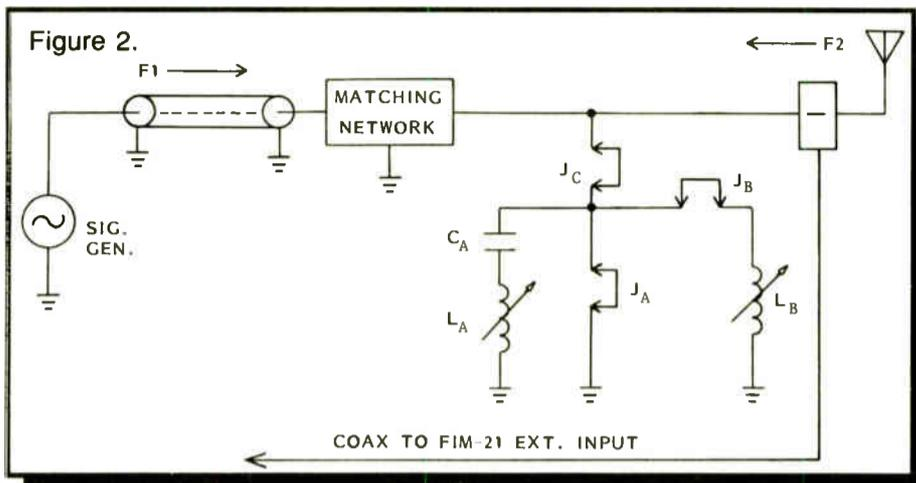

Figure 2 shows the same idea but connected up in a different way. In this case the series resonant path is set to series resonance at the reject frequency F2, while the parallel resonance is set for the pass frequency F1.

Thus the trap system will not "be seen" by the F1 transmitter but the inflow of F2, from a neighboring station, will meet a short circuit to ground through the series resonant L<sub>A</sub>/C<sub>A</sub> path.

Close J<sub>A</sub>, open J<sub>B</sub> and close J<sub>C</sub>. Tune the FIM-21 to the reject frequency F2. Carefully note the reading. Open J<sub>A</sub> and tune L<sub>A</sub> to repeat the same reading. Close J<sub>B</sub> and run L<sub>B</sub> through its entire tuning range and note no change in the reading.

This completes the adjustment of the series resonant F2 reject path. Next we need to make the entire filter block parallel resonant at the pass frequency F1.

Leaving J<sub>A</sub> open, close J<sub>B</sub> and J<sub>C</sub>. Set the signal generator to F1 and tune it in on the FIM-21. Adjust L<sub>B</sub> for a maximum indication on the FIM-21 and then refine the adjustment by tuning L<sub>B</sub> until there is the smallest possible difference in reading when J<sub>C</sub> is alternately open and closed.

This is the comparison of a parallel tuned circuit to its ideal condition, an open circuit. We're done.

## A few caveats

Some cautions must be pointed out. At first glance it seems logical to simply adjust a series resonant circuit for maximum current flow. Don't!

Refer it to the reference short circuit as

discussed above. Maximum current tuning assumes an ideal condition that the generator is of a very low and nearly zero internal impedance and that its internal reactance is absolutely zero.

In the real world this condition is not obtainable and one can be badly fooled by maximum current tuning. The clas-

der to have the Q-measuring voltmeter calibrated to read Q directly. Such a signal generator condition is hardly likely in our situations and by referencing to a built-in test short circuit, it is not necessary.

In the above two examples, F2 was assumed to be lower than F1. Had it been higher, L<sub>2</sub> and L<sub>b</sub> would have been capacitors instead of coils.

## Adjusting trap circuits

The tuning methodologies discussed above make precision adjustments of trap circuits in directional antennas a breeze. In Figure 1, close J1 and open J2.

Disconnect the sampling cable from the FIM-21 input. Call the building to turn the transmitter on, at low power, and ask for a phase reading on that tower. Open J1 and adjust to get that same phase reading back again. Turn the power off and set L2 as discussed originally. We're done.

In figure 2, adjust L<sub>A</sub>/C<sub>A</sub> first. Tune the FIM-21 to the reject frequency F2. Close J<sub>A</sub> and J<sub>C</sub>. Open J<sub>B</sub>. Read the level of F2 on the FIM-21. Open J<sub>A</sub> and set L<sub>A</sub> to repeat the same reading.

Disconnect the sampling cable from the FIM-21 input. Open J<sub>C</sub>, bring the transmitter up on low power and ask for a phase reading. Close J<sub>C</sub> and adjust L<sub>B</sub> to return the same phase reading.

Alternately open and close J<sub>C</sub> and adjust until there is little or no change in the monitor indications for that tower.

(continued on page 35)

## MC MARTIN

### FM Monitor/Relay Receiver

NAB-89

Order During the NAB Show and Receive a Stereo or SCA Demod FREE

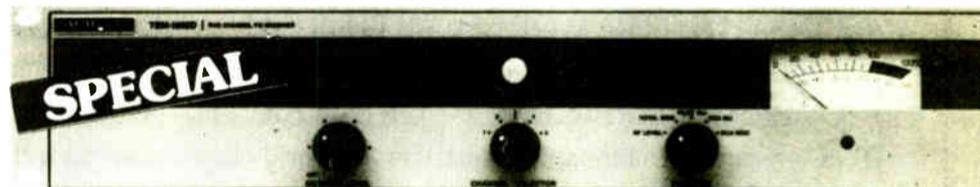

TBM1005D-FM 5 ch.  
TBM1003D-TV ch. 2-13

## When Quality & Sensitivity Count

The McMartin TBM-1005D, 5 channel receiver is ideally suited for the broadcast relay or cable industry.

Along with outstanding sensitivity and selectability the crystal controlled receiver includes a carrier-fail relay, squelch, composite output and (with optional plug in cards) stereo and SCA audio.

Front panel features include: 5 channel selection of RF level, SCA/Pilot injection, modulation and selectable audio with speaker volume control.

Contact your McMartin sales representative or call the factory for more information on this or any other McMartin product.

## MC MARTIN

McMartin Inc. • 201 35th Ave. • Council Bluffs, IA 51501 • Telephone (712) 366-1300 • Telex 484485 • FAX (712) 366-3915

## The Complete RF Exposure Measurement System from Holaday Industries

### Measure Both E and H fields

ANSI RF exposure standard requires measurement of both the electric and magnetic field.

### Automatic Self-zero

Completely automatic self-zeroing eliminates drift, improves accuracy of readings.

### Recognized by Federal Agencies

Evaluated and used by NIOSH, OSHA, EPA and CDRH, as well as state, local health departments and consulting engineers.

Call or write for more information on these reasonably priced systems. Rental systems also available.



**HOLADAY INDUSTRIES, INC.**  
14825 Martin Drive  
Eden Prairie, MN 55344  
Telephone: (612) 934-4920  
Telex: 29-0922 FAX: 612/934-3604

### NBS Probe Design

Isotropic probe design originated by National Bureau of Standards.

### Displays Time Average Reading

Real-Time display of the current six minute relates directly to the ANSI RF average exposure standard.



# Mic Placement in Studio Recording

(continued from page 19)

two or three of these. You lose individual control of each drum in the mix, but this system is much less costly than miking each drum and can sound quite good with some bass boost. Examples: the Crown GLM-100 and GLM-200, Countryman Isomax series, Sennheiser MKE-2, Sony ECM-50 and ECM-44, AKG Micro Mic Series and Shure SM-98.

Remember, you can use any microphone on any instrument if it sounds good to you. Just try it and see if you like it.

## Specific techniques

Provided in the accompanying table are some recommended mics for recording musical instruments and recommended placements for the microphones. If pickup of room reverberation or leakage is excessive, place the mic closer than recommended and roll off the bass if necessary at your mixer to obtain a natural timbre.

For example, suppose you're miking a folksinger playing a guitar in your broadcast studio. You'll have to mic the singer and guitar up close to isolate their sounds so that you can control their mix or balance.

Because this placement often results in a bassy tone quality, you'll have to roll

off some bass at your mixer until the sound is natural.

Many of the techniques suggested here apply when the instrument or voice is recorded alone, as for an overdub.

■ ■ ■

Bruce Bartlett is a microphone project engineer and technical writer with Crown International. He can be reached at 219-294-8000.

Figure 3. Stereo miking a grand piano.

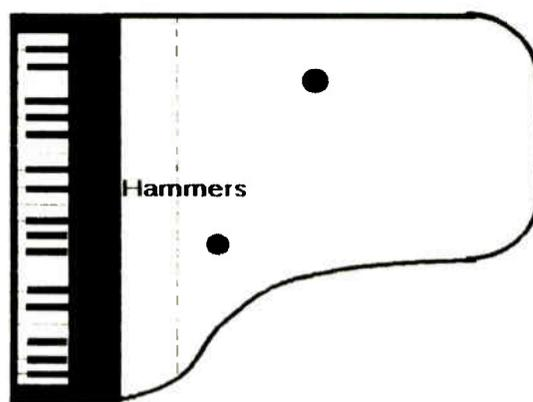

# PC Workstations Come of Age

(continued from page 28)

Studer's DE-4003 Digital Editor will control one or two analog/digital replay and one record deck, with full control of all three transports. The unit features AES/EBU and SDIF-2 input/output ports, and internal memory capable of storing up to 40 seconds of 16-bit stereo audio for edit location.

A high-speed sampling frequency converter enables the DE-4003 to perform rock-and-roll scrub editing. Up to three editing profiles, complete with level change and crossfades, can be stored for comparison.

WaveFrame Corporation's AudioFrame Digital Audio Workstation is a networked system of signal processing and recording modules connected to a master IBM

PS-2 System 50 (or similar) controller. The system is capable of accommodating sampling frequencies between 32 and 50 kHz.

Up to eight simultaneous channels can be input or output from each processing rack; additional racks can be connected to the host for extended capacity. New interface modules handle various combinations of AES/EBU, S/P-DIF, SDIF-1/-2 and other digital formats.

Yamaha's DMP7D all-digital eight-channel system is designed for use with the AD808 interface, which offers eight channels of high-quality A-to-D converters, and various interface units that provide digital connection to AES/EBU, SDIF-2 and other formats. The DA202 provides two channels of high-quality D-to-A conversion for monitoring the

DMP7D's master digital outputs.

In the same way that desktop publishing continues to revolutionize the print-based media, so digital workstations will streamline and enhance the creative capabilities of the radio broadcaster. Most of the hardware described here should be on display at the forthcoming NAB Convention in Las Vegas during late April; see you there!

■ ■ ■

Mel Lambert has been intimately involved with the production industries on both sides of the Atlantic for the past decade, and for seven years served as editor of Recording Engineer/Producer magazine. He is currently president of Media & Marketing, a consulting service for the professional audio industry.

## SOLID STATE POWER !

### IBSS PRESENTS CTE WORLD CLASS SOLID STATE FM POWER

- HIGH EFFICIENCY, AUTO PROTECT, DIGITAL CONTROLS
- FIRST IN THE WORLD WITH REAL AND AFFORDABLE SOLID STATE HIGH POWER!
- OVERALL EFFICIENCY—GREATER THAN 50%!

IBSS is your international headquarters for world class broadcast technology AM and FM shortwave.

ASK US ABOUT THE FABULOUS NEW CRL MBL-100 MODULATION CONTROLLER, SPECIFICALLY DESIGNED FOR VERY HIGH POWER AM AND SHORTWAVE.

*Best skywave performance, no transmitter modifications necessary*  
**SEE IT AT NAB BOOTH 1009**

WHEN IT COMES TO TRANSMISSION, CHECK WITH IBSS FIRST FOR YOUR FULL SYSTEM NEEDS, INCLUDING TURNKEY, PROPRIETARY AND CUSTOM AUDIO PROCESSING SYSTEMS—WE HAVE MADE SUBSTANTIAL IMPROVEMENTS TO THE EFFICIENCY OF EXISTING SYSTEMS ALL OVER THE WORLD

THE WORLD OF TECHNOLOGY IS AT YOUR FEET

- FROM 50 WATTS TO 2 MEGAWATTS
- FROM 200 KILOHERTZ TO 2 GIGAHERTZ

**WHEN YOU TAKE TO THE AIR WITH IBSS**

IBSS PUEDE PROBEER TRANSMISIONES AM de CUALQUIER FUERZA ESTADO SOLIDO HASTA 100 KW. NOSOTROS ESTAREMOS PLASENTEROS DE DARLE LA CUENDA EN SISTEMA COMPLETO DE INSTALACIONES TAN BIEN COMO DE SERVICIOS Y EQUIPO NECESARIO PARA MEJORAR SU INSTALACION ACTUAL—ESPECIALMENTE DE ALTO PODER AM Y ONDA CORTA

**IBSS**

P.O. BOX 303 Binbrook, Ont CANADA L0R 1C0  
FAX: 416-692-4033 PHONE: 416-692-3330 Telex (via Dialcom) 21:ILB001

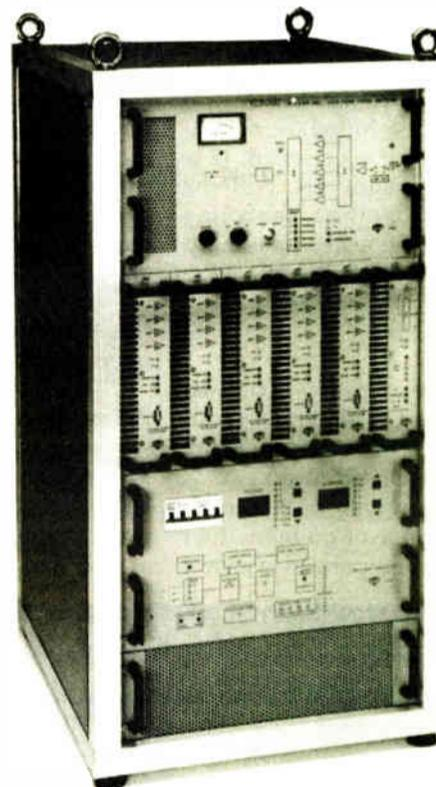

CTE 5 KILOWATT Solid State transmitter costs less than you would expect for solid state—learn more about CTE and maintenance-free solid state walk-away power—NAB booth 1032.

**nautel**

# Let Us Give You A Quote On Our Audio Switcher.

“When we designed our new 23,000 square-foot facility at KLBJ radio, a primary goal was to maximize operational flexibility. So, we looked at the alternate ways to route audio signals. We compared features and specs, as well as costs.

“ITC's AUDIO SWITCHER turned out to be an easy choice. One reason is it's designed specifically for audio applications.

“With the AUDIO SWITCHER, we're wired to and from every satellite, network, studio, and workstation. We're even wired to the Program Director's office. And installation was easy.

“That was September '87. Since then? The AUDIO SWITCHER has worked out wonderfully, and staff reaction has been very, very positive. Changes are easy, and when we reconfigure something, we save both time and money. As far as our return on investment goes, it's been excellent.”

—Bryan King,  
Chief Engineer, KLBJ AM-FM



What more can we say?  
If you'd like detailed information on how you, too, can easily and effectively route audio signals, call International Tapetronics, 3M Broadcasting and Related Products Department toll-free at 1-800-447-0414. In Alaska and Illinois, call collect, 309-828-1381.



**3M**

# This is Radio Systems.

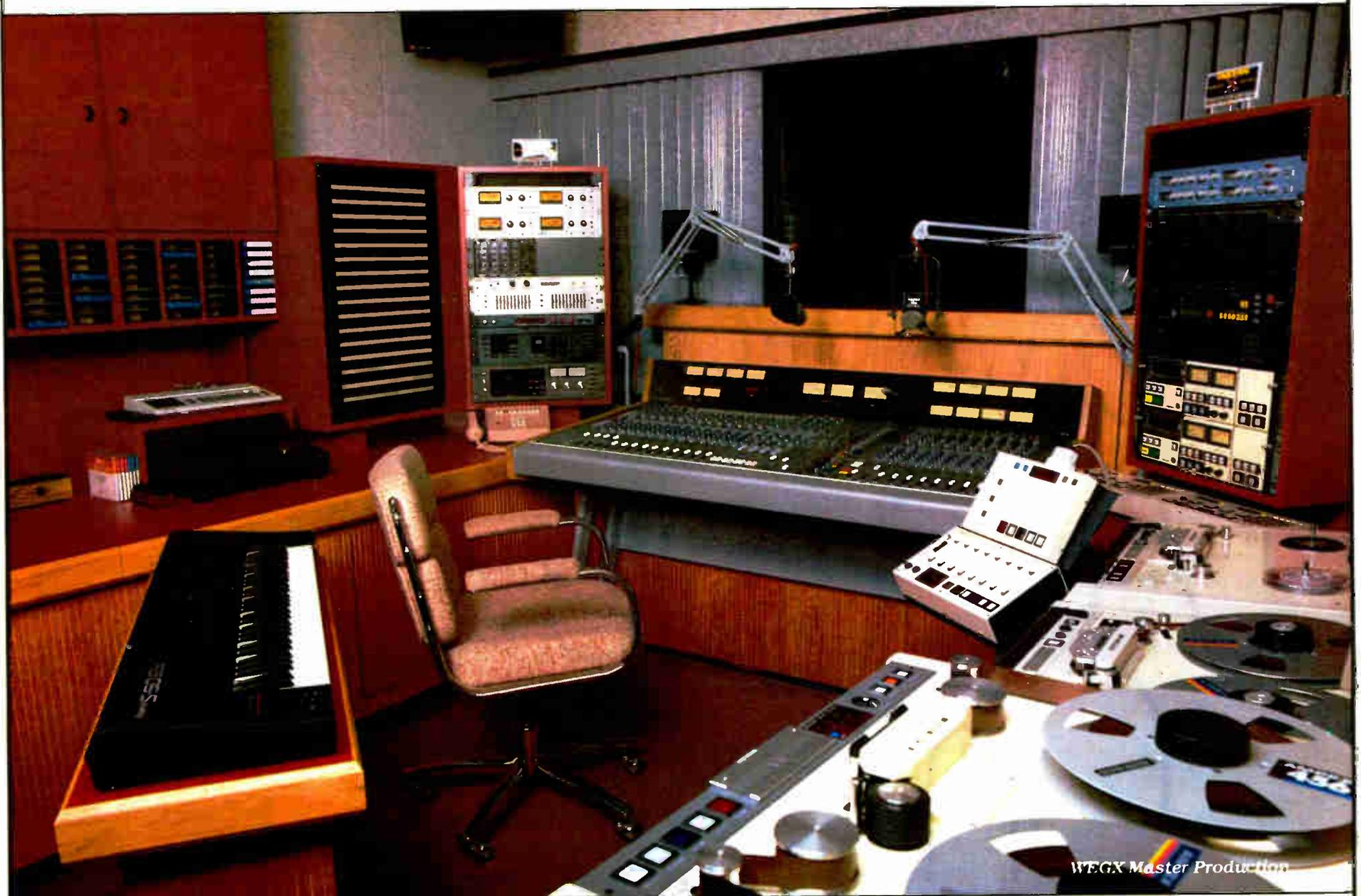

This studio didn't happen overnight. World-class radio facilities like this one are built for the nation's leading broadcasters by Radio Systems.

Why? Because the radio industry has entered a new age, and the entrepreneur who's looking ahead to the 1990's needs his or her radio station built fast, and built right.

Radio Systems is the only full-service radio equipment company. Custom design and wiring is our specialty. Our twelve-member installation department and 9,000 square foot woodshop allow

us to produce studios and RF plants, custom-suited to a station's needs. We're a manufacturer of control consoles, studio products and DAT machines. And we round out our capabilities by providing thousands of popular radio products.

The nation's leading turnkey system supplier is Radio Systems. Ask us for the names of more broadcast professionals who have found that facilities from Radio Systems were their best investment on the road to success in radio.

Then get ready to own the best broadcast facility available anywhere.

## Radio Systems Case Study.

**CUSTOMER:** WEGX, Malrite Inc.  
**MARKET:** Philadelphia, PA  
**PROJECT:** To design and install custom cabinetry and extensive studio interwiring in four studios, for Malrite's aggressive entry into the nation's fifth-largest radio market.



**RADIO SYSTEMS INC.**

110 High Hill Road ■ P.O. Box 458 ■ Bridgeport, NJ 08014-0458  
609/467-8000 ■ FAX 609/467-3044  
800/523-2133

See Us At The NAB!  
Booth #2037

Circle 48 On Reader Service Card

# Tale of Three Sisters

(continued from page 21)

MacLafferty—should he forget to top off the two 10,000 gallon tanks with diesel fuel before the snow flies.

"We go through 30,000 gallons a year and have storage for 20,000 gallons," according to MacLafferty. "That will get us through the winter so we can get the trucks up there to deliver in the spring."

"Usually around the middle of May I'll get a couple of truck-loads just to keep the fuel off the bottom of the tank. I don't like it to get below a couple thousand gallons. We could be in big trouble."

KBRD doesn't pipe fuel in for the same reason the station doesn't bring power lines up to the site. Fuel lines, like power lines, are too expensive to maintain. Instead, trucks make the long trek up to the site on logging roads to deliver fuel. "Normally, the site is accessible, even for a good part of the winter," said MacLafferty.

But then, there are winters when MacLafferty will hitch helicopter rides for two to three months of the season. This winter is one of them.

## Equipment and power

Although topping off the fuel tanks is the number one priority with the first hint of snowfall, MacLafferty said he also gives equipment a thought or two in the winter—and the summer. "I have an auxiliary transmitter up there; redundant STLs, redundant control systems.

Everything is redundant. Double redundant!" he added.

Everything, however, hinges on getting power to the stock of equipment that MacLafferty keeps on hand. But then, MacLafferty has already thought of that. "We have an alternate site at View Park.

It's only a 10 kW ERP, but it sure is better than being dark," MacLafferty explained.

cassion, although not for very long. MacLafferty recalled one incident when the diesel fuel system went south and starved the engines. "What happened is that one of the transfer pumps broke. We were at View Park, our alternate site, for only about four hours."

The chances of tapping into electrical power in the near future are slim, if not nil, for the site. Although the site is also home to a sheriff and fire department repeater station and a Motorola repeater station, both of which generate their own power, MacLafferty doubts that they'll

have new neighbors any time soon. It would take a few new utility customers to justify the expense of routing power lines to the site.

## Advantages of Three Sisters

Although MacLafferty has experienced some unique engineering problems with the site—not to mention the inconvenience of helicopter travel—he does maintain that the site has its advantages. As inaccessible as it is, the height above average terrain surrounding the station's tower is only 1620 feet.

"There's a lot of high ground behind us," he said. "And because of this, although we're 4000 feet above sea level, we're able to run a full Class C."

Lightning hits are also rare. "There are no power lines to hit to act as an antenna," said MacLafferty, although he ad-

mitted that occasionally lightning does hit the tower.

"But," he added, "rarely does it do more than bump us off the air temporarily."

Another unique feature of the site, one that MacLafferty is not altogether sure is a benefit, is the hour and a half drive—road conditions permitting—to the transmitter during off-air emergencies.

"Most engineers have a 15 or 20 minute drive to worry about what went wrong. I have an hour and a half!" noted MacLafferty, adding, "It's very disconcerting if you drive up there and it's too quiet."

■ ■ ■

Dee McVicker is a free-lance writer with a long record in equipment sales. Comments on articles and inquiries about her writing service can be taken at 602-899-8916.

From Radio Systems & Sony

# DAT that works... and works and works!



### It Works For Automation

Replace a cart carousel or several reel-to-reel decks with one RS-1000 DAT machine.

### It Works In the Studio

The RS-1000 works as a live source in your air studio, or for production dubbing.

### It Works For Archiving

Put your entire music library onto digital storage. Each tape holds two hours...digitally.

### Let the RS-1000 work for you!

he only DAT machine with all of these BROADCAST features:

- Full Remote Control
- 44.1 kHz Sampling
- RS-232 Serial Interface
- Automation Interface
- End-of-Message Signals
- Auto Cue-to-cut
- No Cut Play-through
- Large Broadcast Controls
- Balanced Inputs and Outputs
- And Plenty More!



Let Radio Systems and Sony bring the magic of digital audio tape to your radio station.

## RADIO SYSTEMS INC.

110 High Hill Road ■ P.O. Box 458 ■ Bridgeport, NJ 08014-0458

609/467-8000 ■ 800/523-2133 ■ FAX 609/467-3044

# Pass-Reject

(continued from page 31)

We're done.

A few construction notes are in order at this point. Pass coils should be at mutual right angles with respect to reject coils. Keep the distance AB short.

Reference short circuits and J-plugs should be permanently built in just as in the case of test points on a PC board. The toroidal sampling transformer should be permanently installed for both adjustment and future checks.

I have discussed how simple cause-and effect logic combined with a knowledge of the basics can allow us to adjust pass-reject traps with maximum accuracy.

Stray parasitic reactances are absorbed into the act and out of our hair. No bridges are needed at all and are, in fact, quite undesirable.

No bridges? That's right, no bridges. Entire directional arrays have been tuned fully, completely and accurately, with precision transmission line matching and strict adherence to design centers.

This was done with no bridges and with such ease that the motions one goes through put the adjusting engineer in the position of being little more than a human servomotor.

It's beyond the scope of this paper but if your curiosity is piqued, call me for a copy of an IEEE paper on this subject.

■ ■ ■

Frank Colligan can be reached at 301-229-5577.

# How to Avoid Stiff FCC Fines

(continued from page 18)

Many EBS encoder/decoder systems loop the encode tones to the decoder during a test transmission. Your operators should insure that the EBS decoder trips when you send a test, giving a preliminary quality check on the tones. One station was cited for sending only one of the two EBS tones.

Your EBS generator must be type accepted or tested to meet the type acceptance specifications [73.942]. It is unlikely that

cart machines have been tested to meet the requirements of 73.940, so the EBS tones in your test *cannot* come from the cart machine.

Further, make sure the script on your EBS test cart matches that in the EBS Checklist. Don't mess with it by trying to make it a little more entertaining.

## EBS logging

Call the designated chief operator (DCO) at any station monitoring you. Ask her/him to

call you immediately if a week goes by without receiving a test from you.

Occasionally, check the frequencies of the EBS generator (853 and 960 Hz,  $\pm 0.5$  Hz). Check the duration of the tone transmission (20 to 25 seconds). The FCC often checks the tone duration during an inspection.

Note that 73.906(c) requires each of the EBS tones to modulate the transmitter at least 40%, and the tones must be within 1 dB of each other. Many stations

operate the EBS generator (encoder) prior to the audio processor in the audio chain. This makes level testing difficult.

As a minimum, you might insure that the tones leaving the generator are within 1 dB of each other. This is easily checked, because generators are required to have a way of sending one tone at a time for testing.

Because the tones are only 0.17 octave apart, it is unlikely that any equalization or pre-emphasis will introduce 1 dB of twist. However, the audio processing may reduce the modulation below 40% on each tone. You can check this by ad-

justing the modulation monitor peak flasher control down until the light comes on. The light should come on with the peak flasher set to 80% (40 for each tone) or above.

Make sure the EBS receiver is tuned to the assigned station, and that station is audible whenever your station is on the air. One station was cited for having the receiver tuned to itself; others were cited for having no station audible on the receiver.

If you cannot hear your assigned station, try a bigger antenna, or get your assignment changed. FCC rule 73.931(d) requires stations to check the EBS receiver (or wire service or network) to ensure EBS has not been activated prior to beginning station operation.

This is an excellent opportunity to have the sign-on operator ensure the receiver is operating properly on a daily basis. Have the operator log the results of this check. This demonstrates compliance with 73.931(d) and further insures any receiver failure will be quickly noticed.

Many stations have been fined \$300 for not logging in the EBS tests transmitted and received each week. These are to go in the "station log," which is to include the signature of any operator making a log entry.

## DCO log review

Most of the violations (and fines) I saw would not have occurred if the DCO was making the required log review [73.1870(c)(3)]. Here are a few things to check in your weekly review.

First, make sure that all logged parameters indicate operation within terms of license (especially power, DA parameters and power/pattern change times).

All logs should be signed by licensed operators making log entries. Further, these licenses (or permits) should be posted at the principal control point.

The log must indicate a daily inspection of tower lights.

Check for the daily EBS receiver check described above [73.931(d)].

Check to insure an EBS test was transmitted and logged (8:30 AM to local sunset).

Check to insure an EBS test was received and logged.

By the way, I've received several calls recently regarding the public file. Many people wanted to know where to get a copy of *The Public and Broadcasting—A Procedure Manual* which must be in the public file [73.3526(a)(6)].

You can get a copy from the FCC Office of Consumer Affairs by calling 202-632-7000.

Harold Hallikainen is president of Hallikainen & Friends, a broadcast equipment design, manufacture, sales and installation firm. He can be reached at 805-541-0200.

## Rigid Coaxial Transmission Lines Deliver Low Losses...High Gains.

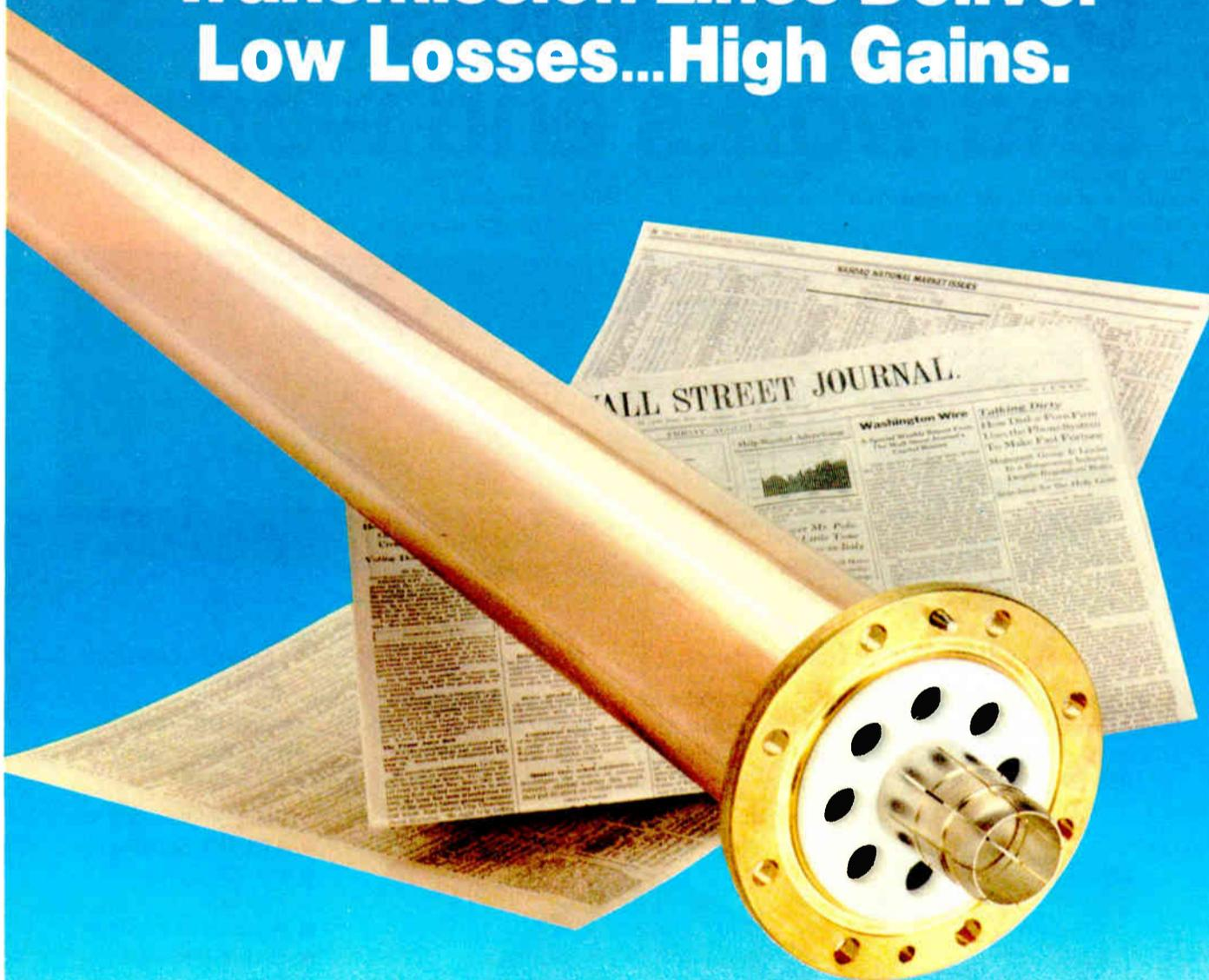

Cablewave Systems delivers everything you need and expect from Rigid Coaxial Transmission Line performance...superior quality, plus optimum mechanical and electrical specifications.

To achieve this, Cablewave Systems fabricates high conductivity, hard-drawn copper tubing with precision machined, pin-type Teflon dielectric insulators. Standard 50 ohm transmission line is offered in sizes from  $\frac{7}{8}$ " thru  $9\frac{3}{16}$ "; 75 ohm in  $6\frac{1}{8}$ " and  $9\frac{3}{16}$ ". All utilize EIA bolt type flanges and inner connectors compatible with EIA

standards, MIL specs and international IEC recommendations. Aluminum outer conductor 50 and 75 ohm transmission lines are available on special order.

To complement our full line of Rigid Coaxial Transmission Lines and accessories, Cablewave Systems also manufactures a complete line of semi-flexible air and foam dielectric coaxial cables and connectors.

For a copy of our 48 page Rigid Coaxial Transmission Line catalog and information on other broadcast and RF communication products, contact Cablewave Systems.

**Cablewave Systems**

**DIVISION OF RADIO FREQUENCY SYSTEMS, INC.**  
60 Dodge Ave., North Haven, CT 06473 • (203) 239-3311



# Roaring '20s' Call Signs

(continued from page 29)

These three complete lists and the station indexes of 1929, 1937 and 1938, loaned to me by Bob Nicholas, make exciting reading.

I wonder how many people knew that Hood River, OR had two stations licensed to the town in 1923. KFHB, issued to P.L. Boardwell, operated at 10 W; KQP, issued to Apple City Radio Club, also had power of 10 watts.

Both stations were evidently short-lived. KQP was listed in 1926, but in Portland, OR, with power of 500 W and transmitting on 212.6 Meters.

The call seems to have vanished, because it does not appear in the *All American Official Radio Log* of 1929, the *Radio Index* of December 1938, or the current edition of *Broadcasting Yearbook*.

Another interesting station that lasted until 1928 was KFEY, licensed to Kellogg, ID. The KFEY license was issued to Bunker Hill & Sullivan Mining & Construction Co. It would be interesting to see how long the station lasted, or if it ever got on the air.

Was the station used to promote the mining company? Was the purpose entertainment? Perhaps the wife of the company president wanted nothing more than to present her favorite music or drama group.

Kellogg is supposed to get an AM and FM station in the near future, if they are not already on the air.

How many have driven between the towers of KWAL in Wallace, ID? The In-

terstate Highway goes between the towers. Wonder what happened to the radials when the highway was built.

One of the old time stations here in the Los Angeles area is KNX, now owned by Columbia Broadcasting. The station was listed as a new station in June of 1923. The license was issued to Electric Lighting Supply Co., Los Angeles, for a station with 250 W of power. What a mighty oak has grown from such a small acorn!

How true the stories are, I do not know, but I was told that three of the local calls here in Southern California were taken from either the location, or the company initials.

KRKD was supposed to have been taken from the location of the station which was in the Spring Arcade Building—thus the "R-K-D". It's an old and still-standing landmark building in Los Angeles.

KNX was located in the annex of the Spring Arcade Building, so NX was supposed to have indicated the location as in the "other building."

MacMillan Petroleum Company put KMPC on the air, so there were the company initials out there as a subliminal advertising message.

Woodmen of the World started WOW in Omaha, hence the origin of the call. WOW went on the air in April 1923, KMPC went on in February 1927 and KNX is credited as going on the air September 1920.

But if KNX went on in 1920, why did

## 57 YEARS AGO

Editor's note: The *RW* of today and the *RW* of old, printed for a period of time in the 1920s and 1930s fortuitously share the same name. In the '30s the *RW* of old changed its look and since the *RW* of today has done likewise with this issue this ad seemed especially appropriate.

### REVISED CODE PROPOSED BY RADIO BOARD

Washington.

Secrecy regarding a proposed new code for the Federal Radio Commission was dispelled when the details were made public by the Commission simultaneous with transmission to Congress of proposed legislation.

The Board proposes:

Station license limitation to one year, instead of three years.

A strong anti-lottery law.

Right to suspend station licenses for 30 days as a milder preventive measure than cancellation.

1600-1700 kc band for television instead of 2850-2950 kc band, sound track on 1550 kc.

#### New Rule for Records

Phonograph records, call letter announcements, and quota distribution also are covered.

Regulations relating to announcements of transcription and phonograph broad-

casts, now General Order 78, will specify only that language describing such production be "clear."

"A mechanical reproduction shall be announced as such just before it is broadcast, except when its use is merely incidental, as for an identification or background. The exact form of announcement is not prescribed, but the language shall be clear and in terms commonly used and understood. The following are examples of statements sufficient for the purpose:

"(a) 'This is a mechanical reproduction.'

"(b) 'This is a player-piano record.'"

#### WMAK Ordered to Quit

WMAK, Buffalo, N. Y., has been ordered off the air by the Federal Radio Commission. The station was operating on a frequency of 1,040 kc. with a power of 1,000 watts and was operated by the Buffalo Broadcasting Corporation.

The Buffalo area would receive adequate service without WMAK, the Commission stated in its decision. The Commission's action sustained Examiner Ralph Walker.

it take *Radio News* until June 1923 to list KNX under the heading of New Broadcasters Licensed? Lest someone object, I will accept *Broadcasting Yearbook* as being the more reliable of the two publications.

Does anyone have any idea as to how WIBU, Poynette, WI got its calls? Jack Parker, on the staff at WUBE in Cincinnati told me the history as he heard it,

so let the answers fly, and we'll see how much legend and how much history there is out there.

George Riggins has experience in radio and electronics dating back to the 1930s. He is also a licensed ham operator and has had his own broadcast sales and service company, Riggins Electronic Sales, for over twenty years. He can be reached at 213-598-7007.

# Splatter matters.

Splatter is a form of radio interference that can drive listeners away from AM radio. It creates distortion in your signal, wastes transmitter power on undesired sidebands and interferes with other stations. Even with an NRSC audio filter, misadjustment of the transmitter or audio processing equipment can still produce an RF spectrum that can exceed NRSC or FCC limitations.

That's why routine monitoring of your station's RF spectrum is a must. But it doesn't mean you'll have to bust your budget on a spectrum analyzer. It just means you need the rugged SM-1 AM Splatter Monitor from Delta Electronics.

For just \$2,150 you can now accurately measure your transmitter's spectral output, monitor transmitter IPM levels and make adjustments to improve clarity. An external audio input helps identify splatter sources.

The Splatter Monitor's unique offset feature tunes spectral segments for closer examination 10 kHz to

100 kHz away from the carrier. Unlike a spectrum analyzer, you can listen to the front panel speaker or your own headphones as you measure splatter levels on the front panel meter. The Splatter Monitor also has an alarm output to drive your remote control.

In this day and age where splatter matters, monitoring it doesn't have to cost you a fortune.

To find out more about the new Delta Splatter Monitor, call (703) 354-3350, or write Delta Electronics, Inc., 5730 General Washington Drive, P.O. Box 11268, Alexandria, VA 22312.

The Above Standard Industry Standard.

DELTA ELECTRONICS

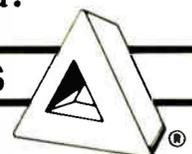

©1988 Delta Electronics, Inc.

# Any of these problems sound familiar? Get to know Modulation Sciences' composite baseband solutions.

## Solutions

### Problems

- Transmitter noise, heat, RF field interference and physical location make the transmitter room a poor place to locate the stereo generator and audio processing. Necessary and critical adjustments are inconvenient at best; nearly impossible at worst!
- Lossy, expensive, hard-to-install 950 MHz semi-rigid coax is often impractical to run from the studio to the STL antenna on the roof.
- Fire codes won't let you run PVC jacketed coax through the ceiling, except in very expensive metal conduits.
- Long composite runs at the transmitter or studio pick up ground loop hum.
- You need to drive multiple exciters without composite level changes and switching or relay hassles.
- The station has two stereo generators and two transmitters. You want a simple way to matrix-switch them without requiring complex backloading.
- It's a pain to use your spectrum analyzer and other test gear to make composite measurements because of the hassles of interrupting the air feed to connect them.
- The PD, the CE and the GM all want to monitor and measure the station's quality. But buying three modulation monitors is out of the question.
- Keeping tabs on the competition's signal quality is important, but it's inconvenient and expensive to do.
- Lots of boxes use composite baseband—the STL, stereo and SCA generators and more. You need an easy, economical way to test their performance, and directly measure composite baseband signals.
- The station has an old modulation monitor gathering dust. You don't trust the readings, but can't it still be useful?

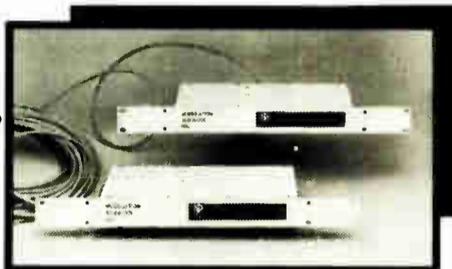

**Modulation Sciences' CLD-2501/2 Composite Driver/Receiver**

- ✓ Lets you put your stereo generators and audio processing where they belong—at the studio.
- ✓ Supports up to 3000 ft. (or two miles, on special order) of flexible, inexpensive, twinax cable – standard or PTFE-jacketed for plenum runs.
- ✓ Fully balanced against hum and noise pickup.
- ✓ 100 dB of immunity to ground-loop related noise and hum.
- ✓ Exceptional stereo separation and SNR performance.
- ✓ One driver can supply two independent receivers (each up to 3000 feet away in different directions) with composite stereo baseband audio and all SCA's.
- ✓ Works with 78 ohm twinax (Belden 9463) twinax for indoor service and 150 ohm twinax (Belden 9182) for outside or direct burial.



**Modulation Sciences' CLD-2504 Composite Distribution Amplifier**

- ✓ Makes distribution of composite baseband signals as easy as distributing audio.
- ✓ 1 composite input, 4 composite outputs.
- ✓ Unity gain with > 50 dB isolation between outputs.
- ✓ High impedance 50Ω input, low impedance outputs.
- ✓ BNC connectors on input and all outputs.
- ✓ Basic performance specs similar to Composite Line Driver.



**Modulation Sciences' FM ModMinder™**

- ✓ Provides all essential measurement functions of a high-quality modulation monitor when fed by any composite baseband audio source.
- ✓ Works with any wideband source of demodulated FM—even consumer tuners or stereo receivers.
- ✓ Displays total modulation percentage, overmodulation peaks, stereo & SCA subcarrier status, subcarrier injection level, allowable increase in modulation—all for about half the cost of a modulation monitor.
- ✓ If you have an old modulation monitor—even one that reads unreliably—that oldie's demodulator section can drive ModMinder. You get unbeatable accuracy at a \$3000 savings over the cost of a new modulation monitor.
- ✓ Plug-in cards adapt ModMinder to measure SCA subcarriers on non-standard frequencies.

**W**hether you have these audio distribution or measurement problems, or some unique puzzles of your own, Modulation Sciences has the convenient, cost-effective composite tools to help you solve them. Any further questions? Of course—so call 800-826-2603 Toll-Free for complete information and specifications on Modulation Sciences' Composite Problem Solvers.

**modulation sciences, inc.**

115 Myrtle Avenue • Brooklyn, New York 11201 • Tel. 718-625-7333 • Toll Free 800-826-2603



# Broadcast Equipment Exchange®

"Broadcast Equipment Exchange" accepts no responsibility for the condition of the equipment listed or for the specifics of transactions made between buyers and sellers.

## AMPLIFIERS

### Want to Sell

KLH 35 stereo amplifier & tuner, less speakers, \$25. P Russell, Bowdoin College, AV Services Sills Hall, Brunswick ME 04011. 207-725-3066.

Ramko SMA-1000E monitor amp, \$75; Stanton phono 310, \$150 ea. Clark B. WFAS, Secor Rd, Hartsdale NY 10530. 914-693-2400.

Spotmaster DA amps, \$75 ea. B Roberts, ARP Studios, POB 325, Mt Pleasant SC 29465. 803-928-3663.

McIntosh C26 preamplifier, solid state unit in mint cond, \$500; McIntosh MC2105, solid state power amplifier 105 watts per chnl, mint cond, \$600. W Konetsko, 135 A Victoria Cover, Greenville NC 27834. 919-355-3079.

Dynaco 70, tube power amp, 35W per chnl, untested, looks clean, \$50/BO. M Gottesman, KSGT, POB 100, Jackson WY 83001. 307-733-2120.

Quad II amp, tube amp, excel cond, sell pair, \$150 ea. C Richardson, Richardson Recdng, 1938 Balt. Annap. Blvd., Annapolis MD 21401. 301-757-3733.

### Want to Buy

EICO HF89, HF85 stereo amps; HH Scott 299D amps; GE AI-320 amps; CCA/QRIT ultimate turntable pre-amps, any cond. K Smith, RR 3 Box 483A, Gorham ME 04038. 207-929-6129.

RCA amps monitor or booster. B Davies, Virgo Prod, 5548 Elmer Ave, No Hollywood CA 91601. 818-761-9831.

Dynaco Stereo 70, any age, any cond. P Hons, Mainline Comm, Poplar St, Portese PA 15946. 814-736-3883.

## ANTENNAS & TOWERS

### Want to Sell

Cablewave FCC 78 50J 155' of 7/8" heliax, in two pieces of 75' ea, BO. M Black, WEOS, Hobart & William Smith College, Geneva NY 14456. 315-789-8970.

LP's & 45's, A/C, top 40, 60's, 70's, & 80's, mint cond, \$245's & \$6/LP's. P Wolf, 813-574-5548.

Celwave power divider 1, 3-1/8 input port by 8, 1" output ports (2), never used & capped, \$2500 pls shpg. B Roberts, ARP Studios, POB 325, Mt Pleasant SC 29465. 803-928-3663.

Celwave 2-bay tuned to 103.1, used less than 4 yrs, heaters included, \$1000. D Mance, WTOJ, 199 Weatha Ave, Watertown NY 13601. 315-782-1240.

ERI LPC-11 FM antenna, 106.7 MHz 11 bay low power w/radomes, max output 50 kW, max input 9.5 kW, make offer. J DeGroot, WKPK, POB 190, Gaylord MI 49735. 517-732-2474.

ERI 2 bay, tuned to 103.9, 3.5 yrs old, taken out of srvs 11/88, BO. R Eller, KBUS, 2775 NE Loop 286, Paris TX. 214-785-1068.

Jampro 2 bay 103.9 w/heaters, \$700. Clark B, WFAS, Secor Rd, Hartsdale NY 10530. 914-693-2400.

Phelps-Dodge 12 bay, 300', utility tower wide-icers tuned to 101.1; 250' 3-1/8" flex line avail approx 1 Mar 89; Harris SX-1A, fire damaged, repairable or many usable parts; also SX-1A spare parts kit; RCA BTA-500R AM xmr for parts. John or Mike, KMZU, 102 N Mason, Carrollton MO 64633. 816-542-0404.

Phelps Dodge 2-bay (2), avail now, \$1000 ea. D Brown, KMCD, 57-1/2 Count St, Fairfield IA 52556. 515-472-4191.

Shively 1413-1, 4-1/8" x 20" rigid coax line, 520' (26) sections, \$250 per section, gd cond. J Pollet, WRNO, 4539 I-10 Serv Rd, Metairie LA 70006. 504-889-2424.

Dielectric coaxial switcher, 3 ports, 1-5/8", 10 kW description, negotiable. C Harrison, Boise Viking Assoc., 5601 Cassia St, Boise ID 83706. 208-344-3511.

Four Bay ERI FM-CP, medium power, near Joplin MO, \$2500. B Dodge, WTUJ, POB 105FM, Hinsdale NH 03451. 603-336-5848.

Phelps-Dodge 2-bay antenna set up, tuned to 88.3 MHz FM, foam filled, BO. Pat Layman, WEAX, Stewart Hall, W Park St, Angola IN 46703. 219-665-3314.

RCA 51.5 ohm solid transmission line, 20' sections, sweep 'L's. K Dick, WVVA, R460 By Pass, Bluefield WV 24701. 304-325-5487.

Scully PR 450-U (2), 4 yrs old, call. J Evans, KNTI, 75 Fourth, Lakeport CA 95453. 707-263-1551.

Truscon solid rod guyed, insulated steel tower, 300', 48" face w/60' top mounted pole. Galvanized & painted, lighting, \$13,000. B Glasser, WHBC, POB 9917, Canton OH 44711. 216-456-7156.

Zenith 3 phase automatic transfer switch, never used, rated 30 kW, \$500. K Dick, WVVA, R460 By Pass, Bluefield WV 24701. 304-325-5487.

Andrew 3' transmission line, about 375' w/end & hangers; about 236' of Cablewave 3' line w/ends; numerous hangers for 3-1/8" rigid transmission line. A Wortmann, WJAG, 309 Braasch, Norfolk NE 68701. 402-371-0780.

Cablewave heliax, 30' of 3" cable, \$2700; RCA stealite coax line, type MI-19314, 1180' rigid copper transmission line, 51.5 ohms impedance, \$600 per section; UTC solid rod tower w/guys & hardware, 500' standing, galv steel, hot dipped, code painted, 380' 3/8" & 120' 24" face, \$2500/BO. T Snider Jr, KIPR, 955 Plaza West Bldg, Little Rock AR 72205. 501-661-7501.

Celwave CFM-LP1 one bay Fm antenna, 4 yrs old, \$750. L Blakeney, WBBS, Rte 2, Box 273B, Taylorsville MS 39168. 601-729-8100.

E.F. Johnson 17 KV DPDT RF contactor, brand new, \$250 plus frt; EF Johnson 5 kW ATU, complete but old, \$150 plus frt. D Gilliam, 1555 W Pampa, Mesa AZ 85202. 602-839-1901.

ERI FML3E 3 bay in crates (10), \$3000; Andrew, misc 1-5/8" connectors, all new. J Phillips, WZOM, 414 Washington, Defiance OH 43512. 419-782-8591.

Phelps Dodge CP1000-4, 4 bay antenna, needs work at 89.7 w/3 radomes, BO. M Black, 315-789-8970.

RCA 20' rigid section, 3-1/8" line w/RF watt-meter connection, 50 ohm rated 10 kW for UHF, \$150. C Haynes, POB 31235, Jackson MS 39206. 601-948-1515.

Utility tower mdl 340, 300', 18" guyed & hardware on the ground. D Barton, KMTI, POB K, Montil UT 84642. 801-835-7391.

### Want to Buy

360' tower to support 3 to 4 bay FM antenna & 3 to 40 LPTV chnl 6 antennas. D Jordan, WDTM, POB 3417, Jackson TN 38303. 901-668-1153.

5 Bay FM antenna at 91.5 MHz & 5 bay antenna at 88.3 MHz for educational FM. K Hill, WHCB, POB 2061, Bristol TN 37621. 615-878-6279.

Phelps Dodge/Celwave CP1000-4 radome needed for FM antenna. M Black, WEOS, Hobart & William Smith College, Geneva NY 14456. 315-789-8970.

10 Bay FM CP antenna for 98.5 MHz, 20 kW de-icers needed. B Dodge, WTUJ, POB 105FM, Hinsdale NH 03451. 603-336-5848.

Dismantled, 500-550' tower, gd cond. Howard, 1220 4th SW, Rochester MN 55902. 507-288-1971.

Guyed FM tower, 340-400' in vg or excel cond, no scrap metal. R Weaver, WPGW, POB 1440, Portland IN 47371. 219-726-8780.

TV transmission line, 4', 950' vertical, plus 50' horizontal, No 6" line please, mounting hardware a plus. A Ezekiel, 215-848-4501.

UHF antennas & splitter & 100 W or 1 kW UHF video xmr. R Destefano, AACR, 156 Lezelle, Worthington OH 43235. 614-846-9234.

One bay FM educational antenna for 91.1 MHz. D Walkden, KFGG, Rt 3 Box 440-F, Corpus Christi TX 78415. 512-265-9600.

## AUDIO PRODUCTION

### Want to Sell

Allison Research Kexex 500 w/LX-100 power supply, \$150/BO. K Smith, RR 3 Box 483A, Gorham ME 04038. 207-929-6129.

Eventide H969 harmonizer, \$2250. G Spaniola, Seller Snd Std, 5014 Peekskill, Sterling Heights MI 48310.

Rane ME-15 stereo graphic EQ, 2/3 octave, absolutely mint, \$250. M Osborne, WKSQ, POB 9494, Ellsworth ME 04805. 207-667-7573.

Shure M68 microphone mixer, 6 chnl, \$75. M Skinner, Color County Bdctg, 341 So Bluff St, St George UT 84770. 801-673-1450.

Shure M68 microphone mixer, 6 chnl, \$75. M Skinner, Color County Bdctg, 341 So Bluff St, St George UT 84770. 801-673-1450.

Shure M63 audio master EQ, companion to M67 remote broadcast mixer, fair cond, \$50. D Sites, 5809-K Cambridge Dr, Springfield VA 22152.

Teac 4 chnl mixing board, vgc, \$175. W Dougherty Jr, WLD Recdng, Music Valley Rt 1, Mill Spring MO 63952. 314-998-2377.

Texar Prisms (2) w/manual, \$2500. S Karwan, KCMJ. 619-320-6818.

Orban 245F stereo synthesizers (2), brand new, unused, current model, \$250 ea. Call Steve 303-499-5533 after 6PM, MST.

Orban 245E stereo synthesizer, BO. J Corcoran, KWWW, POB 638, Wenatchee WA 98801. 509-662-7135.

Dorough DAP310 mono, works, \$275. F Laverman, WMAM, POB 609, Marinett WI 54143. 715-735-6631.

Orban 516EC 3 chnl sibilance controller, excel cond, \$275. P Smith, Summit Recdng Sld, 10639 W Warren, Lakewood CO 80227. 303-985-1993.

Orban Optimod 8000A, factory refurbished, \$1700. J McDermott, KCVO, POB 800, Camdenton MO 65020. 314-346-2763.

Orban 9100A2 stereo, has NRSC update, excel cond, \$2500/BO. P Delaney, WLXR, 201 S Main, LaCross WI 54601. 608-782-8335.

### Want to Buy

## WANTED PULTEC EQ'S

We will pay \$1000.00 for almost any Pultec program EQ models EQP1/EQP1A/EQP1A3.

We will pay \$1500.00 for any Fairchild 660 and \$3000.00 for any Fairchild 670.

Also wanted: EQH2/EQH3/MEQ5/MAVE/C/MB1/TTI & SONTEC EQ any S/ tube or ribbon mics and limiting amps.

**CALL OR WRITE TO:  
Dan Alexander Audio  
2944 San Pablo Ave.  
Berkeley, CA 94702  
(415) 644-2363  
FAX: 415-644-1848**

Orban 8000A & 8100 stereo processors wanted. Cash paid. Please call for quote. Jon Hall, Hall Electronics, POB 7732, Charlottesville VA 22906. 804-977-1100.

Texar audio prisms. J Bahr, WVIS, Box 487, Frederiksted, St Croix, US Virgin Islands, 00841. 809-778-5199.

## AUTOMATION EQUIP

### Want to Sell

Broadcast Products & SMC AR-2000B automation system, controller, (6) Carousels, power supply & tape reader. Includes clock & racks, working, \$3500. J McDonald, Wind River Group, Box 481, Broomfield CO 80020. 303-669-3442.

Sono-Mag 250 (3) stereo Carousels, working when system updated, includes manual, spare cards, rack mounted, \$450 ea or \$1200/all or make offer. R Dammon, WKIL, POB 278, Albany OR 97321. 503-926-2233.

IGM Go-Card 24, 3 yrs old, 300 hrs, like new, all manuals & hardware, \$1000; Sono-Mag 24 tray Carousel, rebuilt 1985, less than 300 hrs use, vgc, \$700. M Crouch, WCHE, 119 W Market St, W Chester PA 19382. 215-692-3131.

IGM Go-Card 24, 3 yrs old, 300 hrs, like new, all manuals & hardware, \$1000; Sono-Mag 24 tray Carousel, rebuilt 1985, less than 300 hrs use, vgc, \$700. M Crouch, WCHE, 119 W Market St, W Chester PA 19382. 215-692-3131.

Kohler automatic transfer switch, solid state, 70 amp single phase. J Lackness, KRIA, 512-828-3737.

SMC Mini-Pro System programmer, 350RS Carousels, (2) RSC-100 Carousel programmers & (2) racks, excel cond, perfect for Satellite. J Bassett, 8787 San Pedro Way, Elk Grove CA 95624. 916-686-6613.

# baei

THE ONLY NAME IN  
**BROADCAST AUTOMATION**  
YOU NEED TO KNOW

To Find Out More  
Call or Write. Better Yet,  
Visit NAB Booth Number 7226

# baei

BROADCAST AUTOMATION INC

4125 Keller Springs Suite 122  
Dallas, Texas 75244-2012  
(214) 380-6800

for the  
**BEST**  
for  
**LESS**  
call us  
**LAST**

Audio & Video  
Equipment & Supplies

Toll-Free in 50 States  
(800) 356-5844

Wisconsin: (800) 362-5445  
Consultation: (608) 271-1100  
Fax: (608) 273-6336

Amplifiers  
Books  
Cases & Cabinets  
CD Players  
Hard of Hearing  
Headsets & Intercoms  
Lighting  
Microphones  
Mixers  
Recorders  
Duplicators  
Signal Processing  
Speakers  
Stands  
Synchronizers  
Tape & Accessories  
Theatrical Supplies  
Turntables  
Video  
Wireless Mics  
and more!

FULL COMPASS SYSTEMS

6729 Seybold Rd. Madison, WI 53719

**AUTO... WTS**

**Kohler automatic transfer switch**, solid state, 70 amp single phase. J Lackness, KRIA, 512-828-3737.

**SMC Mini-Pro System programmer**, 350RS Carousels, (2) RSC-100 Carousel programmers & (2) racks, excel cond, perfect for Satellite. J Bassett, 8787 San Pedro Way, Elk Grove CA 95624. 916-686-6613.

**Sono-Mag MSP1 automation control head**, 2000 event random access, \$3000; Sono-Mag 450 (2) bi-directional mono Carousels, \$1600 ea. W Hanlon, WKFD, 19 Updyke Ave, N Kingstown RI 02852. 401-295-8808.

**Sono-Mag MSP1 automation control head**, 2000 event random access, \$3000; Sono-Mag 450 (2) bi-directional mono Carousels, \$1600 ea. W Hanlon, WKFD, 19 Updyke Ave, N Kingstown RI 02852. 401-295-8808.

**Harris SC-90 controller**, numeric logging, console & power supply, SMC 250 RS Carousel w/interface, BO. B Glasser, WHBC, POB 9917, Canton OH 44711. 216-456-7166.

**IGM Basic A R-R cards**. E Kazmark, KAPA, 2065 Ocean, Raymond WA 98577. 206-875-5551.

**Otari ARS-1000 R-R playback decks** (2) for automation systems, vgc, \$700 ea/BO. C Gustafson, WKZO, 590 W Maple, Kalamazoo MI 49008. 616-345-2101.

**SMC Mini-Pro controller**, (3) 350RS SMC Carousels, (2) RSC-100 Carousel programmers, (2) racks, excel cond, \$8200 FOB Yuma AZ. J Bassett, 699 S Avenue B, Yuma AZ 85364. 916-686-6613.

**SMC 450 mono bi-directional Carousel** (2), \$1625 ea or \$3250/both; SMC MSP-1 2000 event automation control head (RAM), \$3200. W Hanlon, WKFD, 19 Updyke, N Kingstown RI 02852. 401-295-8808.

**SMC DS-20 switcher**; DP-2 Brain; PDC-3A clock; RAC-20 remote control; (3) TS-20 tone sensors; 250 Carousel w/random select adaptor; 350 Carousel; (4) 710 cart decks; (3) ITC 750 R-R decks; Scully 270 R-R deck. Darcy Christianson, KATE, 507-373-2338.

**Sono-Mag SMC TS-25 dual channel 25 Hz tone detector**, brand new, BO. A Weiner, Britton Rd, Monticello ME 04760. 207-538-9538.

**Systemation Including:** (9) Teac V530X cassette decks, Commodore 64 computer, monitor, printer, rack, \$8000. D Rose, KAAA, POB 3939, Kingman AZ 86402. 602-565-3664.

**Harris control system** from an older Harris automation system, working when removed, make offer. R Dammon, WKIL, POB 278, Albany OR 97321. 503-926-2233.

**IGM stereo instacart 48 trays** no wear on any heads, looks new. D Roden, 1701 Monte Sano, Huntsville AL 35801. 205-533-3676.

**IGM Instacarts**, (2) in use, avail 3/1/89, rebuilt 1 yr ago, \$7000 ea. S Rush, KTKK, 3595 S 1300 W, Salt Lake City UT 84119. 801-264-8250.

**MEI MP100 automation controller w/remote control**, \$3000; MEI Control 3 (2) Carousel & controller, \$1000 ea. T Sheen, KWNA, POB 591, Winnemucca NV 89445. 702-623-5203.

**SMC DP-1 automation system**, including 5 stereo Carousels matrixed for mono, 4 Scully 270 bi-directional R-R, logging elect, in five racks, excel cond. D Englehardt, KSQL, 913-823-1111.

**Want to Buy**

**Satellite automation system** in bold face & Carousels & instacarts. B Romeijn, KJNO, 3161 Channel Dr Ste 2, Juneau AK 99801. 907-586-3630.

**Satellite automation system** in bold face & Carousels & instacarts. B Romeijn, KJNO, 3161 Channel Dr Ste 2, Juneau AK 99801. 907-586-3630.

**Carousel 360**, need complete set of circuit cards. D Rose, KAAA, POB 3939, Kingman AZ 86402. 602-565-3664.

**SMC MSP-12 satellite automation** or similar set-up. C Young, WAYX, 1600 Carswell, Waycross GA 31501. 912-283-1230.

**SMC DP-1 automation brain** wanted in working cond for spare parts. G Peterson, KIMM, POB 8205. Rapid City SD 57709. 605-348-1100.

**SMC TS-25 PCB**, interested in other SMC products. V Thompson, KTOT, Box 2810, 575 Pine Knot, Big Bear Lake CA 92315. 714-866-3434.

**SMC 350 Carousel**, compatible w/SMC Mini-Pro automation; also SMC-Otari ARS1000 reproducer. L Amstutz, Lumiere Haiti, 4526 Arlington, Ft Wayne IN 46807. 219-429-8366.

**CAMERAS (VIDEO)**

**Want to Sell**

**Hitachi-Shibaden FP-1500 U** w/control unit, needs work but works, w/schematics, \$500. N Metzger, 612-989-1101.

**Hitachi KP-C100 color chip** w/16mm auto iris lens, \$425. P Russell, Bowdoin College, Sills Hall, Brunswick ME 04011. 207-725-3066.

**ITE H2 tripod head**, excel cond, \$250. M Murphy, 11621 Valle Vista, Lakeside CA 92040. 619-561-2726.

**Sony HVC-2400 Trinicon color camera**, case, HVA-200 AC adaptor, zoom lens, 25' extension cable, mint cond, \$600/BO. T Steele, Steele Comm, 1697 Broadway Rm 1404, NYNY 10019. 212-265-5563.

**Panasonic WV-1410 2/3" B&W vidicon camera** (2), no lens, 120 volts AC, \$75 ea; Onyx 1000 super small B&W chip camera w/lens & pwr supply, \$175. P Russell, WBOR, Sills Hall, Brunswick ME 04011. 207-725-3066.

**RCA PK-701 color studio camera**, \$200; Norelco PCP-90 color camera, \$150. C Haynes, POB 31235, Jackson MS 39206. 601-948-1515.

**Want to Buy**

**Rear lens controls** for Fuji 14:1, 16:1 lens, both focus & zoom, Cannon 12:1 also. H Larson, Matrix Mobile TV, POB 536, San Luis Obispo CA 93406. 805-544-5657.

**Rear lens controls** for Fuji 14:1, 16:1 lens, both focus & zoom, Cannon 12:1 also. H Larson, Matrix Mobile TV, POB 536, San Luis Obispo CA 93406. 805-544-5657.

**Dumont camera chain & related equipment**; also old image orthicon & iconoscope tubes. A Weiner, Britton Rd, Monticello ME 04760. 207-538-9538.

**Manual for Sony DXC5000BP color studio camera**. S Shumate, WVIR, POB 769, Charlottesville VA 22902. 804-977-7082.

**RCA TK1, TK10, TK-30, TK-20 & accessories**; RCA Houston-Fearless studio pedestal or tripod & dolly; Sony DXC-5000, DXC1600 color cameras; RCA TK-41 parts for a restoration. A Weiner, Britton Rd, Monticello ME 04760. 207-538-9538.

**Viewfinder for Sony DXC-1210**, also need gd used Trinicon pick-up tube MF CT-1122, cabinet parts for DXC-1800, will consider entire camera for parts if reasonable. C Lund. 203-756-7761 aft 4PM.

**Sony DXC-M3A 3 tube saticon**, Fujinon 12/1 w/2X ext zoom, ENG VF, 5" VF, rem lens/200 ohm control kit, AC-PS, 6' cable, \$6500. S Christian, Masterpiece Video Prod, 715 Cornwall, Silver Spring MD 20901. 301-439-5731.

**CART MACHINES**

**Want to Sell**

**AudiCord twin transfer record/play mono**, BO. R Meadows, Southeastern Sports Prod, 3216 Granleigh Dr, Tallahassee FL 32308. 904-893-7808.

**Gates Criterion 80 R/P**, new heads & motor, mono, perfect cond, \$600; Gates Criterion 80 rec amp stereo, gd, \$300. P Morton, WRQL, POB 57, Rupert VT 05768. 802-394-7858.

**ITC 3-D**, (2) ITC 3-D triple deck, mono, \$1500 ea; (2) ITC WRA record amps, \$550 ea, mono, all equipment in gd cond w/manuals & in service. D Doelitzsch, WDDD, One Broadcast Center, Marion IL 62959. 618-997-8123.

**ITC SP w/rack mount**, \$800; ITC RP w/delay & all tones, \$1400; Gates Criterion, \$300 ea; Gates Criterion rec amps, \$200 ea. Clark B, WFAS, Secor Rd, Hartsdale NY 10530. 914-693-2400.

**RCA RT-7, BA-7**, several players & record amps & one 4 place cabinet for above, repairable cond, BO. R Meyers, Benchmark Comm Corp., 4700 SW 75 Ave, Miami FL 33155. 305-264-5963.

**Audiopak AA-4 (96)** brand new, never out of case, 6.5 minutes, negotiable. C Harrison, Boise Viking Assoc., 5601 Cassia St, Boise ID 83706. 208-344-3511.

**ITC 99BRPSE**, excel cond, \$3500. T Gaiser, KUZZ, 3223 Sillect, Bakersfield CA 93308. 805-326-1011.

**Rapid Cue 1 R/P, 2 P/B**, make offer. L Houck, Rollin Recording, 210 Altgelt, San Antonio TX 78201. 512-736-5483.

**Rapid Cue recorder-reproducer & playback** total of (3) machines, gd for parts, \$75/lot. A Weiner, Britton Rd, Monticello ME 04760. 207-538-9538.

**Gates/Harris Criterion Compact III** triple deck in gd cond, \$800. B Howard, KOFO, Box 16, Ottawa KS 66067. 913-242-1220.

**ITC Delta III stereo triple deck R/P**, excel cond, new control logic board; ITC Series 99 play only (2), gd cond in service, prices negotiable/BO. M Bostic, WKLX, 259 Monroe, Rochester NY 14607. 716-454-3040.

**ITC playback only**, checked in very gd cond, \$650. F Laverman, WMAM, POB 609, Marinett WI 54143. 715-735-6631.

**ITC RP (2)** mono excel cond, rec/play, rack mount or table top case, \$900 ea. F Laverman, WMAM, POB 609, Marinett WI 54143. 715-735-6631.

**ITC Premium record-play (6)** mint cond, low hrs, 2 delay w/manuals, 3-PDI, \$1295/BO. J Phillips, WZOM, 414 Washington, Defiance OH 43512. 419-782-8591.

**ITC Delta III stereo triple deck R/P**, excel cond, new control logic board; ITC Series 99 play only (2), gd cond in service, prices negotiable/BO. M Bostic, WKLX, 259 Monroe, Rochester NY 14607. 716-454-3040.

**Sono-Mag Mdl 592 stereo record-play**, needs help, \$50 plus frt. S Sibulsky/J Bjornstad, KVNI, 208-664-9271.

**Spotmaster 400A broadcast reel/play cart machine**, works, \$250. F Laverman, WMAM, POB 609, Marinett WI 54143. 715-735-6631.

**ITC 99B Motors SALT-2**, ITC PN 455-0002-000 24V DC brushless servo type w/ceramic shaft, includes 831-0258B servo card, (10), \$50 ea. W Bevis, WING, 717 E David, Dayton OH 45429. 513-292-5858.

**Want to Buy**

**SMC Carousel 350**, need 3 random select machines for educational FM. K Hill, WHCB, POB 2061, Bristol TN 37621. 615-878-6279.

**Stereo record play cart machines** (2). S Glick, Davis/Glick Prod, 11846 Ventura Blvd Ste 306, Studio City CA 91604.

**Ampro 3500 recorder/reproducer cart machine**. D Rose, KAAA, POB 3939, Kingman AZ 86402. 602-565-3664.

**ITC cart machines** wanted, any cond. Parts & other brand machines seriously considered, cash pd. Jon Hall, Hall Electronics, POB 7732, Charlottesville VA 22906. 804-977-1100.

**BE 1070 RPD schematic of delay circuit**. R Delius, WFXC, 2515 Apex Hwy, Durham NC 27713. 919-596-2000.

**Motor for ITC triple deck**. P Anderson, KZBQ, Box 97, Pocatello ID 83204. 208-234-1290.

**CASSETTE & REEL-TO-REEL RECORDERS**

**Want to Sell**

**Ampex 1100 16 trk**, modified, needs work, \$6000; Scully 280, \$300; Inovonics replacement electronics for Ampex or Scully mdl 380, \$300 (2), mdl 275, \$250 (4), like new w/manuals. N Metzger, 312-989-1101.

**Ampex 300 3 decks & 2 electronics**, unmounted, repairable cond, BO. R Meyers, Benchmark Comm Corp., 4700 SW 75 Ave, Miami FL 33155. 305-264-5963.

**STUDER REVOX**  
FACTORY AUTHORIZED SERVICE CENTER  
"SUPERLATIVE SERVICE"

Swiss trained in servicing A77, B77, A700, PR99, A67, B67, A810, A807, B710, A710 & C270. Fast 48-72 hour service w/90 day warranty. Huge parts inventory. VISA/MC. New & used machines available.

**STUDIO-SONICS CORP.**  
2248 N. Palmer Dr. #100  
Schaumburg, IL 60173  
(312) 843-7400

**Ampex AG-440 1/2" 4 trk**, vgc, \$700. S Vandenberg, Hugh Morris Prod, POB 232, Jenison MI 49429. 616-895-3105.

**Ampex 351 w/Inovonics amps**, \$800 ea; Scully 280B wamp in own rack, \$500. Clark B, WFAS, Secor Rd, Hartsdale NY 10530. 914-693-2400.

**Ampex 300 5 tape decks**, most w/ head stacks, tube electronics, three in console, make offer. F Cote, KOLA, 5005 LaMart Dr, Ste 100, Riverside CA 92507. 714-684-9992.

**Ampex 1100 16 trk**, modified, needs work, \$6000; Scully 280, \$300; Inovonics replacement electronics for Ampex or Scully mdl 380, \$300 (2), mdl 275, \$250 (4), like new w/manuals. N Metzger, 312-989-1101.

**Ampex 300 5 tape decks**, most w/ head stacks, tube electronics, three in console, make offer. F Cote, KOLA, 5005 LaMart Dr, Ste 100, Riverside CA 92507. 714-684-9992.

**METROTECH DICTAPHONE LOGGERS**

—PARTS— and Service

**SEQUOIA ELECTRONICS**

209 Lester Lane  
Los Gatos, CA 95032  
(408)356-3232

**MCI JH-110B**, like new w/original head, mono, \$2500. S Moseley, KOJY, 597 N Alta, Dinuba CA 93618. 209-591-1130.

**Sony DTC-1000ES DAT recorder**, perfect cond w/English manual, used little, \$1695. F Forest, Musical starstreams, POB 44, Mill Valley CA 94942. 415-383-7827.

**Tascam EM-1542**, reel motor, for Tascam Series 30 tape decks (32, 34, 38), brand new or swap for Sony TC-850 head block, \$90. J Roper, Imperial Snd Stds, RR31 Box 405, Terre Haute IN 47803. 812-877-2663.

**Hall Electronics**  
Has moved and expanded!  
Call us for the best values on **WARRANTED Rebuilt, off price, and new broadcast Equipment!**  
We **BUY** equipment too!  
Please call for quote.  
Drop us a line or phone for our latest flyer.  
**804-977-1100**  
9:30AM-6:00PM EST  
**1712 Allied St.**  
**Charlottesville, VA 22901**

**Sony DTC-1000ES DAT recorder**, perfect cond w/English manual, used little, \$1695. F Forest, Musical starstreams, POB 44, Mill Valley CA 94942. 415-383-7827.

**Teac 3340-S 4 trk**, 7.5-15 ips w/6 reels, new Ampex 456 grand mstr on 1.5" reels w/boxes, vgc, \$800; Ampex 600 1/2 trk in case, vgc, balanced mic & line inputs, \$400. P Salyers, WOSU, 2400 Olenlangy River Rd, Columbus OH 43210. 614-292-9678.

**CLEAN PATCH BAYS**  
NO DOWN TIME



**VERTIGO BURNISHERS AND INJECTORS RESTORE ORIGINAL PERFORMANCE TO YOUR PATCH BAYS**  
Please write for additional information and order form today.  
**\$29.95 Ea.**  
**VERTIGO RECORDING SERVICES**  
12115 Magnolia Blvd. #116  
North Hollywood, CA 91607 818-907-5161

**Teac gd shape & VU meters**, \$130. W Dougherty Jr, WLD Recdg, Music Valley Rt 1, Mill Spring MO 63952. 314-998-2377 aft 7PM.

**Teac DX-8 dbx unit** for Tascam 80-8 8 trk R-R, \$125. B Roberts, ARP Studios, POB 325, Mt Pleasant SC 29465. 803-928-3663.

**Uher 4000 Report L**, vgc, w/power supply & service manual, \$550 plus shpg. T Vernon, Assn for the Blind, 1800 N 2nd St, Harrisburg PA 17102. 717-238-2531.

**Uher 4000 Report S**, gd cond, with service manual, \$350 plus shpg. T Vernon, Assn for the Blind, 1800 N 2nd St, Harrisburg PA 17102. 717-238-2531.

**Alpha 21, 16:1 hi-spnd**, mono cass dupl, one copy per pass, both sides, auto rewind, gd cond, \$650; VSC Soundpacer, Mdl C-4, varisped, varipitch, cassette rec, AC/DC, new cond, \$100; Superscope RBC-2, 5 V (4 C cells) Nicad battery pack, \$12; Takahata Kogyo tape timer, \$75. E Helvey, POB 1357, Winchester VA 22601. 703-877-1191.

**Ampex 351 r/p electronics w/hw caps**, complete stock & spare parts (2), \$260/both or \$150 ea; Ampex 440C R/P electronics, clean-stocked as spare, \$200; Scully 280 1/4" head-stack hardware-block & 1/4" to 1/2" adjustable supply & tkup guides, under \$100. L Beigel, On-Cue Recdg, POB 85042, Los Angeles CA 90072. 213-466-3595.

**Ampex 351**, new w/original electronics, mono, 1/4" heads, FT, \$750. R Majestic, Otic Inc, 2117 Bay Front Terr, Annapolis MD 21401. 202-485-6228.

**Ampex PR 10 FT 75 to 15 ips**, gd cond, \$250. D Ibel, KICD, 2600 N Highway, Spencer IA 51301. 712-262-1240.

**Ampex 350 2 trk consoles** (2), Auto-tec solid state C 5 conversions, \$2100 ea; Orban equalizer & sibilance controller. J Lee, United Recdg Labs, 681 Fifth, NYNY 10022. 212-751-4660.

**Ampex 440B** in console, vgc, new head, spare new head & parts; Revox A700 vgc, rk or table mt. G Ernste, Bayside Snd, POB 166, Lincoln City OR 97367. 503-996-6020.

**Ampex 350/300 Series head assemblies & parts**, cables, mono & stereo, 1/4" & 1/2", call with needs. T Steele, Steele Comm, 1697 Broadway Rm 1404, NYNY 10019. 212-265-5563.

**Ampex 300 (4)**, BO. E Meier, Rt 4 Box 98, Washington NC 27889. 919-946-2461.

**Crown CX-800 2 trk tube type stereo open reel tape deck** to trade for an old Revox A-77 deck, any configuration. E O'Brien, Imperial Snd Stds, RR31 Box 405, Terre Haute IN 47803. 812-877-2663.

**ITC 750 playback**, gd cond, recently overhauled & aligned, both mechanical & electrical set-up, includes manual, \$150; Scully 280B rec/play, gd cond, recently set-up, includes manual, \$700/roll-around cabinet, \$600/without; ITC 850 rec/play, new capstan motor & reel hubs, recently overhauled & aligned, includes manual, \$500 (available late Feb or early March). D Atkins, RF In, POB 2186, Roswell NM 88201. 505-622-3861.

**Nakamichi OMS-7 CD player**, w/brand new remote, excel cosmetic cond, \$695. J Ritezel, Soundpresentations, 6216 So 153rd St #108, Seattle WA 98188. 206-242-9638.

**Otari ARS 1000 (3)** in gd cond; ITC 750 (3), gd cond. E Kazmark, KAPA, 2065 Ocean, Raymond WA 99577. 206-875-5551.

**Scully 280 2 trk transport 75 & 3.75 ips**, \$250; Scully 280 elect (2), \$100 ea; Ampex AG-440 transport, 2 trk/w xtra qtr trk play hd, 7.5 & 15 ips, gd cond, \$400; Inovonics 2 chnl elect, recently rebuilt w/power supply, \$350; Ampex AG-350 console, gd cond, \$150. E Helvey, POB 1357, Winchester VA 22601. 703-877-1191.

**Stenocord 83**, 18 dictatortranscriber recorders w/mics & 6' controls, uses microcassettes, in gd working cond, \$175/postpaid. L Graziplene, Graiien Research & Development, 3532 N Main, N Java NY 14113. 716-535-7251.

**Uher 4200 report stereo**, \$65 plus UPS; Braun AG TG1000, needs work, \$100 plus UPS. J Baltar, Maine Reel, 67 Green, Augusta ME 04330. 207-623-1941.

**Wollensak 3M 1520AV portable FT**, re-conditioned, 7.5 & 3.75 ips w/manuals, very clean, \$150. J Ellingson, Ellingson Prod, 913 Warwick Dr, Cedar Falls IA 50613. 319-277-8535.

**Ampex ATR100 2 trk stereo** in cabinet on pedestal w/manuals, \$1500; Scully 280B 4 trk in Ruslang roll around stand w/manuals, \$1200. B Carr, WRED, 1201 Fremont Pike, Woodville OH 43469. 419-837-9696.

**Ampex 351 FT 75-15 ips** in console, gd cond, \$325. P Smith, Summit Recdg Std, 10639 W Warren, Lakewood CO 80227. 303-985-1993.

**Magnasync MR-416**, \$1500; Ampex 440C 4 trk w/2 head assemblies, remote, no servo, \$1900; Echoplex revert, fair cond,

**CASSETTE . . . WTB**

MCI/Sony capstan & reel motors, any cond., recd'g heads, most mfgs, machines, new, used. Relapped then sold. Amp Services, 224 Datura St No 614, W Palm Beach FL 33401. 800-826-0601, in FL 305-659-4805.

**Ampex and Scully Spare Parts, Accessories, Motor Remanufacturing.**

**VIF INTERNATIONAL**  
PO Box 1555  
Mtn View CA  
94042

Direct order line (800) 848-4428  
in CA Dial (408) 739-9740  
Telex 62922869 ESL UD  
FAX: 1-408-739-0809

Inovonics 355 dual chnl R/P electronics, 1974 design, w/900 Series power supply. Need both xformers in sync cards, pay \$200 max. L Beigel, On-Cue Recdg, POB 85042, Los Angeles CA 90072. 213-466-3595.

ITC-750 reproduce R-R, want capstan tape guide & brake roller hub. J Nickel, KJSK, POB 99, Columbus NE 68601. 402-564-2891.

Otari & Revox tape machines wanted. Please call for quote. Cash paid. Jon Hall, Hall Electronics, POB 7732, Charlottesville VA 22906. 804-977-1100.

Sony TCM5000EV, voice activated, and/or high-quality microphone. New or used. ASAP. Craig Moskowitz, 1712 N 21st Rd, #7, Arlington VA 22209. 703-243-1321.

Sony TC FX 510R w/pre-end autoreverse & real-time readouts. J Turney, Liberty Audio, 824 W Broad, Richmond VA 23220. 804-788-7008.

Teac 3300S/2T or 6100 2 trk stereo recorder any cond.; Teac 3340, 3440, 40-4, 80-8 4 trk & 8 trk recorders in any cond. B Romonosky, WEBQ, Rt 45 South, Harrisburg IL 62946. 618-252-6307.

Head covers for Tapesonic 70-TRS tape decks, one cast metal lower & one sheet metal upper cover; also a Magnequad PT6-V amp, the no speaker version. C Lund. 203-756-7761 aft 4PM.

Magnafax 1/4" R-R duplicator or Magnafax 1/4" reel to cassette bin loop, consider any cond, also buy manuals or copies for same. J Calloway. 214-272-8726.

Otari DP2700 cassette tape loader/winder, also interested in other manual loaders or salvage or parts for same. J Calloway. 214-272-8726.

Pioneer RT-1050, need transport controls/reels. D Finn, Motive Media, 1615 Hamill, Chattanooga TN 37343. 615-875-2632.

Wollensak 2770 or 2780 cassette tape duplicators or slave units, will consider units in any cond or salvagel/surplus parts for same. J Calloway. 214-272-8726.

**CONSOLES**

**Want to Sell**

Echoplata #2, 4x6 w/steel plate, 1 in 2 out, gd, \$600 or swap for 122BMM Tascam cassette recorder; Fisher home made stereo (3) springs in parrell, gd, \$250; Scully 284B 1" 8 trk in console, \$5000. H L Sewell, Oakridge Music Sld, 2001 Elton Rd, Haltom City TX 76117. 817-838-8001.

Quad-eight film mixer, x1, EQ, compressor, filters, no pwr supply, \$1200; Westrac 3x1 mic mixer for production, \$1100. J Gaffney, Ross-Gaffney, 21W46th, N Y N Y 10036. 212-719-2744.

GE BC 1 A power supply, gd cond, needs minor work, \$30 pls shpg. G Heidenfeldt, 2880 W Lake Rd, Wilson NY 14172. 716-751-6187.

Peavy MC-16 16 chnl stereo mixer, \$2500/BO. M Skinner, Color County Bdcg, 341 So Bluff St, St George UT 84770. 801-673-1450.

**Motor Services**

Professional overhauling of most AC & DC capstan and reel motors. Fastest turnaround, all work guaranteed.

New MCI ceramic shafts  
Any metal capstan shaft resurfaced—\$50



Ramko DC 5MS, electrically excel, visually poor, \$500. P Morton, WRQL, POB 57, Rupert VT 05768. 802-394-7858.

Ramko DC 5MS, electrically excel, visually poor, \$500. P Morton, WRQL, POB 57, Rupert VT 05768. 802-394-7858.

RCA BC-7A stereo dual channel consolette, \$1500. R Pfeil, KPDR, POB 469, Wheeler TX 79096. 806-826-5737.

Sun modified 16 in, 16 tape in, 16 mic in, 16 out, 4 groups 4 main outs, 5 sends, 5 returns, cue, talk back w/patch bay, unbalanced, 22 meters, 6 remote controls for tape, \$5000. N Metzger, 312-989-1101.

Altec 1592A 5 chnl mic mixer, rack mountable to trade for a Sony MX16 or MX20 mixer, any cond. E O'Brien, Imperial Snd Sts, RR31 Box 405, Terre Haute IN 47803. 812-877-2663.

Arrakis 2100SC-12S audio console w/stereo modules, brand new, 12 chnls, 34 balanced inputs, Penny & Giles faders, \$4000. B Ardis, Voice Works, 4160 W 182nd #208, Torrance CA 90504. 213-214-2642.

Collins 2122-1 remote amplifier, 4 chnl portable unit, VU meter, tone control, headset level control, 2 lines output, PA level, \$275 pls shpg. B Kidd, Airwaves Media Sales, POB 976, Rayville LA 71269. 318-728-4574.

Gates Executive 10 input stereo console, gd cond, \$1500. B Glasser, WHBC, POB 9917, Canton OH 44711. 216-456-7166.

RCA mono, 9.5 inputs, modified, tube type, working & tested, \$250; Ampex prehistoric mixer, old but working, 4 inputs, 19" mfg rack, \$150. Bishop E Jackson, WJPC, Waterbury CT 06704. 203-573-0554.

Tascam M-520 20 chnls, 6 months old, mint cond, \$4300. D Miller, Airborne Audio Productions, 12037 Hemlock, Overland Park KS 66213. 913-492-8822.

Tascam Model 5 w/expansion module, 12 in, 4 out /snake, mint cond. J Turney, Liberty Audio, 824 W Broad, Richmond VA 23220. 804-788-7008.

Yard consoles (2), 8 input & 2 output, mono, power chassis missing some tubes, otherwise fully working & tested, \$300. Bishop E Jackson, WJPC, Waterbury CT 06704. 203-573-0554.

Gates Gateway mono console, working when removed, BO. D Taber, WHCK, Box 158, Scottsville KY 42164. 502-237-3149.

Gates Yard recently solid-stated, works OK but needs a little TLC, \$150 plus frt; Gates President, works OK, needs a little work, \$350 plus frt. S Sibulsky/J Bjornstad, KVNI, 208-664-9271.

Harris Stereo 80 console board, weight stereo chnls in fair cond, \$1000/BO. Jim, Audio-com, 8100 Oak Ln #401, Miami Lakes FL 33016. 305-825-4653.

Harris Stereo 80 console board, weight stereo chnls in fair cond, \$1000/BO. Jim, Audio-com, 8100 Oak Ln#401, Miami Lakes FL 33016. 305-825-4653.

Vintage Ampex-Sigma 3761 4 chnl mic mixers (2), powered by Ampex 300, 350, 400 recorders, excel cond, separate power supply avail, \$60 ea or both for \$100 pls UPS shpg. B Leslie, Pro Recdg Svs, 13709 Mapleleaf Dr, Cleveland OH 44125. 216-662-1435.

Spotmaster 8BES100 8 chnl stereo board w/spare cards/parts, \$1750. G Hill, 2809 Camulos Way, Redding CA 96002. 916-222-0345.

Large quantity of equipment: Neumann, Scully turntables; BGW, Haeco, Dynaco amplifiers; Soundcraftsman, Dolby, dbx audio production gear; MCI, Sony, Inovonics, Ampex, Sankyo, Scully cassette & R-R recorders; test equipment; disco & sound equipment and more miscellaneous pieces to numerous to print. Call for information & prices. Tom Steele, Frankford/Wayne Mastering Labs, 1697 Broadway, NY NY 10019. 212-265-5563.

**Want to Buy**

Record cutting head, like a Heco, want amps (2), \$500. H L Sewell, Oakridge Music Sld, 2001 Elton Rd, Haltom City TX 76117. 817-838-8001.

Record cutting head, like a Heco, want amps (2), \$500. H L Sewell, Oakridge Music Sld, 2001 Elton Rd, Haltom City TX 76117. 817-838-8001.

Shure M-67 or M26T 4 channel mic mixer. D Brown, KRED, 5640 Broadway, Eureka CA 95501. 707-443-1621.

Stevenson Interface mdls 104 & 300 modules in working cond. A Allegra, Calvary Baptist Church, 1380 Valley Forge Rd, Lansdale PA 19446. 215-368-4444.

Auditronics 110B-IME module for Auditronics 110B console, clean reasonable. D Payne, WZPL, 1440 N Meridian, Indianapolis IN 46202. 317-637-8000.

Auditronics 200-SLI stereo line input cards for Auditronics 200 console. C Gustafson, WKZD, 590 W Maple, Kalamazoo MI 49008. 616-345-2101.

Shure M67 mic mixer. J Vukelich, Bcct Svs/MN, 4551 Flag Ave N, Minn MN 55428. 612-537-1431.

Teac or Tascam, any 8 to 16 input recording console w/4 or 8 buss output. B Romonosky, WEBQ, Rt 45 South, Harrisburg IL 62946. 618-252-6307.

**DISCO & SOUND EQUIPMENT**

**Want to Sell**

DBX 157 Pro 4 chnls simultaneous play-recd, rack-mountable, (2) 8 chnls, \$500 per 4 chnls. H Fenster, Universal Rehearsal-Recording, 17 West 20th St, NY NY 10011. 212-929-3277.

JBL 4412 has minor marks on cabinets, sound perfect, \$600. D Alexander, WQMX, 4986 Gateway Dr, Akron OH 44256. 216-384-1897.

Midi post prod MacIntosh Tascam 8x4 mix, (2) FB-01 modules, TR-505 Roland/SDR-1000 reverb, analog delay, dbx compressor/limiter, Mac software, \$2300. R Sanchez, KUCV, POB 83111, Lincoln NE 68506. 402-472-3611.

Dolby A-301 stereo play/recd Dolby Type A NR unit w/autotransformer option, vgc, \$400/BO. T Steele, Steele Comm, 1697 Broadway Rm 1404, N Y N Y 10019. 212-265-5563.

MIDI studio equipment: Prophet 2000 sampler keyboard w/disk library; Akai AX-90 polyphonic synthesizer, Yamaha SPX-90 digital effects processor, Korg MR-16 drum sound unit, sequential circuits TOM drum machine, all or separate, like new, make offer. N Rozanov, WCMF, 716-262-4330.

**LIMITERS**

**Want to Sell**

CRL FM-4 System SPP-800, SEP-800, SMP-800 & SG-800 w/manuals & original perf. measurements, \$4000. K George, WUSY, POB 8799, Chattanooga TN. 615-892-3333, Fax: 615-899-7224.

Ramko portable mixer PM-42, \$450; Thomson-CSF 4500 Presence EQ, never used, \$595; CBS-Labs 400 Volumax, good buy, \$100. H.M. Dyer Electronics, 2982 Wixom Rd, Milford MI 48042. 313-685-2560.

**GIVE IT A CALL**

This stereo processor can be pre-programmed with 5 different presets to "call up" for format changes, etc. Unit has slow AGC, 5-band compressor, and either an AM or FM peak limiter. Computer/modern control option available.

**Inovonics**  
(408) 458-0552

CBS 410 & 499 Volumax, \$75 ea; Gates FM top level, \$50 pls shpg. B Roberts, ARP Studios, POB 325, Mt Pleasant SC 29465. 803-928-3663.

Orban 8000A processor/generator, \$1200. C Leasure, WTBO, POB 1644, Cumberland MD 21502. 301-722-6666.

CRL PMC-300A mono, peak modulation limiter, mint cond, \$550. P Mueller, WPSO, 8406 Little Rd, New Port Richie FL 37654. 813-848-8161.

CRL FM-4 System SPP-800, SEP-800, SMP-800 & SG-800 w/manuals & original perf. measurements, \$4000. K George, WUSY, POB 8799, Chattanooga TN. 615-892-3333, Fax: 615-899-7224.

Thompson CSF Labs Volumax 4440A, vgc, \$400 pls shpg. T Vernon, Assn for the Blind, 1800 N 2nd St, Harrisburg PA 17102. 717-238-2531.

Thomson-CSF 4450-A Audimax, never used, \$1295; Thomson-CSF 4500 Presence EQ, never used, \$595; CBS-Labs 400 Volumax, good buy, \$100. H.M. Dyer Electronics, 2982 Wixom Rd, Milford MI 48042. 313-685-2560.

Thomson-CSF 4450-A Audimax, never used, \$1295; Thomson-CSF 4500 Presence EQ, never used, \$595; CBS-Labs 400 Volumax, good buy, \$100. H.M. Dyer Electronics, 2982 Wixom Rd, Milford MI 48042. 313-685-2560.

CBS Audimax III automatic level control, \$200; CBS Volumax 400 automatic peak controller, \$200. K Crosthwait, Rt 5 Box 77, Kingston TN 37763. 615-376-5763.

CRL CC-300 composite controller clips overshoots from stereo generator w/documentation, gd cond, BO. G Paterson, KIMM, POB 8205, Rapid City SD 57709. 605-348-1100.

CRL AM-4 3 piece AM processing, excel cond, \$2000/BO. C Young, WAYX, 1600 Carwell, Waycross GA 31501. 912-283-1230.

Dorrough 610 discriminate audio processors (2), mint cond, w/manuals, sold separately or as a package, \$2995/both. S Parker, WSJF, 1500 Diuguid Rd, Murray KY 42071. 502-753-2400.

Harris MSP-90 booster/limiter, single site, \$1600. D Koehn, KNEN, Box 937, Norfolk NE 68702. 402-379-3300.

Orban 8000A & studio chassis, tone controls, dual chassis, new caps, \$3500. J Phillips, WZOM, 414 Washington, Defiance OH 43512. 419-782-6986.

Orban 9000A/1 AM Optimod, like new, \$2000; Orban 8100/ST studio chassis for split operation of Optimod, \$500; Harris ME-1 modulation enhancer, for MW Series xmtrs, \$100. B Glasser, WHBC, POB 9917, Canton OH 44711. 216-456-7166.

Orban 424A compressor, de-esser, gated lin/rog recovery, couple or split operation, new cond, \$675. C Wilson, Mongo Video, 13123 Moldridge Rd, Wheaton MD 20906. 301-949-1809.

UREI LA5, similar to LA4, wrack mt, \$200/BO. E Helvey, POB 1357, Winchester VA 22601. 703-877-1191.

BE AM-400 compressor-limiter, working, \$150; Orban Optimod-FM 8000A, \$1200. L Albert, WKMS, POB 2266, Murray KY 42071. 502-762-4664.

DAP 310 AGC limiter, \$125. C Leasure, WTBO, POB 1644, Cumberland MD 21502. 301-722-6666.

Gates Solid Statesman AGC (2), BO; Gates Solid Statesman FM (2), BO; CBS Volumax 4000A, BO. B Wilson, WYNA, POB 1407, Whiteville NC 28472. 919-642-9131.

Orban 8000A plus studio ST from 8100 w/cards, BO. J Phillips, WZOM, 414 Washington, Defiance OH 43512. 419-782-8591.

Orban 8100A, 2 yrs old & perfect, \$3900. P Anderson, KZBO, Box 97, Pocatello ID 83204. 208-234-1290.

Orban Optimod 9000A/1 AM processor, NRSC ready, manual, excel, \$1800/BO. D Wiley, Life Bdcg, POB 96, John Day OR 97845. 503-575-1840.

**Want to Buy**

Gates Sta-Level M5167, manual wanted, copy OK; Collins 26U-1 manual wanted, copy OK. T O'Laughlin, WERN, Rt 1 Box 41, Barnereld WI 53507. 608-924-2001.

**MICROPHONES**

**Want to Sell**

Beyer M-380 excel for recording bass, mint cond, \$125; AKG floor mic stands & booms, excel cond, \$25/set. M Osborne, WKSQ, POB 9494, Ellsworth ME 04605. 207-667-7573.

RCA 44BK w/out ribbon, \$100. P Morton, WRQL, POB 57, Rupert VT 05768. 802-394-7858.

Sennheiser MD421 studio mic, like new, used less than 30 days, \$200. R Meadows, South-eastern Sports Prod, 3216 Granleigh Dr, Tallahassee FL 32308. 904-893-7808.

Shure SM-68, like new w/wind-screens & cable, \$160/pr. W Dougherty Jr, WLD Recdg, Music Valley Rt 1, Mill Spring MO 63952. 314-998-2377 aft 7PM.

Shure SM57 (2), \$80; AKG C-951-E (2), \$200; Sennheiser 421 (2), \$100. N Metzger, 312-989-1101.

Shure 545 unidyne III dual impedance, \$75/BO; EV 636 dynamic omni-directional Hi 2 Lo 2, \$50. M Skinner, Color County Bdcg, 341 So Bluff St, St George UT 84770. 801-673-1450.

Bruel & Kjaer 2801 condenser microphone power supply for B&K tube type mics to trade for a Sony C-37A power supply. E O'Brien, Imperial Snd Sts, RR31 Box 405, Terre Haute IN 47803. 812-877-2663.

EV RE15, \$25; Shure SM18B (lapel), \$10; Beyer M500N, \$75. J Thomson, 64688 Sylvan, Bend OR 97701. 503-389-8314.

EV RE45N/D dynamic shotgun, like new, in box complete, \$175. J Ellingson, Ellingson Prod, 913 Warwick Dr, Cedar Falls IA 50613. 319-277-8535.

RCA 77DX w/connector cables, 3 mikes, \$300 ea, J Lee, United Recdg Labs, 681 Fifth, N Y N Y 10022. 212-751-4660.

Shure SM57 (2), \$80 ea; AKG C-451-E (2), \$200 ea; Sennheiser 421 (2), \$200 ea; EV RE16 (2), \$100 ea. N Metzger, 312-989-1101.

RCA HK-111 w/cable, \$250; EV 911 Sound Spot w/cable, \$50; EV 649B w/sealed amp, \$25; Altec 639A needs a gd cleaning, otherwise OK, \$50. S Sibulsky/J Bjornstad, KVNI, 208-664-9271.

RCA 77DX in original box, unused TV model, for collectors w/cord, cover & used desk stand, \$1000. G Hill, 2909 Camulos Way, Redding CA 96002. 916-222-0345.

Sennheiser MKH 416 P48 shotgun mic, new, mint, 48 volt phantom, \$450; AKG CK-4 bi-directional capsule, new, mint, \$195. C Richardson, Richardson Recdg, 1938 Balt. Annap. Blvd., Annapolis MD 21401. 301-757-3733.

**Want to Buy**

RCA or WE 77 or 44 or 639, etc, working or not. B Davies, Virgo Prod, 5548 Elmer Ave, No Hollywood CA 91601. 818-761-9831.

RCA 44 mics. D Miller, Airborne Audio Prod, 12037 Hemlock, Overland Park KS 66213. 913-492-8822.

**MISCELLANEOUS**

**Want to Sell**

Rack, 72" & 19" standard across w/wheels; Ampex mixer MX35 & xformers; Patch bays (4) single inputs & cords; Altec mixers 1567's & xformers; Lafayette audio gen & Heath oscilloscope; Rekokut turntable CVS12 variable speed 25-100RPM's; Ampex 620 spkr-amp; Davon attenuators panel of 8; Presto 6N lead screws. Call Mr. Oliver, 212-874-7660/0274 (PMs).

Operator/service manuals for Ampex AG600; Ampex 602 & 602-2; Ampex 350; Ampex 300 recorder/reproducers, all in excel cond, each \$25. J Newman, Box 7703, Atlanta GA 30357. 404-876-8623.

Acoustical wall covering, looks like Sonex, 800 sq ft, \$800. N Metzger, 312-989-1101.

Blay teletype ribbons, new unopened, over 150 for older teletype machines, BO. M Black, WEOS, Hobart & William Smith College, Geneva NY 14456. 315-789-8970.

**Ron Radio Communications, Inc.**  
P.O. Box 201 Brightwaters, NY 11718  
"Professional Broadcast Engineers Serving the Industry..."

**Authorized dealers for:**  
Audisar Transmitters & Audio Products  
Belar Electronics Mod Monitors  
Delta Electronics  
Energy Onix FM Transmitters 100w to 60KW  
Hnat Hindes Audio Processing & Digital Telephone Hybrid  
Inovonics FMX Stereo Generators  
Jampro FM Antennas  
Kintronic Phasors & Antenna Tuning Units  
L. P. B. Audio Consoles  
Micro Controls Inc. (Composite STL \$ 5,995)

**Specials of the month:(good thru 05/12/89)**  
Inovonics FMX Stereo Generator \$ 1,695.  
Energy Onix 300watt Solid State FM amplifier \$ 3,895  
Energy Onix 500watt Solid State FM amplifier \$ 4,995  
Hnat Hindes Tri-Maze AM NRSC/FM Mono Processor \$ 1,795  
Hnat Hindes SX-87 Telephone Hybrid \$ 425  
Hnat Hindes A-Maze Stereo Processor \$ 1,595  
L.P.B. S-13 8 Channel Stereo Console \$ 4,745  
Belar FM Monitor Package (FMM-2, FMS-2) \$ 2,945  
Audio Pak AA-4 Carts- 70sec-\$4.98, 3.5min-\$5.25, 5.5min-\$6.20

**CALL RON RADIO FOR:**  
Studio Installation  
Transmitter Installation, Maintenance & Emergency Repair  
Frequency Searches, License Applications, & Construction Permit Applications.  
AM Directional Tune-up, Adjustment & Repair  
Weekly, Monthly, or Semi-Annual Technical Inspections...

**1 - 8 0 0 - 6 6 6 - 3 5 2 5**

**HARRIS**

NEW AND USED EQUIPMENT  
CALL US WE HAVE IT OR WILL FIND IT

**POWER SUPPLIES**  
28VDC 3A 120V input 60Hz Lambda Mdl LCS-C-28, (2) \$100 ea; 24VDC 35A 220V input 40-400Hz Lambda LGS Series, (10) \$500 ea; 28VDC 35A 220V input 40-400Hz Lambda LGS Series, (13) \$500 ea; 5VDC 3A 115/220V input 48-440Hz standard power CPSS30-5, \$50; 12VDC 5A 115/230V 50/60Hz, (12) \$150 ea; Anton Bauer ±20VDC 200MA 105-129V input, 60Hz plug into wall, (96) \$20 ea; James Electronics 12VDC 2-8A 110/220V input Lambda mdl LOS-V12, \$100.

**SURGE PROTECTION DEVICES**  
(All Units Are New)

## Do you have a Class A FM Construction Permit and \$100,000?

### GOOD !!

We can build your station COMPLETE for \$100,000. We can make this exceptional offer because we do everything, including erecting a new 300 foot tower with all accessories.

#### OUR PACKAGE INCLUDES:

- \* Modular transmitter/studio/office building delivered and completely installed at your site
- \* Tower, antenna, and transmission line installed
- \* Complete transmitter and monitoring system
- \* Stereo control room complete down to clock on the wall
- \* Complete production room
- \* Fully furnished reception area, manager's office and work, refreshment areas

If the high costs of construction have delayed launching your Class A, WAIT NO LONGER !

— Financing Now Available —

Call Today: Fred at (817) 697-2462 or Don at (512) 448-2420

PARITY RADIO CORPORATION OF TEXAS

Call us about your Class C2 or Directional AM construction, too!

#### MISC ... WTS

Newsroom workstations w/R-R, cart, switcher, phone coupler, in rack, call for details; Omega phone system 30 plus phones w/KSU touch-tone, gd cond, make offer. Clark B, WFAS, Secor Rd, Hartsdale NY 10530. 914-693-2400.

Phasing equipment, 1970 Gates phasor & (4) ATU shelves set up for 1170kHz, 5kW DA-1. For parts list/price info, contact K Buckelew, WOBM, 360 clayton Rd, Howell NJ 07731. 201-364-4400.

Radio Shack 4/P portable mod 4 2 drives built in modem, tons of software, \$250; Radio Shack DMP-120 dot matrix printer, R/S serial & parallel ports; 8 slot S-100 computer frame, 64K memory card, Cromemco 4FDC, frame has pls no drives; Radio Shack Model 100 24K ram great shape, A.C. P/S printer & modem cables manuals, \$250. S Sonnenblick, Media System Assoc, 8400 NW 5th St, Pembroke Pines FL 33024. 305-891-3588.

RCA MI-9472-A matching inductor, BO. T O'Laughlin, WERN, Rt 1 Box 41, Barnerseld WI 53507. 608-924-2001.

Dialight 3/4" bezel mounts & 3/4" switch lenses for 513 Series switches, 1/2 price. J Nickel, KJSK, POB 99, Columbus NE 68601. 402-564-2891.

Extel AH II R printer, \$400/offer. D Koehn, KNEN, Box 937, Norfolk NE 68702. 402-379-3300.

Jack strip, 52 RTS, dbl closed circuit jacks, gnds normalled, gd cond, \$50; Line xmrs (2) EV 502, EV 502B, Shure A86A, \$12.50 ea/all for \$40; Pioneer JA-R102 rk mnt adaptor kit, \$7. E Helvey, POB 1357, Winchester VA 22601. 703-877-1191.

RCA 33A jack panel; 63B & 61B mica capacitors, make offer. B Kidd, Airwaves, Media Sales, POB 976, Rayville LA 71269. 318-728-4574.

Western Electric patch panels, wire wrap or solder type TRS, normalled, great for stereo, 3 rows, 7" rack space, \$35 plus shpg. R Kerbawy, WTNJ, B0x 1127, Beckley WV 25802. 304-877-5592.

Wilcox-Gay Recordio 5A20 disk recorder, BO. D Ibel, KICD, 2600 N Highway, Spencer IA 51301. 712-262-1240.

150/300 & 600/600 Daven or Shallco stereo attenuators out of non-operating equipment; Surplus programs for Tandy 6000 computer, 8" TRS-DOS or Xenix, very reasonable. Q Morrison, KUAD, 600 Main, Windsor CO 80550. 303-686-2791.

150/300 & 600/600 Daven or Shallco stereo attenuators out of non-operating equipment; Surplus programs for Tandy 6000 computer, 8" TRS-DOS or Xenix, very reasonable. Q Morrison, KUAD, 600 Main, Windsor CO 80550. 303-686-2791.

Battery chargers, electronically regulated for 24 volt storage batteries (2), one 25 amp, \$150, one 30 amp, \$175. F Portnoy, 603-267-7331.

Onan 15RJC-4RB/5700 P, 15 kW standby/18.75 kVA AC 120/208 3 phase 60 Hz 1800 rpm natural gas, \$2000. L Vidoli, WEEI, 4450 Prudential Twr, Boston MA 02199. 800-654-6038.

Cannon UA Series, assorted male, female, cable & panel microphone connectors, BO. B Humphreys, Utah State Univ, Logan UT 89322. 801-750-3133.

Cart rack, walnut formica, holds 60 carts, new, \$60/BO. P Wolf, 813-574-5548.

Christie Reflex 20 mdl D6A06 battery pulsing charger for Christie ENG battery packs, make offer. M Garrett, WCIA, 509 S Neil St, Champaign IL 61820. 217-356-8333.

Collins P/N 662-0213-000, \$270. C Leasure, WTBO, POB 1644, Cumberland MD 21502. 301-722-6666.

Henry Syncro Start, never used, \$100; LEL IF611 timer interface for cart machines & turntables; Extel printer mdl AH11R, needs head & belt; 16" turntable; 10" R-R tapes, \$50 ea; (2) Hazeltine 1500 terminals mdl 4DT155207. A Wortmann, WJAG, 309 Braasch, Norfolk NE 68701. 402-371-0780.

Kintronics RFC40-20 RF contactor, never used, \$450. D Tabor, WHCK, Box 150, Scottsville KY 42164. 502-237-3149.

Lorain rack-mount telephone repeaters, will fix line loss in dial-up lines (7) w/hel, as new, \$200 plus frt; Universal data systems (Motorola) 202T data modem, RS-232 to RJ-11C, \$100 plus frt. D Gilliam, 1555 W Pampa, Mesa AZ 85202. 602-839-1901.

Regulated power supplies (3), 2 ea Lamda plus/minus 12-15 volts at 1.4 amps, one needs minor repair, \$20 & \$10; (1) Lambda tube type model 0-324, 230-300 volts at 150 mA, works OK, rack mount, \$50/BO. M Gottesman, KSGT, POB 100, Jackson WY 83001. 307-733-2120.

Soft SPS400A uninterruptable power supply, 400VA, internal battery, terminals for external 24VDC, \$350. F Portnoy, 603-267-7331.

Teledyne thermoelectric generator, new 70 watt for remote power source, BO. D Barton, KMTI, POB K, Monticello UT 84642. 801-835-7301.

Ten line rotary telephones, w/intercom, connector, \$15 ea. M Black, 315-789-8970.

Time & Temperature System, digital, 5 line ready, but expandable, gd money maker or PR vehicle, hear on line at 605-343-7300. D Grant, Willow Creek Bldg, 8601 Woodland Dr, Black Hawk SD 57718. 605-787-4805.

#### Want to Buy

EBS Unit w/FM receiver needed to educational FM. K Hill, WHCB, POB 2061, Bristol TN 37621. 615-878-6279.

NBC Network decoder, tone decoder for NBC talknet. T Hughes, KJDJ, 1160 Marsh, San Luis Obispo CA 93401. 805-541-3031.

Realistic MTX-100 (2) marine transceiver & antennas. P Robillard, Robillard Comm, 1803 N 1st East St, Haynesville LA 71038. 318-624-0105.

Transcription records, 16", RCA Thesaurus Library. B Davies, Virgo Prod, 5548 Elmer Ave, No Hollywood CA 91601. 818-761-9831.

Vu-Data PS940A CRT for Vu-Data scope mdl PS940A or used scope of same model. F Anderson, 3801 Fifth Ave So, Great Falls MI 59405. 406-452-2810.

1410 kHz crystals wanted, to fit Gates BC 1-G xmtr & CSI (CCA) T2.5A xmtr. J DeVan, WZAL, 12 N Cedar, McDonough GA 30253. 404-957-1549.

Manual for VersaCount V-322 FM exciter; Also several 3-4' 19" racks w/doors. B Dodge, WTIJ, POB 105FM, Hinsdale NH 03451. 603-336-5848.

Schematic & service manual for a KLH Burwen DNF 1201A dynamic noise filter; schematic & service manual for a KLH Burwen TNE 7000A transient noise eliminator. R Nelson, LGH Recording, Box 1, Flaxton ND 58737. 701-596-3565.

Broadcast pins or buttons, network, olympic, etc. M Black, 315-789-8970.

Early mono Hi-Fi equipment, Fisher, MacIntosh, Scott, etc, looking for Scott 121-Series preamp, also related literature and/or Audio Engineering & Hi-Fidelity magazines. B Leslie, Pro Recdg Svs, 13709 Mapleleaf Dr, Cleveland OH 44125. 216-662-1435.

Floppy drive for an Apple 2E & 80 col cd (extended). J Schloss, KICD, 2600 Hiway, Spencer IA 51301. 712-262-1240.

WE 310B copy of schematic or any information. R Delius, WFXC, 2515 Apex Hwy, Durham NC 27713. 919-596-2000.

#### MONITORS

##### Want to Sell

EV Sentry 100A, studio monitors, new, \$250/pr. R Cobb, POB 5332, Sun City Center FL 33570. 813-634-1940.

McMartin TBM-44500A main/stereo mod monitor, gd, \$800; McMartin EBS-1 EBS generator, \$100. P Morton, WRQL, POB 57, Rupert VT 05768. 802-394-7858.

TFT 730A SCA monitor, excel cond, make offer. T Hughes, KJDJ, 1160 Marsh, San Luis Obispo CA 93401. 805-541-3031.

McMartin 4500A stereo mod monitor, excel cond; rack mt fixed freq AM rcvr; TBM-3500, TBM3000 & RF amp, \$1500/BO. J Phillips, WZOM, 313 Washington, Defiance OH 43512. 419-782-6986.

RCA BW-66F tube type AM modulation monitor, BO. B Glasser, WHBC, POB 9917, Canton OH 44711. 216-456-7166.

FM receiver module for TFT-760 EBS unit, tuned to 102.9 MHz, \$275. M Patton, WXON, 6819 Cezanne, Baton Rouge LA 70806. 504-292-4189.

TFT 760, new caps, works fine, EBS system, \$500 firm. L Albert, WKMS, POB 2266, Murray KY 42071. 502-762-4664.

##### Want to Buy

FM stereo mod meter, any brand in gd cond. L Amstutz, Lumiere Haiti, 4526 Arlington, Ft Wayne IN 46807. 219-429-8366.

#### MOVIE PRODUCTION EQUIPMENT

##### Want to Sell

16mm underwater movie outfit, Kodak-100 camera, underwater housing, 10mm Switar lens, 1.6F stop, underwater lights, battery & charger, mint cond, \$699. H Deans, 170 Grand, White Plains NY 10601. 914-949-5920.

RCA 35mm film recorder excel cond, \$3500; Moviola 35mm upright (1) Moviola(1) Pix sound head, \$5000. J Faggney, Ross-Gaffney, 21W46th, NNYNY 10036. 212-719-2744.

Projector 16mm sound DeVry Jan top of the line in excel cond, 35mm 3 gang synciscer, 35mm splicer, 16mm snd camera Auricon Pro 1200 complete opt mag in new cond w/zoom lens, BO or consider home 1/2" recorder, 3/4" recorder portable w/camera for news. Leo Meister, 201-667-2323.

B&H 540 Series 16mm sound projector, vgc, pix & sound fine, 2" F-1.6 lens, 1000 W lamp, \$200/BO pls UPS shpg. B Leslie, Pro Recdg Svs, 13709 Mapleleaf Dr, Cleveland OH 44125. 216-662-1435.

Moviola UL-20-535 one film head, one sound head 16mm film editor, complete, \$1500. P Russell, WBOR, Sills Hall, Brunswick ME 04011. 207-725-3066.

Bell & Howell D 35mm printer, BO; RCA 35mm variable area optical recorder. G Gunter, KMAAB, 650 N Bolton St, Jacksonville TX 75766. 214-586-2162.

Bolex 16mm movie camera, reflex focus, 3 lens turret, \$299; Siemens interlock 16mm sound projector SF-TL-615A, mint cond, make offer. H Deans, 170 Grand, White Plains NY 10601. 914-949-5920.

Kodak 7231, 7291, 7292, 5247, 5294 film stock, 16mm & 35mm in 100', 400', 1000'; KEM universal 8 plate 16mm & 35mm film editing table w/heads & screen. J Workman, Maritz, 600 W Lafayette, Detroit MI 48226. 313-963-1200 X501.

#### RECEIVERS & TRANSCIEVERS

##### Want to Sell

Sansui TU7700 tuner/AU 7700 amp, \$125/both or BO. P Wolf, 813-574-5548.

#### WE'VE DONE THE HARD PART

Our new program computes TV & FM Field Strength for you. It uses the FCC algorithm to determine distance to contour, field strength at distance, and bearings between coordinate pairs. It runs on any IBM-PC compatible and incorporates FCC Docket 88-56 rules. Only \$95.00

Jeremy Lansman  
Spectrum Resources  
POB 240-467  
Anchorage AK 99524  
(907) 345-2630

Transceiver Heathkit SB102-1 covers all ham bands in excel working cond, BO or 1/2" recorder 4 head or what have you. Leo Meister, 201-667-2323.

Scientific Atlanta bdct quality rcvrs, mdl SA 414, \$1075. 4.6 meter sat antennas, mdl 8005, \$2500. Equipment shelters, 12' L x 8' W x 9' T, includes A/C, \$1950. Megastar, 702-386-2844.

## DISTRIBUTOR DIRECTORY

The following distributors serving the broadcast industry would be glad to help you with any of your requirements.

<p><b>SPENCER</b> Broadcast &amp; Communications</p> <p>AUDIO—VIDEO—RF Where Service is #1</p> <p>Now in our 10th year</p> <p>CALL 800-228-4899 602-242-2211 FAX 843-2860</p>	<p><b>THE SOURCE</b></p> <p>CALL US FOR ALL YOUR EQUIPMENT NEEDS</p> <p>Toll free: 800-223-8202 In Florida: 305-651-5752</p> <p><b>ELECTREX COMPANY</b></p>	<p><b>Kidd</b> COMMUNICATIONS</p> <p>CALL US FOR... Audi-Cord Cart Machines &amp; Audlopac Carts</p> <ul style="list-style-type: none"> <li>• Bogner TV Antennas • Cablewave Transmission Line</li> <li>• CRL Audio Processing • Eventide Digital Effects • Gentner Patch Bays</li> <li>• Jampro FM &amp; TV Antennas • JBL Speakers • M/A Comm Video STL's</li> <li>• Mark Antennas • Orban Optimod's • Scala Antennas</li> <li>• Soundolier Equipment Racks • Studer-Revox Tape Recorders/Disc Players • Technics Turntables/Disc Players</li> <li>• TTC FM/TV Translators/Transmitters</li> </ul> <p><b>CALL US TODAY! KIDD COMMUNICATIONS</b> 4096 Bridge Street • Suite 4 Fair Oaks CA 95628 916-961-KIDD(5433)</p>	<p>We have the knowledge and ability to provide you the best suited broadcast for your project... always at competitive prices!</p>
<p>SANGAMO-ACUSHNET MICA CAPACITORS</p> <p>PLASTIC CORP.—NON-PCB OIL FILLED CAPACITORS</p> <p>RF-ANTENNA AMMETERS</p> <p>RCA-RAYTHEON-AEL TRANSMITTER PARTS</p> <p>TRANSFORMERS &amp; CHOKES 250 WATT THRU 50 kW</p> <p>COMMERCIAL RADIO COMPANY BOX 43, CAVENDISH VT 05142 802-226-7582</p>	<p><b>STAR SYSTEMS</b></p> <p>Audio Solutions</p> <p>Otari, 3M, Tascam ATR, Nakamichi Pro, Yamaha, Orban, Valley People, Studer/Revov, Fidelipac And much much more!</p> <p>Call for a current quote (603) 894-6565 326D S. Brdwy Salem, NH 03079</p>	<p><b>CORNELL-DUBILIER</b> MICA CAPACITORS</p> <p>FROM STOCK</p> <p><b>JENNINGS VACUUM</b> CAPACITORS</p> <p>FROM STOCK</p> <p><b>JENNINGS VACUUM</b> RELAYS</p> <p><b>SURCOM ASSOCIATES, INC.</b> 2215 Faraday Ave., Suite A Carlsbad, California 92008 (619) 438-4420</p>	<p>FCC's Engineering</p> <p><b>FM and TV Data Bases</b></p> <p>for your P.C.</p> <p>Call today to request a free sample.</p> <p><b>Communications Data, Inc.</b> 6105 E Arlington Blvd Falls Church VA 22044 (703) 534-0034</p>
<p><b>American Media Services</b> Authorized Distributor for Scotch Cart II Broadcast Tape Cartridge &amp; Scotch Open Reel Tape</p> <p>NAT'L: (800) 345-1953 TEXAS: (800) 521-1953 LOCAL: (817) 535-1953 FAX: (817) 536-1953</p>		<p>Call for availabilities.</p> <p>Phone <b>800-336-3045</b></p> <p>World Radio History</p>	

## EMPLOYMENT

To place ads in this section, use the ActionGram form. To respond to box numbers, write Radio World, PO Box 1214, Falls Church, VA 22041, Attn: \_\_\_\_\_

### HELP WANTED

**Assistant Engineer** for #1 radio station in Indiana. 50 KW FM, 5 KW directional AM. E.O.E. Resumes to WFBQWVDE, 6161 Fall Creek Rd., Indianapolis IN 46220.

**CE for Boston FM station.** Excellent troubleshooting, construction, & people skills required. Reply to Radio World, POB 1214, Falls Church VA 22041. Attn: 3-89-5RW.

**Group needs engineers,** AM DA & FM to turn around stations technically. SBE cert a plus. Write to: Radio World, POB 1214, Falls Church VA 22041. Attn: Box 4-89-2RW.

**Salespeople.** Bring your knowledge of electronic parts to career position in friendly environment. Must understand audio/video applications. Resumes only: Yale Electronics, 6616 Sunset Blvd, Hollywood CA 90028. Attn: Sue.

### POSITIONS WANTED

**20 year veteran career broadcaster,** 12 yrs small mkt general mgmt experience seeking growth opportunity. Resume & qualifications upon request to: Radio World, POB 1214, Falls Church VA 22041. Attn: 2-2-89RW.

**20 yr veteran chief seeks small market.** Wizard with satellite, automation, processing, & can make old equipment sing. Can pull air shift, will relocate. 802-394-7858.

**Attention owners & GM's.** Cut costs down to the bone w/m as O.M./P.D. My CHR format will make you number one. FM's only. Fox Hunter, 619-322-8855.

**CE w/20 yrs exper in radio seeking position.** Familiar w/DA's, installation of transmitters & studios. A people person. F White, POB 1825, Marathon FL 33050.

**Electronic Tech Ham Radio,** FCC lic/satellite TV installer for down link, needs position w/radio or TV station in NYC. M Saint-Cyr, 527 Maple St, Brooklyn NY 11225. 718-604-1617.

**Experienced CE seeks new opportunities,** hands-on exper in all phases of FM & AM directional FCC general & SBE sr certification. 804-276-4597.

**Radio Engineering position wanted** by 26 yr old. Has experience & schooling, neat, professional habits, contract work considered, prefer Wisconsin. Chuck, 715-423-6763.

**Bdct school grad, single female, seeks announcing,** audio/video prod position, gen ph., some exper, will relocate. Linda, POB 1025, Cedar Rapids IA 52406.

**Broadcaster, etc., Vietnam vet, American Forces Radio,** native american Indian, needs work. 10 yrs exper. Ralph Nabor, 2342 Harwood St, LA CA 90031. 213-223-2799.

**Central FL DJ, successful entrepreneur,** over 10 yrs exper all facets of bdct, seeks employment near Mt Vernon MO. Reply #70 713 Rose St, Auburndale FL 33823.

**CHR-UC air personality or music director** seeking employment in AM & FM markets. Willing to relocate. For resume & aircheck contact James Torres, 3933 Main, E Chicago IN 46312. 219-397-4261.

**Director of Engineering** for one of Americas top rated, best sounding radio stations, is looking. Hands on, very strong audio & RF, 18 yrs exper. NARTE, SBE & FCC. Reply to: Radio World, POB 1214, Falls Church VA 22041. Attn: Box 3-89-4RW.

**Engineer, 24 yrs exper, NARTE, SBE, FCC general,** all phases of radio, seeks position with radio group or medium market combo. Prefer S.E., excel references. Write to Radio World, POB 1214, Falls Church VA 22041. Attn: 3-89-1RW.

**Engineer, 22 yrs exper all phases AM/FM** bdct engineering including extensive station construction, seeks position as station or group CE or manufacturers sales representative. Patrick Shirley, POB 292, Mumfory NY 14511. 716-538-2976.

**FT contract engineer (AM/FM) seeking position** for TX, OK, ARK, LA area, SBE certified/bdct eng AAS degree. B Gaddis, 1302 E 1st St, Mt Pleasant TX 75455. 214-572-9322.

**Talented, versatile announcer,** 11 yrs exper., looking for work. CW format. NW NC, SW VA preferred. R Wisbon, Rte 1, Box 545, Yadkinville NC 27055. 919-679-2379.

**AM, FM, TV Chief,** 30 yrs exper seeking responsible position in broadcast engineering management. D Larsen, 4554 S 35th West, Idaho Falls ID 83402. 208-524-7260.

**Engineer, mature, extensive exper in AM/FM,** shortwave & TV. General phone, NARTE, BSBA degree. Prefer sunbelt, consider all areas including overseas & equipment mfgs.

Write to: Radio World, POB 1214, Falls Church VA 22041. Attn: Box 4-89-1RW.

**FT radio CE position wanted,** exper in AM/FM radio, professional audio systems, computers; design, installation, maintenance. B.S. degree in engineering; FCC license, Midwest or south preferred. Call Andy at 508-393-5753, evenings before 10PM.

**Program Director/announcer w/BA in Communications,** 6 yrs exper, have done engineer-

ing. James, 608 College Ave, Bluefield WV 24701. 304-327-5651.

### BROADCAST EQUIPMENT SALES REP

Leading national distributor of broadcast audio equipment is expanding our sales rep organization. We seek aggressive professionals. We support your efforts and pay top commissions. Exclusive territories available in most regions of the U.S. Send resume to: Roy Laurence, RADIO RESOURCES, 7483 Candlewood Road, Hanover, MD 21076



### CONSOLE TEST ENGINEER

Audio console manufacturer seeks experienced people for technical department. Solid background in console testing and audio measurements is important. Light engineering skills valuable as position will require frequent involvement with design and engineering departments. Good growth opportunity. Send resume to: Andrew Calvanese, Wheatstone Corporation, 6720 V.I.P. Parkway, Syracuse, NY. 13211

## ADVERTISING MANAGER Broadcasting Equipment

**Broadcast Electronics seeks a creative individual to direct the company's total product promotion and space advertising program. Position reports to VP/Marketing.**

Minimum requirements 2 years industrial product merchandising experience and BS or MS degree, preferably in Journalism. Applicant must possess good writing skills in addition to creativity and management ability.

Salary commensurate with experience, education and abilities. Exceptional benefit package includes profit sharing plan.

Broadcast Electronics is located in a pleasant midwestern city of 50,000 population. Excellent working environment in a modern 70,000 sq. ft. air conditioned headquarters/manufacturing complex. Please send resume in strict confidence to Steve E. Wall, Director of Personnel.

An Equal Opportunity Employer



4100 N. 24th ST., PO BOX 3606, QUINCY, IL 62305, (217)-224-9600

## ACTION-GRAM

### EMPLOYMENT SECTION:

**Help Wanted:** Any company or station can run "Help Wanted" ads at the flat rate of \$25 per listing per month (25 words max). Payment must accompany insert; there will be no invoicing. Blind box numbers will be provided at an extra charge of \$2. Responses will be forwarded to listee, unopened, upon receipt. Call 800-336-3045 for display rates.

**Positions Wanted:** Any individual can run a "Position Wanted" ad, FREE of charge (25 words max.), and it will appear in the following 3 issues of Radio World. Contact information will be provided, but if a box number is required, there is a \$2 fee which must be paid with the listing (there will be no invoicing). Responses will be forwarded to the listee, unopened.

Check as appropriate:  
 Help Wanted                       With Box Number  
 Positions Wanted                   Without Box Number

Text (25 words maximum): \_\_\_\_\_

Name \_\_\_\_\_ Title \_\_\_\_\_  
 Company/Station \_\_\_\_\_  
 Address \_\_\_\_\_  
 City \_\_\_\_\_ State \_\_\_\_\_ Zip \_\_\_\_\_  
 Telephone \_\_\_\_\_

Mail to:  
**BROADCAST EQUIPMENT EXCHANGE**  
 PO Box 1214, Falls Church, VA 22041

## CONSULTANTS

### R.L. HOOVER

Consulting Telecommunications Engineer

11704 Seven Locks Road  
 Potomac MD 20854  
 301-983-0054  
 Member AFCCE

### R.J. GRANDMAISON, P.E.

CONSULTING ENGINEER  
 Applications and Rulemakings  
 11213 Split Rail Lane  
 Fairfax Station, VA 22039  
 (703) 764-0513  
 Member AFCCE

### R. Sequerra Associates Ltd.

RF & audio instrument & product design uniquely for broadcasting

718-225-4159

SPECIALIZING IN ERECTION, REPAIRING, PAINTING AND MAINTENANCE MICROWAVE, RADIO, TWO-WAY, A.M. SYS., TV. TOWERS

### TEXAS STEEPLEJACK CO.

PAINTING AND STEEPLEJACK CONTRACTORS

FULLY INSURED FOR YOUR PROTECTION  
 MARIO RODRIGUEZ 5650 TIMBERCREEK PL. DR.  
 (713)855-1262 HOUSTON, TEXAS 77084

RF and Audio Coast to Coast

### STEVE VANNI ASSOCIATES, INC.

BROADCAST TECHNICAL CONSULTANTS

Project Management Facility Planning  
 Equipment Installations

P.O. Box 422 Auburn, NH 03032 (603) 483-5365

### FM Study Program

FM Searches Within The Budget of Anyone Who Owns An IBM-PC L.R.C.  
 602-293-2374

FCC's Engineering FM and TV Data Bases for your PC  
 Call today to request a free sample.  
 Communications Data, Inc.  
 6105 E Arlington Blvd  
 Falls Church VA 22044  
 (703) 534-0034

### EVANS ASSOCIATES

Consulting Communications Engineers  
 FCC Applications, Design & Field Engineering  
 Broadcast Engineering Software  
 216 N. Green Bay Rd.  
 Thiensville, WI 53092  
 (414) 242-6000  
 Member AFCCE

### W. LEE SIMMONS & ASSOC., INC.

BROADCAST TELECOMMUNICATIONS CONSULTANTS  
 5 Gracefield Road  
 Hilton Head Is., SC 29928  
 (803) 785-4445

### Moffet, Larson & Johnson, Inc.

Consulting Telecommunications Engineers  
 Two Skyline Place  
 5203 Leesburg Pike #800  
 Falls Church VA 22041  
 703-824-5660  
 800-523-3117  
 Member AFCCE

### MIRKWOOD ENGINEERING

Rural & Remote Site Field Engineering  
 50 Park Ave.  
 Claremont, NH 03743  
 603/542-6784

Consulting Communications Engineers  
 • FCC Data Bases  
 • FCC Applications and Field Engineering  
 • Frequency Searches and Coordination  
 • AM-FM-CATV-ITFS-LPTV  
**OWL ENGINEERING, INC.**  
 1306 W. County Road. F, St. Paul, MN 55112  
 (612)831-1338 "Member AFCCE"

### SOFTWARE FM CHANNEL SEARCH

FM Database pool  
 MSDOS  
 EGA Graphics-Color  
 Broadcast Technical Consulting  
**Doug Vernier**  
 Broadcast Consultant  
 1600 Picturesque Drive  
 Cedar Falls, IA 50613  
 319-266-7435

### R.L. Kennedy & Associates

Telecommunications Engineering Consultant  
 Radio-TV-ITFS-Microwave  
 P.O. Box 141  
 Waynesville, NC 28786  
 (704) 648-3283

SPECIALIZING IN ERECTION, REPAIRING, PAINTING AND MAINTENANCE RADIO, TWO-WAY, TV. TOWERS AND FLAG POLES  
**A STEEPLEJACK CO.**  
 PAINTING AND STEEPLEJACK CONTRACTORS  
 FULLY INSURED FOR YOUR PROTECTION  
 DON HIGLEY 3722 ROMA  
 713-462-6105 HOUSTON, TEXAS 77080

### BRENTLINGER BROADCAST ENGINEERING INC.

Charles Jayson Brentlinger President  
 COMPUTERIZED ENGINEERING REPORTS/ALLOCATION STUDIES  
 AM\*FM\*AM  
 DIRECTIONALS\*AUDIO\*STL  
 \*SATELLITE COMMUNICATIONS  
 4338 East Acoma Drive  
 Phoenix, Arizona 85032  
 (602)867-0181

### MAGRILL ENGINEERING

(904) 591-3005  
 APPLICATIONS—CONSTRUCTION  
 UTILITY PROBLEMS SOLVED  
 FAIRFIELD, FLORIDA

International Map Service  
 "The maps you need, when you need them"  
 OVERNIGHT DELIVERY  
 1-800-426-TOPO  
 FAX 303-987-2735  
 Topos, Aeronautical, Terrain Analysis Pkg. and Foreign Maps.

Contact  
**Radio World**  
 PO Box 1214, Falls Church VA 22041  
 for availabilities. Phone 800-336-3045

Use The ActionGram for Immediate Action!

**RECEIVERS ... WTS**

**GE MastrPro** UHF 2-way repeater, TX: 450.250, RX 455.3125, \$2000. S Sheldon, WSJM, 580 E Napier Ave, Benton Harbor MI 49022. 616-925-1111.

**ICOM IC-H16** keyboard programmable commercial VHF handheld transceiver incl CM-8 Nicad, CM-16U charger, flex antenna & programming/service manuals in box, excel phys & elect cond, \$500, but would consider trade for Collins S-line TX/RX, KWM-2A or LPB solid state carrier current xmtr system. D Sites, 5809-K Cambridge Dr, Springfield VA 22152.

**Wegener Transtar-Country**, changed formats, this unit used less than 6 mos. C Harrison, Boise Viking Assoc., 5601 Cassia, Boise ID 83706. 208-344-3511.

**Aircraft Skyphone**, \$300; mobile VHF power amp, max 30 watts in, 80 watts out. C Haynes, POB 31235, Jackson MS 39206. 601-948-1515.

**Aircraft Skyphone**, \$300; mobile VHF power amp, max 30 watts in, 80 watts out. C Haynes, POB 31235, Jackson MS 39206. 601-948-1515.

**Want to Buy**

**Realistic Pro 2** monitor receiver, need owners manual & crystals to fit it; Commodore 64 computer, working or not. C Daniel, Daniel Electronics, Rt 4 Box 336E, Mena AR 71953. 501-394-6654.

**REMOTE & MICROWAVE EQUIPMENT**

**Want to Sell**

**Enterprise Elect 7900** color weather radar system to use w/data from Natl Weather Svcs, BO. L Dupree, KSKL, 1115 Texas Ave, Alexandria LA 71301. 318-445-1234.

**Moseley PCL-101** discrete STL's (2), recent vintage, gd cond, \$2000 ea or \$3000/pr. P Morton, WRQL, POB 57, Rupert VT 05768. 802-394-7858.

**Satellite reception system** for Transtar Format 41. Includes Wegener 1601 mainframe & pwr supply, 1610-01 7.44, 1610 7.04 demodulators, 1608-23 RF, 1689-04 IF downconverters, 2046-07 comm & control module, (2) 1644-02 relay interfaces, Colorado Magnetics NS200B audio cart switcher & all instruction manuals. Used for just over 1 yr, make good offer. J Hansen, KDMG, 100 Court Ave, Ste 103, Des Moines IA 50309. 515-282-1033.

**Equatorial/MP1**, complete UPI satellite news setup including dish/LNA, controller & printer, gd cond, BO. G Peterson, KIMM, POB 8205, Rapid City SD 57709. 605-348-1100.

**Harris 6528** satellite rcvrs, vgc, have approx 60, will make deal on package, \$1000 ea/BO. R Dieterich, WAMO, 411 7th Ave, Pgh PA 15219. 412-471-2181.

**Modulation Assoc.**, analog satellite rcvr, make offer. J Evans, KNTI, 75 Fourth, Lakewood CA 95453. 707-263-1551.

**Moseley PBR-30A** 30 chnl remote control w/2 studio terminals, working when removed, will work duplex or simplex, \$500 as is. C Gustafson, WKZO, 590 W Maple, Kalamazoo MI 49008. 616-345-2101.

**Moseley PCL 2B** dual STL system, (2) xmtr, (2) rcvrs, you ship, \$2500/BO. R Dieterich, WAMO, 411 7th Ave, Pgh PA 15219. 412-471-2181.

**Moseley SC88** subcarrier generators, 67 kHz, 185 kHz. Brand new, \$900; Moseley SCD, 185 kHz, brand new, \$900. J Evans, KNTI, 75 Fourth, Lakewood CA, 95453. 707-263-1551.

**Regency FM mobile radios**, 25 watt, (4) \$75 ea. J Phillips, WZOM, 414 Washington, Defiance OH 43512. 419-782-6986.

**Terracom TCM 601F** microwave receiver, gd cond, w/case, \$2200; ITT/Federal MIL Spec, portable microwave 12 line telephone/telegram system, gd cond, \$7800. M Murphy, 11621 Valle Vista Rd, Lakeside CA 92040. 619-561-2726.

**Belar remote frequency**, modulation & peak flasker panel, \$75/BO. P Russell, WBOR, Sills Hall, Brunswick ME 04011. 207-725-3066.

**Enterprise WR-100-5** weather radar w/digital NTSC colorizer, 8" steerable antenna w/radome, 550 kW peak output, with/without 100' self supporting tower. D Roden, 1701 Monte Sano, Huntsville AL 35801. 205-533-3676.

**Marti RPT-25** xmtr on 450.75/450.65, new cond, \$1300/BO. M Black, WEOG, Geneva NY 14456. 315-789-1929.

**Marti SCG-8** sub carrier generator tuned to 67 KHz, can be retuned, \$350. M Patton, WXON, 6819 Cezanne, Baton Rouge LA 70806. 504-292-4189.

**Moseley PCL-303** STL on 947.0, \$2000; Moseley SCA generators (2) & demod, \$450/ail. M Ripley, KOZE, 208-743-2502.

**Moseley PBR 15AR** PC boards: TU, sub aud mtr proc 51A5327, sib carr demod 51A5331, sub carr gen 51A5320, alarm xmt 51A5335; SU: sub aud up conv 51A5315, sub carr gen 51A5320 (110 kHz pref), alarm det 51A5322. V Thompson, KTOT, Box 2810, 575 Pine Knott, Big Bear Lake CA 92315. 714-866-3434.

**Moseley PBR-21** remote control system, \$800. C Leasura, WTBO, POB 1644, Cumberland MD 21502. 301-722-6666.

**Moseley PCL-505**, (2) xmtrs, (2) rcvrs, gd cond on 947.875/948.125, no combiner, \$2500. P Baumgartner, WMBD, 3131 N University, Peoria IL 61604. 309-688-3131.

**Moseley PBR-21** remote control system, \$800. C Leasura, WTBO, POB 1644, Cumberland MD 21502. 301-722-6666.

**TFT 7610-C** digital telemetry remote, wireless, remote control, needs work, BO. J Bahr, WVIS, Box 487, Frederiksted, St Croix, US Virgin Islands, 00841. 809-778-5199.

**Complete satellite receiver system** for Satcom 1-R, Scientific Atlanta. Includes one 15K card, one 75K card, one voice cue card, dish & LNA. Call David Leyton, 313-238-2022.

**Want to Buy**

**Comrex LX-T** or Gentner single line encoder. M Black, WEOS, Hobart & William Smith College, Geneva NY 14456. 315-789-8970.

**Fairchild Dart 384**, 75 kHz or 15 kHz audio chnl cards. T Hughes, KJDI, 1160 Marsh, San Luis Obispo CA 93401. 805-541-3031.

**Receiver to pick up ABC** entertainment news. D Jordan, WDTM, POB 3417, Jackson TN 38303. 901-668-1153.

**STL for video service**. AACT Inc., 156 Lazelle Rd, Wontington OH 43085. 614-846-9234.

**Telephone lines only**. J Foust, WXEE, Box 1340, Welch WV 24801. 304-436-4191.

**Ampex 400B** remote control. C Wilson, Mongo Video, 13123 Moldridge Rd, Wheaton MD 20906. 301-949-1809.

**Scientific-Atlanta digital audio terminal** power supply. C Gustafson, WKZO, 590 W Maple, Kalamazoo MI 49008. 616-345-2101.

**Stereo STL system**, B Dodge, WTLJ, POB 105FM, Hinsdale NH 03451. 603-336-5848.

**Marti RPT-15** 450 MHz, also need matching rcvr. J Davis, WGRD, 38 W Fulton, Grand Rapids MI 49503. 616-459-4111.

**Moseley PBR-15** w/110KHz SCA return, must be in gd working & cosmetic cond. J Bahr, WVIS, Box 487, Frederiksted, St Croix, US Virgin Islands, 00841. 809-778-5199.

**Remote control** for Am 1000W, telephone lines only. J Foust, WXEE, POB 1340, Welch WV 24801. 304-436-4191.

**Strapping diagram** for WE & KS20159-L4 EOs. M Black, 315-789-8970.

**Working VHF RPU & STL** equip needed for 169 & 217 MHz bands. L Amstutz, Lumiere Haiti, 4526 Arlington, Ft Wayne IN 46807. 219-429-8366.

**STATIONS**

**Want to Sell**

**Wanted AM, AM-FM Combo** or FM in VA, WVA, Maryland or PA if right down & terms. Reply in confidence, all replies will be answered. Brokers welcome. Write to: Radio World, POB 1214, Falls church VA 22041. Attn: 2-3-89RW.

**Class A CP** on edge of market #52, great coverage potential, but lost xmtr site, will sell w/equip for my expenses. P Morton, WRQL, POB 57, Rupert VT 05768. 802-394-7858.

**FM CP's WANTED**

Clients seek CP's any size market. Small, medium, large. Will consider FM upgrades, too!

**Media Market Brokers**

**Don Nahey**  
1-404-323-8081

**Combo AM 1 kW**, FM Class A, 3 acres, automated, retiring, priced to move fast, 3 bdrm hom available. P Robillard, Robillard Comm, 1803 N 1st East St, Haynesville LA 71038. 318-624-0105.

**Wanted AM, AM-FM Combo** or FM in VA, WVA, Maryland or PA if right down & terms. Reply in confidence, all replies will be answered. Brokers welcome. Write to: Radio World, POB 1214, Falls church VA 22041. Attn: 2-3-89RW.

**Will sell up to 45%** of 10 kW AM under construction in Southwestern Montana. Station will serve Bozeman, Butte, Helena, Dillon & Livingston, plus NE Idaho & Yellowstone Natl Park. Also unopposed FM application for Class C now before FCC. Golden Empire Bdcgt, POB 483, Belgrade MT 59714.

**AM 1kW**, large Colorado market, low down, low price. G Erway, 3450 SE Martinique Trace, Stuart FL 33997. 407-283-6871.

**Want to Buy**

**Looking for AM, FM** or CP in east for right price/terms. H Kozlowski, 703-631-0197.

**STEREO GENERATORS**

**Want to Sell**

**Collins 786W-1** plug in SCA generator for Collins 3102-1B, 3102-2, & Continental 510R-1 exciter, \$500. S Keating, 17029 Devonshire #150, Northridge CA 91325. 818-363-6064.

**CRL stereo generator**, excel cond, \$900; BE stereo generator, gd cond, \$500. P Morton, WRQL, POB 57, Rupert VT 05768. 802-394-7858.

**Wilkinson SG1E** stereo generator. E Kazmark, KAPA, 2065 Ocean, Raymond WA 98577. 206-875-5551.

**Wilkinson SG1E**, Collins 786M-1 solid state generator, \$750 & \$400 respectively. J Bahr, WVIS, Box 487, Frederiksted, St Croix, US Virgin Islands, 00841. 809-778-5199.

**Want to Buy**

**Gates M-6146** for use w/6095 exciter. K Smith, RR 3 Box 483A, Gorham ME 04038. 207-929-6129.

**SWITCHERS (VIDEO)**

**Want to Sell**

**EchoLab SE2** video switcher w/sync generator, gd cond, \$800. D Harns, Design Sids Teleprod, 216 Commercial, Waterloo IA 50701. 319-232-5604.

**Routing switcher**, 100 in, 96 out. GE TS301A recently retired from service, gd working order w/all cables, manuals, racks, BO. A Ezekiel, 215-848-4501.

**TAPES, CARTS & REELS**

**Want to Sell**

**A-2 or AA-3 carts**. Sell or trade for other equipment needs. JB Salazar, POB 3246, Laredo TX 79041. 512-722-6832.

**A&D Cartridge Rebuilding Service**  
We clean, load & pack. Serviced within 10 work days! Work guaranteed!  
**3380 Makely Ave., Eau Claire, WI 54701**  
**(715) 835-7347**

**Ampex & 3M used 2" & 1" tapes** on 13" & 10.5" reels, \$20 ea; 3M bdcrt quality video tape, \$10 ea. N Metzger, 312-989-1101.

**Capitol HOLN (60)** pancake 3600' hubs of HOLN A-3 cart recording tape, sold in any quantity, \$15/hub or BO. J Emmel, WWAX, POB 750, Olyphant PA 18447. 717-489-0005.

**Fidelipac master carts**, (1000), 3.5 minutes, \$60 ea, add \$3 per 100 carts. D Peluso, KFM Radio, Las Vegas. 702-732-7753.

**Fidelipac CTR124**, J Lackness, KRIA. 512-828-3737.

**IGM Good Music Series**, 30 14" reels 7.5 ips 2T stereo, gd music, \$30 per reel, delivered. F Anderson, 3801 Fifth Ave So, Great Falls MI 59405. 406-452-2810.

**NAB reels**, 10.5" metal 14", all in gd cond, 1-10, \$1.50 ea, 11-100, \$1.25 ea, 100+, \$1 ea. Falk Recd Svcs, 7914 Fegenbush Ln, Louisville KY 40228. 502-239-1010.

**Several hundred 34" U-matic** cassettes used w/new boxes, ready for new tape reload, BO. R Meyers, Benchmark Comm Corp., 4700 SW 75 Ave, Miami FL 33155. 305-264-5963.

**3M used 1" tape**, 206 (6) full on reels, 208 (2) full, one on reel, other on hub, Ampex 406, partial on hub, \$10/reel or entire lot for \$75. E Helvey, POB 1357, Winchester VA 22601. 703-877-1191.

**3M 1/2" tape**, 206 (12) full, (2) partial hubs, 208 (1) full hub, Ampex 406 (1) full hub, \$5 per hub; (2) 1/2" metal 10" reels, \$3 ea. Entire lot, \$75. E Helvey, POB 1357, Winchester VA 22601. 703-877-1191.

**ABCO Mdl 500** lazy susan cartridge rack, holds 500 carts, 6" high, 21" in diameter, gd cond, (2), \$400 ea. E Swanson, WZTR, 520 W Capitol, Milwaukee WI 53212. 414-964-8300.

**Ampex, Maxwell brands**, one lot of 59 KCA type video cassettes, BO. E Meier, Rt 4 Box 98, Washington NC 27889. 919-946-2461.

**Capitol, Fidelipac**, various lengths & recorded songs, \$1 ea. R Price, KWIK, Box 998, Pocatello ID 83204. 208-233-1133.

**IGM pre-recorded tape**, 30 reels 14 in 2 tr stereo, big band music, \$30 per reel in US. F Anderson, 3801 Fifth Ave South, Great Falls MT 59405. 406-452-2810.

## TRANSCOM CORP.

Fine Used AM & FM Transmitters and Also New Equipment  
For the best deals on Celwave products, Andrew cable, Shively & Comark antennas.

- 1983 CSI 25,000E kW FM
- 1973 RCA BTS 20E1, 20 kW FM
- 1978 Collins 820F, 10 kW AM
- 1966 Collins 21E, 5 kW AM
- 1970 CCA AM 10,000D, 10 kW AM
- 1976 CCA AM 50,000D, 50 kW AM

201 Old York Rd.  
York Plaza Ste 207  
Jenkintown PA 19046  
215-884-0888

Telex No. 910-240-3856 (TRANSCOM CORP. UQ)  
FAX No. 215-884-0738

## THE BEST KEPT SECRET CAN NOW BE TOLD!!

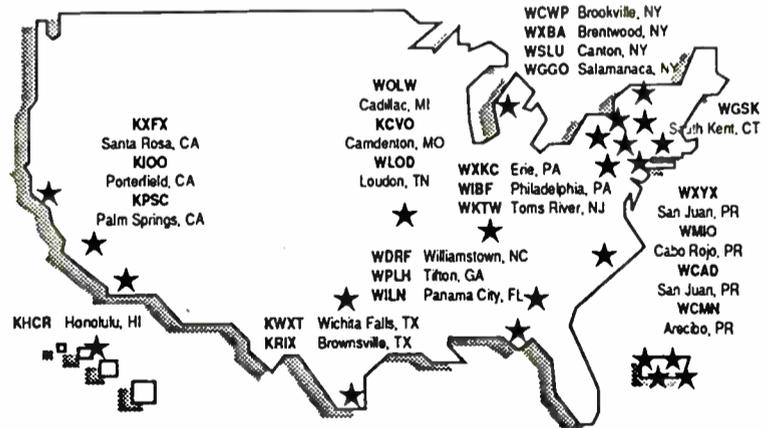

**Energy-Onix FM Transmitters are Nationwide!!**

Two years ago, Bernie Wise, a legend in the broadcast transmitter business, formed Energy-Onix. In this relatively short time, Bernie and his associates have developed a complete line of FM transmitters which can produce 30 watts to 50kw. This line includes solid state transmitters from 30 watts to 2kw, single tube transmitters from 1.5kw to 12kw and two tube transmitters from 1.5kw to 50kw.

*Thirty six of these transmitters are now operating worldwide!!*

All transmitters include understandable solid state controllers with provisions for automatic power output control, VSWR fold-back, VSWR protection and a redundant override system. Of course, when tubes are used they are zero bias triodes with Bernie's field proven circuitry.

**VISIT US AT NAB BOOTH # 1730**



**Energy-Onix**

752 Warren St.  
Hudson, NY 12534

518-828-1690

FAX 518-828-8476

**TAPES . . . WTS**

Record collection, 45 RPM, Neil Diamond, Supremes, Beach Boys, etc, 1960-1980, approx. 500 records, make offer. C Zaleski, Eds Comm Srvs, POB 92, Johnson City NY 13790. 607-798-7111.

Aristocarta, various lengths, sale or trade. Clay Freinwald. 206-383-9700.

**Want to Buy**

Jazz record collections, 10" LP12" LP bebop, swing, dixie, highest prices paid. B Rose, Program Recdgs, 228 East 10th, NUNY 10003. 212-874-3060.

AAA carts, large selection needed. D Brown, KMCD, 57-1/2 Count St, Fairfield IA 52556. 515-472-4191.

Cart tapes needed, large quantity, any quality, preferably cheap. J Smith, WRDV, POB 2012, Warminster PA 18974.

Thesaurus, World & Associated 12" transcriptions by various instrumental artists. J Leon, Leon Recdg Snd, POB 51, Jackson Hgts NY 11372. 800-221-0605 or 718-383-7212.

KCS-20 type small U-matic carts for BVU-100 VCR's, also gd used Beta carts. C Lund. 203-756-7761 aft 4PM.

**TAX DEDUCTIBLE EQUIPMENT**

Eng student desiring donation of old bcdt equip (anything) in repairable cond, will pay all shipping charges. EE student at Purdue. C Gill, POB 371, Indianapolis IN 46206. 317-923-2800.

Christian Boarding School, (9-12) w/sat rcvr seeks VCRs/VTRs & related equipment for record, edit & download to 1/2" VHS or edu pgming. J Mann, Campion Academy SW, 42nd & Academy Dr, Loveland CO 80537. 303-667-5592.

Christian Boarding School, (9-12) w/sat rcvr seeks VCRs/VTRs & related equipment for record, edit & download to 1/2" VHS or edu pgming. J Mann, Campion Academy SW, 42nd & Academy Dr, Loveland CO 80537. 303-667-5592.

Church & Christian school desire sound reinforcement & audio/visual/video prod equip in working cond, tax deductible donations preferred. A Allegra, Calvary Baptist Church, 1380 Valley Forge Rd, Lansdale PA 19446. 215-368-4444.

College station needs donation or R-R, cart machines & other equipment. M Black, WEOS, Hobart & William Smith College, Geneva NY 14456. 315-789-8970.

Donation of equip to church, 34 editing recorders, playback units, audio & video. JB Salazar, ICS, POB 3246, Laredo TX 78044. 512-722-6832.

Eng student desiring donation of old bcdt equip (anything) in repairable cond, will pay all shipping charges. EE student at Purdue. C Gill, POB 371, Indianapolis IN 46206. 317-923-2800.

Full Gospel Business Men's Fellowship is seeking tax deductible donations of all types of new or used audio & video equipment for a LPTV station. D Susong, 1939 Hill Trail Dr, Morristown TN 37814. 615-587-3915.

SCA Subcarrier receivers, any cond, for non-profit radio reading service. T Vernon, Assn for the Blind, 1800 N 2nd St, Harrisburg PA 17102. 717-238-2531.

R-R 10-1/2", 2 chnl stereo recorder needed & 16mm film sound projector for purposes of religious education. J Acuna, Cruzada, POB 760273, OKC OK 73176. 405-631-5877.

FM xmtr, 250-100 watt; also (3) deck tape recorders & R-R & 120" tower, 1-4 bay antenna, sportscaster board. J Setzer, Christian Entertainment Ministries, POB 93, Brookfield MO 64628. 816-376-2502.

Gatesway stereo control board/mixer, Executive or Diplomat, 10 mixing chnl; Ampex R-R recorder 601 mono or stereo; Russco or other similar brand Cue Master, donation or token price, will be used in religious FM in foreign country. D Daniell, Apdo Postal 310, 53102 Cd Satehite, Mexico. 011-525-572-4568.

Mission of the Queen of the Holy Rosary is seeking donation of all types of audio & video equipment, most need at this time R-R, cart machines & stereo console. Tax deduct donations. Mission of QHR, 865 Seneca Creek, W Seneca NY 14224.

Seeking 3-deck BE cart machine, cassette decks. C Sparr, WVMR, Rt 2B, Dunmore WV 24934. 304-799-6004.

Small Christian radio needs small console & (2) turntables & (2) cassette decks, free donation. KISK, 407 S New Madrid, Sikeston MO 63801.

**TEST EQUIPMENT**

**Want to Sell**

General Radio 1606B RF bridge w/accessories, manual & carrying case, \$1500/firm. ST. Carter II, Cartronics, POB 3177, Indialantic FL 32903. 407-727-3015.

**TEST EQUIPMENT**  
*We Buy and Sell*

All types of late model Test Equipment  
Hewlett-Packard, Tektronix, Wavetek,  
Fluke R.F. & Microwave a Specialty

**G.V. BELL & ASSOCIATES**

San Mateo, California  
1-800-366-5240  
(Inside 408/415 area)  
415-366-5240  
FAX 415-369-9698

Coaxial dynamics 81001-A power meter, new, w/external input, 1-5/8 flange, elements from 100W to 5 kW, never used, \$500; London instruments deviation meter, call20b mod monitors, check STL & Marti deviation, etc, tunes to 1 GHz, \$800; HP 330D, fair, \$50; Digimax D-1200 freq ctr, \$250. P Morton, WRQL, POB 57, Rupert VT 05768. 802-394-7858.

Coaxial dynamics 81001-A power meter, new, w/external input, 1-5/8 flange, elements from 100W to 5 kW, never used, \$500; London instruments deviation meter, calib mod monitors, check STL & Marti deviation, etc, tunes to 1 GHz, \$800; HP 330D, fair, \$50; Digimax D-1200 freq ctr, \$250. P Morton, WRQL, POB 57, Rupert VT 05768. 802-394-7858.

Harris 994-7023-001 stereo gain set, new cond, \$700/BO; B&W 410 distortion analyzer, new cond, \$400/BO. S Daltch, Box 8091, Greenville NC 27835. 919-355-6543.

RCA WX-2C (Potomac FIM-120-E) Am field intensity meter, excel physical & electronic cond w/manual, \$400 or consider trade for Revox A-77 or Sparta 5-mixer stereo remote console w/power supply. D Sites, 5809-K Cambridge Dr, Springfield VA 22152.

Tektronix 491 spectrum analyzer, \$1500; Tektronix 492 spectrum analyzer, clean, repairable, \$7800; General Avionix USM-117C solid state portable oscilloscope, excel cond, w/plug-in, book, probes, \$125. M Murphy, 11621 Valle Vista Rd, Lakeside CA 92040. 619-561-2726.

Data-Vue PS940A CRT or used PS940A wigwood CRT. F Anderson, 3801 Fifth Ave South, Great Falls MT 59405. 406-452-2810.

Matec 1204 synchronizer & exponential generator, \$45 plus UPS. J Baltar, Maine Reel, 67 Green, Augusta ME 04330. 207-623-1941.

Potomac AM19 antenna monitor, 2 tower, 2 ref, \$1300. T Gaiser, KAFY, 1527 19th St #300, Bakersfield CA 93301. 805-324-4411.

Signal Corps BC-221-AA frequency meter, BO. D Ibel, KICD, 2600 N Highway, Spencer IA 51301. 712-262-1240.

Tektronix 454 oscilloscope, 19" rack model dual trace, D.C. to 150 MHz, w/manual, excel cond, recent calibration, \$725. S T Carter II, Cartronics, POB 3177, Indialantic FL 32903. 407-727-3015.

Wavetek/SSI 3000/SSI service monitor, gd cond, \$2500. M Murphy, 11621 Valle Vista, Lakeside CA 92040. 619-561-2726.

Potomac Instruments FIM-21 field strength meter 54-1.6 MHz, excel cond, \$900. J Anderson, W 621 Mallon, Spokane WA 99201. 509-326-6229.

**Want to Buy**

20 kW air cooled dummy load in good cond. R Kerbaw, WTNI, Box 1127, Beckley WV 25802. 304-877-5592.

HP 1820A/1840A 250 MHz vertical amp/rime base for 180 Series scope; HP 3200B RF signal generator; HP 1802A, 100 MHz vertical amp for 180 Series scope; RF sweep generator. R Lankton, WDUV, 2600 1st St West, Bradenton FL 34205. 813-749-1420.

Leader 120A, 120B, 125 or 126S audio generator & Leader LDM 170 or 171 distortion meter. H Yund, WTKI, 2200 15th, Gulfport MS 39501. 601-863-3522.

**TRANSMITTERS**

**Want to Sell**

AM xmtrs including: GE 50kW, Collins 21-E 5kW, Gates BC-5E, Raytheon, RCA BTA-5T 1kW, Gates BC-1J, BC-1G, BC-1F, RCA BTA-1R, and many others, warranted. Jerry 315-488-1269.

AM xmtrs including: GE 50kW, Collins 21-E 5kW, Gates BC-5E, Raytheon, RCA BTA-5T 1kW, Gates BC-1J, BC-1G, BC-1F, RCA BTA-1R, and many others, warranted. Jerry 315-488-1269.

AM xmtrs including: GE 50 kW, Collins 21-E 5 kW, Gates BC-5E, Raytheon, RCA BTA-5T 1 kW, Gates BC-1J, BC-1G, BC-1F, RCA BTA-1R, and many others, warranted. Jerry 315-488-1269.

BTF-1E, 1 kW FM RCA xmtr; BTE-10C FM RCA exciter; RCA BFA-4-A, 4 bay antenna; RCA BTS-1A, stereo subcarrier generator; Collins 26U-2 FM stereo limiter, \$5000 takes it all. P Knies, WBDC, POB 330, Huntingburg IN 47542. 812-683-4144.

BTF-1E, 1 kW FM RCA xmtr; BTE-10C FM RCA exciter; RCA BFA-4-A, 4 bay antenna; RCA BTS-1A, stereo subcarrier generator; Collins 26U-2 FM stereo limiter, \$5000 takes it all. P Knies, WBDC, POB 330, Huntingburg IN 47542. 812-683-4144.

CCA FM 10000, refurbished before our purchase 1.5 yrs ago, never used since purchase, now less exciter, first \$7500 takes it. J Nicholson, Central Coast Bdct, POB 666, Lincoln City OR 97367. 503-996-6800.

Dielectric 620-0675 3db hybrid combiner/splitter. Has 4, 3-1/8" flanged ports, never used in perfect cond, \$1800 pls shpg; 3 port RF patch bay 3-1/8" flanged, \$150 pls shpg. B Roberts, ARP Studios, POB 325, Mt Pleasant SC 29465. 803-928-3663.

FM xmtrs including: GE 3kW, Harris 5H, 5G, 5B 5kW, 10kW, Collins 830, CCA 10,000DDS, RCA BTF10-D, 20-25kW CCA 25000DDS, Harris FM 20K, 1kW, Collins 1000D, Gates FM-1B, FM-1C, others. Jerry 315-488-1269.

Gates FM-1B xmtrs (2), 1 hardly used, the other so-so, with brand new The-1 exciter, or with TE-1 exciter, stereo generator and SCA generator, many spare parts, new & spare tubes, sell all or part, call; Collins 250 W, AM for standby, \$400. P Morton, WRQL, PO Box 57, Rupert VT 05768. 802-394-7858.

QEI 695 3.5 kW FM transmitter, 3.5 years old, taken out of service November 1988, BO. R Eller, KBUS, 2775 NE Loop 286, Paris TX. 214-785-1068.

RCA modulation transformer for BTA 5F xmtr, new, in original crate, \$600 pls shpg. G Heidenfeldt, 2880 W Lake Rd, Wilson NY 14172. 716-751-6187.

RCA BTA 5F 5 kW AM excel cond, electronically & physically, in storage ready for immed shipment, includes all floor layouts, manuals, all tubes necessary for operation, \$10,000 plus loading and shipping. G Heidenfeldt, 2880 West Lake Rd, Wilson NY 14172. 716-751-6187.



**High performance at affordable prices.**

10, 20, 30 and 80 W exciters.  
100, 250, 500, 1000 W solid state amplifiers.  
All front panel programmable, broadband.  
1000, 2000, 3000, and 5000 W tube amplifiers.  
2 and 20 W STLs.  
24 Hr. technical support on call.

**Bext, Inc.**  
739 Fifth Avenue.  
San Diego, CA 92101  
619-239-8462  
Telex 229882LJMUR

RCA 100X AM xmtr for parts, transformers, chokes, capacitors, some vacuum, relays, breaker switches, meters, a large supply of 200 watt wirewound resistors & misc. R Elm, WJWC, 1120 E McCuen St, Duluth MN 55808. 218-626-2738.

RCA BTA 50 F 50 kW AM, excel operating cond, recently removed from service, in storage for immed. shipment. Includes all tubes, schematics, floor plans, many extras, electrostatic air filter, solid state rectifiers, magnaphone lightning protection etc, \$18,000 pls loading & shpg. G Heidenfeldt, 2880 W Lake Rd, Wilson NY 14172. 716-751-6187.

Tepeco/Bob Jones J317-M 10 watt FM translator, used 1 month, new cond, \$1500. F Shields, Shields Comm, POB 351, Hunt TX 78024. 512-895-1230.

Bauer 707 AM 1 kW, 970 kHz, gd cond, \$4000. T Gaiser, KAFY, 1527 19th St #300, Bakersfield CA 93301. 805-324-4411.

Collins 830F-1B 10 kW xmtr w/3102-1 exciter on 97.3 MHz, make offer. C Langley, WHSL, POB 5307, Wilmington NC 28406. 919-763-6363.

CSI T1A, 1 kW, gd cond, 1980, on air, avail 3/89, \$6800. M McAnnally, WEKC, POB 1071, Williamsburg KY 40769. 606-549-3000.

Harris FM 2.5K, excel cond. G Spicer, Mid-American Gospel Radio, 1 Paradise Plaza, 1430 Olive St, St Louis MO 63103. 314-241-8442.

Harris FM-20H3/FM-20K w/MX-15 exciter, spare tubes & parts, used as main until 1/89. J Andrews, WSRB, Box 961, Worcester MA 01602. 508-757-9898.

ITA AM5000A 5 kW AM, gd cond, manual & spares, 1050 kHz, BO; Gates BC-1E, 1 kW AM, 1050 kHz, complete or as parts, manual & spares, BO. D Brintall, KBUF, Box 798, Garden City KS 67848. 316-728-2388.

**ARMSTRONG TRANSMITTER CO.**  
Syracuse, NY  
Phone: (315) 488-1269  
Re-Manufacturers of Radio Transmitters

- Used & Rebuilt Units in Stock
- All AM/FM Power Levels
- Reasonable Rates—90 Day Warranty
- PCB Replacement, Retuning & Installation Available
- Trade-Ins Accepted

Visit Our Showroom See Before You Buy

RCA BTA-250M, vgc, tuned to high end of dial, all PCB removed, you ship, \$1500/BO. R Dieterich, WAMO, 411 7th Ave, Pgh PA 15219. 412-471-2181.

SMX 40 solid state exciter, digital, field adjustable, 1/2 price. J Phillips, WZOM, 313 Washington, Defiance OH 43512. 419-782-6986.

BE 3.5 kW FM, 4 yrs old, without exciter, \$16,000. L Blakeney, WBBN, Rte 2, Box 273B, Taylorsville MS 39168. 601-729-8100.

Collins A830W 10 watts FM, tube type FM exciter, tuned to 99.5; Also Harris TE-3 FM exciter tuned to 104.1 includes Orban baseband, \$1000. J Bahr, WVIS, Box 487, Frederiksted, St Croix US Virgin Islands, 00841. 809-778-5199.

Filament transformer for Collins 830F series FM xmtr, new in box. C Leisure, WTBO, POB 1644, Cumberland MD 21502. 301-722-6666.

Gates FM-5B w/Wilkinson exciter, in working cond, w/spare parts & tubes, make offer. K Steeman, WMMJ, 400 H, NE, Washington DC 20002. 202-875-4800.

Gates BC1F currently in operation, avail 6-89. D Tabor, WHCC, Box 158, Scottsville KY 42164. 502-237-3149.

Harris MW-1A (3) PA modules for 1 kW xmtr, working order, \$150 ea. M Patton, WXON, 6819 Cezanne, Baton Rouge LA 70806. 504-292-4189.

Harris FM2.5K, excel cond w/exciter, tuned to 105.5 MHz, \$17,900. G Spicer, 1430 Olive, St Louis MO 63103. 314-241-8442.

Harris MW-1A (3) PA modules for 1-kW xmtr, working order, \$150 ea. M Patton, WXON, 6819 Cezanne, Baton Rouge LA 70806. 504-292-4189.

**SUPER-GEN**  
This high-performance FM Stereo Generator has selectable pre-emphasis, overshoot-controlled lowpass filters, digital pilot/subcarrier synthesis and built-in overmod protection. CBS/NAB's "FMX" system is available as a plug-in option.

**Inovonics**  
SANTA CRUZ, CA (408) 458-0552

McMartin BF-25K, excel cond; Harris SX-1A fire damaged, for parts, also SX-1A spare parts kit; RCA BTA-500R AM for parts, many good 4-250A tubes. John or Mike, KMZU, 102 N Mason, Carrollton MO 64633. 816-542-0404.

Parts for a RCA BTF 20 E1, BO. J Schloss, KICD, 2600 Hiway, Spencer IA 51301. 712-262-1240.

RCA TTU-1B 1kW UHF plus an addtl unit for spare parts, on-air chnl 33, tunable from 24 to 41, BO. C Fox, WTUV, Greenfield Rd, Rome NY 13440. 315-478-4963.

RCA MI-19086-B 12.5 kW UHF-TV filter/plexer for ch 33, excel cond, \$1000. C Fox, WTUV, Greenfield Rd, Rome NY 13440. 315-478-4963.

Versacount V-322 10W FM exciter, tuned to any frequency, recently rebuilt, \$850. M Patton, WXON, 6819 Cezanne, Baton Rouge LA 70806. 504-292-4189.

**Want to Buy**

3.5-5 kW FM to operate on 93.9 MHz, prefer grounded grid final. D Jordan, WDTM, POB 3417, Jackson TN 38303. 901-668-1153.

FM xmtr, 20 kW, gd cond, w/manual, CCA, Harris, Continental or Collins. A Chambers, WAWZ, Box 37, Weston Canal Rd, Zarephath NJ 08890. 201-469-0991.

FM xmtr, 20 kW, gd cond, w/manual, CCA, Harris, Continental or Collins. A Chambers, WAWZ, Box 37, Weston Canal Rd, Zarephath NJ 08890. 201-469-0991.

Gates BFE-10C for a Gates BFE-10C FM xmtr. Shawn Zurbrick, KOSA, 1211 N Whitaker, Odessa TX 79760. 915-337-8301.

Harris or other late mdl AM xmtr, 1,000 watt, must be less than 10 yrs old, gd shape. P

Salois, KPCR, POB 1, Bowling Green MO 63334. 314-324-2283.

UHF band, 100 watt, 1 kW, 10 kW. AACT Inc, 156 Lazelle Rd, Worthington OH 43085. 614-846-9234.

1-1.5 kW FM needed. Non-profit organization can give a tax write-off. Pat Layman, WEAX Stewart Hall, W Park St, Angola IN 46703. 219-665-3314.

FM exciter, 10 to 15 W, must meet specs, prefer not over 5 yrs old, reasonably priced. R Kerbaw, WTNI, Box 1127, Beckley WV 25802. 304-877-5592.

1 kW LPTV xmtr or translator or amplifier wanted, any make, used/demo, any year. S Kafka, Ste 902, 941 O St, Lincoln NE 68508. 402-476-6115.

AEL AM5KD or AM10KD exciter-driver unit and/or oscillator PC card. R Jenkins, WAVL, POB 277, Apollo PA 15613. 412-478-4020.

Any solid state, 1kW AM rebuildable. R Hobbs, WMLR, Rt 1 Box 402B, Hohenwald TN 38462. 615-796-5966.

Any 1.0 kW FM, exciter optional. RM Posey, 400 3rd Ave, Jasper AL 35501. 205-221-2222.

RCA BTA1S, operating cond, prefer 660-780 KHz, original freq. L Amstutz, Lumiere Haiti, 4526 Arlington, Ft Wayne IN 46807. 219-429-8366.

**TUBES**

**Want to Sell**

**REBUILT ELECTRON TUBES**

Partial List: 6423, 23791, TH150, 6425F, 5604, 6696, 6697, 5681, 5682, 5671, 7804, 3CX10, 000H3, 3CX20, 000H3, 4CS5000A, 4CX35, 000C

**Vacuum Tube Industries, Inc.**  
1-800-528-5014  
508-584-4500

833A, \$100; 813, \$40; 645, \$770; 6146B, \$12; 807, \$5.95. New Production 6 month/2000 hr warranty. Stanton 500 AL stylus-generic \$3.95, original \$7.95; 500 cartridge E or AL needle, \$12.95; Shure M-44C cartridge, \$21; generic stylus, \$3.95; original \$11.95 MTS EC cartridge, \$9.95. We ship prepay/COD/Amex. Tri-ode Electronics, Chicago IL 60618. 312-871-7459, Fax: 312-871-7938.

833A, \$100; 813, \$40; 645, \$770; 6146B, \$12; 807, \$5.95. New Production 6 month/2000 hr warranty. Stanton 500 AL stylus-generic \$3.95, original \$7.95; 500 cartridge E or AL needle, \$12.95; Shure M-44C cartridge, \$21; generic stylus, \$3.95; original \$11.95 MTS EC cartridge, \$9.95. We ship prepay/COD/Amex. Tri-ode Electronics, Chicago IL 60618. 312-871-7459, Fax: 312-871-7938.

**TUBE REBUILDING**  
**FREELAND PRODUCTS**

Since 1940  
SAVE ABOUT 50%  
—We buy dud tubes—  
800-624-7626  
504-893-1243  
FAX 504-892-7323

EIMAC 4CX-15000 (2), near new cond, \$800 ea. L Peters, 2211 Rolling Hills, Lancaster TX 75146. 214-223-3786.

Tubes, 4-250A, some new, some gd used, some unknown. John or Mike, KMZU, 102 N Mason, Carrollton MO 64633. 816-542-0404.

EIMAC 3CX1500A7 1500 watt triode, 1987 date code, new in box, \$550. Lauren Libby, Colorado Educational Bldgs, 6166 Del Paz Dr, Colorado Springs CO. 719-593-9861.

## VIDEO PRODUCTION EQUIPMENT

### Want to Sell

Hotronc AD51-TFS frame sync/TBC, \$4000; Prime Image TBC+, \$2750; Lenco TBC-450, \$2500. H.M. Dyer Electronics, 2982 Wixom Rd, Millford MI 48042. 313-685-2560.

Quantel DPE-5000 Plus 2 chnl DVE w/rotation & perspective, 3 sets ctrl panels & switch over, \$10,000. D Thranhardt, 1491 Silver Lake Dr, Norcross GA 30093. 404-381-7632.

Vital VIX114A/4 3 M/E prod switcher w/24", roly & spin wipes, auto transitions, 3 CKs 1 enc. CK edgers in all keyers, \$7000. D Thranhardt, 1491 Silver Lake Dr, Norcross GA 30093. 404-381-7632.

Audio Video Engineering HSC-1 video hum stop coil, eliminates video ground loops, vgc, BO. G Peterson, KIMM, POB 8205, Rapid City SD 57709. 605-348-1100.

Panasonic twin 9" B&W monitors, \$100; RCA TT-1A video delay EQ system, \$75. C Haynes, POB 31235, Jackson MS 39206. 601-948-1515.

Quantel DPE5000SP digital effects, \$7000/BO; Panasonic AV700/NYA970 3/4 time code editing controller & VTRs, \$6000/BO; Ampex/3M 1" & 3/4" video tape; Bosch Compositor II CG, \$6000/BO. J Workman, Maritz, 600 W Lafayette, Detroit MI 48226. 313-963-1200 X501.

Trompeter LPL-75, video patch plugs, 1" pin spacing, new (24), \$3 ea; Vital VI-500 video stab amp w/cable EQ, incl manual, \$100; Co-hu 2614-400 video waveform multiplexers (2), \$50 ea. B Humpherys, Utah State Univ, Logan UT 89322. 801-750-3133.

Ward TA-860 predistortion correction processor, can be used on a wide variety of older TV xmtrs, needs cleaning, make offer. C Fox, WTUV, Greenfield Rd, Rome NY 13440. 315-476-4963.

## VIDEO TAPE RECORDERS

### Want to Sell

Ampex VPR-5800 1" VTR, needs some work, \$200. N Metzger, 312-989-1101.

Sony VO-4800 portable 3/4" VCR, vgc w/AC & two batteries, \$1250; JVC KY-2700 3 hand matched salicon tube color camera w/12:1 servo zoom, AC, battery & hard case, vgc, \$2600; Anton Bauer Super D-14F 4 Nicad 14.4V batteries, belt & charger/case, excel cond, \$900. S Vandenberg, Hugh Morris Prod, POB 232, Jenison MI 49429. 616-895-3105.

JVC 8200, 8250, RM-88, used in news editing, about 3000 hrs/machine, \$1000 ea. K Dick, WVVA, R460 By Pass, Bluefield WV 24701. 304-325-5487.

JVC 6650U, brand new, \$3000. D Miller, Airborne Audio Prod, 12037 Hemlock, Overland Park KS 66213. 913-492-8822.

NEC 3/4" time lapse, \$450 plus UPS. J Balzar, Maine Reel, 67 Green, Augusta ME 04330. 207-623-1941.

Sony VP-2000 & Panasonic NV 2110M, \$95 ea/postpaid. L Graziplene, Graillen Research & Development, 3532 N Main, N Java NY 14113. 716-535-7251.

Ampex VPR-1C (2) 1" tape machines w/TBC2, excel cond. D Roden, 1701 Monte Sano, Huntsville AL 35801. 205-533-3676.

Sony SLM-1000, pair of Beta off-line editing decks, bi-super high band, pre-roll editing, hi-gi stereo, \$2450. C Wilson, Mongo Video, 13123 Moldridge Rd, Wheaton MD 20906. 301-949-1809.

NEC 3/4" video cassette player, like new, \$175. C Haynes, POB 31235, Jackson MS 39206. 601-948-1515.

Sony VO-3800 field recorder w/AC-3000 power adapter, \$600. L Albert, WKMS, POB 2266, Murray KY 42071. 502-762-4664.

**WORLDWIDE DIGITAL CONVERSION**  
ALL FORMATS  
BROADCAST QUALITY  
Pal Multi-dupe/Hi-Band/1"

TK VIDEO 12300 Coppola Drive  
Potomac, MD 20854 301-762-2786

### Want to Buy

Need charger/AC supply & gd used batteries for Panasonic NV 9400; also camera cable for Sony, will cons buying compl sys. Patrick, Video Velocity, Box K, 500 Fandanggo Pass, Virginia City NV 89440. 702-847-9847.

Sony SLO-340 or SLO-320 Beta portable, operating or not, repairable, shoulder strap for BVU-100, carry bag. C Lund. 203-756-7761 aft 4PM.

Sony VO-6800 portable 3/4" U-matic VTR, AC-PS, 8-NP1's w/charger, kangaroo case/strap incl., \$2950.

Sony RM-430 edit controller in used/repairable cond, consider complete editing outfit if reasonable. C Lund, 203-756-7761 aft 4PM.

## Equipment Listings

Radio World's Broadcast Equipment Exchange provides a FREE listing service for all broadcast and pro-sound end users. Simply send your listings to us, following the example below. Please indicate in which category you would like your listing to appear. Mail your listings to the address below. Thank you.

Please print and include all information:

Contact Name: \_\_\_\_\_  
Title \_\_\_\_\_  
Company/Station \_\_\_\_\_  
Address: \_\_\_\_\_  
City \_\_\_\_\_ State \_\_\_\_\_ Zip \_\_\_\_\_  
Phone Number: \_\_\_\_\_

I would like to receive or continue receiving Radio World FREE each month.  YES  NO

Signature \_\_\_\_\_ Date \_\_\_\_\_  
Please circle only one entry for each category.

### I. Type of Firm

- D. Combination AM/FM station
- A. Commercial AM station
- B. Commercial FM station
- C. Educational FM station
- E. Network/group owner
- F. Recording studio
- G. TV station/teleprod facility
- H. Consultant/ind engineer
- I. Mfg, distributor or dealer
- J. Other (specify) \_\_\_\_\_

### II. Job Function

- A. Ownership
- B. General management
- C. Engineering
- D. Programming/production
- E. News operations
- F. Other (specify) \_\_\_\_\_

Brokers, dealers, manufacturers and other organizations who are not legitimate end users can participate in the Broadcast Equipment Exchange on a **paid** basis. Listings are available on a \$25/25 word basis. Call 1-800-336-3045 for details and complete display rates.

WTS: <input type="checkbox"/> WTB: <input type="checkbox"/> Category: _____ Make: _____ Model #: _____ Brief Description: _____ _____ Price: _____
WTS: <input type="checkbox"/> WTB: <input type="checkbox"/> Category: _____ Make: _____ Model #: _____ Brief Description: _____ _____ Price: _____
WTS: <input type="checkbox"/> WTB: <input type="checkbox"/> Category: _____ Make: _____ Model #: _____ Brief Description: _____ _____ Price: _____
WTS: <input type="checkbox"/> WTB: <input type="checkbox"/> Category: _____ Make: _____ Model #: _____ Brief Description: _____ _____ Price: _____
WTS: <input type="checkbox"/> WTB: <input type="checkbox"/> Category: _____ Make: _____ Model #: _____ Brief Description: _____ _____ Price: _____
WTS: <input type="checkbox"/> WTB: <input type="checkbox"/> Category: _____ Make: _____ Model #: _____ Brief Description: _____ _____ Price: _____

**Broadcast Equipment Exchange**  
PO Box 1214  
Falls Church VA 22041

ACTION-GRAM



“Where the ?!%#?! is the ?!%#?! log?” • “Which Chevy spot do I play — 336A or 336B?” • “Who misplaced the liner cards?” • “We’re drowning in paperwork!” • “Great — the stylus broke again, and that’s the last one we have.” • “Who got pizza sauce all over the turntable?” • “Who played these rap songs on the cart?” • “I hit the button, but the [unclear] Whitney Houston cart #127 isn’t in the rack.” • “Who [unclear] four, and the client’s ready to kill [unclear] current again. Two sponsors [unclear] log this time?” • “Where [unclear] half hour?” • “This [unclear] twice in the first hour [unclear] 08. Who took care [unclear] schedule, and the [unclear] those idea it was to [unclear] is going to drive [unclear] night, who stole the [unclear] Where’s the music [unclear] the music log.” • “ [unclear] tomor- row!” • “ [unclear] one on the new Randy [unclear] “Where’s the copy for [unclear] got nine complaints yes [unclear] Springsteen set.” • “Our FC [unclear] one is missing from the station log [unclear] during the ‘Sunday Champ [unclear] CD player is skipping again [unclear] the log again and he played all the 7 AM hour sp [unclear] 000 mistake. . .” • “There’s coffee and gross stuff all over the music log.” • “Marcie thought it would be real cute to play a Barry Manilow song during the ‘Jazz After Dark’ show and our lines were jammed with angry callers, and all of the sponsors pulled their spots off the show.” • “Tom played the new Restless Heart tune three times in a row because it’s his favorite.” • “We had 20 seconds of dead air during AM drive time.”

**Schafer Digital  
announces  
a new breakthrough  
in radio station  
control.**

**DAPS™ 8000**

**Digital Audio Programming Sequencer<sup>SM</sup>**

**Digital audio...Complete live assist...  
Random access...Manual or automatic operation...**

**Finally, you can play it your way.**

**Come see us at NAB:  
Las Vegas Hilton, Suite 571**

COPYRIGHT© 1989 by Schafer Digital  
9431-A Harwin • Houston, TX 77036  
(713) 784-9400

West Coast Representative:  
Schafer International • 5801 Soledad Mountain Road  
La Jolla, CA 92037 • (619) 456-8000



**Kiss 102**

October 17, 1988

Mr. Gary Snow, President  
Wheatstone Corporation  
6720 V.I.P. Parkway  
Syracuse, NY 13211

Dear Gary;

I just wanted to drop you a line and let you know how much we appreciate all of the last minute help with the installation of our A-500 console back in July.

Thanks to you and your staff, we were on the air with the new facility on time and without a single glitch. The A-500 console is a winner!

Our staff enjoys the ease of use of the console, and I enjoyed the ease of installation. Everyone here enjoys our improved audio performance. We would recommend the console to anyone.

By the way, our SP-6 has been installed now for a few weeks and we are taking advantage of its great features and performance. The SP-6 is a wonderful piece of equipment. Again, the installation was easy, and the SP-6's straightforward layout and design make the functions easily accessible and understandable to operations personnel.

You stood by your promise that Wheatstone is a service-oriented company...and then some. Thanks again, Gary, for providing an outstanding product with service to match.

Sincerely,

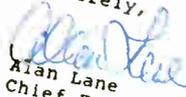
  
Alan Lane  
Chief Engineer

WCKZ  
Beasley Broadcast Group  
704-342-4102

 **Wheatstone Corporation**

6720 V.I.P. Parkway, Syracuse, N.Y. 13211 (315-455-7740)

See us at NAB Booth 1034

Circle 65 On Reader Service Card

World Radio History