



- Introduction . . . . . A2
- Tables and Specifications . . . . . A3
  - Rigid Metal Conduit/Intermediate Metal Conduit Fittings . . . . . A4-A38
- Conduit Outlet Bodies . . . . . A39-A40
- Form 7, Form 8, and Red-Dot®
  - Conduit Outlet Bodies . . . . . A41-A49
- Mogul Conduit Outlet Bodies . . . . . A50-A51
- Aluminum Mogul Conduit Outlet Bodies . . . . . A52-A53
- FS/FD Cast Device Boxes and Covers . . . . . A54-A56
- FS/FD Aluminum Device Boxes and Covers . . . . . A57-A65
- Conduit Expansion Coupling . . . . . A66-A67
- Conduit Outlet Boxes
  - Explosion-Proof, Dust-Ignition-Proof . . . . . A68-A69
- Aluminum Conduit Outlet Boxes
  - Explosion-Proof, Dust-Ignition-Proof . . . . . A70-A79
- Conduit Outlet Bodies
  - Explosion-Proof, Dust-Ignition-Proof . . . . . A80-A81
- Conduit Outlet Elbows
  - Explosion-Proof, Dust-Ignition-Proof . . . . . A82
- RE, PLG, REC Reducers, Plugs and Adapters
  - Explosion-Proof, Dust-Ignition-Proof . . . . . A83
- Three-Piece Couplings
  - Explosion-Proof, Dust-Ignition-Proof . . . . . A84-A85
- Aluminum Three-Piece Couplings
  - Explosion-Proof, Dust-Ignition-Proof . . . . . A86-A87
- Elbows
  - Explosion-Proof, Dust-Ignition-Proof . . . . . A88
- Flexible Couplings
  - Explosion-Proof, Dust-Ignition-Proof . . . . . A89
- Sealing Fittings
  - Explosion-Proof, Dust-Ignition-Proof . . . . . A90-A92
- Aluminum Sealing Fittings
  - Explosion-Proof, Dust-Ignition-Proof . . . . . A93-A96
- Kopr Shield™ Compound . . . . . A97
- Metal Clad Cable Termination Fittings . . . . . A98-A108
- Electrical Metallic Tubing (EMT) Fittings . . . . . A109-A114
- Liquidtight Flexible Metal Conduit Fittings . . . . . A115-A131
- XTRAFLEX® System – Conduit, Tubing, Fittings for Nonmetallic Liquidtight Conduit Material – PVC . . . . . A132-A139
- Flexible Cords and Cable Fittings . . . . . A140-A151
- Flexible Cords and Cable Fittings
  - Non-Metallic . . . . . A152-A153
- WireMesh Grips . . . . . A154
- Non-Metallic Cable Glands . . . . . A155
- Service Entrance Cable Fittings . . . . . A156-A160
- Armored Cable and Flexible Metal Fittings Conduit . . . . . A161-A169
- Non-Metallic Sheathed Cable Fittings . . . . . A170-A175
- Conduit Dimensional Data . . . . . A176-A178

## **Thomas & Betts ... The Complete Product Line**

Since the turn of the century, Thomas & Betts has been a recognized leader in electrical fittings. Industry standards such as Chase® Nipples and Erickson® Couplings were introduced by Thomas & Betts and are still registered trademarks. This leadership continues. Here's why.

### **Innovative Designs**

The real test of product design of electrical fittings lies in two areas: Job-suited installation and life of the job reliability. Thomas & Betts Fittings provide both because we listen. We listen to problems and suggestions from the field. Most of the products in this section result from the good suggestions of knowledgeable electrical people. Many were customer specials to solve particular installation and performance problems. You can benefit from their experience.

### **Approvals and Listings**

Electrical raceways require accessory fittings that provide the mechanical strength, ground continuity, and environmental integrity of the system. As new raceways have been introduced, Thomas & Betts engineers have designed fittings which meet the requirements of the National Electrical Code as well as the listing requirements of the Underwriters' Laboratories and the Canadian Standards Association. You can use Thomas & Betts Fittings with confidence.

### **High Performance Products**

Quality and performance result when engineering design skills are combined with the manufacturing technologies required to produce them. The Thomas & Betts Fittings in this section are produced from many materials and by many manufacturing methods, each carefully selected for its end use suitability. This combination gives you the reliable performance you expect from Thomas & Betts Raceway Fittings.

### **Lower Installed Cost**

It is a function of purchase cost, availability, installation advantage, and performance. Lower installed cost comes in every carton of Thomas & Betts Raceway Fittings.

### DURA-PLATE™ Finish – Corrosion Resistant Finish Protects Fittings in Harsh Environments

Comparative Resistance to Salt Spray per ASTM B-117

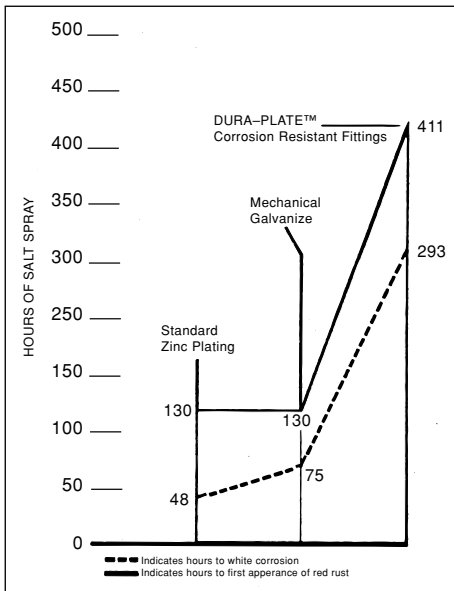

DURA-PLATE™ Corrosion Resistant Fittings have a T&B plating process that provides excellent corrosion resistance on threaded steel and malleable iron fittings for use in harsh environments.

DURA-PLATE™ Corrosion Resistant Fittings utilize an electro-plating process which insures a uniform thickness of protective material over the entire part. Conventional hot dip coatings deposit an uncontrolled build-up of material on the part, especially in threaded areas. This excess build-up must be removed to allow mating parts to function.

The process of removing this build-up in the threads in turn damages the coating and compromises the effectiveness of the protection.

An additional drawback of hot dip coating is the lower ductility of the alloyed interface layer which is formed during the hot dip process which can cause spalling if the item is deformed after coating.

In addition to the uniformity of the coat-

ing, the distinctive gold color of the plating allows immediate recognition that the part has been prepared for exposure to harsh environments and confirms the extra protection by visual inspection.

DURA-PLATE™ Corrosion Resistant Fittings have been subjected to salt spray tests conducted according to ASTM Specification B-117. The results of Corrosion Resistant Fittings tests, along with galvanized parts, appears below:

#### Ordering Information

- Add the prefix "040-" to the standard catalog number; for example a 5332 with DURA-PLATE™ Corrosion Resistant Fittings protection would be ordered as "040-5332".
- Check for catalog numbers in stock.
- Allow 6-8 weeks for delivery, on non-stock items.
- Add 20% to price of standard item.
- Minimum order is standard package quantity.

# T&B® Fittings

## Rigid and Intermediate Metal Conduit Fittings



140 Series  
141AL Series



106 Series

### Locknuts

#### Application

- To connect externally threaded conduit or connector to a threadless opening in a box or enclosure.
- To effectively bond conduit or connector to box or enclosure.

#### Features

- Hardened Steel/Malleable Iron/Copper free Aluminum construction.
- Tightens without deformation.
- Locknuts specially designed to:
  - (i) Provide extended reach for clamping on thin boxes and enclosures.
  - (ii) Cut through protective coating on box and enclosure thereby insuring ground continuity.
  - (iii) Permit tightening from outside.
  - (iv) Prevent loosening under vibration
- 106 Series provided with a hardened cone point screw.

#### Standard Material

**140 Series & 106 Series**  
 $\frac{3}{8}$ " thru 2" steel (hardened)  
 2½" thru 6" Malleable Iron  
 All screws steel

#### 141AL Series

All copper-free aluminum

#### Standard Finish

All Steel and Malleable Iron locknuts including  
 Electro Zinc Plated bonding screws & Chromate Coated  
 All Aluminum locknuts . . . degreased

#### Range

$\frac{3}{8}$ " through 6" conduit (All threads straight pipe [NPS]) (140 Series)  
 $\frac{1}{2}$ " through 4" conduit (106 Series & 141AL Series)

#### Listed/Certified by:

U.L. (U.L. File No. E-23018)  
 CSA [catalog numbers 108, 109 & 111.  
 All 140 Series except catalog number 140.] (LR-2884, LR-4484)

#### Conforms to:

U.L. 514B  
 CSA C22.2 No. 18  
 NEMA FB1  
 NFPA 70-1999 (ANSI)  
 Federal Specification replaced by A-A-50553  
 Federal Standard H-28 (Threads)

#### "Case Hardened Locknuts"

Case hardened locknuts make fittings faster and easier to install. Case hardened locknuts do not slip or turn thereby protecting the biting edge. Case hardened locknuts bite through paint into the enclosure providing excellent continuity of ground (typical T&B/Thomas & Betts fitting with case hardened locknuts successfully passed minimum fault current of 10,000 amps RMS). Case hardened locknuts when assembled in the intended manner will not vibrate loose thereby insuring excellent ground continuity.

# T&B® Fittings

## Rigid and Intermediate Metal Conduit Fittings



A

T&B® Fittings

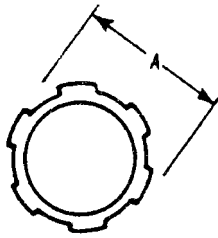

(B) Thickness

Steel or malleable iron (steel thru 2") or Aluminum 624.

### Locknuts

Stl. or M.I.	Cat. No.	Alum.	Size	Dimensions (in.)	
				A	B
139*		—	1/4"	3/4	9/64
140*		—	3/8"	15/16	9/64
141**	141AL		1/2"	1 1/4	5/32
142**	142AL		3/4"	1 3/8	3/16
143	143AL		1"	1 11/16	13/64
144	144AL		1 1/4"	2 5/32	13/64
145	145AL		1 1/2"	2 1/2	13/64
146	146AL		2"	3	7/32
147	147AL		2 1/2"	3 3/16	13/32
148	148AL		3"	4 3/16	13/32
149	149AL		3 1/2"	4 13/16	15/32
150	150AL		4"	5 5/16	15/32
151	151AL		4 1/2"	5 15/16	17/32
152	152AL		5"	6 1/2	17/32
153	153AL		6"	7 3/4	19/32

\* Hex shape

\*\* Case hardened locknuts

Aluminum locknuts comply with federal standard of copper free aluminum; less than .5% copper.

Available with DURA-PLATE® Finish.

U.L. File E-23018

CSA File No. 2884



(B) Thickness

Steel or malleable iron (steel thru 2").

Use anywhere an ordinary locknut is installed to insure positive bonding of conduit to box and prevent loosening due to vibration. Also can be used for Service Entrance applications in conformance with Code. T&B rigid conduit and E.M.T. (thinwall) fittings comply with Federal Specification WF 408c.

### Bonding Locknuts

Cat. No.	Size	Dimensions (in.)	
		A	B
106†	1/2"	1 1/8	.125
107†	3/4"	1 5/8	.140
108	1"	1 15/16	.170
109	1 1/4"	2 5/32	.170
110	1 1/2"	2 1/2	.170
111	2"	3	.187
112†	2 1/2"	3 13/32	.375
113†	3"	4 13/16	.375
114†	3 1/2"	4 29/32	.438
115†	4"	5 7/32	.438

† Not CSA certified.

Available with DURA-PLATE® Finish.

U.L. File No. E-3060

CSA File No. 638

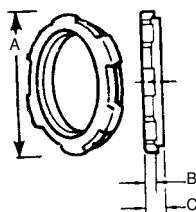

Molded Santoprene Seal  
Color: Blue

Provides positive seal against water and oil. For use with rigid and intermediate metal conduits, or fittings to provide watertight or rain tight seal at all enclosures.

### Sealing Locknuts

Cat. No.	Size	Dimensions (in.)		
		A	B	C
141SL	1/2	1.140	1/8	1/4
142SL	3/4	1.420	5/32	9/32
143SL	1	1.770	11/64	9/32
144SL	1 1/4	2.281	11/64	5/16
145SL	1 1/2	2.598	11/64	9/32
146SL	2	3.175	3/16	19/64

U.L. File No. E-23018

CSA File No. 2884

Thomas & Betts

# T&B® Fittings

## Rigid and Intermediate Metal Conduit Fittings

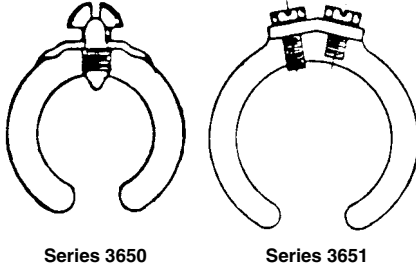

Series 3650

Series 3651



*Especially suited for grounding old work, but equally convenient for new, grounding wedges provide grounding without a jumper except in concentric knockouts. When a jumper is required, it fits under a set screw in the grounding wedge.*

*Update existing installations to meet code requirements for bonding (NEC Sect. 250-72e) without disconnecting wiring. Use on new wiring also.*

1. Loosen bushing ... position wedge.
2. Tighten bushing and bonding screw.

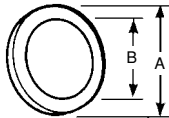

Sealing Ring – Santoprene  
Thermoplastic Rubber

*These sealing rings provide a liquid tight, dust tight, seal of fitting at enclosures.*

### Bonding & Grounding Wedges

#### Application

To effectively bond terminating fitting or conduit to a box or enclosure.

#### Features

- Sizes 3/4" thru 6" equipped with an additional bonding screw to install bonding jumper where required.
- Can be added to an existing installation without disconnecting conductors.

#### Standard Material/Finish

1/2" size Steel/Electro Zinc Plated

3/4" thru 6" size Bronze/Tin Plated

#### Range

1/2" thru 6" conduit

#### Listed/Certified by:

U.L. File #E3060

CSA File #638

#### Conforms to:

U.L. 467

CSA C22.2 No. 41

NFPA-70 1999 (ANSI)

Federal Specification W-F-406



### Grounding Wedges

Cat. No.	Size
3650	1/2"
3651	3/4"
3652	1"
3653	1 1/4"
3654	1 1/2"
3655	2"
3656	2 1/2"
3657	3"
3658	3 1/2"
3659	4"
3661	5"
3662	6"

U.L. File No. E-3060



### Sealing Rings with Stainless Steel Retainer

Cat. No.	Conduit Size	Dimensions (in.)	
		A	B ± 1/64
5302	1/2"	1 11/64	3/4
5303	3/4"	1 1/2	15/16
5304	1"	1 3/4	1 11/64
5305	1 1/4"	2 9/64	1 1/2
5306	1 1/2"	2 &	1 3/4
5307	2"	2 59/64	2 15/64
5308	2 1/2"	3 7/16	2 43/64
5309	3"	4 5/64	3 13/64
5311	4"	5 9/32	4 19/64

NEMA 3R, 4, 6 & 13

U.L. File No. E-13938

CSA File No. 2884

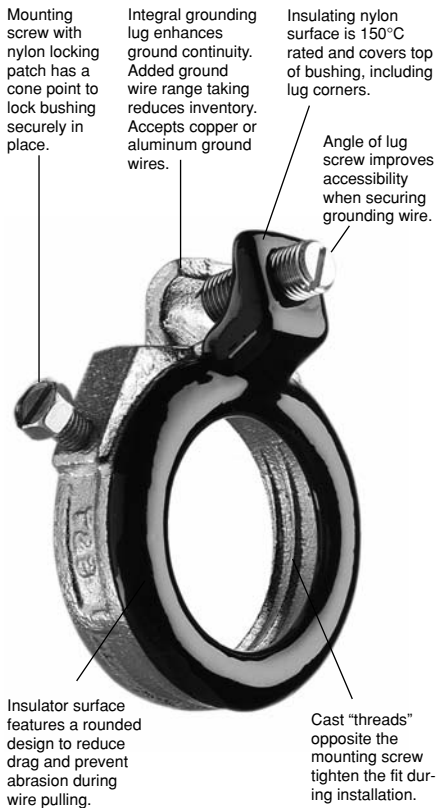

### Blackjack® – Grounding Bushing

#### Innovative design makes installation quicker, easier.

The Blackjack® Grounding Bushing never has to be threaded onto a conduit. It is simply placed in position on either a threaded or non-threaded rigid or IMC conduit, with the grounding lug in perfect position to accept the grounding wire. Even in tight installations.

It's as simple as one, two, three.

Compare the installation with conventional bushings that must be threaded onto the conduit. In tight areas, you

may have to remove the grounding lug, keep up with the loose parts, and then reattach the lug. Then you still have to twist and turn the bushing to get the lug in position to accept the grounding wire.

The Blackjack bushing does away with these needless delays for good, making it the ideal grounding bushing. And the only logical choice for small spaces, corners, and multiple conduit runs. And, because the grounding lug is an integral part of the bushing, it is designed not to fall off or get lost.

#### Innovative design improves performance.

#### The Blackjack® bushing provides superior ground continuity.

The design of the Blackjack bushing has an integral, cast-on grounding lug for better ground continuity. This means that the Blackjack bushing stands up to intense loads.

#### Secure grip forms lasting bond.

The Blackjack bushing's cone-point mounting screw bites securely into both

threaded and non-threaded rigid conduits. And the Blackjack bushing's nylon locking patch is designed to prevent the screw from loosening due to vibration.

#### Reduce inventory.

Because the Blackjack Grounding Bushing is designed for threaded and non-threaded conduits, and the ground lugs are designed to handle an extended range, the number of parts in inventory is reduced by up to two-thirds without losing any application coverage.

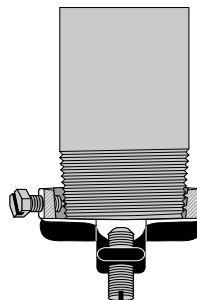

### Blackjack® – Conduit Grounding Bushing

Lug Screw:  
14-4: Slotted  
14-2/0: Slotted  
6-4/0: Internal Hex Drive

#### Standard Material/Finish

Body: Malleable Iron or Aluminum  
Mounting Screw: (1/2"-2") Stainless Steel,  
(2 1/2"-6") Brass  
Lug Screw: Stainless Steel  
Finish: Zinc Plated or Mechanical Galvanized

#### Range

Conduit: 1/2" thru 6" threaded or threadless rigid/IMC  
Wire Range: #14 AWG to 4/0 AWG  
CU/AL

#### Listed/Certified by:

U.L File #E3060  
CSA File #LR2884

#### Conforms to:

U.L. 514B & U.L. 467  
CSA C22.2 No. 18 &  
CSA C22.2 No. 41

# T&B® Fittings

## Rigid and Intermediate Metal Conduit Fittings

### Blackjack™ Grounding Bushing technical information

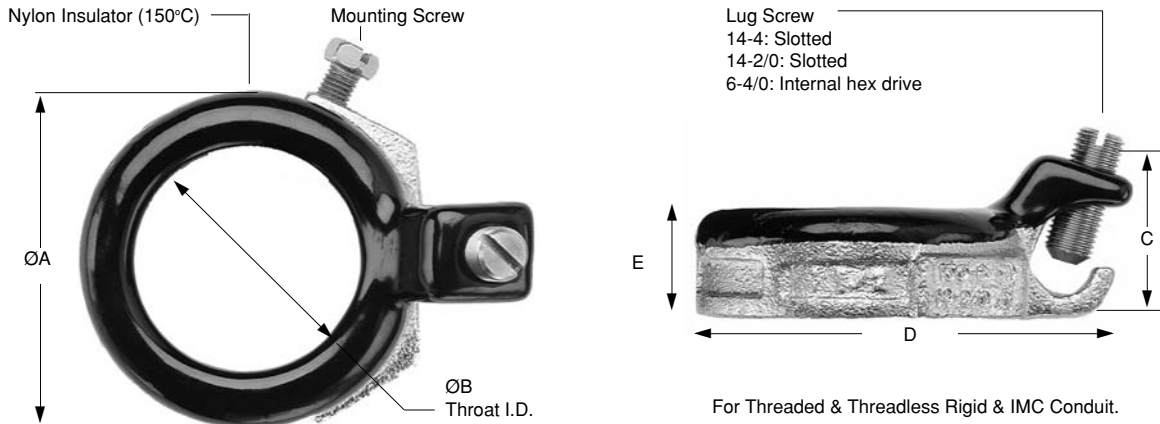

Zinc Plated Malleable Iron	Aluminum	Conduit Size	ØA Max.	ØB Min. Throat I.D.	C Max.	D Max.	E Max.	Wire Range
BG050-14-20	BGA050-14-20	½"	1.251	.569	1.181	2.134	.696	14-2/0
BG050-14-4	BGA050-14-4	½"	1.251	.569	1.027	1.940	.696	14-4
BG075-14-20	BGA075-14-20	¾"	1.533	.772	1.221	2.414	.696	14-2/0
BG075-14-4	BGA075-14-4	¾"	1.533	.772	1.030	2.168	.696	14-4
BG100-14-20	BGA100-14-20	1"	1.783	.993	1.181	2.581	.696	14-2/0
BG100-14-4	BGA100-14-4	1"	1.783	.993	1.027	2.368	.696	14-4
BG125-14-20	BGA125-14-20	1¼"	2.220	1.319	1.181	2.987	.759	14-2/0
BG150-14-20	BGA150-14-20	1½"	2.470	1.553	1.181	3.236	.696	14-2/0
BG200-14-20	BGA200-14-20	2"	2.830	2.010	1.181	3.766	.696	14-2/0
BG250-14-20	BGA250-14-20	2½"	3.418	2.412	1.181	4.341	.978	14-2/0
BG250-6-40	BGA250-6-40	2½"	3.418	2.412	1.524	4.526	.978	6-4/0
BG300-14-20	BGA300-14-20	3"	4.042	3.022	1.181	4.966	.978	14-2/0
BG300-6-40	BGA300-6-40	3"	4.042	3.022	1.524	5.139	.978	6-4/0
BG350-14-20	BGA350-14-20	3½"	4.542	3.491	1.181	5.467	.978	14-2/0
BG350-6-40	BGA350-6-40	3½"	4.542	3.491	1.524	5.639	.978	6-4/0
BG400-14-20	BGA400-14-20	4"	5.042	3.975	1.181	5.966	.978	14-2/0
BG400-6-40	BGA400-6-40	4"	5.042	3.975	1.524	6.139	.978	6-4/0
BG500-14-20	BGA500-14-20	5"	6.136	4.991	1.181	7.045	.978	14-2/0
BG500-6-40	BGA500-6-40	5"	6.136	4.991	1.524	7.207	.978	6-4/0
BG600-14-20	BGA600-14-20	6"	7.199	6.009	1.181	8.087	.978	14-2/0
BG600-6-40	BGAT600-6-40	6"	7.199	6.009	1.524	8.409	.978	6-4/0

#### Suggested Specifications

##### Insulated grounding and bonding bushing (Series BG050-BG600)

Where code requires bonding and grounding of single or multiple metal conduits, or positive bonding and grounding of metal conduit to the box, enclosure or auxiliary gutter, the end of the conduit shall be equipped with an insulated metallic grounding and bonding bushing series BG050-14-20 as manufactured by Thomas & Betts.

Grounding and bonding bushings used shall be approved for the purpose and

(i) Shall be of malleable iron/steel/aluminum construction adequately protected against corrosion.

(ii) Bushing insulator shall be listed or certified for 150°C/302°F application with a flammability rating of 94V-0. Insulator must be positively locked in place.

Please consult factory for mechanically galvanized.



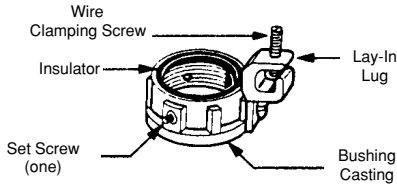

3870 Series

### Threaded Insulated Grounding Bushing

#### Application

- For quick installation of bonding jumper to multiple metal conduits (Rigid and IMC).
- Designed to bush conductors and prevent insulation damage.

#### Features

- Ease of installation, lay in lug design.
- Cast malleable iron body designed to lock insulator in place within body reducing common assembly problem resulting in dislodging of insulator.

- Insulator rated for 150°C/302°F application.

#### Standard Material/Finish:

Body	Electro zinc plated
Lay in lug	Aluminum/tin plated
Insulator	Thermoplastic
	150°C/302°F
	Application with 94V-0 flammability



### Threaded Insulated Grounding Bushing

Cat. No.	Conduit Size	Bushing Dia.	Throat Dia.	Lug Length	Swing Radius	Bushing Height	Wire Range AWG CU/AL
3870-TB	½	1.125	.560	1.310	1.212	.657	14-4
3861	½	1.125	.560	1.675	1.402	.657	8-2/0
3871-TB	¾	1.420	.742	1.310	1.360	.660	14-4
3862	¾	1.420	.742	1.675	1.550	.660	8-2/0
3872	1	1.770	.944	1.310	1.535	.735	14-4
3882	1	1.770	.944	1.675	1.725	.735	8-2/0
3873	1¼	2.190	1.242	1.310	1.745	.735	14-4
3883	1¼	2.190	1.242	1.675	1.935	.735	8-2/0
3874	1½	2.468	1.449	1.310	1.884	.770	14-4
3884	1½	2.468	1.449	1.675	2.074	.770	8-2/0
3875	2	3.031	1.860	1.310	2.165	.770	14-4
3889	2	3.031	1.860	1.675	2.355	.770	8-2/0
3876	2½	3.516	2.222	1.310	2.408	.940	14-4
3886	2½	3.516	2.222	1.675	2.598	.940	8-2/0
3993	2½	3.516	2.222	2.230	2.928	.940	6-4/0
3877	3	4.234	2.761	1.310	2.767	.975	14-4
3887	3	4.234	2.761	1.675	2.957	.975	8-2/0
3994	3	4.234	2.761	2.230	3.287	.975	6-4/0
3878	3½	4.781	3.193	1.310	3.040	.975	14-4
3863	3½	4.781	3.193	1.675	3.230	.975	8-2/0
3995	3½	4.781	3.193	2.230	3.560	.975	6-4/0
3879	4	5.328	3.623	1.310	3.314	.980	14-4
3864	4	5.328	3.623	1.675	3.504	.980	8-2/0
3996	4	5.328	3.623	2.230	3.834	.980	6-4/0
3880	5	6.328	4.542	1.310	3.814	.985	14-4
3865	5	6.328	4.542	1.675	4.000	.985	8-2/0
3998	5	6.328	4.542	2.230	4.334	.985	6-4/0
3881	6	7.406	5.458	1.310	4.353	1.200	14-4
3866	6	7.406	5.458	1.675	4.543	1.200	8-2/0
3999	6	7.406	5.458	2.230	4.875	1.200	6-4/0

Temperature rating 150°C.  
 Meets Coast Guard Regulation CG293  
 Available with DURA-PLATE® Finish.  
 For mechanically galvanized iron, add suffix-MG.

# T&B® Fittings

## Rigid and Intermediate Metal Conduit Fittings

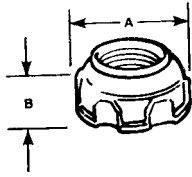

Nylon insulated  
metallic bushings

**Steel or malleable iron (Steel thru 1½")**

The National Electric Code paragraph 373-6C calls for protection of ungrounded conductors by means of smoothly rounded insulating surfaces at the entrance to raceways, pull boxes, junction boxes, etc. T&B insulated throat fittings, recognizable by the distinctive trademarked blue insulating liner in the throat, meet and surpass this Code requirement. In addition, T&B insulated fittings also reduce wire pulling effort by as much as 50%. Temperature rating 105°C.

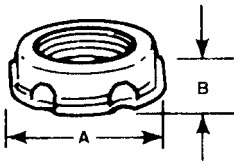

**Aluminum, steel or malleable iron (steel thru 1½").**

Smoothly rounded shoulder covers end of conduit: broad flange covers knockout hole. High ribs make tightening easy with fingers or with wrench. ½" - 1½" size, formed in steel, have extra smooth shoulders. Locknut-type base gives improved bonding and resists loosening under conditions of vibration.

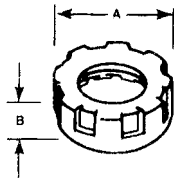

All Plastic  
Insulating  
Bushings

**Impact resistant plastic insulation. These bushings have ribs for gripping when installing. Perfect threads for easy thread on. U.L. Listed 105°C.**

### Insulated Throat Fittings

Cat. No.	Alum.	Size	Dimensions (in.)	
			A	B
1222	1222AL	½"	1½ <sub>32</sub>	29 <sub>64</sub>
1223	1223AL	¾"	1¾ <sub>32</sub>	31 <sub>64</sub>
1224	1224AL	1"	1 <sup>9</sup> / <sub>32</sub>	1½ <sub>32</sub>
1225	1225AL	1¼"	1 <sup>19</sup> / <sub>16</sub>	21 <sub>32</sub>
1226	1226AL	1½"	2¾ <sub>16</sub>	23 <sub>32</sub>
1227	1227AL	2"	2 <sup>11</sup> / <sub>16</sub>	7 <sub>8</sub>
1228	1228AL	2½"	3¾ <sub>16</sub>	31 <sub>32</sub>
1229	1229AL	3"	3 <sup>7</sup> / <sub>32</sub>	15 <sub>16</sub>
1230	1230AL	3½"	4¾ <sub>16</sub>	1¼ <sub>16</sub>
1231	1231AL	4"	4 <sup>7</sup> / <sub>8</sub>	1¾ <sub>32</sub>
1232†	1232AL†	4½"	—	—
586	586AL	5"	5 <sup>31</sup> / <sub>32</sub>	1¾ <sub>32</sub>
587	587AL	6"	7¾ <sub>16</sub>	1 <sup>11</sup> / <sub>32</sub>

† Not CSA Certified

Catalog series 1222 thru 1232, 586 and 587 are available in aluminum. Add suffix AL to Cat. No. The aluminum series are not CSA certified.



### Metallic Bushings

Cat. No.	Alum.	Size	Dimension (in.)	
			A	B
122	122AL	½"	1½ <sub>32</sub>	19 <sub>32</sub>
123	123AL*	¾"	1¼	7 <sub>16</sub>
124	124AL**	1"	1 <sup>9</sup> / <sub>16</sub>	1½
125-TB	125AL	1¼"	1 <sup>29</sup> / <sub>32</sub>	9 <sub>16</sub>
126	126AL	1½"	2 <sup>9</sup> / <sub>32</sub>	19 <sub>32</sub>
127	127AL	2"	2 <sup>21</sup> / <sub>32</sub>	5 <sub>8</sub>
128	128AL	2½"	3¾ <sub>16</sub>	¾
129	129AL	3"	3 <sup>7</sup> / <sub>32</sub>	13 <sub>16</sub>
130-TB	130AL	3½"	4¾ <sub>16</sub>	15 <sub>16</sub>
131-TB	131AL	4"	4 <sup>15</sup> / <sub>16</sub>	1
132-TB	—	4½"	5 <sup>7</sup> / <sub>16</sub>	15 <sub>64</sub>
133-TB	133AL	5"	6	1¾ <sub>16</sub>
134-TB	134AL	6"	7¼	1¼

\* Not U.L. Listed or CSA Certified

\*\* Not CSA Certified

Available with DURA-PLATE® Finish.

U.L. File No. E-23018

CSA File No. 2884



### Plastic Insulating Bushings

Cat. No.	Size	Dimensions (in.)	
		A	B
222-TB	½"	1¼ <sub>16</sub>	¾
223-TB	¾"	1 <sup>9</sup> / <sub>32</sub>	13 <sub>32</sub>
224	1"	1 <sup>9</sup> / <sub>16</sub>	9 <sub>16</sub>
225-TB	1¼"	1 <sup>29</sup> / <sub>32</sub>	9 <sub>16</sub>
226	1½"	2 <sup>7</sup> / <sub>32</sub>	9 <sub>16</sub>
227	2"	2 <sup>25</sup> / <sub>32</sub>	5 <sub>8</sub>
228-TB	2½"	3 <sup>3</sup> / <sub>8</sub>	¾
229-TB	3"	4¼ <sub>16</sub>	¾
230-TB	3½"	4 <sup>5</sup> / <sub>8</sub>	7 <sub>8</sub>
231	4"	5 <sup>1</sup> / <sub>8</sub>	7 <sub>8</sub>
232	4½"	5 <sup>11</sup> / <sub>16</sub>	1
233	5"	6 <sup>9</sup> / <sub>16</sub>	1
234	6"	7 <sup>7</sup> / <sub>16</sub>	1

Flame retardant. U.L. Rated 94V-1.

**Thomas & Betts**



TRIB50 Series

1. Cut conduit end squarely. Remove sharp edges and burrs on inside and outside diameters by reaming or filing.
2. Slip the pop-on bushing over the end of the conduit.

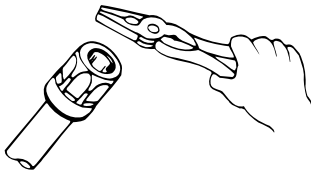

3. Using the flat surface of any standard utility tool such as an electricians pliers (or a hammer with a block of wood for the larger sizes), strike the bushing on its top surface using a series of light blows until the end of the conduit rests against the bushing throat & conduit stop.

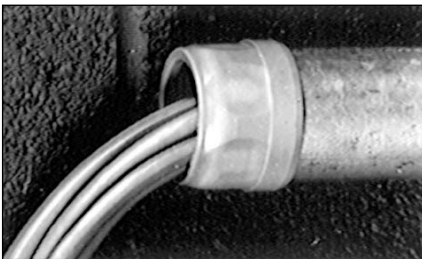

Pop-on Bushing

**Threadless Rigid (and IMC) Insulating Bushings.**

### Insulating Bushing

(For Threadless Rigid Conduit and Intermediate Metal Conduit)

#### Application

- When assembled to the end of a threadless conduit, provides a well rounded insulating surface over which conductors may be pulled or on which conductors may bear while in service.

#### Features

- Designed to be popped onto, and bush, conduit end.
- Fast, easy installation without screws.
- High impact thermoplastic construction.

#### Standard Material

High impact thermoplastic listed for 105°C (221°F) application.  
Flammability Classification 94 V-1.

#### Standard Finish

As molded.

#### Range

½" through 4" conduit

#### Listed by:

U.L. (U.L. File No. E-13938)  
CSA (LR-2884, LR-4484)

#### Conforms to:

U.L. 514B  
NFPA 70-1999 (ANSI)



### Insulated Metallic Bushing

Cat. No.	Size	Dimensions (in.)		
		A	B	C
TRIB-50	½"	19/32	19/32	11/16
TRIB-75	¾"	25/32	125/64	1¼
TRIB-100	1"	1	1½	19/16
TRIB-125	1¼"	15/16	15/8	159/64
TRIB-150	1½"	17/32	171/32	211/64
TRIB-200	2"	131/32	131/16	211/16
TRIB-250	2½"	223/64	2	3¼
TRIB-300	3"	259/64	27/32	329/32
TRIB-350	3½"	33/8	25/16	429/64
TRIB-400	4"	327/32	213/32	5

I.M.C. sizes ½" thru 4"  
U.L. Rated flame retardant 94V-1.  
U.L. File No. E-13938  
CSA File No. 2884

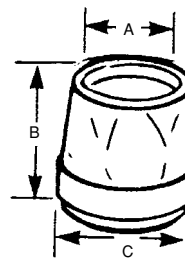

# T&B® Fittings

## Rigid and Intermediate Metal Conduit Fittings



3210 Series

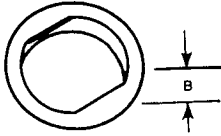

*One-piece knockout bushing quickly snaps into outlet box, switch box, or other enclosure left vacant by wiring modifications or maintenance changes. Provides smooth, rounded insulation surface for easy wire pulling. Easily installed by hand, they are available to fit 1/2" through 2" knockouts. U.L. Listed 105°C. High impact thermoplastic.*

### Knockout Bushings

#### Application

- To bush knockout openings in metal boxes or enclosures.

#### Features

- One piece construction designed to snap in place.
- High impact strength self extinguishing non-dripping (per U.L. 94) thermoplastic construction.

#### Standard Material

Thermoplastic rated for 105°C (221°F) application.

#### Standard Finish

As molded.

#### Range

.875" through 2.469" nominal diameter knockout opening (1/2" through 2" trade size knockouts).

Wall thickness of box or enclosure

.095" max. up to 1" trade size.

.140" max. 1 1/4" through 2" trade size.

#### Listed/Certified by:

U.L. (U.L. File No. E-3803)

CSA (LR-589, LR-4484)

#### Conforms to:

U.L. 514B

CSA C22.2 No. 18

NFPA 70-1999 (ANSI)



### Knockout Bushing

Cat. No.	For use in KO Size*	Dimension (in.)
		B
3210	.875	.360
3211	1.109	.360
3212	1.375	.360
3213	1.734	.400
3214	1.984	.520
3215	2.469	.520

\* Per U.L. and NEMA standards. Refer to "KNOCKOUT" table on page A14.

Oxygen index >28°

U.L. 94V-1

U.L. File No. E-3803

CSA File No. 589

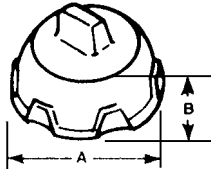

Makes a workmanlike seal against grit, plaster, and mischief. Removable with pliers. As shown 1/2" through 1 1/2" in steel; 1 1/2" and 2" in malleable iron.

### Capped Bushings

Cat. No.	Size	Dimension (in.)	
		A	B
1460	1/2"	1 1/32	1 3/32
1461	3/4"	1 1/4	7/16
1462	1"	1 9/16	1/2
1463	1 1/4"	1 29/32	9/16
1464	1 1/2"	2 7/32	1 19/32
1465	2"	2 21/32	5/8

U.L. File No. E-23018  
CSA File No. 2884

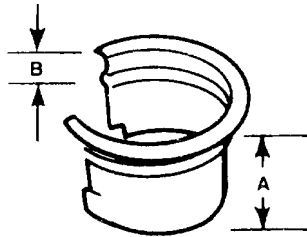

Slip over wires – insert into bushing – snaps into place

High dielectric nylon, 105°C.

An insuliner sleeve snapped into a regular bushing makes a U.L. Listed insulated bushing. For standard rigid conduit, E.M.T. (thinwall conduit) or any standard bushed outlet. Especially suitable for use with flexible metallic conduit.

Converts ordinary bushing to code approved insulated bushing without disturbing wiring.

### INSULINER® Sleeves

Cat. No.	Size	Dimension (in.)	
		A	B
422	1/2"	5/8	.025
423	3/4"	1 1/16	.025
424	1"	7/8	.025
425	1 1/4"	1	.030
426	1 1/2"	1	.030
427	2"	1 1/8	.030
428	2 1/2"	1 1/4	.040
429	3"	1 1/2	.040
430	3 1/2"	1 25/32	.055
431	4"	2 1/32	.055
433	5"	2 1/2	.070
434	6"	2 1/2	.070

Oxygen index >28°  
U.L. File No. E-23018  
CSA File No. 589

# T&B® Fittings

## Rigid and Intermediate Metal Conduit Fittings



1451 Series

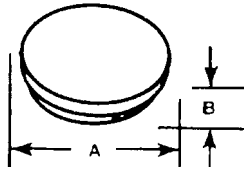

105°C rated by U.L. Made from flame retardant, non-dripping thermoplastic.

### Knockout Plugs

#### Application

- To plug unused knockout openings in a box or enclosure.

#### Features

- One piece construction designed to snap in place.
- High impact strength self-extinguishing non-dripping (per U.L.-94) thermoplastic construction.

#### Standard Material

Thermoplastic rated for 105°C (221°F) application.

#### Standard Finish

As molded.

#### Range

.875" through 2.469" Nominal Diameter Knockout opening (½" through 2" trade size knockouts).

Wall thickness of box or enclosure

.095" max. up to 1" trade size

.140" max. through 2" trade size.

#### Listed/Certified by:

U.L. (U.L. FILE No. E13938)

CSA (LR589)

#### Conforms to:

U.L. 514B

NFPA 70-1999 (ANSI)



### Knock-out Plugs

Cat. No.	Size	Dimensions (in.)	
		A	B
1451	½"	1.060	.400
1452	¾"	1.300	.400
1453	1"	1.590	.400
1454	1¼"	1.860	.450
1455	1½"	2.240	.570
1456	2"	2.740	.570

Wall thickness of electrical box .095 max.

Meets Coast Guard Regulation CB293.

U.L. File No. E-13938

CSA File No. 4484

### Plug, Conduit, Connectors (Push Penny® Plugs)

#### Application

- To plug open end of conduit or connector in order to prevent ingress of trash, dirt or moisture during construction and remodeling.

#### Features

- Wide range of application; can be used with rigid metal conduit, intermediate metal conduit, electrical metallic tubing, all connectors and all bushings.
- Designed to stand up to normal handling and is functionally unaffected by moisture.

#### Standard Material

Polyethylene

#### Standard Finish

As molded

#### Listed/Certified by:

CSA (LR2884, LR4484)

#### Conforms to:

U.L. 514B

CSA C22.2 No. 18

NFPA 70-1999 (ANSI)

NEMA FB1



*Economically seal out grout and plaster from any fitting or raceway conforming to CSA dimensional tolerances. Made of flexible plastic, they push into place and are held fast by pressure against internal surface of fitting or raceway. Eliminates need for separate capped bushing or steel penny and bushing.*

### Push-Penny® Plugs

Cat. No.	Size
1470	½"
1471	¾"
1472	1"
1473	1¼"
1474	1½"
1475	2"
1476*	2½"
1477*	3"
1478*	3½"
1479*	4"

\* Not CSA Certified  
CSA File No. 2884  
UL not applicable



*A penny under a bushing will seal the end of the conduit during construction. Made to fit any bushing. Completely salvageable.*

### Pennies – Steel

Cat. No.	Size
815-TB	½"
816	¾"
817	1"
818	1¼"
819	1½"
820	2"
821	2½"
822	3"
824	3½"
823	4"

U.L. not applicable  
CSA File No. 2884

**T&B® Fittings****Rigid and Intermediate Metal Conduit Fittings**

1942 Series  
842AL Series  
(Non Insulated)

**Nipple (CHASE® Nipple)****Application**

- To effectively bush factory or field-punched, cut, or drilled holes in metal boxes or enclosures.
- To couple boxes back-to-back.

**Features**

- Rugged construction.
- Insulator curled over to:
  - Bush conductors entering/leaving at any angle.
  - Reduce wire pull effort.
  - Protect threads against damage in handling.

**Standard Material****1942 Series**

Body.....½" Steel  
¾" through 6" Malleable Iron  
Insulator .....Nylon

**842AL Series**

All Copper free Aluminum

**Standard Finish**

1942 Series.....Electro Zinc Plated  
& Chromate Coated  
842AL Series.....Degreased

**Range****1942 & 842AL Series**

½" through 6"

All hub threads straight pipe (NPS)

**Listed/Certified by:**

U.L. [All except for Catalog No. 842AL,  
844AL & 845AL]  
(U.L. File No. E-23018)  
CSA (LR-2884, LR-4484)

**Conforms to:**

U.L. 514B  
CSA C22.2 No. 18  
Federal Specification W-F-408  
NFPA 70-1999 (ANSI)  
NEMA FB1  
Federal Standard H-28 (Threads)





Steel or malleable iron or aluminum.

### CHASE® Nipples

Stl. or M.I.	Cat. No.	Alum.	Size	Dimensions (in.)	
				A	B
841TB		—	3/8"	15/16	7/16
842TB		842ALTB†	1/2"	1 1/8	19/32
843TB		843ALTB	3/4"	1 3/8	19/32
844		844AL†	1"	1 11/16	2 1/32
845		845AL†	1 1/4"	2	2 5/32
846		846AL	1 1/2"	2 3/8	1 9/16
847		847AL	2"	2 15/16	3 1/32
848		848AL	2 1/2"	3 9/16	1 1/16
849		849AL	3"	4 3/8	1 1/4
850		850AL	3 1/2"	5 1/8	1 5/16
851		851AL	4"	5	1 5/16
853		853AL	5"	6 1/2	1 5/16
854		854AL	6"	7 1/2	1 3/8

† Not UL Listed  
Available with DURA-PLATE® Finish.  
U.L. File No. E-23018  
CSA File No. 2884

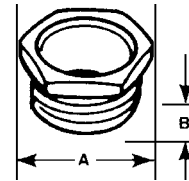

Steel or malleable iron or aluminum.

### CHASE® Nipples – Nylon Insulated

Cat. No.	Size	Dimensions (in.)		
		A	B	C
1942	1/2"	1 3/32	7/16	9/16
1943	3/4"	1 3/8	1 7/32	2 3/32
1944	1"	1 11/16	2 1/32	7/8
1945	1 1/4"	2 1/32	2 5/32	1 1/32
1946	1 1/2"	2 3/8	1 9/16	1 3/32
1947	2"	2 15/16	3 1/32	1 11/32
1948	2 1/2"	3 9/16	1 1/16	1 7/16
1949	3"	4 3/8	1 3/16	1 19/32
1950	3 1/2"	5 1/8	1 5/16	1 25/32
1951	4"	5 1/8	1 5/16	1 9/16
1953	5"	6 3/8	1 5/16	1 9/16
1954	6"	7 3/8	1 3/8	1 7/8

U.L. File No. E-23018  
CSA File No. 2884

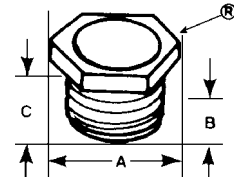

## Rigid and Intermediate Metal Conduit Fittings

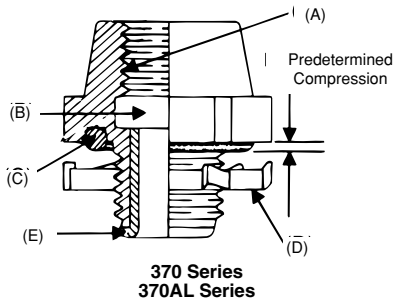
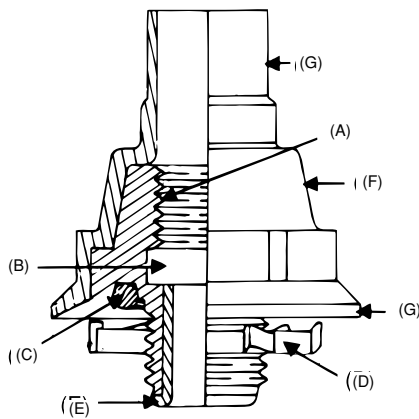
370 Series  
370AL Series

485 Series

**Threaded Hubs (Bullet® Hubs)****(For Threaded Rigid Metal Conduit/IMC/PVC Coated Rigid Metal Conduit)****Application**

- To connect threaded metal conduit (ferrous rigid/non-ferrous rigid/PVC coated/or intermediate metal) to a threadless opening in a box or enclosure in outdoors or indoor location exposed to continuous or intermittent moisture.
- To positively bond conduit to box or enclosure.

**Features**

- Rugged steel/malleable iron/copper free aluminum construction.
- Tapered internal threads for water-tight/dust tight union (A).
- Threads relieved to prevent bottoming of conduit ensuring sound assembly (B).
- Recessed sealing ring at box end. Sealing ring captivated (C).
- Hardened steel/malleable iron/copper free aluminum locknuts designed to provide high quality ground continuity; extended reach of locknut permits clamping on thin boxes and enclosures (D).
- Insulated throat, insulates conductors, prevents abrasion and thinning of conductor insulation, reduces wire pull effort (E).
- Suitable for hazardous location use per following:
  - (i) Class I Division 2, Class II Division 1 & 2, Class III Division 1 & 2 per N.E.C. 501-4 (b); 502-4 (a) and 503-3 (a).

- (ii) Class II Groups E, F, G, & Class III locations per CEC 18-202; 18-252; 18-302; 18-352.
- PVC coated 485 Series
    - (i) Protects connector from extremely corrosive surroundings without affecting integrity of electrical grounding path (F).
    - (ii) Provided with overlapping sleeve for additional seal (G).

National Electrical Code states that, "Where practicable, dissimilar metals in contact anywhere in the system shall be avoided to eliminate the possibility of galvanic action", the only exceptions Aluminum fittings and enclosures, are permitted to be used with steel conduit.

Joint Industrial Council (JIC) Electrical Standards also forbid dissimilar metals in contact for the same reason and require that the fittings for metal conduit be of malleable iron or ductile iron and have impact strength comparable to that of the conduit.

**"Copper Free Aluminum"**

Copper free aluminum castings for fittings have a maximum of 0.4% copper. The most detrimental effect of higher percentage of copper on aluminum base alloy is its decrease in corrosion resistance.

### Threaded Hubs (Bullet® Hubs) – (Continued)

(For Threaded Rigid Metal Conduit/IMC/PVC Coated Rigid Metal Conduit)

#### Standard Material

	370-485 Series	370AL
Body	½" thru 1" Steel 1¼" thru 6" Malleable Iron	All Copper-Free Aluminum
Locknut	½" thru 2" Steel (hardened) 2½" thru 6" Malleable Iron	½" thru 2" Steel (hardened) 2½" thru 4" Copper Free Aluminum
Screws	Steel (hardened)	
'O' Ring	Buna N	
Insulator	Nylon	
Coating	PVC	

#### Standard Finish

	370 Series	370AL Series	485 Series
Hub	Electro Zinc Plated Chromate Coated	As Cast	PVC – Outside. Electro Zinc Plated Chromate Coated Inside
Locknuts	All Ferrous Locknuts	Electro Zinc Plated and Chromate Coated	
Screws	All Electro Zinc Plated & Chromate Coated		

#### Range

370 Series .....½" thru 6" Conduit  
 370AL & 485 Series .....½" thru 4" Conduit  
 All hub threads – straight pipe  
 All female threads – taper pipe  
 (NPT)

#### Listed/Certified by:

U.L. (U.L. File No: E-23018)  
 CSA (LR-637, LR-23086)

#### Conforms To:

U.L. 514B  
 CSA C22.2 No. 18  
 NFPA 70-1999  
 NEMA FB-1  
 JIC EGP1; JIC EMP 1  
 Federal Specification W-F-408  
 Federal Standard H-28 (Threads)

# T&B® Fittings

## Rigid and Intermediate Metal Conduit Fittings



### Nylon insulated

Aluminum, steel, or malleable iron (steel through 1"). With Neoprene "O" Ring provides a watertight threaded hub on enclosures. U.L. Listed 105°C.

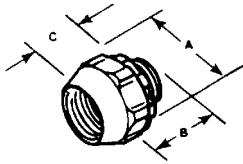

### Steel/Malleable Iron and Aluminum Hub Connectors\*\*†

Cat. No.		Size	Dimensions (in.)			Wall Thk. (max.)
Stl. or M.I.	Alum.**		A	B	C	
370	370AL	½"	1⅜	1¼	¾	⅝
371	371AL	¾"	1⅝	1¼	¾	⅝
372	372AL	1"	2⅜	1⅝	⅞	⅝
373	373AL	1⅝"	2⅞	1⅝	1	⅝
374	374AL	1½"	3⅜	1⅝	1	⅝
375	375AL	2"	3⅝	1⅝	1	⅝
376	376AL	2½"	4⅞	1⅞	1⅞	⅝
377	377AL	3"	5	2½	1½	½
378	378AL	3½"	5⅞	2½	1½	½
379	379AL	4"	6⅞	2½	1½	½
381	—	5"	8	3⅞	—	½
382	—	6"	9⅞	3⅞	—	½

\* Suitable for hazardous locations use in Class I, Div. 2; Class II, Div. 2; Class III, Div. 1 and 2 where general purpose equipment is specifically permitted per NEC Section 500-2(a).

\*\* Aluminum not available with insulated throat.

† U.L. Listed rain tight and CSA Certified watertight and dust tight Available with DURA-PLATE® Finish.

U.L. File No. E-23018

For Stl.: CSA File No. 2284

For AL.: CSA File No. 0637



### Steel or malleable iron (steel thru 1¼").

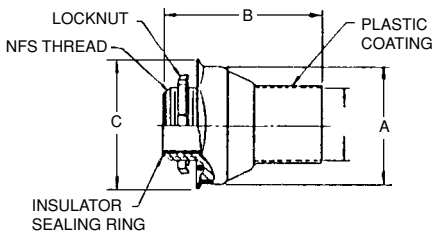

### PVC Coated Hub for Rigid Conduit

Cat. No.	Conduit Size	Dimensions (in.)		
		A	B	C
485	½"	1⅜	2⅞	1⅞
486	¾"	1⅞	2⅞	2⅞
487	1"	1⅞	2⅞	2⅞
488	1¼"	2⅞	3⅞	3⅞
489	1½"	2⅞	3⅞	3½
490	2"	3⅞	3⅞	4
491	2½"	3⅞	4	4½
492	3"	4⅞	4⅞	5⅞
493	3½"	5⅞	4⅞	5⅞
494	4"	5⅞	4⅞	6⅞

Suitable for hazardous locations use per Class I, Div. 2; Class II, Div. 1 & 2; Class III, Div. 1 & 2 NEC 501-4(b); 502-4(a) (2); 503-3(a) where general purpose equipment is specifically permitted per NEC Section 500-2(a).

### Spacing Chart for Bullet® Hubs

Center to Center Spacing											Min. Space from Center of Bullet® Hub to Wall of Box	KO Diameters (min.)
Conduit Sizes												
1/2	3/4	1	1 1/4	1 1/2	2	2 1/2	3	3 1/2	4	4		
1/2	1 1/6	1 5/8	1 3/4	2 1/8	2 3/8	2 5/8	2 7/8	3 5/16	3 1/2	3 7/8	3/4	7/8
3/4	-	1 3/4	1 7/8	2 1/4	2 1/2	2 3/4	3	3 1/2	3 3/4	4 1/8	7/8	1 1/8
1	-	-	2	2 3/8	2 5/8	2 7/8	3 1/8	3 5/8	3 7/8	4 1/4	1 1/8	1 3/8
1 1/4	-	-	-	2 1 1/16	2 1 5/16	3 1/4	3 1/2	4	4 1/4	4 1/2	1 3/8	1 3/4
1 1/2	-	-	-	-	3 1/8	3 1/2	3 3/4	4 1/8	4 3/8	4 3/4	1 5/8	2
2	-	-	-	-	-	3 3/4	4	4 1/2	4 3/4	5	1 7/8	2 1/2
2 1/2	-	-	-	-	-	-	4 1/4	4 3/4	5	5 3/8	2 1/8	3
3	-	-	-	-	-	-	-	5 1/8	5 3/8	5 3/4	2 5/8	3 5/8
3 1/2	-	-	-	-	-	-	-	-	5 5/8	6	2 7/8	4 1/8
4	-	-	-	-	-	-	-	-	-	6 1/4	3 1/4	4 5/8



### BULLET® Hub Connectors – Nylon Insulated

Cat. No.	Size (in.)	Description	Packaging		Wt. per 100
			Carton	Std.	
401	1/2"		25	100	20
402	3/4"		25	50	26
403	1"	Steel or malleable iron (steel through	5	25	44
404-TB	1 1/4"	1 inch). Used with a neoprene "O" ring	5	25	75
405	1 1/2"	to provide a watertight* threaded hub	2	10	100
406-TB	2"	on enclosures. Supplied with 106 series	1	5	138
407	2 1/2"	bonding locknut. Temperature rating: 105°C.	1	5	200
408	3"		1	5	375
409	3 1/2"		-	1	425
410-TB	4"		-	1	500

\*CSA LR2884. Certified watertight and dust tight.

### Spacing Chart for Bullet® Sealing Hubs

Center to Center Spacing												Min. Space from Center of Bullet® Hub to Wall of Box	KO Diameters (min.)	
Conduit Sizes														
1/2	3/4	1	1 1/4	1 1/2	2	2 1/2	3	3 1/2	4	5	6			
1/2	1 1/6	1 5/8	1 3/4	2 1/8	2 3/8	2 5/8	2 7/8	3 5/16	3 1/2	3 7/8	4 7/8	5 5/16	3/4	7/8
3/4	-	1 3/4	1 7/8	2 1/4	2 1/2	2 3/4	3	3 1/2	3 3/4	4 1/8	4 1 1/16	5 1/2	7/8	1 1/8
1	-	-	2	2 3/8	2 5/8	2 7/8	3 1/8	3 5/8	3 7/8	4 1/4	4 1 5/16	5 1 1/16	1 1/8	1 3/8
1 1/4	-	-	-	2 1 1/16	2 1 5/16	3 1/4	3 1/2	4	4 1/4	4 1/2	5 5/16	5 3/4	1 3/8	1 3/4
1 1/2	-	-	-	-	3 1/8	3 1/2	3 3/4	4 1/8	4 3/8	4 3/4	7 7/16	6 3/16	1 5/8	2
2	-	-	-	-	-	3 3/4	4	4 1/2	4 3/4	5	5 3/4	6 1/2	1 7/8	2 1/2
2 1/2	-	-	-	-	-	-	4 1/4	4 3/4	5	5 3/8	6	6 3/4	2 1/8	3
3	-	-	-	-	-	-	-	5 1/8	5 3/8	5 3/4	6 3/8	7 1/8	2 5/8	3 5/8
3 1/2	-	-	-	-	-	-	-	-	5 5/8	6	6 3/4	7 1/2	2 7/8	4 1/8
4	-	-	-	-	-	-	-	-	-	6 1/4	7 1/8	7 7/8	3 1/4	4 5/8
5	-	-	-	-	-	-	-	-	-	-	8	8 3/4	4	5 1/2
6	-	-	-	-	-	-	-	-	-	-	-	8 3/4	9 1/2	6 1/2

## Rigid and Intermediate Metal Conduit Fittings



Never before has a single hub fit like this one. Designed for unequalled performance. The innovative engineering of the T&B® Hub will, quite simply, raise your performance expectations for threaded hubs.

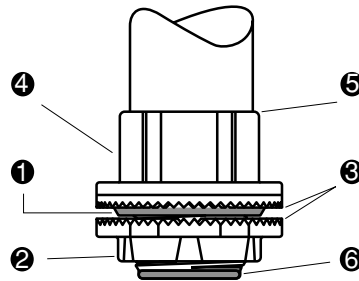

- 1 Sealing Ring And Groove** with innovative profile outperforms standard 'O' ring design. Sealing ring is captivated in place before installation and resists buckling or slipping during installation. The seal groove is designed for optimum compression of the sealing ring. The sealing ring is designed to provide a complete 360° seal, even when the conduit is not perpendicular with the enclosure. (See Figure 1)

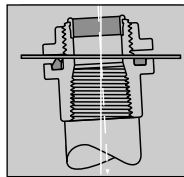

Fig. 1

- 2 Locknut Design** with peripheral slots and a hexagonal/angled spline spaced every 30° enables easy application of torque with wrench or hammer and screwdriver. (See Figures 2 & 3)

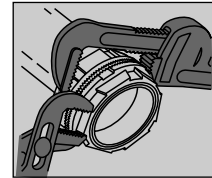

Fig. 2

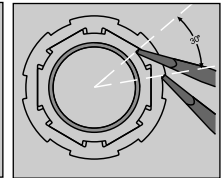

Fig. 3

- 3 Sharper and Deeper Teeth** on locknut and body designed for a more penetrating bite for improved bonding to the enclosure.
- 4 Hexagonal/Splined Body Design** for fast, easy installation with wrench or hammer and screwdriver.
- 5 Precision Machined Tapered Threads** designed to create watertight union.
- 6 Insulated Throat** molded from 105° C rated thermoplastic with a flammability rating of 94 V-O.



## T&amp;B Hub

Cat. No.	Trade Size	A B C D E				
		Dia.			Max. Panel Thickness	Throat Dia.
H050-TB	1/2	1 7/16	1 1/16	7/8	3/16	1 9/32
H075-TB	3/4	1 1/2	1 9/32	2 9/32	3/16	2 5/32
H100-TB	1	2	1 13/16	1 1/4	1/4	1
H125-TB	1 1/4	2 3/8	1 7/8	1 1/16	1/4	1 1/16
H150-TB	1 1/2	2 3/4	1 7/8	1 1/16	1/4	1 17/32
H200-TB	2	3 1/4	1 15/16	1 7/32	1/4	1 31/32
H250-TB	2 1/2	3 3/4	2 3/16	1 9/16	1/4	2 13/32
H300-TB	3	4 3/8	2 23/32	1 9/32	1/4	2 31/32
H350-TB	3 1/2	5	2 23/32	1 5/8	1/4	3 13/32
H400-TB	4	5 1/2	2 23/32	1 7/8	1/4	3 7/8
H500-TB	5	6 7/8	3 1/2	1 15/16	1/4	4 15/16
H600-TB	6	7 11/16	3 3/2	2	5/16	6

Material – Hub and Locknut: zinc or copper free aluminum  
 Insulating Throat: thermoplastic temp. rating – 105°C  
 Flammability Rating: – 94V-0  
 Sealing Ring: Nitrile (BUNA "N")

For Aluminum Hubs add suffix **A** (i.e. H050A). For Chrome Plated Hubs add suffix **CP** (i.e. H050CP). For 316 Stainless Steel Hubs add suffix **GRSST** (i.e. H050GRSST). (1/2" through 2" only.) Meets NEMA sealing requirements for NEMA 3R, 4 & 13 enclosures.

U.L. Listed and CSA Certified. CSA Certified for hazardous locations Class II Groups E,F,G. Class III.

U.L. File No. E-23018 CSA File No. 4484

Chrome Plated Hubs (suffix-"CP") are rated NEMA 4X.

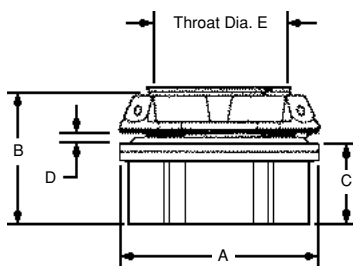

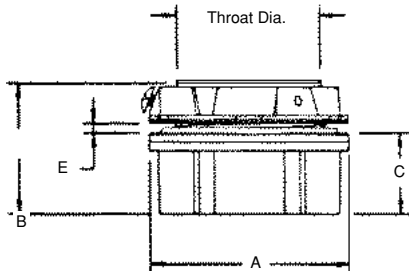
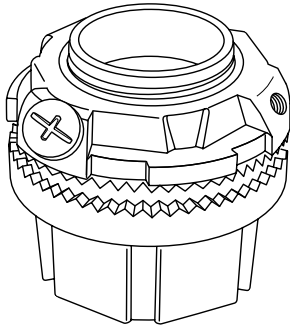

### T&B Grounding Hub

Cat. No.	Trade Size	A Dia.	B	C	D		E	
					Max. Panel Thickness	Throat Dia.		
H050GR-TB	1/2	1 7/16	1 9/16	7/8	3/16	1 9/32		
H075GR-TB	3/4	1 1/2	1 11/16	1 1/2	3/16	2 5/32		
H100GR-TB	1	2	1 13/16	1 1/2	1/4	1		
H125GR-TB	1 1/4	2 3/8	1 7/8	1 1/2	1/4	1 5/16		
H150GR-TB	1 1/2	2 3/4	1 7/8	1 1/2	1/4	1 1/32		
H200GR-TB	2	3 1/4	1 15/16	1 5/8	1/4	1 1/32		
H250GR-TB	2 1/2	3 3/4	2 1/16	1 1/2	1/4	2 13/32		
H300GR-TB	3	4 3/8	2 1/2	1 1/2	1/4	2 31/32		
H350GR-TB	3 1/2	5	2 3/8	1 5/8	1/4	3 13/32		
H400GR-TB	4	5 1/2	2 3/4	1 5/8	1/4	3 7/8		
H500GR-TB	5	6 7/8	3 1/2	1 11/16	1/4	4 15/16		
H600GR-TB	6	7 11/16	3 5/8	2	5/16	6		

Material – Hub and Locknut: zinc or copper free aluminum  
 Insulating Throat: thermoplastic temp. rating – 105°C  
 Flammability Rating: – 94V-0  
 Sealing Ring: Nitrile (BUNA "N")

For Aluminum Hubs add suffix **A** (i.e. H050A). For Chrome Plated Hubs add suffix **CP** (i.e. H050CP). For 316 Stainless Steel Hubs add suffix **GRSST** (i.e. H050GRSST). (1/2" through 2" only.) Meets NEMA sealing requirements for NEMA 3R, 4 & 13 enclosures.  
 U.L. Listed and CSA Certified. CSA Certified for hazardous locations Class II Groups E.F.G. Class III.  
 U.L. File No. E-23018 CSA File No. 4484  
 Chrome Plated Hubs (suffix-"CP") are rated NEMA 4X.



### T&B Grounding and Bonding Locknut

Cat. No.	Trade Size	A		Ground Screw	Max. Conductor Size
		Dia.	Height		
L050GR	1/2	1 1/2	1 9/32	#10-32 x 1/4"	#10
L075GR	3/4	1 11/16	1 9/32	#10-32 x 1/4"	#10
L100GR	1	2	1 9/32	#10-32 x 1/4"	#10
L125GR	1 1/4	2 3/8	1 9/32	1/4-20 x 1/4"	#10
L150GR	1 1/2	2 3/4	1 9/32	1/4-20 x 5/16"	#8
L200GR	2	3 1/4	1 9/32	1/4-20 x 5/16"	#8
L250GR	2 1/2	3 3/4	1 1/16	1/4-20 x 5/16"	#6
L300GR	3	4 3/8	2 3/32	1/4-20 x 5/16"	#6
L350GR	3 1/2	5	2 3/32	1/4-20 x 5/16"	#6
L400GR	4	5 1/2	2 3/32	1/4-20 x 5/16"	#4
L500GR	5	6 7/8	2 3/32	3/8-16 x 3/8"	#2
L600GR	6	7 11/16	2 3/32	3/8-16 x 3/8"	#1

Material – Locknut: zinc or copper free aluminum U.L. File No. E-3060  
 For Aluminum Locknuts add suffix **A**. (i.e. L050GRA) CSA File No. 4484  
 For Chrome Plated Locknuts add suffix **CP**. (i.e. L050CP). For 316 Stainless Steel Locknuts add suffix **SST** (1/2" through 2" only.)

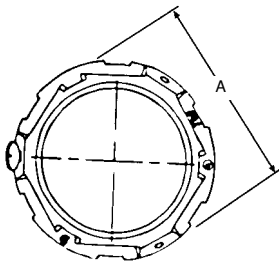

### T&B Hub Centerline Spacing Chart

Conduit Trade Size	1/2"	3/4"	1"	1 1/4"	1 1/2"	2"	2 1/2"	3"	3 1/2"	4"	5"	6"
1/2"	1 9/16											
3/4"	1 3/8	1 25/32										
1"	1 27/32	1 9/16	2 1/8									
1 1/4"	2 1/2	2 3/4	2 11/16	2 1/2								
1 1/2"	2 7/8	2 9/16	2 1/2	2 11/16	2 7/8							
2"	2 15/32	2 3/4	2 3/4	2 15/16	3 1/8	3 3/8						
2 1/2"	2 23/32	2 53/64	3	3 3/16	3 3/8	3 3/8	3 3/8					
3"	3 1/2	3 3/4	3 1/2	3 1/2	3 11/16	3 11/16	4 3/16	4 1/2				
3 1/2"	3 11/32	3 31/64	3 5/8	3 13/16	4	4 1/4	4 3/8	5 1/8	5 1/8			
4"	3 19/32	3 45/64	3 7/8	4 1/16	4 1/4	4 1/2	4 3/4	5 1/8	5 3/8	5 3/8		
5"	4 9/32	4 23/64	4 9/16	4 3/4	4 15/16	5 3/16	5 7/16	5 3/4	6 1/16	6 3/16	7	
6"	4 11/16	4 51/64	4 31/32	5 5/32	5 11/32	5 19/32	5 27/32	6 3/32	6 19/32	6 23/32	7 13/32	7 19/32
Nearest Obstruction to Center of Hub	2 7/32	6 1/4	1 1/8	1 5/16	1 1/2	1 3/4	2	2 3/16	2 5/8	2 7/8	2 9/16	3 13/32

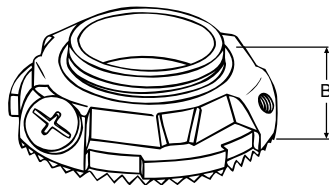

Grounding Locknut for Hubs

## Rigid and Intermediate Metal Conduit Fittings

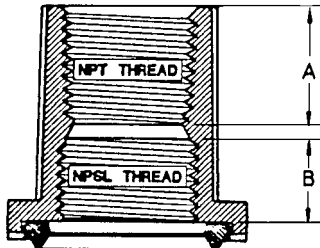
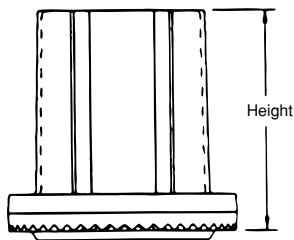
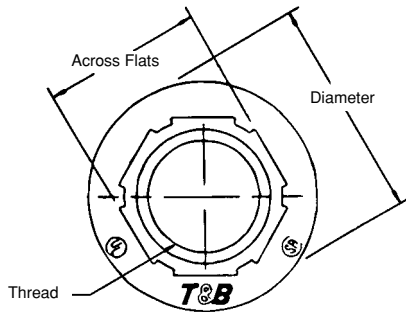

## T&amp;B Bulkhead Fittings

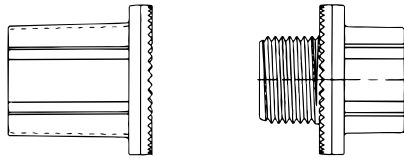
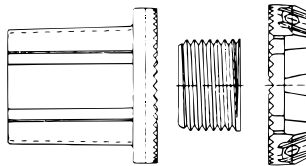
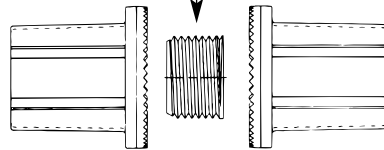
Nipple Nut  
Included

## Bulkhead Fitting

Cat. No.	Trade Size
H050BHD	½"
H075BHD	¾"
H100BHD	1"
H125BHD	1¼"
H150BHD	1½"
H200BHD	2"
H250BHD	2½"
H300BHD	3"
H350BHD	3½"
H400BHD	4"
H500BHD	5"
H600BHD	6"

## Thru Bulkhead Fitting

Cat. No.	Trade Size
H050TBF	½"
H075TBF	¾"
H100TBF	1"
H125TBF	1¼"
H150TBF	1½"
H200TBF	2"

## Thru Bulkhead Hub

Cat. No.	Trade Size
H050TBH	½"
H075TBH	¾"
H100TBH	1"
H125TBH	1¼"
H150TBH	1½"
H200TBH	2"

Trade Size	Thread	Height	Diameter	Across Flats	A	B
½"	½"-14	1 <sup>13</sup> / <sub>32</sub>	1 <sup>7</sup> / <sub>16</sub>	1	¾	½
¾"	¾"-14	1 <sup>15</sup> / <sub>32</sub>	1 <sup>11</sup> / <sub>16</sub>	1¼	2 <sup>5</sup> / <sub>32</sub>	1 <sup>7</sup> / <sub>32</sub>
1"	1"-11½	1 <sup>11</sup> / <sub>16</sub>	2	1 <sup>17</sup> / <sub>32</sub>	2 <sup>9</sup> / <sub>32</sub>	1 <sup>19</sup> / <sub>32</sub>
1¼"	1¼"-11½	1 <sup>25</sup> / <sub>32</sub>	2¾	1 <sup>27</sup> / <sub>32</sub>	2 <sup>9</sup> / <sub>32</sub>	2 <sup>1</sup> / <sub>32</sub>
1½"	1½"-11½	1 <sup>19</sup> / <sub>16</sub>	2¾	1 <sup>1</sup> / <sub>8</sub>	2 <sup>9</sup> / <sub>32</sub>	2 <sup>1</sup> / <sub>32</sub>
2"	2"-11½	1 <sup>27</sup> / <sub>32</sub>	3¼	2 <sup>5</sup> / <sub>8</sub>	1 <sup>15</sup> / <sub>16</sub>	2 <sup>1</sup> / <sub>32</sub>
2½"	2½"-8	2 <sup>9</sup> / <sub>32</sub>	3¾	3 <sup>1</sup> / <sub>8</sub>	1 <sup>17</sup> / <sub>32</sub>	7 <sup>7</sup> / <sub>8</sub>
3"	3"-8	2 <sup>9</sup> / <sub>16</sub>	4¾	3 <sup>25</sup> / <sub>32</sub>	1 <sup>15</sup> / <sub>16</sub>	2 <sup>9</sup> / <sub>32</sub>
3½"	3½"-8	2 <sup>9</sup> / <sub>16</sub>	5	4 <sup>9</sup> / <sub>32</sub>	1 <sup>3</sup> / <sub>8</sub>	7 <sup>7</sup> / <sub>8</sub>
4"	4"-8	2 <sup>9</sup> / <sub>16</sub>	5½	4 <sup>27</sup> / <sub>32</sub>	1 <sup>9</sup> / <sub>8</sub>	7 <sup>7</sup> / <sub>8</sub>
5"	5"-8	2 <sup>23</sup> / <sub>32</sub>	6 <sup>5</sup> / <sub>8</sub>	5 <sup>29</sup> / <sub>32</sub>	1 <sup>15</sup> / <sub>32</sub>	7 <sup>7</sup> / <sub>8</sub>
6"	6"-8	3	7 <sup>11</sup> / <sub>16</sub>	7 <sup>1</sup> / <sub>32</sub>	1½	3 <sup>13</sup> / <sub>32</sub>

Material – Hub, Body and Locknut: zinc or copper free aluminum  
 Insulating Throat: Thermoplastic temp. rating – 105°C  
 Flammability Rating: – 94V-0  
 Nitrile (BUNA "N")  
 Sealing Ring

For Aluminum Bulkheads add suffix **A**.

For Chrome Plated Bulkheads add suffix **CP**.

Meets NEMA sealing requirements for NEMA 3R, 4 & 13 enclosures.

CSA Certified for hazardous locations Class II Groups E,F,G. Class III.

U.L. File No. E-3060

CSA File No. 4484



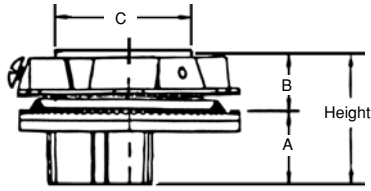

Dia. (Ø)

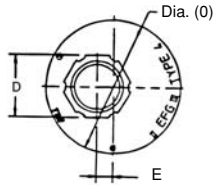

### Offset Reducers

Cat. No.	Trade Size	Height	Dia. (Ø)	A Dia.	B	C	D	E
H150-H075ORGR	1½"-¾"	1 <sup>25</sup> / <sub>32</sub> "	2¾"	1 <sup>5</sup> / <sub>16</sub> "	2 <sup>3</sup> / <sub>32</sub> "	1 <sup>2</sup> / <sub>32</sub> "	1 <sup>9</sup> / <sub>32</sub> "	1 <sup>11</sup> / <sub>32</sub> "
H150-H100ORGR	1 <sup>9</sup> / <sub>32</sub> "-1"	1 <sup>25</sup> / <sub>32</sub> "	2¾"	1 <sup>1</sup> / <sub>16</sub> "	2 <sup>3</sup> / <sub>32</sub> "	1 <sup>2</sup> / <sub>32</sub> "	1 <sup>9</sup> / <sub>16</sub> "	7 <sup>3</sup> / <sub>32</sub> "
H150-H125ORGR	1 <sup>9</sup> / <sub>32</sub> "-1¼"	1 <sup>25</sup> / <sub>32</sub> "	2¾"	1 <sup>1</sup> / <sub>16</sub> "	2 <sup>3</sup> / <sub>32</sub> "	1 <sup>2</sup> / <sub>32</sub> "	1 <sup>7</sup> / <sub>8</sub> "	1 <sup>1</sup> / <sub>32</sub> "
H250-H200ORGR	2½"-2"	2½"	3¾"	1 <sup>3</sup> / <sub>16</sub> "	1 <sup>5</sup> / <sub>16</sub> "	2 <sup>2</sup> / <sub>32</sub> "	2 <sup>1</sup> / <sub>32</sub> "	3 <sup>3</sup> / <sub>32</sub> "

Material – Offset Reducer and Locknut: Zinc or copper free aluminum  
 Insulating Throat: Thermoplastic Temp. Rating – 105°C  
 Flammability Rating – 94V-0  
 Sealing Ring: Nitrile (BUNA "N")

For Aluminum Offset Reducer add suffix **A**.  
 For Chrome Plated Offset Reducer add suffix **CP**.  
 Meets NEMA sealing requirements for NEMA 3R, 4 & 13 enclosures.  
 CSA Certified for hazardous locations Class II Groups E,F,G. Class III.  
 U.L. File No. E-3060  
 CSA File No. 4484



### Capoffs

Cat. No.	Trade Size	Height	Diameter	A	B	C
H050CAP	½"	1 <sup>9</sup> / <sub>32</sub> "	1 <sup>7</sup> / <sub>16</sub> "	1 <sup>9</sup> / <sub>32</sub> "	2 <sup>7</sup> / <sub>32</sub> "	¾"
H075CAP	¾"	1 <sup>15</sup> / <sub>32</sub> "	1 <sup>11</sup> / <sub>16</sub> "	1 <sup>9</sup> / <sub>32</sub> "	1 <sup>1</sup> / <sub>16</sub> "	¾"
H100CAP	1"	1 <sup>11</sup> / <sub>16</sub> "	2"	1 <sup>1</sup> / <sub>16</sub> "	1 <sup>3</sup> / <sub>16</sub> "	¼"
H125CAP	1¼"	1 <sup>25</sup> / <sub>32</sub> "	2¾"	2 <sup>3</sup> / <sub>32</sub> "	1 <sup>2</sup> / <sub>32</sub> "	¼"
H150CAP	1½"	1 <sup>19</sup> / <sub>16</sub> "	2¾"	2 <sup>3</sup> / <sub>32</sub> "	1 <sup>2</sup> / <sub>32</sub> "	¼"
H200CAP	2"	1 <sup>27</sup> / <sub>32</sub> "	3¼"	2 <sup>3</sup> / <sub>32</sub> "	2 <sup>3</sup> / <sub>8</sub> "	¼"
H250CAP	2½"	2 <sup>9</sup> / <sub>32</sub> "	3¾"	7 <sup>7</sup> / <sub>8</sub> "	2 <sup>2</sup> / <sub>32</sub> "	¼"
H300CAP	3"	2 <sup>9</sup> / <sub>16</sub> "	4¾"	7 <sup>7</sup> / <sub>8</sub> "	3 <sup>1</sup> / <sub>32</sub> "	1 <sup>1</sup> / <sub>32</sub> "
H350CAP	3½"	2 <sup>9</sup> / <sub>16</sub> "	5"	2 <sup>9</sup> / <sub>32</sub> "	4 <sup>1</sup> / <sub>32</sub> "	1 <sup>1</sup> / <sub>32</sub> "
H400CAP	4"	2 <sup>9</sup> / <sub>16</sub> "	5½"	2 <sup>9</sup> / <sub>32</sub> "	4 <sup>1</sup> / <sub>2</sub> "	1 <sup>1</sup> / <sub>32</sub> "
H500CAP	5"	2 <sup>23</sup> / <sub>32</sub> "	6 <sup>5</sup> / <sub>8</sub> "	2 <sup>9</sup> / <sub>32</sub> "	5 <sup>3</sup> / <sub>16</sub> "	1 <sup>1</sup> / <sub>32</sub> "
H600CAP	6"	3"	7 <sup>5</sup> / <sub>8</sub> "	3 <sup>1</sup> / <sub>32</sub> "	6 <sup>5</sup> / <sub>8</sub> "	1 <sup>1</sup> / <sub>32</sub> "

Material – Capoff and Locknut: zinc or copper free aluminum  
 Insulating Throat: Thermoplastic temp. rating – 105°C  
 Flammability Rating – 94V-0  
 Sealing Ring: Nitrile (BUNA "N")

For Aluminum Capoff add suffix **A**.  
 For Chrome Plated Capoff add suffix **CP**.  
 Meets NEMA sealing requirements for NEMA 3R, 4 & 13 enclosures.  
 CSA Certified for hazardous locations Class II Groups E,F,G. Class III.  
 U.L. File No. E-3060  
 CSA File No. 4484

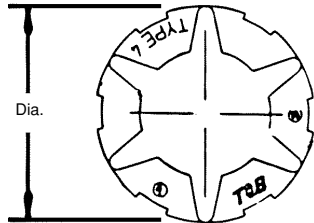
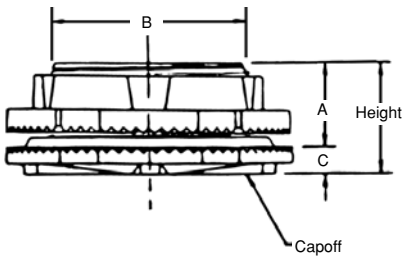

# T&B® Fittings

## Rigid and Intermediate Metal Conduit Fittings



8123 Series



8130 Series



8120 Series

### Threadless Connector/Coupling

(For Threadless Rigid Metal Conduit and Intermediate Metal Conduit)

#### Application

- To connect and effectively bond threadless rigid metal conduit/intermediate metal conduit to a box or enclosure, or to couple ends of threadless conduit.

#### Features

- Steel/Malleable Iron Construction.
- Case hardened ring bites into conduit for high quality continuity and grip.
- Nylon insulator firmly secured in place protects conductors and reduces wire pulling effort by as much as 50%; prevents thread damage in handling.
- Case hardened steel locknut or malleable iron locknut designed to provide a positive bond.
- Suitable for concrete tight application.
- Capable of carrying ground fault currents up to 10,000 amps RMS ( $\frac{1}{2}$ " through  $1\frac{1}{2}$ " size) and 20,000 amps RMS (2" and above sizes). ...duration of current 3 cycles.

#### Listed/Certified by:

U.L. (U.L. File No: E-23018)  
CSA (LR-2884, LR-4484)

#### Standard Material

Nut, Gland. . . .  $\frac{1}{2}$ " to 1" Steel –  $1\frac{1}{4}$ " to 4" Malleable Iron  
Body . . . . . All Malleable Iron  
Ring. . . . . Steel (case hardened)  
Insulator . . . . . Nylon  
Locknut . . . . .  $\frac{1}{2}$ " thru 2" Steel (hardened) 2" thru 4" Malleable Iron

#### Standard Finish

Electro Zinc Plated & Chromate Coated

#### Range

8123 & 8120 Series . . . . .  $\frac{1}{2}$ " through 4" Size Conduit  
8130 Series . . . . .  $\frac{1}{2}$ " through 2" Size Conduit  
All hub threads . . . . . Straight Pipe (NPS)

#### Conforms to:

U.L. 514B  
CSA C22.2 No. 18  
NFPA 70-1999 (ANSI)  
NEMA FB1  
Federal Specification W-F-408  
Federal Standard H-28 (Threads)

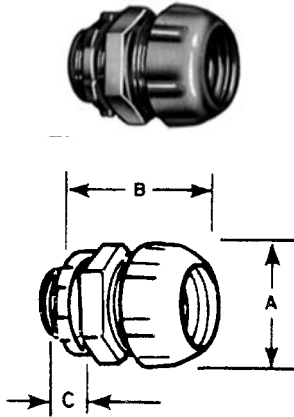

**A split steel ring with diagonal serrations grips the conduit and bites into it for positive ground. Makes a permanent connection and eliminates the need for cutting a thread on the conduit. Insulation helps to guarantee continuity of service with protection of the conductor at the critical point – the connector bushing. Malleable iron construction.**

### Nylon Insulated Threadless Connectors

Cat. No. Nylon Insul.	Non- Insul.	Conduit Size	Dimensions (in.)		
			A	B	C
8123	8121	½"	1⅞	1⅞	1½
8223	8221	¾"	1⅞	1¾	1½
8323	8321	1"	1⅞	2	9/16
8423	8421	1¼"	2⅞	2⅞	1⅞
8523	8521	1½"	2⅞	2⅞	¾
8623	8621	2"	3¼	2⅞	7/8
8723-TB	8721	2½"	4⅞	3⅞	1⅞
8823	8821	3"	4⅞	4	1⅞
8853	8851	3½"	5½	4⅞	1⅞
8973	8971	4"	6⅞	4⅞	1⅞

Available with DURA-PLATE® Finish.  
U.L. File No. E-23018  
CSA File No. 2884

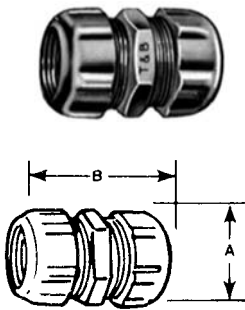

**Eliminate conduit threading. Tightened with a wrench they make a U.L. Listed and CSA Certified concrete-tight connection. Malleable iron.**

### Threadless Couplings

Cat. No.	Size	Dimensions (in.)	
		A	B
8120	½"	1⅞	2
8220	¾"	1⅞	2⅞
8320	1"	1⅞	2⅞
8420	1¼"	2⅞	2⅞
8520	1½"	2⅞	3⅞
8620	2"	3¼	3⅞
8720	2½"	3⅞	5⅞
8820	3"	4⅞	5½
8850	3½"	5⅞	5½
8970	4"	5⅞	5½

Available with DURA-PLATE® Finish.  
U.L. File No. E-23018  
CSA File No. 2884



# T&B® Fittings

## Rigid and Intermediate Metal Conduit Fittings

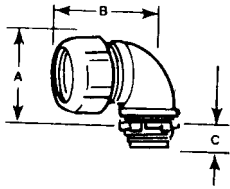

*Ideal for entering enclosure or conduit body at right angles. Eliminates need to thread conduit. As with straight couplings, this connector makes a concrete-tight connection. Malleable iron.*

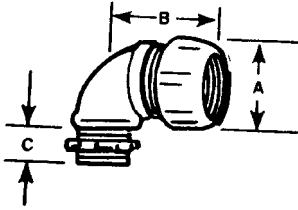

*This elbow has all of the advantages of the insulated short elbow except for the insulation. Malleable iron.*



### Threadless Short Elbows – Nylon Insulated

Cat. No.	Size	Dimensions (in.)		
		A	B	C
8130	½"	1 1/32	1 ½	½
8131	¾"	1 5/8	1 ¾	5/16

Available with DURA-PLATE® Finish.  
U.L. File No. E-23018  
CSA File No. 2884



### Threadless Short Elbows

Cat. No.	Size	Dimensions (in.)		
		A	B	C
8030	½"	1 3/8	1 ½	7/16
8031	¾"	1 1/4	1 ¾	½

Available with DURA-PLATE® Finish.  
U.L. File No. E-23018  
CSA File No. 2884



8125 Series



8124 Series

### Set Screw Connector/Coupling

(For Threadless Rigid Metal Conduit and Intermediate Metal Conduit)

#### Application

- To connect and effectively bond threadless rigid metal conduit or intermediate metal conduit to a box or enclosure or to couple ends of threadless conduit.

#### Features

- Thickwall steel or malleable iron body.
- Hardened hex head cup point screw to provide high quality bond.
- Screw captivated, will not vibrate loose.
- Nylon insulated throat meets and exceeds all code requirements for bushing:
  - (i) Prevents thinning of insulation.
  - (ii) Reduces installation effort.
  - (iii) Prevents first thread damage.
- Coupling provided with positive center stop.
- Suitable for concrete tight application.
- Capable of carrying ground fault currents up to 10,000 amps RMS ( $\frac{1}{2}$ " through  $1\frac{1}{2}$ " size) and 20,000 amps RMS (2" and above sizes).

#### Standard Material

Body.....	$\frac{1}{2}$ " thru 2" Steel
	2 $\frac{1}{2}$ " thru 4" Malleable Iron
Locknut .....	$\frac{1}{2}$ " thru 2" Steel (hardened)
	2 $\frac{1}{2}$ " thru 4" Malleable Iron
Screw .....	Steel (hardened)
Insulator .....	Nylon

#### Standard Finish

Electro Zinc Plated & Chromate Coated

#### Listed/Certified by:

U.L. (U.L. File No: E-23018)  
CSA (LR-2884, LR-4484)

#### Conforms to:

U.L. 514B  
CSA C22.2 No. 18  
NFPA 70-1999 (ANSI)  
NEMA FB1  
Federal Specification W-F-408  
Federal Standard H-28 (Threads)

# T&B® Fittings

## Rigid and Intermediate Metal Conduit Fittings

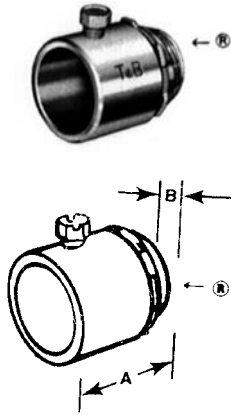

Eliminate conduit threading with these set screw connectors. Captive hex head screws tighten down onto conduit for positive holding strength and ground. The connectors are furnished with insulated throats reducing wire pulling effort by as much as 50%. Approved concrete tight.

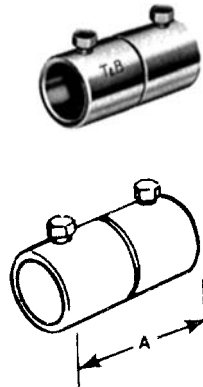

Eliminate the need for threading conduit ends when joining rigid conduit with these set screw couplings. Captive hex head screws provide positive holding strength and ground continuity. Approved concrete tight.

### Insulated Set-Screw Connector

Cat. No.	Conduit Size	Dimensions (in.)	
		A	B
8125	½"	1⅜	1⅜
8225	¾"	1½	7⁄16
8325	1"	1⅞	35⁄64
8425	1¼"	2	5⁄8
8525	1½"	2⅝	5⁄8
8625-TB	2"	2⅞	11⁄16
8725-TB	2½"	3⅞	1
8825	3"	3⅞	1
8855	3½"	3⅞	11⁄16
8975	4"	4⅞	1½

Sizes ½"-2" made of steel. Sizes 2½"-4" are malleable iron.  
Available with DURA-PLATE® Finish.  
U.L. File No. E-23018  
CSA File No. 2884



### Set Screw Coupling

Cat. No.	Conduit Size	Dimension (in.)
		A
8124	½"	2½
8224	¾"	2⅞
8324-TB	1"	2⅞
8424	1¼"	3
8524	1½"	3⅞
8624	2"	3⅞
8724	2½"	3⅞
8824-TB	3"	4¼
8854	3½"	4⅞
8974	4"	5⅞

Sizes ½"-2" made of steel; sizes 2½"-4" are malleable iron.  
Available with DURA-PLATE® Finish.  
U.L. File No. E-23018  
CSA File No. 2884

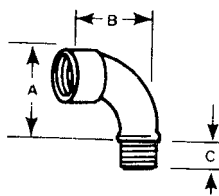

The non-insulated elbow has smoothly rounded shoulders to protect conductor insulation. Malleable iron.

### Bushed Elbows

Cat. No.	Size	Dimension (in.)		
		A	B	C
460-TB	1/2"	1 1/8	1 13/16	5/8
461TB	3/4"	1 1/2	2 1/4	5/8
462	1"	1 13/16	2 11/16	3/4
463	1 1/4"	2 1/4	3 3/8	3/4

Available with DURA-PLATE® Finish.  
U.L. File No. E 23018  
CSA File No. 2884

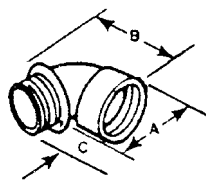

The integral insulation of the insulated elbow is a guarantee that the bushing of every fitting will be smooth. Malleable iron.

### Short Elbows – Nylon Insulated

Cat. No.	Size	Dimension (in.)		
		A	B	C
4290	1/2"	1 7/32	1 1/4	1/2
4291	3/4"	1 7/16	1 5/8	9/16
4292	1"	1 23/32	1 9/8	1 1/16
4293	1 1/4"	2 7/32	2 1/8	1 3/16
4294	1 1/2"	2 15/32	2 3/8	1 3/16
4295	2"	3	2 3/8	1 3/16

Available with DURA-PLATE® Finish.  
Not U.L. or CSA.

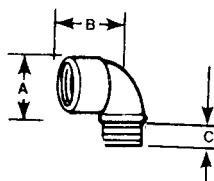

When an insulated elbow is not desired, the non-insulated short elbow should be used. Malleable iron.

### Short Elbows

Cat. No.	Size	Dimension (in.)		
		A	B	C
4250	1/2"	1 5/16	1 1/4	7/16
4251	3/4"	1 7/32	1 5/8	1/2
4252	1"	1 13/16	1 9/8	5/8
4253	1 1/4"	2 3/32	2 1/8	1 1/16
4254	1 1/2"	2 9/16	2 3/8	1 1/16
4255	2"	3 3/32	2 3/8	1 1/16

Available with DURA-PLATE® Finish.  
U.L. File #E-23018  
CSA File No. 589

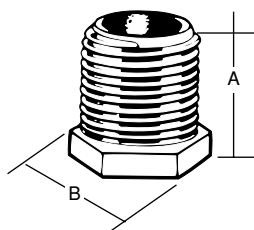

### Conduit Nipples – Die Cast Zinc 1" Long

Cat. No.	Size	A	B
HA-211	1/2"	1"	1 5/16"
HA-212	3/4"	1"	1 3/8"
HA-213	1"	1"	1 1/8"

U.L. File No. E-1275 1/2" & 3/4" only

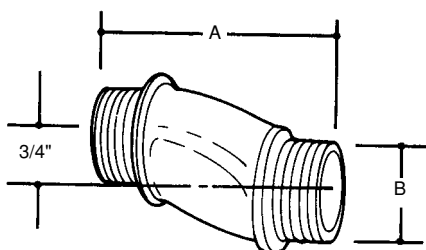

### Offset Nipples – Die Cast Zinc

Cat. No.	Size	A	B
HO-221	1/2"	2.60"	1.00"
HO-222	3/4"	2.62"	1.32"
HO-223	1"	2.68"	1.51"
HO-224	1 1/4"	2.85"	1.85"
HO-225	1 1/2"	2.88"	2.08"
HO-226	2"	3.19"	2.71"

3/4" offset.  
U.L. File No. E-1275

## Rigid and Intermediate Metal Conduit Fittings



674 Series  
675AL Series

### Threaded Coupling (Erickson® Coupling)

(For Threaded Rigid Metal Conduit and Intermediate Metal Conduit)

#### Application

- To couple and effectively bond threaded ends of rigid metal conduit/intermediate metal conduit where neither length of conduit can be rotated.

#### Features

- Malleable Iron/Steel/Copper free Aluminum Construction.
- Free fitting threads insure easy assembly.
- Permits conduit coupling without rotating either conduit.
- Provides rigid in-line coupling with high quality grounding; will not loosen under vibration.
- Suitable for concrete tight application.
- Capable of carrying ground fault currents up to 10,000 amps RMS (½" through 1½" size) and up to 20,000 amps RMS (2" and above) (duration of fault current 3 cycles) (674 series tested).

#### Standard Material

##### 674 Series

Bushing & Case .....Malleable Iron  
Ring .....Steel & Malleable Iron

##### 675AL Series

Bushing & Case .....Aluminum  
Ring .....Aluminum

#### Standard Finish

674 Series: Electro Zinc Plated & Chromate Coated  
675AL Series: Degreased

#### Range

⅜" thru 6" Conduit (malleable iron)  
½" thru 6" Conduit (aluminum)  
All straight pipe threads (NPS)

#### Listed/Certified by:

U.L. (U.L. File No. E-23018)  
CSA (LR-2884, LR-4484)

#### Conforms to:

U.L. 514B  
CSA C22.2 No. 18  
NEMA FB1  
NFPA 70-1999 (ANSI)  
Federal Specification W-F-408  
Federal Standard H-28 (Threads)

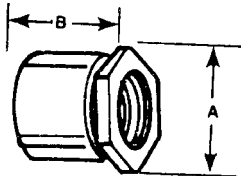

With an ERICKSON® coupling, a conduit run may be completed when neither conduit can be turned. A conduit run may also be broken without taking down the whole run. Conduit joined with ERICKSON® Couplings is rigid and in line and vibration will not loosen the connections. Malleable iron.

### ERICKSON® Couplings

Cat. No.	Cat. No. Alum.*	Size	Dimensions (in.)	
			A	B
674	—	⅜"	1⅛	1⅛
675	675AL	½"	1⅞ <sub>32</sub>	1¼
676	676AL	¾"	1⅞ <sub>16</sub>	1⅞ <sub>32</sub>
677	677AL	1"	1⅞ <sub>32</sub>	1⅞ <sub>16</sub>
678	678AL	1¼"	2⅞	1⅞ <sub>16</sub>
679	679AL	1½"	2⅞	1⅞ <sub>32</sub>
680TB	680AL	2"	3⅞ <sub>32</sub>	2⅞ <sub>32</sub>
681	681AL	2½"	3⅞ <sub>32</sub>	2⅞ <sub>16</sub>
682	682AL	3"	4⅞ <sub>16</sub>	2⅞ <sub>32</sub>
683	683AL	3½"	5	3
684	684AL	4"	5½	3⅞ <sub>16</sub>
685	685AL	4½"	6¼	3⅞ <sub>32</sub>
686	686AL	5"	6⅞ <sub>32</sub>	3¾
687	687AL	6"	8	4⅞ <sub>32</sub>

\* Copper Free Aluminum.  
U.L. Listed and CSA Certified concrete-tight.  
U.L. File No. E-23018  
CSA File No. 2884





# T&B® Fittings

## Rigid and Intermediate Metal Conduit Fittings

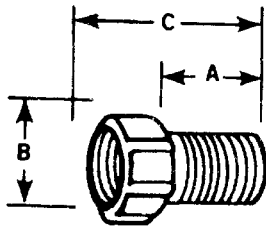

*Ideal when longer thread length is needed. Will combine with any fitting having a male thread. Male thread of panel connector extension is 1" long. Malleable iron.*

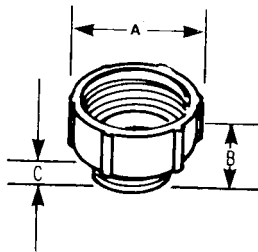

*Adapt an outlet hole to the next larger size of conduit. Rough ends of conduit carefully covered by built-in bushing. Malleable iron.*

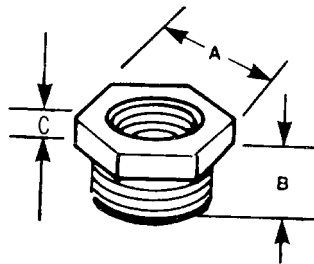

*Adapt any outlet to the next smaller size of conduit. Hex shoulder makes wrench tightening convenient. Malleable iron.*



### Panel Connector Extensions

Cat. No.	Size	Dimensions (in.)		
		A	B	C
1440	½"	1¼	1⅜	1⅞
1441	¾"	1⅝	1⅞	2
1442	1"	1¾	1⅞	1⅞
1443	1¼"	1¾	1⅞	1⅞

U.L. File No. E-23018  
CSA File No. 2884



### Male Enlargers\*

Cat. No.	Size	Dimensions (in.)		
		A	B	C
1245	½" to ¾"	1⅜	1⅞	½
1246	¾" to 1"	1⅞	1¼	1⅞
1244	1" to 1¼"	2⅞	1⅞	½
1247	1¼" to 1½"	2⅞	1⅞	⅞

\* All items shown in this chart are suitable for use in hazardous locations where general purpose equipment is specifically permitted by the NEC; Class I, Div. 2; Class II, Div. 1 & 2; Class III, Div. 1 & 2, NEC 501-4(b); 502-4(a)(b); 503-3(a)(b). Available with DURA-PLATE® Finish. U.L. File No. E-23018  
CSA File No. 2884



### Female Reducers\*

Cat. No.	Size	Dimensions (in.)		
		A	B	C
1250	¾" to ½"	1⅞	⅞	⅞
1261	1" to ½"	1⅞	2½	⅞
1251	1" to ¾"	1⅞	1⅞	⅞
1262	1¼" to ½"	1⅞	2⅞	⅞
1263	1¼" to ¾"	1⅞	2⅞	⅞
1252	1¼" to 1"	1¾	2⅞	⅞
1253	1½" to 1¼"	2	1⅞	¼
1254	2" to 1½"	2⅞	1⅞	⅞
1255	2½" to 2"	3	1¼	⅞
1256	3" to 2½"	3⅞	1½	½
1257	3½" to 3"	4⅞	1⅞	½
1258	4" to 3½"	4⅞	1⅞	½

\* All items shown in this chart are suitable for use in hazardous locations where general purpose equipment is specifically permitted by the NEC; Class I, Div. 2; Class II, Div. 1 & 2; Class III, Div. 1 & 2, NEC 501-4(b); 502-4(a)(b); 503-3(a)(b). Available with DURA-PLATE® Finish. U.L. File No. E-23018  
CSA File No. 2884

# T&B® Fittings

## Rigid and Intermediate Metal Conduit Fittings

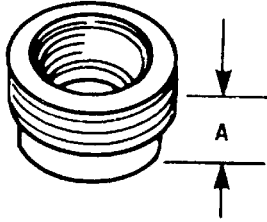

For reducing the threaded opening in conduit bodies or any female threaded fitting. Smooth, built-in bushing completely covers rough ends of conduit. Iron or steel construction. Steel thru 606, also 614 & 615.

### Threaded Reducers\*

Cat. No.		Size	Dimension (in.)	
Stl. on MI	Alum.		A	
600TB	600ALTB	1/2" to 3/8"	9/16	
601TB	601ALTB	3/4" to 1/2"	9/16	
602TB	602ALTB	1" to 1/2"	5/8	
603TB	603ALTB	1" to 3/4"	5/8	
604TB	604ALTB	1 1/4" to 1/2"	13/16	
605	605AL	1 1/4" to 3/4"	7/8	
606	606AL	1 1/4" to 1"	15/16	
607	607AL	1 1/2" to 1/2"	13/16	
608	608AL	1 1/2" to 3/4"	13/16	
609	609AL	1 1/2" to 1"	15/16	
610	610AL	1 1/2" to 1 1/4"	3/4	
611	611AL	2" to 1/2"	15/16	
612	612AL	2" to 3/4"	15/16	
613	613AL	2" to 1"	15/16	
614	614AL	2" to 1 1/4"	15/16	
615	615AL	2" to 1 1/2"	7/8	

U.L. File No. E-23018  
CSA File No. 2884

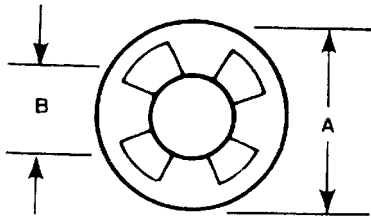

Washers reduce knockout hole in outlet box. Newly designed of galvanized steel. These washers, used in pairs, interlock and form a rib which centers the washers and conduit in the knockout.

### Reducing Washers

Cat. No.	Size	Dimensions (in.)	
		A	B
3700	3/4" to 3/8"	1 3/8	45/64
3701	3/4" to 1/2"	1 3/8	7/8
3702	1" to 3/8"	1 3/8	45/64
3703	1" to 1/2"	1 3/8	7/8
3704	1" to 3/4"	1 3/8	1 3/32
3705	1 1/4" to 3/8"	2	45/64
3706	1 1/4" to 1/2"	2	7/8
3707	1 1/4" to 3/4"	2	1 3/32
3708	1 1/4" to 1"	2	1 23/64
3709	1 1/2" to 3/8"	2 1/4	45/64
3710	1 1/2" to 1/2"	2 1/4	7/8
3711	1 1/2" to 3/4"	2 1/4	1 3/32
3712	1 1/2" to 1"	2 1/4	1 23/64
3713	1 1/2" to 1 1/4"	2 1/4	1 23/32
3714	2" to 1/2"	2 3/4	7/8
3715	2" to 3/4"	2 3/4	1 3/32
3716	2" to 1"	2 3/4	1 23/64
3717	2" to 1 1/4"	2 3/4	1 23/32
3718	2" to 1 1/2"	2 3/4	1 31/32

U.L. File No. E-13938  
CSA File No. 2884



1275 Series  
1276AL Series

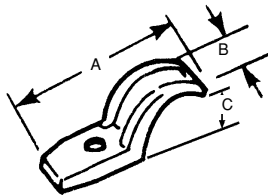
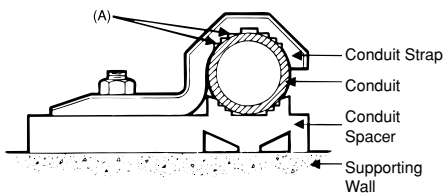

*Designed to fit each size of conduit snugly. High reinforcing ribs on each side increase strength, reduce weight. Hot-dipped galvanized finish. Malleable iron.*

### Conduit Straps

(For Rigid Metal Conduit and Intermediate Metal Conduit)

#### Application

- To support and securely fasten rigid metal conduit and intermediate metal to the supporting surface.

#### Features

- Rugged malleable iron/copper free aluminum construction – snugly fits on the conduit.
- Designed to prevent accumulation of moisture and start of corrosion on vertical run of conduit (A).
- Galvanized finish... 1275 Series.
- Copper free aluminum... 1276AL Series.

#### Standard Material

1275 Series . . . . . 1976AL Series  
Malleable Iron . . . . . All copper free aluminum

#### Standard Finish

1275 Series . . . . . 1276AL Series  
Hot Dipped . . . . . As Cast Galvanized

#### Range

1275 Series . . . . . 1276AL Series  
3/8" through . . . . . 1/2" through 6" conduit  
6" conduit

#### Listed/Certified by:

CSA (LR-2884, LR-4484)

#### Conforms to:

CSA C22.2 No. 18  
NFPA 70-1999 (ANSI)



### Pipe Straps – Malleable Iron or Aluminum

Cat. No.		Size	A	B	C	Screw Size
Mal. Iron	Alum.					
1275†	1275AL	3/8"	1 7/8"	1 1/16"	3/4"	#12
1276†	1276AL†	1/2"	2 5/32"	2 1/32"	1 1/32"	1/4"
1277†	1277AL†	3/4"	2 9/16"	1 1/16"	1 7/32"	1/4"
1278†	1278AL†	1"	3"	3/4"	1 7/32"	1/4"
1279†	1279AL†	1 1/4"	3 3/4"	1 3/16"	1 7/8"	5/16"
1280†	1280AL	1 1/2"	4 3/16"	1 5/16"	2 1/8"	3/8"
1281*	1281AL	2"	5 3/16"	1 1/8"	2 1/64"	7/16"
1282*	1282AL	2 1/2"	5 5/16"	1 1/2"	2 3/4"	1/2"
1283*	1283AL	3"	6 1/16"	1 5/8"	3 1/32"	1/2"
1284	1284AL	3 1/2"	7 19/32"	1 3/4"	3 29/32"	5/8"
1285*	1285AL	4"	8 5/16"	1 7/8"	4 1/32"	5/8"
1286	1286AL	4 1/2"	9 3/16"	1 5/16"	4 5/16"	5/8"
1287	1287AL	5"	9 5/16"	2"	5 5/32"	5/8"
1288	1288AL	6"	11 1/2"	2 7/16"	6 17/32"	5/8"

\* May be used with EMT of same size.

† Not snap on type.

U.L. not applicable.

CSA File No. 2884

# T&B® Fittings

## Rigid and Intermediate Metal Conduit Fittings

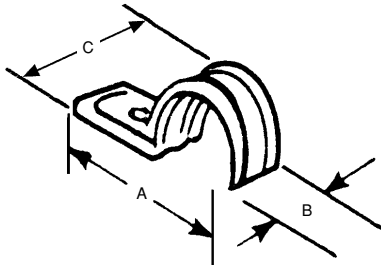

*Elongated bolt hole makes alignment easy, even when holes in mounting surface are off center. Snap on features. Steel.*

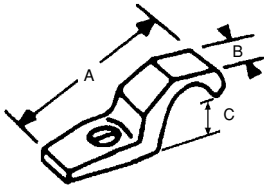

*Malleable iron. Designed to fit each size of conduit snugly. High reinforcing ribs on each side increase strength, reduce weight.*

### Pipe Straps – Steel

Cat. No.	Conduit Size	A	B	C	Screw Size
1210†	3/8"	1 <sup>15</sup> / <sub>32</sub>	3/4	1 <sup>1</sup> / <sub>16</sub>	1/4"
1211	1/2"	2	3/4	1 <sup>9</sup> / <sub>16</sub>	1/4"
1212	3/4"	2 <sup>5</sup> / <sub>16</sub>	3 <sup>3</sup> / <sub>4</sub>	1"	1/4"
1213	1"	3 <sup>13</sup> / <sub>16</sub>	3/4	1 <sup>1</sup> / <sub>64</sub>	1/4"
1214	1 <sup>1</sup> / <sub>4</sub> "	2 <sup>31</sup> / <sub>32</sub>	1 <sup>9</sup> / <sub>16</sub>	1 <sup>9</sup> / <sub>16</sub>	3/8"
1215	1 <sup>1</sup> / <sub>2</sub> "	3 <sup>23</sup> / <sub>32</sub>	1 <sup>13</sup> / <sub>16</sub>	1 <sup>13</sup> / <sub>16</sub>	3/8"
1216	2"	4 <sup>7</sup> / <sub>16</sub>	2 <sup>5</sup> / <sub>16</sub>	2 <sup>5</sup> / <sub>16</sub>	3/8"

† Not snap on type.  
U.L. not applicable.  
CSA File No. 2884

### Corrosion Resistant PVC Coated Rigid Conduit Straps

Cat. No.	Size	Bolt Size	Dimensions (in.)		
			A	B	C
1275CR	3/8"	1/4"	1 <sup>7</sup> / <sub>8</sub>	1 <sup>1</sup> / <sub>16</sub>	3/4
1276CR	1/2"	1/4"	2 <sup>5</sup> / <sub>32</sub>	2 <sup>1</sup> / <sub>32</sub>	1 <sup>1</sup> / <sub>32</sub>
1277CR	3/4"	1/4"	2 <sup>9</sup> / <sub>16</sub>	1 <sup>1</sup> / <sub>16</sub>	1 <sup>7</sup> / <sub>32</sub>
1278CR	1"	1/4"	3	3/4	1 <sup>1</sup> / <sub>32</sub>
1279CR	1 <sup>1</sup> / <sub>4</sub> "	3/8"	3 <sup>3</sup> / <sub>4</sub>	1 <sup>3</sup> / <sub>16</sub>	1 <sup>7</sup> / <sub>8</sub>
1280CR	1 <sup>1</sup> / <sub>2</sub> "	3/8"	4 <sup>3</sup> / <sub>16</sub>	1 <sup>5</sup> / <sub>16</sub>	2 <sup>1</sup> / <sub>8</sub>
1281CR	2"	1/2"	5 <sup>3</sup> / <sub>16</sub>	1 <sup>1</sup> / <sub>8</sub>	2 <sup>1</sup> / <sub>64</sub>

U.L. not applicable.

# T&B® Fittings

## Rigid and Intermediate Metal Conduit Fittings

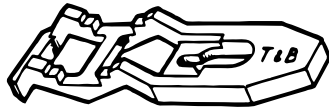

1350 Series  
1350AL Series

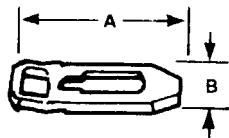
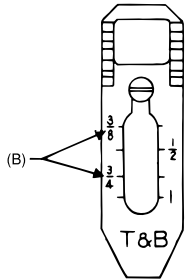
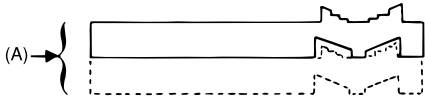
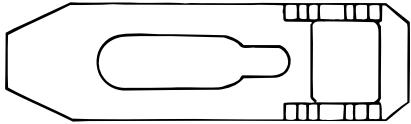

Used with T&B conduit straps to permit space between conduit and mounting surface. Eliminates need for costly offset-bending conduit and possible corrosive moisture traps when conduit is mounted directly to a surface. Hot-dipped galvanized finish, pre-mountable and stackable to eliminate offsetting. Malleable iron.

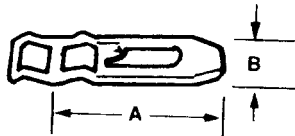

Corrosion-resistant, PVC-coated, malleable iron. Pre-mountable, stackable to eliminate offsetting.

Spacers can be stacked for offsets on wall or into outlet box. Prevents conduit rusting from wall condensation. Eliminates offsetting of conduit.

### Conduit Spacers

(For Rigid Metal Conduit, Intermediate Metal Conduit and Electrical Metallic Tubing)

#### Application

- Provides mounting surface for conduit where installation requires air space between conduit and supporting surface.

#### Features

- Prevents conduit rusting from wall condensation.
- Spacers can be stacked one atop the other facilitating installation and eliminating expensive conduit offsetting (A).
- Designed to cover wide range; marked with accurate size marking for proper positioning (B).
- Galvanized finish on 1350 Series.
- Copper free aluminum alloy, 1350AL Series.

#### Standard Material

**1350 Series . . . . . 1350AL Series**  
Malleable Iron . Copper free aluminum

#### Standard Finish

**1350 Series . . . . . 1350AL Series**  
Hot Dipped . . . . . As Cast Galvanized

#### Range

½" through 6" conduit

#### Listed/Certified by:

CSA (LR-2884, LR-4484, LR-4484)

#### Conforms to:

CSA C22.2 No. 18  
NFPA 70-1999 (ANSI)



### Pipe Spacers

Cat. No.		Size	Screw Size	Dimensions (in.)	
Mal. Iron	Alum.			A	B
1350	1350AL	½", ¾", 1"	#7	3"	7/8"
1351	1351AL	1¼"-1½"-2"	#12	5"	1 3/16"
1352	1352AL	2½"-3"	#12	9 5/16"	1 3/4"
1353	1353AL	3½"-4"	#14	7 7/16"	2"
1354	1354AL	4½"-5"-6"	#16	10 5/16"	2 5/16"

Conforms to NEC SECT. 300-5-c  
U.L. not applicable.  
CSA File Nos. 2884 and 4484

### Pipe Spacers – PVC coated

Cat. No.	Conduit Size	Screw Size	Dimensions (in.)	
			A	B
1350CR	½"-¾"-1"	#7	3	7/8
1351CR	1¼"-1½"-2"	#12	5	3/8
1352CR	2½"-3"	#12	6 5/16	1 3/4
1353CR	3½"-4"	#14	7 7/16	2
1354CR	4½"-5"-6"	#16	10 5/16	2 5/16

U.L. not applicable.  
Conforms to NEC SECT. 300-5-c.

# T&B® Fittings

## Rigid and Intermediate Metal Conduit Fittings

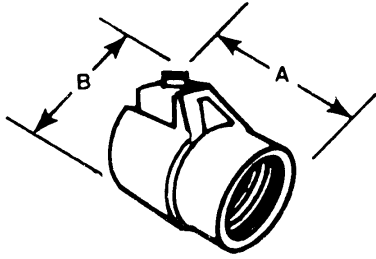

A one-piece fitting that couples armored cable or flexible conduit to threaded rigid conduit. Tite-Bite® wedge holds conduit securely with a double grip. With a Chase® nipple this fitting will connect flexible conduit to outlet boxes, allowing more wiring space in the box than the usual connector. U.L. Listed as a grounding means under NEC 350-5. Malleable iron.

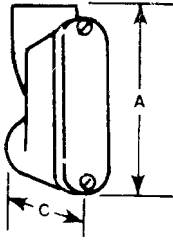

T&B entrance ells mount flat against the wall eliminating the need for offsetting the conduit. Designed for a straight pull in either direction and carefully bushed, these entrance ells make it easy to pull heavy wires without damage to the insulation. Made of copper free aluminum.



Includes bolts. Steel



These supports will fit any flange, tapered or straight up to 5/8" thick. The broad hook holds the conduit at any desired angle. Holds standard rigid conduit, E.M.T., or I.M.C. Malleable iron.

### TITE-BITE® Combination Couplings – Armored Cable for Threaded Rigid

Cat. No.	Size	Dimensions (in.)	
		A	B
440	1/2"	1 5/8	1 7/32
441	3/4"	1 3/4	2 1/8
442	1"	2	2 1/32

U.L. File No. E-23018  
CSA File No. 2884



### Entrance Ells

Cat. No.	Conduit Size	Dimensions (in.)	
		A	C
1490	1/2"	3 11/64	1 19/32
1491	3/4"	3 9/16	1 7/8
1492	1"	4 1/4	2 7/32
1493	1 1/4"	5 31/64	2 13/16
1494	1 1/2"	6 1/4	2 7/8
1495	2"	6 3/4	3 &
1496	2 1/2"	13 9/64	5 7/8
1497	3"	13 3/64	6 1/2
1498	3 1/2"	16 29/64	7 17/32
1499	4"	16 29/64	7 17/32

U.L. File No. E-23018  
CSA File Nos. 2884 and 589

### Beam Clamps Adjustable

Cat. No.	Description
700TB	Fits Flange 2 3/4"-7 3/8"
701	Fits Flange 7"-12"
703	Special Bolt and 3 Nuts

CSA File No. 2884.



### Conduit Supports

Cat. No.	Size
690	1/2"
691TB	3/4"
692TB	1"
693TB	1 1/4"

CSA File No. 2884

**Thomas & Betts**

# T&B® Fittings

## Conduit Outlet Bodies



### T&B Conduit Fittings for Ordinary and Hazardous Locations

Thomas & Betts offers a broad range of conduit bodies, conduit boxes, conduit fittings, unions, sealing fittings, drains and cable fittings for both ordinary and hazardous locations. Complete information on applications, features, materials, finishes, size range and certifications is provided in the following pages.



#### Conduit Bodies (for ordinary locations)

For raceway systems to provide pull outlets, 90° bends, splices, taps, mounting outlets, etc.

- FORM 7 For neat, compact installation of rigid threaded conduit.
- FORM 8 For heavier conductors using rigid threaded conduit.
- Red•Dot® Aluminum Die-Cast For rigid threaded conduit installation – copper-free aluminum.
- Red•Dot® Thinwall (EMT) For set-screw installation using thinwall conduit. (EMT) – copper-free aluminum.
- Mogul Conduit Fittings For larger conduits, spacious, accessible wiring chambers.



#### Cast Device Boxes (for ordinary locations)

For raceway systems to accommodate wiring devices, serve as pull boxes, and provide entrances for taps and splices.

*FS/FD Single and Double Gang Cast Device Boxes*

#### Cast Conduit Outlet Boxes (for hazardous locations)

Round cast outlet boxes used with rigid conduit to serve as pull and splice boxes, easy access to wiring, act as a housing for instruments, apparatus, etc.  
*GUA Conduit Outlet Bodies*

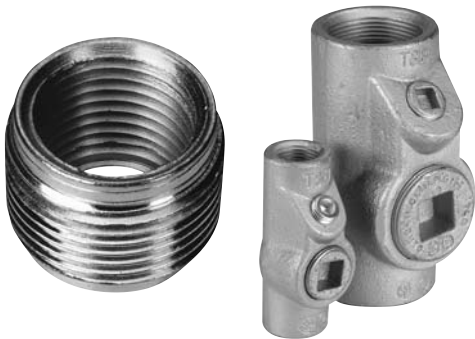

#### Reducers, Plugs, Unions (for ordinary and hazardous locations)

Includes reducers for connecting conduit of dissimilar dimensions, plugs for unused conduit openings and hubs, and unions for threaded conduit systems.  
*RE, PLG REC Reducers, Plugs and Adapters, UNY/UNF Unions*

#### Sealing Fittings and Drains (for ordinary and hazardous locations)

Cast fittings used with rigid conduit to seal sections from passage of vapors, flame or gases or explosions. Drains provide ventilation as a breather and as a drain in moist locations.

*EYS/EYD Sealing Fittings & ECD Drains*



#### Cable Fittings (for ordinary and hazardous locations)

For armored, metal clad, jacketed or unjacketed and unarmored cables through a bulkhead or enclosure in ordinary or hazardous areas.

# T&B® Fittings

## Form 7, Form 8, and Red•Dot® Conduit Outlet Bodies



### Conduit Outlet Bodies

---

#### Application

Conduit Bodies are installed in conduit systems to:

- Connect conduit sections.
- Act as pull outlets when conductors are being installed.
- Provide easy access for splices in branch conductors.
- Make 90-degree bends in conduit runs.
- Act as mounting outlets for wiring devices and lighting fixtures.
- Provide access to conductors for maintenance and future system changes.

#### Features

- Standard features include tapered (NPT) threads, integral bushings to protect wire insulation.
- T&B Form 7 bodies and covers are interchangeable with other manufacturer's Form 7 bodies and covers.
- T&B Form 8 bodies and covers are interchangeable with other manufacturer's Form 8 bodies and covers.

#### Materials

- Conduit Bodies (Form 7 and Form 8) - Sand cast class 30 Gray iron alloy.
- Red•Dot® die cast aluminum, copper-free.
- Covers - Sand cast gray iron alloy, and stamped sheet steel-stainless steel screws.
- Gaskets - Neoprene

#### Finish

- Conduit Bodies - zinc-plating with an aluminum acrylic coating.
- Covers - gray iron zinc-plating with an aluminum acrylic coating, and stamped steel zinc-plating with a clear chromate coating.











#### Compliances

- UL Standard: 514A, 514B
- Fed. Spec: W-C-586D
- CSA Standard: C22.2 No. 18





### Threaded Rigid Bodies



Shape	Hub Size										
	1/2	3/4	1	1-1/4	1-1/2	2	2-1/2	3	3-1/2	4	
 <b>LB</b>	Form 7	LB17	LB27	LB37	LB47	LB57	LB67	LB77	LB87	LB97	LB107
	Form 8	LB18	LB28	LB38	LB448	LB58	LB68	LB78	LB888	LB98	LB108
	Threaded Aluminum	ALB1	ALB2	ALB3	ALB4	ALB5	ALB6	ALB7	ALB8	ALB9	ALB10
	EMT Aluminum	BLB1	BLB2	BLB3	BLB4	BLB5	BLB6	BLB7	BLB8	BLB9	BLB10
 <b>T</b>	Form 7	T17	T27	T37	T47	T57	T67	T77	T87	T97	T107
	Form 8	T18	T28	T38-TB	T448	T58	T68	T78	T88-TB		
	Threaded Aluminum	AT1	AT2	AT3	AT4	AT5	AT6	AT7	AT8	AT9	AT10
	EMT Aluminum	BT1	BT2	BT3	BT4	BT5	BT6				
 <b>C</b>	Form 7	C17	C27	C37	C47	C57	C67	C77-TB	C87		
	Form 8	C18	C28	C38	C448	C58-TB	C68	C78	C88		
	Threaded Aluminum	AC1	AC2	AC3	AC4	AC5	AC6	AC7	AC8	AC9	AC10
	EMT Aluminum	BC1	BC2	BC3	BC4	BC5	BC6				
 <b>LL</b>	Form 7	LL17	LL27	LL37	LL47	LL57	LL67	LL77	LL87	LL97	LL107
	Form 8	LL18	LL28	LL38	LL448	LL58	LL68	LL78	LL888		
	Threaded Aluminum	ALL1	ALL2	ALL3	ALL4	ALL5	ALL6	ALL7	ALL8	ALL9	ALL10
	EMT Aluminum	BLL1	BLL2	BLL3	BLL4	BLL5	BLL6				
 <b>LR</b>	Form 7	LR17	LR27	LR37	LR47	LR57	LR67	LR77	LR87	LR97	LR107
	Form 8	LR18	LR28	LR38	LR448	LR58	LR68	LR78	LR888		
	Threaded Aluminum	ALR1	ALR2	ALR3	ALR4	ALR5	ALR6	ALR7	ALR8	ALR9	ALR10
	EMT Aluminum	BLR1	BLR2	BLR3	BLR4	BLR5	BLR6				
 <b>X</b>	Form 7	X17	X27	X37	X47	X57	X67				
	Form 8	X18	X28	X38	X448	X58	X68				
 <b>*L</b>	Form 7	L17-TB	L27-TB	L37-TB	L47-TB	L57-TB	L67-TB				
	Threaded Aluminum	ALRL1	ALRL2	ALRL3	ALRL4	ALRL5	ALRL6				
	EMT Aluminum	BLRL1	BLRL2	BLRL3	BLRL4	BLRL5	BLRL6				
 <b>E</b>	Form 7	E17	E27	E27							
	Threaded Aluminum	AE1	AE2	AE3							
 <b>TA</b>	Form 7	TA17	TA27	TA37	TA47	TA57	TA67				
 <b>TB</b>	Form 7	TB17-TB	TB27	TB37	TB47	TB57	TB67				
		TB18	TB28	TB38	TB48	TB58	TB68				

\*Furnished with one stamped steel cover

# T&B® Fittings

## Form 7, Form 8, and Red•Dot® Conduit Outlet Bodies

### Covers and Gaskets

Shape	Hub Size										
	1/2	3/4	1	1-1/4	1-1/2	2	2-1/2	3	3-1/2	4	
 <p><b>Stamped Steel</b></p>	Form 7	170S	270S	370S	470S	570S	670S	870S	870S	970S	970S
	Form 8	180	280	380	480	580	680	880	880	980	980
	Red•Dot®	SCV1	SCV2	SCV3	SCV4	SCV4	SCV5	CV6	CV6	CV7	CV7
 <p><b>Gray Iron</b></p>	Form 7	170F	270F	370F	470F	570F	670F	870F	870F	970F	970F
	Form 8	180F	280F	380F	480F	580F	680F	880F	880F	980F	980F
 <p><b>Gasket</b></p>	Form 7	GASK 571	GASK 572	GASK 573	GASK 574	GASK 575	GASK 576	GASK 578	GASK 578	GASK 579	GASK 579
	Form 8	GASK 581N	GASK 582N	GASK 583N	GASK 584N	GASK 585N	GASK 586N	GASK 588N	GASK 588N	GASK 589N	GASK 589N
	Red•Dot®	GKN1	GKN2	GKN3	GKN4	GKN4	GKN5	GKN6	GKN6	GKN7	GKN7

For ordering purposes please use GASK in the catalog number. (Example: GASK 571)

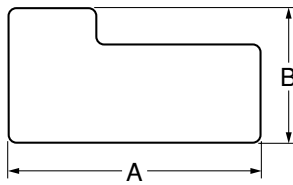
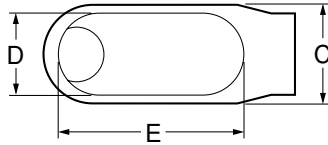

LB Form 7 and Form 8

### LB Form 7

Cat. No.	Size	Dimensions (in.)					
		A	B	C	D	E	CI
LB17	½	4.60	2.20	1.35	.95	3.20	4.0
LB27	¾	5.25	2.40	1.65	1.15	3.80	6.6
LB37	1	6.00	2.65	1.80	1.35	4.55	10.6
LB47	1¼	6.45	3.20	2.20	1.80	5.00	18.8
LB57	1½	7.25	3.90	2.45	2.05	5.45	26.4
LB67	2	8.30	4.45	3.10	2.45	6.40	51.0
LB77	2½	10.55	5.20	4.25	3.60	8.40	102.0
LB87	3	10.55	5.95	4.25	3.60	8.40	132.0
LB97	3½	12.85	6.70	5.25	4.55	10.25	210.0
LB107	4	12.85	7.20	5.25	4.55	10.25	243.0



### LB Form 8

Cat. No.	Size	Dimensions (in.)					
		A	B	C	D	E	CI
LB18	½	4 <sup>15</sup> / <sub>16</sub>	2.219	1 <sup>3</sup> / <sub>8</sub>	1	3 <sup>5</sup> / <sub>16</sub>	4.9
LB28	¾	5 <sup>5</sup> / <sub>16</sub>	2.438	1 <sup>9</sup> / <sub>16</sub>	1 <sup>3</sup> / <sub>16</sub>	3 <sup>7</sup> / <sub>16</sub>	8.0
LB38	1	6 <sup>1</sup> / <sub>2</sub>	2.813	1 <sup>3</sup> / <sub>4</sub>	1 <sup>3</sup> / <sub>8</sub>	4 <sup>9</sup> / <sub>16</sub>	13.0
LB48	1¼	7 <sup>1</sup> / <sub>32</sub>	3 <sup>1</sup> / <sub>32</sub>	2 <sup>3</sup> / <sub>16</sub>	1 <sup>3</sup> / <sub>4</sub>	5 <sup>5</sup> / <sub>16</sub>	23.5
LB58	1½	9 <sup>1</sup> / <sub>8</sub>	4 <sup>1</sup> / <sub>32</sub>	2 <sup>3</sup> / <sub>4</sub>	2 <sup>1</sup> / <sub>8</sub>	6 <sup>1</sup> / <sub>2</sub>	45.0
LB68	2	11	4 <sup>1</sup> / <sub>32</sub>	3 <sup>3</sup> / <sub>4</sub>	3	8 <sup>9</sup> / <sub>16</sub>	88.0
LB78	2½	13 <sup>15</sup> / <sub>16</sub>	6 <sup>1</sup> / <sub>8</sub>	5	4 <sup>1</sup> / <sub>4</sub>	10 <sup>7</sup> / <sub>16</sub>	110.0
LB888	3	13 <sup>15</sup> / <sub>16</sub>	6 <sup>1</sup> / <sub>2</sub>	5	4 <sup>1</sup> / <sub>4</sub>	10 <sup>7</sup> / <sub>16</sub>	110.0
LB98	3½	16 <sup>7</sup> / <sub>8</sub>	7 <sup>9</sup> / <sub>16</sub>	6 <sup>1</sup> / <sub>4</sub>	5 <sup>7</sup> / <sub>16</sub>	13 <sup>7</sup> / <sub>16</sub>	250.0
LB108	4	16 <sup>7</sup> / <sub>8</sub>	7 <sup>9</sup> / <sub>16</sub>	6 <sup>1</sup> / <sub>4</sub>	5 <sup>7</sup> / <sub>16</sub>	13 <sup>7</sup> / <sub>16</sub>	250.0

### LB Threaded Aluminum

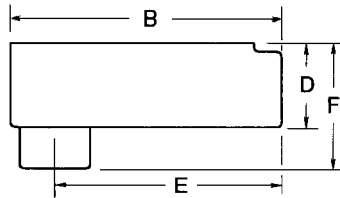
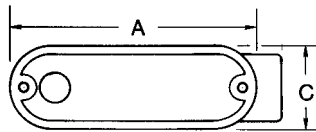

LB Threaded Aluminum and EMT Aluminum

Cat. No.	Size	Dimensions (in.)						
		A	B	C	D	E	F	CI
ALB1	½	3 <sup>7</sup> / <sub>8</sub>	4 <sup>9</sup> / <sub>32</sub>	1 <sup>5</sup> / <sub>16</sub>	1 <sup>7</sup> / <sub>16</sub>	3 <sup>1</sup> / <sub>2</sub>	2 <sup>1</sup> / <sub>16</sub>	4.3
ALB2	¾	4 <sup>5</sup> / <sub>8</sub>	5 <sup>1</sup> / <sub>8</sub>	1 <sup>1</sup> / <sub>32</sub>	1 <sup>5</sup> / <sub>8</sub>	4 <sup>1</sup> / <sub>4</sub>	2 <sup>7</sup> / <sub>16</sub>	7.3
ALB3	1	5 <sup>3</sup> / <sub>8</sub>	5 <sup>15</sup> / <sub>16</sub>	1 <sup>3</sup> / <sub>4</sub>	1 <sup>7</sup> / <sub>8</sub>	4 <sup>9</sup> / <sub>16</sub>	2 <sup>3</sup> / <sub>4</sub>	11.8
ALB4	1¼	7 <sup>1</sup> / <sub>4</sub>	7 <sup>7</sup> / <sub>8</sub>	2 <sup>1</sup> / <sub>2</sub>	2 <sup>1</sup> / <sub>2</sub>	6 <sup>1</sup> / <sub>2</sub>	3 <sup>3</sup> / <sub>16</sub>	32.0
ALB5	1½	7 <sup>1</sup> / <sub>4</sub>	7 <sup>7</sup> / <sub>8</sub>	2 <sup>1</sup> / <sub>2</sub>	2 <sup>3</sup> / <sub>4</sub>	6 <sup>5</sup> / <sub>16</sub>	3 <sup>3</sup> / <sub>16</sub>	32.0
ALB6	2	9 <sup>1</sup> / <sub>2</sub>	9 <sup>9</sup> / <sub>16</sub>	3 <sup>1</sup> / <sub>8</sub>	3 <sup>7</sup> / <sub>16</sub>	8	4 <sup>1</sup> / <sub>2</sub>	69.5
ALB7	2½	12 <sup>1</sup> / <sub>4</sub>	13	4 <sup>1</sup> / <sub>2</sub>	3 <sup>7</sup> / <sub>8</sub>	10 <sup>7</sup> / <sub>32</sub>	5 <sup>1</sup> / <sub>4</sub>	190.0
ALB8	3	12 <sup>1</sup> / <sub>4</sub>	13	4 <sup>1</sup> / <sub>2</sub>	4 <sup>1</sup> / <sub>2</sub>	10 <sup>1</sup> / <sub>2</sub>	5 <sup>7</sup> / <sub>8</sub>	190.0
ALB9	3½	15	16 <sup>5</sup> / <sub>16</sub>	5 <sup>1</sup> / <sub>2</sub>	5 <sup>9</sup> / <sub>16</sub>	13 <sup>1</sup> / <sub>2</sub>	6 <sup>5</sup> / <sub>16</sub>	366.0
ALB10	4	15	16 <sup>5</sup> / <sub>16</sub>	5 <sup>1</sup> / <sub>2</sub>	5 <sup>9</sup> / <sub>16</sub>	13 <sup>1</sup> / <sub>2</sub>	6 <sup>5</sup> / <sub>16</sub>	366.0

### LB EMT Aluminum

Cat. No.	Size	Dimensions (in.)						
		A	B	C	D	E	F	CI
BLB1	½	3 <sup>7</sup> / <sub>8</sub>	4 <sup>9</sup> / <sub>32</sub>	1 <sup>5</sup> / <sub>16</sub>	1 <sup>7</sup> / <sub>16</sub>	3 <sup>1</sup> / <sub>2</sub>	2 <sup>1</sup> / <sub>16</sub>	4.3
BLB2	¾	4 <sup>5</sup> / <sub>8</sub>	5 <sup>1</sup> / <sub>8</sub>	1 <sup>1</sup> / <sub>32</sub>	1 <sup>5</sup> / <sub>8</sub>	4 <sup>1</sup> / <sub>4</sub>	2 <sup>7</sup> / <sub>16</sub>	7.3
BLB3	1	5 <sup>3</sup> / <sub>8</sub>	5 <sup>15</sup> / <sub>16</sub>	1 <sup>3</sup> / <sub>4</sub>	1 <sup>7</sup> / <sub>8</sub>	4 <sup>9</sup> / <sub>16</sub>	2 <sup>3</sup> / <sub>4</sub>	11.8
BLB4	1¼	7 <sup>1</sup> / <sub>4</sub>	7 <sup>7</sup> / <sub>8</sub>	2 <sup>1</sup> / <sub>2</sub>	2 <sup>1</sup> / <sub>2</sub>	6 <sup>1</sup> / <sub>2</sub>	3 <sup>3</sup> / <sub>16</sub>	32.0
BLB5	1½	7 <sup>1</sup> / <sub>4</sub>	7 <sup>7</sup> / <sub>8</sub>	2 <sup>1</sup> / <sub>2</sub>	2 <sup>3</sup> / <sub>4</sub>	6 <sup>5</sup> / <sub>16</sub>	3 <sup>3</sup> / <sub>16</sub>	32.0
BLB6	2	9 <sup>1</sup> / <sub>2</sub>	9 <sup>9</sup> / <sub>16</sub>	3 <sup>1</sup> / <sub>8</sub>	3 <sup>7</sup> / <sub>16</sub>	8	4 <sup>1</sup> / <sub>2</sub>	69.5
BLB7	2½	12 <sup>1</sup> / <sub>4</sub>	13	4 <sup>1</sup> / <sub>2</sub>	3 <sup>7</sup> / <sub>8</sub>	10 <sup>7</sup> / <sub>32</sub>	5 <sup>1</sup> / <sub>4</sub>	190.0
BLB8	3	12 <sup>1</sup> / <sub>4</sub>	13	4 <sup>1</sup> / <sub>2</sub>	4 <sup>1</sup> / <sub>2</sub>	10 <sup>1</sup> / <sub>2</sub>	5 <sup>7</sup> / <sub>8</sub>	190.0
BLB9	3½	15	16 <sup>5</sup> / <sub>16</sub>	5 <sup>1</sup> / <sub>2</sub>	5 <sup>9</sup> / <sub>16</sub>	13 <sup>1</sup> / <sub>2</sub>	6 <sup>5</sup> / <sub>16</sub>	366.0
BLB10	4	15	16 <sup>5</sup> / <sub>16</sub>	5 <sup>1</sup> / <sub>2</sub>	5 <sup>9</sup> / <sub>16</sub>	13 <sup>1</sup> / <sub>2</sub>	6 <sup>5</sup> / <sub>16</sub>	366.0

# T&B® Fittings

## Form 7, Form 8, and Red•Dot® Conduit Outlet Bodies

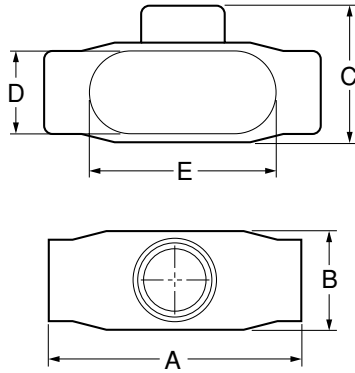

T Form 7 and Form 8

### T Form 7

Cat. No.	Size	Dimensions (in.)					
		A	B	C	D	E	CI
T17	½	5.60	1.80	2.35	.95	3.20	6.0
T27	¾	6.20	2.00	2.60	1.15	3.80	9.1
T37	1	7.35	2.30	3.10	1.35	4.55	16.9
T47	1¼	7.30	2.30	3.05	1.80	5.00	19.3
T57	1½	8.60	2.60	3.80	2.05	5.45	27.5
T67	2	9.50	3.20	4.25	2.45	6.40	50.0
T77	2½	12.10	3.65	5.80	3.60	8.40	102.0
T87	3	12.10	4.40	5.80	3.60	8.40	132.0
T97	3½	14.65	4.90	7.05	4.55	10.25	210.0
T107	4	14.65	5.40	7.05	4.55	10.25	243.0



### T Form 8

Cat. No.	Size	Dimensions (in.)					
		A	B	C	D	E	CI
T18	½	5¼ <sub>16</sub>	1¼	2½ <sub>32</sub>	1	3¼ <sub>16</sub>	6.0
T28	¾	6¾ <sub>32</sub>	2	2½ <sub>16</sub>	1¾ <sub>16</sub>	3½ <sub>16</sub>	9.0
T38-TB	1	7¾ <sub>16</sub>	2¼	2½ <sub>8</sub>	1¾ <sub>8</sub>	4¾ <sub>16</sub>	15.0
T48	1¼	8½	2½	3¾ <sub>32</sub>	1¾	5½ <sub>16</sub>	24.0
T58	1½	10¾	2¾ <sub>32</sub>	4	2½	6½	46.5
T68	2	12¼	3¾ <sub>16</sub>	5	3	8¾ <sub>16</sub>	88.0
T78	2½	15¾	4¾ <sub>16</sub>	6¼ <sub>16</sub>	4¼	10¾	110.0
T88-TB	3	15¾	4¾ <sub>16</sub>	6¼ <sub>16</sub>	4¼	10¾	110.0

### T Threaded Aluminum

Cat. No.	Size	Dimensions (in.)							
		A	B	C	D	E	F	G	CI
AT1	½	3¾	4¾	1¾ <sub>64</sub>	1¾	2¼ <sub>32</sub>	2¼ <sub>16</sub>	1¾ <sub>16</sub>	4.3
AT2	¾	4¾	5½	1¾ <sub>32</sub>	1¾	2¾ <sub>32</sub>	2¼ <sub>32</sub>	1¾ <sub>16</sub>	7.3
AT3	1	5¾	5¾ <sub>16</sub>	1¾	1¾	3¼	2¾	1	11.8
AT4	1¼	7¼	7¾	2½	2½	4¾ <sub>16</sub>	3¾ <sub>32</sub>	1¾	32.0
AT5	1½	7¼	7¾	2½	2¾	4¾ <sub>16</sub>	3¾ <sub>32</sub>	1½	32.0
AT6	2	9½	10¾ <sub>16</sub>	3¾	3¾ <sub>16</sub>	5¾ <sub>32</sub>	4	1¾ <sub>32</sub>	69.5
AT7	2½	12¼	13	4½	4½	6¾	5¾ <sub>32</sub>	2¾ <sub>16</sub>	190.0
AT8	3	12¼	13	4½	4½	6¾	5¾ <sub>32</sub>	2¾ <sub>16</sub>	190.0
AT9	3½	15	16¾ <sub>16</sub>	5½	5¾ <sub>16</sub>	8¾ <sub>16</sub>	6¾ <sub>16</sub>	3	366.0
AT10	4	15	16¾ <sub>16</sub>	5½	5¾ <sub>16</sub>	8¾ <sub>16</sub>	6¾ <sub>16</sub>	3	366.0

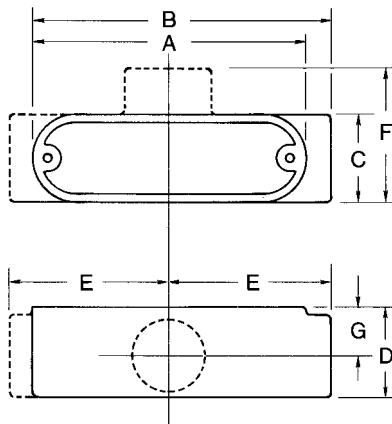

T Threaded Aluminum and EMT Aluminum

### T EMT Aluminum

Cat. No.	Size	Dimensions (in.)							
		A	B	C	D	E	F	G	CI
BT1	½	3¾	4¾	1¾ <sub>64</sub>	1¾	2¼ <sub>32</sub>	2¼ <sub>16</sub>	1¾ <sub>16</sub>	4.3
BT2	¾	4¾	5½	1¾ <sub>32</sub>	1¾	2¾ <sub>32</sub>	2¼ <sub>32</sub>	1¾ <sub>16</sub>	7.3
BT3	1	5¾	5¾ <sub>16</sub>	1¾	1¾	3¼	2¾	1	11.8
BT4	1¼	7¼	7¾	2½	2½	4¾ <sub>16</sub>	3¾ <sub>32</sub>	1¾	32.0
BT5	1½	7¼	7¾	2½	2¾	4¾ <sub>16</sub>	3¾ <sub>32</sub>	1½	32.0
BT6	2	9½	10¾ <sub>16</sub>	3¾	3¾ <sub>16</sub>	5¾ <sub>32</sub>	4	1¾ <sub>32</sub>	69.5

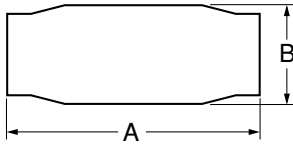
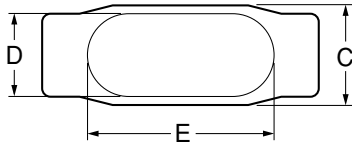

C Form 7 and Form 8

### C Form 7

Cat. No.	Size	Dimensions (in.)					
		A	B	C	D	E	CI
C17	½	5.45	1.40	1.45	.95	3.20	4.0
C27	¾	6.05	1.60	1.65	1.15	3.80	6.6
C37	1	6.75	1.90	1.80	1.35	4.55	10.6
C47	1¼	7.30	2.30	2.20	1.80	5.00	18.8
C57	1½	8.60	2.60	2.45	2.05	5.45	26.4
C67	2	9.50	3.20	3.05	2.45	6.40	51.0
C77-TB	2½	12.10	3.65	4.25	3.60	8.40	102.0
C87	3	12.10	4.40	4.25	3.60	8.40	132.0



### C Form 8

Cat. No.	Size	Dimensions (in.)					
		A	B	C	D	E	CI
C18	½	5 <sup>1</sup> / <sub>16</sub>	1 <sup>7</sup> / <sub>16</sub>	1 <sup>3</sup> / <sub>8</sub>	1	3 <sup>5</sup> / <sub>16</sub>	4.9
C28	¾	6 <sup>3</sup> / <sub>32</sub>	1 <sup>1</sup> / <sub>16</sub>	1 <sup>3</sup> / <sub>16</sub>	1 <sup>3</sup> / <sub>16</sub>	3 <sup>5</sup> / <sub>16</sub>	8.0
C38	1	7 <sup>9</sup> / <sub>16</sub>	1 <sup>15</sup> / <sub>16</sub>	1 <sup>3</sup> / <sub>4</sub>	1 <sup>3</sup> / <sub>8</sub>	4 <sup>9</sup> / <sub>16</sub>	13.0
C48	1¼	8½	2 <sup>3</sup> / <sub>8</sub>	2 <sup>3</sup> / <sub>16</sub>	1 <sup>3</sup> / <sub>4</sub>	5 <sup>5</sup> / <sub>16</sub>	23.5
C58-TB	1½	10 <sup>9</sup> / <sub>16</sub>	2 <sup>25</sup> / <sub>32</sub>	2 <sup>3</sup> / <sub>4</sub>	2 <sup>1</sup> / <sub>8</sub>	6½	45.0
C68	2	12¼	3 <sup>3</sup> / <sub>16</sub>	3 <sup>3</sup> / <sub>4</sub>	3	8 <sup>9</sup> / <sub>16</sub>	88.0
C78	2½	15 <sup>5</sup> / <sub>16</sub>	4 <sup>7</sup> / <sub>16</sub>	5	4¼	10 <sup>7</sup> / <sub>16</sub>	110.0
C88	3	15 <sup>5</sup> / <sub>16</sub>	4 <sup>9</sup> / <sub>16</sub>	5	4¼	10 <sup>7</sup> / <sub>16</sub>	110.0

### C Threaded Aluminum

Cat. No.	Size	Dimensions (in.)							
		A	B	C	D	E	F	G	CI
AC1	½	3 <sup>7</sup> / <sub>8</sub>	4 <sup>3</sup> / <sub>8</sub>	1 <sup>2</sup> / <sub>16</sub>	1 <sup>3</sup> / <sub>8</sub>	2 <sup>1</sup> / <sub>32</sub>	2 <sup>1</sup> / <sub>16</sub>	1 <sup>3</sup> / <sub>16</sub>	4.3
AC2	¾	4 <sup>5</sup> / <sub>8</sub>	5 <sup>1</sup> / <sub>8</sub>	1 <sup>7</sup> / <sub>32</sub>	1 <sup>5</sup> / <sub>8</sub>	2 <sup>25</sup> / <sub>32</sub>	2 <sup>1</sup> / <sub>32</sub>	1 <sup>5</sup> / <sub>16</sub>	7.3
AC3	1	5 <sup>3</sup> / <sub>8</sub>	5 <sup>15</sup> / <sub>16</sub>	1 <sup>3</sup> / <sub>4</sub>	1 <sup>7</sup> / <sub>8</sub>	3¼	2 <sup>5</sup> / <sub>8</sub>	1	11.8
AC4	1¼	7¼	7 <sup>7</sup> / <sub>8</sub>	2½	2½	4 <sup>3</sup> / <sub>16</sub>	3 <sup>7</sup> / <sub>32</sub>	1 <sup>3</sup> / <sub>8</sub>	32.0
AC5	1½	7¼	7 <sup>7</sup> / <sub>8</sub>	2½	2¾	4 <sup>9</sup> / <sub>16</sub>	3 <sup>17</sup> / <sub>32</sub>	1½	32.0
AC6	2	9½	10 <sup>3</sup> / <sub>16</sub>	3 <sup>1</sup> / <sub>8</sub>	3 <sup>3</sup> / <sub>16</sub>	5 <sup>1</sup> / <sub>32</sub>	4	1 <sup>3</sup> / <sub>32</sub>	69.5
AC7	2½	12¼	13	4½	4½	6 <sup>7</sup> / <sub>8</sub>	5 <sup>29</sup> / <sub>32</sub>	2 <sup>7</sup> / <sub>16</sub>	190.0
AC8	3	12¼	13	4½	4½	6 <sup>7</sup> / <sub>8</sub>	5 <sup>29</sup> / <sub>32</sub>	2 <sup>7</sup> / <sub>16</sub>	190.0
AC9	3½	15	16 <sup>7</sup> / <sub>16</sub>	5½	5 <sup>5</sup> / <sub>16</sub>	8 <sup>9</sup> / <sub>16</sub>	6 <sup>1</sup> / <sub>16</sub>	3	366.0
AC10	4	15	16 <sup>7</sup> / <sub>16</sub>	5½	5 <sup>5</sup> / <sub>16</sub>	8 <sup>9</sup> / <sub>16</sub>	6 <sup>1</sup> / <sub>16</sub>	3	366.0

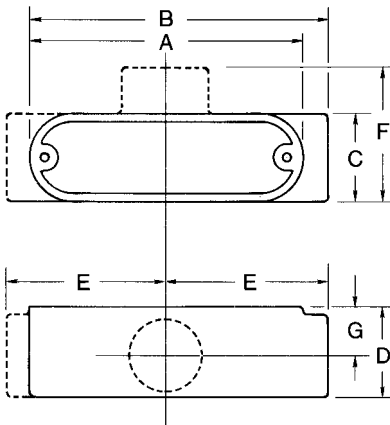

T Threaded Aluminum and EMT Aluminum

### C EMT Aluminum

Cat. No.	Size	Dimensions (in.)							
		A	B	C	D	E	F	G	CI
BC1	½	3 <sup>7</sup> / <sub>8</sub>	4 <sup>3</sup> / <sub>8</sub>	1 <sup>2</sup> / <sub>16</sub>	1 <sup>3</sup> / <sub>8</sub>	2 <sup>1</sup> / <sub>32</sub>	2 <sup>1</sup> / <sub>16</sub>	1 <sup>3</sup> / <sub>16</sub>	4.3
BC2	¾	4 <sup>5</sup> / <sub>8</sub>	5 <sup>1</sup> / <sub>8</sub>	1 <sup>7</sup> / <sub>32</sub>	1 <sup>5</sup> / <sub>8</sub>	2 <sup>25</sup> / <sub>32</sub>	2 <sup>1</sup> / <sub>32</sub>	1 <sup>5</sup> / <sub>16</sub>	7.3
BC3	1	5 <sup>3</sup> / <sub>8</sub>	5 <sup>15</sup> / <sub>16</sub>	1 <sup>3</sup> / <sub>4</sub>	1 <sup>7</sup> / <sub>8</sub>	3¼	2 <sup>5</sup> / <sub>8</sub>	1	11.8
BC4	1¼	7¼	7 <sup>7</sup> / <sub>8</sub>	2½	2½	4 <sup>3</sup> / <sub>16</sub>	3 <sup>7</sup> / <sub>32</sub>	1 <sup>3</sup> / <sub>8</sub>	32.0
BC5	1½	7¼	7 <sup>7</sup> / <sub>8</sub>	2½	2¾	4 <sup>9</sup> / <sub>16</sub>	3 <sup>17</sup> / <sub>32</sub>	1½	32.0
BC6	2	9½	10 <sup>3</sup> / <sub>16</sub>	3 <sup>1</sup> / <sub>8</sub>	3 <sup>3</sup> / <sub>16</sub>	5 <sup>1</sup> / <sub>32</sub>	4	1 <sup>3</sup> / <sub>32</sub>	69.5

# T&B® Fittings

## Form 7, Form 8, and Red•Dot® Conduit Outlet Bodies

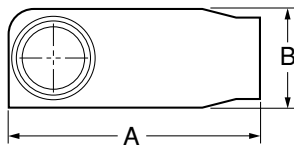
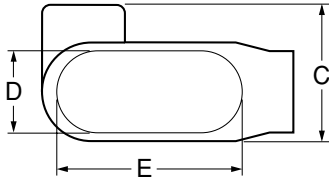

LL Form 7 and Form 8

### LL Form 7

Cat. No.	Size	Dimensions (in.)					
		A	B	C	D	E	CI
LL17	½	4.60	1.40	1.45	.95	3.20	4.0
LL27	¾	5.25	1.60	1.65	1.15	3.80	6.6
LL37	1	6.00	1.90	2.60	1.35	4.55	10.6
LL47	1¼	6.45	2.30	3.05	1.80	5.00	18.6
LL57	1½	7.90	2.60	3.80	2.05	5.45	26.4
LL67	2	8.30	3.20	4.25	2.45	6.40	51.0
LL77	2½	10.55	3.65	5.80	3.60	8.40	102.0
LL87	3	10.55	4.40	5.80	3.60	8.40	132.0
LL97	3½	12.85	4.90	7.03	4.55	10.25	210.0
LL107	4	12.85	5.40	7.03	4.55	10.25	243.0



### LL Form 8

Cat. No.	Size	Dimensions (in.)					
		A	B	C	D	E	CI
LL18	½	4 <sup>15</sup> / <sub>16</sub>	1 <sup>7</sup> / <sub>16</sub>	2 <sup>5</sup> / <sub>32</sub>	1	3 <sup>5</sup> / <sub>16</sub>	4.9
LL28	¾	5 <sup>9</sup> / <sub>16</sub>	1 <sup>11</sup> / <sub>16</sub>	2 <sup>9</sup> / <sub>16</sub>	1 <sup>3</sup> / <sub>16</sub>	3 <sup>5</sup> / <sub>16</sub>	8.0
LL38	1	6 <sup>15</sup> / <sub>32</sub>	1 <sup>15</sup> / <sub>16</sub>	2 <sup>9</sup> / <sub>16</sub>	1 <sup>9</sup> / <sub>16</sub>	4 <sup>9</sup> / <sub>16</sub>	13.0
LL48	1¼	7 <sup>17</sup> / <sub>32</sub>	2 <sup>9</sup> / <sub>16</sub>	3 <sup>3</sup> / <sub>32</sub>	1 <sup>3</sup> / <sub>4</sub>	5 <sup>5</sup> / <sub>16</sub>	23.5
LL58	1½	9 <sup>1</sup> / <sub>16</sub>	2 <sup>25</sup> / <sub>32</sub>	4	2 <sup>1</sup> / <sub>16</sub>	6 <sup>1</sup> / <sub>2</sub>	45.0
LL68	2	11	3 <sup>9</sup> / <sub>16</sub>	5	3	8 <sup>9</sup> / <sub>16</sub>	88.0
LL78	2½	13 <sup>15</sup> / <sub>16</sub>	4 <sup>7</sup> / <sub>16</sub>	6 <sup>11</sup> / <sub>16</sub>	4 <sup>1</sup> / <sub>4</sub>	10 <sup>7</sup> / <sub>8</sub>	110.0
LL888	3	13 <sup>15</sup> / <sub>16</sub>	4 <sup>9</sup> / <sub>16</sub>	6 <sup>11</sup> / <sub>16</sub>	4 <sup>1</sup> / <sub>4</sub>	10 <sup>7</sup> / <sub>8</sub>	110.0

### LL Threaded Aluminum

Cat. No.	Size	Dimensions (in.)									
		A	B	C	D	E	F	G	H	CI	CI <sup>LRL Style Only</sup>
ALL1	½	3 <sup>7</sup> / <sub>8</sub>	3 <sup>1</sup> / <sub>2</sub>	4 <sup>5</sup> / <sub>16</sub>	1 <sup>5</sup> / <sub>16</sub>	1 <sup>3</sup> / <sub>8</sub>	3 <sup>9</sup> / <sub>16</sub>	2	2 <sup>5</sup> / <sub>32</sub>	4.3	4.8
ALL2	¾	4 <sup>9</sup> / <sub>8</sub>	4 <sup>1</sup> / <sub>8</sub>	5 <sup>1</sup> / <sub>8</sub>	1 <sup>17</sup> / <sub>32</sub>	1 <sup>5</sup> / <sub>8</sub>	4 <sup>1</sup> / <sub>8</sub>	2 <sup>5</sup> / <sub>16</sub>	7 <sup>7</sup> / <sub>8</sub>	7.3	7.5
ALL3	1	5 <sup>3</sup> / <sub>8</sub>	4 <sup>7</sup> / <sub>8</sub>	5 <sup>5</sup> / <sub>16</sub>	1 <sup>3</sup> / <sub>4</sub>	1 <sup>7</sup> / <sub>8</sub>	4 <sup>7</sup> / <sub>8</sub>	2 <sup>1</sup> / <sub>2</sub>	1	11.8	12.5
ALL4	1¼	7 <sup>1</sup> / <sub>4</sub>	6 <sup>1</sup> / <sub>2</sub>	7 <sup>7</sup> / <sub>8</sub>	2 <sup>1</sup> / <sub>2</sub>	2 <sup>3</sup> / <sub>4</sub>	6 <sup>5</sup> / <sub>16</sub>	3 <sup>3</sup> / <sub>8</sub>	1 <sup>1</sup> / <sub>2</sub>	32.0	36.5
ALL5	1½	7 <sup>1</sup> / <sub>4</sub>	6 <sup>1</sup> / <sub>2</sub>	7 <sup>7</sup> / <sub>8</sub>	2 <sup>1</sup> / <sub>2</sub>	2 <sup>3</sup> / <sub>4</sub>	6 <sup>5</sup> / <sub>16</sub>	3 <sup>3</sup> / <sub>8</sub>	1 <sup>1</sup> / <sub>2</sub>	32.0	36.5
ALL6	2	9 <sup>1</sup> / <sub>2</sub>	8 <sup>9</sup> / <sub>16</sub>	10 <sup>3</sup> / <sub>16</sub>	3 <sup>3</sup> / <sub>8</sub>	3 <sup>7</sup> / <sub>16</sub>	8 <sup>3</sup> / <sub>16</sub>	3 <sup>15</sup> / <sub>16</sub>	1 <sup>15</sup> / <sub>16</sub>	69.5	73.8
ALL7	2½	12 <sup>1</sup> / <sub>4</sub>	11 <sup>1</sup> / <sub>4</sub>	13	4 <sup>1</sup> / <sub>2</sub>	4 <sup>1</sup> / <sub>2</sub>	10 <sup>1</sup> / <sub>4</sub>	5 <sup>1</sup> / <sub>2</sub>	2 <sup>7</sup> / <sub>8</sub>	190.0	
ALL8	3	12 <sup>1</sup> / <sub>4</sub>	11 <sup>1</sup> / <sub>4</sub>	13	4 <sup>1</sup> / <sub>2</sub>	4 <sup>1</sup> / <sub>2</sub>	10 <sup>1</sup> / <sub>4</sub>	5 <sup>1</sup> / <sub>2</sub>	2 <sup>7</sup> / <sub>8</sub>	190.0	
ALL9	3½	15	14 <sup>7</sup> / <sub>16</sub>	16 <sup>1</sup> / <sub>4</sub>	5 <sup>1</sup> / <sub>2</sub>	5 <sup>1</sup> / <sub>2</sub>	12 <sup>3</sup> / <sub>4</sub>	6 <sup>1</sup> / <sub>2</sub>	3	366.0	
ALL10	4	15	14 <sup>7</sup> / <sub>16</sub>	16 <sup>1</sup> / <sub>4</sub>	5 <sup>1</sup> / <sub>2</sub>	5 <sup>1</sup> / <sub>2</sub>	12 <sup>3</sup> / <sub>4</sub>	6 <sup>1</sup> / <sub>2</sub>	3	366.0	

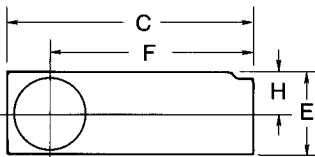
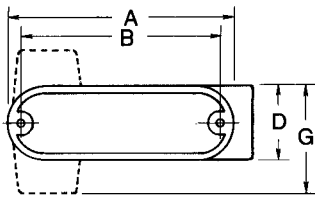

LL Threaded Aluminum and EMT Aluminum

### LL EMT Aluminum

Cat. No.	Size	Dimensions (in.)									
		A	B	C	D	E	F	G	H	CI	CI <sup>LRL Style Only</sup>
BLL1	½	3 <sup>7</sup> / <sub>8</sub>	3 <sup>1</sup> / <sub>2</sub>	4 <sup>5</sup> / <sub>16</sub>	1 <sup>5</sup> / <sub>16</sub>	1 <sup>3</sup> / <sub>8</sub>	3 <sup>9</sup> / <sub>16</sub>	2	2 <sup>5</sup> / <sub>32</sub>	4.3	4.8
BLL2	¾	4 <sup>9</sup> / <sub>8</sub>	4 <sup>1</sup> / <sub>8</sub>	5 <sup>1</sup> / <sub>8</sub>	1 <sup>17</sup> / <sub>32</sub>	1 <sup>5</sup> / <sub>8</sub>	4 <sup>1</sup> / <sub>8</sub>	2 <sup>5</sup> / <sub>16</sub>	7 <sup>7</sup> / <sub>8</sub>	7.3	7.5
BLL3	1	5 <sup>3</sup> / <sub>8</sub>	4 <sup>7</sup> / <sub>8</sub>	5 <sup>5</sup> / <sub>16</sub>	1 <sup>3</sup> / <sub>4</sub>	1 <sup>7</sup> / <sub>8</sub>	4 <sup>7</sup> / <sub>8</sub>	2 <sup>1</sup> / <sub>2</sub>	1	11.8	12.5
BLL4	1¼	7 <sup>1</sup> / <sub>4</sub>	6 <sup>1</sup> / <sub>2</sub>	7 <sup>7</sup> / <sub>8</sub>	2 <sup>1</sup> / <sub>2</sub>	2 <sup>3</sup> / <sub>4</sub>	6 <sup>5</sup> / <sub>16</sub>	3 <sup>3</sup> / <sub>8</sub>	1 <sup>1</sup> / <sub>2</sub>	32.0	36.5
BLL5	1½	7 <sup>1</sup> / <sub>4</sub>	6 <sup>1</sup> / <sub>2</sub>	7 <sup>7</sup> / <sub>8</sub>	2 <sup>1</sup> / <sub>2</sub>	2 <sup>3</sup> / <sub>4</sub>	6 <sup>5</sup> / <sub>16</sub>	3 <sup>3</sup> / <sub>8</sub>	1 <sup>1</sup> / <sub>2</sub>	32.0	36.5
BLL6	2	9 <sup>1</sup> / <sub>2</sub>	8 <sup>9</sup> / <sub>16</sub>	10 <sup>3</sup> / <sub>16</sub>	3 <sup>3</sup> / <sub>8</sub>	3 <sup>7</sup> / <sub>16</sub>	8 <sup>3</sup> / <sub>16</sub>	3 <sup>15</sup> / <sub>16</sub>	1 <sup>15</sup> / <sub>16</sub>	69.5	73.8

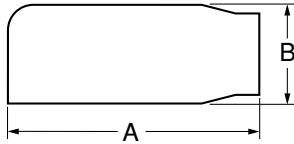
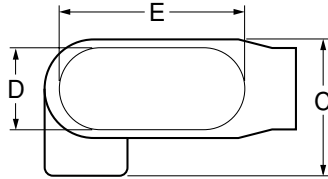

LR Form 7 and Form 8

### LR Form 7

Cat. No.	Size	Dimensions (in.)					
		A	B	C	D	E	CI
LR17	½	4.60	1.40	1.45	.95	3.20	4.0
LR27	¾	5.25	1.60	1.65	1.15	3.80	6.6
LR37	1	6.00	1.90	2.60	1.35	4.55	10.6
LR47	1¼	6.45	2.30	3.05	1.80	5.00	18.8
LR57	1½	7.90	2.60	3.80	2.05	5.45	26.4
LR67	2	8.30	3.20	4.25	2.45	6.40	51.0
LR77	2½	10.55	3.65	5.80	3.60	8.40	102.0
LR87	3	10.55	4.40	5.80	3.60	8.40	132.0
LR97	3½	12.85	4.90	7.03	4.55	10.25	210.0
LR107	4	12.85	5.40	7.03	4.55	10.25	243.0



### LR Form 8

Cat. No.	Size	Dimensions (in.)					
		A	B	C	D	E	CI
LR18	½	4 <sup>5</sup> / <sub>16</sub>	1 <sup>7</sup> / <sub>16</sub>	2 <sup>5</sup> / <sub>32</sub>	1	3 <sup>5</sup> / <sub>16</sub>	4.4
LR28	¾	5 <sup>9</sup> / <sub>16</sub>	1 <sup>11</sup> / <sub>16</sub>	2 <sup>5</sup> / <sub>16</sub>	1 <sup>3</sup> / <sub>16</sub>	3 <sup>15</sup> / <sub>16</sub>	8.0
LR38	1	6 <sup>15</sup> / <sub>32</sub>	1 <sup>15</sup> / <sub>16</sub>	2 <sup>5</sup> / <sub>8</sub>	1 <sup>3</sup> / <sub>8</sub>	4 <sup>9</sup> / <sub>16</sub>	13.0
LR48	1¼	7 <sup>17</sup> / <sub>32</sub>	2 <sup>3</sup> / <sub>8</sub>	3 <sup>3</sup> / <sub>32</sub>	1 <sup>3</sup> / <sub>4</sub>	5 <sup>5</sup> / <sub>16</sub>	23.6
LR58	1½	9 <sup>1</sup> / <sub>8</sub>	2 <sup>25</sup> / <sub>32</sub>	4	2 <sup>1</sup> / <sub>8</sub>	6 <sup>1</sup> / <sub>2</sub>	45.0
LR68	2	11	3 <sup>9</sup> / <sub>16</sub>	5	3	8 <sup>9</sup> / <sub>16</sub>	88.0
LR78	2½	13 <sup>15</sup> / <sub>16</sub>	4 <sup>7</sup> / <sub>16</sub>	6 <sup>11</sup> / <sub>16</sub>	4 <sup>1</sup> / <sub>4</sub>	10 <sup>7</sup> / <sub>8</sub>	110.0
LR888	3	13 <sup>15</sup> / <sub>16</sub>	4 <sup>3</sup> / <sub>16</sub>	6 <sup>11</sup> / <sub>16</sub>	4 <sup>1</sup> / <sub>4</sub>	10 <sup>7</sup> / <sub>8</sub>	110.0

### LR Threaded Aluminum

Cat. No.	Size	Dimensions (in.)									
		A	B	C	D	E	F	G	H	CI	CI <sup>LRL Style Only</sup>
ALR1	½	3 <sup>7</sup> / <sub>8</sub>	3 <sup>1</sup> / <sub>2</sub>	4 <sup>5</sup> / <sub>16</sub>	1 <sup>5</sup> / <sub>16</sub>	1 <sup>1</sup> / <sub>8</sub>	3 <sup>9</sup> / <sub>16</sub>	2	2 <sup>5</sup> / <sub>32</sub>	4.3	4.8
ALR2	¾	4 <sup>5</sup> / <sub>8</sub>	4 <sup>1</sup> / <sub>8</sub>	5 <sup>1</sup> / <sub>8</sub>	1 <sup>17</sup> / <sub>32</sub>	1 <sup>5</sup> / <sub>8</sub>	4 <sup>1</sup> / <sub>8</sub>	2 <sup>5</sup> / <sub>16</sub>	7 <sup>7</sup> / <sub>8</sub>	7.3	7.5
ALR3	1	5 <sup>3</sup> / <sub>8</sub>	4 <sup>7</sup> / <sub>8</sub>	5 <sup>5</sup> / <sub>16</sub>	1 <sup>3</sup> / <sub>4</sub>	1 <sup>7</sup> / <sub>8</sub>	4 <sup>7</sup> / <sub>8</sub>	2 <sup>1</sup> / <sub>2</sub>	1	11.8	12.5
ALR4	1¼	7 <sup>1</sup> / <sub>4</sub>	6 <sup>1</sup> / <sub>2</sub>	7 <sup>7</sup> / <sub>8</sub>	2 <sup>1</sup> / <sub>2</sub>	2 <sup>3</sup> / <sub>4</sub>	6 <sup>5</sup> / <sub>16</sub>	3 <sup>3</sup> / <sub>8</sub>	1 <sup>1</sup> / <sub>2</sub>	32.0	36.5
ALR5	1½	7 <sup>1</sup> / <sub>4</sub>	6 <sup>1</sup> / <sub>2</sub>	7 <sup>7</sup> / <sub>8</sub>	2 <sup>1</sup> / <sub>2</sub>	2 <sup>3</sup> / <sub>4</sub>	6 <sup>5</sup> / <sub>16</sub>	3 <sup>3</sup> / <sub>8</sub>	1 <sup>1</sup> / <sub>2</sub>	32.0	36.5
ALR6	2	9 <sup>1</sup> / <sub>2</sub>	8 <sup>9</sup> / <sub>16</sub>	10 <sup>9</sup> / <sub>16</sub>	3 <sup>3</sup> / <sub>8</sub>	3 <sup>7</sup> / <sub>16</sub>	8 <sup>3</sup> / <sub>16</sub>	3 <sup>1</sup> / <sub>16</sub>	1 <sup>15</sup> / <sub>16</sub>	69.5	73.8
ALR7	2½	12 <sup>1</sup> / <sub>4</sub>	11 <sup>1</sup> / <sub>4</sub>	13	4 <sup>1</sup> / <sub>2</sub>	4 <sup>1</sup> / <sub>2</sub>	10 <sup>1</sup> / <sub>4</sub>	5 <sup>1</sup> / <sub>2</sub>	2 <sup>7</sup> / <sub>8</sub>	190.0	
ALR8	3	12 <sup>1</sup> / <sub>4</sub>	11 <sup>1</sup> / <sub>4</sub>	13	4 <sup>1</sup> / <sub>2</sub>	4 <sup>1</sup> / <sub>2</sub>	10 <sup>1</sup> / <sub>4</sub>	5 <sup>1</sup> / <sub>2</sub>	2 <sup>7</sup> / <sub>8</sub>	190.0	
ALR9	3½	15	14 <sup>7</sup> / <sub>16</sub>	16 <sup>1</sup> / <sub>4</sub>	5 <sup>1</sup> / <sub>2</sub>	5 <sup>1</sup> / <sub>2</sub>	12 <sup>3</sup> / <sub>4</sub>	6 <sup>1</sup> / <sub>2</sub>	3	366.0	
ALR10	4	15	14 <sup>7</sup> / <sub>16</sub>	16 <sup>1</sup> / <sub>4</sub>	5 <sup>1</sup> / <sub>2</sub>	5 <sup>1</sup> / <sub>2</sub>	12 <sup>3</sup> / <sub>4</sub>	6 <sup>1</sup> / <sub>2</sub>	3	366.0	

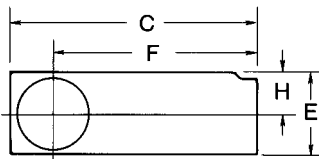
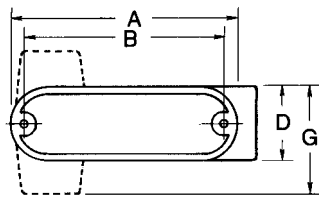

LR Threaded Aluminum and EMT Aluminum

### LR EMT Aluminum

Cat. No.	Size	Dimensions (in.)									
		A	B	C	D	E	F	G	H	CI	CI <sup>LRL Style Only</sup>
BLR1	½	3 <sup>7</sup> / <sub>8</sub>	3 <sup>1</sup> / <sub>2</sub>	4 <sup>5</sup> / <sub>16</sub>	1 <sup>5</sup> / <sub>16</sub>	1 <sup>1</sup> / <sub>8</sub>	3 <sup>9</sup> / <sub>16</sub>	2	2 <sup>5</sup> / <sub>32</sub>	4.3	4.8
BLR2	¾	4 <sup>5</sup> / <sub>8</sub>	4 <sup>1</sup> / <sub>8</sub>	5 <sup>1</sup> / <sub>8</sub>	1 <sup>17</sup> / <sub>32</sub>	1 <sup>5</sup> / <sub>8</sub>	4 <sup>1</sup> / <sub>8</sub>	2 <sup>5</sup> / <sub>16</sub>	7 <sup>7</sup> / <sub>8</sub>	7.3	7.5
BLR3	1	5 <sup>3</sup> / <sub>8</sub>	4 <sup>7</sup> / <sub>8</sub>	5 <sup>5</sup> / <sub>16</sub>	1 <sup>3</sup> / <sub>4</sub>	1 <sup>7</sup> / <sub>8</sub>	4 <sup>7</sup> / <sub>8</sub>	2 <sup>1</sup> / <sub>2</sub>	1	11.8	12.5
BLR4	1¼	7 <sup>1</sup> / <sub>4</sub>	6 <sup>1</sup> / <sub>2</sub>	7 <sup>7</sup> / <sub>8</sub>	2 <sup>1</sup> / <sub>2</sub>	2 <sup>3</sup> / <sub>4</sub>	6 <sup>5</sup> / <sub>16</sub>	3 <sup>3</sup> / <sub>8</sub>	1 <sup>1</sup> / <sub>2</sub>	32.0	36.5
BLR5	1½	7 <sup>1</sup> / <sub>4</sub>	6 <sup>1</sup> / <sub>2</sub>	7 <sup>7</sup> / <sub>8</sub>	2 <sup>1</sup> / <sub>2</sub>	2 <sup>3</sup> / <sub>4</sub>	6 <sup>5</sup> / <sub>16</sub>	3 <sup>3</sup> / <sub>8</sub>	1 <sup>1</sup> / <sub>2</sub>	32.0	36.5
BLR6	2	9 <sup>1</sup> / <sub>2</sub>	8 <sup>9</sup> / <sub>16</sub>	10 <sup>9</sup> / <sub>16</sub>	3 <sup>3</sup> / <sub>8</sub>	3 <sup>7</sup> / <sub>16</sub>	8 <sup>3</sup> / <sub>16</sub>	3 <sup>1</sup> / <sub>16</sub>	1 <sup>15</sup> / <sub>16</sub>	69.5	73.8

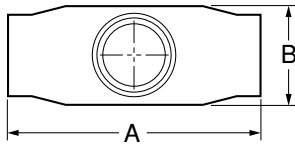
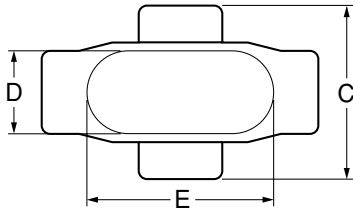

X Form 7 and Form 8

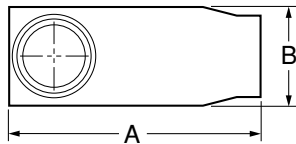
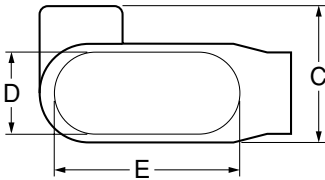

L Form 7

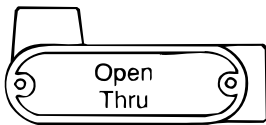
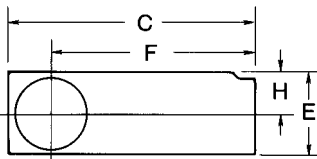
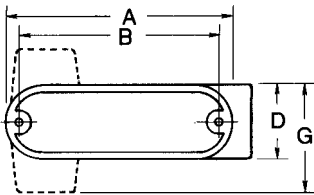

LRL Threaded Aluminum and EMT Aluminum

**X Form 7**

Cat. No.	Size	Dimensions (in.)					
		A	B	C	D	E	CI
X17	1/2	5.60	1.80	3.05	.95	3.20	6.0
X27	3/4	6.20	2.00	3.30	1.15	3.80	9.1
X37	1	7.35	2.30	3.80	1.35	4.55	16.9
X47	1 1/4	7.30	2.30	3.85	1.80	5.00	19.3
X57	1 1/2	8.60	2.60	5.05	2.05	5.45	27.5
X67	2	9.50	3.20	5.45	2.45	6.40	52.8



**X Form 8**

Cat. No.	Size	Dimensions (in.)					
		A	B	C	D	E	CI
X18	1/2	5 1/16	1 3/4	2 9/32	1	3 5/16	6.0
X28	3/4	6 3/32	2	3 1/16	1 3/8	3 15/16	9.0
X38	1	7 5/16	2 1/4	3 1/2	1 3/8	4 9/16	15.0
X48	1 1/4	8 1/2	2 5/8	4 1/8	1 3/4	5 5/16	24.0
X58	1 1/2	10 3/8	2 15/32	5 1/4	2 1/8	6 1/2	46.5
X68	2	12 1/4	3 3/16	6 1/4	3	8 3/16	88.0



**L Form 7**

Cat. No.	Size	Dimensions (in.)				
		A	B	C	D	E
L17-TB	1/2	4.60	1.40	1.45	.95	3.20
L27-TB	3/4	5.25	1.60	1.65	1.15	3.80
L37-TB	1	6.00	1.90	2.60	1.35	4.55
L47-TB	1 1/4	6.45	2.30	3.05	1.80	5.00
L57-TB	1 1/2	7.90	2.60	3.80	2.05	5.45
L67-TB	2	8.30	3.20	4.25	2.45	6.40

**L Threaded Aluminum**

Cat. No.	Size	Dimensions (in.)									
		A	B	C	D	E	F	G	H	CI	CI LRL Style Only
ALRL1	1/2	3 7/8	3 1/2	4 5/16	1 9/16	1 3/8	3 9/16	2	2 5/32	4.3	4.8
ALRL2	3/4	4 5/8	4 1/8	5 1/8	1 7/32	1 3/8	4 1/8	2 5/16	7/8	7.3	7.5
ALRL3	1	5 3/8	4 7/8	5 5/8	1 3/4	1 7/8	4 7/8	2 1/2	1	11.8	12.5
ALRL4	1 1/4	7 1/4	6 1/2	7 7/8	2 1/2	2 3/4	6 5/16	3 3/8	1 1/2	32.0	36.5
ALRL5	1 1/2	7 1/4	6 1/2	7 7/8	2 1/2	2 3/4	6 5/16	3 3/8	1 1/2	32.0	36.5
ALRL6	2	9 1/2	8 9/16	10 3/16	3 3/8	3 7/8	8 3/16	3 15/16	1 15/16	69.5	73.8

**L EMT Aluminum**

Cat. No.	Size	Dimensions (in.)									
		A	B	C	D	E	F	G	H	CI	CI LRL Style Only
BLRL1	1/2	3 7/8	3 1/2	4 5/16	1 9/16	1 3/8	3 9/16	2	2 5/32	4.3	4.8
BLRL2	3/4	4 5/8	4 1/8	5 1/8	1 7/32	1 3/8	4 1/8	2 5/16	7/8	7.3	7.5
BLRL3	1	5 3/8	4 7/8	5 5/8	1 3/4	1 7/8	4 7/8	2 1/2	1	11.8	12.5
BLRL4	1 1/4	7 1/4	6 1/2	7 7/8	2 1/2	2 3/4	6 5/16	3 3/8	1 1/2	32.0	36.5
BLRL5	1 1/2	7 1/4	6 1/2	7 7/8	2 1/2	2 3/4	6 5/16	3 3/8	1 1/2	32.0	36.5
BLRL6	2	9 1/2	8 9/16	10 3/16	3 3/8	3 7/8	8 3/16	3 15/16	1 15/16	69.5	73.8



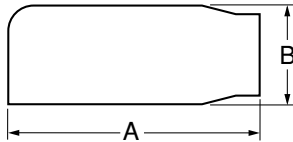
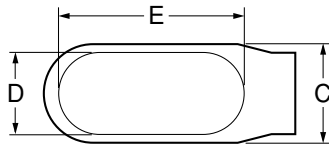

E Form 7

### E Form 7

Cat. No.	Size	Dimensions (in.)					
		A	B	C	D	E	CI
E17	½	4.60	1.40	1.45	.95	3.20	6.0
E27	¾	5.25	1.60	1.65	1.15	3.80	9.1
E37	1	6.00	1.90	1.80	1.35	4.55	16.9

### E Threaded Aluminum

Cat. No.	Size	Dimensions (in.)							
		A	B	C	D	E	F	G	CI
AE-1	½	3 <sup>7</sup> / <sub>16</sub>	4 <sup>3</sup> / <sub>16</sub>	1 <sup>2</sup> / <sub>16</sub>	1 <sup>3</sup> / <sub>16</sub>	2 <sup>1</sup> / <sub>32</sub>	2 <sup>1</sup> / <sub>16</sub>	1 <sup>3</sup> / <sub>16</sub>	4.3
AE-2	¾	4 <sup>5</sup> / <sub>16</sub>	5 <sup>1</sup> / <sub>16</sub>	1 <sup>7</sup> / <sub>32</sub>	1 <sup>5</sup> / <sub>16</sub>	2 <sup>2</sup> / <sub>32</sub>	2 <sup>1</sup> / <sub>32</sub>	1 <sup>5</sup> / <sub>16</sub>	7.3
AE-3	1	5 <sup>5</sup> / <sub>16</sub>	5 <sup>15</sup> / <sub>16</sub>	1 <sup>3</sup> / <sub>4</sub>	1 <sup>7</sup> / <sub>16</sub>	3 <sup>1</sup> / <sub>4</sub>	2 <sup>5</sup> / <sub>16</sub>	1	11.8

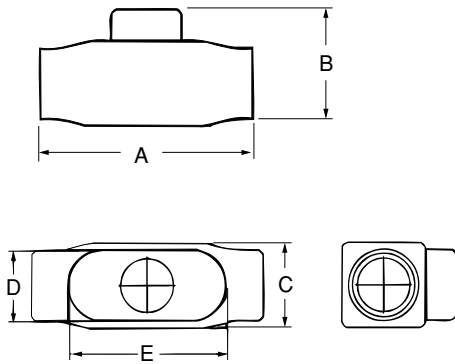

TB Form 8

### TB Form 8

Cat. No.	Size	Dimensions (in.)					
		A	B	C	D	E	CI
TB18	½	5 <sup>1</sup> / <sub>16</sub>	2 <sup>5</sup> / <sub>16</sub>	1 <sup>3</sup> / <sub>16</sub>	1	3 <sup>3</sup> / <sub>16</sub>	6.0
TB28	¾	6 <sup>3</sup> / <sub>32</sub>	2 <sup>7</sup> / <sub>16</sub>	1 <sup>3</sup> / <sub>16</sub>	1 <sup>3</sup> / <sub>16</sub>	3 <sup>1</sup> / <sub>16</sub>	9.0
TB38	1	7 <sup>5</sup> / <sub>16</sub>	3 <sup>1</sup> / <sub>4</sub>	1 <sup>3</sup> / <sub>4</sub>	1 <sup>3</sup> / <sub>16</sub>	4 <sup>9</sup> / <sub>16</sub>	15.0
TB484	1¼	8 <sup>1</sup> / <sub>2</sub>	3 <sup>3</sup> / <sub>16</sub>	2 <sup>3</sup> / <sub>16</sub>	1 <sup>3</sup> / <sub>4</sub>	5 <sup>5</sup> / <sub>16</sub>	24.0
TB58	1½	10 <sup>9</sup> / <sub>16</sub>	3 <sup>1</sup> / <sub>16</sub>	2 <sup>3</sup> / <sub>4</sub>	2 <sup>1</sup> / <sub>16</sub>	6 <sup>1</sup> / <sub>2</sub>	46.5
TB68	2	12 <sup>1</sup> / <sub>4</sub>	4 <sup>1</sup> / <sub>4</sub>	3 <sup>3</sup> / <sub>4</sub>	3	8 <sup>9</sup> / <sub>16</sub>	88.0



## Mogul Conduit Outlet Bodies

**Application**

Mogul bodies are installed in conduit systems to:

- Act as pull outlets for conductors that are stiff, due to large size or type of insulation.
- Provide the longer openings needed when pulling large conductors.
- Prevent sharp bends and kinks in large conductors (protects insulation during installation.)
- Provide ample openings for splices and taps.
- Provide access to wiring for maintenance, and future system changes.

**Features**

Mogul bodies have:

- Long openings.
- Provision for easy bends.
- Tapered tapped hubs with integral bushings.
- Stainless Steel cover screws.
- Covers and gaskets included.

**Standard Materials**

- Class 30 Gray iron alloy.

**Standard Finishes**

- Electrogalvanized and aluminum acrylic paint.

**Certifications and Compliances:**

- UL Standard: 514B
- Fed. Spec.: W-C-586d
- CSA Standard: C22.2 No.18
- UL listed for wet locations.

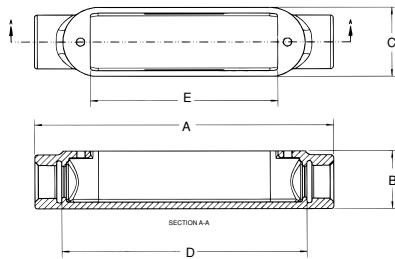
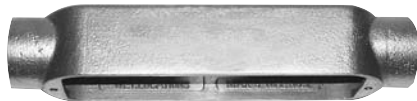

BC

**BC Mogul Series**

Cat. No.	Size	Dimensions (in.)					
		A	B	C	D	E	CI
BC3-TB	1	9.56	1.88	2.25	7.84	6	20.0
BC4-TB	1¼	9.56	2.31	2.25	7.84	6	25.0
BC5-TB	1½	13.75	2.56	3	11.45	10	60.0
BC6-TB	2	13.75	3.31	3	11.45	10	78.0
BC7-TB	2½	18.38	3.63	4.25	15.61	15	180.0
BC8-TB	3	18.38	4.38	4.25	15.82	15	225.0
BC9-TB	3½	23.75	4.88	5.25	20.50	20	410.0
BC10-TB	4	23.75	5.38	5.25	20.50	20	460.0

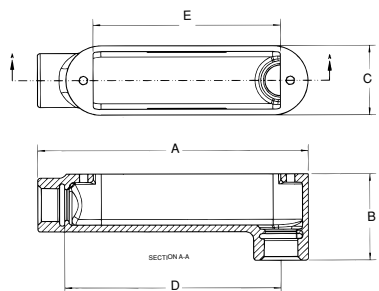
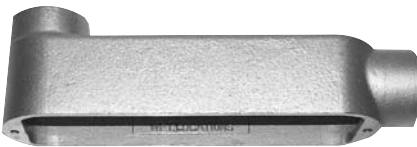

BLB

**BLB<sup>+</sup> Mogul Series**

Cat. No.	Size	Dimensions (in.)					
		A	B	C	D	E	CI
BLB3-TB	1	8.66	2.80	2.25	6.92	6	20.0
BLB4-TB	1¼	8.66	2.70	2.25	6.70	6	25.0
BLB5-TB	1½	12.58	2.56	3	10.36	10	62.0
BLB6-TB	2	12.58	4.16	3	10.13	10	78.0
BLB7-TB	2½	16.94	5.10	4.25	13.89	15	170.0
BLB8-TB	3	16.94	5.81	4.25	13.59	15	210.0
BLB9-TB	3½	22.16	6.50	5.25	18.32	20	410.0
BLB10-TB	4	22.16	7.00	5.25	18.06	20	460.0

# T&B® Fittings

## Mogul Conduit Outlet Bodies

A

T&B® Fittings

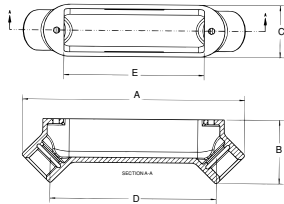

BUB

### BUB Mogul Series

Cat. No.	Size	Dimensions (in.)					
		A	B	C	D	E	CI
BUB3-TB	1	9.49	2.75	2.25	7.01	6	20.0
BUB4-TB	1½	9.55	3.21	2.25	6.71	6	25.0
BUB5-TB	1½	16.68	6.67	3	10.47	10	62.0
BUB6-TB	2	13.68	4.28	3	10.20	10	78.0
BUB7-TB	2½	18.30	5.03	4.25	13.97	15	170.0
BUB8-TB	3	18.30	5.67	4.25	13.50	15	210.0
BUB9-TB	3½	23.74	6.72	5.25	18.07	20	385.0
BUB10-TB	4	23.74	7.22	5.25	17.73	20	430.0

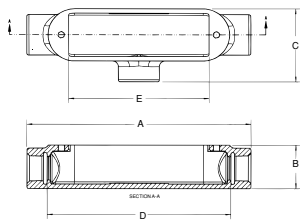
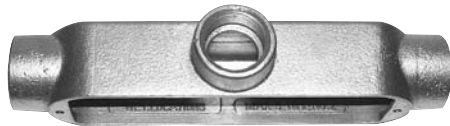

BT

### BT Mogul Series

Cat. No.	Size	Dimensions (in.)					
		A	B	C	D	E	CI
BT3-TB	1	9.56	1.88	3.16	7.84	6	20.0
BT4-TB	1½	9.56	2.31	3.16	7.84	6	25.0
BT5-TB	1½	13.75	2.56	4.06	11.45	10	62.0
BT6-TB	2	13.75	3.31	4.06	11.45	10	78.0
BT7-TB	2½	18.38	3.63	5.59	15.61	15	180.0
BT8-TB	3	18.38	4.38	5.72	15.82	15	225.0
BT9-TB	3½	23.75	4.88	6.88	20.50	20	410.0
BT10-TB	4	23.75	5.38	6.88	20.50	20	460.0

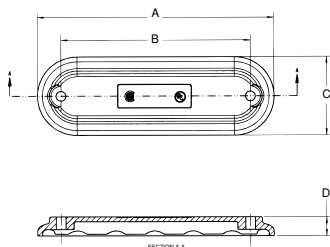

BG

### BG Mogul Series Replacement Covers

Cat. No.	Size	Dimensions (in.)				
		A	B	C	D	E
BG48T-B	1 to 1¼	8.27	6.62	2.77	.67	-
BG68-TB	1½ to 2	12	10.62	3.60	.82	-
BG88-TB	2½ to 3	16.22	12.44	4.97	.85	2.75
BG98-TB	3½ to 4	21.21	16.63	5.96	.87	3.75

**Aluminum Mogul Conduit Outlet Bodies**

Meets NEC Article 370-28, NEMA 3R  
6-1 Ratio  
Suitable for use in  
Wet Locations

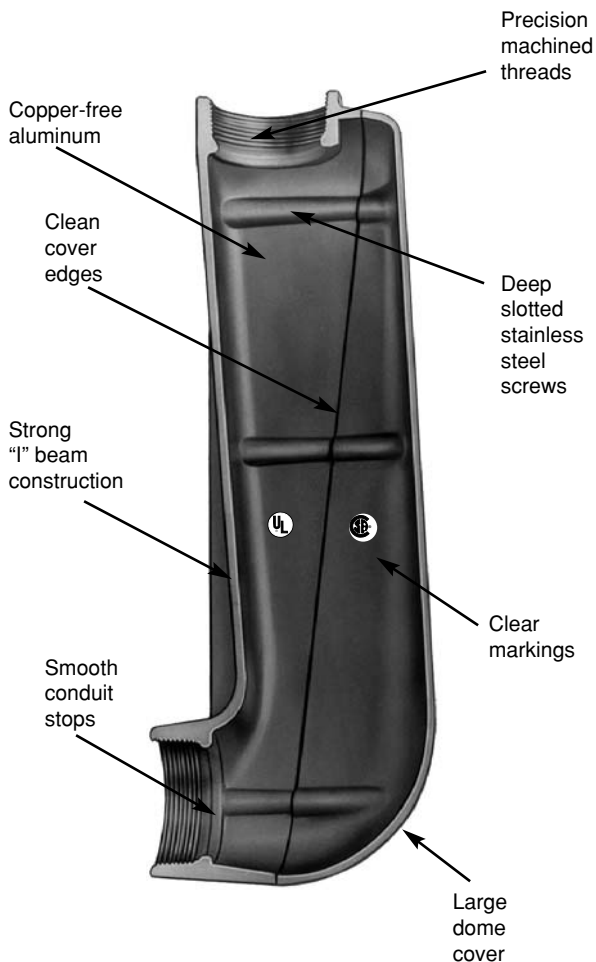

MALB

**Application**

- Raintight junction for bringing electrical service into a location.
- Spacious, accessible wiring chamber provides a convenient location to pull conductors and make splices.

**Features/Benefits**

- Copper-free\* aluminum provides increased corrosion resistance.
- Precision cast and machined surfaces permit safer wire pulling.
- Clean cover edges provide good gasket sealing.
- Precision NPT threaded hubs allow trouble-free field installation for rigid and IMC conduit.
- Deep slotted stainless steel cover screws for faster installation.
- Clear UL, CSA and cubic content markings speed approval by inspectors.
- Dome style cover permits easy wire pulling.
- Meets NEC Article 370-28, 6-1 ratio.

**Standard Materials**

- Mogul Pulling Elbows: Die cast aluminum alloy A360 with less than .004 copper content (copper-free). Stainless steel screws.
- Gaskets: Composition

**Standard Finish**

- Aluminum lacquer finish

**Compliances**

- UL Listed
- CSA Certified
- Federal Spec. W-C-586
- NEC Article 370-28

**Sample Specifications**

- Mogul Pulling Elbows shall be die cast copper-free\* aluminum alloy A360. All conduit stops shall be coined and free of rough edges. Mogul Pulling Elbows shall be finished with aluminum lacquer.

Mogul Pulling Elbows shall be Red•Dot® Catalog No. \_\_\_\_\_

\*Less than .004 copper content

# T&B® Fittings

## Aluminum Mogul Conduit Outlet Bodies

Meets NEC Article 370-28, NEMA 3R  
6-1 Ratio  
Suitable for use in  
Wet Locations

T&B® Fittings



MALB-3 through -6



MALB-7 through -10



MGKV-4 through -7

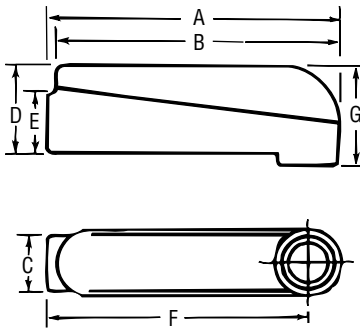

MALB

### Complete with Cover, Gasket and Screws – Raintight

Cat. No.	Hub Size	Unit Qty.	Std. Pkg.	Wt. lbs. per 100
MALB-3	1"	1	10	174
MALB-4	1¼"	2	10	160
MALB-5	1½"	1	1	400
MALB-6	2"	1	1	375

Cat. No.	Hub Size	Unit Qty.	Std. Pkg.	Wt. lbs. per 100
MALB-7	2½"	1	1	1100
MALB-8	3"	1	1	1060
MALB-9	3½"	1	1	1900
MALB-10	4"	1	1	1800

Cat. No.	Hub Size	Unit Qty.	Std. Pkg.	Wt. lbs. per 100
MGKV-4	1" or 1¼"	1	5	3
MGKV-5	1½" or 2"	1	5	4
MGKV-6	2½" or 3"	1	5	5
MGKV-7	3½" or 4"	1	5	5

### MALB

Size	A	B	C	D	E	F	G
1"	9 <sup>5</sup> / <sub>16</sub>	9 <sup>1</sup> / <sub>16</sub>	2½	2¾	2 <sup>1</sup> / <sub>16</sub>	8½	3 <sup>5</sup> / <sub>16</sub>
1¼"	9 <sup>5</sup> / <sub>16</sub>	9 <sup>1</sup> / <sub>16</sub>	2½	2¾	2 <sup>1</sup> / <sub>16</sub>	8½	3 <sup>5</sup> / <sub>16</sub>
1½"	14 <sup>1</sup> / <sub>32</sub>	14¼	2¾	4	2 <sup>3</sup> / <sub>16</sub>	13	5 <sup>7</sup> / <sub>32</sub>
2"	14 <sup>1</sup> / <sub>32</sub>	14¼	2¾	4	2 <sup>3</sup> / <sub>16</sub>	13	5 <sup>7</sup> / <sub>32</sub>
2½"	21 <sup>1</sup> / <sub>16</sub>	21 <sup>3</sup> / <sub>32</sub>	4½	5 <sup>5</sup> / <sub>16</sub>	4 <sup>3</sup> / <sub>16</sub>	18	7 <sup>2</sup> / <sub>32</sub>
3"	21 <sup>1</sup> / <sub>16</sub>	21 <sup>3</sup> / <sub>32</sub>	4½	5 <sup>5</sup> / <sub>16</sub>	4 <sup>3</sup> / <sub>16</sub>	18	7 <sup>2</sup> / <sub>32</sub>
3½"	28 <sup>5</sup> / <sub>16</sub>	28 <sup>1</sup> / <sub>16</sub>	5½	6½	5 <sup>3</sup> / <sub>16</sub>	24	9 <sup>3</sup> / <sub>32</sub>
4"	28 <sup>5</sup> / <sub>16</sub>	28 <sup>1</sup> / <sub>16</sub>	5½	6½	5 <sup>3</sup> / <sub>16</sub>	24	9 <sup>3</sup> / <sub>32</sub>

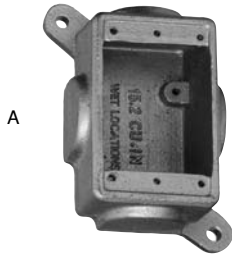

A

Dead-End

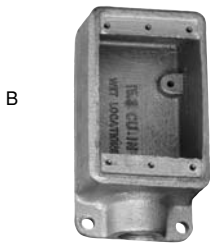
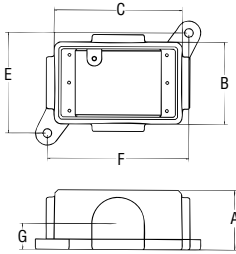

B

Dead-End

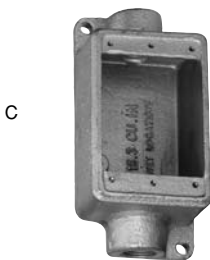
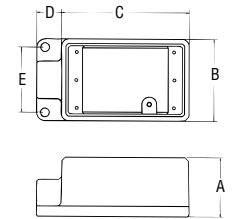

C

Thru-Feed

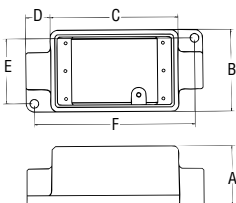

**Application**

Cast device boxes are installed to:

- Accommodate wiring devices.
- Act as pull boxes for conductors in a threaded rigid conduit system, including an internal ground screw.
- Provide openings to make splices and taps in conductors.
- Provide access to conductors for maintenance and future system changes.
- Connect conduit sections.

**Features**

All hubs have NPT Threads with a minimum of five full threads and integral bushing. Internal grounding screw standard on boxes.

- Suitable for wet locations when used with gasketed covers.
- Available in shallow (FS) or deep (FD) boxes. Use FD if device to be enclosed exceeds 1 1/8" in depth.
- Use blank bodies where special arrangements of conduit hubs or entrances are required.
- All cover holes are #6-32.
- Mounting lugs are standard on all FS and FD boxes.

**Size Range**

- Hubs - 1/2" to 1" NPT

**Materials**

- Boxes: Class 30 Gray iron alloy
- Covers: Sand cast AL alloy and sheet steel
- Gaskets: Neoprene

**Finish**

- Zinc-plated with aluminum acrylic paint

**Listing Certifications**

- UL: 514A (wet locations when used with gasketed covers)
- CSA: C22.2 No.18

**Shallow Single Gang Cast Device Boxes**

Cat. No.	Fig.	Hub Size	Dimensions (Inches)							Throat Dia.		
			A	B	C	D	E	F	G	Min.	Max.	
<b>Dead-End</b>												
FS019-TB	A	Blank	2	2 3/4	4 3/32	-	3 3/8	4 2 3/32	7/8	-	N/A	N/A
FS1-TB	B	1/2	2	2 3/4	4 3/32	7/8	2 3/16	-	-	-	0.570	0.610
FS2-TB	B	3/4	2	2 3/4	4 3/32	7/8	2 3/16	-	-	-	0.755	0.810
FS3-TB	B	1	2	2 3/4	4 3/32	7/8	2 3/16	-	-	-	0.935	1.035
<b>Thru-Feed</b>												
FSC1-TB	C	1/2	2	2 3/4	4 3/32	7/8	2 3/16	5 3/8	-	-	0.570	0.610
FSC2-TB	C	3/4	2	2 3/4	4 3/32	7/8	2 3/16	5 3/8	-	-	0.755	0.810
FSC3-TB	C	1	2	2 3/4	4 3/32	7/8	2 3/16	5 3/8	-	-	0.935	1.035

**Deep Single Gang Cast Device Boxes**

Cat. No.	Fig.	Hub Size	Dimensions (Inches)							Throat Dia.		
			A	B	C	D	E	F	G	Min.	Max.	
<b>Dead-End</b>												
FD019-TB	A	Blank	2 19/16	2 3/4	4 3/32	-	3 3/8	4 2 3/32	1 3/8	-	N/A	N/A
FD1-TB	B	1/2	2 19/16	2 3/4	4 3/32	7/8	2 3/16	-	-	-	0.570	0.610
FD2-TB	B	3/4	2 19/16	2 3/4	4 3/32	7/8	2 3/16	-	-	-	0.755	0.810
FD3-TB	B	1	2 19/16	2 3/4	4 3/32	7/8	2 3/16	-	-	-	0.935	1.035
<b>Thru-Feed</b>												
FDC1-TB	C	1/2	2 19/16	2 3/4	4 3/32	7/8	2 3/16	5 3/8	-	-	0.570	0.610
FDC2-TB	C	3/4	2 19/16	2 3/4	4 3/32	7/8	2 3/16	5 3/8	-	-	0.755	0.810
FDC3-TB	C	1	2 19/16	2 3/4	4 3/32	7/8	2 3/16	5 3/8	-	-	0.935	1.035

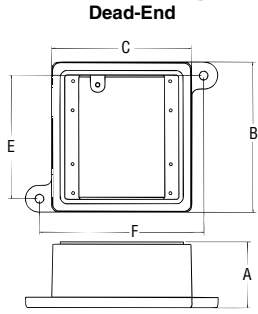
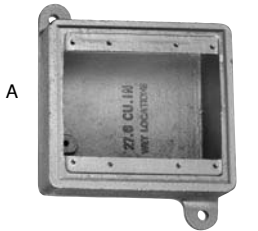

Dead-End

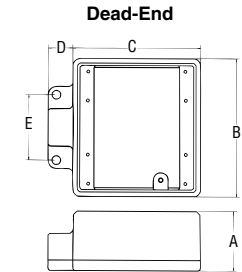

Dead-End

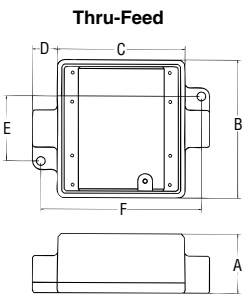

Thru-Feed

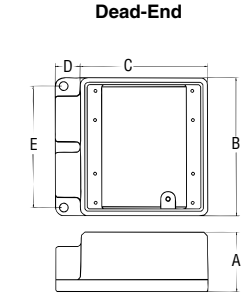

Dead-End

### Shallow Double Gang Cast Device Boxes

Cat. No.	Fig.	Hub Size	Dimensions (Inches)						Throat Dia.	
			A	B	C	D	E	F	Min.	Max.
<b>Dead-End</b>										
FS062-TB	A	Blank	2	4 $\frac{5}{8}$	4 $\frac{3}{32}$	–	4 $\frac{1}{8}$	5 $\frac{1}{2}$	N/A	N/A
FS12-TB	B	$\frac{1}{2}$	2	4 $\frac{5}{8}$	4 $\frac{3}{32}$	$\frac{7}{8}$	2 $\frac{3}{16}$	–	0.570	0.610
FS22-TB	B	$\frac{3}{4}$	2	4 $\frac{5}{8}$	4 $\frac{3}{32}$	$\frac{7}{8}$	2 $\frac{3}{16}$	–	0.755	0.810
FS32-TB	B	1	2	4 $\frac{5}{8}$	4 $\frac{3}{32}$	$\frac{7}{8}$	2 $\frac{3}{16}$	–	0.935	1.035
<b>Thru-Feed</b>										
FSC12-TB	C	$\frac{1}{2}$	2	4 $\frac{5}{8}$	4 $\frac{3}{32}$	$\frac{7}{8}$	2 $\frac{3}{16}$	5 $\frac{3}{8}$	0.570	0.610
FSC222-TB	C	$\frac{3}{4}$	2	4 $\frac{5}{8}$	4 $\frac{3}{32}$	$\frac{7}{8}$	2 $\frac{3}{16}$	5 $\frac{3}{8}$	0.755	0.810
FSC32-TB	C	1	2	4 $\frac{5}{8}$	4 $\frac{3}{32}$	$\frac{7}{8}$	2 $\frac{3}{16}$	5 $\frac{3}{8}$	0.935	1.035

### Deep Double Gang Cast Device Boxes

Cat. No.	Fig.	Hub Size	Dimensions (Inches)						Throat Dia.	
			A	B	C	D	E	F	Min.	Max.
<b>Dead-End</b>										
FD062-TB	A	Blank	2 $\frac{13}{16}$	4 $\frac{5}{8}$	4 $\frac{3}{32}$	–	4 $\frac{1}{8}$	5 $\frac{1}{2}$	N/A	N/A
FD12-TB	B	$\frac{1}{2}$	2 $\frac{13}{16}$	4 $\frac{5}{8}$	4 $\frac{3}{32}$	$\frac{7}{8}$	2 $\frac{3}{16}$	–	0.570	0.610
FD22-TB	B	$\frac{3}{4}$	2 $\frac{13}{16}$	4 $\frac{5}{8}$	4 $\frac{3}{32}$	$\frac{7}{8}$	2 $\frac{3}{16}$	–	0.755	0.810
FD32-TB	B	1	2 $\frac{13}{16}$	4 $\frac{5}{8}$	4 $\frac{3}{32}$	$\frac{7}{8}$	2 $\frac{3}{16}$	–	0.935	1.035
<b>Thru-Feed</b>										
FDC12-TB	C	$\frac{1}{2}$	2 $\frac{13}{16}$	4 $\frac{5}{8}$	4 $\frac{3}{32}$	$\frac{7}{8}$	2 $\frac{3}{16}$	5 $\frac{3}{8}$	0.570	0.610
FDC222-TB	C	$\frac{3}{4}$	2 $\frac{13}{16}$	4 $\frac{5}{8}$	4 $\frac{3}{32}$	$\frac{7}{8}$	2 $\frac{3}{16}$	5 $\frac{3}{8}$	0.755	0.810
FDC32-TB	C	1	2 $\frac{13}{16}$	4 $\frac{5}{8}$	4 $\frac{3}{32}$	$\frac{7}{8}$	2 $\frac{3}{16}$	5 $\frac{3}{8}$	0.935	1.035

### Double Gang Cast Device Boxes, Double Hub

Cat. No.	Fig.	Hub Size	Dimensions (Inches)					Throat Dia.	
			A	B	C	D	E	Min.	Max.
FSS222-TB	D	$\frac{3}{4}$	2	4 $\frac{5}{8}$	4 $\frac{3}{32}$	$\frac{7}{8}$	4 $\frac{1}{16}$	0.755	0.810
FDS222-TB	D	$\frac{3}{4}$	2 $\frac{13}{16}$	4 $\frac{5}{8}$	4 $\frac{3}{32}$	$\frac{7}{8}$	4 $\frac{1}{16}$	0.755	0.810

# T&B® Fittings

## FS/FD Cast Device Boxes and Covers



DSS100-TB

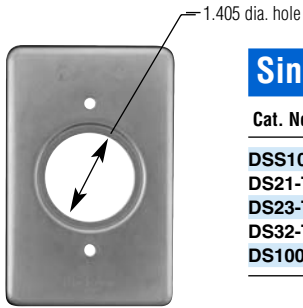

DS21-TB

### Single Gang Covers

Cat. No.	Description
DSS100-TB	Blank, Sheet Steel
DS21-TB	Round Receptacle, Sheet Steel
DS23-TB	Duplex Receptacle, Sheet Steel
DS32-TB	Single Switch, Sheet Steel
DS100G-TB	Blank, Cast Aluminum



DS23-TB



DS32-TB

### Double Gang Covers

Cat. No.	Description
S1002-TB	Blank, Sheet Steel
S32232-TB	2 Receptacle/Switch, Sheet Steel
S32212-TB	Single Receptacle/Switch, Sheet Steel
S232-TB	2 Dual Receptacle, Sheet Steel
S322-TB	2 Switch, Sheet steel
S1002GSA-TB	Blank, Cast Aluminum with Gasket



DS100G-TB



S1002-TB



S32232-TB

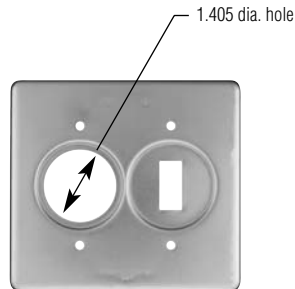

S32212-TB



S232-TB

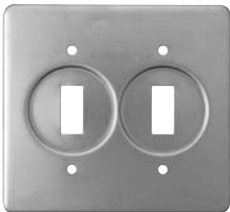

S322



S1002GSA-TB





AFS



2AFSC



CWP-G

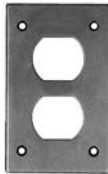

CDR

### Application

- Industrial grade FS device boxes and raintight covers protect wiring devices, switches, electronic components, and terminal blocks in Dry, Damp and Wet Locations.
- Spacious, accessible wiring chamber provides a convenient location to maintain or change a system, pull conductors and make splices.
- Junction for branch conduits.
- Aluminum boxes can be used with steel rigid conduit.

### Features/Benefits

- Copper-free\* aluminum, stainless steel cover springs and hinge pins provide increased corrosion resistance.
- Die cast construction, boxes with securely fastened mounting plates and industrial designed covers combine to produce a rugged protective enclosure for devices on industrial and OEM applications.
- Clean cover edges provide good gasket sealing.
- Precision NPT threaded hubs allow trouble-free field installation for rigid or IMC conduit.
- Clear UL, CSA and cubic content markings speed approval by inspectors.
- Boxes - external hub design provides increased wiring room.

### Standard Materials

- Die cast aluminum alloy A360 with less than .004 copper content (copper-free).
- Cover hinge pins and springs: Stainless steel.

### Standard Finish

- Aluminum lacquer finish.

### Compliances:

- UL Listed
- Boxes CSA Certified with factory installed ground screw \*\*
- Covers CSA Certified
- Federal Spec. W-C-586

### Sample Specifications

- Industrial grade FS device boxes and covers shall be die cast copper-free\* aluminum alloy A360. All conduit stops shall be coined and free of rough edges. Raintight covers shall have stainless steel springs and hinge pins and are suitable for use in wet locations with cover closed (CFSB, CFST and CFSTF suitable for wet locations). Industrial grade FS device boxes and covers shall be finished with aluminum lacquer. Industrial grade FS device boxes and covers shall be Red•Dot® Catalog No. \_\_\_\_\_

\*Less than .004 copper content

\*\*Consult factory for lead time and minimum quantity.

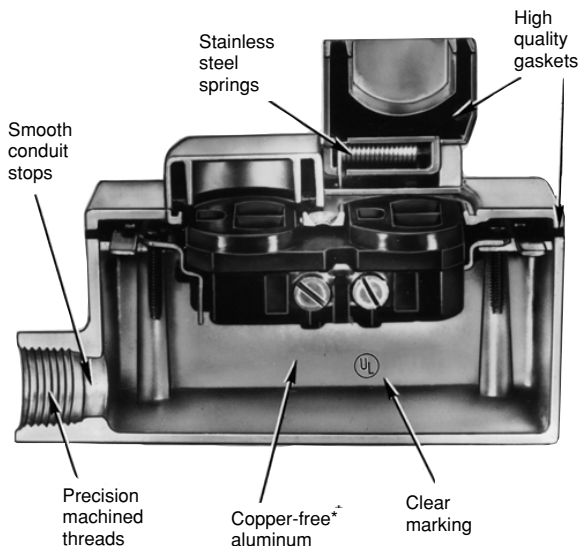

# T&B® Fittings

## FS/FD Aluminum Device Boxes and Covers

Suitable for use  
in Wet Locations  
NEMA 3R



AFS



AFSC



AFSS



AFSCC



ADFS



ADFSC



2AFS



2AFSC



2ADFS



FSMG-TB

### Single Gang Boxes \*Raintight

Cat. No.	Hub Size	Unit Qty.	Std. Pkg.	Wt. lbs. per 100
<b>Standard, 1 Hole Box, Dead End</b>				
* AFS-1	1/2"	5	25	68
* AFS-2	3/4"	5	25	74
* AFS-3	1"	5	25	72
<b>Standard, 2 Hole Box, Through Feed</b>				
* AFSC-1	1/2"	5	25	72
* AFSC-2	3/4"	5	25	88
* AFSC-3	1"	5	25	79
<b>Standard, 2 Hole Box, Dead End</b>				
* AFSS-1	1/2"	5	25	80
* AFSS-2	3/4"	5	25	76
<b>Standard, 3 Hole Box, Through Feed</b>				
* AFSCC-1	1/2"	5	25	88
* AFSCC-2	3/4"	5	25	80
<b>Deep, 1 Hole Box, Dead End</b>				
* ADFS-1	1/2"		5	74
* ADFS-2	3/4"		5	78
* ADFS-3	1"		5	80
<b>Deep, 2 Hole Box, Through Feed</b>				
* ADFSC-1	1/2"		5	76
* ADFSC-2	3/4"		5	90
* ADFSC-3	1"		5	90

\*Raintight when used with appropriate Red•Dot® covers.

### Two Gang Boxes \*Raintight

Cat. No.	Hub Size	Unit Qty.	Std. Pkg.	Wt. lbs. per 100
<b>Standard, 1 Hole Box, Dead End</b>				
* 2AFS-1	1/2"	2	10	115
* 2AFS-2	3/4"	2	10	95
* 2AFS-3	1"	2	10	90
<b>Standard, 2 Hole Box, Through Feed</b>				
* 2 AFSC-1	1/2"	2	10	104
* 2AFSC-2	3/4"	2	10	102
<b>Deep, 1 Hole Box, Dead End</b>				
* 2ADFS-1	1/2"		3	128
* 2ADFS-2	3/4"		3	143
* 2ADFS-3	1"		3	129

\*Raintight when used with appropriate Red•Dot® covers.

### Multi-Gang Boxes \*Raintight

Cat. No.	Hub Size	Std. Pkg.	Wt. lbs. per 100
FSMG-TB	4" threadless Conduit	1	242

\*Raintight when used with appropriate Red•Dot® covers.

**Thomas & Betts**



CWPDR



CWPDR-FS



CWPV-DR



CFSDR



CWP-G



CFSH-G



CWPV-G



CFSR-G



CFSR Series

### Single Gang Covers Complete with Gasket and Screws \*Raintight

Cat. No.	Description	Unit Qty.	Std. Pkg.	Wt. lbs. per 100
<b>For Duplex Receptacles, Horizontal</b>				
* CWPDR	Duplex receptacle cover with 2 spring doors, Device Mount	1	25	40
* CWPDR-FS	Box Mount	1	25	40
<b>For Duplex Receptacles, Vertical</b>				
* CFSDR	Box Mount	1	25	38
<b>For GFCI Receptacles Horizontal</b>				
* CFSH-G	Box Mount	1	25	40
<b>For GFCI Receptacles Vertical</b>				
* CWPV-G	GFCI receptacle cover 2 $\frac{1}{2}$ " x 1 $\frac{1}{2}$ " rectangular opening Device Mount	1	25	40
* CFSR-G	Box Mount	1	25	40

\*Raintight when used with appropriate Red•Dot® boxes.

Cat. No.	Nominal Size	Max. Device Face Dia.	Unit Qty.	Std. Pkg.	Wt. lbs per 100
<b>For Single Receptacles Vertical (Box Mount Only)</b>					
* CFSR-L	1 $\frac{1}{16}$ "	1.600"	1	25	40
* CFSR-S	1 $\frac{3}{8}$ "	1.395"	1	25	40
* CFSR-X	1 $\frac{7}{32}$ "	1.865"	1	25	40
* CFSR-XL	2 $\frac{1}{8}$ "	2.145"	1	25	40
* CFSR-Y	1 $\frac{3}{4}$ "	1.750"	1	25	40

\*Raintight when used with appropriate Red•Dot® boxes.

# T&B® Fittings

## FS/FD Aluminum Device Boxes and Covers



CFST



CFSTF



CFSB

### Single Gang Covers Complete with Gasket and Screws

#### \*Raintight

Cat. No.	Description	Unit Qty.	Std. Pkg.	Wt. lbs. per 100
<b>Switch Cover</b>				
* CFST	Plunger Style, Switch Cover, Box Mount NEMA 3R	1	25	40
<b>Switch Cover</b>				
* CFSTF	Front Lever, Switch Cover, Box Mount NEMA 4	1	25	40
<b>Blank Cover</b>				
* CFSB	Blank Cover, Box Mount, NEMA 3R	20	100	14

\*Raintight when used with appropriate Red•Dot® boxes.

## FS/FD Aluminum Device Boxes and Covers

Suitable for use in  
Wet Locations with Cover  
Closed NEMA 3R



2CWPDR



2CWTDR



2CWPR-M



2CFSR-M



2CFST



2CFSB

### Two Gang Covers Complete with Gasket and Screws

#### \*Raintight

Cat. No.	Description	Unit Qty.	Std. Pkg.	Wt. lbs. per 100
<b>For Two Duplex Receptacles</b>				
* 2CWPDR	Two Duplex Receptacle Cover with 2 Spring Doors, Device Mount	1	10	48
<b>For Switch and Duplex Receptacle</b>				
* 2CWTDR	Switch and Duplex Receptacle Cover, Box/Device Mount	1	10	48
<b>For Single Receptacle</b>				
* 2CWPR-M	Single Receptacle Cover, Hole Dia. 2 1/4", Device Mount	1	10	48
* 2CFSR-M	Single Receptacle Cover, Hole Dia. 2 1/4", Box Mount	1	10	48
<b>For Two Switches</b>				
* 2CFST	Plunger Style Switch Cover, Box Mount	1	10	26
<b>Blank</b>				
* 2CFSB	Blank Cover, Box Mount	10	50	25

\*Raintight when used with appropriate Red•Dot® boxes.

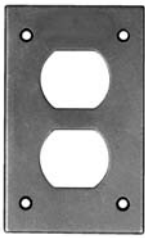

CDR



CTS



CR Series



FS-GKV

### Single Gang Covers Complete with Gasket and Screws

Cat. No.	Description	Unit Qty.	Std. Pkg.	Wt. lbs. per 100
----------	-------------	-----------	-----------	------------------

#### For Duplex Receptacles

CDR	Duplex receptacle Cover, Box Mount	20	100	11
-----	------------------------------------	----	-----	----

#### For Switches

CTS	Switch Cover, Box Mount	20	100	14
-----	-------------------------	----	-----	----

Cat. No.	Nominal Size	Max. Device Face Dia.	Unit Qty.	Std. Pkg.	Wt. lbs. per 100
----------	--------------	-----------------------	-----------	-----------	------------------

#### For Single Receptacles (Box Mount Only)

CRL	1 $\frac{1}{8}$ "	1.600"	20	100	12
-----	-------------------	--------	----	-----	----

CRS	1 $\frac{3}{8}$ "	1.395"	20	100	12
-----	-------------------	--------	----	-----	----

CRX-L	2 $\frac{1}{8}$ "	2.145"	20	100	12
-------	-------------------	--------	----	-----	----

Cat. No.	Description	Std. Pkg.	Wt. lbs. per 100
----------	-------------	-----------	------------------

#### Gasket

FS-GKV	Composition Gasket	100	2
--------	--------------------	-----	---



2CDR



2CTS

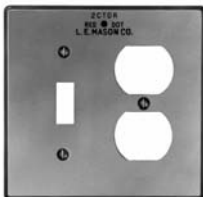

2CTDR



2FS-GKV

### Two Gang Covers Complete with Gasket and Screws

Cat. No.	Description	Unit Qty.	Std. Pkg.	Wt. lbs. per 100
----------	-------------	-----------	-----------	------------------

#### For Two Duplex Receptacles

2CDR	Two Duplex Receptacle Cover, Device Mount	10	50	24
------	---	----	----	----

#### For Two Switches

2CTS	Switch Cover, Device Mount	10	50	24
------	----------------------------	----	----	----

#### For Switch and Duplex Receptacles

2CTDR	Switch and Duplex Receptacle Cover, Device Mount	10	50	24
-------	--	----	----	----

#### Gasket

2FS-GKV	Composition Gasket		50	3
---------	--------------------	--	----	---

# T&B® Fittings

## FS/FD Aluminum Device Boxes and Covers

### Dimensions and Cubic Inches (CI) Single Gang Boxes

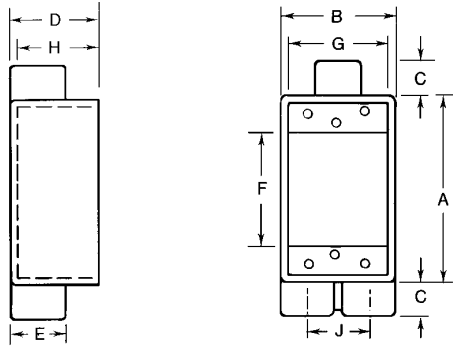

AFS, AFSC, AFSS, AFSCC

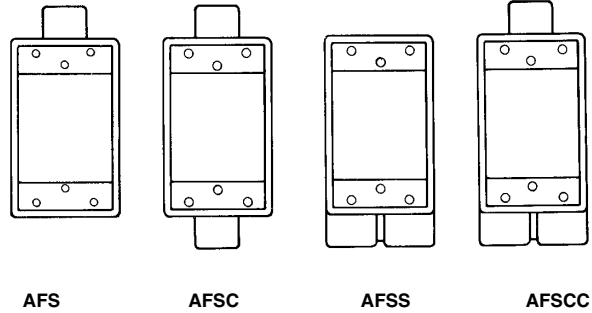

Cat. No.	Hub Size	A	B	C	D	E	F	G	H	J	CI
AFS-1	1/2"	4 9/16	2 13/16	1 3/16	2 1/16	1 1/8	2 7/8	2 9/16	1 15/16		21.6
AFS-2	3/4"	4 9/16	2 13/16	1 3/16	2 1/16	1 1/16	2 7/8	2 9/16	1 15/16		21.6
AFS-3	1"	4 9/16	2 13/16	1 3/16	2 1/16	1 1/16	2 7/8	2 9/16	1 15/16		21.6
AFSC-1	1/2"	4 9/16	2 13/16	1 3/16	2 1/16	1 1/8	2 7/8	2 9/16	1 15/16		21.6
AFSC-2	3/4"	4 9/16	2 13/16	1 3/16	2 1/16	1 1/16	2 7/8	2 9/16	1 15/16		21.6
AFSC-3	1"	4 9/16	2 13/16	1 3/16	2 1/16	1 1/16	2 7/8	2 9/16	1 15/16		21.6
AFSS-1	1 1/2"	4 9/16	2 13/16	1 3/16	2 1/16	1 3/8	2 7/8	2 9/16	1 15/16	1 1/2	21.6
AFSS-2	3/4"	4 9/16	2 13/16	1 3/16	2 1/16	1 3/8	2 7/8	2 9/16	1 15/16	1 1/2	21.6
AFSCC-1	1/2"	4 9/16	2 13/16	1 3/16	2 1/16	1 3/8	2 7/8	2 9/16	1 15/16	1 1/2	21.6
AFSCC-2	3/4"	4 9/16	2 13/16	1 3/16	2 1/16	1 3/8	2 7/8	2 9/16	1 15/16	1 1/2	21.6

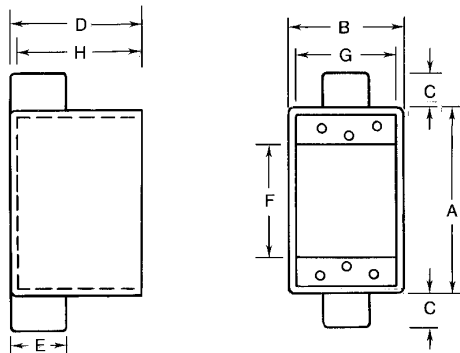

ADFS, ADFSC

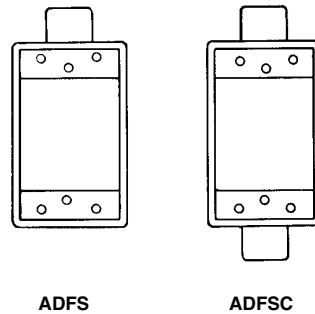

Cat. No.	Hub Size	A	B	C	D	E	F	G	H	CI
ADFS-1	1/2"	4 9/16	2 13/16	7/8	3 1/16	1 1/8	2 7/8	2 9/16	2 15/16	31.3
ADFS-2	3/4"	4 9/16	2 13/16	7/8	3 1/16	1 1/16	2 7/8	2 9/16	2 15/16	31.3
ADFS-3	1"	4 9/16	2 13/16	7/8	3 1/16	1 1/16	2 7/8	2 9/16	2 15/16	31.3
ADFC-1	1 1/2"	4 9/16	2 13/16	7/8	3 1/16	1 1/8	2 7/8	2 9/16	2 15/16	31.3
ADFC-2	3/4"	4 9/16	2 13/16	7/8	3 1/16	1 1/16	2 7/8	2 9/16	2 15/16	31.3
ADFC-3	1"	4 9/16	2 13/16	7/8	3 1/16	1 1/16	2 7/8	2 9/16	2 15/16	31.3

### Dimensions and Cubic Inches (CI) Two Gang Boxes

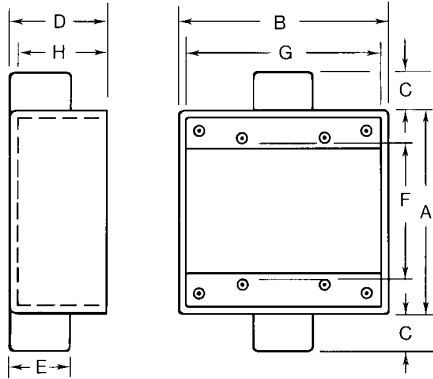

2AFS, 2AFSC

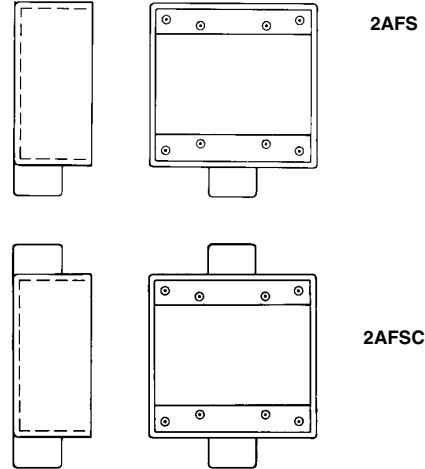

Cat. No.	Hub Size	A	B	C	D	E	F	G	H	CI
2AFS-1	1/2"	4 9/16	4 5/8	1 3/16	2 1/16	1 3/8	2 7/8	4 3/8	1 15/16	36.0
2AFS-2	3/4"	4 9/16	4 5/8	1 3/16	2 1/16	1 3/8	2 7/8	4 3/8	1 15/16	36.0
2AFS-3	1"	4 9/16	4 5/8	7/8	2 1/16	1 11/16	2 7/8	4 3/8	1 15/16	36.0
2AFSC-1	1/2"	4 9/16	4 5/8	1 3/16	2 1/16	1 3/8	2 7/8	4 3/8	1 15/16	36.0
2AFSC-2	3/4"	4 9/16	4 5/8	1 3/16	2 1/16	1 3/8	2 7/8	4 3/8	1 15/16	36.0

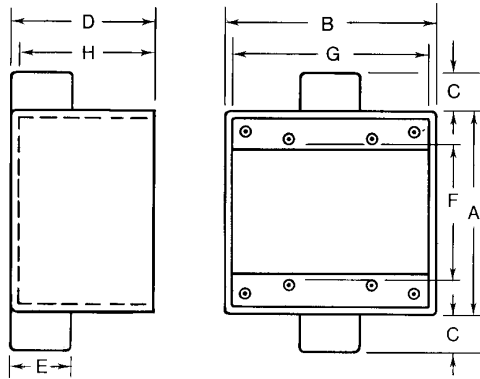

2ADFS, 2ADFSC

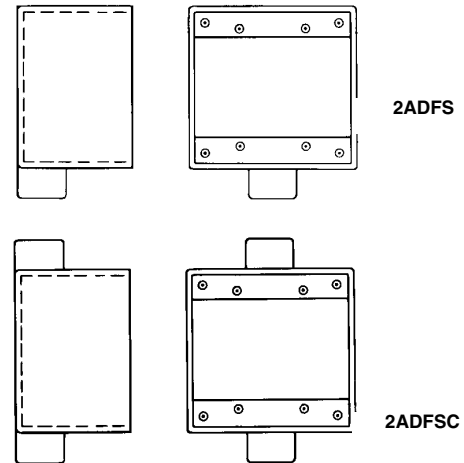

Cat. No.	Hub Size	A	B	C	D	E	F	G	H	CI
2ADFS-1	1/2"	4 9/16	4 5/8	1 3/16	3 3/32	1 3/8	2 7/8	4 3/8	2 31/32	54.0
2ADFS-2	3/4"	4 9/16	4 5/8	1 3/16	3 3/32	1 3/8	2 7/8	4 3/8	2 31/32	54.0
2ADFS-3	1"	4 9/16	4 5/8	7/8	3 3/32	1 11/16	2 7/8	4 3/8	2 31/32	54.0
2ADFSC-2	3/4"	4 9/16	4 5/8	1 3/16	3 3/32	1 3/8	2 7/8	4 3/8	2 31/32	54.0
2ADFSC-3	1"	4 9/16	4 5/8	7/8	3 3/32	1 11/16	2 7/8	4 3/8	2 31/32	54.0

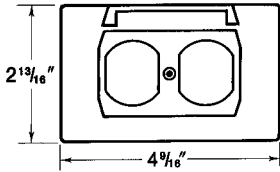

CWPDR

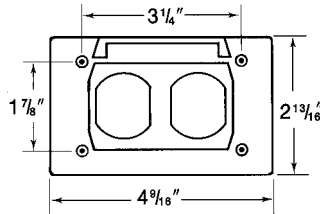

CWPDR-FS

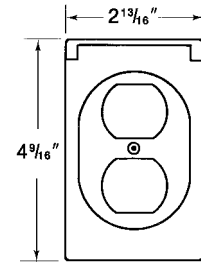

CWPV-DR

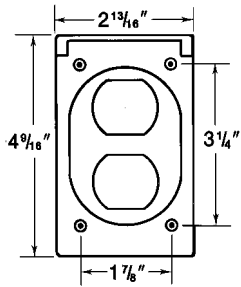

CFSDR

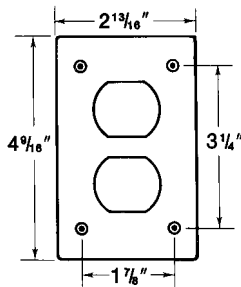

CDR

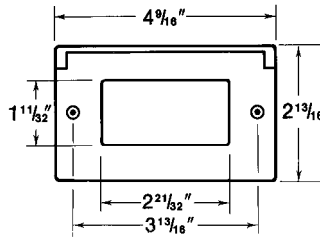

CWP-G

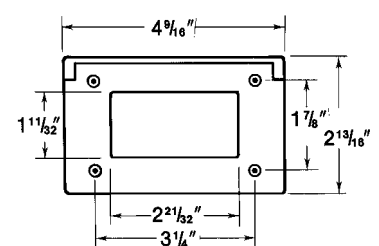

CFSH-G

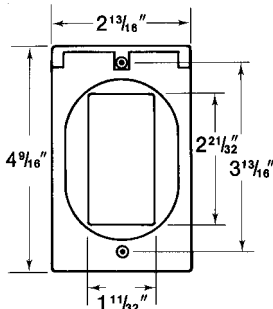

CWPV-G

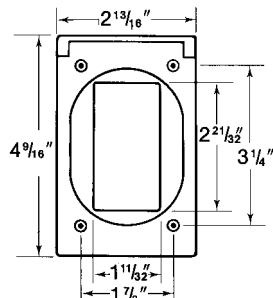

CFSR-G

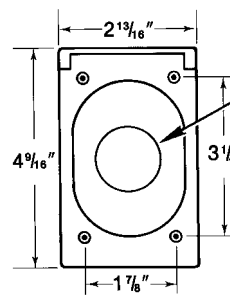

CFSR Series

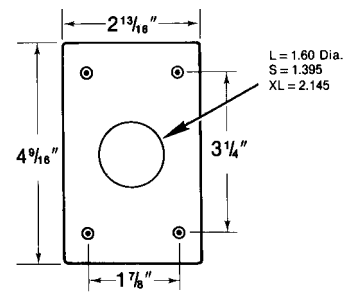

CR Series

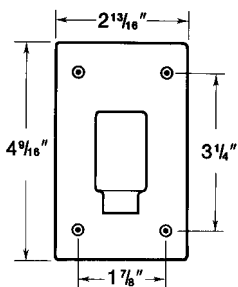

CFST

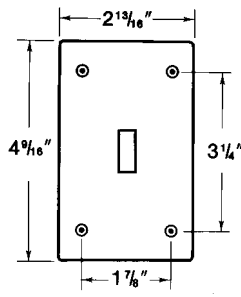

CTS

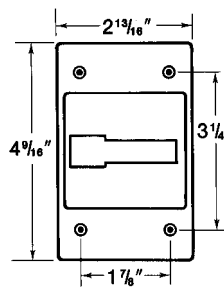

CFSTF

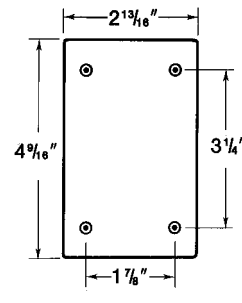

CFSB



### Dimensions Two Gang Covers

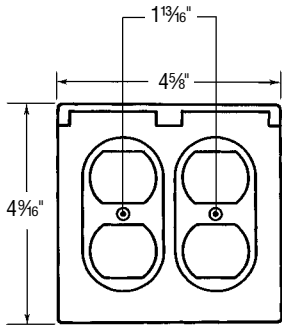

2CWPDR

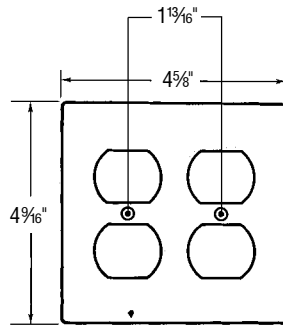

2CDR

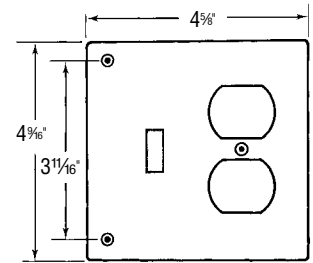

2CTDR

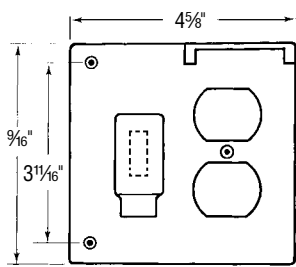

2CWTDR

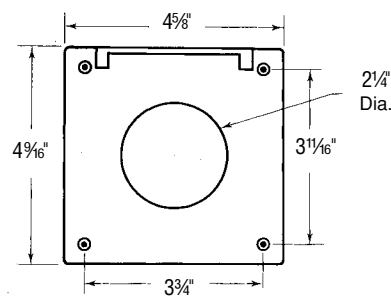

2CFSR-M

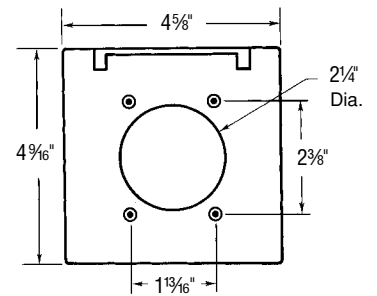

2CWPR-M

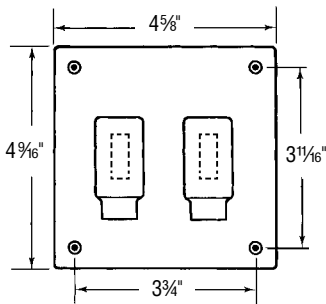

2CFST

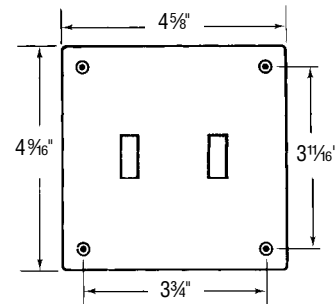

2CTS

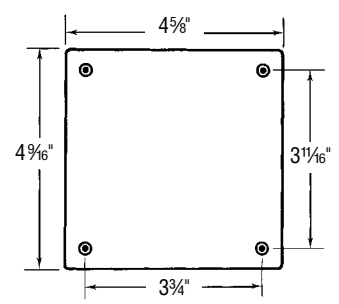

2CFSB



8" Movement

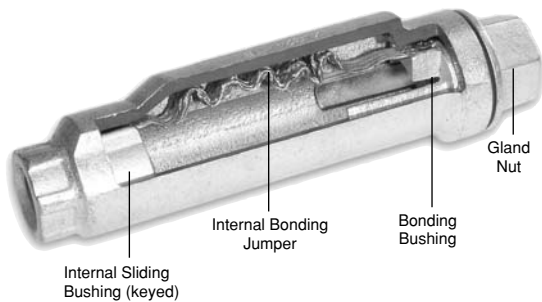

4" Movement

### ***Innovative Design Makes Installations Easier.***

- No disassembly necessary to install
- Fast, simple, and requires fewer steps
- True Internal Bonding Jumper - no external grounding strap required
- Tamper-proof internal jumper protected from the environment
- Exceeds code requirements for long conduit runs to permit linear movement



### ***XJG-TB Rigid Conduit Expansion Coupling***

#### **No Disassembly Required.**

Whenever you install a rigid expansion coupling in a long conduit run, you normally need three hands, two strong backs and lots of patience. Now you can relax. T&B introduces the new, no-hassle Rigid Conduit Expansion Coupling. Installation's just a few turns and you're done. The T&B Rigid Conduit Expansion Coupling features innovations that provide conveniences to the installer, saving time and money on the job. There's no disassembly needed during the installation, requiring fewer tools and less opportunities for lost pieces.

The new XJG-TB Rigid Conduit Expansion Coupling also packs an

added punch: It's the only fitting of its kind that features a true internal bonding jumper. This eliminates the need for additional external bonding jumpers, so there's fewer parts to buy and install.

If you need a fitting that can give and take without a lot of hassle, reach for T&B's new XJG-TB Rigid Conduit Expansion Coupling. It's the latest breakthrough in the industry's leading line of conduit fittings. Contact your local representative for more information regarding the XJG-TB Rigid Conduit Expansion Coupling and the complete line of conduit fittings from the name you trust for quality design and manufacturing, Thomas & Betts.

**1**

Slide the fitting onto the conduit until it stops at the internal sliding bushing. Tighten and you're ready. No parts to reassemble!

**2**

With a wrench, tighten the gland nut to compress the Teflon packing, creating a rain-tight seal around the conduit.

**3**

Thread the next length of conduit into the other end of the fitting and tighten. You're done!

# T&B® Fittings

## Conduit Expansion Coupling

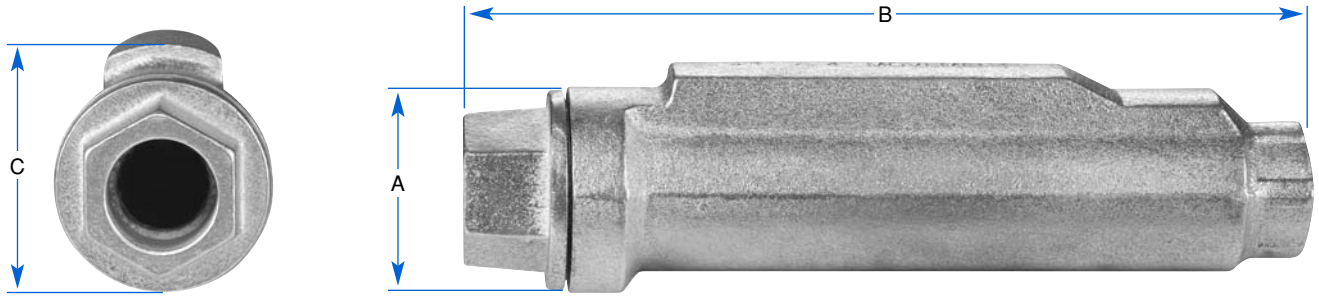

### XJG Conduit Expansion Coupling

Cat No.	Size	Movement	A Diameter	B Length	C Height
XJG24-TB	¾"	4"	2.43	10.00	2.75
XJG28-TB	¾"	8"	2.43	14.00	2.75
XJG34-TB	1"	4"	2.67	10.00	2.99
XJG38-TB	1"	8"	2.67	14.00	2.99
XJG44-TB	1¼"	4"	3.36	10.56	3.68
XJG48-TB	1¼"	8"	3.36	14.56	3.68
XJG54-TB	1½"	4"	3.36	10.56	3.68
XJG58-TB	1½"	8"	3.36	14.56	3.68
XJG64-TB	2"	4"	3.86	11.25	4.18
XJG68-TB	2"	8"	3.86	15.25	4.18
XJG74-TB	2½"	4"	4.96	12.12	5.25
XJG78-TB	2½"	8"	4.96	16.12	5.25
XJG84-TB	3"	4"	4.96	12.12	5.25
XJG88-TB	3"	8"	4.96	16.12	5.25
XJG94-TB	3½"	4"	6.37	12.87	6.75
XJG98-TB	3½"	8"	6.37	16.87	6.75
XJG104-TB	4"	4"	6.37	12.87	6.75
XJG108-TB	4"	8"	6.37	16.87	6.75
XJG1208-TB	5"	8"	7.99	18.87	8.56

Please consult Technical Services for special orders and availability of products not shown in this list.



**Listed / Certified By:**

**UL** (File E23018, Std. 514B)  
Suitable for Wet Locations

**CSA** (File LR2884, Std. C22.2 No. 18)

### Suggested Specifications

#### Expansion Fittings for Rigid Steel or Intermediate Metal Conduit

Where raceways require expansion fittings to compensate for thermal expansion and contraction and where expansion fittings and telescoping sections of metal raceway shall be made electrically continuous by bonding jumpers or other means:

- Fitting will be constructed from malleable or ductile iron with exterior and interior zinc plating for corrosion protection.
- The fitting shall be constructed so that disassembly is not required during installation.
- Fitting shall be raintight after installation.
- The fitting shall have an internal bonding jumper constructed of a tinned copper braid, sized to meet UL fault current test requirements and comply with bonding requirements - NEC article 250.98
- External bonding jumper shall not be required to comply with NEC requirements.
- Accepted Manufacturers: Thomas & Betts - XJG-TB Series

### Standard Materials / Finish

- Body** . . . . . Malleable or Ductile Iron, available PVC Coated
- Internal Bonding Jumper** . . . Tinned Copper Braid
- Exterior and Interior Finish** . Zinc Plating, Aluminum Acrylic Paint
- Packing** . . . . . PTFE/Synthetic Fiber Material (Teflon®) Coated

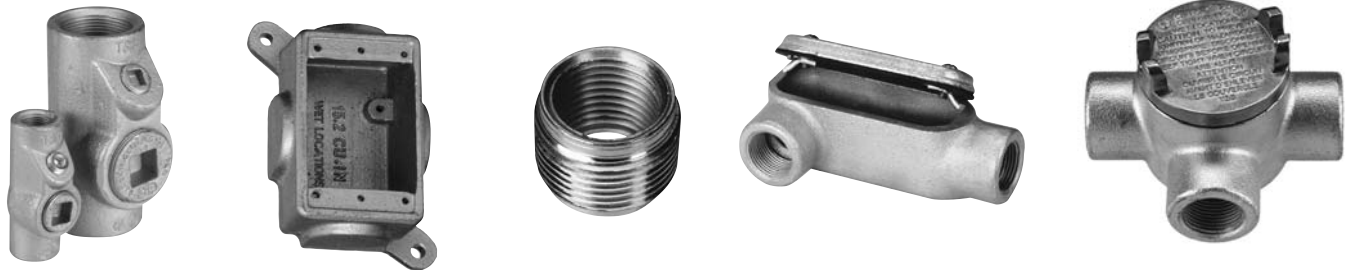

**Our complete line makes specifying easy too.**

Thomas & Betts offers a wide variety of quality fittings suitable for outdoor use and hazardous locations.

# T&B® Fittings

## Conduit Outlet Boxes Explosionproof, Dust-Ignitionproof

Cl.I, Div. 1 & 2, Groups C, D  
Cl.II, Div. 1, Groups E, F, G  
Cl.III, Div. 1 & 2  
NEMA 3, 4, 7 CD, 9 EFG

Explosionproof  
Dust-Ignitionproof  
Raintight  
Wet Locations

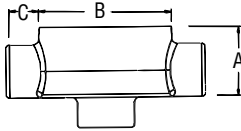
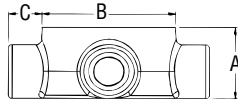

GUA



GUAB



GUAC



GUAD

### Application

GUA boxes can be used for hazardous location conduit runs for the following:

- Allows for mounting of fixture outlets (when used with appropriate covers).
- Provides easy access to wiring.
- Provides junction in conduit for wire pulling and splices.
- Changes direction in rigid conduit systems.
- Attaches two or more pieces of conduit in long runs.
- Guards against damage to wires in rigid conduit.

### Features

- All hubs have a minimum of five full threads and integral bushing.
- All boxes are furnished with internal grounding screw.
- Cover supplied with "O" ring gasket.

### Size Range

- ½" NPT to 2" NPT
- Access opening 2" to 5" diameter

### Materials

- Bodies: Grade 60-45-10 Ductile Iron (Complies with ASTM standard A536)
- Covers: Die cast aluminum

### Finish

- Boxes: Zinc-plated with aluminum acrylic paint
- Covers: Natural

### Listing Certifications

- UL514A (wet locations when used with gasketed covers)
- UL886
- CSA: C22.2 No. 30



## GUA Conduit Outlet Boxes

Cat. No.	Hub Size	Dimensions (Inches)				Throat Dia.		Cubic In. Capacity
		A	B	C	D	Min.	Max.	
GUA14-TB	½	1 13/16	2 1/2	7/8	1 11/16	.570	.610	5.5
GUA16-TB	½	2	3 1/2	7/8	2	.570	.610	13.5
GUA24-TB	¾	2	2 1/2	7/8	1 7/8	.755	.810	5.3
GUA26-TB	¾	2	3 1/2	7/8	2	.755	.810	13.3
GUA36-TB	1	2 5/16	3 1/2	7/8	2 3/16	.935	1.035	16.2
GUA47-TB	1 1/4	2 11/16	4 3/8	1	2 3/32	1.260	1.360	29
GUA59-TB	1 1/2	3 3/16	5 3/4	1 1/16	3 5/64	1.470	1.590	70
GUAB14-TB	½	2 1/4	2 1/2	7/8	2 5/16	.570	.610	6.9
GUAB16-TB	½	2	3 1/2	7/8	2	.570	.610	13.5
GUAB24-TB	¾	2 1/2	2 1/2	7/8	2 3/8	.755	.810	7.9
GUAB26-TB	¾	2	3 1/2	7/8	2	.755	.810	13.5
GUAB36-TB	1	2 5/16	3 1/2	1	2 15/16	.935	1.035	15.4
GUAB47-TB	1 1/4	2 11/16	4 3/8	1	2 3/32	1.260	1.360	27.5
GUAB59-TB	1 1/2	3 3/16	5 3/4	1 1/16	3 5/64	1.470	1.590	73.6
GUAB69-TB	2	4 1/16	5 3/4	1 1/16	4 3/64	1.880	2.047	80
GUAB79-TB	2 1/2	4 1/16	5 3/4	1 1/8	4 3/64	2.320	2.380	98
GUAC14-TB	½	2 1/4	2 1/2	7/8	2 5/16	.570	.610	6.8
GUAC16-TB	½	2	3 1/2	7/8	2	.570	.610	13.1
GUAC24-TB	¾	2	2 1/2	7/8	1 7/8	.755	.810	5.3
GUAC26-TB	¾	2	3 1/2	7/8	2	.755	.810	13.3
GUAC36-TB	1	2 5/16	3 1/2	7/8	2 3/16	.935	1.035	16.2
GUAC47-TB	1 1/4	2 11/16	4 3/8	1	2 3/32	1.260	1.360	29.3
GUAC49-TB	1 1/4	3 3/16	5 3/4	1	3 3/16	1.260	1.360	73.6
GUAC59-TB	1 1/2	3 3/16	5 3/4	1 1/16	3 3/16	1.470	1.590	74
GUAC69-TB	2	4 1/16	5 3/4	1 1/16	4 3/64	1.880	2.047	77.8
GUAD14-TB	½	1 13/16	2 1/2	7/8	1 11/16	.570	.610	5.6
GUAD16-TB	½	2	3 1/2	7/8	2	.570	.610	12.5
GUAD24-TB	¾	2	2 1/2	7/8	1 7/8	.755	.810	5.2
GUAD26-TB	¾	2	3 1/2	7/8	2	.755	.810	13.1
GUAD36-TB	1	2 5/16	3 1/2	7/8	2 3/16	.935	1.035	16
GUAD49-TB	1 1/4	3 3/16	5 3/4	1	3 3/16	1.260	1.360	76

# T&B® Fittings

Conduit Outlet Boxes  
Explosionproof, Dust-Ignitionproof

CI.I, Div. 1 & 2, Groups C, D  
CI.II, Div. 1, Groups E, F, G  
CI.III, Div. 1 & 2  
NEMA 3, 4, 7 CD, 9 EFG

Explosionproof  
Dust-Ignitionproof  
Raintight  
Wet Locations

T&B® Fittings



GUAL



GUAM



GUAN



GUAT



GUAW



GUAX

## GUA Conduit Outlet Boxes (continued)

Cat. No.	Hub Size	Dimensions (Inches)				Throat Dia.		Cubic In. Capacity
		A	B	C	D	Min.	Max.	
GUAL14-TB	½	2¼	2½	⅞	2¾	.570	.610	7.1
GUAL16-TB	½	2	3½	⅞	2	.570	.610	13.4
GUAL24-TB	¾	2	2½	⅞	1⅞	.755	.810	5.3
GUAL26-TB	¾	2	3½	⅞	2	.755	.810	13.3
GUAL36-TB	1	2⅝	3½	⅞	2⅝	.935	1.035	16.2
GUAL47-TB	1¼	2⅞	4⅞	1	2⅝	1.260	1.360	30
GUAL49-TB	1¼	3⅞	5¼	1	3⅝	1.260	1.360	74.5
GUAL59-TB	1½	3⅞	5¼	1⅞	3⅝	1.470	1.590	74
GUAL69-TB	2	4⅞	5¼	1⅞	4⅝	1.880	2.047	77.8
GUAM14-TB	½	1⅞	2½	⅞	1⅞	.570	.610	5.6
GUAM16-TB	½	2	3½	⅞	2	.570	.610	12.5
GUAM24-TB	¾	2	2½	⅞	1⅞	.755	.810	6.2
GUAM26-TB	¾	2	3½	⅞	2	.755	.810	12.5
GUAM36-TB	1	2⅝	3½	⅞	2⅝	.935	1.035	14
GUAM47-TB	1¼	2⅞	4⅞	1	2⅝	1.260	1.360	29.2
GUAM69-TB	2	4⅞	5¼	1⅞	4⅝	1.880	2.047	80
GUAN14-TB	½	2⅞	2½	⅞	2	.570	.610	6.8
GUAN16-TB	½	2	3½	⅞	2	.570	.610	13.5
GUAN24-TB	¾	2⅝	2½	⅞	2⅝	.755	.810	7.7
GUAN26-TB	¾	2	3½	⅞	2	.755	.810	14
GUAN36-TB	1	2⅝	3½	⅞	2⅝	.935	1.035	16.9
GUAN47-TB	1¼	2⅞	4⅞	1	2⅝	1.260	1.360	31.5
GUAN59-TB	1½	4⅞	5¼	1⅞	4⅝	1.470	1.590	84
GUAN69-TB	2	4⅞	5¼	1⅞	4⅝	1.880	2.047	84
GUAT14-TB	½	2¼	2½	⅞	2¾	.570	.610	7
GUAT16-TB	½	2	3½	⅞	2	.570	.610	13.5
GUAT24-TB	¾	2	2½	⅞	1⅞	.755	.810	5.3
GUAT26-TB	¾	2	3½	⅞	2	.755	.810	13.3
GUAT36-TB	1	2⅝	3½	1	2⅝	.935	1.035	15.9
GUAT37-TB	1	2⅝	3½	⅞	2⅝	.935	1.035	23.3
GUAT47-TB	1¼	2⅞	4⅞	1	2⅝	1.260	1.360	29.3
GUAT49-TB	1¼	3⅞	5¼	1	3⅝	1.260	1.360	77.2
GUAT59-TB	1½	3⅞	5¼	1⅞	3⅝	1.470	1.590	77.7
GUAT69-TB	2	4⅞	5¼	1⅞	3⅝	1.880	2.047	77.8
GUAT79-TB	2½	4⅞	5¼	1⅞	4⅝	2.320	2.380	95
GUAW14-TB	½	1⅞	2½	⅞	1⅞	.570	.610	5.2
GUAW16-TB	½	2	3½	⅞	2	.570	.610	13
GUAW24-TB	¾	2	2½	⅞	1⅞	.755	.810	6.5
GUAW26-TB	¾	2	3½	⅞	2	.755	.810	13
GUAX14-TB	½	1⅞	2½	⅞	1⅞	.570	.610	5.2
GUAX16-TB	½	2	3½	⅞	2	.570	.610	13.5
GUAX24-TB	¾	2	2½	⅞	1⅞	.755	.810	5.3
GUAX26-TB	¾	2	3½	⅞	2	.755	.810	13.3
GUAX36-TB	1	2⅝	3½	1	2⅝	.935	1.035	16
GUAX37-TB	1	2⅝	3½	⅞	2⅝	.935	1.035	23.3
GUAX47-TB	1¼	2⅞	4⅞	1	2⅝	1.260	1.360	30
GUAX49-TB	1¼	3⅞	5¼	1	3⅝	1.260	1.360	72
GUAX59-TB	1½	3⅞	5¼	1⅞	3⅝	1.470	1.590	71
GUAX69-TB	2	4⅞	5¼	1⅞	4⅝	1.880	2.047	77.8

## GUA Conduit Device Box Replacement Covers

Cat. No.	Opening Dia.
GUA04-TB	2
GUA06-TB	3
GUA07-TB	3⅞
GUA09-TB	5

**T&B® Fittings****Aluminum Conduit Outlet Boxes  
Explosion-Proof, Dust-Ignition-Proof**

CI.I, Div. 1 & 2, Groups C, D  
 CI.II, Div. 1, Groups E, F, G  
 CI.III, Div. 1 & 2  
 NEMA 3, 4, 7 CD, 9 EFG

Explosionproof  
 Dust Ignition-proof  
 Raintight  
 Wet Locations



GAX



GAFX

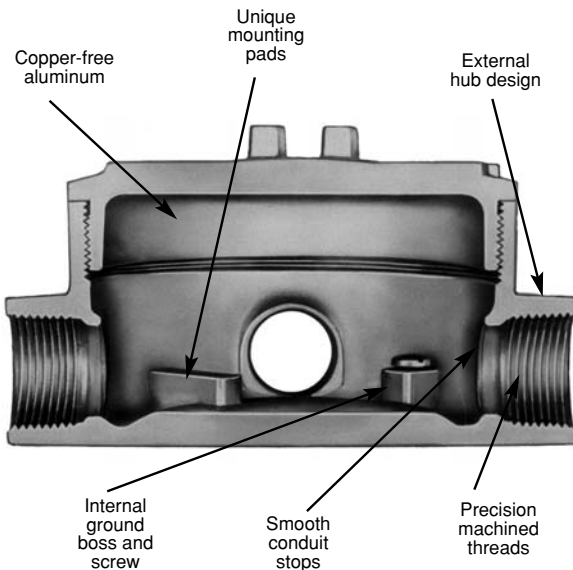

GAJU

**Application**

- Junction for branch conduits in hazardous locations.
- Accessible wiring chamber provides a convenient location to maintain or change a system, pull conductors and make splices.
- Unique mounting pads and external hub design ideal for installations of OEM devices or instruments.

**Features/Benefits**

- Copper-free\* aluminum provides increased corrosion resistance.
- Precision cast and machined surfaces permit safer wire pulling.
- Precision NPT threaded hubs allow trouble-free field installation for rigid or IMC conduit.
- Die cast construction and industrial design combine to produce a rugged protective enclosure for devices on industrial and OEM applications.
- Clear UL, CSA and cubic content markings speed approval by inspectors.

**Standard Materials**

- Die cast aluminum alloy A360 with less than .004 copper content (copper-free).

**Standard Finish**

- Aluminum lacquer finish

**Compliances**

- UL Listed
- CSA Certified
- Suitable for hazardous locations
- NEMA 4 rated when ordered with O-ring installed
- Federal Spec W-C-586

**Sample Specifications**

- Outlet boxes for hazardous locations shall be die cast copper-free\* aluminum alloy A360 and suitable for use in Class I, Groups C, D, Class II, Groups E, F, G and Class III areas. All conduit stops shall be coined and free of rough edges. Outlet boxes for hazardous locations shall be finished with aluminum lacquer. Outlet boxes shall be Red•Dot® Catalog No. \_\_\_\_\_

\*Less than .004 copper content.

# T&B® Fittings

Aluminum Conduit Outlet Boxes  
Explosion-Proof, Dust-Ignition-Proof

CI.I, Div. 1 & 2, Groups C, D  
CI.II, Div. 1, Groups E, F, G  
CI.III, Div. 1 & 2  
NEMA 3, 4, 7 CD, 9 EFG

Explosionproof  
Dust Ignition-proof  
Raintight  
Wet Locations

A

T&B® Fittings

## External Hubs with Installed Green Ground Screw



GAC



GAE

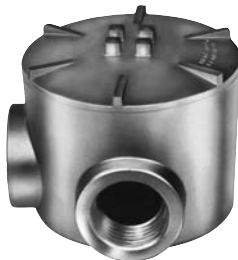

GAL



GALB



GAT

### Through Feed with Surface Cover

Cat. No.	Hub Size	Unit Qty.	Std. Pkg.	Wt. lbs. per 100
▶ GAC-1	½"	1	5	115
▶ GAC-2	¾"	1	5	115
▶ GAC-3	1"	1	5	115
▶ GAC-4	1¼"	1	5	175
▶ GAC-5	1½"	1	4	247
▶ GAC-6	2"	1	4	253

### Dead End with Surface Cover

Cat. No.	Hub Size	Unit Qty.	Std. Pkg.	Wt. lbs. per 100
▶ GAE-1	½"	1	5	110
▶ GAE-2	¾"	1	5	110
▶ GAE-3	1"	1	5	110

### L Style with Surface Cover

Cat. No.	Hub Size	Unit Qty.	Std. Pkg.	Wt. lbs. per 100
▶ GAL-1	½"	1	5	115
▶ GAL-2	¾"	1	5	115
▶ GAL-3	1"	1	5	115
▶ GAL-4	1¼"	1	5	175
▶ GAL-5	1½"	1	4	247
▶ GAL-6	2"	1	4	253

### LB Style with Surface Cover

Cat. No.	Hub Size	Unit Qty.	Std. Pkg.	Wt. lbs. per 100
▶ GALB-1	½"	1	5	115
▶ GALB-2	¾"	1	5	115
▶ GALB-3	1"	1	5	115
▶ GALB-4	1¼"	1	5	175
▶ GALB-5	1½"	1	4	247
▶ GALB-6	2"	1	4	253

### T Style with Surface Cover

Cat. No.	Hub Size	Unit Qty.	Std. Pkg.	Wt. lbs. per 100
▶ GAT-1	½"	1	5	120
▶ GAT-2	¾"	1	5	120
▶ GAT-3	1"	1	5	120
▶ GAT-4	1¼"	1	5	180
▶ GAT-5	1½"	1	4	48
▶ GAT-6	2"	1	4	406

- Made to order items. Consult factory for lead time and minimum quantities.
- ▶ Suffix-OR: O-ring available for NEMA 4 rating. Consult factory for lead time and price.

**Thomas & Betts**

**T&B® Fittings****Aluminum Conduit Outlet Boxes  
Explosion-Proof, Dust-Ignition-Proof**

Cl.I, Div. 1 & 2, Groups C, D  
Cl.II, Div. 1, Groups E, F, G  
Cl.III, Div. 1 & 2  
NEMA 3, 4, 7 CD, 9 EFG

Explosionproof  
Dust Ignition-proof  
Raintight  
Wet Locations



GAX



GAFX



GAS



GAD

**External Hubs with Installed Green Ground Screw and Covers****X Style with Surface Cover**

Cat. No.	Hub Size	Unit Qty.	Std. Pkg.	Wt. lbs. per 100
† GAX-1	½"	1	5	125
† GAX-2	¾"	1	5	125
† GAX-3	1"	1	5	125
† • GAX-4	1¼"	1	5	210
† • GAX-5	1½"	1	4	257
† • GAX-6	2"	1	4	413

**X Style with Flange and Surface Cover**

Cat. No.	Hub Size	Unit Qty.	Std. Pkg.	Wt. lbs. per 100
† GAFX-1	½"	1	4	135
† GAFX-2	¾"	1	4	135
† GAFX-3	1"	1	4	135

**Surface Style Cover**

Cat. No.	Cover Opening	Fits Boxes	Std. Pkg.	Wt. lbs. per 100
• GAS-123	3¼"	½", ¾", 1"	1	36
• GAS-4	3²⁹⁄₃₂"	1¼"	1	52
• GAS-56	5¾"	1½", 2"	1	69

**Dome Style Cover (Class I, Group D only)**

Cat. No.	Cover Opening	Fits Boxes	Inside Height	Std. Pkg.	Wt. lbs. per 100
• GAD-123	3¼"	½", ¾", 1"	2½"	1	71

• Made to order items. Consult factory for lead time and minimum quantities.

† Suffix-OR: O-ring available for NEMA 4 rating. Consult factory for lead time and price.



# T&B® Fittings

**Aluminum Conduit Outlet Boxes**  
**Explosion-Proof, Dust-Ignition-Proof**

CI.I, Div. 1 & 2, Groups C, D  
 CI.II, Div. 1, Groups E, F, G  
 CI.III, Div. 1 & 2  
 NEMA 3, 4, 7 CD, 9 EFG

Explosionproof  
 Dust Ignition-proof  
 Raintight  
 Wet Locations

**A**

**T&B® Fittings**

## External Hubs with Installed Green Ground Screw, Covers and Plugs



**GAJU**



**GAJ**

### U Style with Canopy Cover

Cat. No.	Hub Size	Unit Qty.	Std. Pkg.	Wt. lbs. per 100
• GAJU-1	1/2"	1	5	130
• GAJU-2	3/4"	1	5	130
• GAJU-3	1"	1	5	130
• GAJU-5	1 1/2"	1	1	267
• GAJU-6	2"	1	1	273

### Canopy Style Cover

Cat. No.	Cover Opening	Fits Boxes	Unit Qty.	Std. Pkg.	Wt. lbs. per 100
• GAJ-123	3 1/16"	1/2", 3/4", 1"	1	10	44
• GAJ-4	3 23/32"	1 1/4"	1	5	61
• GAJ-56	5 3/16"	1 1/2", 2"	1	5	78

• Made to order items. Consult factory for lead time and minimum quantities.

# T&B® Fittings

## Aluminum Conduit Outlet Boxes Explosion-Proof, Dust-Ignition-Proof

### Dimensions and Cubic Inches (CI)

CI.I, Div. 1 & 2, Groups C, D  
CI.II, Div. 1, Groups E, F, G  
CI.III, Div. 1 & 2  
NEMA 3, 4, 7 CD, 9 EFG

Explosionproof  
Dust Ignition-proof  
Raintight  
Wet Locations

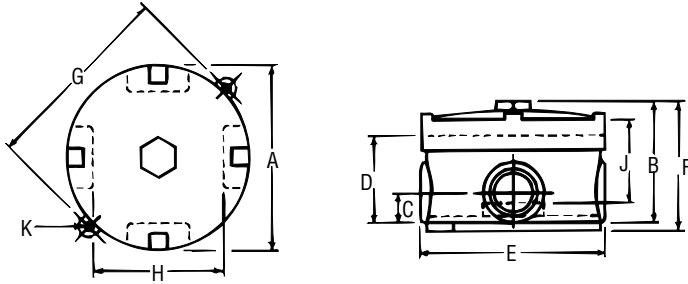

### EXUN & EXUNL

Hub Size	A	B	C	D	E	F	G	H	J	K	CI
1/2"	3 3/32"	3 1/8"	2 21/32"	2 1/16"	4	3 3/8"	4 1/4"	1 1/4"	1 9/16"	1 7/64"	20.3
3/4"	3 31/32"	3 1/8"	2 21/32"	2 1/16"	4	3 3/8"	4 1/4"	1 1/4"	1 9/16"	1 7/64"	20.3
1"	3 31/32"	3 5/16"	3/4"	2 1/4"	4	3 9/16"	4 1/4"	1 1/16"	1 9/16"	1 7/64"	20.0

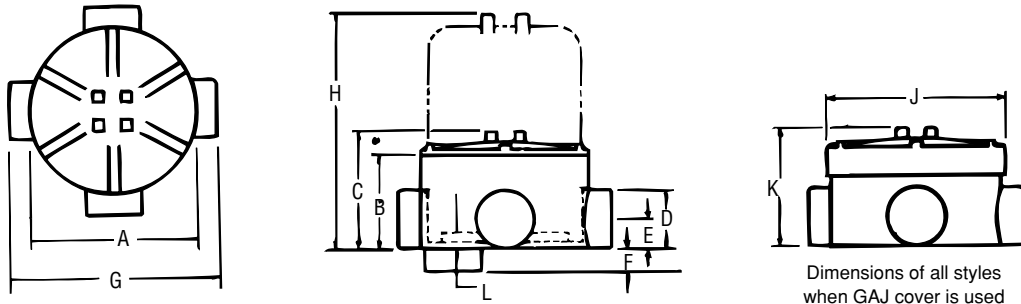

### GAC, GAE, GAL, GALB, GAT, GAX

Cover Opening	Hub Size	A	B	C	D	E	F	G	H	J	K	L	CI
3 1/16"	1/2"	4"	2 1/4"	2 15/16"	1 3/8"	1 1/16"	1 1/16"	5 3/16"	5 9/16"	4 3/16"	3 3/16"	9/16"	18.8
3 1/16"	3/4"	4"	2 1/4"	2 15/16"	1 3/8"	1 1/16"	1 1/16"	5 3/16"	5 9/16"	4 3/16"	3 3/16"	9/16"	18.8
3 1/16"	1"	4"	2 1/4"	2 15/16"	1 5/8"	1 9/16"	2 7/32"	5 1/2"	5 9/16"	4 3/16"	3 3/16"	9/16"	18.8
3 29/32"	1 1/4"	4 3/16"	3"	3 11/16"	2 1/16"	1 1/32"	7/8"	5 11/16"	—	4 9/16"	3 15/16"	5/8"	28.0
5 3/16"	1 1/2"	5 3/4"	4 1/4"	5 1/16"	2 7/8"	1 7/16"	7/8"	6 5/8"	—	6 7/16"	5 15/32"	1 3/16"	69.3
5 3/16"	2"	5 3/4"	4 1/4"	5 1/16"	2 7/8"	1 7/16"	7/8"	6 5/8"	—	6 7/16"	5 15/32"	1 3/16"	69.3

# T&B® Fittings

## Aluminum Conduit Outlet Boxes Explosion-Proof, Dust-Ignition-Proof

CI.I, Div. 1 & 2, Groups C, D  
CI.II, Div. 1, Groups E, F, G  
CI.III, Div. 1 & 2  
NEMA 3, 4, 7 CD, 9 EFG

Explosionproof  
Dust Ignition-proof  
Raintight  
Wet Locations

A

T&B® Fittings

### Dimensions and Cubic Inches (CI)

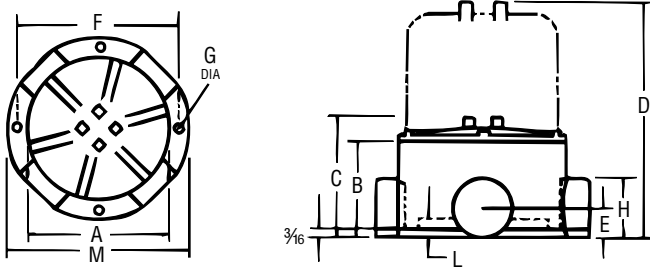

### GAFX

Cover Opening	Hub Size	A	B	C	D	E	F	G	H	L	M	CI
3 1/16"	1/2"	4"	2 1/4"	2 15/16"	5 9/16"	1 1/16"	4 1/2"	1/4"	1 3/8"	9/16"	5 3/16"	20.0
3 1/16"	3/4"	4"	2 1/4"	2 19/16"	5 9/16"	1 1/16"	4 1/2"	1/4"	1 3/8"	9/16"	5 3/16"	20.0
3 1/16"	1"	4"	2 1/4"	2 15/16"	5 9/16"	1 3/16"	4 3/4"	5/16"	1 5/8"	9/16"	5 1/2"	19.0

Note: All GAF units supplied as X configuration with proper number of explosion-proof close-up plugs to make C, T or L.

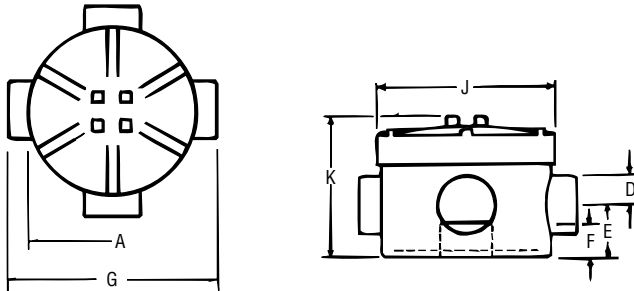

### GAJU

Cover Opening	Hub Size	A	D	E	F	G	J	K	CI
3 1/16"	1/2"	4"	1 3/16"	1 1/2"	3 1/32"	5 3/16"	4 3/16"	4"	23.8
3 1/16"	3/4"	4"	1 3/16"	1 1/2"	3 1/32"	5 3/16"	4 3/16"	4"	23.8
3 1/16"	1"	4"	1 3/16"	1 1/2"	3 1/32"	5 3/16"	4 3/16"	4"	23.8
3 29/32"	1 1/4"	4 5/16"	2 1/16"	1 1/32"	7/8"	5 1 1/16"	4 3/4"	3 15/16"	33.3
5 3/16"	1 1/2"	5 3/4"	1 7/16"	2 1/16"	1 1/2"	6 5/8"	6 7/16"	6 3/16"	82.8
5 3/16"	2"	5 3/4"	1 7/16"	2 1/16"	1 1/2"	6 5/8"	6 7/16"	6 3/16"	82.8

Note: All GA & GAF series boxes are supplied with GAS or GAJ style covers. To order these boxes with GAD dome cover, consult factory.

**Thomas & Betts**

**T&B® Fittings****Aluminum Conduit Outlet Boxes  
Explosion-Proof, Dust-Ignition-Proof**

CI.I, Div. 1 & 2, Groups C, D  
 CI.II, Div. 1, Groups E, F, G  
 CI.III, Div. 1 & 2  
 NEMA 3, 4, 7 CD, 9 EFG

Explosionproof  
 Dust Ignition-proof  
 Raintight  
 Wet Locations



EXUN



EXUNL

**Application**

- Junction for branch conduits in hazardous locations.
- Accessible wiring chamber provides a convenient location to maintain or change a system, pull conductors and make splices.
- Internal hub design ideal for installation where space is limited.

**Features/Benefits**

- Copper-free\* aluminum provides increased corrosion resistance.
- Precision cast and machined surfaces permit safer wire pulling.
- Precision NPT threaded hubs allow trouble-free field installation for rigid or IMC conduit.
- Die cast construction and industrial design combine to produce a rugged protective enclosure for devices on industrial and OEM applications.
- Clear UL, CSA and cubic content markings speed approval by inspectors.

**Standard Materials**

- Die cast aluminum alloy A360 with less than .004 copper content (copper-free).

**Standard Finish**

- Aluminum lacquer finish

**Compliances**

- UL Listed
- CSA Certified
- Suitable for hazardous locations
- Federal Spec W-C-586

**Sample Specifications**

- Outlet boxes for hazardous locations shall be die cast copper-free\* aluminum alloy A360 and suitable for use in Class I, Groups C, D, Class II, Groups E, F, G and Class III areas. All conduit stops shall be coined and free of rough edges. Outlet boxes for hazardous locations shall be finished with aluminum lacquer. Outlet boxes shall be Red•Dot® Catalog No. \_\_\_\_\_

\*Less than .004 copper content.

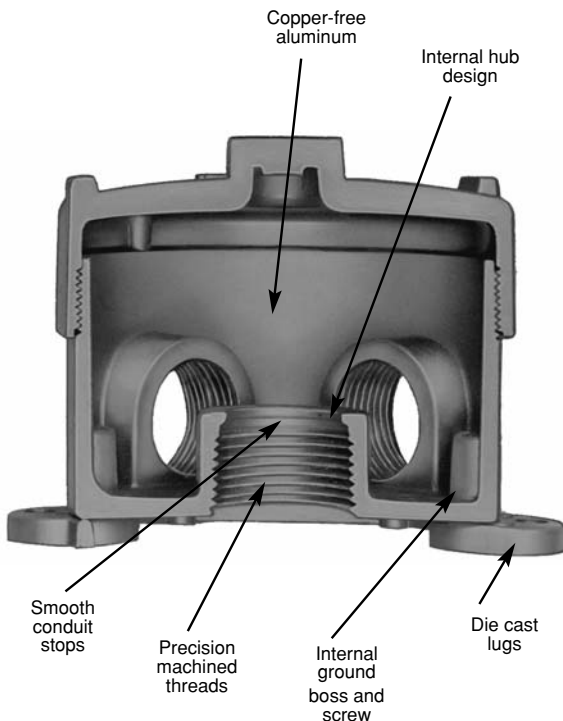

# T&B® Fittings

## Aluminum Conduit Outlet Boxes Explosion-Proof, Dust-Ignition-Proof

CI.I, Div. 1 & 2, Groups C, D  
CI.II, Div. 1, Groups E, F, G  
CI.III, Div. 1 & 2  
NEMA 3, 4, 7 CD, 9 EFG

Explosionproof  
Dust Ignition-proof  
Raintight  
Wet Locations

A

T&B® Fittings

### Internal Hubs with Installed Green Ground Screw



EXUN-1



EXUN-11

#### 5 Hole Box

Cat. No.	Hub Size	Description	Unit Qty.	Std. Pkg.	Wt. lbs. per 100
EXUN-1	1/2"	5 outlets	1	5	140
EXUN-2	3/4"	with 3 close-up plugs	1	5	140
EXUN-3	1"	with 3 close-up plugs	1	5	140

#### 4 Hole Box

Cat. No.	Hub Size	Description	Unit Qty.	Std. Pkg.	Wt. lbs. per 100
EXUN-11	1/2"	4 outlets	1	5	140
EXUN-22	3/4"	with 2 close-up plugs	1	5	140

**T&B® Fittings****Aluminum Conduit Outlet Boxes  
Explosion-Proof, Dust-Ignition-Proof**

CI.I, Div. 1 & 2, Groups C, D  
 CI.II, Div. 1, Groups E, F, G  
 CI.III, Div. 1 & 2  
 NEMA 3, 4, 7 CD, 9 EFG

Explosionproof  
 Dust Ignition-proof  
 Raintight  
 Wet Locations

**GASS****Application**

- Junction for branch conduits in hazardous locations.
- Accessible wiring chamber provides a convenient location to maintain or change a system, pull conductors and make splices.

**Features/Benefits**

- Copper-free\* aluminum alloy provides increased corrosion resistance.
- Extra wide 3¾" opening provides more hand space for easy access to the wiring chamber.
- Precision cast and machined surfaces permit safer wire pulling.
- Large capacity 31 cu. in. chamber provides more wiring space.
- Precision NPT threaded hubs allow trouble-free field installation for rigid or IMC conduit.
- Sand cast construction and industrial design combine to produce a rugged protective enclosure for devices on industrial and OEM applications.
- Clear UL, CSA and cubic content markings speed approval by inspectors.
- Hub spacing allows use of EXFU and EXMU unions.

**Standard Materials**

- Box - Sand Cast aluminum alloy A356. 2-T6
- Cover - Die Cast aluminum alloy A360 with less than .004 copper content (copper-free)

**Standard Finish**

- Aluminum lacquer finish

**Compliances**

- UL Listed
- CSA Certified
- NEC

**Sample Specifications**

- Enclosure for hazardous locations. The box shall be cast copper-free\* aluminum alloy A356.2-T6 . Suitable for use in hazardous locations: Suitable for use in Class I, Groups C, D; Class II, Groups E, F, G; and Class III areas. Enclosures shall be finished with aluminum lacquer. Outlet boxes shall be Red•Dot® Catalog No. \_\_\_\_\_

\*Less than .004 copper content.

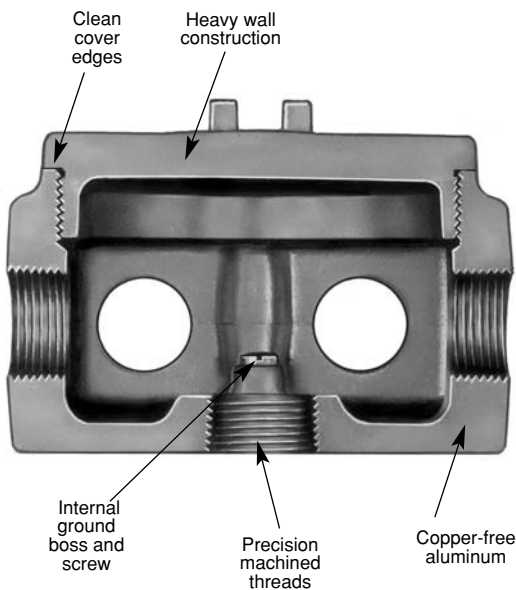

# T&B® Fittings

## Aluminum Conduit Outlet Boxes Explosion-Proof, Dust-Ignition-Proof

CI.I, Div. 1 & 2, Groups C, D  
CI.II, Div. 1, Groups E, F, G  
CI.III, Div. 1 & 2  
NEMA 3, 4, 7 CD, 9 EFG

Explosionproof  
Dust Ignition-proof  
Raintight  
Wet Locations

A

T&B® Fittings

### Internal Hubs with Installed Green Ground Screw, Cover and Plugs



GASS

Cat. No.	Hub Size	Unit Qty.	Std. Pkg.	Wt. lbs. per 100
GASS-1	1/2"	1	5	282
GASS-2	3/4"	1	5	278
GASS-3	1"	1	5	274

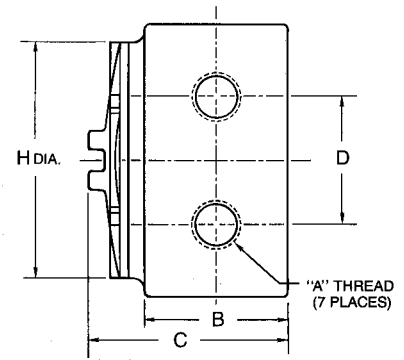
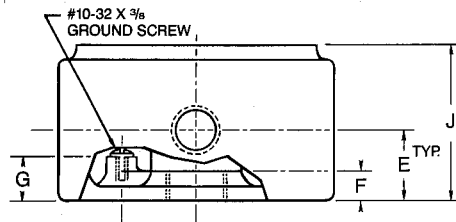
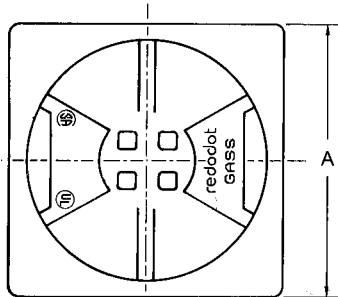

Dimensions of all styles  
when GASS cover is used

### GASS

Cover Opening	Hub Size	A	B	C	D	E	F	G	H	J	CI
4"	1/2"	4 5/8	2 3/8	3 3/8	2 3/16	1 3/16	1/2	3/4	4	2 5/8	31
4"	3/4"	4 5/8	2 3/8	3 3/8	2 3/16	1 3/16	1/2	3/4	4	2 5/8	31
4"	1"	4 5/8	2 3/8	3 3/8	2 3/16	1 3/16	1/2	3/4	4	2 5/8	31

**T&B® Fittings****Aluminum Conduit Outlet Bodies  
Explosion-Proof, Dust-Ignition-Proof**

CI.I, Div. 1 & 2, Groups C, D  
 CI.II, Div. 1, Groups E, F, G  
 CI.III, Div. 1 & 2  
 NEMA 3, 4, 7 CD, 9 EFG

Explosionproof  
 Dust Ignition-proof  
 Raintight  
 Wet Locations

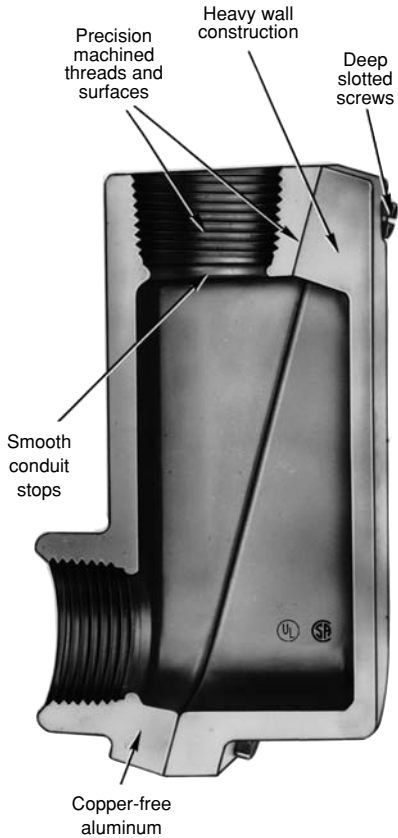
**Application**

- Junction for branch conduits.
- Accessible wiring chamber provides a convenient location to pull conductors and make splices.

**Features/Benefits**

- Copper-free\* aluminum provides increased corrosion resistance.
- Precision cast and machined surfaces permit safer wire pulling.
- Precision NPT threaded hubs allow trouble-free field installation for rigid or IMC conduit.
- Deep slotted cover screws for faster installation.
- Clear UL, CSA and cubic content markings speed approval by inspectors.

**Standard Materials**

- Die cast aluminum alloy A360 with less than .004 copper content (copper-free).

**Standard Finish**

- Aluminum lacquer finish

**Compliances**

- UL Listed
- CSA Certified
- Suitable for hazardous locations

**Sample Specifications**

- Conduit fittings for hazardous locations shall be die cast copper free\* aluminum alloy A360. Suitable for use in hazardous locations: Class I, Groups C, D; Class II, Groups E, F, G and Class III. All conduit stops shall be coined and free of rough edges. Conduit fittings shall be finished with aluminum lacquer. Conduit fittings shall be Red•Dot® Catalog No. \_\_\_\_\_

\*Less than .004 copper content.



EXLB



EXT

**LB Style Conduit Body – Aluminum**

Cat. No.	Hub Size	Std. Pkg.	Wt. lbs. per 100
EXLB-1	½"	5	76
EXLB-2	¾"	5	94
EXLB-3	1"	5	132

**T Style Conduit Body – Aluminum**

Cat. No.	Hub Size	Unit Qty.	Std. Pkg.	Wt. lbs. per 100
EXT-1	½"	5	25	92
EXT-2	¾"	5	25	115
EXT-3	1"	5	5	172

**Thomas&Betts**



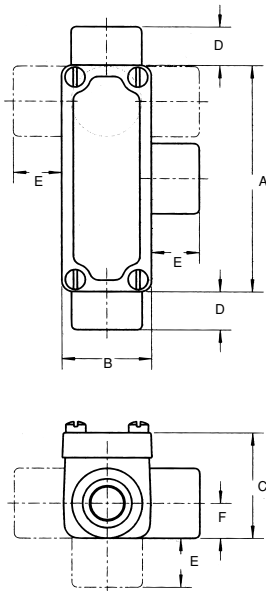

### Application

OE series are installed in conduit systems within hazardous areas to:

- Protect conductors in threaded rigid conduit.
- Act as pulling and splice fittings.
- Interconnect lengths of conduit.
- Change direction of conduit.
- Provide access for maintenance and future system changes.

### Features

OE conduit bodies have:

- Tapered threaded hubs for ground continuity.
- Smooth integral hub bushings to protect conductor insulation when pulling.
- Five different hub arrangements.
- Accurately machined body with blind tapped screw holes.
- Most compact design of all hazardous area outlet bodies.
- Sizes up to 1".

### Standard Materials

- Bodies: Grade 60-45-10 Ductile Iron (Complies with ASTM standard A536)

### Standard Finish

- Electrogalvanized and aluminum acrylic paint.

### Size Ranges

- Hub – ½" and ¾"

### Certifications and Compliances

- NEC/CEC: Class I, Division 1 & 2, Groups C, D  
Class II, Division 1, Groups E, F, G  
Class II, Division 2, Groups F, G  
Class III

## OE Series – Iron Conduit Outlet Bodies

Cat. No.	Hub Size	A	B	C	D	E	F
OEC1-TB	½"	4.06	1.62	1.90	0.69	0.88	0.63
OEC2-TB	¾"	4.35	1.88	2.19	0.69	0.88	0.76
OET1-TB	½"	4.06	1.62	1.90	0.69	0.88	0.63
OET2-TB	¾"	4.35	1.88	2.19	0.69	0.88	0.76
OELL1-TB	½"	4.06	1.62	1.90	0.69	0.88	0.63
OELL2-TB	¾"	4.35	1.88	2.19	0.69	0.88	0.76
OELR1-TB	½"	4.06	1.62	1.90	0.69	0.88	0.63
OELR2-TB	¾"	4.35	1.88	2.19	0.69	0.88	0.76
OELB1-TB	½"	4.06	1.62	1.90	0.69	0.88	0.63
OELB2-TB	¾"	4.35	1.88	2.19	0.69	0.88	0.76

# T&B® Fittings

## Conduit Outlet Elbows Explosionproof, Dust-Ignitionproof

Cl.I, Div. 1 & 2, Groups C, D  
Cl.II, Div. 1, Groups E, F, G  
Cl.III, Div. 1 & 2  
NEMA 3, 4, 7 CD, 9 EFG

Explosionproof  
Dust-Ignitionproof  
Raintight  
Wet Locations



LBY

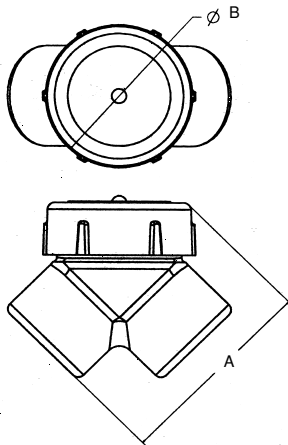

### LBY Elbows have:

- Maximum volume for bends within a compact overall size.
- Screw on cover for ease of installation and removal.
- Cover opening on an angle, permitting conductors to be pulled straight through either hub.
- Tapered threaded hubs and integral bushing for rigid threaded conduit.



GYF

## Conduit Bodies and Capped Elbows

### Application

LBY/GYF elbows are installed in conduit systems within hazardous areas to:

- Make 90° bends in conduit systems where space is limited.
- Act as pull outlets.
- Provide access to conductors for maintenance and future system changes.

### Features

- Maximum volume for bends within a compact overall size.
- Screw on cover for ease of installation and removal.
- Cover opening on an angle, permitting conductors to be pulled straight through either hub.
- Tapered threaded hubs and integral bushing for rigid threaded conduit.

### LBY –

Class I, Division 1 & 2, Groups C,D  
Class II, Division 1, Groups F,G  
Class III  
Class I, Division 1 & 2, Groups C,D  
Class II, Division 1, Groups F,G  
Class III



## Capped Iron Elbow – Female to Female

Cat. No.	Hub Size	A	B	Throat Dim.	
				Min	Max
LBY15-TB	½	2 <sup>5</sup> / <sub>16</sub>	2	0.570	0.610
LBY25-TB	¾	2 <sup>13</sup> / <sub>16</sub>	2¼	0.755	0.810
LBY35-TB	1	3 <sup>3</sup> / <sub>2</sub>	2½	0.955	1.035
LBY45-TB	1¼	3¾	2 <sup>15</sup> / <sub>16</sub>	1.260	1.360
LBY55-TB	1½	4¼	3 <sup>3</sup> / <sub>8</sub>	1.470	1.590
LBY65-TB	2	5½	4	1.880	2.047



## Capped Aluminum Elbow – Female to Female

Cat. No.	Hub Size	Unit Qty.	Std. Pkg.	Wt. lbs. per 100
GYF-1	½"	10	50	23
GYF-2	¾"	5	25	40
GYF-3	1"	5	25	60
• GYF-4	1¼"	2	10	80
GYF-5	1½"	2	10	95

- Made to order items. Consult factory for lead time and minimum quantities.

**Thomas & Betts**

# T&B® Fittings

## RE, PLG, REC Reducers, Plugs and Adapters Explosionproof, Dust-Ignitionproof

CI.I, Div. 1 & 2, Groups A, B, C, D    Explosionproof  
CI.II, Div. 1, Groups E, F, G    Dust-Ignitionproof  
CI.III, Div. 1 & 2

A

T&B® Fittings



### Application

- RE and REC reducers are used in threaded heavy wall conduit systems.
- RE reduces conduit hubs to a smaller size.
- REC connects two different sizes of conduit together or is used to replace a coupling and reducer in an installation.
- PLG plugs are used for closing threaded conduit hubs.

### Features

- All Hubs have NPT threads with a minimum of five full threads and integral bushing for preventing damage to wires.

### Materials

- Machined Reducers: Steel
- Cast Reducers: Gray Iron

- Funnel Reducers: Iron
- Recessed Plugs: Gray Iron
- red•dot® Recessed Plugs: Copper-free Aluminum

### Standard Finishes

- Cast zinc-plated with aluminum acrylic paint
- Machine zinc-plated with clear chromate finish

### Listing Certifications

- UL: 886
- CSA: C22.2 No.30
- NEC/CEC: CI.I, Div. 1 & 2, Groups A, B, C, D  
CI.II, Div. 1, Groups E, F, G  
CI.III

For hazardous and non-hazardous locations



### Reducing Bushings

Cat. No.	A Male (NPT)	B Female (NPT)
RE21-TB	3/4	1/2
RE31-TB	1	1/2
RE32-TB	1	3/4
RE41-TB	1 1/4	1/2
RE42-TB	1 1/4	3/4
RE43-TB	1 1/4	1
RE51-TB	1 1/2	1/2
RE52-TB	1 1/2	3/4
RE53-TB	1 1/2	1
RE54-TB	1 1/2	1 1/4
RE61-TB	2	1/2
RE62-TB	2	3/4
RE63-TB	2	1
RE64-TB	2	1 1/4
RE65-TB	2	1 1/2
RE73-TB	2 1/2	1
RE74-TB	2 1/2	1 1/4
RE75-TB	2 1/2	1 1/2
RE76-TB	2 1/2	2
RE83-TB	3	1
RE84-TB	3	1 1/4
RE85-TB	3	1 1/2
RE86-TB	3	2
RE87-TB	3	2 1/2
RE96-TB	3 1/2	2
RE97-TB	3 1/2	2 1/2
RE98-TB	4	3
RE106-TB	4	2
RE107-TB	4	2 1/2
RE108-TB	4	3

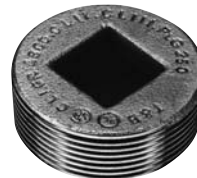

### Recessed Plugs

Cat. No.	Threads (NPT)
<b>With Flush Head for Hazardous and Non-Hazardous Locations</b>	
PLG1-TB	1/2
PLG2-TB	3/4
PLG3-TB	1
PLG4-TB	1 1/4
PLG5-TB	1 1/2
PLG6-TB	2
PLG7-TB	2 1/2
PLG8-TB	3
PLG9-TB	3 1/2
PLG10-TB	4

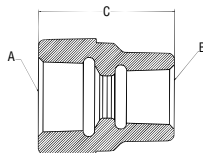

### REC Series Reducers

Cat. No.	A (NPT)	B (NPT)	C
<b>Funnel Shaped Reducers for Hazardous and Non-Hazardous Locations</b>			
REC21-TB	3/4	1/2 - 14	1 1/8
REC31-TB	1	1/2 - 14	2
REC32-TB	1	3/4 - 14	2



### Aluminum Recessed Plugs

Cat. No.	Hub Size
<b>With Flush Head for Hazardous and Non-Hazardous Locations</b>	
XPLG-1†	1/2"
XPLG-2†	3/4"
XPLG-3†	1"
XPLG-4*	1 1/4"
XPLG-5*	1 1/2"
XPLG-6*	2"
XPLG-7*	2 1/2"
XPLG-8*	3"
XPLG-9*	3 1/2"
XPLG-10*	4"

Made to order items. Consult factory for lead time and minimum quantities.

† Not U.L. Listed

\* U.L. Listed E 34438

**Thomas & Betts**

**T&B® Fittings****Three-Piece Couplings**  
**Explosionproof, Dust-Ignitionproof**

CI.I, Div. 1 & 2, Groups A,B,C,D  
 CI.II, Div. 1, Groups E, F, G  
 CI.III, Div. 1 & 2

Explosionproof  
 Dust-Ignitionproof

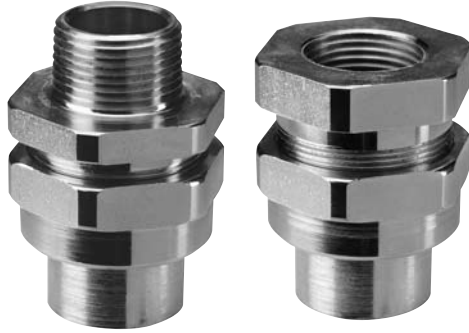

UNY

UNF

**Application**

UNY and UNF unions are installed in threaded thickwall conduit systems:

- UNY – to connect conduit to a conduit fitting, junction box, or device enclosure.
- UNF – to connect conduit to conduit, or to provide a means for future modification of the conduit system.

**Standard Finishes**

- Steel – electrogalvanized with chromate treatment.
- Iron alloy, malleable iron – electrogalvanized and aluminum acrylic paint

**Certifications and Compliances\***

- NEC/CEC
  - Class I, Division 1 & 2, Groups A,B,C,D
  - Class II, Division 1, Groups E,F,G
  - Class III
    - UNF, UNY ½" – 1"
- UL – Conduit unions for use in Cat. Nos. UNF/UNY followed by 105, 205, or 305; for use in:
  - Class I, Division 1 & 2, Groups A,B,C,D
  - Class II, Division 1, Groups E,F,G
  - Class III
    - UNF, UNY ½", ¾", 1"
- CSA – Conduit unions for use in Cat. Nos. UNF/UNY followed by 105, 205, 305, 405 or 505; for use in:
  - Class I, Division 1 & 2, Groups B,C,D
  - Class II, Division 1, Groups E,F,G
  - Class III
    - UNF, UNY ½", ¾", 1", 1¼", 1½"
- UL – Conduit unions for use in Cat. Nos. UNF/UNY followed by 405 or 505; for use in:
  - Class I, Division 1 & 2, Groups B,C,D
  - Class II, Division 1, Groups E,F,G
  - Class III
    - UNF, UNY 1¼", 1½"
- UL & CSA – Conduit unions for use in Cat. Nos. UNF/UNY, EL Series followed by 605, 905, or 1005; for use in:
  - Class I, Division 1 & 2, Groups C,D
  - Class II, Division 1, Groups E,F,G
  - Class III
    - UNF, UNY 2", 2½", 3", 3½", 4"

# T&B® Fittings

Three-Piece Couplings  
Explosionproof, Dust-Ignitionproof

Cl.I, Div. 1 & 2, Groups C, D  
Cl.II, Div. 1, Groups E, F, G  
Cl.III, Div. 1 & 2  
NEMA 3, 4, 7 CD, 9 EFG

Explosionproof  
Dust-Ignitionproof  
Raintight  
Wet Locations



A

T&B® Fittings



UNY

## UNY Male Unions

Cat. No.	TR Size	Overall Length/Inches	Overall Dia./Inches
<b>For Hazardous and Non-Hazardous Locations</b>			
UNY105-TB	1/2	2 <sup>5</sup> / <sub>16</sub>	1 1/2
UNY205-TB	3/4	2 <sup>7</sup> / <sub>16</sub>	1 <sup>13</sup> / <sub>16</sub>
UNY305-TB	1	2 <sup>3</sup> / <sub>4</sub>	2
UNY405-TB	1 1/4	3 <sup>1</sup> / <sub>16</sub>	2 3/4
UNY505-TB	1 1/2	3 <sup>5</sup> / <sub>16</sub>	3 <sup>1</sup> / <sub>16</sub>
UNY605-TB	2	3 <sup>1</sup> / <sub>2</sub>	3 <sup>9</sup> / <sub>16</sub>
UNY705-TB	2 1/2	4 <sup>3</sup> / <sub>16</sub>	4 <sup>5</sup> / <sub>16</sub>
UNY805-TB	3	5 <sup>1</sup> / <sub>32</sub>	5 <sup>1</sup> / <sub>16</sub>
UNY905-TB	3 1/2	5 <sup>1</sup> / <sub>2</sub>	5 <sup>1</sup> / <sub>16</sub>
UNY1005-TB	4	5 <sup>5</sup> / <sub>16</sub>	6 <sup>3</sup> / <sub>16</sub>

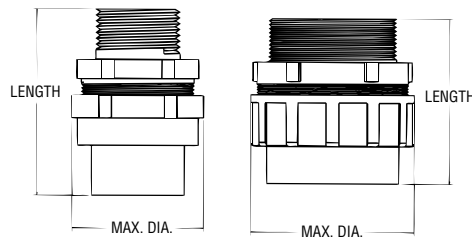

UNF

## UNF Female Unions

Cat. No.	TR Size	Overall Length/Inches	Overall Dia./Inches
<b>For Hazardous and Non-Hazardous Locations</b>			
UNF105-TB	1/2	1 <sup>1</sup> / <sub>16</sub>	1 1/2
UNF205-TB	3/4	2 <sup>1</sup> / <sub>16</sub>	1 <sup>13</sup> / <sub>16</sub>
UNF305-TB	1	2 <sup>9</sup> / <sub>32</sub>	2
UNF405-TB	1 1/4	2 <sup>1</sup> / <sub>4</sub>	2 3/4
UNF505-TB	1 1/2	2 <sup>3</sup> / <sub>4</sub>	3 <sup>1</sup> / <sub>16</sub>
UNF605-TB	2	2 <sup>1</sup> / <sub>2</sub>	3 <sup>9</sup> / <sub>16</sub>
UNF705-TB	2 1/2	3 <sup>1</sup> / <sub>2</sub>	4 <sup>9</sup> / <sub>16</sub>
UNF805-TB	3	4	5 <sup>1</sup> / <sub>16</sub>
UNF905-TB	3 1/2	4 <sup>9</sup> / <sub>32</sub>	5 <sup>1</sup> / <sub>16</sub>
UNF1005-TB	4	4 <sup>1</sup> / <sub>4</sub>	6 <sup>3</sup> / <sub>16</sub>



Thomas & Betts

**T&B® Fittings****Aluminum Three-Piece Couplings  
Explosion-Proof, Dust-Ignition-Proof**

EXFU



EXMU

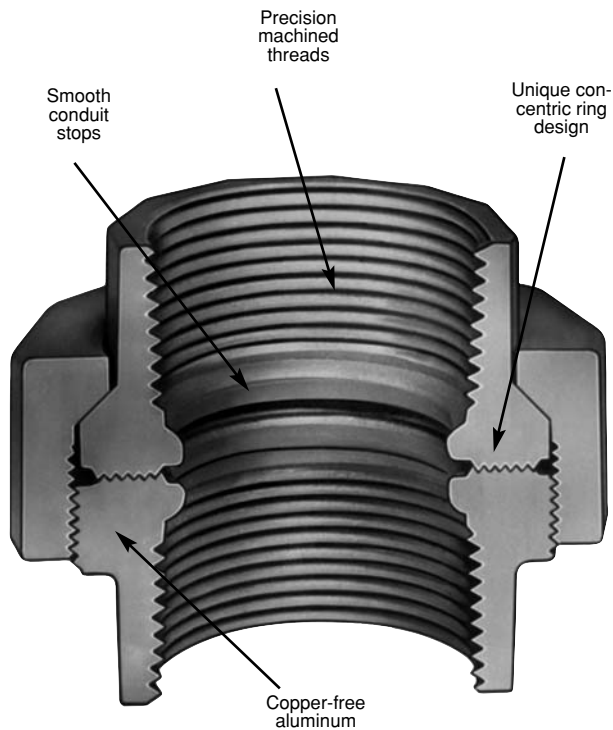

CI.I, Div. 1 & 2, Groups C, D  
 CI.II, Div. 1, Groups E, F, G  
 CI.III, Div. 1 & 2  
 NEMA 3, 4, 7 CD, 9 EFG

Explosionproof  
 Dust Ignition-proof  
 Raintight  
 Wet Locations  

**Application**

- Unions are used as connecting elements between enclosures, fittings or boxes which permit future changes to the system in both hazardous and non-hazardous areas.

**Features/Benefits**

- Copper-free\* aluminum provides increased corrosion resistance.
- Precision cast and machined surfaces permit safer wire pulling.
- Precision NPT threaded hubs allow trouble-free field installation for rigid or IMC conduit.
- Clear UL, CSA and cubic content markings speed approval by inspectors.
- Unique concentric ring design insures critical flame path control.

**Standard Materials**

- Die cast aluminum alloy A360 with less than .004 copper content (copper-free).
- EXMU nipples are galvanized steel.

**Standard Finish**

- Aluminum lacquer finish

**Compliances**

- UL Listed
- CSA Certified
- Suitable for hazardous locations
- Federal Spec W-C-586

**Sample Specifications**

- Conduit unions for hazardous locations shall be die cast copper-free\* aluminum alloy A360. Suitable for use in hazardous locations: Class I, Groups C, D; Class II, Groups E, F, G and Class III. All conduit stops shall be coined and free of rough edges. Conduit unions shall be finished with aluminum lacquer. Conduit unions shall be Red•Dot® Catalog No. \_\_\_\_\_

\*Less than .004 copper content.

# T&B® Fittings

## Aluminum Three-Piece Couplings Explosion-Proof, Dust-Ignition-Proof

CI.I, Div. 1 & 2, Groups C, D  
CI.II, Div. 1, Groups E, F, G  
CI.III, Div. 1 & 2  
NEMA 3, 4, 7 CD, 9 EFG

Explosionproof  
Dust Ignition-proof  
Raintight  
Wet Locations

A

T&B® Fittings



### Male and Female Unions

#### Female to Female

Cat. No.	Hub Size	Unit Qty.	Std. Pkg.	Wt. lbs. per 100
EXFU-1	½"	5	25	24
EXFU-2	¾"	5	25	33
EXFU-3	1"	5	25	42
EXFU-4	1¼"	5	25	53
EXFU-5	1½"	5	25	68
• EXFU-6	2"	2	10	130
• EXFU-7	2½"	2	10	270
• EXFU-8	3"	1	5	310
• EXFU-9	3½"	1	5	340
• EXFU-10	4"	1	1	374



#### Male to Female

Cat. No.	Hub Size	Unit Qty.	Std. Pkg.	Wt. lbs. per 100
EXMU-1	½"	5	25	24
EXMU-2	¾"	5	25	35
EXMU-3	1"	5	25	45
• EXMU-4	1¼"	5	25	64
• EXMU-5	1½"	5	25	84
• EXMU-6	2"	2	10	155
• EXMU-7	2½"	2	10	300
• EXMU-8	3"	1	5	340
• EXMU-9	3½"	1	5	400
• EXMU-10	4"	1	1	410

• Made to order items. Consult factory for lead time and minimum quantities.



EXFU



EXMU

**T&B® Fittings****Elbows****Explosionproof, Dust-Ignitionproof**

CI.I, Div. 1 & 2, Groups C, D  
 CI.II, Div. 1, Groups E, F, G  
 CI.III, Div. 1 & 2  
 NEMA 3, 4, 7 CD, 9 EFG

Explosionproof  
 Dust-Ignitionproof  
 Raintight  
 Wet Locations

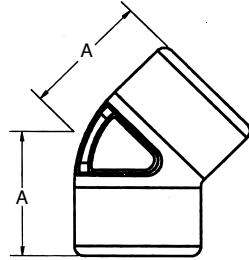
**45° Female Elbow**

Cat. No.	Hub Size	A
EL1-TB	½	1.268
EL2-TB	¾	1.402
EL3-TB	1	1.643
EL4-TB	1¼	1.846
EL5-TB	1½	2.14
EL6-TB	2	2.326
EL7-TB	2½	2.848
EL8-TB	3	3.149
EL9-TB	3½	3.533
EL10-TB	4	3.975

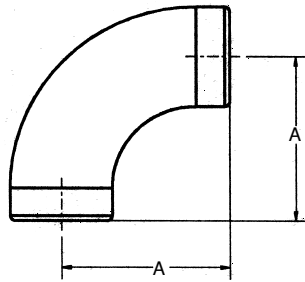
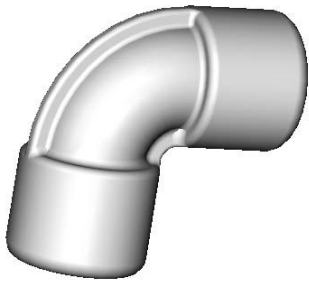
**90° Female Elbow**

Cat. No.	Hub Size	A
EL19-TB	1½	1.75
EL29-TB	¾	1.965
EL39-TB	1	2.15
EL49-TB	1¼	2.425
EL59-TB	1½	4.047
EL69-TB	2	5.02
EL79-TB	2½	6.375

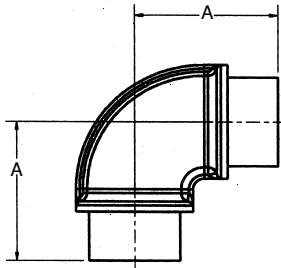
**90° Male Elbow**

Cat. No.	Hub Size	A
EL195-TB	½	1.422
EL295-TB	¾	1.625
EL395-TB	1	1.875

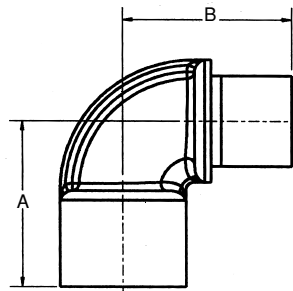
**90° Male & Female Elbow**

Cat. No.	Hub Size	A	B
EL196-TB	½	1.695	1.675
EL296-TB	¾	1.933	1.813
EL396-TB	1	2.085	2.17
EL496-TB	1¼	2.46	2.281



# T&B® Fittings

Flexible Couplings  
Explosionproof, Dust-Ignitionproof

Cl. I, Div. 1 & 2, Groups A, B, C, D  
Cl. II, Div. 1, Groups E, F, G  
Cl. III, Div. 1 & 2

NEMA7 ABCD  
9EFG  
12

A

T&B® Fittings



EXFC Series

## Male to Male

Cat. No.	Conduit Size	Flex Length	Std. Pkg.	Wt. lbs per 100
• EXFC-104	½"	4"	1	175
EXFC-106	½"	6"	1	200
EXFC-108	½"	8"	1	225
EXFC-110	½"	10"	1	238
EXFC-112	½"	12"	1	250
EXFC-115	½"	15"	1	262
EXFC-118	½"	18"	1	300
• EXFC-121	½"	21"	1	312
EXFC-124	½"	24"	1	325
EXFC-127	½"	27"	1	337
• EXFC-130	½"	30"	1	350
• EXFC-133	½"	33"	1	375
EXFC-136	½"	36"	1	400
• EXFC-204	¾"	4"	1	200
EXFC-206	¾"	6"	1	225
EXFC-208	¾"	8"	1	237
EXFC-210	¾"	10"	1	250
EXFC-212	¾"	12"	1	262
EXFC-215	¾"	15"	1	300
EXFC-218	¾"	18"	1	312
• EXFC-221	¾"	21"	1	325
EXFC-224	¾"	24"	1	337
• EXFC-227	¾"	27"	1	350
• EXFC-230	¾"	30"	1	375
• EXFC-233	¾"	33"	1	400
EXFC-236	¾"	36"	1	450
EXFC-306	1"	6"	1	225
EXFC-308	1"	8"	1	250
EXFC-310	1"	10"	1	262
• EXFC-312	1"	12"	1	275
• EXFC-315	1"	15"	1	300
• EXFC-318	1"	18"	1	325
EXFC-321	1"	21"	1	350
• EXFC-324	1"	24"	1	375
• EXFC-327	1"	27"	1	412
• EXFC-330	1"	30"	1	450
• EXFC-333	1"	33"	1	487
EXFC-336	1"	36"	1	525
• EXFC-412	1¼"	12"	1	650
• EXFC-415	1¼"	15"	1	700
• EXFC-418	1¼"	18"	1	750
• EXFC-421	1¼"	21"	1	825
• EXFC-424	1¼"	24"	1	875
• EXFC-427	1¼"	27"	1	950
• EXFC-430	1¼"	30"	1	1025
• EXFC-433	1¼"	33"	1	1075
• EXFC-436	1¼"	36"	1	1125
• EXFC-512	1½"	12"	1	825
• EXFC-515	1½"	15"	1	900
• EXFC-518	1½"	18"	1	1000
• EXFC-521	1½"	21"	1	1100
• EXFC-524	1½"	24"	1	1200
• EXFC-527	1½"	27"	1	1300
• EXFC-530	1½"	30"	1	1400
• EXFC-533	1½"	33"	1	1500
• EXFC-536	1½"	36"	1	1600

• Made to order items. Consult factory for lead time and minimum quantities.  
Unions are not supplied with flexible couplings as shown in photo.

**Thomas & Betts**

# T&B® Fittings

## Sealing Fittings Explosionproof, Dust-Ignitionproof



### Application

EYD drain and inspection sealing fittings:

- Restrict the passage of gases, vapors or flames from one portion of the electrical installation to another at atmospheric pressure and normal ambient temperatures.
  - Limit explosions to the sealed-off enclosure.
  - Prevent precompression or “pressure piling” in conduit systems.
- Drain sealing fittings are installed in vertical conduit runs and at low points in conduit systems to prevent accumulation of condensate above seal.

### Features:

EYD drain sealing fittings include:

- Drain to provide continuous, automatic drainage of condensate.
- Large openings with threaded closures to provide easy access to conduit hubs for making dams.
- Integral bushings to protect conductor insulation from damage.
- Tapered-tapped hubs to ensure ground continuity.

### Standard Materials

- Bodies, and inspection or drain covers – Gray iron alloy and/or ductile iron.
- Closure for drain – copper-free aluminum or ductile iron.
- Small closure plug – Gray iron alloy and/or steel.
- Drain – stainless steel.
- Removable nipples – steel.

### Standard Finish

- Gray iron alloy and ductile iron – electrogalvanized and aluminum acrylic paint.
- Copper-free aluminum – natural.
- Stainless steel – natural
- Steel – electrogalvanized.

### Options

- Copper-free aluminum bodies, nipples and enclosures – see listings

### Size Ranges

- EYD – ½" – 4"

### Certifications and Compliances\*

NEC/CEC:

- EYD11 – 31-TB  
Class I, Division 1 & 2, Groups A,B,C,D.  
Class II, Division 1, Groups E,F,G.  
Class III.
- EYD41 – 101-TB  
Class I, Division 1 & 2, Groups C,D.  
Class II, Division 1, Groups E,F,G.  
Class II, Division 2, Groups F,G.  
Class III.
- UL Standard: 886
- CSA Standard: C22.2
- **Seals are approved to be used with Crouse-Hinds® Sealing Compound and Fiber.**

Crouse-Hinds® is a trademark of Cooper Industries, Inc.

# T&B Fittings

Sealing Fittings  
Explosionproof, Dust-Ignitionproof

Cl. I, Div. 1 & 2, Groups A, B, C, D\*  
Cl. II, Div. 1, Groups E, F, G  
Cl. III, Div. 1 & 2

NEMA7  
9EFG  
12



T&B Fittings



## EYD Drain Seals

Cat. No.	Size	A	B	Turning Radius
EYD11-TB	½	3.81	1.50	1.75
EYD21-TB	¾	4.08	1.75	1.98
EYD31-TB	1	4.85	2.19	2.19
EYD41-TB	1¼	5.00	2.25	1.80
EYD51-TB	1½	5.44	2.44	2.00
EYD61-TB	2	6.25	3.00	2.32
EYD71-TB	2½	7.50	3.50	2.69
EYD81-TB	3	8.50	4.25	3.15
EYD91-TB	3½	9.19	4.75	3.38
EYD101-TB	4	9.75	5.25	3.64

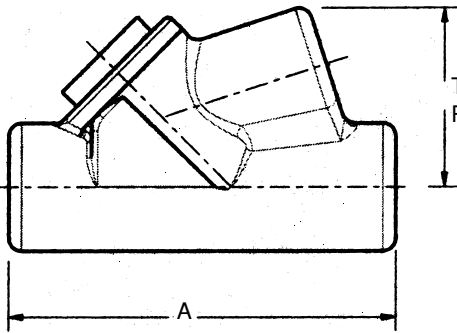

EYD ½" - 1"

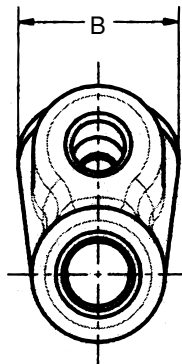

EYD ½" - 1"

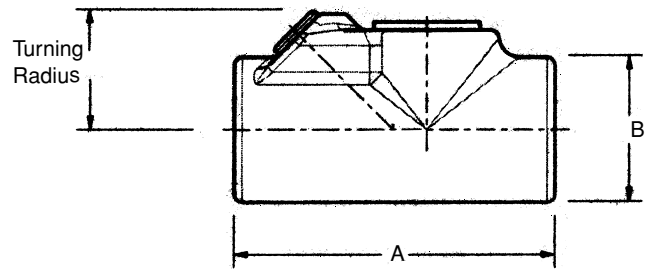

EYD 1¼" - 4"



## Drains/Breathers for Hazardous Locations

Cat. No.	Size	Dim. "D"
ECD15	½	.975
ECD384	¾	.407
ECD284	¼	.327

### Application

The Thomas & Betts Universal drain/breather fittings can be used as drains or breathers depending on the installation.

- To use as a drain, the product must be installed in the bottom of the enclosure or the lowest point where an NPT threaded opening exists. It can also be used in a seal fitting or a "T" conduit body. These must be in a lower section of the conduit system. This will allow moisture inside the conduit system to drain out.
- To use as a breather, installation should be done at the top of an enclosure or in upper sections of conduit systems. This will permit air exchange and keep moisture accumulation inside the conduit system to a minimum, Thomas & Betts recommends the use of at least 2 devices (one drain and one breather) for maximum efficiency.

**Thomas & Betts**

# T&B® Fittings

**Sealing Fittings**  
**Explosionproof, Dust-Ignitionproof**

Cl. I, Div. 1 & 2, Groups A, B, C, D\*  
 Cl. II, Div. 1, Groups E, F, G  
 Cl. III, Div. 1 & 2

Explosionproof  
 Dust-Ignitionproof

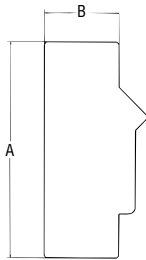

EYS11-TB – EYS101-TB

## EYS Sealing Fittings

### Application

- EYS sealing fittings can be installed in either vertical or horizontal applications.
- Seals sections of conduit runs from passage of vapors, flame, or gases.
- Seals off sections of conduit system during explosion.
- Limits precompression or pressure piling in conduit system.

### Features

- All hubs have a minimum of five full threads, integral bushings to protect conductor insulation from damage, and large access openings for easier packing of sealing medium.
- Seals are approved to be used with Crouse-Hinds® Sealing Compound and Fiber.**

### Size Range

- ½" NPT to 4" NPT

### Materials

- Bodies: Ductile Iron
- Plugs: Gray Iron
- Nipples: Steel, supplied with EYS fittings

### Finish

- Bodies: Zinc-plated with aluminum acrylic paint
- Plugs: Zinc-plated with aluminum acrylic paint
- Nipples: Zinc-plated

### Listing Certifications and Compliances

- UL886
- CSA: C22.2 No. 30
- \* EYS seals are approved to be used with Crouse-Hinds® Chico®A compound and Chico®X fiber.
- CHCHICO – X6 (8 oz. Chico X Fiber)
- CHCHICO – A3 (1 lb. can Sealing Compound)
- CHCHICO – A4 (1 lb. can/1 oz. Chico X Fiber)

### NEC/CEC:

#### EYS1-3TB\*

Cl. I, Div. 1 & 2, Groups A, B, C, D

#### EYS4-5TB\*

Cl. I, Div. 1 & 2, Groups C, D

#### EYS11-31TB\*

Cl. I, Div. 1 & 2, Groups A, B, C, D

Cl. II, Div. 1, Groups E, F, G

Cl. III

#### EYS41-101TB\*

Cl. I, Div. 1 & 2, Groups C, D

Cl. II, Div. 1, Groups E, F, G

Cl. III

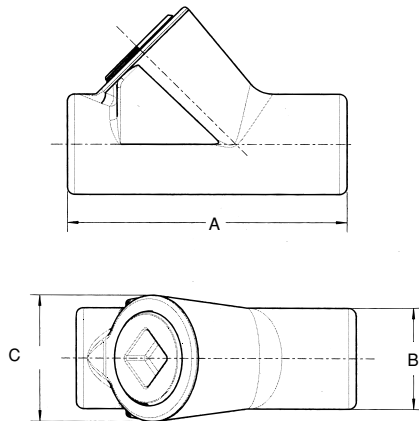

EYS1-TB – EYS5-TB

## EYS Sealing Fittings

Cat. No.	Hub Size	Dimensions (Inches)			Turning Radius
		A	B	C	
EYS1-TB*	½	3.31	1.25	1.50	1.66
EYS2-TB*	¾	3.65	1.50	1.75	1.96
EYS3-TB*	1	4.25	1.75	2.19	2.40
EYS4-TB*	1¼	5.00	2.25	2.45	3.11
EYS5-TB*	1½	5.69	2.45	3.00	3.62
EYS11-TB	½	3¾	1¼	-	1¾
EYS21-TB	¾	3½½	1½	-	1¼
EYS31-TB	1	4¼	1¾	-	1½½
EYS41-TB	1¼	5	2¼	-	1¾½
EYS51-TB	1½	5⅞	2⅞	-	2
EYS61-TB	2	6¼	3	-	2⅞
EYS71-TB	2½	7½	3½	-	2¼½
EYS81-TB	3	8½	4¼	-	3⅝
EYS91-TB	3½	9⅞	4¾	-	3¾
EYS101-TB	4	9¾	5¼	-	3⅞½

Crouse-Hinds® and Chico® are trademarks of Cooper Industries, Inc.

\*Vertical Only



# T&B® Fittings

## Aluminum Sealing Fittings Explosion-Proof, Dust-Ignition-Proof

**Red•Dot®** CI.I, Div. 1 & 2, Groups C, D  
CI.II, Div. 1, Groups E, F, G  
CI.III, Div. 1 & 2  
NEMA 3, 4, 7 CD, 9 EFG

Explosionproof  
Dust Ignition-proof  
Raintight  
Wet Locations



**A**  
T&B® Fittings



EYVF



EVHF



EVHF

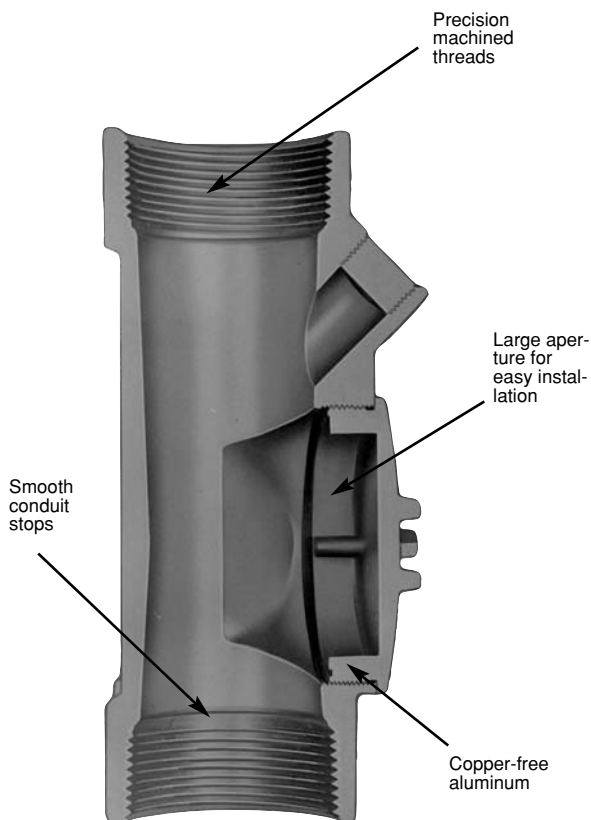

### Application

- Limits flames and/or explosions to area within electrical system where they originate.
- Limits pressure piling.
- Required by NEC for conduit systems in hazardous locations 18" from an enclosure housing a heat producing or arcing device; on 2" and larger system which enters an enclosure containing splices; wherever conduit leaves a Class I, Division I area and enters a non-hazardous area.

### Features/Benefits

- Copper-free\* aluminum provides increased corrosion resistance.
- Precision cast and machined surfaces permit safer wire pulling.
- Precision NPT threaded hubs allow trouble-free field installation for rigid or IMC conduit.
- Large opening provides maximum working room for creating dam and seal pouring to speed up installation.
- Compact design permits close construction of parallel conduit runs.

### Standard Materials

- Sealing Fittings: Die cast aluminum alloy A360 with less than .004 copper content (copper-free).
- Sealing Cement
- Fiber: Flame retardant Kaowool Type A fiber.

### Standard Finish

- Aluminum lacquer finish

### Compliances

- UL Listed
- CSA Certified
- Suitable for hazardous locations
- Federal Spec W-C-586

### Sample Specifications

- Sealing fittings for hazardous locations shall be die cast copper-free\* aluminum alloy A360. Suitable for use in hazardous locations: Class I, Groups C, D; Class II, Groups E, F, G and Class III. All conduit stops shall be coined and free of rough edges. Sealing fittings for hazardous locations shall be finished with aluminum lacquer. Sealing fittings shall be Red•Dot® Catalog No. \_\_\_\_\_

\*Less than .004 copper content.

**Thomas & Betts**

**T&B® Fittings**

**Aluminum Sealing Fittings**  
**Explosion-Proof, Dust-Ignition-Proof**

**Red-Dot®**

Cl.I, Div. 1 & 2, Groups C, D  
 Cl.II, Div. 1, Groups E, F, G  
 Cl.III, Div. 1 & 2  
 NEMA 3, 4, 7 CD, 9 EFG

Explosionproof  
 Dust Ignition-proof  
 Raintight  
 Wet Locations

**Vertical and Horizontal**

EYVF

**Vertical**

Cat. No.	Hub Size	Unit Qty.	Std. Pkg.	Wt. lbs. per 100
† EYVF-1	½"	5	25	50
† EYVF-2	¾"	5	25	54
† EYVF-3	1"	5	25	100
EYVF-11	½"	10	50	35
EYVF-22	¾"	10	50	40
EYVF-33	1"	4	20	60

**Vertical/Horizontal**

Cat. No.	Hub Size	Unit Qty.	Std. Pkg.	Wt. lbs. per 100
EVHF-1	½"	10	50	41
EVHF-2	¾"	5	25	50
EVHF-3	1"	5	25	60
EVHF-4	1¼"	4	20	70
EVHF-5	1½"	1	5	60
EVHF-6	2"	1	1	125
• EVHF-7	2½"	1	1	150
• EVHF-8	3"	1	1	250
• EVHF-9	3½"	1	1	300
• EVHF-10	4"	1	1	400

• Made to order items. Consult factory for lead time and minimum quantities.

† Packaged with an adequate amount of sealing compound and plugs installed.



EVHF-1 through -3



EVHF-4 through -10

### Preparation

#### Applications

Red•Dot® sealing cement is used for making seals in sealing fittings. The insulation in the conductors sealed in the cement may be approved thermoplastic or rubber, with or without lead covering. The sealing cement should not be used for insulating.

#### Characteristics

Red•Dot® sealing cement is not affected by gasoline, alcohol, acetone, ether, naphtha, petroleum, benzol or lacquer solvent.

#### Preparation

- (1) Use a clean mixing vessel for each batch.
- (2) Thoroughly mix powder before adding water.
- (3) Do not use if temperature is below 40°F.
- (4) Mix 1 part water to 2 parts cement.
- (5) Allow cement to set for 72 hours before use.

#### Standard Dams

- (1) Push the conductors away from the filling opening and force them apart so that they do not touch each other or the walls of the fitting or conduit along their length. If the conductors do touch, the sealing cement will not form a closed path between them.
- (2) Force the packing fiber between each conductor and the inside walls. Be sure that the dam is strong enough and tight enough to prevent the considerable weight of the fluid sealing cement from seeping out.

#### Pouring

- (1) Pour the mixed cement into the fitting slowly so as not to trap air in the seal.
- (2) Replace the close-up plugs to insure that they engage not less than 5 full threads.

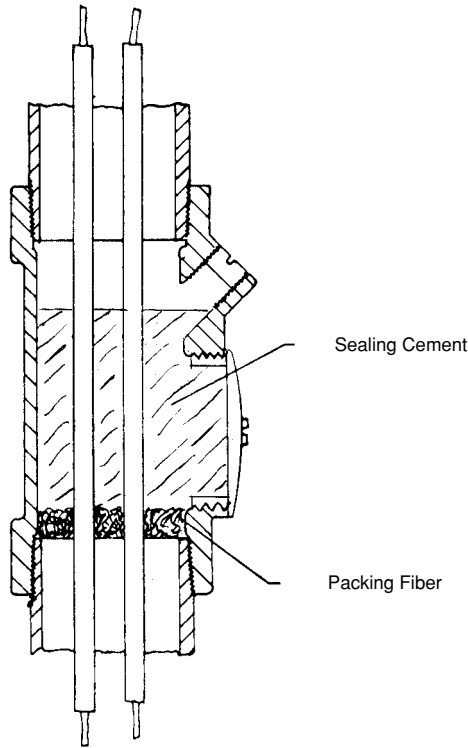

Vertical Installation  
for EYVF or EVHF Fittings

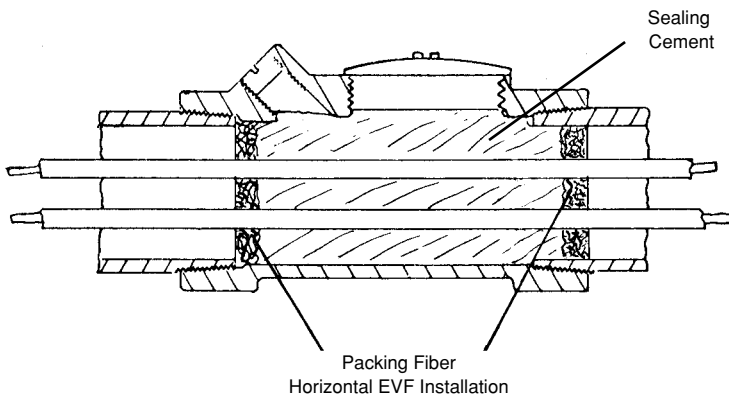

Horizontal EVF Installation

# T&B® Fittings

**Sealing Fittings  
Explosion-Proof, Dust-Ignition-Proof**

CI.I, Div. 1 & 2, Groups C, D  
CI.II, Div. 1, Groups E, F, G  
CI.III, Div. 1 & 2  
NEMA 3, 4, 7 CD, 9 EFG

Explosionproof  
Dust Ignition-proof  
Raintight  
Wet Locations



EXSC



EXPF

## Sealing Cement and Fiber for Red-Dot® Sealing Fittings

### Sealing Cement • Can be used on Red-Dot® EYV, EVH series fittings only.

Cat. No.	Quantity	Volume Cubic Inches	Std. Pkg.	Wt. lbs per 100
EXSC-2	3.2 oz.	2.75"	25	20
EXSC-8	13 oz.	11.50"	15	81
EXSC-16	1 lb., 10 oz.	23.00"	10	163

### Packing Fiber • Can be used on Red-Dot® EYV, EVH series fittings only.

Cat. No.	Quantity	Volume Cubic Inches	Std. Pkg.	Wt. lbs per 100
EXPF-16	1 lb.		1	112

### Approximate amount of cement and fiber required

Cat. No.	Hub Size	Cement Quantity	Fiber Quantity
EYVF-11	½"	2 oz.	½ oz.
EYVF-22	¾"	3 oz.	⅙ oz.
EYVF-33	1"	4 oz.	⅙ oz.
EVHF-1	½"	2 oz.	½ oz.
EVHF-2	¾"	2 oz.	½ oz.
EVHF-3	1"	4 oz.	¼ oz.
EVHF-4	1¼"	4 oz.	¼ oz.
EVHF-5	1½"	6 oz.	½ oz.
EVHF-6	2"	12 oz.	1 oz.
EVHF-7	2½"	15 oz.	1½ oz.
EVHF-8	3"	40 oz.	2 oz.
EVHF-9	3½"	45 oz.	3 oz.
EVHF-10	4"	50 oz.	4 oz.



# T&B® Fittings

## Kopr-Shield™ Compound



**Kopr-Shield™ by Thomas & Betts meets the requirements of Section 300.6(A) in the 2002 NEC Code for Protection Against Corrosion.**

*“Where corrosion protection is necessary and the conduit is threaded in the field, the threads shall be coated with an approved electrically conductive, corrosion-resistant compound.”*

### The Copper Colloidal Surface Treatment That Protects, Lubricates and Enhances Conductivity Between All Electrical Connections

Good connections are one of the most important aspects of electrical work. Mechanics know how much down-time is caused when fluids or oils leak into the raceway system or looking for a weak link in a ground system caused by a high resistance connection. Mechanics also know how much time is spent keeping contacts, switches, lugs and other connectors clean or replacing parts because of “green scourage” build-up. Thomas & Betts has the solution to improve connections made in thousands of electrical and raceway installations made each day by electricians everywhere.

Kopr-Shield™ compound is a unique homogenized blend of pure, polished colloidal copper, rust and corrosion inhibitors that simultaneously protects, lubricates and enhances the conductivity of the mating surfaces to which it is applied. Extremely adhesive, Kopr-Shield™ compound flows smoothly into uneven contours and voids, making application easy, protection and lubrication complete and positive. A stable compound, it will not settle-out, thin, thicken, harden, or dry out under the most severe environmental conditions.

Kopr-Shield™ Compound has excellent temperature characteristics – brushed on at –50F to 250F (other compounds either turn solid or run like water at these extremes). Even at 1800F, Kopr-Shield™ remains intact for short terms.

Kopr-Shield™ Compound may be used to advantage in all electrical installations. When the environment is hostile to good electrical and mechanical connections, Kopr-Shield™ Compound is a must!

#### Use Kopr-Shield™ Compound for Battery Lugs and Cables.

- Prevention of “Green Scourage” corrosion.
- Reduction of resistance.
- Ease of terminal installation and removal.

#### Use Kopr-Shield™ Compound for Raceways.

- Lubrication – Ease of assembly and disassembly.
- Grounding Continuity Improved – Exceeds code requirements.

#### Use Kopr-Shield™ Compound for Fuse Clips.

- Even Heat Distribution – Elimination of hot spots.
- Oxidation Prevention – Prevents carbon path formation.
- Lubrication – Easy installation and removal of fuses.

#### Use Kopr-Shield™ Compound for Wiping Contacts, Drum Switches and Slip Rings.

- Prevention of galling, burning, pitting and discoloration.
- Suppression of arcing and dissipation of coronas.
- Lubrication for ease of operation.

### Kopr-Shield™

Cat. No.	Description	Std. Pkg.	Wt. Lbs./C
201-31879	1½ oz. Container with brush	96	11.46
201-31879-1	4 oz. Container with brush	24	38.54
CP8-TB	8 oz. Container with brush	12	64.58
CP16	16 oz. Container with brush	12	120.83
CP128	1 Gallon Can	4	952.00

Kopr-Shield™ is a product of Jet Lube, Inc.

# T&B® Fittings

## Metal Clad Cable Termination Fittings

### Metal Clad Cable Teck Cable Aluminum Sheathed Cable

#### **Metal Clad Cable (Type MC) Ref. NEC Article 334\***

“Metal Clad Cable Type MC is a factory assembly of one or more conductors, each individually insulated and enclosed in a metallic sheath of interlocking tape, or a smooth or corrugated tube.”

Metal Clad Cable Type MC is rated for use up to 5,000 volts. The National Electrical Code permits use of metallic sheath as an equipment grounding conductor.

Metal Clad Cables are available with a variety of phase conductor insulations such as crosslinked polyethylene, and silicone rubber ethylene propylene, depending on rated temperature of conductors and working potential. Metallic sheath can be of galvanized steel, aluminum, copper or bronze. A special outer covering such as PVC or Neoprene over metallic sheath is usually provided for environmental protection.

Metal clad cable is not permitted in locations where it could be subject to physical damage. Metal clad cable can be used exposed, concealed, in cable tray, in any approved raceway, and with minor exceptions in hazardous locations. Type MC cable can also be used for services, feeders, branch circuits, power, lighting, control and signal circuits.

Use of metal clad cable is permitted in wet locations, or where exposed to destructive corrosive conditions or can

be directly buried in earth, concrete or exposed to cinder fills, strong chlorides, caustic alkalis, vapors, chlorine or hydrochloric acids provided the construction of cable, the conductors within the metallic sheath, the metallic sheath and protective cover over metallic sheath comply with requirements enumerated in Sec. 334-3 of the National Electrical Code.

Bend radius restrictions are dependent on the size of the cable and the type of sheath, i.e. smooth, interlocked armor, corrugated sheath or shielded conductors and varies from 7 times to 15 times cable external diameter.

NEC Article 334 requires that approved fittings be used for termination. Where single-conductor cables carrying alternating current enter a ferrous metal box or enclosure, procedures described in NEC Section 300-20 must be followed to reduce effects of heating due to induced currents. These procedures include recommended arrangements of conductors, cutting of slots in metal between individual conductor holes, passing of conductors through insulating walls, or use of non-magnetic aluminum sheathed cable and aluminum terminating fittings.

Portions of this section reprinted by permission from NFPA 70-1999, National Electrical Code®, Copyright © 1977, National Fire Protection Association, Boston, MA.

Please refer to the following for further details and complete information:

1. NEC Article 334...Metal Clad Cable (Type MC)
  2. U.L. 4, ANSI C33.9...Safety Standards for Type MC Metal Clad Cable
  3. U.L. 514B, Safety Standards for Outlet Boxes & Fittings
  4. W-F-406...Federal Specification. Fittings for Cable, Power Electrical & Conduit Metal, Flexible
  5. NEMA FM-1...Standards Publication. Fittings and Supports for Conduit and Cable Assemblies
- In the 1978 National Electric Code, Aluminum Sheathed Cable is classified as type MC metal clad cable (NEC Article 334); however in 1975 National Electric Code Aluminum Sheathed Cable was classified as type ALS cable and covered under a separate article (NEC Article 331)

### *Metal Clad Cable Teck Cable Aluminum Sheathed Cable – continued*

#### **Teck Cables**

Teck cable derived its name from one of its first users, the Teck-Hughes Gold Mines in Kirkland Lake, Ontario. Teck 90 is CSA Type designation. Trade designation of this cable is Armored Cable.

Teck cables up to 5,000 volt working potential are manufactured in accordance with CSA Standard C22.2 No. 131 and are provided with a bare ground conductor and an optional outer jacket. Depending on phase conductor insulation the cables are designated as Teck 90 (X-LINK) when insulation is cross-linked polyethylene and Teck 90 (EP) when insulation is ethylene propylene. Both cables are rated for 90°C service (dry location) and 75°C (wet locations). When Teck cable is suitable for installation down to minus 40°F the cables are marked Teck 90 (X-LINK) minus 40 or Teck 90 (EP) minus 40.

Over 5,000 volts working potential Teck cables are manufactured in accordance with IPCEA standards and are certified by CSA. Cables are provided with or without ground wire as required.

Teck cables with outer jacket may be used for exposed or concealed

wiring in wet or dry locations, indoors/outdoors and in corrosive environments. Teck cables are suitable for use in ventilated, non-ventilated and ladder type cable troughs, in ventilated flexible cable ways in both dry and wet locations. Teck cable with outer jacket is suitable for direct earth burial and for Class II Division 2, Class III Division 1 & 2 hazardous locations per Canadian Electric Code.

Some of the features of Teck cable are its flexibility and ease of installation. Absence of dead air space within cable increases heat transfer and minimize condensation. Overall protective covering provides good environmental protection.

Bend radii for permanent training during installation usually varies between 7 times to 12 times the cable diameter depending on cable construction and manufacturer's recommendations. Larger radii bends are required for other conditions.

Section 12-3028 of the Canadian Electric Code requires that the terminating fittings used must provide adequate strain relief to terminal connections and ensure electrical continuity without injury to non-metallic sheath.

Continuity is mandatory whether or not the armour is used as a grounding conductor. Except for dry locations free from corrosive atmosphere, the non-metallic jacket is not permitted to be stripped back to a point where armour is exposed after installation.

Where single conductor cables carrying 200 amps or more enter metal boxes through separate openings certain precautions are required to prevent overheating of the metal by induction. Use of non-ferrous or non-metallic box connectors, locknuts and bushings and installation of non-magnetic panel inserts is suggested in the code. Please refer to the following for further details and complete information:

1. CEC Section 12...Wiring Methods  
CEC Section 4...Conductors
2. CSA C22.2 No. 131 & 131S (Supplement #1)...Safety Standard for Type Teck Cable
3. CSA C22.2 No. 18...Safety Standards for Outlet Boxes, Conduit Boxes and Fittings

#### **Please Note**

The excerpts and other material herein, whether relating to the National Electrical Code, the Underwriters Laboratories, Inc. listing, to industry practice or otherwise, is not intended to provide all relevant information required for use and installation. Reference to original or primary source material and data is mandatory before any application or use is made of the product.

**Metal Clad Cable Termination Fittings****The Star® Teck Extreme™ STE/STEX Series Cable Fitting**

The Star Teck STE cable fitting series is designed for optimum integrity in ordinary applications. The STEX series is specially designed for classified hazardous areas. Both are designed to stand up to the harshest and most corrosive environment.

**Application**

- Provides means for passing armored, metal clad, jacketed or unjacketed and unarmored cables through a bulkhead or enclosure in hazardous areas. (These fittings are suitable for hazardous areas when used with T&B sealing compound.)
- Forms a mechanical grip and water and/or oil-resistant termination.
- Provides grounding continuity of cable armor.

**Features**

- Removable armor-stop for greater cable ranges.
- Built-in sealing device.
- Patented Elastomeric collar ring/bushing.
- Built-in jacket stripping gauge.
- Patented powergrip grounding ring.

**Range**

- Star Teck Extreme fittings are designed to accommodate a broad range of cables. Each hub range overlaps the adjacent hub range, thereby minimizing the possibility of mismatched cables and fittings in the field. They are available in hub sizes from ½" to 4" and will handle outer jacket diameters from 0.525" to 4.340".

**Materials**

- Aluminum is standard material.

**Cord & Cable Type**

- JMC, MC

**Environment Classification**

- STE\* Series
  - Ordinary Location
  - Class I, Division 2†
- –NEMA 4, 4X, 6P
- –STE050 - STE200
  - NEMA 6P
- –STE250 - 400
  - NEMA 4
- –STE050 - 400
  - NEMA 4X
- STEX\*\* Series
  - Ordinary Location
  - Class I, Division 1, Groups A,B,C,D
  - Class II, Division 1, Groups E,F,G
  - NEMA 4, 4X, 6P

\* These fittings are suitable for Class I hazardous locations when used in combination with a certified Class I hazardous location sealing fitting.

\*\* May be used in hazardous areas approved MC type cable (or equal) when installed in accordance with NEC/CEC requirements. Not applicable to all STEX series.



**STE Series**  
Ordinary



**STEX Series**  
Hazardous Locations

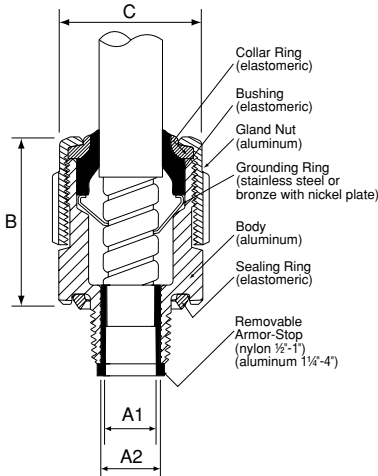

### Star® Teck Extreme™ Jacketed Metal-Clad Cable Fittings

Cat. No.	Hub Size a.p.†	Strip Length	Gland Torque (lb.-in.)	Range Over Jacket		Range Over Armor		A1: Throat Dia. Min. w/End Stop	A2: Throat Dia. Min. wo/End Stop	B* Overall	C Max. Alum.
				Min.	Max.	Min.	Max.				
<b>Ordinary</b>											
STO50-462*	½	1¼	300	.525	.650	.415	.570	N/A*	.395	2.020	1.224
STE050*	½	1¼	300	.600	.985	.520	.895	.505	.612	2.650	1.630
STE075*	¾	1¼	600	.860	1.205	.780	1.125	.655	.816	2.900	2.080
STE100*	1	1¼	700	.950	1.375	.870	1.295	.785	1.044	3.020	2.300
STE125*	1¼	1¼	1000	1.150	1.625	.990	1.465	.970	1.250	4.010	2.820
STE150*	1½	1¾	1200	1.440	1.965	1.280	1.805	1.260	1.562	4.290	3.250
STE200*	2	1¾	1600	1.825	2.375	1.665	2.215	1.645	1.995	4.120	3.600
STE250	2½	2½	1600	2.265	2.840	2.105	2.680	2.075	2.424	5.320	4.750
STE300	3	2½	1600	2.670	3.270	2.545	3.145	2.531	2.890	5.400	5.400
STE350	3½	2½	1600	3.220	3.870	3.090	3.640	3.065	3.460	5.360	5.900
STE400	4	2½	1600	3.665	4.340	3.550	4.225	3.525	3.941	5.415	6.400

### Hazardous Locations

STX050-462*	½	1¼	300	.525	.650	.415	.570	N/A*	.395	2.500	1.630
STX050-464*	½	1¼	300	.600	.760	.490	.680	N/A*	.485	2.530	1.630
STEX075*	¾	1¼	600	.600	.985	.520	.895	.504	.678	3.400	1.820
STEX100*	1	1¼	700	.860	1.205	.780	1.125	.650	.833	3.580	2.300
STEX125*	1¼	1¼	1000	.950	1.375	.870	1.295	.834	1.065	3.920	2.510
STEX150*	1½	1¾	1200	1.150	1.625	.990	1.465	.958	1.273	5.020	3.260
STEX200*	2	1¾	1600	1.440	1.965	1.280	1.805	1.250	1.560	5.120	3.620
STEX250†	2½	2½	1600	1.825	2.375	1.665	2.215	1.640	1.995	5.170	4.580
STEX300†	3	2½	1600	2.265	2.840	2.105	2.680	2.075	2.461	6.610	5.100
STEX350†	3½	2½	1600	2.670	3.270	2.545	3.145	2.531	2.864	7.380	5.790
STEX400†	4	2½	1600	3.220	3.870	3.090	3.640	3.055	3.461	7.650	6.190
STX400-484†	4	-	1600	3.810	4.030	3.680	3.870	-	-	-	-
STX400-485†	4	-	1600	3.965	4.185	3.835	4.025	-	-	-	-

To specify other material, add the appropriate suffix to the category number.

Desired Material	Suffix	Example
Aluminum fitting with ground lock nut	GR	STE-050GR
Steel with zinc plate	S	STE-050S
Brass with nickle plate	BN	STE-050BN
Aluminum with-pvc coating	PVC	STE-050PVC
Steel with pvc coating	S-PVC	STE-050S-PVC

UL Listed #84H3

\* These products are UL Listed Watertight NEMA Type 6P

\* The 1/2 fittings do not have a removable armor stop.

† CSA approved for hazardous location.

### Sealing Compounds – Used for Hazardous Locations

Cat. No.	Description	Volume
SC4-KIT	Liquid type sealing compound for use in control cable applications	2.8 fl. oz.
SC65	Putty Type Sealing Compound	60 grams

# T&B® Fittings

## Metal Clad Cable Termination Fittings



### Star® Teck Jacketed Metal-Clad Cable Fittings

Overlapping range of sizes. Star® Teck jacketed metal-clad cable fittings are designed to accommodate a broad range of cables, thereby minimizing the possibility of mismatched cables and fittings in the field.

**Easy Installation**  
Exclusive power-grip. Provides a grip that's high up on the cable — not on the first convolution — so strip length and cutting of cable are not critical.

**Dependable Grounding**  
Power-Grip grounding ring is non-magnetic stainless steel. Provides 360° long-term dependable grounding. It makes immediate contact with the cable.

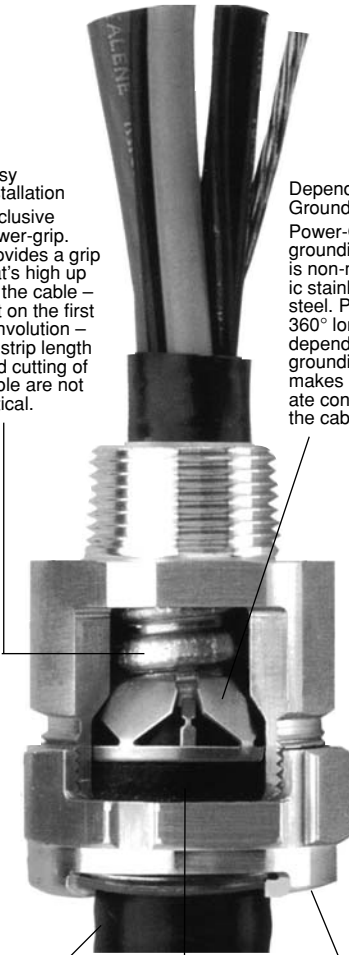

**Dependable Service**  
Stainless steel retaining ring. Withstands corrosive environments. Non-magnetic.

**Watertight**  
Tapered bushing. Cone shaped to provide a secure, tight fit while eliminating cupping or water in vertical installations.

**Easy to Install in Tight Spaces**  
Low profile gland nut fits tight spaces. Has grooves for screwdriver installation, and flats for a wrench. Durable and reusable with funnel entry for easy cable insertion.

#### Application

- Provide means for passing armored, metal clad, jacketed or unjacketed and unarmored cables through a bulkhead or enclosure in hazardous areas (These fittings are suitable for hazardous areas when used with T&B sealing compound.)
- Form a mechanical grip and water and/or oil-resistant termination
- Provide grounding continuity of cable armor

#### Cord & Cable Type

- JMC, MC

#### Features

- **Easy Installation**  
Exclusive power-grip. Provides a grip that's high up on the cable—not on the first convolution—so strip length and cutting of cable are not critical.
- **Dependable Service**  
Stainless steel retaining ring. Withstands corrosive environments. Non-magnetic.
- **Dependable Grounding**  
Power-Grip grounding ring is non-magnetic stainless steel. Provides 360° long-term dependable grounding. It makes immediate contact with the cable.

#### • Watertight

Tapered bushing. Cone shaped to provide a secure, tight fit while eliminating cupping or water in vertical installations.

#### • Easy to Install in Tight Spaces

Low profile gland nut fits tight spaces. Has grooves for screwdriver installation, and flats for a wrench. Durable and reusable with funnel entry for easy cable insertion.

#### Materials

Aluminum is standard material. The body and gland nut on hub sizes ½" to 1" are made of steel and 1¼" to 4" are made of malleable iron.

#### Environment Classification

- Suitable for hazardous locations. Class 1 Div. 2; Class II Div. 2; Class III. Where explosion proof or dust proof fittings are required by code use Star Teck XP fittings (STX Series).

#### Range

- They are available in hub sizes from ½ to 4 inches, and will handle outer jacket diameters from 0.525 to 4.340 inches.

### Installing the STAR® TECK Fitting



1. Prepare cable

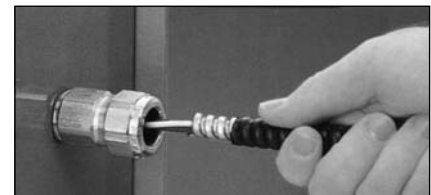

2. Insert cable



3. Tighten gland nut

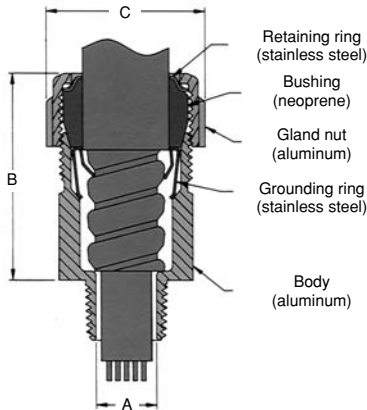

**Overlapping range of sizes. Star® Teck jacketed metal-clad cable fittings are designed to accommodate a broad range of cables, thereby minimizing the possibility of mismatched cables and fittings in the field. They are available in hub sizes from ½ to 4 inches, and will handle outer jacket diameters from 0.525 to 4.340 inches. Suitable for hazardous locations. Class 1 Div. 2; Class II Div. 2; Class III. Where explosion proof or dust proof boxes are required by code use Star Teck XP fittings (STX050-462 Series).**

### Star® Teck Jacketed Metal-Clad Cable Fittings

Cat. No.	Hub Size NPT	Range Over Jacket (in.)		Dimensions (in.)		
		min.	max.	A	B*	C
ST050-462	½	0.525	0.650	0.395	2.020	1.224
ST050-464	½	0.600	0.760	0.485	2.020	1.363
ST050-465	½	0.725	0.885	0.612	2.133	1.633
ST050-466	½	0.825	0.985	0.612	2.133	1.633
ST075-467	¾	0.880	1.065	0.819	2.450	2.080
ST075-468	¾	1.025	1.205	0.819	2.450	2.080
ST100-469	1	1.187	1.375	1.039	2.601	2.230
ST125-470	1¼	1.350	1.625	1.182	3.282	2.824
ST125-550	1¼	1.500	1.625	1.370	3.282	2.824
ST125-471	1¼	1.600	1.875	1.370	3.282	2.824
ST150-472	1½	1.700	1.965	1.557	3.620	3.260
ST150-473	1½	1.900	2.187	1.600	3.620	3.260
ST200-551	2	1.900	2.187	1.715	3.640	3.620
ST200-474	2	2.100	2.375	1.995	3.640	3.620
ST200-475	2	2.300	2.565	2.057	3.640	4.020
ST200-476	2	2.500	2.750	2.057	3.640	4.020
ST250-477	2½	2.380	2.640	2.230	4.700	4.750
ST250-478	2½	2.580	2.840	2.430	4.700	4.750
ST300-479	3	2.790	3.060	2.630	4.700	5.050
ST300-480	3	3.000	3.270	2.860	4.790	5.480
ST300-481	3	3.210	3.480	3.032	4.790	5.480
ST350-482	3½	3.420	3.690	3.260	4.790	5.980
ST350-483	3½	3.610	3.870	3.430	4.790	5.980
ST400-484	4	3.810	4.030	3.590	4.840	6.435
ST400-485	4	3.965	4.185	3.745	4.840	6.435
ST400-486	4	4.120	4.340	3.900	4.840	6.435

\* Approximate dimension before installation.

U.L. File No. E 38947

CSA File No. LR 23086

#### Suggested specifications for metal-clad cable fitting.

- All metal-clad cable fittings for jacketed interlocked armor cable or continuous corrugated cable shall be approved by a nationally recognized testing laboratory, inspection agency or product evaluation organization.
  - Where corrugated-jacketed metal-clad cable exposed to intermittent or continuous moisture is terminated into a threaded opening, the fitting shall be watertight type furnished with:
    - An elastomeric beveled bushing.
    - A funnel entry, splined gland nut.
    - A non-magnetic stainless steel grounding device with dual grounding action.
    - A taper threaded hub.
    - A hexagonal body and gland nut as manufactured by Thomas & Betts (aluminum series ST050-464).
  - Where cable is terminated into a threadless opening, a suitable moisture resistant elastomeric gasket as manufactured by Thomas & Betts, series 5262, shall be provided between the outside of enclosure and fitting shoulder.
  - With single conductor cable and/or in corrosive environments, aluminum fittings such as Thomas & Betts series ST050-464 shall be installed.
- Class I Div 2; Class II Div. 2; Class III. Where explosion-proof or dust-ignition-proof boxes are required by Teck fitting must be used in conjunction with an approved sealing fitting.

## Metal Clad Cable Termination Fittings

Sealing chamber is easier to fill, requires less sealing compound — saves time, material. Flame path is optimally designed to allow for easy insertion into hub. Quick-turn lock secures assembly during installation.

Hub has hexagonal shape for dependable tool grip.

Internal splines allow installer to tighten gland nut either on or off enclosure.

Union features twist-on action for easy connection and disconnection; red color assures high visibility, easy recognition. Union also serves as a "puller" during disassembly.

Stainless steel retaining ring. Withstands corrosive environments. Non-magnetic.

Copper-free construction. All-aluminum body and gland nut resist corrosion, oxidation.

Tapered bushing. Cone-shaped to provide secure, tight fit while eliminating cupping of water in vertical installations.

Exclusive Power Grip. Provides grip that's high up on cable armor — not on first convolution — so precise cable preparation is not critical. Non-magnetic stainless steel Power Grip grounding ring assures 360° long-term dependable grounding. It provides phenomenal tensile pullout resistance.

Low profile gland nut fits tightest spaces. Has grooves for hammer/screwdriver installation and flats for wrench-gripping. Durable and reusable with funnel entry for easy cable insertion.

## Star® Teck XP Jacketed Metal-Clad Cable Fittings



## Application

- Provide means for passing armored, metal clad, jacketed or unjacketed and unarmored cables through a bulkhead or enclosure in hazardous areas (These fittings are suitable for hazardous areas when used with T&B sealing compound.)
- Form a mechanical grip and water and/or oil-resistant termination.
- Provide grounding continuity of cable armor.

## Cord &amp; Cable Type

- JMC, MC

## Features

- Sealing chamber is easier to fill, requires less sealing compound — saves time, material. Flame path is optimally designed to allow for easy insertion into hub. Quick-turn lock.
- Internal splines.
- Union features twist-on action; red color for high visibility.

- Exclusive Power Grip. Provides grip that's high up on cable armor. Non-magnetic stainless steel Power Grip grounding ring.
- Low profile gland nut.

## Materials

Aluminum is standard material. The body and gland nut on hub sizes ½" to 1" are made of aluminum and 1¼" to 4" are made of aluminum.

## Environment Classification

- Suitable for hazardous locations. Class 1 Div. 2; Class II Div. 2; Class III. Where explosion proof or dust proof fittings are required by code use Star Teck XP fittings (STX Series).

## Range

- They are available in hub sizes from ½ to 4 inches, and will handle outer jacket diameters from 0.525 to 4.185 inches.

## Easy installation saves time, money!



1. Prepare cable



2. Install Star® Teck XP on cable



3. Tighten gland nut



4. Pot cable (using liquid or putty)

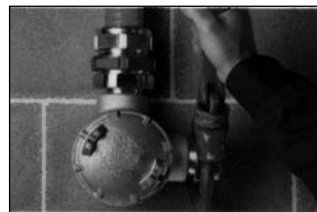

5. Install hub on enclosure

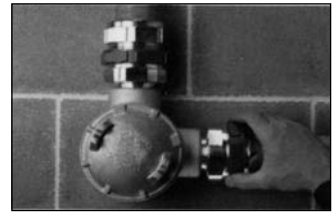

6. Insert cable and tighten red union



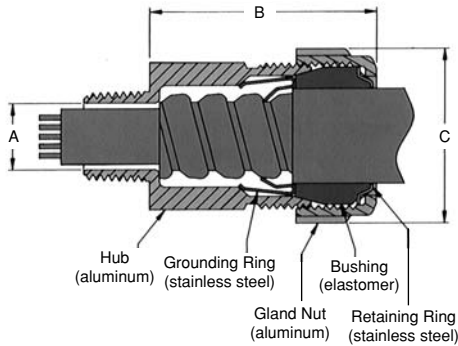

### Star® Teck XP Jacketed Metal Clad Cable Fittings

Cat. No.	Hub Size N.P.T.	Range Over Jacket (in.)		Dimensions (in.)			Sealing Compound Required	
		min.	max.	A min.	B	C	SC65** Putty (grams)	SCA-KIT** Liquid (cc)
STX050-462	½	0.525	0.650	0.395	2.50	1.63	7	4
STX050-464	½	0.600	0.760	0.485	2.50	1.63	7	4
STX075-465	¾	0.725	0.885	0.612	2.62	1.82	14	7
STX075-466	¾	0.825	0.985	0.720	2.62	1.82	14	7
STX100-467	1	0.880	1.065	0.755	2.83	2.30	30	16
STX100-468	1	1.025	1.205	0.900	2.83	2.30	30	16
STX125-469	1¼	1.187	1.375	1.062	3.05	2.51	45	22
STX150-470	1½	1.357	1.625	1.182	3.76	3.26	80	43
STX150-550	1½	1.500	1.625	1.370	3.76	3.26	80	43
STX150-471	1½	1.600	1.875	1.470	3.76	3.26	80	43
STX200-472	2	1.700	1.965	1.557	4.05	3.62	125	66
STX200-473	2	1.900	2.187	1.757	4.05	3.62	125	66
STX200-474	2	2.100	2.375	1.995	4.15	4.02	150	80
STX250-475	2½	2.300	2.565	2.185	4.31	4.58	341	164
STX250-476	2½	2.500	2.750	2.365	4.31	4.58	341	164
STX300-478	3	2.580	2.840	2.460	5.64	5.10	497	239
STX300-479	3	2.790	3.060	2.660	5.80	5.33	609	293
STX350-480	3½	3.000	3.270	2.864	6.32	5.79	965	464
STX350-481	3½	3.210	3.480	3.062	6.32	5.79	965	464
STX400-482	4	3.420	3.690	3.290	6.63	6.19	1323	636
STX400-483	4	3.610	3.870	3.460	6.63	6.19	1323	636
STX400-484	4	3.810	4.030	3.630	7.09	6.90	1645	791
STX400-485	4	3.965	4.185	3.775	7.09	6.90	1645	791

**U.L. Listed For:** Connectors When Used With Putty Type or Liquid Type Compound

½ thru 3"	Class I	Div. 2	Groups A, B, C, D
	Class II	Div. 2	Groups F, G
	Class III		
	Enclosure Type 4		

**Connectors When Used With Putty Type or Liquid Type Compound**

3½" & 4"	Class I	Div. 2	Groups B, C, D
	Class II	Div. 2	Groups F, G
	Class III		
	Enclosure Type 4		

**CSA Certified For:**

Class I	Division 1 and 2	Groups A, B, C, D
Class II	Division 1 and 2	Groups E, F, G
Class III, SL (Integral Seal)		
Enclosure Type 4		

\* Approximate dimension before installation.

\*\* 1 unit of SC65 putty type sealing compound contains 50 g. 1 unit of SC4-Kit liquid type sealing compound contains 66 cc. and includes a dispensing syringe and fibre damming material.

U.L. File No. E-38947

CSA File No. LR 23086

CAUTION: Star® Teck XP fittings must be installed with Thomas & Betts catalog numbers SC4-Kit or SC65 sealing compound (purchase separately). See installing instructions.

### Sealing Compounds

Cat. No.	Description	Volume
SC4-KIT	Liquid type sealing compound for use in control cable applications	2.8 fl. oz.
SC65	Putty Type Sealing Compound	60 grams

U.L. File No. E-82038

CSA File No. LR 638

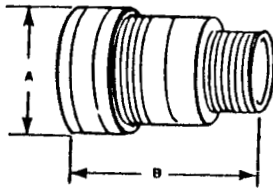

Connector  
Aluminum



*In corrosive environments, the T&B neoprene boot provides maximum corrosion protection to the connector. Simply match the connector hub size to the boot hub size to select the proper boot.*



### Spin-On® Series II Connectors and Accessories

Cat. No.	Hub Size (in.)	Cable Range Over Armor (in.)	A Dia. (in.)	B (in.)	Optional Corrosion Resistant Boot Cat. No.
2-050-008	½	.380-.435	1¼	1⅞	NB050
2-050-010	½	.436-.500	1¼	1⅞	NB050
2-050-020	½	.501-.580	1¼	1⅞	NB050
2-050-030	½	.581-.650	1¼	1⅞	NB050
2-075-040	¾	.651-.730	1½	2⅞	NB075
2-075-050	¾	.731-.820	1½	2⅞	NB075
2-075-060	¾	.821-.880	1½	2⅞	NB075
2-100-070	1	.881-0.960	2	2⅞	NB100
2-100-080	1	.961-1.030	2	2⅞	NB100
2-100-090	1	1.031-1.100	2	2⅞	NB100
2-100-100	1	1.101-1.180	2	2⅞	NB100
2-125-110	1¼	1.181-1.240	2¼	2⅞	NB125
2-125-120	1¼	1.241-1.310	2¼	2⅞	NB125
2-125-130	1¼	1.311-1.390	2¼	2⅞	NB125
2-150-140	1½	1.391-1.480	2½	2⅞	NB150
2-150-150	1½	1.481-1.570	2½	2⅞	NB150
2-150-160	1½	1.571-1.660	2½	2⅞	NB150
2-200-170	2	1.661-1.750	3	2⅞	NB200
2-200-180	2	1.751-1.840	3	2⅞	NB200
2-200-190	2	1.841-1.930	3	2⅞	NB200
2-200-200	2	1.931-2.030	3	2⅞	NB200
2-250-210	2½	2.031-2.150	3¾	3⅞	NB250
2-250-220	2½	2.151-2.270	3¾	3⅞	NB250
2-250-230	2½	2.271-2.390	3¾	3⅞	NB250
2-250-240	2½	2.391-2.510	3¾	3⅞	NB250
2-300-250	3	2.511-2.640	4½	3⅞	NB300
2-300-260	3	2.641-2.770	4½	3⅞	NB300
2-300-270	3	2.771-2.900	4½	3⅞	NB300
2-300-280	3	2.901-3.040	4½	3⅞	NB300
2-350-390	3½	3.041-3.170	5	3⅞	NB350
2-350-300	3½	3.171-3.310	5	3⅞	NB350
2-350-310	3½	3.311-3.450	5	3⅞	NB350
2-350-320	3½	3.451-3.590	5	3⅞	NB350
2-400-330	4	3.591-3.730	5½	3⅞	NB400
2-400-340	4	3.731-3.870	5½	3⅞	NB400
2-400-350	4	3.871-4.010	5½	3⅞	NB400

U.L. File No. E38947  
CSA File No. LR 2884

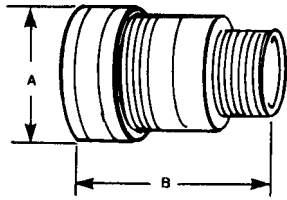

**Compound filled connector kit.**  
Each SPIN-ON® X catalog number is a complete kit. Used to install a complete gas blocked connector in a hazardous location.

- Red anodized gland identifies the hazardous location fitting.
- Three-piece construction; Gland-Body-Insert with O Ring.
- Overall length ½ less than conventional.
- Installation time 50% less than conventional.
- Full tapered hub threads – gas tight thread engagement.
- Machined Aluminum Construction, good looks – corrosion resistance.
- Furnished complete – includes compound.
- Factory-Packaged compound – no other on-site materials.
- Sealing Compound consistency pre-mixed – no job site variations.
- Neoprene boots available; additional corrosion protection.
- For control cable applications order liquid compound separately.

### Spin-On® X Connectors for Hazardous Locations

Cat. No.	Hub Size (in.)	Cable Range Over Armor (in.)	A Dia. (in.)	B (in.)
4-075-008	¾"	.380-.435	1½"	2½"
4-075-010	¾"	.436-.500	1½"	2½"
4-075-020	¾"	.501-.580	1½"	2½"
4-075-030	¾"	.581-.650	1½"	2½"
4-075-040	¾"	.651-.730	1½"	2½"
4-100-050	1"	.731-.820	2"	2½"
4-100-060	1"	.821-.880	2"	2½"
4-100-070	1"	.881-.960	2"	2½"
4-100-080	1"	.961-1.030	2"	2½"
4-125-090	1¼"	1.031-1.100	2¼"	2½"
4-125-100	1¼"	1.101-1.180	2¼"	2½"
4-125-110	1¼"	1.181-1.240	2¼"	2½"
4-125-120	1¼"	1.241-1.310	2¼"	2½"
4-150-130	1½"	1.311-1.390	2½"	2½"
4-150-140	1½"	1.391-1.470	2½"	2½"
4-150-150	1½"	1.471-1.550	2½"	2½"
4-200-160	2"	1.551-1.660	3"	2½"
4-200-170	2"	1.661-1.750	3"	2½"
4-200-180	2"	1.751-1.840	3"	2½"
4-200-190	2"	1.841-1.930	3"	2½"
4-250-200	2½"	1.931-2.030	3½"	3½"
4-250-210	2½"	2.031-2.150	3½"	3½"
4-250-220	2½"	2.151-2.270	3½"	3½"
4-250-230	2½"	2.271-2.390	3½"	3½"
4-300-240	3"	2.391-2.510	4½"	3½"
4-300-250	3"	2.511-2.640	4½"	3½"
4-300-260	3"	2.641-2.770	4½"	3½"
4-300-270	3"	2.771-2.900	4½"	3½"
4-350-280	3½"	2.901-3.040	5"	3½"
4-350-290	3½"	3.041-3.170	5"	3½"
4-350-300	3½"	3.171-3.310	5"	3½"
4-350-310	3½"	3.311-3.450	5"	3½"
4-400-320	4"	3.451-3.590	5½"	3½"
4-400-330	4"	3.591-3.730	5½"	3½"
4-400-340	4"	3.731-3.870	5½"	3½"
4-400-350	4"	3.871-4.010	5½"	3½"

Kit contains: The SPIN-ON® X connector, and new Putty Type Compound.

Suffix Cat. No. with S for steel, B for brass.

SPIN-ON® X is U.L. Listed for: Class I, Div. 2, Groups A, B, C, & D in ¾", 1", 1¼", 1½", 2", 2½" Hub sizes. Class I, Div. 2, Groups C & D in 3", 3½", and 4" Hub sizes. The entire line is U.L. listed for Class II, Div. 2, Groups F & G and Class III. CSA certified through 4" Hub size for Class I, Groups A, B, C, D; Class II, Groups E, F, G; and Class III.

U.L. File No. E 82038

CSA File No. LR 638

### Liquid Type Sealing Compounds

Cat. No.	Description	Volume
SC4-KIT	Liquid type sealing compound for use in control cable applications	2.8 fl. oz.
SC65	Putty Type Sealing Compound Same as Spin-On® X Blue Compound	60 grams

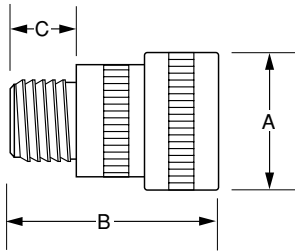

### The T&B TC Series Tray Cable Connector

The Thomas & Betts TC Series of connectors are designed specifically for transitioning tray cable from horizontal cable tray to terminations in enclosures. The precision machined aluminum interiors are ideally suited for use with sunlight-oil resistant cable.

#### Application

- Provides means for passing TC type cable from cable tray installations into an enclosure or threaded bulk-head

#### Cord & Cable Type

- TC (rated for 90°C cable)

#### Features

- Precision machined parts
- Full tapered hub threads
- Gas tight thread engagement

#### Materials

Body, gland nut and insert copper free aluminum

#### Environment Classification

- Ordinary Locations
- Class I, Division 2†, Groups A, B, C, D (¾" - 2½")
- Class I, Division 2, Groups C, D (3" - 4")
- Class II, Division 2, Groups F, G

#### Range

.225" - 3.790"



### Tray Cable Connectors

Cat. No.	Hub Size	A ±.062	B ±.062	Cable Range Dia. (inches)
4-075TC	¾"	1.72	2.10	.275-.600
4-100TC	1"	2.10	2.33	.575-.900
4-125TC	1¼"	2.35	2.70	.860-1.180
4-150TC	1½"	2.78	2.87	1.095-1.420
4-200TC	2"	3.16	3.17	1.280-1.780
4-250TC	2½"	4.00	3.80	1.700-2.200
4-300TC	3"	4.69	3.86	2.150-2.700
4-350TC	3½"	5.22	4.10	2.650-3.230
4-400TC	4"	5.63	4.00	3.180-3.790

NOTE: When installed with the two part epoxy in the intended manner the fittings are suitable for the following hazardous locations:

¾" thru 2½" – Class I Div. 2, Groups A, B, C, D  
Class II Div. 2, Groups F, G

3" thru 4" – Class I Div. 2, Groups C, D  
Class II Div. 2, Groups F, G.

- Suitable for use with sunlight-oil resistant tray cable
- Suitable for 90° Cable
- CSA Certified – Class I Div. 2, Groups A, B, C, D  
Class II Div. 2, Groups E, F, G  
Class III
- "SL" Integral Seal

### Electrical Metallic Tubing (EMT)

#### Ref. NEC Article 348

Electrical Metallic Tubing (EMT) is similar to rigid steel conduit but is much lighter, weighing approximately 40 percent as much as rigid steel conduit of the same nominal size. EMT can be used for both exposed or concealed work provided, where during installation or afterwards, it is not subjected to severe physical damage. Use of EMT is restricted to systems not exceeding 600 volts and to non-hazardous locations except (Class II Division 2 NEC Section 502-4 (b)).

Galvanized Steel EMT installed in concrete on grade or above generally requires no supplementary corrosion protection. However, when installed in concrete below grade level and in contact with soil or cinders supplementary corrosion protection consisting of a protective coating of bitumastic or asphalt base paint or plastic is generally applied. According to NEC Section 348-1, EMT run in or under permanently moist cinder fill must be encased in at least two inches of cinder free concrete unless the conduit is at least 18 inches below the fill.

Aluminum EMT cannot be directly embedded in concrete containing soluble chlorides such as calcium chloride, unwashed beach sand, sea water or coral bearing aggregates. When adequately treated with a protective coating of bitumastic or asphalt base paint or plastic coating the raceway can be installed in concrete containing chlorides.

NEC Sections 384-4 and 300-6 require that in wet locations where walls are frequently washed or where there are surfaces of absorbent material the entire wiring system including boxes, fittings, conduits and cables must be supported such that there is at least ¼ inch air space between it and the supporting surface.

Connectors and couplings are required to be of concrete tight type when embedded in masonry or concrete or in dry locations and of the rain tight type when installed in wet locations (NEC Section 348-8).

According to NEC Section 373-6, where No. 4 or larger underground conductors enter or leave a conduit, an insulating bushing with a smooth well rounded insulating surface must be provided to protect conductors, unless the terminating fitting is equipped with an insulated throat, firmly secured in place providing equivalent protection. The insulating bushing or insulating material must have a temperature rating of not less than the insulation temperature rating of installed conductors.

NEC Section 300-10 requires that the raceways be metalically joined together into a continuous electric conductor and must be mechanically connected to all boxes, fittings and cabinets as to provide effective electrical continuity.

EMT is not permitted to be threaded. Cut ends of tubing are required to be reamed. Code requires that EMT be adequately supported and restricts bends in one run to the equivalent of four quarters i.e. 360 degrees total.

Portions of this section reprinted by permission from NFPA 70-1978, National Electrical Code®, Copyright© 1977, National Fire Protection Association, Boston, MA.

For further details and complete information please refer to the following:

1. NEC Article 348...Electrical Metallic Tubing
2. ANSI C80.3...Electrical Metallic Tubing, Zinc Coated, Specifications for
3. ANSI C33.98, UL797...Standards for Safety. Electrical Metallic Tubing.
4. Fittings for Rigid Metal Conduit and Electrical Metallic Tubing, Specifications for
5. U.L. 514B, Standards for Safety, Outlet Boxes and Fittings
6. WW-C-563...Conduit, Metal, Rigid, and Bend and Elbow, Electrical Conduit, Thin-wall Type (EMT)
7. W-F-408...Fittings for Conduit, Metal, Rigid, (Thickwall & Thinwall (EMT) Type)
8. NEMA FB-1...Standards Publication. Fittings and Supports for Conduit & Cable Assemblies.
9. CEC Section 12-1500...Electrical Metallic Tubing
10. CSA C22.2 No. 83...Safety Standards for Electrical Metallic Tubing
11. CSA C22.2 No. 18...Safety Standards for Outlet Boxes, Conduit Boxes and Fittings

#### Please Note

The excerpts and other material herein, whether relating to the National Electrical Code, the Underwriters Laboratories, Inc. listing, to industry practice or otherwise, is not intended to provide all relevant information required for use and installation. Reference to original or primary source material and data is mandatory before any application or use is made of the product.



**Series 5123 Insulated**  
EMT Connector (Rain tight)  
(Compression Type)



**Series 5120**  
EMT Coupling (Rain tight)  
(Compression Type)



**Series 530**  
Combination Coupling  
(Rain tight)  
Rigid/IMC to EMT

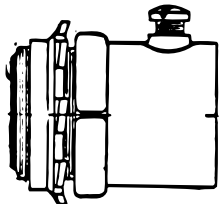

**Series TC121-E or TC721-E**  
Insulated EMT Connector  
(Concrete tight)  
(Set Screw Type)



**Series 1350**  
Pipe Spacers

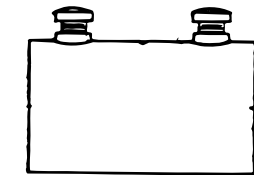

**Series TK121-E**  
EMT Coupling (Concrete tight)  
(Set Screw Type)

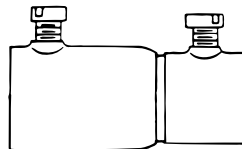

**Series HT-221**  
Combination Coupling  
(Concrete tight)  
Rigid/IMC to EMT  
(Set Screw Type)  
Zinc Die Cast



**Series 106**  
Bonding Locknut



**Series 4176**  
Pipe Straps

### Suggested Specifications for Electrical Metallic Tubing (EMT) Fittings

- Ferrous Electrical Metallic Tubing (E.M.T.) shall be of the hot dipped galvanized type conforming to applicable specifications WW-563/ANSI C33.98/ANSI C80.3/U.L. 797/CSA C22.2 No. 83. E.M.T. protected solely by enamel shall not be used.
- Where lengths of EMT are coupled together or connected to boxes or enclosures or where EMT is coupled to threaded rigid metal conduit or IMC, fittings approved for intended applications shall be used, and:
  - (1) Shall be of rugged steel/malleable iron construction electro zinc plated inside/outside including threads. Connector throat shall be bushed with a nylon insulator.
  - (2) Shall be of rain tight type for installations exposed to weather or wet locations such as Thomas & Betts series 5123, 5120 and 530.
  - (3) Shall be of concrete tight type for installations in poured concrete such as Thomas & Betts series TC121, TC721, or TK121.
 Rain tight type fittings may be substituted for concrete tight application.
- Where electrical metallic tubing and associated fittings are used as part of equipment grounding system:
  - (1) A bonding type locknut such as Thomas & Betts series 106 shall be installed where hub type fitting terminates into a threadless opening.
  - (2) Compression ring type fittings such as Thomas & Betts series 5123 and 5120 shall be used for terminating and coupling.
- EMT shall be securely fastened in place at intervals as specified by the code using straps, hangers and other supporting assemblies as indicated on plans, and as manufactured by Thomas & Betts, series 4176 straps. In wet locations or where supporting surfaces are of absorbent materials vertical and horizontal runs of conduit shall be firmly supported such that there is at least ¼" air space between conduit and supporting surface.
- Spacers and supporting straps shall be of rugged malleable iron or steel construction hot dipped galvanized and conforming to requirements of Canadian Standards Association Standard C22.2 No. 18 as manufactured by Thomas & Betts, series 4176 straps and series 1350 spacers.



5123 Series\*



5120 Series

\* 4230 Series – 90° Connectors

### Fittings for Electrical Metallic Tubing (EMT) Compression Type, Rain tight

#### Application

- To connect and effectively bond electrical metallic tubing to a box or an enclosure.
- To provide a rain tight connection between tubing and the connector.
- To couple ends of tubing.

#### Features

- Rugged all steel construction.
- Rings designed to positively bond conduit to fitting; unique locknut design provides effective bond between fitting and box or enclosure; ground continuity is assured.
- Nylon insulator firmly secured in place – protects conductors, reduces wire pulling effort and prevents thread damage in handling.
- Locknuts are designed with extended reach to lock fitting on to a thin box or an enclosure.
- Locknuts tighten without deformation; will not vibrate loose.

#### Standard Material

All Steel except Insulator.  
Insulator.....Thermoplastic, U.L.  
Rated 105°C

#### Standard Finish

All Steel Parts .....Electro Zinc Plated  
& Chromate Coated  
Insulator.....As Molded

#### Range

Conduit Size... ½" thru 2"  
Hub Size... ½" thru 2" NPS  
Hubs provided with straight pipe threads NPS.

#### Listed/Certified by:

U.L. (U.L. File No. E-16592)  
CSA (LR-4484, LR-8994)

#### Conforms to:

U.L. 514B  
CSA C22.2 No. 18  
NFPA 70-1999 (ANSI)  
NEMA FB1  
Federal Specification W-F-408  
Federal Standard H-28 (Threads)

# T&B® Fittings

## Electrical Metallic Tubing (EMT) Fittings

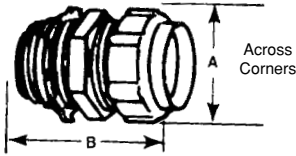

### EMT Connectors – Nylon Insulated

Cat. No.	Size	Dimensions (in.)	
		A	B
5123	1/2"	13/64	121/32
5223	3/4"	121/64	127/32
5323	1"	111/16	17/8
5423	1 1/4"	2 1/16	2 11/32
5523	1 1/2"	2 5/16	2 23/32
5623	2"	2 25/32	2 13/16

U.L. Listed and CSA Certified rain tight.  
U.L. File No. E 9043  
CSA File No. 8994

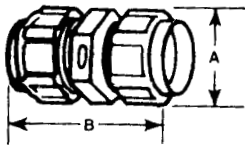

### EMT Couplings

Cat. No.	Size	Dimensions (in.)	
		A	B
5120	1/2"	1 1/16	1 27/32
5220	3/4"	1 5/16	2 1/8
5320	1"	1 11/16	2 1/8
5420	1 1/4"	2 1/16	2 23/32
5520	1 1/2"	2 5/16	3 1/16
5620	2"	2 3/4	3 3/32

U.L. Listed and CSA Certified rain tight.  
U.L. File No. E 9043  
CSA File No. 8994

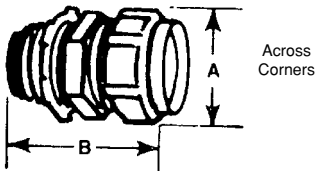

### EMT Connectors

Cat. No.	Size	Dimensions (in.)	
		A	B
5121	1/2"	1 1/16	1 3/16
5221	3/4"	1 5/16	1 21/32
5321	1"	1 11/16	1 3/4
5421	1 1/4"	2 1/16	1 11/32
5521	1 1/2"	2 5/16	2 3/16
5621	2"	2 3/4	2 3/4

U.L. Listed and CSA Certified rain tight.  
T&B E.M.T. (thinwall) fittings comply with Federal Spec. WF408B.  
U.L. File No. E 9043  
CSA File No. 8994



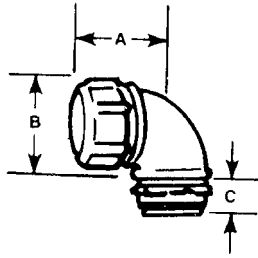

*Ideal for cramped locations or tight corners where large radius conduit elbows will not fit or would appear unworkmanlike. Shoulders on body of 1/2" size are hex-shaped to provide positive holding for standard installation tools. Use insulated type for simple, and safe, installations. Malleable iron. U.L. rated 105°C.*

### Short Elbows – Insulated\*

Cat. No.	Size	Dimension (in.)		
		A	B	C
4240	1/2"	1 7/16	1 9/32	7/16
4241-TB	3/4"	1 11/16	1 19/32	1/2
4242	1"	1 7/8	1 27/32	5/8
4243	1 1/4"	2 3/4	2 15/32	1 1/16
4244	1 1/2"	3 1/16	2 3/4	1 1/16
4245	2"	3 3/8	3 5/16	1 1/16

U.L. Listed and CSA Certified rain tight.  
U.L. File No. E 09043  
CSA File No. 2884

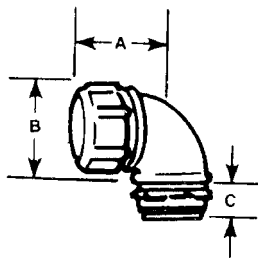

*Ideal for cramped locations or tight corners where large radius conduit elbows will not fit or would appear unworkmanlike. Shoulders on body of 1/2" size are hex-shaped to provide positive holding for standard installation tools.*

### Short Elbows Malleable Iron\*

Cat. No.	Size	Dimension (in.)		
		A	B	C
4230	1/2"	1 7/16	1 9/32	7/16
4231	3/4"	1 11/16	1 19/32	1/2
4232	1"	1 7/8	1 27/32	5/8
4233	1 1/4"	2 3/4	2 15/32	1 1/16
4234	1 1/2"	3 1/16	2 3/4	1 1/16
4235	2"	3 3/8	3 5/16	1 1/16

U.L. Listed and CSA Certified rain tight.  
U.L. File No. E 09043  
CSA File No. 2884

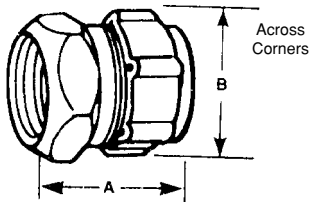

*For connecting EMT to threaded rigid and intermediate metal conduit.*

### Combination Coupling – Steel\*

Cat. No.	Size	Dimensions (in.)	
		A	B
530-TB	1/2"	1 3/8	1 1/16
531	3/4"	1 1/2	1 11/32
532	1"	1 19/32	1 21/32

U.L. Listed and CSA Certified rain tight.  
U.L. File No. E 09043  
CSA File No. 2884

\* All items shown on this page are suitable for use in hazardous locations where general purpose equipment is specifically permitted by the NEC; Class I, Div. 2; Class II, Div. 1 & 2; Class III, Div. 1 & 2, 502-4(a)(b); 503-3(a)(b).

# T&B® Fittings

## Electrical Metallic Tubing (EMT) Fittings



Oval Hole for  
Screw Size (C)

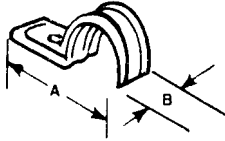

*Elongated bolt hole makes alignment easy, even when holes in mounting surface are out of alignment. Snap on features hold strap in place.*



Oval Hole for Screw Size (C)

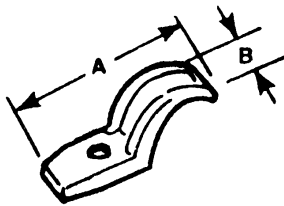

*Designed to fit each size of conduit snugly. High reinforcing ribs on each side increase strength, reduce weight. Hot dipped galvanized finish.*

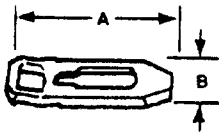

*Used with T&B conduit straps to permit space between conduit and mounting surface. Eliminates need for costly offset-bending conduit and possible corrosive moisture traps when conduit is mounted directly to a surface. Malleable iron. Hot-dipped galvanized finish, pre-mountable and stackable to eliminate offsetting.*



### Pipe Straps – Steel

Cat. No.	Size	Dimensions (in.)		
		A	B	C (Bolt Hole)
4159	½"	1 <sup>7</sup> / <sub>32</sub>	¾	¼
4160	¾"	2 <sup>1</sup> / <sub>32</sub>	¾	¼
4161	1"	2 <sup>11</sup> / <sub>32</sub>	¾	¼
4162	1¼"	2 <sup>7</sup> / <sub>16</sub>	¾	¼
4163	1½"	3 <sup>1</sup> / <sub>16</sub>	1¼	1 <sup>1</sup> / <sub>32</sub>
4164	2"	4 <sup>1</sup> / <sub>16</sub>	1½	1 <sup>3</sup> / <sub>32</sub>

Not U.L. Listed  
CSA File No. 2884 and 4484



### Pipe Straps – Malleable Iron

Cat. No.	Size	Dimensions (in.)		
		A	B	C (Bolt Hole)
4176	½"	2 <sup>5</sup> / <sub>32</sub>	2 <sup>1</sup> / <sub>32</sub>	¼
4177	¾"	2 <sup>9</sup> / <sub>16</sub>	1 <sup>1</sup> / <sub>16</sub>	¼
4178	1"	3	¾	¼
4179	1¼"	3¾	1 <sup>3</sup> / <sub>16</sub>	5 <sup>1</sup> / <sub>16</sub>
4180	1½"	4 <sup>3</sup> / <sub>16</sub>	1 <sup>5</sup> / <sub>16</sub>	¾
4181	2"	5 <sup>3</sup> / <sub>16</sub>	1½	7 <sup>1</sup> / <sub>16</sub>
1282	2½"	5 <sup>15</sup> / <sub>16</sub>	1½	1½
1283	3	6 <sup>11</sup> / <sub>16</sub>	1 <sup>5</sup> / <sub>8</sub>	1½
1284	3½"	7 <sup>19</sup> / <sub>32</sub>	1¾	5 <sup>1</sup> / <sub>8</sub>
1285	4"	8 <sup>5</sup> / <sub>16</sub>	1 <sup>7</sup> / <sub>8</sub>	5 <sup>1</sup> / <sub>8</sub>

Not U.L. Listed.  
CSA File No. 2884 and 4484



### Pipe Spacers

Cat. No.	Size	Dimensions (in.)	
		A	B
1350	½", ¾", 1"	3"	7 <sup>1</sup> / <sub>8</sub>
1351	1¼"-1½"-2"	5"	1 <sup>3</sup> / <sub>16</sub> "
1352	2½"-3"	9 <sup>9</sup> / <sub>16</sub> "	1¾"
1353	3½"-4"	7 <sup>7</sup> / <sub>16</sub> "	2"
1354	4½"-5"-6"	10 <sup>9</sup> / <sub>16</sub> "	2 <sup>3</sup> / <sub>16</sub> "

Conforms to NEC 300-5-C.  
CSA File No. 2884



### Our Liquidtight Line is the End-All for Liquidtight Dust-Tight Connections.

All our high-performance products are designed to deliver excellent reliability as well as ease of installation in virtually any application. And you benefit from our expertise through our liquidtight and dust-tight connections available for a variety of conduits as well as portable cord.

Thomas & Betts offers the largest and most technologically advanced line of liquidtight fittings in the industry, including connectors for highly-specialized applications such as power and petrochemical plants, paper mills, robot manufacturers, packaging equipment, machine tool building, and other OEM and MRO applications. At Thomas & Betts, we integrate the latest manufacturing technologies with the highest quality materials available. So you can be assured of reliable, liquidtight products that offer improved on-the-job performance and reduced installation time and costs.

### The Revolver™ Grounding Fitting Is The Latest Labor-Saving Innovation From Thomas & Betts.

The Revolver liquidtight grounding fitting is our latest breakthrough in convenience to save time and money on the job. The grounding lug of the Revolver can be rotated in a full circle, for convenient positioning that doesn't change when you tighten it. It's the newest innovation in Thomas & Betts' versatile line of Liquidtight Connectors— fittings you can count on for liquidtight and dust-tight connections. Because all our products revolve around your needs.

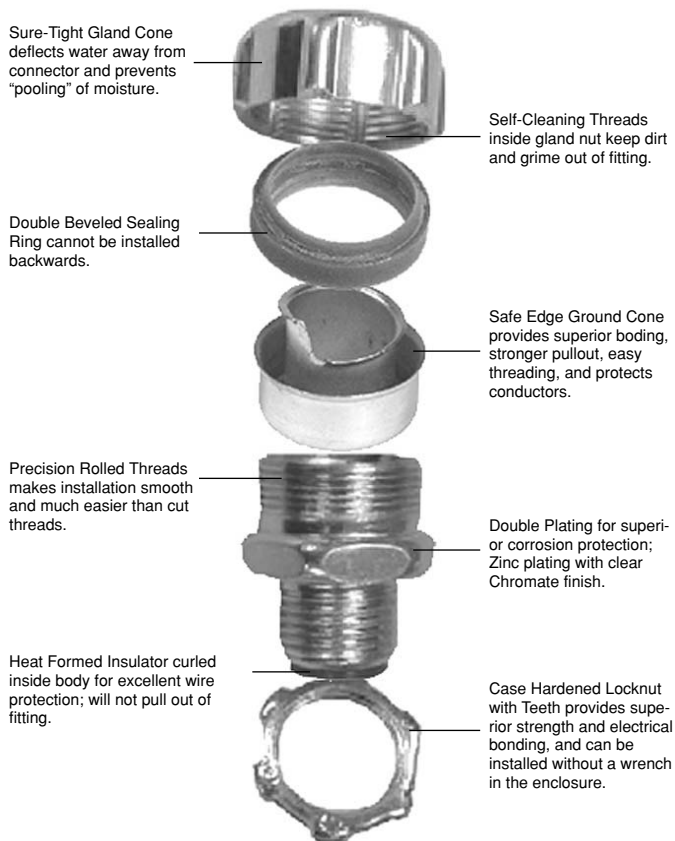

Revolver™ Grounding Fitting saves time and money with rotating ground lug

**Liquidtight Flexible Metal Conduit Fittings****Liquidtight Connectors****Liquidtight Flexible Metal Conduit Fittings**

Thomas & Betts Liquidtight fittings for flexible metal conduits are suitable for a wide range of installations, including heavy industrial applications. Our Liquidtight fittings are designed to stand up to demanding, wet or corrosive environments, including power and petrochemical plants, paper mills, and anywhere high performance is a requirement.

**Features of Thomas & Betts Liquidtight fittings include:**

- Safe Edge™ ground cone design that

accepts variations in raceway convolutions and provides a positive bond.

- Continuous sealing ring which completely surrounds the conduit to ensure a liquid-tight seal.
- Zinc chromatic plating for longer life and exceptional appearance.
- The broadest liquid-tight line in the industry, including PVC coated, externally grounded, aluminum series, Chase® style, non-metallic Bullet series, wire mesh grips, and more.

**Liquidtight Fittings for Special Applications****The Revolver™ Externally Grounded Fitting**

The grounding lug of the new Revolver connector can be rotated in a full circle for convenient positioning that doesn't change when you tighten it. Plus, it's available for the first time in aluminum. It's a major breakthrough in convenience that saves time and money on the job while delivering a quality connection.

**Chase-Style Fittings**

Where space is tight, our Chase fittings allow for compact connections within an enclosure.

**PVC-Coated Connectors**

When environmental conditions are particularly harsh and corrosive, our PVC-coated connectors are the best choice for both indoor and outdoor applications. The PVC coating protects exposed surfaces for long-lasting, reliable connections.

**Sealing Gaskets**

Thomas & Betts sealing gaskets are resistant to oil, coolants, and hydraulic fluids as well as water, with a stainless steel retaining clip that assures a quality seal. They're the ideal match to our Liquidtight connectors for a safe and secure seal.

**Liquidtight Flexible Non-Metallic Conduit Fittings**

When non-metallic, Type A or EFC conduits are called for, Thomas & Betts' XTRAFLEX System has our outstanding Bullet fittings and conduits for liquid- and dust-tight connections.

**Bullet fittings:**

- Feature one piece construction and a captive o-ring for ease of installation.
- Provide a positive seal between the conduit and the connector.
- Have a tapered thread hub and sealing o-ring for a tight seal to the box or other enclosure.

- Are constructed of non-burning, non-dripping thermoplastic for high strength chemical resistance.
- Feature a smooth insulated body for maximum dielectric strength.
- Have a patented, serrated design that provides high mechanical pullout strength.
- Include a complete range of flexible, non-metallic conduits – including both smooth and corrugated varieties – to complete our XTRAFLEX System.



5331 Series\*  
5231 AL Series



5361 Series



5271 Series

\* 5341 Series...  
same as 5331, except 45° Connectors  
5351 Series...  
same as 5331, except 90° Connectors

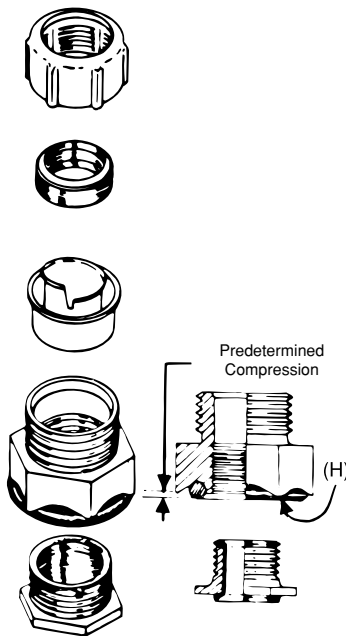

5361 Series  
Chase® Style

### Liquidtight Flexible Metal Conduit Connectors

#### Application

- Used where flexible metal raceway is installed in outdoor or indoor locations where exposed to continuous or intermittent moisture.
- To positively bond conduit to box or enclosure.

#### Features

- Ability to install quickly with low torque effort.
- Ground cone design offers following advantages:
  - (1) Compresses metallic convolutions; provides high quality ground contact with low impedance and high raceway holding power (A).
  - (2) Single helical thread on ground cone is easy to install without cross thread; accepts variations in raceway diameters and convolution pitch (B).
  - (3) Rolled over edge protects conductors (C).

Sealing ring design has following exclusive features:

- (1) Grips and seals at leading and trailing edge – will not abrade raceway jacket (D).
- (2) Provided with grooves on inside diameter for anti-sleeving (E).
- (3) Shoulders on both ends for extra sealing (F).
- (4) Symmetrical shape assures fool-proof assembly.

- Can be disconnected and reused.
- Watertight/oil tight installation at box or enclosure termination is assured by:
  - (1) External taper thread hub on 5331 series and use of sealing gasket 5262 series (G).
  - (2) Captivated sealing 'O' ring on 5361 series (H).
  - (3) Taper tapped hole on 5271 series.
- Suitable for use in Class I Division 2, Class II Division 1 and 2 and Class III Division 1 and 2 Hazardous Locations per N.E.C. Section 500.
- Suitable as a grounding means per N.E.C. Section 351-9 (up to 1¼" trade size on).
- ½" & 1¼" sizes Laboratory tested to carry ground fault current of up to 1000 amps RMS with duration of fault current 3 cycles.

- Conforms with JIC requirements.
- Available with imperial, I.S.O. & PG threaded hub.

#### Standard Material

##### 5331-5361-5271 Series

Body, Gland, Locknut & Ground Cones: All steel or malleable iron.

Sealing Ring and Insulator: All thermoplastic

Sealing Gasket: Stainless Steel and Buna N

##### 5231 AL Series

All Copper-free Aluminum (non-insulated)

##### 5332SST Series

31L Stainless Steel insulated

##### 5332B Series

Marine grade brass insulated avant

#### Standard Finish

##### 5331-5361-5271 Series

Electro Zinc Plated & Chromate Coated

##### 5231 AL Series

Copper-free Aluminum

#### Range

5331 Series	.....	¾" thru 6"* conduit
5341 Series	.....	¾" thru 4" conduit
5351 Series	.....	¾" thru 4" conduit
5361 Series	.....	¾" thru 4" conduit
5271 Series	.....	¾" thru 1¼" conduit
5231 AL Series	.....	¾" thru 4" conduit
5332SST Series	.....	½" & ¾" conduit
5332B Series	.....	½" & ¾" conduit

All hubs provided with taper pipe threads (NPT)

#### Listed/Certified by:

U.L....(U.L. File No. E-23018)  
CSA...(LR-2884, LR-4484, LR-9555)

#### Conforms to:

U.L. 514B  
CSA C22.2 No. 18  
NEMA FB-1  
NFPA 70-1999 (ANSI)  
JIC EGP1  
JIC EMP1  
Federal Specification W-F-406  
Federal Standard H-28 (Threads)

## Liquidtight Flexible Metal Conduit Fittings

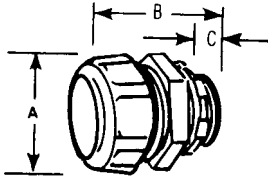

Steel malleable iron, or aluminum tapered hub threads. With safe-edge ground thru 4" cone and double bevel seating ring (through 2").



## Straight Connectors\*

Insulated Steel	Cat. No.				Conduit Size	Dimensions (in.)		
	Aluminum	Non-Insulated Steel	Stainless Steel	Brass		A	B	C
5229 <sup>†</sup>	–	–	–	–	¼	2 <sup>7</sup> / <sub>32</sub>	1 <sup>3</sup> / <sub>8</sub>	1 <sup>5</sup> / <sub>32</sub>
5330 <sup>†</sup>	–	–	–	–	5 <sup>1</sup> / <sub>16</sub>	6 <sup>3</sup> / <sub>64</sub>	1 <sup>3</sup> / <sub>8</sub>	1 <sup>5</sup> / <sub>32</sub>
5331 <sup>†**</sup>	5231AL	5231 <sup>†</sup>	–	–	¾	1 <sup>5</sup> / <sub>32</sub>	1½	9 <sup>1</sup> / <sub>16</sub>
5332 <sup>†</sup>	5232AL	5232 <sup>†</sup>	5332SST	5332B	½	1 <sup>3</sup> / <sub>8</sub>	1 <sup>1</sup> / <sub>16</sub>	9 <sup>1</sup> / <sub>16</sub>
5333 <sup>†</sup>	5233AL	5233 <sup>†</sup>	5333SST	5333B	¾	1 <sup>21</sup> / <sub>32</sub>	1 <sup>3</sup> / <sub>8</sub>	9 <sup>1</sup> / <sub>16</sub>
5334 <sup>†</sup>	5234AL	5234 <sup>†</sup>	–	–	1	1 <sup>7</sup> / <sub>8</sub>	2 <sup>1</sup> / <sub>16</sub>	¾
5335 <sup>†</sup>	5235AL	5235 <sup>†</sup>	–	–	1¼	2 <sup>9</sup> / <sub>32</sub>	2½	1 <sup>9</sup> / <sub>16</sub>
5336	5236AL	5236	–	–	1½	2 <sup>23</sup> / <sub>32</sub>	2 <sup>1</sup> / <sub>16</sub>	1 <sup>9</sup> / <sub>16</sub>
5337	5237AL	5237	–	–	2	3¼	3 <sup>1</sup> / <sub>16</sub>	7 <sup>1</sup> / <sub>8</sub>
5338	5238AL	5238	–	–	2½	3¾	4 <sup>1</sup> / <sub>8</sub>	1
5339	5239AL	5239	–	–	3	4½	4¼	1
5340	5240AL	5240	–	–	4	5½	4½	1½
5385 <sup>†</sup>	–	5285	–	–	5	8¾	7	1 <sup>7</sup> / <sub>8</sub>
5386 <sup>†</sup>	–	–	–	–	6	8¾	8½	2

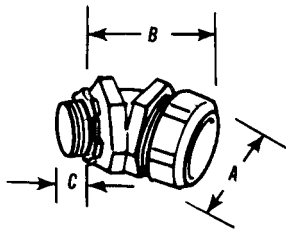

Malleable iron, tapered hub threads. With safe-edge ground cone and double bevel seating ring (through 2").



## 45° Angle Connectors\*

Insulated	Cat. No.		Conduit Size	Dimensions (in.)		
	Non-Insulated			A	B	C
5341 <sup>†**</sup>	5241 <sup>†</sup>		¾	1 <sup>7</sup> / <sub>32</sub>	1 <sup>1</sup> / <sub>16</sub>	9 <sup>1</sup> / <sub>16</sub>
5342 <sup>†</sup>	5242 <sup>†</sup>		½	1 <sup>3</sup> / <sub>8</sub>	1 <sup>7</sup> / <sub>8</sub>	9 <sup>1</sup> / <sub>16</sub>
5343 <sup>†</sup>	5243 <sup>†</sup>		¾	1 <sup>21</sup> / <sub>32</sub>	2 <sup>1</sup> / <sub>8</sub>	9 <sup>1</sup> / <sub>16</sub>
5344 <sup>†</sup>	5244 <sup>†</sup>		1	1 <sup>7</sup> / <sub>8</sub>	2¼	¾
5345 <sup>†</sup>	5245 <sup>†</sup>		1¼	2 <sup>9</sup> / <sub>32</sub>	2¾	1 <sup>3</sup> / <sub>16</sub>
5346	5246		1½	2 <sup>23</sup> / <sub>32</sub>	3 <sup>3</sup> / <sub>8</sub>	1 <sup>3</sup> / <sub>16</sub>
5347	5247		2	3¼	3 <sup>7</sup> / <sub>8</sub>	7 <sup>1</sup> / <sub>8</sub>
5348	5248		2½	3¾	4¼	1
5349	5249		3	4½	4¼	1
5350	5250		4	5½	4 <sup>5</sup> / <sub>8</sub>	1½

\* Suitable for hazardous locations use in Class I, Div. 2; Class II, Div. 1 and 2; Class III, Div. 1 and 2, where general purpose equipment is specifically permitted per NEC Section 500-2(a).

\*\* ¾" Conduit Fitting has ½" hub.

<sup>†</sup> U.L. Listed as grounding means under NEC 351-7.

<sup>‡</sup> Not U.L. Listed.

Note: U.L. Listed liquidtight; and CSA Certified watertight.

Available with DURA-PLATE® Finish.

U.L. File No. E-23018

CSA File No. 2884

For Wiremesh Grips refer to pages A119, A154.



### Standard Liquid Tight – Female Hub Adapter

Cat. No.	Conduit Size	Dimensions (in.)	
		A	B
5271†	3/8"	1 1/2"	1 1/16"
5272†	1/2"	1 3/8"	1 1/4"
5273†	3/4"	1 7/8"	1 1/2"
5274†	1"	1 7/8"	2 1/8"
5275†	1 1/4"	2 3/8"	2 1/2"

† U.L. Listed as grounding means under NEC 351-7.

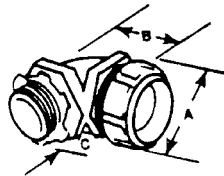

### 90° Angle Connectors

Cat. No.			Hub Size	Conduit Size	Dimensions (in.)		
Insulated	Non-Insulated	Aluminum			A	B	C
5351	5251	5251AL	1/2"	3/8"	1 5/8"	1 3/8"	9/16"
5352	5252	5252AL	1/2"	1/2"	1 3/8"	1 1/4"	9/16"
5353	5253	5253AL	3/4"	3/4"	1 7/8"	1 3/4"	9/16"
5354	5254	5254AL	1"	1"	1 7/8"	2 3/16"	3/4"
5355	5255	5255AL	1 1/4"	1 1/4"	2 3/8"	2 3/4"	13/16"
5356	5256	5256AL	1 1/2"	1 1/2"	2 3/8"	2 9/16"	13/16"
5357	5257	5257AL	2"	2"	3 1/4"	3 7/16"	7/8"
5358	5258	–	2 1/2"	2 1/2"	3 3/4"	8 7/16"	1"
5359	5259	–	3"	3"	4 1/2"	10 1/4"	1"
5360	5260	–	4"	4"	5 1/2"	12 5/8"	1 1/8"

\* Suitable for hazardous locations use in Class I, Div. 2; Class II, Div. 1 and 2; Class III, Div. 1 and 2, where general purpose equipment is specifically permitted per NEC Section 500-2(a).

\*\* 3/8" Conduit Fitting has 1/2" hub.

† U.L. Listed as grounding means under NEC 351-7.

‡ Not U.L. Listed.

Note: U.L. Listed liquidtight; and CSA Certified watertight.

Available with DURA-PLATE® Finish.

U.L. File No. E-23018

CSA File No. 2884

For Wiremesh Grips refer to pages A119, A154.

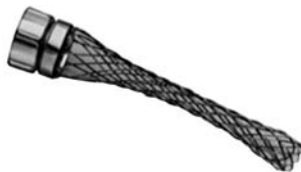

Prevents severe conduit bends and pullout.

### Wiremesh Grips for Liquidtight Fittings

Cat. No.	Conduit Size	Liquidtight Connectors			90° Chase	Chase	Adapter
		Straight	45°	90°			
WMG-LT1	3/8"	5331	5341	5351	5361	5371	5271
WMG-LT2	1/2"	5332	5342	5352	5362	5372	5272
WMG-LT3	3/4"	5333	5343	5353	5363	5373	5273
WMG-LT4	1"	5334	5344	5354	5364	5374	5274
WMG-LT5	1 1/4"	5335	5345	5355	5365	–	5275
WMG-LT6	1 1/2"	5336	5346	5356	5366	–	5276
WMG-LT7	2"	5337	5347	5357	5367	–	5277
WMG-LT8	2 1/2"	5338	5348	5358	5368	–	5278
WMG-LT9	3"	5339	5349	5359	5369	–	5279
WMG-LT10	4"	5340	5350	5360	5370	–	5282

Order wiremesh grip separately: no need to duplicate inventory.

U.L. File No. E23018

CSA File No. 2884 & 4484

## Liquidtight Flexible Metal Conduit Fittings

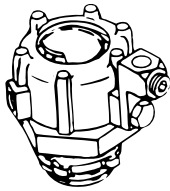

Series 5331GR

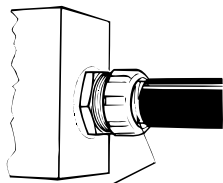
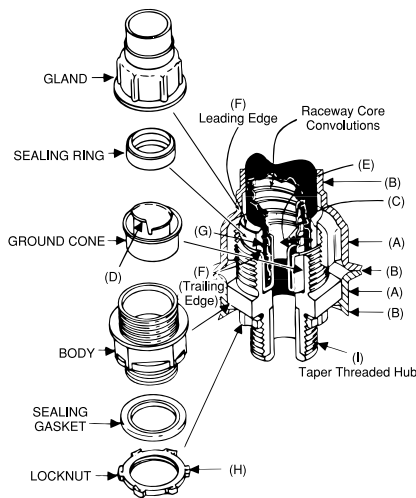
**Sleeving**

**Raceway Jacket pulls off – exposing core and affecting liquidtight termination. Feature (E) on sealing ring helps overcome this problem.**

**External Bonding Liquidtight Flexible Metal Conduit Connectors****Application**

- Used where external bonding jumper is required around liquidtight flexible metal conduit.
- To positively bond conduit to box or enclosure.
- Used where flexible raceway is installed in outdoor or indoors location where exposed to continuous or intermittent moisture.

**Features**

- Designed with provision to install bonding jumper in several positions.
- Designed to accept mechanical or compression lug.
- Ability to install quickly with low torque effort.
  - (i) Compressed metallic convulsions; assures ground contact with low impedance and high raceway holding power (A).
  - (ii) Single helical thread on ground cone is easy to install without cross thread; accepts variations in raceway diameters and convolution pitch (B).
  - (iii) Rolled over edge protects conductors (C).
- Sealing ring design has following exclusive features:
  - (i) Grips and seals at leading and trailing edge – will not abrade raceway jacket (D).
  - (ii) Provided with grooves on inside diameter for anti-sleeving (E).
  - (iii) Shoulders on both ends for extra sealing (F).
  - (iv) Symmetrical shape assures fool-proof assembly.
- Can be disconnected and reused.
- Watertight/oil tight installation at box or enclosure termination is assured by:
  1. External taper thread hub on 5331GR series and use of sealing gasket 5262 series (G).
  2. Taper tapped hole on 5271 series.
- Suitable for use in Class I Division 2, Class II Division 1 & 2 and Class III Division 1 & 2 Hazardous Locations per NEC Article 500.

- Suitable as a bonding means per U.L. 467 and NEC Article 351-9.
- Conforms with JIC requirements.

**Standard Material**

Lugs: High conductivity copper (for copper conductor only).  
 Body, Gland, Locknut & Ground Cones: All steel or malleable iron.  
 Sealing Ring and Insulator: All thermoplastic.  
 Sealing Gasket: Stainless Steel and Santoprene.  
 Strap: Steel.

**Standard Finish**

All Electro Zinc Plated and Chromate Coated except lugs.  
 Lugs: Bright Dipped.

**Range**

5331GR Series (straight connectors with male hub): 3/8" thru 6" conduit.  
 5341GR Series (45°): 3/8" thru 4" conduit.  
 5351GR Series (90°): 3/8" thru 4" conduit.  
 5232ALGR Series: 3/8" thru 1" conduit.  
 All hubs provided with taper pipe threads (NPT).

**Listed/Certified by:**

U.L. File #E-23018  
 CSA

**Conforms to:**

U.L. 467  
 U.L. 514B  
 CSA C22.2 No. 18  
 CSA22.2 No. 41  
 NEMA FB-1  
 NFPA 70-1999 (ANSI)  
 JIC EGP1  
 JIC EMP1  
 Federal Specification W-F-406  
 Federal Standard H-28 (threads)

<sup>1</sup> Per C.E. Code, this method is not permissible.



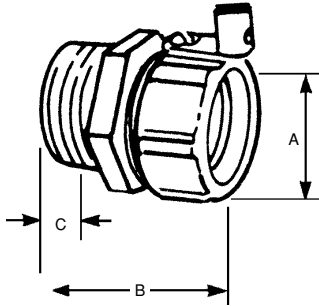

Malleable iron, tapered hub threads.

### Straight Grounding Fittings\*

Steel Insulated	Cat. No.		Conduit Size	Dimensions (in.)			Ground Wire D
	Steel Non-Insulated	Aluminum Non-Insulated		A	B	C	
5331GR**	5231GR	5231 ALGR	3/8"	1 1/2	1 1/2	9/16	14-8
5332GR	5232GR	5232ALGR	1/2"	1 3/8	1 9/16	9/16	14-8
5333GR	5233GR	5233ALGR	3/4"	1 2 1/2	1 5/8	9/16	14-4
5334GR	5234GR	5234ALGR	1"	1 7/8	2 1/16	3/4	14-4
5335GR	5235GR		1 1/4"	2 1/4	2 1/2	13/16	8-1/0
5336GR	5236GR		1 1/2"	3 1/4	2 11/16	13/16	4-2/0
5337GR	5237GR		2"	3 13/16	3 1/16	7/8	4-2/0
5338GR	5238GR		2 1/2"	4 7/8	4 1/8	1	2-4/0
5339GR	5239GR		3"	5 5/8	4 1/4	1	2-4/0
5340GR	5240GR		4"	6 1/8	4 1/2	1 1/8	2-4/0
5385GR	5285GR		5"	8 3/8	7	1 7/8	2-4/0
5386GR	-		6"	8 7/32	8 1/2	2	2-4/0

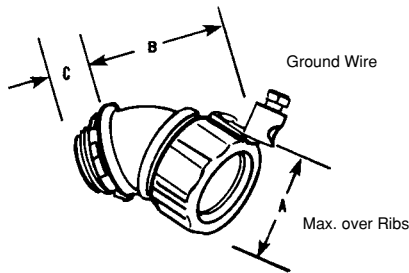

Malleable iron, tapered hub threads.

### 45° Angle Grounding Fittings

Insulated	Cat. No.		Conduit Size	Dimensions (in.)			Ground Wire D
	Non-Insulated			A	B	C	
5341GR**	5241GR**		3/8"	1 5/8	1 9/16	9/16	14-8
5342GR	5242GR		1/2"	1 3/8	1 7/8	9/16	14-8
5343GR	5243GR		3/4"	1 2 1/2	2 1/8	9/16	14-4
5344GR	5244GR		1"	1 7/8	2 1/4	3/4	14-4
5345GR	5245GR		1 1/4"	2 1/4	2 3/4	13/16	8-1/0
5346GR	5246GR		1 1/2"	3 1/4	3 3/8	13/16	4-2/0
5347GR	5247GR		2"	3 13/16	3 7/8	7/8	4-2/0
5348GR	5248GR		2 1/2"	4 7/8	4 1/4	1	2-4/0
5349GR	5249GR		3"	5 5/8	4 1/4	1	2-4/0
5350GR	5250GR		4"	6 1/8	4 5/8	1 1/8	2-4/0

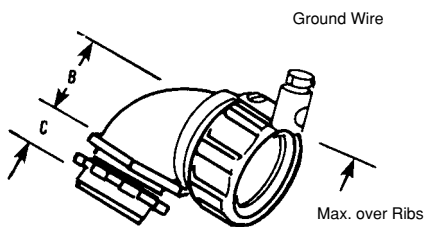

Malleable iron tapered hub threads.

### 90° Angle Grounding Fittings

Steel Insulated	Cat. No.		Conduit Size	Dimensions (in.)			Ground Wire D
	Steel Non-Insulated	Aluminum Non-Insulated		A	B	C	
5351GR**	5251GR**	5251ALGR	3/8"	1 5/8	1 1/4	9/16	14-8
5352GR	5252GR	5252ALGR	1/2"	1 3/8	1 7/8	9/16	14-8
5353GR	5253GR	5253ALGR	3/4"	1 2 1/2	1 13/16	9/16	14-4
5354GR	5254GR	5254ALGR	1"	1 7/8	2 1/16	3/4	14-4
5355GR	5255GR		1 1/4"	2 1/4	2 1/2	13/16	8-1/0
5356GR	5256GR		1 1/2"	3 1/4	2 15/16	13/16	4-2/0
5357GR	5257GR		2"	3 13/16	3 7/8	7/8	4-2/0
5358GR	5258GR		2 1/2"	4 7/8	8 7/8	1	2-4/0
5359GR	5259GR		3"	5 5/8	10 1/4	1	2-4/0
5360GR	5260GR		4"	6 1/8	12 5/8	1 1/8	2-4/0

\*\* 3/8" conduit fittings have 1/2" trade size hub. With safe-edge ground cone (through 4") and double bevel sealing ring (through 2"). U.L. Listed liquidtight; and CSA Certified watertight. Suitable for hazardous locations use in Class I, Div. 2; Class II, Div. 1 and 2; Class III, Div. 1 and 2, where general purpose equipment is specifically permitted per NEC Section 500-2(a). Available with DURA-PLATE® Finish. U.L. File No. E 3060. CSA File No. 638

Note: 3/8"-1" fittings include Revolver™ grounding device. For sizes 1 1/4" and up, fittings are supplied with a copper mechanical lug.

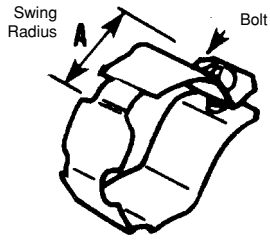
**T&B® Fittings****Liquidtight Flexible Metal Conduit Fittings**

*For retrofit applications. Includes strap, nut and bolt.*

**External Grounding Strap**

Cat. No.	Conduit Size	A	B Bolt Size
GR1W	3/8"	1	10-24
GR2W	1/2"	1 1/6	10-24
GR3W	3/4"	1 3/8	1/4-20
GR4W	1"	1 1/2	1/4-20
GR5W	1 1/4"	1 7/8	5/16-18

U.L. File No. E-3060  
CSA File No. 638



3321 Series\*

\*3361 Series...  
same as 3321, except 90°  
3341 Series...  
same as 3321, except 45°

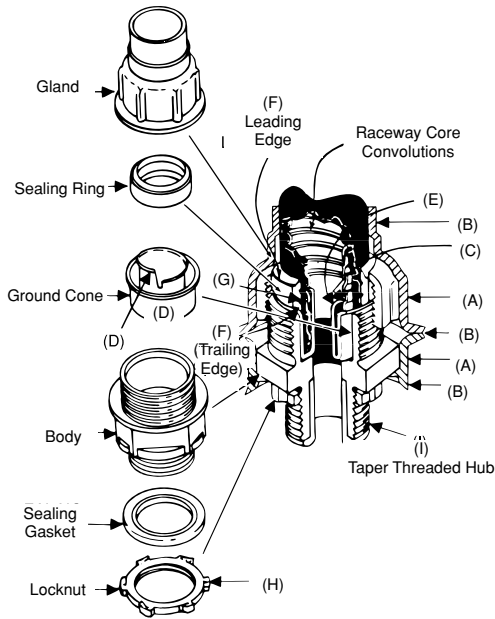

3321 Series

### Liquidtight Flexible Metal Conduit Connectors (PVC Coated)

#### Application

- Used where liquidtight flexible metal conduit is installed in outdoor or indoor locations where exposed to environmental conditions that are more than normally corrosive to exposed surfaces.
- To positively bond conduit to box or enclosure.

#### Features

- PVC coated to protect connector from extremely corrosive surroundings without effecting integrity of electrical grounding path (A).
- Provided with overlapping sleeve for additional seal (B).
- Ability to install quickly with low torque effort.
- Ground cone design offers following advantages:
  - (1) Compresses metallic convolutions; provides high quality ground contact with low impedance & high raceway holding power (C).
  - (2) Single helical thread on ground cone is easy to install without cross threading; accepts variations in raceway diameters and convolution pitch (D).
  - (3) Rolled over edge protects conductors (E).
- Sealing ring design has following exclusive features:
  - (1) Grips and seals at leading and trailing edge – will not abrade raceway jacket (F).
  - (2) Provided with grooves on inside diameter for anti-sleeving (G).
  - (3) Shoulders on both ends for extra sealing.
  - (4) Symmetrical shape assures fool-proof assembly.
- Hardened steel or malleable iron locknut (H).
- Can be disconnected and reused.
- Watertight/oil tight installation at box or enclosure termination is provided by – external taper thread hub and sealing gasket (I).

- Suitable for use in Class I Division 2, Class II Division 1 & 2 and Class III Division 1 & 2 Hazardous Locations per N.E.C. Article 500.
- Suitable as a grounding means per N.E.C. Section 351-9 (up to 1/4" trade size).
- Conforms with JIC requirements.

#### Standard Material

Body, Gland, Locknut & Ground Cones: All steel or malleable iron.  
Sealing Ring and Insulator: All thermoplastic.  
Sealing Gasket, Retainer – Stainless Steel: Resilient Seal: Santoprene.  
Coating – PVC.  
Outside of body & gland...PVC Coated.  
Inside of body & gland...Electro Zinc Plated & Chromate Coated.  
Locknut & Sealing Gasket, Retainer...Electro Zinc Plated & Chromate Coated.

#### Range

3321, 3361 & 3341 Series...3/8" thru 4" conduit.  
All hubs provided with taper pipe threads (NPT).

#### Listed/Certified by:

U.L.....(U.L. File E23018)  
CSA .....(LR-2884, LR-4484)

#### Conforms to:

U.L. 514B  
CSA C22.2 No. 18  
NEMA FB-1  
NFPA 70-1999 (ANSI)  
JIC EGP1  
JIC EMP1  
Federal Specification W-F-406  
Federal Standard H-28 (THREADS)

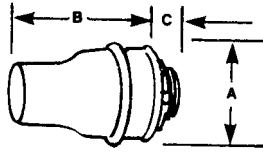

Straight PVC Coated  
Nylon Insulated  
Steel or Malleable  
NPT hub threads

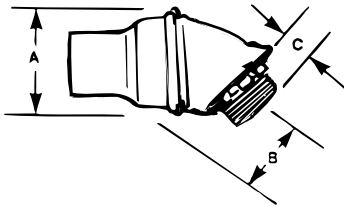

45° PVC Coated  
Nylon Insulated  
NPT hub threads

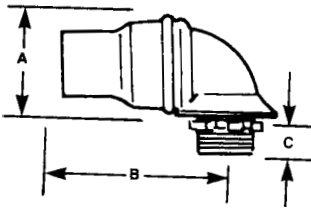

90° PVC Coated  
Nylon Insulated  
NPT hub threads

### Corrosion Resistant PVC Jacketed Liquidtight Connectors

Cat. No.	Conduit Size	A	B	C
<b>Straight PVC Coated</b>				
3321†	3/8"	1 <sup>15</sup> / <sub>32</sub> "	2 <sup>5</sup> / <sub>16</sub> "	9/ <sub>16</sub> "
3322†	1/2"	1 <sup>9</sup> / <sub>16</sub> "	2 <sup>1</sup> / <sub>2</sub> "	9/ <sub>16</sub> "
3323†	3/4"	1 <sup>15</sup> / <sub>16</sub> "	2 <sup>25</sup> / <sub>32</sub> "	9/ <sub>16</sub> "
3324†	1"	2 <sup>1</sup> / <sub>4</sub> "	3 <sup>19</sup> / <sub>32</sub> "	3/ <sub>4</sub> "
3325†	1 <sup>1</sup> / <sub>4</sub> "	2 <sup>11</sup> / <sub>16</sub> "	4 <sup>1</sup> / <sub>4</sub> "	1 <sup>3</sup> / <sub>16</sub> "
3326	1 <sup>1</sup> / <sub>2</sub> "	3 <sup>1</sup> / <sub>8</sub> "	4 <sup>1</sup> / <sub>16</sub> "	1 <sup>3</sup> / <sub>16</sub> "
3327	2"	3 <sup>5</sup> / <sub>8</sub> "	5 <sup>5</sup> / <sub>16</sub> "	7/ <sub>8</sub> "
3328	2 <sup>1</sup> / <sub>2</sub> "	4 <sup>3</sup> / <sub>8</sub> "	6 <sup>3</sup> / <sub>8</sub> "	1"
3329	3"	5 <sup>3</sup> / <sub>16</sub> "	6 <sup>1</sup> / <sub>2</sub> "	1"
3331	4"	6 <sup>7</sup> / <sub>16</sub> "	6 <sup>3</sup> / <sub>4</sub> "	1 <sup>1</sup> / <sub>8</sub> "
<b>45° PVC Coated</b>				
3341†	3/8"	1 <sup>15</sup> / <sub>32</sub> "	1 <sup>1</sup> / <sub>8</sub> "	9/ <sub>16</sub> "
3342†	1/2"	1 <sup>5</sup> / <sub>8</sub> "	1 <sup>1</sup> / <sub>4</sub> "	9/ <sub>16</sub> "
3343†	3/4"	1 <sup>15</sup> / <sub>16</sub> "	1 <sup>7</sup> / <sub>16</sub> "	9/ <sub>16</sub> "
3344†	1"	2 <sup>1</sup> / <sub>4</sub> "	1 <sup>19</sup> / <sub>16</sub> "	3/ <sub>4</sub> "
3345†	1 <sup>1</sup> / <sub>4</sub> "	2 <sup>11</sup> / <sub>16</sub> "	2 <sup>1</sup> / <sub>16</sub> "	1 <sup>3</sup> / <sub>16</sub> "
3346	1 <sup>1</sup> / <sub>2</sub> "	3 <sup>1</sup> / <sub>8</sub> "	2 <sup>11</sup> / <sub>16</sub> "	1 <sup>3</sup> / <sub>16</sub> "
3347	2"	3 <sup>5</sup> / <sub>8</sub> "	3 <sup>3</sup> / <sub>16</sub> "	7/ <sub>8</sub> "
3348	2 <sup>1</sup> / <sub>2</sub> "	4 <sup>3</sup> / <sub>8</sub> "	3 <sup>19</sup> / <sub>16</sub> "	1"
3349	3"	5 <sup>3</sup> / <sub>16</sub> "	4 <sup>9</sup> / <sub>16</sub> "	1"
3352	4"	6 <sup>7</sup> / <sub>16</sub> "	5 <sup>3</sup> / <sub>4</sub> "	1 <sup>1</sup> / <sub>8</sub> "
<b>90° PVC Coated</b>				
3361†	3/8"	1 <sup>15</sup> / <sub>32</sub> "	2 <sup>3</sup> / <sub>16</sub> "	9/ <sub>16</sub> "
3362†	1/2"	1 <sup>9</sup> / <sub>16</sub> "	2 <sup>1</sup> / <sub>2</sub> "	9/ <sub>16</sub> "
3363†	3/4"	1 <sup>15</sup> / <sub>16</sub> "	2 <sup>29</sup> / <sub>32</sub> "	9/ <sub>16</sub> "
3364†	1"	2 <sup>1</sup> / <sub>4</sub> "	3 <sup>19</sup> / <sub>32</sub> "	3/ <sub>4</sub> "
3365†	1 <sup>1</sup> / <sub>4</sub> "	2 <sup>11</sup> / <sub>16</sub> "	4 <sup>1</sup> / <sub>2</sub> "	1 <sup>3</sup> / <sub>16</sub> "
3366	1 <sup>1</sup> / <sub>2</sub> "	3 <sup>1</sup> / <sub>8</sub> "	4 <sup>15</sup> / <sub>16</sub> "	1 <sup>3</sup> / <sub>16</sub> "
3367	2"	3 <sup>5</sup> / <sub>8</sub> "	5 <sup>11</sup> / <sub>16</sub> "	7/ <sub>8</sub> "
3368	2 <sup>1</sup> / <sub>2</sub> "	4 <sup>3</sup> / <sub>8</sub> "	11 <sup>1</sup> / <sub>8</sub> "	1"
3369	3"	5 <sup>3</sup> / <sub>16</sub> "	12 <sup>1</sup> / <sub>2</sub> "	1"
3371	4"	6 <sup>7</sup> / <sub>16</sub> "	14 <sup>7</sup> / <sub>8</sub> "	1 <sup>1</sup> / <sub>8</sub> "

† U.L. Listed as grounding means per NEC. SECT. 351.7

Complies with J.I.C. standards and Federal Specs WF 406B, WF 408B

Suitable for hazardous locations use in Class I, Div. 2; Class II, Div. 1 and 2; Class III, Div. 1 and 2, where general purpose equipment is specifically permitted per NEC Section 500-2(a).

Meets Coast Guard CG293

U.L. File No. E 23018

CSA File No. 2884

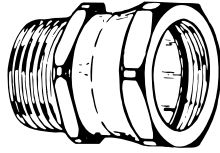

41 Series

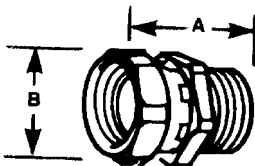
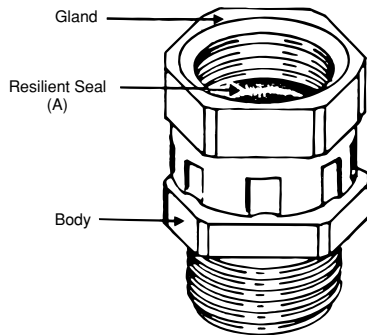
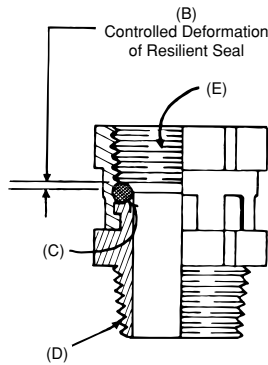

**Steel, zinc plated and chromated. Ideal for angle fittings where swing clearance is not available.**

### Liquidtight Union for Threaded Hub

#### Application

- To couple threaded end of a fitting or a pipe to a tapped opening in a box or enclosure where rotation of fitting or pipe is limited or restricted.

#### Features

- Design provides high quality bond between fitting or pipe to the union.
- Provided with resilient seal (A).
- Resilient seal subjected to controlled deformation; positive seal and reusability are assured (B).
- Unique design centralizes throat openings of threaded hub and union (C).
- Permits orientation of fitting in any predetermined direction for a safe, functional and neat assembly.
- Provided with taper threaded hub for liquidtight assembly (D).
- Straight pipe threads on gland accept a straight or taper threaded hub on fitting or pipe to be coupled (E).
- Suitable for hazardous location use per NEC Article 501 Class I, Division 2, Article 502 Class II, Division 1 & 2 and Article III Division 1 & 2.

#### Standard Material/Finish

Gland...Steel/Electro Zinc Chromate Coated  
Body...Steel/Electro Zinc Chromate Coated  
'O' Ring...Buna N/As Molded

#### Range

Hub (External Thread)... $\frac{1}{2}$ " &  $\frac{3}{4}$ " NPT  
Gland (Internal Threads)... $\frac{1}{2}$ " &  $\frac{3}{4}$ " NPS

#### Listed/Certified by:

U.L....(U.L. File No. E-23018)  
CSA...(LR-2884, LR-4484)

#### Conforms to:

U.L. 514B  
CSA C22.2 No. 18  
NEMA FB1  
NFPA 70-1999 (ANSI)  
Federal Standard W-F-408  
Federal Standard W-F-406  
Federal Standard H-28 (Threads)

Note: For additional product information refer to Thomas & Betts publication 600.1



### Liquidtight Union for Threaded Hub

Cat. No.	Conduit Size	A	B
41-TB	$\frac{1}{2}$ "	$1\frac{29}{64}$ "	1"
42-TB	$\frac{3}{4}$ "	$1\frac{15}{16}$ "	$1\frac{1}{4}$ "

U.L. File No. E 23018  
CSA File No. 2884

# T&B® Fittings

## Liquidtight Flexible Metal Conduit Fittings

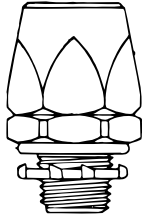

**Series 6302**  
Liquidtight Flexible Non-Metallic  
Conduit Connectors

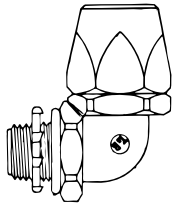

**Series 6322**  
Liquidtight Flexible Non-Metallic  
Conduit Connectors

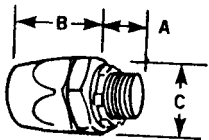

90° Angle Connector

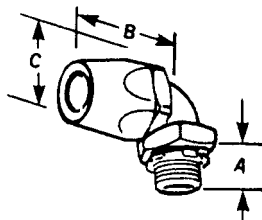

Straight Connector

**Designed especially for the Type A, all plastic raceways now in use for dynamic machine tool applications.**

**Fittings are constructed of a high-strength, chemically resistant thermoplastic tougher than the raceway itself.**

**Neoprene sealing ring is furnished with connector providing a liquidtight seal for knockout applications.**

### Liquidtight Flexible Non-Metallic Liquidtight Type A Conduit Connectors

#### Application

- To provide a liquidtight, dust tight connection between flexible, non-metallic conduit and a box or an enclosure.

#### Features

- Serrated, design provides high mechanical pullout strength (A).
- Unique component parts (body/-gland) design insures positive seal between conduit and connector (B).
- Tapered thread hub and sealing 'O' ring provide a liquidtight/dust tight seal to a box or an enclosure (C).
- High strength, chemical resistant, non-burning, non-dripping thermoplastic construction.
- Smooth insulated body throughout for maximum dielectric strength.
- Captive 'O' ring and reduced number of parts save installation time (D).

#### Standard Material

Body...Thermoplastic  
Gland...Thermoplastic  
'O' Ring...Neoprene  
Locknut...Steel (Case Hardened)

#### Standard Finish

Body, Gland & 'O' Ring .....As Molded  
Locknut.....Electro Zinc

#### Range

Conduit Size .....½" thru 1¼"  
Hub Size .....½" thru 1¼" N.P.T.



### Thermoplastic Fittings for Liquidtight Flexible Non-Metallic Conduit Type A

#### Corrosion Resistant Applications

Cat. No.	Conduit Size	A	B	C Cross Corners
<b>Straight Connector</b>				
6302	½"	.60"	1.68"	1.48"
6303	¾"	.61"	1.85"	1.76"
6304	1"	.77"	1.89"	2.10"
6305	1¼"	.79"	2.30"	2.67"
<b>90° Angle Connector</b>				
6322	½"	.60"	1.56"	1.48"
6323	¾"	.61"	1.74"	1.76"
6324	1"	.77"	1.78"	2.10"
6325	1¼"	.79"	2.13"	2.67"

Meets Coast Guard CG293  
U.L. File No. E 23018

# T&B® Fittings

## Liquidtight Flexible Metal Conduit Fittings

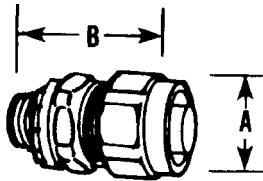

- Nylon insulated throat.
- T&B Sealing Ring to seal knockouts.
- Steel or malleable iron.
- U.L. Listed.
- NPT hub threads to seal in female threads.
- High mechanical pull-out strength.
- Provides positive seal against water, oil and dust.

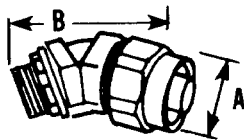
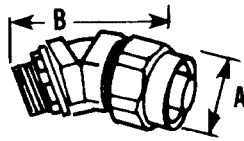

### Steel/Malleable Iron Liquidtight Flexible Non-Metallic Conduit Type A

Cat. No.	Conduit Size	Hub Thread	A	B
3720-TB*	3/8"	1/2 - 14 NPT	1 1/2"	2"
3721-TB	1/2"	1/2 - 14 NPT	1 3/8"	2 1/8"
3722-TB	3/4"	3/4 - 14 NPT	1 5/8"	2 1/4"
3723	1"	1 - 11 1/2 NPT	1 7/8"	2 1/2"
3724-TB	1 1/4"	1 1/4 - 11 1/2 NPT	2 3/8"	2"
3725	1 1/2"	1 1/2 - 11 1/2 NPT	2 3/4"	3 3/8"
3726	2"	2 - 11 1/2 NPT	3 1/2"	3 3/8"

\* Not U.L. Listed  
 U.L. File No. E 23018  
 See charts below for 45 and 90 degree fittings for this series

### 45° Metallic Connector for Non-Metallic Conduit Type A

Cat. No.	Conduit Size	Hub Thread	A	B
3730-TB*	3/8"	1/2 - 14 NPT	1 5/8"	2 1/2"
3731-TB	1/2"	1/2 - 14 NPT	1 3/8"	2 3/8"
3732	3/4"	3/4 - 14 NPT	1 5/8"	3"
3733-TB	1"	1 - 11 1/2 NPT	1 7/8"	3 1/2"
3734-TB	1 1/4"	1 1/4 - 11 1/2 NPT	2 3/8"	4 1/8"
3735-TB	1 1/2"	1 1/2 - 11 1/2 NPT	2 3/4"	4 7/8"
3736	2"	2 - 11 1/2 NPT	3 1/2"	5 1/2"

\* Not U.L. Listed  
 U.L. File No. E 23018

### 90° Metallic Connector for Non-Metallic Conduit Type A

Cat. No.	Conduit Size	Hub Thread	A	B
3740*	3/8"	1/2 - 14 NPT	1 5/8"	1 5/8"
3741	1/2"	1/2 - 14 NPT	1 3/8"	1 3/4"
3742	3/4"	3/4 - 14 NPT	1 5/8"	2 1/4"
3743-TB	1"	1 - 11 1/2 NPT	1 7/8"	2 3/8"
3744-TB	1 1/4"	1 1/4 - 11 1/2 NPT	2 3/8"	3 1/4"
3745	1 1/2"	1 1/2 - 11 1/2 NPT	2 3/4"	3 1/2"
3746-TB	2"	2 - 11 1/2 NPT	2 7/8"	4 1/8"

\* Not U.L. Listed  
 U.L. File No. E 23018



# T&B® Fittings

## Liquidtight Flexible Metal Conduit Fittings

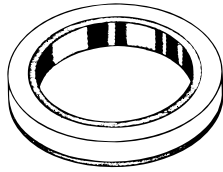

5262 Series

### Liquidtight Sealing Gasket

#### Application

- When used with an externally threaded connector provides a tight seal against oil, fumes or moisture at the knockout opening.

#### Features

- Design locks resilient sealing material in steel.
- Steel retainer protects seal from extruding out under torque and limits compression to an optimum predetermined value; provides high quality seal.
- Resilient material flows and seals rough surfaces.

#### Standard Material

Retainer .....Stainless Steel  
Sealing Material.....Santoprene  
Thermoplastic Rubber

#### Range

1/2" thru 4" Hub Size

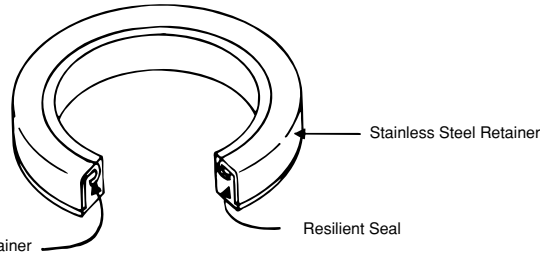

Resilient Sealing Material Locked in Steel Retainer

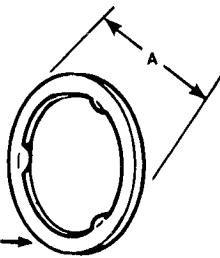

#### NEMA 3R, 4, 6 & 13

For use with T&B Fittings. Sealing material resists oil, coolants, and hydraulic fluids as well as water.

### Sealing Ring with Stainless Steel Retainer

Cat. No.	Conduit Size	Dimension (in.)	
		A	B
5299**	1/4"	.80"	.11"
5261**	3/8"	.95"	.11"
5262	1/2"	1.16"	.18"
5263	3/4"	1.49"	.19"
5264	1"	1.75"	.19"
5265	1 1/4"	2.15"	.22"
5266	1 1/2"	2.42"	.23"
5267	2"	2.92"	.23"
5268	2 1/2"	3.44"	.23"
5269	3"	4.08"	.23"
5270	4"	5.29"	.31"

\*\* U.L. not applicable  
U.L. File No. E 13938  
CSA File No. 2884

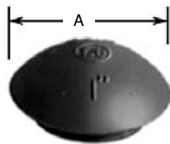

#### NEMA 3R, 4, 6 & 13

Made of flame retardant neoprene, these new K.O. plugs meet U.L. 514 flammability test. They provide a raintight, dust, and oil-tight reusable seal for electrical knockouts. NEMA 3R, 4, 6 & 13 boxes can be saved or re-used whenever a K.O. is no longer used. No tools needed to install; just push into hole ... they snap in. Temperature range - 30°C to 105°C.

### Liquidtight K.O. Plug

Cat. No.	Size	A
5710	1/2"	1 3/32"
5711	3/4"	1 1/2"
5712	1"	1 7/32"
5713	1 1/4"	2 7/32"
5714	1 1/2"	2 1/2"
5715	2"	3 3/32"
5716	2 1/2"	3 21/32"
5717	3"	4 19/64"
5718	4"	5 19/64"

U.L. Listed raintight  
CSA not applicable  
Meets Coast Guard Regulation CG293  
U.L. File No. E 13938  
CSA File No. 2884



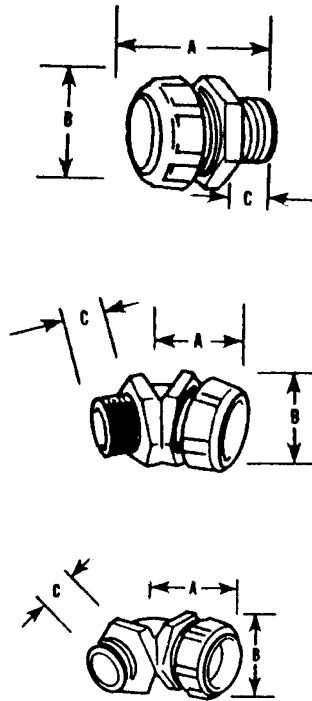

**Fittings for Liquidtight flexible metal conduit with metric threads of ISO Form (BS-4568-SA BS 162).**

### ISO Metric Thread Liquidtight Fittings\*

Cat. No.	Flexible Conduit Size	Metric ISO Thread	A mm	B mm	C mm
<b>Nylon insulated straight connectors</b>					
9330	1/4"	16	36	21	12
9331	1/4"	20	36	21	12
9306	5/16"	16	36	26	12
9360	3/8"	16	40	29	16
9361	3/8"	20	40	29	16
9362	1/2"	20	42	35	16
9363	3/4"	25	45	42	16
9364	1"	32	54	47	23
<b>Nylon insulated 45° angle connectors</b>					
9340	3/8"	16	27	29	16
9341	3/8"	20	27	29	16
9342	1/2"	20	27	35	16
9343TB	3/4"	25	31	42	16
9344	1"	32	34	47	23
<b>Nylon insulated 90° angle connectors</b>					
9350	3/8"	16	35	29	16
9351	3/8"	20	35	29	16
9352TB	1/2"	20	39	35	16
9353TB	3/4"	25	43	42	16
9354TB	1"	32	48	47	23

U.L. Listed Liquidtight.

CSA certified watertight.

\* All items shown on this page are suitable for use in hazardous location where general purpose equipment is specifically permitted by the NEC; Class I Div. 2, Class II, Div. 1 & 2; Class III, Div. 1 & 2, NEC 501-4(b); 502-4(a)(b); 503-3(a)(b).

U.L. File No. E 23018

CSA File No. 2884

# T&B® Fittings

## Liquidtight Flexible Metal Conduit Fittings

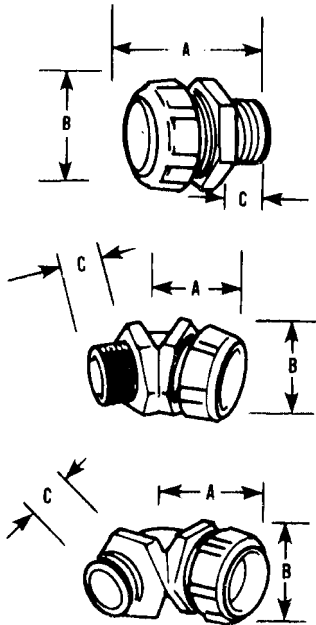

Fittings for Liquidtight flexible metal conduit with metric threads of PG Form (DIN 40430).

### PG Metric Thread Liquidtight Fittings\*

Cat. No.	Flexible Conduit Size	Metric PG Thread	A mm	B mm	C mm
<b>Nylon insulated straight connectors</b>					
7330	¼"	9	36	21	12
7331	¼"	11	36	21	12
7360	⅝"	9	36	26	12
7361	¾"	11	40	29	14
7362	¾"	13.5	40	29	14
7363	1½"	16	41	35	14
7364	¾"	21	43	42	14
7365	1"	29	56	47	19
7366	1¼"	36	67	58	21
7367	1½"	42	72	69	21
7368	2"	48	81	83	21
<b>Nylon insulated 45° angle connectors</b>					
7341	¾"	11	27	29	14
7342	¾"	13.5	27	29	14
7343	½"	16	30	35	14
7344-TB	¾"	21	34	42	14
7345	1"	29	44	47	19
7346	1¼"	36	51	58	19
7347	1½"	42	60	69	21
7348-TB	2"	48	73	76	24
<b>Nylon insulated 90° angle connectors</b>					
7351	¾"	11	37	29	14
7352	¾"	13.5	37	29	14
7353	½"	16	40	35	14
7354	¾"	21	44	42	14
7355	1"	29	56	47	21
7356	1¼"	36	70	58	21
7357	1½"	42	75	69	21
7358	2"	48	87	83	24

\* All items shown on this page are suitable for use in hazardous location where general purpose equipment is specifically permitted by the NEC; Class I Div. 2, Class II, Div. 1 & 2; Class III, Div. 1 & 2, NEC 501-4(b); 502-4(a)(b); 503-3(a)(b).

† U.L. Listed as grounding means under NEC 351-7.

U.L. Listed liquidtight.

CSA Certified watertight.

U.L. File No. E-23018

CSA File No. 2884

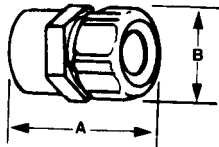

T&B Liquidtight flexible metal and Liquidtight flexible nonmetallic fittings with internal threads to accept AN-MS connector shells.  
Material: Steel

### Liquidtight Flexible Metal/MS Connectors

Cat. No.	Trade Size	Internal Thread		Dimensions (in.)	
		AN-MS Conn. Shell Size	Thread Size	A	B
LTA03810	¾"	10SL, 12, 12S¾" – 24 UNEF-2B		1½"	1
LTA05014	½"	14, 14S¾" – 20 UNEF-2B		1⅞"	1¼"
LTA05016	½"	16, 16S¾" – 20 UNEF-2B		1⅞"	1¼"
LTA05018	½"	18 1" – 20 UNEF-2B		1⅞"	1¼"
LTA07520	¾"	20, 221¾" – 18 UNEF-2B		1⅞"	1½"
LTA10020	1"	20, 221¾" – 18 UNEF-2B		1¾"	1⅝"
LTA10024	1"	25, 281⅞" – 18 UNEF-2B		1¾"	1⅝"

U.L. File No. E 23018

CSA File No. 2884

**Thomas & Betts**

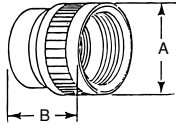

Fig. 1

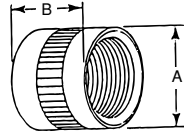

Fig. 2

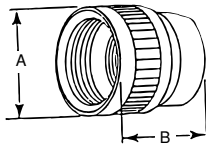

Fig. 3

**Mechanical adapter with internal threads to mate with NPT threaded fittings and MS type connectors.  
Material: aluminum**

### NPT/MS Connector Adapters

Cat. No.	N.P.T. Thread	AN-MS Connector Shell Size	Thread Size	Std. Pkg.	Dimensions (in.)		
					A	Fig.	B
<b>MSA05014</b>	½"	14, 14S	¾" – 20 UNEF-2B	10	1.000	1	1.175
<b>MSA05016</b>	½"	16, 16S	7⁄8" – 20 UNEF-2B	10	1.000	2	1.175
<b>MSA05018</b>	½"	18	1" – 20 UNEF-2B	10	1.125	3	1.175
<b>MSA07516</b>	¾"	16, 16S	7⁄8" – 20 UNEF-2B	10	1.250	1	1.356
<b>MSA07518</b>	¾"	18	1" – 20 UNEF-2B	10	1.250	1	1.300
<b>MSA07520</b>	¾"	20, 22	1 1⁄8" – 18 UNEF-2B	10	1.375	3	1.300
<b>MSA10020</b>	1"	20, 22	1 3⁄8" – 18 UNEF-2B	10	1.500	1	1.431
<b>MSA10024</b>	1"	24, 28	1 7⁄8" – 18 UNEF-2B	10	1.625	3	1.313
<b>MSA10032</b>	1"	32	1 3⁄4" – 18 UNS-2B	10	2.000	3	1.576
<b>MSA10036</b>	1"	36	2" – 18 UNS-2B	10	2.250	3	1.738

All items shown on this page are suitable for use in hazardous location where general purpose equipment is specifically permitted by the NEC; Class I Div. 2; Class II, Div. 1 & 2; Class III, Div. 1 & 2, NEC 501-4(b); 502-4(a)(b); 503-3(a)(b).

# T&B® Fittings

## XTRAFLEX® System – Conduit, Tubing, Fittings for Nonmetallic Liquidtight Conduit



- **Clamping fingers.** Outside surface has friction reducing ridges; inner surface teeth bite into conduit or tubing to enhance clamping and sealing action.
- **Fitting ferrule is designed to accept variations in conduit sizes and field conduit cuts.**
- **Ferrule profile is smooth, reducing friction to assure a tight conduit-to-fitting seal.**
- **Friction reducing ridges and teeth provide a true double seal and high pullout resistance.**
- **Elongated gland nut provides additional strain relief for 90° pull and easy hand grip.**
- **Rugged low-profile nonmetallic body and gland construction provides space savings.**
- **Captivated sealing "O" ring features predetermined compression to provide a reliable seal at enclosure.**
- **Steel locknut firmly secures fitting to box or enclosure.**

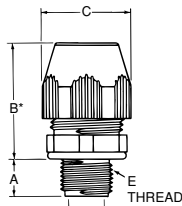

FIGURE 1  
(STRAIGHT)

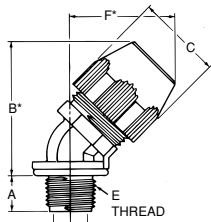

FIGURE 2  
(45 DEGREE)

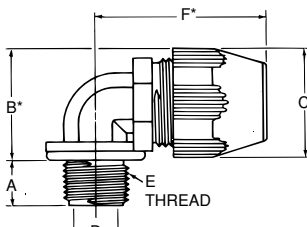

FIGURE 3  
(90 DEGREE)

### The BULLET® nonmetallic liquidtight fitting – easy to use, built to take it.

This engineering breakthrough meets the demand for a tough, reusable, non-metallic liquidtight fitting for use with XTRAFLEX® Type B conduit or flexible tubing.

The BULLET® nonmetallic fitting provides a reliable liquidtight seal that combines high pullout resistance and ease of installation.

#### Engineered to meet your needs.

The BULLET® nonmetallic fitting meets your performance requirements when terminating Type B liquidtight nonmetallic conduit or flexible nonmetallic tubing to a box or enclosure with knockout opening or threaded hub. Fittings meet the watertight requirements for NEMA type 4 and type 6 enclosures and conform to UL514B, and CSA No. 22.2 #227.2 specifications.

#### Ease of installation.

Installations can be performed quickly and easily because BULLET® liquidtight fittings can be installed without

disassembly. BULLET® nonmetallic fittings are resistant to numerous caustics and solvents.

And the BULLET® fitting is economical because it can be used over and over again without sacrificing the quality of the original seal. When used with the XTRAFLEX® raceway system you can meet most machine or industrial requirements where liquidtight protection is needed.

#### Corrosion resistant. Built to take it.

The BULLET® liquidtight fitting is manufactured from weather resistant thermoplastic materials, and is suitable for indoor or outdoor corrosive environments.

The BULLET® fitting is resistant to detergents, cleaners, oils, sanitizers, paints, cutting fluids and wiring pulling compounds—just about any liquid usually found in industrial, plant or marine environments. It also surpasses industry standards for cold impact and simulated hammer blows.



### Plastic Bullet® Liquidtight Fittings for T&B LTC Nonmetallic Liquidtight Conduit Type B and T&B EFC Flexible Tubing

Cat. No.	Fig.	Trade Size (in)	A ±.015 (.040) (in.) (mm)	*B ±.035 (0.90) (in.) (mm)	C ±.015 (0.40) Across Corners (in.) (mm)	Min. Throat Dia. D (in.) (mm)	E Thread NPT (in.)	F* (in.) (mm) Approx.
LT38P	1		.570	1.595 (40.51)	1.354	.417		—
LT438P	2	¾	(14.48)	2.012 (51.10)	(34.39)	(10.59)	½-14	1.534 (38.95)
LT938P	3			1.380 (35.05)				1.880 (47.75)
LT50P	1		.570	1.636 (41.55)	1.448	.550		—
LT450P	2	½	(14.48)	2.092 (53.14)	(36.78)	(13.97)	½-14	1.590 (40.39)
LT950P	3			1.489 (37.82)				1.986 (50.44)
LT75P	1		.582	1.757 (44.63)	1.740	.740		—
LT475P	2	¾	(14.78)	2.452 (62.28)	(44.20)	(18.80)	¾-14	1.821 (46.25)
LT975P	3			1.790 (45.47)				2.212 (56. )
LT100P	1		.726	1.923 (48.84)	2.068	.940		—
LT4100P	2	1	(18.44)	2.684 (68.17)	(52.53)	(23.88)	1-11½	2.034 (51.66)
LT9100P	3			2.104 (53.44)				2.508 (63.70)
LT125P	1		.750	2.164 (54.97)	2.494	1.257		—
LT4125P	2	1¼	(19.05)	3.264 (82.91)	(63.35)	(31.93)	1¼-11½	2.385 (60.58)
LT9125P	3			2.564 (65.13)				2.856 (72.54)
LT150P	1		.767	2.353 (59.77)	2.784	1.453		—
LT4150P	2	1½	(19.48)	3.605 (91.57)	(70.71)	(36.91)	1½-11½	2.604 (66.14)
LT9150P	3			2.854 (72.49)				3.144 (79.86)
LT200P	1		.794	2.605 (66.17)	3.362	1.883		—
LT4200P	2	2	(20.17)	4.210 (106.93)	(85.39)	(47.83)	2-8	3.050 (77.47)
LT9200P	3			3.432 (87.17)				3.675 (93.34)

\* After Assembly  
U.L. File No. E-23018  
CSA File No. 52391

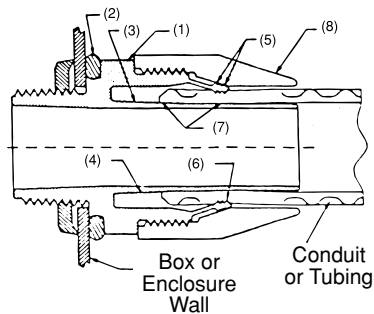

### Specification Sheet – Bullet® Liquidtight Fittings or Liquidtight Flexible Nonmetallic Conduit and Tubing

#### Application

A series of non-metallic connectors designed to provide a liquidtight seal when terminating liquidtight non-metallic conduit (U.L. Type B) or liquidtight non-metallic tubing to a box or enclosure with knockout opening or a threaded hub.

#### Plastic Bullet® Liquidtight Fittings Feature

- Connector assembles to conduit without disassembly and is designed to be installed with a positive installation criteria (gland bottoms on body shoulder).
- Rugged low profile non-metallic body and gland construction (1); the connector is equipped with a steel locknut to firmly secure connector to box or an enclosure and a sealing “O” ring.
- Captivated sealing “O” ring (2) with predetermined compression for a reliable seal at enclosure.
- Connector ferrule designed to accept variations in conduit inside diameter and is tolerant of field conduit cuts (3).
- The profile of ferrule is designed to reduce friction between conduit I.D. and ferrule (4) allowing conduit to seat properly for an effective seal.
- Outer surface of the clamping fingers provided with friction reducing ridges (5) for ease of installation; the inner surface is designed with conduit biting teeth to enhance clamping and sealing action (6).
- Performance of connectors tested to simulate adverse installation conditions.

- Provides a double sealing action (7).
- Elongated gland nut profile (8) designed to provide additional strain relief for 90° pull and an easy hand grip.
- Performance of connector unaffected by exposure to detergents, cleaners, and sanitizers commonly encountered in food processing plants and typical industrial environment; also unaffected by cutting fluids, wiring pulling compounds and Marine environment. The connector meets industry standards for cold impact and simulated hammer blow.

#### Standard Material/Finish

- Body Gland – weather stabilized thermoplastic (black).
- “O” Ring – nitrile (blue).
- Locknut – Steel/electro zinc plated.
- Material temperature rating – thermoplastic -40°C to 105°C.
- Material Flammability Rating: U.L. 94-V2.

#### Listed/Certified by:

U.L. (File# E23018);  
CSA (File# LR52391)

#### Conforms to:

- CSA 22.2 #227.2 & CSA 22.2 #227.3
- ANSI/U.L.514B-1988
- Watertight requirements of NEMA Type 4 and NEMA Type 6 enclosures.
- Federal Standard H28 (NPT threads).
- Suitable for hazardous locations – Class I Div. 2; Class II Div. 1 & 2; Groups E,F, & G; Class III per N.E.C.; Article 501-4, 502-4 and 503-3.

#### Suggested Specification:

Where liquidtight flexible nonmetallic conduit (U.L. Type B) or liquidtight flexible nonmetallic tubing is terminated to a box or enclosure, the nonmetallic connectors used shall be able to be installed without disassembly and provide a positive installation criteria. In the installed condition, the connector must provide a seal meeting watertight requirements of NEMA Type 4 and Type 6 enclosures. The performance of connectors shall be unaffected by exposure to detergents, sanitizers, cutting fluids, wire pulling compounds and oil base industrial paints. The connector must also be capable of withstanding Marine environment and cold impact simulating a hammer blow. Installed connectors shall be of the elongated gland type as manufactured by Thomas & Betts LT38P series.

## XTRAFLEX® System – Conduit, Tubing, Fittings for Nonmetallic Liquidtight Conduit

Table 1 – Behavior of EMS20-1B.1 IN: Aqueous Solutions of Inorganic Salts at Room Temperature

Salt Solutions	Visual Change	Ratings*
10% Ammonium Chloride	Unchanged	F
10% Aluminum Chloride	Unchanged	F
10% Sodium Hypochlorite (0.1% Cl <sub>2</sub> )	White coating after 18 days	G
10% Calcium Chloride	Unchanged	F
10% Chrome Alum	Unchanged	G
10% Ferric Chloride	Unchanged yellowing	P
5% Potassium Dichromate	Unchanged yellowing	P
10% Potassium Nitrate	Unchanged	G
1% Potassium Permanganate	Decomposed	NR
10% Copper Sulfate	Unchanged	G
10% Magnesium Chloride	Unchanged	G
10% Magnanese Sulfate	Unchanged	G
10% Sodium Sulfate	Unchanged	G
10% Sodium Bisulfite	Unchanged	G
5% Mercuric Chloride	Swelled	P
10% Zinc Chloride	Unchanged	F

\* These abbreviations are used for the ratings:

E- Excellent      P- Poor  
G- Good          NR- Not Recommended  
F- Fair            S- Solvent

Table 2 – Behavior of EMS20-1B.1 IN: Acids, Bases, Halogens, etc.

Reagent	Temp °F	Visual Change	Ratings*
Sulfuric Acid (Conc)	75	Dissolves	S, NR
Sulfuric Acid (Dilute)	75	Partially dissolves	P, NR
Hydrochloric Acid (Conc)	75	Dissolves	S, NR
Hydrochloric Acid (Dilute)	75	Partially dissolves	P, NR
Hydrochloric Acid (20-40%)	73	Etched after 1 sec.	P
Phosphoric Acid (Conc)	75	Dissolves	S, NR
Nitric Acid (Conc)	75	Dissolves	S, NR
Acetic Acid (Conc)	75	Partially Dissolves	P, NR
Acetic Acid (Conc)	200	Dissolves	S, NR
Acetic Acid (Dilute)	75	Etched	F, NR
Formic Acid (Conc)	75	Dissolves	S, NR
Formic Acid (Dilute)	75	Partially Dissolves	P, NR
Chlorine	–	Strong Attack	NR
Bromine	–	Strong Attack	NR
Phenol	75	Dissolves	S, NR
O-Chlorophenol	75	Dissolves	S, NR
m-Chlorophenol	75	Dissolves	S, NR
p-Chlorophenol	75	Dissolves	S, NR
Cresol	75	Dissolves	S, NR
Dimethylformamide	75	Strong Attack	NR
gamma-Butyrolactone	75	Strong Attack	NR
Xylenols	75	Dissolves	S, NR
Sodium Hydroxide (1%)	73	Unchanged	E
Sodium Hydroxide (5%)	73	Minimal effect	E
Sodium Hydroxide (5%)	158	Minimal effect	E
Sodium Hydroxide (10%)	73	Minimal effect	E
Sodium Hydroxide (10%)	158	Some "crazing" after 30 days	P
Potassium Hydroxide (5%)	73	Minimal effect	E
Potassium Hydroxide (5%)	158	Minimal effect	E
Potassium Hydroxide (10%)	73	Minimal effect	E
Potassium Hydroxide (10%)	158	Some "crazing" after 30 days	P
Hydrogen Peroxide (0.5%)	73	Unchanged	G
Hydrogen Peroxide (1%)	73	Brittle after 54 days	NR
Hydrogen Peroxide (3%)	73	Brittle after 54 days	NR
Hydrogen Peroxide (10%)	73	Degrades	NR
Hydrogen Peroxide (30%)	73	Degrades	NR

\* These abbreviations are used for the ratings:

E- Excellent      P- Poor  
G- Good          NR- Not Recommended  
F- Fair            S- Solvent

Table 3 – Behavior of EMS20-1B.1 IN: Organic Solvents at Room Temperature

Reagent	Visual Change	Ratings*
Benzyl Alcohol	Coarse surface after 2 days	NR
Butyl Alcohol	Temporary loss of stiffness	G
Ethyl Alcohol	Temporary loss of stiffness	G
Isopropyl Alcohol	Temporary loss of stiffness	G
Methyl Alcohol	Temporary loss of stiffness	G
Butyl Acetate	Temporary loss of stiffness	G
Ethyl Acetate	Unchanged	E
Methyl Acetate	Unchanged	E
Amyl Acetate	Unchanged	E
Ether (Diethyl)	Unchanged	E
Tetrahydrofuran	Unchanged	E
Acetone	Unchanged	E
Benzaldehyde	Unchanged	E
Cyclohexanone	Unchanged	E
Dichlorethylene	Unchanged	E
Trichlorethylene	Temporary loss of stiffness	G
Perchlorethylene	Temporary loss of stiffness	G
Dichlormethane	Unchanged	E
Chloroform	Temporary loss of stiffness	G
Carbon Tetrachloride	Temporary loss of stiffness	G
Carbon Disulfide	Unchanged	E
Pyridine	Unchanged	E
Benzene	Unchanged	E
Monochlorobenzene	Unchanged	E
Toluene	Unchanged	E
Xylene	Unchanged	E
Kerosene	Unchanged	E
Turpentine	Unchanged	E
Tetralin	Unchanged	E
Decalin	Unchanged	E
Gasoline	Unchanged	E
Petroleum	Unchanged	E
Mineral Oil	Unchanged	E
Resorcinol	Dissolves	NR

\* These abbreviations are used for the ratings:

E- Excellent      P- Poor  
G- Good          NR- Not Recommended  
F- Fair            S- Solvent

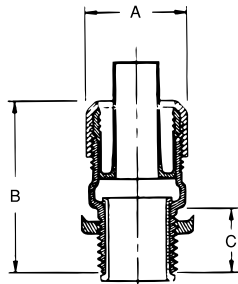

Figure 1

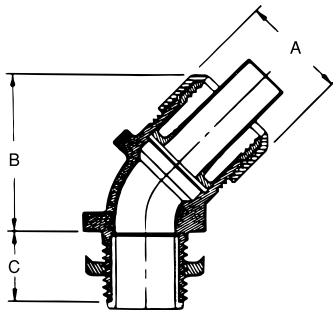

Figure 2

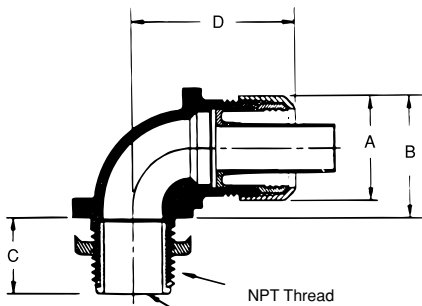

Figure 3

### Metallic Bullet® Liquidtight Connectors for T&B LTC Nonmetallic Liquidtight Conduit Type B and T&B EFC Flexible Tubing

Cat. No.	Fig.	Trade Size (in.)	A ±.030 (.80) (in.) (mm)	*B ±.060 (1.50) (in.) (mm)	C ±.045 (1.15) (in.) (mm)	D (in.) (mm)	Thread NPT (in.)
LT38M	1		1.156	1.500 (38.1)	0.562 (14.3)	–	
LT438M	2	¾	(29.4)	1.962 (49.8)	0.562 (14.3)		½-14
LT938M	3			1.312 (33.3)	0.625 (15.9)	1.375 (34.9)	
LT50M	1		1.375	1.562 (39.7)	0.562 (14.3)	–	
LT450M	2	½	(34.9)	1.875 (47.6)	0.562 (14.3)		½-14
LT950M	3			1.437 (36.5)	0.625 (15.9)	1.562 (39.7)	
LT75M	1		1.656	1.625 (41.2)	0.625 (15.9)	–	
LT475M	2	¾	(42.1)	2.125 (54.0)	0.562 (14.3)		¾-14
LT975M	3			1.750 (44.4)	0.625 (15.9)	1.750 (44.4)	
LT100M	1		1.875	2.062 (52.4)	0.750 (19.0)	–	
LT4100M	2	1	(47.6)	2.250 (57.1)	0.812 (20.6)		1-11½
LT9100M	3			1.937 (49.2)	0.812 (20.6)	2.187 (55.5)	
LT125M	1		2.375	2.500 (63.5)	0.812 (20.6)	–	
LT4125M	2	1¼	(60.3)	2.750 (69.8)	0.812 (20.6)		1¼-11½
LT9125M	3			2.500 (63.5)	0.812 (20.6)	2.750 (69.8)	
LT150M	1		2.750	2.687 (68.2)	0.812 (20.6)	–	
LT4150M	2	1½	(69.8)	2.750 (69.8)	0.812 (20.6)		1½-11½
LT9150M	3			2.812 (71.4)	0.812 (20.6)	2.937 (74.6)	
LT200M	1		3.468	3.062 (77.8)	0.812 (20.6)	–	
LT4200M	2	2	(88.1)	3.875 (98.4)	0.875 (22.2)		2-11½
LT9200M	3			3.500 (88.9)	0.875 (22.2)	3.437 (87.3)	

\* After Assembly  
U.L. File No. E-23018  
CSA File No. 52391

#### Suggested Specification:

Where liquidtight flexible nonmetallic conduit (U.L. Type B) or liquidtight flexible nonmetallic tubing is terminated to a box or enclosure, the metallic connectors used shall be able to be installed without disassembly and provide a positive installation criteria. In the installed condition, the connector must provide a seal, meeting watertight requirements of NEMA Type 4 and Type 6 enclosures with conduit and NEMA Type 4 enclosures with tubing. Installed connectors shall be as manufactured by Thomas & Betts LT38M series.

Material: Body/Gland–Steel/MI  
Insert–Nylon

**XTRAFLEX® System – Conduit, Tubing, Fittings for Nonmetallic Liquidtight Conduit  
Material – PVC**

When you have a conduit application in a liquidtight environment, it's time to load up the T&B Bullet®. Thomas & Betts introduces the ISO Metric Bullet® liquidtight fittings for use with the 3/8", 1/2", and 3/4" Xtraflex® EFC and LTC nonmetallic liquidtight conduit series.

The T&B Bullet® liquidtight fitting and EFC non-metallic conduit are suited for OEM applications as in the machine tool industry where environments include continuous motion, vibration, and exposure to moisture, oil, dirt and dust.

The T&B Bullet® liquidtight fitting and LTC non-metallic conduit are also suitable for construction applications where ISO metric threading and liquidtight systems are installed.

The Xtraflex® system offers a lightweight, liquidtight flexible conduit solution for industrial applications. The Xtraflex® system allows fast, easy installation and high performance in demanding industrial applications.

**ISO Metric Bullet® Liquidtight Fitting**

Cat. No.	Angle of Fitting	Conduit Size	Knockout Size	Unit Package	Standard Package	UPC Number
LT38M-ISO20	Straight	3/8"	1/2"	25	100	786210-62281
LT50M-ISO20	Straight	1/2"	1/2"	25	100	786210-62282
LT75M-ISO25	Straight	3/4"	3/4"	25	50	786210-62283
LT438M-ISO20	45°	3/8"	1/2"	25	50	786210-62284
LT450M-ISO20	45°	1/2"	1/2"	25	50	786210-62285
LT475M-ISO25	45°	3/4"	3/4"	10	50	786210-62286
LT938M-ISO20	90°	3/8"	1/2"	25	50	786210-62288
LT950M-ISO20	90°	1/2"	1/2"	25	50	786210-62289
LT975M-ISO25	90°	3/4"	3/4"	10	50	786210-62290

\*Meets watertight requirements of NEMA Type 4 enclosure or IP 56 rating with LTC conduit or EFC tubing with installed T&B Bullet liquidtight fittings. Connector Locknut not included.

**ISO Metric Bullet® Liquidtight Fitting Non-Metallic**

Cat. No.	Angle of Fitting	Conduit Size	Knockout Size	Unit Package	Standard Package	UPC Number
LT38P-ISO20	Straight	3/8"	1/2"	25	100	786210-66444
LT50P-ISO20	Straight	1/2"	1/2"	25	100	786210-66613
LT75P-ISO25	Straight	3/4"	3/4"	25	50	786210-66443
LT938P-ISO20	90°	3/8"	1/2"	25	50	786210-66612
LT950P-ISO20	90°	1/2"	1/2"	25	50	786210-66640
LT975M-ISO25	90°	3/4"	3/4"	10	50	786210-66611

\*Testing: UL and CSA listed; NEMA 4, 6, 6P; IP 67 when used with LTC conduit or EFC tubing with installed T&B Bullet liquidtight fitting.



# T&B® Fittings

## XTRAFLEX® System – Conduit, Tubing, Fittings for Nonmetallic Liquidtight Conduit Material – PVC



A

T&B® Fittings



### Corrugated Flexible Nonmetallic Tubing

Cat. No.	Conduit Size	I.D. (in.)		O.D. (in.)	
		min.	max.	min.	max.
EFC025*	¼"	.390	.405	.560	.575
EFC038	⅜"	.484	.504	.690	.710
EFC050	½"	.622	.642	.820	.840
EFC075	¾"	.820	.840	1.030	1.050
EFC100	1"	1.041	1.066	1.290	1.315
EFC125	1¼"	1.380	1.410	1.630	1.660
EFC150	1½"	1.575	1.600	1.865	1.900
EFC200	2"	2.020	2.045	2.340	2.375

\* Not CSA Certified.  
Underwriters Recognized  
U.L. File No. 96548  
CSA File No. 067241  
See technical data next page.  
Use with Bullet® Liquidtight Fittings.

#### Available Colors

Cat. No. LTC –	Color of Conduit
w/o suffix	Black
-1	Orange
-2	Blue

#### OEM Grade U.L. Recognized

- Material – PVC.
- Black color standard.
- Maximum flexibility in tight applications.
- Extremely fast installation.
- Liquidtight with specified fittings.
- Good tensile strength provides excellent pullout protection.
- Smooth inner diameter allows easy wire pulling.
- Broad operating temperature range – 18°C to +60°C (-2°F to +140°F).
- Flammability Rating VW-1 (Vertical Wire) UL224.

#### Recommended industrial applications

- Protection of fiber optic cable.
- Installation of instrumentation and control cable.
- Indoor/outdoor lighting.
- Packaging equipment.
- Marine and shipboard wiring.
- Flexing – component wiring protection on robots, graphic arts equipment, etc.

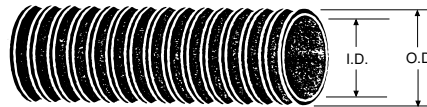

#### Commercial Grade U.L./CSA Listed

- Gray color standard
- 80°C temperature rated
- UV resistant
- Material – PVC



### Commercial Grade Type B Nonmetallic Liquidtight Conduit

Cat. No.	Size	I.D. (in.)		O.D. (in.)	
		min.	max.	min.	max.
LTC038GY	⅜"	.484	.504	.690	.710
LTC050GY	½"	.622	.642	.820	.840
LTC075GY	¾"	.820	.840	1.030	1.050
LTC100GY	1"	1.041	1.066	1.290	1.315
LTC125GY	1¼"	1.380	1.410	1.630	1.660
LTC150GY	1½"	1.575	1.600	1.865	1.900
LTC200GY	2"	2.020	2.045	2.340	2.375

U.L. Listed, U.L. File No. 95745  
CSA Certified, CSA File No. LL 80349  
See technical tables on next page.



Thomas & Betts

# T&B® Fittings

## XTRAFLEX® System – Conduit, Tubing, Fittings for Nonmetallic Liquidtight Conduit Material – PVC

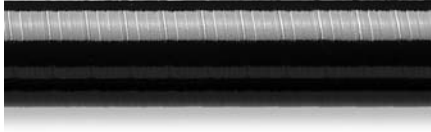

### Industrial Grade U.L./CSA Listed

- **Material – PVC.**
- **Liquidtight nonmetallic conduit Type B.**
- **Black color standard.**
- **Fast installation – even in tight, cramped spaces.**
- **Smooth inner diameter allows easy wire pulling.**
- **Smooth outer jacket – uses material approved for outdoor use, is sunlight resistant and oil resistant.**
- **Tested to CSA and U.L. requirements.**
- **Lightweight and liquidtight.**
- **Temperature range of -18°C to +105°C (-2°F to +221°F).**
- **Flammability Rating – UL1660.**
- **Marked at one-foot intervals for fast, easy measuring and cutting.**

### Recommended industrial applications

- **Machine tools.**
- **Motor hookups.**
- **Food processing equipment.**
- **Extensions from wireways.**
- **Sensor and microswitch wiring found in control consoles.**

## Smooth Liquidtight Nonmetallic Conduit Type B

Cat. No.	Conduit Size	I.D. (in.)		O.D. (in.)	
		min.	max.	min.	max.
LTC038	3/8"	.484	.504	.690	.710
LTC050	1/2"	.622	.642	.820	.840
LTC075	3/4"	.820	.840	1.030	1.050
LTC100	1"	1.041	1.066	1.290	1.315
LTC125	1 1/4"	1.380	1.410	1.630	1.660
LTC150	1 1/2"	1.575	1.600	1.865	1.900
LTC200	2"	2.020	2.045	2.340	2.375

Rated at 600V

XTRAFLEX® Type B suitable for use in hazardous location (for LTC Series only) where general purpose equipment is specifically permitted by the NEC; Class I Div. 2; Class II, Div. 1 & 2; Class III, Div. 1 & 2, NEC 501-4(b); 502-4(a)(b); 503-3(a)(b).

U.L. Listed, U.L. File No. E95745

CSA Certified, CSA File No. LL80349

See technical data below.

Use with Bullet® Liquidtight Fittings.

### Available Colors

Cat. No.	Color of Conduit	Color of Marking
LTC –		
w/o suffix	Black	Orange
-1	Orange	Black
-2	Blue	Black

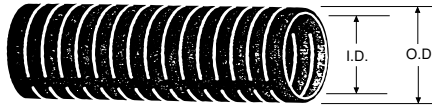

## XTRAFLEX® Conduit and Tubing Technical Data\*

LTFNMC = Liquidtight flexible nonmetallic conduit.

LTFNMT = Liquidtight flexible nonmetallic tubing.

Xtraflex® Conduit & Tubing	Style	Color	Size Range	U.L. Temp Rating	CSA Temp Rating	Voltage Rating	U.L. Oil Resistant	U.L. Outdoor	U.L. Direct Burial
LTC038 Series	UL Type B LTFNMC	Black Black	3/8"-2"	105°C Dry 60°C Wet 70°C Oil	75°C-18 C	600V	Yes	Yes	Yes
LTC038-1, -2 Series	UL Type B LTFNMC	Orange, Blue	1/2"-1"	105°C Dry 60°C Wet 70°C Oil	–	600V	Yes	No	Yes
LTC038GY Series	UL Type B LTFNMC	Grey	3/8"-2"	80°C Dry 60°C Wet 70°C Oil	–	600V	Yes	Yes	Yes
EFC025 Series**	LTFNMT	Black	1/4"-2"	105°C	75°C-18 C	300V	Yes	Yes	No
EFC025-1, -2** Series	LTFNMT	Orange, Blue	1/2"-1"	105°C	–	300V	Yes	No	No

\* For a complete test report, contact Customer Service.

\*\* U.L. Component Recognized

### XTRAFLEX® Nonmetallic Conduit Type B and Flexible Tubing

A = Satisfactory Chemical	B = Be Expected to Change Chemical	C = Not Recommended Chemical	
Acetate Solvents . . . . .	C	Lubricating Oils . . . . .	A
Acetic Acid (10%) . . . . .	A	Magnesium Chloride . . . . .	A
Acetic Acid (Glacial) . . . . .	B	Magnesium Hydroxide . . . . .	A
Acetone . . . . .	C	Magnesium Sulphate . . . . .	A
Acrylonitrile . . . . .	A	Malic Acid . . . . .	A
Adipic Acid . . . . .	A	Methyl Acetate . . . . .	C
Alcohol Butyl . . . . .	A	Methyl Bromide . . . . .	C
Alcohol Ethyl . . . . .	A	Methyl Ethyl Ketone . . . . .	C
Alcohol Isopropyl . . . . .	A	Methylene Chloride . . . . .	C
Alcohol Methyl . . . . .	A	Mineral Oils . . . . .	A
Aluminum Acetate . . . . .	A	Monochlorobenzene . . . . .	C
Aluminum Chloride . . . . .	A	Naphtha . . . . .	B
Aluminum Hydroxide . . . . .	A	Naphthalene . . . . .	C
Aluminum Sulfate . . . . .	A	Nitric Acid (10%) . . . . .	A
Allyl Chloride . . . . .	C	Nitric Acid (40%) . . . . .	A
Ammonia (0.88S.G.Aqueous) . . . . .	A	Nitric Acid (70%) . . . . .	C
Ammonia (Dry Gas) . . . . .	A	Nitrobenzene . . . . .	C
Ammonia (Liquid) . . . . .	C	Nitrogen Fertilizers . . . . .	A
Ammonium Chloride . . . . .	A	Oleic Acid . . . . .	A
Ammonium Hydroxide . . . . .	A	Oxalic Acid . . . . .	A
Animal Oils . . . . .	A	Palmitic Acid . . . . .	A
Amyl Acetate . . . . .	C	Paraffin . . . . .	A
Aniline Oils . . . . .	B	Pentane . . . . .	B
Aromatic Hydrocarbons . . . . .	C	Perchloroethylene . . . . .	C
Asphalt . . . . .	C	Phenol . . . . .	B
ASTM Fuel A . . . . .	B	Phosphoric Acid . . . . .	A
ASTM Fuel B . . . . .	C	Pitch . . . . .	A
ASTM #1 Oil . . . . .	A	Potassium Hydroxide . . . . .	A
ASTM #3 Oil . . . . .	B	Propane . . . . .	A
Barium Chloride . . . . .	A	Sea Water . . . . .	A
Barium Hydroxide . . . . .	A	Sodium Hydroxide (10%) . . . . .	A
Barium Sulfide . . . . .	A	Sodium Hydroxide (50%) . . . . .	A
Benzene . . . . .	C	Sodium Cyanide . . . . .	A
Benzine . . . . .	B	Soybean Oil . . . . .	A
Bordeaux Mixture . . . . .	A	Stearic Acid . . . . .	C
Borax . . . . .	A	Styrene . . . . .	C
Boric Acid . . . . .	A	Sulphur Dioxide (Dry) . . . . .	A
Brine . . . . .	A	Sulphur Dioxide (Moist) . . . . .	B
Bromine Traces . . . . .	C	Sulphur Dioxide (Liquid) . . . . .	C
Butyl Acetate . . . . .	C	Sulphuric Acid (45%) . . . . .	A
Calcium Hydroxide . . . . .	A	Sulphuric Acid (60%) . . . . .	B
Calcium Hypochlorite . . . . .	A	Sulphuric Acid (98%) . . . . .	C
Carbonic Acid . . . . .	B	Sulphurous Acid (30%) . . . . .	A
Carbon Dioxide . . . . .	A	Tannic Acid . . . . .	A
Carbon Disulphite . . . . .	C	Tartaric Acid . . . . .	A
Carbon Monoxide . . . . .	A	Tetrahydrofuran . . . . .	C
Carbon Tetrachloride . . . . .	C	Toluene . . . . .	C
Casein . . . . .	A	Trichlorethylene . . . . .	C
Chlorine (Dry) . . . . .	A	Triethanolamine . . . . .	A
Chlorine (Wet Gas) . . . . .	B	Tricresyl Phosphate . . . . .	C
Chlorine (Water) . . . . .	C	Turpentine . . . . .	B
Chlorobenzene . . . . .	C	Urea . . . . .	A
Chlorinated Hydrocarbons . . . . .	C	Vinegar . . . . .	A
Chloroform . . . . .	C	Vinyl Acetate . . . . .	C
Chromic Acid . . . . .	A	Vinyl Chloride . . . . .	C
Citric Acid . . . . .	A	Water . . . . .	A
Coal Tar . . . . .	C	Xylene . . . . .	C
Copper Chloride . . . . .	A	Zinc Chloride . . . . .	A
Copper Nitrate . . . . .	A	Zinc Sulphate . . . . .	A
Copper Sulphate . . . . .	A		
Cottonseed Oil . . . . .	B		
Creosote . . . . .	C		
Cresol . . . . .	C		
Cresylic Acid . . . . .	A		
Cyclohexane . . . . .	A		
Cyclohexanone . . . . .	C		
DDT Weed Killer . . . . .	A		
Detergent Synthetic . . . . .	A		
Developers Photographic . . . . .	A		
Dextrin . . . . .	A		
Dextrose . . . . .	A		
Dibutyle Phthalate . . . . .	C		
Dichlorobenzene . . . . .	C		
Diesel Oil . . . . .	B		
Diethylene Glycol . . . . .	A		
Diethyl Ether . . . . .	C		
Di-isodecyl Phthalate . . . . .	C		
Dioclyle Phthalate . . . . .	C		
Emulsifiers . . . . .	A		
Emulsions Photographic . . . . .	A		
Ethyl Acetate . . . . .	C		
Ethylene Dichloride . . . . .	C		
Ethylene Glycol . . . . .	A		
Fatty Acid . . . . .	A		
Ferric Chloride . . . . .	A		
Ferric Sulphate . . . . .	A		
Ferrous Chloride . . . . .	A		
Ferrous Sulphate . . . . .	A		
Fixing Solution Photographic . . . . .	A		
Fluorine . . . . .	C		
Formaldehyde (40%) . . . . .	C		
Formic Acid (40%) . . . . .	A		
Formic Acid (50%) . . . . .	B		
Formic Acid (100%) . . . . .	C		
Fuel Oil . . . . .	B		
Glacial Acetic Acid . . . . .	B		
Glucose . . . . .	A		
Glycerine . . . . .	A		
Grape Sugar . . . . .	A		
Grease . . . . .	A		
Heptane . . . . .	B		
Hexane . . . . .	B		
Hydrobromic Acid . . . . .	A		
Hydrochloric Acid (10%) . . . . .	A		
Hydrochloric Acid (40%) . . . . .	A		
Hydrofluoric Acid (10%) . . . . .	A		
Hydrofluoric Acid (40%) . . . . .	B		
Hydrofluoboric Acid . . . . .	A		
Hydrofluosilicic Acid . . . . .	A		
Hydrogen Peroxide . . . . .	A		
Hydrogen Sulphide . . . . .	A		
Iso-octan . . . . .	A		
Isopropyl Acetate . . . . .	C		
Kerosene . . . . .	B		
Ketones . . . . .	C		
Lactic Acid (10%) . . . . .	A		
Lactic Acid (100%) . . . . .	C		
Lacquer Solvents . . . . .	B		
Linseed Oil . . . . .	A		

Note: These chemical resistance ratings are based upon information supplied by the raw material manufacturers. It is intended as a general guideline only. To determine specific suitability, samples should be tested by user under actual conditions. Operating Condition: 70°F.



### *Flexible Cord Connectors*

#### **The Ranger™ Series Cord Connector Fittings**

Our Ranger Liquidtight fittings are the only connectors able to take a .250 inch cable range.

#### **These unique connectors feature:**

- Connectors which take twice the cable range of ordinary strain relief connectors.

- Smaller overall size which makes it easy to fit into tight spaces.
- Gland nut design that restricts cable bending.
- Choice of aluminum, steel and non-metallic materials.
- Straight, 45° and 90° designs.



#### **Liquidtight Flexible Cord and Power Cable Fittings**

We also offer Liquidtight fittings designed to handle the unique connection demands of flexible cords and power cables applications, where exceptional mechanical strain relief is needed in addition to a dependable seal against dust, oil, and other liquids.

The patented design of our flexible cord and power cable fittings are ideal for installations such as robot manufacturers, packaging equipment, machine tool building and other industrial OEM and MRO applications.

#### **The advantages these fittings offer include:**

- Neoprene bushing to make liquid-tight installations by applying pressure against the cable for the full length of the bushing.
- CSA certified water tight, and U.L. listed for liquid-tightness strain relief and as an outlet bushing.
- Metal and plastic assemblies capable of accepting a wide range of cords.
- Black Beauty™ non-metallic cord connector offers the convenience of tool-free installation, with a segmented chuck for high mechanical pullout performance, and neo-prene bushings for a secure, liquid-tight installation.



**Whatever the application. Whatever the size. Thomas & Betts is your connection to tough, versatile cord and cable fittings.**

Thomas & Betts offers a complete line of rugged, reliable cord and cable fittings. All fittings are produced to the highest standards, combining innovative design and precision manufacturing methods to provide the products you need for your specific applications. Combining proven performance, installation advantages and availability of ranges, T&B is also your connection to lower installed costs for the life of your cord and cable requirements.

Use this guide to help you specify the fitting you need for your cord and cable requirements.

### Cord and Cable Requirements

Cord and Cable Type	T&B Fitting
S, SO, SV, ST, STD, SJ, SJO, SJT, SJTO, SVO	Ranger™ 2920NM# Series, 2920# Series Liquidtight Strain Relief 2500# Series
TC	Tray Cable TC Series
JMC, MC	Star® Teck Extreme™ STE/STEX Series
S, SO, SV, ST, STD, SJ, SJO, SJT, SJTO, SVO	Wire Mesh Grips WMG-PC Series for Portable Cord

### Considerations for Selection

- Selection of the proper device or fitting involves consideration of the type of cable to be installed and the environment that will surround the cable installation.
- A proper matching of the cable and its fitting is necessary to prevent physical damage to the cable when installed.

### Cord and Cable Descriptions

**Type TC** power and control tray cable is a factory assembly of two or more insulated conductors, with or without associated bare or covered grounding conductors under a nonmetallic sheath, for installation in cable trays, in raceways, or where supported by a messenger wire.

**Type MC** metal clad cable is a factory assembly of one or more insulated circuit conductors with or without optical-fiber members enclosed in a metallic sheath of interlocking tape, or a smooth or corrugated tube.

**Type SJ**, tradename is Junior Hard Service Cord. The outer covering is Thermoset and it is a pendant or portable cord used in damp locations for hard usage.

**Type SJO**, tradename is Junior Hard Service Cord. The outer covering is oil-resistant Thermoset.

**Type SJT**, tradename is Junior Hard Service Cord. The outer covering is Thermoplastic.

**Type SJTO**, tradename is Junior Hard Service Cord. The outer covering is oil resistant Thermoplastic.

**Type SO**, tradename is Hard Service Cord. The outer covering is oil-resistant Thermoset and it is a pendant or portable cord used in damp locations for extra hard usage.





2920 Series



2920AL Series



2516 Series

**Liquidtight Flexible Cord and Cable Connectors**

**Application**

- A liquidtight connector to connect flexible cord or cable to an enclosure and provide adequate strain relief

**Features**

- Liquidtight connection with enclosure is assured by:
  - (A) Taper threaded hub on 2520 series for female hub application
  - (B) Using sealing ring series 5262 with 2520 series for knockout application
  - (C) Captivated sealing 'O' ring on 2631 series
  - (D) Neoprene bushing makes liquidtight installation; applies pressure against cable the full length of bushing
  - (E) Thermoplastic or stainless steel retaining ring
    - (1) Will not abrade cord/cable jacket
    - (2) Reduces installing torque effort
- U.L. Listed liquidtight, strain relief and as an outlet bushing; CSA certified watertight

**Standard Material**

- Gland, Body ..Steel/Malleable Iron/Zinc Die Cast
- Retaining Ring .....Thermoplastic/ Stainless Steel
- Bushing.....Neoprene
- 'O' Ring .....Buna N

**Standard Finish**

- Electro Zinc Plated & Chromate Coated

**Range**

- 2520 Series, straight.....125" outside diameter to 3.200" outside diameter Cord or Cable
- 2200 Series, 45°.....125" outside diameter to 1.485" outside diameter Cord or Cable
- 2267 Series, 90°.....125" outside diameter to 1.875" outside diameter Cord or Cable
- Cord/Cable Type.....S, SO, SV, ST, STO, SJ, SJO, SJT, SJTO, SVO & SVT

**Listed/Certified by:**

- U.L.....(U.L. File No. E-13938)
- CSA .....LR-589, LR-4484

**Conforms to:**

- U.L. 514
- CSA 22.2 No. 18
- ANSI C33.84, NFPA 70-1978 (ANSI)

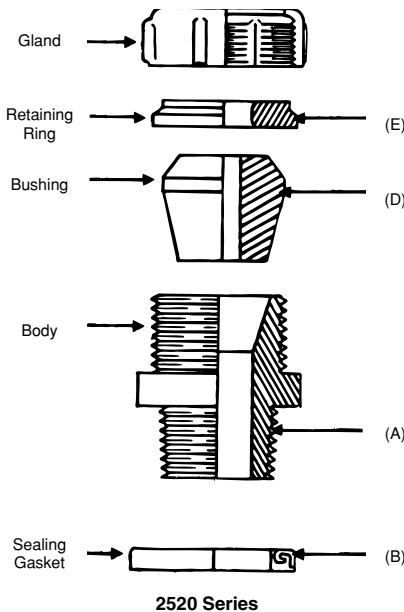

2520 Series

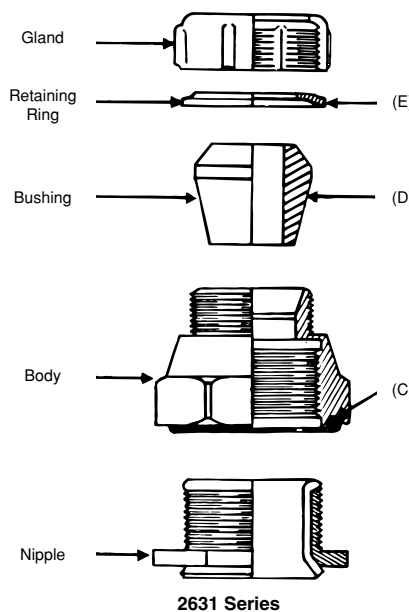

2631 Series



2920 Series



2920NM Series



2920AL Series



2516 Series

### Suggested Specifications for Flexible Cord and Cable Fittings

- Flexible cord or cable and associated fittings shall be suitable for conditions of use and location and approved for the purpose by a nationally recognized testing laboratory, inspection agency or product evaluation organization.
- Flexible cord or cable shall be so connected to the device or fitting that tension will not be transmitted to joints or terminal screws. Sufficient slack shall be provided to avoid sharp flexing and straining. Cord or cable shall be installed in such a manner that liquid will tend to run off the surface instead of draining towards the fitting.
- Where flexible cord or cable exposed to intermittent or constant moisture and subjected to mechanical strain is terminated into a threaded or threadless opening, terminating fittings shall be of watertight strain relief type such as Thomas & Betts series 2920, 2920AL, 2920NM, 2520, 2631 or 2672. Fittings shall be equipped with a beveled moisture resistant/oil resistant synthetic rubber bushing.
- Where space is limited inside the enclosure, a female hub type fitting such as Thomas & Betts series 2631 shall be furnished. A captivated resilient sealing 'O' ring shall be included to positively protect against damage from overtorquing.

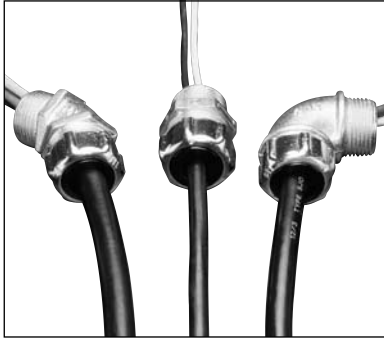

### The Ranger™ Series of Steel Liquidtight Cord Connectors

The Ranger Series Steel Liquidtight Connector takes twice the cable range of most ordinary strain relief connectors. T&B's Ranger Connectors allow you to reduce your inventory and save time, with one connector that can do the work of two.

#### Application

- Provide means for passing a cord cable (armored or unarmored) into an enclosure, through a bulkhead or into a rigid conduit.
- Form a mechanical grip and water and/or oil-resistant seal for cord and unarmored or jacketed armored round cables.
- Form a non-slip connection or termination for flexible cord, cable (armored or unarmored).
- Provide grounding continuity of cable armor.

#### Cord & Cable Type

- S, SO, SV, ST, STD, SJ, SJO, SJT, SJTO, SVD

#### Features

- Extended range with superior strain relief.

- Reduced overall size, fits into tighter spaces.
- Gland nut designed to restrict cable bending.

#### Materials

Body: Steel-2920 series, Malleable Iron-4920 & 4960 series

Gland Nut, Grip: Steel-all series

Bushing: Rubber

#### Environment Classification

- Ordinary Locations
- Wet or dry locations

#### Range

Cord Range .125" to .950"

Hub Size Range ½" to 1"



### Steel Liquidtight Strain Relief Connectors – straight

Cat. No.	Hub Size	Throat Dia.	Cord Range	Dimensions (in.)		
				A	B	C
2920	½	⅞	.125-.375	1½	1¾	⅝
2921	½	⅞	.310-.560	1½	1¾	⅝
2922	½	⅞	.500-.750	1½	1¾	⅝
2930	¾	1⅜	.125-.375	1¾	1 <sup>25</sup> / <sub>32</sub>	¾
2931	¾	1⅜	.310-.560	1¾	1 <sup>25</sup> / <sub>32</sub>	¾
2932	¾	1⅜	.500-.750	1¾	1 <sup>25</sup> / <sub>32</sub>	¾
2940	1	1⅞	.310-.560	1¾	1¾	1⅞
2941	1	1⅞	.500-.750	1¾	1¾	1⅞
2942	1	1 <sup>31</sup> / <sub>32</sub>	.700-.950	1¾	1 <sup>7</sup> / <sub>8</sub>	1 <sup>31</sup> / <sub>32</sub>

### Steel Liquidtight Strain Relief Connectors – 45° angle

Cat. No.	Hub Size	Throat Dia.	Cord Range	Dimensions (in.)		
				A	B	C
4920	½	3 <sup>7</sup> / <sub>64</sub>	.125-.375	1½	1 <sup>1</sup> / <sub>16</sub>	9 <sup>1</sup> / <sub>16</sub>
4921	½	3 <sup>7</sup> / <sub>64</sub>	.310-.560	1½	1 <sup>1</sup> / <sub>16</sub>	9 <sup>1</sup> / <sub>16</sub>
4922	½	3 <sup>7</sup> / <sub>64</sub>	.500-.750	1½	1 <sup>7</sup> / <sub>16</sub>	9 <sup>1</sup> / <sub>16</sub>
4930	¾	2 <sup>5</sup> / <sub>32</sub>	.125-.375	1¾	1 <sup>7</sup> / <sub>16</sub>	5 <sup>1</sup> / <sub>8</sub>
4931	¾	2 <sup>5</sup> / <sub>32</sub>	.310-.560	1¾	1 <sup>7</sup> / <sub>16</sub>	5 <sup>1</sup> / <sub>8</sub>
4932	¾	2 <sup>5</sup> / <sub>32</sub>	.500-.750	1¾	1 <sup>7</sup> / <sub>16</sub>	5 <sup>1</sup> / <sub>8</sub>
4940	1	1 <sup>5</sup> / <sub>16</sub>	.310-.560	1¾	1 <sup>1</sup> / <sub>2</sub>	2 <sup>5</sup> / <sub>32</sub>

### Steel Liquidtight Strain Relief Connectors – 90° angle

Cat. No.	Hub Size	Throat Dia.	Cord Range	Dimensions (in.)		
				A	B	C
4960	½	1 <sup>9</sup> / <sub>32</sub>	.125-.375	1½	1¾	⅝
4961	½	1 <sup>9</sup> / <sub>32</sub>	.310-.560	1½	1¾	⅝
4962	½	1 <sup>9</sup> / <sub>32</sub>	.500-.750	1½	1 <sup>23</sup> / <sub>64</sub>	⅝
4970	¾	2 <sup>5</sup> / <sub>32</sub>	.125-.375	1¾	1 <sup>25</sup> / <sub>32</sub>	1 <sup>1</sup> / <sub>16</sub>
4971	¾	2 <sup>5</sup> / <sub>32</sub>	.310-.560	1¾	1 <sup>25</sup> / <sub>32</sub>	1 <sup>1</sup> / <sub>16</sub>
4972	¾	2 <sup>5</sup> / <sub>32</sub>	.500-.750	1¾	1 <sup>25</sup> / <sub>32</sub>	1 <sup>1</sup> / <sub>16</sub>
4980	1	1	.310-.560	1¾	2 <sup>1</sup> / <sub>2</sub>	1 <sup>3</sup> / <sub>16</sub>

All items shown on this page are suitable for use in hazardous locations where general purpose equipment is specifically permitted by the NEC.

NEC 501-4(b).

U.L. File No. E-13938

CSA File No. 52391

For wire mesh grips refer to pages A119, A154.





### The Ranger™ Series of Nonmetallic Liquidtight Cord Connectors

The Ranger Series Nonmetallic Liquidtight Cord Connector takes twice the cable range of most ordinary strain relief connectors. T&B's Ranger Connectors allow you to reduce your inventory and save time, with one connector that can do the work of two. The sturdy nylon material adds corrosion resistance to your installation.

#### Application

- Provide means for passing a cord cable (armored or unarmored) into an enclosure, through a bulkhead or into a rigid conduit.
- Form a mechanical grip and water and/or oil-resistant seal for cord and unarmored or jacketed armored round cables.
- Form a non-slip connection or termination for flexible cord, cable (armored or unarmored).
- Provide grounding continuity of cable armor.

#### Cord & Cable Type

- S, SO, SV, ST, STD, SJ, SJO, SJT, SJTO, SVD

#### Features

- Extended range with superior strain relief.

- Reduced overall size, fits into tighter spaces.
- Gland nut designed to restrict cable bending.

#### Materials

Weather Stabilized Nylon, Temperature rated -34°C to 105°C

Bushing: Rubber

#### Environment Classification

- Ordinary Locations
- Wet or dry locations

#### Range

Cord Range .Straight -.125" to .950"  
90° -.125" to .750"

Hub Size Range Straight -1/2" to 1"  
90° - 1/2" to 3/4"



### Nonmetallic Liquidtight Strain Relief Connector – straight

Cat. No.	Trade or Hub Size	Throat Dia.	Cord Range	Dimensions (in.)		
				A	B	C
2920NM	1/2"	.55	.125-.375	1 1/32	2 1/8	5/8
2921NM	1/2"	.55	.310-.560	1 1/32	2 1/8	5/8
2922NM	1/2"	.55	.500-.750	1 1/32	2 5/32	5/8
2930NM	3/4"	.79	.125-.375	1 1/32	2 3/16	5/8
2931NM	3/4"	.79	.310-.560	1 1/32	2 3/16	5/8
2932NM	3/4"	.79	.500-.750	1 1/32	2 3/16	5/8
2940NM	1"	.98	.310-.560	1 1/32	2 1 1/2	25/32
2941NM	1"	.98	.500-.750	1 1/32	2 1 1/2	25/32
2942NM	1"	.98	.700-.950	1 3/64	2 3/8	25/32

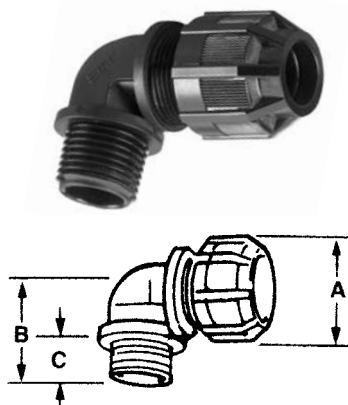

### Nonmetallic Liquidtight Strain Relief Connector – 90° elbow

Cat. No.	Trade or Hub Size	Throat Dia.	Cord Range	Dimensions (in.)		
				A	B	C
4960NM	1/2"	.55	.125-.375	1 1/32	1 1/4	5/8
4961NM	1/2"	.55	.310-.560	1 1/32	1 1/4	5/8
4970NM	3/4"	.79	.125-.375	1 1/32	1 3/8	5/8
4971NM	3/4"	.79	.310-.560	1 1/32	1 3/8	5/8
4972NM	3/4"	.79	.500-.750	1 1/32	1 3/8	5/8

U.L. File No. E 13938  
CSA File No. 52391  
Meets Coast Guard CG293



### The Ranger™ Series of Aluminum Liquidtight Cord Connectors

The Ranger Series Aluminum Liquidtight Connector takes twice the cable range of most ordinary strain relief connectors. T&B's Ranger Connectors allow you to reduce your inventory and save time, with one connector that can do the work of two. The sturdy aluminum material adds corrosion resistance to your installation.

#### Application

- Provide means for passing a cord cable (armored or unarmored) into an enclosure, through a bulkhead or into a rigid conduit.
- Form a mechanical grip and water and/or oil-resistant seal for cord and unarmored or jacketed armored round cables.
- Form a non-slip connection or termination for flexible cord, cable (armored or unarmored).
- Provide grounding continuity of cable armor.

#### Cord & Cable Type

- S, SO, SV, ST, STD, SJ, SJO, SJT, SJTO, SVD

#### Features

- Extended range with superior strain relief.

- Reduced overall size, fits into tighter spaces.
- Gland nut designed to restrict cable bending.

#### Materials

Body: Aluminum  
Gland Nut, Grip: Aluminum-all series  
Bushing: Rubber

#### Environment Classification

- Ordinary Locations
- Wet or dry locations

#### Range

Cord Range .125" to .950"  
Hub Size Range ½" to 1"

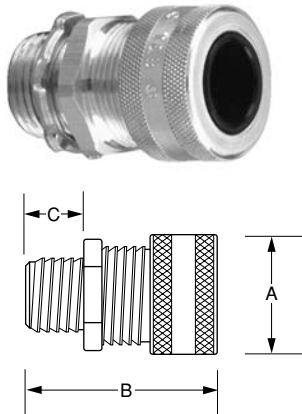

### Aluminum Liquidtight Strain Relief Connectors – straight

Cat. No.	Hub Size	Throat Dia.	Cord Range	Dimensions (in.)		
				A	B	C
2920AL	½	⅞	.125-.375	1½	1¾	⅝
2921AL	½	⅞	.310-.560	1½	1¾	⅝
2922AL*	½	⅞	.500-.750	1⅝	1¾	⅝
2930AL	¾	1⅜	.125-.375	1¾	1⅝ <sup>25</sup> / <sub>32</sub>	¾
2931AL	¾	1⅜	.310-.560	1⅝	1⅝ <sup>25</sup> / <sub>32</sub>	¾
2932AL	¾	1⅜	.500-.750	1¾	1⅝ <sup>25</sup> / <sub>32</sub>	¾
2940AL	1	1⅞	.310-.560	1⅝	1¾	1⅞
2941AL	1	1⅞	.500-.750	1¾	1¾	1⅞
2942AL	1	1⅞ <sup>31</sup> / <sub>32</sub>	.700-.950	1¾	1⅞	1⅞ <sup>31</sup> / <sub>32</sub>

For 1-2" Aluminum Strain Relief Connectors, see next page.

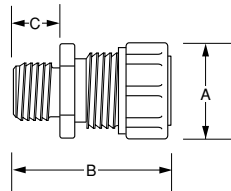

### Aluminum Liquidtight Strain Relief Connectors – straight

Cat. No.	Hub Size	Throat Dia.	Cord Range	Dimensions (in.)		
				A	B	C
2541AL	(.250-.375)	1"	.49 <sup>64</sup> "	1 <sup>11</sup> / <sub>16</sub>	1 <sup>23</sup> / <sub>32</sub>	9 <sup>1</sup> / <sub>16</sub>
2542AL	(.375-.500)	1"	.49 <sup>64</sup> "	1 <sup>11</sup> / <sub>16</sub>	1 <sup>23</sup> / <sub>32</sub>	9 <sup>1</sup> / <sub>16</sub>
2544AL	(.500-.625)	1"	.49 <sup>64</sup> "	1 <sup>11</sup> / <sub>16</sub>	1 <sup>23</sup> / <sub>32</sub>	9 <sup>1</sup> / <sub>16</sub>
2545AL	(.625-.750)	1"	.49 <sup>64</sup> "	1 <sup>11</sup> / <sub>16</sub>	1 <sup>23</sup> / <sub>32</sub>	9 <sup>1</sup> / <sub>16</sub>
2546AL	(.750-.880)	1"	.63 <sup>64</sup> "	1 <sup>11</sup> / <sub>16</sub>	1 <sup>7</sup> / <sub>8</sub>	9 <sup>1</sup> / <sub>16</sub>
2547AL	(.875-.985)	1"	.63 <sup>64</sup> "	1 <sup>11</sup> / <sub>16</sub>	1 <sup>7</sup> / <sub>8</sub>	9 <sup>1</sup> / <sub>16</sub>
2548AL*	(.880-1.065)	1"	.29 <sup>32</sup> "	2 <sup>1</sup> / <sub>16</sub>	2 <sup>3</sup> / <sub>8</sub>	2 <sup>5</sup> / <sub>32</sub>
2549AL*	(1.065-1.205)	1"	.29 <sup>32</sup> "	2 <sup>1</sup> / <sub>16</sub>	2 <sup>3</sup> / <sub>8</sub>	2 <sup>5</sup> / <sub>32</sub>
2558AL	(.880-1.065)	1 <sup>1</sup> / <sub>4</sub> "	1 <sup>1</sup> / <sub>64</sub> "	2 <sup>1</sup> / <sub>8</sub>	2 <sup>9</sup> / <sub>32</sub>	5 <sup>5</sup> / <sub>8</sub>
2559AL	(1.065-1.205)	1 <sup>1</sup> / <sub>4</sub> "	1 <sup>1</sup> / <sub>64</sub> "	2 <sup>1</sup> / <sub>8</sub>	2 <sup>9</sup> / <sub>32</sub>	5 <sup>5</sup> / <sub>8</sub>
2556AL*	(1.187-1.375)	1 <sup>1</sup> / <sub>4</sub> "	1 <sup>1</sup> / <sub>4</sub> "	2 <sup>5</sup> / <sub>16</sub>	2 <sup>1</sup> / <sub>2</sub>	1 <sup>3</sup> / <sub>16</sub>
2557AL*	(1.375-1.485)	1 <sup>1</sup> / <sub>4</sub> "	1 <sup>1</sup> / <sub>4</sub> "	2 <sup>5</sup> / <sub>16</sub>	2 <sup>1</sup> / <sub>2</sub>	1 <sup>3</sup> / <sub>16</sub>
2562AL	(.812-1.000)	1 <sup>1</sup> / <sub>2</sub> "	1 <sup>7</sup> / <sub>16</sub> "	2 <sup>5</sup> / <sub>16</sub>	2 <sup>1</sup> / <sub>2</sub>	1 <sup>3</sup> / <sub>16</sub>
2563AL	(1.000-1.187)	1 <sup>1</sup> / <sub>2</sub> "	1 <sup>7</sup> / <sub>16</sub> "	2 <sup>5</sup> / <sub>16</sub>	2 <sup>7</sup> / <sub>16</sub>	1 <sup>1</sup> / <sub>16</sub>
2564AL	(1.187-1.375)	1 <sup>1</sup> / <sub>2</sub> "	1 <sup>7</sup> / <sub>16</sub> "	2 <sup>1</sup> / <sub>4</sub>	2 <sup>7</sup> / <sub>16</sub>	1 <sup>1</sup> / <sub>16</sub>
2565AL*	(1.375-1.625)	1 <sup>1</sup> / <sub>2</sub> "	1 <sup>29</sup> / <sub>64</sub> "	2 <sup>3</sup> / <sub>4</sub>	2 <sup>5</sup> / <sub>8</sub>	1 <sup>3</sup> / <sub>16</sub>
2573AL	(1.125-1.375)	2"	1 <sup>7</sup> / <sub>8</sub> "	2 <sup>3</sup> / <sub>4</sub>	2 <sup>5</sup> / <sub>8</sub>	1 <sup>3</sup> / <sub>16</sub>
2574AL	(1.375-1.625)	2"	1 <sup>7</sup> / <sub>8</sub> "	2 <sup>3</sup> / <sub>4</sub>	2 <sup>5</sup> / <sub>8</sub>	1 <sup>3</sup> / <sub>16</sub>
2575AL	(1.625-1.875)	2"	1 <sup>7</sup> / <sub>8</sub> "	2 <sup>3</sup> / <sub>4</sub>	3 <sup>1</sup> / <sub>2</sub>	1 <sup>3</sup> / <sub>16</sub>
2576AL*	(1.750-1.965)	2"	1 <sup>29</sup> / <sub>32</sub> "	3 <sup>3</sup> / <sub>32</sub>	3 <sup>1</sup> / <sub>2</sub>	1 <sup>3</sup> / <sub>16</sub>
2577AL*	(1.937-2.187)	2"	1 <sup>29</sup> / <sub>32</sub> "	3 <sup>3</sup> / <sub>32</sub>	3 <sup>1</sup> / <sub>2</sub>	1 <sup>3</sup> / <sub>16</sub>

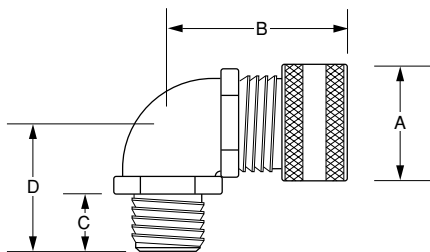

### Aluminum Liquidtight Strain Relief Connectors – 90° elbow

Cat. No.	Trade or Hub Size	Throat Diam.	Cord Range	Dimensions (in.)			
				A	B	C	D
4960AL	1/2	19 <sup>3</sup> / <sub>32</sub>	.125-.375	1 <sup>1</sup> / <sub>8</sub>	1 <sup>3</sup> / <sub>4</sub>	5 <sup>5</sup> / <sub>8</sub>	1 <sup>5</sup> / <sub>16</sub>
4961AL	1/2	19 <sup>3</sup> / <sub>32</sub>	.360-.560	1 <sup>1</sup> / <sub>8</sub>	1 <sup>3</sup> / <sub>4</sub>	5 <sup>5</sup> / <sub>8</sub>	1 <sup>5</sup> / <sub>16</sub>
4962AL*	1/2	19 <sup>3</sup> / <sub>32</sub>	.500-.750	1 <sup>5</sup> / <sub>16</sub>	1 <sup>23</sup> / <sub>64</sub>	5 <sup>5</sup> / <sub>8</sub>	1 <sup>3</sup> / <sub>8</sub>
4970AL	3/4	25 <sup>3</sup> / <sub>32</sub>	.125-.375	1 <sup>5</sup> / <sub>16</sub>	1 <sup>29</sup> / <sub>32</sub>	1 <sup>1</sup> / <sub>16</sub>	1 <sup>15</sup> / <sub>32</sub>
4971AL	3/4	25 <sup>3</sup> / <sub>32</sub>	.310-.560	1 <sup>5</sup> / <sub>16</sub>	1 <sup>25</sup> / <sub>32</sub>	1 <sup>1</sup> / <sub>16</sub>	1 <sup>15</sup> / <sub>32</sub>
4972AL	3/4	25 <sup>3</sup> / <sub>32</sub>	.500-.750	1 <sup>5</sup> / <sub>16</sub>	1 <sup>29</sup> / <sub>32</sub>	1 <sup>1</sup> / <sub>16</sub>	1 <sup>15</sup> / <sub>32</sub>
4980AL	1	1	.310-.560	1 <sup>5</sup> / <sub>16</sub>	2 <sup>1</sup> / <sub>32</sub>	1 <sup>3</sup> / <sub>16</sub>	1 <sup>3</sup> / <sub>4</sub>
4981AL	1	1	.500-.750	1 <sup>5</sup> / <sub>16</sub>	2 <sup>1</sup> / <sub>32</sub>	1 <sup>3</sup> / <sub>16</sub>	1 <sup>3</sup> / <sub>4</sub>
4982AL	1	1	.700-.950	1 <sup>9</sup> / <sub>16</sub>	2 <sup>1</sup> / <sub>16</sub>	1 <sup>3</sup> / <sub>16</sub>	2

\* It may be necessary to remove sufficient outer covering of cable to permit conductors to pass through connector body.  
 All items shown on this page are suitable for use in hazardous locations where general purpose equipment is specifically permitted by the NEC, NEC 501-4(b).  
 U.L. File No. E-13938  
 CSA File No. 52391

For wire mesh grips refer to pages A119, A154.

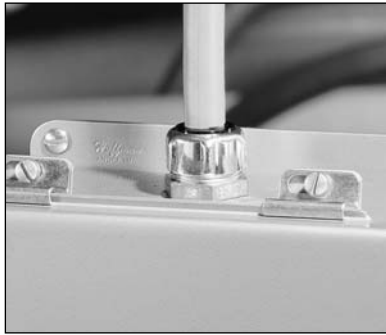

**T&B Liquidtight Strain Relief Cord Connectors**

The T&B Steel Liquidtight Strain Relief Cord Connector is suited for most general control and power cable applications. This series features sturdy neoprene bushings and tapered hub threads.

**Application**

- Provide means for passing a cord cable (armored or unarmored) into an enclosure, through a bulkhead or into a rigid conduit.
- Form a mechanical grip and water and/or oil-resistant seal for cord and unarmored or jacketed armored round cables.
- Form a non-slip connection or termination for flexible cord, cable (armored or unarmored).
- Provide grounding continuity of cable armor.

**Cord & Cable Type**

- S, SO, SV, ST, STD, SJ, SJO, SJT, SJTO, SVD

**Features**

- Extended range with superior strain relief.

- Reduced overall size, fits into tighter spaces.
- Gland nut designed to restrict cable bending.

**Materials**

Body: Steel-2920 series, Malleable Iron-4920 & 4960 series

Gland Nut, Grip: Steel-all series

Bushing: Rubber

**Environment Classification**

- Ordinary Locations
- Wet or dry locations

**Range**

Cord Range .125" to .950"

Hub Size Range 1/2" to 1"

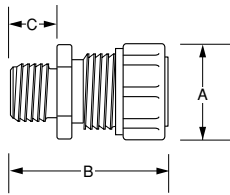

Fig. 1

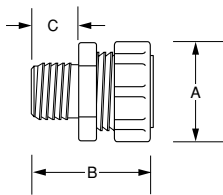
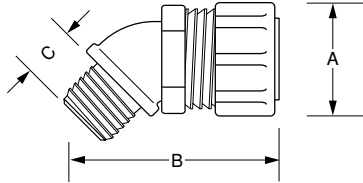

Fig. 2

**Liquidtight Strain Relief Connectors**

Cat. No.	Cable Size Range min.-max.	Hub Size	Throat Dia. (min.) Fig.	Dimensions (in.)			Bushing Part No.	Gland-Nut Model No.	Retainer Model No.	Body Model No.	
				A	B	C					
2516†	(.060-.125)	1/4"	23/64"	2	3/64"	1 7/16"	15/32"	035-73377-5	035-73377-3	035-73377-9	035-73377-1
2517†	(.120-.250)	1/4"	23/64"	2	1/64"	1 7/16"	15/32"	035-73377-6	035-73377-3	035-73377-9	035-73377-1
2518†	(.060-.150)	3/8"	29/64"	2	3/32"	1 1/2"	15/32"	035-73377-7	035-73377-4	035-73377-9	035-73377-2
2519†	(.150-.300)	3/8"	29/64"	2	3/32"	1 1/2"	15/32"	035-73377-8	035-73377-4	035-73377-9	035-73377-2
2520	(.125-.250)	1/2"	9/16"	1	1 1/2"	1 5/8"	5/8"	053-71411-1	053-71411-37	035-72735-1	053-71411-43
2521	(.250-.375)	1/2"	9/16"	1	1 1/8"	1 5/8"	5/8"	053-71411-2	053-71411-37	035-72735-1	053-71411-43
2522	(.375-.500)	1/2"	9/16"	1	1 1/8"	1 5/8"	5/8"	053-71411-3	053-71411-37	035-72735-2	053-71411-43
2523	(.450-.560)	1/2"	9/16"	1	1 1/8"	1 5/8"	5/8"	053-71411-4	053-71411-37	035-72735-2	053-71411-43
2524*	(.500-.625)	1/2"	5/8"	1	1 3/8"	1 3/4"	5/8"	053-71411-59	053-71411-38	035-72735-3	033-72259-21
2525*	(.625-.750)	1/2"	5/8"	1	1 3/8"	1 3/4"	5/8"	053-71411-60	053-71411-38	035-72735-3	033-72259-21
2530	(.125-.250)	3/4"	13/16"	1	1 3/8"	1 3/4"	9/16"	033-72259-1	053-71411-38	035-72735-4	053-71411-44
2531	(.250-.375)	3/4"	13/16"	1	1 3/8"	1 3/4"	9/16"	053-71411-5	053-71411-38	035-72735-4	053-71411-44
2532	(.375-.500)	3/4"	13/16"	1	1 3/8"	1 3/4"	9/16"	053-71411-58	053-71411-38	035-72735-4	053-71411-44
2534	(.500-.625)	3/4"	13/16"	1	1 3/8"	1 3/4"	9/16"	053-71411-59	053-71411-38	035-72735-3	053-71411-44
2535	(.625-.750)	3/4"	13/16"	1	1 3/8"	1 3/4"	9/16"	053-71411-60	053-71411-38	035-72735-3	053-71411-44
2536*	(.750-.880)	3/4"	3/4"	1	1 3/8"	1 5/8"	5/8"	053-71411-61	053-71411-39	035-72735-5	033-72259-22
2541	(.250-.375)	1"	49/64"	1	1 1/16"	1 23/32"	9/16"	053-71411-5	053-71411-38	035-72735-4	053-71411-45
2542	(.375-.500)	1"	49/64"	1	1 1/16"	1 23/32"	9/16"	053-71411-58	053-71411-38	035-72735-4	053-71411-45
2544	(.500-.625)	1"	49/64"	1	1 1/16"	1 23/32"	9/16"	053-71411-59	053-71411-38	035-72735-3	053-71411-45
2545	(.625-.750)	1"	49/64"	1	1 1/16"	1 23/32"	9/16"	053-71411-60	053-71411-38	035-72735-3	053-71411-45
2546	(.750-.880)	1"	49/64"	1	1 1/16"	1 17/8"	9/16"	053-71411-61	053-71411-39	035-72735-5	053-71411-46
2547	(.875-.985)	1"	49/64"	1	1 1/16"	1 7/8"	9/16"	053-71411-62	053-71411-39	035-72735-5	053-71411-46
2548*	(.880-1.065)	1"	29/32"	1	2 1/16"	2 3/8"	25/32"	053-71411-63	053-71411-40	035-72735-6	033-72259-23
2549*	(1.065-1.205)	1"	29/32"	1	2 1/16"	2 3/8"	25/32"	053-71411-64	053-71411-40	035-72735-6	033-72259-23
2558	(.880-1.065)	1 1/4"	1 1/64"	1	2 1/8"	2 5/8"	5/8"	053-71411-63	053-71411-40	035-72735-6	053-71411-47
2559	(1.065-1.205)	1 1/4"	1 1/64"	1	2 1/8"	2 5/8"	5/8"	053-71411-64	053-71411-40	035-72735-6	053-71411-47
2556*	(1.187-1.375)	1 1/4"	1 1/4"	1	2 5/16"	2 1/2"	13/16"	053-71411-18	053-71411-41	035-72735-7	033-72259-24
2557*	(1.375-1.485)	1 1/4"	1 1/4"	1	2 5/16"	2 1/2"	13/16"	033-72259-2	053-71411-41	035-72735-7	033-72259-24
2562	(.812-1.000)	1 1/2"	1 1/64"	1	2 5/16"	2 1/2"	13/16"	033-72259-3	053-71411-41	035-72735-7	053-71411-48
2563	(1.000-1.187)	1 1/2"	1 1/64"	1	2 5/16"	2 1/2"	13/16"	053-71411-17	053-71411-41	035-72735-7	053-71411-48
2564	(1.187-1.375)	1 1/2"	1 1/64"	1	2 1/4"	2 7/16"	1 1/8"	053-71411-18	053-71411-41	035-72735-7	053-71411-48
2565*	(1.375-1.625)	1 1/2"	1 29/64"	1	2 3/4"	2 9/8"	13/16"	053-71411-65	053-71411-42	035-72735-8	033-72259-25
2573	(1.125-1.375)	2"	1 7/8"	1	2 3/4"	2 5/8"	13/16"	053-71411-66	053-71411-42	035-72735-8	053-71411-49
2574	(1.375-1.625)	2"	1 7/8"	1	2 3/4"	2 5/8"	13/16"	053-71411-65	053-71411-42	035-72735-8	053-71411-49
2575	(1.625-1.875)	2"	1 7/8"	1	2 3/4"	3 1/8"	13/16"	053-71411-67	053-71411-42	035-72735-8	053-71411-49
2576*	(1.750-1.965)	2"	1 29/64"	1	3 3/32"	3 1/2"	13/16"	033-72259-5	033-72259-17	035-72735-9	033-72259-26
2577*	(1.937-2.187)	2"	1 29/64"	1	3 3/32"	3 1/2"	13/16"	033-72259-6	033-72259-17	035-72735-9	033-72259-26
2584	(1.750-1.965)	2 1/2"	2"	1	3 3/32"	3 3/4"	1 1/32"	033-72259-5	033-72259-17	035-72259-14	033-72259-27
2585	(1.937-2.187)	2 1/2"	2"	1	3 3/32"	3 3/4"	1 1/32"	033-72259-6	033-72259-18	033-72259-14	033-72259-27
2586*	(2.156-2.360)	2 1/2"	2 5/32"	1	3 5/16"	4 1/4"	1 1/32"	033-72259-7	033-72259-19	033-72259-15	033-72259-28
2587*	(2.350-2.565)	2 1/2"	2 29/64"	1	3 5/16"	4 1/4"	1 1/32"	033-72259-8	033-72259-19	033-72259-15	033-72259-28
2592	(2.156-2.360)	3"	2 19/64"	1	3 5/16"	4 1/4"	1 1/32"	033-72259-7	033-72259-19	033-72259-15	033-72259-29
2593	(2.350-2.565)	3"	2 19/64"	1	3 5/16"	4 1/4"	1 1/32"	033-72259-8	033-72259-19	033-72259-15	033-72259-29
2594	(2.535-2.750)	3"	2 19/64"	1	3 5/16"	4 1/4"	1 1/32"	033-72259-9	033-72259-19	033-72259-15	033-72259-29
2595*	(2.735-2.985)	3"	2 19/64"	1	4 1/16"	4 13/16"	1 1/8"	033-72259-10	033-72259-20	033-72259-16	033-72259-30
2596*	(2.970-3.220)	3"	2 19/64"	1	4 1/16"	4 13/16"	1 1/8"	033-72259-11	033-72259-20	033-72259-16	033-72259-30

For wire mesh grips refer to pages A119, A154.



### Liquidtight Strain Relief Connectors – 45°

Cat. No.	Cable Size min.-max.	Hub Size	Dimensions (in.)			Throat Dia.
			A	B	C	
2200	(.125-.250)	½"	1½	1¾	¾	¾
2201	(.250-.375)	½"	1½	1¾	¾	¾
2202	(.375-.500)	½"	1½	1¾	¾	¾
2203	(.450-.560)	½"	1½	1¾	¾	¾
2204*	(.500-.625)	½"	1¾	1¾	¾	¾
2205*	(.625-.750)	½"	1¾	1¾	¾	¾
2206	(.125-.250)	¾"	1¾	1¾	¾	¾
2207	(.250-.375)	¾"	1¾	1¾	¾	¾
2208	(.375-.500)	¾"	1¾	1¾	¾	¾
2209	(.500-.625)	¾"	1¾	1¾	¾	¾
2210	(.625-.750)	¾"	1¾	1¾	¾	¾
2211*	(.750-.880)	¾"	1¾	1½	1½	¾
2213	(.375-.500)	1"	1¾	1½	¾	¾
2214	(.500-.625)	1"	1¾	1½	¾	¾
2215	(.625-.750)	1"	1¾	1½	¾	¾
2216	(.750-.875)	1"	1¾	1½	¾	¾
2217*	(.875-.985)	1"	1¾	1½	¾	¾
2218*	(.880-1.065)	1"	2¼	1¾	¾	¾
2219*	(1.065-1.205)	1"	2¼	1¾	¾	¾
2220*	(.880-1.065)	1¼"	2¼	1¾	¾	¾
2221*	(1.065-1.205)	1¼"	2¼	1¾	¾	¾
2222*	(1.187-1.375)	1¼"	2¼	1¾	¾	¾
2223*	(1.375-1.485)	1¼"	2¼	1¾	¾	¾

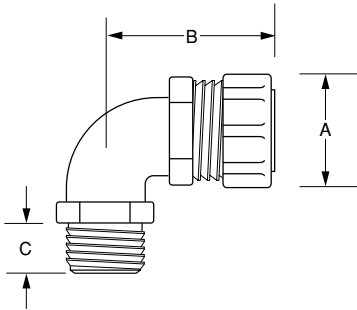

### Liquidtight Strain Relief Connectors – 90°

Cat. No.	Cable Size min.-max.	Hub Size	Dimensions (in.)			Throat Dia.
			A	B	C	
2267	(.125-.250)	½"	1½	1¾	¾	¾
2268	(.250-.375)	½"	1½	1¾	¾	¾
2269	(.375-.500)	½"	1½	1¾	¾	¾
2270	(.450-.560)	½"	1½	1¾	¾	¾
2250*	(.500-.625)	½"	1¾	1½	¾	¾
2251*	(.625-.750)	½"	1¾	1½	¾	¾
2252	(.125-.250)	¾"	1¾	1¾	¾	¾
2271	(.250-.375)	¾"	1¾	1¾	¾	¾
2272	(.375-.500)	¾"	1¾	1¾	¾	¾
2273	(.500-.625)	¾"	1¾	1¾	¾	¾
2274*	(.620-.750)	¾"	1¾	1¾	¾	¾
2253*	(.750-.880)	¾"	1¾	1¾	¾	¾
2254	(.375-.500)	1"	1¾	2	¾	1
2255	(.500-.625)	1"	1¾	2	¾	1
2256*	(.625-.750)	1"	1¾	2	¾	1
2275	(.750-.875)	1"	1¾	2	¾	1
2276	(.875-.985)	1"	1¾	2	¾	1
2257*	(.880-1.065)	1"	2¼	2¾	¾	¾
2258*	(1.065-1.205)	1"	2¼	2¾	¾	¾
2277	(.880-1.065)	1¼"	2¼	2¾	¾	¾
2278	(1.065-1.205)	1¼"	2¼	2¾	¾	¾
2279*	(1.187-1.375)	1¼"	2¼	2¾	¾	¾
2280*	(1.375-1.485)	1¼"	2¼	2¾	¾	¾
2281	(.812-1.000)	1½"	2¼	2¾	¾	¾
2282	(1.000-1.187)	1½"	2¼	2¾	¾	¾
2283*	(1.187-1.375)	1½"	2¼	2¾	¾	¾
2284	(1.125-1.375)	2"	2¾	3¼	¾	¾
2285	(1.375-1.625)	2"	2¾	3¼	¾	¾
2286	(1.625-1.875)	2"	2¾	3¼	¾	¾

\* Remove sufficient outer covering of cable to permit conductors to pass thru connector body.

† U.L. not applicable.

Complies with JIC standards.

U.L. Listed as liquidtight strain relief, and outlet bushing. CSA certified watertight.

Temperature rating 105°C.

Suitable for hazardous locations use where general purpose equipment is specifically permitted per NEC Section 501-4(b).

U.L. File No. E 13938

CSA File No. 589 & 4484

For wire mesh grips refer to pages A119, A154.

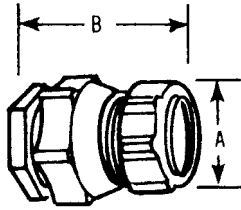

### CHASE® Liquidtight Cord Connectors

Cat. No.	Cable Size Range Size (in.)	Throat Dia.	Cord Range	Dimensions (in.)	
				B	C
2631	(.125-.250)	½"	¾"	1 ⅙"	1 ⅝"
2632	(.250-.375)	½"	¾"	1 ⅙"	1 ⅝"
2633	(.375-.500)	½"	¾"	1 ⅙"	1 ⅝"
2634	(.450-.560)	½"	¾"	1 ⅙"	1 ⅝"
2637	(.125-.250)	¾"	2 ⅝"	1 ⅙"	1 ¾"
2638	(.250-.375)	¾"	2 ⅝"	1 ⅙"	1 ¾"
2639	(.375-.500)	¾"	2 ⅝"	1 ⅙"	1 ¾"
2640	(.500-.625)	¾"	2 ⅝"	1 ⅙"	1 ¾"
2641	(.625-.750)	¾"	2 ⅝"	1 ⅙"	1 ¾"
2644	(.250-.375)	1"	1"	1 ⅝"	1 ⅜"
2645	(.375-.500)	1"	1"	1 ⅝"	1 ⅜"
2646	(.500-.625)	1"	1"	1 ⅝"	1 ⅜"
2647	(.625-.750)	1"	1"	1 ⅝"	1 ⅜"
2648	(.750-.880)	1"	1"	1 ⅝"	1 ⅜"
2649	(.885-.985)	1"	1"	1 ⅝"	1 ⅜"

Suitable for hazardous locations use in Class I, Div. 2; Class II, Div. 1 and 2; Class III, Div. 1 and 2, where general purpose equipment is specifically permitted per NEC Section 500-2(a).

Complete with "O" Ring seal and nylon insulated throat, and neoprene bushing.

U.L. Listed as liquidtight strain relief, and outlet bushing. CSA certified watertight.

Temperature Rating; 105°C.

U.L. File No. E 13938

CSA File No. 589

CHASE® Liquidtight Cord Connectors are ideal for installation where space is limited inside the enclosure.

### Multi-Hole Flexible Cord and Cable Connectors

Cat. No.	Hub Size, In.	Dia. No.	Cord Dia.
2520-2	½"	2	.220
2530-2	¾"	2	.220
2531-2	¾"	2	.260
2531-3	1"	3	.260
2541-2	1"	2	.300
2542-2	1"	2	.375
2540-3	1"	3	.225
2541-3	1"	3	.300
2540-4	1"	4	.220
2555-2	1 ¼"	2	.500

Note: Range of cord dia. ± .010.

In many applications you have only room for one fitting but you need to run two cables, for example, proximity switches. Now you can provide strain relief and liquidtight protection with T&B's new multi-hole liquidtight strain relief connectors. With the ever increasing number of signal cables, now you have a solution to the problem of how to strain relieve multiple cables in one fitting.

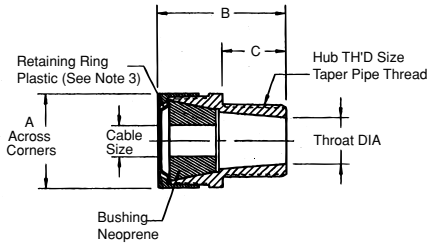

### Watertight Strain Relief Connectors (Straight)

Cat. No.	Hub THD Size (Taper THD)	Cable Size		A	B Max.	C	on Bushing	Marking Bushing Part. No.	Throat Dia. (Min.)
		Min.	Max.						
2558AL	1¼	.880	1.065	2¾ <sub>32</sub>	2¾ <sub>32</sub>	19 <sub>16</sub>	.880-1.065	053-71411-63	1¼ <sub>64</sub>
2559AL	1¼	1.065	1.205	2¾ <sub>32</sub>	2¾ <sub>32</sub>	19 <sub>16</sub>	1.065-1.205	053-71411-64	1¼ <sub>64</sub>
2556AL	1¼	1.187	1.375	2½ <sub>32</sub>	2½	19 <sub>16</sub>	2564	053-71411-18	1¼
2557AL	1¼	1.375	1.485	2½ <sub>32</sub>	2½	19 <sub>16</sub>	None	033-72259-2	1¼
2562AL	1½	.812	1.000	2½ <sub>32</sub>	2½	11 <sub>16</sub>	None	033-72259-3	17 <sub>16</sub>
2563AL	1½	1.000	1.187	2½ <sub>32</sub>	27 <sub>16</sub>	11 <sub>16</sub>	2563	053-71411-17	17 <sub>16</sub>
2564AL	1½	1.187	1.375	2½ <sub>32</sub>	27 <sub>16</sub>	11 <sub>16</sub>	2564	053-71411-18	17 <sub>16</sub>
2565AL	1½	1.375	1.625	23 <sub>16</sub>	25 <sub>16</sub>	19 <sub>16</sub>	1.375-1.625	053-71411-65	129 <sub>64</sub>
2573AL	2	1.125	1.375	219 <sub>16</sub>	25 <sub>16</sub>	19 <sub>16</sub>	1.125-1.375	053-71411-66	17 <sub>8</sub>
2574AL	2	1.375	1.625	219 <sub>16</sub>	25 <sub>16</sub>	11 <sub>16</sub>	1.375-1.625	053-71411-65	17 <sub>8</sub>
2575AL	2	1.625	1.875	219 <sub>16</sub>	25 <sub>16</sub>	11 <sub>16</sub>	1.625-1.875	053-71411-67	17 <sub>8</sub>
2576AL	2	1.750	1.965	37 <sub>32</sub>	3½	27 <sub>32</sub>	10412	033-72259-5	129 <sub>32</sub>
2577AL	2	1.937	2.187	37 <sub>32</sub>	3½	27 <sub>32</sub>	10413	033-72259-6	129 <sub>32</sub>
2584AL	2½	1.750	1.965	37 <sub>32</sub>	3¾	1½ <sub>32</sub>	10412	033-72259-5	2
2585AL	2½	1.937	2.187	37 <sub>32</sub>	3¾	1½ <sub>32</sub>	10413	033-72259-6	2
2586AL	2½	2.156	2.360	319 <sub>16</sub>	4¼	1½ <sub>32</sub>	10414	033-72259-7	25 <sub>32</sub>
2587AL	2½	2.350	2.565	319 <sub>16</sub>	4¼	1½ <sub>32</sub>	10415	033-72259-8	25 <sub>32</sub>
2592AL	3	2.156	2.360	319 <sub>16</sub>	4¼	1½ <sub>32</sub>	10414	033-72259-7	219 <sub>32</sub>
2593AL	3	2.350	2.565	319 <sub>16</sub>	4¼	1½ <sub>32</sub>	10415	033-72259-8	219 <sub>32</sub>
2594AL	3	2.535	2.750	319 <sub>16</sub>	4¼	1½ <sub>32</sub>	10416	033-72259-9	219 <sub>32</sub>
2595AL	3	2.735	2.985	411 <sub>16</sub>	419 <sub>16</sub>	11 <sub>16</sub>	None	033-72259-10	219 <sub>16</sub>
2596AL	3	2.990	3.220	411 <sub>16</sub>	419 <sub>16</sub>	11 <sub>16</sub>	None	033-72259-11	219 <sub>16</sub>

**Notes:**

1. Cord or cable will not pass thru body without removing outer covering.
2. Listed under "UL" file No. E13938A and "CSA" file No. 589 except Cat. No.'s 2516, 2517, 2518, and 2519.
3. 2½" and 3" sizes have stainless steel retaining rings.
4. Cat. No. 2558AL through 2575AL have machined aluminum body with stamped sheet aluminum gland. All others have cast aluminum body and gland. All bodies and glands are etched clean and wax coated for easy assembly.
5. Alumishield to be on gland to prevent galling of threads.

# T&B® Fittings

## Flexible Cords and Cable Fittings – Non-Metallic



2672 Series

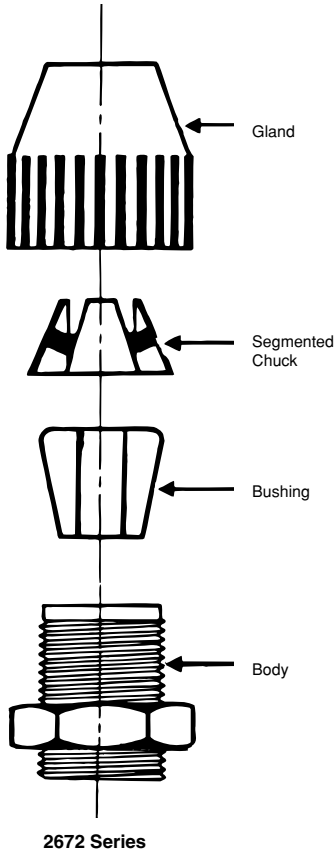

2672 Series

### Liquidtight Flexible Cord Connectors – Black Beauty™ Series

#### Application

- A liquidtight connector to connect flexible cord to a box or enclosure and provide adequate strain relief.

#### Features

- Taper Thread hub seals in female hub (A).
- Neoprene bushing provides liquidtight installation (B).
- Hand tightens – no tools needed for assembly.
- Segmented chuck provides high mechanical pullout performance – will not cut or damage cord jacket (C).
- Corrosion and weather resistant plastic is excellent for outdoor/indoor use.
- Plastic parts improve dielectric strength and provide insulated throat (D).
- Wide range – reduces inventories.

#### Listed/Certified by:

U.L. ....(U.L. File No. E-23018)  
CSA .....LR-2884, LR-4484

#### Standard Material

Body, Gland &  
Segmented Chuck ..Weather stabilized  
thermoplastic rated for -34°C (-29°F)  
to 105°C (221°F) application.

Bushing.....Neoprene

#### Standard Finish

All parts as molded.

#### Range

.250 outside diameter  
to 1.020 outside  
diameter .....Type S, SO, SV, ST, STO,  
SJ, SJO, SJT, SJTO,  
SVTO, SVO, SVT Flexible  
Cords & Cables

#### Conforms to:

U.L. 514B  
CSA C22.2 No. 18  
NFPA 70-1999 (ANSI)  
Federal Standard H-28 (Threads)

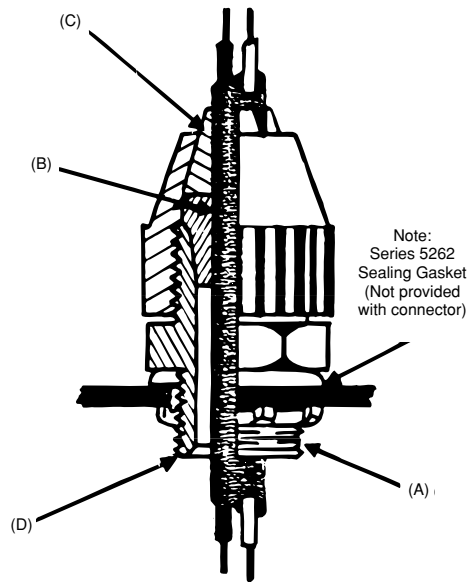

Typical Installation



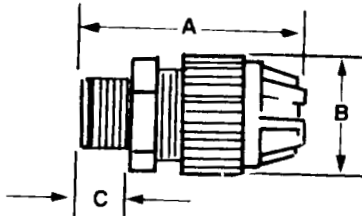

- Weather Stabilized Nylon.
- U.L. 94-V2.
- Temperature Rating: -34°C to +105°C.
- Meets Coast Guard CG293.

### Nonmetallic Liquidtight Strain Relief Connector – straight

Cat. No.	Trade or Hub Size	Throat Diam. (in.)	Cord Range (in.)	Dimensions (in.)		
				A	B	C
2671	3/8"	0.33	.125-.275	2.0	.90	.46
2690	1/2"	0.33	.125-.275	2.3	.90	.60
2672	1/2"	0.55	.250-.400	2.6	1.27	.60
2673*	1/2"	0.55	.400-.560	2.6	1.27	.60
2691*	1/2"	0.54	.660-.780	3.0	1.57	.60
2692*	1/2"	0.54	.660-.780	3.0	1.57	.60
2693	3/4"	0.55	.250-.400	2.7	1.27	.62
2694*	3/4"	0.55	.400-.560	2.7	1.27	.62
2674	3/4"	0.79	.560-.690	3.0	1.57	.62
2675	3/4"	0.79	.660-.780	3.0	1.57	.62
2696*	3/4"	0.76	.770-.895	3.2	1.89	.62
2676	1"	0.98	.660-.780	3.3	1.89	.77
2677	1"	0.98	.770-.895	3.3	1.89	.77
2678*	1"	0.98	.870-1.020	3.3	1.89	.77
2699	1"	0.98	.890-1.090	4.2	2.58	.77
2702	1 1/4"	1.25	.890-1.090	4.2	2.58	.80
2703	1 1/4"	1.25	1.080-1.280	4.0	2.58	.80
2704	1 1/4"	1.25	1.270-1.470	4.0	2.58	.80
2705-TB	1 1/2"	1.47	.890-1.150	4.2	2.95	.82
2706	1 1/2"	1.47	1.140-1.400	4.3	2.95	.82
2707	1 1/2"	1.47	1.390-1.650	4.3	2.95	.82
2708	2"	1.89	1.190-1.530	5.1	3.50	.84
2709	2"	1.89	1.520-1.860	4.9	3.50	.84
2710*	2"	1.89	1.850-2.190	4.9	3.50	.84

\* Remove sufficient outer covering of cable to permit conductors to pass thru connector body.

U.L. File No. E 13938

CSA File No. 52391

All items shown on this page are suitable for use in hazardous location where general purpose equipment is specifically permitted by the NEC. Class I, Div. 2. Class II, Div. 1 & 2. Class III, Div. 1 & 2. NEC 501-4(b), 502-4(a)(b), 503-3(a)(b).

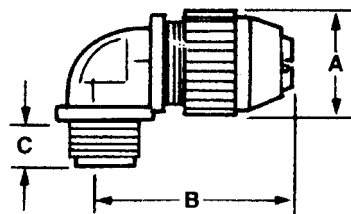

90° angle, standard size body.

- Weather Stabilized Nylon.
- U.L. 94-V2.
- Temperature Rating: -34°C to +105°C.
- Meets Coast Guard CG293.

### Nonmetallic Liquidtight Strain Relief Connector – 90° elbow

Cat. No.	Trade or Hub Size	Throat Diam. (in.)	Cord Range (in.)	Dimensions (in.)		
				A	B	C
2680	3/8"	.33	.125-.275	2 3/32	1 1/4	.460
2681	1/2"	.55	.250-.400			
2682*	1/2"	.55	.400-.560			
2683	3/4"	.78	.560-.690			
2684	3/4"	.78	.660-.780			
2688	1"	.98	.560-.690	1 7/32	3 1/4	.770
2685	1"	.98	.660-.780	1 7/32	3 1/4	.770
2686	1"	.98	.770-.895	1 7/32	3 3/16	.770
2687*	1"	.98	.870-1.020	1 7/32	3	.770

\* Remove sufficient outer covering of cable to permit conductors to pass thru connector body. 90° angle, standard size body.

U.L. File No. E 13938

CSA File No. 52391

All items shown on this page are suitable for use in hazardous locations where general purpose equipment is specifically permitted by the NEC. Class I, Div. 2. Class II, Div. 1 & 2. Class III, Div. 1 & 2. NEC 501-4(b), 502-4(a)(b), 503-3(a)(b).



Wiremesh grips support the following Liquidtight Cord Fittings Series.



2920 Series



2920AL Series



2516 Series

### The T&B WMG-PC Series Wiremesh Grips for Portable Cord

T&B Wiremesh grips are ordered separately and fit with your existing inventory of Ranger™ connectors and liquidtight strain relief connectors. There's no need to duplicate inventory.

#### Application

- Provides high gripping strength for adequate cable support and strain relief without damage to the cable sheath
- Compression of a tapered neoprene bushing, assures the watertight integrity of the fittings
- To meet National Electric Code or NEC requirements for electrical installations in hazardous atmospheres, a sealing fitting may be required in conjunction with the cable and cord fitting

#### Cord & Cable Type

- S, SO, SV, ST, STD, SJ, SJO, SJT, SJTO, SVD

#### How to select proper wiremesh grip:

1. Determine O.D. of portable cord e.g. .200
2. Determine size of knockout or threaded hub e.g. ½"
3. Select Cat. No. of strain relief connector e.g. 2520, 2920AL.
4. Match up O.D. with grip range and strain relief to determine Cat. No. of Wiremesh Grip (e.g. .200 + 2520 = WMP-PC1)

#### Features

- Prevents severe cord bends and pullouts
- Used in aluminum and/or steel fittings

#### Materials

Wiremesh made of stainless steel. Retaining rings made of aluminum.

#### Environment Classification

- Ordinary Locations

#### Range

.187 – 3.220



## Wiremesh Grips for Portable Cord

Cat. No.	Grip Range	Strain Relief Connector								
		Straight			45°		90°			
		Ranger™ Steel	Ranger™ Aluminum	T&B Steel	Ranger™ Steel	T&B Steel	Ranger™ Steel	Ranger™ Aluminum	T&B Steel	
WMG-PC1	.187-250	2920	2920AL	2520	4920	2200	4960	4960AL	2267	
WMG-PC2	.250-.375	2920	2920AL	2521	4920	2201	4960	4960AL	2268	
WMG-PC3	.375-.500	2921	2921AL	2522	4921	2202	4961	4961AL	2269	
WMG-PC4	.500-.625	2922	2922AL	2524	4922	2204	4962	4962AL	2250	
		2932	2932AL	2534	4932	2209	4972	4972AL	2273	
		2941	2941AL	2544	4941	2214	4981	4981AL	2255	
WMG-PC5	.625-.750	2922	2922AL	2525	4922	2205	4962	4962AL	2251	
		2932	2932AL	2535	4932	2210	4972	4972AL	2274	
		2941	2941AL	2545	4941	2215	4981	4981AL	2256	
WMG-PC6	.187-.250	2930	2930AL	2530	4930	2206	4970	4970AL	2252	
WMG-PC7	.250-.375	2930	2930AL	2531 2541	4930	2207	4970	4970AL	2271	
WMG-PC8	.375-.500	2931	2931AL	2532	4931	2208	4961	4961AL	2272	
		2940	2940AL	2542	4940	2213	4980	4980AL	2254	
WMG-PC9	.750-.875	2942	2942AL	2536	4942	2211	4982	4982AL	2253	
		2941	2941AL	2546	4941	2216	4981	4981AL	2275	
WMG-PC10	.875-1.000			2547		2217			2276	
WMG-PC11	.875-1.000			2548		2218			2257	
				2558		2220			2277	
WMG-PC12	1.000-1.125			2548		2218			2257	
				2558		2220			2277	
				2549		2219			2258	
				2559		2221			2278	
WMG-PC13	1.125-1.250			2549		2221	2258	2258	2219	
				2559		2221			2278	
WMG-PC14	1.125-1.250			2556		2222	2279	2279	2222	
				2563		—			2282	
				2564		—			2283	
WMG-PC15	1.250-1.375			2256		2222			2279	
				2564		—			2283	
WMG-PC16*	1.375-1.500			2557		2223			2280	
WMG-PC17*	1.125-1.250			2573		—			2284	

Cat. No.	Grip Range	Strain Relief Connector	
		Straight	90°
		T&B Steel	T&B Steel
WMG-PC18*	1.250-1.375	2573	2284
WMG-PC19*	1.375-1.500	2565	2285
		2574	
WMG-PC20*	1.500-1.625	2565	2285
		2574	
WMG-PC21*	1.625-1.750	2575	2286
WMG-PC22*	1.750-1.875	2575	2286
WMG-PC23	1.750-1.875	2576	
		2584	
WMG-PC24	1.875-2.000	2576	
		2584	
WMG-PC25	1.937-2.062	2577	
		2585	
WMG-PC26*	2.062-2.187	2577	
		2585	
WMG-PC27	2.125-2.250	2586	
		2592	
WMG-PC28	2.250-2.375	2586	
		2592	
WMG-PC29	2.350-2.475	2587	
		2593	
WMG-PC30	2.475-2.600	2587	
		2593	
		2594	
WMG-PC31*	2.625-2.750	2594	
WMG-PC32*	2.735-2.860	2595	
WMG-PC33*	2.860-2.985	2595	
WMG-PC34*	2.970-3.095	2596	
WMG-PC35*	3.095-3.220	2596	

\*Replacement Gland Nut Supplied With These Catalog Numbers Only

### Low profile cable gland perfect for tight spots

T&B Nylon Cable Glands have a sturdy cable sealing mechanism which results in superior strain relief. The compact size ensures quick and easy installation in cramped spaces. The non-metallic construction provides excellent corrosion, chemical and impact resistance. The glands have long threads and locknuts are available.



- Halogen free
- Flame Retardant UL 94V0
- Rated IP 68 5 BAR, suitable for NEMA 4 enclosures
- UL Listed\*, CSA listed for certain ranges of cable
- Working Temperatures -30°C(-86F) to +80°C(176°F)  
Continuous, +150°C(276°F) Intermittent
- Meets VDE ratings

*Sturdy Nylon 6 for strong, lightweight construction. Gray color shown, also available in black.*



## Non-Metallic Cable Glands

Catalog No. Fittings	Thread Size	Color	Cord Range		Length of Thread		Use T&B Locknut Cat. No.	Unit Pkg.	Std. Pkg.
			In.	MM	In.	MM			
<b>NPT Threads</b>									
CC-NPT38-B	3/8"	BLACK	.197-.394	5-10mm	.590	15mm	-	50	250
CC-NPT38-G	3/8"	GRAY	.197-.394	5-10mm	.590	15mm	-	50	250
CC-NPT12-B	1/2"	BLACK	.394-.551	10-14mm	.590	15mm	LN501	50	250
CC-NPT12-G	1/2"	GRAY	.394-.551	10-14mm	.590	15mm	LN501	50	250
CC-NPT34-B	3/4"	BLACK	.512-.709	13-18mm	.590	15mm	LN502	25	100
CC-NPT34-G	3/4"	GRAY	.512-.709	13-18mm	.590	15mm	LN502	25	100
CC-NPT1-B	1"	BLACK	.709-.984	18-25mm	.709	18mm	LN503	20	100
CC-NPT1-G	1"	GRAY	.709-.984	18-25mm	.709	18mm	LN503	20	100
<b>ISO/Metric Threads</b>									
CC-ISO16-G	16	GRAY	.197-.394	5-10mm	.394	10mm	LN-ISO16-G	50	200
CC-ISO20-G	20	GRAY	.236-.473	6-12mm	.590	15mm	LN-ISO20-G	50	200
CC-ISO25-G	25	GRAY	.512-.709	13-18mm	.590	15mm	LN-ISO25-G	25	100
CC-ISO32-G	32	GRAY	.709-.984	18-25mm	.590	15mm	LN-ISO32-G	20	100
<b>PG Threads</b>									
CC-PG7-G	7	GRAY	.118-.256	3-6.5mm	.315	8mm	LN-PG7-G	50	200
CC-PG9-G	9	GRAY	.157-.315	4-8mm	.315	8mm	LN-PG9-G	50	200
CC-PG11-G	11	GRAY	.197-.394	5-10mm	.315	8mm	LN-PG11-G	25	100
CC-PG135-G	13 1/2	GRAY	.236-.473	6-12mm	.354	9mm	LN-PG135-G	25	100
CC-PG16-G	16	GRAY	.394-.551	10-14mm	.394	10mm	LN-PG16-G	25	100
CC-PG21-G	21	GRAY	.512-.709	13-18mm	.433	11mm	LN-PG21-G	10	50
CC-PG29-G	29	GRAY	.709-.984	18-25mm	.433	11mm	LN-PG29-G	10	50
CC-PG36-G	36	GRAY	.867-1.26	22-32mm	.512	13mm	LN-PG36-G	10	50

\*Listed under UL file E13938, control #137B NPT and PG threaded Cable Glands are UL Listed, ISO/Metric Threaded Cable Glands are not UL Listed.

# T&B® Fittings

## Service Entrance Cable Fittings



**Series 4175**  
Pipe Strap (EMT)



**Series 1275/1275AL**  
Pipe Strap  
(Rigid Metal Conduit & I.M.C.)



**Series 1350/1350AL**  
Pipe Spacer  
(Rigid Metal Conduit I.M.C. & EMT)



**Series 1490**  
Entrance ELL



**Series 3870**  
Bonding & Grounding Bushing – Insulated



**Series 106**  
Bonding Locknut

### Suggested Specifications for Service Entrance Fittings

- All service fittings shall be approved for the purpose by a nationally recognized testing laboratory, inspection agency, or product evaluation organization.
  - Where service raceway consists of a rigid metal conduit, intermediate metal conduit, electrical metallic tubing or where service entrance cable is used as service conductors, a suitable rain tight service head conforming to Federal Standard W-C-586 shall be provided.
  - Service raceway shall be securely fastened in place to the supporting surface at intervals as specified by the Code using suitable straps and spacers; straps and spacers shall be of malleable iron or steel construction, hot dipped galvanized or electro zinc plated conforming to Canadian Standards Association Standard C22.2 No. 18 and as manufactured by Thomas & Betts: series 1275 or 4175 straps and series 1350 spacers; aluminum straps or spacers such as series 1275AL and series 1350AL may be substituted when installed in environmental conditions that are more than normally corrosive.
  - Where threaded rigid metal service raceway enters the building the raceway shall be equipped with a cast malleable iron/copper free aluminum entrance ell suitably bushed with a burr free end stop and taper tapped holes as manufactured by Thomas & Betts, series 1490.
  - For grounding and bonding of service raceway, end of raceway or the terminating fitting shall be equipped with bonding locknuts and insulated metallic grounding and bonding bushing as required.
- Bonding locknuts shall be of hardened steel or malleable iron construction, electro zinc plated, and provided with hardened bonding screws as manufactured by Thomas & Betts, series 106 bonding locknuts.
- Insulated metallic grounding and bonding bushing shall be of malleable iron/steel construction, electro zinc plated and assembled with an insulator listed or certified for 150°C/302°F service as manufactured by Thomas & Betts, series 3870.



**Series 2111**  
Service Entrance Cable Connector



**Series 2116**  
Underground Feeder Cable Connector



**Series 3302M**  
Two Screw Connector (Insulated)



**Series 5262, 5302**  
Sealing Gasket



**Series 1341**  
Cable Strap

### **Suggested Specifications for Service Entrance Fittings – (Continued)**

- Where service entrance cable is used as overhead service conductors and code requires use of a service head, entrance caps shall be installed; caps shall be cast metal type of suitable ferrous or non ferrous metal equipped with thermoset insulators and proper knockout openings; caps when installed with proper drip loop must assure rain tight conditions.
- Terminating fittings for service entrance cable (Type SE or USE) or underground feeder and branch – circuit cable (Type UF) in locations where exposed to intermittent or constant moisture or in dry locations and subjected to mechanical strain shall be of watertight strain relief type as manufactured by Thomas & Betts, series 2111 or 2116; fittings shall be constructed of ferrous or non ferrous metal and equipped with taper threaded hub, beveled moisture resistant/oil resistant synthetic rubber bushing. In dry locations nylon insulated two screw type fittings of malleable iron/steel construction electro zinc plated inside outside including threads such as series 3302M manufactured by Thomas & Betts may be substituted.
- Where service entrance cable is terminated into a threadless opening using hub type fittings, a gasket shall be provided between the outside of box or enclosure and fitting shoulder; gasket shall be of moisture resistant/oil resistant synthetic rubber type adequately protected by and permanently retained to a metallic retainer as manufactured by Thomas & Betts, series 5262 or 5302.
- Service entrance cable shall be adequately supported at intervals enumerated in code using cable straps conforming to requirements of Canadian Standards Association Standard CSA 22.2 No. 18; cable straps shall be of malleable iron/steel construction, hot dipped galvanized or electro zinc plated as manufactured by Thomas & Betts, series 1341.
- At the point where the service cable enters the building a suitable sill plate shall be provided; sill/wall plate shall be sealed to assure rain tight conditions.

**T&B® Fittings****Service Entrance Cable Fittings****Service Entrance Cable Connector**

(Type SE/Type Use)

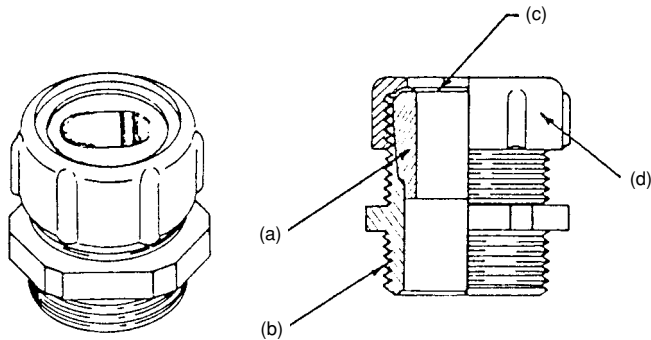
**2111 Series****Application**

- To connect service entrance cables to a meter box or an enclosure.

**Standard Material/Finish**

Body...Zinc Die Cast/as cast  
 Gland...Steel/Electro Zinc Plated & Chromate Coated  
 Retaining Ring...Stainless Steel/Passivated  
 Bushing...Neoprene/as molded

**Range**

Oval (Flat) Cable Size....260 x .500 thru 1.062 x 1.765  
 Type USE Cable Size...3 #12 thru 3-4/0 AWG Conductors  
 Hub Size...½" thru 2" NPT (taper pipe threads)

**Features**

- Neoprene bushing, resists oil and water; grips cable the full length of the bushing providing adequate strain relief without damaging outer jacket (A).
- Taper threaded body (B).
- Stainless steel retaining ring protects cable jacket against abrasion; reduces installing torque effort (C).
- Rugged ribbed steel gland construction (D).
- Suitable for Type SE & USE Service Entrance Cable.

**Listed by:**

U.L. (U.L. File No. E15170)  
 CSA (LR589, LR4484)

**Conforms to:**

UL514, NEMA FB1, Federal Standard  
 H-28 (Threads), NFPA70-1999 (ANSI)

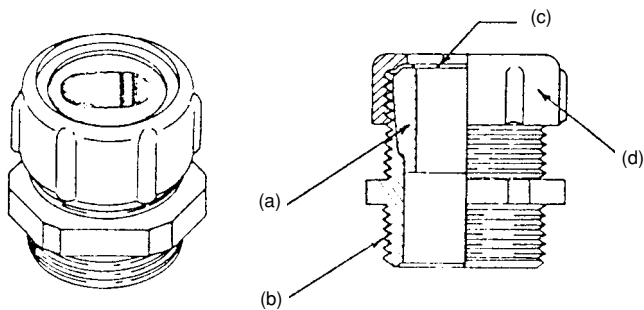
**Underground Feeder Cable Connectors****2116 Series****Application**

- To connect underground feeder cables to a box or an enclosure.

**Standard Material/Finish**

Body...Zinc Die Cast/as cast  
 Gland...Steel/Electro Zinc Plated & Chromate Coated  
 Retaining Ring...Stainless Steel/Passivated  
 Bushing...Neoprene/as molded

**Range**

Oval (Flat) Cable Size....235 x .500 thru .260 x .740  
 Hub Size...½" thru 1" NPT (tapered pipe threads)

**Features**

- Neoprene bushing resists oil and water; grips cable the full length of the bushing providing adequate strain relief without damaging outer jacket (A).
- Taper threaded body (B).
- Stainless steel retaining ring protects cable jacket against abrasion; reduces installing torque effort (C).
- Rugged ribbed steel gland construction (D).

**Listed by:**

U.L.  
 CSA (LR2884)

**Conforms to:**

UL514B, NEMA FB1, Federal Standard  
 H-28 (Threads), NFPA70-1999 (ANSI)



Oil and water resistant neoprene bushing is especially designed for sealing around underground feeder cable. Stainless steel retaining ring provides a bearing surface for the glandnut and eliminates cable twist. Ribbed glandnut is strong and easily tightened with a wrench to make a connection of high strength.

### Underground Liquidtight Feeder Cable Fittings

Cat. No.	Hub Size	Cable Opening	Dimensions (in.)									
			A	B	C	D		E		F	G	H
						min.	max.	min.	max.			
2116-TB*	½"	.235 x .500	1 1/16	5/8	1	.060	.235	.350	.500	9/16	1 1/8	1 1/8
2237	¾"	.230 x .430	1 9/16	9/16	1 1/2	.080	.230	.320	.430	1 3/16	1 3/8	1 3/8
2238	¾"	.235 x .465	1 9/16	9/16	1 1/2	.050	.235	.340	.465	1 3/16	1 3/8	1 3/8
2239	¾"	.240 x .685	1 9/16	9/16	1 1/2	.060	.240	.500	.685	1 3/16	1 3/8	1 3/8

\* Not CSA Certified.  
U.L. File No. E-23017  
CSA File No. 2884

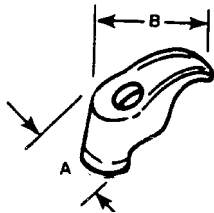
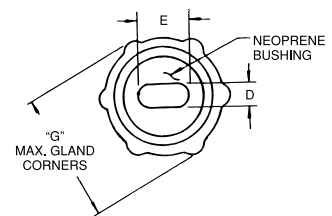
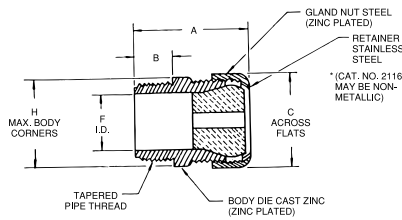

Each strap takes a wide range of sizes because of the rocking action of the foot. Hole is for ¼" screw. Malleable iron, hot dipped galvanized construction.

### Cable Straps

Cat. No.	Wire Size	Dimensions (in.)	
		A	B
1341-TB	2-#10	5/8	1 1/8
1344	3-#6 or 3-#8	5/8	1 15/16
1345*	3-#4 or 3-#2	1 1/16	1 59/64
1346	3-1/0	3/4	2 7/16
1347	3-4/0	3/4	2 25/32

\* Steel, hot dipped galvanized.  
U.L. not applicable.  
CSA Certified.



A design with two tapers inside the body – a slow one and a fast one – permits the stocking of fewer connectors for varied cable sizes and allows maximum take-up. The tapered neoprene bushings are resistant to oil, sunlight, and water. Hex gland and body take the same wrench opening and a stainless steel slip ring prevents cable from twisting as gland ring is being tightened. Threads on the body are tapered for watersealing.



### Watertight Connectors for Oval Cable

Cat. No.	Hub Size	Dimensions (in.)					Oval Cable Range	
		A	B	C	D	E	max.	min.
2111	1/2"	1 3/4	1 1/4	5/8	1 1/8	1 1/8	.420 x .560	.380 x .520
2232	3/4"						.385 x .600	.260 x .500
2233	3/4"					1 1/8	.500 x .750	.375 x .625
2234	3/4"						.555 x .800	.490 x .675
2432	1"	1 1/16	1 1/4	5/16	1 1/8		.385 x .600	.260 x .500
2433	1"					1 3/4	.500 x .750	.375 x .625
2434	1"						.555 x .800	.430 x .675
2438	1"	1 3/4	1 1/2	25/32	1 1/16	1 3/4	.565 x .855	.440 x .730
2439	1"						.635 x .975	.510 x .850
2442	1 1/4"						.635 x .975	.510 x .850
2443	1 1/4"	2 1/16	1 5/16	5/8	2 1/16	2 1/8	.640 x 1.050	.490 x .900
2446	1 1/4"						.750 x 1.150	.565 x .965
2454	1 1/2"	2 1/4	2 1/8		2 5/16	2 5/16	.840 x 1.275	.655 x 1.090
2447	1 1/2"						.880 x 1.425	.695 x 1.240
2448	2"			1 1/16			.968 x 1.500	.790 x 1.390
2449	2"	2 3/8	2 3/8		2 3/4	2 1/2	1.062 x 1.765	.850 x 1.550
2450	2"						1.820 x 1.190	1.700 x 1.050

U.L. File No. E-15170  
CSA File No. 589

Note/Reminder: These may be obsoleted and replaced.

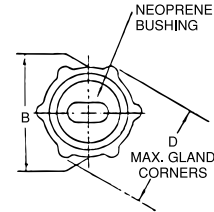
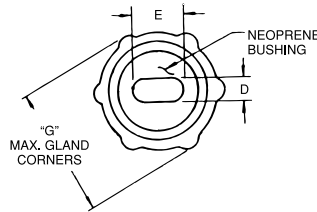

- Tapered threaded hub.
- Liquidtight and Dust tight; hand tightens – no tools required.
- Corrosive and weather resistant nylon for outdoor and indoor applications.



### Nylon UF Cable Fittings for Corrosive Environments

Cat. No.	Hub Size	UF Cable Range		A	B	C
		max.	min.	max.	± .060	± .060
2827	1/2"	.550 x .280	.400 x .190	2.60	1.270	.600
2828	3/4"	.675 x .280	.525 x .190	3.00	1.570	.620
2829	3/4"	.775 x .280	.625 x .190	3.00	1.570	.620

U.L. File No. 15170  
CSA File No. 589

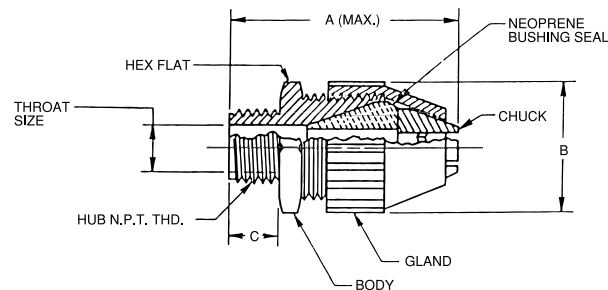



### Armored Cable and Flexible Metal Conduit

#### Armored Cable (Type AC) – Ref. NEC Article 333

National Electric Code defines type AC armored cable as, “A fabricated assembly of insulated conductors in a flexible metallic enclosure.”

- ACT** indicates an armored cable employing conductors having thermoplastic (Type T) insulation.
- AC** indicates an armored cable employing conductors having rubber insulation of code grade.
- ACH** indicates an armored cable employing conductors having rubber insulation of the heat resistant (75°C) grade.
- ACHH** indicates an armored cable employing conductors having rubber insulation of the heat resistant (90°C) grade.
- ACU** indicates an armored cable employing conductors having rubber insulation of latex grade.
- ‘L’** used as a suffix indicates that a lead covering has been applied over the conductor assembly.

All above cables may employ copper or aluminum or copperclad aluminum conductors with the following sizes and are rated for 600 volts or less:

- No. 14 AWG to No. 1 AWG Copper
- No. 12 AWG to No. 1 AWG Aluminum or Copperclad Aluminum

Type AC cables except ACL carry an internal bonding strip of copper or aluminum in intimate contact with the armor for its entire length. Armored cable can be used for both exposed or concealed locations. With lead covered conductors (Type ACL) the cable can be embedded in masonry or concrete and can be used in damp locations or where exposed to oil.

Armored cable is not permitted in locations where it will be subjected to physical damage or corrosive fumes. Armored cable cannot be used for direct burial in earth.

With minor exceptions armored cable is also not permitted to be used in hoists or elevators, storage battery rooms, any hazardous locations, in commercial garages and in theaters or similar locations.

Codes require that cable shall be supported with straps or staples without damaging conductors and also limit the minimum bend radius to 5 times the diameter of type AC cable. Certain precautions are prescribed in code where cable is installed through joist rafters or similar wood members.

According to NEC 333-9 where armored cable is terminated, a fitting is required to protect conductors from abrasion. In addition a bushing is required between the conductors and armor. Design of fitting has to be such that the insulating bushing is visible for inspection. Bushing is not required with lead covered cables when properly installed.

Portions of this section reprinted by permission from NFPA 70-1999, National Electrical Code®, Copyright © 1977, National Fire Protection Association, Boston, MA.

Please refer to the following for further details and complete information:

1. NEC Article 333...Armored Cable (Type AC Cable)
2. U.L. 4, ANSI C33.9...Safety Standards for Armored Cable
3. U.L. 514B, Safety Standards for Outlet Boxes and Fittings
4. W-F-406...Federal Specification. Fittings for Cable, Power, Electrical and Conduit, Metal, Flexible
5. NEMA FB-1...Standards Publication. Fittings & Supports for Conduit and Cable Assemblies
6. CEC Section 12-700...Wiring Methods (Armored Cable)
7. CSA C22.2 No. 51...Safety Standards for Armored Cables
8. CSA C22.2 No. 18...Safety Standards for Outlet Boxes, Conduit Boxes and Fittings

#### Please Note

The excerpts and other material herein, whether relating to the National Electrical Code, the Underwriters Laboratories, Inc. listing, to industry practice or otherwise, is not intended to provide all relevant information required for use and installation. Reference to original or primary source material and data is mandatory before any application or use is made of the product.

# T&B® Fittings

## Armored Cable and Flexible Metal Conduit Fittings

### Armored Cable and Flexible Metal Conduit – continued

#### Flexible Metal Conduit – Ref. NEC Article 350

Flexible metal conduit can be used for exposed or concealed work in dry locations. It can be used for wet locations provided conductors within are lead covered or other approved type.

Flexible metal conduit cannot be used underground or embedded in poured concrete or aggregate. With rubber covered conductors the conduit cannot be exposed to oil, gasoline or other materials having a deteriorating effect on rubber.

With minor exceptions use of flexible metal conduit is not permitted in hoists, in storage battery rooms and in any hazardous locations. Use of flexible metal conduit is restricted to systems under 600 volts.

According to NEC Article 350-5, flexible metal conduit no longer than six feet and containing circuit conductors protected by overcurrent device rated for 20 amps or less is suitable as a grounding means provided, it is terminated in fittings approved for the purpose.

Flexible metal conduit longer than six feet is permitted to be used as a grounding means provided the conduit and the fitting are approved for the purpose. To date there is no flexible metal conduit approved for the purpose by the Underwriters Laboratories.

In Class I & II, Division 2 hazardous areas, the conduit itself cannot be used as the grounding means. A bonding jumper must be installed in accordance with NEC Section 250-79(e). Flexible metal conduit is available with steel or aluminum armor in trade size  $\frac{5}{16}$ " to 4". With few exceptions where  $\frac{5}{16}$ " and  $\frac{3}{8}$ " trade sizes are used, Code prohibits use of conduit less than  $\frac{1}{2}$ " trade size. Bends in concealed work are restricted to 360 degrees total. No angle connectors are permitted in concealed raceway installations.

Portions of this section reprinted by permission from NFPA 70-1999, National Electrical Code®, Copyright © 1977, National Fire Protection Association, Boston, MA.

Please refer to the following for further details and complete information:

1. NEC Article 350...Flexible Metal Conduit
2. U.L. 1, ANSI C33.92...Safety Standards for Flexible Metal Conduit
3. U.L. 514B, Safety Standards for Outlet Boxes and Fittings
4. W-F-406...Federal Specification. Fittings for Cable, Power, Electrical and Conduit, Metal Flexible
5. WW-C-566...Federal Specification. Conduit, Metal, Flexible
6. NEMA FB1...Standards Publication. Fittings and Supports for Conduit and Cable Assemblies
7. CEC 12-1100...Wiring Method (Rigid & Flexible Conduit)
8. CSA C22.2 No. 56...Safety Standards for Flexible Metallic Conduit and Liquid-Tight Flexible Metal Conduit
9. CSA C22.2 No. 18...Safety Standards for Outlet Boxes, Conduit Boxes and Fittings



**Series 3110**  
Armored Cable Connector &  
Flexible Metal Conduit



**Series 422**  
Insuliner® Sleeve

**Series 390**  
Anti Short Bushing

### ***Suggested Specifications for Armored Cable and Flexible Metal Conduit Fittings***

- Armored cable (metal clad cable type AC) and flexible metal conduit shall conform to provisions of following applicable standards:

Armored Cable...U.L. 4/ANSI  
C33.9/CSA 22.2 No. 51

Flexible Metal Conduit...U.L. 1/ANSI  
C33.92/WW-C-566/CSA 22.2 No. 56

Type of cable used and conductors within flexible metal conduit shall be suitable for conditions of use and location.

- Where armored cable or flexible metal conduit terminates into a threadless or threaded opening, it shall be assembled with approved fittings; fittings shall be of malleable iron/steel construction, electro zinc

plated inside outside, equipped with nylon insulated throat and shall be of angled saddle type as manufactured by Thomas & Betts, series 3110. Direct bearing screw type fittings shall not be used.

Suitable bushing as manufactured by Thomas & Betts, series 422 or 390, shall be provided between the conductors and armor.

- Where approved armored cable or flexible metal conduit is used as an equipment grounding conductor terminating fitting used shall be of the grounding type as manufactured by Thomas & Betts, series 3110.

# T&B® Fittings

## Armored Cable and Flexible Metal Conduit Fittings

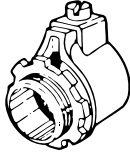

3110 Series

### Armored Cable & Flexible Metal Conduit Connectors

#### Application

- To connect and effectively bond armored cable or flexible metal conduit to a box or an enclosure.

#### Features

- Provided with a saddle designed to:
  - (1) Firmly secure conduit in place without damaging cable armor (Mechanical holding power of angled wedge assembly increases with increased strain.)
  - (2) Provide high quality bond between conduit or cable and is unaffected by vibrations.
  - (3) Centralize conduit or cable with respect to throat opening for conductors.
- Insulated throat protects conductors during and after installation, reduces wire pull effort and prevents thread damage in handling.
- Locknuts designed to provide effective bond between connector and box or enclosure, will not vibrate loose.
- Designed with fewer screws – reduces installation time and cost.

- Rugged all steel or malleable iron construction.
- Suitable as a grounding means per N.E.C. Article 350-5 (thru 3" trade size only).
- Suitable for hazardous location use per Class 1 Division 2 N.E.C. 501-4 (b).

#### Standard Material/Finish

Body.....	Steel or malleable iron/ Electro Zinc Plated & Chromate Coated
Saddle .....	Steel/Electro Zinc Plated & Chromate Coated
Screws .....	Steel/Electro Zinc Plated & Chromate Coated
Insulator .....	Thermoplastic/As Molded

#### Conforms to:

U.L. 514B  
CSA C22.2 No. 18  
NEMA FB1

#### Listed/Certified by:

U.L. (U.L. File No. 23018)  
CSA (LR-2884, LR-4484)

Range	Hub Size	Conduit Size	Cable Opening
3110 Series Straight Connectors	1/4" thru 5" NPS	3/8" thru 5"	.437" to 5.500"
3130 Series 90° Connectors	1/4" thru 4" NPS	3/8" thru 4"	.437" to 4.560"
(All hubs provided with straight pipe threads NPS.)			

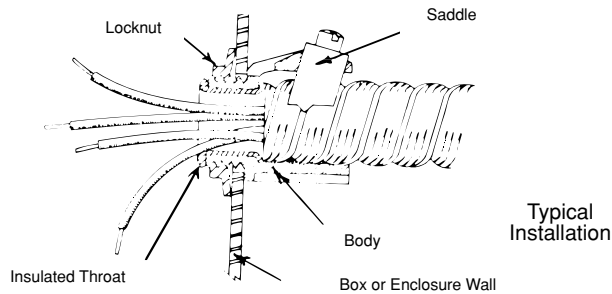

Typical Installation

# T&B® Fittings

## Armored Cable and Flexible Metal Conduit Fittings



A

T&B® Fittings

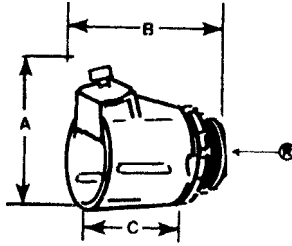

**Steel or malleable iron.**  
The tough lining of insulation and the Tite-Bite® principles make these connectors a "must" when conductors are subject to conditions of vibration or strain.

### TITE-BITE® Connectors\* – Nylon Insulated

Cat. No.	Cable Opening		Trade Size	K.O. Size	Dimensions (in.)		
	max.	min.			A†	B	C
3110**	.656	.437	3/8"	1/2"	1 1/4	1 1/8	7/8
3112	.937	.750	1/2"	1/2"	1 1/4	1 1/8	7/8
3115	1.125	.906	3/4"	3/4"	1 5/8	1 3/4	1 1/2
3117	1.468	1.250	1"	1"	2 3/8	1 3/4	1 1/8
3118***	1.750	1.562	1 1/4"	1 1/4"	2 3/4	2	1 1/4
3119***	2.031	1.812	1 1/2"	1 1/2"	3 1/8	2 5/8	1 3/4
3120***	2.500	2.312	2"	2"	3 3/4	2 3/4	1 5/8
3121***	3.062	2.812	2 1/2"	2 1/2"	4 3/8	3 1/4	2 1/4
3122***	3.562	3.312	3"	3"	5	3 1/4	2 1/4
3123****	4.060	3.620	3 1/2"	3 1/2"	–	–	–
3124***	4.560	4.120	4"	4"	–	–	–
3125†††	5.500	4.600	5"	5"	–	–	–

\* U.L. Listed as a grounding means under NEC 350-5.

\*\* U.L. Listed for armored cable only.

\*\*\* U.L. Listed for flexible metal conduit only.

Material: Steel thru 3/4" trade size.

† Approximate dimension with screw at minimum height.

U.L. File No. E 23018

CSA File No. 2884

†† CSA not applicable.

††† Not U.L. Listed or CSA Certified.



### TITE-BITE® Connectors\*

Cat. No.	Cable Opening		Trade Size	K.O. Size	Dimensions (in.)		
	max.	min.			A†	B	C
300TB**	.656	.437	3/8"	1/2"	1 1/4	1 5/8	7/8
302	.937	.750	1/2"	1/2"	1 5/8	1 1/4	1 1/4
304	1.093	.906	3/4"	3/4"	1 7/8	1 1/4	1 1/2
306	1.468	1.250	1"	1"	2 1/8	1 3/4	1 1/8
308***	1.750	1.562	1 1/4"	1 1/4"	2 5/8	2 1/2	1 1/4
310***	2.031	1.812	1 1/2"	1 1/2"	2 5/8	2 3/8	1 3/4
312***	2.500	2.312	2"	2"	3 1/8	2 3/8	1 5/8
314***	3.062	2.812	2 1/2"	2 1/2"	3 1/2	3 1/8	2 1/4
316***	3.562	3.312	3"	3"	4 1/8	3 3/8	2 1/4

\* U.L. Listed as a grounding means under NEC 350-5.

\*\* U.L. Listed for armored cable only.

\*\*\* U.L. Listed for flexible metal conduit only.

† Approximate dimension with screw at minimum height.

U.L. File No. E 23018

CSA File No. 2884

Material: Steel thru 3/4" trade size.

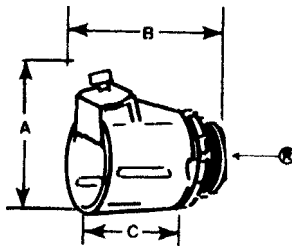

**Steel or malleable iron.**  
Easy to install with double grip saddle. These connectors are completely salvageable. The 3/8" and 1/2" sizes are made of formed steel which produce a uniform high quality and a smooth throat that protects conductor insulation. 3/4" and larger size are malleable iron.

**Thomas & Betts**

# T&B® Fittings

## Armored Cable and Flexible Metal Conduit Fittings

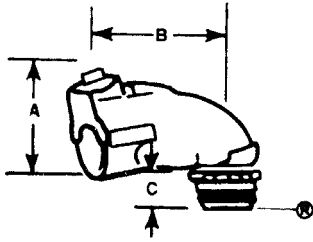

**Steel or malleable iron.**  
Available with or without insulated throat, this Tite-Bite® connector line is by far the easiest and best to install when making sharp bends at the enclosure or equipment. It has all of the advantages of the straight connector with only one screw to tighten, except in the larger sizes where there are two. A peep hole on top provides for easy inspection of the ABC bushing. Narrow design makes it easy to install connectors in adjacent knockouts.

### TITE-BITE® Connectors\* – 90° angle nylon insulated

Cat. No.	Cable Opening		Trade Size	K. O. Size	Dimensions (in.)		
	max.	min.			A†	B	C
3130*	.656	.437	3/8"	1/2"	1 1/2	1 1/2	19/16
3132*	.937	.750	1/2"	1/2"	1 7/8	2 3/16	1 15/16
3135*	1.093	.906	3/4"	3/4"	2 1/8	2 1/8	3/4
3137	1.468	1.250	1"	1"	2 1/2	2 1/8	1/2
3138***	1.750	1.562	1 1/4"	1 1/4"	3 5/16	3 3/2	9/16
3139***	2.031	1.812	1 1/2"	1 1/2"	4	4 1/8	1 1/16
3140***	2.500	2.312	2"	2"	4 5/8	5 1/8	1 1/16
3141***	3.062	2.812	2 1/2"	2 1/2"	6 3/2	6	3/4
3142***	3.562	3.312	3"	3"	7 1/2	7 1/8	3/4
3143†††	4.060	3.620	3 1/2"	3 1/2"	–	–	–
3144***	4.560	4.120	4"	4"	–	–	–

\* U.L. Listed as a grounding means under NEC 350-5.  
\*\*\* U.L. Listed for flexible metal conduit only.  
† Approximate dimension with screw at minimum height.  
†† Not U.L. Listed or CSA Certified.  
U.L. File No. E 23018  
CSA File No. 2884

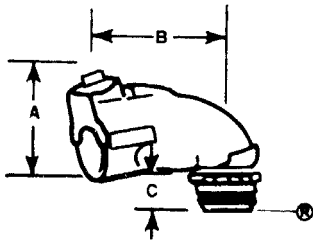

The angle clip gives secure mechanical grip that tightens under tension or vibration. Throat is long enough to install in cast housing knockouts. The 3/8" and 1/2" sizes are of steel construction. The 3/4" and larger sizes are malleable iron.

### TITE-BITE® Connectors\* – 90° angle

Cat. No.	Cable Opening		Trade Size	K. O. Size	Dimensions (in.)		
	max.	min.			A†	B	C
321	.656	.437	3/8"	1/2"	1 1/2	1 1/2	3/8
323	.937	.750	1/2"	1/2"	1 7/8	2 3/8	1 1/2
325	1.093	.906	3/4"	3/4"	2 1/8	2 1/8	3/4
326TB	1.468	1.250	1"	1"	2 1/2	2 1/8	1
327***	1.750	1.562	1 1/4"	1 1/4"	3 1/8	3 3/8	–
328***	2.031	1.812	1 1/2"	1 1/2"	4 1/8	4 1/8	–
329***	2.500	2.312	2"	2"	4 3/8	4 3/2	–
330***	3.062	2.812	2 1/2"	2 1/2"	6 1/2	6	–
331***	3.562	3.312	3"	3"	5 2/2	7	–

\* U.L. Listed as a grounding means under NEC 350-5.  
\*\*\* U.L. Listed for flexible metal conduit only.  
† Approximate dimension with screw at minimum height.  
U.L. File No. E 23018  
CSA File No. 2884



### TITE-BITE® Aluminum Sheathed Cable Connectors

Cat. No.	Dia. Range Alum. Sheath (in.)	Hub Size
2492	(.370–.500)	1/2"

U.L. Listed as a grounding means for steel MC cable and ALS. For dry location.  
U.L. File No. E 36017  
CSA File No. 589  
Tite-Bite® Connectors are approved for continuous sheathed corrugated MC cable.



- Unique saddle design firmly secures cable in place, provides holding power in excess of listing agency requirements, and assures high quality bonding.
- Removable bushing design covers wide range, reduces inventories.
- Can be used on smooth or corrugated aluminum sheathed and steel MC cable.
- One screw provides quick installation.

# T&B® Fittings

## Armored Cable and Flexible Metal Conduit Fittings

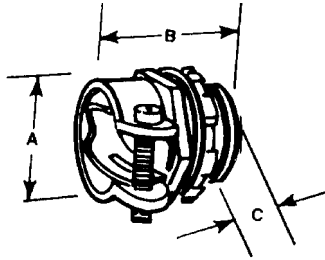

T&B squeeze connectors will fit every size of armored cable, leaded cable and flexible conduit. Malleable iron or steel construction. Part No. 253 is steel.

### Squeeze Connectors\*

Cat. No.	Cable Opening		Trade Size	K. O. Size	Dimensions (in.)		
	max.	min.			A†	B	C
252***	.531	.437	3/8"	3/8"	13/16	25/32	11/32
253TB**	.585	.455	3/8"	1/2"	31/32	1 13/64	5/8
254-TB	.938	.812	1/2"	1/2"	1 1/32	1 3/8	13/32
255	1.094	.938	3/4"	3/4"	1 1/4	1 17/32	7/8
256	1.375	1.250	1"	1"	1 19/32	1 5/8	1 1/2
257***	1.656	1.500	1 1/4"	1 1/4"	1 7/8	1 23/32	1 7/32
258***	1.875	1.688	1 1/2"	1 1/2"	2 1/4	1 7/8	1 5/8
259***	2.500	2.313	2"	2"	2 31/32	2 3/8	1 11/16
249***	3.062	2.812	2 1/2"	2 1/2"	3 5/16	2 11/16	3/4
277***	3.563	3.312	3"	3"	3 13/16	2 7/8	3/4

\* U.L. Listed as a grounding means under NEC 350-5.  
 \*\* U.L. Listed for armored cable only. Fitting material steel.  
 \*\*\* U.L. Listed for flexible metal conduit only.  
 † Approximate dimension with screw at minimum height.  
 U.L. File No. E 23018  
 CSA File No. 2884



3/4" and 1/2" sizes made in steel. Cap lifts off by simply loosening screws part way. Only two screws to tighten. 3/4" size and larger made of malleable iron.

### Squeeze Connectors – 90° angle

Cat. No.	Cable Opening		Trade Size	K. O. Size	Dimensions (in.)		
	max.	min.			A	B	C
266-TB*	.656	.406	3/8"	1/2"	1 1/2	1 19/32	1 7/16
272**	.812	.688	3/8"	1/2"	1 1/16	1 100	—
268-TB	.937	.813	1/2"	1/2"	1 11/16	1 13/16	1 7/8
279	1.000	.875	3/4"	3/4"	1 19/16	2 1/16	1 13/16
270	1.125	1.000	3/4"	3/4"	1 7/8	1 3/4	1 13/16
273TB	1.406	1.187	1"	1"	2 3/8	2 3/32	2 7/16
274***	1.656	1.375	1 1/4"	1 1/4"	3	3	3
275***	1.875	1.625	1 1/2"	1 1/2"	3 3/8	3 3/16	4
276***	2.500	2.125	2"	2"	4 1/2	3 3/16	4 7/8

\* U.L. Listed as a grounding means under NEC350-5.  
 \*\* U.L. Listed for armored cable only.  
 \*\*\* U.L. Listed for flexible metal conduit only.  
 U.L. File No. E23018  
 CSA File No. 2884

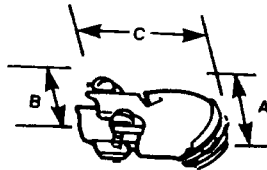

3/4" and 1/2" sizes made in steel. Cap lifts off by simply loosening screws part way.

### Squeeze Connector – 45° angle

Cat. No.	Cable Opening		Trade Size	K. O. Size	Dimensions (in.)		
	max.	min.			A	B	C
265*	.656	.406	3/8"	1/2"	1 17/32	1 5/32	1 1/8
267	.937	.813	1/2"	1/2"	1 23/32	1 1/2	1 1/4
269	1.125	1.000	3/4"	3/4"	2	1 7/32	1 9/16

\* U.L. Listed as a grounding means under NEC350-5.  
 U.L. File No. E-23018  
 CSA File No. 2884

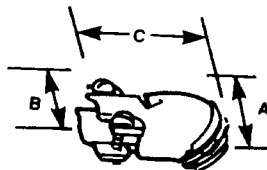

# T&B® Fittings

## Armored Cable and Flexible Metal Conduit Fittings

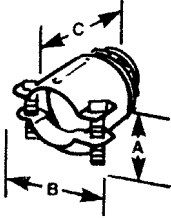

Formed steel body with carefully round bushing. The armor gripping saddle stays open by itself when cable is being inserted.

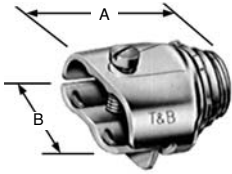

Malleable iron.  
For non-metallic and armored cable.

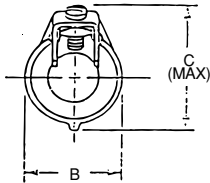
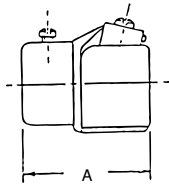

TITE-BITE® Connector design holds flexible metal cable firmly in place with a single screw rather than two screws.

### Two-Screw Connectors

Cat. No.	Cable Opening		Trade Size	K.O. Size	Dimensions (in.)		
	max.	min.			A	B	C
3301-TB**	.656	.250	3/8"	1/2"	31/32	15/16	1 1/16
3312-TB	.937	.500	1/2"	1/2"	1 3/32	1 1/8	1 3/8

\*\* U.L. Listed for armored cable only.  
U.L. File No. E 1383  
CSA File No. 2884

### Duplex Clamp Connector

Cat. No.	K.O. Size	Dimensions (in.)	
		A	B
291-TB	1/2"	1 13/32"	1 11/16"

\* U.L. Listed as grounding means under NEC 350-5.  
U.L. File No. E 1383  
CSA File No. 2884



### Adapter – EMT to Flex

Cat. No.	Size	Dimensions (in.)		
	Flex to EMT	A	B	C
503TB	1/2" - 1/2"	1 21/32	1 3/16	1 7/8
504	3/4" - 3/4"	1 25/32	1 7/16	2 1/8
505-TB	1" - 1"	2 1/32	2 1/16	2 5/8

CSA File No. 8994  
U.L. File No. E-23018



# T&B® Fittings

## Armored Cable and Flexible Metal Conduit Fittings



A

T&B® Fittings

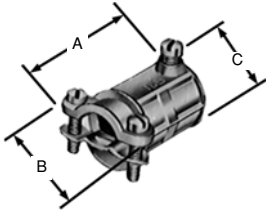

**A one piece fitting that couples 3/8" flexible metal conduit to 1/2" electrical metallic tubing (EMT).**

### Combination Coupling

Cat. No.	Size	Dimensions (in.)		
	Flex to EMT	A	B	C
449-TB*	3/8" - 1/2"	1 21/32	1 11/32	15/16

\* U.L. Listed as a grounding means under NEC 350-5.  
 Cable opening: max. .656, min. .250  
 U.L. File No. E-23018  
 CSA File No. 2884



### Anti-Short Bushing

Cat. No.	Size
390	14-2, 14-3, 12-2
391	14-4, 12-3, 6-1, and 4-1
392	12-4, 10-2, 10-3 and 2-1
393	10-4, 8-2, 8-3, and 1-1
394	8-4, 6-2, 6-3, 4-2, 4-3, and 6-4

Colorized  
 Temperature Rating: 240°F  
 CSA File No. 589  
 U.L. not applicable.



**Anti-short bushings are made of smooth plastic, and designed to protect conductor insulation from rough edges of armored cable and flexible metal conduit.**



**Elongated bolt hole makes alignment easy, even when holes in mounting surface are off center. Snap on features hold strap in place.**

### Strap

Cat. No.	Size
65-TB	3/8" Flex

# T&B® Fittings

## Non-Metallic Sheathed Cable Fittings

### Non-Metallic Sheathed Cable

#### Ref. NEC Article 336

Code defines Non-Metallic Sheathed Cable as, "A factory assembly of two or more insulated conductors having an outer sheath of moisture resistant, flame retardant, non-metallic material."

Non-metallic sheathed cable is constructed of insulated conductors (14 to 2 AWG Copper or 12 to 2 AWG Aluminum or Copperclad Aluminum), and an outer non-metallic sheath classified as Type NM or Type NMC.

Non-metallic sheath cable is provided with or without a bare or insulated equipment grounding conductor. Non-metallic sheathed cable is rated for 60°C service with voltage limitation of 600 volts.

Type NM – has flame retardant moisture resistant sheath.

Type NMC – has flame retardant moisture resistant, fungus resistant – and corrosion resistant sheath.

Non-metallic sheathed cable is permitted by code to be used exposed or concealed in one, two or multifamily dwellings or other structures not exceeding three floors. Use of Type NM cable is restricted to dry locations where as Type NMC can be used in dry, moist, damp or corrosive environments.

Non-metallic sheath cable (both Type NM & NMC) is not permitted to be used as a service conductor, in commercial garages, in hoists or cannot be embedded in cement, concrete or aggregate. With minor exceptions use of non-metallic sheathed cable is also prohibited in theaters or any hazardous locations.

NEC Section 336-5 requires that cable be secured in place by suitable means so as not to injure the cable. Adequate protection for cable is also required when run is exposed, through joists or rafters, through floors, in unfinished basements and accessible attics.

Cable bends are limited to a minimum of five times the diameter of the cable.

NEC 300-4(b) requires that cable be protected from physical damage when it passes through factory or field punched, cut or drilled holes in metal members. A bushing or grommet firmly secured in place is recommended.

Portions of this section reprinted by permission from NFPA 70-1999, National Electrical Code®, Copyright © 1977, National Fire Protection Association, Boston, MA. Please refer to the following for further details and complete information:

1. NEC Article 336...Non-Metallic Sheathed Cable (Type NM & NMC)
2. NEC Article 300...Wiring Methods
3. U.L. 719, ANSI C33.56...Safety Standards for Non-Metallic Sheathed Cable
4. U.L. 514B, Safety Standards for Outlet Boxes and Fittings
5. NEMA FB-1...Standards Publication. Fittings and Supports for Conduit and Cable Assemblies
6. CEC Section 12-600...Wiring methods (Non-Metallic Sheathed Cable)
7. CSA C22.2 No. 48...Safety Standards for Non-Metallic Sheathed Cable
8. CSA C22.2 No. 18...Safety Standards for Outlet Boxes, Conduit Boxes and Fittings

#### Please Note

The excerpts and other material herein, whether relating to the National Electrical Code, the Underwriters Laboratories, Inc. listing, to industry practice or otherwise, is not intended to provide all relevant information required for use and installation. Reference to original or primary source material and data is mandatory before any application or use is made of the product.

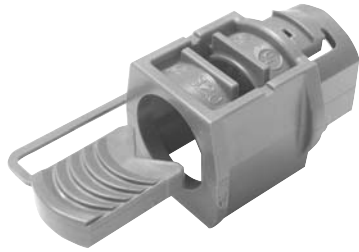

**Series 3300**  
Non-Metallic Sheathed Cable  
and Flexible Cord Connectors  
(All Plastic)



**Series 3302M**  
Non-Metallic Sheathed Cable  
and Flexible Cord Connectors  
(Steel)



**Series 3210**  
Knockout Bushings



**Series 1942**  
Insulated Nipples

### Suggested Specifications for Non-Metallic Sheathed Cable

- Where non-metallic sheathed cable or flexible cord terminates into a threaded or threadless opening, terminating fittings used shall be approved for the purpose by nationally recognized laboratory, inspection agency or product evaluation organization.
  - Terminating fittings shall be of malleable iron, steel, or thermoplastic construction designed to provide adequate strain relief and positively prevent damage to jacket or conductor insulation such as series 3300 or 3302M manufactured by Thomas & Betts.
- Ferrous metal fittings shall be electro zinc plated inside/outside including threads and bushed with a nylon insulated throat.

Thermoplastic material used for connector construction shall be of high impact strength suitable for 105°C/221°F service with a U.L. flammability rating of 94V-1.

- Where non-metallic sheathed cable passes through either factory or field punched, cut or drilled holes in metallic members, the cable shall be protected by thermoplastic bushing such as series 3210 manufactured by Thomas & Betts. Bushing shall be firmly secured in opening. Nylon bushed metallic fittings such as Thomas & Betts series 1942 may be substituted as required.

# T&B® Fittings

## Non-Metallic Sheathed Cable Fittings



**3302M Series**  
Non-Metallic Sheathed  
Cable Connector

Typical Installation

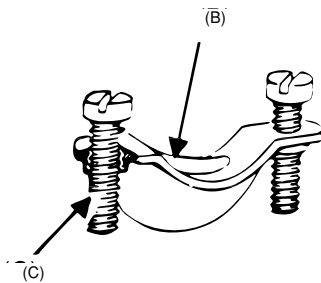
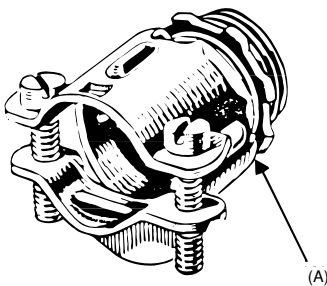
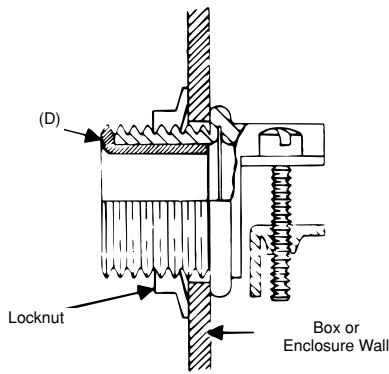

### Non-Metallic Sheathed Cable & Flexible Cord Connectors (Steel)

#### Application

- To connect non-metallic sheathed cable and flexible cord to a box or an enclosure.

#### Features

- Rugged all steel/malleable iron construction (A).
- Rounded cable clamp grip provides superior mechanical holding power without damaging conductor insulation or outer jacket (B).
- Clamp designed to cover body opening for a neat and safe installation
- Screws thread into clamp and not body; screw heads are snug with body and ends of screws do not project beyond the body (C).

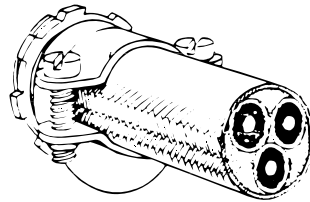

Typical Installation  
(Flexible Cord)

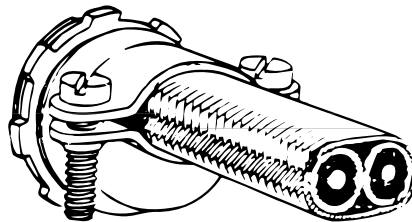

Typical Installation  
(NM-Sheathed Cable)

- Insulator firmly secured in place protects conductors and reduces wire pulling effort; protects threads from damaging during handling (D).
- Locknut designed to secure connector to a box or enclosure; will not vibrate loose.

#### Standard Material

Body .....	1/2" thru 1" Steel; 1/4" thru 2" Malleable Iron
Clamp .....	1/2" thru 1 1/4" Steel; 1/4" thru 2" Malleable Iron
Locknut .....	All Steel
Insulator .....	Thermoplastic

#### Standard Finish

All steel and malleable iron parts –  
Electro Zinc Plated & Chromate  
Coated

#### Range

Hub Size .....	1/2" thru 2" Hubs provided with straight pipe threads (NPS.)
Cable .....	2 #14 thru 4 #4 Type NM
Cable Outside Diameter .....	.250" to 1.150"

#### Listed/Certified by:

U.L. (U.L. File No: E-23017)  
CSA (LR-589, LR-2884)

#### Conforms to:

U.L. 514B  
CSA C22.2 No. 18  
NFPA 70-1999 (ANSI)  
NEMA FB1  
Federal Standard H-28 (Threads)



### Two-screw Connectors

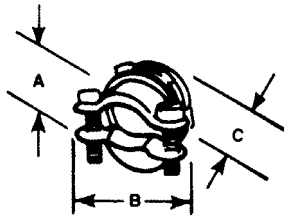

*Steel or malleable iron. Rounded cable grip and smooth bushing protect the cable sheath and wire insulation. Since saddle is threaded, screws do not travel or extend beyond the connector body as it is clamped to the cable. An extra lip on the saddle closes the unused part of the connector opening.*

Non-Insulated Cat. No.	Insulated Cat. No.	K.O. Size	U.L. Listed & CSA Certified for the following Single (1) and Pairs of (2) NM & NMC Cable	U.L. Listed & CSA Certified for the following Service Entrance Cables	A	B	C	Cable Opening	
								max.	min.
3302-TB*	3302M-TB	½"	(1) 2#14, 2#12, 2#10, 3#14, 3#12, 3#10, (2) 2#14, 2#12	2#12 thru 2#4, 3#12, 3#10	¾"	1 ¼"	1"	.590	.250
3303-TB	3303M	¾"	(1) 2#8, 2#6, 3#8 (2) 2#12, 2#10, 2#8, 3#14 (1) 3#8, 3#6, 3#4	2#8 thru 2#1/0, 3#8, 3#6, 2#6 + #8 GND 2#1, 2#1/0, 3#6 thru 3#2,	1 ¼"	1 ½"	1 ¼"	.750	.530
3304	3304M	1"	(2) 2#8, 3#10  (1) 3#8, 3#6, 3#4	2#4 + #6 GND, 2#3 + #5 GND, 2#2 + #4 GND 3#2 thru 3#2/0, 2#1 + #3	1 ½"	1 ¾"	1 ¼"	.990	.690
3305	3305M	1 ¼"	(2) 2#8, 2#6, 2#4, 3#8	GND, 2#1/0 + #2 GND, 2#2/0 + #1 GND	1 ½"	2 ½"	1 ½"	1.320	.850
3306	3306M	1 ½"	(1) 3#4	3#3/0, 3#4/0, 2#3/0 + #1/0 GND, 2#4/0 + #2/0 GND	2 ¾"	2 ¾"	1 ½"	1.515	.930
3307	3307M	2"	Max. 1.98", Min. 1.15"						
3308†	—	2 ½"	Max. 2.38", Min. 1.5"						
3309†	—	3"	Max. 2.88", Min. 1.75"	—	2 ¾"	3 ¼"	1 ¾"	1.980	1.150
3310†	—	3 ½"	Max. 3.38", Min. 2.25"						
3311†	—	4"	Max. 3.88", Min. 2.5"						

\* U.L. Listed for use with rubber and thermoplastic flexible cords (both single and multiple cords and 2 oval cables).

† Not U.L. Listed or CSA certified.

U.L. Listed for multiple cords and cables.

CSA File No. 2884

U.L. File No. E-23013 – ½" – 1 ½"; U.L. File No. E-15170 – 2"

# T&B® Fittings

## Non-Metallic Sheathed Cable Fittings



3300 Series

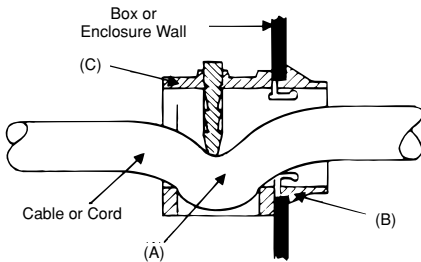

### Non-Metallic Sheathed Cable and Flexible Cord Connectors (All Plastic)

#### Application

- To connect non-metallic sheathed cable and flexible cord to a box or an enclosure.

#### Features

- Design provides strain relief by partially deflecting cable (A); therefore:
  - (1) Connector will not damage outer covering or jacket of cable, or conductor insulation; designed to give safe trouble free installation.
  - (2) Holding power and cable strain relief are not effected by surface finish of outer covering or cable jacket.
  - (3) Connector provides superior holding power far in excess of listing agency requirements.
- Snap-in one piece design; accommodates variation in knockout dimensions, saves installation time (B).
- All high impact thermoplastic construction provides:
  - (1) Insulated throat; conductors are protected from abrasion.
  - (2) Improved dielectric strength, and eliminates potential shorts.
  - (3) Corrosion resistance.

- Wide range – reduces inventories.
- Connector may be pre-installed in box K.O., or on cable.

#### Standard Material

All high impact thermoplastic – U.L. Class 94V-1 suitable for 105°C application.

#### Standard Finish

As Molded



#### Listed/Certified by:

U.L. (U.L. File No: E-23017)  
CSA (Cat. #3201, 3350) for factory installation  
(LR-589, LR-2884)

#### Conforms to:

U.L. 514B  
CSA C22.2 #18 (Where applicable)  
ANSI C33.84, NFPA 70-1999 (ANSI)

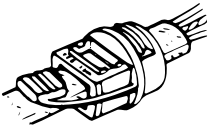
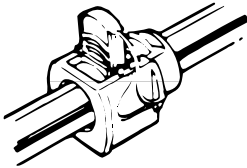
#### Typical Installation

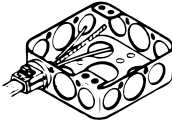
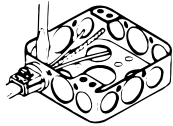
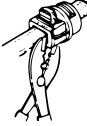
 <p><b>1. Remove sheath from end of cable (4" or more as required). Insert cable through connector as shown (Cable under button).</b></p>	 <p><b>2. Insert button into cavity.</b></p>	 <p><b>3. With grooved pliers, or parallel jaw type pliers (commercially available) squeeze button into cord or wires as far into connector body as possible.</b> <i>Note: It may be necessary to re-adjust pliers to insure button is properly installed.</i></p>
 <p><b>4. Snap connector into knockout box. If desired this step can be done prior to Step 1.</b></p>	 <p><b>5. To remove from knockout box depress ears.</b></p>	 <p><b>6. To remove from cable cut connector as shown.</b></p>

#### Range

Cat. No.	Knockout Size	Cable/ Cord Range
3300	½"	10-2, 12-2 & 14-2 type NM Cable. .125" to .300" outside diameter cord
3201 & 3350	½"	10-3, 12-3, 14-3, 10-2, 12-2, 14-2 Type NM Cable; also multiple (2) 12-2 and 14-2 Type NM Cable; .300" to .600" outside diameter cord
3202	¾"	8-3 and 6-3 type NM cables; also Multiple (2) 14-3 and 10-2 Type NM Cable; .500" to .850" outside diameter cord

# T&B® Fittings

## Non-Metallic Sheathed Cable Fittings



A

T&B® Fittings

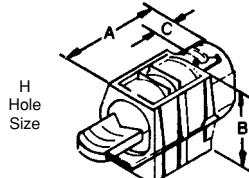
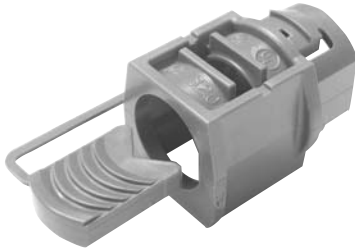

Figure 1

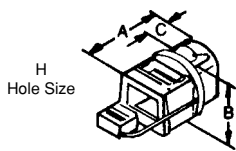
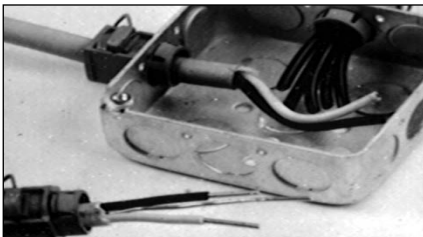
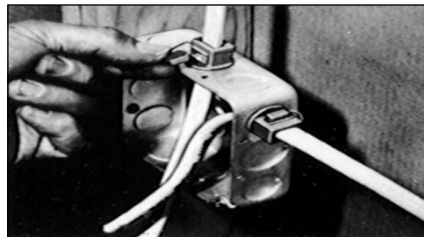

Figure 2

**High impact thermoplastic. U.L. 94-V1. Features push-in design. Captive locking wedge secures cable with single squeeze of standard electrician's pliers. Provides excellent insulation, strain-relief and high pull-out value.**



**Cat. No. 3201 is ideal for multiple flexible cords and cable.**



**Snap captive locking wedge into connector's cavity.**



**Press locking wedge into cavity which locks onto cable.**

### All Plastic Connector for NM Cable and Flexible Cord

Cat. No.	Size Range	K.O. Size	Fig.	Dimensions (in.)					F	
				A	B	C	D	E	Max. Thk. Enclosure	H
<b>3300</b>	For use with 10-2, 12-2 and 14-2 NM cables; 18-2 and 18-3 SJ and SJO cords and 18-2 SV, SVO, SJT and SJTO cords, single or multiple; cord capacity .125-.300 diameter	½"	2	1½"	1⅝"	¾"	.880	.795	.080	5/16" x 9/16"
<b>3201</b>	For use with 10-3, 12-3, 14-3, 10-2, 12-2, 4-2 NM cables; multiple (2) 12-2 and 14-2 NM cables; single and multiple flexible cords in wire range .300 in. to .600 in.	½"	1	1½"	1"	7/16"	.880	.795	.080	2½" dia.
<b>3202</b>	For use with 8-3 and 6-3 NM cables; (2) 14-3, 14-2, 12-2 and 10-2 NM cables; single and multiple flexible cords in wire range .500 in. to .850 in.	¾"	1	1½"	1⅝"	7/16"	1.100	1.005	.090	7/8" dia.

U.S. Pat. 3,493,205  
 Temperature Rating: 105°C  
 CSA File Nos. 584 and 2884  
 U.L. File No. E-23017



**No locknut required. No special tools required. High impact thermoplastic with steel insert.**

### Snap-In Connector for Flexible Metal Conduit

Cat. No.	Conduit Size	K.O. Size	Dimensions (in.)			Unit Quan.
			A	B	C	
<b>100-TB</b>	¾"	½"	2⅞"	1⅞"	1⅜"	50
<b>100BP</b>	¾"	½"	2⅞"	1⅞"	1⅜"	250

100BP sold in multiples of unit package.  
 Temperature Rating: 105°C  
 U.L. 94-V1  
 CSA File No. 0589

**Thomas & Betts**

# T&B® Fittings

## Conduit Dimensional Data

### U.L. Recommended Dimensions and Weights of Rigid Metal Conduit

Trade Size (in.)	Thds. per in.	I.D. (in.)	O.D. (in.)	Wall Thickness (in.)	Min. wt. at 100' Lengths with One Coupling Attached (lbs.)
¼	18	0.364	.540	.088	38.5
⅜	18	0.493	.675	.091	51.5
½	14	0.622	.840	.109	79.0
¾	14	0.824	1.050	.113	105.0
1	11½	1.049	1.315	.133	153.0
1¼	11½	1.380	1.660	.140	201.0
1½	11½	1.610	1.900	.145	249.0
2	11½	2.067	2.375	.154	332.0
2½	8	2.469	2.875	.203	527.0
3	8	3.068	3.500	.216	682.6
3½	8	3.548	4.000	.226	831.0
4	8	4.026	4.500	.237	972.3
4½	8	4.506	5.000	.247	1150.0
5	8	5.047	5.563	.258	1313.6
6	8	6.065	6.625	.280	1745.3

### U.L. Dimensions for Intermediate Metallic Conduit† – Type I (10 ft. lgths.)

Trade Size (in.)	O.D. (in.)		Wall Thickness (in.)
	min.	max.	
½	.810	.820	.070*
¾	1.024	1.034	.075*
1	1.285	1.295	.085*
1¼	1.630	1.645	.085*
1½	1.875	1.890	.090*
2	2.352	2.367	.095*
2½	2.847	2.867	.130**
3	3.466	3.486	.130**
3½	3.961	3.981	.130**
4	4.456	4.476	.130**

\* (+.015, -.000)

\*\* (+.020, -.000)

† IMC Threads are the same as Rigid Metal Conduit Threads.

### U.L. Dimensions for Intermediate Metallic Conduit – Type II (10 ft. lgths.)

Trade Size (in.)	O.D. (in.)		Wall Thickness (in.)
	min.	max.	
½	.825	.840	.085*
¾	1.035	1.050	.085*
1	1.300	1.315	.108*
1¼	1.645	1.660	.108*
1½	1.885	1.900	.108*
2	2.360	2.375	.108*
2½	2.850	2.875	.155**
3	3.475	3.500	.155**
3½	3.975	4.000	.160**
4	4.475	4.500	.160**

\* (+.020, -.000)

\*\* (+.025, -.000)



### Knockout (sliphole) Sizes for Electrical Conduits and Connectors

Trade Size (in.)	Knockout Diameter		
	nom.	min.	max.
¼	.575	.559	.605
⅜	.718	.703	.734
½	.875	.859	.906
¾	1.109	1.094	1.141
1	1.375	1.359	1.406
1¼	1.734	1.719	1.766
1½	1.984	1.958	2.000
2	2.469	2.433	2.500
2½	2.969	2.938	3.000
3	3.594	3.563	3.625
3½	4.125	4.063	4.156
4	4.641	4.563	4.672
4½	5.109	5.063	5.166
5	5.719	5.625	5.750
6	6.813	6.700	6.844

Sizes ¼" thru 1¼" are per U.L. 514.

Sizes ½" thru 6" per proposed revision to NEMA Engineering Bulletin No. 71, Aug. 1976.

### U.L. Recommended Dimensions and Weight of Electrical Metallic Tubing (EMT)

Trade Size (in.)	O.D. (in.)	I.D.* (in.)	Wall Thickness (in.)	Min. Accept Wt. Ft. (lbs.)
⅜	.577 ± .005	.493	.042	.230
½	.706 ± .005	.622	.042	.285
¾	.922 ± .005	.824	.049	.435
1	1.163 ± .005	1.049	.057	.640
1¼	1.510 ± .005	1.380	.065	.950
1½	1.740 ± .005	1.610	.065	1.100
2	2.197 ± .005	2.067	.065	1.400
2½	2.875 ± .010	2.731	.072	2.050
3	3.500 ± .015	3.356	.072	2.500
3½	4.000 ± .020	3.834	.083	3.250
4	4.500 ± .020	4.334	.083	3.700

\* Not a requirement – included for information only.

**T&B® Fittings****Conduit Dimensional Data****U.L. Recommended Diameters for Flexible Metal Conduit (Greenfield)**

Trade Size (in.)	Max. O.D. (in.)	O.D. (in.)	
		min.	max.
5/16	.510	.312	.393
3/8	.610	.375	.645
1/2	.920	.625	.835
3/4	1.105	.812	—
1	1.380	1.000	—
1 1/4	1.630	1.250	—
1 1/2	1.950	1.500	—
2	2.450	2.000	—
2 1/2	3.060	3.500	—
3	3.560	3.000	—
3 1/2	4.060	3.500	—
4	4.560	4.000	—

**U.L. Recommended Diameters for Liquidtight Flexible Metal Conduit**

Trade Size (in.)	I.D. (in.)		O.D. (in.)	
	min.	max.	min.	max.
3/8	.484	.504	.690	.710
1/2	.622	.642	.820	.840
3/4	.820	.840	1.030	1.050
1	1.041	1.066	1.290	1.315
1 1/4	1.380	1.410	1.630	1.660
1 1/2	1.575	1.600	1.865	1.900
2	2.020	2.045	2.340	2.375
2 1/2	2.480	2.505	2.840	2.875
3	3.070	3.100	3.460	3.500
3 1/2	3.500	3.540	3.960	4.000
4	4.000	4.040	4.460	4.500

**Diameter of Liquidtight Non-Metallic Flexible Conduit**

Trade Size (in.)	I.D. (in.)		O.D. (in.)	
	min.	max.	min.	max.
3/8	.485	.505	.755	.775
1/2	.620	.640	.910	.930
3/4	.815	.835	1.150	1.170
1	1.030	1.055	1.415	1.440
1 1/4	1.370	1.395	1.800	1.825
1 1/2	1.585	1.620	2.045	2.080
2	2.045	2.080	2.605	2.640